

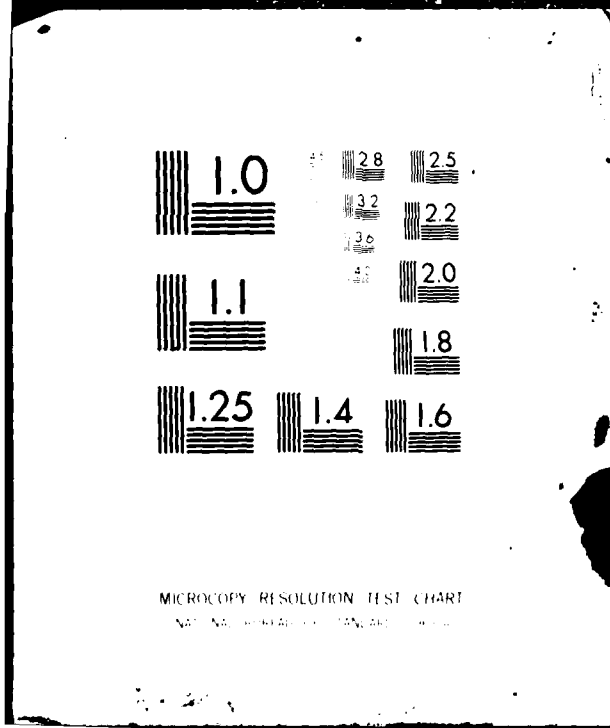

5 4 4 8



AD A115448

12

TR-278

Technical Report

# A Surface Recovery Technique For Deep Moored Vertical Arrays

**Marshall A. Paige  
Peter J. Heuser  
Lee A. Lindquist  
Carlos R. Mayoral  
John H. Sellack**

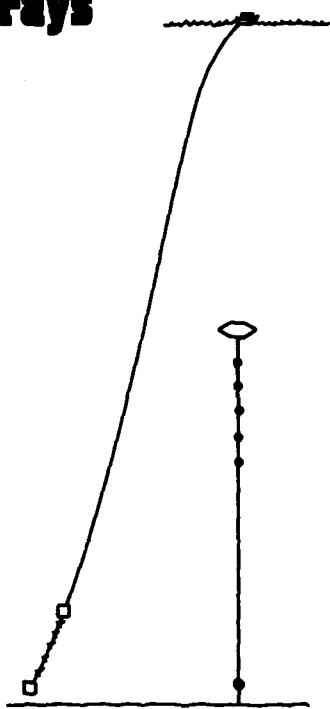

**August 1981**

Approved for public release; distribution unlimited.

PREPARED BY  
COMMANDING OFFICER,  
NAVAL OCEANOGRAPHIC OFFICE  
NSTL STATION, BAY ST. LOUIS, MS 39522

PREPARED FOR 82 06 11 016  
COMMANDER,  
NAVAL OCEANOGRAPHY COMMAND  
NSTL STATION, BAY ST. LOUIS, MS 39529

DTIC FILE COPY

DTIC  
ELECTE  
JUN 11 1982  
H D



## FOREWORD

The requirement to retrieve a malfunctioning instrumented array anchored in a depth of 4550 meters, resulted in the development and successful execution of a surface recovery technique. This engineering report is intended to provide sufficient design and procedural details to facilitate utilization of the technique by others unfortunate enough to find themselves in the same predicament.



C.H. BASSETT  
Captain, USN  
Commanding Officer

UNCLASSIFIED

SECURITY CLASSIFICATION OF THIS PAGE (When Data Entered)

REPORT DOCUMENTATION PAGE		READ INSTRUCTIONS BEFORE COMPLETING FORM
1. REPORT NUMBER TR 278	2. GOVT ACCESSION NO. AD-A115 448	3. RECIPIENT'S CATALOG NUMBER
4. TITLE (and Subtitle) A Surface Recovery Technique for Deep Moored Vertical Arrays		5. TYPE OF REPORT & PERIOD COVERED Final
		6. PERFORMING ORG. REPORT NUMBER
7. AUTHOR(s) Marshall A. Paige      John H. Selleck Peter J. Heuser Lee A. Lindquist Carlos R. Mayoral		8. CONTRACT OR GRANT NUMBER(s)
9. PERFORMING ORGANIZATION NAME AND ADDRESS Naval Oceanographic Office NSTL Station Bay St. Louis, Mississippi 39522		10. PROGRAM ELEMENT, PROJECT, TASK AREA & WORK UNIT NUMBERS
11. CONTROLLING OFFICE NAME AND ADDRESS		12. REPORT DATE August 1981
		13. NUMBER OF PAGES 35
14. MONITORING AGENCY NAME & ADDRESS (if different from Controlling Office)		15. SECURITY CLASS. (of this report) Unclassified
		15a. DECLASSIFICATION/DOWNGRADING SCHEDULE
16. DISTRIBUTION STATEMENT (of this Report) Approved for Public Release; Distribution unlimited		
17. DISTRIBUTION STATEMENT (of the abstract entered in Block 20, if different from Report)		
18. SUPPLEMENTARY NOTES		
19. KEY WORDS (Continue on reverse side if necessary and identify by block number) Recovery Salvage Mine Sweeping Deep Ocean Recovery		
20. ABSTRACT (Continue on reverse side if necessary and identify by block number) A surface recovery technique was developed for the retrieval of a vertically oriented array which had been anchored at a depth of 4550 meters. The array was severed within 100 meters of the bottom in order to retrieve two faulty anchor releases as well as the scientific instrumentation.		

SDIC  
SELECTED  
JUN 11 1982  
H

DD FORM 1473  
1 JAN 73

EDITION OF 1 NOV 65 IS OBSOLETE  
S/N 0102-014-6601

UNCLASSIFIED  
SECURITY CLASSIFICATION OF THIS PAGE (When Data Entered)

## Contents

	Page
I. Introduction	1
II. Design Goals and Considerations	1
III. Moored Sweepline Technique	2
IV. Design Details - Sweepline Array	2
V. Determining Array Geometry - Catenary Analysis	3
VI. Navigation and Positioning	11
VII. The Recovery Operation	13
VIII. Acoustic Release Failure Analysis	15
IX. Conclusions	15
X. Recommendations	16

## Figures

Figure 1 - MAVA	17
Figure 2 - Moored Sweepline Technique	18
Figure 3 - Configuration of Towed Recovery Array	19
Figure 4 - General Configuration of Sweepline Array	20
Figure 5 - Anchor/Depressor Weight Rigging Detail	21
Figure 6 - Sentinel Weight Rigging Detail	22
Figure 7 - Pinger/Release Rigging Detail	23
Figure 8 - Grapnel Rigging Detail	24
Figure 9 - Recovery Array Geometry	25
Figure 10 - Sweepline Geometry	25
Figure 11 - Free Body Diagram at Sentinel	26
Figure 12 - Array Geometry and Imaginary Segment	26
Figure 13 - Geometry of Imaginary Segment	27
Figure 14 - Extended Array Geometry	27
Figure 15 - Catenary Detail - Case 1	28
Figure 16 - Catenary Detail - Case 2	29
Figure 17 - Transponder Net	30
Figure 18 - Transponder Net Geographical Orientation	31
Figure 19 - Electronic Equipment	32
Figure 20 - MAVA Deflection vs Current	33
Figure 21 - Plotting Sheet	34
Figure 22 - Position Details	35

## Tables

Table 1 - Fixed Constants	10
Table 2 - Measurable and Calculatable Parameters	10
Table 3 - Calculated Parameters	10



Accession For	<input type="checkbox"/>	<input type="checkbox"/>	<input type="checkbox"/>	
Classification				
Classification/				
Availability Codes				
Avail and/or				
Special				

A

## I. Introduction

In August 1980 an acoustic array, referred to as MAVA (Moored Acoustic Vertical Array), was deployed by the Naval Oceanographic Office off the coast of France and moored in a depth of 4550 meters. Attempts to recover the array, which was equipped with dual acoustic anchor releases, were unsuccessful. One release failed to respond in any way to surface interrogation while the other, although functioning in the transpond mode, would not release on command.

During December of 1980 MAVA was successfully recovered using a technique which this report will describe in detail.

## II. Design Goals and Considerations

The basic goal of the recovery operation was to retrieve the MAVA instrument package and the data it was expected to contain.

MAVA is a single, taut line array which consists of a positively buoyant subsurface instrument package and a vertical hydrophone array. The array is attached to an anchor by means of  $\frac{1}{2}$  inch diameter kevlar line, a dual anchor release package and  $\frac{1}{4}$  inch diameter 3X19 construction wire rope, figure 1. In this particular case, MAVA had been configured to position the instrument package at a depth of 1900 meters. The water depth was 4550 meters at the mooring location. The anchor releases were located 100 meters off the bottom.

Bathymetric and geophysical data for the area indicated that the muddy bottom was nearly flat with no indications of obstructions.

Ocean current data for the area, although sparse, indicated surface currents up to .5 knot diminishing to .1 knot at the bottom.

Statistical weather information for the area indicated that the conditions would be poor to severe with the probability of the latter increasing significantly in January and February. The decision was therefore made to attempt the recovery early in December.

An important consideration in planning the recovery operation was navigation. Loran C was not available in the recovery area for geographical fixes. The only available means of navigation was Satellite Navigation and dead reckoning was required between satellite fixes. Accurate satellite fixes were generally available every one to two hours.

During the initial stages of selecting the recovery technique, several candidate schemes were considered. Submersibles or remote vehicles were found to be unavailable. Towing a cable with a large grapnel at the end and trying to snag the array seemed to have little chance for success. A technique used successfully by Woods Hole Oceanographic Institute at lesser depths was also considered. Briefly this consisted of circling the array while paying out cable on the bottom. Grapnels were attached periodically along the cable length. Having circled the array, the ship would steam off pulling the cable and grapnels around the array in an attempt to cut or snag it.

The expectation of poor weather and high sea state, which could greatly complicate locating the MAVA buoy when it surfaced despite its being equipped with two radio beacons and two zeron flashers, led to the decision to sever MAVA below the dual anchor release package. This would permit acoustically tracking the functioning anchor release hanging from the surfaced array. The opportunity to retrieve the anchor releases and perform failure analysis was additional motivation to sever MAVA within 100 meters of the bottom.

Given the conditions of extreme water depth, poor navigation aids and the expectation of poor weather conditions, it was obvious that the ability to control and position the recovery apparatus was of paramount importance.

### III. Moored Sweepline Technique

The general concept of the moored sweepline technique is shown in figure 2. An acoustically instrumented array, 600 meters long and equipped with cutting grapnels, was anchored on the bottom at a predetermined location near MAVA. The ship then steamed away from the anchor point while cable was being payed out until the sweepline was positioned in a horizontal attitude. A weight (4500 pounds in water) attached to the upper end of the sweepline created the desired taut, horizontal configuration. The ship was then maneuvered such that the sweepline would pivot about the anchor and intersect MAVA at some point between the anchor and the dual release package.

Instrumentation of the array with two transponders and a pinger permitted continuous determination of both horizontal position and vertical configuration of the array. A transponder net was deployed in the vicinity of MAVA for this purpose. Details of this instrumentation and its utilization are provided in subsequent sections of this report.

The controlling factor in successfully performing the sweepline operation was the ability to maneuver the array to the intended anchor point and to control the position of the sweepline in both the horizontal and vertical planes during the sweeping operation. To maximize control of the recovery array during the anchoring phase, the approach was made at a speed of less than one knot, figure 3, and the ship was headed directly into the wind and seas thus minimizing the tendency for the wind to set the ship off course. During the sweeping phase of the operation, the wind (20-25 knots) was used to "sail" the ship around MAVA.

The recovery operation was conducted from the USNS KANE, a 285 foot long AGS class ship. The KANE is equipped with a trainable bow thruster. The deck machinery used in the recovery operation consisted of a Western Gear traction winch capable of a 30,000 pound line pull and a slack tensioner. The winch was equipped with 12,000 meters of 9/16 inch diameter, 3X19 construction wire rope.

### IV. Design Details - Sweepline Array

The general layout of the recovery array is shown in figure 4, while details of the construction and hardware are given in figures 5 through 8. Basically, the array consisted of a sweepline stretched between two weights. The lower weight, termed the depressor weight, was a steel cylinder weighing

2000 pounds in water. Steel was used in lieu of concrete to minimize the physical size of the weight and to ease shipboard storage and handling. A 110 pound "Bruce" anchor was attached to the depressor weight. This provided the necessary horizontal holding force to fix the end of the array on the sea floor. An EG&G Model 322 acoustic release, installed in-line between the "Bruce" anchor and depressor weight, provided a means to release the sweepline from the bottom, figure 5.

The upper sweepline weight was designated the sentinel weight. This 4500 pound (in water) steel cylinder was attached to the array 600 meters above the depressor weight. Its purpose was to create the horizontal attitude of the sweepline. Attachment of the sentinel weight to the array, where the cable would make a transition from a horizontal to a vertical orientation, was made in such a way that a sharp bend in the cable was precluded, figure 6. A pinger and an acoustic release were attached above the sentinel weight to provide vertical and horizontal positioning information, figure 7.

Seven grapnels, designed and fabricated at NAVOCEANO, were distributed along the center portion of the sweepline. These were designed to hook the  $\frac{1}{4}$ -inch wire rope mooring line and wedge it into a sharp-edged V-notch, figure 8. It was intended that this cutting action would damage the cable enough to cause it to fail in tension.

#### V. Determining Array Geometry - Catenary Analysis

As previously noted, the recovery operation was carried out at very low speed. This condition was imposed to permit a static analysis of the cable geometry to be made thus providing the required information concerning the vertical configuration of the cable during the sweeping operation. Given the positions of the ship and sentinel as determined from acoustic ranging to the transponder net and the altitude of the sentinel using a pinger, the exact altitude of the sweepline at any point along its length was determined. Thus it was possible to control the sweepline altitude by either varying the ship's position or by varying the amount of cable payed out.

The geometry assumed by the sweepline and cable with fixed anchor and sentinel weight formed two distinct catenaries joined at the sentinel. This geometry is illustrated in figure 9. The anchor and depressor weight are at point A with the sentinel weight at point B. The arclength  $\overline{AB}$  is the sweepline which forms one catenary while the rest of the cable, arclength  $\overline{BC}$ , forms the other.

In order to set up the catenary analysis, it was necessary to decide what parameters were known or could be determined by direct measurements, and what variables would have to be calculated from the analysis. Tables of fixed constants, measured parameters and calculated variables were set up. The nomenclature for these values are given in tables 1, 2, and 3 on page 10.

Table 1 cites the "Fixed Parameters." These values would not change during the retrieval operation, but were input values that could be changed at any time up until the actual operation commenced. The linear density of

the cable would not change unless a different cable were used. The depth at the anchor point, given to be 4515 meters, was a value that could be changed if required. The depressor and sentinel weights were approximate values that would be refined when the weights were actually constructed, and the length of the sweepline would be fixed at the time the sweepline array was deployed.

Table 2 lists those parameters that could be measured during the operation. For the catenary calculations these values are redundant and some could serve as inputs for the calculations while the rest provide a means for checking the accuracy of the theoretically computed values. Furthermore, any of these values could be computed from the other inputs using the catenary equations. If any of the instrumentation failed, the analysis provided a means for calculating the missing parameter.

Table 3 lists some calculated values used in determining the sweepline and cable geometries. This information would be used to ensure that the sweepline was off the bottom and simultaneously below the MAVAs releases.

Usual catenary calculations employ a coordinate system whose origin is offset some vertical distance from the lowest point of the catenary (i.e., where the catenary becomes horizontal). This is demonstrated in figure 10 where the offset is  $c$ .  $H$  is the horizontal tension at the bottom and  $T$  is the tension at the top of the catenary. The arclength is  $s$  and  $W$  is the weight of the cable occurring at the midpoint of the arc.

It could not be assumed that the sweepline would form the geometry depicted in figure 10. If too much cable were payed out, some of the line would lay on the bottom. This would have the effect of moving point A farther down the cable, resulting in a new catenary of shorter arclength. In this case the standard catenary equations would hold; however, an adjustment in the position of point A and coordinate system would be required. On the other hand, if not enough cable were payed out to achieve the geometry shown, then the assumption that the cable was horizontal at point A would be incorrect.

This led to two cases for consideration:

- Case 1 - sweepline catenary is horizontal at point A
- Case 2 - sweepline catenary is not horizontal at point A

This first case was solved using standard catenary equations. The second case required some additional analysis and introduced new parameters for consideration. Both cases will be considered separately.

#### Catenary Analysis for Case 1

Figure 10 can be considered a free-body diagram of the sweepline anchored at point A without the sentinel weight. The vertical coordinate offset  $c$  is calculated from:

$$c = \frac{s^2 - d^2}{2d} \quad (1)$$

where:  $s$  = catenary segment arclength,  
 $d$  = height of point B off bottom

The arclength  $s$  would be fixed when the array was assembled. The height  $d$  would be measured during the operation using an acoustic pinger attached to the cable. For a given arclength and height, the horizontal length  $x$  of the cable is:

$$x = c \ln \frac{y}{c} + \frac{y^2}{c} - 1 \quad (2)$$

where:  $y = c + d$

The horizontal distance  $x$  between the anchor and sentinel would be determined from positions acquired using acoustic transponder navigation. A transponder was attached at the sentinel location. This value was, therefore, an input to the calculations. However, should the transponder fail to operate the parameter could be calculated using equation (2). Furthermore, the measured value could be used as a check of the analysis by comparing it with the calculated value.

The tension at the bottom of the catenary is given by:

$$H = cw \quad (3)$$

where:  $w$  = linear density of cable

The tension at the top of the catenary is:

$$T = yw \quad (4)$$

The weight of the catenary is the linear density times the length:

$$W = sw \quad (5)$$

Summing forces in the  $x$  and  $y$  directions and dividing yields the angle between the tension vector and the horizontal at point B:

$$\theta = \tan^{-1} \frac{W}{H} \quad (6)$$

A free-body diagram of point B, where the sentinel weight attaches to the two cable segments, is depicted in figure 11. In this figure,  $P$  represents the sentinel weight,  $T$  and  $\theta$  represent the tension and its direction in the lower catenary cable segment, and  $T'$  and  $\theta'$  represent the tension and its direction in the upper catenary cable segment. Summation of forces in equilibrium yields:

$$\theta' = \tan^{-1} \frac{T \sin \theta + P}{T \cos \theta} \quad (7)$$

and

$$T' = \frac{T \sin \theta + P}{T \cos \theta} \quad (8)$$

The cable segment  $\overline{BC}$  forms a portion of a catenary whose loading conditions are calculated for point B. In order to use standard catenary analysis, the segment can be extended to include an imaginary portion of cable which would form a single continuous catenary with the same resultant loads at point B. This concept is illustrated in figure 12.

The segment  $\overline{A'B}$  is the imaginary portion with arclength  $s'$ , horizontal length  $x'$  and horizontal tension  $H'$ . The vertical displacement for the catenary coordinate system is  $c'$ . Figure 13 depicts a free-body diagram of this segment. The parameters in this figure are calculated as follows. The value of  $y'$  is:

$$y' = \frac{T'}{w} \quad (9)$$

The horizontal tension  $H'$  is:

$$H' = T' \cos \theta \quad (10)$$

The coordinate displacement  $c'$  is:

$$c' = \frac{H'}{w} \quad (11)$$

The height  $d'$  is given by:

$$d' = y' - c' \quad (12)$$

The horizontal distance is then:

$$x' = c' \ln \frac{y'}{c'} + \frac{y'^2}{c'} - 1 \quad (13)$$

The arclength  $s'$  is:

$$s' = \sqrt{y'^2 - c'^2} \quad (14)$$

The weight of the imaginary segment is:

$$W' = s'w \quad (15)$$

For the entire catenary  $\overline{A'C}$  in figure 12, we have:

$$D' = D + d' - d \quad (16)$$

and

$$Y' = D' + c' \quad (17)$$

The horizontal distance is:

$$X' = c' \ln \frac{Y'}{c'} + \frac{Y'^2}{c'} - 1 \quad (18)$$

The arclength  $S'$  is:

$$S' = \gamma'^2 - c'^2 \quad (19)$$

Equations (9) through (15) provide the parameters for the imaginary catenary segment  $\overline{A'B}$ , while equations (16) through (19) give the required parameters for the entire catenary  $\overline{A'C}$  (imaginary and actual segments). It is now a simple matter of subtracting the imaginary segment from the entire catenary yielding the required parameters for segment  $\overline{BC}$ , the actual catenary segment.

The horizontal distance  $X$  for the catenary segment  $\overline{BC}$  is:

$$X = X' - x' \quad (20)$$

The tension in the cable at point C (ship's position) is:

$$T'' = Y'w \quad (21)$$

The arclength  $S$  is:

$$S = S' - s' \quad (22)$$

The total length of cable  $\overline{ABC}$  shown in figure 9 is given by:

$$S_t = S + s \quad (23)$$

The total weight of the cable plus load is:

$$W_t = S_t w + P \quad (24)$$

The total horizontal distance  $X_t$  is:

$$X_t = X + x \quad (25)$$

In summary, the known values are:

- $w$  = linear density of cable
- $s$  = length of sweepline
- $d$  = height of sentinel
- $P$  = weight of sentinel
- $D$  = depth from surface to bottom

The calculated parameters, not including intermediate values, are:

- $H$  = horizontal tension at anchor
- $T$  = tension in sweepline at sentinel
- $T'$  = tension in cable at sentinel
- $T''$  = tension in cable at ship
- $x$  = horizontal distance of sweepline
- $x_T$  = horizontal distance from anchor to ship.
- $S_T$  = total cable payed out from anchor to ship

The calculated values are used to indicate the tensions in the cable and the geometry of the cable. As previously mentioned, the tension at the ship,  $T''$ , and the distances  $x$ ,  $X_T$  and  $S_T$  could be measured inputs. In fact, such measurements could serve as a means of verifying the theory and the calculations.

### Catenary Analysis for Case 2

We will next consider the case when the sweepline is not horizontal at the anchor. In this case, the sweepline segment forms a portion of a catenary. Development of the analysis can be made along the same lines used for the cable segment  $\overline{BC}$  in Case 1; which is to assume the catenary segment to be extended so the usual catenary calculations may be applied. This is illustrated in figure 14.

In this case the loading conditions are unknown. For a direct analysis of this situation values for at least two parameters must be assumed. For our purposes the values  $s$ , the segment arclength  $A'B$ , and  $\theta$ , the angle of the sweepline at the sentinel, were chosen. The analysis proceeds as follows.

Select  $s$  and  $\theta$ . Known values are  $s_a$ , the actual length of the sweepline from anchor to sentinel, and  $w$ , the linear density of the cable. The horizontal tension at  $A'$ , the bottom of the imaginary catenary segment, is calculated from equation (6) by:

$$H = \frac{W}{\tan \theta} \quad (26)$$

Where  $W$  is the weight of the total segment including the imaginary part and is calculated using equation (5). From equation (3) the coordinate system vertical displacement is:

$$c = \frac{H}{W} \quad (27)$$

Using equation (1) the vertical distance from  $A'$  to  $B$  is:

$$d = -c + c^2 + s^2 \quad (28)$$

The horizontal distance  $x$  is given by equation (2). The tension  $T$  at the top of the sweepline is calculated from equation (4).

Using equation (28) the vertical height of the imaginary segment  $\overline{A'A}$  is

$$d' = -c + c^2 + s'^2 \quad (29)$$

Where:

$$s' = s - s_a$$

From equation (13) the horizontal length for the imaginary segment is:

$$x' = c \ln \frac{y'}{c} + \frac{y'^2}{2c} - 1 \quad (30)$$

Where:  $y' = c + d'$

Therefore, the horizontal distance for the actual catenary segment  $\overline{AB}$  is:

$$x_a = x - x' \quad (31)$$

The vertical height is:

$$d_a = d - d' \quad (32)$$

The tension at A, the anchor, is:

$$t' = y'w \quad (33)$$

The tension occurs at an angle  $\theta$  given by equation (6) as:

$$\theta = \tan^{-1} \frac{W}{H} \quad (34)$$

The tension at point A may be divided into horizontal and vertical components. The vertical component tends to lift the depressor weight decreasing the horizontal load that it can hold. The tension components are given by:

$$P_H = t' \cos \theta \quad (35)$$

$$P_V = t' \sin \theta \quad (36)$$

Equations (26) through (36) may be used to analyze the sweepline tensions and geometry. Equations (7) through (25) of Case 1 may be used to calculate the rest of the cable parameters (substituting  $x_a$  for  $s$  and  $d_a$  for  $d$  where required).

In summary, the following values are assumed:

- $s$  = length of lower catenary segment including imaginary portion and sweepline
- $\theta$  = angle of sweepline at sentinel

The known values are:

- $s_a$  = length of sweepline
- $w^a$  = linear density of cable
- $P$  = weight of sentinel
- $D$  = depth from surface to bottom

The calculated values included:

- $P_H$  = horizontal tension load at anchor
- $P_V$  = vertical tension load at anchor
- $T$  = tension in sweepline at sentinel
- $x_a$  = horizontal distance of sweepline
- $d_a$  = height of sentinel
- $\theta'$  = angle of sweepline at anchor
- $T''$  = tension of cable at ship
- $X_T$  = total horizontal distance from anchor to ship
- $S_T$  = total line payed out from anchor to ship

Again, many of the calculated values could be measured directly with instrumentation. Tables were developed using values of  $s$  from 670 meters to 1200 meters and  $\theta$  varying from  $5^\circ$  to  $80^\circ$  (it was estimated that a sweepline length of approximately 600 meters would be used). Plots were also made drawn to scale of the cable and sweepline at the various geometries. It was felt that from instrument readings visual "interpolation" of cable geometries between the various plots could be made. In this way a visual indication of cable behavior could be made in real time, hopefully, without the need of simultaneous calculations. Examples of the catenary plots which were thus generated are shown in figure 15 and 16.

#### TABLES

Table 1. Fixed Constants

- $w$  - linear density of 9/16 in. dia. cable
- $D$  - ocean depth at MAVA
- $s$  - length of sweepline
- $P$  - weight of sentinel

Table 2. Measureable and Calculatable Parameters

- $T''$  - tension of cable at ship
- $d$  - height of sentinel off bottom
- $x$  - horizontal distance between anchor and sentinel
- $X$  - horizontal distance between sentinel and ship
- $S$  - amount of cable payed out

Table 3. Calculated Parameters

- $H$  - horizontal tension at bottom of catenary
- $T$  - tension at top of sweepline
- $T'$  - tension at bottom of cable
- $W$  - weight of cable
- $\theta$  - angle at top of sweepline
- angle at bottom of cable
- $P_H$  - horizontal component of cable tension at depressor
- $P_V$  - vertical component of cable tension at depressor

## VI. Navigation and Positioning

The requirement for accurately monitoring the ship and sweepline array positions during the recovery operation dictated the need to deploy an acoustic transponder net in the vicinity of the MAVA. The critical assumption had been made that the one functioning anchor release on the MAVA would continue to function long enough to deploy the transponder net. This assumption was made following an analysis of the life expectancy of the transponder batteries. It was further assumed that the MAVA transponder would function long enough to complete the retrieval operation. Thus it was decided to use the MAVA transponder as one corner of a triangular net therefore reducing the number of transponder arrays which had to be deployed. A backup transponder array was available, however, in the event that the MAVA transponder failed during the operation.

The general configuration of the transponder net is shown in figure 17. The transponder arrays were rigged such that the transponder was positioned 100 meters from the bottom. Transponders "A" and "B" were deployed 1.5 miles from MAVA to form a right triangular navigation net. The line from transponder "A" to MAVA was oriented with respect to the prevailing wind direction for the area during the month of December.

Determination of the exact geometry of the navigation net was done in several steps. First, the depth of each transponder ("A", "B", MAVA) was determined by taking depth soundings above each transponder and also by measuring the minimum slant range to each transponder. The length of each leg of the triangular net was determined by measuring the slant ranges to the transponders at each end of the leg while slowly crossing that leg. These slant range data pairs were then converted to horizontal ranges and added together. When the sum of the two horizontal ranges reached a minimum, the length of that leg was defined. By determining the length of each side of the triangle in this manner, the net geometry was defined.

Orientation of the navigation net relative to magnetic north was done by running a straight course between two satellite fixes and continuously plotting horizontal distances to MAVA and transponder "A" from dead reckoning (DR) positions along the ship's track. The bearing of the line between "A" and MAVA was thus determined, figure 18.

A precision, hull mounted speed sensor had been installed for the purpose of determining the DR positions during the operation. The sensor was designed and built at NAVOCEANO using a 4 cm. diameter rotor. The low threshold (3 cm/sec) and high accuracy ( $\pm 2$  cm/sec) of the sensor was particularly suited to the low speed recovery operation.

The sentinel was instrumented with an acoustic transponder and pinger. The former permitted acoustic ranging to the transponder net while the latter provided the height off the bottom data required to convert slant ranges to horizontal ranges. The altitude of the sentinel was also used in order to define the catenary shape of the sweepline array.

A Benthos Model 2214 bottom finding pinger provided sentinel altitude information. It was thought that a continuously operating pinger might interfere with interrogation of the acoustic releases so a modification was made to the pinger to permit an adjustable on-off duty cycle. A circuit was designed and installed in the pinger; an operating cycle of 19 seconds on and 57 seconds off was selected.

AMF/EG&G Model 322 acoustic releases were used for transponders. Eight were selected for the operation, each with a different receiver channel. Special attention was given to the two releases to be attached to the sweep-line. The tilt function was disconnected in these two, and both were retuned to receive a 9.0 kHz and transmit at 11.0 kHz. Also, the sensitivity was increased to -92 dB/320 MV P/P (millivolts peak to peak) which later proved to be a problem. The increase in sensitivity caused random pinging of the transponders as they were being towed in the water. This was attributed to flow generated noise. This problem was eliminated when the sensitivity of the transponders was reduced to -88 dB/320 MV P/P. Command receiver channels 1 and 3 were chosen for the sweepline acoustic releases to minimize the possibility of adjacent channel interface.

The acoustic releases for the navigational markers were also retuned. The reply frequency was set at 9.5 kHz for transponder "A" and 10.5 kHz for transponder "B". Command receiver channels 7 and 5 were selected for transponders "A" and "B" respectively. A third marker, designated "C", was also set up but never used. The remaining acoustic releases were prepared as backups for the navigational markers and sweepline array transponders.

The deck units used to receive each of the different transponder returns were a AMF/EG&G 206A receiver and a AMF/EG&G 301 receiver. A AMF/EG&G Model 200 coder and amplifier connected to a AMF/EG&G 301 transducer were used to interrogate the transponders.

The 206A is a 4 channel receiver capable of simultaneous reception and decoding of four discrete frequencies. The readout is in milliseconds. The count is started when the interrogation pulse is sent out and each channel stops when it receives a reply. The 206A was tuned to receive frequencies of 9.5 kHz, 10.0 kHz, 10.5 kHz and 11.0 kHz.

The 301 receiver is a single channel receiver and displays bearing and range in kiloyards. This receiver was modified so that the trigger pulse, initiated by the 206A also reset the 301 receiver. The receive frequency for the 301 was tuned to 10.0 kHz. The Model 301 transducer which was used is permanently hull mounted on the USNS KANE. This arrangement of receiver equipment was found to be workable. However, early on in the operation it was discovered that interrogation range was very limited. Two miles from the transponder net, the ship's engines had to be stopped and forward motion had to slow before return signals could be received from the transponders.

Upon investigation, it was found that using the hull mounted 12 kHz wide beam transducer and associated transceiver resulted in a much higher signal to noise ratio. This eliminated the need to stop the ship's engines in order to receive the transponder replies. The AMF/EG&G 206A receiver's

input was wired to the audio jack on the PFR recorder being used to monitor the 12 kHz wide beam system. Range to the transponders was thus increased to 6 miles. The 12 kHz return from the bottom finding pinger was also strong. It was discovered that the duty cycle of the pinger could be ignored because no interference was noted between the pinger and transponders.

Ship and sentinel positions were determined using the equipment setup illustrated in figure 19. The choice of transmit and receive frequencies for the various transponders was dictated by the transmit and receive frequencies of the functioning MAVA release. The ship's position was determined by transmitting an 11 kHz ping to the transponders in the net ("A", "B", MAVA). They in turn responded by transmitting pings of 9.5 kHz, 10.5 kHz and 10.0 kHz respectively. These signals were then decoded by the AMF/EG&G 206A receiver. Conversion of the three round trip travel times into horizontal ranges to each transponder permitted plotting the ship's position at the intersection of the three radii. The sentinel position was determined by transmitting a 9 kHz ping to the sentinel transponder which in turn transmitted at 11 kHz. The sentinel transmit ping (11 kHz) was then received by "A", "B", and MAVA which in turn transmitted at their designated frequencies. Once again, these signals were decoded by the AMF/EG&G 206A receiver which displayed the following four round trip times: 1) Ship-Sentinel-Ship; 2) Ship-Sentinel-"A"-Ship; 3) Ship-Sentinel-"B"-Ship; 4) Ship-Sentinel-MAVA-Ship. Having determined the travel times from the ship to "A" (as measured using a direct interrogation at 11 kHz) and from the ship to the sentinel, these may be subtracted from the overall round trip time yielding the slant range between the sentinel and "A". Given the vertical position of the sentinel, as determined by the difference between the direct and bottom return from the pinger, the horizontal range from the sentinel to "A" was calculated. This process was then repeated for the "B" and MAVA transponders. The three radii were then plotted to intersect at the sentinel position.

## VII. The Recovery Operation

The operation commenced on the 8th of December when the still functioning MAVA transponder was located. By the end of the day on the 10th of December the transponder net had been deployed and its geometry accurately determined. The major difficulty encountered during this phase was navigation. Without Loran C, we were forced to dead reckon between satellite fixes and occasionally got "lost".

On December 11th, degrading weather conditions (30 knot winds) forced a hold on launching the recovery array until midday. By 1830 hours the sweepline array was in the water, but the pinger had quit working, the line tension monitoring system was reading zero (line tension was actually 7500 lb) and the sweepline transponders were pinging at random! By 0930 the next morning (12 December) we had desensitized the sentinel transponder, deactivated the anchor transponder, repaired the bad pinger, and fixed and recalibrated the line tension monitoring system. At 1000 hours, while lowering the array to the bottom, the line tension system went out again. It was decided to proceed without a tension measurement and rely on the catenary analysis to predict line tension.

Having lowered the array to 100 meters off the bottom, the run toward the targeted drop point for the anchor began. As previously stated, the run was made directly into the wind and seas at speeds below one knot. Figure 17 illustrates the targeted drop points, one for passing MAVA on the right, the other for passing MAVA on the left.

Due to deep ocean currents, a deflection of MAVA from the vertical was anticipated. Potentially this could cause premature interference between MAVA and the recovery array if the horizontal sweepline were laid too close to the MAVA anchor. To avoid this situation, the maximum deflection of MAVA was calculated using a subsurface moored array design program. Figure 20 shows the results of this computer analysis. The curves represent the deflected configuration of MAVA in unidirectional, constant velocity current profiles. Ocean current data for the recovery area indicated a .2 knot current at the buoy decaying to .1 knot on the bottom. Assuming a .3 knot worst case situation, it was determined that the sweepline should be laid no closer than 215 meters from the MAVA anchor, figure 17. The shaded area of figure 17 was chosen as the acceptable area within which we could anchor considering the length of the sweepline, placement of the grapnels and the desire to perform the sweeping operation while heading into the wind and seas.

A plotting sheet was used which had a one inch grid divided into tenths of an inch. Positions were plotted at a scale of 1 inch = 400 meters. A plotting resolution of 10 meters was easily obtained. Figure 21 is a reproduction of the plotting sheet.

At 1600 hours on 12 December, the array was lowered to the bottom and 100 meters of slack cable was payed out. The drop point chosen was the one on the left in Figure 17. The positioning data indicated that the anchor was dropped within 20 meters of this point. The ship was maneuvered to guide the sentinel to the left of MAVA by at least 215 meters. Ship and sentinel positions were plotted every three to five minutes. For many of the fixes, the three position radii from the net transponders crossed at a single point providing welcome reassurance during an anxious period.

Maneuvering of the ship was accomplished by making appropriate changes in engine RPM, rudder angle, bow thruster power and direction while observing compass heading, wind speed and direction, and "course-made-good." The major advantage of deploying and positioning the sweepline while heading directly into the wind and seas was being able to precisely control the ship's position and speed. The 20-25 knot winds were used to advantage in two ways. First, movement of the ship from the anchor point was limited by throttling back and using the wind and cable tension to slow or back the ship as required. Secondly, during the sweeping maneuver, the wind was used to "sail" the ship around MAVA by maintaining a heading slightly off the wind thus causing the ship to crab in the desired lateral direction.

As the ship progressed, cable was payed out at approximately 10-15 m/min. The pinger indicated that the sentinel was moving to its desired altitude. At approximately 1700 hour, one hour after anchoring, the sweepline had been extended. The sentinel was 460 meters from the anchor point

and 220 meters above the bottom. The minimum distance from the sweepline to MAVA was 280 meters. The ship was then maneuvered to begin the sweeping operation. Contact of the sweepline with MAVA was made at 1850 hours. At that time the sentinel was 580 meters from the sweepline anchor and 105 meters above the bottom. Total line out was 5190 meters. Figure 22 illustrates the above sweepline configurations.

Inspection of the catenary plots indicated that the intersection of the sweepline with MAVA occurred very close to the midpoint of the 100 meter cable between the MAVA anchor and dual release package. Furthermore, the catenary analysis indicated a theoretical static line tension of 11,500 pounds. The distance between the ship and anchor point was limited to 2000 meters during the sweeping operation to keep line tensions at or below this value. It was feared that with the addition of dynamic loading caused by fifteen foot seas, the 23,000 pound elastic limit of the wire rope could be exceeded. The lack of tension data was aggravated by the fact that the cable slack tensioner had developed a leak and was inoperative.

It was hoped that MAVA would be cut free by the action of the 9/16 inch diameter sweepline chafing against the 1/4 inch diameter MAVA mooring line. At 2155 hours, after three hours of sweepline contact with MAVA and a 180 degree sweep, there was no indication that this had occurred. The decision was made to fire the lower anchor release which held the sweepline to the "Bruce" anchor. The sentinel was observed to move rapidly following the release from the anchor. At 2258 hours, one hour and three minutes later, MAVA surfaced. The surfacing was announced by a shipboard radio receiver which picked up the signal from the radio transponder on the MAVA buoy.

Subsequent inspection of the MAVA dual release package showed that the 1/2 inch diameter cable had been severed by one of the grapnels directly below the Nicopress sleeves at the attachment point. Apparently, the grapnel had moved up the wire rope and lodged at that point.

#### VIII. Acoustic Release Failure Analysis

A failure analysis was conducted on the recovered MAVA anchor releases with the following conclusions. One release failed to operate in either the transpond mode or the command release mode because the connector between the transducer and the electronics had come loose. All connectors of this type have been modified to provide a positive locking feature. The second release, while functioning in the transpond mode would not release upon command. The failure was attributed to a faulty squib. Gun oil, used to clean the firing chamber, had worked its way into the propellant thus causing the failure.

#### IX. Conclusions

The moored sweepline technique described above worked exceptionally well considering the depth of water, sea state and wind speed. Control of the array during anchoring and sweeping phases was not overly difficult.

Throughout the operation, theoretical indications and actual experience agreed very closely.

It is speculated that the primary limitation factor in utilizing this technique at depths greater than 4500 meters would be the increase in line tensions.

#### X. Recommendations

As in any operation of this type, problems were encountered and lessons were learned. Although the recovery technique described in this report worked exceptionally well, the following recommendations for improving or simplifying the operation are provided.

It is recommended that release of the sweepline from the "Bruce" anchor take place as soon as it is clear that the sweepline is in contact with the mooring line.

An improvement in the cutting action of the sweepline could be achieved by using a mine sweeping cable equipped with cable cutters or line chippers. Grapnels should be attached to the lower end as a back up.

Severe weather conditions at the time would have made retrieval of the sentinel weight very dangerous. Consequently, after removal of the sentinel pinger and transponder, the sweepline array was cut away. The result was the loss of the sentinel, grapnels, depressor weight, 600 meters of cable and the bottom anchor release. To reduce the possibility of such a loss, it is recommended that the sentinel transponder (anchor release) be installed between the sentinel and the array so that the sentinel can be jettisoned if necessary.

Electronic equipment problems were limited to the bottom finding pinger. Failures were traced to cold solder joints and faulty batteries resulting in power loss at low temperature. Modifying the pinger to have an on-off duty cycle proved to be unnecessary as interference with the acoustic transponders was not observed.

A major improvement in the conduct of the operation would be the use of a computer/plotter to ease the burden of manual data reduction and plotting.

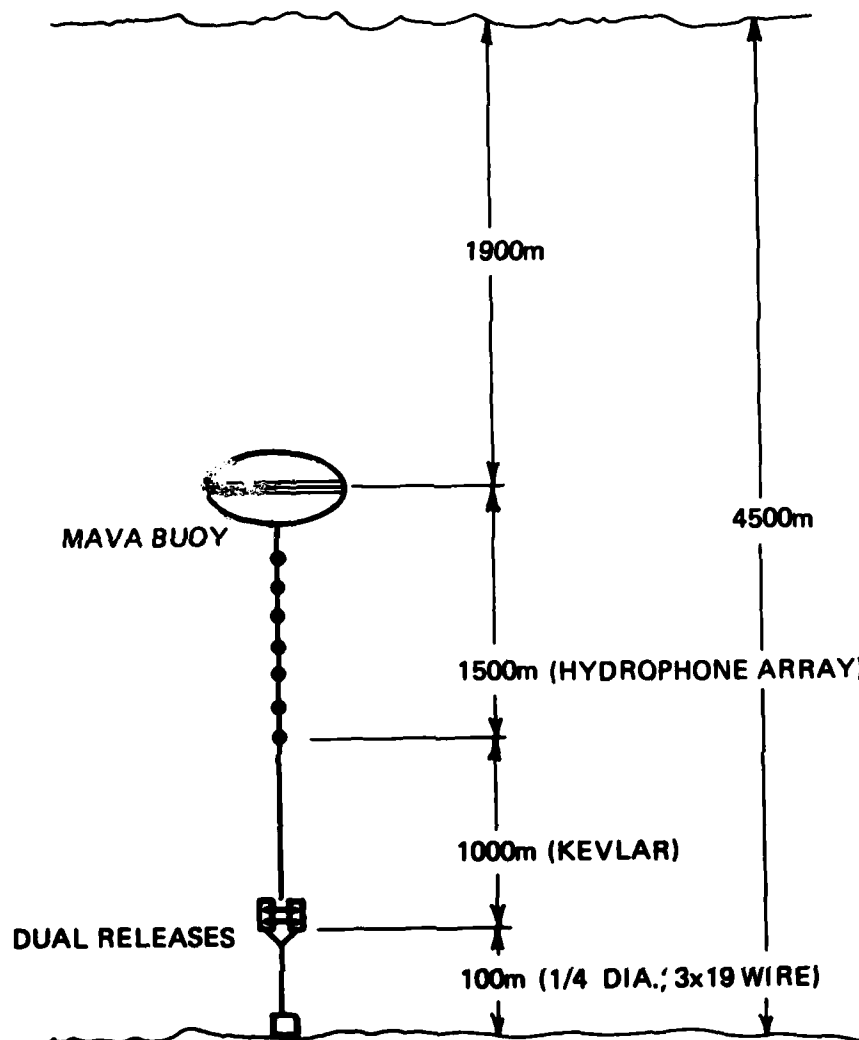

FIGURE 1 MAVA

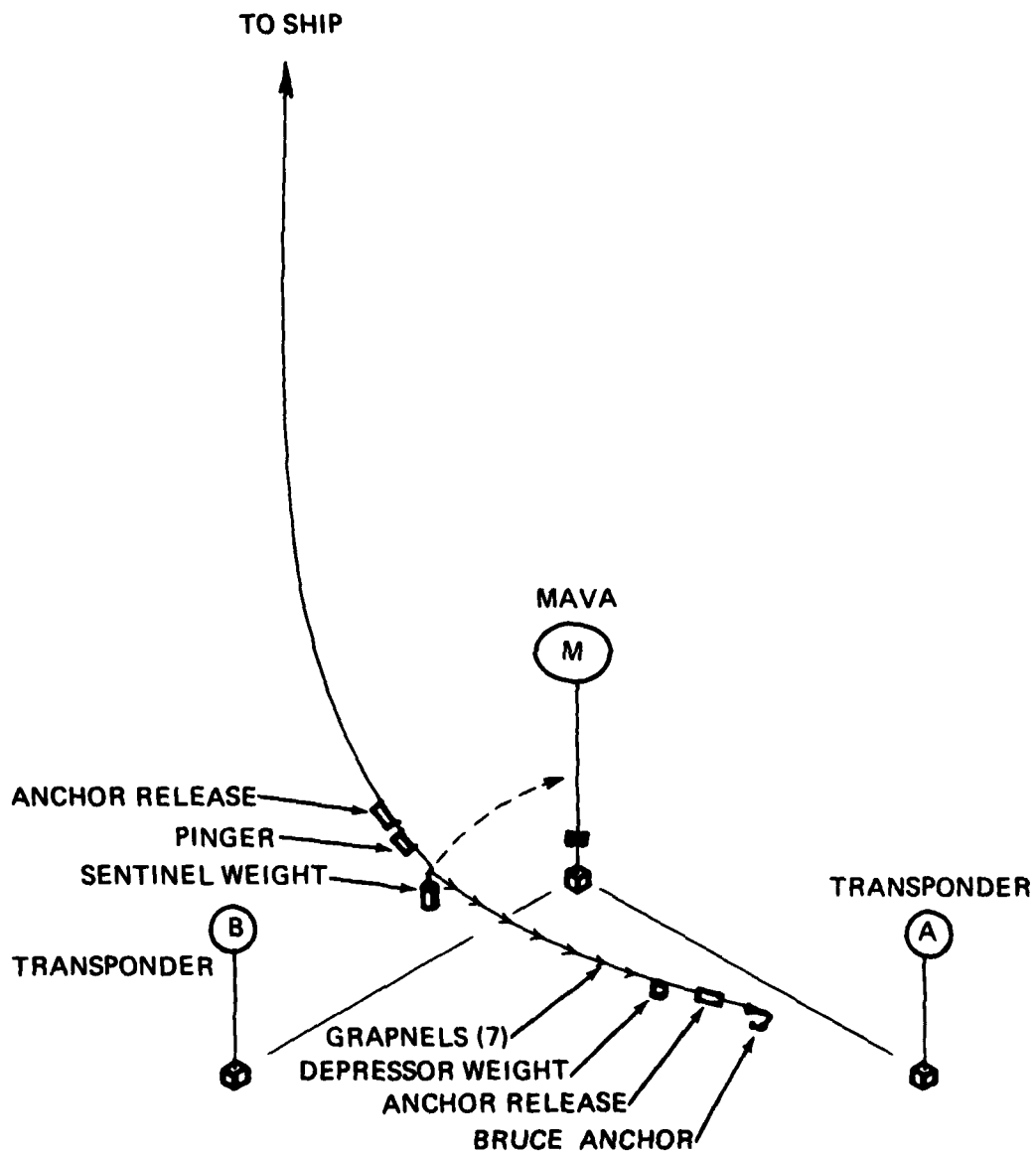
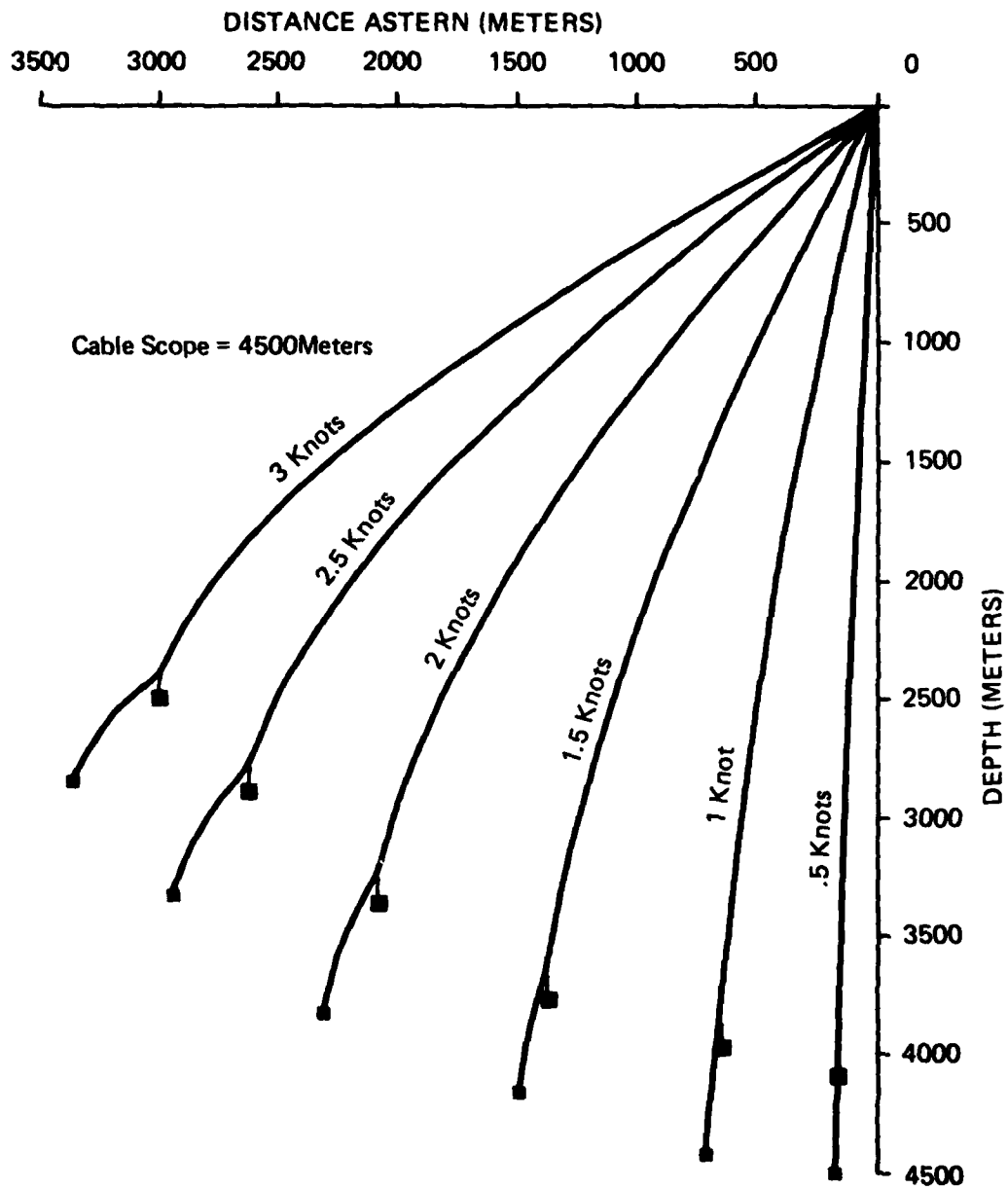
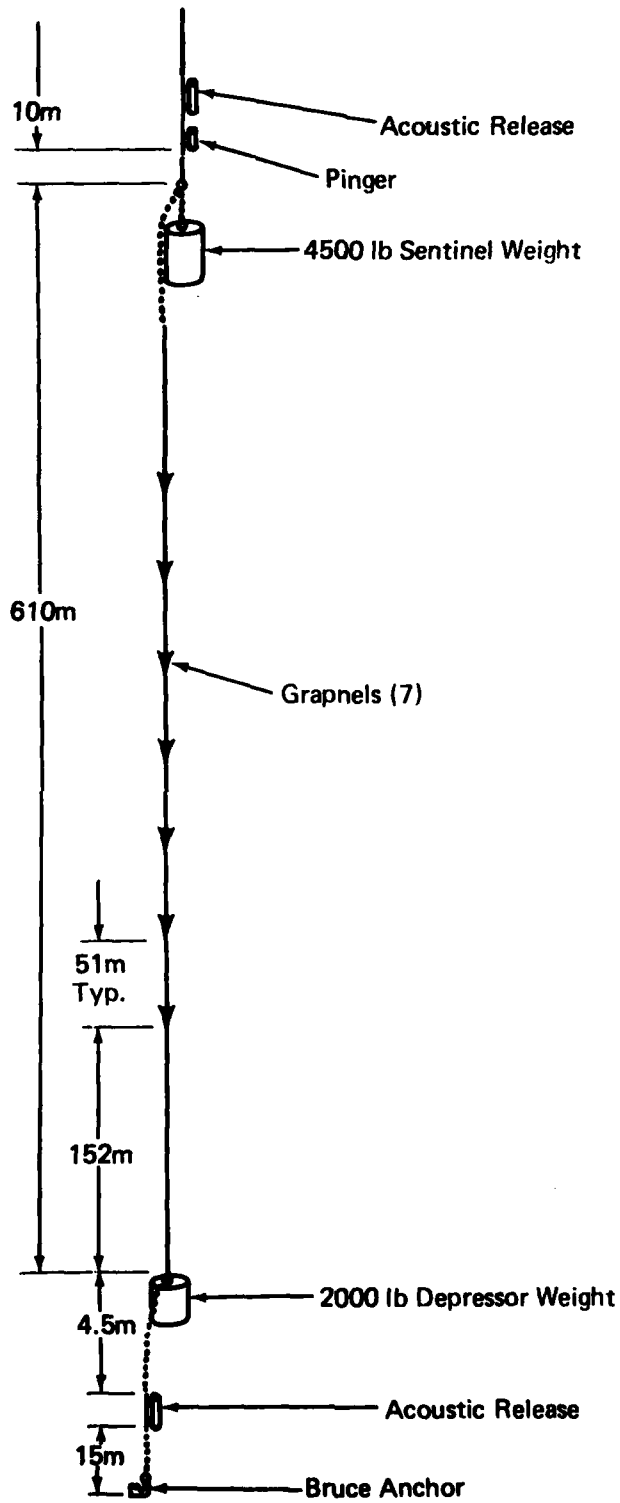

FIGURE 2 MOORED SWEEPLINE TECHNIQUE



**FIGURE 3 CONFIGURATION OF TOWED RECOVERY ARRAY**



**FIGURE 4 GENERAL CONFIGURATION OF SWEEPLINE ARRAY**

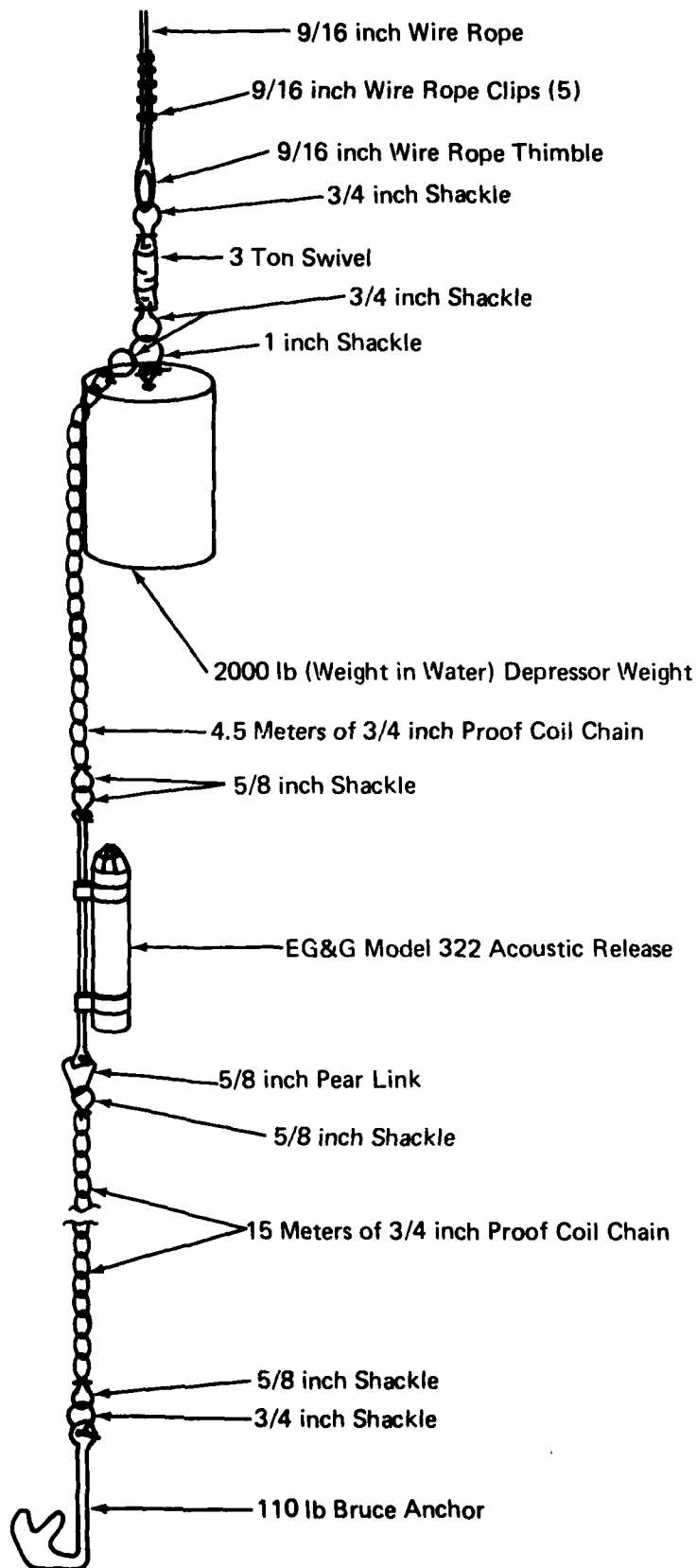

**FIGURE 5 ANCHOR/DEPRESSOR WEIGHT RIGGING DETAIL**

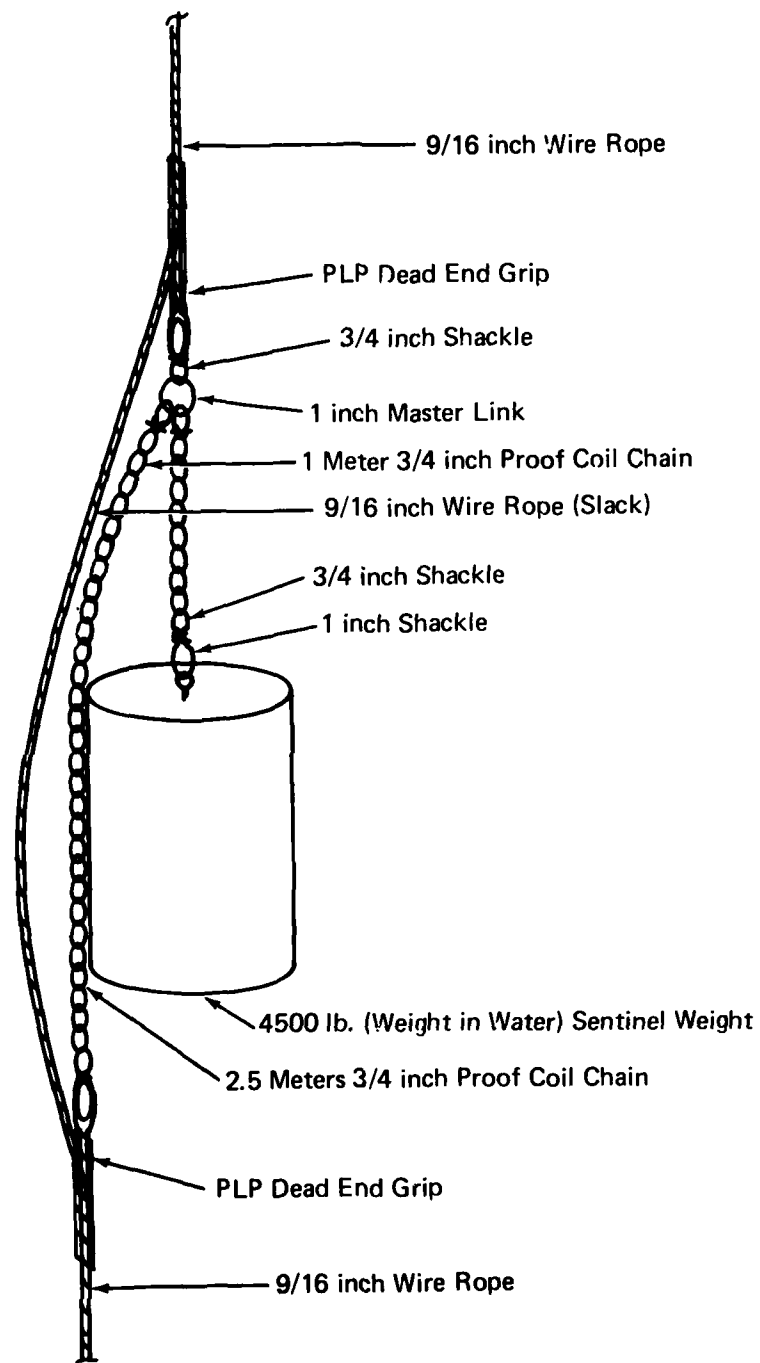

**FIGURE 6 SENTINEL WEIGHT RIGGING DETAIL**

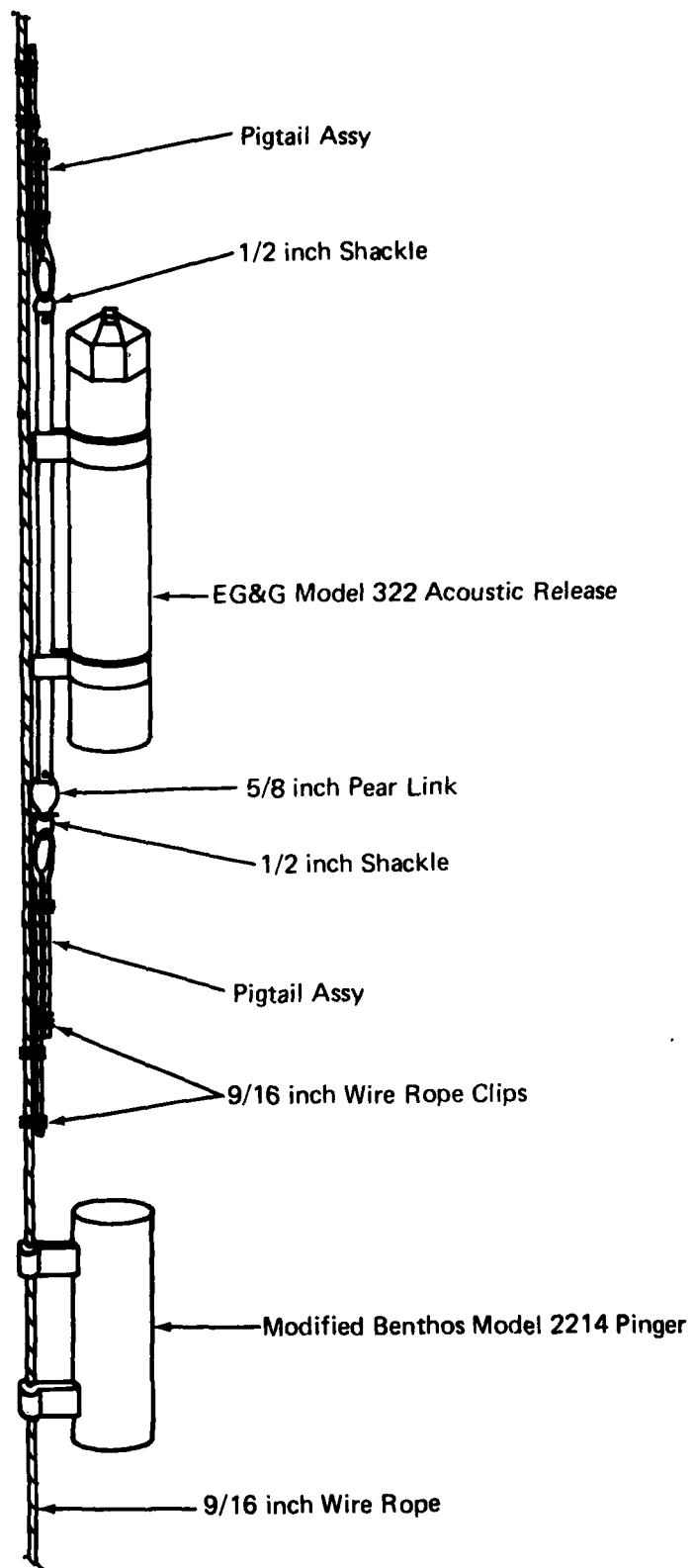

**FIGURE 7 PINGER/RELEASE RIGGING DETAIL**

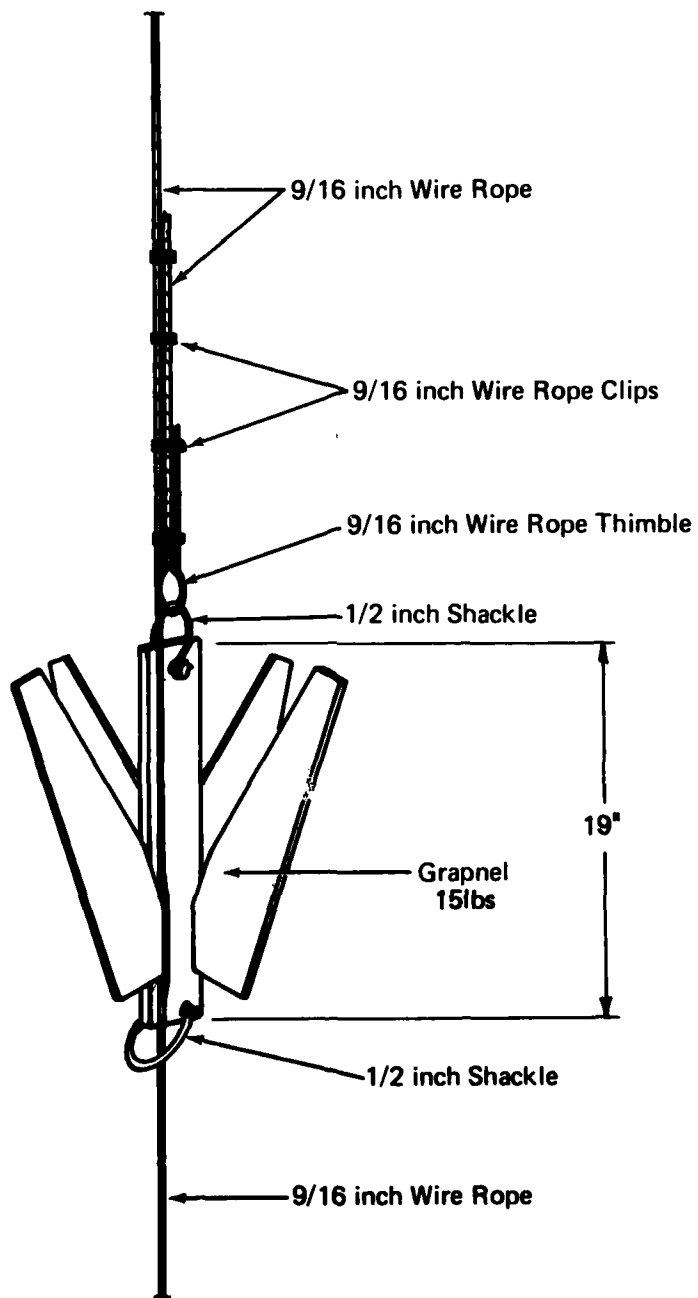

**FIGURE 8 GRAPNEL RIGGING DETAIL**

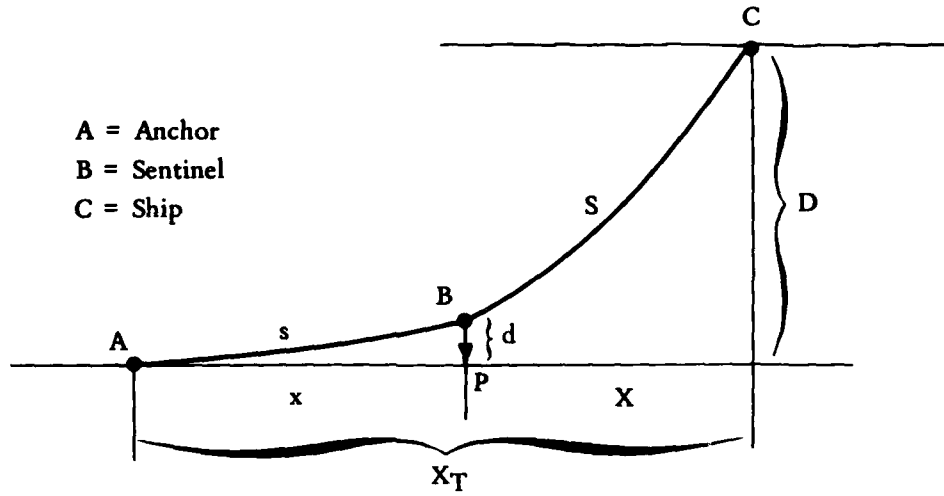

FIGURE 9 RECOVERY ARRAY GEOMETRY

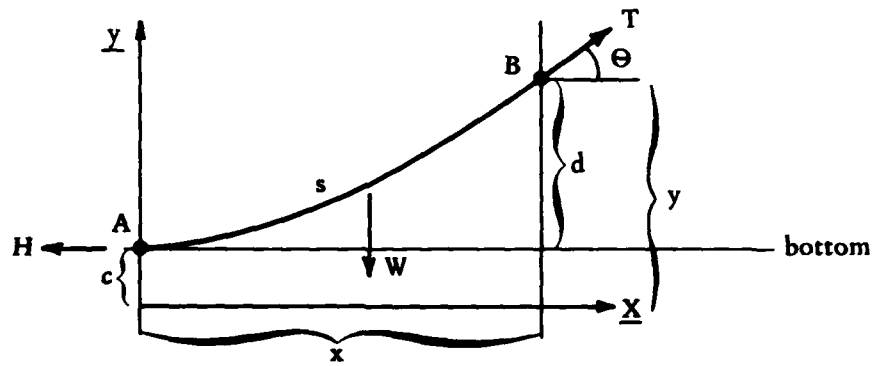

FIGURE 10 SWEEPLINE GEOMETRY



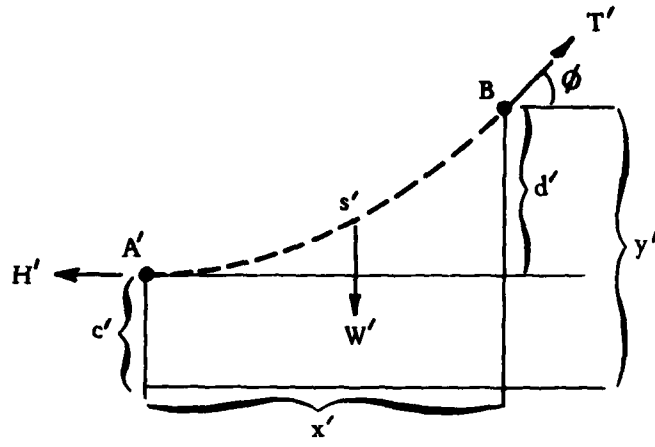

FIGURE 13 GEOMETRY OF IMAGINARY SEGMENT

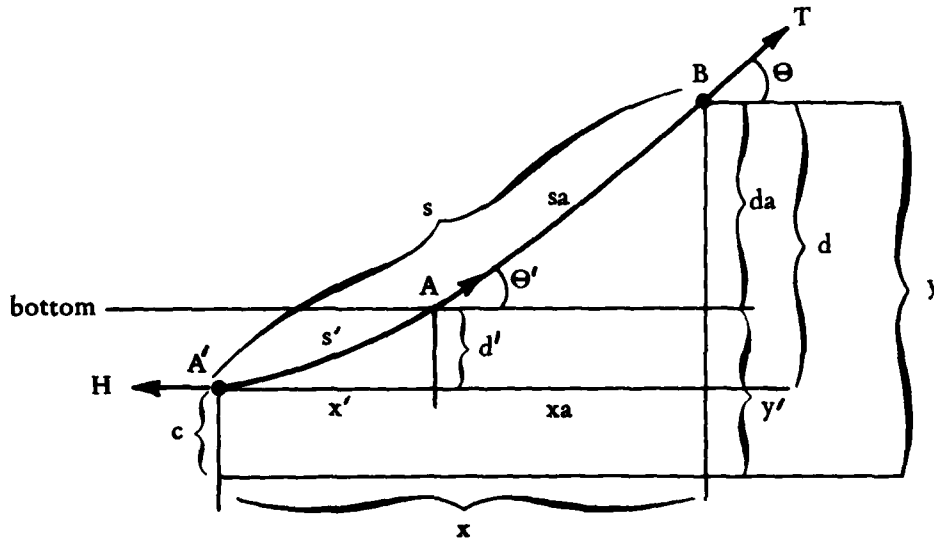

FIGURE 14 EXTENDED ARRAY GEOMETRY

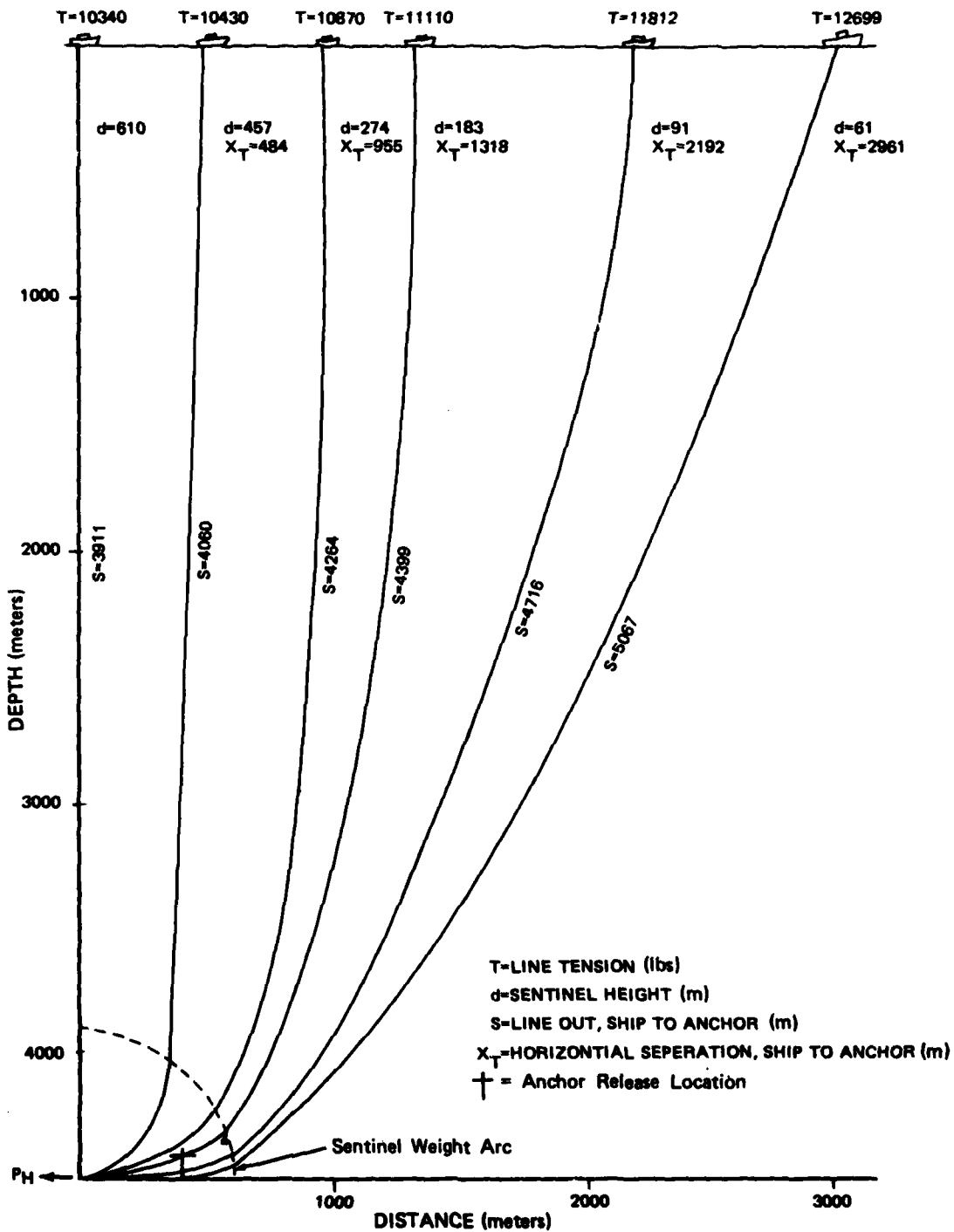

FIGURE 15 CATENARY DETAIL - CASE 1

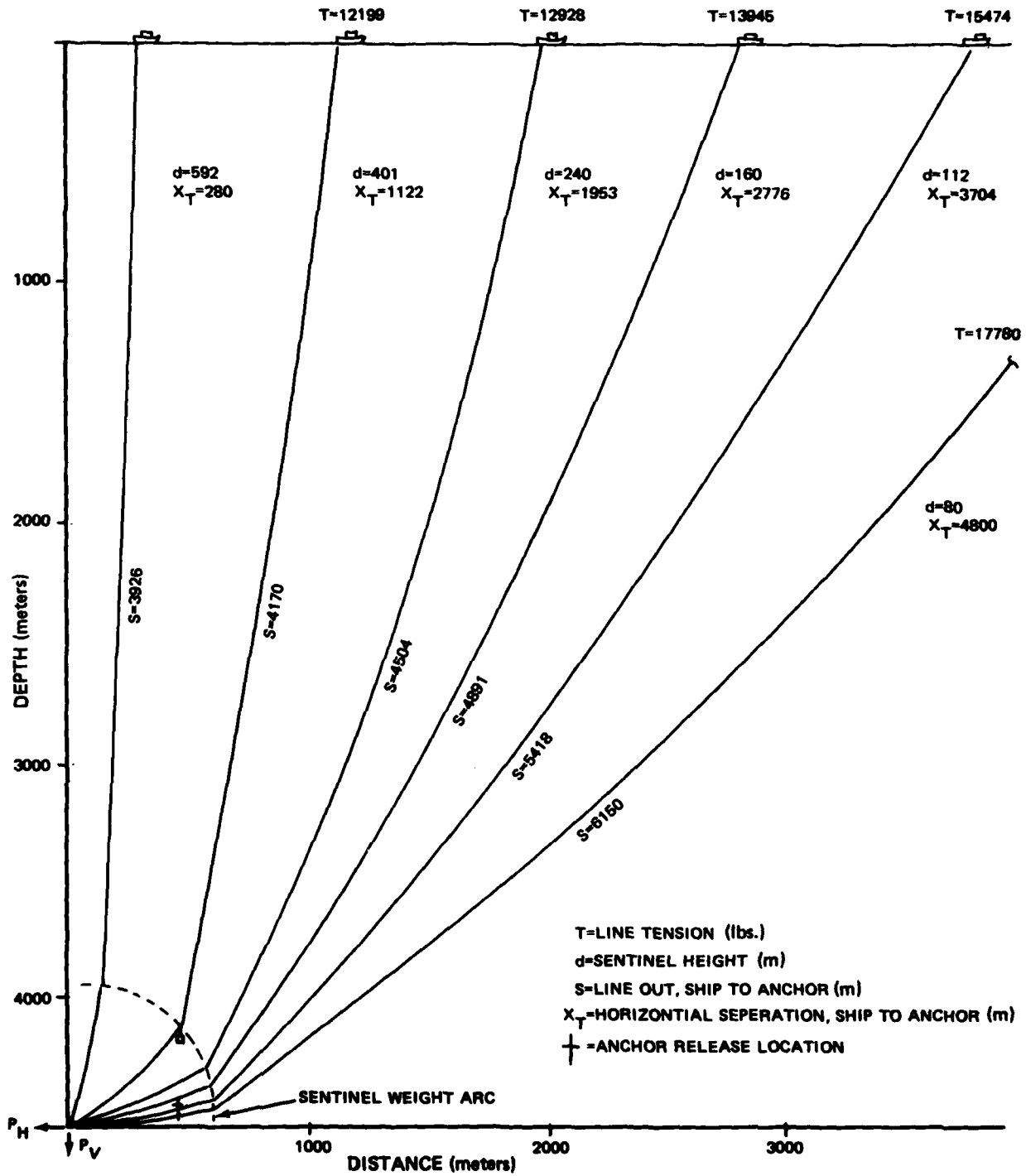

FIGURE 16 CATENARY DETAIL - CASE 2

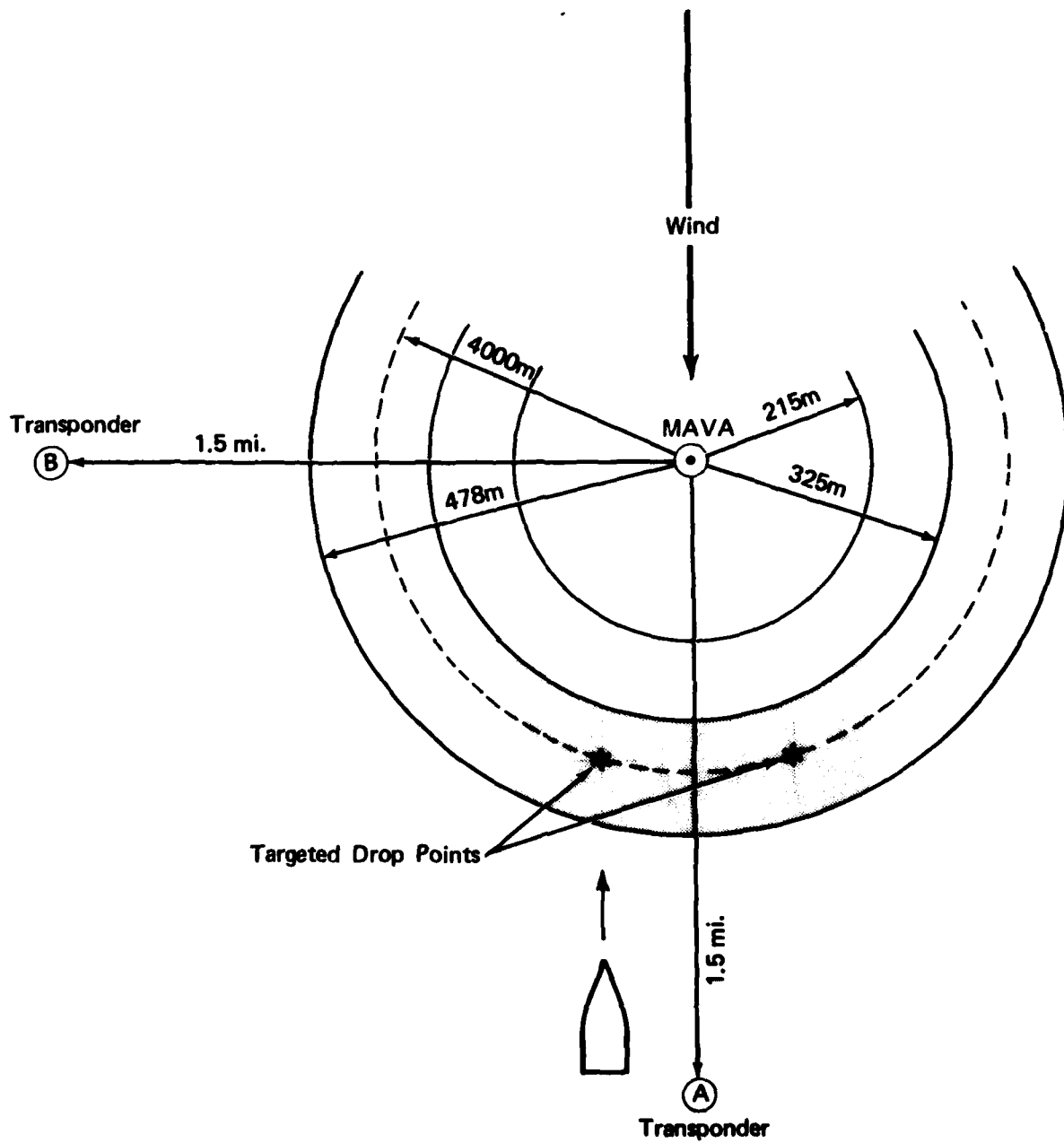
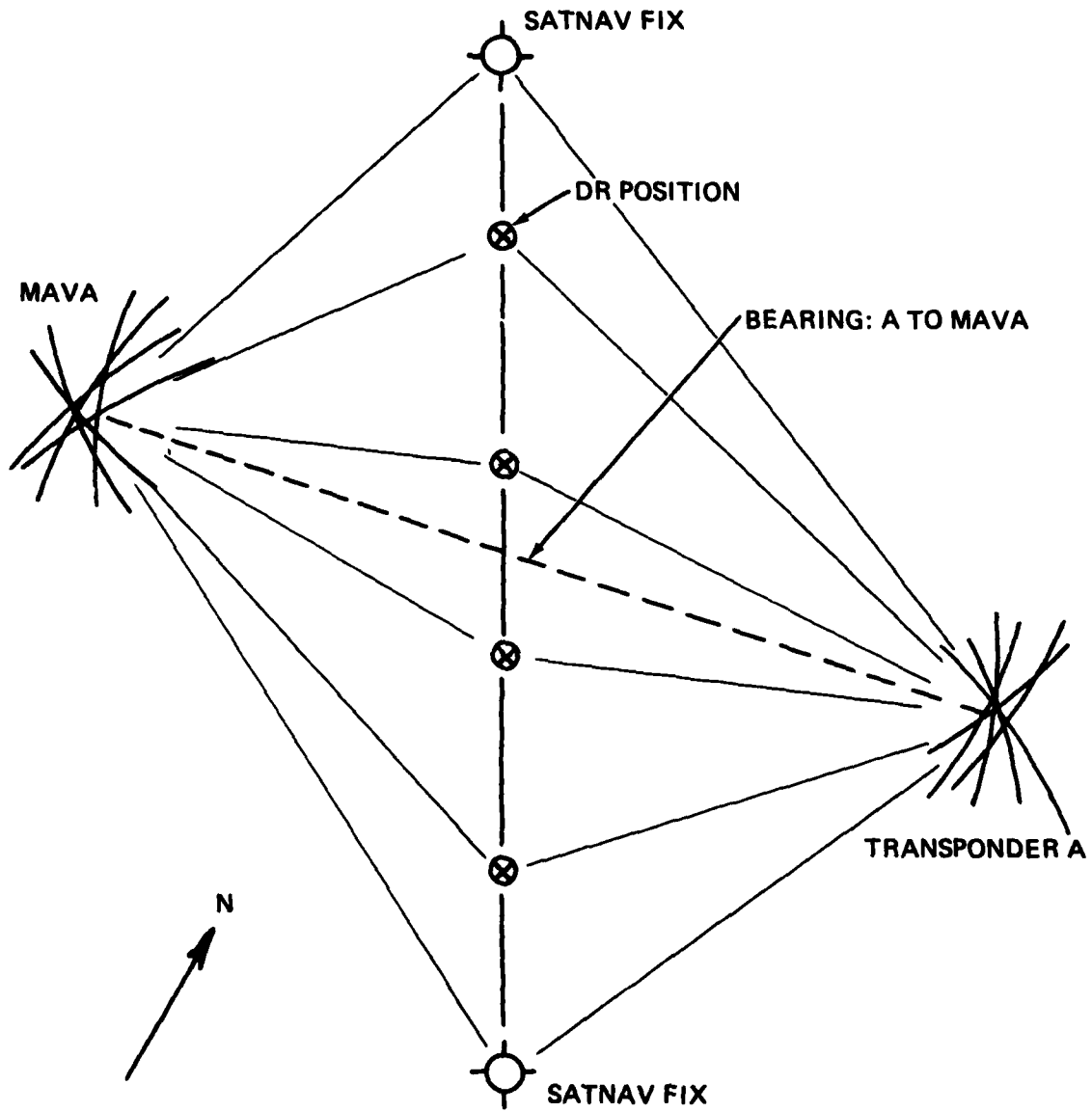

FIGURE 17 TRANSPONDER NET



**FIGURE 18 TRANSPONDER NET GEOGRAPHICAL ORIENTATION**

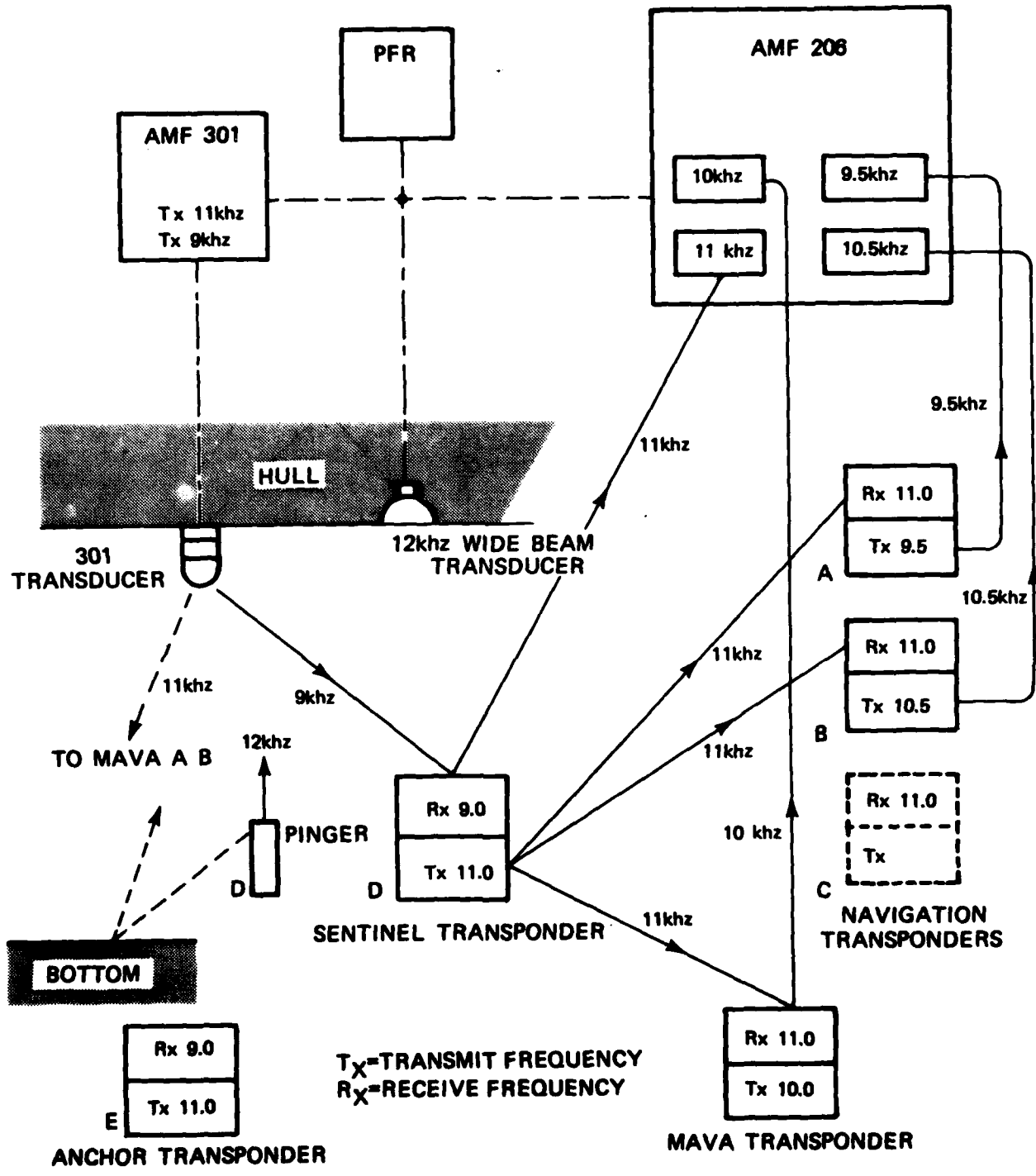

FIGURE 19 ELECTRONIC EQUIPMENT

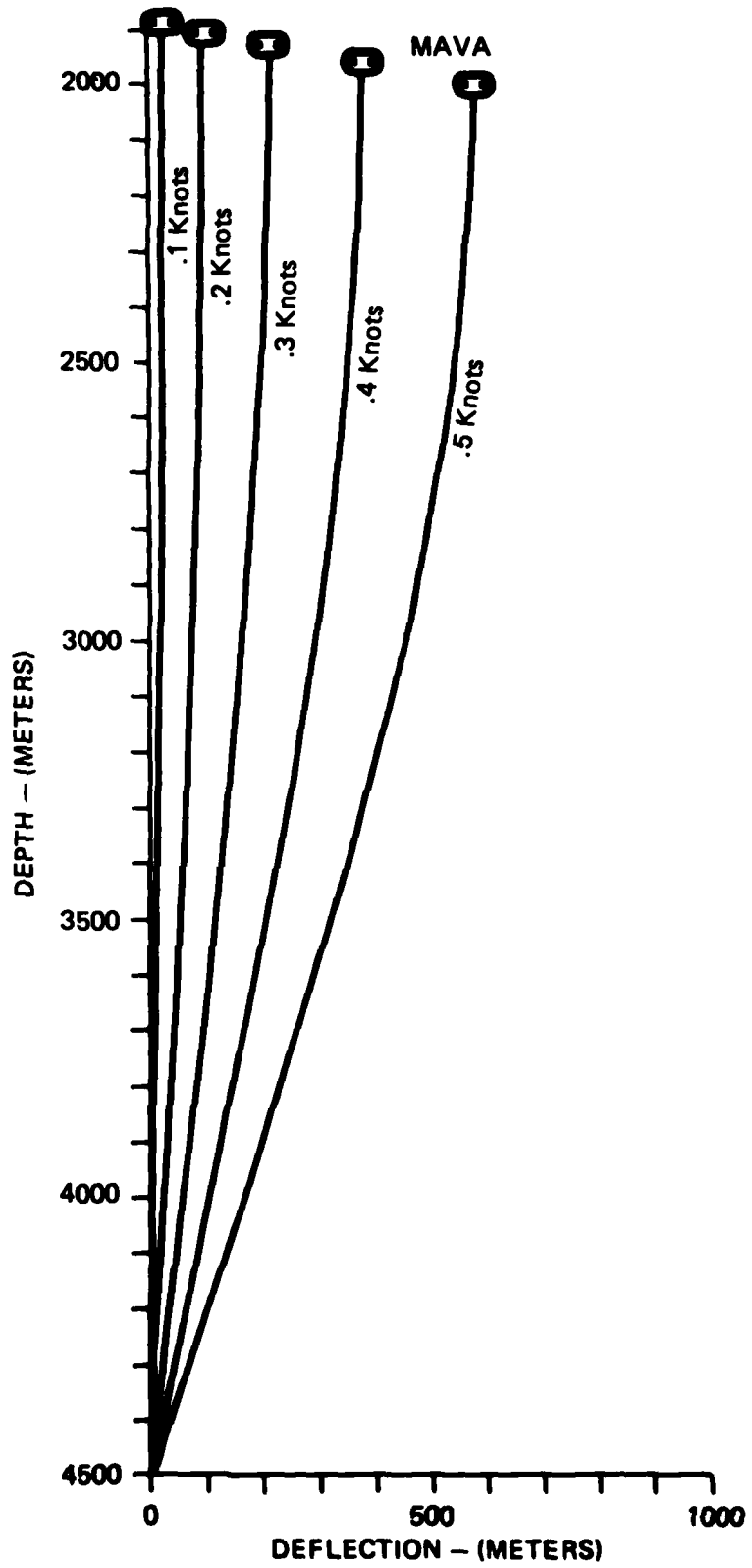

FIGURE 20 MAVA DEFLECTION VS. CURRENT



FIGURE 21 PLOTTING SHEET

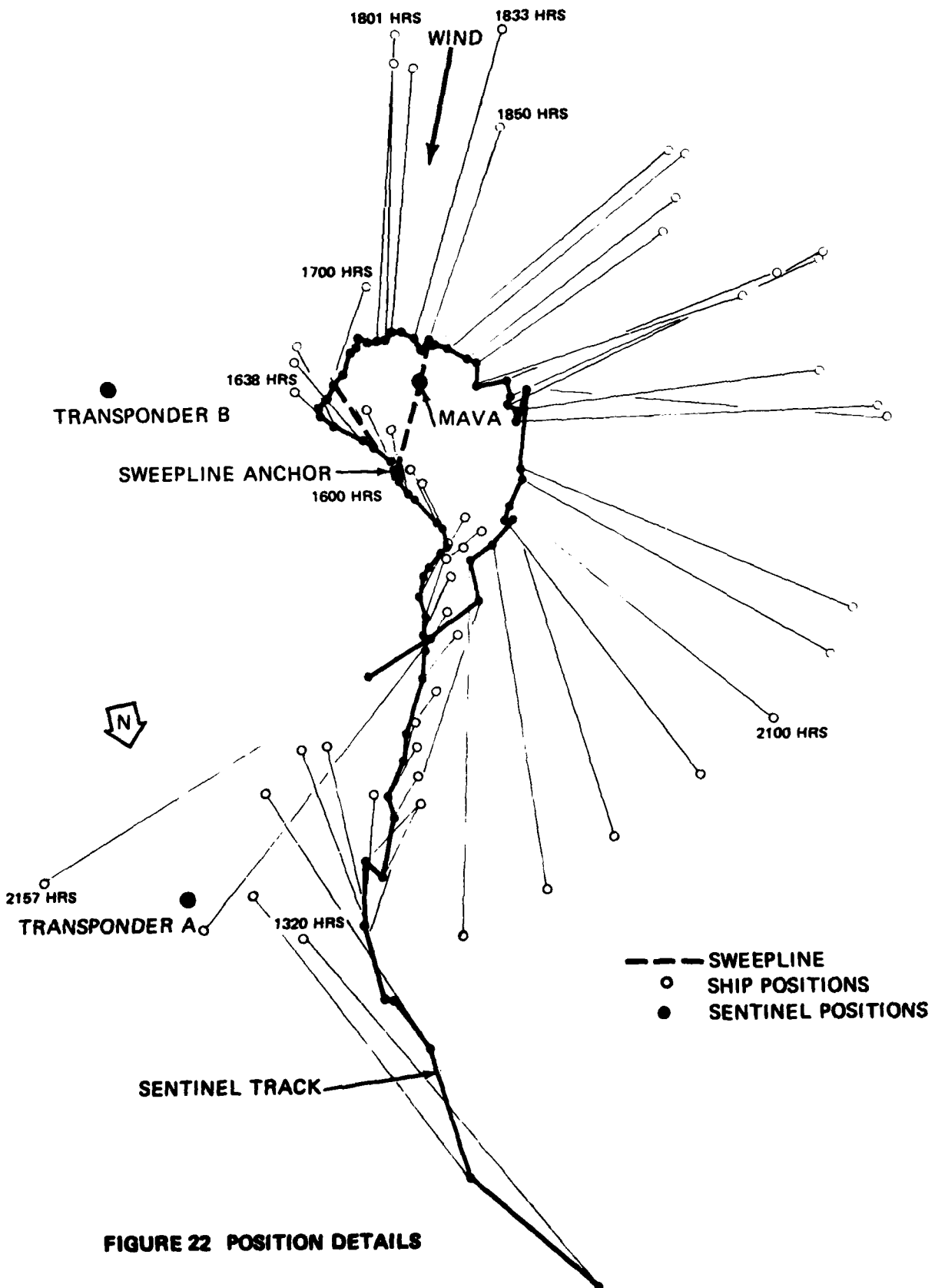

FIGURE 22 POSITION DETAILS

DISTRIBUTION LIST

COMNAVOCEANCOM	1
CNO (OP 952)	1
ONR (Code 480)	1
NORDA	1
NUSCDET NEW LONDON	1
NUSCDET NEWPORT	1
NOSC	1
NAVENENVSA	1
NRL	1
NAVPGSCOL	1
DTIC	12
WHOI	1
UC/SIO	1
MPL	1
OSU	1
UW	1
UM/RSMAS	1
TAMU	1
UNH	1
JHU/APL	1

END

DATE

FILMED

77802

WTS

AD-A115 448

NAVAL OCEANOGRAPHIC OFFICE NSTL STATION WS  
A SURFACE RECOVERY TECHNIQUE FOR DEEP MOORED VERTICAL ARRAYS. (U)  
AUG 81 M A PAIGE, P J HEUSER, L A LINDQUIST  
NOO-TR-278

F/G 13/10

UNCLASSIFIED

NL

2-2

1

1

1

1

1

1

1

1

1

1

1

1

1

1

1

1

1

1

1

1

1

1

1

1

1

1

1

1

1

1

1

1

1

1

1

1

1

1

1

1

1

1

1

1

1

1

1

1

1

1

1

1

1

1

1

1

1

1

1

1

1

1

1

1

1

1

1

END  
DATE  
FILMED  
9 82  
DTIC

AD  
A1154

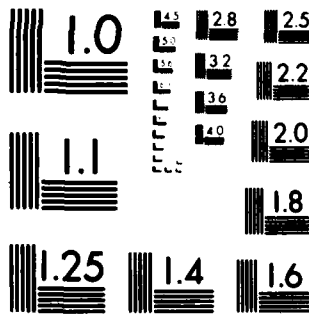

MICROCOPY RESOLUTION TEST CHART  
NATIONAL BUREAU OF STANDARDS 1963-A

**SUPPLEMENTARY**

**INFORMATION**



**DEPARTMENT OF THE NAVY**

**U.S. NAVAL OCEANOGRAPHIC OFFICE**

**NSTL STATION**

**BAY ST. LOUIS, MISSISSIPPI 39522**

**IN REPLY REFER TO**

**Code 6300**

**21 June 1982**

AD-A115448

**CHANGE No. 1**

**Naval Oceanographic Office**

**Technical Report TR-278, "A Surface Recovery Technique For Deep Moored Vertical Arrays," should be revised as indicated below:**

- 1. Replace pages 5-10 with revised pages 5-10**
- 2. Page 2, paragraph 1, line 3: change zonon to xenon**
- 3. Page 30, figure 17: change 4000m to 400m**

**82 08 13 088**

The arclength  $s$  would be fixed when the array was assembled. The height  $d$  would be measured during the operation using an acoustic pinger attached to the cable. For a given arclength and height, the horizontal length  $x$  of the cable is:

$$x = c \ln \left( \frac{y}{c} + \sqrt{\left(\frac{y}{c}\right)^2 - 1} \right) \quad (2)$$

where:  $y = c + d$

The horizontal distance  $x$  between the anchor and sentinel would be determined from positions acquired using acoustic transponder navigation. A transponder was attached at the sentinel location. This value was, therefore, an input to the calculations. However, should the transponder fail to operate the parameter could be calculated using equation (2). Furthermore, the measured value could be used as a check of the analysis by comparing it with the calculated value.

The tension at the bottom of the catenary is given by:

$$H = cw \quad (3)$$

where:  $w$  = linear density of cable

The tension at the top of the catenary is:

$$T = yw \quad (4)$$

The weight of the catenary is the linear density times the length:

$$W = sw \quad (5)$$

Summing forces in the  $x$  and  $y$  directions and dividing yields the angle between the tension vector and the horizontal at point B:

$$\theta = \tan^{-1} \frac{W}{H} \quad (6)$$

A free-body diagram of point B, where the sentinel weight attaches to the two cable segments, is depicted in figure 11. In this figure,  $P$  represents the sentinel weight,  $T$  and  $\theta$  represent the tension and its direction in the lower catenary cable segment, and  $T'$  and  $\theta'$  represent the tension and its direction in the upper catenary cable segment. Summation of forces in equilibrium yields:

$$\theta' = \tan^{-1} \frac{T \sin \theta + P}{T \cos \theta} \quad (7)$$

and

$$T' = \frac{T \sin \theta + P}{\cos \theta} \quad (8)$$

The cable segment  $\overline{BC}$  forms a portion of a catenary whose loading conditions are calculated for point B. In order to use standard catenary analysis, the segment can be extended to include an imaginary portion of cable which would form a single continuous catenary with the same resultant loads at point B. This concept is illustrated in figure 12.

The segment  $\overline{A'B}$  is the imaginary portion with arclength  $s'$ , horizontal length  $x'$  and horizontal tension  $H'$ . The vertical displacement for the catenary coordinate system is  $c'$ . Figure 13 depicts a free-body diagram of this segment. The parameters in this figure are calculated as follows. The value of  $y'$  is:

$$y' = \frac{T'}{w} \quad (9)$$

The horizontal tension  $H'$  is:

$$H' = T' \cos \theta \quad (10)$$

The coordinate displacement  $c'$  is:

$$c' = \frac{H'}{w} \quad (11)$$

The height  $d'$  is given by:

$$d' = y' - c' \quad (12)$$

The horizontal distance is then:

$$x' = c' \ln \left( \frac{y'}{c'} + \sqrt{\left(\frac{y'}{c'}\right)^2 - 1} \right) \quad (13)$$

The arclength  $s'$  is:

$$s' = \sqrt{y'^2 - c'^2} \quad (14)$$

The weight of the imaginary segment is:

$$W' = s'w \quad (15)$$

For the entire catenary  $\overline{A'C}$  in figure 12, we have:

$$D' = D + d' - d \quad (16)$$

and

$$Y' = D' + c' \quad (17)$$

The horizontal distance is:

$$x' = c' \ln \left( \frac{Y'}{c'} + \sqrt{\left(\frac{Y'}{c'}\right)^2 - 1} \right) \quad (18)$$

The arclength  $S'$  is:

$$S' = \sqrt{Y'^2 - C'^2} \quad (19)$$

Equations (9) through (15) provide the parameters for the imaginary catenary segment  $A'B$ , while equations (16) through (19) give the required parameters for the entire catenary  $A'C$  (imaginary and actual segments). It is now a simple matter of subtracting the imaginary segment from the entire catenary yielding the required parameters for segment  $BC$ , the actual catenary segment.

The horizontal distance  $X$  for the catenary segment  $BC$  is:

$$X = X' - x' \quad (20)$$

The tension in the cable at point C (ship's position) is:

$$T'' = Y'w \quad (21)$$

The arclength  $S$  is:

$$S = S' - s' \quad (22)$$

The total length of cable  $\overline{ABC}$  shown in figure 9 is given by:

$$S_t = S + s \quad (23)$$

The total weight of the cable plus load is:

$$W_t = S_t w + P \quad (24)$$

The total horizontal distance  $X_t$  is:

$$X_t = X + x \quad (25)$$

In summary, the known values are:

- w = linear density of cable
- s = length of sweepline
- d = height of sentinel
- P = weight of sentinel
- D = depth from surface to bottom

The calculated parameters, not including intermediate values, are:

- H = horizontal tension at anchor
- T = tension in sweepline at sentinel
- T' = tension in cable at sentinel
- T'' = tension in cable at ship
- x = horizontal distance of sweepline
- $x_t$  = horizontal distance from anchor to ship
- $S_t$  = total cable payed out from anchor to ship

The calculated values are used to indicate the tensions in the cable and the geometry of the cable. As previously mentioned, the tension at the ship,  $T''$ , and the distances  $x$ ,  $X_T$  and  $S_T$  could be measured inputs. In fact, such measurements could serve as a means of verifying the theory and the calculations.

### Catenary Analysis for Case 2

We will next consider the case when the sweepline is not horizontal at the anchor. In this case, the sweepline segment forms a portion of a catenary. Development of the analysis can be made along the same lines used for the cable segment  $BC$  in Case 1; which is to assume the catenary segment to be extended so the usual catenary calculations may be applied. This is illustrated in figure 14.

In this case the loading conditions are unknown. For a direct analysis of this situation values for at least two parameters must be assumed. For our purposes the values  $s$ , the segment arclength  $A'B$ , and  $\theta$ , the angle of the sweepline at the sentinel, were chosen. The analysis proceeds as follows.

Select  $s$  and  $\theta$ . Known values are  $s_a$ , the actual length of the sweepline from anchor to sentinel, and  $w$ , the linear density of the cable. The horizontal tension at  $A'$ , the bottom of the imaginary catenary segment, is calculated from equation (6) by:

$$H = \frac{W}{\tan \theta} \quad (26)$$

Where  $W$  is the weight of the total segment including the imaginary part and is calculated using equation (5). From equation (3) the coordinate system vertical displacement is:

$$c = \frac{H}{W} \quad (27)$$

Using equation (1) the vertical distance from  $A'$  to  $B$  is:

$$d = -c + \sqrt{c^2 + s^2} \quad (28)$$

The horizontal distance  $x$  is given by equation (2). The tension  $T$  at the top of the sweepline is calculated from equation (4).

Using equation (28) the vertical height of the imaginary segment  $A'A$  is"

$$d' = -c + \sqrt{c^2 + s'^2} \quad (29)$$

Where:

$$s' = s - s_a$$

From equation (13) the horizontal length for the imaginary segment is:

$$x' = c \ln \left( \frac{y'}{c} + \sqrt{\left(\frac{y'}{c}\right)^2 - 1} \right) \quad (30)$$

Where:  $y' = c + d'$

Therefore, the horizontal distance for the actual catenary segment  $\overline{AB}$  is:

$$x_a = x - x' \quad (31)$$

The vertical height is:

$$d_a = d - d' \quad (32)$$

The tension at A, the anchor, is:

$$t' = y'w \quad (33)$$

The tension occurs at an angle  $\theta$  given by equation (6) as:

$$\theta = \tan^{-1} \frac{W}{H} \quad (34)$$

The tension at point A may be divided into horizontal and vertical components. The vertical component tends to lift the depressor weight decreasing the horizontal load that it can hold. The tension components are given by:

$$P_H = t' \cos \theta \quad (35)$$

$$P_V = t' \sin \theta \quad (36)$$

Equations (26) through (36) may be used to analyze the sweepline tensions and geometry. Equations (7) through (25) of Case 1 may be used to calculate the rest of the cable parameters (substituting  $x_a$  for  $x$  and  $d_a$  for  $d$  where required).

In summary, the following values are assumed:

- $s$  = length of lower catenary segment including imaginary portion and sweepline
- $\theta$  = angle of sweepline at sentinel

The known values are:

- $s_a$  = length of sweepline
- $w_a$  = linear density of cable
- $P$  = weight of sentinel
- $D$  = depth from surface to bottom

The calculated values included:

$P_H$  = horizontal tension load at anchor  
 $P_V$  = vertical tension load at anchor  
 $T$  = tension in sweepline at sentinel  
 $x_a$  = horizontal distance of sweepline  
 $d_a$  = height of sentinel  
 $\theta'$  = angle of sweepline at anchor  
 $T''$  = tension of cable at ship  
 $X_T$  = total horizontal distance from anchor to ship  
 $S_T$  = total line payed out from anchor to ship

Again, many of the calculated values could be measured directly with instrumentation. Tables were developed using values of  $s$  from 670 meters to 1200 meters and  $\theta$  varying from  $50^\circ$  to  $80^\circ$  (it was estimated that a sweepline length of approximately 600 meters would be used). Plots were also made drawn to scale of the cable and sweepline at the various geometries. It was felt that from instrument readings visual "interpolation" of cable geometries between the various plots could be made. In this way a visual indication of cable behavior could be made in real time, hopefully, without the need of simultaneous calculations. Examples of the catenary plots which were thus generated are shown in figure 15 and 16.

#### TABLES

Table 1. Fixed Constants

$w$  - linear density of 9/16 in. dia. cable  
 $D$  - ocean depth at MAVA  
 $s$  - length of sweepline  
 $P$  - weight of sentinel

Table 2. Measureable and Calculatable Parameters

$T''$  - tension of cable at ship  
 $d$  - height of sentinel off bottom  
 $x$  - horizontal distance between anchor and sentinel  
 $X$  - horizontal distance between sentinel and ship  
 $S$  - amount of cable payed out

Table 3. Calculated Parameters

$H$  - horizontal tension at bottom of catenary  
 $T$  - tension at top of sweepline  
 $T'$  - tension at bottom of cable  
 $W$  - weight of cable  
 $\theta$  - angle at top of sweepline  
 $\phi$  - angle at bottom of cable  
 $P_H$  - horizontal component of cable tension at depressor  
 $P_V$  - vertical component of cable tension at depressor

DATE  
ILMEI  
— 8