

AD-A132 282

MODE S BEACON SYSTEM: FUNCTIONAL DESCRIPTION REVISION C
(U) MASSACHUSETTS INST OF TECH LEXINGTON LINCOLN LAB
V A ORLANDO ET AL. 15 JUL 83 ATC-42-REV-C

1/2

UNCLASSIFIED

DOT/FAA/PM-83/8 F19628-80-C-0002

F/G 17/9

NI



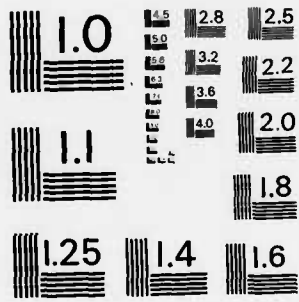

MICROCOPY RESOLUTION TEST CHART
NATIONAL BUREAU OF STANDARDS-1963-A

ADA 132282

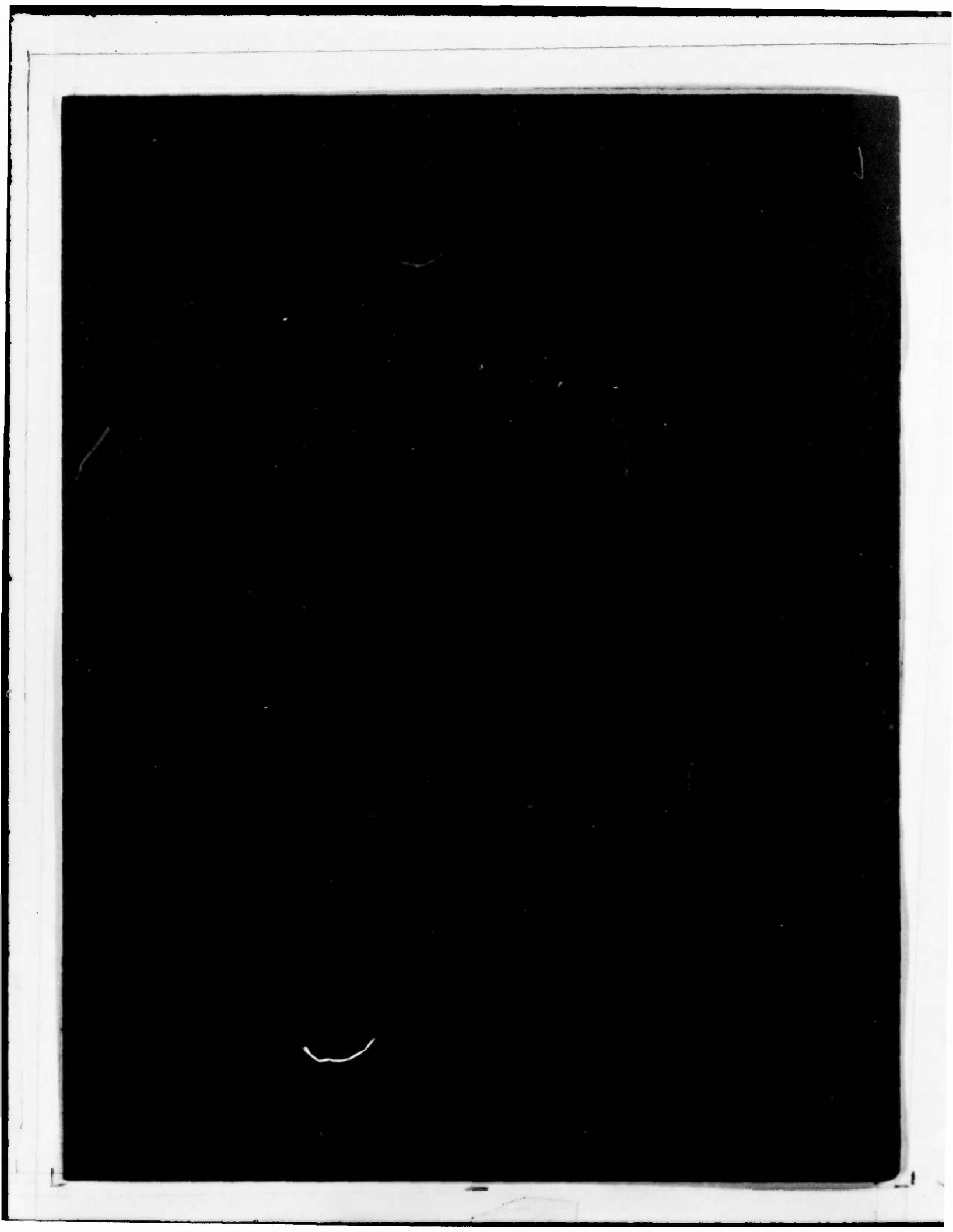

1. Report No. DOT/FAA/PM-83/8	2. Government Accession No. A132 282	3. Recipient's Catalog No.	
4. Title and Subtitle Mode S Beacon System: Functional Description		5. Report Date 15 July 1983	8. Performing Organization Code
7. Author(s) V.A. Orlando, P.R. Drouilhet		8. Performing Organization Report No. ATC-42 Revision C	
9. Performing Organization Name and Address Massachusetts Institute of Technology Lincoln Laboratory P.O. Box 73 Lexington, MA 02173-0073		10. Work Unit No. Proj. No. 052-241-04	11. Contract or Grant No. DOT-FA72-WA1261
12. Sponsoring Agency Name and Address Department of Transportation Federal Aviation Administration Systems Research and Development Service Washington, DC 20591		13. Type of Report and Period Covered Project Report	
15. Supplementary Notes The work reported in this document was performed at Lincoln Laboratory, a center for research operated by Massachusetts Institute of Technology, under Air Force Contract F19628-80-C-0002.			
18. Abstract <p>This document provides a functional description of the Mode S Beacon System, a combined secondary surveillance radar (beacon) and ground-air-ground data link system capable of providing the aircraft surveillance and communications necessary to support ATC automation in future traffic environments. Mode S is capable of common-channel interoperation with the current ATC beacon system, and may be implemented over an extended transition period. Mode S will provide the surveillance and communication performance required by ATC automation, the reliable communications needed to support data link services, and the capability of operating with a terminal or enroute, radar digitizer-equipped, ATC surveillance radar.</p> <p>The material contained in this document updates and expands the information presented in "Mode S Beacon System: Functional Description", DOT/FAA/RD-82/52, 27 October 1982.</p>			
17. Key Words Air Traffic Control Surveillance Data Link Data Link Beacon Mode S		18. Distribution Statement Document is available to the public through the National Technical Information Service, Springfield, Virginia 22151	
19. Security Classif. (of this report) Unclassified	20. Security Classif. (of this page) Unclassified	21. No. of Pages	22. Price

CONTENTS

	<u>Page</u>
CHAPTER 1 OVERVIEW AND SUMMARY	1
Introduction	1
The Mode S Concept	1
Mode S Elements	3
Mode S Surveillance	6
ATCRBS Surveillance	8
Mode S Data Link	11
Coverage Management	14
Mode S /ATC Interface	15
Other Interfaces	15
System Performance Summary	16
CHAPTER 2 THE MODE S LINK	17
Signal Waveforms	17
Mode S Signal Content	22
Error Protection	24
Acquisition and Lockout Protocols	24
Basic Surveillance Protocols	32
Standard Uplink Message Protocol (Comm-A)	34
Standard Downlink Message Protocol (Comm-B)	37
Extended Length Uplink Message Protocol (Comm-C)	45
Extended Length Downlink Message Protocol (Comm-D)	47
Message Protocol Independence	50
Capability Reporting	50
Flight Identification Protocol	52
Utility Message Protocol	53
CHAPTER 3 THE MODE S SENSOR	55
Channel Management	57
Clock	65
Modulator/Transmitter	65
Antenna System	65
Multichannel Receiver	70
Mode S Reply Processing	72
ATCRBS Reply Processing	75
Surveillance Processing	79
Data Link Processing	87
Network Management	91
Performance Monitoring	97
Message Routing Management	97
CHAPTER 4 THE MODE S TRANSPONDER	99
CHAPTER 5 PERFORMANCE	107
Link Reliability	107
Monopulse Performance	114
Capacity	118

CONTENTS (CONT'D)

	<u>Page</u>
CHAPTER 6 SURVEILLANCE PERFORMANCE VALIDATION	123
Field Measurements Program	123
Experimental Results	127
Summary	127
REFERENCES	130
APPENDIX A COMPREHENSIVE INDEX OF FIELDS	A-1
APPENDIX B SIGNIFICANCE OF INTERROGATION AND REPLY FIELDS	B-1

Accession For	
NTIS GRA&I	<input checked="" type="checkbox"/>
DTIC TAB	<input type="checkbox"/>
Unannounced	<input type="checkbox"/>
Justification	
By _____	
Distribution/	
Availability Codes	
Dist	Avail and/or Special
A	



ILLUSTRATIONS

<u>Fig.</u>		<u>Page</u>
1-1	Air traffic control radar beacon system (ATCRBS)	2
1-2	Mode S system elements	4
1-3	Conventional sliding window detector	9
1-4	Monopulse reply degarbling	10
1-5	False target geometry	12
2-1	ATCRBS/Mode S all-call interrogation	19
2-2	ATCRBS reply	20
2-3	Mode S interrogation	21
2-4	Mode S reply	23
2-5	Summary of Mode S uplink formats	25
2-6	Summary of Mode S downlink formats	26
2-7	Address/parity field generation	28
2-8	Combined interrogation for site selective acquisition	30
3-1	Mode S sensor functional block diagram	56
3-2	ATCRBS/Mode S time sharing	58
3-3	Mode S roll-call scheduling	60
3-4	Mode S cycles	61
3-5	Channel management	63
3-6	Modulator/Transmitter	66
3-7	Sum and difference antenna patterns	67
3-8	Mode S joint use enroute sensor	69
3-9	Elevation patterns of five-foot open-array antennas	71
3-10	Multi-channel receiver	73
3-11	Mode S reply processing	74
3-12	ATCRBS reply processing	76
3-13	ATCRBS reply decoding	78
3-14	Surveillance processing	81
3-15	Mode S surveillance processing	82
3-16	ATCRBS surveillance processing	84
3-17	Radar surveillance processing	86
3-18	Data-Link processing	88
3-19	Input message processing	89
3-20	Output message processing	90
3-21	Network management	92
3-22	Coverage map grid structure	93
3-23	Coverage coordination	95
3-24	Performance monitoring	98
4-1	Transponder panel	100
4-2	Mode S transponder	103
4-3	Diversity transponder	104
4-4	Standard message interface timing diagram	106

ILLUSTRATIONS (CONT'D)

<u>Fig.</u>		<u>Page</u>
5-1	Vertical lobing	109
5-2	Aircraft antenna fading	110
5-3	Miss probability	112
5-4	Mode S link reliability for a terminal ground station	113
5-5	Noise induced monopulse error	115
5-6	Monopulse estimate with interference	117
5-7	Maximum monopulse error with target on boresight	119
5-8	Capacity plots	121
6-1	Mode S Experimental Facility (MODSEF)	124
6-2	Transportable Measurement Facility (TMF)	125
6-3	TMF site selection criteria	126
6-4	Transportable Measurements Facility (TMF) sites	126
6-5	ARTS/Mode S ATCRBS mode comparison, Philadelphia (80 x 80 nmi)	128
6-6	Expansion of Figure 6-5 square ABCD (20 x 20 nmi)	128
6-7	Surveillance performance comparison, average site	129

TABLES

<u>Table</u>		<u>Page</u>
2-1	Mode S Field Descriptions	27
2-2	Surveillance Interrogation/Reply Protocol	33
2-3	Example of a Linked Comm-A Message Delivery	38
2-4	Example of Ground-Initiated Comm-B Delivery	40
2-5	Example of Non-Selective Air-Initiated Comm-B Delivery	42
2-6	Example of Multisite Air-Initiated Comm-B Delivery	44
2-7	Example of Multisite Uplink ELM Delivery	48
2-8	Example of Multisite Downlink ELM Delivery	51
3-1	Control Message Handling	96
5-1	Mode S Link Power Budget (Terminal Sensor)	108

TABLES IN APPENDICES

A-1	Field Index	A-2
A-2	Structure of Special Designator (SD) Field	A-11
A-3	Structure of Utility Message (UM) Field	A-13
B-1	Significance of Mode S-Only All-Call Interrogation Fields	B-2
B-2	Significance of All-Call Reply Fields	B-3
B-3	Significance of Surveillance and Comm-A Interrogation Fields	B-4
B-4	Significance of Surveillance and Comm-B Reply Fields	B-5
B-5	Significance of Comm-C Interrogation Fields	B-6
B-6	Significance of Comm-D Reply Fields	B-7
B-7	Significance of Special Surveillance Interrogation Fields	B-8
B-8	Significance of Special Surveillance Reply Fields	B-9

CHAPTER 1

OVERVIEW AND SUMMARY

INTRODUCTION

The Mode S Beacon System is a combined secondary surveillance radar (beacon) and ground-air-ground data link system capable of providing the aircraft surveillance and communications necessary to support ATC automation in the dense traffic environments expected in the future. It is capable of common-channel interoperation with the current Air Traffic Control Radar Beacon System (ATCRBS) defined in Fig. 1-1, and thus may be implemented at low user cost over an extended ATCRBS-to-Mode S transition period. In supporting ATC automation, Mode S will provide the accurate surveillance needed to support automated decision making, and the reliable communications needed to support data link services. In order to meet these requirements at en route facilities, Mode S sensors may operate with back-to-back beacon antennas to provide twice the beacon data rate available from a standard antenna. When operating in conjunction with a terminal or enroute digitizer-equipped, ATC surveillance radar, a Mode S sensor will use the radar returns either to reinforce beacon tracks, or in cases of absence or failure of a transponder, to provide radar target reports.

A central Mode S design requirement was assurance that the system could be implemented in an evolutionary manner. By the time deployment of Mode S begins, approximately 1987, there will be on the order of 200,000 aircraft equipped with ATCRBS transponders, and approximately 500 ground-based interrogators. Mode S is designed to operate in this environment, and in a way that would permit the gradual transition to an all-Mode S operation.

The capability for such a transition has been achieved by providing a high degree of compatibility between Mode S and ATCRBS. Mode S uses the same interrogation and reply frequencies as ATCRBS, and the signal formats have been chosen to permit substantial commonality in hardware. This degree of compatibility permits an economic and smooth transition, in which (a) Mode S interrogators will provide surveillance of ATCRBS-equipped aircraft, and (b) Mode S transponders will reply to ATCRBS interrogators.

Thus Mode S equipment, both on the ground and in aircraft, can be introduced gradually and continue to interoperate with existing systems during an extended transition phase.

THE MODE S CONCEPT

The fundamental difference between Mode S and ATCRBS (Ref. 1) is the manner of addressing aircraft, or selecting which aircraft will respond to an interrogation. In ATCRBS, the selection is spatial, i.e., aircraft within the mainbeam of the interrogator respond. As the beam sweeps around, all angles are interrogated, and all aircraft within line-of-sight of the antenna respond. In Mode S, each aircraft is assigned a unique address code.

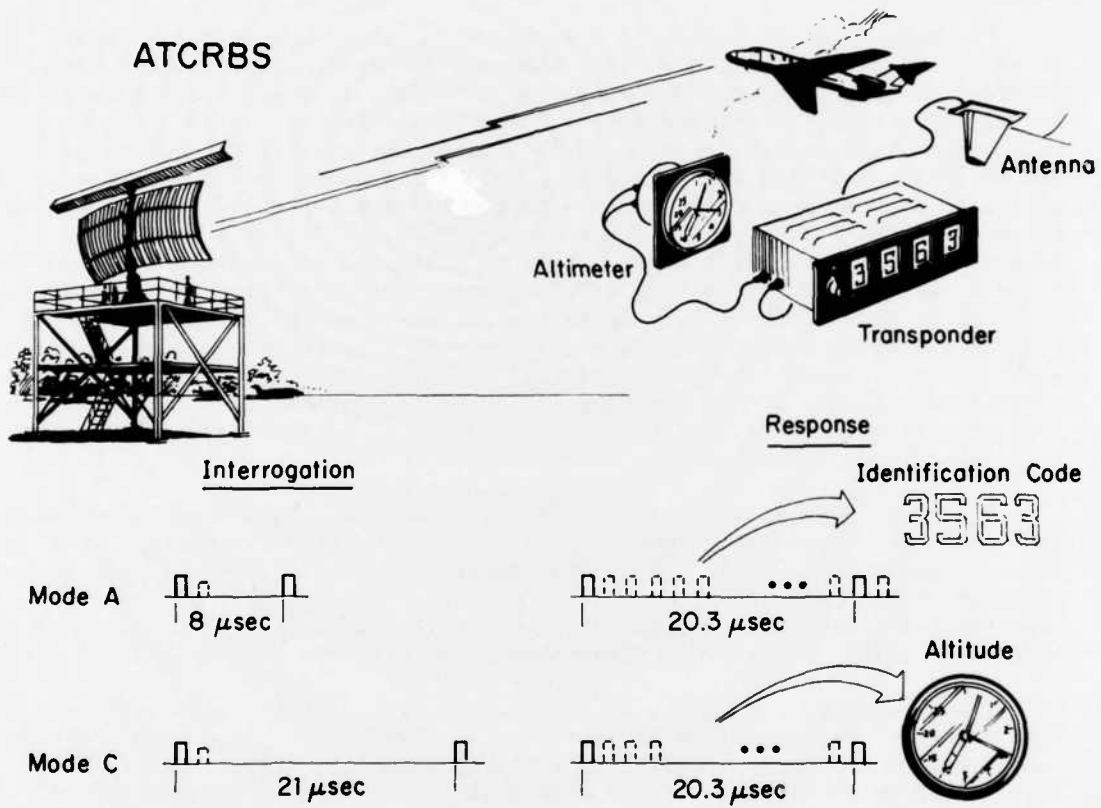

Fig. 1-1. Air traffic control radar beacon system (ATCRBS).

Selection of which aircraft is to respond to an interrogation is accomplished by including the aircraft's address code in the interrogation. Each such interrogation is thus directed to a particular aircraft. Narrow-beam antennas will continue to be used, but primarily for minimizing interference between sites and as an aid in the determination of aircraft azimuth.

Two major advantages accrue from the use of discrete address for surveillance. First, an interrogator is now able to limit its interrogation to only those targets for which it has surveillance responsibility, rather than to continuously interrogate all targets within line-of-sight. This prevents surveillance system saturation caused by all transponders responding to all interrogators within line-of-sight. Secondly, appropriate timing of interrogations ensures that the responses from aircraft do not overlap, eliminating the mutual interference which results from the overlapping of replies from closely spaced aircraft (so-called synchronous garble).

In addition to the improved surveillance capability, the use of the discrete address in interrogations and replies permits the inclusion of messages to or from a particular aircraft, thereby providing the basis for a ground-air and air-ground digital data link.

MODE S ELEMENTS

As illustrated in Fig. 1-2, the Mode S system is comprised of the sensors, transponders, and the signals-in-space which form the link between them. Mode S provides surveillance and ground-air-ground communication service to air traffic control facilities including en route (ARTCC) and terminal (TRACON and TRACAB).

The Mode S link employs signal formats used for ATCRBS, and adds to these the signal waveforms and message formats necessary to acquire Mode S-equipped aircraft, and for discretely-addressed surveillance and data link interrogations and replies. The principal characteristics of the Mode S signals are as follows:

Interrogation -

Frequency: 1030 MHz
Modulation: Differential Phase-Shift Keying (DPSK)
Data Rate: 4 Mbps

Reply -

Frequency: 1090 MHz
Modulation: Pulse Position (PPM)
Data Rate: 1 Mbps

Interrogation and Reply -

Data block: 56-bit or 112-bit
Parity code: 24-bit (included in data block)

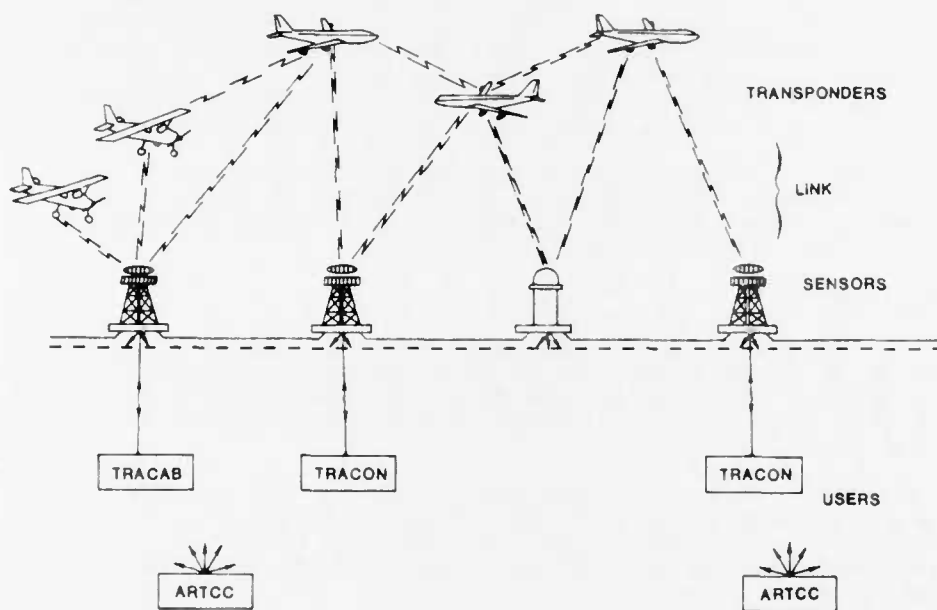

Fig. 1-2. Mode S system elements.

A more complete summary of the Mode S signal formats is contained in Chapter 2.

The Mode S sensor provides surveillance of ATCRBS- and Mode S-equipped aircraft, and operates as a store and forward communication relay for data link communication between aircraft and ATC facilities. In addition, the sensor accepts digitized radar target reports from a collocated radar and combines these with the beacon reports into a composite surveillance output stream. When beacon and radar reports occur on the same target, the radar report is suppressed and the beacon report tagged as radar-reinforced. Radar-only output reports are provided on targets that are not beacon equipped.

To discretely interrogate Mode S-equipped aircraft, the sensor maintains a file of the identity and approximate position of all such aircraft within its defined area of coverage.

Each sensor's operation is controlled by a prestored map defining its coverage volume, which may be different in normal operation and in the event of various system failures, e.g., the failure of an adjacent sensor.

In a netted configuration, each sensor may communicate with adjacent sensors via a common ATC facility to hand off targets as they pass from the region of one sensor's coverage to that of an adjacent sensor. In addition, in regions of overlapping coverage, this intersensor communication may be used to assist in the reacquisition of a lost target.

In general, each sensor can provide surveillance and communication services to several ATC facilities, i.e., all those whose areas of control responsibility overlap the coverage area of the sensor. The interface between the sensor and each control facility comprises a one-way circuit for the transmission of surveillance data, both radar and beacon, and a two-way circuit for the interchange of data link messages. The latter is also used to transmit various status and control messages between the sensor and the ATC facility.

The Mode S transponder includes all of the functions of an ATCRBS transponder, and adds to these the ability to decode Mode S interrogations and to format and transmit the appropriate replies. For data link, the transponder functions primarily as a modem. On receipt of a ground-to-air transmission, it verifies the correctness of the received message using the error-detecting code. Once verified, the transponder transfers the message contents to one or more external devices. For air-to-ground messages, the transponder accepts the message contents from an external input device, and formats and encodes the data for transmission as part of the reply to a subsequent interrogation.

MODE S SURVEILLANCE

The principal features of Mode S surveillance are as follows:

- Unique address
- All-call acquisition
- All-call lockout
- Range-ordered roll-call interrogation
- Adaptive reinterrogation
- Monopulse direction-finding
- Positive handoff
- Multisensor coverage

Each Mode S-equipped aircraft has a permanently assigned unique 24-bit address. This 24-bit address will be included in all discretely-addressed interrogations to that aircraft, and in all Mode S replies from that aircraft.

The Mode S sensor range-orders interrogations to Mode S-equipped aircraft in such a way that the replies do not overlap. The use of monopulse direction finding on the reply permits the sensor to provide surveillance of Mode S-equipped aircraft, generally within a single interrogation/reply cycle per rotation (scan) of the interrogator antenna. If a reply to the interrogation is not received, or is received but not successfully decoded, the interrogator has the capability of reinterrogating (several times if necessary) the aircraft during the time the aircraft is in the antenna beam.

In order to be discretely interrogated, an aircraft must be on the sensor's roll-call file, i.e., the sensor must know its address and approximate position. To acquire targets not yet on any sensor's roll-call file each sensor transmits all-call interrogations. A Mode S-equipped aircraft will respond to such an interrogation with its unique address, and be added to the sensor's roll-call file.

Once on the sensor's roll-call file, the Mode S-equipped aircraft may be locked out from replying to subsequent Mode S all-call interrogations. This lockout condition is under positive control of the Mode S sensor and is transmitted to the Mode S transponder as part of the Mode S discrete interrogation. The use of Mode S lock-out eliminates unnecessary all-call replies and therefore minimizes interference (particularly all-call synchronous garble) on the air-to-ground channel.

While Mode S lock-out can minimize synchronous garble on acquisition, it cannot eliminate it completely nor is it effective in the case where a Mode S sensor resumes operation after a period of inactivity and must therefore acquire many Mode S aircraft simultaneously. These latter cases are handled by a feature called "the stochastic acquisition mode". In this mode, the Mode S sensor interrogates garbling aircraft with a special all-call interrogation that instructs them to reply with a specified less-than-unity reply probability. The resulting reduced reply rate means that some all-call

replies will be received ungarbled and these aircraft will thus be acquired. Once an aircraft is acquired it is locked out and hence no longer interferes with the all-call replies from the remaining unacquired aircraft. The process is repeated until all aircraft are acquired.

The use of Mode S lockout to minimize interference on all-call replies means that provision must be made to hand off the Mode S address to an adjacent site in areas of multisensor coverage. In a non-netted configuration, Mode S aircraft are handed off to an adjacent sensor using one of the following techniques.

Site Addressed Lockout. The Mode S transponder can be selectively and independently locked out to special all-call interrogations originating from up to 15 different sensor sites. Adjacent sites using different site address numbers are completely unaffected by the other sites' lockout activity and hence can perform acquisition and lockout in a completely autonomous manner.

Cooperative Unlocking. This technique requires that each site selectively unlock aircraft at surveillance boundaries in order to allow them to be acquired by the adjacent sensor's normal all-call interrogations.

Lockout Override. A special all-call interrogation can be used that instructs the Mode S transponder to ignore any previous lockout instructions. The resulting all-call garbage is handled by the stochastic acquisition mode. While offering reduced performance compared to the other alternatives, the approach provides a means for sensors with overlapping coverage to operate with no site-to-site coordination. Hence it may be useful for operation across national boundaries or for mobile interrogators.

Provision has also been made for sensor-to-sensor transmission of the aircraft's address and position where Mode S sensors with overlapping coverage can communicate via a common ATC facility.

If for any reason an aircraft ceases to receive discretely-addressed interrogations for a period of approximately 18 seconds (corresponding to a few interrogator scans), any existing lockout will lapse so that the aircraft may be reacquired by normal Mode S acquisition.

In regions of airspace visible to more than one Mode S sensor, each Mode S target will generally be simultaneously on the roll-call of at least two sensors to provide continuity of surveillance and data link service in the event of a link or sensor failure.

ATCRBS SURVEILLANCE

The Mode S sensor provides surveillance of ATCRBS aircraft with quality better than that of presently operating equipment. This is important because of the high density of ATCRBS-equipped aircraft that will be experienced during the early years of the ATCRBS-to-Mode S transition.

Conventional ATCRBS Azimuth Determination

Conventional ATCRBS processors determine azimuth through a technique known as a "sliding window detector" as shown in Fig. 1-3. This azimuth measurement technique uses a high pulse repetition frequency (PRF) of up to 450 per second in order to provide the twelve or more replies needed for azimuth determination for a terminal sensor. A second characteristic of this technique is that a failure to receive replies in the middle of the reply run can lead to the declaration of the presence of two targets, neither of which is at the azimuth of the true target. The phenomenon is known as an "azimuth split".

The ATCRBS Mode of Mode S

The principal characteristics of ATCRBS surveillance provided by a Mode S sensor are:

- Monopulse direction finding,
- Reduced interrogation rate,
- Improved reply degarbling,
- False target identification.

The use of monopulse on ATCRBS replies eliminates the disadvantages of the sliding window detector. Nominally the sensor could operate with only one reply per ATCRBS mode for each target during one scan of the antenna. However, this would lead to frequent target report declarations due to the chance reception of the replies (usually referred to as "fruit") elicited by adjacent sensors. To reduce this effect, the Mode S sensor is set to a PRF that produces 4 replies (2 for each of the ATCRBS modes) within the antenna 3-dB beamwidth. Typically, this is about one-third the PRF of a conventional sensor. This reduction in ATCRBS interrogation rate causes an immediate and significant reduction in the ATCRBS interference environment when an ATCRBS sensor is replaced by a Mode S sensor.

A second consequence of the use of monopulse is its ability to aid in the decoding of synchronously garbled replies from aircraft near the same range and azimuth. An example of a synchronous garble situation is shown in Fig. 1-4. The monopulse estimates for each reply pulse readily identify the reply to which each of the received pulses belong. In the example shown the pulses themselves are not overlapped so that pulse timing alone could have lead to the correct sorting of pulses into replies. Monopulse degarbling however continues to operate into regions of pulse overlap that could not be resolved by pulse timing alone. It therefore reduces the susceptibility of the ATCRBS mode to synchronous garble.

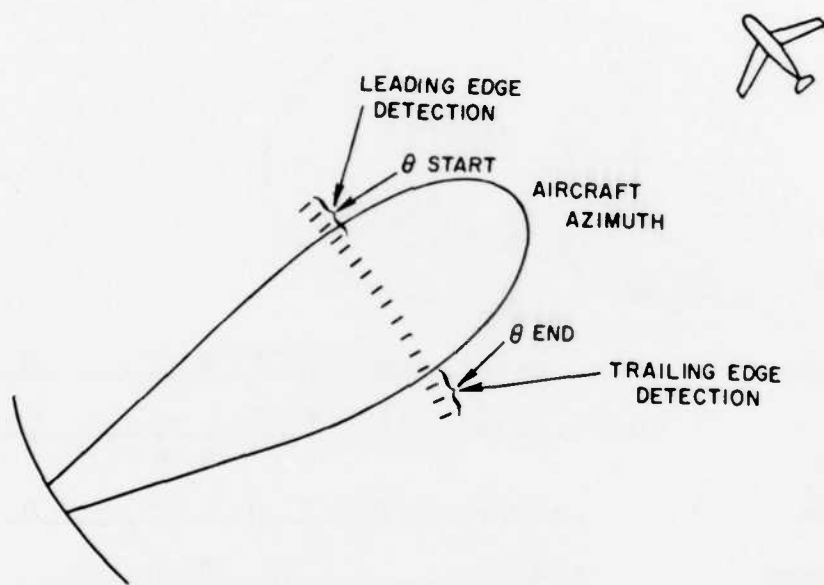

Fig. 1-3. Conventional sliding window detector.

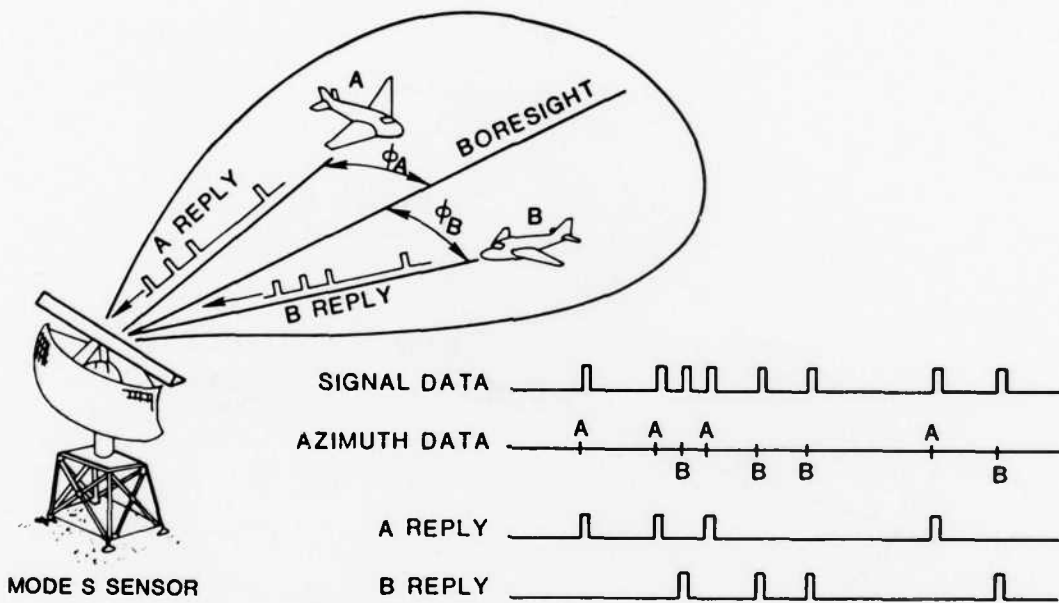

Fig. 1-4. Monopulse reply degarbling.

A major current problem in ATCRBS is the appearance of false targets due to reflection from large objects such as buildings, or hillsides as illustrated in Fig. 1-5. The Mode S sensor is programmed to identify and flag such false targets using both target reply parameters (e.g., Mode-A code) and the pre-stored geometry of principal reflecting surfaces.

In side-by-side experimental measurements comparing the performance of the ATCRBS mode of a Mode S sensor with currently operational ATCRBS equipment, it has been shown that the new system provides improvements in range and azimuth accuracies of about 4:1, as well as significant improvement in target report reliability. A summary of these measurements is given in Chapter 6. Details are provided in Ref. 2.

MODE S DATA LINK

Mode S provides both ground-to-air and air-to-ground data link capability. Air-to-ground messages may be either pilot-initiated, e.g., a request for a clearance change or for weather information, or ground-initiated, e.g., to read out onboard instrumentation.

The critical nature of many of the messages to be carried by Mode S requires a high degree of message integrity; it must be known both at the transponder and at the sensor that a message has been received correctly before the transaction can be considered complete. The required message integrity is ensured by providing for error detection, and technical acknowledgement.

Error-detecting codes are used on both interrogations and replies to essentially eliminate the acceptance of a message containing an error. When the presence of an (uncorrectable)* error is detected, the whole transmission is rejected. Technical acknowledgement of the correct receipt of an uplink message is achieved by the receipt of a correct reply at the proper time. Technical acknowledgement for a downlink message is provided by an acknowledgment included in a subsequent interrogation. If an error had been detected, no acknowledgment would be received and the message would be repeated.

The three main classes of messages accommodated by Mode S are:

- Surveillance data,
- Standard message,
- Extended-length message.

Surveillance Data

Surveillance data may be included in each normal Mode S interrogation and reply (with the exception of the extended length message and all-call formats). In an interrogation, this may include a command to lockout the

*The sensor can correct certain types of error occurring in replies. Since the transponder has no error-correction capability, an interrogation is only accepted when it is free of error.

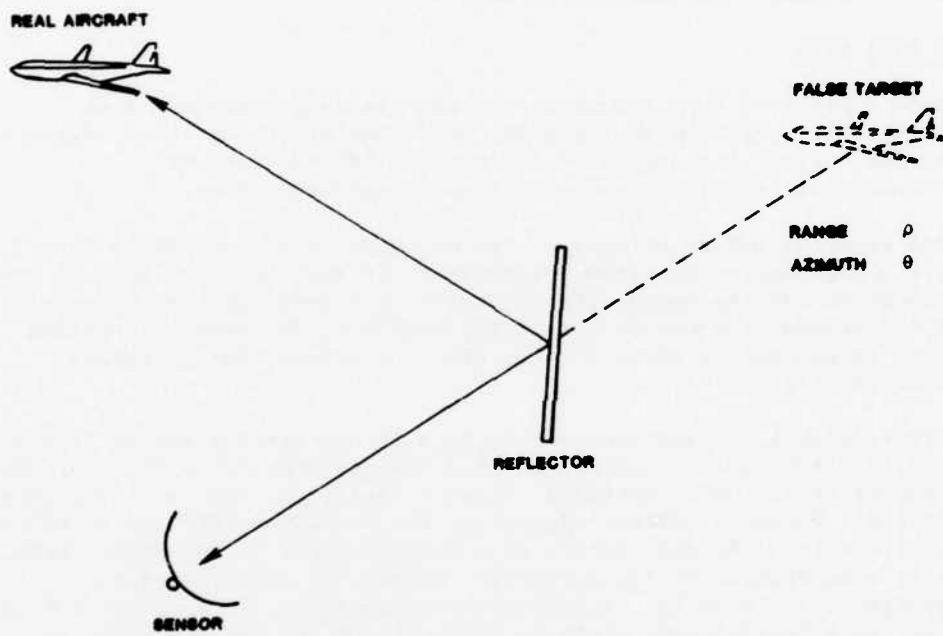

Fig. 1-5. False target geometry.

transponder to all-call interrogations. Normally, in a reply this includes an altitude report identical to the ATCRBS Mode-C report. However, either the ground or the pilot may initiate the inclusion of the ATCRBS Mode A code in place of the altitude report, e.g., to indicate an emergency condition.

Standard Message

Most Mode S data link transmissions will be handled as one 56-bit standard message included as part of a 112-bit interrogation or reply. These transmissions include surveillance data in addition to the data link message, and thus will generally be used in place of, rather than in addition to, a surveillance interrogation and/or reply. Provision is also made for the linking of up to four Comm-A message segments.

In order to prevent interference between Mode S replies from different aircraft, the control field of each interrogation specifies the length of the associated reply. Thus when a long reply is needed the interrogator knows in advance and schedules the proper time the reply should be received and allows enough time to receive the long replies. When an aircraft-initiated air-to-ground data link message is to be sent, a bit is set in the control field of a reply that requests the interrogator to schedule a long reply in response to a subsequent interrogation. The long reply, containing the data link message, is then transmitted when directed by the interrogator.

Extended Length Message

Each standard message must be acknowledged before the transmission of the next one. In order to provide for the more efficient transmission of longer messages, an extended-length message (ELM) capability is incorporated. Using this, a sequence of up to sixteen 80-bit message segments (within 112-bit transmissions) can be transmitted, either ground-to-air or air-to-ground, and acknowledged with a single reply or interrogation. This acknowledgment indicates which, if any, of the message segments were not received (or received in error), so that only those need be retransmitted.

Extended-length messages do not contain surveillance data and thus cannot substitute for a surveillance interrogation and/or reply. As in the case of the air-to-ground standard message, the transponder must request permission to transmit an air-to-ground ELM, and then does so under interrogator control.

Multisite Operation

The data link protocol for the ground-to-air standard message operates correctly in areas of overlapping sensor coverage without any requirements for site-to-site coordination. This permits the autonomous delivery of time-critical tactical messages under any circumstances. The other protocols, e.g., the air-to-ground standard and the extended length messages, require that only one sensor at a time exercise these protocols for a particular aircraft in order to avoid message loss or error.

COVERAGE MANAGEMENT

Mode S limits its discrete interrogations to aircraft of interest, i.e., to those within a defined coverage volume. This contrasts with ATRBS in which all aircraft within line-of-sight are interrogated. Control of the Mode S sensor's surveillance and communications functions is based upon a prestored map which defines the action of the sensor for the regions of airspace within its visibility.

For an isolated sensor (one for which there are no other Mode S sensors with contiguous or overlapping coverage), the surveillance management functions are quite simple. They consist of defining the regions of airspace in which:

- (a) the sensor provides surveillance and data-link service, and
- (b) the sensor locks out Mode S-equipped aircraft from responding to all-call interrogations.

As Mode S sensors are deployed, multiple coverage will exist at higher altitudes. Mode S includes a network management function to control the operation of the Mode S sensors in this environment. Non-netted sensors will coordinate their surveillance activities using one of the techniques previously described. Data link coordination is effected through the use of multisite coordination features incorporated in the Mode S transponder. Netted sensors will communicate via a common ATC facility both to hand off aircraft as they cross surveillance boundaries, and to assist one another in maintaining continuity of surveillance and data link service.

As in the isolated sensor case, the basis for network management is a map prestored at each sensor which defines its responsibilities for aircraft in each region of airspace. Not only does this map define the actions of the sensor itself, it also designates which adjacent sensors provide coverage of the same region of airspace and defines the location of coverage boundaries. Non-netted sensors use the map to determine when to use the transponder multisite coordination features for downlink or ELM transactions as well as to determine when to initiate periodic Mode S unlocking to enable acquisition by an adjacent sensor. Netted sensors refer to this map to determine which adjacent sensor can give it assistance in maintaining track on a given target, and when a sensor should initiate a handoff of the aircraft to another sensor.

Multiple sensor coverage is exploited in Mode S to assure a continuity of both surveillance and data link service. Where such multiple coverage is available, an aircraft is always maintained simultaneously on roll-call by at least two sensors, thereby providing instantaneous backup in the event of the failure of one sensor/aircraft link. If for some reason a netted sensor loses contact with an aircraft, it calls on the adjacent tracking sensor for assistance in reacquiring the aircraft.

In order to preclude possible ambiguities which can occur when two sensors simultaneously have an aircraft on their roll, a single sensor is normally designated primary in each region of airspace. The special functions which are the responsibility of the primary sensor are:

- (a) readout of air-to-ground data-link messages,
- (b) lockout to Mode S all-calls,
- (c) ELM transactions.

The determination of which Mode S sensor is to act as primary for a particular aircraft is made by the air traffic control facility which has control responsibility for the aircraft. This is done to ensure that air initiated data link messages are read out by the sensor connected to the controlling ATC facility. For uncontrolled aircraft, the Mode S sensors make the assignment themselves, based on coverage map information.

MODE S /ATC INTERFACE

The Mode S /ATC interface is particularly simple in the case of an isolated Mode S sensor interacting with a single control facility, e.g., a sensor at an airport interconnected only with the local TRACON. In this situation the sensor provides surveillance data to the TRACON, and operates as a relay point for data link messages between aircraft and ATC.

In general, however, each sensor is capable of providing surveillance and communication service for more than one facility, and in turn each control facility may receive data from more than one sensor. This capability of greater connectivity permits control facilities to take advantage of multiple coverage to maintain surveillance and data link service in the event of an equipment or link failure at a particular sensor. Surveillance boundaries between adjacent sensors are determined primarily by coverage geometry; these will not be the same as the control boundaries between adjacent ATC facilities, which are determined by air traffic flow patterns.

In general, a control facility will use the data from only one sensor to maintain its track on a particular aircraft. For an en route facility, data on the same aircraft may be available from another sensor as an instantaneous backup. Typically the data from the sensor designated as primary would be used, as presumably this sensor would have best coverage in a particular region of airspace. The control facility may use any sensor which has an aircraft in its track file for the transmission of standard ground-to-air data link messages to that aircraft.

OTHER INTERFACES

The Mode S sensor will interface with other external devices and facilities. These include:

Data Link. In general, the data link processors will use the Mode S sensor as a communications modem and will therefore use a communications interface, similar to those employed by the ATC facilities. Such processors will communicate with Mode S sensors via the National Airspace Data Interchange Network (NADIN).

MTD/SRAP. Digitized radar data will be input to the Mode S sensor via a special input port designated for this purpose. Provision is made to interface with either the Moving Target Detector (MTD) or the Sensor Receiver and Processor (SRAP).

Military Air Defense Command. A special configuration of the back-to-back Mode S sensor will operate at joint use sites. This configuration will include interfaces to military equipment to permit the coordination of beacon surveillance and secure IFF modes of operation. A special surveillance output interface is included to provide the military ATC facility with data in the proper format.

SYSTEM PERFORMANCE SUMMARY

Surveillance -

Capacity	- 250, 400 or 700 aircraft per sensor
Azimuth accuracy	- 0.06 deg. (1σ), $\pm 0.033^\circ$ bias
Range accuracy	- 25 feet (1σ), ± 30 feet bias
Data update interval	- 4 seconds (terminal sensor beacon data)
	- 5 seconds (enroute sensor with back-to-back antenna)
	- 10 seconds (enroute sensor primary radar data)

Data Link -

Capacity	All identified ATC messages require a few percent of available capacity.
Delivery Reliability	> 0.99 in 4 seconds for short tactical messages
Undetected error rate	< 10^{-7}

System Reliability -

- Multiple coverage.
- Automatic monitoring and network reconfiguration.
- Automatic switching to standby sensor channel without loss of database in case of failure.
- Remote maintenance monitor.

The available interrogation time is sufficient to permit a sensor to maintain discrete-address surveillance of more than 1000 aircraft. This is considerably in excess of the maximum expected aircraft load.

The achievable range measurement accuracy is dominated primarily by transponder turn-around time uncertainty.

CHAPTER 2

THE MODE S LINK

SIGNAL WAVEFORMS

There are five signal types used by Mode S for surveillance of ATCRBS- and Mode S-equipped aircraft, and data link communication with Mode S-equipped aircraft. These are:

- (a) The ATCRBS/Mode S all-call interrogation, used for surveillance of ATCRBS-equipped aircraft and acquisition of Mode S-equipped aircraft not already on a sensor's roll-call.
- (b) The ATCRBS-only all-call interrogation, used for surveillance of ATCRBS equipped aircraft in conjunction with the Mode S-only all-call. It does not elicit a response from Mode S-equipped aircraft.
- (c) The ATCRBS reply, used by ATCRBS transponders in replying to ATCRBS and ATCRBS/Mode S all-call interrogations and by Mode S transponders in replying to ATCRBS interrogators.
- (d) The Mode S interrogation, used for roll-call surveillance and data-link communication to Mode S-equipped aircraft. It is also used for the Mode S-only all-call interrogation format needed for the stochastic acquisition mode, site addressed acquisition and lockout override functions.
- (e) The Mode S reply, used by Mode S transponders in response to Mode S interrogations, ATCRBS/Mode S all-call interrogations and Mode S-only all-call interrogations.

To maximize hardware compatibility between Mode S and ATCRBS, Mode S interrogations and replies use the same frequencies as are used for ATCRBS interrogations and replies, i.e., 1030 and 1090 MHz, respectively.

The characteristics of these signal types are summarized in the following paragraphs, together with the most common Mode S data block formats. A more detailed description of the Mode S interrogations and replies is presented in the Mode S National Standard (Ref. 3).

ATCRBS/Mode S and ATCRBS-Only All-Call Interrogations

The ATCRBS/Mode S and ATCRBS-only all-call interrogations are similar to the corresponding ATCRBS interrogations as defined in the United States National Standard for ATCRBS (Ref. 4) but with an additional pulse P_4 following P_3

(Fig. 2-1). A P_4 pulsewidth of 1.6 μsec defines the ATCRBS/Mode S all-call interrogation, while a P_4 pulse width of 0.8 μsec defines the ATCRBS-only all-call interrogation.

An ATCRBS transponder is unaffected by the presence of the P_4 pulse. It will respond with a normal ATCRBS reply. A Mode S transponder will recognize the interrogation as a Mode S all-call or ATCRBS-only all-call and transmit a Mode S reply containing its discrete address to the former (if it is not in a lockout state) and not respond to the latter.

As in ATCRBS, Mode S interrogator sidelobe suppression (SLS or ISLS) is accomplished by the transmission of a control pulse P_2 on an SLS control pattern (usually omni-directional in azimuth). If this pulse is received by either an ATCRBS or Mode S transponder at an amplitude exceeding that of the P_1 pulse of the interrogation, the transponder will not reply.

ATCRBS Reply

The ATCRBS reply signal characteristics are as defined in the United States National Standard for ATCRBS. The signal format is depicted in Fig. 2-2.

Mode S Interrogation

The Mode S interrogation is formed by three pulses, P_1 , P_2 and P_6 as illustrated in Fig. 2-3.

Pulses P_1 and P_2 form the preamble and are spaced 2 μs apart. An ATCRBS transponder that receives this interrogation will interpret the pair as an ATCRBS sidelobe suppression command and will remain in suppression ($35 \pm 10 \mu\text{sec}$) during the remainder of the Mode S interrogation. Without such suppression, the subsequent Mode S P_6 pulse would, with high probability, trigger the ATCRBS transponder, causing a spurious reply.

The P_6 pulse of the Mode S interrogation is either 16.25 or 30.25 μs long and contains the data in the form of DPSK (Differential Phase Shift Keying) modulation at a 4 Mbps rate. A phase reversal of the rf carrier at the beginning of a bit interval represents a binary one while the absence of such reversal denotes a binary zero.

The 4 Mbps rate permits transmission of 112-bit messages within the nominal ATCRBS suppression interval. DPSK provides superior interference immunity, increased fade margin, and greater multipath immunity than pulse amplitude modulation (PAM). These advantages are realized at a small increment in transponder cost.

Transmit sidelobe suppression is accomplished by the transmission of a control pulse (P_5) on an SLS control pattern. If the control pulse amplitude received by the transponder exceeds the amplitude of the interrogation, the sync phase reversal will be obscured and the interrogation will be rejected. The P_5 pulse must be used with the Mode S-only all-call interrogation to prevent unwanted replies from aircraft in the sidelobes. With discrete address

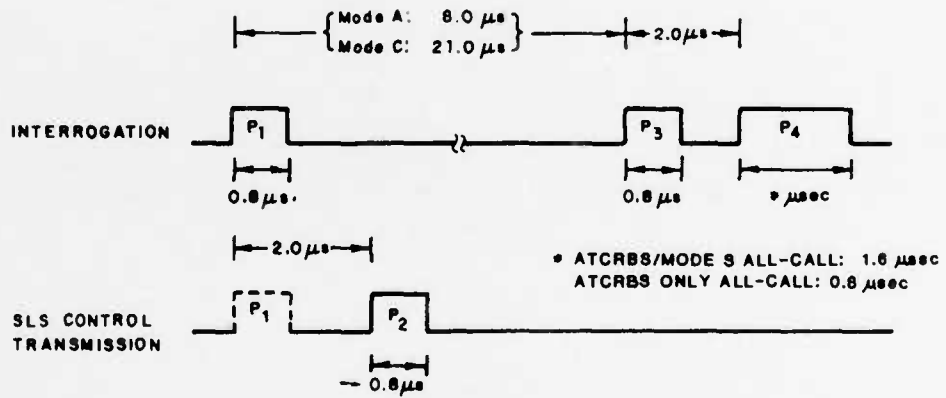

Fig. 2-1. ATCRBS/Mode S all-call interrogation.

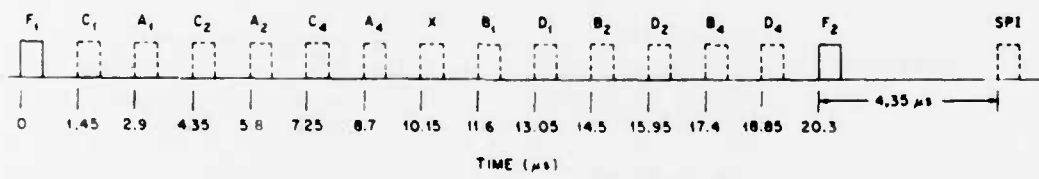

Fig. 2-2. ATCRBS reply.

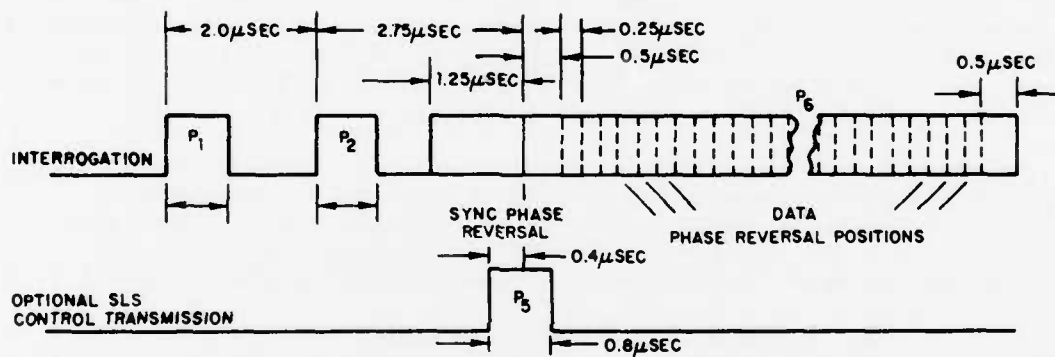

Fig. 2-3. Mode S interrogation.

interrogations, transmit SLS is not required to prevent sidelobe replies, as in general, an aircraft will be interrogated only when in the mainbeam of the interrogator antenna. However, transmit SLS on discretely-addressed interrogations minimizes the probability of an aircraft erroneously accepting an interrogation directed to another aircraft; most such interrogations will be received through an interrogator antenna sidelobe, and thus will be rejected by the transponder without decoding.

Mode S Reply Waveform

A Mode S reply consists of a preamble and a data block containing 56 or 112 pulses. The signal format is depicted in Fig. 2-4.

The preamble consists of a series of four 0.5 μ s pulses. The data block begins 8.0 μ s after the leading edge of the first preamble pulse. Binary data are transmitted at a 1 Mbps data rate using pulse position modulation (PPM) as follows: in the 1.0 μ s interval corresponding to each data bit, a 0.5 μ s pulse is transmitted in the first half of the interval if the data bit is a 1, and in the second half of the interval if the data bit is a 0.

Transponder cost considerations limited the choice of reply signal formats to ones that could be generated by the proven, low-cost, pulsed-cavity oscillator transmitters currently used in ATCRBS transponders. Within that constraint, the reply format has been designed to achieve reliable air-to-ground operation in the presence of heavy ATCRBS interference.

The four-pulse preamble is designed to be easily distinguished from ATCRBS replies. It can be reliably recognized and used as a source of reply timing in the presence of one overlapping ATCRBS reply, while at the same time resulting in a low rate of false alarms arising from multiple ATCRBS replies.

The choice of PPM for the data modulation permits reliable bit detection in the presence of ATCRBS interference. In addition, PPM results in a constant number of pulses in each reply, assuring sufficient energy for an accurate monopulse estimate.

Operation at 1 Mbps, in combination with the use of the 24-bit parity check coding described below, further enhances downlink reliability by permitting the correction of any error pattern which can result from a single ATCRBS reply interfering with the desired Mode S reply.

MODE S SIGNAL CONTENT

The information transmitted in Mode S interrogations and replies is contained in data blocks that can carry either 56 or 112 bits of information. The interrogation data block is formed by the sequence of (DPSK) phase reversals within P_6 , while the reply data block is represented by the pulse position modulation of the Mode S reply waveform.

Information within each data block is encoded in fields, each field existing for a dedicated purpose. All data blocks contain at least two essential fields, the format descriptor and the address/parity field. The

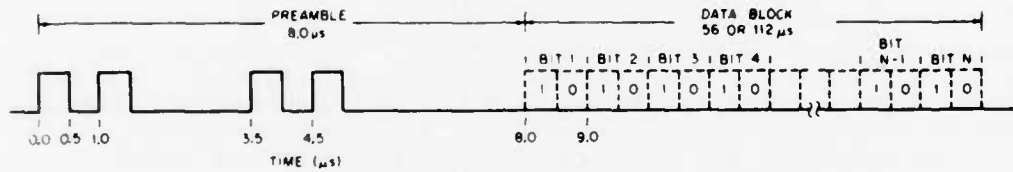

Fig. 2-4. Mode S reply.

format descriptor is transmitted at the beginning of each data block while the address/parity field is transmitted at the end. For different purposes and missions of the Mode S system, 25 different formats can be used; 8 are presently defined as indicated in Figs. 2-5 and 2-6. Mode S field definitions are provided in Table 2-1 and Appendices A and B. A complete specification of the Mode S link is given in Ref. 3.

ERROR PROTECTION

The 24-bit address/parity field contains the aircraft's 24-bit unique address code overlaid on 24 parity check bits generated from the preceding part of the transmission. Figure 2-7 illustrates the downlink encoding process, where the overlaying is accomplished by a bit-by-bit modulo 2 summation. This combined address/parity field requires fewer bits than would be needed if address and parity information were coded separately.

An error occurring anywhere in the reception of an interrogation or a reply will modify the decoded address. On the uplink, the transponder will not accept the message and will not reply, since the interrogation does not appear to be addressed to it. On the downlink, the sensor will recognize that an error has occurred, since the reply does not contain the expected address. Because the interrogator knows the address of the transponder replying to a discrete interrogation, the interrogator can perform a limited amount of error-correction. The code parameters have been selected to permit the correction of many error patterns which span no more than 24 bits. In particular, most bursts of errors caused by interference from a simultaneously-received ATCRBS reply can be corrected.

Details of the Mode S error protection techniques are given in Ref. 16.

ACQUISITION AND LOCKOUT PROTOCOLS

Acquisition of an aircraft initially occurs as the result of the receipt of a reply to an all-call interrogation. This reply, identified by DF = 11, contains the 3-bit CA field (used for capability reporting as described later), and the 24-bit AA field that contains the aircraft's Mode S address. The AA field is contained within the message as data and is therefore protected by the error coding of the PI field. The PI field is encoded by the transponder using an address known by the sensor. The sensor can therefore perform the same error detection and correction on the all-call reply as it does on the roll-call reply.

The interrogation used by the sensor to elicit all-call replies depends upon the acquisition technique in effect at that site. The acquisition techniques are as follows.

Non-Selective Acquisition and Lockout

This form of acquisition uses the ATCRBS/Mode S all-call interrogation shown in Fig. 2-1. After the address is acquired in the all-call reply, lockout is achieved by setting a Code 1 in the PC field of discrete surveillance interrogations, UF = 4,5,20 or 21. Once set, the non-selective

**Format
No.**

	UF	
0	(0 0000)	-3-(RL:1)--4--(AQ:1)--18--(AP:24). . . . Short Special Surveillance
1	(0 0001)	-----27------(AP:24)
2	(0 0010)	-----27------(AP:24)
3	(0 0011)	-----27------(AP:24)
4	(0 0100)	(PC:3)(RR:5)(DI:3)(SD:16)(AP:24). . . . Surveillance, Altitude Request
5	(0 0101)	(PC:3)(RR:5)(DI:3)(SD:16)(AP:24). . . . Surveillance, Identity Request
6	(0 0110)	-----27------(AP:24)
7	(0 0111)	-----27------(AP:24)
8	(0 1000)	-----27------(AP:24)
9	(0 1001)	-----27------(AP:24)
10	(0 1010)	-----27------(AP:24)
11	(0 1011)	(PR:4)(II:4)(--19 one's--)(AP:24). . . . Mode S Only All-Call
12	(0 1100)	-----27------(AP:24)
13	(0 1101)	-----27------(AP:24)
14	(0 1110)	-----27------(AP:24)
15	(0 1111)	-----27------(AP:24)
16	(1 0000)	-3-(RL:1)--4--(AQ:1)--18--(MU:56)(AP:24). .Long Special Surveillance
17	(1 0001)	-----83------(AP:24)
18	(1 0010)	-----83------(AP:24)
19	(1 0011)	-----83------(AP:24)
20	(1 0100)	(PC:3)(RR:5)(DI:3)(SD:16)(MA:56)(AP:24). .Comm-A, Altitude Request
21	(1 0101)	(PC:3)(RR:5)(DI:3)(SD:16)(MA:56)(AP:24). .Comm-A, Identity Request
22	(1 0110)	-----83------(AP:24)
23	(1 0111)	-----83------(AP:24)
24	(11)	(RC:2)(NC:4)(MC:80)(AP:24). .Comm-C (ELN)

- Notes: (1) (XX:M) denotes a field designated "XX" which is assigned M bits.
 (2) ---N--- denotes free coding space with N available bits.
 (3) For uplink formats (UF) 0 through 23 the format number corresponds to the binary code in the first 5 bits of the interrogation. Format number 24 is arbitrarily defined as the format beginning with "11" in the first two bit positions while the following three bits vary with the interrogation content.

Fig. 2-5. Summary of Mode S Uplink Formats.

Format No.	DF	
0	(0 0000)	(VS:1)--7--(RI:4)--2--(AC:13)(AP:24) Short Special Surveillance
1	(0 0001)	-----27----- (AP:24)
2	(0 0010)	-----27----- (AP:24)
3	(0 0011)	-----27----- (AP:24)
4	(0 0100)	(FS:3)(DR:5)(UM:6)(AC:13)(AP:24) Surveillance, Altitude
5	(0 0101)	(FS:3)(DR:5)(UM:6)(ID:13)(AP:24) Surveillance, Identity
6	(0 0110)	-----27----- (AP:24)
7	(0 0111)	-----27----- (AP:24)
8	(0 1000)	-----27----- (AP:24)
9	(0 1001)	-----27----- (AP:24)
10	(0 1010)	-----27----- (AP:24)
11	(0 1011)	(CA:3)(AA:24)(PI:24) All-Call Reply
12	(0 1100)	-----27----- (AP:24)
13	(0 1101)	-----27----- (AP:24)
14	(0 1110)	-----27----- (AP:24)
15	(0 1111)	-----27----- (AP:24)
16	(1 0000)	(VS:1)--7--(RI:4)--2--(AC:13)(MV:56)(AP:24) . . Long Special Surveillance
17	(1 0001)	-----83----- (AP:24)
18	(1 0010)	-----83----- (AP:24)
19	(1 0011)	-----83----- (AP:24)
20	(1 0100)	(FS:3)(DR:5)(UM:6)(AC:13)(MB:56)(AP:24) . . Comm-B, Altitude
21	(1 0101)	(FS:3)(DR:5)(UM:6)(ID:13)(MB:56)(AP:24) . . Comm-B, Identity
22	(1 0110)	-----83----- (AP:24)
23	(1 0111)	-----83----- (AP:24)
24	(11)--1--	(KE:1)(ND:4)(MD:80)(AP:24) . . Comm-D (ELM)

- Notes: (1) (XX:M) denotes a field designated "XX" which is assigned M bits.
(2) ---N--- denotes free coding space with N available bits.
(3) For downlink formats (DF) 0 through 23 the format number corresponds to the binary code in the first 5 bits of the reply. Format number 24 is arbitrarily defined as the format beginning with "11" in the first two bit positions while the following three bits may vary with the reply content.
(4) All formats are shown for completeness, although a number of them are unused.

Fig. 2-6. Summary of Mode S Downlink Formats.

TABLE 2-1

MODE S FIELD DESCRIPTIONS

<u>Code</u>	<u>Field Name</u>	<u>Downlink (D)/Uplink (U) Meaning</u>
AA	Address Announced	D aircraft identification in All-Call reply
AC	Altitude Code	D equivalent to aircraft Mode-C code
AP	Address/Parity	U/D error detection field
AQ	Acquisition	U part of air-to-air protocol
CA	Capability	D aircraft report of system capability
DF	Downlink Format	D downlink descriptor
DI	Designator Identification	U describes content of SD field
DR	Downlink Request	D aircraft requests permission to send data
FS	Flight Status	D aircraft's situation report
ID	Identification	D equivalent to ATCRBS identity number
II	Interrogator Identification	U site number for multisite features
KE	Control, ELM	D part of Extended Length Message protocol
MA	Message, Comm-A	U message to aircraft
MB	Message, Comm-B	D message from aircraft
MC	Message, Comm-C	U long message segment to aircraft
MD	Message, Comm-D	D long message segment from aircraft
MU	Message, Comm-U	U air-to-air message to aircraft
MV	Message, Comm-V	D air-to-air message from aircraft
NC	Number, C-segment	U part of ELM protocol
ND	Number, D-segment	D part of ELM protocol
PC	Protocol	U operating commands for the transponder
PI	Parity/Interr.Identity	D reports source of interrogation
PR	Probability of Reply	U used in stochastic acquisition mode
RC	Reply Control	U part of ELM protocol
RI	Reply Information	D aircraft status information for TCAS
RL	Reply Length	U commands air-to-air reply length
RR	Reply Request	U commands details of reply
SD	Special Designator	U control codes to transponder
UF	Uplink Format	U format descriptor
UM	Utility Message	D protocol message
VS	Vertical Status	D aircraft status, airborne or on the ground

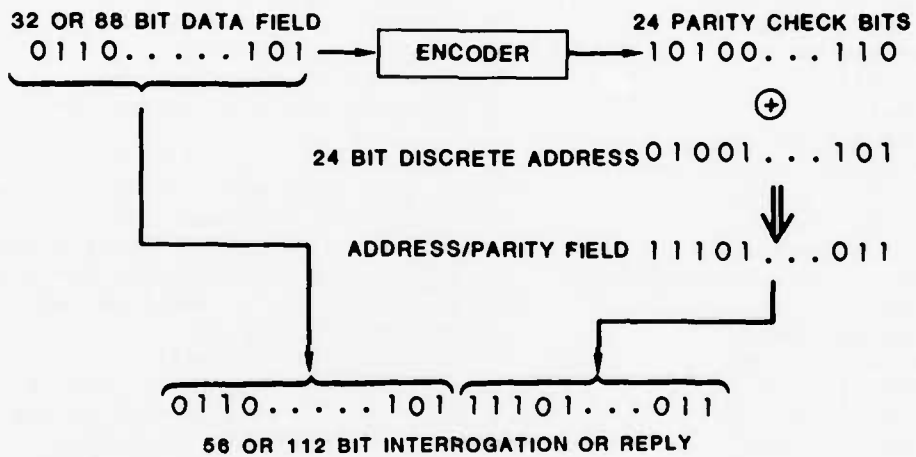

Fig. 2-7. Address/parity field generation.

lockout state remains in effect for a period of approximately 18 seconds. It is refreshed every scan by the sensor to maintain the aircraft in the locked-out state.

Site Addressed Acquisition and Lockout

This form of acquisition uses the Mode S-only all-call interrogation, UF = 11. The site address of the interrogating site is contained in the II field. Site addresses of 1 to 15 are valid (a site address of zero is interpreted as a non-selective interrogation). The transponder replies to this interrogation if it is not in a state of lockout to that specific site address. The transponder has a total of 16 independent lockout timers to maintain the lockout state requested by the ground sensors, (i.e, 15 site addressed and one non selective lockout timer).

The PI field of an all-call reply, DF-11, elicited by a Mode S-only all-call interrogation is encoded using the site address received in the II field. The 4-bit site address is used as the lowest order 4 bits and then zero-filled to form a 24-bit "Mode S address". This address is used in the encoding of the PI field in exactly the same manner as the transponder Mode S address is used to generate the AP field. Sensors operating in the multisite mode decode all-call replies using their own interrogator identity code as the expected address. All-call fruit replies produced by adjacent interrogators will not be accepted by the local sensor since they would be encoded using a different site address. This filtering of all-call replies by site address eliminates the possibility of extraneous all-call tracks being formed by Mode S fruit replies.

Site addressed lockout is effected through coding in the SD field. The DI field defines the data content of the SD field. Regardless of the DI code, the first four bits of the SD field contain the site address in the IIS subfield (see Table A-1). Lockout to that address can be controlled by the sensor by setting the DI field equal to 1 or 7 and the LOS subfield equal to 1. Once set, lockout for each site address remains in effect for approximately 18 seconds unless refreshed by the ground sensor.

When the system is operating in the multisite mode, separate identification of Mode S and ATCRBS targets can be achieved by the use of the ATCRBS-only All Call, together with the Mode S All-Call, UF=11.

As the name implies, the Mode S-only all-call interrogation elicits replies only from Mode S transponders. It is therefore used in conjunction with the ATCRBS-only all-call interrogation (distinguished by a short P4 pulse as indicated in Fig. 2-1). This latter interrogation elicits replies only from ATCRBS transponders and therefore complements the Mode S-only all-call so that ATCRBS and Mode S transponders reply to at most one of the interrogations. This avoids the possibility of having the same aircraft under surveillance as both an ATCRBS and a Mode S aircraft.

The benefit of a shared listening interval could be obtained by pairing the two all-call interrogations as shown in Fig. 2-8. The spacing between the interrogations is made to be consistent with the receipt of zero-range-difference ATCRBS and Mode S replies. This allows more than enough time for an ATCRBS transponder to recover from the sidelobe suppression state caused by the P1-P2 Mode S interrogation preamble.

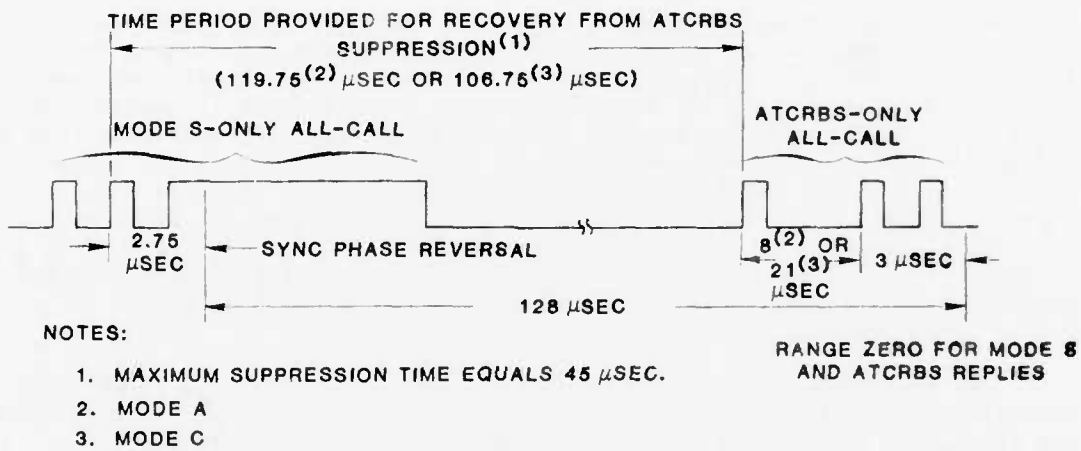

Fig. 2-8. Combined interrogation for site selective acquisition.

Stochastic Acquisition

This form of acquisition uses the Mode S-only all-call interrogation, DF = 11. The defined reply probability is contained in the PR field and can be selected from the values 1, 1/2, 1/4, 1/8 or 1/16 for codes from 0 to 4 respectively. The transponder will not reply if a lockout condition applies. Otherwise, the transponder executes a random process and replies only if it is consistent with the defined reply probability. For example, if the transponder generated a random number between zero and one, it would only reply to a PR code 2 if:

- (1) a lockout condition did not apply, and
- (2) the generated random number was less than or equal to 0.250.

This random reply process permits the reception of ungarbled all-call replies at the expense of additional delay (and additional interrogations) required for acquisition. The ability to assign a range of probabilities is intended to permit relatively rapid automatic reacquisition of worst case traffic loads. Implementation includes the following two modes:

(a) Initial Acquisition Mode - This mode is executed after a period of Mode S sensor inactivity. It consists of periodic Mode S-only all-call interrogations (4-6 per beam dwell) followed by a listening interval out to the range of interest. These are interspersed with scheduled Mode S intervals to permit discrete interrogation and lockout of Mode S addresses acquired on the previous scan. The minimum probability assignment used for this purpose is a site adaptation parameter chosen to match the Mode S traffic load handled by this site. The program for reacquisition begins at this lowest probability level and then moves to higher probability levels after several scans in order to reduce the overall acquisition time. Aircraft not acquired initially, as well as all-call garble situations which "pop-up" during normal operation, are handled as described in the following paragraph.

(b) Adaptive Acquisition Mode - Undecodable Mode S replies received during the all-call listening interval are tested for range correlation. Reports formed of 3 or more replies per dwell are interpreted as evidence of an all-call synchronous garble occurrence.

A trial Mode S track is initiated at the approximately range and azimuth of the correlated replies. On the next scan, the sensor interrogates using a Mode S-only all-call with a specified reply probability of 1/2. With high probability, an ungarbled reply will be received from one of the two transponders in the garble situation during the four or more interrogation opportunities, thereby permitting discrete interrogation and lockout on the following scan.

If acquisition is not successful the trial track will be dropped since the continued garble situation will lead to the initiation of a fresh trial track. Residual garbling caused by more than two aircraft in the initial garble set will also result in a new trial track. The last aircraft in the garble set will be acquired by the normal ATRBS/Mode S all-call process in use at that site.

Lockout Override

This form of acquisition combines features of the site-addressed and stochastic acquisition approaches. It uses the Mode S-only all-call, DF = 11, but employs PR codes 8 through 12 that define reply probabilities of 1, 1/2, 1/4, 1/8, and 1/16 respectively but instruct the transponder to disregard the lockout state in making a reply decision. This will of course result in the continued possibility of garbled all-call replies since both acquired and unacquired Mode S aircraft can reply to the all-call interrogations. The stochastic mode is used to handle the resulting garble.

The ATCRBS-only all-call interrogation is used in conjunction with the Mode S-only all-call to provide surveillance of ATCRBS aircraft.

BASIC SURVEILLANCE PROTOCOLS

Interrogation Reply Protocol

Basic roll-call surveillance of Mode S aircraft is performed using surveillance or Comm-A interrogations.

A surveillance or Comm-A interrogation (UF = 4 or 20) will elicit a short surveillance reply with altitude (DF = 4) if the value of the RR field of the interrogators is less than 16. If RR is greater than or equal to 16, a UF=4 or 20 interrogation will elicit a Comm-B reply with altitude (DF = 20). A similar rule applies to the read out of Mode A code information.

The interrogation/reply protocol for altitude and identity requests is summarized in Table 2-2.

Alert Protocol

Knowledge of the current value of the transponder Mode A code is important to the ATC system since (a) the code is used to signal emergency conditions, and (b) it is needed to identify an aircraft in handoffs to non-Mode S facilities. Provision is therefore made to notify the ground any time that the Mode A code is changed.

Notice of change is detected on the ground by receipt of a surveillance or Comm B reply (DF = 4, 20 or 21) with the FS field containing code value 2,3 or 4. This defines an "alert" condition and results in the sensor scheduling an additional interrogation using interrogation UF equals 5 or 21 to cause a readout of the current Mode A value in the elicited reply. A normal code change will result in the reporting of an alert condition for a period of approximately 18 seconds. This allows sufficient time for ground interrogators to detect the alert condition and to read the Mode A code. If an emergency Mode A code is used, the alert state will not time-out, but will remain on for the duration of the declared emergency.

In the absence of an alert condition, the surveillance protocol will routinely elicit altitude and not identity, except on the first scan of roll-call interrogation, when both are requested.

TABLE 2-2.

SURVEILLANCE INTERROGATION/REPLY PROTOCOL

UPLINK FORMAT	DOWNLINK FORMAT	
	RR < 16	RR > 16
4	4	20
5	5	21
20	4	20
21	5	21

Special Designator (SD) Protocol

The SD field can be used for special communications or surveillance protocols. Provision is made for the SD field to be multiplexed for different uses. The significance of coding in the SD field is indicated by the DI field. A DI code value of zero means that the SD field is not used. At present, only two of the seven significant values of DI have been defined. DI = 1 indicates that the SD field contains multisite and linked Comm-A information. DI = 7 indicates that the SD field contains a Comm-B extended data readout request.

STANDARD UPLINK MESSAGE PROTOCOL (COMM-A)

Comm-A interrogations (UF = 20 or 21) are used for the ground-to-air transmission of short "tactical" ATC messages. It is assumed that, before any such transfer is initiated, the ground system has knowledge (from a previous capability report) of the Comm-A capability of the addressed aircraft and hence of the set of permissible message types.

Single Segment Comm-A Protocol

The standard uplink message is transmitted by a Comm-A interrogation (UF = 20 or 21) with the appropriate message type and message text in the MA field. The first eight bits of the 56-bit Comm-A message field contain the ADS subfield. This subfield represents the message type code and identifies the type of information encoded in the following 48 message bits. For convenience, the high order 4-bits are called the ADS1 code, and the low order 4-bits the ADS2 code.

The reply will ordinarily be a surveillance reply with altitude unless some transaction involving an air-to-ground data link transmission is being carried on simultaneously. An acceptable reply received by the interrogator constitutes an implicit transponder technical acknowledgement of the ground-to-air message. If no reply is received, the message is scheduled for one or more repeat transmissions. The transaction is not necessarily completed with receipt of an acceptable reply, however, since a pilot acknowledgement is required for some messages.

Linked Comm-A Message Protocol

Provision is made for the linking of up to 4 Comm-A message segments (received on different interrogation/reply cycles) into a single message entity. For short messages, the linked Comm-A message protocol is inherently more efficient than the extended length message (ELM) protocol, since (a) Comm-A delivery can take place during a surveillance measurement, and (b) no coordination with adjacent sites is required before message delivery. Thus the linked Comm-A message will be used for messages that are too long for a single Comm-A segment and whose message delivery requirements cannot be satisfied by the ELM.

Coding for the linking of Comm-A message segments is contained in the SD field and is transparent to the transponder. Detection and assembly of the linked Comm-A message segments will be performed by a data link device interfaced to the transponder. The device will wait until all message segments have been received before releasing the message for further processing.

When DI = 1 or 7 the SD field contains the TMS subfield in bits 29 through 32, coded as follows:

- (a) TMS equals 0 through 3 signifies that the MA field contains a single segment Comm-A message.
- (b) TMS equals 4 through 11 identifies the first segment of a linked Comm A message.
- (c) TMS equals 12, 13 and 14 signify the second, third and final segment respectively.
- (d) TMS equals 14 announces the end of the linked message.

The Comm-A protocol for single segment messages has been designed to be robust in that no coordination with adjacent sites is required before delivery. In order to retain this desirable characteristic, each linked Comm-A segment must include the site address in the IIS subfields of the SD field. This permits the correct association of interleaved segments that may occur when more than one sensor at a time is delivering a linked Comm A message to the same aircraft.

The following protocol for linked Comm-A messages must be observed:

- (a) Only one linked Comm-A can be in process for a given site/aircraft pair - this prevents ambiguities that could lead to garbled and lost messages.
- (b) Segment one is delivered first - this announces the initiation of a linked Comm-A message from a particular site number. The avionics can then wait until the final segment is received before displaying the message. The first segment can also serve as a message cancel for a partially delivered message since the receipt of an initial segment should clear any previous linked Comm-A message for that particular site.
- (c) The first segment must be successfully delivered before delivering the next segment - this eliminates the need for any additional technical acknowledgement other than the reply to the interrogation that delivered the segment. It also eliminates the need for a special message start protocol.

- (d) Segments two and three (if used) may be delivered in either order but must be successfully delivered before delivering the last segment - this distinction in the coding of these segments (rather than a single code for "intermediate segment") is necessary. This segment numbering prevents errors if a particular segment is delivered more than once due to the occurrence of a downlink failure that prevented the sensor from receiving the technical acknowledgement to a correctly delivered segment.
- (e) The final segment is the last segment transmitted - this announces the end of a linked Comm-A transfer. Note that used in combination with the other codes, this permits the transfer of linked Comm-A messages with two, three or four segments.
- (f) The final segment must be successfully delivered before beginning a new linked Comm-A message to the same aircraft - this eliminates the need for a special message clear protocol.

ADS Coding of Linked Comm-A Messages

The TMS coding of the first segment permits the transfer of linked Comm A messages where:

- (a) Multiple ADS (TMS = 4 through 7) - Each segment contains its own ADS code, and thus each message segment consists of 48 data bits.
- (b) Single ADS (TMS = 8 through 11) - Only the first segment contains an ADS code that applies to all message segments. Thus the first segment contains 48 data bits but succeeding segments contain 56 data bits.

The resulting message capacity in bits for a linked Comm-A message is as follows:

No. of Segments	Multiple ADS	Single ADS
2	96	104
3	144	160
4	192	216

Priority and Acknowledgement

The TMS field also contains additional control information that can apply to single segment or linked Comm-A messages:

- (a) Priority (TMS = 1,3,5,7,9 or 11) - A message can be identified as having normal or high priority. This is intended to be used in the case where more than one message is in process in a data link device. High priority messages would be handled before normal priority messages.
- (b) Acknowledgement (TMS = 2,3,6,7,10 or 11) - Certain ATC messages will require an explicit pilot acknowledgement of receipt and acceptance of a message. The acknowledgement indication in the TMS field is intended for use by a data link device to indicate (on the message display) that an explicit acknowledgement is required.

Readout of such an acknowledgement is handled by the air-initiated Comm-B message protocol.

Linked Comm-A Delivery Example

An example of a linked Comm-A message delivery is presented in Table 2-3.

Comm-A Broadcast Messages

Transponders equipped for data link will recognize UF=20 and 21 interrogations sent to an address of all "ones" as a broadcast Comm-A message. The transponder will receive the Comm-A message contained in the interrogation but will not generate a reply. Further processing of the message is dependent upon the ADS code contained in the MA field and the data link equipment of the aircraft.

Broadcast messages are intended for the efficient transfer of a message of interest to all aircraft. The absence of a transponder reply means that the ground will not have positive confirmation that this message was received by a particular aircraft. For this reason, broadcast messages will generally be restricted to information that is transmitted periodically in order to ensure a high probability of successful delivery.

STANDARD DOWNLINK MESSAGE PROTOCOL (COMM-B)

The Comm-B air-to-ground data link carries two kinds of message traffic:

- (a) ground-initiated, for readout of on-board data sources and
- (b) air-initiated.

Each Comm-B message field contains an 8-bit message type code called the BDS subfield. For convenience of description, the high order four bits are referred to as the BDS1 code and the low order four bits as the BDS2 code.

Ground-Initiated Transfer of Comm-B Messages

A ground initiated Comm-B message transfer is triggered by a surveillance or Comm-A interrogation with an RR code greater than 16. The RR code value minus 16 equals the BDS1 value of the message requested by the interrogation. Thus an RR value of 17 is equivalent to a BDS1 value of 1 or "0001" in binary form.

TABLE 2-3

EXAMPLE OF A LINKED COMM-A MESSAGE DELIVERY

Scenario: Message has three segments, uses a single ADS code and requests a pilot acknowledgement.

(a) INTERR	(a) REPLY	RELEVANT FIELDS	SIGNIFICANCE
A		TMS=6 MA ADS	First segment of linked Comm-A Defines single ADS and Pilot Acknowledgement Required Comm-A message, segment 1 Defines type of information encoded in this and the following MA message
	S or B	-	First segment technical acknowledgement ^(b)
A		TMS=12 MA	Second segment of linked Comm-A Comm-A message, segment 2
	S or B	-	Second segment technical acknowledgement ^(b)
A		TMS=14 MA	Final segment of linked Comm-A Comm-A message, segment 3
	S or B	-	Final segment technical acknowledgement ^(b)
Notes:			
(a) S = Surveillance, A = Comm-A, B = Comm-B			
(b) Sensor will repeat delivery of each segment until technical acknowledgement is received.			

The BDS2 value of the requested message is assumed to be zero (i.e., "0000") unless it is otherwise specified in the SD field of the requesting interrogation. When the DI field code equals 7, the SD field contains an extended data readout request containing the RRS subfield that specifies the BDS2 code. Thus an interrogation with RR=19, DI=7 and RRS=5 specifies a message with a BDS1 value of 3 and a BDS2 of 5, (i.e. "0011 0101").

A ground-initiated Comm-B request triggers an immediate Comm-B reply with the MB field containing the BDS code and the requested data. If the aircraft is not equipped to supply the requested BDS code, it responds with an MB field of 56 zeros. This situation is detectable on the ground since a BDS code of 0 is not a valid code. No acknowledgements are involved in the case of ground-initiated Comm-B transactions; failure to receive the data correctly on the ground simply causes a repeat of the request.

An example of a ground-initiated Comm-B message delivery is presented in Table 2-4.

Air-Initiated Transfer of Comm-B Messages

An air-initiated Comm-B message could be started by setting up a message text on some input device and pushing an appropriate "send" button. This causes the B-flag to be set to "one", and causes the DR code of every surveillance or Comm B reply (DF=4,5,20 or 21) to be set to an appropriate value that indicates that an air-initiated Comm-B message is waiting. The protocol used by the sensor to transfer this message depends upon the operating environment of that sensor.

(a) Non-selective Transfer of Air-Initiated Comm-B Messages - The non-selective protocol is used: (1) if the sensor does not have overlapping coverage with any other Mode S sensor, or (2) if it communicates with its neighboring sensors to ensure that only one sensor at a time is responsible for Comm-B message transfer. In this case, the sensor transmits a surveillance or Comm-A interrogation with RR=16 (read air-initiated Comm-B) and either DI≠7 (no extended data readout) or an RRS=0 (no request) if DI=7. This specifies a BDS1 and a BDS2 value of zero, (i.e., BDS equals "0000 0000" in binary). This BDS code uniquely defines a request to read an air-initiated Comm-B message. The transponder responds with the waiting Comm-B message with a (non-zero) BDS code identifying the type of information encoded in the Comm-B message being delivered.

Because of the asymmetry between sensor and transponder (with the sensor not routinely replying to every air-to-ground transmission), an explicit ground technical acknowledgement is required. When the air-to-ground message is successfully received by the sensor, the sensor sets a code value of 4 into the PC field of the next surveillance or Comm A interrogation. When PC=4 (Cancel-B) is received by the transponder, the B-flag is cleared. The transaction is complete when the ground receives the elicited reply, indicating successful receipt of the Cancel-B instruction.

TABLE 2-4

EXAMPLE OF GROUND-INITIATED COMM-B DELIVERY

Scenario: Ground readout of Comm-B message with BDS1=3 and BDS2=5

(a) INTERR	(a) REPLY	RELEVANT FIELDS	SIGNIFICANCE
S or A		RR=19	Readout of Comm-B with BDS1=3
		DI=7	Extended data readout SD field
		RRS=5	BDS2 of requested Comm-B
	B	MB	Ground-initiated Comm-B message
		BDS ^(b)	Defines MB message type
<p>Notes:</p> <p>(a) S = Surveillance, A = Comm-A, B = Comm-B</p> <p>(b) BDS equals "0011 0101" for the requested message.</p>			

This protocol can result in the receipt of more than one Cancel-B instruction for a particular message if the interrogation is received by the transponder, but the ground does not receive the reply. The absence of the expected reply will cause the ground to repeat the interrogation at the next opportunity.

If the transponder has a second air-initiated Comm-B message waiting to be transferred, it indicates its presence to the ground by sending the appropriate DR code in its reply to the message that delivered the "Cancel-B" acknowledgement to the previous message. Note that the avionics must not permit a message to be cleared until after it has been read at least once. This prevents the multiple clears that can be received due to a downlink failure from clearing a second waiting message that has not as yet been transferred to the ground. The possibility of downlink failure also prohibits the sensor from both reading and clearing a Comm-B message in the same interrogation, since multiple delivery of such an interrogation would certainly result in the loss of an undelivered Comm-B message.

An example of a non-selective air-initiated Comm-B message delivery is presented in Table 2-5.

(b) Multisite Transfer of Air-Initiated Comm B Messages - If it is possible for more than one sensor to service an air-initiated Comm-B message request, the multisite protocol must be used to avoid duplicate message delivery and possible loss of messages. This loss can occur when (1) a transponder has more than one air-initiated message ready for delivery and (2) the interleaved read and cancel instructions from the multiple sites results in the following sequence. Sensor A has cleared message 1 and has had a downlink failure in reading message 2. This is followed by a cancel from Sensor B (intending to cancel message 1) that in fact cancels message 2, which is lost since it has not been successfully read by either sensor. The multisite protocol handles this problem by allowing any sensor to read the air-initiated message, but only one reserved site to cancel it.

When a sensor using the multisite protocol receives a surveillance or Comm-B reply with a DR code that indicates an air-initiated Comm-B is waiting, it responds with a surveillance or Comm-A interrogation with:

RR Code = 16 (Read air initiated Comm-B)
DI Code = 1 (Multisite SD field)
MBS Code = 1 (Comm-B Reservation)
RSS Code = 1 (Report Comm-B reservation status in UM)
IIS Code = sensor site address

The transponder stores the address of the first site to make such a reservation and includes this "reserved" site number in the IIS subfield of the UM field of its reply. A site that sees its own address in the reply knows that it has the responsibility for handling the message. A second site that reads the Comm-B message before it is cleared (by the first site) will know that this is a duplicate delivery since the reserved site number is different from its own site number.

TABLE 2-5

EXAMPLE OF NON-SELECTIVE AIR-INITIATED COMM-B DELIVERY

(a) INTERR	(a) REPLY	RELEVANT FIELDS	SIGNIFICANCE
S or A		-	-
	S or B	DR=1	Air-initiated Comm-B waiting
S or A		RR=16	Readout of air-initiated Comm-B
	B	DR=1 ^(b) MB BDS	Air-initiated Comm-B message waiting Air-initiated Comm-B message Defines MB message type
S or A		PC=4	Non-selective Comm-B cancellation
	S or B	DR=0 ^(c)	Comm-B cleared

Notes:

- (a) S = Surveillance, A = Comm-A, B = Comm-B
- (b) The message has not yet been cancelled.
- (c) If DR=1 in the reply to an air-initiated Comm-B cancellation, it indicates the presence of another air-initiated Comm-B message.

The reserved site clears a delivered air-initiated Comm-B message with a surveillance or Comm-A interrogation with:

DI Code = 1 (Multisite SD field)
MBS Code = 2 (Comm-B close out)
IIS Code = the sensor site address

The transponder does not reset the B-flag (i. e., set DR=0) until a closeout message is received from the reserved site.

If the message is not closed out by the received site within 18 seconds (due perhaps to a link fade), the reservation times out and can thus be reserved by any other sensor that is in contact with the aircraft.

An example of a multisite air-initiated Comm-B message delivery is presented in Table 2-6.

(c) Air-Directed Multisite Comm-B Delivery - The multisite Comm-B protocol makes it possible for an aircraft to route an air-initiated message to a particular sensor. This capability is important in a multisite environment since it makes it possible for a pilot acknowledgement message to be routed to the sensor that delivered the message being acknowledged.

When a Comm-A message is delivered, the data link avionics equipment will receive the SD field along with the MA field, and will thus be able to associate the sending site address (in the IIS subfield) with the Comm-A message. When a pilot acknowledgement is generated, the data link avionics equipment will cause the transponder to reserve the message for the desired site address at the same time that the message is made available for delivery. Thus, even the initial reply indicating the B-flag set (in the DR field) will show that a reservation already exists for the desired site (in the UM field). This allows the desired sensor 18 seconds to initiate readout of the message. After 18 seconds the reservation times out and the message protocol reverts to the normal multisite rules.

Linked Comm-B Messages

The Mode S link protocols could accommodate linked Comm-B messages. As for the uplink case, the transponder could be transparent to the linking protocol. A block of four consecutive BDS codes could be reserved for linked Comm-B messages, one each for segments 1 through 4 of the linked Comm-B message. The data link avionics could initiate a linked Comm-B transfer by sending the last message segment (e.g. segment 3 for a three-segment message) as an air-initiated message. The sensor would detect the BDS code in the received Comm-B segment and initiate a ground initiated Comm-B transfer to read out the other message segments. When the sensor had received all of the Comm-B segments, it would clear the air-initiated message that began the sequence. Receipt of the clear to the final message segment would serve as a technical acknowledgement for the entire linked Comm-B message. This protocol

TABLE 2-6

EXAMPLE OF MULTISITE AIR-INITIATED COMM-B DELIVERY

Scenario: Local site interrogator address = 4

(a) INTERR	(a) REPLY	RELEVANT FIELDS	SIGNIFICANCE
S or A		-	-
	S or B	DR=1	Air-initiated Comm-B waiting
S or A		RR=16 DI=1 MBS=1 RSS=1 IIS=4	Readout of air-initiated Comm-B Multisite SD field Comm-B reservation Request for Comm-B reservation status in UM Local site's interrogator identification
	B	DR=1 IDS=1 IIS=4(b) MB BDS	Air-initiated Comm-B waiting Comm-B reservation status is in IIS Site 4 (the local site) is the reserved site Contains the air-initiated message Defines the contents of MB
S or A		DI=1 MBS=2 IIS=4	Multisite SD field Multisite Comm-B closeout Local site's interrogator identification
	S or B	DR=0(c)	Comm-B closed out (IIS field is also cleared in the transponder)

Notes:

- (a) S = Surveillance, A = Comm-A, B = Comm-B
- (b) If IIS \neq 4, the local site is not the reserved site and no further action is taken on the message.
- (c) If DR=1 in the reply to a Comm-B closeout, it indicates the presence of another air-initiated Comm-B message.

could work with either the non-selective or multisite delivery protocols. In the later case, the presence of a reservation during the entire delivery process would ensure that all message segments are read by the same site.

Since the normal BDS code values would be used in the linked Comm-B protocol described above, an additional 8-bit field would be needed following the BDS subfield of the first message segment to define the message type. Thus it would define the BDS code for the message being delivered.

EXTENDED LENGTH UPLINK MESSAGE PROTOCOL (COMM-C)

The Extended-Length Message (ELM) protocol provides for more efficient transmission of long data link messages by permitting the grouping of up to 16 message segments into a single entity that can be acknowledged by a single reply. Each segment is included in a single Comm-C transmission (UF equals 24). The limit of 16 segments refers solely to the manner in which the message is transferred over the link. Longer messages can be accommodated through the use of a message continuation indicator within the text field of the last segment of an ELM.

Basic Ground-to-Air Extended-Length Message Transfer

Ground-to-Air Extended-Length Messages are transmitted using the Comm-C format with three different reply control codes (RC code = 0, 1 and 2). The three reply control codes designate an initializing segment, intermediate segments and a final segment. (Note that the minimum length of a ground-to-air ELM is two segments since the protocol requires at least an initializing and a final segment). The transfer of all segments may take place without any intervening air-to-ground replies, as described in the following paragraphs. In this way, channel loading is minimized. Message segments (one per Comm-C interrogation) may be transmitted at a rate up to one per 50 usec. This minimum spacing is required to permit the resuppression of ATRBS transponders. Delivery of the message may take place during a single scan or over a few scans depending on the length of the message, the channel interference level, and the sensor loading. Normally, sufficient time will be available within one scan to permit complete delivery of the message.

(a) Initializing Segment Transfer - The extended length message transaction for an N-segment message (segment numbers 0 through N-1) is initiated by a Comm-C interrogation with RC code = 0. The transponder does not reply. Receipt of this interrogation (in effect a "dial up") causes the ELM interface within the transponder to initialize its message storage and bookkeeping registers in preparation for a new ELM transfer. Also delivered in the initial interrogation is the text of the final message segment in the MC field, and its segment number (N-1) in the NC field. This "last segment first" protocol is used to inform the transponder of the length of the message. If an initializing segment is received before the completion of an earlier ground-to-air ELM transfer, the effect is to abort the earlier message and replace it with the newer one. If the ELM processor fails to receive an initializing segment, it will not store any received segments.

(b) Intermediate Segment Transfers - Message delivery proceeds with the transmission of intermediate segments (any sequence of N-2 segments chosen from segments N-2 through 0) via Comm-C interrogations with RC code = 1 (intermediate), again delivered without replies. Each message segment is identified with its segment number in the NC field. The ELM processor stores each segment in the appropriate storage location based on this number. In this way, the message processor reassembles the message, and its bookkeeping function keeps track of which segments have been received. Intermediate segments may be delivered in any order, once the ELM processor has been initialized with segment N-1. If the entire message consists of only two segments, there will be no intermediate transfers.

(c) Final Segment Transfer - The interrogator transmits the final segment of a Comm-C interrogation with RC code = 2 (final). Its segment number is in the NC field and the text is in the MC field as before. This RC code elicits a Comm-D format (DF code = 24) with KE code = 1 (acknowledgment in MD) and a cumulative transponder technical acknowledgement in the MD field. The cumulative transponder Technical Acknowledgement Subfield (TAS) consists of a bit string (maximum length of 16 bits) that indicates which segments of the ELM have been received. The first bit represents the state of the first (N=0) segment, etc., with the states defined as; 1 = segment received, and 0 = segment not received. Thus at all times this field represents the current status of segment delivery from the time of ELM initiation. If the interrogator does not receive a reply to the Comm-C interrogation containing the final segment, this interrogation is repeated until a reply is successfully received.

If one or more segments of the ELM were not received by the transponder, this fact is indicated by zeros in the corresponding bit positions in TAS. The interrogator retransmits the missing segments with RC code = 1, except for the final one which has RC code = 2 to request an updated TAS. This process continues until the ground receives a cumulative TAS indicating that all segments have been delivered.

When all segments have been received by the transponder, the interrogator knows that its last transfer was indeed final and closes out the transaction.

The ELM processor in the transponder transfers the message to the appropriate output device as soon as it senses the presence of all segments.

Non-Selective Comm-C Protocol

The non-selective protocol may be used when only one sensor at a time has the responsibility for delivering an uplink ELM message. Using this protocol, a sensor delivers an uplink ELM as described above and then terminates the delivery by sending a PC code = 5 (Cancel C) in a surveillance or Comm-A interrogation.

Multisite Comm-C Protocol

The multisite Comm-C protocol is used to coordinate the activities of multiple sensors so that only one sensor at a time is "reserved" for uplink ELM activity. Before beginning an uplink ELM, a sensor uses the multisite protocol to obtain a reservation by transmitting a surveillance or Comm-A interrogation with:

DI code = 1 (Multisite SD)
MES code = 1 (Comm-C Reservation)
RSS code = 2 (Report Comm-C reservation status in UM)
IIS code = the sensor site address

The transponder reply to this interrogation includes the site address (in IIS subfield of the UM field) of the sensor currently reserved for Comm-C activity. A sensor seeing its own site address as the reserved site will proceed with the uplink ELM. If a different site is designated as the reserved site, uplink ELM activity is not initiated this scan and a reservation request may be attempted again on the following scan.

When the uplink ELM delivery is complete, the reserved sensor closes out the delivery by sending a surveillance or Comm-A interrogation with:

DI code = 1 (Multisite SD)
MES code = 2 (Comm-C closeout)
IIS code = the sensor site address

The transponder only accepts the closeout if the IIS field in the interrogation matches the reserved Comm-C IIS code stored in the transponder.

A reservation remains in effect for 18 seconds from the time of last delivery activity, i.e. the reservation itself or any segment delivery or TAS request. If delivery activity ceases for more than 18 seconds before delivery is complete, it is assumed that the sensor is no longer in contact and the reservation is cancelled along with any segments that have been delivered up to that point. The transponder is then able to grant a reservation to any other sensor that is currently in contact.

An example of a multisite uplink ELM delivery is presented in Table 2-7.

EXTENDED LENGTH DOWNLINK MESSAGE PROTOCOL (COMM-D)

The transfer of an air-to-ground ELM is similar to the ground-to-air process. Differences between the two protocols result primarily from the fact that (1) all channel activity is ground initiated and (2) the transponder can reply with longer communications formats only when given specific permission by the ground.

Basic Air-to-Ground Extended Length Message Transfer

Air-to-Ground Extended-Length-Messages are transmitted (under ground control) using the Comm-D reply (DF=24).

TABLE 2-7

EXAMPLE OF MULTISITE UPLINK ELM DELIVERY

Scenario: Multisite delivery of 3-segment uplink ELM by local site with interrogator address = 6

(a) INTERR	(a) REPLY	RELEVANT FIELDS	SIGNIFICANCE
S or A		DI=1 MES=1 RSS=2 IIS=6	Multisite SD field Comm-B reservation Request for Comm-C reservation status in UM Local site's interrogator identification
	S or B	IDS=2 IIS=6 ^(b)	Comm-C reservation status is in IIS Site 6 (the local site) is the reserved site
C		RC=0 NC=2 MC CDS	Initializing segment delivery Announces a 3 segment ELM Segment 3 of uplink ELM Defines the ELM message type
	None		Reply not elicited by RC=0
C		RC=1 NC=1 MC	Intermediate segment delivery Indicates MC contains segment 2 Segment 2 of uplink ELM
	None		Reply not elicited by RC=1
C		RC=2 NC=0 MC	Segment delivery and request for technical acknowledgement Indicates MC contains segment 1 Segment 1 of uplink ELM
	D	KE=1 TAS ^(c)	MD contains technical acknowledgement of uplink ELM in TAS Technical acknowledgement of segments 1 to 3
S or A		DI=1 MES=2 IIS=6	Multisite SD field Multisite Comm-C closeout Local site's interrogator identification
	S or B	-	Technical acknowledgement of closeout command

Notes:

- (a) S = Surveillance, A = Comm-A, B = Comm-B, C = Comm-C, D = Comm-D
- (b) If IIS ≠ 6, the local site is not the reserved site and no further action is taken this scan. The IIS subfield is in the UM field.
- (c) The sensor will resend any segment not acknowledged by TAS.

(a) Initialization - An N-segment air-to-ground ELM transfer is initiated by a surveillance or Comm-B reply containing DR code ≥ 16 . The number of message segments to be transferred is equal to the DR code number minus 15.

Thus a DR code of 21 indicates the presence of a 6-segment downlink ELM ready for delivery.

(b) Message Delivery - The interrogator requests the air-to-ground transmission of ELM segments using a single Comm-C transmission with RC code = 3 (request Comm-D). In this format, the first 16-bits of the MC field form a special 16-bit Segment Request Subfield (SRS), in which the successive bit positions correspond to segment numbers 0 through 15. The designated response is a series of Comm-D replies containing those message segments for which the corresponding SRS bit is set to one. (The transponder is thus not told which segments have been successfully received, but those which are to be transmitted.) The successive Comm-D replies of the response are transmitted with a nominal spacing of 136 μ sec between preambles (16 μ sec between the end of a reply and the succeeding preamble.) Although the precise spacing of segments in the response is known to the interrogator, each segment is transmitted as a full Comm-D reply with a preamble in order to resynchronize the reply decoder in case the preceding segment is not correctly received.

After the complete response to the Comm-C interrogation has been received, another Comm-C interrogation with an updated SRS subfield is transmitted to request segments not yet received (either because they were not requested in the first response, or because they were received in error). The transponder replies again with the requested segments. The cycle is repeated until all segments have been received. As with uplink ELM's this process may take place within a scan or over several scans. When all segments have been received, the complete message is transferred to the designated recipient.

Non-Selective Comm-D Protocol

When the non-selective protocol is used, a sensor delivers a downlink ELM as described above. It then terminates the delivery by sending a PC code = 6 (Cancel-D) in a surveillance or Comm-A interrogation.

Multisite Comm-D Protocol

When the multisite Comm-D protocol is used, a sensor obtains a reservation before beginning the readout of a Comm-D message. This is done by transmitting a surveillance or Comm-A interrogation with:

DI code = 1 (Multisite SD)
MES code = 3 (Comm-D reservation)
RSS code = 3 (Report Comm-D reservation status in UM)
IIS code = the sensor site address

The transponder reply to this interrogation includes the site address (in the UM field) of the sensor currently reserved for Comm-D activity. A sensor seeing its own site address as the reserved site will proceed with the downlink ELM transfer. If a different site is designated as the reserved site, downlink ELM activity is not initiated on this scan. A new reservation request may be attempted next scan if the DR code indicates that a Comm-D message is still pending.

When the downlink ELM delivery is complete, the reserved sensor closes out the delivery by sending a surveillance or Comm-A interrogation with:

DI code = 1 (Multisite SD)
MES code = 4 (Comm-D Closeout)
IIS code = the sensor site address

The transponder only accepts the closeout if the IIS field in the interrogation matches the reserved Comm-D IIS code stored in the transponder.

A reservation will timeout if 18-seconds pass with no delivery activity. The transponder is then able to grant a reservation to another site for transfer of the downlink ELM.

An example of a multisite downlink ELM delivery is presented in Table 2-8.

Air-Directed Multisite Comm-D Delivery

The technique used for air-directed Comm-D delivery is equivalent to the air-directed Comm-B protocol described earlier.

MESSAGE PROTOCOL INDEPENDENCE

The Mode S communication protocols are defined in such a way that the Comm-A, B, C, and D protocols are completely independent. This means that delivery activity for the different message types can be freely interleaved without restriction. If the multisite protocol is used, it is possible for the Comm-B, C, and D reservation to be granted to three different sites.

CAPABILITY REPORTING

The ground system must know what capability of an aircraft has to accept and provide data link information. This is accomplished through the reporting of transponder capability.

Capability Report

Basic transponder capability is reported in the CA field of the Mode S all-call reply (DF=11). This field informs the ground system of the capability category as follows:

TABLE 2-8

EXAMPLE OF MULTISITE DOWNLINK ELM DELIVERY

Scenario: Multisite delivery of 2-segment downlink ELM to local site with interrogator address = 2

(a) INTERR	(a) REPLY	RELEVANT FIELDS	SIGNIFICANCE
S or A		-	
	S or B	DR=17	Announces presence of 2-segment downlink ELM
S or A		DI=1 MES=3 RSS=3 IIS=2	Multisite SD field Comm-D reservation Request for Comm-D reservation status in UM Local site's interrogator identification
	S or B	IDS=3 IIS=2 ^(b)	Comm-D reservation status is in IIS Site 2 (the local site) is the reserved site
C		RC=3 SRS	MC contains request for downlink ELM delivery in SRS Indicates delivery request for segments 1 and 2
	D	KE=0 ^(c) NC=0 MD	Downlink ELM in MD Indicates MD contains segment 1 Segment 1 of downlink ELM
	D	KE=0 ^(c) NC=1 MD	Downlink ELM in MD Indicates MD contains segment 2 Segment 2 of downlink ELM
S or A		DI=1 MES=4 IIS=2	Multisite SD field Multisite Comm-D closeout Local site's interrogator identity
	S or B	DR=0 ^(d)	Comm-D closed out

Notes:

- (a) S = Surveillance, A = Comm-A, B = Comm-B, C = Comm-C, D = Comm-D
- (b) If IIS ≠ 2, local site is not the reserved site and no further action is taken on this message.
- (c) If all segments are not successfully received, the sensor will send another SRS requesting redelivery of missing segment(s).
- (d) If DR ≠ 0 in reply to a Comm-D closeout, it indicates the presence of another air-initiated message (either B or D depending on the value of DR).

- CA = 0 signifies no data link capability
- 1 signifies Comm-A/B capability
- 2 signifies Comm-A/B/C capability
- 3 signifies Comm-A/B/C/D capability

For each category of capability, the transponder can handle both the non-selective and the multisite modes. Additional details of the specific transponder capability for codes 1-3 are obtained by reading the transponder extended capability report via a ground-initiated Comm-B message, as described in the following section.

A transponder reporting CA code = 2 can handle uplink ELM's. This includes the ability to transmit the single Comm-D format required for technical acknowledgement of the uplink ELM transfer.

A transponder reporting CA code = 3 has the communication capability of the Comm-C transponder, and in addition it has the registers and logic to accept and process downlink extended length messages, in addition to the higher duty cycle transmitter needed to send bursts of long Mode S replies.

Extended Capability Report

A sensor obtains the extended capability report of a transponder so equipped by sending a ground-initiated Comm-B request to read out BDS1 code = 1 and BDS2 code = 0, (i.e., BDS = "0001 0000").

The extended capability report contains details that inform the ground of the specific Comm-A, Comm-B and ELM capability that currently exists onboard the aircraft. This information is given in sufficient detail to unambiguously define the message type codes that the avionics can handle. The capability is updated onboard the transponder at least every four seconds to ensure that the reported capability reflects the current status of the avionics equipment.

The extended capability will normally be read by a sensor immediately after the aircraft is put on the sensor's roll-call. In addition, any time that the transponder detects a change in aircraft capability, it causes a transfer of the extended capability report to the ground as an air-initiated message. This is accomplished by transmitting a surveillance or Comm-A interrogation to an aircraft with:

RR = 17 (Read Comm-B with BDS1 = 1)
DI ≠ 7 or (DI=7 and RRS=0) (No extended data readout so BDS2 = 0)

FLIGHT IDENTIFICATION PROTOCOL

All aircraft employ a flight identification code for air traffic control purposes. Some aircraft (usually general aviation) employ the aircraft registration number that is painted on the aircraft. Other aircraft (principally those used for air carrier and military flights) employ variable flight identification codes based on the commercial flight number or the military call sign.

Mode S transponders with Comm-B capability could automatically report this flight identification data. General aviation aircraft could permanently report the registration number. Other aircraft could employ a pilot input device to allow manual selection of the identification code for each flight.

A sensor obtains the flight identification report by sending a ground-initiated Comm-B request to readout BDS1 code = 2 and BDS2 code = 0, (i.e. BDS = "0010 0000"). This is accomplished by transmitting a surveillance or Comm-A interrogation to an aircraft with:

RR = 18 (Read Comm-B with BDS1 = 2)
DI ≠ 7 or (DI=7 and RRS=0) (No extended data readout so BDS2 = 0)

UTILITY MESSAGE PROTOCOL

The function of the UM field has been previously described in connection with the multisite communications protocols. If the content of the UM field in a reply is not specified by the interrogation, the UM field contains the site number reserved for multisite Comm-B or D activity (if any). If both message protocols are in use, the reporting of the Comm-B reserved site takes precedence over the reporting of the Comm-D reserved site.

The specific activity (Comm-B or D) being reported is defined by the IDS subfield (of the UM field). This is followed by the IIS subfield that gives the site number of the reserved site.

The voluntary reporting of reserved B and D sites eliminates unnecessary attempts by other sensors to transfer a message if reservation has already been granted.

CHAPTER 3

THE MODE S SENSOR

The Mode S sensor performs surveillance of Mode S- and ATRCBS-equipped aircraft within its assigned area of coverage, and acts as a communication relay for data-link messages between Mode S-equipped aircraft and air traffic control facilities. In addition, the sensor may accept digital target reports from a collocated radar, and merge these into a common surveillance output stream, correlating the radar and beacon reports when both exist on the same target.

The sensor interfaces with the airborne transponders via the RF link, and (when netted) with adjacent sensors and ATC facilities via low-baud-rate digital communication circuits.

The functional architecture of the sensor is illustrated in Fig. 3-1. Most sensor functions are conveniently categorized according to the time scale on which they operate, as follows:

- (a) Those that involve the generation and processing of signals, and therefore operate on a microsecond time scale; e.g.:

- modulator/transmitter
- multichannel receiver
- Mode S and ATRCBS reply processors

- (b) Those that involve channel transactions, and operate at a millisecond time scale, commensurate with the dwell time of the interrogator antenna on a target; e.g.: channel management and ATRCBS reply correlation

- (c) Those that are paced by the antenna scan time, and therefore operate on a time scale the order of a second; e.g.:

- surveillance processing
- data link processing
- network management
- performance monitoring

Two additional functional elements, which do not fall into the above categories, are the antenna system and the clock.

The remainder of this chapter describes each of these functions in turn, and their major interactions. Because of its central importance to overall sensor operation, channel management is considered first, followed by those functions responsible for the generation and processing of channel signals, and finally those involved in surveillance and data link message distribution and multisensor network coordination.

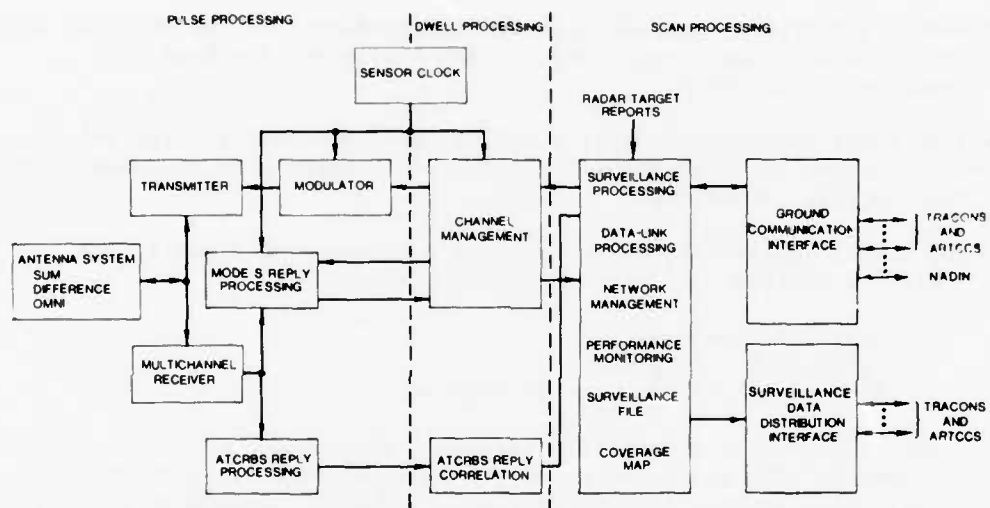

NOTE: TRACON = Terminal Radar Approach Control Facility
 ARTCC = Air Route Traffic Control Center
 NADIN = National Airspace Data Interchange Network

Fig. 3-1. Mode S sensor functional block diagram.

CHANNEL MANAGEMENT

Channel management regulates all activity on the RF channel through control of the modulator/transmitter and the ATCRBS and Mode S reply processors. Its principal function is the scheduling of ATCRBS and Mode S interrogations.

When configured for back-to-back antenna operation, channel management separately schedules interrogations for each antenna face, and controls switching between the faces.

To provide surveillance of both ATCRBS- and Mode S-equipped aircraft with minimal mutual interference, the RF channel is time-shared between the all-call modes and the roll-call mode as illustrated in Fig. 3-2.

ATCRBS and All-Call Scheduling

ATCRBS interrogations are scheduled at the beginning of an ATCRBS period as determined by a site adaptation input that defines the sensor time line. To reduce the incidence of fruit and second-time-around target reports, these interrogations can be pseudo-randomly jittered from the nominal interrogation time.

In any of the above modes, a range of ATCRBS interrogation rates can be accommodated. In order to provide a maximum of channel time for roll-call activity, the sensor has been designed for a nominal ATCRBS rate of two interrogations per mode, e.g., A,C,A,C per beam dwell.

Following each ATCRBS interrogation, the sensor processes ATCRBS replies for an interval corresponding to the maximum desired coverage range at the current antenna azimuth. When the desired coverage range is short, initiation of the subsequent Mode S interval may be delayed to allow replies from longer-range ATCRBS targets to "ring out" so that they do not interfere with roll-call replies in the following roll-call interval.

In order to conserve channel time, Mode S all-call acquisition is also performed during the ATCRBS listening period. Replies from unacquired Mode S and ATCRBS aircraft may be elicited one of two ways:

- (a) Through use of the ATCRBS/Mode S all-call interrogation.
- (b) By using a Mode S-only all-call interrogation followed by an ATCRBS-only all-call interrogation.

The latter approach must be used with the site addressed acquisition, stochastic acquisition, and lockout override functions because the coding for these functions is contained in format UF=11, the Mode S-only All-Call.

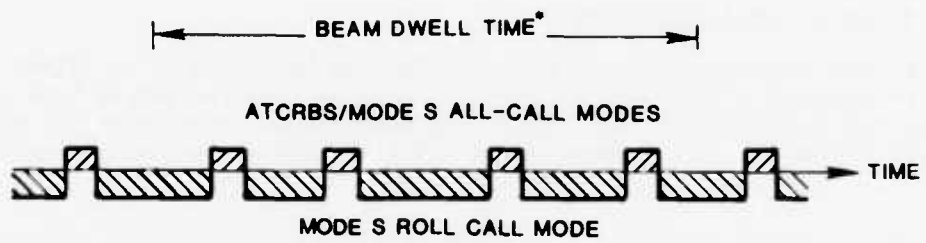

* TYPICALLY 25-30 MS FOR A TERMINAL SENSOR

Fig. 3-2. ATCRBS/Mode S time sharing.

Mode S Roll-Call Scheduling

Scheduling of Mode S roll call interrogations and replies occurs under the following principal ground rules:

- (a) Mode S interrogations are addressed only to aircraft within the antenna beam.
- (b) Channel time is allocated to each Mode S interrogation and reply based upon a prediction of aircraft range.
- (c) Mode S surveillance and data link procedures may require more than one interrogation to each aircraft. Therefore, the sensor is able to reinterrogate an aircraft while it remains in the beam.

The sensor maintains an active target list, comprising those Mode S aircraft that are within the antenna beam, and makes repeated passes through this list, scheduling discretely-addressed Mode S interrogations and replies on a nonconflicting basis. A single aircraft may appear on one or more of the resulting schedules of interrogations and replies, so that multiple surveillance and communication tasks can be accomplished. In the case of a failure to receive a reply, the capability for repeated scheduling of interrogations to an aircraft provides a high overall surveillance/ communication reliability.

The principal elements of Mode S roll-call scheduling are illustrated in Fig. 3-3. The intervals of time devoted to Mode S roll-call activity are called Mode S periods. During a Mode S period, one or more roll-call schedules are produced. A schedule is a set of interrogation and reply times that allows the sensor to carry out one interrogation-reply pair per aircraft to some or all of the aircraft on the active target list without providing a second transaction to any aircraft. The interrogations are timed so that nonoverlapping blocks of channel time are assigned to each individual interrogation and reply. If insufficient time is available to schedule all aircraft on the list, the time is allocated to aircraft according to a preassigned transaction priority.

Roll-call scheduling begins with the first (longest range) aircraft on the list, scheduling an interrogation at the assigned start time of the schedule; next, the expected reply arrival time is computed and a suitable listening period provided. Subsequent aircraft are scheduled by placing their reply listening periods in sequence and computing the corresponding interrogation times. A cycle is completed when the next interrogation, if so scheduled, would overlap the first reply. This interrogation is deferred to start a new cycle.

Several types of transactions must be efficiently combined in forming a Mode S schedule. Since the aircraft on the active target list are in various stages of completion, with respect to Mode S activity, each may require a different kind of transaction. Figure 3-4(a) illustrates a typical cycle comprised of long and short interrogations, coupled with long and short replies.

The cycles shown in Figs. 3-4(b) and 3-4(c) illustrate the inclusion of downlink and uplink ELM transactions.

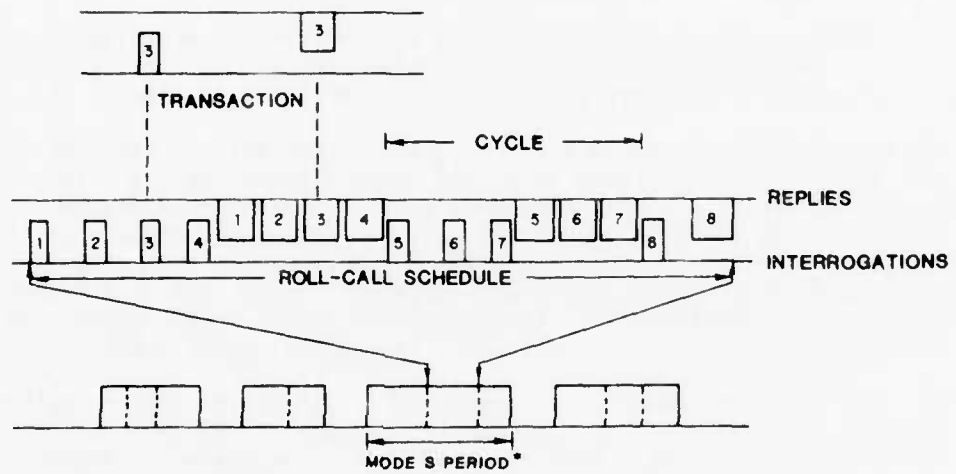

* This MODE S period comprises three schedules. The second includes eight transactions, grouped in three cycles of 4, 3 and 1 transactions, respectively.

Fig. 3-3. Mode S roll-call scheduling.

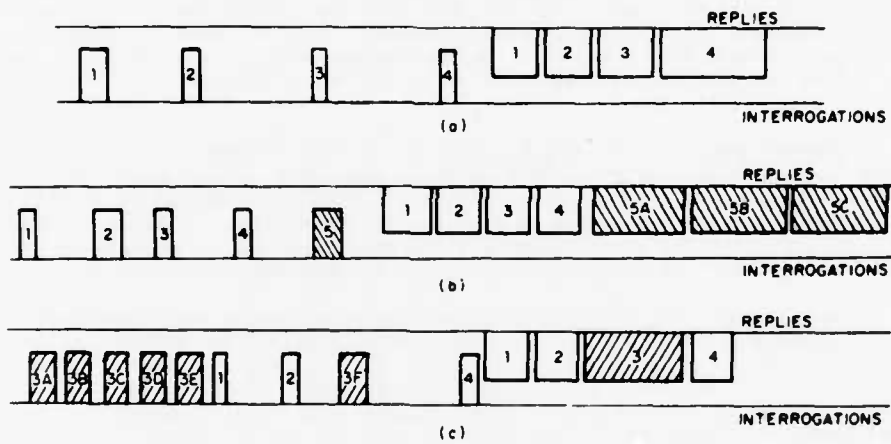

Fig. 3-4. Mode S cycles.

Channel Management Organization

The five subfunctions which comprise channel management are (a) channel control, (b) transaction preparation, (c) target list update, (d) roll-call scheduling, and (e) transaction update.

The data flow between these subfunctions, and their interfaces with other sensor functions, are illustrated in Fig. 3-5.

Interfaces: Channel management receives inputs from surveillance processing, data-link processing, and network management. Surveillance processing provides channel management with the predicted position (azimuth and range) of Mode S aircraft. Data link processing provides organized lists of pending uplink messages for each Mode S aircraft. Network management controls the track state to define the kinds of service, both surveillance and communication, to be afforded each aircraft.

Channel management has control over the modulator/transmitter unit and the Mode S and ATCRBS reply processors. Channel management communicates with these units by generating interrogation and reply control commands and by receiving Mode S reply data blocks. When an aircraft leaves the beam, a record of channel activity and downlink message content is passed on to the surveillance processing, data link processing, and network management functions.

Channel Control: Channel control monitors the system real-time clock and the antenna pointing direction, assuring that all ATCRBS and Mode S activities take place at the proper time and in the proper sequence. The other four channel management subfunctions are periodically activated by channel control. In addition, channel control regulates the flow of control commands to the modulator/transmitter and to the reply processors, and it directs the transfer of Mode S reply data blocks from the Mode S reply processor to channel management. In the back-to-back configuration, commands to the modulator/transmitter include an antenna face designation.

Transaction Preparation: At regular intervals, channel control directs transaction preparation to provide a list of aircraft about to enter the beam. For the back-to-back configuration, there are two such lists, corresponding to the two beams. Transaction preparation consults the surveillance file which contains predicted position, the pending uplink message data placed there by data link processing, and control information generated by network management. If uplink messages and/or downlink message requests are pending for an aircraft entering the beam, transaction preparation will determine the number and type of transactions required to accomplish these tasks.

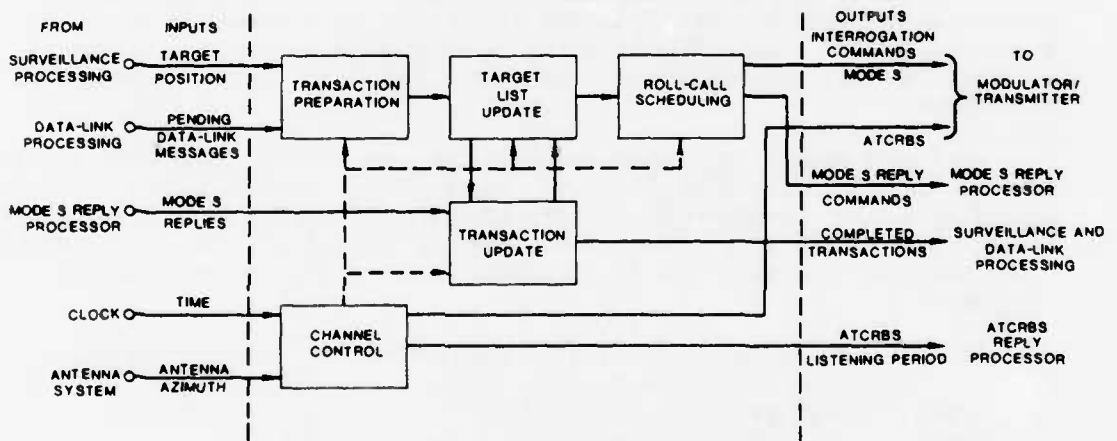

(The dashed lines from the channel control function indicate the flow of control data.)

Fig. 3-5. Channel management.

Transaction preparation creates a list of data blocks, one for each new aircraft, containing a complete specification of the required set of transactions needed to accomplish all pending surveillance and communication tasks.

Target List Update: An active target list is updated regularly by the target list update subfunction. The entries on this list are the data blocks which have been formulated by the transaction preparation subfunction. Data blocks on new targets, supplied by transaction preparation, are merged into the list, while old targets, either leaving the beam or completely serviced, are removed.

In order to facilitate the computation of a non-conflicting schedule of interrogations and replies, an active target list is arranged in order of decreasing target range. This ordering is maintained each time the list is modified. In the back-to-back configuration, two active target lists are maintained.

Roll-call Scheduling: As directed by channel control, roll-call scheduling operates on the contents of an active target list to produce Mode S schedules according to the procedures described earlier. If insufficient time remains for a complete schedule (i.e., one transaction per aircraft on the active target list) then the available time is allocated based on transaction priority as follows:

- Level 1 - Interrogations for altitude, ATRCBS ID, and high priority Comm-A/Comm-B messages.
- Level 2 - High priority uplink ELM's
- Level 3 - Additional (low priority) Comm-A/Comm-B messages.
- Level 4 - Uplink ELM's
- Level 5 - Downlink ELM's.

The outputs of roll-call scheduling are Mode S interrogation control blocks specifying interrogation time, power level, and data-block contents, and reply control blocks specifying expected reply time and address.

Transaction Update: If a target enters the beam with several transactions to be carried out, these transactions will normally take place on successive schedules. The transaction update function examines each reply and, if the transaction was successful, modifies the target's data block so that the next pending transaction will be carried out in the subsequent schedule. If the transaction was unsuccessful, it will be repeated in the next schedule, and the next pending transaction delayed to a later schedule. Finally, transaction update indicates the completion of targets for which no further transactions are pending.

CLOCK

Each Mode S sensor is equipped with a "time-of-day" clock that permits precisely-timed coordination of activities at different sensors. Site-to-site synchronization of ± 2.5 milliseconds is required for utilization of multi-site surveillance data.

System time is continuously available to the modulator/transmitter, Mode S and ATRBS reply processors, and channel management. In addition, the sensor clock provides timing references for the generation of both Mode S and ATRBS interrogation waveforms, and the demodulation of replies.

MODULATOR/TRANSMITTER

The modulator/transmitter (Fig. 3-6) accepts digital control inputs from channel management and generates the requisite RF interrogation signals. For each interrogation to be transmitted, the control inputs specify the mode, the transmission time (with 1/16 μ s resolution), and, for a Mode S interrogation, the contents of the data block prior to encoding. The modulator generates the sequence of parity check bits and combines them with the specified discrete address.

Mode S interrogations may be transmitted at low or high power (nominally 100 or 800 watts respectively) under control of channel management. ATRBS transmit power is site-adaptable with nominal values of 300 watts for a terminal sensor and 800 watts for an enroute sensor.

An auxiliary transmitter is required for the generation of the SLS control pulses, since the Mode S SLS pulse (P_5) is transmitted simultaneously with the Mode S interrogation.

ANTENNA SYSTEM

The Mode S sensor employs a rotating fan-beam antenna having a sum (Σ) pattern and a difference (Δ) pattern (Fig. 3-7a). The interrogation is transmitted, and the reply received, on the sum pattern; the reply is also received on the difference pattern, and the ratio of the amplitudes of the signals received on the difference and sum patterns (Fig. 3-7b) is used to estimate the off-boresight angle of the target, i.e., the angular difference between the target position and the antenna pointing angle.

In addition to the sum and difference patterns, the antenna system includes an SLS control pattern. This pattern is used for the transmission of the P_2 and P_5 sidelobe suppression pulses. It is also used on receive, where comparison of the amplitudes of the same signal received on the sum pattern and the control pattern permits rejection of signals received via a sidelobe of the sum pattern.

To perform its function, the gain of the SLS control pattern exceeds that of the sum pattern in all directions except those corresponding to the main beam of the sum pattern, i.e., it should "cover" the sidelobes of the sum pattern.

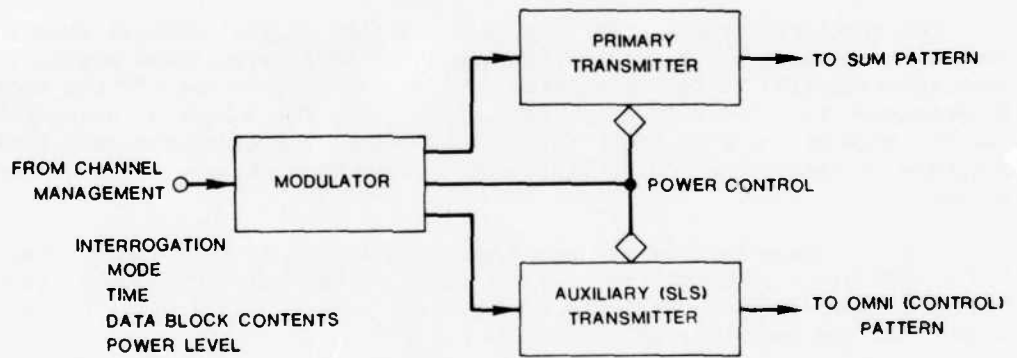
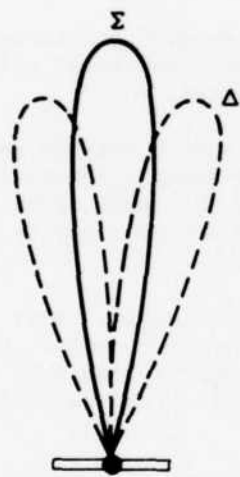
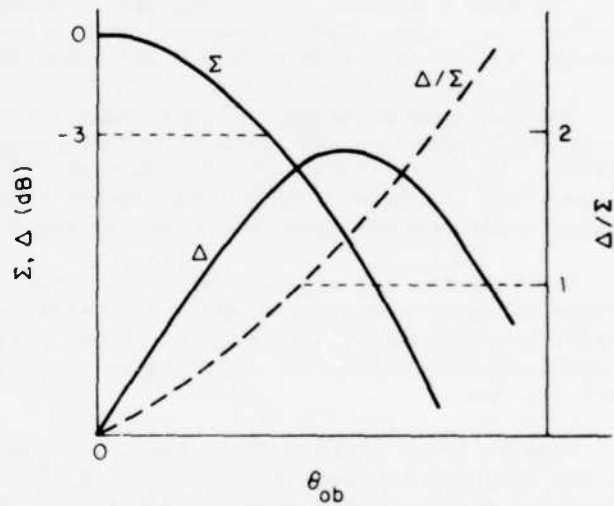

Fig. 3-6. Modulator/Transmitter.



a



b

Σ SUM
 Δ = DIFFERENCE
 θ_{ob} = OFF-BORESIGHT ANGLE

Fig. 3-7. Sum and difference antenna patterns.

Historically a separate antenna has been used to generate the SLS control pattern which has nearly constant gain as a function of azimuth, i.e., is omnidirectional in azimuth; the control pattern is thus referred to as the omni (Ω) pattern. However, other control pattern characteristics are employed such as that associated with an SLS antenna designed as an "integral" part of the sum and difference antenna. Generally this approach employs an auxiliary control pattern radiator in the rearward direction to ensure adequate coverage of the sum backlobes.

Antenna Configuration

The Mode S antenna system may either stand alone, mounted on its own pedestal, or it may share a pedestal with a radar sensor. The latter will normally be the case when a Mode S and radar are collocated.

When sharing a pedestal with a radar antenna, the Mode S antenna may employ a completely separate radiating structure, mounted, for example, above the radar antenna. On slowly rotating radar antennas (long-range air route surveillance radars which rotate at 5 to 6 rpm), back-to-back Mode S antennas may be used to realize a data update rate twice that of the host radar.

The back-to-back antennas may be mounted atop the collocated radar antenna if space permits. If space is restricted, such as in a radome, the forward antenna may be chin-mounted on the radar feed support boom with the rearward antenna mounted at approximately the same height on the backside of the radar antenna.

Some en route interrogators operate jointly for the benefit of both the FAA and the Military Air Defense Command. In this situation the antennas and associated microwave signal paths may be configured to allow the military exclusive use of one antenna (the front face) for their Mode 4 surveillance purposes when requested. Each such military request would generally encompass an azimuth wedge of from 10 to 30 degrees within a single scan. The enroute Mode S update rate, would of course, revert to one-half of the normal rate during this interval.

A block diagram of the configuration of a Mode S sensor and military interrogator operating jointly is shown in Fig. 3-8.

Azimuth Pattern Characteristics

The choice of azimuth beamwidth is constrained by two conflicting requirements. A broad beam results in a higher target capacity, i.e., the sensor can provide discrete-address surveillance and data-link service to a larger number of aircraft (see Chapter 5). A narrow beam provides higher azimuth measurement accuracy. The most generally useful range of 3-dB azimuth beamwidth for the Mode S sensor appears to be 2.4 to 4 degrees.

Both sum and difference patterns must have low amplitude azimuth sidelobes to minimize the effects of sidelobe interference on reply detection and monopulse azimuth estimation.

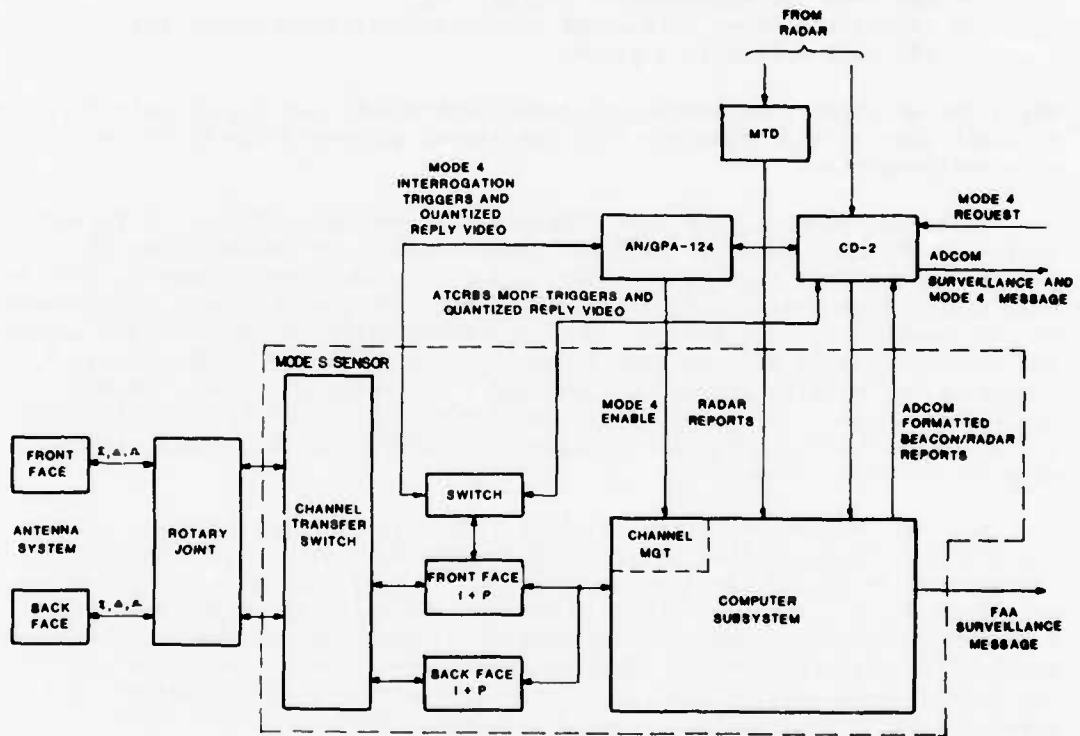

Fig. 3-8. Mode S joint use enroute sensor.

Elevation Pattern Characteristics

A rapid cutoff of the antenna patterns at the horizon is desirable to minimize the energy incident on, and reflected by, the ground, and thereby to:

- (a) decrease the magnitude of lobing; and
- (b) reduce the error introduced in the azimuth measurement due to off-axis multipath signals.

While the specific requirements on lower edge cutoff are highly site-dependent, a cutoff rate of approximately 2 dB per degree appears adequate for most typical site environments.

Above the horizon, the Mode S sensor must provide coverage to elevation angles of 30 to 40 degrees. Current beacon sensors use antennas having relatively constant gain with elevation angle (termed sector beams); used with sensitivity-time control (STC), this minimizes the dynamic range requirements of the receiver. A more tapered pattern (intermediate between the sector beam and the cosecant-squared pattern frequently used in radar applications) is preferred for Mode S. The tapered pattern has greater gain near the horizon, providing a higher fade margin for long-range, low-elevation angle targets. Its lower gain at high elevation angles is balanced by the reduced range of aircraft at those elevations.

Each of the above pattern characteristics is typified in Figs. 3-9(a) and 3-9(b). Figure 3-9(a) illustrates the measured elevation pattern of a representative Mode S five-foot open array designed for constant gain with elevation angle. Figure 3-9(b) illustrates the measured elevation pattern of a five-foot open array with a more nearly cosecant-squared characteristic as a function of elevation angle. Both antennas have a sharp lower edge cutoff. The peak-of-beam gain of the tapered pattern antenna is approximately 3-4 dB greater than that of the constant gain antenna (not shown in figures).

MULTICHANNEL RECEIVER

The multichannel receiver accepts the three RF signals from the sum, difference, and omni (control) patterns of the antenna system, and produces three outputs for use by the ATRBS and Mode S reply processors. These outputs are:

- (a) $\log \Sigma$ - the log amplitude of the sum pattern signal;
- (b) $\log \Omega$ - the log amplitude of the omni pattern; and
- (c) $f(\Delta/\Sigma)$ - a bipolar video signal proportional to the ratio of the amplitudes of the difference and sum pattern signals.

The $\log \Sigma$ signal is the "principal" receiver output, used for the detection of reply pulses. Comparison of the amplitudes of the $\log \Sigma$ and $\log \Omega$ signals indicates whether a pulse detected in the $\log \Sigma$ output was received via the mainlobe ($\log \Sigma > T^* + \log \Omega$) or via a sidelobe ($\log \Sigma < T^* + \log \Omega$) of

*A preset threshold.

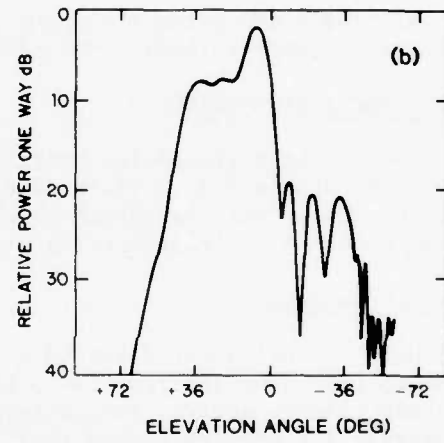
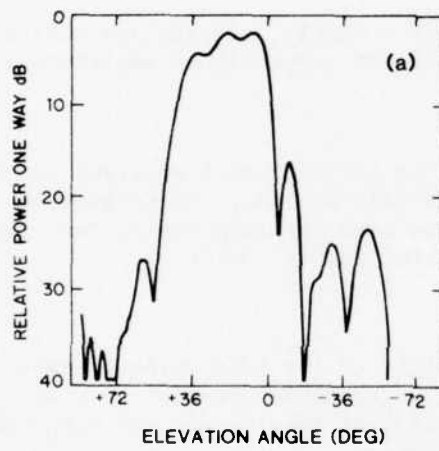

Fig. 3-9. Elevation patterns of five-foot open-array antennas.

the sum pattern. The digitized value of the $f(\Delta/\Sigma)$ signal from each received pulse is compared with a prestored antenna/receiver calibration curve to provide an estimate of the angle of arrival of the signal relative to the antenna boresight.

Figure 3-10 is a block diagram of a possible realization of the multi-channel receiver. The figure illustrates the use of the so-called "half-angle monopulse processor" to generate a $f(\Delta/\Sigma)$ output which is unambiguous (i.e., single-valued) over the full range of values of Δ/Σ , approximately according to the relationship:

$$f(\Delta/\Sigma) = 2 \tan^{-1} (\Delta/\Sigma).$$

The half-angle monopulse processor provides a highly accurate and stable calibration characteristic over a wide range of input signal amplitudes.

MODE S REPLY PROCESSING

Mode S reply processing operates on the multi-channel receiver outputs to detect and decode Mode S all-call and roll-call replies, and to generate an estimate of aircraft range and azimuth from each detected reply. The principal steps in Mode S reply processing are depicted in Fig. 3-11.

Preamble Detection

Mode S replies are detected on the basis of the four-pulse preamble waveform preceding the reply data block. The preamble detector provides accurate time-of-arrival estimation for aircraft ranging and for synchronization of message bit processing and reply decoding.

In the case of replies to roll-call interrogations, channel management provides to the preamble detector an estimate of expected reply time and an uncertainty window. A reply is accepted only if its preamble is detected within this window. Since the reply processor cannot start decoding a new reply when it is still decoding an earlier one, the use of this window minimizes the probability that the reply decoder will miss the desired reply due to Mode S fruit.

Message Bit Processing

Message bit processing operates on sampled video waveforms to produce a sequence of demodulated message bits, and a confidence bit (high or low) for each demodulated message bit.

Since a message bit is transmitted as a pulse in one of two possible positions, depending on whether the bit value is a 0 or a 1, bit decisions are based primarily on the relative amplitudes of the signals received in these two pulse positions. The sidelobe flag is used to help resolve ambiguous situations in which a signal is received in both pulse positions.

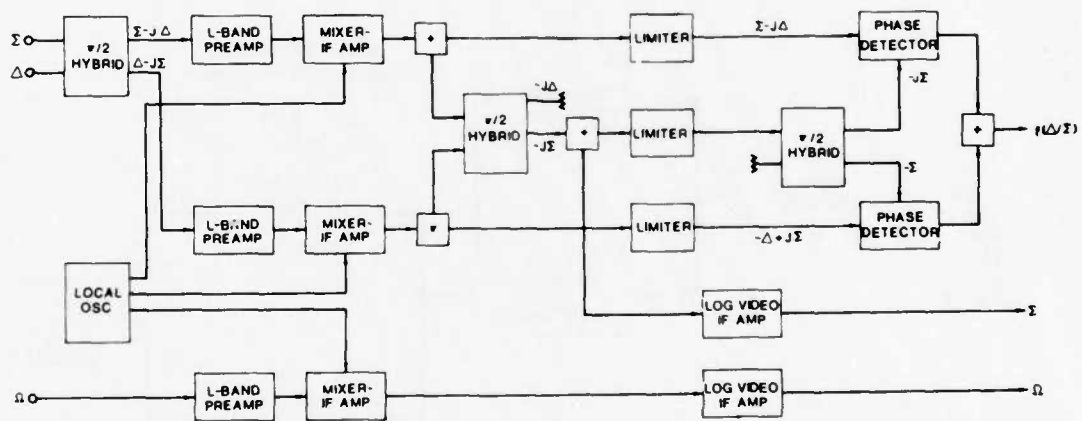

Fig. 3-10. Multi-channel receiver.

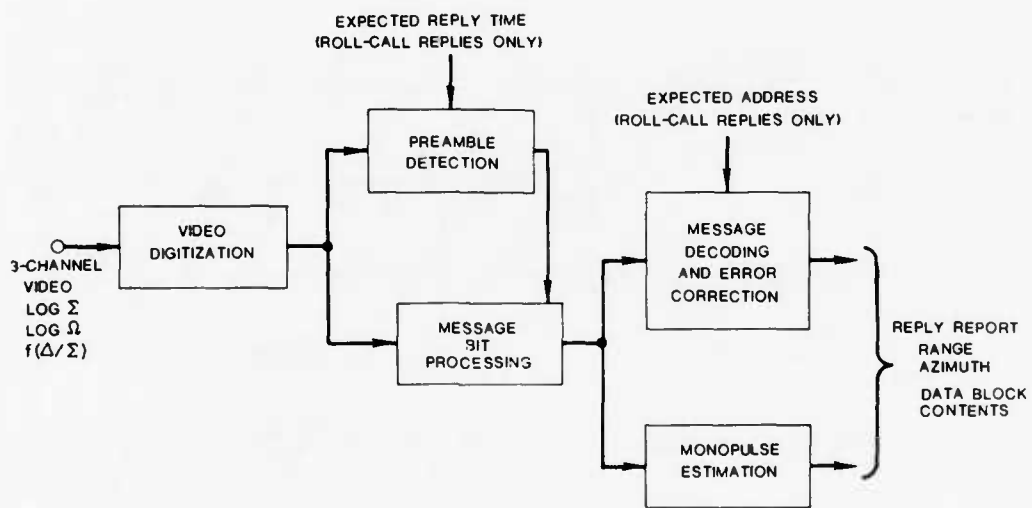

Fig. 3-11. Mode S reply processing.

Bit decisions are indicated as high confidence only when a mainbeam signal appears in one pulse position, and either no signal or a sidelobe signal appears in the other.

Message Decoding and Error Correction

Message decoding uses the parity check code to detect errors in the demodulated message. Since the parity check bits for roll-call replies are combined with the transponder address, the decoder must know the expected address (supplied by channel management) in order to perform error detection.

Whenever a decoded reply contains errors, error correction is attempted if the total number of low-confidence bits in the reply does not exceed a preset threshold. The use of this threshold minimizes the possibility of erroneously "correcting" a reply that contains a very large number of errors. Error correction will be successful only if:

- (a) all errors are confined within a span of 24 contiguous bits, and
- (b) all errors occur in bits flagged as low confidence.

Garbling by a single strong ATCRBS reply, which can result in bit decision errors spanning no more than 24 bits, usually results in a correctable error pattern. Thus, with high probability the Mode S data block will be correctly decoded unless it is garbled by more than one strong ATCRBS reply.

ATCRBS REPLY PROCESSING

The ATCRBS processing subsystem has been designed to produce accurate, reliable target reports at low interrogation rates in order to maximize the channel time available for the roll-call mode of operation. Monopulse information is used both to determine target azimuth and to assist in the decoding of overlapped replies. Sidelobe fruit replies are detected and rejected by comparison of the signal amplitudes received on the sum and omni patterns. ATCRBS Modes A, C, and 2 replies are processed, and the extracted codes included in the target report.

ATCRBS reply processing takes place in three successive steps (Fig. 3-12):

- (a) Reply decoding operates on the three video outputs of the multichannel receiver to detect ATCRBS replies, and, for each detected reply, provides an estimate of target range, azimuth, code and code confidence.
- (b) Reply correlation attempts to combine all replies received from an aircraft during one interrogator antenna scan into a single target report containing target range, azimuth, code and code confidence for each mode (A,C,2) in which the target responded.
- (c) Report-to-track correlation edits, and corrects as necessary, target reports by comparing them with a track file generated from reports received on previous scans. This step assists in the elimination of mainbeam fruit, the flagging of false targets, and the correction of missing and garbled code pulses.

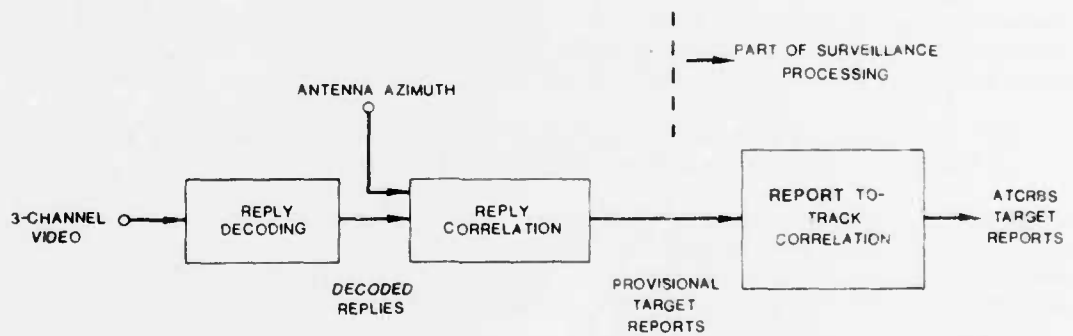

Fig. 3-12. ATCRBS reply processing.

The first two steps are described in the remainder of this section. The final step, report-to-track correlation, is discussed in a later section on surveillance processing.

Reply Decoding

The major elements of ATCRBS reply decoding are illustrated in Fig. 3-13.

Video Digitization: provides a digital representation of pulses whose widths are within an acceptable range. This representation includes leading edge location, a monopulse sample, and a sidelobe flag. Overly long pulses are assumed to have resulted from an overlapping of pulses from two replies, and pseudoleading edges are inserted based on the observed trailing edge position.

A monopulse sample is produced for each pulse of acceptable width, except for pulses which are overlapped enough to result in garbled monopulse samples.

Bracket Detection: is based on the detection of two pulses in the leading edge data stream that have the appropriate spacing ($\approx 20.3 \mu\text{s}$). Bracket pulse pairs for which both pulses are flagged as sidelobe pulses are not declared, and thus sidelobe replies are not decoded.

Garble Sensing and Phantom Elimination: Garble sensing is based on the time separation of two detected bracket pairs that would result in overlapping pulse decode regions for the two replies. The incorrect declaration of a bracket pair made up of pulses from two garbling replies is termed a "phantom." Phantoms produced by two garbling replies will be correctly eliminated if no additional garbling reply occurs for $20.3 \mu\text{s}$.

Code Extraction: Code extraction is initiated by the declaration of a bracket pair that defines the possible information pulse locations. Information pulses are associated with a reply (bracket pair) on the basis of their leading edge location relative to the bracket pair and their monopulse sample values relative to a monopulse reference. The initial monopulse reference is the monopulse sample of the first framing pulse, except when that pulse is in a possible garble region of an earlier reply or is labelled as sidelobe. If the first framing pulse is not suitable, the monopulse sample of the second framing pulse is used as the monopulse reference. If that pulse is also not suitable, the reply is rejected.

Each information pulse decision is accompanied by a confidence bit (high/low confidence). A pulse is decoded as high confidence, '1', if it falls within one of the acceptable pulse decoding regions of the reply being decoded and its monopulse sample correlates with the monopulse reference of that reply and not with any garbling reply (if any). A pulse position is decoded as high confidence, '0', if no pulse is detected in its decode region and no pulse leading edge is detected in the sample position just ahead of this decode region.

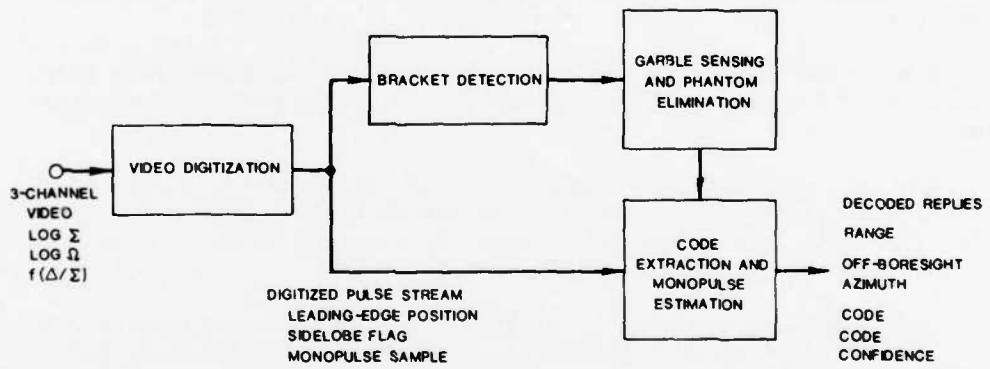

Fig. 3-13. ATCRBS reply decoding.

Monopulse Estimation: Each pulse which lies within a valid information pulse position of a detected reply and which correlates with the monopulse reference of that reply is used to update the reference by averaging the reference value and the sample value. The monopulse estimate for a decoded ATRCBS reply is the final value of the monopulse reference for the reply at the time the F_2 pulse has been processed. In order to avoid an erroneous monopulse estimate because of a bad reference sample at the start of pulse decoding, an ATRCBS monopulse estimate is not declared unless it includes at least two monopulse samples.

Reply Correlation

The function of reply correlation is to combine all replies received from a transponder in one scan into a single target report. Each reply received from reply processing is correlated (compared) in range, azimuth and high-confidence code pulses with existing target report files. If a reply does not correlate with any existing target report file, a new file is started with the reply.

Code correlation is done by comparing only high-confidence code positions of a reply with the high-confidence code positions of the code estimate contained in the target report file. This code estimate (Mode 2, A or C) is updated by forming a new estimate consisting of the composite of the current file code estimate and the high confidence code positions of the correlating reply. Likewise, the composite confidence bit sequence for each reply mode is updated by adding to the high confidence positions in the target report file any new high confidence positions in the correlating reply.

The azimuth estimate provided in a target report consists of the azimuth estimate of the reply closest to boresight when replies are received only on one side of boresight, or the average of the azimuths of the two replies which straddle boresight.

SURVEILLANCE PROCESSING

Surveillance processing maintains target files on all ATRCBS, Mode S, and radar-only aircraft within the sensor's coverage volume. Its principal functions are:

- (a) To predict next-scan position of Mode S aircraft for interrogation scheduling;
- (b) To edit and correct ATRCBS target reports based upon data from previous scans;
- (c) To perform radar/beacon correlation of target reports from a collocated radar;

- (d) To filter radar-only target reports based upon data from previous scans;
- (e) To disseminate composite ATCRBS/radar, Mode S /radar and radar-only surveillance data to ATC users.

The data flow between the principal elements of surveillance processing is illustrated in Fig. 3-14.

Mode S Surveillance Processing

Mode S surveillance processing (Fig. 3-15) operates on the set of Mode S replies received from an aircraft during a scan to produce a target report on that aircraft and a prediction of its position on the next scan.

A single Mode S report for a given address is selected to represent the surveillance data for each track. Many replies with the same address may be present; either because of multiple roll-calls for data-link activity or because this aircraft is just being acquired and has answered an all-call. The report selection process includes finding the reply that is near beam center to maximize azimuthal accuracy, and also finding the reply at shortest range to exclude false (reflected) targets.

The Mode S all-call reports whose addresses do not match an existing track are examined in the track initiation process to determine if an address match can be made with uncorrelated reports held over from the previous scan. When a match is found, a test for false track due to reflection is made; if the test is negative, a newly-initiated track is entered into the surveillance file. The still-unmatched reports are saved for one scan and are also used in radar correlation.

The occurrence of synchronous garble of Mode S all-call replies is signified by the receipt of two or more undecodable all-call replies at a consistent range during a beam dwell. When this condition is detected, an acquisition track is initiated at the range and azimuth of the detected reply. Channel management will then schedule stochastic Mode S-only all-call interrogations for this track when it appears on the active target list. If a successful reply is received, the aircraft will then be discretely interrogated and locked out to remove it from the garbling set. Acquisition tracks are only retained for one scan since continued garbling will result in generation of a fresh acquisition track each scan.

Finally, all Mode S reports that match with tracks, and radar reports that correlate with coasted tracks, (i.e., tracks that were not matched to a Mode S report this scan), are used to update and project the Mode S track ahead one scan. This new projection is used by channel management to determine when to schedule the next roll-call interrogation to the aircraft.

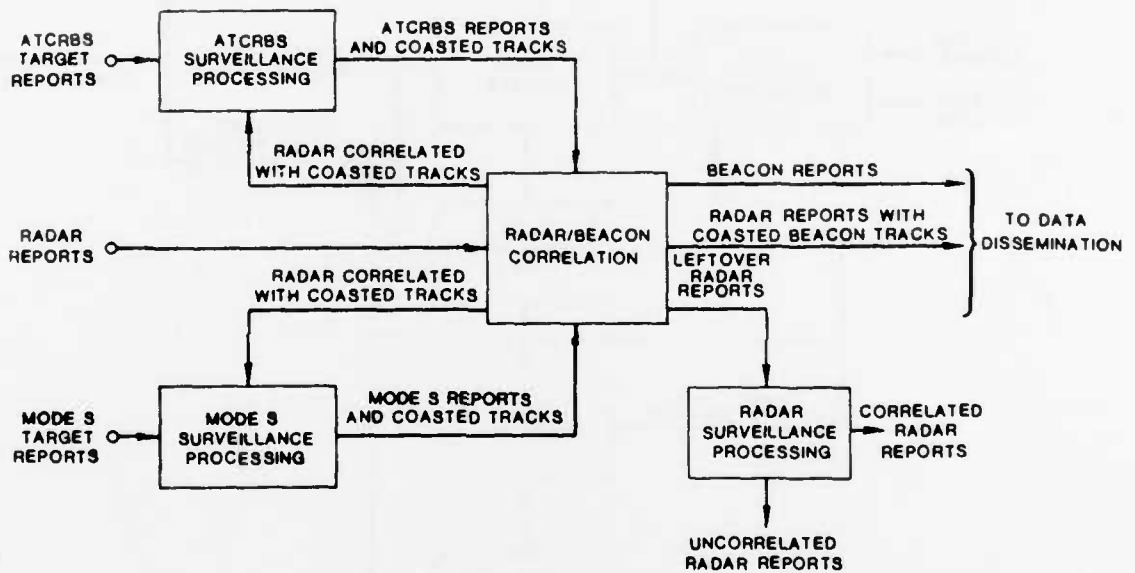

Fig. 3-14. Surveillance processing.

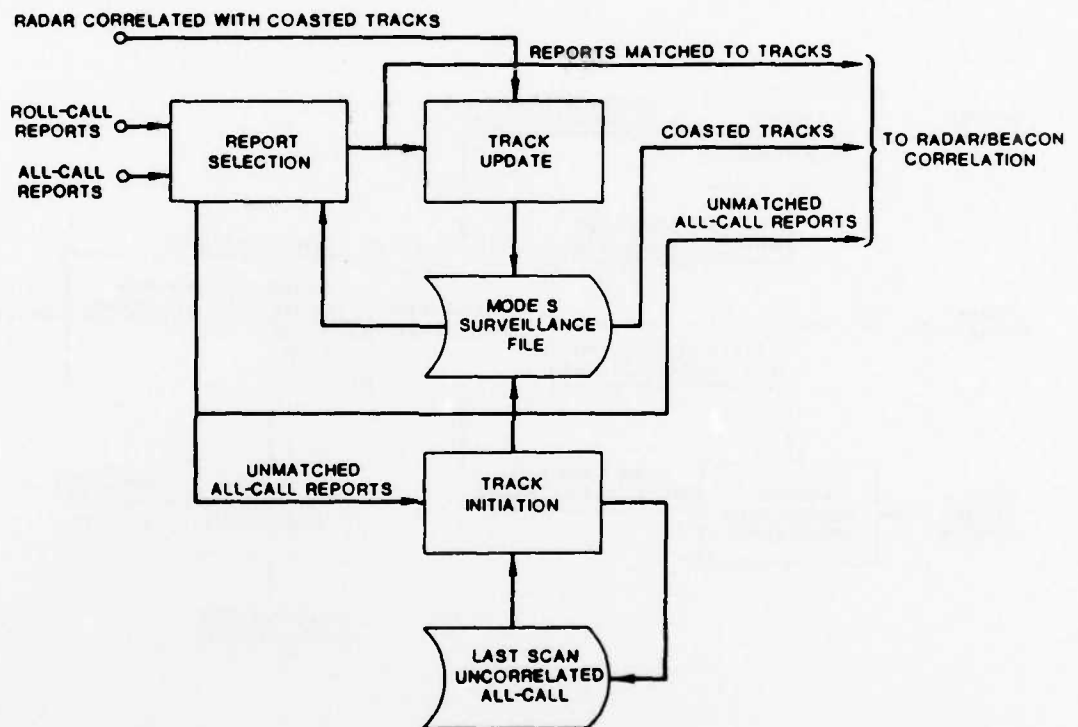

Fig. 3-15. Mode S surveillance processing.

ATCRBS Surveillance Processing

ATCRBS surveillance processing (Fig. 3-16) edits, and corrects as necessary, ATCRBS target reports by comparing reports received on the current scan with target tracks derived from reports received on previous scans. Editing includes eliminating residual fruit replies which may have been passed by the ATCRBS reply correlator, and flagging reports suspected of being due to reflections, i.e., false targets. When target reports correlate with an existing track, missing or low-confidence code bits may be corrected by insertion of the corresponding bits from the track file.

The lack of a unique identity code as part of each ATCRBS reply (as opposed to Mode S replies) makes necessary a report-to-track correlation function as the first step in ATCRBS surveillance processing. Report-to-track correlation is based upon the several attributes of the report. A report is said to be associated with a track if it falls within a specified range, azimuth, altitude association interval. Then, if only one ATCRBS report associates with a single track, that report/track pair is declared correlated. For those cases where more than one report associates with a track, or more than one track associates with a report, or both, report and track correlations are based upon the following factors:

- (a) code match
- (b) number of replies in the report
- (c) altitude match
- (d) track maturity
- (e) distance parameter.

During track update, a special code situation is sensed. If the Mode A code of the report does not match the code of the track, it is assumed that a code change has been made in the aircraft and a transition situation is noted. After three scans of consistent new code, the track file code is updated.

ATCRBS fruit are discarded by rejection of all reports that do not correlate with a track and which are comprised of a single Mode A reply, a single Mode C reply, or two replies - one Mode A and one Mode C.

The test for determining whether a report is false (i.e., due to a reflection) is initiated by comparing the ATCRBS report azimuth with a stored table of reflections zones. If the report is in one of the reflection zones, then an image location is calculated and compared against known tracks. If a known track with matching altitude and Mode A code could have caused the report, the report and any track started from it will be tagged as potentially false. Each scan thereafter, the false track is examined to see if it continues to satisfy the "false track" criteria.

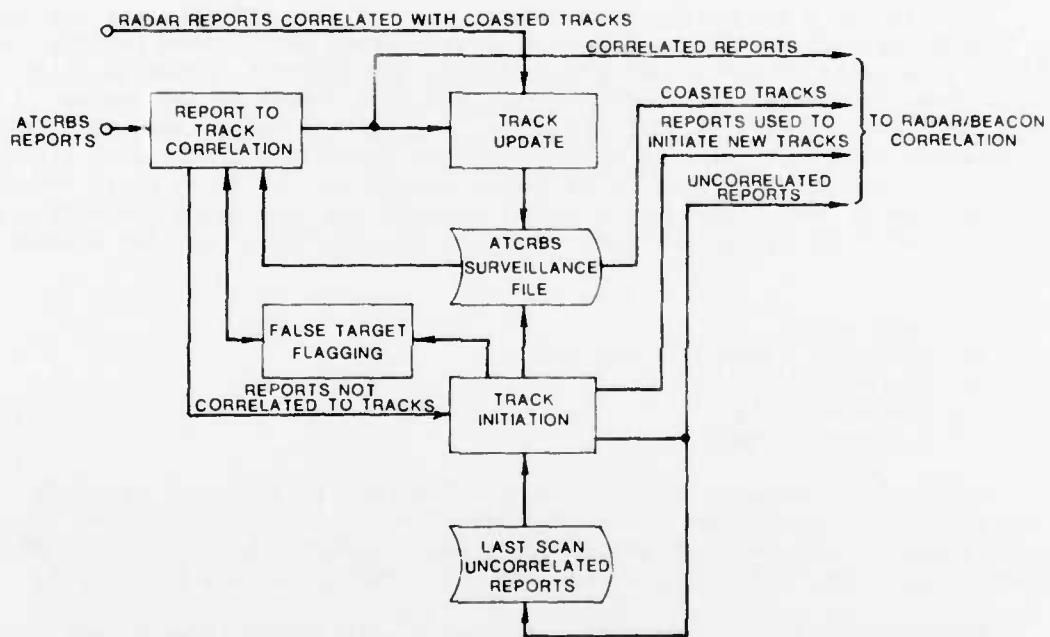

Fig. 3-16. ATCRBS surveillance processing.

Radar/Beacon Correlation

The last step in beacon surveillance processing prior to data dissemination is the comparison of radar reports from a collocated radar with the result of Mode S and ATRBS report processing.

A radar report correlates with a beacon report or track if it satisfies certain distance criteria. When a radar report and a beacon report correlate, the beacon report is said to be radar reinforced. When a radar report correlates with a beacon track for which no beacon report was received during the current scan, the track is updated using the radar report, and a radar substitution report is disseminated.

Radar Surveillance Processing

Radar surveillance processing (Fig. 3-17) compares current scan radar reports with those received on previous scans in order to filter out reports representing false alarms from clutter, birds, automobiles, or other system effects. Only radar reports not correlating with beacon reports or tracks enter into this process, thus preventing two tracks from being created for one aircraft. Only radar reports correlating with existing radar tracks are output, thereby preventing a high false alarm rate from affecting surveillance link throughput.

Since radar reports have neither an identity code nor an altitude, both the report-to-track correlation and track initiation procedures are more subject to error than with ATRBS reports. The process of association is essentially one of range and azimuth testing, although the presence of doppler velocity in an MTD radar system provides another, although weak, association attribute.

To overcome the higher false alarm rate and lack of correlation criteria, radar tracking is more cautious than the ATRBS version. In particular:

- (a) more reports are required to initiate a track,
- (b) reports are flagged in certain site-dependent areas known to contain roads or severe clutter,
- (c) more smoothing is employed in the prediction equations.

Surveillance Data Output

At the completion of surveillance processing there are several classes of reports to be disseminated. These are:

- (a) beacon, radar reinforced;
- (b) beacon, not radar reinforced;
- (c) radar correlated with coasted beacon tracks; and
- (d) correlated radar.

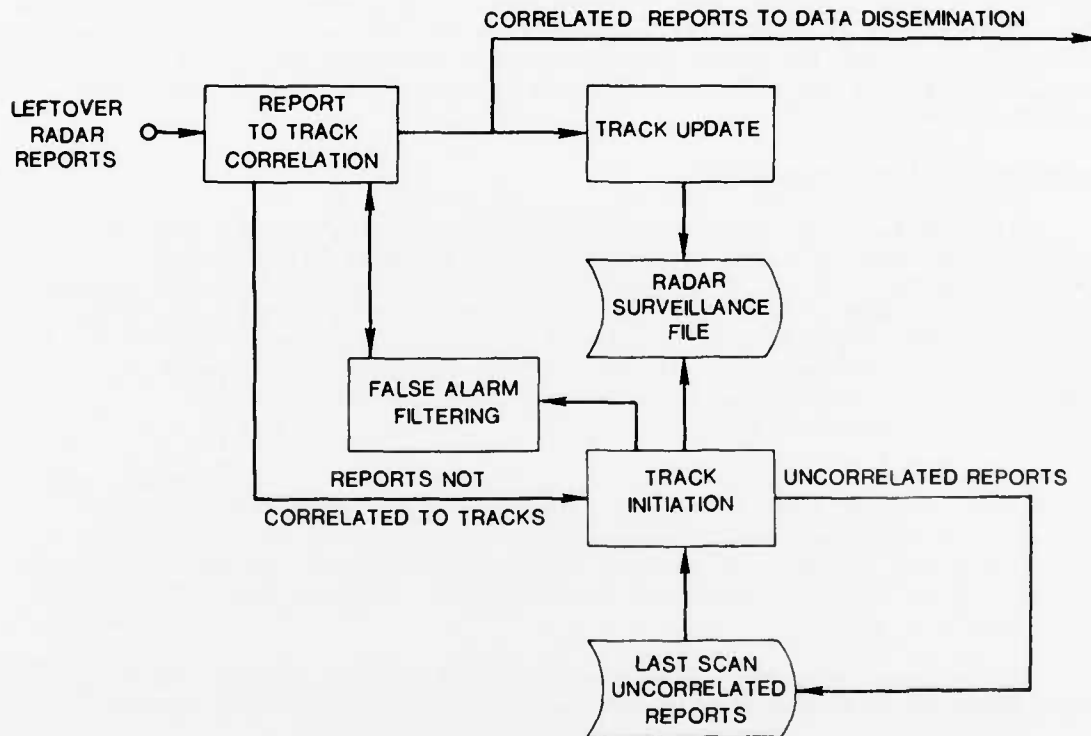

Fig. 3-17. Radar surveillance processing.

Reports are selected for dissemination to connected ATC facilities through the use of a site adaptable dissemination map. This dissemination map defines the areas of interest for each ATC facility in terms of a minimum and maximum range and altitude for each $11\ 1/4^\circ$ azimuth sector.

DATA LINK PROCESSING

Data link processing regulates the flow of messages on the air-ground link. This is accomplished through the maintenance of a file, called the active message list, which contains a record of all of the pending communications activities. Entries in this file are organized by Mode S address and are used by channel management to determine the number and type of interrogations and replies to schedule for an aircraft when it is available in the antenna main-beam.

As shown in Fig. 3-18, the two major subfunctions of data link processing operate to update the active message list. Input processing handles messages received from ground users of Mode S and in general is involved with additions of ground-to-air messages to the active message list. Output processing examines the transaction record prepared by channel management. The transaction record together with reply message contents indicate which communication activities are complete and which, if any, transponders are requesting an air-to-ground message transfer.

Input Processing (Fig. 3-19)

Communication messages (Ref. 6) are received from the ATC interface. In order to be considered for delivery during the current scan, a message must be received by the sensor at least two sectors ($22\ 1/2^\circ$) ahead of the azimuth at which the addressed aircraft will enter the antenna beam. A test is made to determine the status of the addressed Mode S aircraft in the local surveillance file. If the Mode S aircraft is not contained in the file, an immediate message reject notice is generated and sent to the message originator. If the Mode S aircraft is in the file but has not replied to interrogations for one or more scans, requests for uplink delivery will be accepted but the sender will be issued a message delay notice. The message type is detected and the active message list is updated. This updating takes place according to an implicit and a user defined priority. The implicit structure of data link processing and channel management places downlink extended length messages at a lower priority than the shorter, standard messages or uplink ELM's. Further priority assignment can be made by the ATC authority. If a message is flagged as priority, then it enters the active message list for the addressed aircraft ahead of any pending low priority messages of the same category.

Output Processing (Fig. 3-20)

Mode S replies from the current scan are checked for an indication of successful uplink message delivery and for requests for new air-to-ground message transfers. Downlink messages included in the replies are detected, flagged as complete, and routed to intended recipients as indicated by

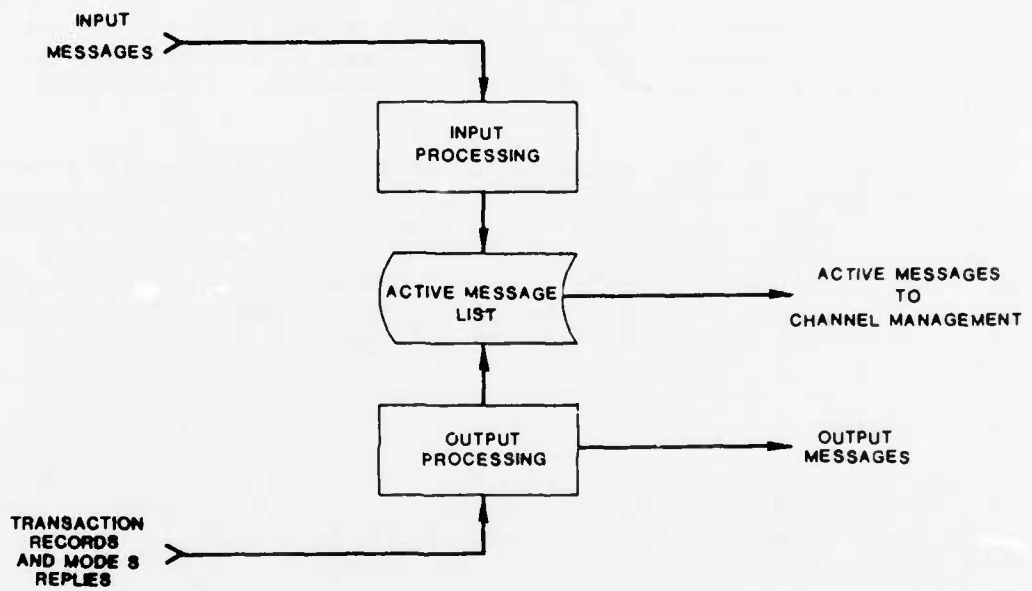

Fig. 3-18. Data-Link processing.

(c) Report-to-track correlation units, and correct to identify target reports by comparing them with a track file generated from reports received on previous scans. This step assists in the elimination of mainbeam fruit, the flagging of false targets, and the correction of missing and garbled code pulses.

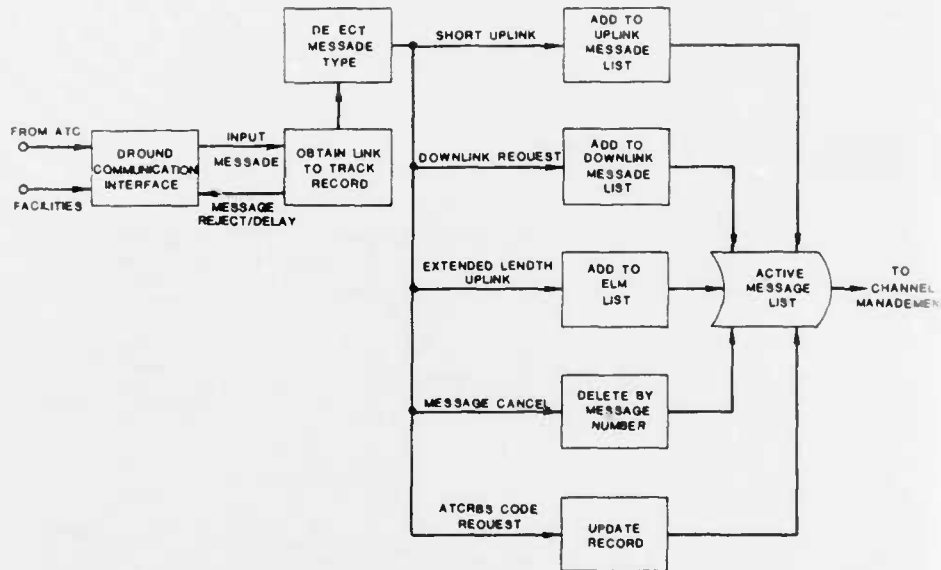

Fig. 3-19. Input message processing.

AD-A132 282

MODE S BEACON SYSTEM: FUNCTIONAL DESCRIPTION REVISION C
(U) MASSACHUSETTS INST OF TECH LEXINGTON LINCOLN LAB
V A ORLANDO ET AL. 15 JUL 83 ATC-42-REV-C

2/2

UNCLASSIFIED

DOT/FAA/PM-83/8 F19628-80-C-0002

F/G 17/9

NL



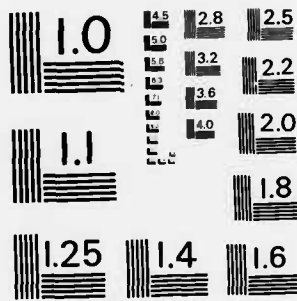

MICROCOPY RESOLUTION TEST CHART
NATIONAL BUREAU OF STANDARDS - 1963 - A

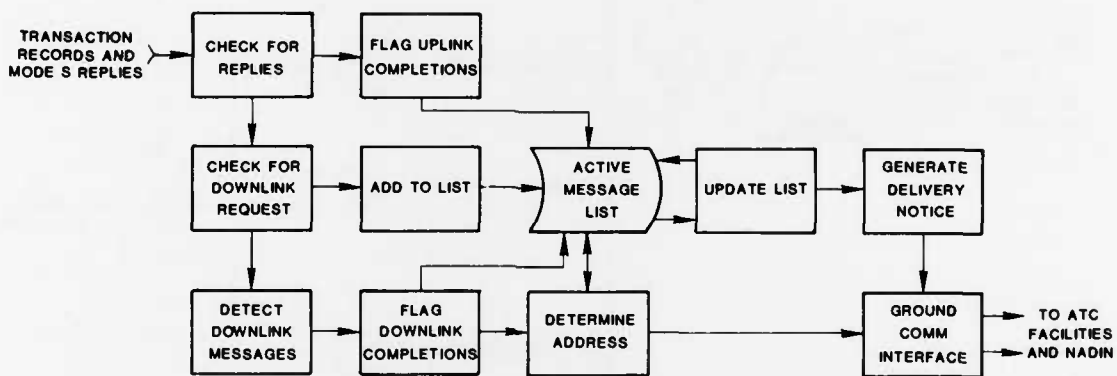

Fig. 3-20. Output message processing.

information stored in the active message list (for ground-initiated messages), or to all appropriate ground facilities (for pilot-initiated messages). In the latter case, the dissemination rules depend on the character of the downlink message (as defined in a message definition subfield) and on aircraft position. The final task involves updating the list to reflect additions and completions this scan, and the generation of delivery notices.

NETWORK MANAGEMENT

Network management provides for continuity of surveillance and data link services in situations where adjacent sensors have overlapping coverage. When netted, Mode S sensors exchange surveillance data to hand off targets between sensors and to maintain surveillance continuity and rapid target reacquisition in the event of a temporary link interruption. This multisensor coordination is directed by the network management function, operating under the control of the sensor coverage map.

An overall block diagram of the network management function is presented in Fig. 3-21. Once each scan, each Mode S track is processed by coverage coordination to determine if a boundary crossing has occurred. For non-netted sensors, this event will cause the coverage coordination function to manage Mode S lockout status in order to permit acquisition via all-call interrogations. In the case of netted sensors, a check is made for a boundary crossing or a track state change. Either of these events will cause control message handling to initiate a sequence of messages. The former results in a flow of track data to the sensor whose boundary was crossed; the latter results in a request, or cancellation of a previous request, for surveillance data to fill in during a link interruption. Control message handling also processes network control messages from adjacent sensors and ATC facilities and retrieves or stores data in the surveillance file as required.

The Coverage Map

The extent and type of coverage to be provided by each sensor is controlled by a data file known as the sensor coverage map. In general, two major boundaries are defined by this map;

- (a) the maximum range at which the sensor is to provide surveillance coverage, and
- (b) the area where the sensor is assigned primary responsibility (for uncontrolled aircraft only).

The coverage map is implemented in a $\rho - \theta$ grid as shown in Fig. 3-22. For each element of the grid, termed a cell, a sensor priority list is specified, with a lower altitude cutoff defined for each sensor. The position of a sensor in the list specifies its surveillance function in that cell; primary, secondary, or backup. Sensor coverage boundaries are thus defined by a change in sensor ordering between adjacent cells. For each controlled aircraft, a message from an ATC facility assigning primary or secondary status has the effect of overriding the map designation.

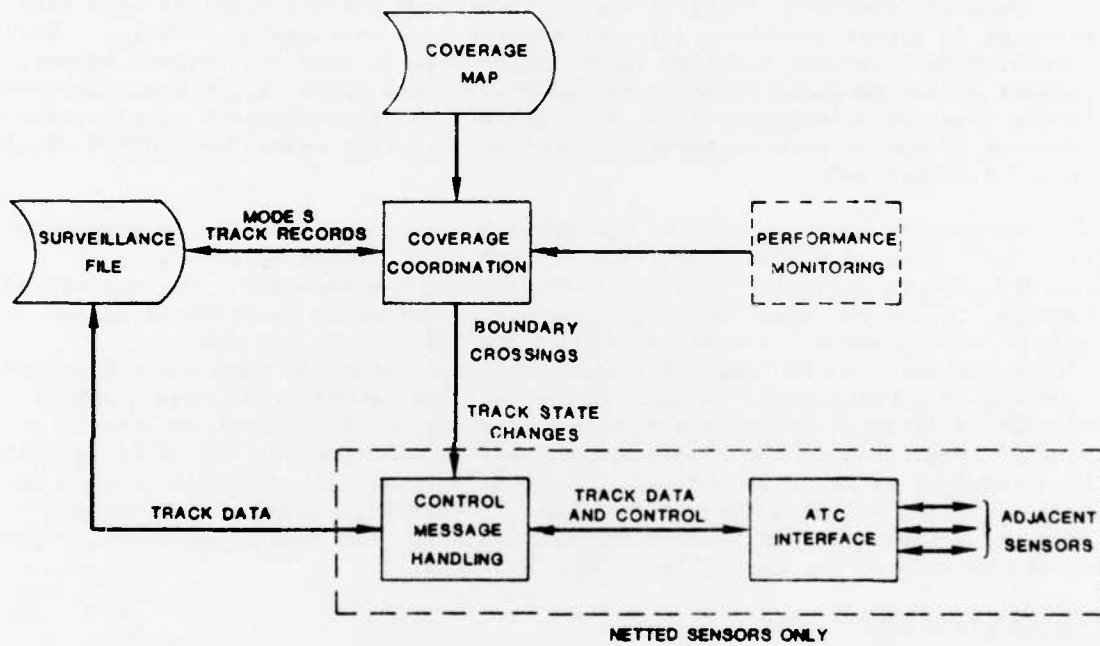

Fig. 3-21. Network management.

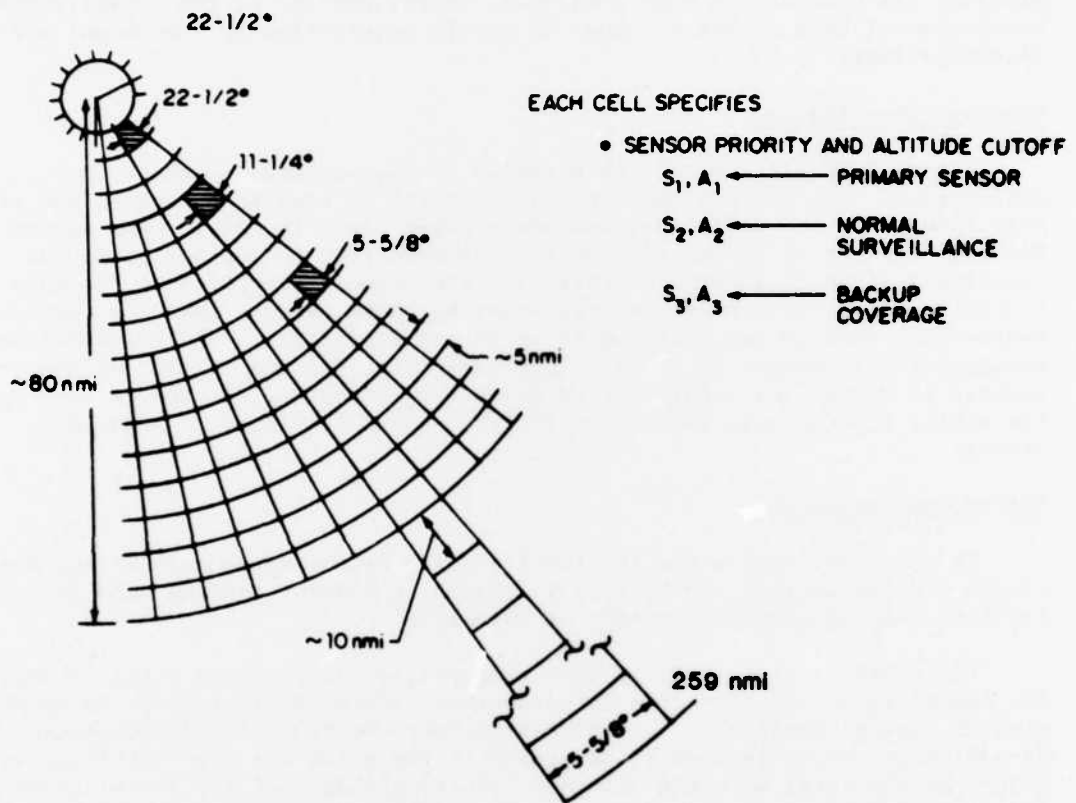

Fig. 3-22. Coverage map grid structure.

In the event of a sensor failure, that sensor is flagged as inactive, effectively deleting it from the sensor priority list. In this way the primary and secondary coverage areas of active sensors are automatically enlarged to take over (to the extent possible) the area formerly serviced by the failed sensor. In the event of failure of sensor-to-sensor communications for a netted sensor, the sensor affected is temporarily treated as non-connected. That is, aircraft are unlocked to Mode S all-call interrogations at the surveillance boundaries of this sensor in order to permit acquisition by its normal all-call interrogations.

Coverage Coordination

Figure 3-23 illustrates the elements of the coverage coordination subfunction. The current position of the track is used to determine the present cell index. If the cell index has not changed since the last scan, and no failure/recovery of an adjacent sensor has occurred, no further action on coverage assignment is done. Otherwise, the sensor priority list for this cell is retrieved from the coverage map, deleting those sensors that the performance monitoring function has declared to be in a failed state. The resulting sensor assignment is compared to the previous assignment (stored as part of the track record) to detect the occurrence of a boundary crossing. If one is detected, the action depends upon whether or not the sensor is netted to adjacent sensors.

Netted Configuration

In configurations where the local and adjacent sensors communicate via a common ATC facility, an indication is passed to control message handling to initiate the appropriate sequence of messages.

The present track state is then compared to the previous state to detect the beginning or end of a link interruption. Again, an indication is passed to control message handling to begin or terminate the flow of adjacent sensor data. An additional check is made to determine if the track was just initiated as a result of the local sensor's all-call interrogations. If so, surveillance data on this track is disseminated to the other assigned sensor(s) in the cell by control message handling, using the same message sequence as for a surveillance boundary crossing.

Where the new cell data indicate a primary/secondary status different from the one in effect for an uncontrolled aircraft, a primary coordination message exchange is initiated. A typical primary coordination exchange involves a local sensor initiating a request for primary assignment to an adjacent sensor when an aircraft first enters the local sensor's primary coverage area. If the adjacent sensor has not as yet acquired the track then it will respond with a "primary approved" message. If the adjacent sensor has the aircraft in track and assigned primary (due to the overlapping primary assignment needed for continuous primary coverage) then it will send a "primary disapproved" message. The coordination is completed when the adjacent sensor's map no longer indicates primary status for this aircraft. The adjacent sensor sends a request for secondary assignment to the local sensor and assigns itself secondary when an "accept primary" response is received.

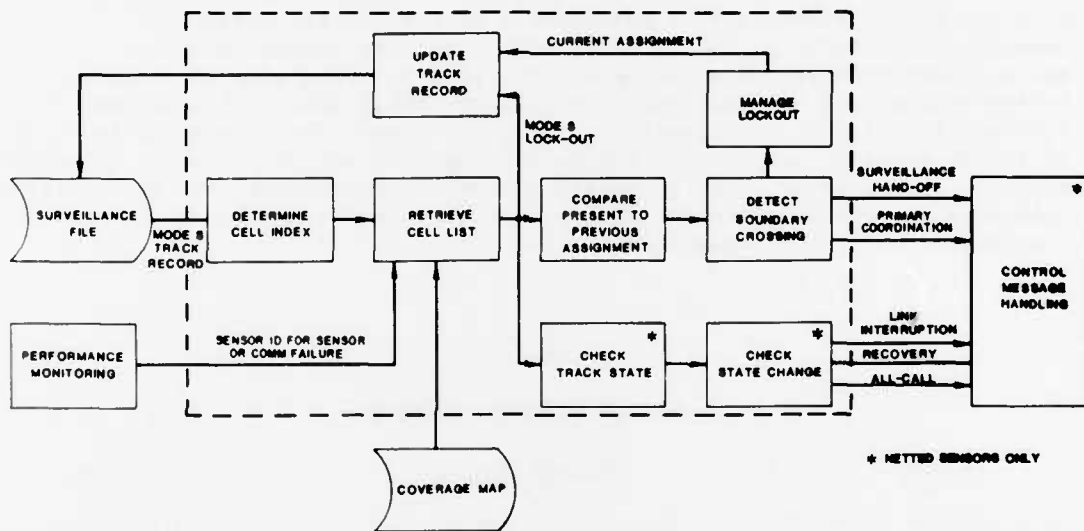

Fig. 3-23. Coverage coordination.

Certain events cause a sequence of messages to be exchanged between Mode S sensors. These events, and the resulting messages, are listed in Table 3-1.

Messages on ATCRBS targets are limited to an exchange of track data on request for Mode-C equipped aircraft. The sequence of ATCRBS control messages used to establish this exchange is similar to that shown in Table 3-1 for the Mode S track state change event.

Non-netted Configuration

In configurations in which an adjacent assigned sensor does not communicate with the local sensor (either permanently or temporarily because of communications failure), it is necessary to provide another means of surveillance handoff. This can be accomplished by using site-addressed all-call interrogations or, alternatively, by intermittently unlocking each Mode S aircraft to all-call interrogations for a few scans. The parameters for a cycle of unlock and lock periods for the latter approach are chosen so as to minimize possible interference while providing adequate opportunities for acquisition. Communication coordination for either configuration is handled by the transponder multisite communications features.

TABLE 3-1
CONTROL MESSAGE HANDLING

<u>Event</u>	<u>Message Sequence</u>	<u>To/From</u>
Surveillance Handoff	Send Data Start to Send Track Data to Receive Cancel Request from Send Data Stop to	The New Active Sensor in the Cell
Track State Change	Send Data Request to Send Data Start from Receive Track Data from Send Cancel Request to Receive Data Stop from	The Other Active Sensor(s) in the Cell
All-Call Acquisition	Send Data Start to Send Track Data to Receive Cancel Request from Send Data Stop to	The Other Active Sensor(s) in the Cell
Primary/Secondary Coordination (for uncontrolled aircraft)	Send Request for Primary/ Secondary Assignment to Receive Primary Approved/ Disapproved/Accepted from	The Other Active Sensor(s) in the Cell

PERFORMANCE MONITORING

The ability of the sensor to perform its surveillance and communication tasks is continuously checked by the performance monitoring function (Fig. 3-24). Three categories of checks are performed:

- (a) Overall checks for proper surveillance and data-link operation.
- (b) Internal checks on the status of the sensor hardware and software.
- (c) External checks on the status of adjacent sensors (when netted) and their ability to provide the local sensor with correct surveillance data.

The results of these checks are evaluated once per scan to determine the status of the sensor. Possible status conditions are:

- (a) Normal operation (condition green) - no abnormal indications.
- (b) Marginal operation (condition yellow) - operational but becoming marginal.
- (c) Failed state (condition red) - sensor operation ceases.

Declared sensor status is reported once per scan to the ATC interface along with condition codes that define the reason(s) for the yellow or red condition. A simplified version of this message indicating only the declared condition is sent to all netted adjacent sensors.

The sensor performance monitoring function interfaces with the FAA's remote maintenance monitoring subsystem (RMMS). The RMMS also receives the sensor status message and, in addition, has the capability of remotely controlling sensor functions such as initial loading and start up, parameter modification and the switching of redundant elements.

Calibration Performance Monitoring Equipment (CPME)

The CPME is a transponder-like device, several of which are deployed in close proximity to each sensor.

CPME's serve as the basis for the overall operational surveillance checks by providing replies from "aircraft" with known identification and position (range, azimuth, altitude). Overall operational communication checks are performed by loop tests with the CPME. In these tests an uplink test message delivered to the CPME causes it to initiate a downlink message with the same text as contained in the uplink message.

The ability to obtain surveillance data from an adjacent netted sensor is also checked using the CPME. In this case, the local sensor requests data on the CPME of an adjacent sensor. Data received in response to the request are checked against the stored data to verify correct delivery.

MESSAGE ROUTING MANAGEMENT

Message handling between sensor functions and the external interfaces is performed by the sensor message routing management function. The principal flow of messages is from the external interface to the local network management, performance monitoring and data link processing functions. Additional tasks are performed on outgoing messages, particularly to support requirements of data link users not connected to ATC facilities.

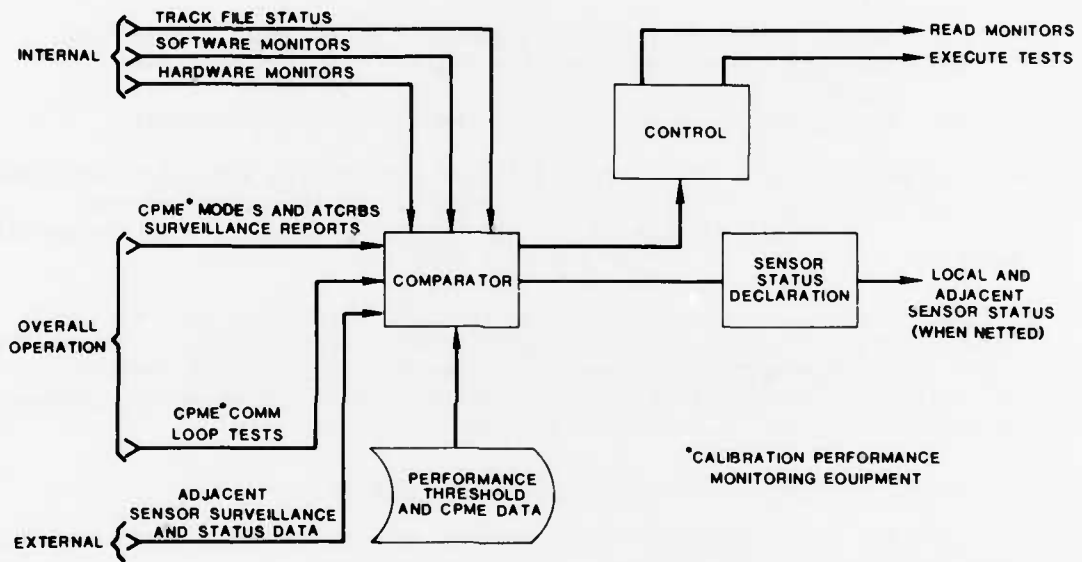

Fig. 3-24. Performance monitoring.

CHAPTER 4

THE MODE S TRANSPONDER

The Mode S transponder receives and decodes ATCRBS and Mode S interrogations, recognizing which Mode S interrogations are addressed to it*. Based upon the type of interrogation, and the contents of the control field in the Mode S interrogation, the transponder formats and transmits the appropriate ATCRBS or Mode S reply. As in the case of an ATCRBS transponder, inputs from an encoding altimeter are required for altitude reporting.

For data link transactions, both standard and ELM, the transponder acts as a modem. Uplink messages, once verified**, are passed on to external display devices. Downlink messages are accepted from external message input devices, encoded by the addition of parity check bits, and transmitted. The transponder does not interpret or modify in any way the contents of such messages.

By keeping most data link functions external to the transponder, the complexity and cost of the basic transponder can be kept at the minimum required for its surveillance functions. The additional costs associated with the data link functions are incurred only by users desiring those services.

Mode S transponders may be equipped with a standard message interface, providing outputs to standard message input/output devices. Only transponders used in installations with data link devices will need the additional logic and control functions required for accepting and transmitting extended-length messages.

The Pilot Interface - Controls and Indicators

Figure 4-1 depicts the controls and indicators of a Mode S transponder as they might be arranged on the front panel of a general aviation transponder. (The same functions would be provided for an air carrier transponder, but as part of a remotely-mounted control head.) All normal ATCRBS controls and indicators are retained, including:

- 4096 code selector
- Ident button
- ATCRBS reply indicator
- Power switch

*Each Mode S transponder must be able to recognize the discrete address set into it, and the address used in Mode S-only all-call interrogations and one-way, broadcast transmissions.

**Recognition of its address is implicit verification that the contents of the interrogation were correctly decoded.

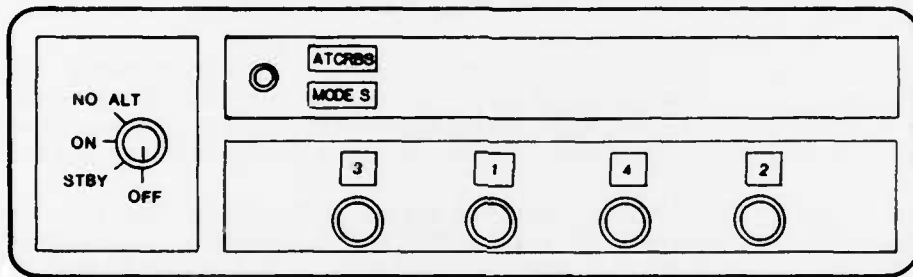

Fig. 4-1. Transponder panel.

In the "ON" position of the power switch, altitude reports are included in Mode C and Mode S replies. A "NO ALT" position is included to inhibit altitude reporting in both Mode C and Mode S.

Each time the pilot changes the transponder's 4096 code an alert code is automatically set in the next Mode S reply. The interrogator then reads out the new code which possibly could report an emergency condition. This scheme allows the 4096 code to be used for limited air-to-ground communication. The alert code is transmitted to the ground for 18 seconds unless the 4096 code set by the pilot indicates an emergency, in which case the alert persists until the emergency code is removed by the pilot.

Performance Characteristics

The performance characteristics of a Mode S transponder are similar to those of an ATCRBS transponder designed for the same class of service. In fact, when operating in the ATCRBS mode (receiving and replying to ATCRBS interrogations), the Mode S transponder conforms to all requirements of the ATCRBS transponder Technical Standard Order. Power output and sensitivity requirements for Mode S transponders are as follows:

	<u>General Aviation below 15000 ft</u>	<u>Air Carrier</u>
Minimum Power Output	18.5 dBW	21 dBW
Maximum Power Output	27 dBW	27 dBW
Sensitivity	-74 ±3 dBm	-74 ±3 dBm

The values for sensitivity and power are measured at the antenna end of the cable between the transponder and antenna.

Two important performance characteristics peculiar to the Mode S transponder are:

- (a) The Mode S reply delay (the time between the sync phase reversal in the Mode S interrogation and the beginning of the reply) is 128 μ s. This provides sufficient time for the transfer of the message contents of the interrogation to an external display device before beginning transmission of the reply.
- (b) In order to enhance Mode S link reliability in the presence of interference from ATCRBS interrogators, the Mode S transponder is required to recover its sensitivity for Mode S interrogations rapidly following the receipt of an ATCRBS P1-P2 suppression pair, and to

decode Mode S interrogations in the presence of interfering pulses whose amplitudes are at least 6 dB below that of the Mode S interrogation.

Block Diagram

The principal elements of the Mode S transponder, and their interconnection, are depicted in Fig. 4-2. Many elements are similar or identical to the corresponding elements of an ATRBS transponder. In particular, the RF units, comprising the receiver, transmitter, and modulator, are essentially identical to the corresponding ATRBS units.

Diversity

All aircraft types exhibit nulls in certain directions in their transponder antenna patterns due to airframe shielding. While these nulls are generally confined to angles above the horizon, and thus do not seriously affect the ground-to-air link when the aircraft is in straight and level flight, they can cause degradation of the link when the aircraft is in other flight attitudes. These nulls can cause failure of the air-to-air link used by airborne collision avoidance systems.

In order to maintain adequate link reliability, large aircraft may be equipped with a diversity transponder. Two antennas located so that at least one is visible from any direction, are connected to the transponder. Probably the simplest form of the diversity transponder is one that employs two receivers, selection logic, and a switch to connect the transmitter to either antenna (Fig. 4-3). The selection logic examines the interrogation as received on each antenna, selects the stronger signal and switches the transmission to the corresponding antenna for the reply.

Data Link Interfaces

Mode S transponders used for data link transactions may have two types of interfaces.

Standard-Length Message interface: A transponder with this interface is capable of transferring data in both directions using the Comm-A and the Comm-B formats. Hence, the interface must also be capable of supporting all of the requirements of the Comm-B air-to-ground message protocol. One feature of this protocol is that it requires the transponder to reply to an interrogation with data that is designated or selected by the contents of that interrogation. This requirement can be met in either of two ways:

- a. The transponder can be designed to buffer the content of the air-to-ground data link messages internally, or
- b. The transponder can be equipped with a data interface that transfers the contents of an interrogation out of the transponder before the reply is generated so that these contents can be used by an external device to select the appropriate data for inclusion in the reply.

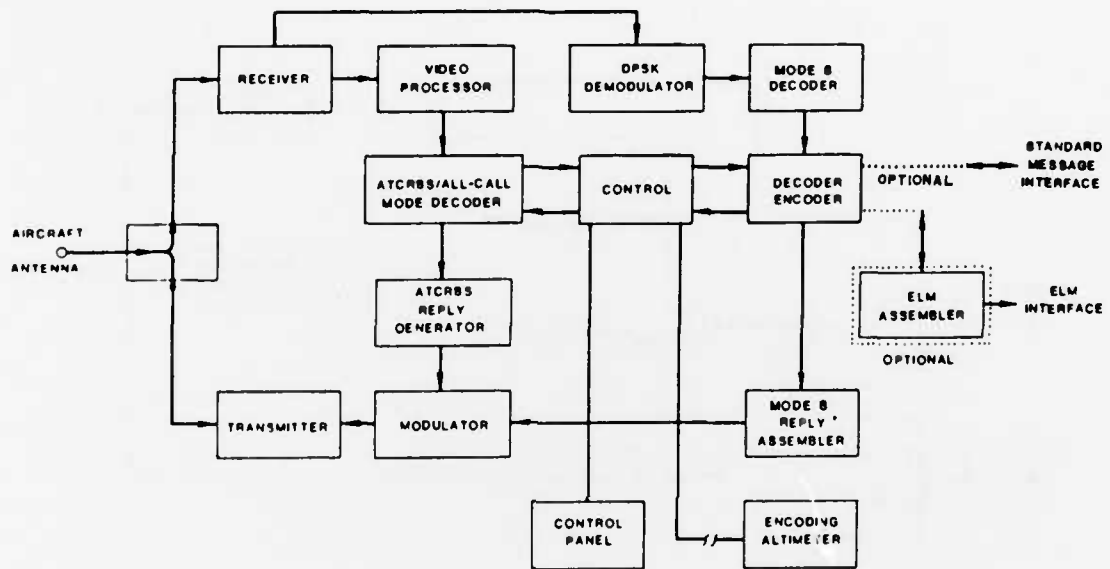

Fig. 4-2. Mode S transponder.

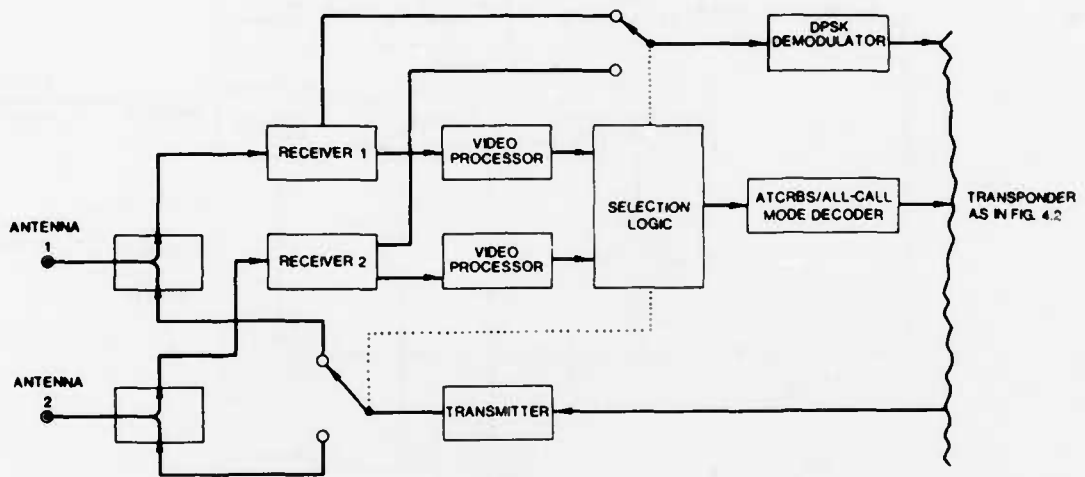

Fig. 4-3. Diversity transponder.

The second type of interface is designated as a "real time" interface. It has the advantage that the necessary control logic and data buffers need not be included in the transponder. A further advantage is that multiple data peripherals can be accommodated without modifying the transponder in any way.

A practical realization of a real time interface has been employed in experimental Mode S transponders. Known as the "standard message interface", it consists of a unidirectional clock line and a bidirectional data line (similar to the two-way serial bus used in conventional computer interfaces). The data rate in either direction is 1 Mbps. The data line is a differential, 3-state line, allowing bidirectional party-line operation. Any one of the devices attached to the data line (including the transponder) may drive the line at the appropriate time. The clock line, which is a two-state line since it is driven only by the transponder, allows I/O devices to time their operations so that they extract data from the data line at the proper time and so that they may merge data into the reply data stream at the appropriate time.

Figure 4-4 is a timing diagram for the standard message interface. After the uplink transmission has been verified, the entire uplink message block, including all control fields but excluding the parity field, is transferred out over the interface. This allows flexibility for expansion to additional display and readout functions. Data to be transferred into the interface are synchronized so that they can be merged into the downlink transmission without buffering.

A take-over feature is provided such that an attached device can sense the format and content of an interrogation for which the transponder may not have the necessary reply capability because this new format may not have existed at the time of transponder construction. If the attached device generates a take-over pulse, the transponder lets the attached device generate the complete downlink format for the reply.

Extended-Length Message Interface: A transponder equipped for extended length message operation is capable of receiving, verifying, storing and acknowledging an uplink ELM transmission and also may be capable of assembling and transmitting an ELM downlink message. The content of an ELM message enters and leaves the transponder via an interface tailored to the data handling system of the aircraft.

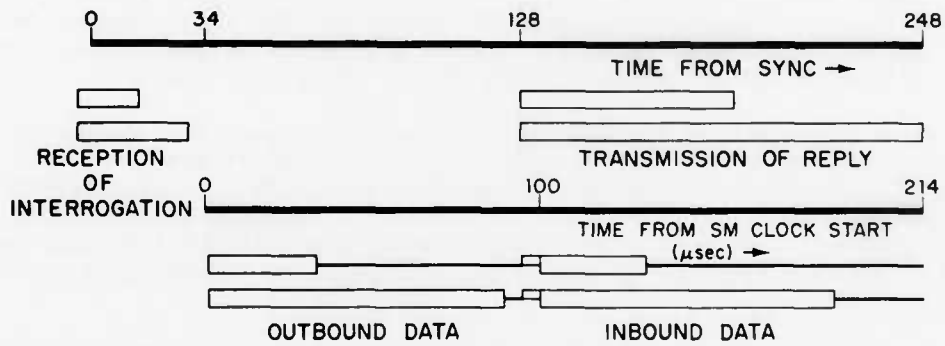

Fig. 4-4. Standard message interface timing diagram.

CHAPTER 5

PERFORMANCE

To adequately support an increasingly automated air traffic control system, Mode S must provide reliable and accurate surveillance and data link communication for large numbers of aircraft. This chapter summarizes three particularly important aspects of Mode S performance: link reliability in the presence of interference and fading, the azimuth measurement accuracy achievable with off-boresight monopulse, and the target capacity of a sensor using roll-call interrogation.

LINK RELIABILITY

The term link reliability is used to denote the probability of a successful link transaction such as a surveillance update or delivery of a data link message. Limitations on link reliability are primarily due to interference and fading. This section summarizes these effects, illustrating the link reliability achievable under various typical conditions.

Link Power Budget

Table 5-1 gives Mode S link power budgets for an aircraft at 50 nmi range and 0.5° elevation angle, and using a typical antenna for a terminal interrogator. Two uplink power modes are shown. Most interrogations are transmitted at low power to minimize uplink interference. In the high power mode the uplink and downlink have essentially equal fade allowances, and this equality continues to hold at all other ranges and elevation angles.

Interrogator Antenna Lobing

The character and magnitude of ground-reflection-induced vertical lobing for interrogator antennas having different rates of lower-edge cutoff are illustrated in Fig. 5-1. The figure compares the performance of (1) the antenna used with the Mode S Experimental Facility (MODSEF) at Lincoln Laboratory, (2) an ASR-7 antenna fitted with an SSR feed and (3) the conventional "hogtrough" antenna. Vertical lobing depends on, among other things, the extent of flat ground in the vicinity of the antenna; the case represented in Fig. 5-1 is moderately severe in this respect, although not unusual. Oscillatory behavior of the pattern is evident, with the worst fades occurring at about 1° in elevation. Moderate changes in antenna height will shift the frequency of this oscillation within approximately the same envelope. The smaller null-depth of an antenna having a vertical pattern with sharp lower-edge cutoff is evident (Refs. 6 and 10).

Aircraft Antenna Fading

Installed aircraft antenna fading in free space is illustrated in Fig. 5-2, based on scale model measurements (Refs. 7, 12, 13, 14, 15). Each curve shows the probability of fade greater than a given magnitude for a particular type aircraft in a particular phase of flight (level or turning). The data in this figure are shown in separate plots according to whether or not the aircraft are equipped with antenna diversity and whether or not they are in straight or turning flight.

TABLE 5-1

MODE S LINK POWER BUDGET (TERMINAL SENSOR)

PARAMETER	UPLINK		DOWNLINK
	HIGH POWER MODE	LOW POWER MODE	
Transmitter Power	59 dBm	50 dBm	57 dBm
Coupling Loss, Sensor to Antenna		-1 dB	
Coupling Loss, Transponder to Antenna		-3 dB	
Ground Antenna Gain	Peak	21 dB	
	Elevation Factor (0.5 deg.)	-5 dB	
Aircraft Antenna Gain (nom)		0 dB	
Path Loss	Free-space (50 nmi)	-132 dB	-132.5 dB
	Atmospheric	-0.5 dB	-0.5 dB
Received Power	-61.5 dBm	-70.5 dBm	-64 dBm
Minimum Triggering Level	-77 dBm	-77 dBm	-79 dBm
Nominal Margin	15.5 dB	6.5 dB	15 dB

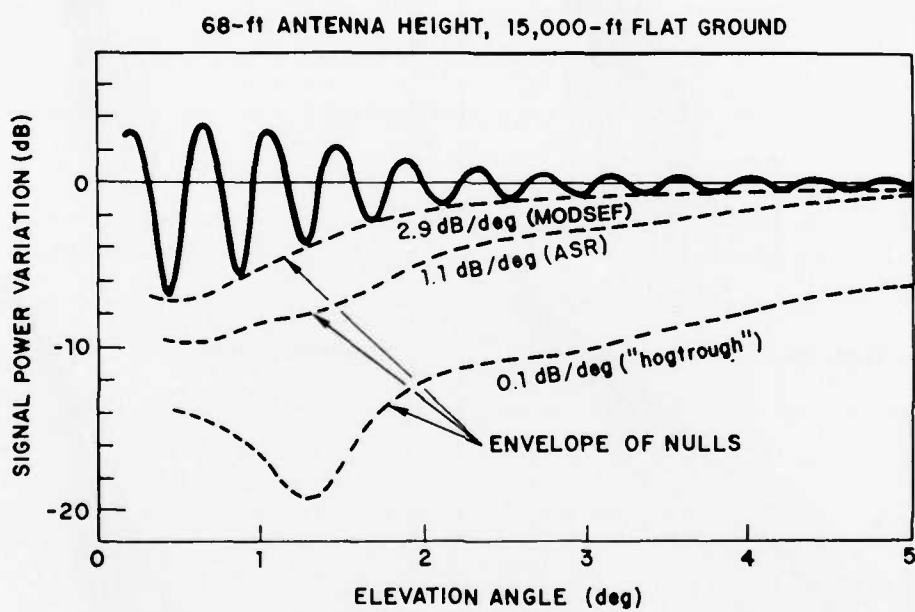

Fig. 5-1. Vertical lobing.

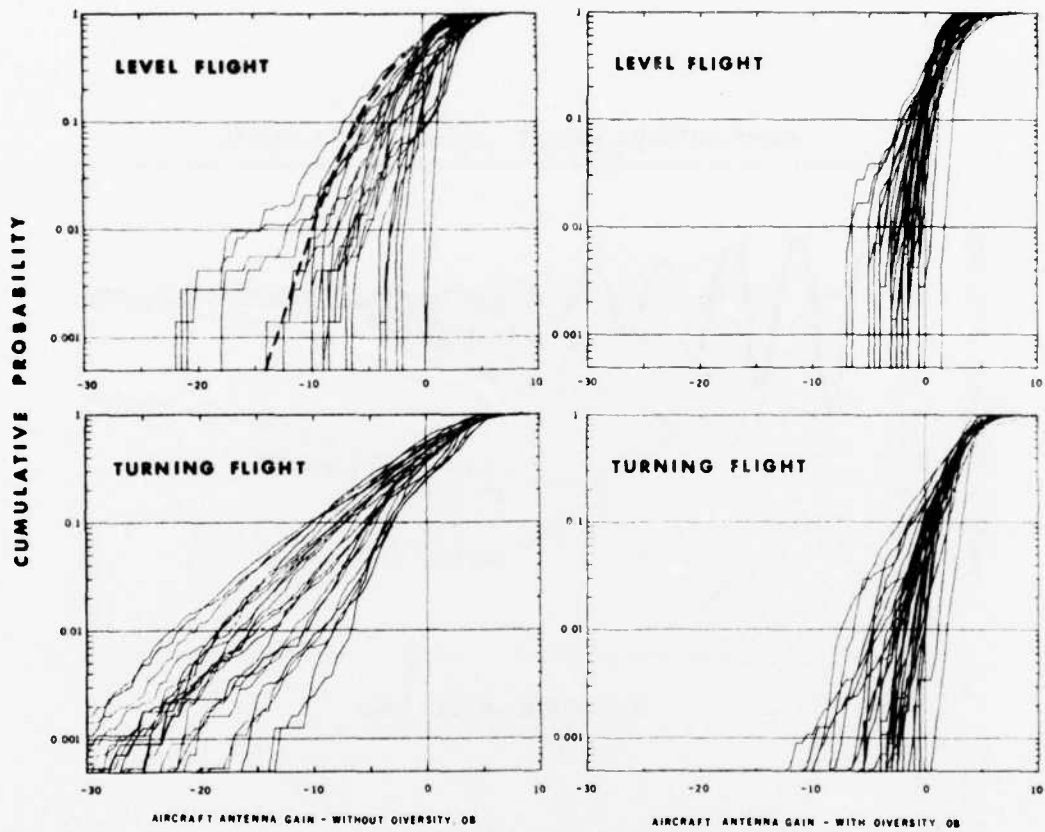

Fig. 5-2. Aircraft antenna fading.

It is evident that there are substantial differences among various aircraft types, and for the system to be tolerant to those aircraft-to-aircraft differences and still provide useful levels of link reliability, it is necessary to have at least 10 dB power margin just for aircraft antenna fading.

Interference Effects

Interference effects on link reliability are illustrated in Fig. 5-3. This figure shows miss probability for a single interrogation/reply versus received signal power level with and without interference. A heavy ATCRBS interference environment is assumed, representative of the interrogator and traffic densities predicted for the Northeastern United States in the mid-1980's time period.

At nominal received power levels, the round-trip miss probability due to interference is only a few percent. However, link fades, when they occur, cause power to drop and miss probability to rise substantially. For example, when received power drops to a few dB above the "minimum triggering level", roundtrip miss probability increases to about 40% (the bulk of this increase being due to the large amount of interference that exceeds a signal of this amplitude).

Since to a good approximation the occurrence of interference is independent from one try to the next, the ability to make multiple attempts in the event of a miss (adaptive reinterrogation) can substantially reduce its effect. The residual miss probability of a maximum of five tries is shown in Fig. 5-3. The miss probability with interference is now approximately the same as without, i.e., with noise alone. With adaptive reinterrogation, therefore, link reliability is determined by fade statistics rather than interference statistics; to a good approximation, the link reliability is the probability that fading is no worse than the link margin (Refs. 8 and 9). Furthermore, since reinterrogations, if any, are transmitted in the high-power mode, it follows that link reliability is determined almost entirely by the link budget in the high-power mode.

Net Link Reliability

Combining fade statistics with the available link margin leads to an estimate of link reliability in various cases. In the example considered above (Table 5-1), at 50 nmi and 0.5 deg. elevation, the nominal margin is 15 dB, which must be sufficient to offset adverse deviations due to vertical lobing, aircraft antenna fading, transponder sensitivity deviations, etc. Allowing 7 dB for vertical lobing and transponder parameters, the remaining 8 dB when applied to the "typical" aircraft characteristic (shown as a dotted line in Fig. 5-2) results in a link reliability of about 99% for straight flight, non-diversity.

Similar calculations have been carried out for numerous values of range and altitude, leading to the results shown in Fig. 5-4. These calculations are more elaborate than the simple calculations given above: the model includes a population of transponder powers and sensitivities (over the tolerance ranges

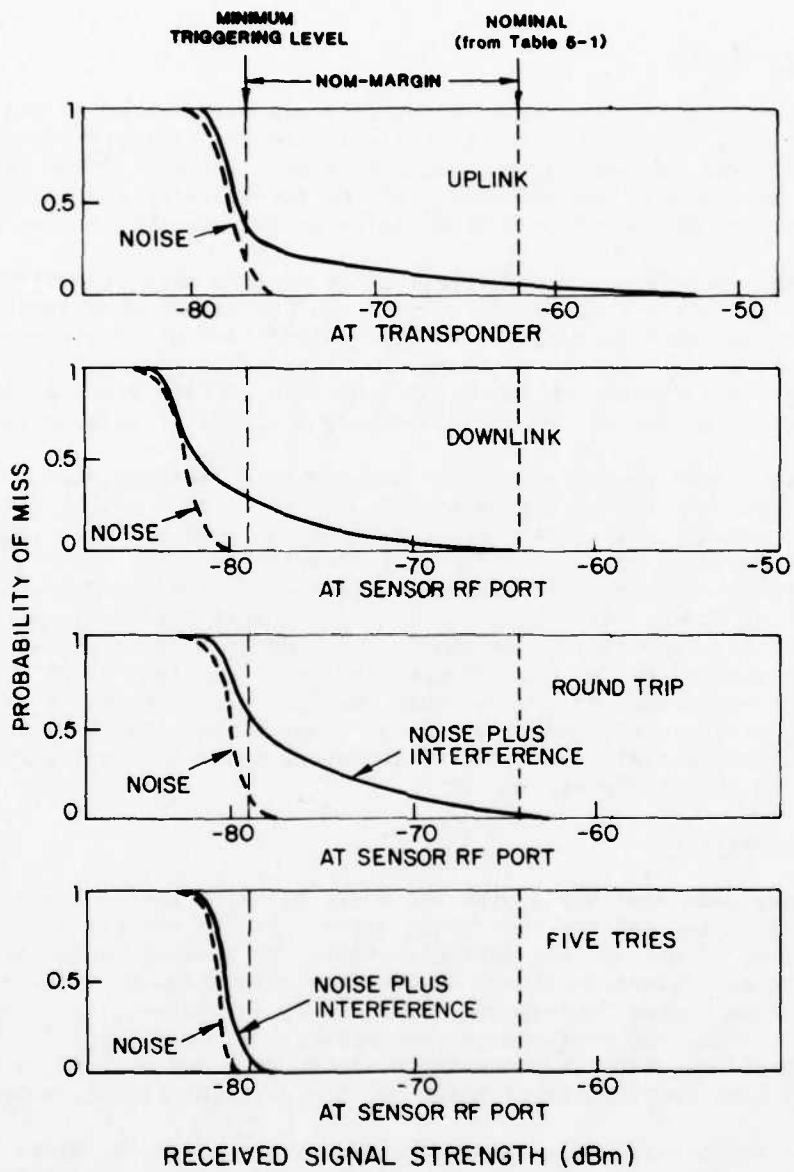

Fig. 5-3. Miss Probability.

NOTE: Two Scan Link Reliability LR_2 = Fraction of Aircraft for Which Surveillance Update is Successful at Least Once in the Next Two Scans.

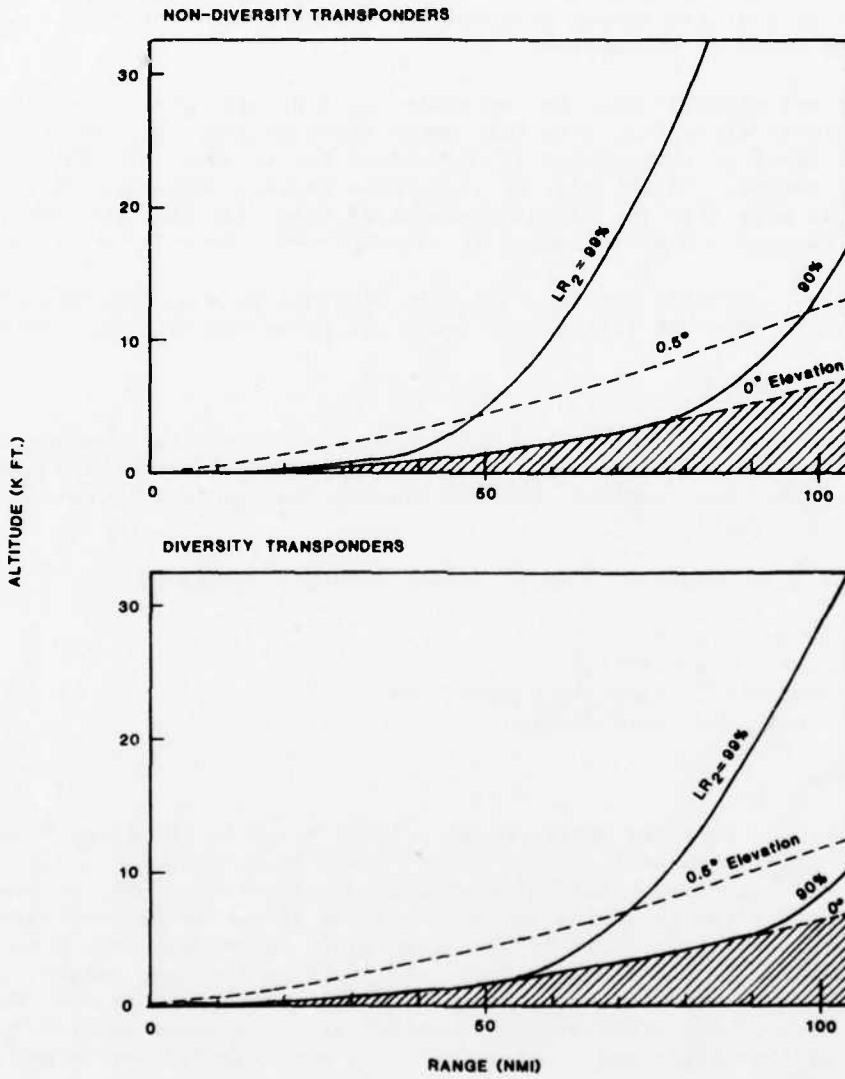

Fig. 5-4. Mode S link reliability for a terminal ground station.

given in Chapter 4), statistical representation of vertical lobing, and a mix of turning and straight flying aircraft. The two-scan link reliability plotted was adopted because it is a more useful figure of merit for characterization of a Mode S sensor due to the following: (1) in turning situations the geometry is continually changing with time, the result being that it is somewhat unlikely for a miss to occur for two scans in succession; (2) in most contexts, the adverse consequences of a single missed scan are not severe relative to the consequences of two missed scans in succession.

Results are given in Fig. 5-4 separately for diversity equipped aircraft and non-diversity aircraft. Note that performance degrades at longer ranges, but a useful level of performance is maintained out to about 100 nmi even for the terminal sensor. In the case of an enroute sensor, antenna gain is typically 4 dB more than the example considered here, and thus comparable levels of link reliability are provided out to ranges greater by a factor of about 1.6.

In summary, reliable link operation is possible in a severe interference environment, the level of reliability being set primarily by fade statistics.

MONOPULSE PERFORMANCE

As described in Chapter 3, the monopulse receiver-processor makes an estimate of the off-boresight angle for each received pulse of the ATCRBS or Mode S reply, and then combines the individual measurements to provide a single estimate for the whole reply.

The four major sources of error in the monopulse estimate are:

- (a) receiver noise,
- (b) processor inaccuracy,
- (c) variation with elevation angle, and
- (d) multipath and interference.

Receiver Noise

The effect of receiver noise on rms azimuth error is illustrated in Fig. 5-5 for an interrogator antenna having a Δ/ϵ beamwidth of 4° , i.e., $\Delta/\epsilon = 1$ at $\pm 2^\circ$ off-boresight. For pulse signal-to-noise ratio (SNR) as low as 20 dB, a few dB above the operating threshold of the interrogator receiver, the rms azimuth error on each pulse is less than 0.2° . Averaging over N pulses in a Mode S reply, or in one or more ATCRBS replies from the same target, will reduce the noise-induced rms error of the overall measurement by \sqrt{N} . Note that the azimuth error for a given signal-to-noise ratio increases relatively slowly with off-boresight angle out to $\Delta/\epsilon = 1$, more rapidly for larger off-boresight angles.

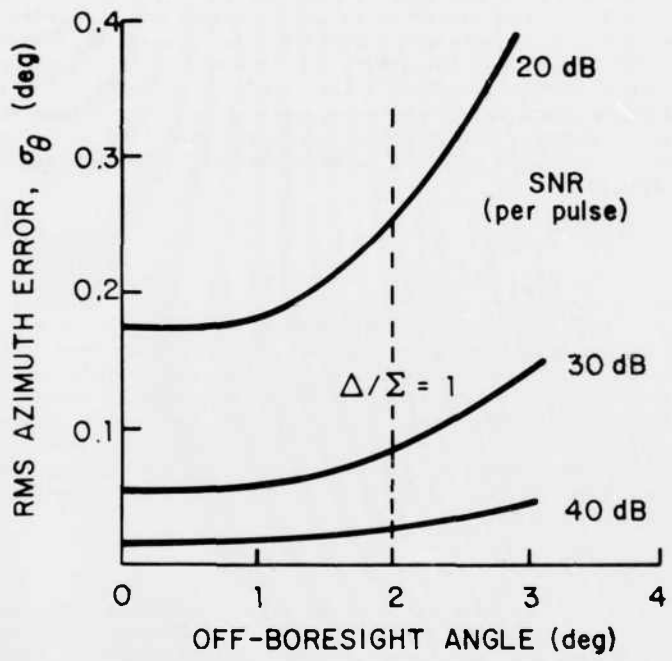

Fig. 5-5. Noise induced monopulse error.

Processor Inaccuracy

The monopulse receiver-processor must operate over approximately a 60-dB input signal range and must accommodate a ± 3 MHz variation in the center frequency of replies. While the processor can be precisely calibrated, and this calibration maintained by closed-loop techniques, for any one operating point (signal and frequency), some variation in off-boresight estimate will occur as the parameters of the received signals deviate from this calibration point. As in the case of receiver noise, the errors due to those effects increase with off-boresight angle, gradually out to $\Delta/\Sigma = 1$, and more rapidly thereafter. With careful design, practical monopulse processors can be realized which exhibit processor-induced errors substantially less than $1/40$ beamwidth (0.1° for a 4° beamwidth) averaged over the range of expected received signal amplitude and frequency.

Variation with Elevation Angle

The monopulse receiver-processor measures Δ/Σ and translates this into an estimate of the off-boresight angle according to a prestored calibration curve for the antenna. The calibration curve is strictly valid only at the elevation angle at which it was measured, typically one or two degrees above the horizon. For targets at relatively high elevation angles (15° and above), a change in the slope of Δ/Σ versus off-boresight angle can cause significant errors in the off-boresight angle measurement for targets near the beam edge. However, since such high elevation angles can occur only for relatively short-range targets, the resulting cross-range error is small. Thus, it is not necessary to compensate measurements on such targets for the measurement error resulting from their high elevation angle.

Multipath and Interference

Interfering signals overlaying the pulses in the desired reply can cause significant error in the monopulse estimate even if their amplitude is substantially less than that of the reply. Such interference may arise from replies, generated by other transponders, which are received in the mainlobe or sidelobes of the interrogator antenna, or from the desired signal arriving by one or more alternate paths.

The most important multipath effect is reflection from the terrain between the interrogator and transponder. If this terrain is essentially flat, it will not effect the apparent angle-of-arrival of the signal but can affect its amplitude. A reduction in received amplitude due to an apparent null can lead to an increased error in the monopulse estimate due to other causes, for example, receiver noise.

If the terrain causing the reflection is tilted, the composite signal arriving at the interrogator antenna will appear to come from a different direction than the actual target azimuth. In this case, the azimuth estimate will depend on the relative amplitude and phase of the multipath signal, as shown in Fig. 5-6 for the case of a target on-boresight and the reflector (interference) a half beamwidth off-boresight. For a given amplitude of

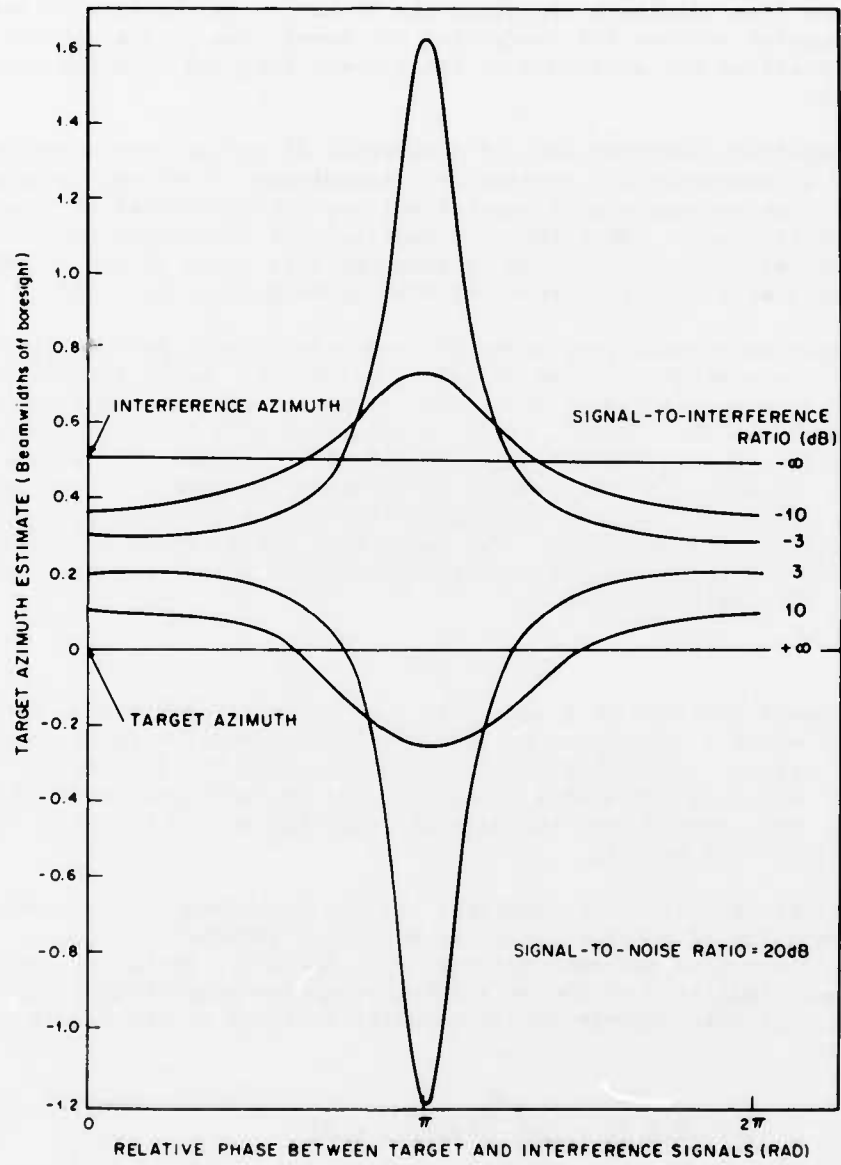

Fig. 5-6. Monopulse Estimate With Interference.

interference, the error is largest when the reflected (interference) signal is out-of-phase with the direct signal. For this worst case of out-of-phase interference, the error as a function of the relative azimuth of the interference is shown in Fig. 5-7 for an interference/target amplitude ratio of 0.5. Errors from multipath are minimized by narrowing the azimuth beamwidth of the interrogator antenna and sharpening the lower edge of the antenna beam, thereby minimizing the amplitude of the signals received from the terrain reflections.

The magnitude and frequency of occurrence of reflection-induced errors are highly site-dependent. Particularly troublesome sites may require resiting of the antenna and/or special antenna configurations to provide adequate performance. (Note that the magnitude of reflection-induced errors using monopulse direction finding is comparable to those of the sliding-window detector/estimator used in current ATRBS interrogators, Ref. 11).

Overlapping signals from other transponders (fruit) produce single-pulse azimuth errors similar to those caused by multipath. Large interfering signals will cause correspondingly large errors in the azimuth estimate. However, unlike multipath interference, fruit interference will be incoherent from pulse-to-pulse, and in general will not affect all pulses of a reply. The main protection against such interference is to sense its presence (the confidence flag) and eliminate that particular measurement from the computation of the azimuth estimate for the reply. The relatively small errors caused by weak interference can be treated as additional receiver noise, and averaged out over a sequence of received pulses.

CAPACITY

The capacity of a Mode S sensor is most generally defined as the number of aircraft to which a sensor can provide discrete-address surveillance and data link service. With this broad definition, capacity depends not only on the sensor operating characteristics, but also on the number of interrogations needed for each aircraft and the azimuth distribution, or bunching, of aircraft around the sensor.

A simpler definition of capacity, and one providing a more easily interpreted point of reference, is the number of transactions (interrogation/reply pairs) a sensor can make per degree of azimuth. Using this definition, analysis and simulation of the Mode S interrogation scheduling algorithm have led to the following expression for capacity in terms of the sensor operating parameters:

$$n = 18.5 \left[T - 360 \frac{N_a}{\theta} (2R/c + t_a) \right]$$

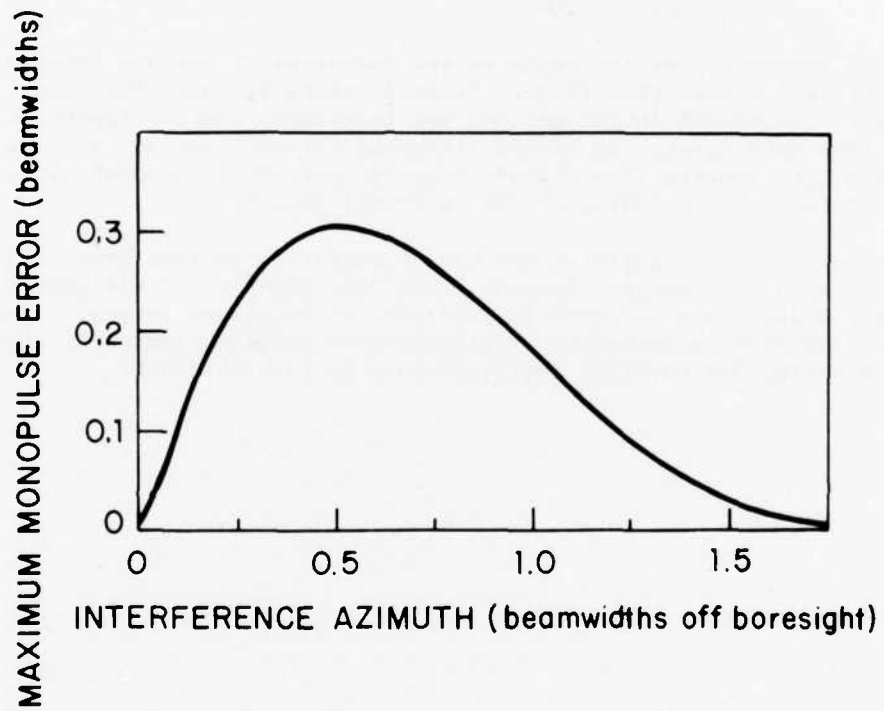

Fig. 5-7. Maximum monopulse error with target on boresight.

where:

n = number of transactions per degree
R = operating range
T = interrogator antenna scan period
 θ = interrogator antenna beamwidth
 N_a = number of ATRBS interrogations per beamwidth
 t_a = ATRBS listening period
c = speed of light

Figure 5-8 presents plots of capacity vs. interrogator antenna beamwidth for various values of operating range. Typical values are used for scan time (4 seconds) and ATRBS interrogations per beamwidth (four). Except on the longest (200 nmi) range, the ATRBS listening interval was set at 2 ms to allow time for ATRBS replies from distant targets (outside the operating range) to ring out before the beginning of the roll-call periods.

The very large capacity of the Mode S sensor is evident from these curves. For anticipated interrogator antenna beamwidths ($2.4^\circ - 4^\circ$) and operating range, the channel can accommodate more than 40 calls per degree, a number fully sufficient to accommodate expected sensor loading, including effects of azimuth bunching and multiple interrogations to each aircraft.

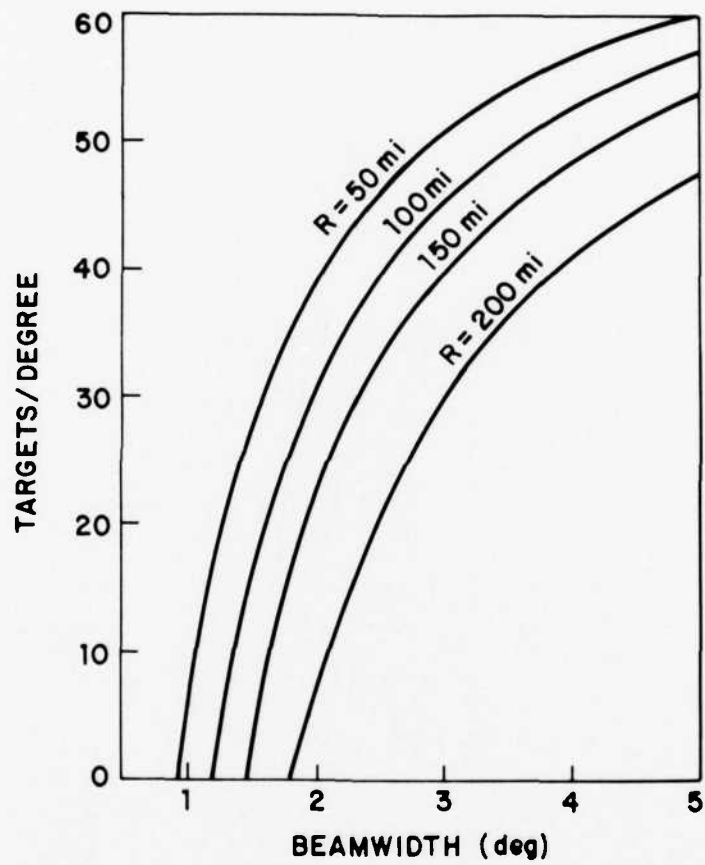

Fig. 5-8. Capacity plots.

CHAPTER 6

SURVEILLANCE PERFORMANCE VALIDATION

Initial validation of the Mode S design was performed at the Mode S Experimental Facility (MODSEF, Fig. 6-1) located on a hill adjacent to Lincoln Laboratory. The MODSEF is a flexible beacon test facility that is capable of performing Mode S and ATCRBS processing functions.

FIELD MEASUREMENTS PROGRAM

While validation at MODSEF was a necessary first step, it was not sufficient to validate the Mode S design since MODSEF is a very benign site in terms of problems frequently encountered at operational sites such as high traffic density, fruit, multipath and false target reflectors. For this reason, a Transportable Measurements Facility was built and operated at a number of sites across the United States.

The TMF, described in Fig. 6-2 and is basically the "front-end" of the Mode S sensor including a choice of two antennas, a transmitter and a receiver. The output of the receiver is digitized video, which in an actual sensor would be interfaced with the ATCRBS and Mode S reply processors. In the TMF, this digitized video is recorded, along with timing and other information. The TMF data thus recorded at the operational site location was returned to Lincoln Laboratory for data reduction and evaluation. This included playback of the recorded digitized video through simulated ATCRBS and Mode S reply processors. The resulting target reports were then operated upon the surveillance processing routines. Analysis of the outputs of these programs served to validate and characterize Mode S design performance.

The TMF was operated in problem areas that offer high traffic densities and unusual siting difficulties (Ref. 2). A list of selected sites along with the rationale for site selection is presented in Fig. 6-3. In addition, measurements were also made at Salt Lake City, Utah to aid in the selection of a new ATCRBS sensor site and at Warwick Rhode Island as part of a multisensor experiment with the MODSEF. The complete set of TMF locations is shown in Fig. 6-4.

Experiments conducted at each site generally included data collection for a period of 20 minutes to one hour. In all, a total of over 350 experiments were run at the collection of TMF sites.

At each of the operational sites, the TMF was positioned near the existing SSR sensor in order to experience similar environmental conditions. At each of these sites, several experiments were run with simultaneous data recording performed at the existing Automated Radar Terminal System (ARTS). The resulting set of data provided the opportunity to obtain a side-by-side comparison of the ATCRBS mode of Mode S with the conventional ARTS processor.



Fig. 6-1. Mode S experimental facility (MODSEF).

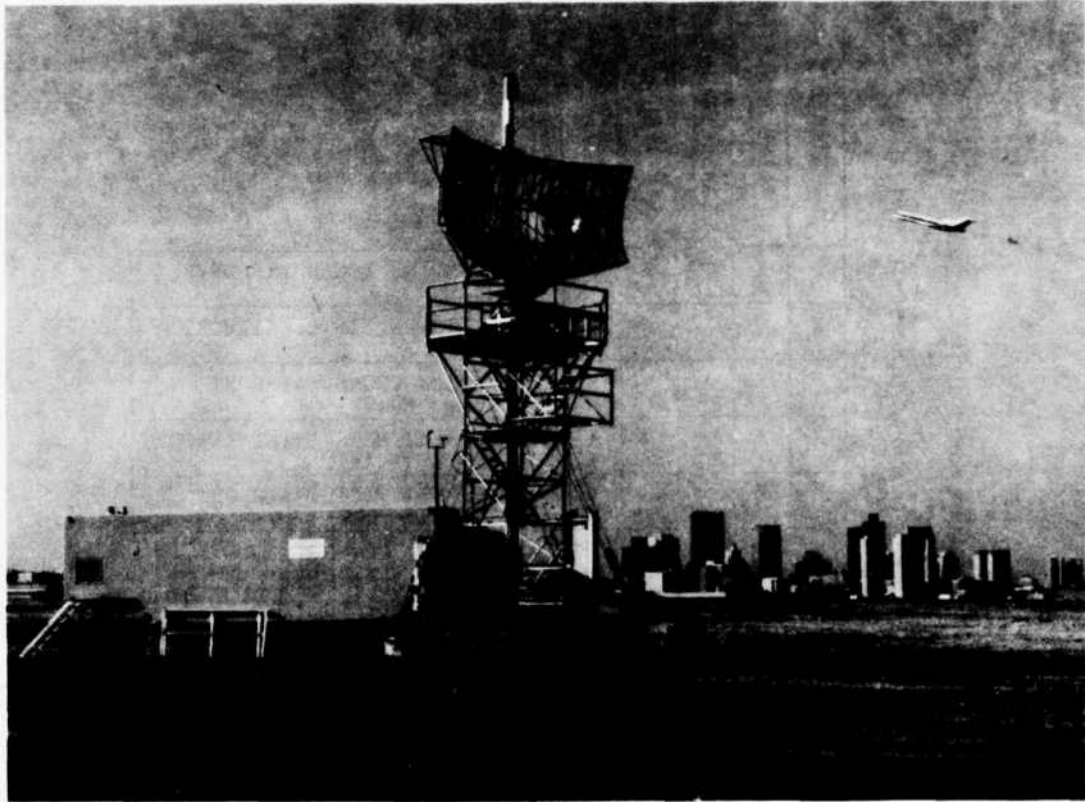

Fig. 6-2. Transportable measurements facility (TMF).

ENVIRONMENTAL CHARACTERISTICS

TRAFFIC	FALSE TARGETS	GARBLE MULTIPATH	VERTICAL LOBBING	OBSTRUCTION	INTERFERENCE	
	X		X	X		BOSTON, LOGAN AIRPORT
X					X	PHILA. INTL. AIRPORT
	X	X		X		LAS VEGAS, AIRPORT
X	X		X	X	X	LOS ANGELES INTL. AIRPORT
	X			X		WASH. INTL. AIRPORT

Fig. 6-3. TMF site selection criteria.

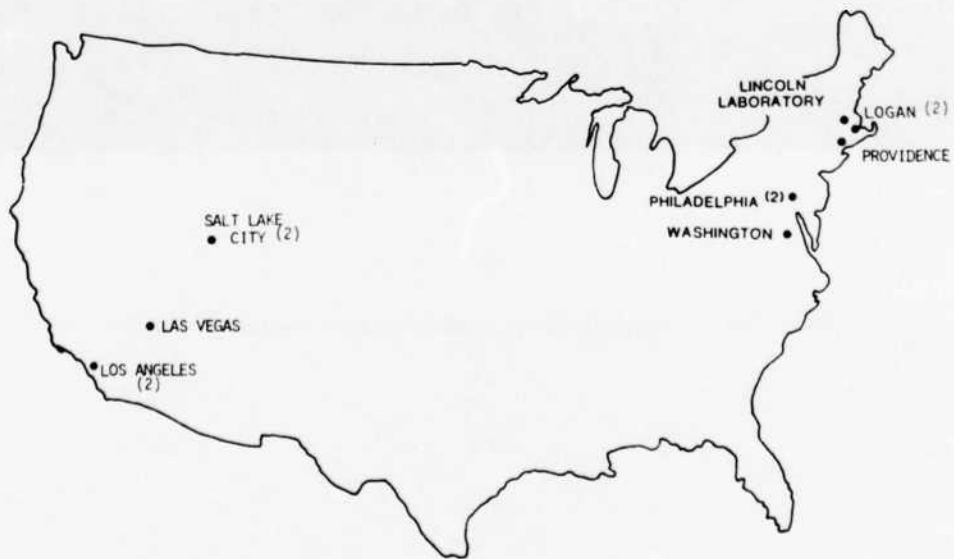

Fig. 6-4. Transportable measurements facility (TMF) sites.

EXPERIMENTAL RESULTS

Results typical of ARTS/Mode S ATCRBS mode comparison are shown in Fig. 6-5 and Fig. 6-6. Each figure shows a dot corresponding to the unsmoothed, measured position of a single target report, hence the sequence of dots represent the flight paths of aircraft. A comparison of the figures readily shows the improved positional accuracy and track continuity of Mode S ATCRBS mode versus conventional processing. The improvement is most obvious in the case of crossing tracks.

Figures 6 through 7 show a quantitative comparison of surveillance performance representing an average of typical data for each of the following sites: Boston, Washington, D.C., Philadelphia, Los Angeles, Salt Lake city and Las Vegas. The quantities compared are defined as follows:

Blip/Scan Ratio - the probability of generating a target report during one scan.

No Altitude - the percentage of Mode C reports that did not contain a valid altitude.

No Code - the percentage of Mode A reports that did not contain a valid code.

Range Error - the standard deviation from a second order polynomial fit to a sliding sequence of range measurement points, centered on the report being evaluated. The error is calculated only for established straight-line tracks at elevation angles between 0.5 and 40 degrees and at ranges between 2 and 45 nmi.

Azimuth Error - same as range error, but in the azimuth dimension.

SUMMARY

These results indicate that both range and azimuth accuracies applicable to Mode S or ATCRBS surveillance are 4 times better than those provided by current terminal ATCRBS equipment. Blip/scan ratio for monopulse ATCRBS is 98% or better, and remains high in crossing track situations where the performance of existing equipment is observed to degrade. Significantly, this improvement in ATCRBS performance was accomplished with 1/4 the PRF of the present equipments.

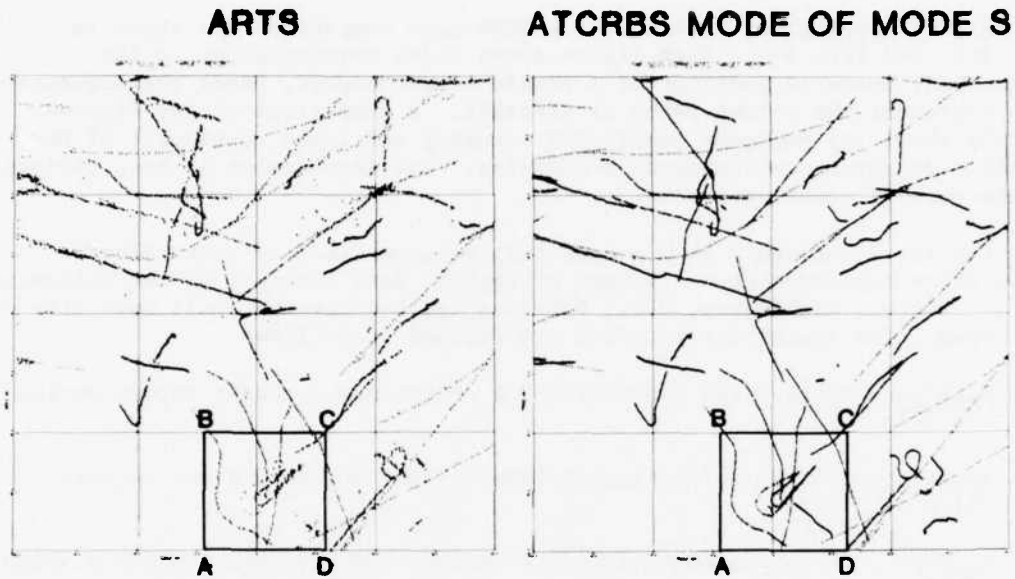

Fig. 6-5. ARTS/Mode S ATCRBS mode comparison, Philadelphia (80 x 80 nmi).

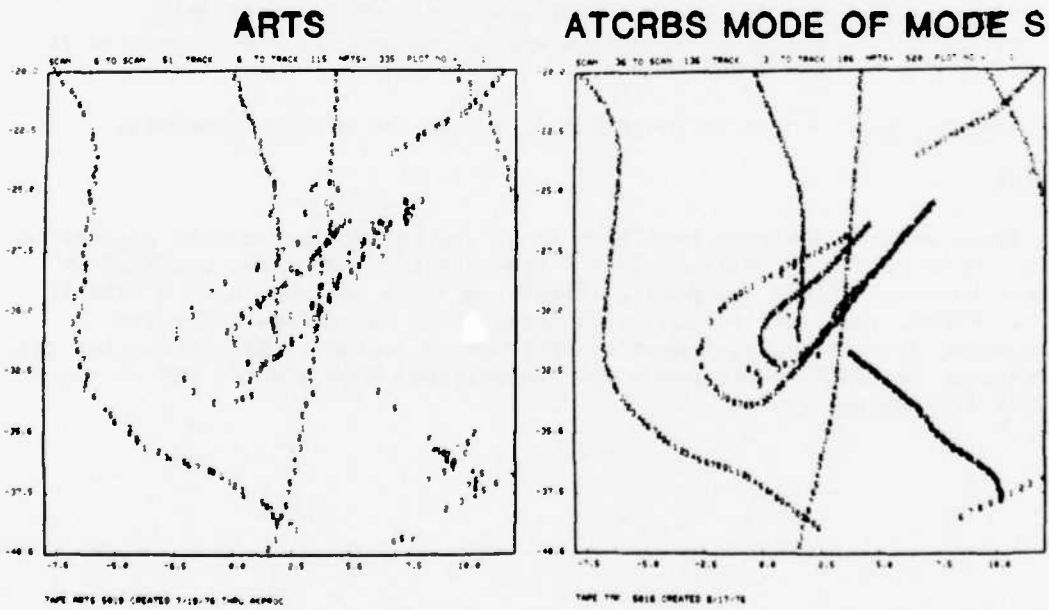

Fig. 6-6. Expansion of Fig. 6-5 square ABCD (20 x 20 nmi).

	ARTS		SSR MODE OF MODE S	
	ALL	CROSSINGS	ALL	CROSSINGS
BLIP/SCAN	94.6%	86.9%	98.0%	96.6%
NO ALTITUDE	2.7%	8.3%	1.4%	3.0%
NO CODE	1.5%	7.4%	0.7%	3.0%
RANGE ERROR (1σ)	124 ft.		24 ft.	
AZIMUTH ERROR (1σ)	0.16 deg		0.04 deg	

Fig. 6-7. Surveillance performance comparison, average site.

REFERENCES

1. "Report of Department of Transportation Air Traffic Control Advisory Committee," (December 1969).
2. W.I. Wells, "Verification of DABS Sensor Surveillance Performance (ATCRBS Mode) at Typical ASR Sites Throughout CONUS," Project Report ATC-79, Lincoln Laboratory, M.I.T., (20 December 1977), FAA-RD-77-113.
3. U.S. National Standard for the Mode Select Beacon System, FAA Order 6365.1A.
4. Selection Order: U.S. National Standard for the IFF Mark X (SIF) Air Traffic Control Radar Beacon System (ATCRBS) Characteristics; DOT/FAA Order 1010.51A (8 March 1971).
5. "DABS/ATC Facility Surveillance and Communication Message Formats," FAA-RD-80-14.
6. Development of a Discrete Address Beacon System Quarterly Technical Summary, Lincoln Laboratory, M.I.T., (1 July 1974), pp 36-37, FAA-RD-74-136.
7. Ibid, pp. 55-58.
8. Development of a Discrete Address Beacon System, Quarterly Technical Summary, Lincoln Laboratory, M.I.T., (1 January 1974), pp 14-17, FAA-RD-74-8.
9. Development of a Discrete Address Beacon System, Quarterly Technical Summary, Lincoln Laboratory, M.I.T., (1 April 1974), pp. 19-21, FAA-RD-74-85.
10. Ibid, pp. 5-9.
11. Ibid, pp. 49-50.
12. G.J. Schlieckert, "An Analysis of Aircraft L-Band Beacon Antenna Patterns", Project Report ATC-37, Lincoln Laboratory, M.I.T., (15 September 1975), FAA-RD-74-114.
13. D.W. Mayweather, "Model Aircraft L-Band Beacon Antenna Pattern Gain Maps", Project Report ATC-44, Lincoln Laboratory, M.I.T. (16 May 1975), FAA-RD-75-75.
14. K.J. Keeping, J-C Sureau, "Scale Model Pattern Measurements of Aircraft L-Band Beacon Antennas", Project Report ATC-47, Lincoln Laboratory, M.I.T., (4 April 1975), FAA-RD-75-23.
15. W.H. Harman, "Effects of RF Power Deviations on BCAS Link Reliability", Project Report ATC-76, Lincoln Laboratory, M.I.T. (7 June 1977), FAA-RD-77-78.
16. J.L. Gertz, "Fundamentals of Mode S Parity Coding", Project Report ATC-117, Lincoln Laboratory, M.I.T. (To Be Published).

APPENDIX A

COMPREHENSIVE INDEX OF FIELDS

Bit Numbering and Sequence.

The bits are numbered in order of their transmission, beginning with bit 1. If numerical values are encoded by groups (fields) of bits then the bit transmitted first is the most significant bit (MSB) unless otherwise stated.

Fields.

Information is coded in fields which consist of at least one bit. The decimal equivalent of the binary code formed by the bit sequence within a field is used as the designator of the field function or command. As an example, the 5-bit UF field is used to designate the uplink format type. The surveillance interrogation with identity is designated by a UF code of 00101. Since $00101_2 = 5_{10}$, this format is designated as UF=5.

(a) Essential Fields - Each Mode S transmission contains two essential fields: One describing the format and the other a 24-bit field which contains either the address or the interrogator identity overlaid on parity. The format descriptor is the field at the beginning of the transmission and the 24-bit field always occurs at the end of the transmission. The formats are described by the UF (Uplink Format) or DF (Downlink Format) descriptors.

(b) Mission Fields - The remaining coding space is used to transmit the mission fields. For specific missions, a specific set of fields is prescribed. Mission fields have two-letter designators.

(c) Subfields - Subfields may appear within mission fields. Subfields are labeled with three-letter designators.

Field Descriptions.

The fields are described in alphabetical order in the following paragraphs. An index is provided in Table A-1.

1. AA Address, Announced.

This 24-bit (9-32) downlink field contains the aircraft address in the clear and is used in DF=11, the all-call reply.

2. AC Altitude Code.

This 13-bit (20-32) downlink field contains the altitude code and is used in formats DF= 0,4,16 and 20. If the M-bit (26) is zero, the pattern of ref 4, 2.7.13.2.5, is used in the remaining bits in the sequence: C1, A1, C2, A2, C4, A4, M, B1, zero, B2, D2, B4, D4. Zero is transmitted in each of the 13 bits if altitude information is not available. If the M-bit (26) is set to "one", metric altitude is contained in this field.

TABLE A-1
FIELD INDEX

Ref.	Field	Sub Field	Name	Bits		Formats
				No.	Positions	U=Up D=Down
1	AA		Address Announced	24	9-32	D
2	AC		Altitude Code	13	20-32	D
3	AP		Address/Parity	24	33-56	U/D
				24	89-112	
4	AQ		Acquisition	1	14	U
5	CA		Capability	3	6-8	D
6	DF		Downlink Format	5	1-5	D
7	DI		Designator Identification	3	14-16	U
8	DR		Downlink Request	5	9-13	D
9	FS		Flight Status	3	6-8	D
10	ID		Identification	13	20-32	D
11	II		Interrogator Identification	4	10-13	U
12	KE		Control ELM	1	4	D
13	MA		Message, Comm-A	56	33-88	U
13.1		ADS	A-Definition Subfield	8	33-40	U
14	MB		Message, Comm-B	56	33-88	D
14.1		ACS	Comm-A Capability Subfield	20	45-64	D
14.2		BCS	Comm-B Capability Subfield	16	65-80	D
14.3		BDS	B-Definition Subfield	8	33-40	D
14.4		CFS	Continuation Subfield	4	41-44	D
14.5		ECS	Extended Capability Subfield	8	81-88	D
14.6		FIS	Flight Identification Subfield	48	41-88	D
15	MC		Message, Comm-C	80	9-88	U
15.1		CDS	C-Definition Subfield	8	9-16	U
15.2		SRS	Segment Request Subfield (RC=3)	16	9-24	U
16	MD		Message, Comm-D	80	9-88	D
16.1		DDS	D-Definition Subfield	8	9-16	D
16.2		TAS	Transmission Acknowledgement Subfield (KE=1)	16	17-32	D
17	MU		Message, Comm-U	56	33-88	U
18	MV		Message, Comm-V	56	33-88	D
19	NC		Number, C-Segment	4	5-8	U
20	ND		Number, D-Segment	4	5-8	D
21	PC		Protocol	3	6-8	U
22	PI		Parity/Interrogator Identity	24	33-56	D
23	PR		Probability of Reply	4	6-9	U
24	RC		Reply Control	2	3,4	U
25	RI		Reply Information	4	14-17	D
26	RL		Reply Length	1	9	U
27	RR		Reply Request	5	9-13	U

TABLE A-1 (Continued)

Ref.	Field	Sub Field	Name	Bits		Formats
				No.	Positions	U=Up D=Down
28	SD		Special Designator	16	17-32	U
28.1		IIS	Interrogator Identification Subfield	4	17-20	U
28.2		LOS	Lockout Subfield (DI=1 or 7)	1	26	U
28.3		MBS	Multisite Comm-B Subfield (DI=1)	2	21,22	U
28.4		MES	Multisite ELM Subfield (DI=1)	3	23-25	U
28.5		RRS	Reply Request Subfield (DI=7)	4	21-24	U
28.6		RSS	Reservation Status Subfield (DI=1)	2	27,28	U
28.7		TMS	Tactical Message Subfield (DI=1)	4	29-32	U
29	UF		Uplink Format	5	1-5	U
30	UM		Utility Message	6	14-19	D
30.1		IDS	Identifier Designator Subfield	2	18,19	D
30.2		IIS	Interrogator Identification Subfield	4	14-17	D
31	VS		Vertical Status	1	6	D

3. AP Address/Parity.

This 24-bit field (33-56 or 89-112) contains parity overlaid on the address and appears at the end of all transmissions on both uplink and downlink with the exception of format DF=11.

4. AQ Acquisition, Special.

This 1-bit field (14) designates formats UF=0, 16 as acquisition transmissions and is repeated as received by the transponder in bit 14 of the RI field of DF= 0, 16.

5. CA Capability.

This 3-bit (6-8) downlink field reports transponder capability and is used in DF=11, the all-call reply. The codes are:

- 0 = No extended capability report available
- 1 = Comm A/B and extended capability report available
- 2 = Comm A/B/C and extended capability report available
- 3 = Comm A/B/C/D and extended capability report available
- 4-7 = Not assigned

6. DF Downlink Format.

This field is the transmission descriptor in all downlink formats and is coded according to Fig. 2-6.

7. DI Designator, Identification.

This 3-bit (14-16) uplink field identifies the coding contained in the SD field in formats UF=4, 5, 20, 21. The codes are:

- 0 = SD not used
- 1 = SD contains multisite information
- 2-6 = Not assigned
- 7 = SD contains extended data readout request

8. DR Downlink Request.

This 5-bit (9-13) downlink field is used to request extraction of downlink messages from the transponder by the interrogator and appears in formats DF= 4, 5, 20, 21. The codes are:

- 0 = No downlink request
- 1 = Request to send Comm-B message (B bit set)
- 2-15 = Not assigned
- 16-31 = (used for Comm-D protocol)

Codes 1-15 take precedence over codes 16-31.

9. FS Flight Status.

This 3-bit (6-8) downlink field reports the flight status of the aircraft and is used in formats DF= 4, 5, 20, 21. The codes are:

<u>Code</u>	<u>Alert</u>	<u>SPI</u>	<u>Airborne</u>	<u>On-the-Ground</u>
0	no	no	yes	no
1	no	no	no	yes
2	yes	no	yes	no
3	yes	no	no	yes
4	yes	yes		either
5	no	yes		either
6 and 7	are not assigned			

10. ID Identification, 4096 code.

This 13-bit (20-32) downlink field in DF = 5,21 contains the "4096" identification code reporting the numbers set by the pilot.

11. II Interrogator Identification.

This 4-bit (10-13) uplink field identifies the interrogator and appears in UF=11, the Mode S-only all-call. The same information also may appear in the IIS subfields of the SD and UM fields.

12. KE Control, ELM.

This 1-bit (4) downlink field defines the content of the ND and MD fields in Comm-D replies, DF=24. If KE=0, MD is part of an ELM reply; if KE=1, MD contains the acknowledgement for an uplink ELM.

13. MA Message, Comm-A.

This 56-bit (33-88) uplink field contains messages directed to the aircraft and is part of Comm-A interrogations, UF=20, 21.

13.1 ADS A-Definition Subfield in MA.

This 8-bit (33-40) subfield defines the content of the MA message field. ADS is expressed in two groups of 4 bits each, ADS1 (33-36) and ADS2 (37-40).

14. MB Message, Comm-B.

This 56-bit (33-88) downlink field contains messages to be transmitted to the interrogator and is part of the Comm-B replies DF=20, 21.

14.1. ACS Comm-A Capability Subfield in MB.

This 20 bit (45-64) subfield appears in the extended capability report and indicates the tactical uplink data link service(s) supported by this installation. If all bits are zero, no Comm-A data link services are supported.

14.2. BCS Comm-B Capability Subfield in MB.

This 16-bit (65-80) subfield appears in the extended capability report and indicates the installed data sources that can be accessed by the ground for transmission via a ground-initiated Comm-B. If all bits are zero, no data is accessible by a ground-initiated Comm-B.

14.3. BDS B-Definition Subfield in MB.

This 8-bit (33-40) subfield defines the content of the MB message field. BDS is expressed in two groups of 4 bits each, BDS1 (33-36) and BDS2 (37-40).

14.4 CFS Continuation Subfield in MB.

This 4-bit (41-44) subfield appears in the extended capability report and contains the BDS2 value of the next additional capability report (if any) available from this installation.

14.5 ECS Extended Capability Subfield in MB.

This 8 bit (81-88) subfield appears in the extended capability report and indicates the ELM capability of the installation. If all bits are zero, no ELM data link services are supported.

14.6 FIS Flight Identification Subfield in MB.

If a surveillance or Comm-A interrogation (UF=4, 5, 20, 21) contains RR=18 and DI other than 7, the transponder will report its flight identification number in the 48-bit (41-88) FIS subfield of MB.

15. MC Message, Comm-C.

This 80-bit (9-88) uplink field contains one segment of a sequence of segments transmitted to the transponder in the ELM (extended length message) mode. It may also contain a command to deliver MD segments for a downlink ELM. MC is part of UF=24.

15.1 CDS C-Definition Subfield in MC.

This 8-bit (9-16) subfield defines the content of an uplink ELM message. It is included in segment zero.

15.2. SRS Segment Request Subfield in MC.

If a Comm-C interrogation (UF=24) contains RC=3 it also contains a list of segment requests in the 16-bit (9-24) SRS subfield. Starting with bit 9, which denotes the first segment, each of the bits is set to one if the transmission of the corresponding segment is requested.

16. MD Message, Comm-D.

This 80-bit (9-88) downlink field contains one segment of a sequence of segments transmitted by the transponder in the ELM (extended length message) mode. It may also contain a summary of received MC segments of an uplink ELM. MD is part of DF=24.

16.1. DDS D-Definition Subfield in MD.

This 8-bit (9-16) subfield of the MD field defines the content of a downlink ELM message. It is included in segment zero.

16.2. TAS Transmission Acknowledgement Subfield in MD.

This 16-bit (17-32) subfield of the MD field reports the segments received so far in a Comm-C sequence. Starting with bit 17, which denotes segment number zero, each of the bits is set to one if the corresponding segment of the sequence has been received. TAS appears in MD if KE=1 in the same reply.

17. MU Message, Comm U.

This 56-bit (33-88) uplink field contains information used in air-to-air exchanges and is part of the long special surveillance interrogation UF=16. This message field does not use the Comm-A protocol.

18. Message, Comm-V.

This 56-bit (33-88) downlink field contains information used in air-to-air exchanges and is part of the long special surveillance reply DF=16. This message field does not use the Comm-B protocol.

19. NC Number of C-Segment.

This 4-bit (5-8) uplink field gives the number of a segment transmitted in an uplink ELM and is part of a Comm-C interrogation, UF=24.

20. ND Number of D-Segment.

This 4-bit (5-8) downlink field gives the number of a segment transmitted in a downlink ELM and is part of a Comm-D reply, DF=24.

21. PC Protocol.

This 3-bit (6-8) uplink field contains operating commands to the transponder and is part of surveillance and Comm-A interrogations UF=4, 5, 20, 21. The codes are:

- 0 = No changes in transponder state
- 1 = Non-Selective all-call lockout
- 2 = Not assigned
- 3 = Not assigned
- 4 = Cancel B
- 5 = Cancel C
- 6 = Cancel D
- 7 = Not assigned

22. PI Parity/Interrogator Identity.

This 24-bit (33-56) downlink field contains the parity overlaid on the interrogator's identity code. PI is part of the reply to the Mode S-only all-call, DF=11.

23. PR Probability of Reply.

This 4-bit (6-9) uplink field contains commands to the transponder which specify the probability of reply to the Mode S-only all-call interrogation UF=11 that contains the PR. A command to disregard any lockout state can also be given. The assigned codes are as follows:

- 0 = Reply with probability = 1
- 1 = Reply with probability = 1/2
- 2 = Reply with probability = 1/4
- 3 = Reply with probability = 1/8
- 4 = Reply with probability = 1/16
- 5,6,7 = Do not reply
- 8 = Disregard lockout, reply with probability = 1
- 9 = Disregard lockout, reply with probability = 1/2
- 10 = Disregard lockout, reply with probability = 1/4
- 11 = Disregard lockout, reply with probability = 1/8
- 12 = Disregard lockout, reply with probability = 1/16
- 13,14,15 = Do not reply

On receipt of a Mode S-only all-call containing a PR code of 1-4 or 9-12, the transponder executes a random process and makes a reply decision for this interrogation in accordance with the commanded probability. The random occurrence of replies enables the interrogator to acquire closely spaced aircraft whose replies would otherwise synchronously garble each other.

24. RC Reply Control.

This 2-bit (3,4) uplink field designates the transmitted segment as initial, intermediate or final if valued at 0,1,2 respectively. RC=3 is used to request Comm-D downlink action by the transponder. RC is part of the Comm-C interrogation, UF=24.

25. RI, Reply Information Air-to-Air.

This 4-bit (14-17) downlink field appears in the special surveillance replies DF=0,16 and reports airspeed capability and type of reply to the interrogating aircraft. The coding is as follows:

- 0-7 = Codes indicate that this is the reply to an air-to-air non-acquisition interrogation.
- 8-15 = Codes indicate that this is an acquisition reply
 - 8 = No maximum airspeed data available
 - 9 = Airspeed is up to 75 knots
 - 10 = Airspeed is between 75 and 150 knots
 - 11 = Airspeed is between 150 and 300 knots
 - 12 = Airspeed is between 300 and 600 knots
 - 13 = Airspeed is between 600 and 1200 knots
 - 14 = Airspeed is more than 1200 knots.
 - 15 = Not assigned

Bit 14 of this field replicates the AQ bit of the interrogation resulting in the coding scheme above.

26. RL Reply Length.

This 1-bit (9) uplink field in UF=0,16 commands a reply in DF=0 if set to 0 and a reply in DF=16 if set to 1.

27. RR Reply Request.

This 5-bit (9-13) uplink field contains length and content of the reply requested by the interrogation. RR is part of the surveillance and Comm-A interrogations UF=4, 5, 20, 21. The codes are outlined in the table below:

RR Code	Reply Length	MB Content
0-15	Short	-----
16	Long	Air initiated Comm-B
17	Long	Extended Capability
18	Long	Flight ID
19-31	Long	Not assigned

If the first bit of the RR code is a one, the last four bits of the 5-bit RR code, if transformed into their decimal equivalent, designate the number (BDS1) of the requested source. BDS2 is assumed to be zero if not specified (by DI=7 and RRS).

28. SD Special Designator.

This 16-bit (17-32) uplink field can contain control codes affecting transponder protocol and is part of surveillance and Comm-A interrogations UF=4, 5, 20, 21. The content of this field is specified by the DI field.

The structure of the SD field for DI=1 and DI=7 is shown in Table A-2.

28.1. IIS Interrogator Identification Subfield in SD.

This 4-bit subfield (17-20) appears in all SD fields regardless of the DI code. IIS is the interrogator identification. For a given interrogator, the same code is used for IIS and II.

28.2. LOS Lockout Subfield in SD.

This 1-bit subfield (26) appears in the SD field if the DI code = 1 or 7 from the interrogator indicated in IIS of the same interrogation. If set to 1 LOS initiates a multisite all-call lockout to Mode S-only all-calls (UF=11). If LOS is set to "0", no change in lockout state is commanded.

28.3. MBS Multisite Comm-B Subfield in SD.

This 2-bit subfield (21,22) appears in the SD field if DI code = 1. It is used in the multisite Comm-B protocol as follows:

- 0 = No Comm-B action
- 1 = Comm-B reservation
- 2 = Comm-B closeout

28.4. MES Multisite ELM Subfield in SD.

This 3-bit (23-25) subfield appears in the SD field if DI code = 1. It is used in the multisite ELM protocols as follows:

- 0 = No ELM action
- 1 = Comm-C reservation
- 2 = Comm-C closeout
- 3 = Comm-D reservation
- 4 = Comm-D closeout
- 5 = Comm-C reservation and Comm-D closeout
- 6 = Comm-C closeout and Comm-D reservation
- 7 = Comm-C and Comm-D closeouts

28.5. RRS Reply Request Subfield in SD.

This 4-bit (21-24) uplink subfield in SD gives the BDS2 code of a requested Comm-B reply if DI code = 7.

28.6. RSS Reservation Status Subfield in SD

This 2-bit (27,28) subfield appears in the SD field if DI = 1. It requests the transponder to report its reservation status in the UM field as follows:

- 0 = No request
- 1 = Report Comm-B reservation status in UM
- 2 = Report Comm-C reservation status in UM
- 3 = Report Comm-D reservation status in UM

TABLE A-2
STRUCTURE OF SPECIAL DESIGNATOR (SD) FIELD

Structure of SD if DI=1

Position	No. of Bits	Subfield	Name	Significance
17-20	4	IIS	Interrogator Identification	Identification of Interrogating Site
21-22	2	MBS	Multisite Comm-B	Reserve/Closeout Multisite Comm-B
23-25	3	MES	Multisite ELM	Reserve/Closeout Multisite ELM
26	1	LOS	Lockout	Multisite Lockout Control
27-28	2	RSS	Reservation Status	Reservation Status Request
29-32	4	TMS	Tactical Message	Comm-A Linking, Priority and Acknowledgement

Structure of SD if DI=7

Position	No. of Bits	Subfield	Name	Significance
17-20	4	IIS	Interrogator Identification	Identification of Interrogating Site
21-24	4	RRS	Reply Request	Specifies BDS2 Code of Requested MB Messages
25	1	Not assigned		
26	1	LOS	Lockout	Multisite Lockout Control
27-28	2	Not assigned		
29-32	4	TMS	Tactical Message	Comm-A Linking, Priority and Acknowledgement

28.7 TMS Tactical Message Subfield in SD.

This 4-bit (29-32) subfield appears in the SD field if DI code = 1 or 7. It is used to specify Comm-A message link, priority and acknowledgement request as follows:

- 0 = No action
- 1 = Unlinked, priority
- 2 = Unlinked, acknowledge
- 3 = Unlinked, priority, acknowledge
- 4 = Linked 1st segment, single ADS
- 5 = Linked 1st segment, single ADS, priority
- 6 = Linked 1st segment, single ADS, acknowledge
- 7 = Linked 1st segment, single ADS, priority, acknowledge
- 8 = Linked 1st segment, multiple ADS
- 9 = Linked 1st segment, multiple ADS, priority
- 10 = Linked 1st segment, multiple ADS, acknowledge
- 11 = Linked 1st segment, multiple ADS, priority, acknowledge
- 12 = Second segment
- 13 = Third segment
- 14 = Final segment
- 15 = Not assigned

29. UF Uplink Format.

This field is the transmission descriptor in all uplink formats and is coded according to Fig. 2-5.

30. UM Utility Message

This 6-bit (14-19) downlink field in DF= 4, 5, 20, 21 contains control and status information. The structure of the UM field is shown in Table A-3.

30.1 IDS Identification Designator Subfield in UM.

This 2-bit (18-19) subfield of the UM field reports the type of reservation made by the interrogator identified in IIS. Assigned coding is:

- 0 = no information available
- 1 = Comm-B reservation active
- 2 = Comm-C reservation active
- 3 = Comm-D reservation active

30.2 IIS, Interrogator Identification Subfield in UM.

This 4-bit (14-17) subfield of the UM field reports the identity of the interrogator that has made a multisite reservation.

31. VS Vertical Status.

This 1-bit (6) downlink field in DF=0, 16 indicates (when set to zero) that the aircraft is airborne and indicates (when set to one) that the aircraft is on the ground.

TABLE A-3

STRUCTURE OF UTILITY MESSAGE (UM) FIELD

Structure of UM

Position	No. of Bits	Subfield	Name	Significance
14-17	4	IIS	Interrogator Identification	*Reserved Site No. for Multisite Protocols
18-19	2	IDS	Interrogation Designator	*Reservation Type - Comm B, C or D

* If DI=1 and RSS ≠ 0:

UM content is specified by uplink RSS code.

Otherwise, if Multisite Comm-B or Comm-D Active:

UM contains Comm-B reservation status (if active) or else Comm-D reservation status

Otherwise, if Multisite Comm-B and Comm-D are Inactive:

UM field contains all zeros.

APPENDIX B

SIGNIFICANCE OF INTERROGATION AND REPLY FIELDS

<u>Table</u>	<u>Format</u>
B-1	Mode S-Only All-Call Interrogation
B-2	All-Call Reply
B-3	Surveillance and Comm-A interrogation
B-4	Surveillance and Comm-B Reply
B-5	Comm-C Interrogation
B-6	Comm-D Reply
B-7	Special Surveillance Interrogation
B-8	Special Surveillance Reply

TABLE B-1

SIGNIFICANCE OF MODE S-ONLY ALL-CALL INTERROGATION FIELDS

Field	Significance
Uplink Format (UF)	<ul style="list-style-type: none">• Identifies interrogation as a Mode S-only all-call format
Probability (PR)	<ul style="list-style-type: none">• Specifies the probability to be used in generating a reply• Used by the stochastic acquisition and lockout override modes
Interrogator Identification (II)	<ul style="list-style-type: none">• Contains the site number of the interrogating site• Used in conjunction with multisite lockout
Address/Parity (AP)	<ul style="list-style-type: none">• Error detection coding combined with the "all ones" all-call address

TABLE B-2
SIGNIFICANCE OF ALL-CALL REPLY FIELDS

Field	Significance
Downlink Format (DF)	<ul style="list-style-type: none"> ● Identifies reply as an all-call reply
Capability (CA)	<ul style="list-style-type: none"> ● Indicates communications capability of the transponder as: None (CA=0) Standard message uplink and downlink (CA=1) Standard message plus uplink ELM (CA=2) Standard plus uplink and downlink ELM (CA=3) ● Indicates presence of extended capability reporting (CA=1,2 or 3)
Addressed Announced (AA)	<ul style="list-style-type: none"> ● Contains the aircraft's 24-bit Mode S address
Parity/ Interrogator Identity	<ul style="list-style-type: none"> ● Combines error detection and the site number of the interrogator that elicited the reply ● Site number equals zero if non-selective interrogation is used

TABLE B-3

SIGNIFICANCE OF SURVEILLANCE AND COMM-A INTERROGATION FIELDS

Field	Significance
Uplink Format (UF)	<ul style="list-style-type: none"> • Identifies interrogation as surveillance (UF=4,5) or Comm-A (UF=20,21) format • Indicates whether reply should contain altitude (UF=4,20) or ATCRBS code (UF=5,21)
Protocol (PC)	<ul style="list-style-type: none"> • Controls non-selective lockout • Clears non-selective Comm-B and ELM message transactions
Reply Request (RR)	<ul style="list-style-type: none"> • Indicates whether the reply will be short (RR<16) or long (RR>16) • Specifies BDS1 code of requested Comm-B message
Designator ID (DI)	<ul style="list-style-type: none"> • Indicates the structure of the SD field
Special Designator (SD)	<ul style="list-style-type: none"> • Contains coding used for: <ul style="list-style-type: none"> - Multisite lockout and communications protocols - Specification of the BDS2 code (if non-zero) of a requested Comm-B message - Linking, priority and acknowledgement of Comm-A messages
Comm-A Message (MA)	<ul style="list-style-type: none"> • The 56-bit uplink message
Address/Parity (AP)	<ul style="list-style-type: none"> • Combined error detection and Mode S address coding

TABLE B-4

SIGNIFICANCE OF SURVEILLANCE AND COMM-B REPLY FIELDS

Field	Significance
Downlink Format (DF)	<ul style="list-style-type: none"> • Identifies reply as surveillance (DF=4,5) or Comm-B (DF=20,21) • Indicates whether reply contains altitude (DF=4,20) or ATCRBS code (DF=5,21)
Flight Status (FS)	<ul style="list-style-type: none"> • Indicates alert status of aircraft if <ul style="list-style-type: none"> - ATCRBS code is changed (alert condition will time out) - ATCRBS code is an emergency code (alert condition will persist) • Indicates if pilot has activated the transponder SPI button • Indicates whether the aircraft is airborne or on the ground
Downlink Request (DR)	<ul style="list-style-type: none"> • Indicates presence of waiting air-initiated Comm-B or downlink extended length message
Utility Message (UM)	<ul style="list-style-type: none"> • Identifies reserved site for multisite Comm-B, C or D protocols
Altitude Code (AC)	<ul style="list-style-type: none"> • Mode C altitude code
Identification (ID)	<ul style="list-style-type: none"> • Aircraft 4096 ATCRBS code
Comm-B Message (MB)	<ul style="list-style-type: none"> • The 56-bit downlink message
Address/Parity (AP)	<ul style="list-style-type: none"> • Combined error detection and Mode S address coding

TABLE B-5

SIGNIFICANCE OF COMM-C INTERROGATION FIELDS

Field	Significance
Uplink Format (UF)	<ul style="list-style-type: none"> Identifies interrogation as a Comm-C format
Reply Control (RC)	<ul style="list-style-type: none"> Indicates initialization of an uplink ELM (RC=0) <ul style="list-style-type: none"> MC contain final segment and NC segment number to indicate message length Instructs transponder not to respond to this interrogation Indicates intermediate segment of uplink ELM (RC=1) <ul style="list-style-type: none"> MC contains intermediate segment Instructs transponder not to reply to this interrogation Indicates segment delivery with technical acknowledgement request (RC=2) <ul style="list-style-type: none"> MC contains message segment Instructs transponder to reply with Comm-D format with MD containing technical acknowledgement of uplink ELM delivery Indicates request for downlink ELM segments as indicated in segment request subfield of MC field (RC=3)
Number, C Segment (NC)	<ul style="list-style-type: none"> Identifies the segment number of the uplink ELM segment contained in the MC field
Message Comm-C (MC)	<ul style="list-style-type: none"> The 80-bit uplink Comm-C message
Address/Parity (AP)	<ul style="list-style-type: none"> Combined error detection and Mode S address coding

TABLE B-6

SIGNIFICANCE OF COMM-D REPLY FIELDS

Field	Significance
Downlink Format (DF)	<ul style="list-style-type: none">• Identifies reply as a Comm-D format
Control, ELM (KE)	<ul style="list-style-type: none">• Indicates that ND and MD are part of a downlink ELM (KE=0)• Indicates that MD contains acknowledgement for an uplink ELM (KE=1)
Number, D-Segment (ND)	<ul style="list-style-type: none">• Identifies the segment number of the downlink ELM segment contained in the MD field
Message, Comm-D (MD)	<ul style="list-style-type: none">• The 80-bit downlink Comm-D message
Address/Parity (AP)	<ul style="list-style-type: none">• Combined error detection and Mode S address coding

TABLE B-7

SIGNIFICANCE OF SPECIAL SURVEILLANCE INTERROGATIONS FIELDS

Field	Significance
Uplink Format (UF)	<ul style="list-style-type: none"> • Identifies interrogation as a short (UF=0) or long (UF=16) special surveillance format
Reply Length (RL)	<ul style="list-style-type: none"> • Indicates whether the transponder is to reply with a short (RL=0) or long (RL=1) special surveillance reply
Acquisition (AQ)	<ul style="list-style-type: none"> • Indicates if this is an air-to-air acquisition interrogation (AQ=1) or a non-acquisition interrogation (AQ=0) • Controls the contents of the RI field of the elicited reply
Message Comm U (MU)	<ul style="list-style-type: none"> • The 56-bit message from the CAS aircraft to the interrogated aircraft (present if UF=16)
Address/Parity (AP)	<ul style="list-style-type: none"> • Combined error detection and Mode S address coding

TABLE B-8

SIGNIFICANCE OF SPECIAL SURVEILLANCE REPLY FIELDS

Field	Significance
Downlink Format (UF)	<ul style="list-style-type: none">• Identifies the reply as a short (DF=0) or long (DF=16) special surveillance reply
Vertical Status (VS)	<ul style="list-style-type: none">• Indicates whether the aircraft is airborne (VS=0) or on the ground (VS=1)
Reply Information (RI)	<ul style="list-style-type: none">• Contains maximum airspeed data for an acquisition reply (RI>7)• Contains CAS data for a non-acquisition reply (RI<7)
Altitude Code (AC)	<ul style="list-style-type: none">• The aircraft Mode C altitude code
Message, Comm V (MV)	<ul style="list-style-type: none">• The 56-bit message from the replying aircraft to the CAS aircraft (CAS present if DF=16)
Address/Parity (AP)	<ul style="list-style-type: none">• Combined error detection and Mode S address coding

END

DATE
FILMED

10-83

DTI

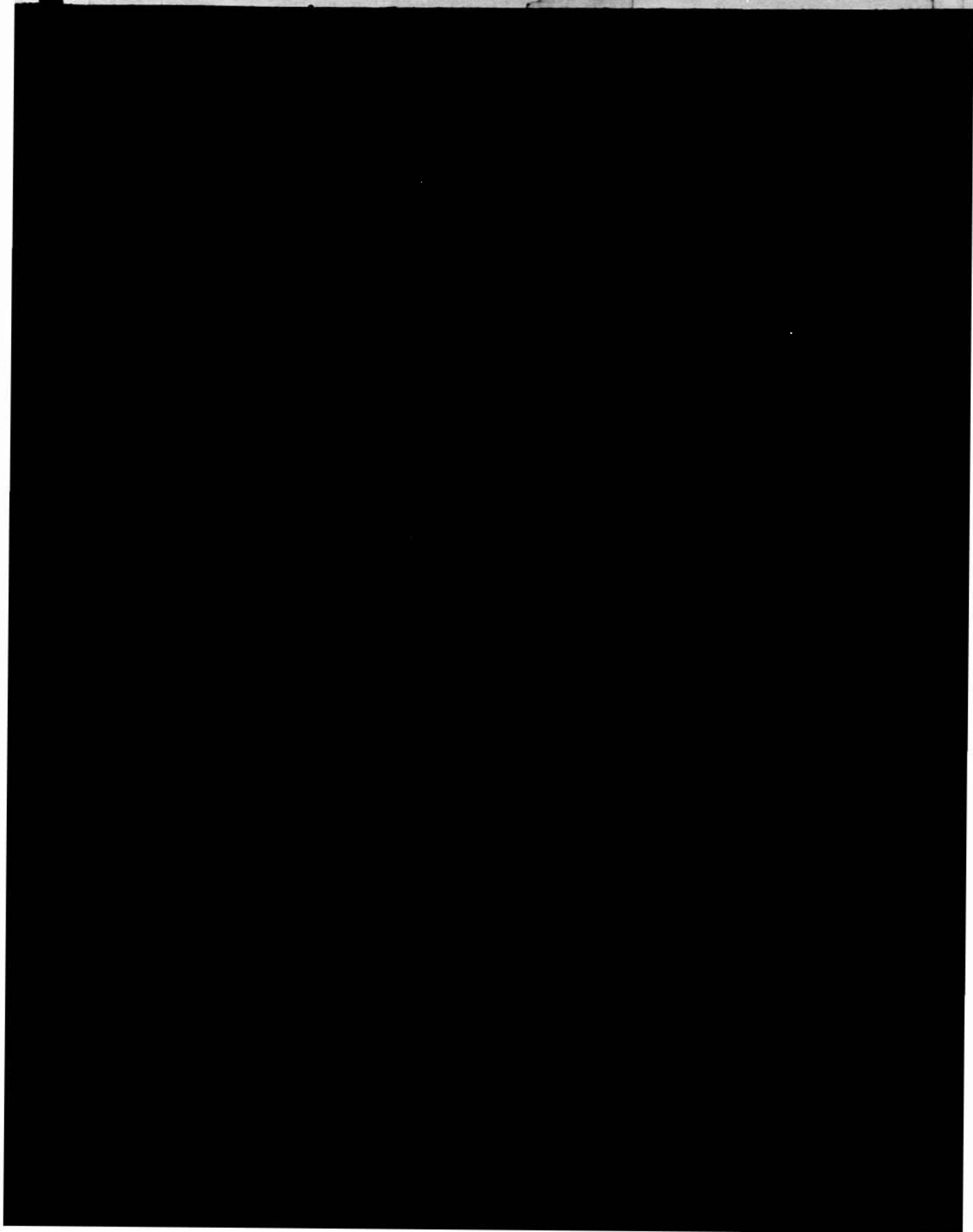

Address/Parity
(AP)

• Combined error detection and Mode 3 address coding

B-4

Address/Parity
(AP)

• Combined error detection and Mode S address coding

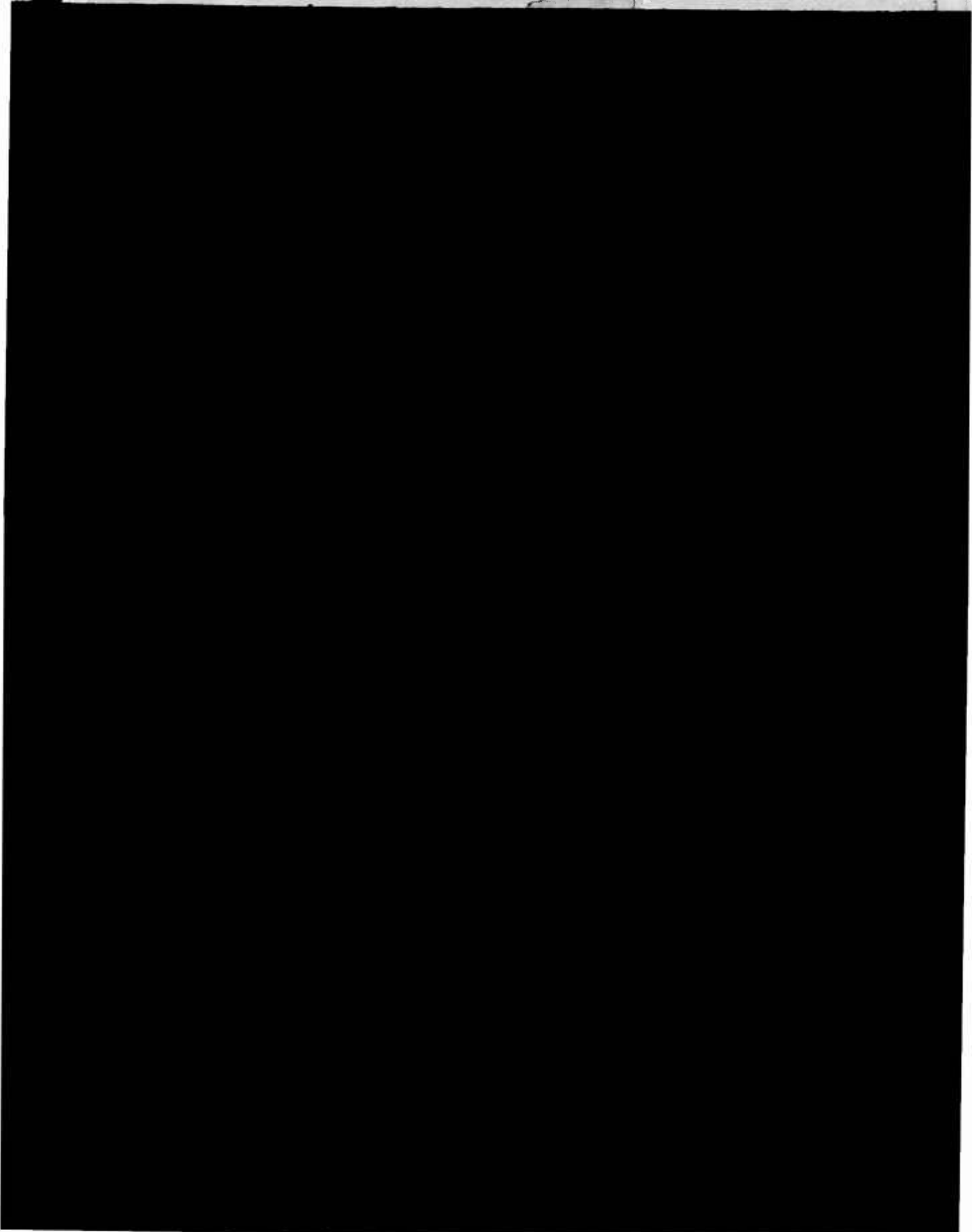

B-6

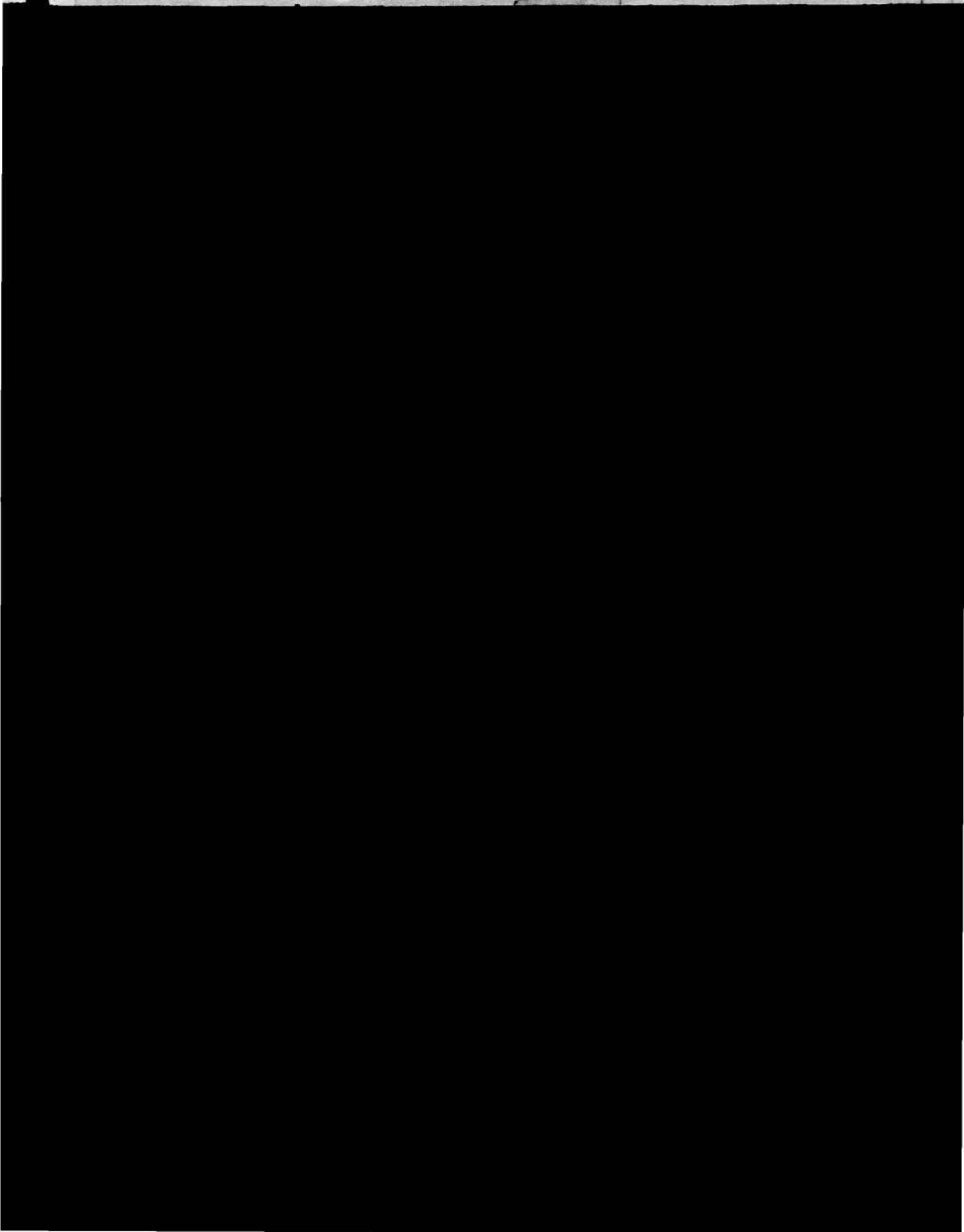

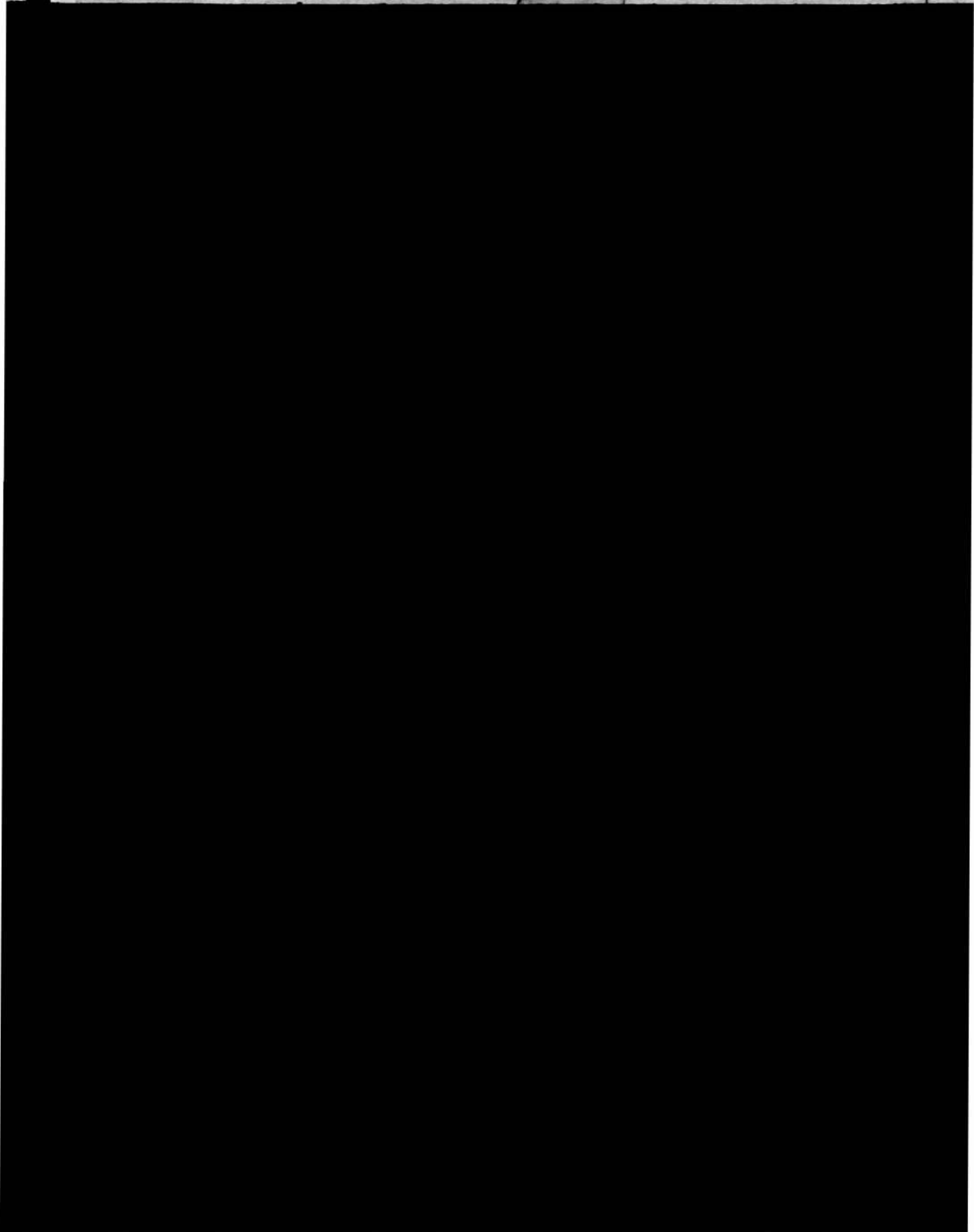

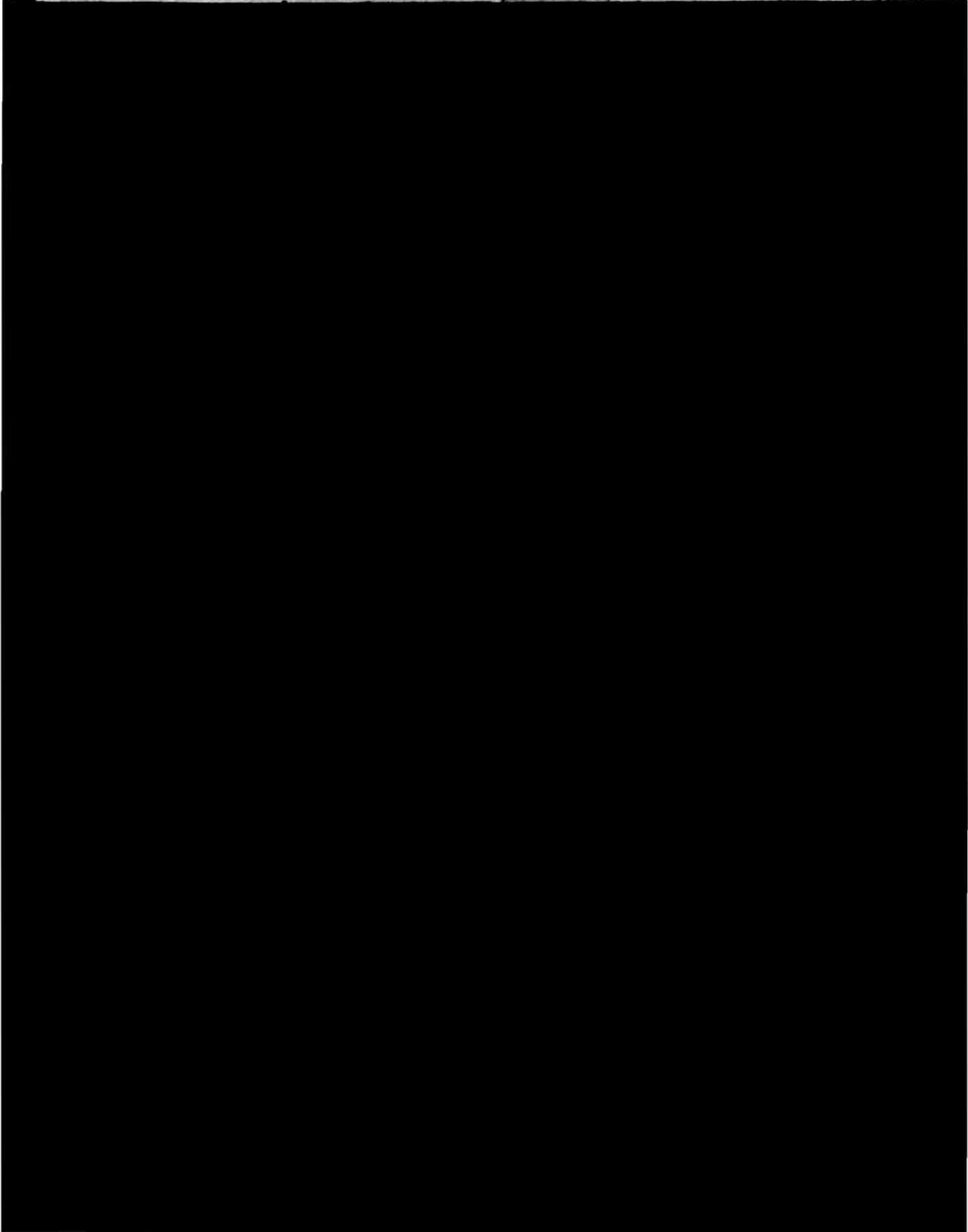
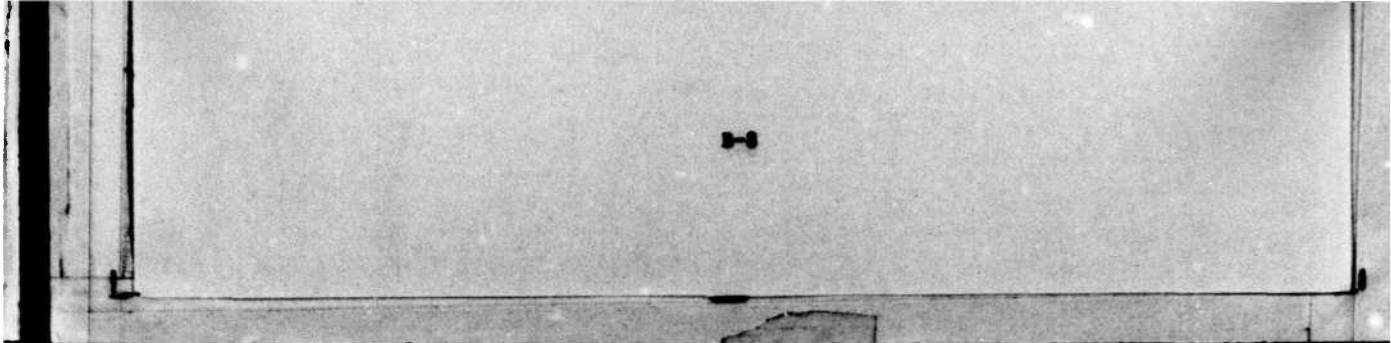

DTI