

AD-R141 474

COMPARISON OF AIRBORNE TURBULENCE-INDICATING DOPPLER  
RADAR SYSTEMS WITH G. (U) NATIONAL OCEANIC AND  
ATMOSPHERIC ADMINISTRATION BOULDER CO WE. B L TROTTER

1/1

UNCLASSIFIED

13 JAN 83 DOT/FAR/PH-84/3 DTFA01-81-Y-10557 F/G 1779

NL

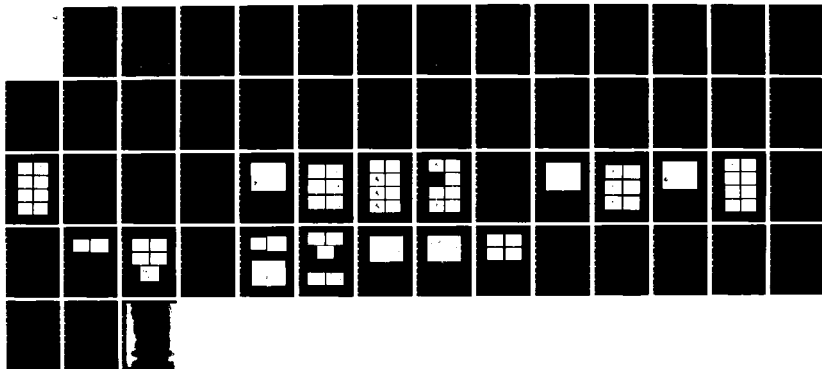

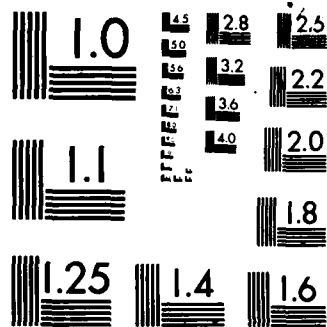

MICROCOPY RESOLUTION TEST CHART  
NATIONAL BUREAU OF STANDARDS-1963-A

12

DOT/FAA/PM-84/3

Program Engineering &  
Maintenance Service  
Washington, D.C. 20591

# Comparison of Airborne Turbulence- Indicating Doppler Radar Systems With Ground-Based Doppler Radar Systems

B.L. Trotter  
U.S. Department of Commerce  
National Oceanic and Atmospheric Administration  
325 Broadway, Boulder, CO 80303

AD-A141 474

January 1983

This document is available to the U.S. public  
through the National Technical Information  
Service, Springfield, Virginia 22161.

DTIC FILE COPY

DTIC  
ELECTE  
MAY 23 1984  
S E D



U.S. Department of Transportation  
Federal Aviation Administration

\*Original contains color  
plates: All DTIC reproductions  
will be in black and  
white\*

**NOTICE**

**This document is disseminated under the sponsorship of the Department of Transportation in the interest of information exchange. The United States Government assumes no liability for its contents or use thereof.**

ERRATA

Remove front cover and Technical Report Documentation Page  
for report number DOT/FAA/PM-83/37, "Comparison of Airborne  
Turbulence-Indicating Doppler Radar Systems with Ground-Based  
Doppler Radar Systems," and replace them with attachments.  
The report number should have been DOT/FAA/PM-84/3.

Accession For	
NTIS GRA&I	<input checked="" type="checkbox"/>
DTIC TAB	<input type="checkbox"/>
Unannounced	<input type="checkbox"/>
Justification	
By _____	
Distribution/	
Availability Codes	
Dist	Avail and/or Special
A-1	

APM-13  
May 16, 1984  
Attachments



1. Report No. DOT/FAA/PM-84/3	2. Government Accession No. <i>A141 474</i>	3. Recipient's Catalog No.	
4. Title and Subtitle Comparison of Airborne Turbulence-Indicating Doppler Radar Systems with Ground-Based Doppler Radar Systems		5. Report Date Jan. 13, 1983	
		6. Performing Organization Code MGA240	
7. Author(s) B. L. Trotter		8. Performing Organization Report No.	
9. Performing Organization Name and Address U.S. Dept. of Commerce National Oceanic and Atmospheric Administration Weather Modification Program Office 325 Broadway, Boulder, CO 80303		10. Work Unit No. (TRAIS)	
		11. Contract or Grant No. DTFA01-81-Y-10557	
12. Sponsoring Agency Name and Address U.S. Department of Transportation Federal Aviation Administration Program Engineering & Maintenance Service Washington, D.C. 20591		13. Type of Report and Period Covered Final Report May 15, 1981, to March 15, 1982	
		14. Sponsoring Agency Code FAA APM 310	
15. Supplementary Notes			
16. Abstract  To promote air safety, FAA has undertaken the task of maintaining current knowledge of the state of the design of turbulence-indicating weather radars. The airborne turbulence-indicating radar is a translation of ground-based radar technology to the airborne environment. Comparisons are made between data sets of the airborne turbulence-indicating radars and a ground-based Doppler radar with turbulence (second moment) capabilities. No comparison is intended between the airborne systems.			
17. Key Words Doppler Radar Airborne Radar Airborne Turbulence Turbulence Avoidance Radar		18. Distribution Statement This document is available to the U.S. public through the National Technical Information Service, Springfield, Virginia 22161.	
19. Security Classif. (of this report) Unclassified	20. Security Classif. (of this page) Unclassified	21. No. of Pages 49	22. Price

### METRIC CONVERSION FACTORS

Approximate Conversions to Metric Measures				Approximate Conversions from Metric Measures			
Symbol	When You Know	Multiply by	To Find	Symbol	When You Know	Multiply by	To Find
<b>LENGTH</b>							
m	meters	39.37	inches	cm	centimeters	0.01	meters
ft	feet	0.3048	meters	m	meters	1.1	meters
in	inches	2.54	centimeters	km	kilometers	0.62137	miles
mi	miles	1.60934	kilometers	<b>AREA</b>			
<b>AREA</b>							
sq ft	square feet	0.092903	square meters	sq cm	square centimeters	0.155000	square inches
sq yd	square yards	0.846356	square meters	sq m	square meters	1.195990	square yards
sq mi	square miles	2.599987	square kilometers	ha	hectares	2.471054	square miles
ac	acres	0.404686	hectares	<b>MASS (weight)</b>			
<b>MASS (weight)</b>							
oz	ounces	28.3495	grams	g	grams	0.035274	ounces
lb	pounds	453.592	grams	kg	kilograms	2.204623	pounds
short ton	short tons	907.185	kilograms	t	tonnes (1000 kg)	1.102311	short tons
<b>VOLUME</b>							
<b>VOLUME</b>							
l	liters	1.05669	quarts	ml	milliliters	0.033814	fluid ounces
qt	quarts	0.946353	liters	l	liters	1.05669	quarts
pt	pints	0.473176	liters	m <sup>3</sup>	cubic meters	35.2335	gallons
gal	gallons	3.78541	liters	m <sup>3</sup>	cubic meters	1.35	cubic feet
cu ft	cubic feet	0.028317	cubic meters	<b>TEMPERATURE (exact)</b>			
cu yd	cubic yards	0.764555	cubic meters	<b>TEMPERATURE (exact)</b>			
<b>TEMPERATURE (exact)</b>							
°F	Fahrenheit temperature	$(F - 32) \times \frac{5}{9}$	Celsius temperature	°C	Celsius temperature	$C \times \frac{9}{5} + 32$	Fahrenheit temperature

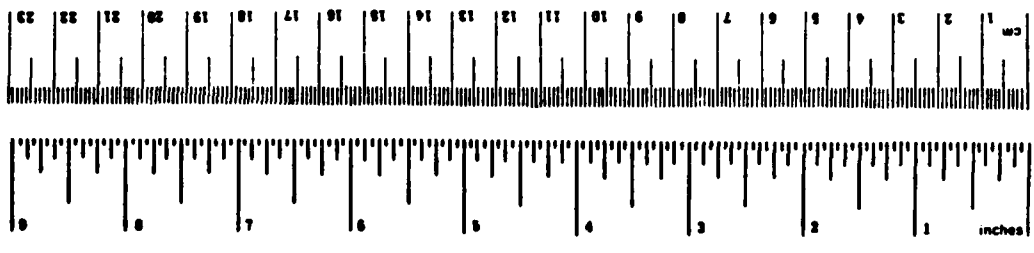

60 mph = 52.1 knots (nautical miles per hour)  
 60 mph = 88' / sec  
 1 mph = .87 knots  
 1 knot = 1.15 mph

\* 1 in = 2.54 exactly. For other exact conversions and more detailed tables, see NBS Misc. Publ. 78, Units of Weights and Measures, Price \$7.25, SD Catalog No. C13.10 286.

<sup>89/3</sup>  
DOT/FAA/PM-~~63737~~

Program Engineering &  
Maintenance Service  
Washington, D.C. 20591

# **Comparison of Airborne Turbulence- Indicating Doppler Radar Systems With Ground-Based Doppler Radar Systems**

**B.L. Trotter**  
**U.S. Department of Commerce**  
**National Oceanic and Atmospheric Administration**  
**325 Broadway, Boulder, CO 80303**

**January 1983**

This document is available to the U.S. public  
through the National Technical Information  
Service, Springfield, Virginia 22161.



US Department of Transportation  
**Federal Aviation Administration**

NOTICE

This document is disseminated under the sponsorship of the Department of Transportation in the interest of information exchange. The United States Government assumes no liability for its contents or use thereof.

1. Report No. <i>84/8</i> DOT/FAA/PM-89/97		2. Government Accession No.		3. Recipient's Catalog No.	
4. Title and Subtitle Comparison of Airborne Turbulence- Indicating Doppler Radar Systems with Ground-Based Doppler Radar Systems				5. Report Date Jan. 13, 1983	
				6. Performing Organization Code MGA240	
7. Author(s) B. L. Trotter				8. Performing Organization Report No.	
9. Performing Organization Name and Address U.S. Dept. of Commerce National Oceanic and Atmospheric Administration Weather Modification Program Office 325 Broadway, Boulder, CO 80303				10. Work Unit No. (TRAIS)	
				11. Contract or Grant No. DTFA01-81-Y-10557	
12. Sponsoring Agency Name and Address U.S. Dept. of Transportation Federal Aviation Administration APM 310, Washington, DC 20591				13. Type of Report and Period Covered Final Report May 15, 1981, to March 15, 1982	
				14. Sponsoring Agency Code FAA APM 310	
15. Supplementary Notes					
16. Abstract  <p>To promote air safety, FAA has undertaken the task of maintaining current knowledge of the state of the design of turbulence-indicating weather radars. The airborne turbulence-indicating radar is a translation of ground-based radar technology to the airborne environment. Comparisons are made between data sets of the airborne turbulence-indicating radars and a ground-based Doppler radar with turbulence (second moment) capabilities. No comparison is intended between the airborne systems.</p>					
17. Key Words Doppler Radar Airborne Radar Airborne Turbulence Turbulence Avoidance Radar			18. Distribution Statement This document is available to the U.S. public through the National Technical Information Service, Springfield, Virginia 22161.		
19. Security Classif. (of this report) Unclassified		20. Security Classif. (of this page) Unclassified		21. No. of Pages 49	22. Price

# METRIC CONVERSION FACTORS

## Approximate Conversions to Metric Measures

Symbol	When You Know	Multiply by	To Find	Symbol
<b>LENGTH</b>				
in	inches	2.5	centimeters	cm
ft	feet	30	centimeters	cm
yd	yards	0.9	meters	m
mi	miles	1.6	kilometers	km
<b>AREA</b>				
sq in	square inches	6.5	square centimeters	cm <sup>2</sup>
sq ft	square feet	0.09	square meters	m <sup>2</sup>
sq yd	square yards	0.8	square meters	m <sup>2</sup>
sq mi	square miles	2.6	square kilometers	km <sup>2</sup>
acres	acres	0.4	hectares	ha
<b>MASS (weight)</b>				
oz	ounces	28	grams	g
lb	pounds	0.45	kilograms	kg
	short tons (2000 lb)	0.9	tonnes	t
<b>VOLUME</b>				
tblsp	tablespoons	5	milliliters	ml
fl oz	fluid ounces	15	milliliters	ml
c	cup	30	milliliters	ml
pt	pints	0.24	liters	l
qt	quarts	0.47	liters	l
gal	gallons	0.35	liters	l
ft <sup>3</sup>	cubic feet	3.8	liters	l
yd <sup>3</sup>	cubic yards	0.03	cubic meters	m <sup>3</sup>
		0.76	cubic meters	m <sup>3</sup>
<b>TEMPERATURE (exact)</b>				
°F	Fahrenheit temperature	5/9 (after subtracting 32)	Celsius temperature	°C

\* 1 in = 2.54 (exactly). For other exact conversions and more detailed tables, see NBS Misc. Publ. 286, Units of Weights and Measures, Price \$2.25, SO Catalog No. C1310 286.

60 mph = 52.1 knots (nautical miles per hour)  
 60 mph = 88'/sec      1g = 32.2'/'sec

Symbol	When You Know	Multiply by	To Find	Symbol
<b>LENGTH</b>				
mm	millimeters	0.04	inches	in
cm	centimeters	0.4	inches	in
m	meters	3.3	feet	ft
km	kilometers	1.1	yards	yd
		0.6	miles	mi
<b>AREA</b>				
cm <sup>2</sup>	square centimeters	0.16	square inches	in <sup>2</sup>
m <sup>2</sup>	square meters	1.2	square yards	yd <sup>2</sup>
km <sup>2</sup>	square kilometers	0.4	square miles	mi <sup>2</sup>
ha	hectares (10,000 m <sup>2</sup> )	2.5	acres	acres
<b>MASS (weight)</b>				
g	grams	0.035	ounces	oz
kg	kilograms	2.2	pounds	lb
t	tonnes (1000 kg)	1.1	short tons	short tons
<b>VOLUME</b>				
ml	milliliters	0.03	fluid ounces	fl oz
l	liters	2.1	pints	pt
l	liters	1.06	quarts	qt
l	liters	0.26	gallons	gal
m <sup>3</sup>	cubic meters	35	cubic feet	ft <sup>3</sup>
m <sup>3</sup>	cubic meters	1.3	cubic yards	yd <sup>3</sup>
<b>TEMPERATURE (exact)</b>				
°C	Celsius temperature	9/5 (then add 32)	Fahrenheit temperature	°F

1 mph = .87 knots  
 1 knot = 1.15 mph

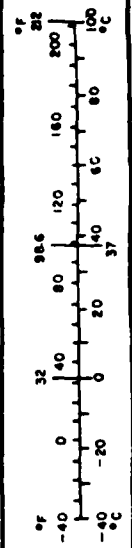

# Contents

	Page
Technical Report Documentation Page . . . . .	i
Metric Conversion Factors . . . . .	ii
Contents . . . . .	iii
List of Illustrations . . . . .	iv
List of Tables . . . . .	v
List of Abbreviations and Symbols . . . . .	vi
Introduction . . . . .	1
Purpose . . . . .	1
System Descriptions . . . . .	1
Summary of Results . . . . .	3
Conduct of Test . . . . .	6
Chronology . . . . .	6
Procedure . . . . .	10
Data Acquisition and Evaluation . . . . .	11
Radar Number One . . . . .	11
Radar Number Two . . . . .	26
Conclusions . . . . .	33
Radar Number One . . . . .	36
Radar Number Two . . . . .	37
Recommendations . . . . .	40
Acknowledgments . . . . .	42
References . . . . .	42

List of Illustrations

RADAR NUMBER ONE		Page
Figure 1	Basic Flight Pattern for Test Runs	9
Figure 2	Flight Track During Test of Radar Number One	12
Figures 3A-3D	Ground Radar, Run Number One	13
Figures 3E-3H	Airborne Radar, Run Number One--Target Head-on to 90° Off Heading	13
Figure 4	Airborne Radar Ground Clutter Pattern--Effects of Uncorrected Aircraft Translational Motion on Measured Velocities	17
Figures 5A-5C	Ground Radar, Run Number One--Data for Crossing Leg	18
Figures 5D-5F	Airborne Radar, Run Number One--Data for Crossing Leg	18
Figures 6A-6D	Ground Radar, Run Number Two	19
Figures 6E-6G	Airborne Radar, Run Number Two--Head-on to 90° Off Heading	19
Figure 7A	Ground Radar, Run Number Two--Continued	20
Figures 7B, 7C	Ground Radar, Run Number Two--Crossing Pattern	20
Figures 7D, 7E	Airborne Radar, Run Number Two--Head-on to 90° Off Heading, Continued	20
Figures 7F, 7G	Airborne Radar, Run Number Two--Crossing Pattern Leg	20
Figure 8	Airborne Reflectivity (Wx) Corresponding to Turbulence in Figure 7G	22
Figures 9A-9C	Ground Radar, Run Number Three	23
Figures 9D-9E	Airborne Radar, Run Number Three	23
Figure 10	Airborne Reflectivity Corresponding to Figure 9D	24
Figures 11A-11D	Ground Radar, Run Number Three--Data for Crossing Pattern Leg	25
Figure 11E-11H	Airborne Radar, Run Number Three--Data for Crossing Pattern	25

RADAR NUMBER TWO

		Page
Figure 12	Location of Reference Points for Test of Radar Number Two	27
Figure 13A	Airborne Radar Location of Echoes Shown in Figure 12	28
Figure 13B	Ground Radar Location of Echoes Shown in Figure 12	28
Figures 14A-14D	Airborne Radar, Run Number One--Spectrum Widths	29
Figure 14E	Ground Radar, Run Number One--Spectrum Widths	29
Figure 15	Radar Echo Locations at Start of Run Number Two	31
Figure 16	Ground Radar, Run Number Two--Spectrum Widths	31
Figures 17A-17C	Airborne Radar, Run Number Two--Spectrum Width	32
Figure 18A, 18B	Airborne Reflectivity at Low Altitude Showing Ground Clutter and Target Locations, Run Number Three	32
Figure 19	Ground Radar, Run Number Three--Echo Location	33
Figure 20	Ground Radar, Run Number Three--Spectrum Widths	34
Figures 21A-21D	Airborne Radar, Run Number Three--Spectrum Width	35

## List of Tables

		Page
Table 1	Radar Characteristics	2
Table 2	Turbulence Color Chart	14
Table 3	Values for the Equation for Velocity Spectrum Spreading Due to Antenna Scanning Motion	15

## List of Abbreviations and Symbols

ASL	Above Sea Level
CDT	Central Daylight Time
DME	Distance-Measuring Equipment
ERL	Environmental Research Laboratories
FAA	Federal Aviation Administration
IFR	Instrument Flight Rules
K	Thousand
km	Kilometer
MHz	Megahertz
m/s	Meters per second
$\mu$ s	Microseconds
nmi	Nautical mile
NOAA	National Oceanic and Atmospheric Administration
NSSL	National Severe Storms Laboratory
PPS	Pulses Per Second
PRF	Pulse Repetition Frequency
RF	Radio Frequency
STC	Sensitivity Time Control
S.D.	Standard Deviation
VFR	Visual Flight Rules
VOR	Variable Omni Range
WMPO	Weather Modification Program Office
Wx	Weather
$\sigma_s$	Velocity spectrum spreading due to antenna scanning motion
$\alpha$	Rotational rate of antenna
$\lambda$	Wavelength
$\theta_z$	Two-way half-power beam width
$\sigma_b$	Velocity spectrum spreading due to translational motion of aircraft plus mean wind speed
$V_w$	Mean wind speed
$\beta$	Angle of wind relative to transmitted beam center
$V_{ac}$	Aircraft ground speed
$\gamma$	Angle of transmitted beam to the aircraft ground track

## INTRODUCTION

### Purpose

The comparison of the airborne Doppler radars with a ground-based Doppler was initiated by the Weather Modification Program Office (WMPO) of the National Oceanic and Atmospheric Administration's Environmental Research Laboratories, with the Federal Aviation Administration (FAA) as a sponsoring agency, to investigate specific needs of the commercial air carriers: (1) improve the margin of operational safety to both man and equipment, and (2) initiate new equipment designs that will promote energy conservation. The design of the turbulence-indicating radar (Doppler techniques) can contribute to filling both of the above needs. The radars to be tested were designed by private companies. All companies, who had an operational Doppler radar at the time of the test, were welcomed to be part of the test group. Basic questions to be answered from the results of the test are the following: can the radars be used to detect some of the hazards associated with turbulence in thunderstorms, and can the radars be used to avoid these detected hazards without flying long distances around the storms or convective cells? It is important to remember that the radars being tested require the presence of hydrometeors to give an indication of turbulence. Therefore, clear-air turbulence would not be detected by the equipment.

### Systems Descriptions

When dealing with Doppler radar equipment, one often encounters terms having to do with spectral moments. The moments normally encountered are the zeroth moment (intensity estimate), the first moment (velocity estimate),

and the second moment (spectrum width estimate). For this test, the second moment estimates are of primary interest. The width of the velocity spectrum can give a direct indication of the degree of turbulence within the sampled volume. An exact measure of the moments is difficult because of the inaccuracies in the measuring equipment and the randomly varying signal in the sample volume being measured. The statistical uncertainty of the moments can be reduced by taking large numbers of measurement samples of the volume and averaging the resultant measurements.

The radar systems involved in this test have, as part of their designs, processors that will determine the average width of the velocity spectrum. That width is used as an indication of turbulence. The theory and design of the equipment was not provided by the vendors. Therefore, the information on detailed system description will be limited to the information contained in Table 1.

Table 1. Radar Characteristics

	NSSL S-Band	Radar Manufacturer Number One X-Band	Radar Manufacturer Number Two C-Band
Beamwidth	0.9° Pencil	3.1° Pencil	6° Pencil
Polarization	Vertical	Vertical	Horizontal
Scan Rate	9°/s	45°/s	45°/s
PRF	768 PPS	1600 PPS	1446 PPS
Pulse Width	1 $\mu$ s	6 $\mu$ s	5.75 $\mu$ s
Frequency	2850 MHz	9345 MHz	5440 MHz
Processor	Correlation Estimator	Correlation Estimator	Estimate of Mean Velocity Input S.D.

## SUMMARY OF THE RESULTS

During the time period of July 1981 to July 1982, two commercially manufactured airborne radars, designed to indicate turbulent areas in radar weather returns, were flight tested in the Oklahoma City, Oklahoma, area. The observations resulting from the test are made taking at face value the data from the tests as presented by the radar manufacturers. All equipment installation and calibration and all data recording were made by the individual manufacturers.

Additionally, no attempt was made to try to operate under identical geographic or meteorological conditions when testing the two radars. The common elements in the tests consisted of requiring measuring and recording instrumentation that could be installed on and interfaced with the normal DC-9 avionics and of using the same ground radar to compare against the airborne radars. It should also be emphasized that no attempt was made to compare the signal processing/product display techniques between the airborne and ground based radar to try to make a scientific comparison. The tests performed on the radar systems therefore produced a subjective analysis rather than an objective, scientific analysis. The equipment tested were installed in the Federal Aviation Administrations DC-9, tail number N29. For discussion purposes, the radars tested will be called Radar Number One and Radar Number Two, from the order of the systems tested.

Airborne data were compared with ground radar data in four areas:

1. Radar return location
2. Radar return size and strength--reflectivity

3. Radar return second moment--magnitude and location within the radar return
4. Change in second-moment magnitude with changes in look angle relative to radar return.

Second-trip echoes and ground clutter contamination are two additional areas for comment. These features are peculiar to the individual radar design and cannot be compared with the ground-based Doppler radar.

#### Radar Number One

The spatial position of the radar return was easily reconstructed from both the airborne and ground-based radar data. The return size and shape from the two data sets were in good agreement. The distribution and mean of the spectrum width data (turbulence) for the airborne radar were lower than the data from the ground-based radar. The data processor for the airborne radar included no velocity correction techniques for look-angle changes. Consequently, there were indications of spectrum width changes of as much as 4 m/s between head-on returns and the same returns appearing at 90° off heading. When the turbulence mode was selected, a substantial number of second-trip echoes existed on the radar display. The appearance of ground clutter on the radar display was shown as additional areas of turbulence. The display contamination with ground clutter was more evident at lower altitudes.

#### Radar Number Two

The spatial position of the radar weather returns for both the airborne and ground radars was easily located from recorded data. Agreement between

the spatial positions of the ground and airborne radar returns was satisfactory. The target areas and reflectivity for both data sets compared well with each other. The spectrum width data (turbulence) of the two radars compared quite well when the airborne radar was looking at the target from head on to approximately  $30^{\circ}$  off the aircraft heading. As the look angle to the target increased to greater than  $30^{\circ}$ , the area where turbulence exceeded the threshold level decreased when compared with the same target at a head-on look angle. No second-trip echoes were observed on the radar display. At altitudes of 20K ft ASL, no appreciable amount of ground clutter contamination of the radar display was observed. However, at 10K ft ASL ground clutter contamination increased significantly.

## CONDUCT OF TEST

### Chronology

Formal preparation for the flight testing of the turbulence-indicating radars started in January 1981. The initial planning involved personnel from the FAA, WMPO, and the National Severe Storms Laboratory (NSSL).

In April 1981, a meeting was held in Oklahoma City, with representatives from FAA, WMPO, NSSL and three equipment manufacturers. The meeting was to lay the following foundations for the equipment to be tested and the tests themselves. A DC-9 aircraft would be made available for the tests by the FAA Flight Training Center on a non-interference basis. The only FAA-furnished equipment for the test other than the aircraft would be a gyro for stabilization signals for the radar antenna, and a VOR and DME for aircraft position. All recording and processing equipment would have to be furnished by the equipment manufacturers. The aircraft would have one wiring configuration installed to be used by all manufacturers. The test of each manufacturer's equipment would be in three phases. In the first phase, the radar equipment would be tested on the ground at NSSL (Norman, Oklahoma) to compare the airborne radar's velocity spectrum width (turbulence) measuring capability with that of NSSL's ground-based Doppler radar. The ground tests would be for the sole purpose of establishing whether the designs of the airborne radars were sufficiently advanced to proceed to an actual flight test. The second phase of the test would be the installation and flight worthiness test on the DC-9, to ensure that the equipment would operate in the airborne environment. The

third phase would be the actual flight test using the NSSL radar as a baseline for comparison.

The ground test of the equipment was conducted during June and July 1981. Only two of the three equipment manufacturers had equipment available for ground test. Those were identified as Radar Number One and Radar Number Two in the Summary of Results section.

In August 1981, Radar Number One an X-band radar, was installed on the FAA DC-9. The first flight to verify system performance in an airborne environment was on August 26, 1981. A second system check flight was needed and was flown on September 9, 1981. On September 24, 1981, the first data acquisition flight was made. Little usable data were recorded during this flight. The expectation was that no suitable weather would be available for test work, so the tests were postponed until spring of 1982. Radar Number One was removed from the DC-9 in November 1981, and a preliminary installation of Radar Number Two, a C-band radar, was initiated. No tests were made using Radar Number Two, after this preliminary installation.

A second meeting was held in Oklahoma City on March 19, 1982. Again, the three equipment manufacturers were present as well as representatives from FAA, WMPO and NSSL. The discussion centered around the flight patterns to be flown for the tests and time available for the tests. The tests were scheduled to start on May 3, 1982, and terminate on June 11, 1982. Each equipment manufacturer would be given a 2-wk period, or until a good data set was acquired, to test its equipment. The installation of Radar Number Two, was completed on May 3, 1982, and on May 5, 1982, its first data flight was made.

One hour into the flight, the flight conditions required instrument flight rules (IFR) and some turbulence was encountered. The pilot's decision was to cancel the flight. No data were taken. During the second flight on May 11, 1982, three complete data runs were made. On the fourth run, turbulence was encountered, and the pilot terminated the flight. On May 20, 1982, Radar Number Two equipment was removed from the DC-9 and Radar Number One was installed, but the aircraft was then unavailable for test use until June 7, 1982, due to classes and scheduled maintenance.

On June 7, a local flight was made to check out the aircraft and the installation of Radar Number One. June 9, 1982, was the first data flight. Three complete data runs were made before a failure in the airborne radar terminated the mission. A review of the data set showed it adequate for an evaluation. Radar Number One was to have been removed June 11, 1982, however, FAA let the equipment remain on the DC-9 until June 18, 1982. The test program was extended until the last of June.

The manufacturer of Radar Number Two installed a second radar from its product line, an X-Band radar, on the DC-9 on June 21, 1982. On June 24, 1982, a data flight was made; however, an internal switch in the radar equipment was incorrectly positioned and the data set was invalid. On June 30, 1982, the aircraft was again down for maintenance until July 7, 1982. It was decided to continue the test until July 23, 1982. No suitable weather was in the test area during the extended period. The test was terminated on July 23, 1982, with no data being recorded for evaluation.

The basic flight pattern flown during each data run is shown in Figure 1. Slight modifications to the pattern were made so that the existing weather patterns could best be accommodated.

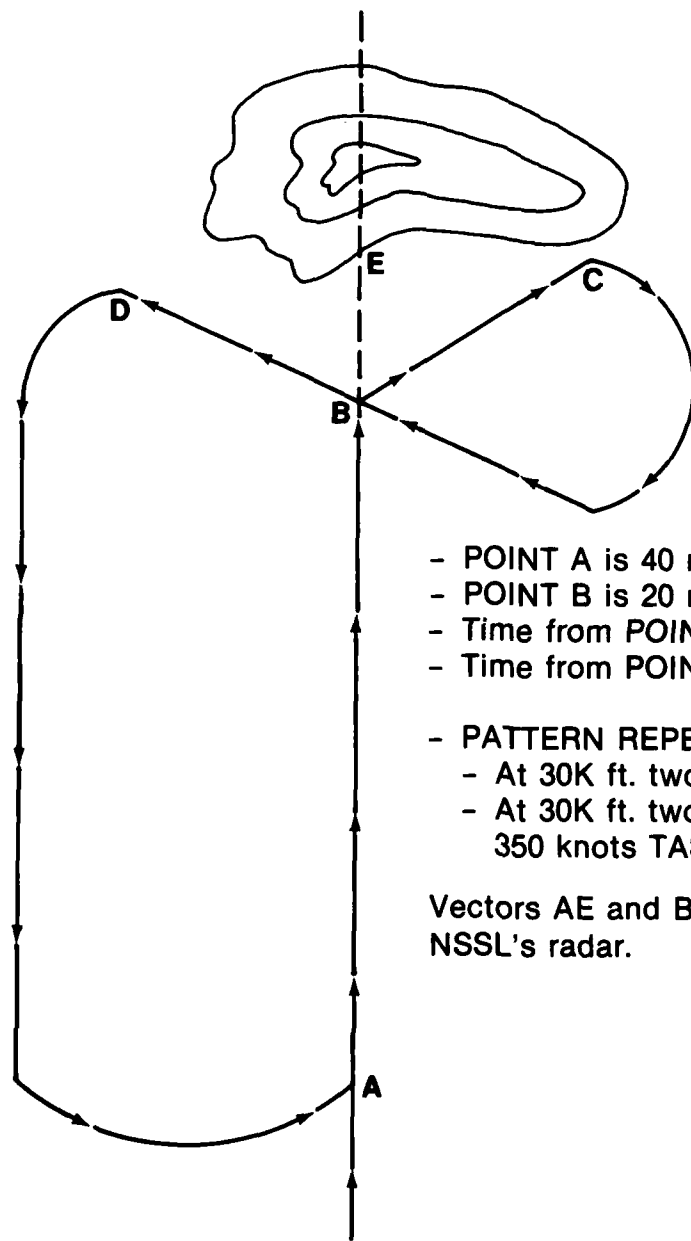

- POINT A is 40 miles to E.
- POINT B is 20 miles to E.
- Time from POINT B to C is 4 minutes.
- Time from POINT B to D is 4 minutes.
  
- **PATTERN REPETITION**
  - At 30K ft. two runs at 470 knots TAS
  - At 30K ft. two runs at 240 and at 350 knots TAS

Vectors AE and BD will be supplied by NSSL's radar.

Fig. 1

Basic Flight Pattern for Test Runs.

## Procedure

The everyday conduct of the test was established to be as routine as possible. Each day started when the Test Manager called NSSL for the daily forecast. The forecast for the afternoon was usually made by 1100 CDT. If suitable weather was anticipated for the afternoon or evening, a call-in update procedure was initiated. The aircraft was usually not available before 1600 CDT because of FAA training classes. As the afternoon hourly updates progressed, all personnel were on a standby basis. The standby continued until weather suitable for the tests was predicted to enter the area or until the forecast dictated cancellation. If the weather was suitable, a takeoff time was set. Shortly before takeoff, a call to NSSL was made to confirm the forecast.

Once the aircraft was airborne, NSSL vectored the aircraft to the weather target and suggested a heading to fly the initial leg of the pattern in Figure 1. Coordination between NSSL and the aircraft pilot established turning points and located any weather in the area that made modification of the flight track necessary. A requirement established and maintained by the DC-9 pilots was that all test flights be under visual flight rules (VFR). This one requirement negated many chances to obtain a data set, either because the weather was too deep or the turning paths were blocked off. Prior to each flight a request was made for the FAA control center to record the DC-9 position for its entire flight. Only one flight position plot was recorded by the control center. Aircraft position was recorded by using the VOR and DME instruments. The flight continued until weather conditions or equipment failure caused termination, or until a complete data set was obtained. Data acquired during the flight test were reviewed immediately after the airplane landed to determine the acceptability of the data and success of the flight.

## DATA ACQUISITION AND EVALUATION

### Radar Number One

Data for the evaluation of this radar were acquired on June 9, 1982, from 1739 to 1832 CDT. The weather system was located approximately 43.2 nmi (80 km) south-southeast of Will Rogers World Airport at Oklahoma City, Oklahoma. Figure 2 shows the flight track of the aircraft with respect to the Oklahoma City VOR and NSSL. Only one flight track during a data acquisition time is shown; the other tracks are similar to it.

Data from run number one show that the RF returns from the airborne radar were comparable in size and shape with those of the ground-based radar. The target spatial correlations between the NSSL data and the airborne data were very good.

The velocity spectral width data from NSSL indicate velocities of 4 to 10 m/s. See Figures 3A-3D. The velocities indicated by the airborne radar for corresponding times are from 2 m/s to greater than 8 m/s (Figures 3E-3H). Table 2 provides the color representation for turbulence (levels) for both airborne Radar Number One and Radar Number Two. The head-on look at the target (Figure 3E) by the airborne radar should have a minimum of contamination from radar beam width and aircraft ground speed. Yet over half of the velocities as measured by the airborne radar are less than 6 m/s. The ground radar indicates that most of the velocities are greater than 6 m/s (see Figure 3A). The ranges of velocities are in agreement, but the velocity distributions are not. As the target moves from the head-on position to 90° off the aircraft heading (Figure 3F-3H), a severe change occurs in the velocity distribution.

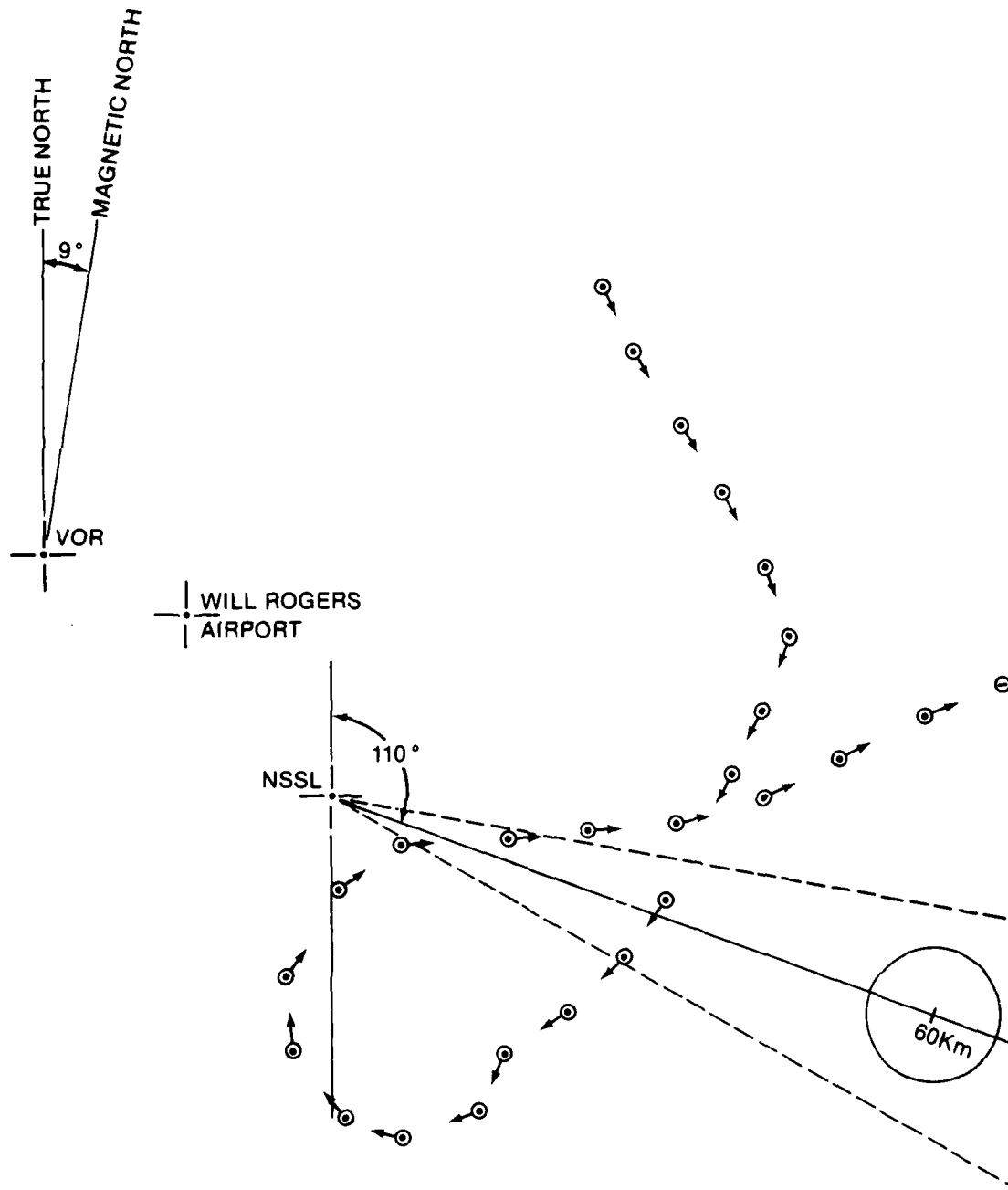
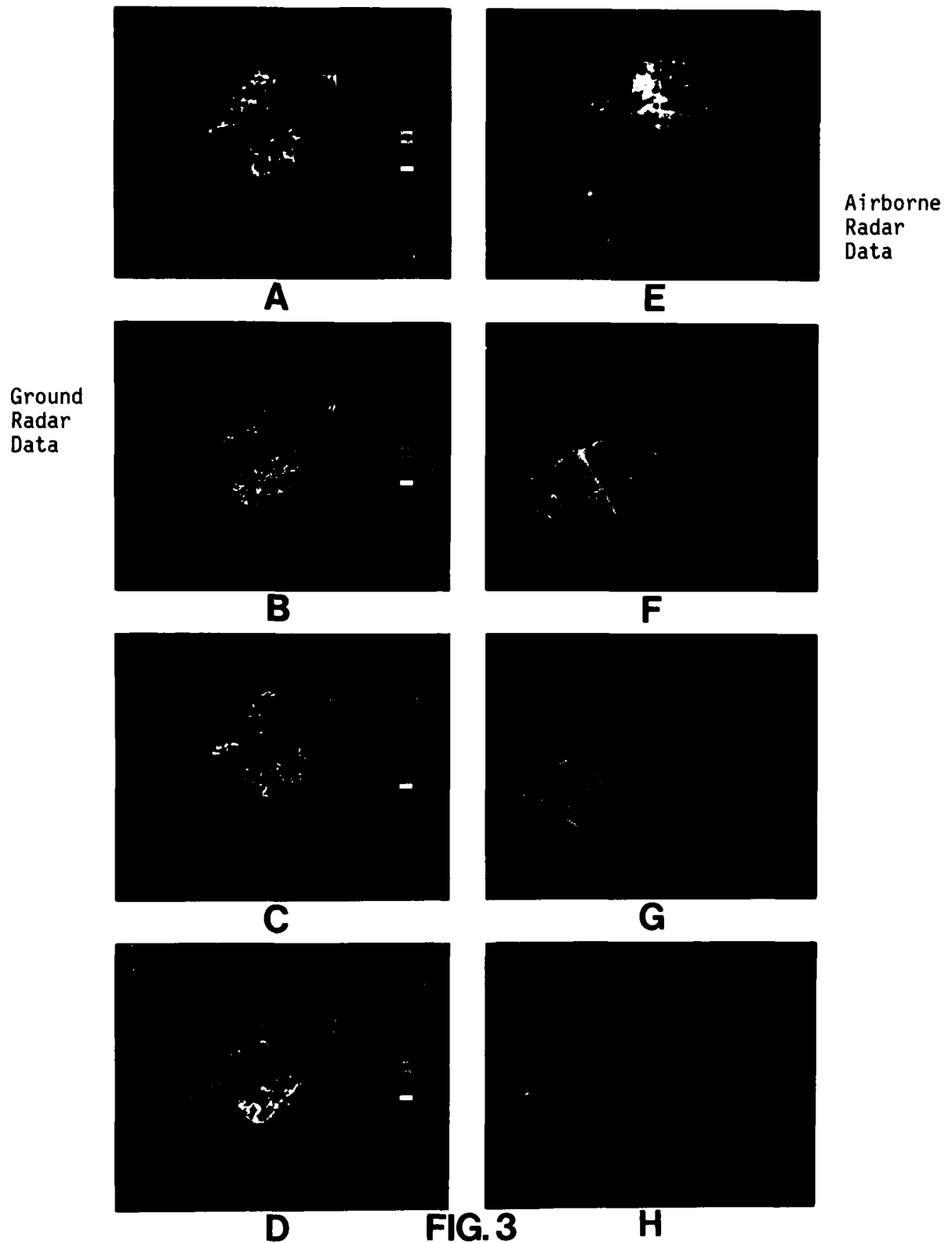

Fig. 2  
 Flight Track During Test of Radar Number One.



**FIG. 3**

Radar Number One, run number one.

Table 2. Turbulence Color Chart

Color	Radar Number One Velocity (m/s)	Radar Number Two Velocity (m/s)
Green	2	--
Yellow	4	--
Red	6	--
Magenta	8	5 or 5.8*

\* Dependent on aircraft ground speed.

A change in the presented velocity spectral width data should be expected if no corrections were applied to the second-moment data as a function of antenna position and ground speed. The velocity spectral width distribution determined for a head-on look at a meteorological target from an aircraft would not be the same as that for a look at the same target when that target is located 90° off the aircraft ground track. Major factors that contribute directly to the spreading of the velocity spectrum must be considered. First is the prevailing wind velocity relative to the center of the transmitted RF beam. Second is the aircraft ground velocity relative to the center of the RF beam. Third is the antenna scan rate and range to the target in question. All of the above items have a varying degree of influence on the width of the velocity spectrum and therefore on the velocity number used as an indicator for turbulence. The predominant effects come from the translational motion of the aircraft and the scanning motion of the radar antenna.

The equation for velocity spectrum spreading due to the scanning motion of the antenna is (Nathanson, 1969)

$$\sigma_s = \frac{\alpha\lambda}{10.7 \theta_z} \quad (\text{m/s})$$

where  $\alpha$  = rotational rate of antenna (rad/s)

$\lambda$  = wavelength of transmitted frequency (m)

$\theta_z$  = two-way half-power beam width (rad).

Values for these parameters are given in Table 3.

Table 3.--Values for the Equation for Velocity Spectrum Spreading Due to Antenna Scanning Motion

Radar No. One	Radar No. Two
$\alpha = 0.785 \text{ rad/s}$	$\alpha = 0.785 \text{ rad/s}$
$\lambda = 0.032 \text{ m}$	$\lambda = 0.055 \text{ m}$
$\theta_z = 0.039 \text{ rad}$	$\theta_z = 0.074 \text{ rad}$
$\sigma_s = 0.060 \text{ m/s}$	$\sigma_s = 0.054 \text{ m/s}$

The effect of the antenna scanning motion is small for both airborne radars.

The effect of the translational motion of the aircraft combined with the mean wind speed is (Trotter et al., 1981)

$$\sigma_b = 0.42\theta_z (V_w \sin \beta + V_{ac} \sin \gamma)$$

where  $V_w$  = mean wind speed (m/s)

$\beta$  = angle of wind relative to RF beam center

$V_{ac}$  = ground speed of the aircraft

$\gamma$  = angle of beam relative to the aircraft ground track.

$V_w$  will be very small compared with  $V_{ac}$  and can be assumed to be zero. Therefore,  $\sigma_b = 0.42\theta_z V_{ac} \sin \gamma$ . When  $V_{ac} = 225$  m/s and  $\gamma$  varies between  $0^\circ$  and  $90^\circ$ ,  $\sigma_b$  will vary between 0 m/s and 3.7 m/s.

It is obvious that if no correction is made to the measured velocity spectrum the indicated spectrum spread at  $90^\circ$  look angles will be higher than at  $0^\circ$  look angles. This change on the radar display will show as an increase in velocity (spectrum spread) as a target area goes from  $0^\circ$  (head on) to  $90^\circ$ . This effect is very obvious in the ground clutter pattern shown in Figure 4.

It is of interest to return to Figure 3E, to point out some other intriguing features. The picture shows a target echo starting at the origin and going out 11 km in range, on a  $290^\circ$  radial. This target echo is possibly due to either a fault in the receiving system or to a second-trip echo. Similar echoes are shown in Figure 5D-5F. In all cases these echoes can do nothing but confuse the aircraft radar operator, since the target indicated is either not real or is not at its actual range.

Figure 3H shows targets that are either noise or ground clutter. In either case the targets would inject an element of uncertainty in the interpretation of the radar display.

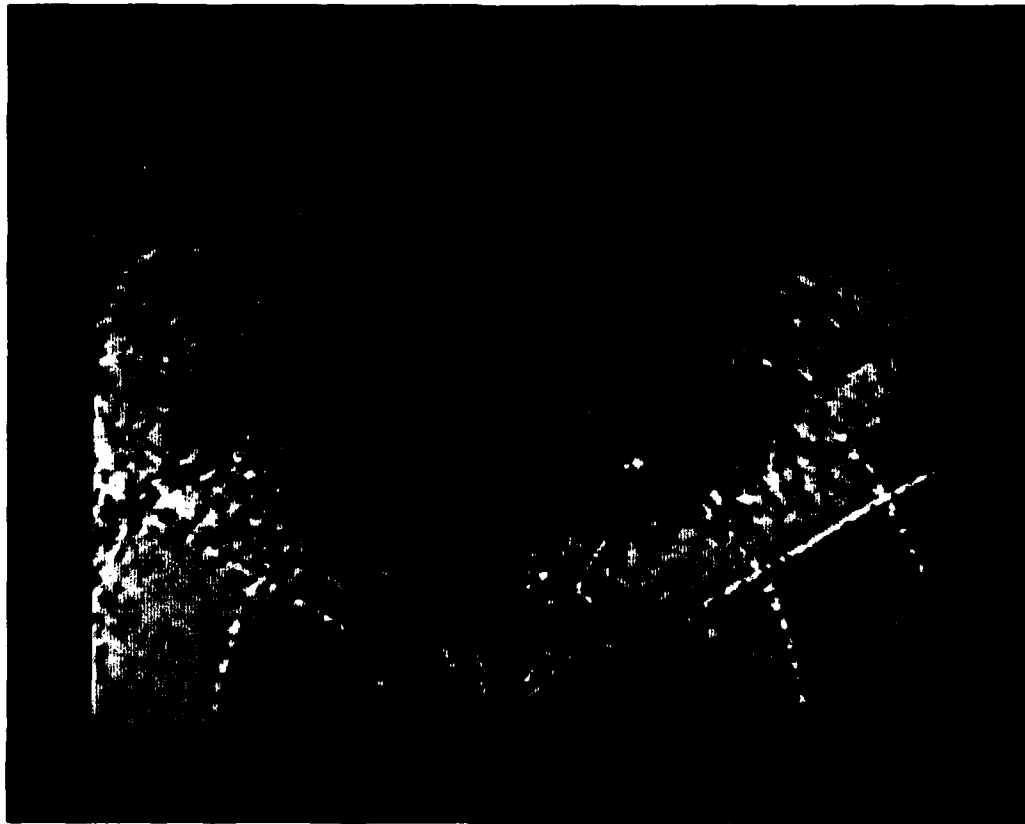

**FIG. 4**

Airborne radar ground clutter pattern effects of uncorrected aircraft translational motion on measured velocities. Radar Number One.

The sequence of photos for run number two is shown in Figures 6 and 7. The aircraft was still at 31K ft ASL, and the ground speed was approximately 188 m/s. The flight track was essentially the same as shown in Figure 2, but was shifted to the east-northeast by 13 km. Observation of the ground radar and airborne radar photographs reveals the following: The airborne radar shows a target whose estimated spectral velocities are predominantly 4 to

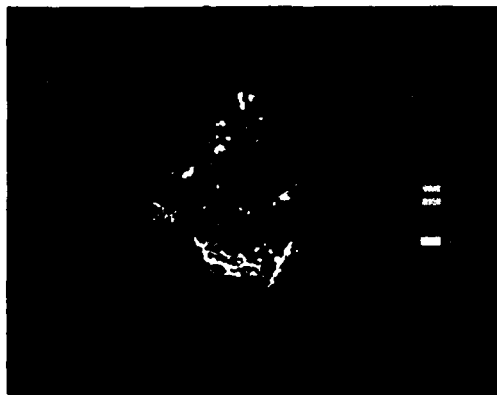

**A**

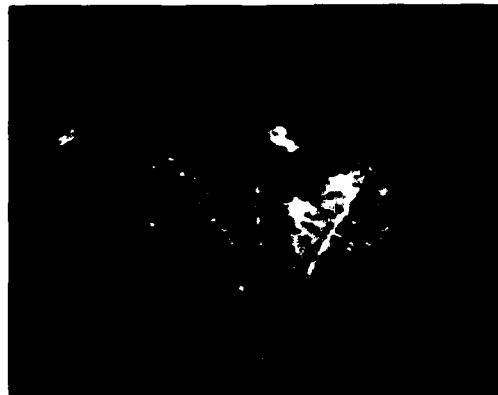

**D**

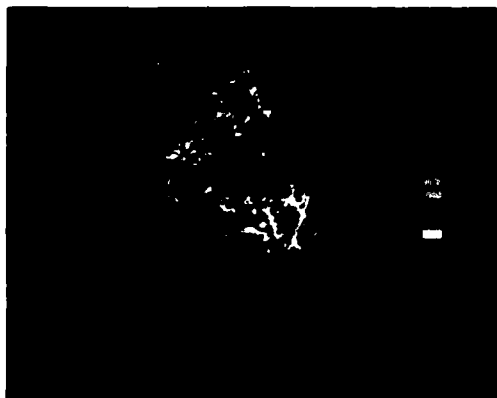

**B**



**E**

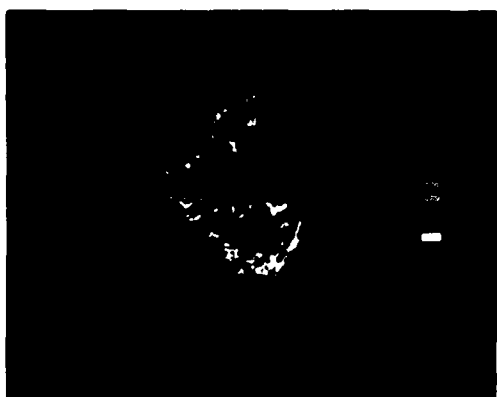

**C**



**F**

**FIG. 5**

Ground Radar

Airborne Radar

Data for crossing leg, Radar Number One, run number one.

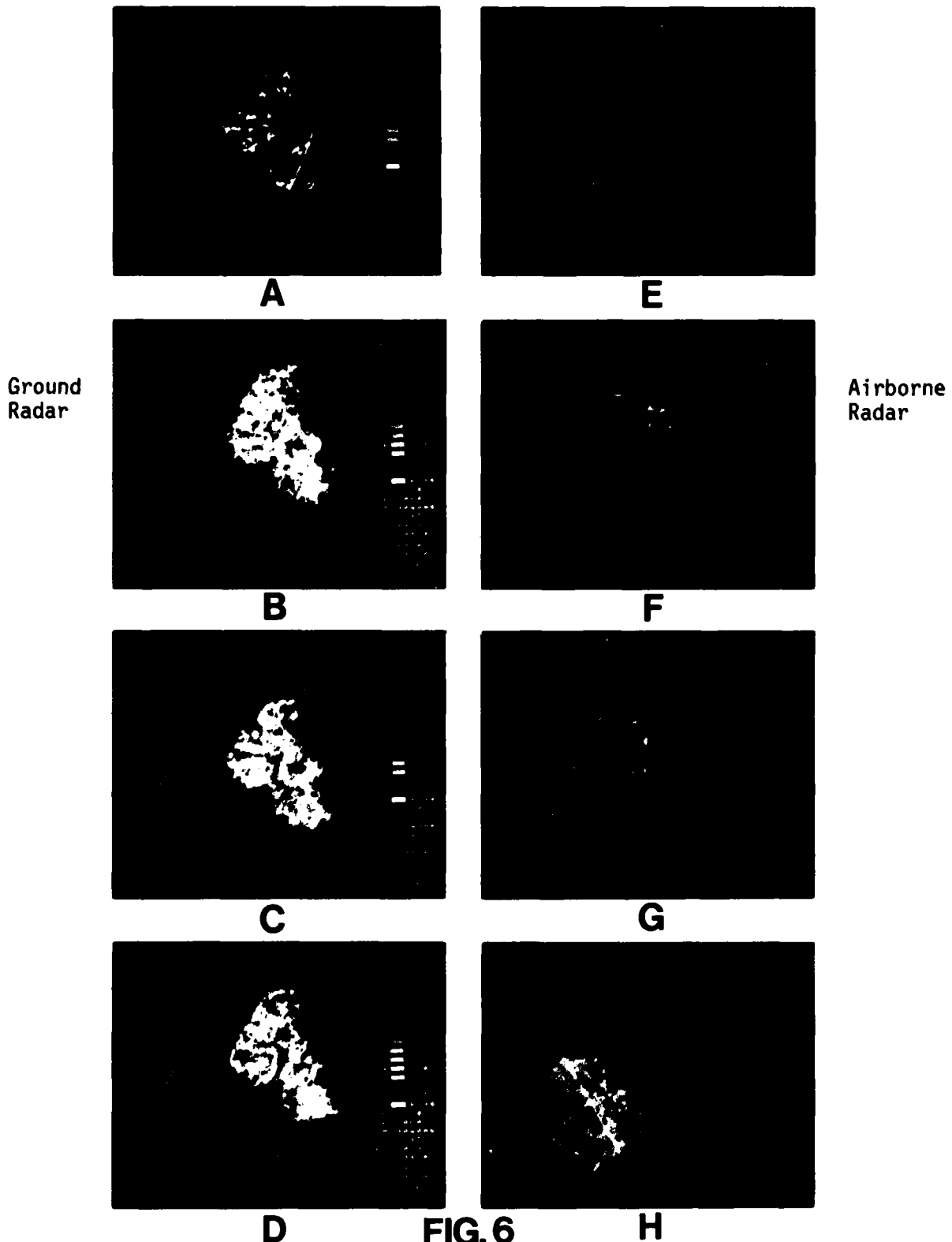

**A**

**E**

Ground  
Radar

Airborne  
Radar

**B**

**F**

**C**

**G**

**D**

**H**

**FIG. 6**

Radar Number One, run number two.

A:  
Ground  
Radar  
Run 2,  
Continued  
From  
Figure 6

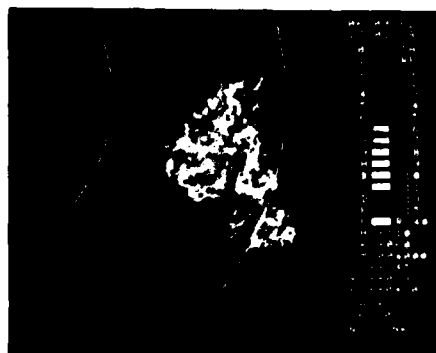

A

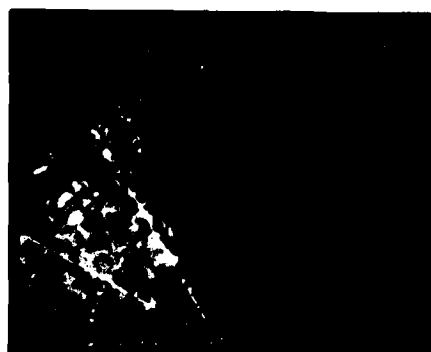

D

D, E:  
Airborne  
Run 2,  
Continued  
From  
Figure 6

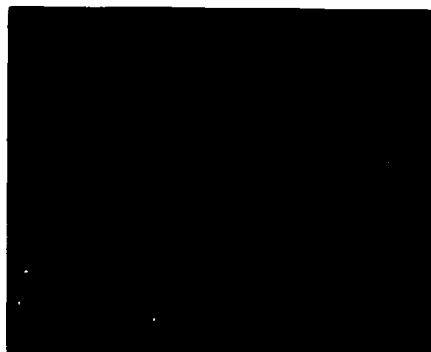

E

B, C:  
Ground  
Radar  
Run 2,  
Crossing  
Leg



B



F

F, G:  
Airborne  
Radar  
Run 2,  
Crossing  
Leg



C

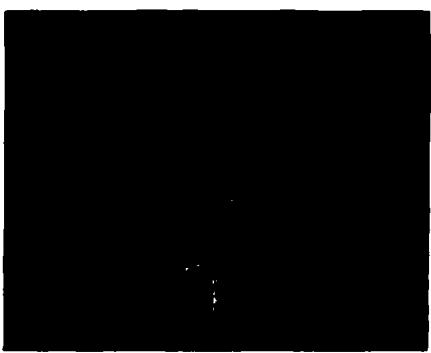

G

FIG. 7

Radar Number One, run number two continued; and crossing leg of run number two.

6 m/s (yellow). The ground radar shows the same target, with predominant velocities of 6 to 9 m/s. The discrepancy in the velocities continues with the airborne and ground radar sequential pictures. When the airborne target is located between  $60^{\circ}$  and  $90^{\circ}$  (Figures 7D and 7E) the predominant velocities are shown to be greater than 8 m/s. This is the same velocity increase correlated with off-heading angle that was noted on the first run. Again when the target was off the the right side of the aircraft (Figures 7F and 7G), on the crossing part of the run, the increase in measured velocity with increased look angle is shown. Comparison of Figures 7F and 7G shows targets ahead of the aircraft, with velocities of 8 m/s, and closing in range. The reflectivity photograph (Figure 8) shows no targets at the ranges indicated on the two photographs of turbulent areas. It can only be concluded that the targets ahead of the aircraft are second-trip echoes (echoes originating at a range other than the range indicated).

For run number three the ground speed was approximately 400 kn, and the altitude was 16K ft ASL. The geometry of the target position and the locations of NSSL and the aircraft are shown in Figure 2, but for run number three offset to the northeast. The airborne radar target distributions of spectral width velocities are shown in Figures 9 and 10. The predominant estimated velocity spectral width in the airborne radar data (Figure 9D) is less than 6 m/s (yellow). The ground radar has a predominant velocity of 6 to 7 m/s. Both radars indicate areas where the spectral width is greater than 6 m/s. The airborne radar in Figures 9D and 9E show an increase in ground returns with the lower operating aircraft altitude. The ground returns do not appear in the reflectivity photograph (Figure 10). The difference in the weather (reflectivity) and turbulence modes appears to be receiving system sensitivity.

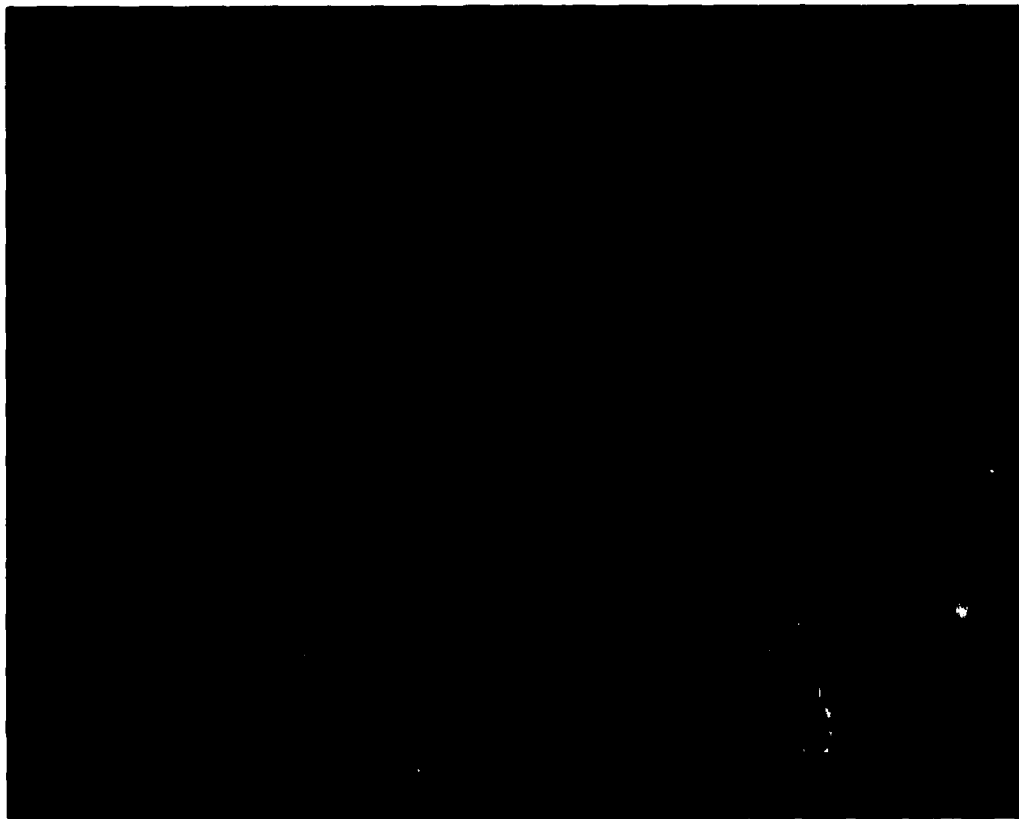

**FIG. 8**

Radar Number One airborne reflectivity (Wx) corresponding to turbulence in Figure 7G.

The return in the turbulence mode always covers a larger area than the same target in the weather mode. This was observed on all runs with this radar. Again, present during this run were the second-trip-type echoes, (Figures 11E-11H). These echoes produce a hazard by indicating areas of turbulence when nothing exists at that range in space to produce a radar return.

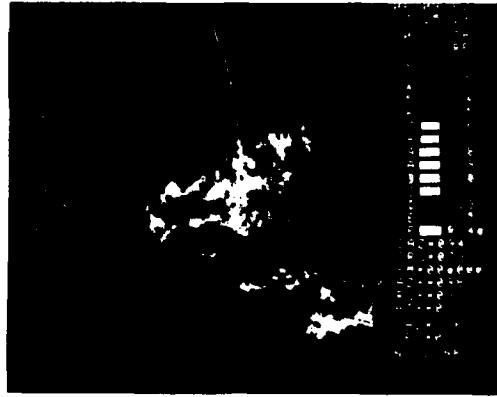

**A**

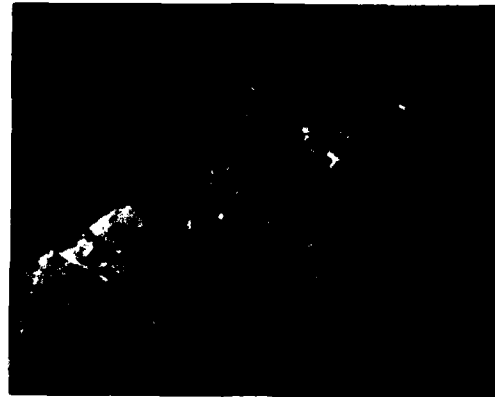

**D**

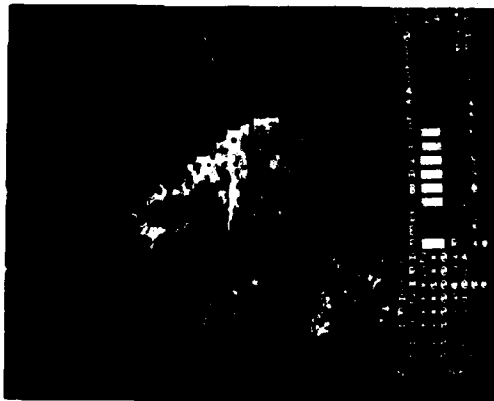

**B**

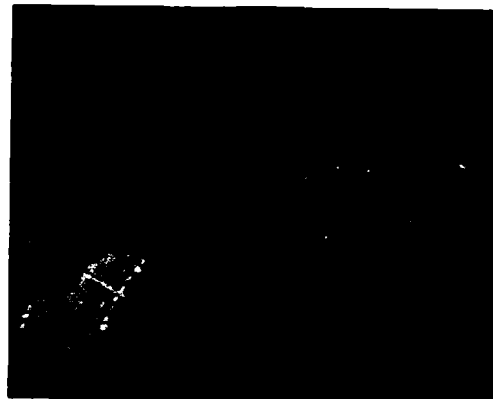

**E**



**C**

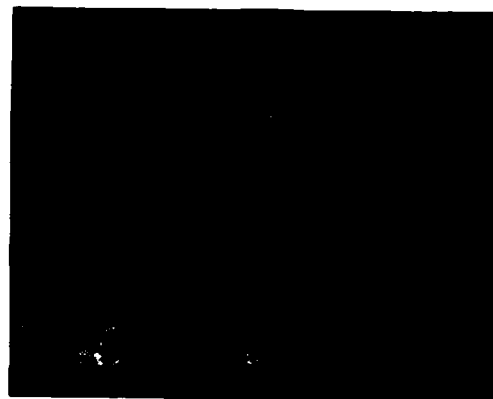

**F**

Ground Radar

**FIG. 9**

Airborne Radar

Radar Number One, run number three.

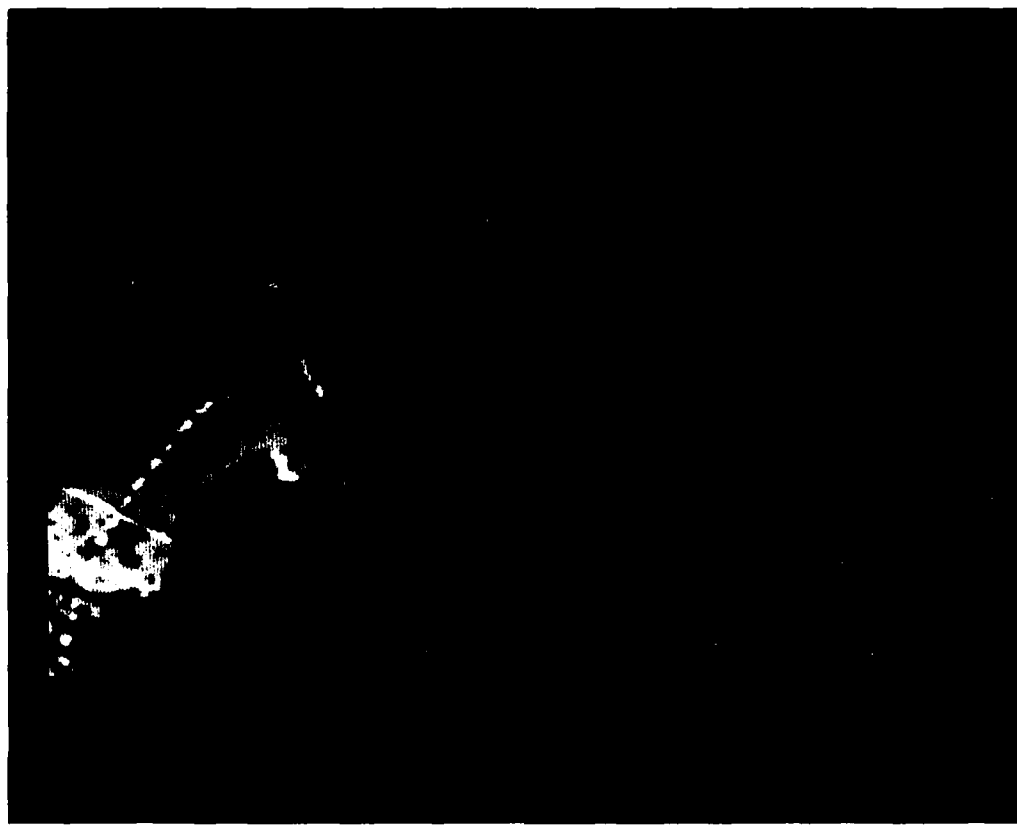

**FIG. 10**

Airborne reflectivity, Radar Number One, run number three, corresponding to Figure 9D.

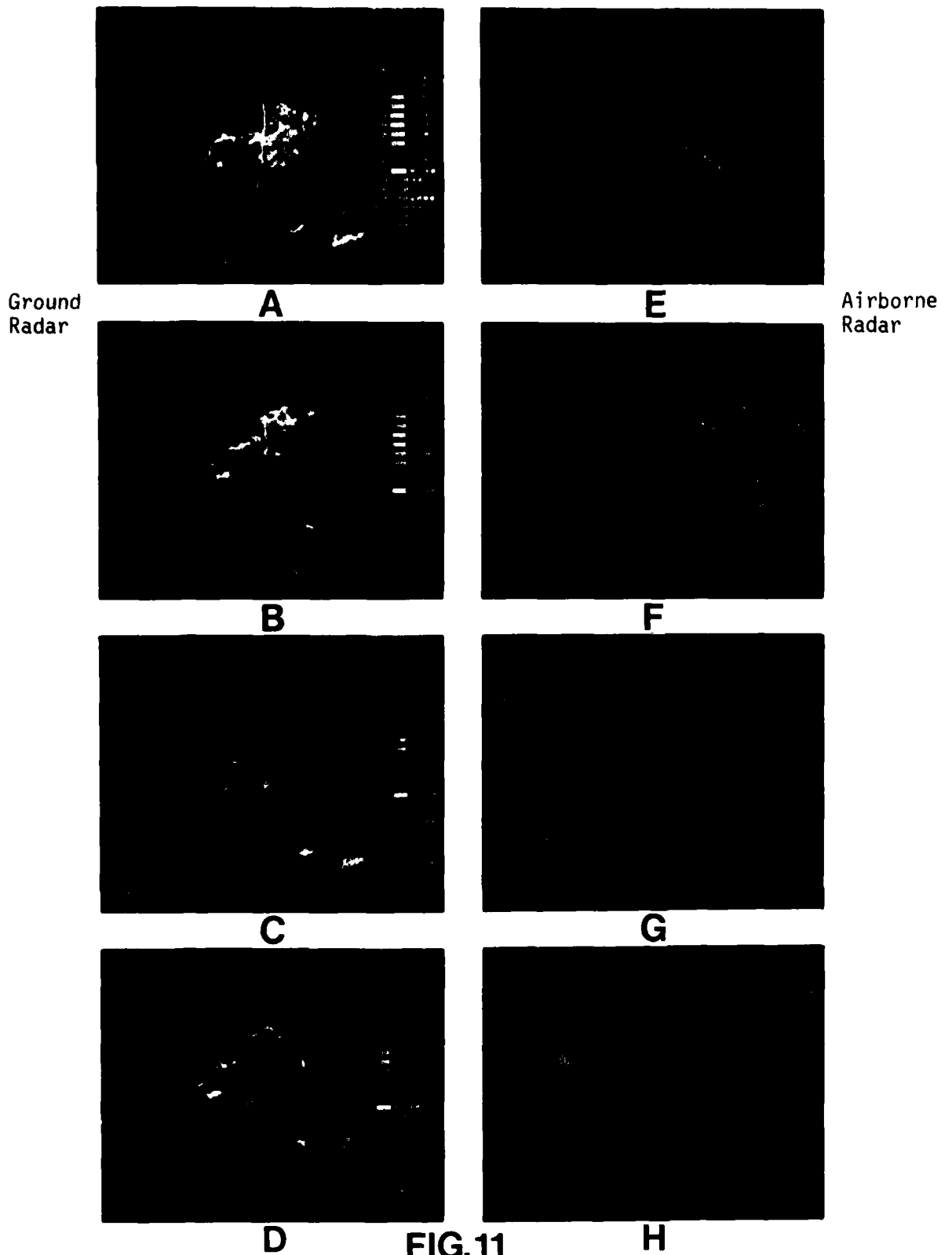

**FIG.11**

Radar Number One, run number three, the crossing leg.

## Radar Number Two

The scheme used by Radar Number Two to display turbulent areas is somewhat different from that of Radar Number One. Instead of displaying different levels of velocity spectral width (turbulence), Radar Number Two displays only a single turbulence level, represented by the magenta color, for areas the aircraft should not enter.

The test data from Radar Number Two were taken on May 11, 1982. The turbulent weather was located northeast of the Altus, Oklahoma. The flight altitude to start the test was 25K ft ASL rather than 31K ft as per the test plan. Layered weather cells prevented working at 31K ft. Aircraft ground speed for the first run was 360 knots. Figure 12 shows the approximate location of the aircraft, NSSL and Oklahoma City VOR during the runs. The geometry of the figure is not exact due to having to rely solely on manually recorded VOR/DME readouts for the aircraft position. To save some flight time, we designed the flight track to approach echo number one head on and let echo number two (see Figure 12) slide to the right side of the radar scope, so that we could measure the effects on velocity spectral spreading (changes in indicated turbulence) when the look angle to the target varied from  $0^{\circ}$  to  $90^{\circ}$ .

Figure 13A is the airborne radar display showing the location of echoes one, two and three. Figure 13B is a picture of the ground radar display showing the same three echoes. An additional echo is shown in Figure 13B, located near echo number one, that is not shown in Figure 13A. That echo is below the 20 dBZ threshold level of the airborne radar.

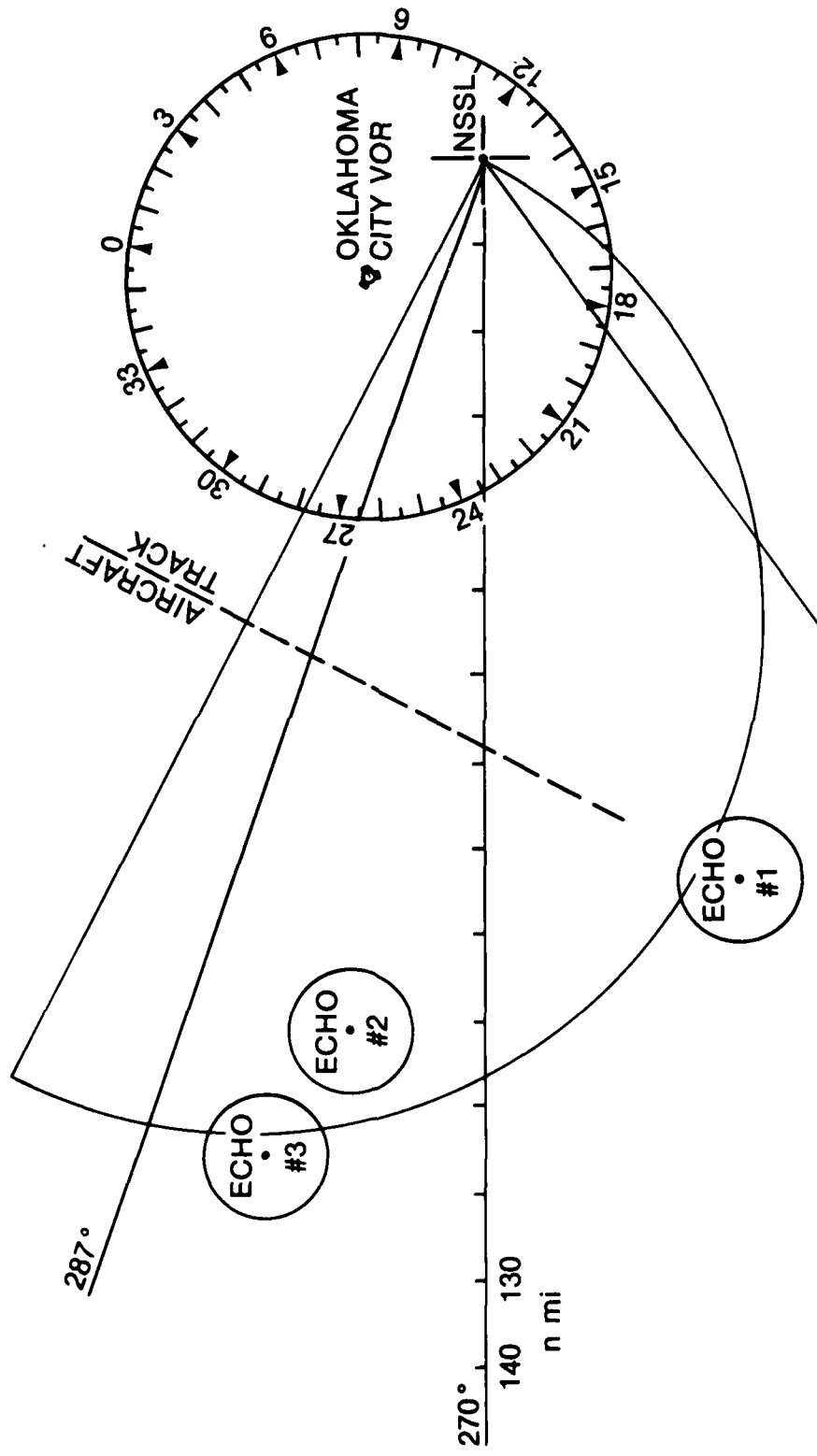
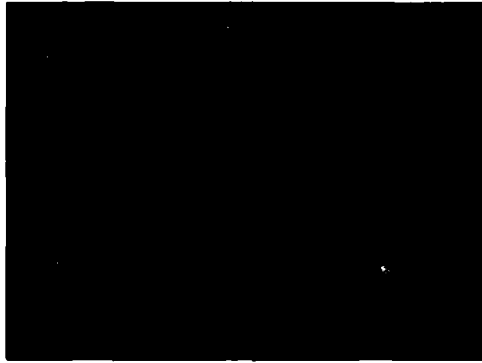
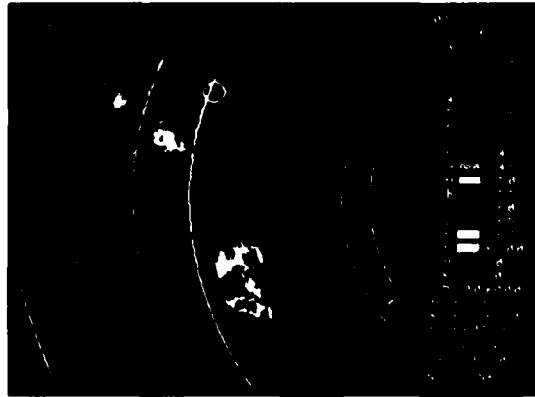

Fig. 12  
 Location of Reference Points for Test of Radar Number Two.



**A**

Airborne Radar



**B**

Ground Radar

**FIG. 13**

Location of echoes shown in Figure 12.

Figures 14A-14D show the target head on and as it slides to the right side of the radar scope. Figure 14E is the velocity spectral width data for the ground radar. Some of the turbulent areas that are shown in Figure 14B are not shown at a 60° look angle (Figure 14C). There are two possible reasons for the decrease in turbulent areas. One could be the effect of the STC (Sensitivity Time Control) function on the video being received by the radar. The second could be an overcorrection for the translational motion. Whether the reduction in turbulent area is caused by STC or the implemented algorithm, consideration must be given to the possible results of having a hazardous area and not displaying it versus having a falsely indicated hazardous area. The area where turbulence exceeds 5 m/s (established turbulence threshold for Radar Number Two) compares well with the area greater than 5 m/s for the ground radar. No second-trip echoes were observed on the airborne radar scope. Some small areas of random turbulence were noted; see Figures 14C and 14D.

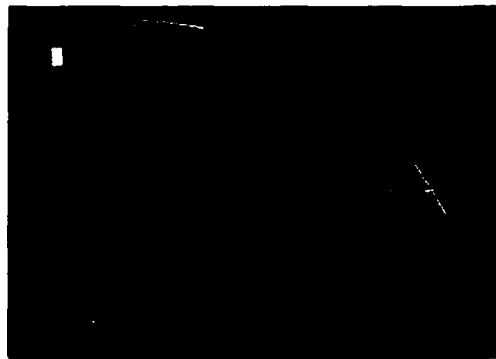

A

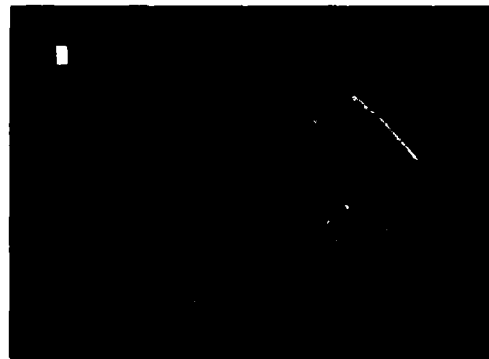

C



B

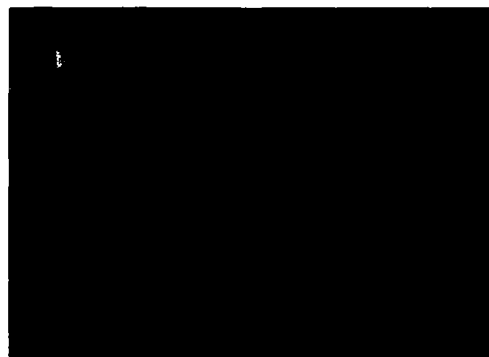

D

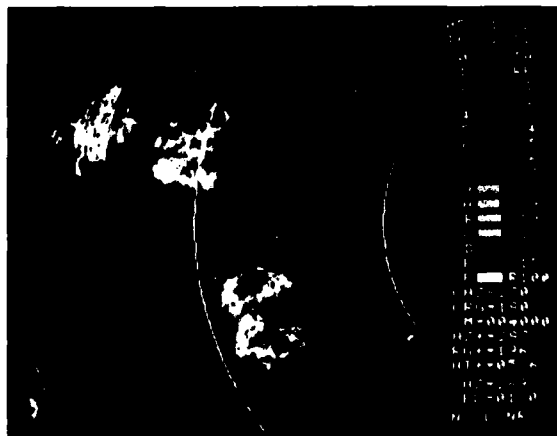

E

FIG. 14

Spectrum widths, Radar Number Two, run number one.

A-D: Airborne Radar

E: Ground Radar

The second run against the weather target was much the same as the first. The conditions in Figure 12 were still valid. The aircraft altitude was 20K ft ASL, and the ground speed was 355 knots. The echo locations are shown in Figures 15A and 15B. The reflectivity levels of the echoes in Figures 15A and 15B are similar. The patterns for velocity spectral widths that exceed 5 m/s are also similar (see Figures 16 and 17C). The change in the velocity spectral widths when the look angle to the echo changes from 0° to 60° is shown in Figures 17A-17C. Again as the area of indicated turbulence came within the STC correction range, the area of turbulence decreased. No evidence of second-trip echoes was found. Small random spots of turbulence were occasionally present.

Run number three was made at an altitude of 10K ft ASL. The aircraft ground speed was 250 knots. At the lower altitude the ground clutter increased significantly. Figures 18A and 18B show weather echoes one and two imbedded in ground clutter. Figure 19 shows the echoes as seen by the ground radar. Echo number one (see Figure 13B) has begun to break up. Echoes two and three are still intact. Again, the areas of reflectivity between airborne and ground radars compare quite well. The velocity spectral widths as shown by the ground radar are for the most part 5 m/s and greater (see Figure 20). This area of velocity spectral width is similar in the airborne data (Figure 21A). Figures 21A-21D show the weather echo sliding to the right side of the aircraft. The effects on change in velocity spectral width with look angle cannot accurately be estimated because the antenna tilt angle was being changed. Figures 21A, 21C and 21D show that strong ground returns will be processed and appear to be areas of turbulence.

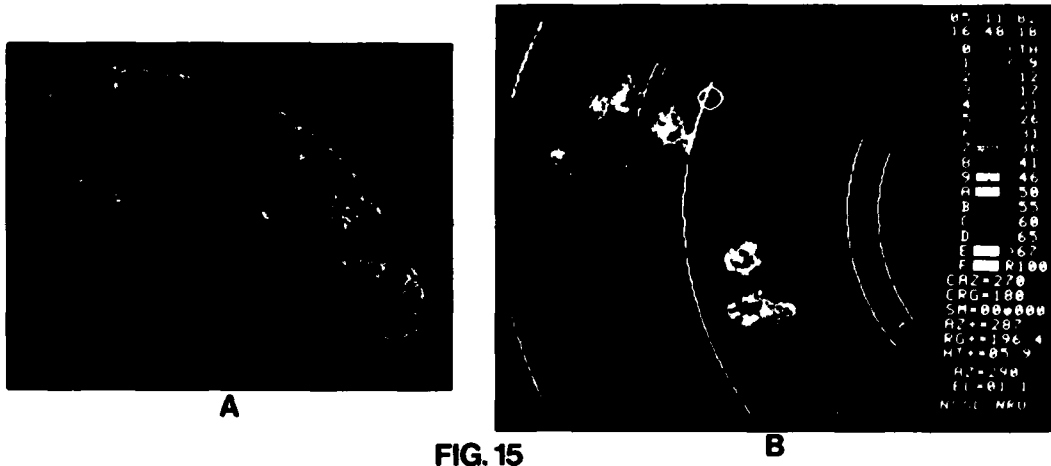

FIG. 15

Airborne Radar

Ground Radar

Radar echo locations at the start of run number two, Radar Number Two.

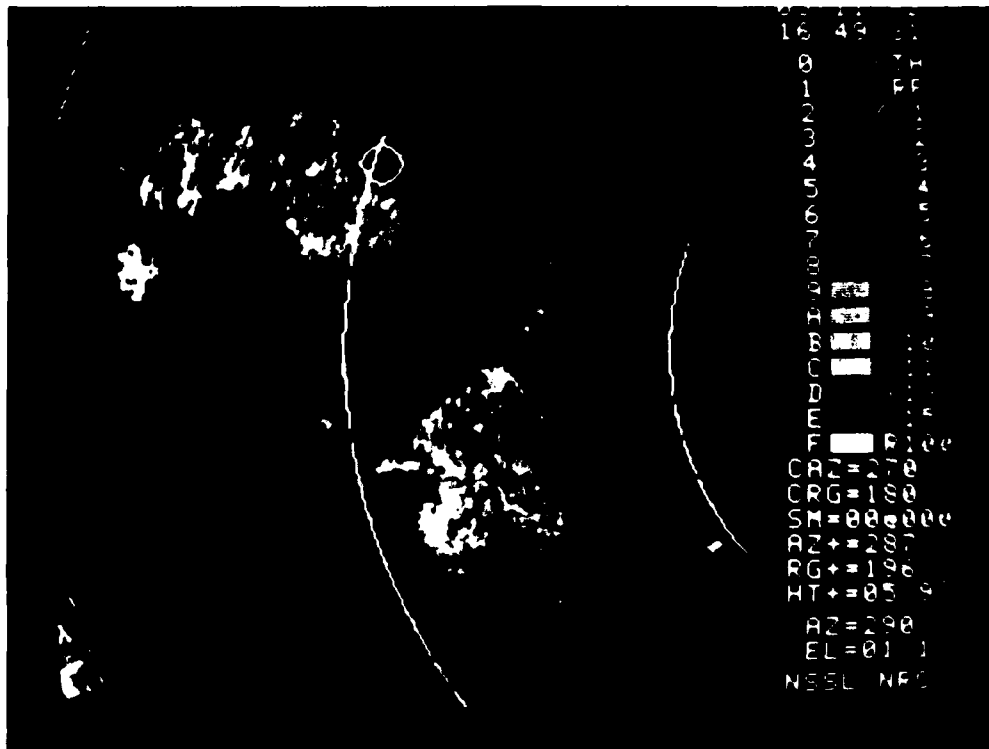
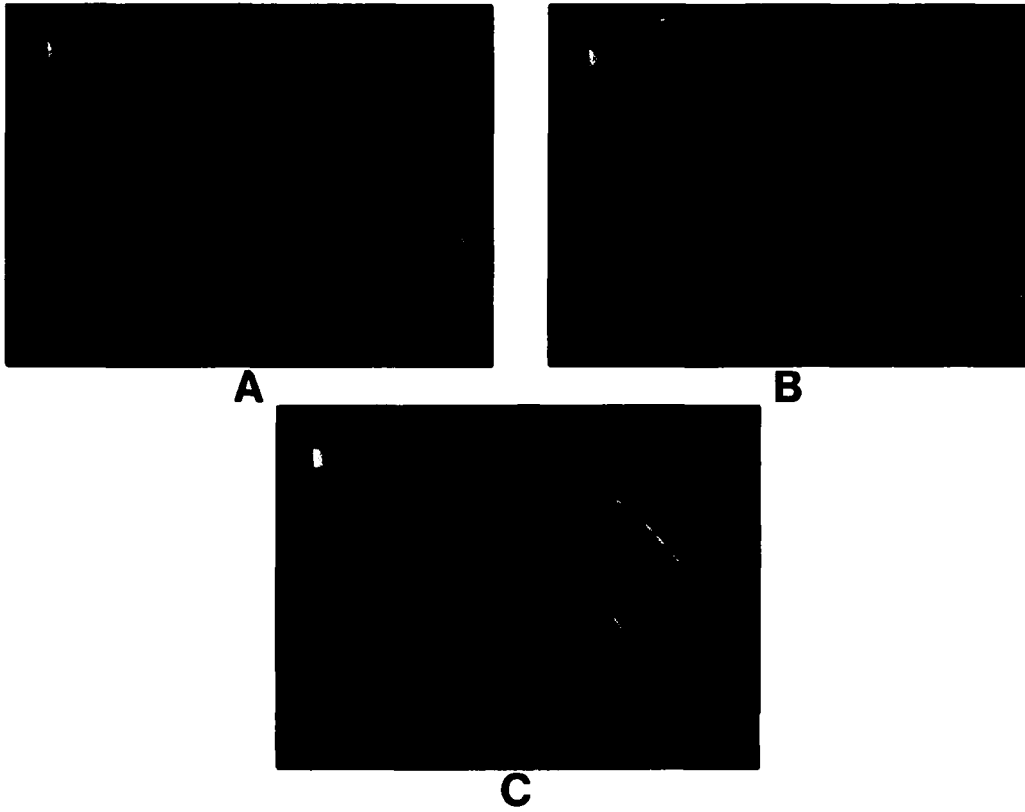

FIG. 16

Ground radar spectrum widths, Radar Number Two, run number two.



**C**  
**FIG.17**

Airborne radar spectrum widths, Radar Number Two, run number two.

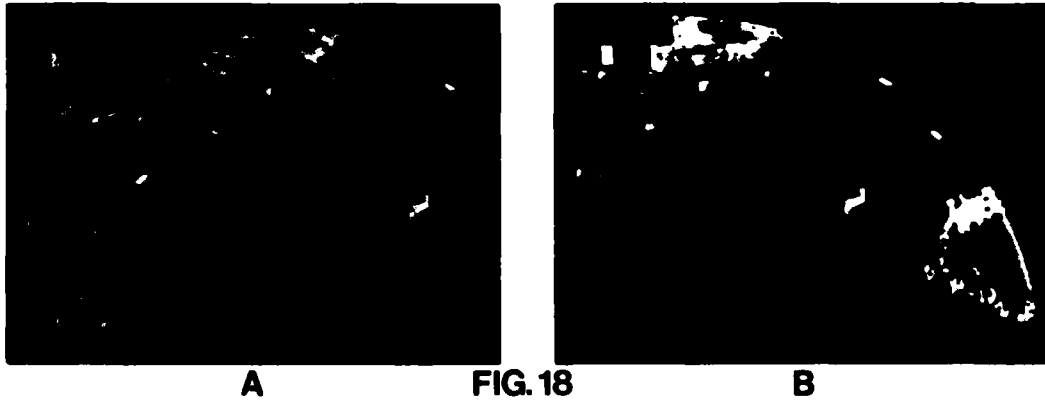

**A** **FIG.18** **B**

Airborne reflectivity at low altitude showing weather echo locations and ground clutter, Radar Number Two, run number three.

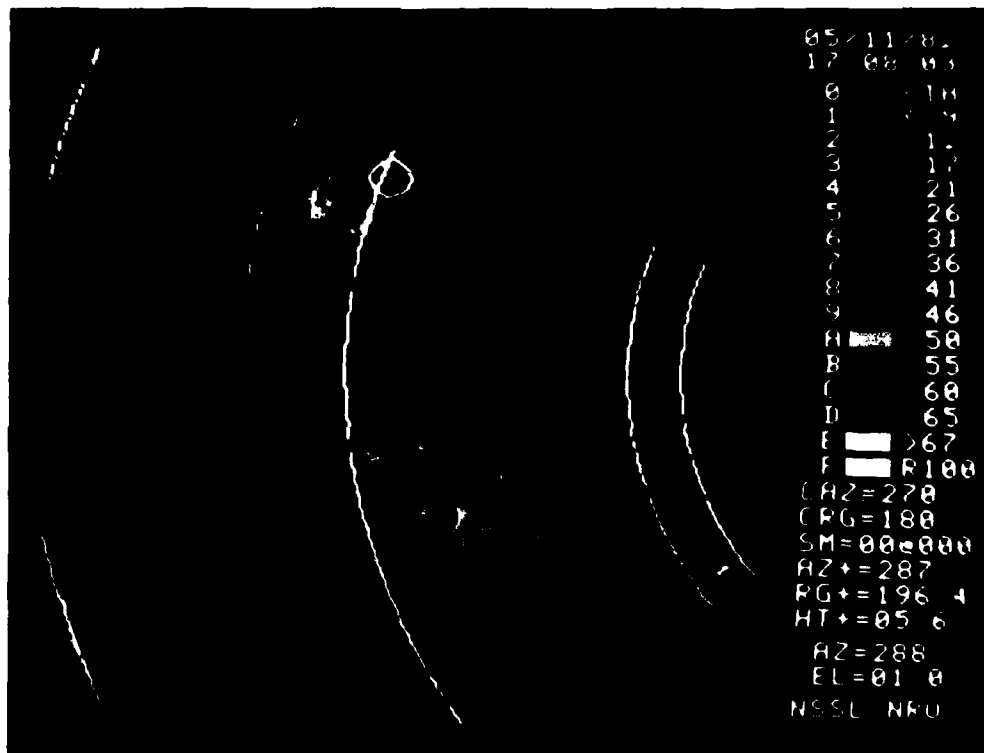

**FIG. 19**

Ground radar (reflectivity) echo location, Radar Number Two, run number three.

CONCLUSIONS

The basic purpose of this evaluation was to determine the utility of airborne Doppler radar for detecting the hazards associated with thunderstorms and for its use in avoiding these hazards without flying long distances around storms or convective cells. This implies that the equipment is to be used to determine areas in which storms and convective cells can be penetrated safely with the aircraft.



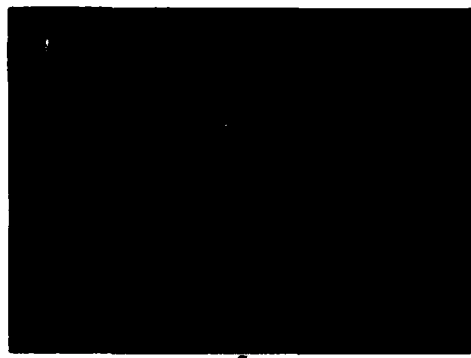

**A**



**B**

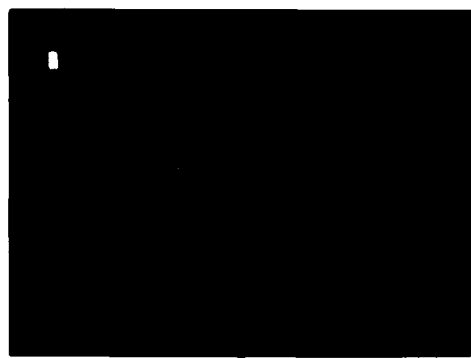

**C**

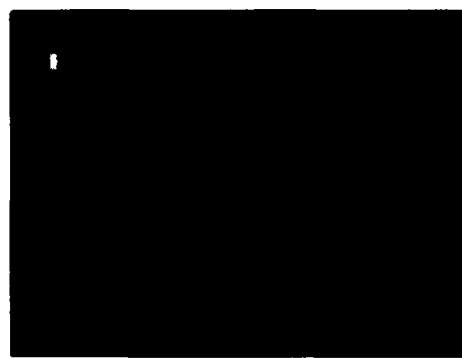

**D**

**FIG. 21**

Airborne radar spectrum width, Radar Number Two, run number three.

Results of comparisons of both Radar Number One and Radar Number Two with ground-based radar are given below.

#### Radar Number One

A review of the data from Radar Number One produced the following:

1. The RF returns from the airborne radar were generally of the same area/size as those from the ground-based radar. Consideration was given to the different receivers and (data processing) thresholds for the airborne and ground systems. Insufficient data were available to determine the attenuation of RF returns because of meteorological conditions.
2. The displayed reflectivity of the RF returns of the ground and airborne radars were similar. Exact reflectivity patterns were not expected because of the characteristics of the radars and the different look angles to the RF returns.
3. The turbulence mode of the radar, which was the prime area of inspection, did show that the manufacturer was able to generate and display areas where the radial velocity spectrum widths exceeded preset thresholds.
4. The areas of the greatest radial velocity spectral width seldom occurred at the same spatial location as indicated by the returns of the ground and airborne radars.

5. The uncorrected radial velocities for translational motion of the airborne radar may produce an inaccurate display when the target is more than  $30^\circ$  off the ground track.
6. The presence of second trip echoes, at both high and low altitudes produce targets on the display that are not at the proper range.
7. Ground returns that were only occasionally seen at the high altitude were very prevalent at the lower altitude. The ground targets carry no distinguishing characteristics to tell the radar operator that they are not turbulent weather systems.

#### Radar Number Two

The test data for Radar Number Two showed the following:

1. The target echoes were in the same spatial position as indicated by the ground-based radar.
2. The target echo reflectivity was comparable with the ground radar for all runs.
3. The areas where the velocity spectral width exceeded 5 m/s compared quite well with the ground-based radar data.

4. The variation in velocity spectral width with target look angle produced an indicated decrease in the area where the velocities exceeded 5 m/s. Possible causes for the decrease have already been given in the analysis.
5. No visual evidence of second trip echoes was found in the data. This could well be the result of meteorological conditions.
6. Ground clutter contamination of the data was found at the low operating altitude and low antenna elevation pointing angles. This contamination makes display interpretation more difficult.
7. The scheme of displaying a single area of turbulence (above a given threshold), an area to be avoided, facilitates quick display interpretation, but at the same time emphasizes the importance of accuracy in establishing and maintaining a safe threshold.
8. The translational motion of the aircraft caused significant deviations in the measured velocity spectral widths depending on the antenna positions.
9. The STC function appears to degrade the accuracy of both the weather/reflectivity mode and the turbulence (spectral width) mode of operation within 11 km of the aircraft positions.

The results of the evaluation show that it is possible to present, on a radar display, areas in thunderstorms where the radial velocity deviation from a measured mean radial velocity exceeds a predetermined value. The deviation

from the mean radial velocity spectral width is classified by the equipment manufacturers as turbulence. The spectral width of the measured radial velocities is given in the literature as the sum of four prime contributors. Those are shear, antenna rotation, drop-size fall speeds and turbulence. The major contributors are shear and turbulence. The turbulence contributor to velocity spectral width has been found to be mostly isotropic above the boundary layer (Zrnic' and Lee, 1982). If this is true, then the turbulence is not dependent on aspect angle and the display will define areas that should be avoided. The shear, whether it be horizontal or vertical, theoretically has eddies at the periphery of the shear zones that make it detectable, even though the shear is orthogonal to the radar beam. Therefore, even shear regions could possibly be displayed as areas for aircraft to avoid.

The manufacturers of the radars in the evaluation used approximately 5 m/s, as the magnitude of the deviation from an average velocity, to define an area that should be avoided. The use of a single value for a representation of turbulence is questionable: Will that velocity produce the same effect on all classes and types of aircraft? Does the value include or compensate for all error sources that would impose a tolerance on the value? The evaluation produced no data with which to answer these two questions.

Radar Number One displayed levels of turbulence on its radar display, just as reflectivity levels are displayed. Radar Number Two displayed only a single area of turbulence that should be avoided. The display of turbulence information should reduce to a very minimum the need for interpretation of data by the radar operator.

## RECOMMENDATIONS

The radar manufacturers are to be commended for taking needed steps to include the latest Doppler processing technology, developed in the research community, in their equipment. However, applying technology developed in one discipline to another discipline usually requires some modification to the basic techniques or different knowledge of the peripheral parameters to the new application. Such is the case for airborne turbulence-indicating radars.

The initial intent of this evaluation was to limit the data to that which could be compared with data set taken by the ground-based Doppler, located at the National Severe Storms Laboratory. However, as the test progressed, questions were raised and research of the questions showed their answers or lack of answers to be pertinent to the evaluation results. The questions and concerns are addressed below in the System Concepts section.

It is my recommendation that the following be investigated and implemented in the system(s).

### Engineering

1. Develop and use an algorithm to prevent changes in look angles from changing the magnitudes of detected areas of turbulence.
2. Implement a scheme that will eliminate second-trip echoes from the radar display (Hennington, 1981).

3. Eliminate all ground clutter returns from the turbulence mode of operation.

#### System Concepts

1. Decide which system is applicable for determining the safest flight, what areas of turbulence should be categorically avoided and what areas of turbulence should be avoided at the discretion of the radar operator.
2. Decide how areas of shear should be displayed (signature) when viewed from different angles.
3. Determine the influence that the measured spectral width in velocity (turbulence) has on different classes and types of aircraft; i.e., relate the changes in spectral widths to different gust velocities and to aircraft types.

#### Scientific

1. Confirm previous work showing that convective areas produce turbulence that is isotropic.

## ACKNOWLEDGMENTS

The test program for the turbulence-indicating airborne radars would not have been as successful without the interest, close support and cooperation of many people in specialized organizations. Special recognition should go to Mr. Byron Mayberry and Mr. Don Walters of FAA's Air Carriers Operations for providing the aircraft and pilots; Mr. James Kirk of FAA's Avionics Engineering Section for equipment installation and interface; Mr. Jean Lee and Mr. Dale Sirmans of NOAA's NSSL facility for weather briefing, flight coordination and ground systems equipment. The manufacturers are commended for taking the initiative for designing airborne Doppler radars and providing them for evaluation.

## REFERENCES

Hennington, L., "Reducing the Effects of Doppler Radar Ambiguities," Journal of Applied Meteorology, Vol. 20, No. 12, pp. 1543-1546, Dec. 1981.

Nathanson, F. E., "Radar Design Principles," McGraw-Hill, 1969, 626 pp.

Trotter, B. L., R. G. Strauch, and C. L. Frush, "Evaluation of a Meteorological Airborne Pulse Doppler Radar," NOAA Technical Memorandum ERL WMPO-45, July 1981.

Zrnic, D. S., and J. T. Lee, "Pulsed Doppler Radar Detects Weather Hazards to Aviation," Journal of Aircraft, Vol. 19, No. 2, pp. 183-190, Feb. 1982.

END

FILMED

1/1

ADATIC