

MICROCOPY RESOLUTION TEST CHART
NATIONAL BUREAU OF STANDARDS-1963-A

AD-F300579

4

AD-A151 561

AD

B
R
L

MEMORANDUM REPORT BRL-MR-3429

PHYSICAL RESPONSE OF FLAT STEEL
PLATES TO DROP HAMMER IMPACTS

William P. Wright
Wayne A. Slack
Willis F. Jackson

January 1985

DTIC
ELECTE
MAR 11 1985
S B D

DTIC FILE COPY

APPROVED FOR PUBLIC RELEASE; DISTRIBUTION UNLIMITED.

US ARMY BALLISTIC RESEARCH LABORATORY
ABERDEEN PROVING GROUND, MARYLAND

85 03 08 056

Destroy this report when it is no longer needed.
Do not return it to the originator.

Additional copies of this report may be obtained
from the National Technical Information Service,
U. S. Department of Commerce, Springfield, Virginia
22161.

The findings in this report are not to be construed as an official
Department of the Army position, unless so designated by other
authorized documents.

The use of trade names or manufacturers' names in this report
does not constitute indorsement of any commercial product.

Unclassified

SECURITY CLASSIFICATION OF THIS PAGE (When Data Entered)

REPORT DOCUMENTATION PAGE		READ INSTRUCTIONS BEFORE COMPLETING FORM	
1. REPORT NUMBER MEMORANDUM REPORT BRL-MR-3429	2. GOVT ACCESSION NO. AD-A151561	3. RECIPIENT'S CATALOG NUMBER FRA/ORD-84-07	
4. TITLE (and Subtitle) PHYSICAL RESPONSE OF FLAT STEEL PLATES TO DROP HAMMER IMPACTS		5. TYPE OF REPORT & PERIOD COVERED FINAL	
		6. PERFORMING ORG. REPORT NUMBER	
7. AUTHOR(s) William P. Wright, Wayne A. Slack, & Willis F. Jackson		8. CONTRACT OR GRANT NUMBER(s)	
9. PERFORMING ORGANIZATION NAME AND ADDRESS US Army Ballistic Research Laboratory ATTN: AMXBR-TBD Aberdeen Proving Ground, MD 21005-5066		10. PROGRAM ELEMENT, PROJECT, TASK AREA & WORK UNIT NUMBERS DOT AN DTFR53-82-X-00275	
11. CONTROLLING OFFICE NAME AND ADDRESS US Army Ballistic Research Laboratory ATTN: AMXBR-OD-ST Aberdeen Proving Ground, MD 21005-5066		12. REPORT DATE January 1985	
		13. NUMBER OF PAGES 94	
14. MONITORING AGENCY NAME & ADDRESS (if different from Controlling Office) Department of Transportation Federal Railroad Administration 400 Seventh Street, S.W., Washington, DC 20590		15. SECURITY CLASS. (of this report) Unclassified	
		15a. DECLASSIFICATION/DOWNGRADING SCHEDULE	
16. DISTRIBUTION STATEMENT (of this Report) Approved for public release, distribution unlimited.			
17. DISTRIBUTION STATEMENT (of the abstract entered in Block 20, if different from Report)			
18. SUPPLEMENTARY NOTES Funded by the Federal Railroad Administration under Agreement Number DTFR53-82-X-00275 This report supersedes IMR No. 784 dated August 1983.			
19. KEY WORDS (Continue on reverse side if necessary and identify by block number) Railroad Tank Cars Safety Structural Response Steel - ASTM A-515			
20. ABSTRACT (Continue on reverse side if necessary and identify by block number) A series of impact tests using the FRA/BRL Drop Hammer Facility was performed. The tests consisted of the creation of controlled damage to flat steel plates which had properties exceeding the minimum ASTM standards required for steel used in the construction of tank cars (ASTM A-515, Grade 70 steel). The plates responded in the form of dents which reflected the shapes and sizes of tups which were driven on to the plates and the sizes of dies on which the plates were placed. As expected, the shapes of the dents were similar to the			

Unclassified

SECURITY CLASSIFICATION OF THIS PAGE(When Data Entered)

shapes of the tups and as the die diameters were increased from test to test, the amount of bending relative to the kinetic energy on impact increased. The depths of the dents increased as the kinetic energy of the tups increased and the diameters of the dies increased. A total of 73 tests were conducted with various hammer heights, tup shapes and sizes, and die diameters. The maximum dent depth as a function of impacting kinetic energy was shown to be a function which scales.

Unclassified

SECURITY CLASSIFICATION OF THIS PAGE(When Data Entered)

TABLE OF CONTENTS

	Page Number
LIST OF FIGURES	5
LIST OF TABLES	7
INTRODUCTION	9
FRA/BRL DROP HAMMER FACILITY	10
TEST PROCEDURES	13
TEST DATA FOR THE FLAT 5.5 INCH TUP	14
TEST DATA FOR THE HEMISPHERICAL 5.5 INCH TUP	16
TEST DATA FOR THE HEMISPHERICAL 3.75 INCH TUP	22
TEST DATA FOR THE HEMISPHERICAL 2.0 INCH TUP	22
SCALING OF THE DENT DEPTH VERSUS ENERGY	26
SUMMARY	27
ACKNOWLEDGEMENT	28
LIST OF SYMBOLS	29
APPENDIX A - SUMMARY OF INITIAL CONDITIONS OF IMPACT TESTS	31
APPENDIX B - PHOTOGRAPHS OF STEEL PLATES FOLLOWING IMPACT TESTS	33
APPENDIX C - DIAL MICROMETER MEASUREMENTS OF DENT DEPTHS	71
DISTRIBUTION LIST	93

S DTIC
 ELECTE **D**
 MAR 11 1985
 B



Accession For	
NTIS GRA&I	<input checked="" type="checkbox"/>
DTIC TAB	<input type="checkbox"/>
Unannounced	<input type="checkbox"/>
Justification	
By.....	
Distribution/.....	
Availability Codes	
Dist	Avail and/or Special
A-1	

LIST OF FIGURES

	Page Number
1. The FRA/BRL Drop Hammer Facility	11
2. The Tup and Die Assemblage of the FRA/BRL Drop Hammer Facility	12
3. A Typical Example of the DM Dent Depth Plots	13
4. Steel Plate Response to 5.5 Inch Flat Tup in Test Number 1	15
5. The DM Measurements of Impact Dent From Test Number 1	15
6. Steel Plate Response to 5.5 Inch Flat Tup in Test Number 2	16
7. Dent Depth Summary of the 5.5 Inch Flat Tup Data	17
8. Steel Plate Response to 5.5 Inch Hemispherical Tup in Test Number 15	18
9. Steel Plate Response to 5.5 Inch Hemispherical Tup in Test Number 25	19
10. Steel Plate Response to 5.5 Inch Hemispherical Tup in Test Number 32	19
11. Steel Plate Response to 5.5 Inch Hemispherical Tup in Test Number 33	20
12. Steel Plate Response to 5.5 Inch Hemispherical Tup in Test Number 14	20
13. The DM Measurements of Impact Dent From Test Number 20	21
14. Dent Depth Summary of the 5.5 Inch Hemispherical Tup Data	21
15. Steel Plate Response to 3.75 Inch Hemispherical Tup in Test Number 40	23
16. The DM Measurements of Impact Dent From Test Number 34	23
17. Dent Depth Summary for the 3.75 Inch Hemispherical Tup Data	24
18. Steel Plate Response to 2.0 Inch Hemispherical Tup in Test Number 55	25
19. The DM Measurements of Impact Dent From Test Number 61	25
20. Dent Depth Summary for the 2.0 Inch Hemispherical Tup	26
21. Summary of Dent Depth Versus Energy for the Hemispherical Tup Impact Data	27

LIST OF TABLES

	Page Number
1. INITIAL CONDITIONS FOR TESTS USING THE 5.5 INCH FLAT TUP	14
2. INITIAL CONDITIONS FOR TESTS USING THE 5.5 INCH HEMISPHERICAL TUP ..	17
3. INITIAL CONDITIONS FOR TESTS USING THE 3.75 INCH HEMISPHERICAL TUP .	22
4. INITIAL CONDITIONS FOR TESTS USING THE 2.0 INCH HEMISPHERICAL TUP ..	24

INTRODUCTION

The Ballistic Research Laboratory (BRL) was under contract to the Federal Railroad Administration (FRA), Department of Transportation (DOT) to conduct a study dealing with the safety aspects of clearing wrecked tank cars loaded with hazardous materials under pressure. The key issue in this regard was to develop procedures which can enable personnel to make assessments in order to predict the level of safety for those involved in moving and/or unloading the damaged tank car. The historical data which supported the decision to research this subject includes the fact that 24 fatalities and 118 injuries have been sustained due to tank car ruptures during wreck-clearing operations. The worst occurred following a 23 car derailment at Waverly, Tennessee on February 24, 1978. (Ref. 1) In that incident, a damaged tank car containing liquid petroleum gas (LPG) ruptured two days after the derailment while preparations for having its lading transferred were in progress. The lading was released and the ensuing fire killed 16 persons and injured 43 others. Another incident occurred on April 18, 1979 at Crestview, Florida, where several wreck-clearing personnel were exposed to anhydrous ammonia from a tank car which unexpectedly ruptured. (Ref. 2) These incidents show that wreck-clearing crews, emergency response teams, and the public are in danger even after the initial hazards in a derailment involving hazardous materials are neutralized.

The solution to the problem will require advanced technology in at least two areas. One is the development of a data base which can serve as basic information describing how tank car materials respond to dynamic impacts. That is, once damage is sustained, what are the characteristics of the types of damage that can be used to predict potential rupture of the tank car? The other is to apply nondestructive evaluation (NDE) techniques on sample-damaged specimens in order to determine their effectiveness in locating flaws and their ability to identify specific types of flaws. These two in combination are necessary for developing an accurate procedure for evaluating a damaged tank car.

The work described in this report consisted of a series of impact tests using the FRA/BRL Drop Hammer Facility and was one of the efforts performed under the project entitled Tank Car Damage Assessment. The facility was used to create controlled damage to flat steel plates with properties similar to steel used in the construction of tank cars used to transport propane. The response of the plates to the impacts was in the form of dents which reflected the shapes and sizes of tups which were driven onto the plates and the sizes of dies on which the plates were placed. The objectives of these experiments were three fold. (1) One was to create in the plates actual flaws on which

¹"Railroad Accident Report - Derailment of Louisville and Nashville Railroad Company's Train No. 584 and Subsequent Rupture of Tank Car Containing Liquefied Petroleum Gas, Waverly, Tennessee, February 22, 1978," NTSB-RAR-79-1, U.S. National Transportation Safety Board, Washington, D.C. 20594, 8 February, 1979.

²"Railroad Accident Report - Louisville and Nashville Railroad Company Freight Train Derailment and Puncture of Hazardous Materials Tank Cars, Crestview, Florida, April 8, 1979," NTSB-RAR-79-11, U.S. National Transportation Safety Board, Washington, D.C. 20594, September 1979.

various NDE techniques could be applied. This was to enable BRL to recommend those NDE techniques which can be used to assess the derailed tank car. {2} The second objective was to initiate the development of a data base which can be used directly in evaluating the integrity of a damaged tank car. {3} The third objective was to determine if this type of test data can be scaled to the actual conditions of a full scale tank car.

FRA/BRL DROP HAMMER FACILITY

The FRA/BRL Drop Hammer Facility was designed to enable one to inflict controlled damage on materials placed under the hammer. An overall view of the facility is shown in Figure 1. The hammer is a massive weight of 4,574 Kg {10,084 lbs} which is raised vertically to some predetermined height depending on the amount of kinetic energy desired on impact. The hammer is raised by a cable attached to its top end with a special hook which allows the hammer to drop with a minimum of delay once the procedure is initiated. This mechanism is referred to as the quick release. To trigger the quick release, a pin is pulled from its initial position by a device called an actuator. The actuator pulls on the pin gradually due to a hydraulic pump hand worked by a technician. A device which records the velocity of the hammer is called the comb. The data generated by the comb and associated accelerometers are fed directly into a computer and serve as basic data from which calculations are performed.

A diagram of the interacting parts which create the damage is presented in Figure 2. The hammer does not impact the material directly, but has an object called a tup attached to the bottom end. The tup is threaded to the hammer and can be of arbitrary shape and size. In the figure, the striking surface of the tup is shown to be flat with the tip consisting of a layer of hardened steel. Below the flat surface of the tup, the diagram indicates the die which is also composed of hardened steel. The die is held in place by a die holder which lies in a recess carved in the heavy steel base on which the entire structure is attached. If the tup perforates a plate, it can pass through the opening in the die. In the tests described in this report, the cutting edge of the dies were rounded off to yield more realistic results.

There are important questions concerning the lack of realism in these tests. For one thing, the use of a die brings to mind immediately that there is no similar situation with respect to a tank car being punched by the coupler of another tank car or some other object as the tank car is overturned. On the other hand, our choice of using flat plates requires something such as a die in order to achieve depth in the dents. That is, a flat surface under the flat plate would be an even worse simulation and the damage sustained of less value. An alternative would be to construct three dimensional models but the cost of performing the tests would have risen greatly and perhaps the end results would not have been of a quality to warrant such an increase in expenditures. Another question concerns the fact the edges of the plates were not restrained as is the case when a portion of a tank car is impacted. Again, to restrain the edges to improve the simulation would have required a great deal of effort and since this was an exploratory portion of the program, such an expenditure was undesirable. Eventually, once these plates have been analyzed and other parallel portions of the program advanced, models can be designed and appropriate steps taken to include all of the characteristics of real tank car impacts.

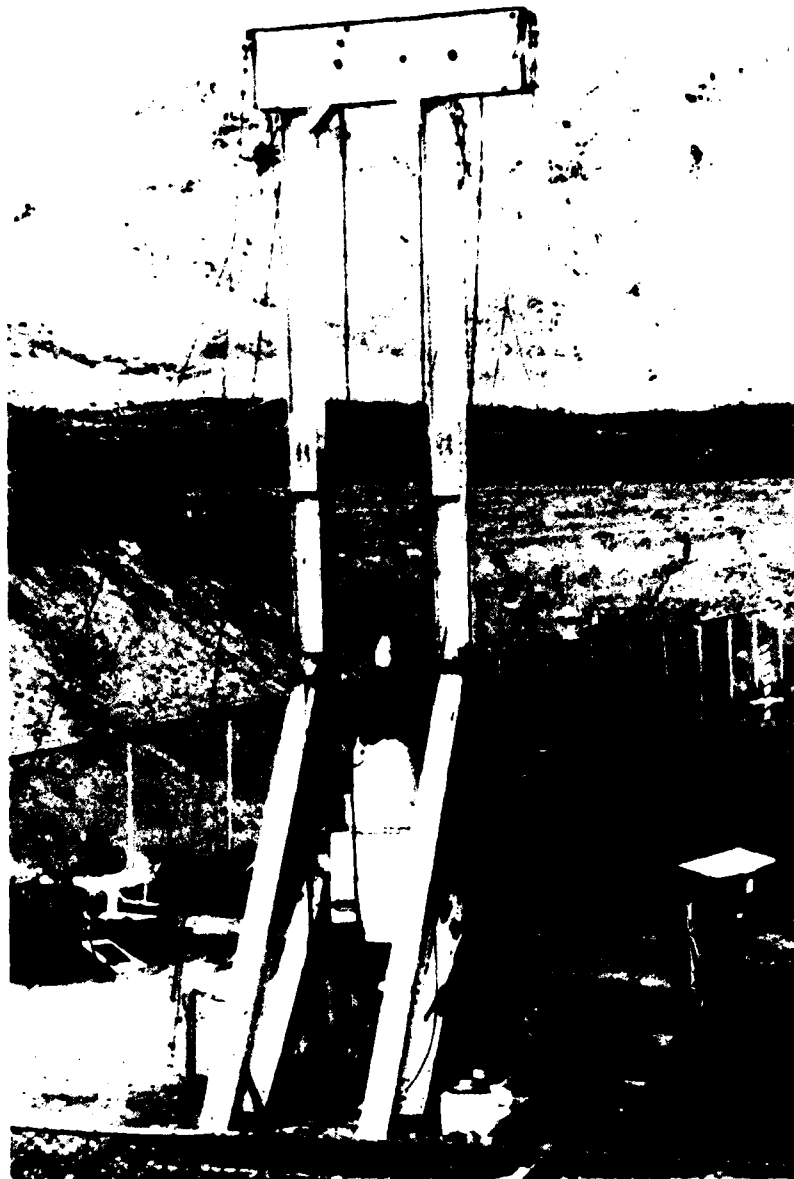

Figure 1: The FRA/BRL Drop Hammer Facility

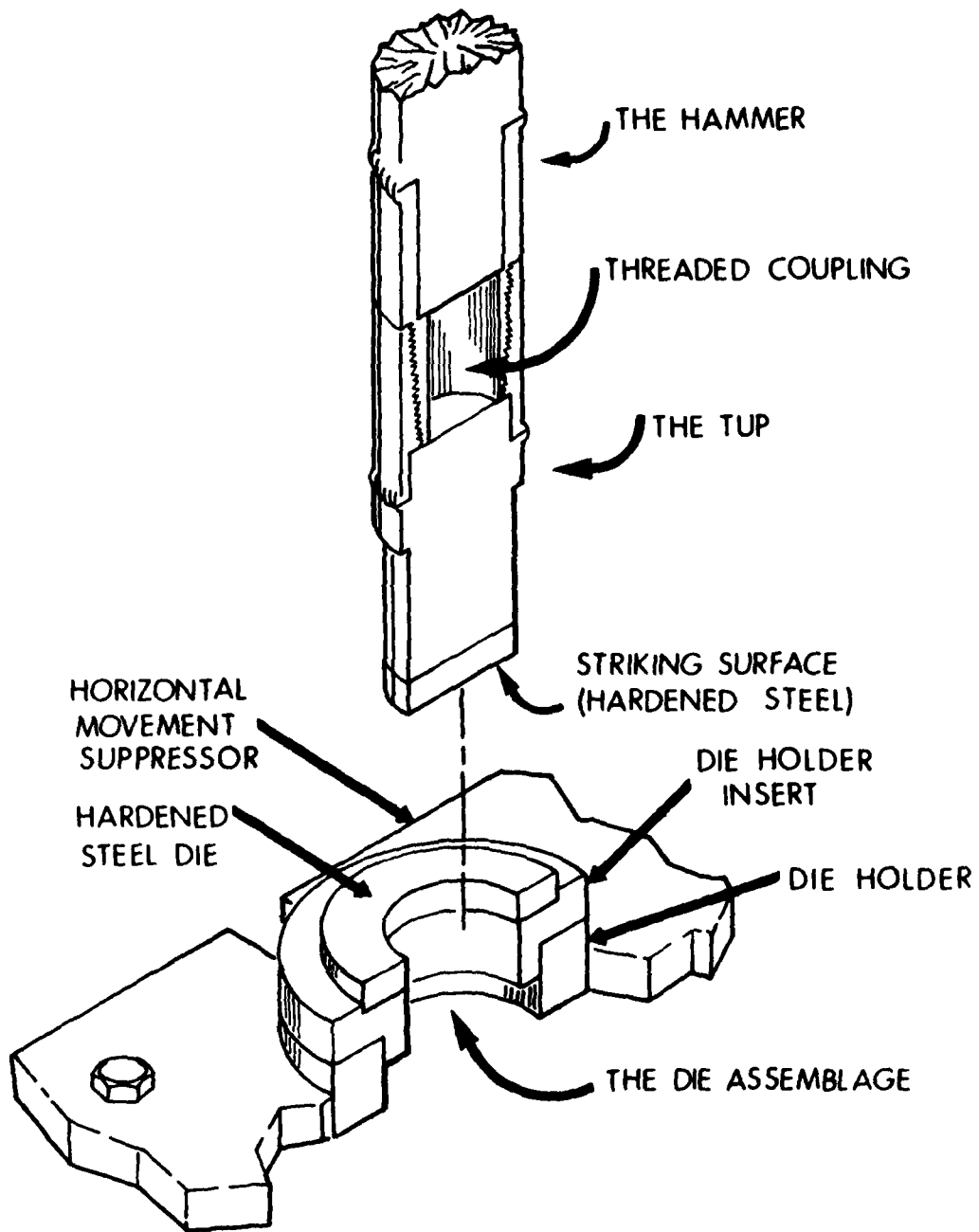

Figure 2: The Tup and Die Assemblage of the FRA/BRL Drop Hammer Facility

TEST PROCEDURES

The data generated was intended to be applicable to tank cars. Therefore, the plates used in the tests were made of steel which exceeded the minimum standards required in the construction of railroad cars. The steel was ASTM A515, Grade 70, with a minimum tensile strength of 4.9217×10^7 Kgs/meter² and a minimum elongation in 5.08 cm {2 inches} of 20 percent. The Brinell Hardness of each of the plates were measured and were included as the last three digits in the Identification Numbers {ID} which were written on the plates and attached to all of the various forms in which the data were recorded.

The tups used in the tests were of the following three sizes - 5.08 cm {2 inch}, 9.525 cm {3.75 inch}, and 13.97 cm {5.5 inch} diameters. In the largest size, both a flat tup and a hemispherical tup were used. In the other two sizes, there were only hemispherical tups. The four different die diameters used were 15.24 cm {6.0 inches}, 20.96 cm {8.25 inches}, 27.94 cm {11.0 inches}, and 34.93 cm {13.75 inches}. In addition to using various combinations of tup size and die diameters, various impact energies were used by raising the hammer to various heights. The plates were of all the same thickness of 0.9525 cm {3/8 inches} which is the thickness of the shell of the propane tank car.

The test data were recorded in two different ways. One was simply to photograph both sides of the plate following each of the tests. The other consisted of measuring the depth of the dent along a diagonal using a dial micrometer {DM}. A typical sample of a DM measurement is presented in Figure 3. The abscissa in the figure represents positions along the diagonal from one corner at zero to 86.35 cm {34 inches} indicated by the vertical line denoted as the "plate corner". The horizontal line drawn along the entire length of the diagonal to the "plate corner" and located at the zero value on the ordinate represents the original position of the surface points on the impact side of the plate. The drawing of the die in the figure was located by assuming that the die was centered on the deepest point in the dent as determined by the DM. The center of the tup was located on the same basis. In practice, while there was a deliberate effort to center the plate on the center of the die, this was not possible to do exactly. However, the variation in the placement of the plates had no affect on the quality or the usefulness of the data.

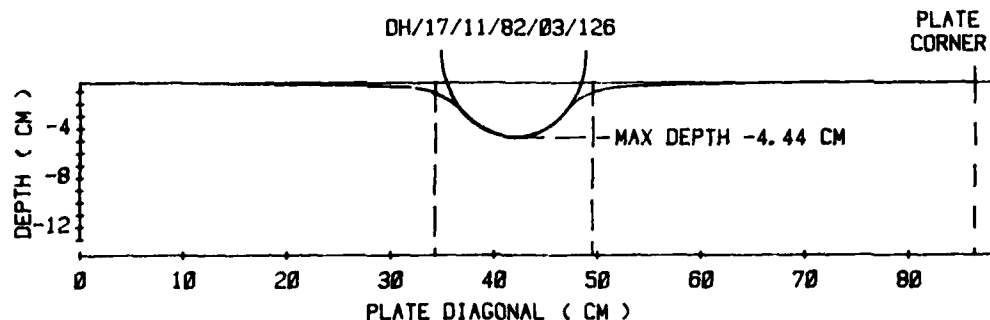

Figure 3: A Typical Example of the DM Dent Depth Plots

TEST DATA FOR THE FLAT 5.5 INCH TUP

In this series of impact tests, the shape of the tup was flat with a diameter of 14.0 cm {5.5 inches}. The symbol for this tup size and shape is T_{LF} in the discussion which follows. A total of nine tests were performed using the T_{LF} tup and three dies of different diameters. A summary of the initial conditions of these tests is presented in Table 1.

TABLE 1: INITIAL CONDITIONS FOR TESTS USING THE 5.5 INCH FLAT TUP

Test No.	Identification Number	Tup Diameter		Die Diameter		Hammer Height	
		{cm}	{Inches}	{cm}	{Inches}	{cm}	{Inches}
1.	DH-16-11-82-02-145	14.0	5.5	15.2	6.0	81.3	32.0
2.	DH-16-11-82-03-136	14.0	5.5	15.2	6.0	82.6	32.5
3.	DH-16-11-82-04-153	14.0	5.5	15.2	6.0	83.8	33.0
4.	DH-16-11-82-04-153	14.0	5.5	21.0	8.25	86.4	34.0
5.	DH-16-11-82-05-134	14.0	5.5	21.0	8.25	91.4	36.0
6.	DH-16-11-82-06-160	14.0	5.5	21.0	8.25	96.5	38.0
7.	DH-16-11-82-07-167	14.0	5.5	21.0	8.25	101.6	40.0
8.	DH-16-11-82-08-175	14.0	5.5	28.0	11.0	106.7	42.0
9.	DH-17-11-82-01-198	14.0	5.5	28.0	11.0	111.8	44.0

In the first three tests listed in Table 1, the die diameter was only 1.27 cm {0.5 inches} larger than the tup diameter. Past experience using this combination had previously shown that the primary failure mechanism would be shear in these tests. The reason is due to the fact that the bulk of the energy deposition is concentrated around the edge of the tup which causes a punching type action {Ref.3}. Figure 4 presents the impact side and the bottom side of the plate for Test Number 1. Both photographs shows the flat impression reflecting the flat tup. There were no visible cracks on either side of the plate.

The DM measurements for Test Number 1 are presented in Figure 5. The diameter of the bottom of the dent, measured from the plot, is less than the diameter of the tup. This indicates that the tup's impacting surface failed to reach the bottom of the dent. However, the hammer bounces when the tup fails to perforate so that as the hammer rebounds, the plate probably contracted because of the elasticity of the plate material.

In Test Number 2, the height of the hammer was only 1.27 cm {0.5 inches} higher than in Test Number 1, but the tup completely sheared through the plate. The plate and the sheared out plug are presented in Figure 6. Since this test resulted in shear and the hammer height was only slightly higher than in Test Number 1, it appears likely that shear bands exist in the plate from Test Number 1. A verification of this will require an NDE analysis and/or a metallurgical fracture mechanical analysis on the plate. The plate in Test

³Charles E. Anderson, Jr., et al, "Analysis of the BRL/FRA Drop Hammer Facility," Final Report 6970/1, Southwest Research Institute, San Antonio, TX 78284, October 1982.

Number 2 sustained some bending outside the diameter of the die, but it appears that the major portion of the energy was expended in the shearing process. Since the hammer height was even higher in Test Number 3, that test also produced a sheared out plug.

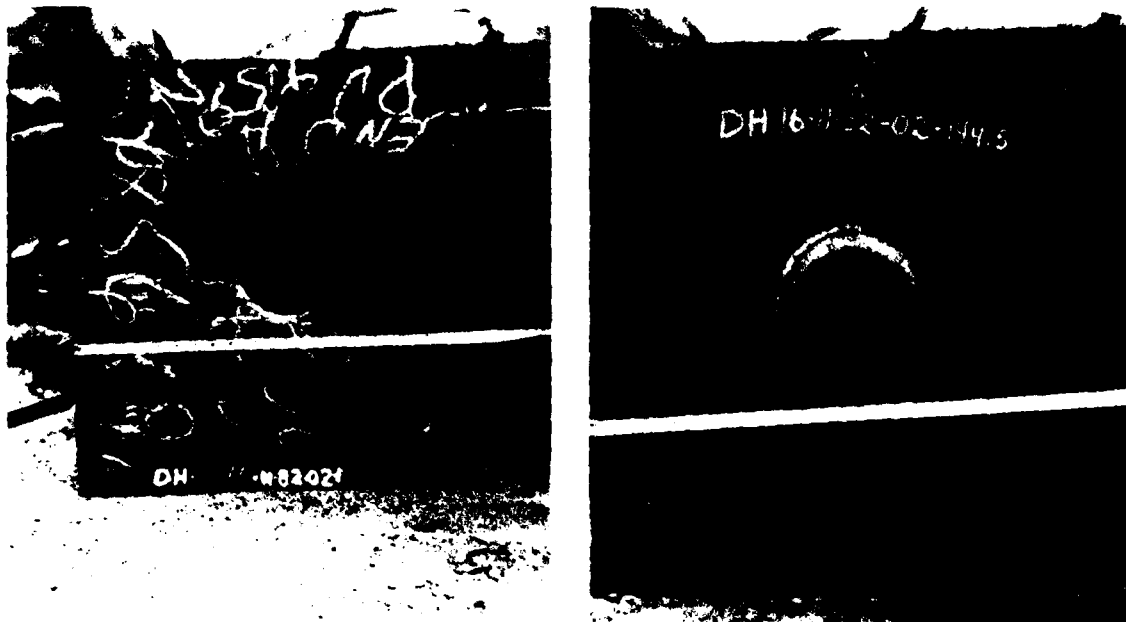

IMPACT SIDE

BOTTOM SIDE

Figure 4: Steel Plate Response to 5.5 Inch Flat Tip in Test Number 1

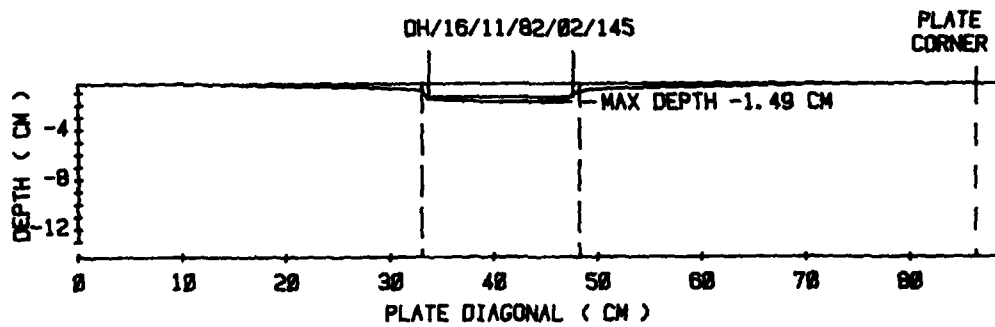

Figure 5: The DM Measurements of Impact Dent From Test Number 1

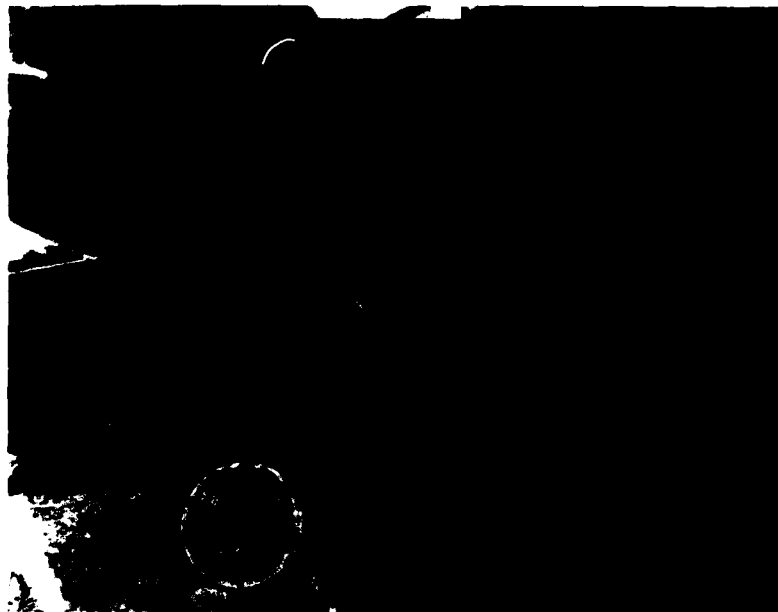

Figure 6: Steel Plate Response to 5.5 Inch Flat Tup in Test Number 2

In the remaining tests there were no perforations, thus the dent depths for each were measured. In order to present the dent depth data on one plot, the potential energy of the hammer {hammer height} was divided by the presented area of the die. The results are presented in Figure 7. In general, for a specific kinetic energy {potential energy}, the maximum depth of the dents increased as the die diameter was increased. This was attributed to an increase in the bending mode between the edge of the tup and the edge of the die. The curves were drawn merely to assist in visualizing the trend of the data.

TEST DATA FOR THE HEMISPHERICAL 5.5 INCH TUP

All of the remaining impact tests were performed using hemispherical tups. The largest tup diameter used was 13.97 cm {5.5 inches} and the symbolic designation for this shape and size is T_{LH} . It was anticipated that the penetrating capability of the T_{LH} tup would be greater than that demonstrated by using the T_{LF} tup since the initial area of contact between the tup and the plate would be a point. This therefore would cause the force per unit area to be far greater during the early portion of the tup-plate interaction. In addition, the response of the plate was expected to tend toward the bending mode and away from the shear mode which would tend to cause deeper dents.

A total of 24 impacts using the T_{LH} tup are listed in Table 2. For each of the die sizes, the hammer was raised to a height of 25.4 cm {10 inches} on the first drop and then the heights were increased in each following test until the tup perforated the plate {caused a severe crack}. In Test Number 21, the hammer facility failed so no information was obtained. The tup perforated

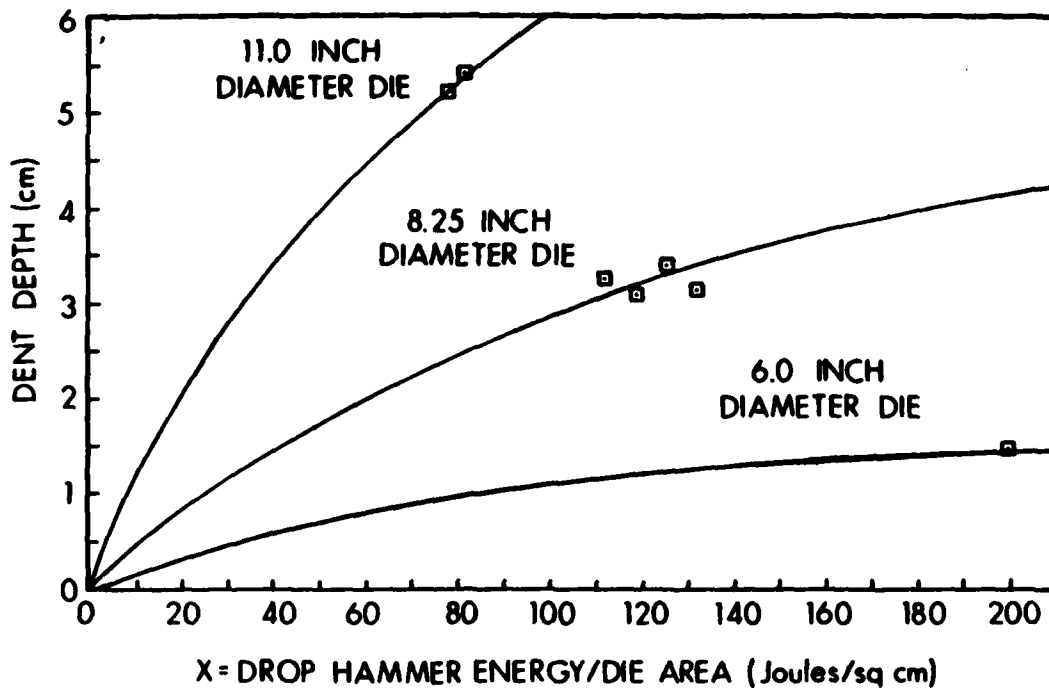

Figure 7: Dent Depth Summary of the 5.5 Inch Flat Top Data

TABLE 2: INITIAL CONDITIONS FOR TESTS USING THE 5.5 INCH HEMISPHERICAL TUP

Test No.	Identification Number	Top Diameter {cm}	Top Diameter {Inches}	Die Diameter {cm}	Die Diameter {Inches}	Hammer Height {cm}	Hammer Height {Inches}
10	DH-26-04-83-03-160	14.0	5.5	15.2	6.0	25.4	10
11	DH-26-04-83-04-160	14.0	5.5	15.2	6.0	50.8	20
12	DH-17-11-82-02-131	14.0	5.5	15.2	6.0	76.5	30
13	DH-17-11-82-03-126	14.0	5.5	15.2	6.0	106.7	42
14	DH-26-04-83-05-160	14.0	5.5	15.2	6.0	127.0	50
15	DH-26-04-83-06-160	14.0	5.5	15.2	6.0	177.8	70
16	DH-26-04-83-01-160	14.0	5.5	21.0	8.3	25.4	10
17	DH-26-04-83-02-160	14.0	5.5	21.0	8.3	76.2	30
18	DH-18-11-82-09-149	14.0	5.5	21.0	8.3	127.0	50
19	DH-18-11-82-10-126	14.0	5.5	21.0	8.3	152.4	60
20	DH-18-11-82-11-149	14.0	5.5	21.0	8.3	177.8	70
21	DH-18-11-82-12-140	14.0	5.5	21.0	8.3	228.6	90
22	DH-25-04-83-20-160	14.0	5.5	28.0	11.0	25.4	10
23	DH-25-04-83-21-160	14.0	5.5	28.0	11.0	76.2	30
24	DH-25-04-83-22-160	14.0	5.5	28.0	11.0	127.0	50
25	DH-25-04-83-23-160	14.0	5.5	28.0	11.0	177.8	70
26	DH-25-04-83-16-160	14.0	5.5	35.0	14.0	25.4	10
27	DH-25-04-83-17-160	14.0	5.5	35.0	14.0	76.2	30
28	DH-25-04-83-18-160	14.0	5.5	35.0	14.0	127.0	50
29	DH-25-04-83-19-160	14.0	5.5	35.0	14.0	177.8	70
30	DH-26-04-83-15-160	14.0	5.5	35.0	14.0	203.2	80
31	DH-26-04-83-16-160	14.0	5.5	35.0	14.0	203.2	80
32	DH-27-04-83-01-160	14.0	5.5	35.0	14.0	203.2	80
33	DH-27-04-83-02-160	14.0	5.5	35.0	14.0	203.2	80

the plates on Test Numbers 15, 25, 32, and 33. The photographs of the impacted plates are presented in Figures 8 through 11. The impact side and the bottom side of the plate for Test Number 15, where the die diameter was 15.3 cm (6.0 inches) and the hammer height was 178.0 cm (70 inches), are presented in Figure 8. In that test a punched-out plug was achieved which lodged inside the die. The impact side and the bottom side of the plate for Test Number 25 are presented in Figure 9. The die diameter for this test was 28.0 cm (11.0 inches) and the hammer height was 178.0 cm (70 inches). The large crack generated probably started on one side of the bulge and propagated circumferentially toward the edges of the bulge. The impact sides and the bottom sides of the plates for Test Number 32 and 33 are presented in Figures 10 and 11 respectively. The die diameter was 35.0 cm (13.75 inches). The crack in each plate was similar to the one generated in the previous test discussed. For those tests in which die diameters greater than 15.2 cm (6.0 inches) were used, the data indicates that ductile cracks forms rather than shear plugs. The responses of the plates consist of initial crack formation and crack enlargement as the hammer height is increased (more kinetic energy on impact). The damage mechanism was probably severe thinning of the steel around the sides of the bulge as the tups penetrated and then the thinned metals separated by ductile fracture.

An example of the plate response to the tup when no perforation occurred is presented in Figure 12. The die diameter was 15.3 cm (6.0 inches). The shape and size of the tup and the diameter of the die was dominant in forming the geometry of the dent. Figure 13 presents an example of the DM plots for the tests where no severe cracking occurred. The dent depth as functions of the drop hammer energy/die diameter ratio (joules/sq. cm) data are presented in Figure 14. The curves indicate a gradual increase in the dent depth as the energy per area increased and the dent depth increased at a faster rate for the larger die diameters.

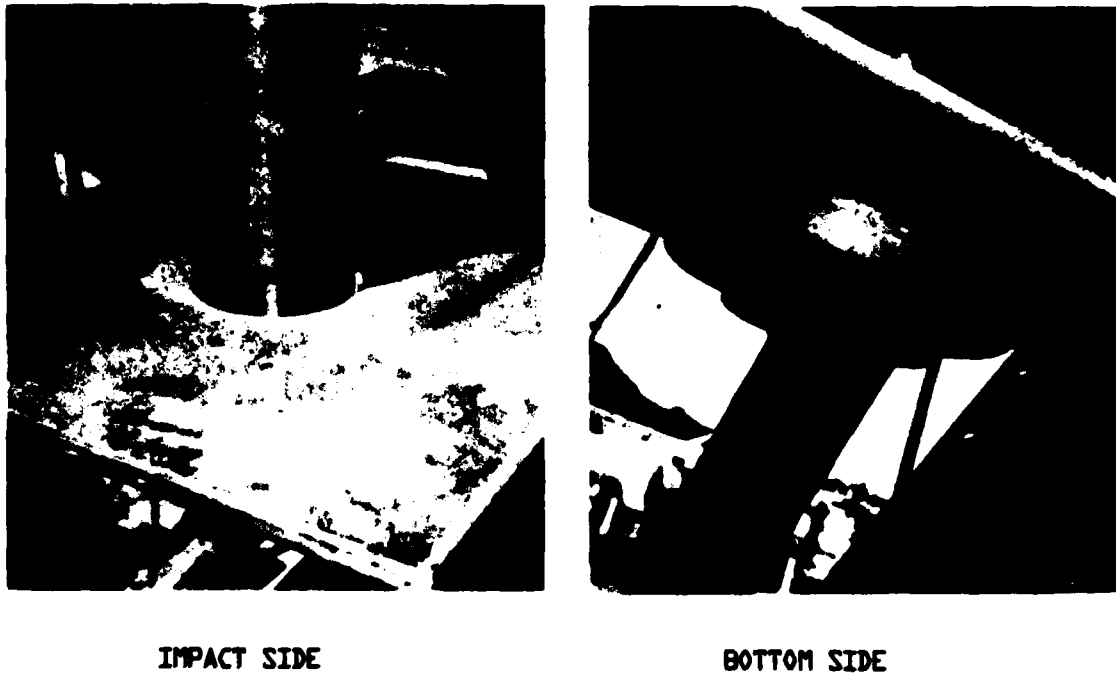

Figure 8: Steel Plate Response to 5.5 Inch Hemispherical Tup in Test Number 15



IMPACT SIDE



BOTTOM SIDE

Figure 9: Steel Plate Response to 5.5 Inch Hemispherical Tup in Test Number 25



IMPACT SIDE



BOTTOM SIDE

Figure 10: Steel Plate Response to 5.5 Inch Hemispherical Tup in Test Number 32



IMPACT SIDE



BOTTOM SIDE

Figure 11: Steel Plate Response to 5.5 Inch Hemispherical Tup in Test Number 33



IMPACT SIDE

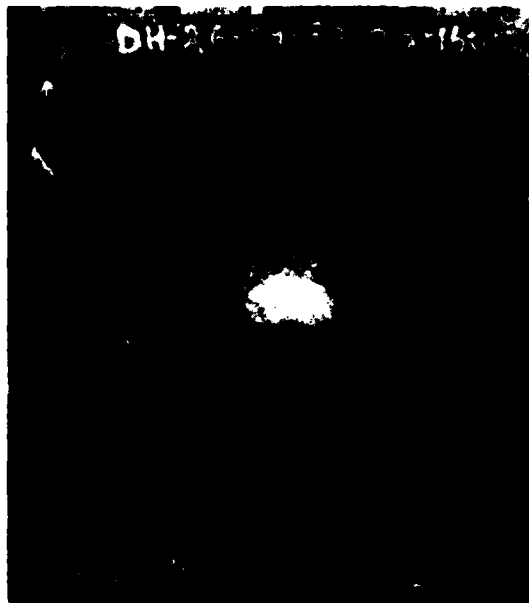

BOTTOM SIDE

Figure 12: Steel Plate Response to 5.5 Inch Hemispherical Tup in Test Number 14

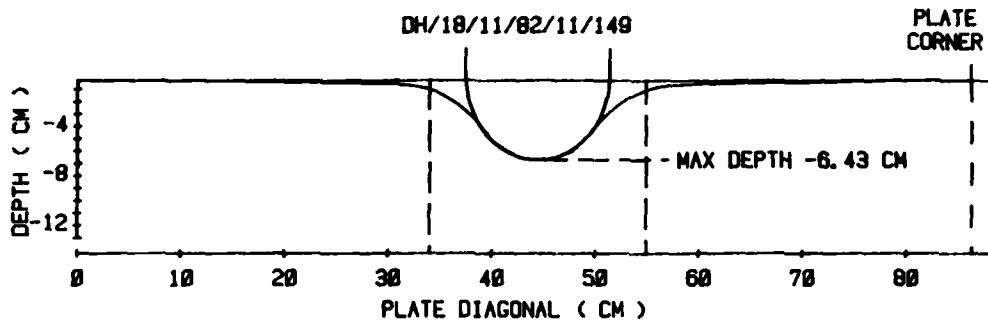

Figure 13: The DM Measurements of Impact Dent From Test Number 20

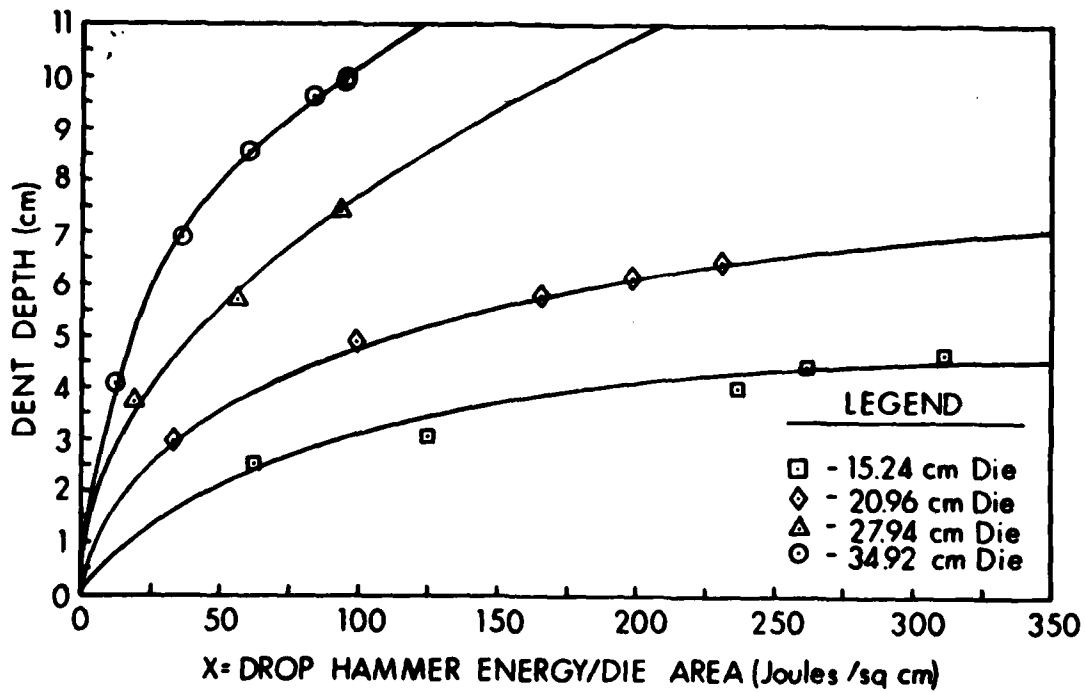

Figure 14: Dent Depth Summary of the 5.5 Inch Hemispherical Tup Data

TEST DATA FOR THE HEMISPHERICAL 3.75 INCH TUP

The next group of tests were done using a hemispherical tup with a maximum diameter of 9.5 cm {3.75 inches}. The symbol designation for this tup is T_{MH} . In general, it was expected that the response by the plates to impacts using the T_{MH} tup would be similar to the results using the larger size tup, but that the depths would be greater with respect to the hammer height. The initial conditions for the 15 tests using this tup are listed in Table 3.

TABLE 3: INITIAL CONDITIONS FOR TESTS USING THE 3.75 INCH HEMISPHERICAL TUP

Test No.	Identification Number	Tup Diameter {cm}	Tup Diameter {Inches}	Die Diameter {cm}	Die Diameter {Inches}	Hammer Height {cm}	Hammer Height {Inches}
34	DH-25-04-83-01-160	9.6	3.75	15.2	6.0	25.4	10.0
35	DH-25-04-83-02-160	9.6	3.75	15.2	6.0	50.8	20.0
36	DH-25-04-83-03-160	9.6	3.75	15.2	6.0	76.2	30.0
37	DH-25-04-83-04-160	9.6	3.75	15.2	6.0	101.6	40.0
38	DH-25-04-83-05-160	9.6	3.75	21.0	8.25	25.4	10.0
39	DH-25-04-83-06-160	9.6	3.75	21.0	8.25	50.8	20.0
40	DH-25-04-83-07-160	9.6	3.75	21.0	8.25	76.2	30.0
41	DH-25-04-83-08-160	9.6	3.75	21.0	8.25	101.6	40.0
42	DH-25-04-83-09-160	9.6	3.75	28.0	11.0	25.4	10.0
43	DH-25-04-83-10-160	9.6	3.75	28.0	11.0	50.8	20.0
44	DH-25-04-83-11-160	9.6	3.75	28.0	11.0	76.2	30.0
45	DH-25-04-83-12-160	9.6	3.75	35.0	13.75	25.4	10.0
46	DH-25-04-83-13-160	9.6	3.75	35.0	13.75	50.8	20.0
47	DH-25-04-83-14-160	9.6	3.75	35.0	13.75	76.2	30.0
48	DH-25-04-83-15-160	9.6	3.75	35.0	13.75	101.6	40.0

Figure 15 presents a view of the impact side and the bottom side of a sample impacted plate using the T_{MH} tup. The response of the plate was similar to that obtained for the larger T_{MH} hemispherical tup. Figure 16 presents a sample of the DM measurements for this group of tests which also is similar to the previously discussed group. The dent depth as functions of drop hammer energy/die area {joules/sq. cm} are presented in Figure 17. The trends are similar to the previous group's results but the dent depths are greater as anticipated.

TEST DATA FOR THE HEMISPHERICAL 2.0 INCH TUP

The remaining tests were performed using a 5.08 cm {2 inch} diameter hemispherical tup designated with the symbol T_{SH} . It was expected that the depth of the dents as functions of hammer height would increase significantly due to the much greater energy/area concentration. The initial conditions for these tests are summarized in Table 4.

An example of one of the tests, where a 15.2 cm {6.0 inch} diameter die was used is presented in Figure 18. The imprint of the perimeter of the die is visible in both photographs. Figure 19 presents a sample DM measurement plot for Test Number 61 where a 21.0 cm {8.3 inch} diameter die was used. In general, the plates experienced a great deal of bending due to the relatively large distance between the edge of the die and the tup.

In practically all of the T_{SH} tup tests, visible cracks were observed on the bottom side of the plates at or near the apex of the bulges. The seriousness of this type of crack with respect to a tank car rupture cannot be estimated at the present. However, the data indicates that for a bend with a radius of curvature of 2.54 cm {1.0 inches} and a dent depth of 3.81 cm {1.5



IMPACT SIDE

BOTTOM SIDE

Figure 15: Steel Plate Response to 3.75 Inch Hemispherical Tip in Test Number 40

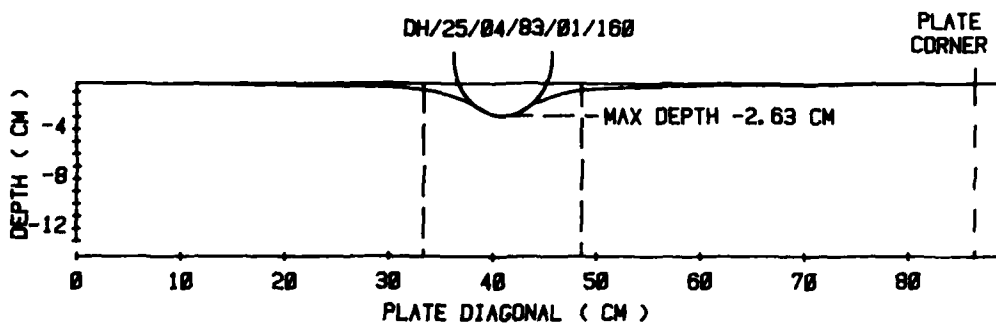

Figure 16: The DM Measurements of Impact Dent From Test Number 34

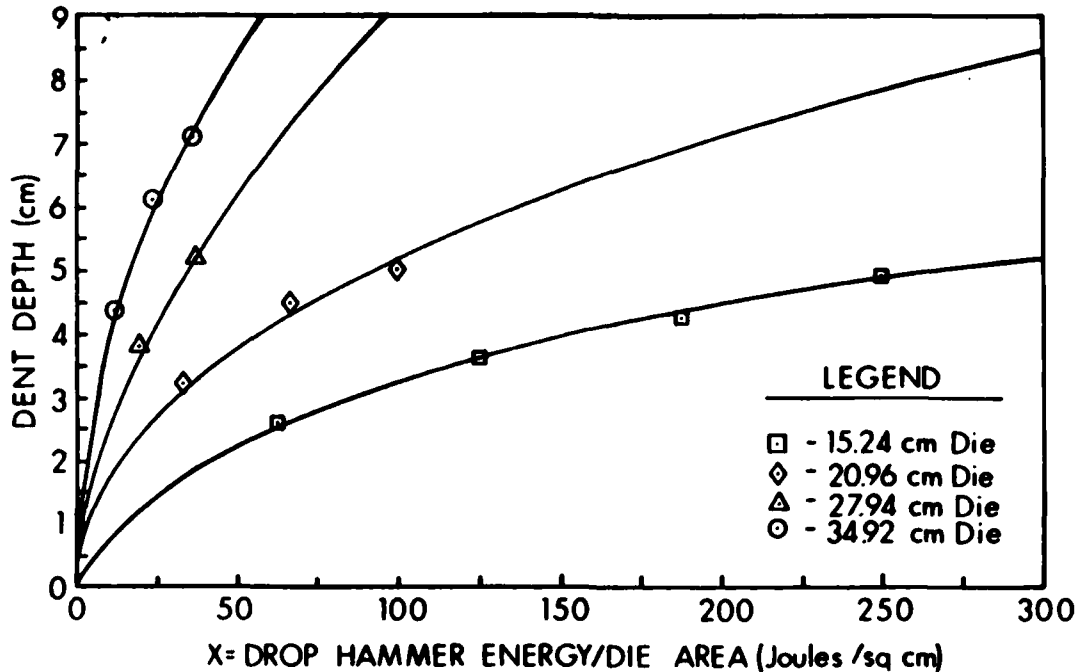

Figure 17: Dent Depth Summary for the 3.75 Inch Hemispherical Tup Data

TABLE 4: INITIAL CONDITIONS FOR TESTS USING THE 2.0 INCH HEMISPHERICAL TUP

Test No.	Identification Number	Top Diameter (cm)	Top Diameter (Inches)	Die Diameter (cm)	Die Diameter (Inches)	Hammer Height (cm)	Hammer Height (Inches)
49	DH-26-04-83-07-160	5.1	2.0	15.2	6.0	10.2	4.0
50	DH-26-04-83-08-160	5.1	2.0	15.2	6.0	20.3	8.0
51	DH-17-11-82-04-140	5.1	2.0	15.2	6.0	30.5	12.0
52	DH-17-11-82-05-167	5.1	2.0	15.2	6.0	33.0	13.0
53	DH-17-11-82-06-167	5.1	2.0	15.2	6.0	35.6	14.0
54	DH-17-11-82-09-147	5.1	2.0	15.2	6.0	38.1	15.0
55	DH-17-11-82-07-167	5.1	2.0	15.2	6.0	40.6	16.0
56	DH-17-11-82-08-136	5.1	2.0	15.2	6.0	43.2	17.0
57	DH-26-04-83-09-160	5.1	2.0	21.0	6.0	10.2	4.0
58	DH-26-04-83-10-160	5.1	2.0	21.0	8.3	20.3	8.0
59	DH-18-11-82-01-179	5.1	2.0	21.0	8.3	30.5	12.0
60	DH-17-11-82-12-171	5.1	2.0	21.0	8.3	33.0	13.0
61	DH-17-11-82-11-157	5.1	2.0	21.0	8.3	40.6	16.0
62	DH-17-11-82-10-167	5.1	2.0	21.0	8.3	45.7	18.0
63	DH-26-04-83-11-160	5.1	2.0	28.0	11.0	10.2	4.0
64	DH-26-04-83-12-160	5.1	2.0	28.0	11.0	20.3	8.0
65	DH-18-11-82-04-160	5.1	2.0	28.0	11.0	30.5	12.0
66	DH-18-11-82-03-179	5.1	2.0	28.0	11.0	33.0	13.0
67	DH-18-11-82-02-171	5.1	2.0	28.0	11.0	35.6	14.0
68	DH-26-04-83-13-160	5.1	2.0	35.0	13.8	10.2	4.0
69	DH-26-04-83-14-160	5.1	2.0	35.0	13.8	20.3	8.0
70	DH-18-11-82-08-167	5.1	2.0	35.0	13.8	33.0	13.0
71	DH-18-11-82-05-171	5.1	2.0	35.0	13.8	35.6	14.0
72	DH-18-11-82-07-163	5.1	2.0	35.0	13.8	35.6	14.0
73	DH-18-11-82-06-160	5.1	2.0	35.0	13.8	38.1	15.0



IMPACT SIDE

BOTTOM SIDE

Figure 18: Steel Plate Response to 2.0 Inch Hemispherical Tup in Test Number 55

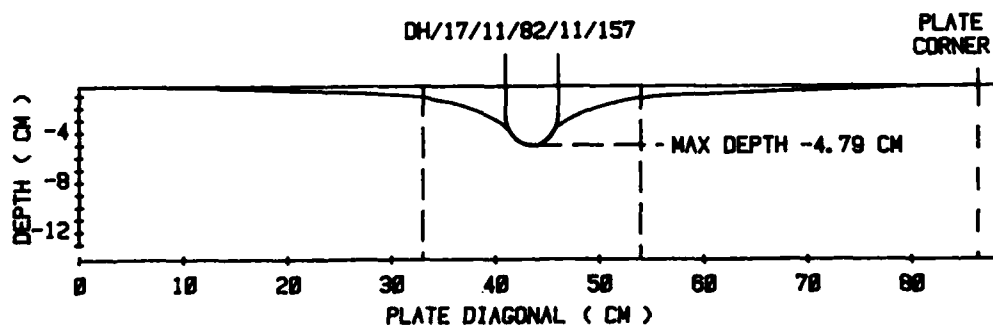

Figure 19: The DM Measurements of Impact Dent From Test Number 61

inches) to 6.35 cm (2.5 inches), there will be surface cracking on the inside of the tank car. This is an example of how these data can be used in assessing a damaged tank car. Such a correlation can be expanded to include other flaw data obtained by using NDE techniques. Figure 20 presents a plot of the dent depth as functions of drop hammer energy/die area (joules/sq. cm). Again, these curves are similar to those obtained from test data obtained using the larger diameter tups.

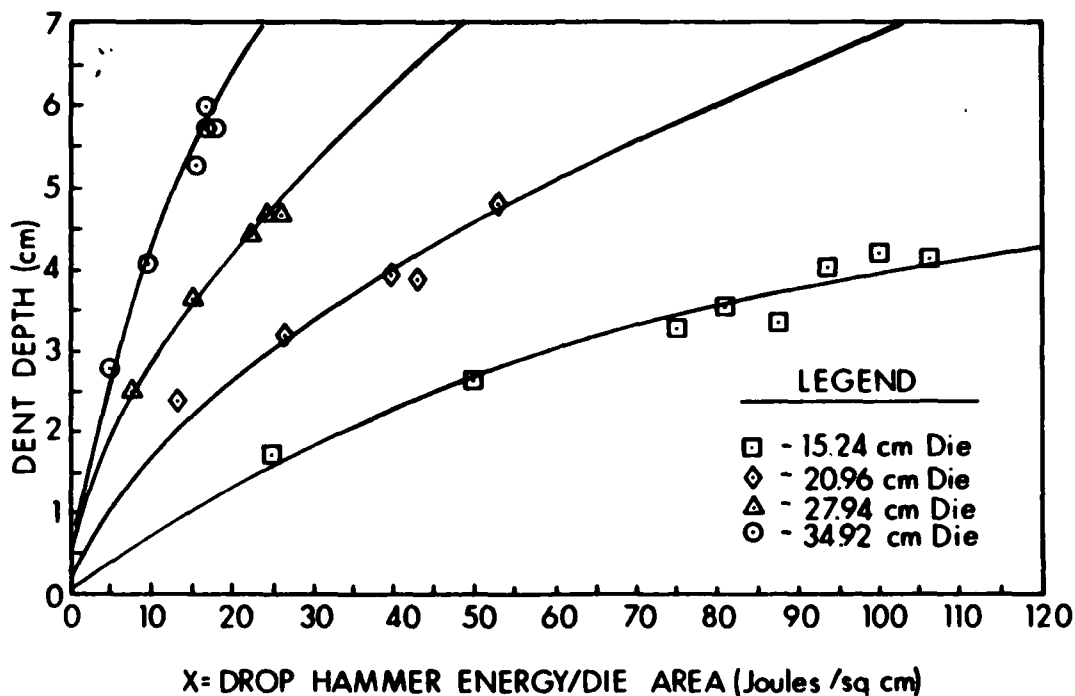

Figure 20: Dent Depth Summary for the 2.0 Inch Hemispherical Tup

SCALING OF THE DENT DEPTH VERSUS ENERGY

As with any test program, in the event the data scales, a great deal of future test reduction may be realized. Consequently, an attempt to scale the dent depth as a function of drop hammer energy was pursued. The results of this effort are presented in Figure 21. As Figure 21 shows, the scaling was done by nondimensionalizing the X and Y terms. These terms are defined as follows:

$$X = \{ \{ E / S \} * \{ D_T / D_D \} \}^{0.5}$$

and

$$Y = \{ DD / d \} * \{ D_T / D_D \}^{0.25}$$

where:

DD is depth of dent (cm),

d is plate thickness (1.5875 cm = 5/8 inches),

D_D is die diameter (cm),

E is plate density times tup velocity squared (kg/m-sec²),

S is ultimate strength of plate material (4.5×10^6 kg/m-sec²) = 65,000 psi
 and the density of the steel was assumed to be equal to 7.78 gm/cc.

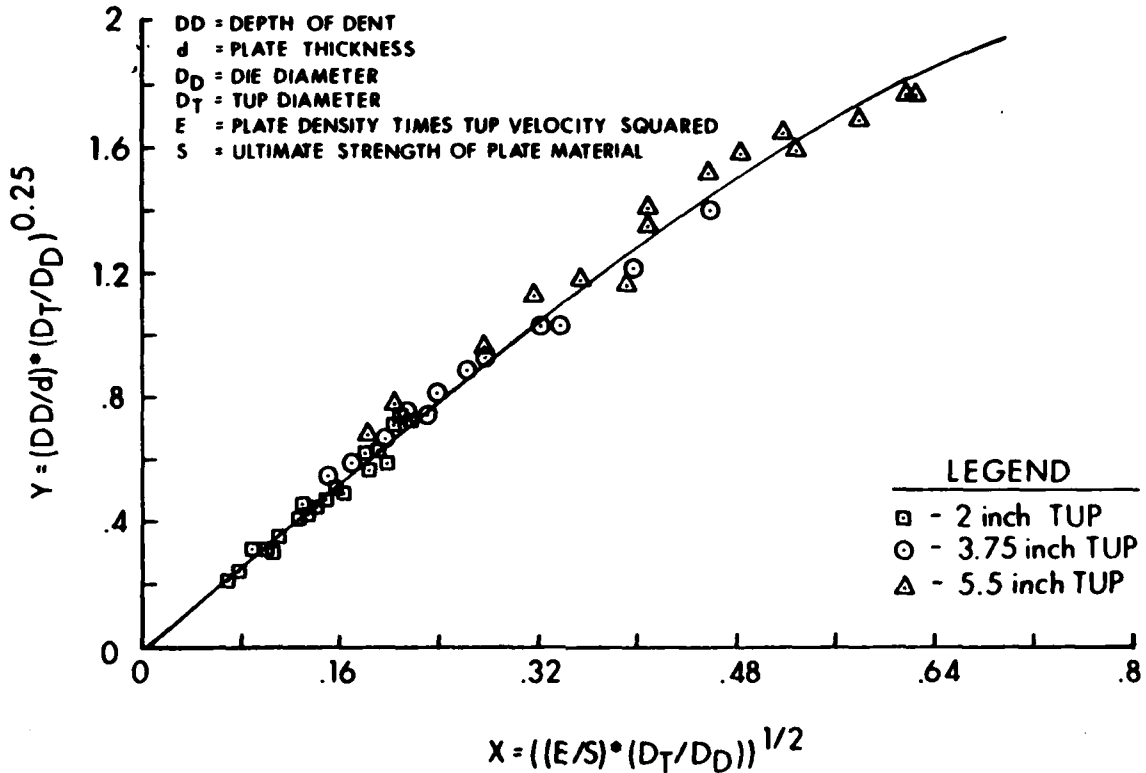

Figure 21: Summary of Dent Depth Versus Energy for the Hemispherical Tup Impact Data

These scaling relations were obtained using nondimensionalizing techniques in a totally empirical way. The most important aspect of this exercise is that the result shows that there is a high probability that these kinds of test data can be scaled. Additional work is required in the form of data generation for other initial conditions. For example, it would be very useful if expressions could be developed for scaling to other plate thicknesses and materials.

SUMMARY

The discussion indicates that tank car type steel is very ductile and that brittle fracture can only be expected after the material has experienced a great deal of strain hardening. It was shown that for 3.81 cm {1.5 inch} to 6.35 cm {2.5 inch} deep dents with a radius of curvature of 2.54 cm {1 inches}, ductile cracking can be expected on the inside surface of a dented tank car with a shell constructed with steel used in this program. The data indicates that the depth of the dent measured from the original surface of the plate increases as the radius of the die increases for corresponding values of hammer heights. Also, the depths of the dents are greater for hemispherical tups than for flat tups for corresponding hammer heights. However, the chance of

shear is much greater for the flat tup (with a relatively sharp cutting edge) than for a hemispherical tup with the same diameter.

The dent depth as a function of impact energy (hammer height) scales according to the ratio of tup diameter to die diameter. However, the scaling relations obtained are preliminary and additional work is required to generate scaling procedures useful for assessing damaged tank cars. The information presented in this report will be useful in resolving the general problem, but the most important data to be gained from the impacted plates will be obtained using NDE techniques and parallel evaluations using metallurgical and fracture mechanical procedures.

ACKNOWLEDGEMENT

The authors would like to acknowledge Mr John A. Zook of the Ballistic Research Laboratory for his contribution in the development of the scaling procedure presented in this report.

LIST OF SYMBOLS

- BRL - Ballistic Research Laboratory
- FRA - Federal Railroad Administration
- DOT - Department of Transportation
- LPG - Liquid Petroleum Gas
- NDE - Nondestructive Evaluation
- ASTM - American Society for Testing and Materials
- DM - Dial Micrometer
- T_{LF} - The 5.5 Inch Diameter - Flat Tup
- DF - Drop Hammer
- T_{LH} - The 5.5 Inch Diameter - Hemispherical Tup
- T_{MH} - The 3.75 Inch Diameter - Hemispherical Tup
- T_{SH} - The 2.0 Inch Diameter - Hemispherical Tup
- DD - Depth of Dent
- d - Plate Thickness
- D_D - Die Diameter
- D_T - Tup Diameter
- E - Plate Density Times the Tup Velocity Squared
- S - Ultimate Strength of Plate Material

APPENDIX A
SUMMARY OF INITIAL CONDITIONS OF IMPACT TESTS

Test No.	Identification Number	Tup Diameter {Inches}	Die Diameter {Inches}	Hammer Height {Inches}	Geometry of Tup
1	DH-16-11-82-02-145	5.5	6.0	32.0	Flat
2	DH-16-11-82-03-136	5.5	6.0	32.5	Flat
3	DH-16-11-82-01-153	5.5	6.0	33.0	Flat
4	DH-16-11-82-04-153	5.5	8.25	34.0	Flat
5	DH-16-11-82-05-134	5.5	8.25	36.0	Flat
6	DH-16-11-82-06-160	5.5	8.25	38.0	Flat
7	DH-16-11-82-07-167	5.5	8.25	40.0	Flat
8	DH-16-11-82-08-175	5.5	11.0	42.0	Flat
9	DH-17-11-82-01-198	5.5	11.0	44.0	Flat
10	DH-26-04-83-03-160	5.5	6.0	10.0	Hemisphere
11	DH-26-04-83-04-160	5.5	6.0	20.0	Hemisphere
12	DH-17-11-82-02-131	5.5	6.0	38.0	Hemisphere
13	DH-17-11-82-03-126	5.5	6.0	42.0	Hemisphere
14	DH-26-04-83-05-160	5.5	6.0	50.0	Hemisphere
15	DH-26-04-83-06-160	5.5	6.0	70.0	Hemisphere
16	DH-26-04-83-01-160	5.5	8.25	10.0	Hemisphere
17	DH-26-04-83-02-160	5.5	8.25	30.0	Hemisphere
18	DH-18-11-82-09-149	5.5	8.25	50.0	Hemisphere
19	DH-18-11-82-10-126	5.5	8.25	60/0	Hemisphere
20	DH-18-11-82-11-149	5.5	8.25	70.0	Hemisphere
21	DH-18-11-82-12-140	5.5	8.25	90.0	Hemisphere
22	DH-25-04-83-20-160	5.5	11.0	10.0	Hemisphere
23	DH-25-04-83-21-160	5.5	11.0	30.0	Hemisphere
24	DH-25-04-83-22-160	5.5	11.0	50.0	Hemisphere
25	DH-25-04-83-23-160	5.5	11.0	70.0	Hemisphere
26	DH-25-04-83-16-160	5.5	13.95	10.0	Hemisphere
27	DH-25-04-83-17-160	5.5	13.95	30.0	Hemisphere
28	DH-25-04-83-18-260	5.5	13.95	50.0	Hemisphere
29	DH-25-04-83-19-160	5.5	13.95	70.0	Hemisphere
30	DH-26-04-83-15-160	5.5	13.95	80.0	Hemisphere
31	DH-26-04-83-16-160	5.5	13.95	80.0	Hemisphere
32	DH-27-04-83-01-160	5.5	13.95	80.0	Hemisphere
33	DH-27-04-83-02-160	5.5	13.95	80.0	Hemisphere
34	DH-25-04-83-01-160	3.75	6.0	10.0	Hemisphere
35	DH-25-04-83-02-160	3.75	6.0	20.0	Hemisphere
36	DH-25-04-83-03-160	3.75	6.0	30.0	Hemisphere
37	DH-25-04-83-04-160	3.75	6.0	40.0	Hemisphere
38	DH-25-04-83-05-160	3.75	8.25	10.0	Hemisphere
39	DH-25-04-83-06-160	3.75	8.25	20.0	Hemisphere
40	DH-25-04-83-07-160	3.75	8.25	30.0	Hemisphere
41	DH-25-04-83-08-160	3.75	8.25	40.0	Hemisphere
42	DH-25-04-83-09-160	3.75	11.0	10.0	Hemisphere
43	DH-25-04-83-10-160	3.75	11.0	20.0	Hemisphere
44	DH-25-04-83-11-160	3.75	11.0	30.0	Hemisphere
45	DH-25-04-83-12-160	3.75	13.75	10.0	Hemisphere
46	DH-25-04-83-13-160	3.75	13.75	20.0	Hemisphere

APPENDIX A
SUMMARY OF INITIAL CONDITIONS OF IMPACT TESTS
{Continuation}

Test No.	Identification Number	Tup Diameter {Inches}	Die Diameter {Inches}	Hammer Height {Inches}	Geometry of Tup
47	DH-25-04-83-14-160	3.75	13.75	30.0	Hemisphere
48	DH-25-04-83-15-160	3.75	13.75	40.0	Hemisphere
49	DH-26-04-83-07-160	2.0	6.0	4.0	Hemisphere
50	DH-26-04-83-08-160	2.0	6.0	8.0	Hemisphere
51	DH-17-11-82-04-140	2.0	6.0	12.0	Hemisphere
52	DH-17-11-82-05-167	2.0	6.0	13.0	Hemisphere
53	DH-17-11-82-06-167	2.0	6.0	14.0	Hemisphere
54	DH-17-11-82-09-147	2.0	6.0	15.0	Hemisphere
55	DH-17-11-82-07-167	2.0	6.0	16.0	Hemisphere
56	DH-17-11-82-08-136	2.0	6.0	17.0	Hemisphere
57	DH-26-04-83-09-160	2.0	8.25	4.0	Hemisphere
58	DH-26-04-83-10-160	2.0	8.25	8.0	Hemisphere
59	DH-18-11-82-01-179	2.0	8.25	12.0	Hemisphere
60	DH-17-11-82-12-171	2.0	8.25	13.0	Hemisphere
61	DH-17-11-82-11-157	2.0	8.25	16.0	Hemisphere
62	DH-17-11-82-19-167	2.0	8.25	18.0	Hemisphere
63	DH-26-04-83-11-160	2.0	11.0	4.0	Hemisphere
64	DH-26-04-83-12-160	2.0	11.0	8.0	Hemisphere
65	DH-18-11-82-04-160	2.0	11.0	12.0	Hemisphere
66	DH-18-11-82-03-179	2.0	11.0	13.0	Hemisphere
67	DH-18-11-82-02-171	2.0	11.0	14.0	Hemisphere
68	DH-26-04-83-13-160	2.0	13.75	4.0	Hemisphere
69	DH-26-04-83-14-160	2.0	13.75	8.0	Hemisphere
70	DH-18-11-82-08-167	2.0	13.75	13.0	Hemisphere
71	DH-18-11-82-05-171	2.0	13.75	14.0	Hemisphere
72	DH-18-11-82-07-163	2.0	13.75	14.0	Hemisphere
73	DH-18-11-82-06-160	2.0	13.75	15.0	Hemisphere

APPENDIX B
PHOTOGRAPHS OF STEEL PLATES FOLLOWING IMPACT TESTS

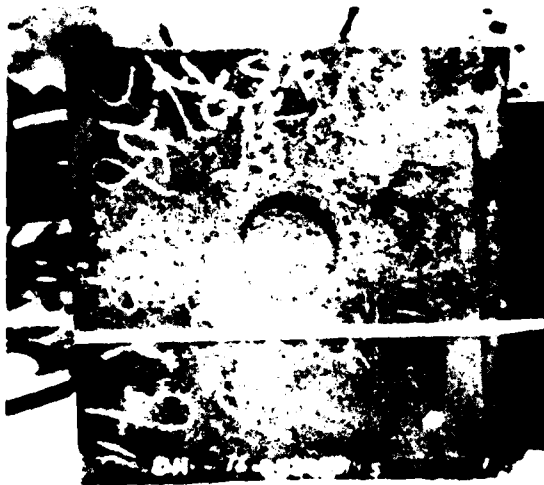

IMPACT SIDE

BOTTOM SIDE

Figure B1: Steel Plate Response to 5.5 Inch Flat Tup in Test Number 1

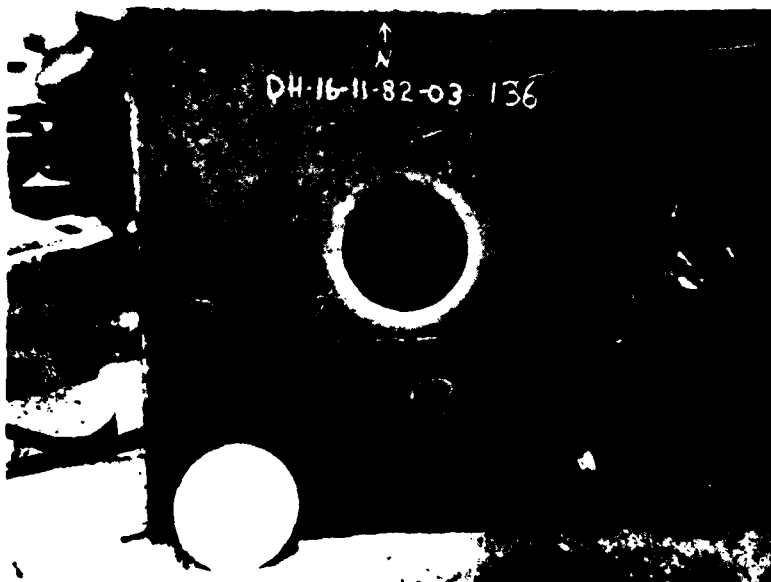

Figure B2: Steel Plate Response to 5.5 Inch Flat Tup in Test Number 2



Figure B3: Steel Plate Response to 5.5 Inch Flat Top in Test Number 3



IMPACT SIDE



BOTTOM SIDE

Figure B4: Steel Plate Response to 5.5 Inch Flat Top in Test Number 4



IMPACT SIDE



BOTTOM SIDE

Figure 85: Steel Plate Response to 5.5 Inch Flat Tup in Test Number 5



IMPACT SIDE



BOTTOM SIDE

Figure 86: Steel Plate Response to 5.5 Inch Flat Tup in Test Number 6



IMPACT SIDE



BOTTOM SIDE

Figure B7: Steel Plate Response to 5.5 Inch Flat Tup in Test Number 7



IMPACT SIDE



BOTTOM SIDE

Figure B8: Steel Plate Response to 5.5 Inch Flat Tup in Test Number 8

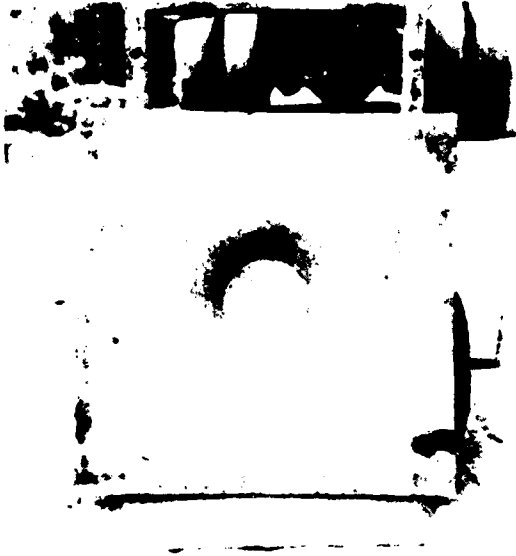

IMPACT SIDE



BOTTOM SIDE

Figure B9: Steel Plate Response to 5.5 Inch Flat Tup in Test Number 9

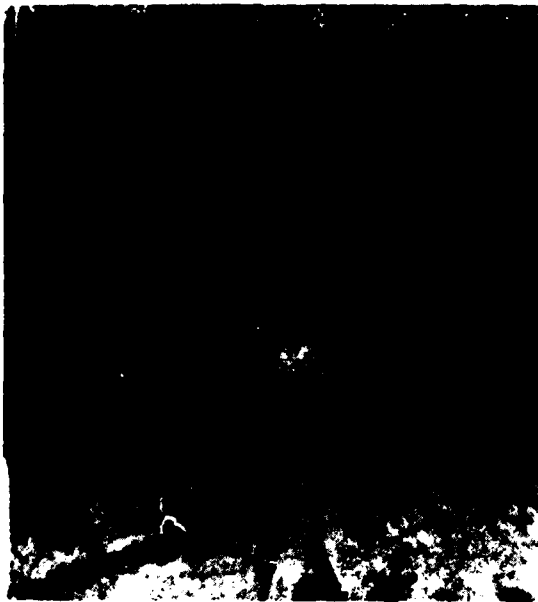

IMPACT SIDE

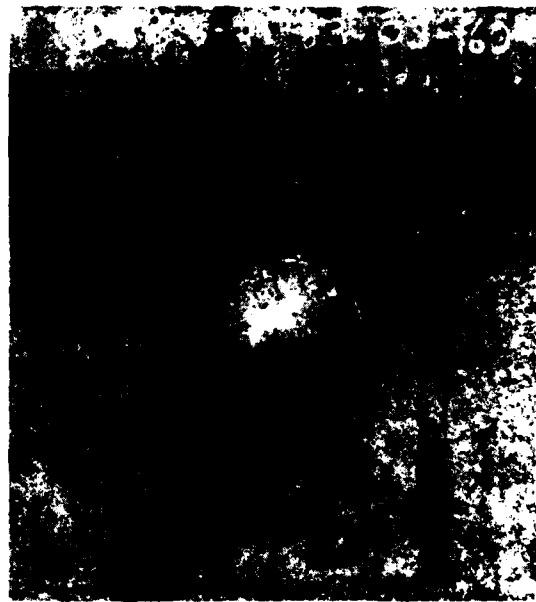

BOTTOM SIDE

Figure B10: Steel Plate Response to 5.5 Inch Hemispherical Tup in Test Number 10



IMPACT SIDE



BOTTOM SIDE

Figure B11: Steel Plate Response to 5.5 Inch Hemispherical Tup in Test Number 11



IMPACT SIDE

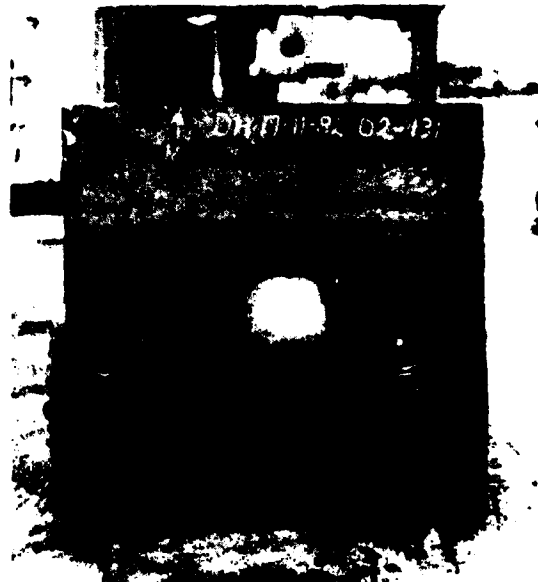

BOTTOM SIDE

Figure B12: Steel Plate Response to 5.5 Inch Hemispherical Tup in Test Number 12

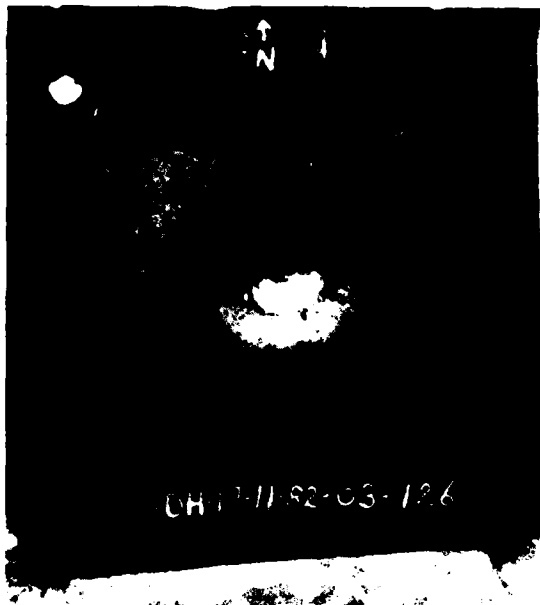

IMPACT SIDE

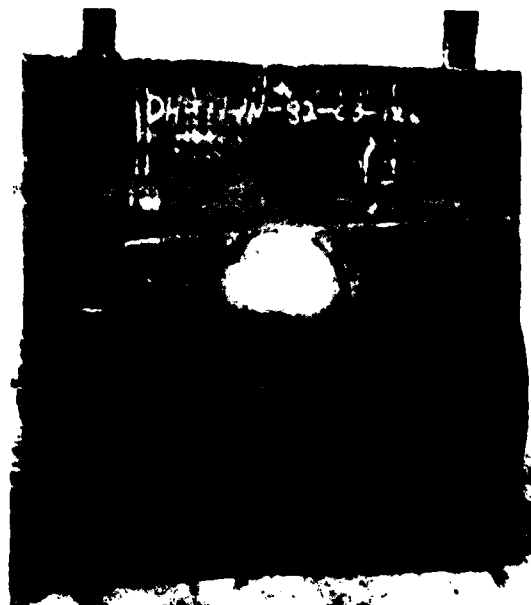

BOTTOM SIDE

Figure B13: Steel Plate Response to 5.5 Inch Hemispherical Tup in Test Number 13



IMPACT SIDE

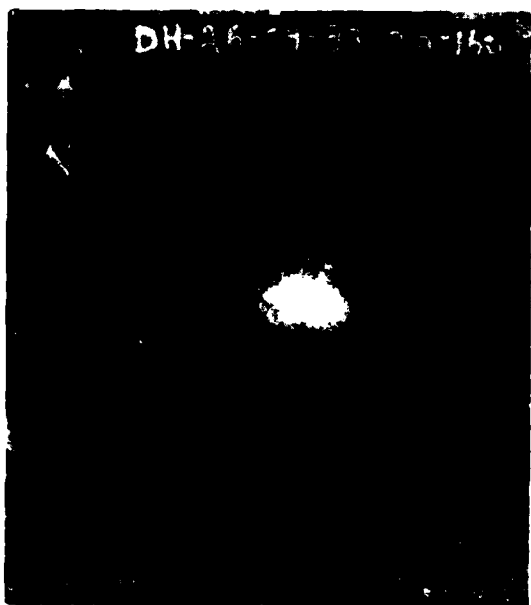

BOTTOM SIDE

Figure B14: Steel Plate Response to 5.5 Inch Hemispherical Tup in Test Number 14



IMPACT SIDE



BOTTOM SIDE

Figure B15: Steel Plate Response to 5.5 Inch Hemispherical Tup in Test Number 15

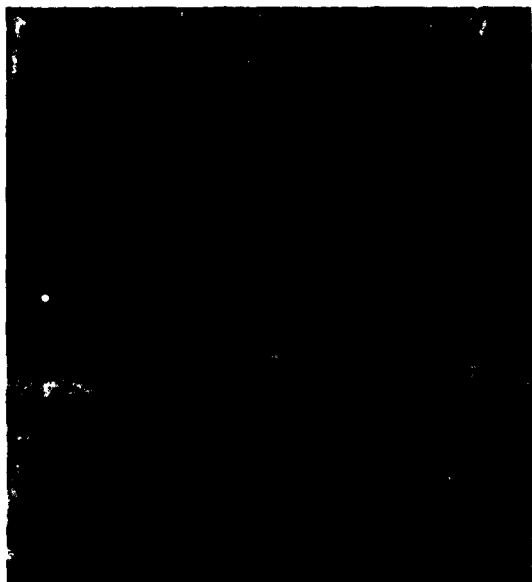

IMPACT SIDE

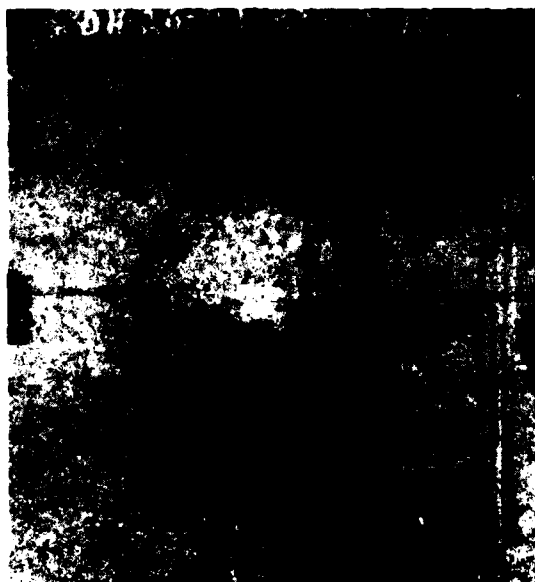

BOTTOM SIDE

Figure B16: Steel Plate Response to 5.5 Inch Hemispherical Tup in Test Number 16

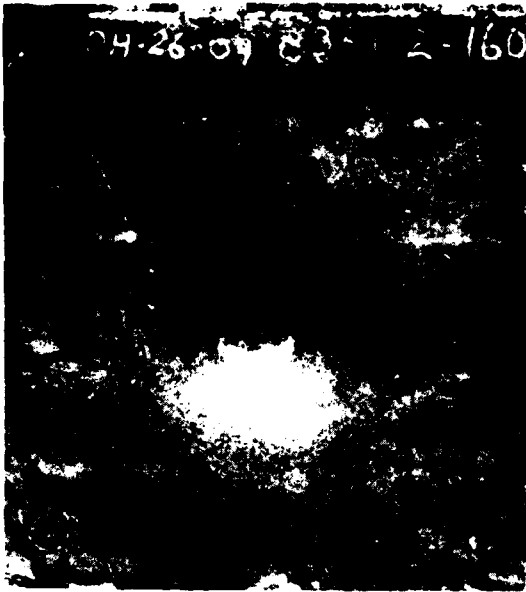

IMPACT SIDE

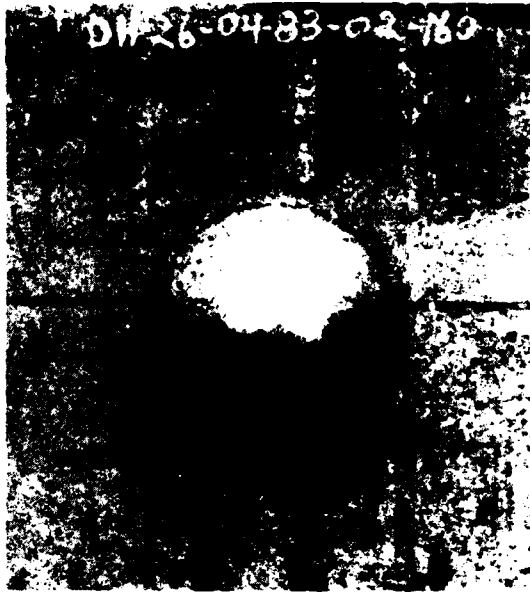

BOTTOM SIDE

Figure B17: Steel Plate Response to 5.5 Inch Hemispherical Tup in Test Number 17

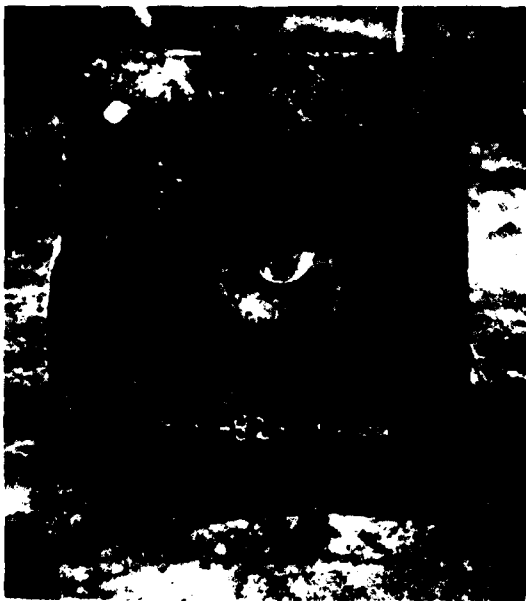

IMPACT SIDE



BOTTOM SIDE

Figure B18: Steel Plate Response to 5.5 Inch Hemispherical Tup in Test Number 18



IMPACT SIDE

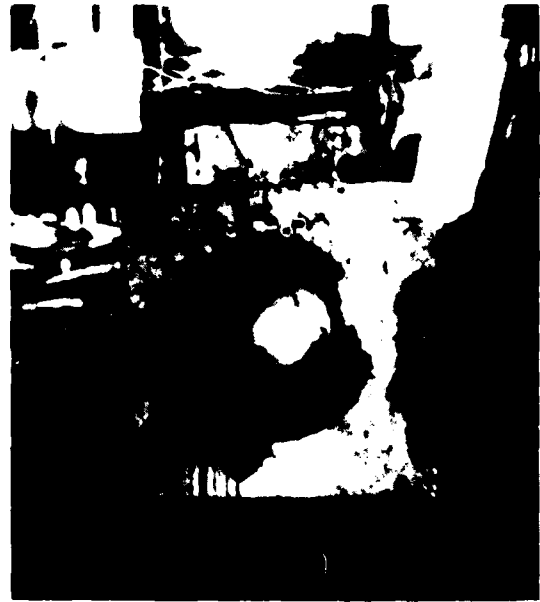

BOTTOM SIDE

Figure B19: Steel Plate Response to 5.5 Inch Hemispherical Tup in Test Number 19

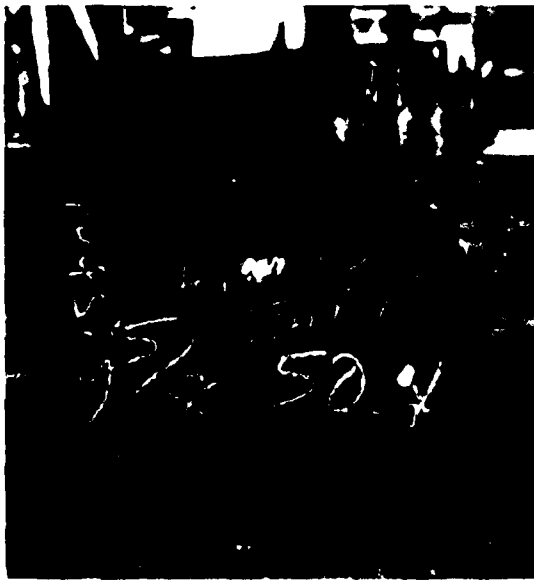

IMPACT SIDE



BOTTOM SIDE

Figure B20: Steel Plate Response to 5.5 Inch Hemispherical Tup in Test Number 20

NO DATA

NO DATA

IMPACT SIDE

BOTTOM SIDE

Figure B21: Steel Plate Response to 5.5 Inch Hemispherical Tup in Test Number 21

PHOTO MISSING

PHOTO MISSING

IMPACT SIDE

BOTTOM SIDE

Figure B22: Steel Plate Response to 5.5 Inch Hemispherical Tup in Test Number 22

PHOTO MISSING

PHOTO MISSING

IMPACT SIDE

BOTTOM SIDE

Figure B23: Steel Plate Response to 5.5 Inch Hemispherical Tup in Test Number 23

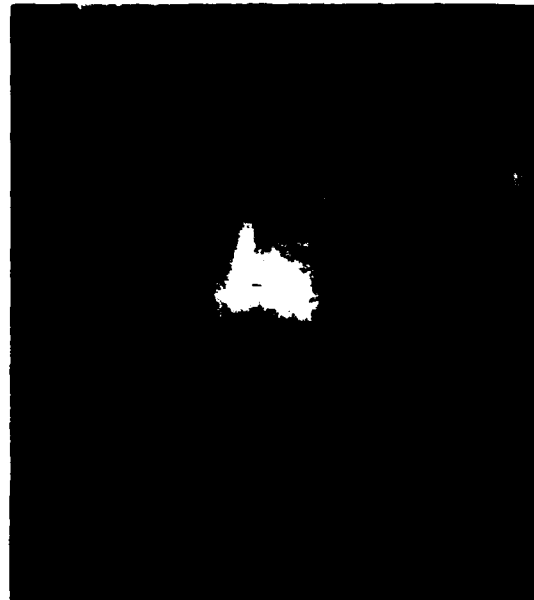

IMPACT SIDE

BOTTOM SIDE

Figure B24: Steel Plate Response to 5.5 Inch Hemispherical Tup in Test Number 24



IMPACT SIDE



BOTTOM SIDE

Figure B25: Steel Plate Response to 5.5 Inch Hemispherical Tup in Test Number 25



IMPACT SIDE

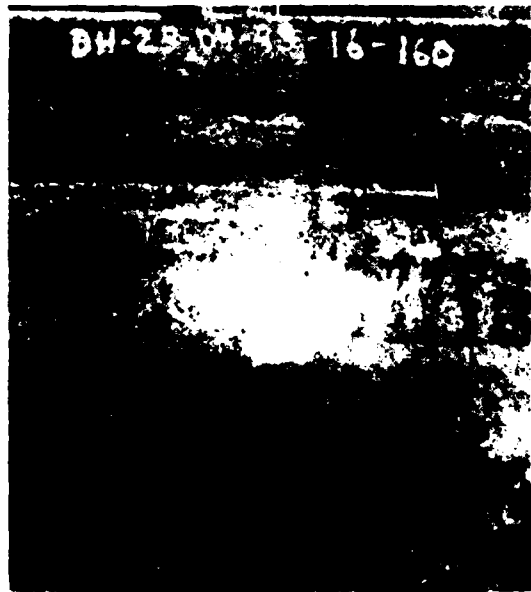

BOTTOM SIDE

Figure B26: Steel Plate Response to 5.5 Inch Hemispherical Tup in Test Number 26

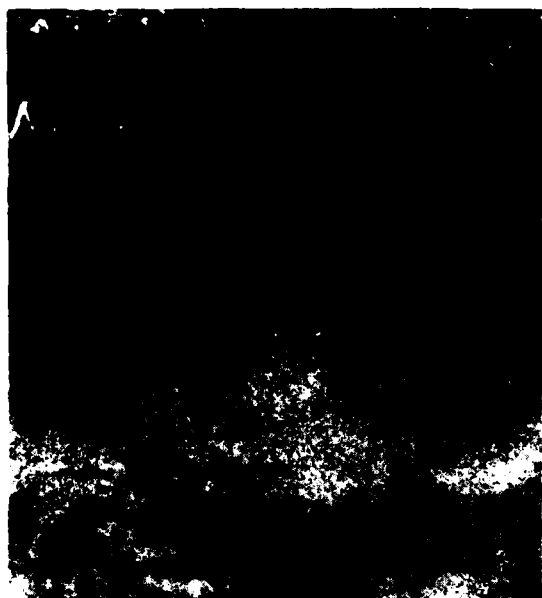

IMPACT SIDE

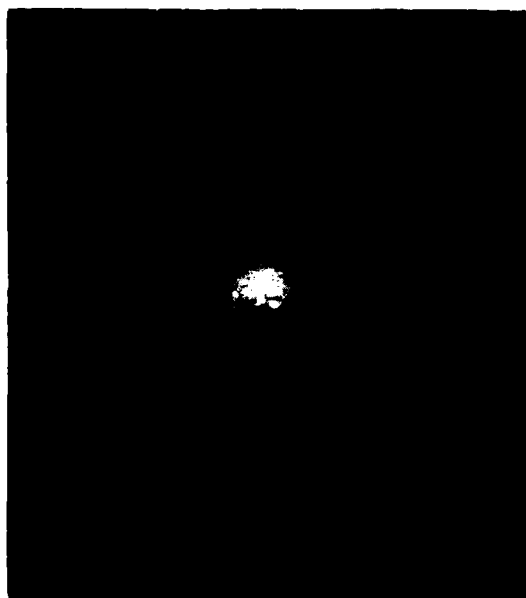

BOTTOM SIDE

Figure B27: Steel Plate Response to 5.5 Inch Hemispherical Tip in Test Number 27



IMPACT SIDE

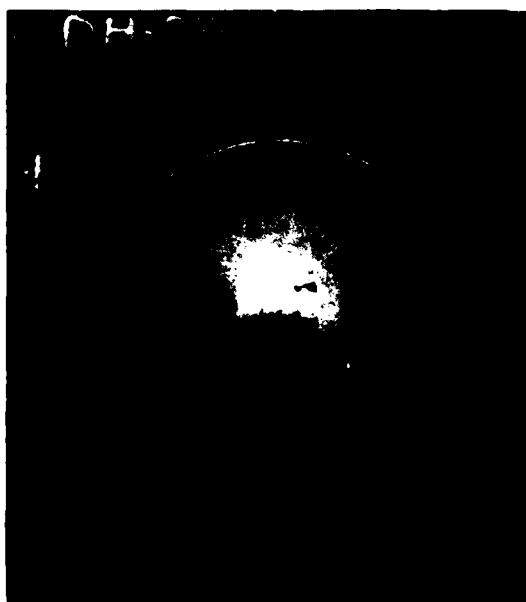

BOTTOM SIDE

Figure B28: Steel Plate Response to 5.5 Inch Hemispherical Tip in Test Number 28



IMPACT SIDE

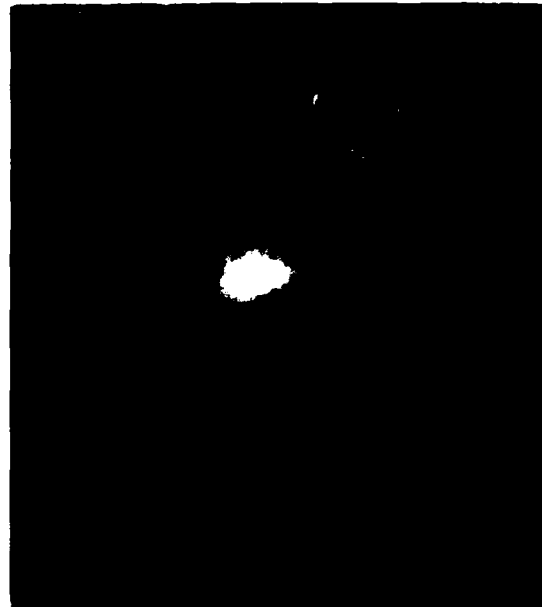

BOTTOM SIDE

Figure B29: Steel Plate Response to 5.5 Inch Hemispherical Tup in Test Number 29

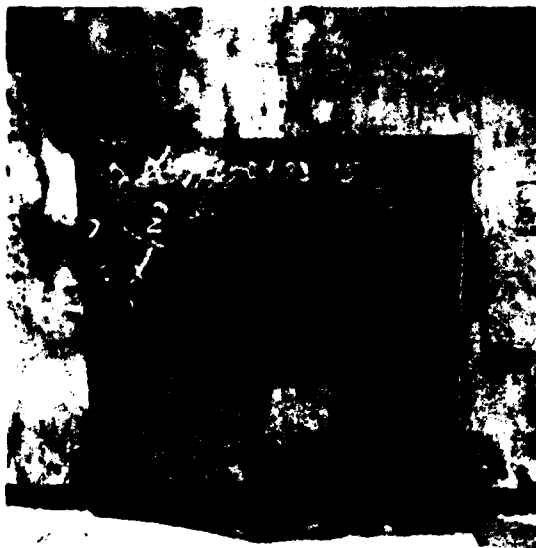

IMPACT SIDE

PHOTO MISSING

BOTTOM SIDE

Figure B30: Steel Plate Response to 5.5 Inch Hemispherical Tup in Test Number 30



IMPACT SIDE

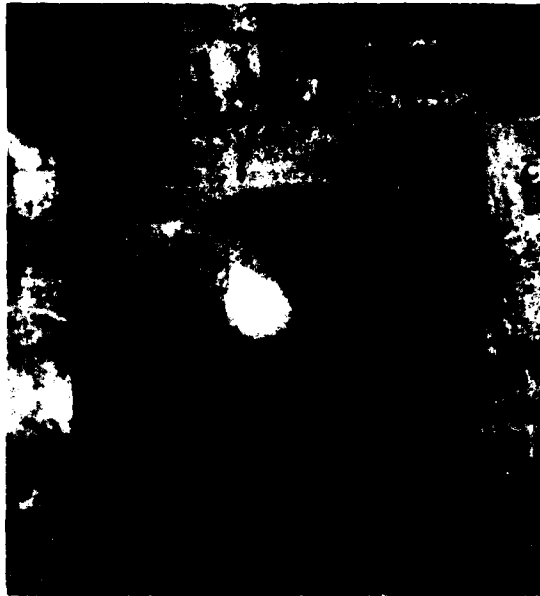

BOTTOM SIDE

Figure B31: Steel Plate Response to 5.5 Inch Hemispherical Tup in Test Number 31



IMPACT SIDE



BOTTOM SIDE

Figure B32: Steel Plate Response to 5.5 Inch Hemispherical Tup in Test Number 32



IMPACT SIDE



BOTTOM SIDE

Figure B33: Steel Plate Response to 5.5 Inch Hemispherical Tup in Test Number 33

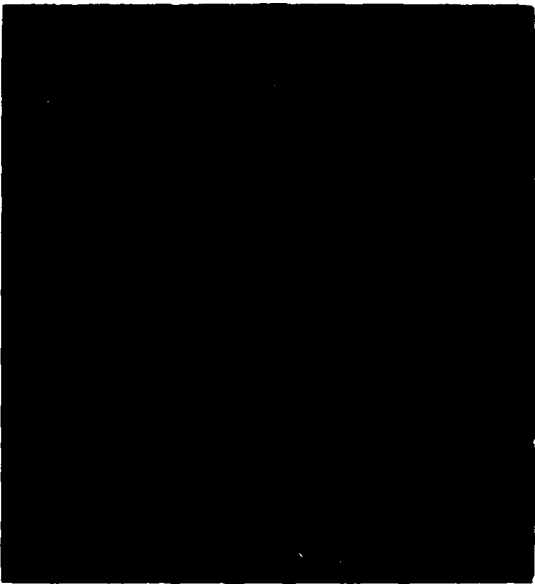

IMPACT SIDE



BOTTOM SIDE

Figure B34: Steel Plate Response to 3.75 Inch Hemispherical Tup in Test Number 34

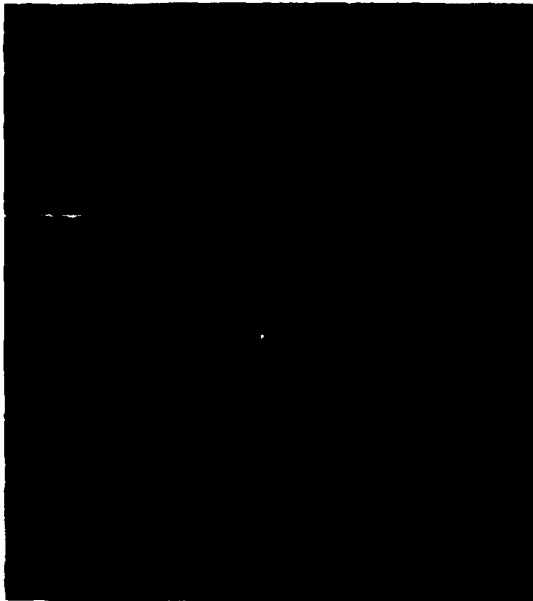

IMPACT SIDE

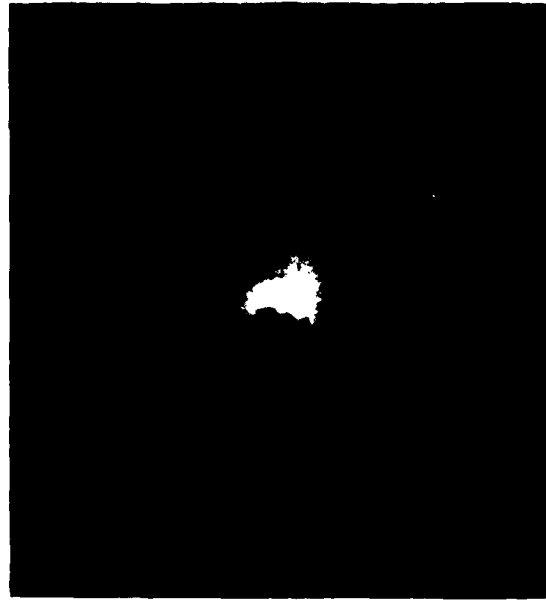

BOTTOM SIDE

Figure B35: Steel Plate Response to 3.75 Inch Hemispherical Tup in Test Number 35

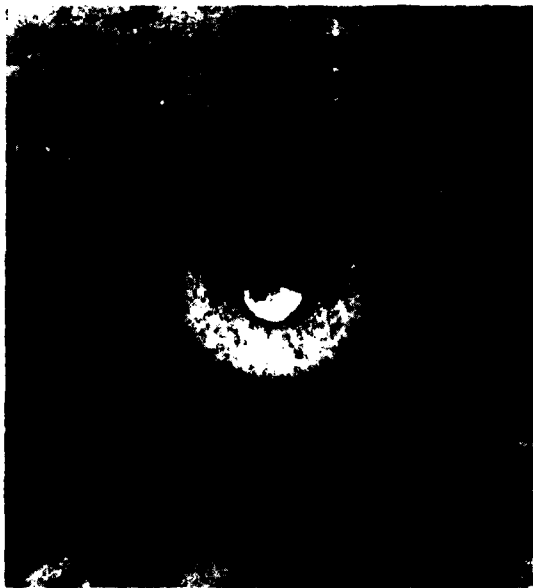

IMPACT SIDE

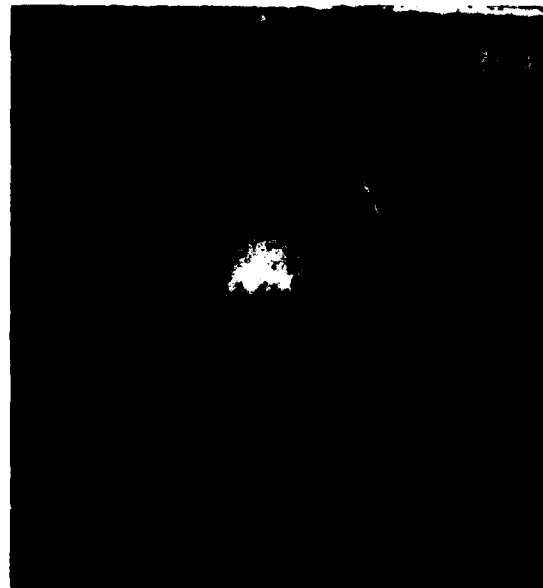

BOTTOM SIDE

Figure B36: Steel Plate Response to 3.75 Inch Hemispherical Tup in Test Number 36

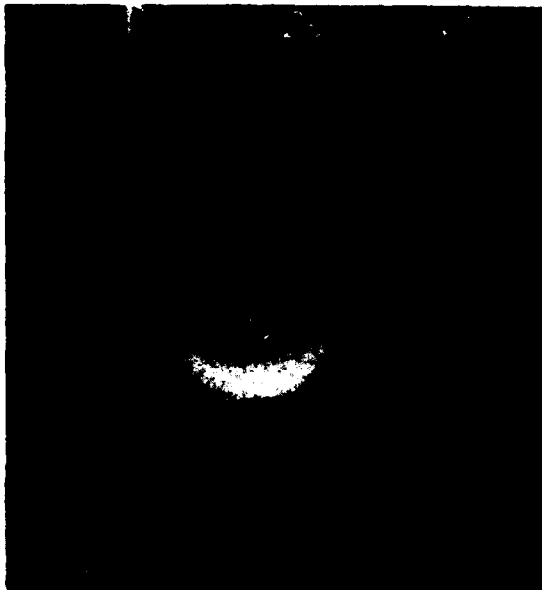

IMPACT SIDE

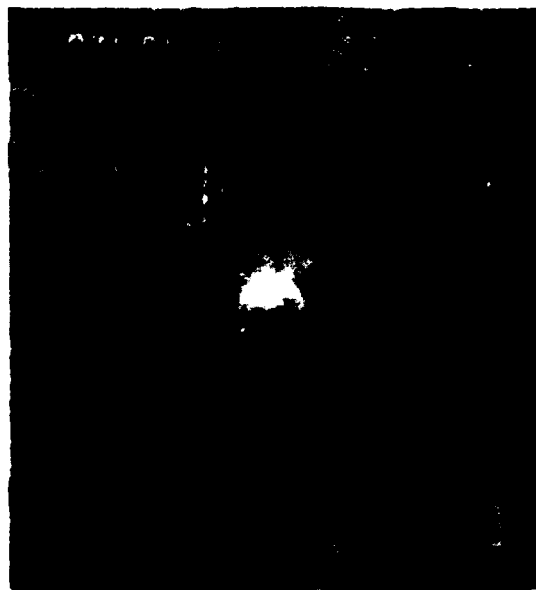

BOTTOM SIDE

Figure B37: Steel Plate Response to 3.75 Inch Hemispherical Tup in Test Number 37

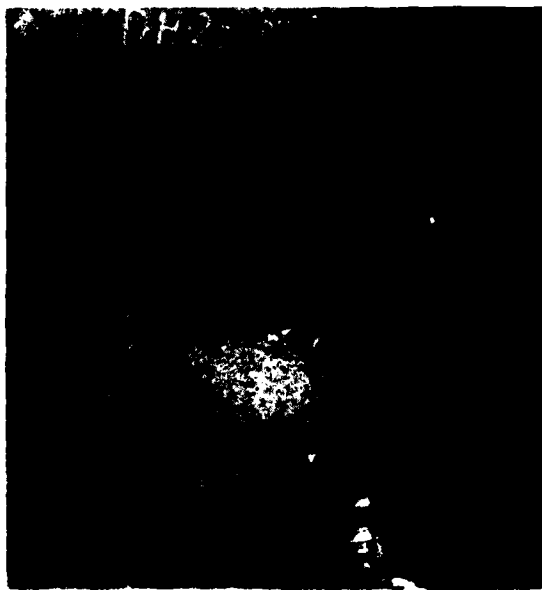

IMPACT SIDE

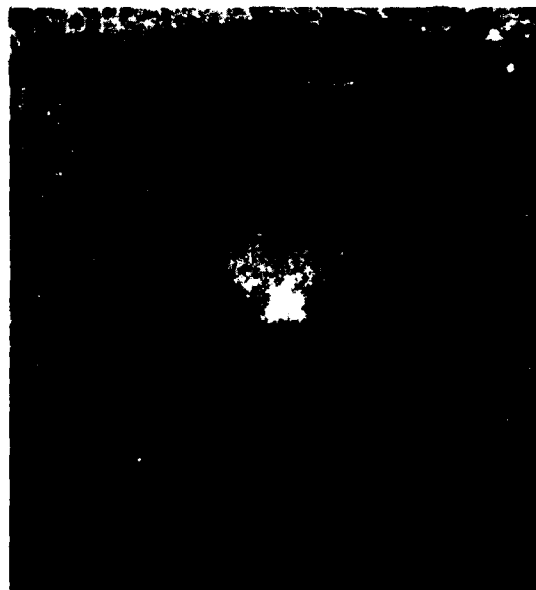

BOTTOM SIDE

Figure B38: Steel Plate Response to 3.75 Inch Hemispherical Tup in Test Number 38



IMPACT SIDE

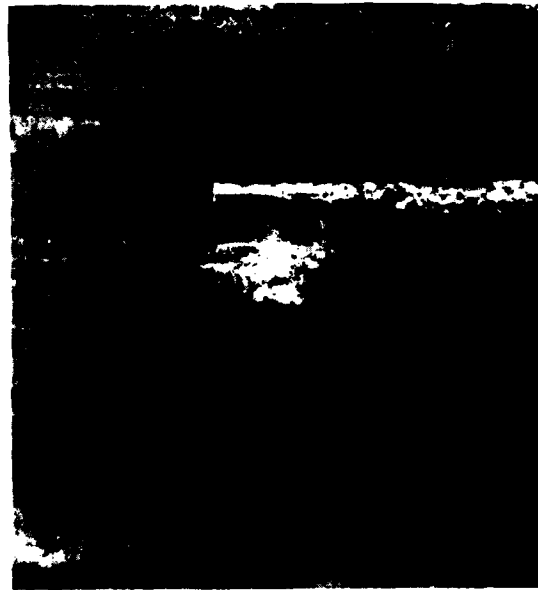

BOTTOM SIDE

Figure B39: Steel Plate Response to 3.75 Inch Hemispherical Tup in Test Number 39



IMPACT SIDE



BOTTOM SIDE

Figure B40: Steel Plate Response to 3.75 Inch Hemispherical Tup in Test Number 40



IMPACT SIDE



BOTTOM SIDE

Figure B41: Steel Plate Response to 3.75 Inch Hemispherical Tup in Test Number 41

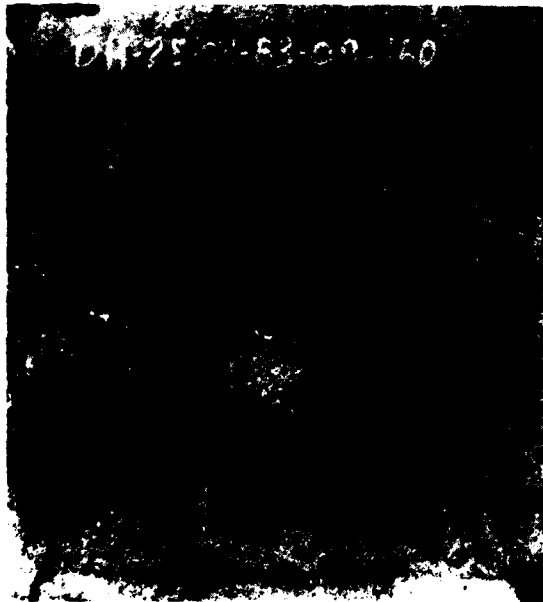

IMPACT SIDE

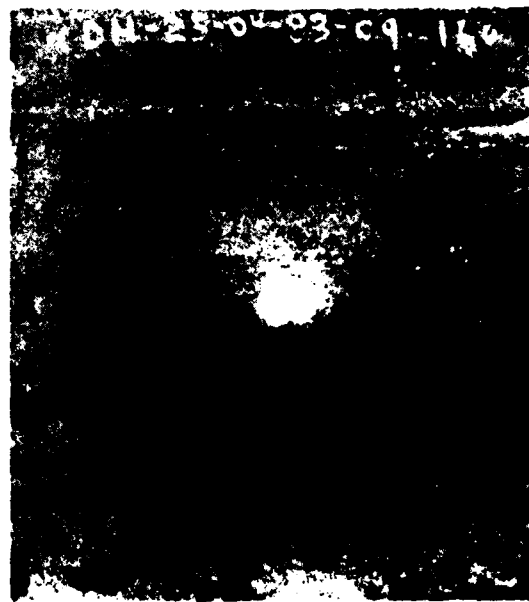

BOTTOM SIDE

Figure B42: Steel Plate Response to 3.75 Inch Hemispherical Tup in Test Number 42



IMPACT SIDE

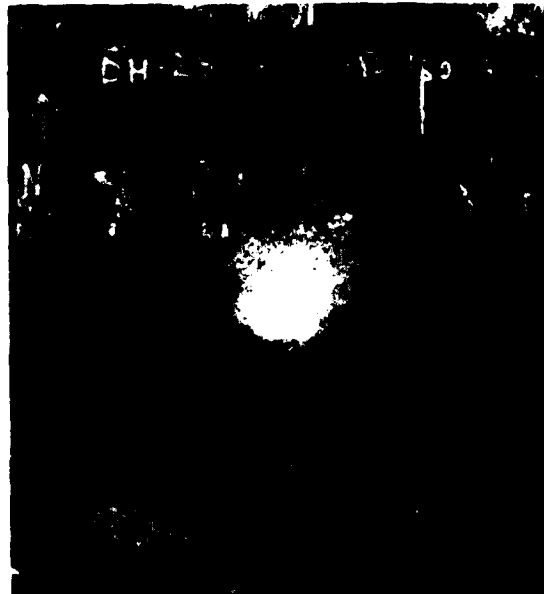

BOTTOM SIDE

Figure B43: Steel Plate Response to 3.75 Inch Hemispherical Tup in Test Number 43



IMPACT SIDE

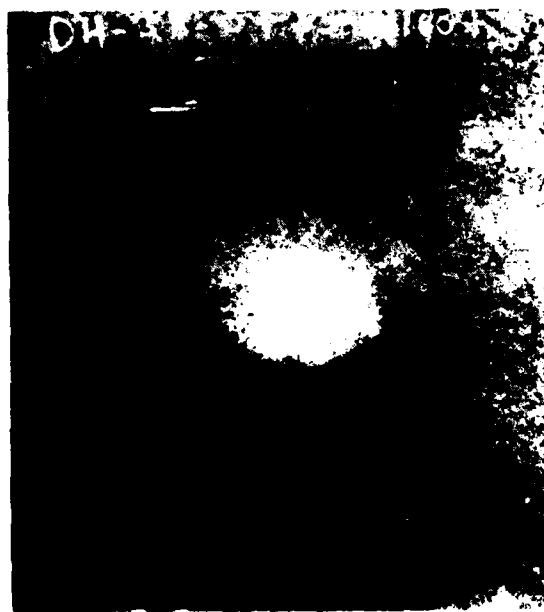

BOTTOM SIDE

Figure B44: Steel Plate Response to 3.75 Inch Hemispherical Tup in Test Number 44

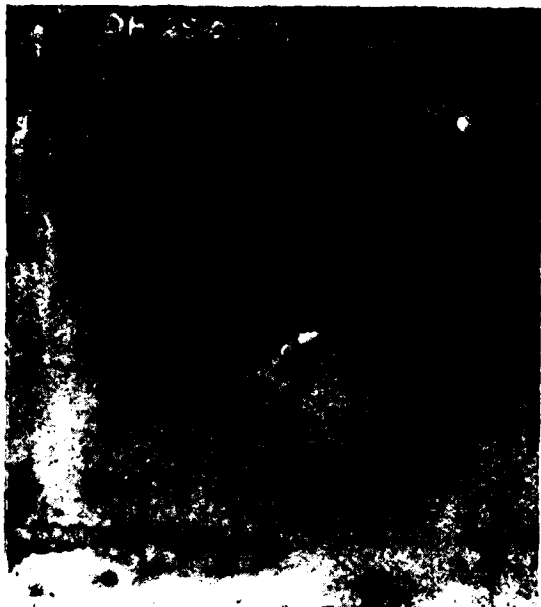

IMPACT SIDE

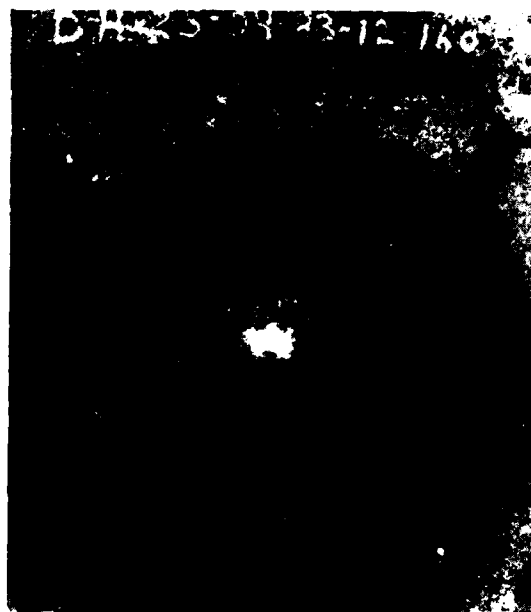

BOTTOM SIDE

Figure B45: Steel Plate Response to 3.75 Inch Hemispherical Tup in Test Number 45



IMPACT SIDE



BOTTOM SIDE

Figure B46: Steel Plate Response to 3.75 Inch Hemispherical Tup in Test Number 46



IMPACT SIDE

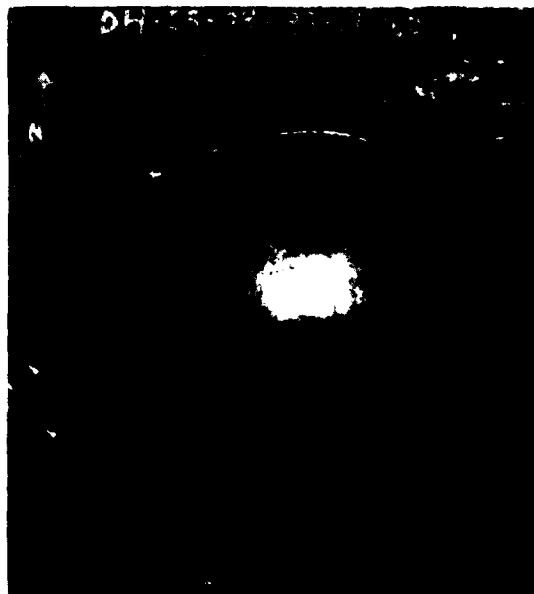

BOTTOM SIDE

Figure B47: Steel Plate Response to 3.75 Inch Hemispherical Tup in Test Number 47



IMPACT SIDE

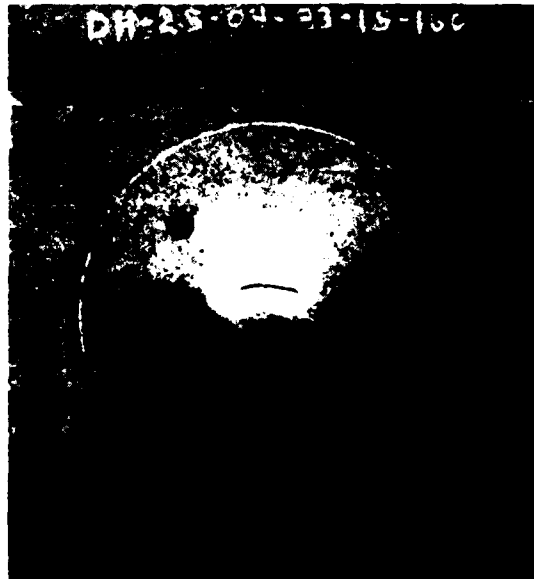

BOTTOM SIDE

Figure B48: Steel Plate Response to 3.75 Inch Hemispherical Tup in Test Number 48



IMPACT SIDE

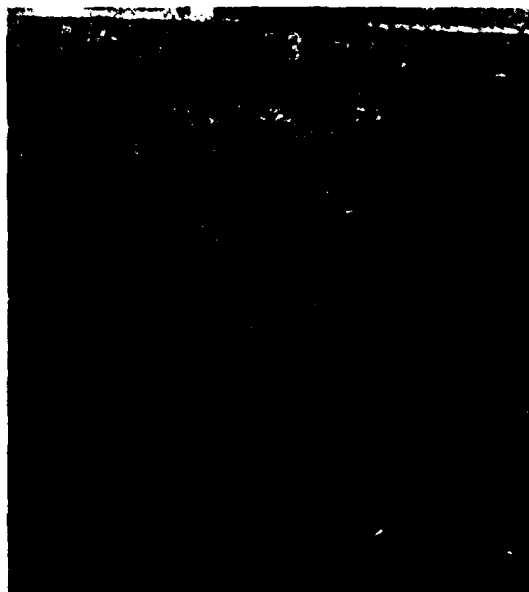

BOTTOM SIDE

Figure B49: Steel Plate Response to 2 Inch Hemispherical Tup in Test Number 49



IMPACT SIDE



BOTTOM SIDE

Figure B50: Steel Plate Response to 2 Inch Hemispherical Tup in Test Number 50

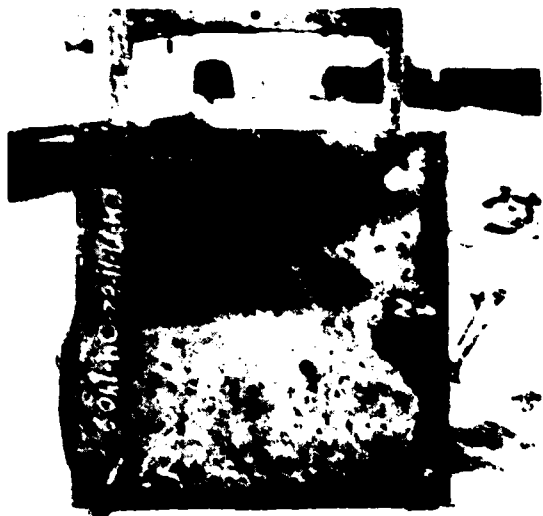

IMPACT SIDE

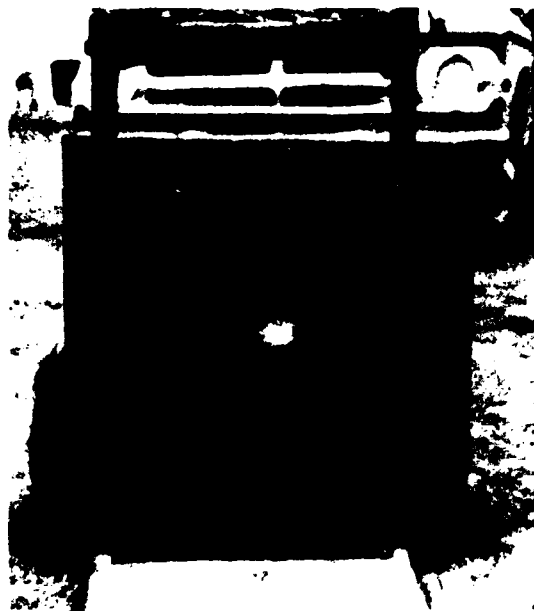

BOTTOM SIDE

Figure B51: Steel Plate Response to 2 Inch Hemispherical Tup in Test Number 51

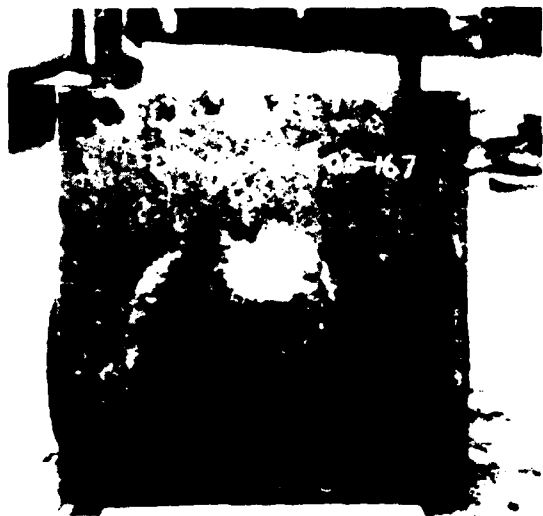

IMPACT SIDE



BOTTOM SIDE

Figure B52: Steel Plate Response to 2 Inch Hemispherical Tup in Test Number 52

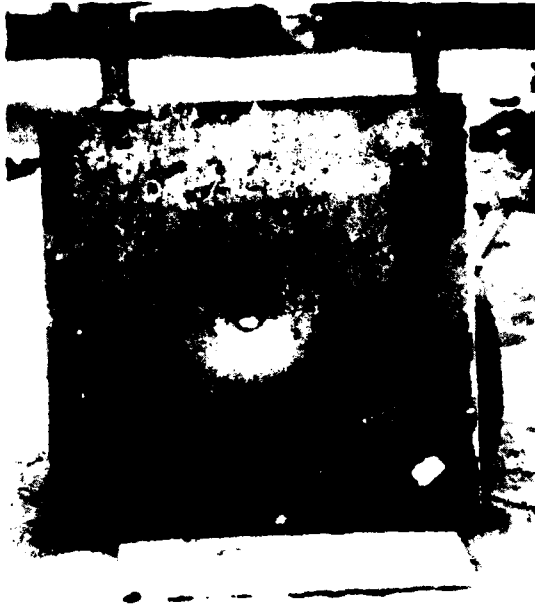

IMPACT SIDE



BOTTOM SIDE

Figure B53: Steel Plate Response to 2 Inch Hemispherical Tup in Test Number 53



IMPACT SIDE



BOTTOM SIDE

Figure B54: Steel Plate Response to 2 Inch Hemispherical Tup in Test Number 54



DH-17-4-82 11-167

IMPACT SIDE

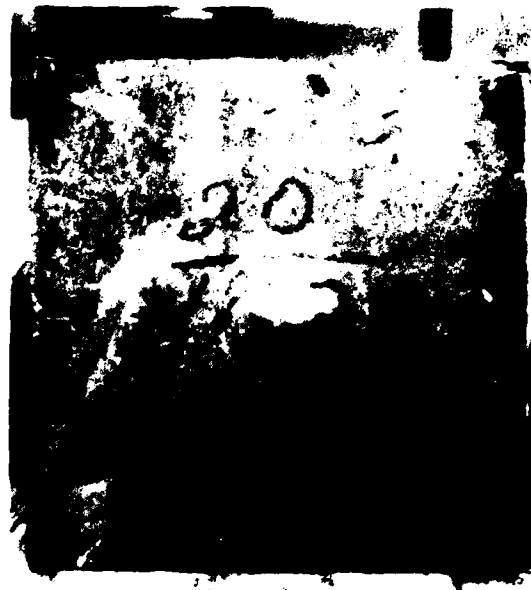

BOTTOM SIDE

Figure B55: Steel Plate Response to 2 Inch Hemispherical Tup in Test Number 55



IMPACT SIDE



BOTTOM SIDE

Figure B56: Steel Plate Response to 2 Inch Hemispherical Tup in Test Number 56



IMPACT SIDE

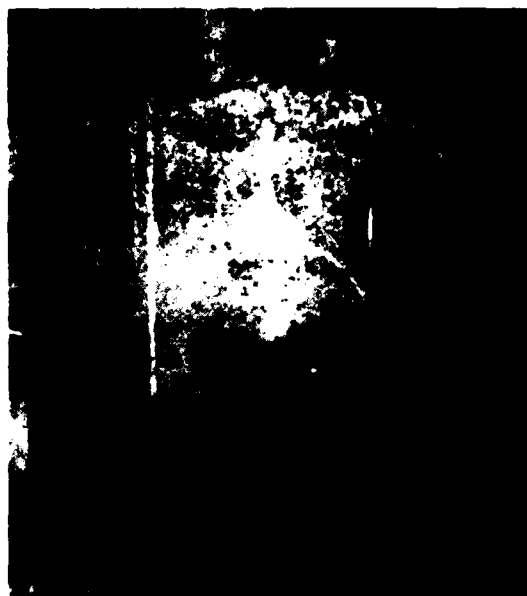

BOTTOM SIDE

Figure B57: Steel Plate Response to 2 Inch Hemispherical Tup in Test Number 57

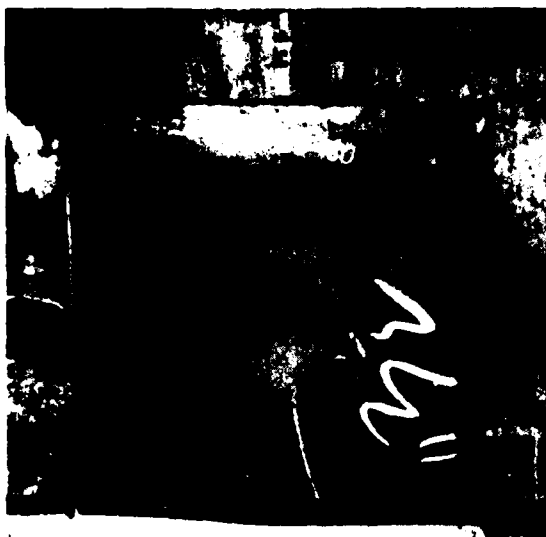

IMPACT SIDE

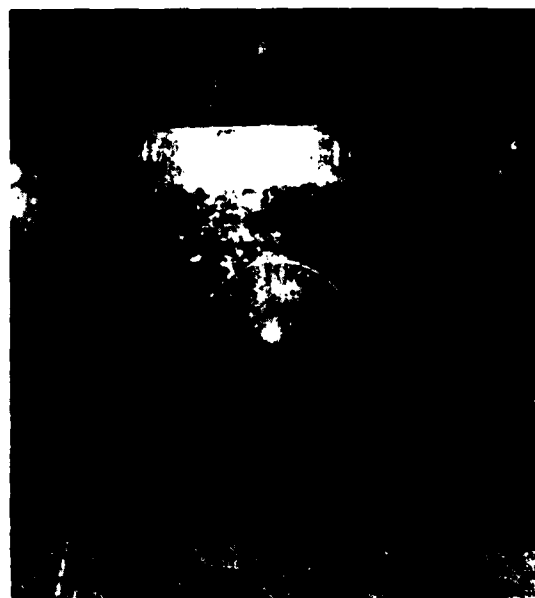

BOTTOM SIDE

Figure B58: Steel Plate Response to 2 Inch Hemispherical Tup in Test Number 58

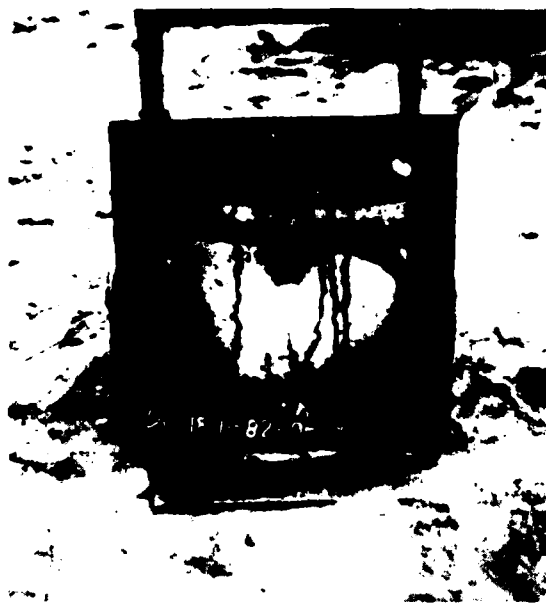

IMPACT SIDE



BOTTOM SIDE

Figure B59: Steel Plate Response to 2 Inch Hemispherical Tup in Test Number 59

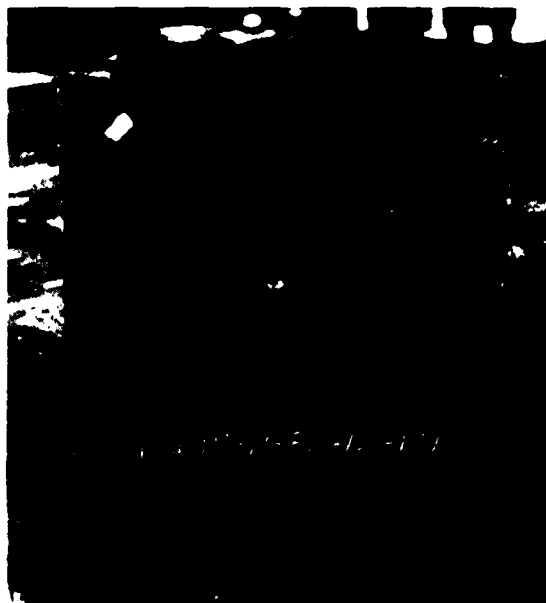

IMPACT SIDE



BOTTOM SIDE

Figure B60: Steel Plate Response to 2 Inch Hemispherical Tup in Test Number 60



IMPACT SIDE

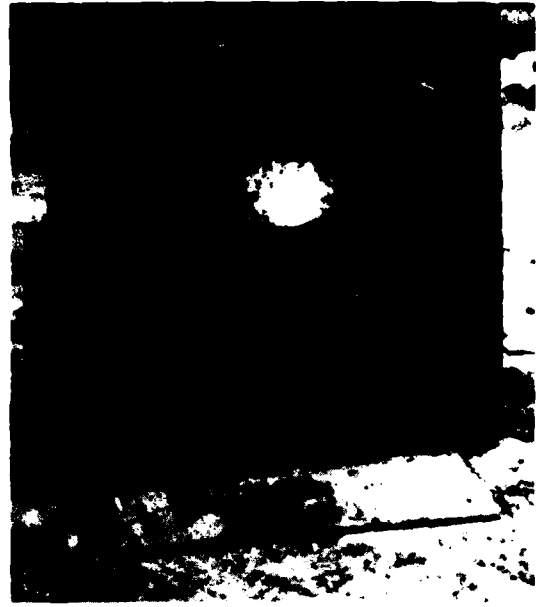

HEMISPHERICAL

Figure B61: Steel Plate Response to 2 Inch Hemispherical Tup in Test Number 61



IMPACT SIDE

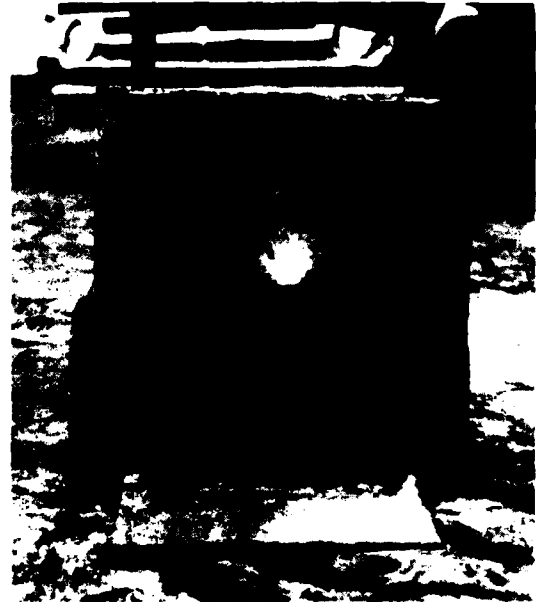

BOTTOM SIDE

Figure B62: Steel Plate Response to 2 Inch Hemispherical Tup in Test Number 62



IMPACT SIDE



BOTTOM SIDE

Figure B63: Steel Plate Response to 2 Inch Hemispherical Tup in Test Number 63



IMPACT SIDE



BOTTOM SIDE

Figure B64: Steel Plate Response to 2 Inch Hemispherical Tup in Test Number 64



IMPACT SIDE



BOTTOM SIDE

Figure B65: Steel Plate Response to 2 Inch Hemispherical Tip in Test Number 65

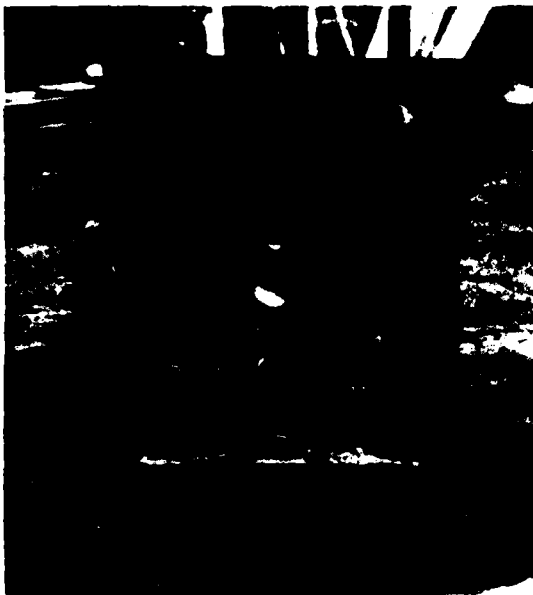

IMPACT SIDE



BOTTOM SIDE

Figure B66: Steel Plate Response to 2 Inch Hemispherical Tip in Test Number 66



IMPACT SIDE



BOTTOM SIDE

Figure 867: Steel Plate Response to 2 Inch Hemispherical Tip in Test Number 67



IMPACT SIDE



BOTTOM SIDE

Figure 868: Steel Plate Response to 2 Inch Hemispherical Tip in Test Number 68



IMPACT SIDE



BOTTOM SIDE

Figure B69: Steel Plate Response to 2 Inch Hemispherical Tup in Test Number 69



IMPACT SIDE

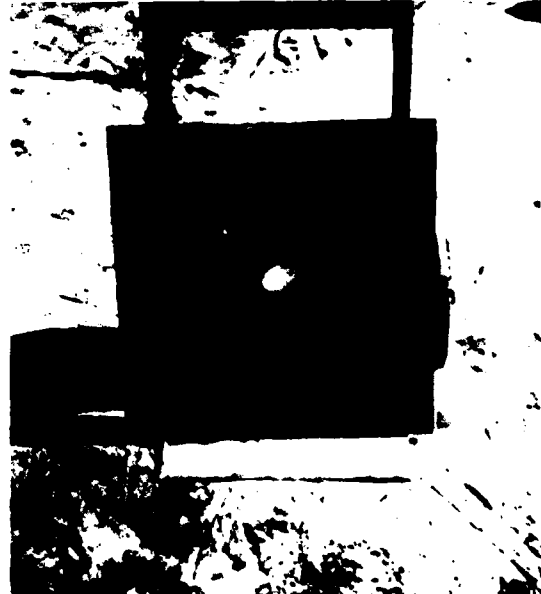

BOTTOM SIDE

Figure B70: Steel Plate Response to 2 Inch Hemispherical Tup in Test Number 70

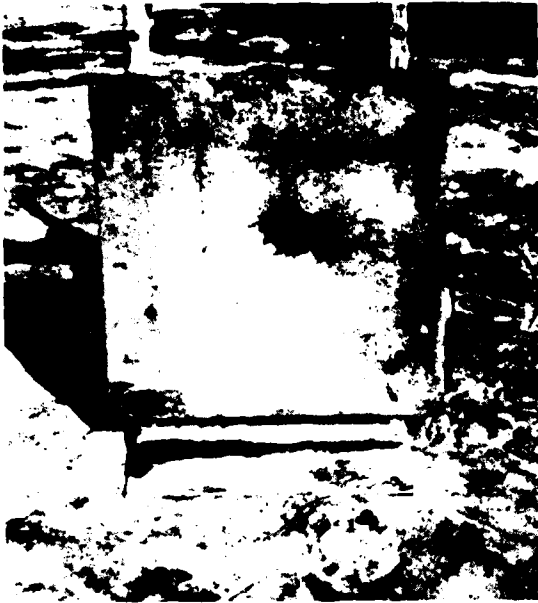

IMPACT SIDE



BOTTOM SIDE

Figure B71: Steel Plate Response to 2 Inch Hemispherical Tup in Test Number 71



IMPACT SIDE

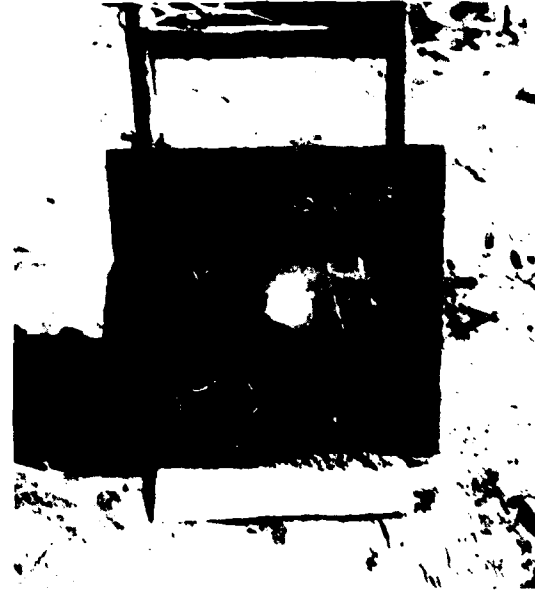

BOTTOM SIDE

Figure B72: Steel Plate Response to 2 Inch Hemispherical Tup in Test Number 72



IMPACT SIDE



BOTTOM SIDE

Figure B73: Steel Plate Response to 2 Inch Hemispherical Tup in Test Number 73

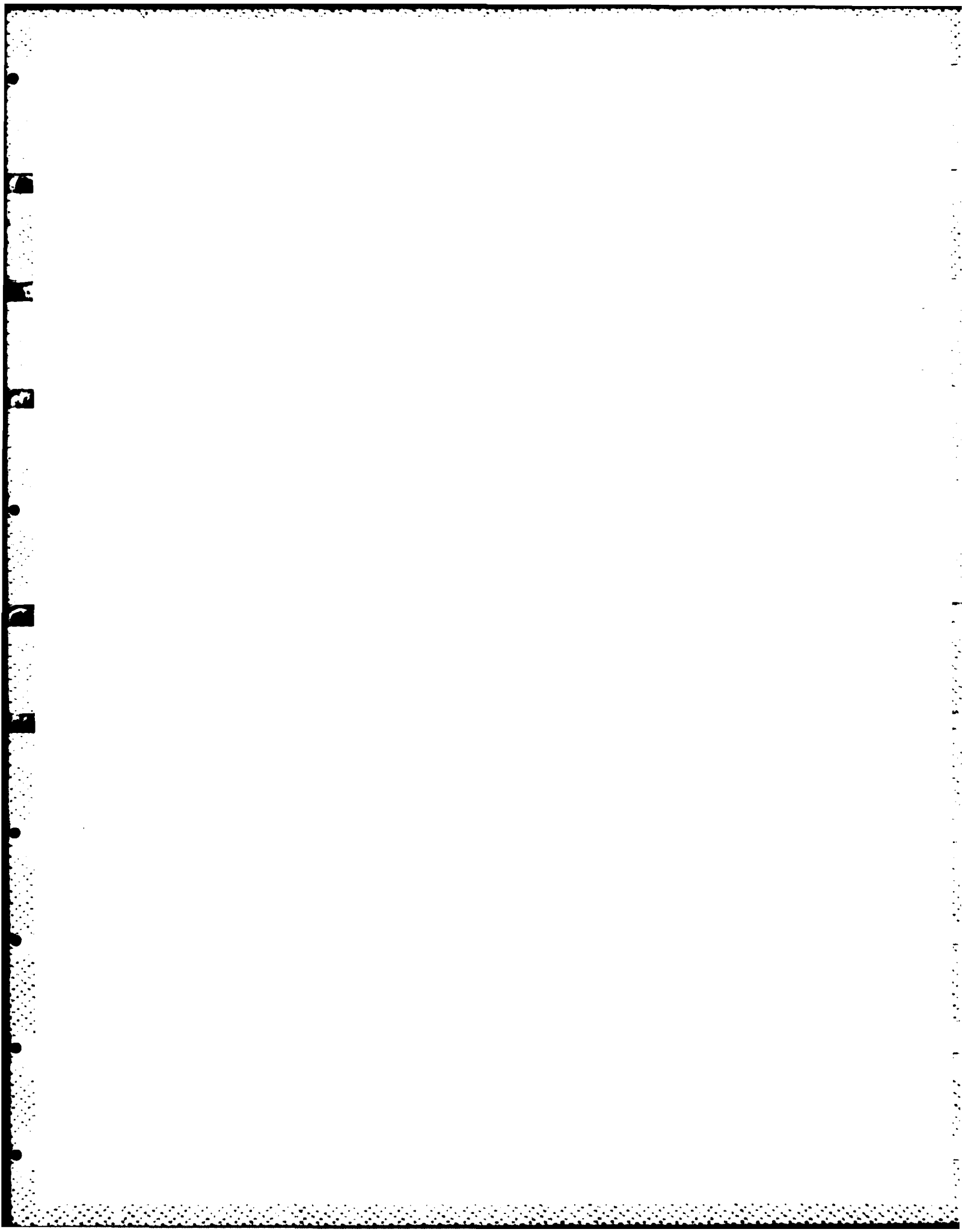

APPENDIX C
DIAL MICROMETER MEASUREMENTS OF DENT DEPTHS

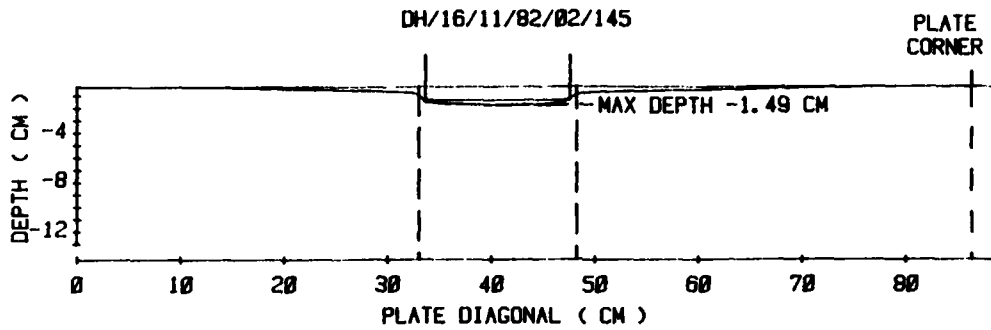

Figure C1: Dial Micrometer Measurements of Dent Depths for Test Number 1

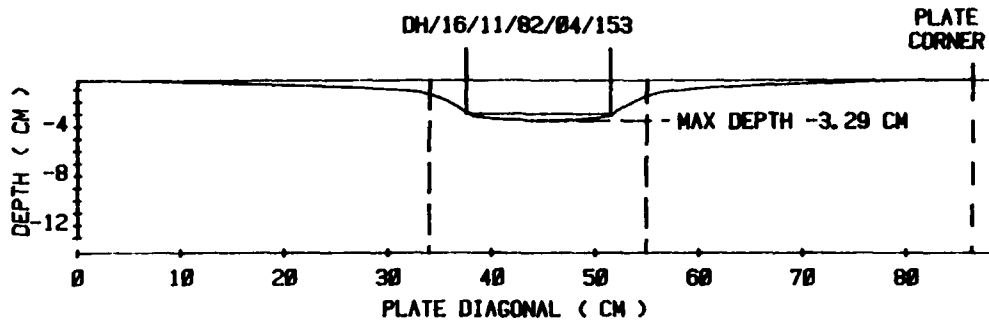

Figure C2: Dial Micrometer Measurements of Dent Depths for Test Number 4

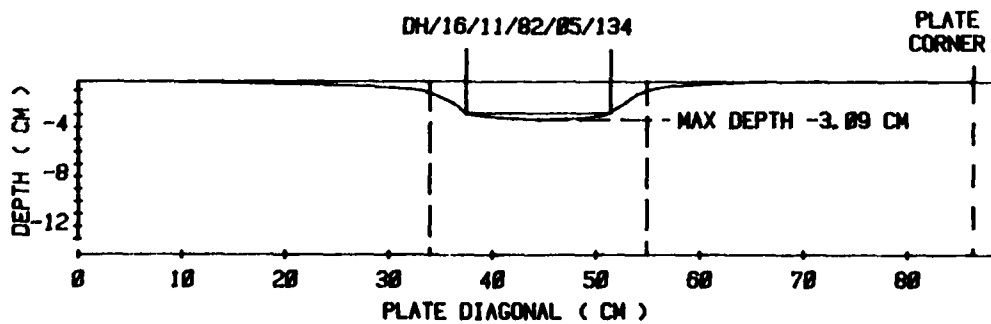

Figure C3: Dial Micrometer Measurements of Dent Depths for Test Number 5

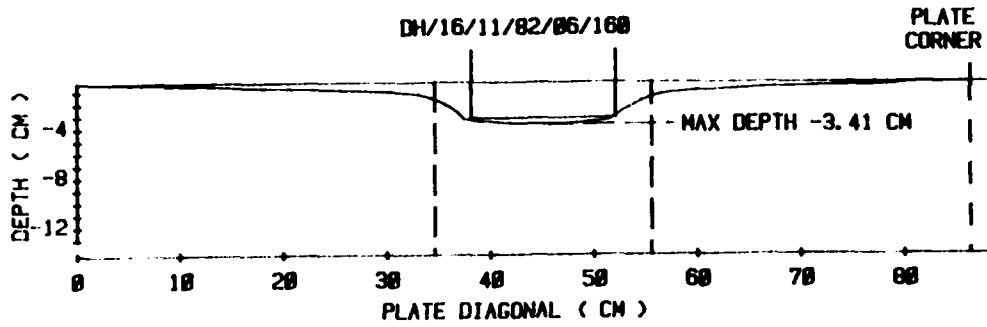

Figure C4: Dial Micrometer Measurements of Dent Depths for Test Number 6

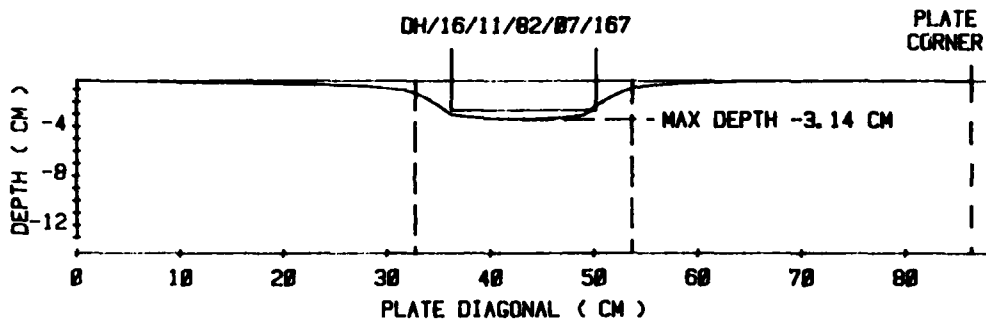

Figure C5: Dial Micrometer Measurements of Dent Depths for Test Number 7

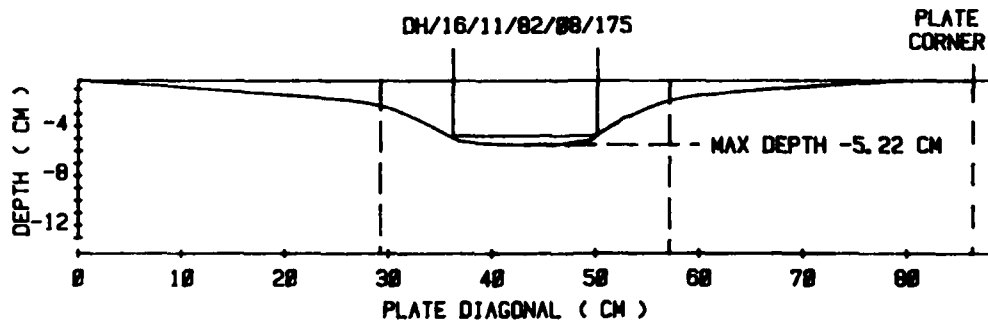

Figure C6: Dial Micrometer Measurements of Dent Depths for Test Number 8

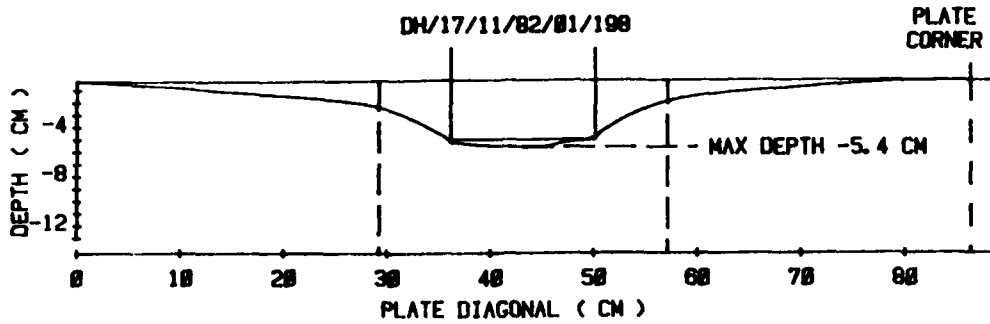

Figure C7: Dial Micrometer Measurements of Dent Depths for Test Number 9

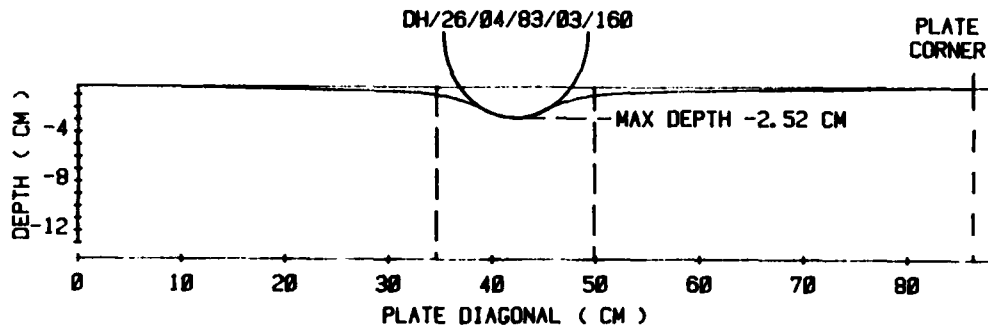

Figure C8: Dial Micrometer Measurements of Dent Depths for Test Number 10

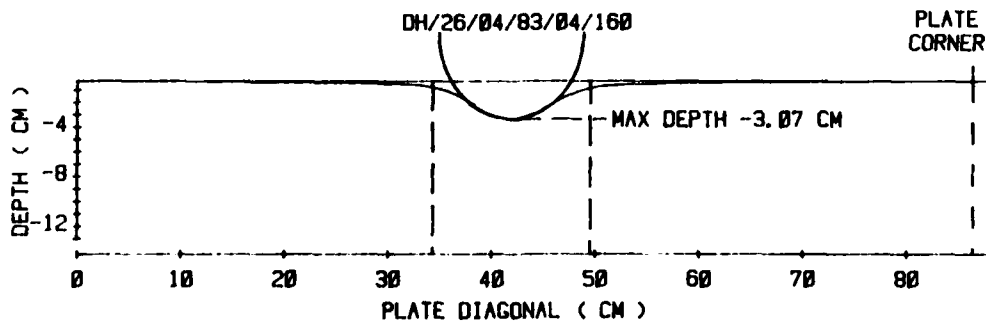

Figure C9: Dial Micrometer Measurements of Dent Depths for Test Number 11

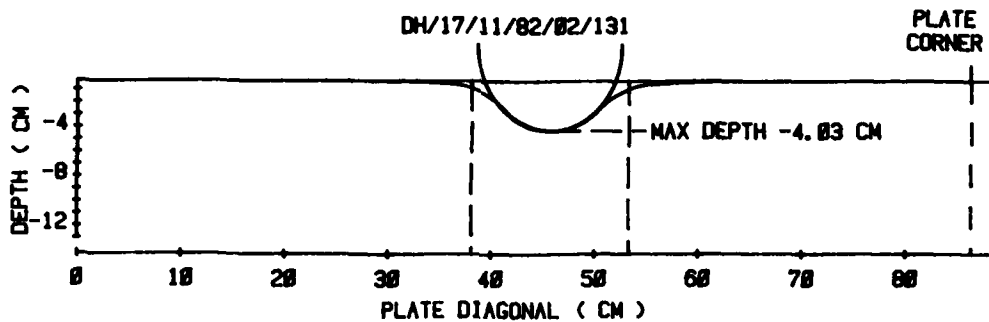

Figure C10: Dial Micrometer Measurements of Dent Depths for Test Number 12

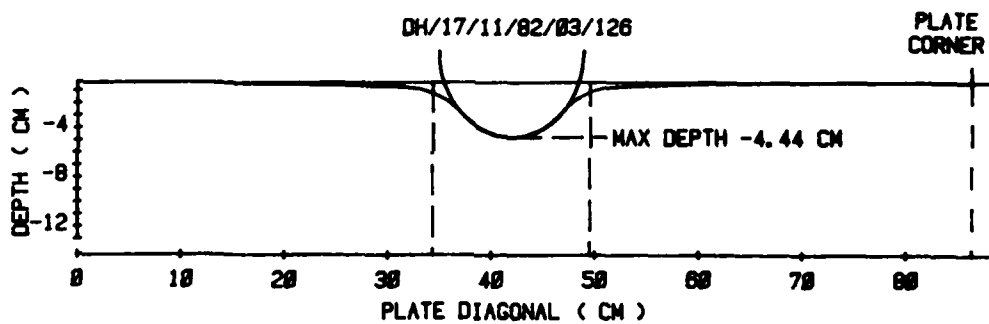

Figure C11: Dial Micrometer Measurements of Dent Depths for Test Number 13

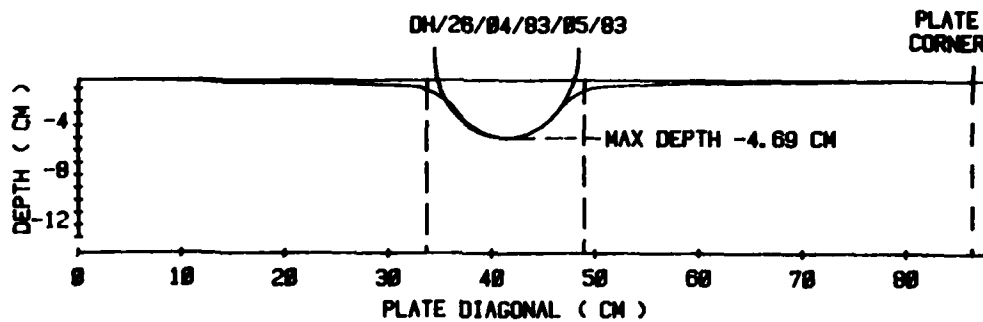

Figure C12: Dial Micrometer Measurements of Dent Depths for Test Number 14

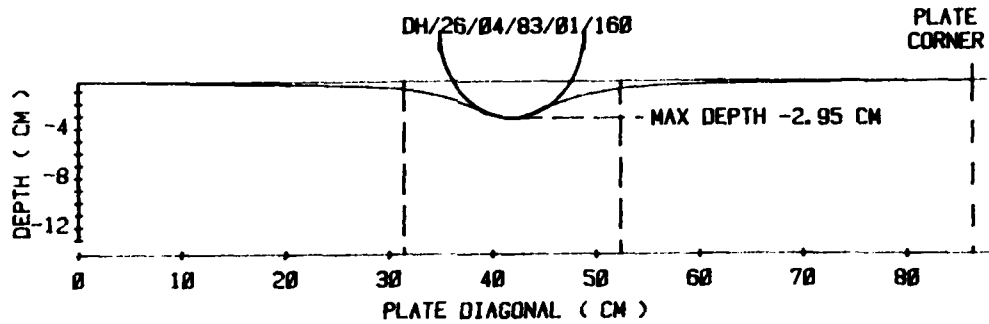

Figure C13: Dial Micrometer Measurements of Dent Depths for Test Number 16

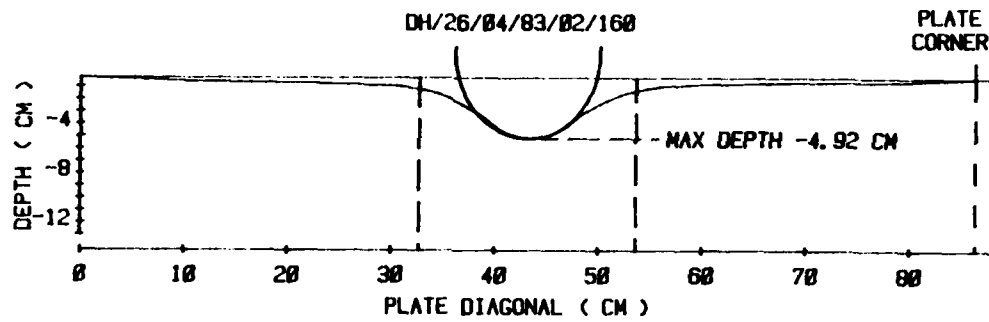

Figure C14: Dial Micrometer Measurements of Dent Depths for Test Number 17

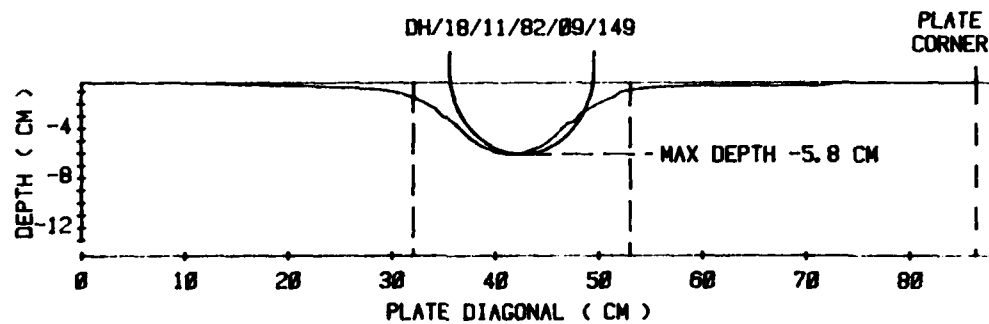

Figure C15: Dial Micrometer Measurements of Dent Depths for Test Number 18

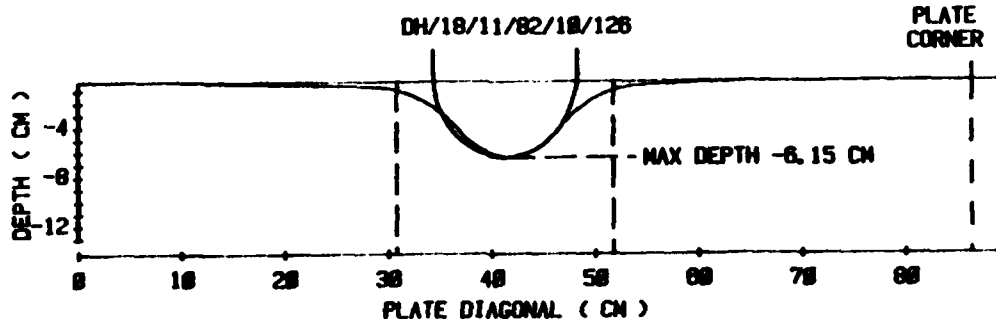

Figure C16: Dial Micrometer Measurements of Dent Depths for Test Number 19

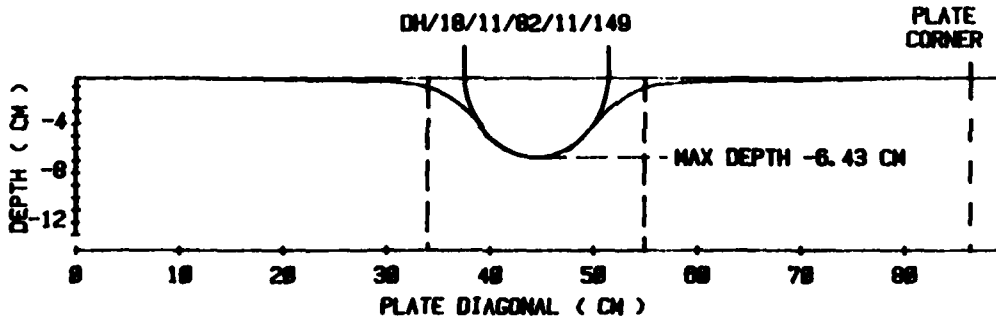

Figure C17: Dial Micrometer Measurements of Dent Depths for Test Number 20

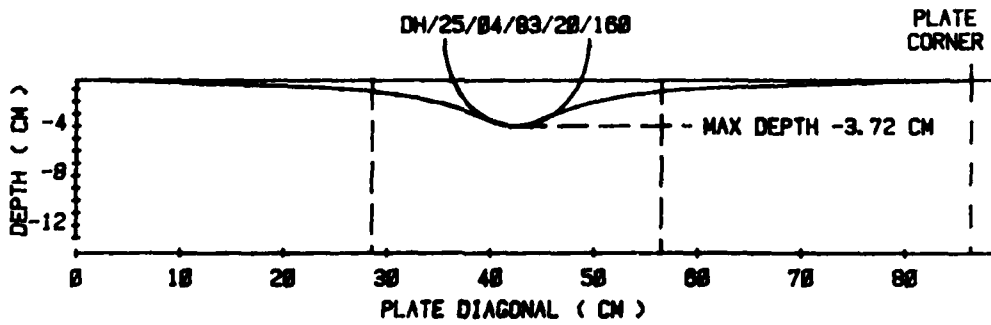

Figure C18: Dial Micrometer Measurements of Dent Depths for Test Number 22

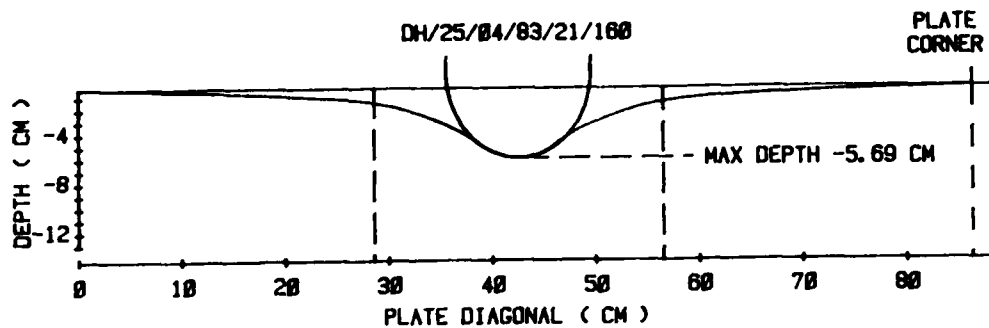

Figure C19: Dial Micrometer Measurements of Dent Depths for Test Number 23

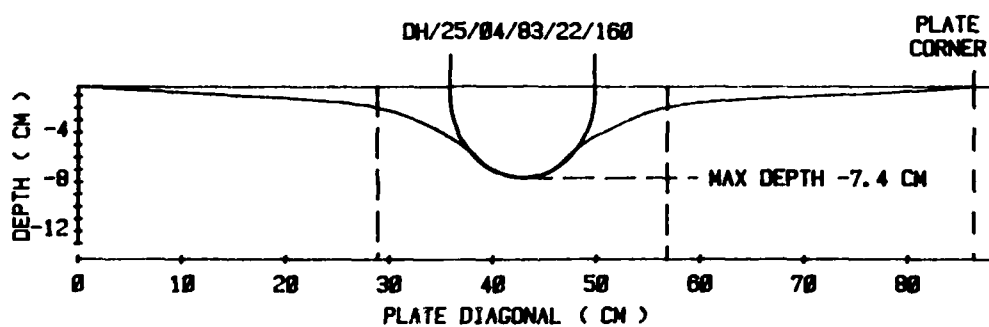

Figure C20: Dial Micrometer Measurements of Dent Depths for Test Number 24

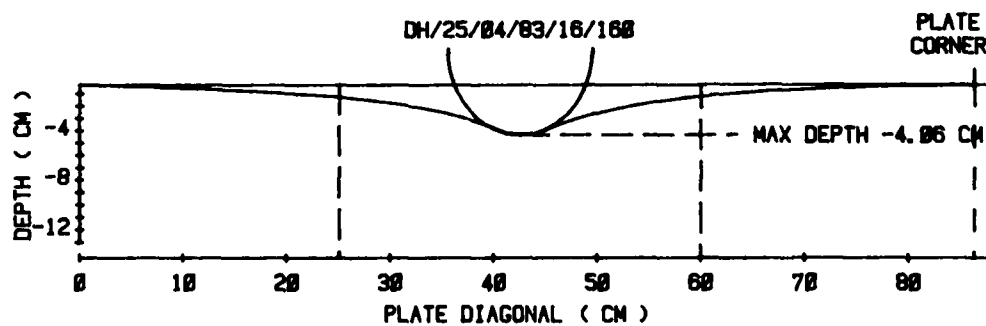

Figure C21: Dial Micrometer Measurements of Dent Depths for Test Number 26

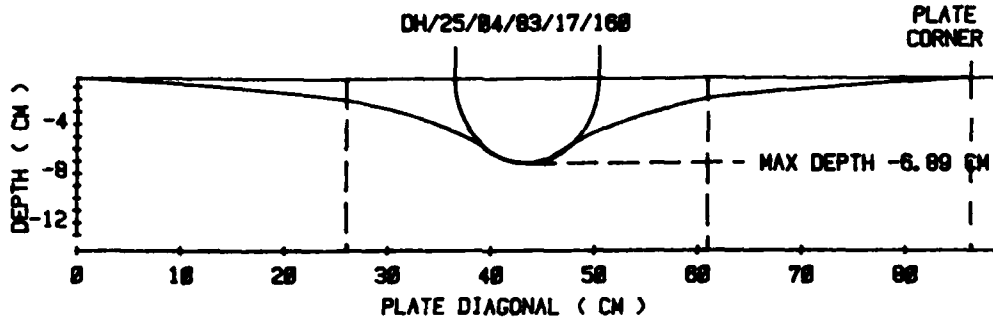

Figure C22: Dial Micrometer Measurements of Dent Depths for Test Number 27

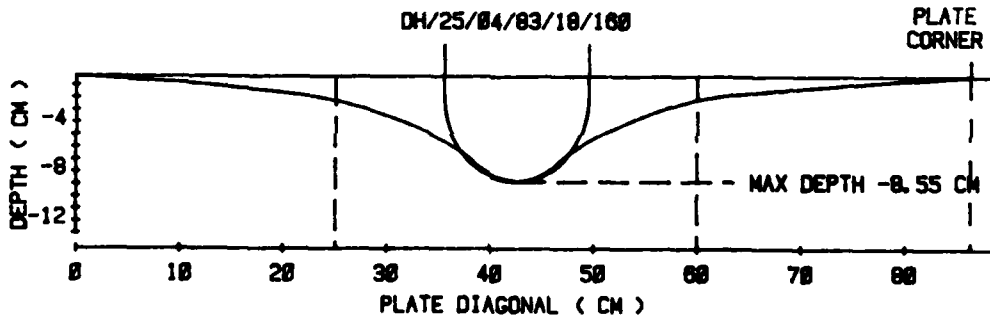

Figure C23: Dial Micrometer Measurements of Dent Depths for Test Number 28

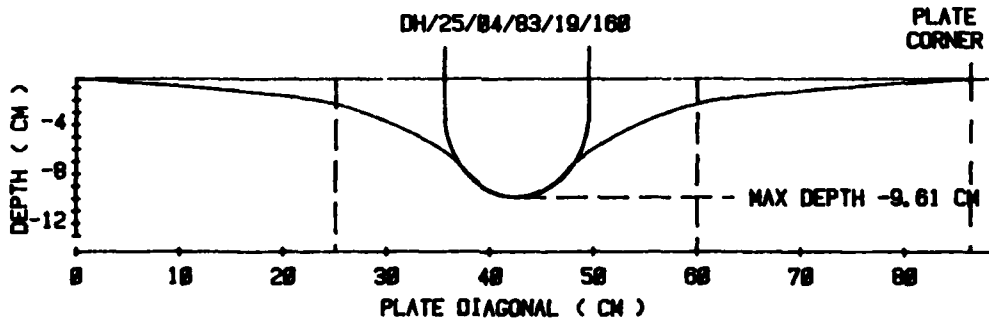

Figure C24: Dial Micrometer Measurements of Dent Depths for Test Number 29

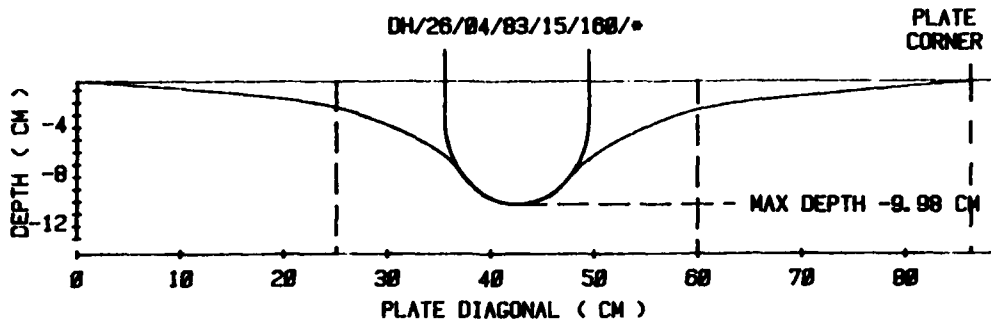

Figure C25: Dial Micrometer Measurements of Dent Depths for Test Number 30

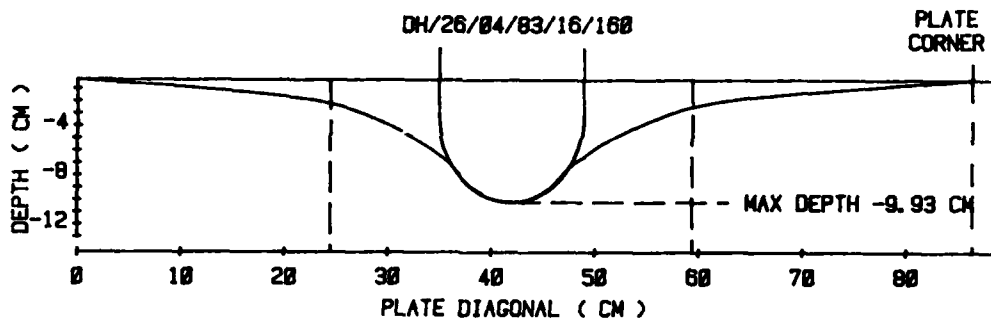

Figure C26: Dial Micrometer Measurements of Dent Depths for Test Number 31

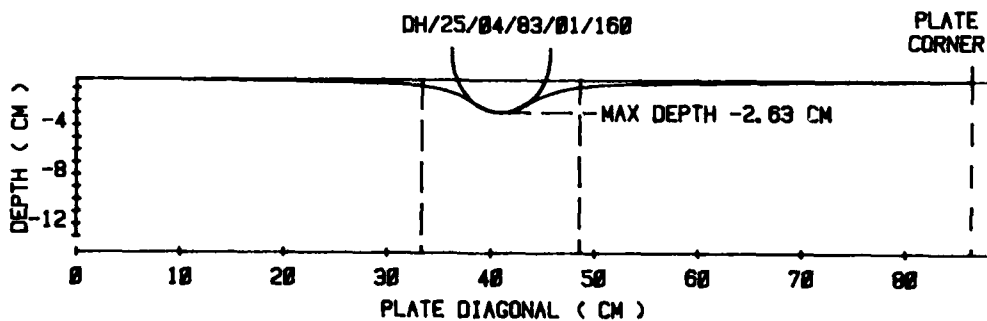

Figure C27: Dial Micrometer Measurements of Dent Depths for Test Number 34

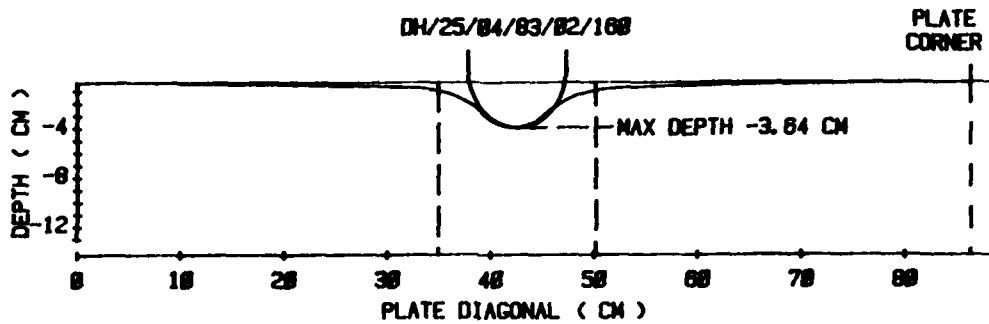

Figure C28: Dial Micrometer Measurements of Dent Depths for Test Number 35

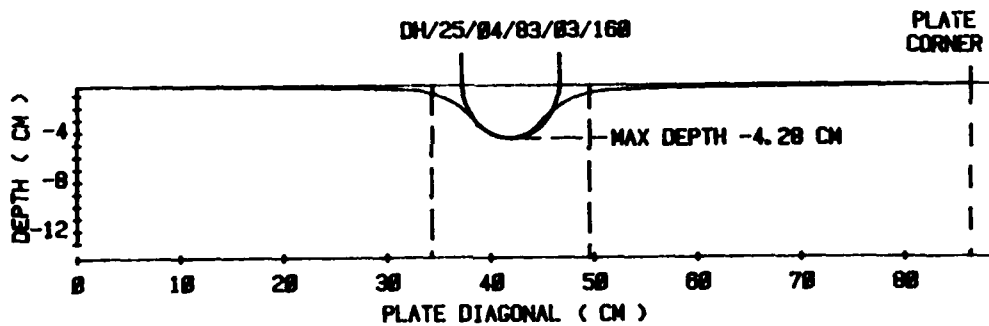

Figure C29: Dial Micrometer Measurements of Dent Depths for Test Number 36

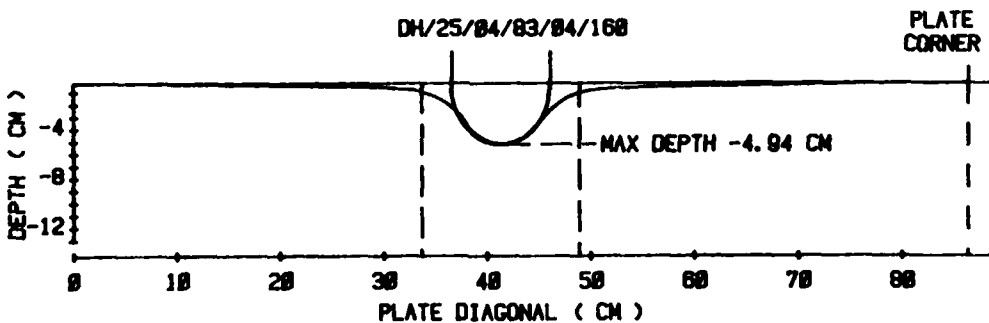

Figure C30: Dial Micrometer Measurements of Dent Depths for Test Number 37

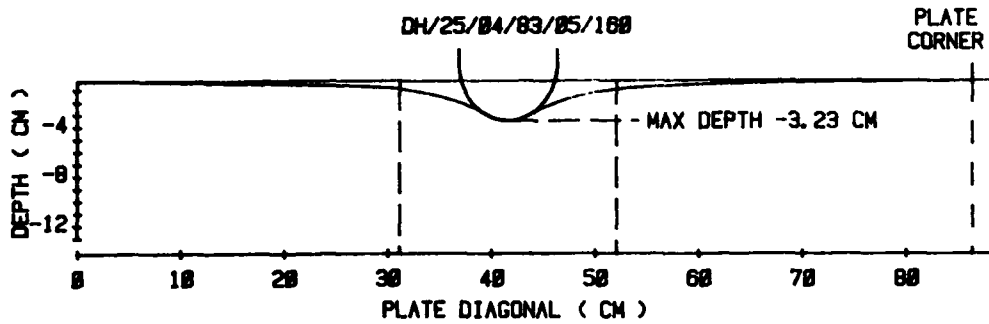

Figure C31: Dial Micrometer Measurements of Dent Depths for Test Number 38

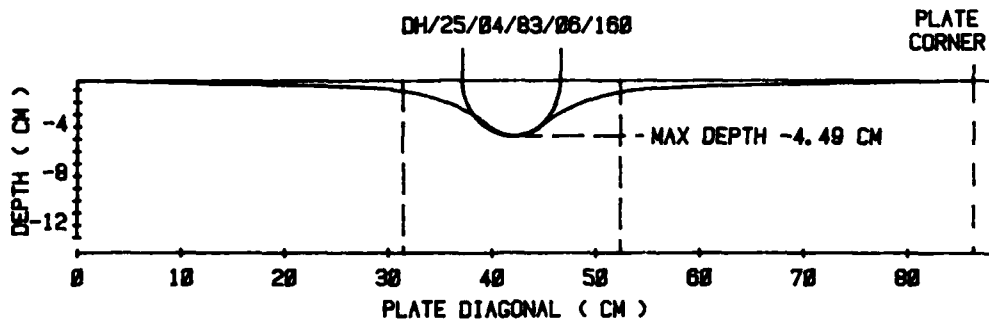

Figure C32: Dial Micrometer Measurements of Dent Depths for Test Number 39

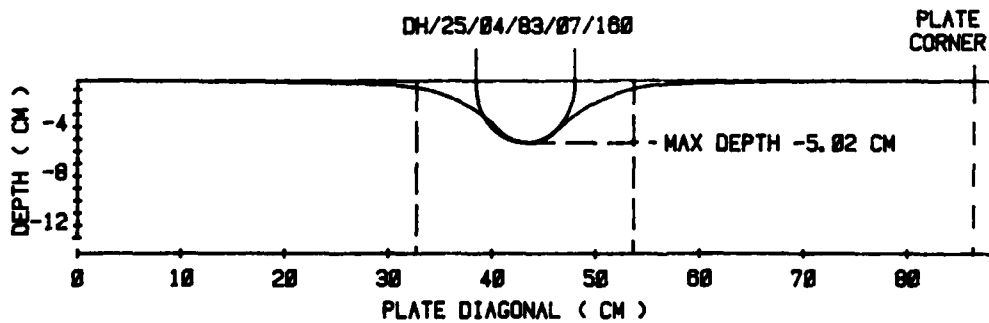

Figure C33: Dial Micrometer Measurements of Dent Depths for Test Number 40

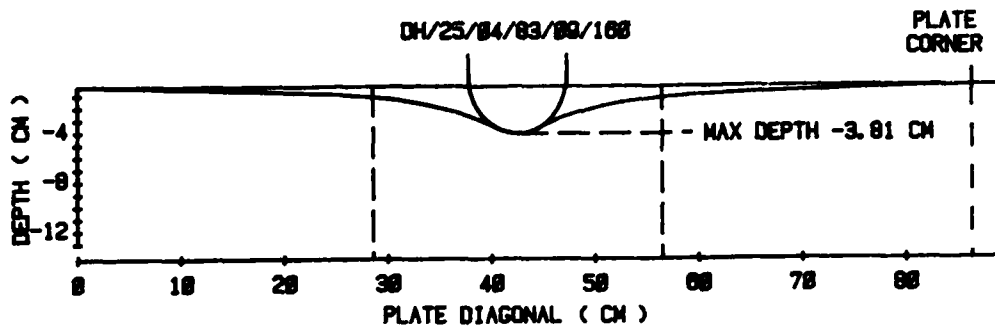

Figure C34: Dial Micrometer Measurements of Dent Depths for Test Number 42

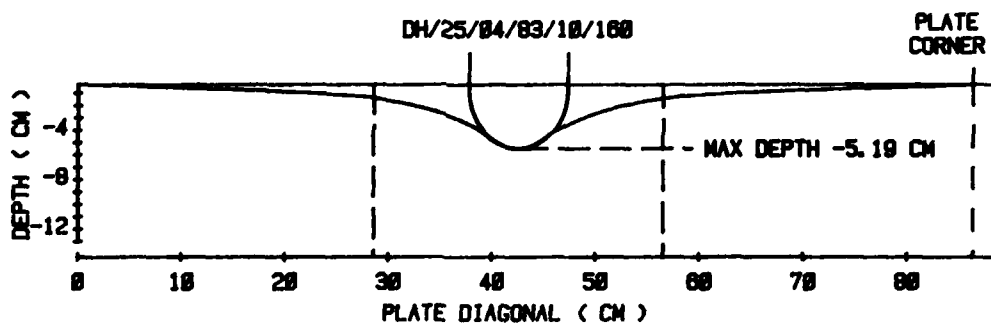

Figure C35: Dial Micrometer Measurements of Dent Depths for Test Number 43

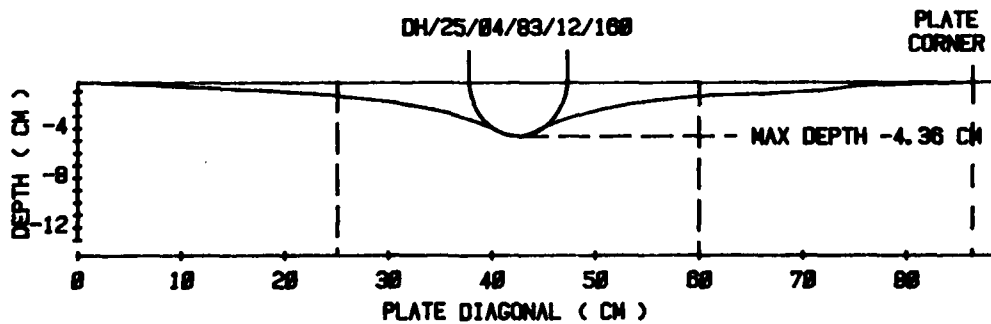

Figure C36: Dial Micrometer Measurements of Dent Depths for Test Number 45

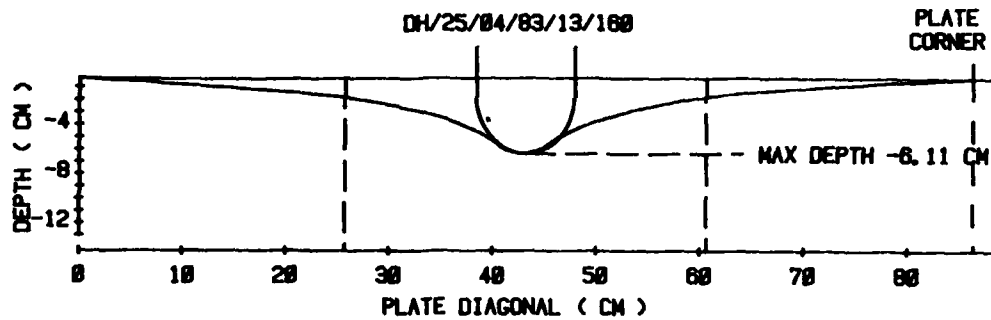

Figure C37: Dial Micrometer Measurements of Dent Depths for Test Number 46

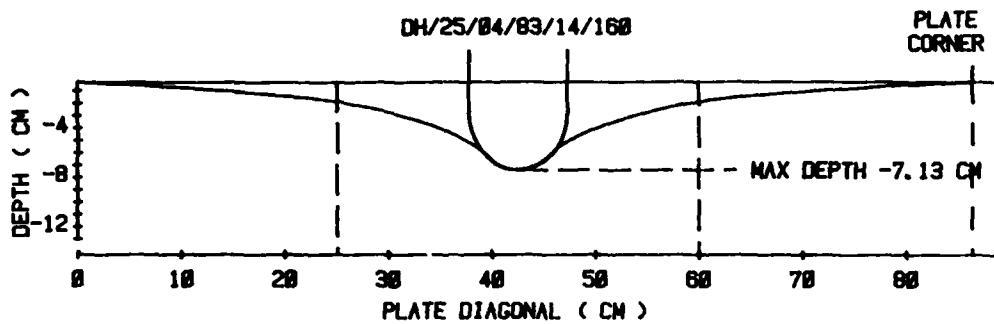

Figure C38: Dial Micrometer Measurements of Dent Depths for Test Number 47

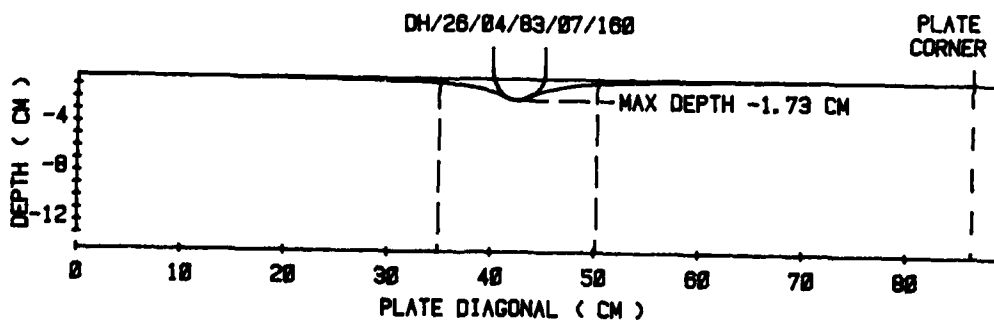

Figure C39: Dial Micrometer Measurements of Dent Depths for Test Number 49

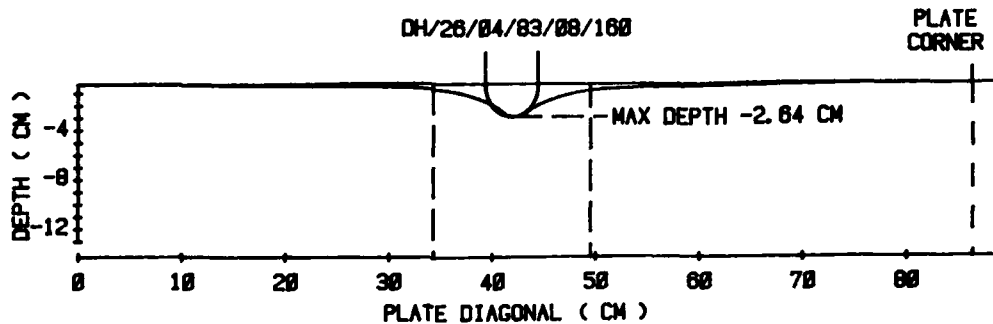

Figure C40: Dial Micrometer Measurements of Dent Depths for Test Number 50

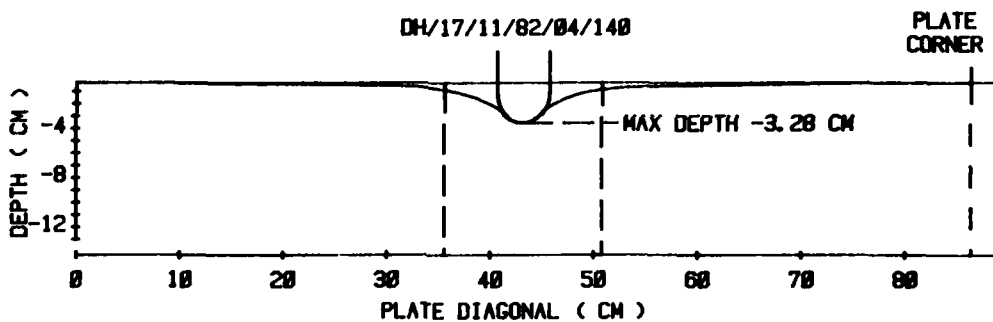

Figure C41: Dial Micrometer Measurements of Dent Depths for Test Number 51

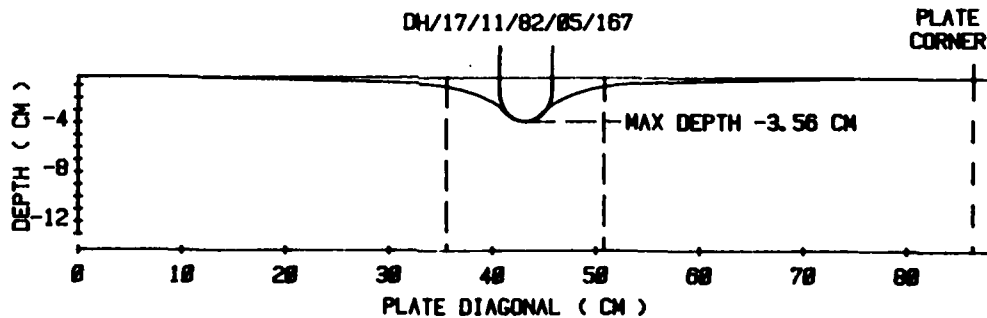

Figure C42: Dial Micrometer Measurements of Dent Depths for Test Number 52

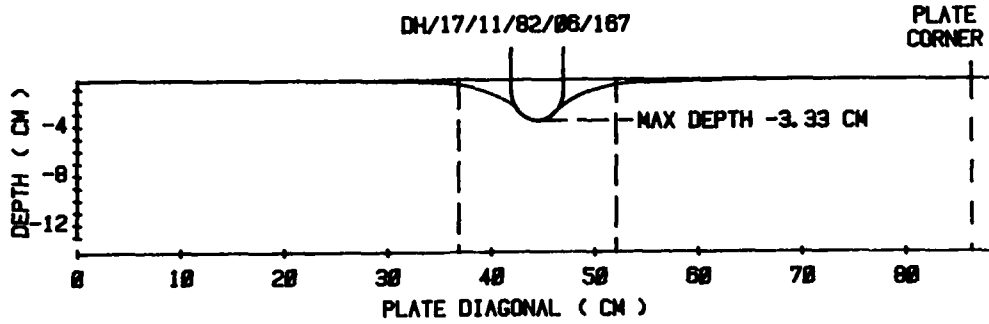

Figure C43: Dial Micrometer Measurements of Dent Depths for Test Number 53

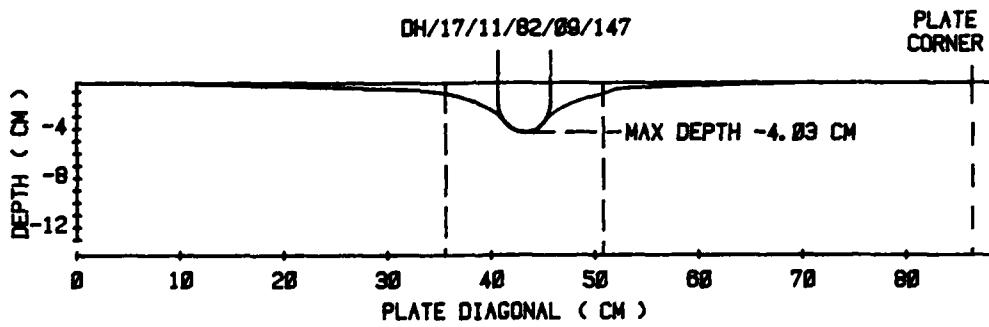

Figure C44: Dial Micrometer Measurements of Dent Depths for Test Number 54

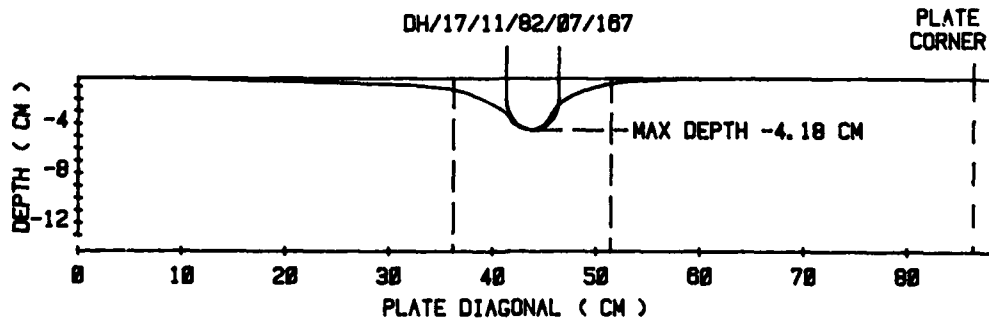

Figure C45: Dial Micrometer Measurements of Dent Depths for Test Number 55

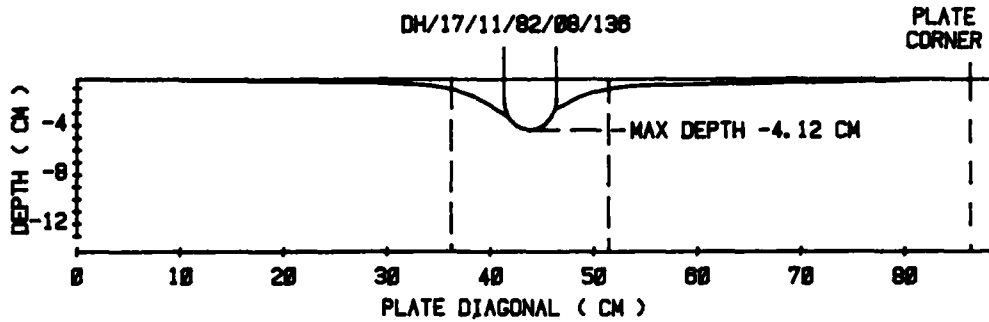

Figure C46: Dial Micrometer Measurements of Dent Depths for Test Number 56

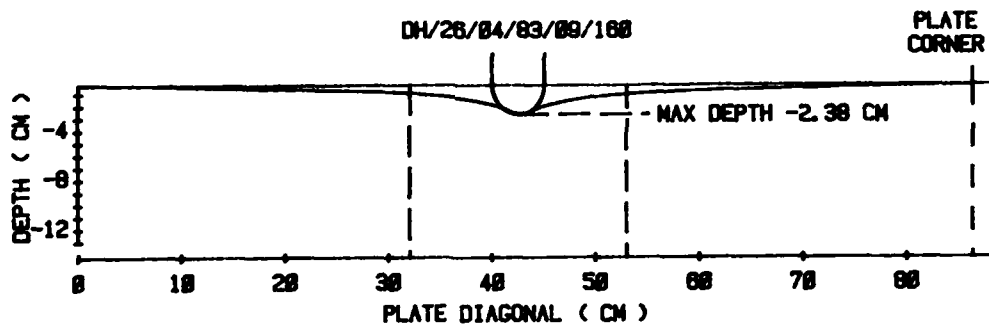

Figure C47: Dial Micrometer Measurements of Dent Depths for Test Number 57

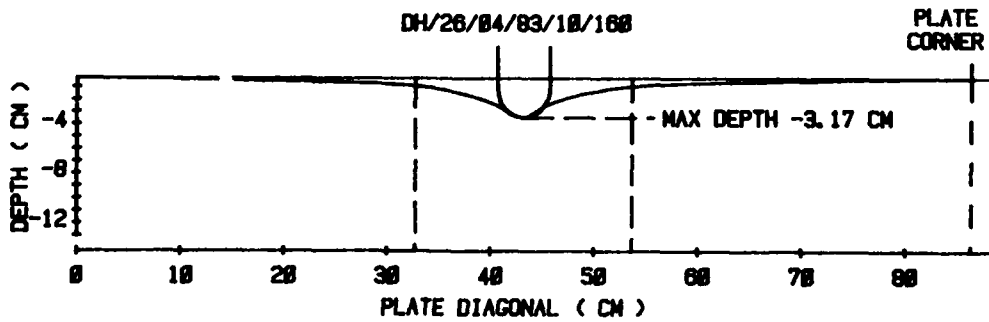

Figure C48: Dial Micrometer Measurements of Dent Depths for Test Number 58

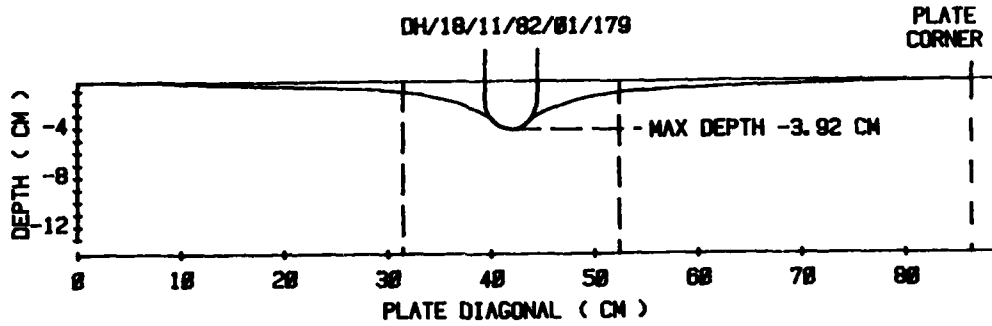

Figure C49: Dial Micrometer Measurements of Dent Depths for Test Number 59

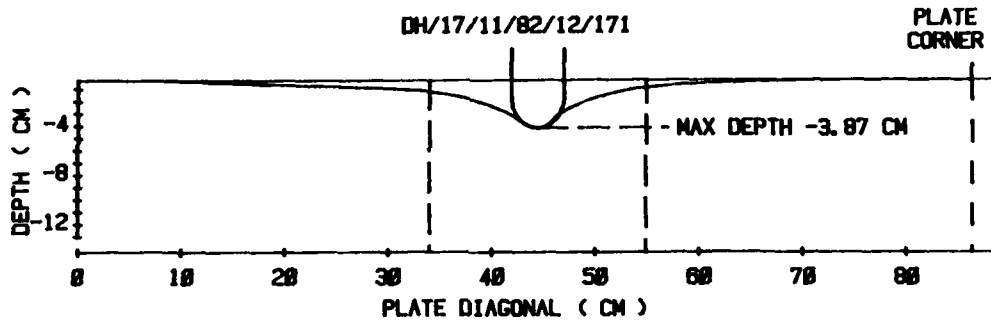

Figure C50: Dial Micrometer Measurements of Dent Depths for Test Number 60

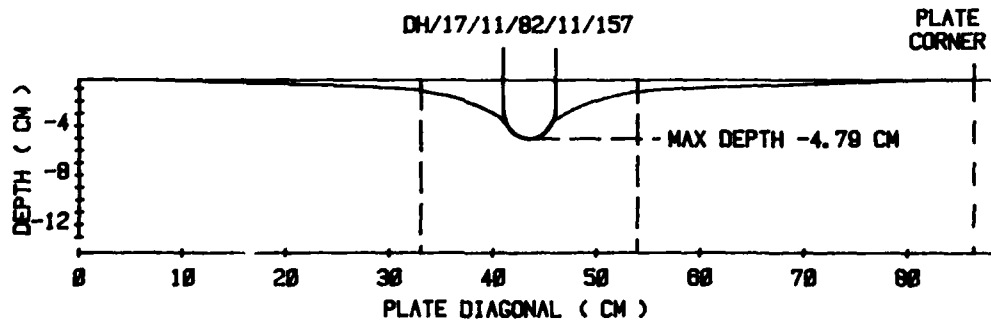

Figure C51: Dial Micrometer Measurements of Dent Depths for Test Number 61

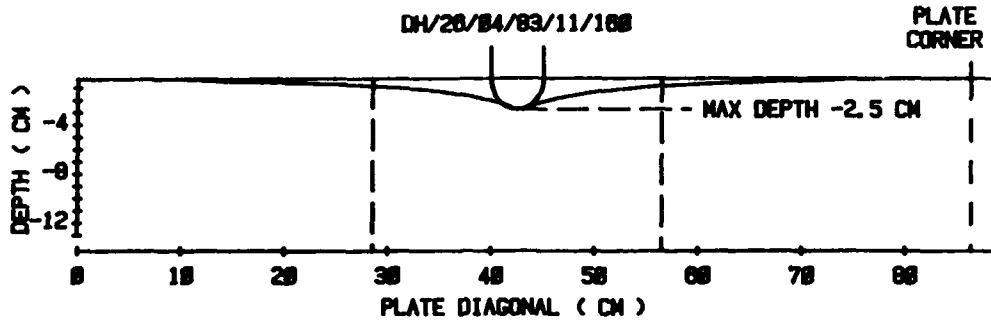

Figure C52: Dial Micrometer Measurements of Dent Depths for Test Number 63

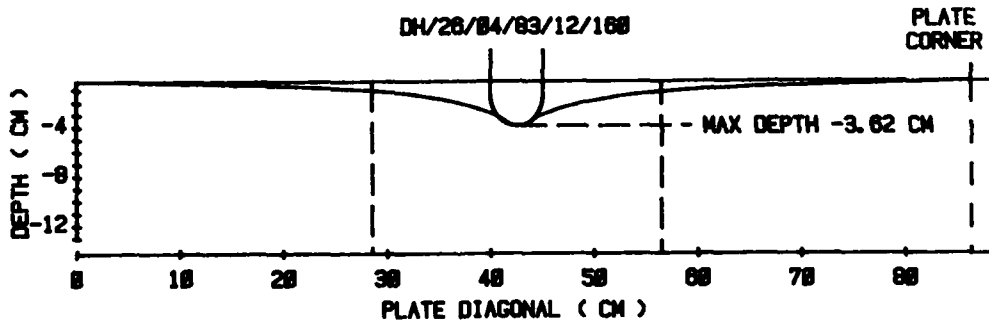

Figure C53: Dial Micrometer Measurements of Dent Depths for Test Number 64

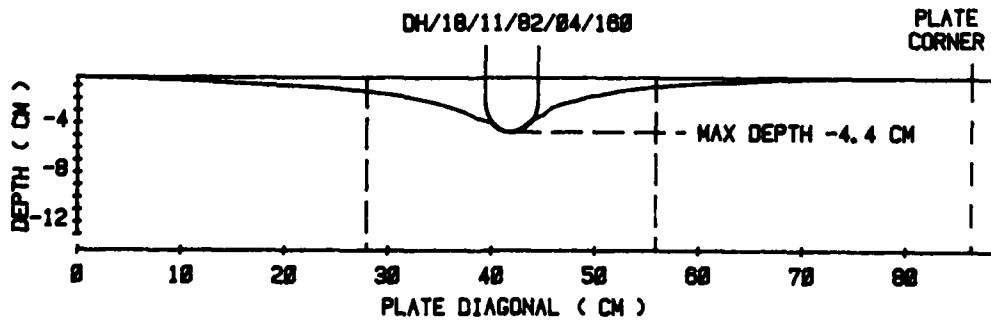

Figure C54: Dial Micrometer Measurements of Dent Depths for Test Number 65

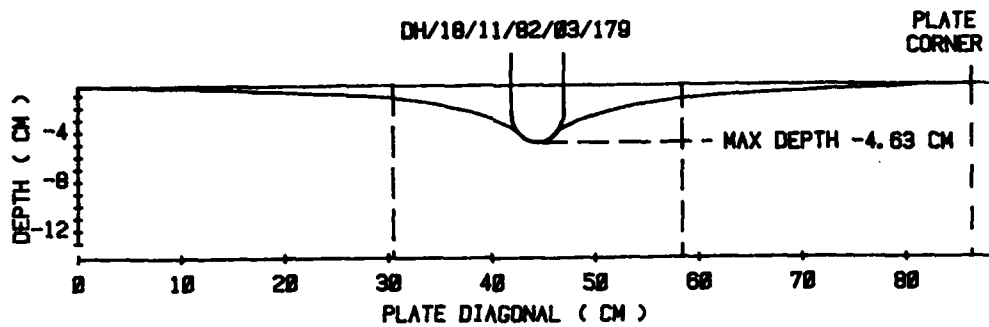

Figure C55: Dial Micrometer Measurements of Dent Depths for Test Number 66

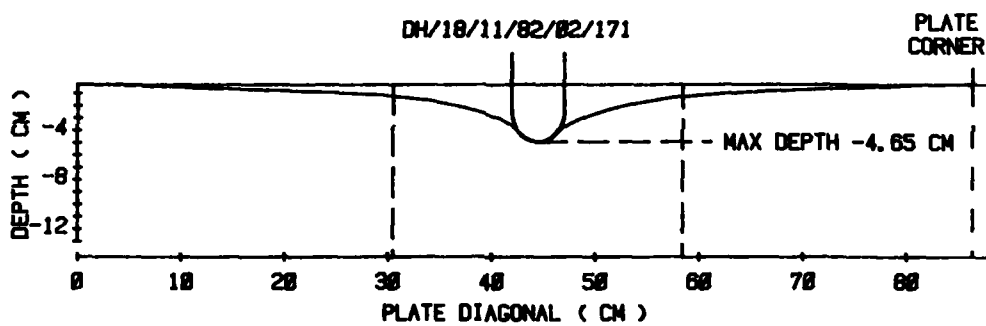

Figure C56: Dial Micrometer Measurements of Dent Depths for Test Number 67

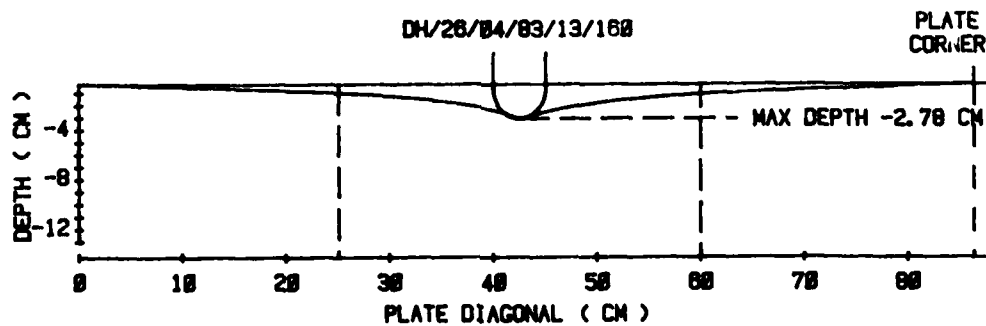

Figure C57: Dial Micrometer Measurements of Dent Depths for Test Number 68

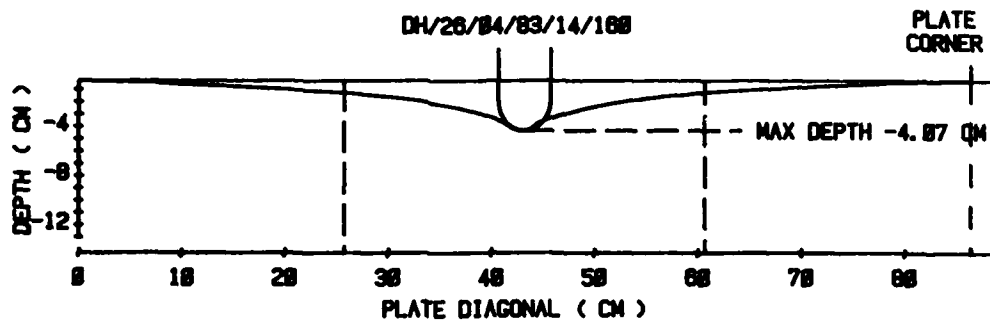

Figure C58: Dial Micrometer Measurements of Dent Depths for Test Number 69

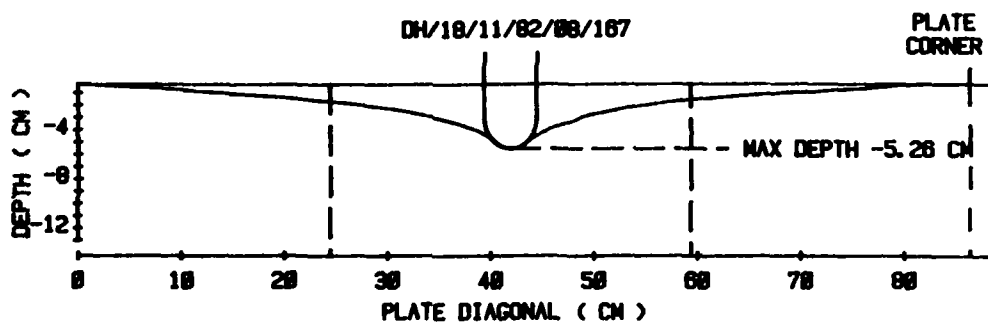

Figure C59: Dial Micrometer Measurements of Dent Depths for Test Number 70

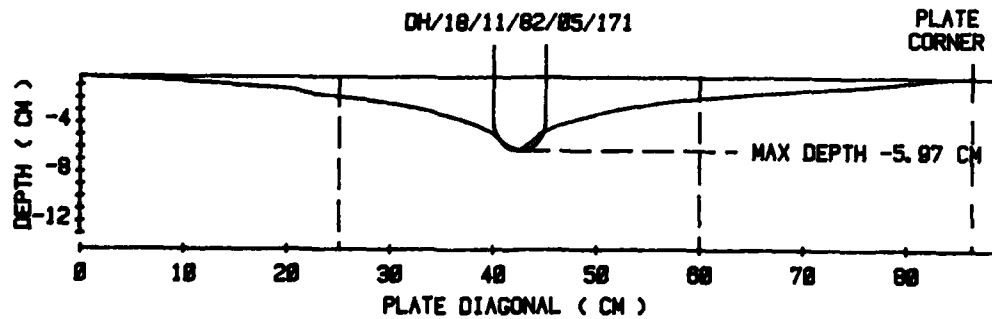

Figure C60: Dial Micrometer Measurements of Dent Depths for Test Number 71

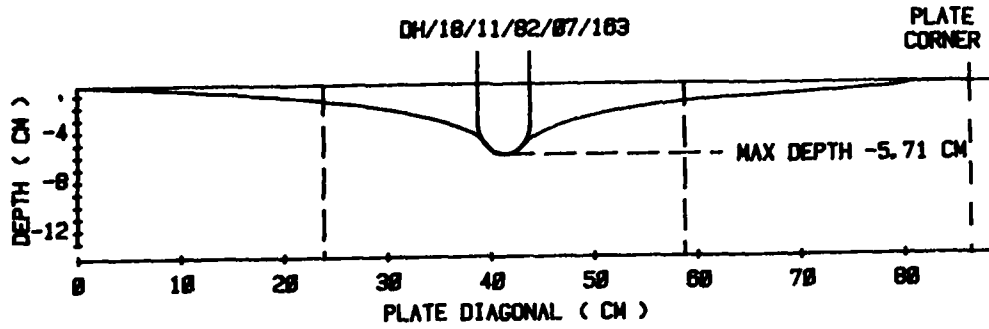

Figure C61: Dial Micrometer Measurements of Dent Depths for Test Number 72

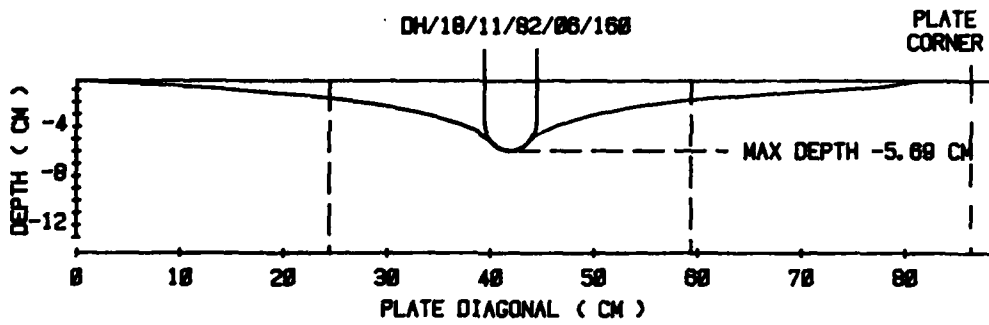

Figure C62: Dial Micrometer Measurements of Dent Depths for Test Number 73

DISTRIBUTION LIST

No. of Copies	Organization	No. of Copies	Organization
12	Commander Defense Technical Info Center ATTN: DTIC-DDA Cameron Station Alexandria, VA 22314	1	Director US Army Air Mobility Research and Development Laboratory Ames Research Center Moffett Field, CA 94035
1	Commander US Army Materiel Command ATTN: AMCDRA-ST 5001 Eisenhower Avenue Alexandria, VA 22333	1	Commander US Army Communications Research and Development Command ATTN: AMDCO-PPA-SA Fort Monmouth, NJ 07703
1	Commander Armament R&D Center US Army AMCCOM ATTN: SMCAR-TDC Dover, NJ 07801	1	Commander US Army Electronics Research and Development Command Technical Support Activity ATTN: DELSD-L Fort Monmouth, NJ 07703-5301
1	Commander Armament R&D Center US Army AMCCOM ATTN: SMCAR-TSS Dover, NJ 07801	1	Commander US Army Missile Command ATTN: AMSMI-R Redstone Arsenal, AL 35898
1	Commander US Army Armament Material Readiness Command ATTN: SMCAR-ESP-L Rock Island, IL 61299	1	Commander US Army Missile Command ATTN: AMSMI-YDL Redstone Arsenal, AL 35898
1	Director Benet Weapons Laboratory Armament R&D Center US Army AMCCOM ATTN: SMCAR-LCB-TL Watervliet, NY 12189	1	Commander US Army Tank Automotive Command ATTN: AMSTA-TSL Warren, MI 48090
1	Commander US Army Aviation Research and Development Command ATTN: AMSAV-E 4300 Goodfellow Blvd St Louis, MO 63120	1	Director US Army TRADOC Systems Analysis Activity ATTN: ATAA-SL White Sands Missile Range, NM 88002

DISTRIBUTION LIST

No. of Copies	Organization	No. of Copies	Organization
1	HQDA DAMA-ART-M Washington, DC 20310		<u>Aberdeen Proving Ground</u>
1	Commander US Army Communications Rsch and Development Command ATTN: AMSEL-ATDD Fort Monmouth, NJ 07703		Dir, USAMSAA ATTN: AMXSU-D AMXSU-MP, H. Cohen
1	Commandant US Army Infantry School ATTN: ATSH-CD-CS0-OR Fort Benning, GA 31905		Cdr, USATECOM ATTN: AMSTE-TO-F Cdr, CRDC, AMCCOM ATTN: SMCCR-RSP-A SMCCR-MU SMCCR-SPS-IL
1	Commander US Army Development & Employment Agency ATTN: MODE-TED-SAB Fort Lewis, WA 98433		
1	AFWL/SUL Kirtland AFB, NM 87117		
10	Federal Railroad Administration Rail Vehicle Safety Res Div ATTN: Ms. Claire L. Orth (COTR) Room 5423 400 Seventh Street, S.W. Washington, DC 20590		
3	EG&G Idaho, Inc. Idaho National Engineering Lab. ATTN: Dr. James A. Seydel Post Office Box 1625 Idaho Falls, ID 83415		
1	Air Force Armament Laboratory ATTN: AFATL/DL0DL Eglin AFB, FL 32542-5000		

USER EVALUATION SHEET/CHANGE OF ADDRESS

This Laboratory undertakes a continuing effort to improve the quality of the reports it publishes. Your comments/answers to the items/questions below will aid us in our efforts.

1. BRL Report Number _____ Date of Report _____
2. Date Report Received _____
3. Does this report satisfy a need? (Comment on purpose, related project, or other area of interest for which the report will be used.) _____

4. How specifically, is the report being used? (Information source, design data, procedure, source of ideas, etc.) _____

5. Has the information in this report led to any quantitative savings as far as man-hours or dollars saved, operating costs avoided or efficiencies achieved, etc? If so, please elaborate. _____

6. General Comments. What do you think should be changed to improve future reports? (Indicate changes to organization, technical content, format, etc.) _____

CURRENT ADDRESS

Name _____

Organization _____

Address _____

City, State, Zip _____

7. If indicating a Change of Address or Address Correction, please provide the New or Correct Address in Block 6 above and the Old or Incorrect address below.

OLD ADDRESS

Name _____

Organization _____

Address _____

City, State, Zip _____

(Remove this sheet along the perforation, fold as indicated, staple or tape closed, and mail.)

FOLD HERE

Director
US Army Ballistic Research Laboratory
ATTN: AMXBR-OD-ST
Aberdeen Proving Ground, MD 21005-5066



NO POSTAGE
NECESSARY
IF MAILED
IN THE
UNITED STATES

OFFICIAL BUSINESS
PENALTY FOR PRIVATE USE, \$300

BUSINESS REPLY MAIL
FIRST CLASS PERMIT NO 12062 WASHINGTON, DC
POSTAGE WILL BE PAID BY DEPARTMENT OF THE ARMY

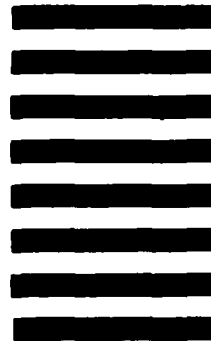

Director
US Army Ballistic Research Laboratory
ATTN: AMXBR-OD-ST
Aberdeen Proving Ground, MD 21005-9989

FOLD HERE

END

FILMED

4-85

DTIC