



Calhoun: The NPS Institutional Archive
DSpace Repository

Theses and Dissertations

Thesis and Dissertation Collection

1986-12

Radiation characteristics of selected long wire
antennas as a function of geometry using
computer modeling techniques

Gillespie, Robert James, Sr.

Monterey, California: U.S. Naval Postgraduate School

<http://hdl.handle.net/10945/22058>

Downloaded from NPS Archive: Calhoun



Calhoun is a project of the Dudley Knox Library at NPS, furthering the precepts and goals of open government and government transparency. All information contained herein has been approved for release by the NPS Public Affairs Officer.

Dudley Knox Library / Naval Postgraduate School
411 Dyer Road / 1 University Circle
Monterey, California USA 93943

<http://www.nps.edu/library>

NPS62-87-004

NAVAL POSTGRADUATE SCHOOL

Monterey, California



THESIS

RADIATION CHARACTERISTICS OF SELECTED LONG
WIRE ANTENNAS AS A FUNCTION OF GEOMETRY
USING COMPUTER MODELING TECHNIQUES

by

Robert James Gillespie Sr.

December 1986

Thesis Advisor:

Richard W. Adler

Approved for public release; distribution unlimited

Prepared for:
Marine Corps Development and Education Command
Quantico, VA 22134

T230525

NAVAL POSTGRADUATE SCHOOL
Monterey, CA 93943

Rear Admiral R.C. Austin
Superintendent

D.A. Schradly
Provost

This thesis was prepared in conjunction with research sponsored by the Development Center, C-3 Division, MCDEC, Quantico, VA, under work order M54026WR06 EK.

Reproduction of all or part of this report is authorized.

REPORT DOCUMENTATION PAGE

a REPORT SECURITY CLASSIFICATION UNCLASSIFIED		1b RESTRICTIVE MARKINGS	
a SECURITY CLASSIFICATION AUTHORITY		3 DISTRIBUTION / AVAILABILITY OF REPORT Approved for public release; distribution is unlimited	
b DECLASSIFICATION / DOWNGRADING SCHEDULE		5 MONITORING ORGANIZATION REPORT NUMBER(S) NPS62-87-004	
PERFORMING ORGANIZATION REPORT NUMBER(S) NPS62-87-004		5 MONITORING ORGANIZATION REPORT NUMBER(S) NPS62-87-004	
a NAME OF PERFORMING ORGANIZATION Naval Postgraduate School	6b OFFICE SYMBOL (If applicable) Code 62	7a NAME OF MONITORING ORGANIZATION Naval Postgraduate School	
c ADDRESS (City, State, and ZIP Code) Monterey, California 93943-5000		7b ADDRESS (City, State, and ZIP Code) Monterey, California 93943-5000	
a NAME OF FUNDING / SPONSORING ORGANIZATION Marine Corps Development and Education Command	8b OFFICE SYMBOL (If applicable)	9 PROCUREMENT INSTRUMENT IDENTIFICATION NUMBER M54026WR06 EK	
c ADDRESS (City, State, and ZIP Code) Quantico, Virginia 22134		10 SOURCE OF FUNDING NUMBERS	
		PROGRAM ELEMENT NO	PROJECT NO
		TASK NO	WORK UNIT ACCESSION NO
11 TITLE (Include Security Classification) RADIATION CHARACTERISTICS OF SELECTED LONG WIRE ANTENNAS AS A FUNCTION OF GEOMETRY USING COMPUTER MODELING TECHNIQUES			
12 PERSONAL AUTHOR(S) Millespie, Robert J. Sr.			
13a TYPE OF REPORT Master's Thesis	13b TIME COVERED FROM _____ TO _____	14 DATE OF REPORT (Year, Month Day) 1986 December	15 PAGE COUNT 377
16 SUPPLEMENTARY NOTATION			
COSATI CODES		18 SUBJECT TERMS (Continue on reverse if necessary and identify by block number)	
FIELD	GROUP	Antenna Modeling, Long Wire Antennas, Radiation Characteristics, Marine Corps	
	SUB-GROUP		
17 ABSTRACT (Continue on reverse if necessary and identify by block number)			
<p>This thesis, sponsored by the Marine Corps Development and Education Command, Quantico, VA, examines the far field patterns of five high frequency long wire antenna configurations through the use of the Numerical Electromagnetics Code (NEC). Lossy ground and the effects of variations made to these structures are considered. The resulting far field patterns are contained in the appendix.</p> <p>The antenna configurations vary in length from 1.87 to 17.19 wavelengths and in their height above ground from 0.103 to 0.610 wavelengths. Variations in the antennas end-regions include: the use of a ground rod or radial screen attached to the transmitter, terminating the far end of the antenna, and varying the shape of the transmitter from a small box (radio-sized) to a large (vehicle-sized) configuration.</p> <p>It is concluded that both the antenna height and length determine the far</p>			
19 DISTRIBUTION / AVAILABILITY OF ABSTRACT <input checked="" type="checkbox"/> UNCLASSIFIED/UNLIMITED <input type="checkbox"/> SAME AS RPT <input type="checkbox"/> DTIC USERS		21 ABSTRACT SECURITY CLASSIFICATION UNCLASSIFIED	
20a NAME OF RESPONSIBLE INDIVIDUAL Richard W. Adler		22b TELEPHONE (Include Area Code) (408) 646-2352	22c OFFICE SYMBOL 62Ab

#3 continued
field geometry, and that end-region variations also impact,
though to a lesser degree, on the pattern. Tables of comparative
results are provided.

Approved for public release; distribution is unlimited

Radiation Characteristics of Selected
Long Wire Antennas as a Function of Geometry
Using Computer Modeling Techniques

by

Robert James Gillespie Sr.
Captain, United States Marine Corps
B.S., United States Naval Academy, 1978

Submitted in partial fulfillment
of the requirements for the degree of

MASTER OF SCIENCE IN ELECTRICAL ENGINEERING

from the

NAVAL POSTGRADUATE SCHOOL
December 1986

ABSTRACT

This thesis, sponsored by the Marine Corps Development and Education Command, Quantico, VA, examines the far field patterns of five high frequency long wire antenna configurations through the use of the Numerical Electromagnetics Code (NEC). Lossy ground and the effects of variations made to these structures are considered. The resulting far field patterns are contained in the appendix.

The antenna configurations vary in length from 1.87 to 17.19 wavelengths and in their height above ground from 0.103 to 0.610 wavelengths. Variations in the antennas end-regions include: the use of a ground rod or radial screen attached to the transmitter, terminating the far end of the antenna, and varying the shape of the transmitter from a small box (radio-sized) to a large (vehicle-sized) configuration.

It is concluded that both the antenna height and length determine the far field geometry, and that end-region variations also impact, though to a lesser degree, on the pattern. Tables of comparative results are provided.

TABLE OF CONTENTS

I.	INTRODUCTION-----	7
	A. TACTICAL HIGH FREQUENCY (HF) COMMUNICATION REQUIREMENTS-----	7
	B. THE LONG WIRE ANTENNA-----	8
	1. Long Wire Antennas in Free Space-----	10
	2. Transition to a Practical Structure-----	11
	C. TRANSMISSION AND PROPAGATION CONSIDERATIONS-	18
	1. The Link Equation-----	18
	2. The Ionosphere-----	20
II.	NATURE OF THE INVESTIGATION-----	24
	A. BACKGROUND-----	24
	B. ENVIRONMENTAL CONSIDERATIONS AND ANTENNA CONFIGURATIONS-----	25
	C. INVESTIGATION CRITERIA-----	30
	1. Radiation Patterns-----	30
	2. Take Off Angles and Frequencies-----	31
III.	DETAILS OF THE FAR FIELD PATTERN INVESTIGATION--	33
	A. THE NUMERICAL ELECTROMAGNETICS CODE (NEC)---	33
	B. NEC COMPUTER MODEL DEVELOPMENT-----	34
	C. RESULTS-----	38
	1. General Observations-----	39
	2. The Effect of Antenna Height-----	41
	3. Sensitivity of the Antenna to Geometric Variation-----	41
	4. Effects Exclusive of Antenna Height and Length-----	42

5.	The Composite Effects of Antenna Height and Length-----	44
6.	The HMMWV Mounted Radio Configuration---	48
IV.	SUMMARY AND APPLICATION OF THE FINDINGS-----	49
A.	AN OVERVIEW-----	49
B.	GENERAL CONSIDERATIONS-----	50
C.	FREQUENCIES OF OPERATION-----	50
D.	GEOMETRY SELECTION AND PERFORMANCE CHARACTERISTICS-----	52
E.	CONSTRUCTION CONSIDERATIONS-----	56
V.	CONCLUSIONS-----	59
VI.	RECOMMENDATIONS-----	61
APPENDIX A:	SERVICE PUBLICATIONS LIST-----	63
APPENDIX B:	NUMERICAL ELECTROMAGNETICS CODE DATA SETS-----	64
APPENDIX C:	RADIATION PATTERNS OF ANTENNA 1-----	68
APPENDIX D:	RADIATION PATTERNS OF ANTENNA 2-----	126
APPENDIX E:	RADIATION PATTERNS OF ANTENNA 3-----	162
APPENDIX F:	RADIATION PATTERNS OF ANTENNA 4-----	198
APPENDIX G:	RADIATION PATTERNS OF ANTENNA 5-----	235
APPENDIX H:	RADIATION PATTERNS USING THE HMMWV-----	271
APPENDIX I:	RADIATION PATTERNS OF THE DOUBLET ANTENNA-----	341
LIST OF REFERENCES	-----	369
BIBLIOGRAPHY	-----	370
INITIAL DISTRIBUTION LIST	-----	371

I. INTRODUCTION

A. TACTICAL HIGH FREQUENCY (HF) COMMUNICATION REQUIREMENTS

This investigation into the performance of field expedient long wire antennas was conducted in order to provide the Marine Corps with the necessary information to optimize the construction and orientation of a high frequency field expedient long wire antenna configuration. Although the specific type of field expedient antenna was not specified, the following guidance was received concerning a likely communications scenario wherein the antenna would be employed:

- The communication link under consideration is a shore based, point to point, long range (1000 to 1500 nautical mile), high frequency radio teletype link.
- It is desirable to maintain a single hop sky wave communication link.
- The transceiver is capable of generating up to 400 watts peak envelope power (PEP).
- The transceiver may be vehicularly mounted. However, the particular vehicle to be employed is to be considered transparent to the nature of the investigation.

The typical antenna configuration might include either a whip or a horizontally oriented half wave dipole which radiate in an omnidirectional manner (or nearly so). In a point to point communication circuit, however, they are much less efficient in terms of directed power than a

directional antenna. The long wire antenna which can easily be configured as either a bi- or unidirectional antenna with a comparatively narrow beamwidth is one example of an alternative antenna with this advantage.

The long wire antenna is only one of many HF antennas that can be constructed as field expedient and is capable of meeting the needs of the long range communication link. Due to its relative ease of construction for the range of frequencies being considered, it may, under a variety of circumstances, be the preferred choice.

Although emphasis is placed on the construction of the antenna in a field environment, it is assumed that certain materials available through the supply system, or available at the organizational level in the form of SL-3 components, are accessible for the construction of the antenna. Certain prefabrications and material acquisitions may be necessary in order to support the full range of antenna configurations investigated.

B. THE LONG WIRE ANTENNA

The "long wire antenna" has been defined in a strict sense as an antenna consisting of a single straight wire, either unbroken or with a feedpoint gap at a current maximum when the antenna has a standing wave current distribution; whose overall length is greater than one-half wave length [Ref. 1]. In addition to this strict sense

definition, several derivatives of the long wire antenna exist, including the "sloping V" and the "vertical half rhombic" to name two, that will often be categorized under the heading of "long wire antennas". All of these antenna are directional.

The long wire antenna may be constructed to operate in either a standing wave or travelling wave mode. By leaving the ends of the antenna open ended, current and voltage distributions form standing wave patterns along the length of the structure as a result of the reflected waveforms. These standing wave patterns are similar to those experienced on open ended transmission lines. Antennas that exhibit current and voltage standing wave patterns formed by reflections from the open end of the wire are referred to as "standing wave" or "resonant" antennas. [Ref. 2]

If the antenna is elevated at a small height above the ground relative to a wavelength at the operating frequency, and if the end(s) of the antenna is (are) terminated¹ with a resistive load, then complete elimination of reflected current is possible [Ref. 2]. The antenna in this configuration can be seen, through image theory, as a guiding structure along which the waves travels and radiates

¹Depending on the configuration chosen for the antenna, either one end (e.g., an end fed long wire), or both ends (e.g., an other-than-end fed long wire) may require termination.

energy. Energy that has neither been radiated to the surrounding environment nor dissipated due to the resistance of the antenna wire, is dissipated in the terminating resistor. The value of the load resistor to achieve the desired impedance match is equal to the characteristic impedance of the wire near the ground [Ref. 2]. In this configuration the structure is said to support travelling waves, as opposed to standing waves, and is called a "travelling wave" antenna.

Most literature that addresses long wire antennas and their derivatives, formulate the mathematical expressions to describe their performance by deploying the antennas in free space or over perfectly conducting ground. The obvious reason of course is that by approaching them in this fashion, many simplifying assumptions may be made. Unfortunately, tactical conditions tend to void these simplistic scenarios, and typically, conditions of poorly conducting or lossy ground are encountered in the form of sandy, arid soil. Notwithstanding this argument, the general characteristics of the long wire antenna in free space will briefly be described to develop a baseline from which the investigation proceeds.

1. Long Wire Antennas in Free Space

Strict sense long wire antennas project a far field radiation pattern in the form of multiple cones of radiation. The axes of the cones coincide with the axis of the

antenna wire, and the sides of the cones are inclined at various angles with respect to the wire. The following general observations apply [Ref. 1]:

- a. There is a lobe in the radiation pattern for each half wavelength of wire length.
- b. The largest lobe of the radiation pattern is the one forming the smallest angle with the wire. For the travelling wave (terminated) case, this lobe is in the direction of the current flow only. For the standing wave (unterminated) case, the radiation pattern is symmetric with respect to the wire axis and so has a complimentary major lobe toward the other end of the wire.
- c. Half of the lobes are tilted forward, and half of them tilted backward. If the antenna is an odd number of half wavelength long, there is an odd number of lobes, so one of them will be normal to the wire.
- d. With travelling waves, the field strength pattern has lobes of diminishing amplitude, the smallest being in the direction opposite that of current flow.
- e. Regions of little or no radiation, called nulls, are symmetrically distributed about the plane normal to the middle of the wire.
- f. Typical deviations from idealized current distributions modify the relative lobe amplitudes slightly, and fill in the zeros slightly, but do not affect the angles of the lobes of maximum radiation or the nulls in the radiation pattern.

2. Transition to a Practical Structure

a. Effects of the Earth as a Ground Plane

The introduction of a ground plane to the long wire antenna introduces ground reflections which directly affect the far field radiation patterns. The presence of the ground also affects the radiation resistance and the input impedance due to mutual coupling between the antenna

and its image. The resistance of the wire used for the antenna is usually small, but in a very long wire, the total resistance may be appreciable. In addition to its direct affect on the input impedance, this resistance also changes the form of the current distribution on the wire in both the resonant and nonresonant antennas and, as a result, further affects the radiation pattern. [Ref. 3]

The earth acts as a fairly good conductor at frequencies up to 3 MHz. At higher frequencies however, the ground may take on characteristics more closely aligned with those of a lossy dielectric rather than a good conductor [Ref. 4]. At these frequencies, the earth's conductivity varies greatly depending on the soil composition. Some typical values are given in Table 1. For land based systems, rich soil represents "good" conditions while rocky or sandy arid soil represents poor conditions.

With relatively low conductivity, electric fields generated by the antenna penetrate into the lossy earth and excite currents which in turn give rise to ohmic loss. This loss appears as an increase in the antenna's input resistance and thereby lowers the radiation efficiency of the antenna [Ref. 5]. Some additional insight into this area was gained through the work of George Hagn of SRI International, Arlington, Virginia, whose findings indicate that the conductivity and dielectric constant of

typical soil samples are not fixed, but vary as a function of frequency. Refer to Figures 1.1 and 1.2.

TABLE 1
TYPICAL VALUES FOR GENERAL GROUND CLASSIFICATIONS

Ground Conditions	Conductivity (mhos/meter)	Dielectric Constant (farads/meter)
GOOD	0.01	30
FAIR	0.005	12
POOR	0.001	5

b. Geometry²

In transitioning from the sterile free space environment to the practical tactical environment, several changes must be made which will impact upon the antennas geometry. It is expected that each change made will contribute in varying degrees to the specific measurable characteristics of the antenna, such as the far field radiation patterns and input impedance. The results of introducing specific changes to the antenna geometry do not lend themselves to the broad based and well documented results as

²The term geometry as used here is applied in a broad sense to include the physical orientation of the long wire section of the antenna, the driving point or feed point geometry, and any near field structures that are purposely introduced into the system to physically support or electrically excite the antenna elements, or modify the far field radiation characteristics of the antenna.

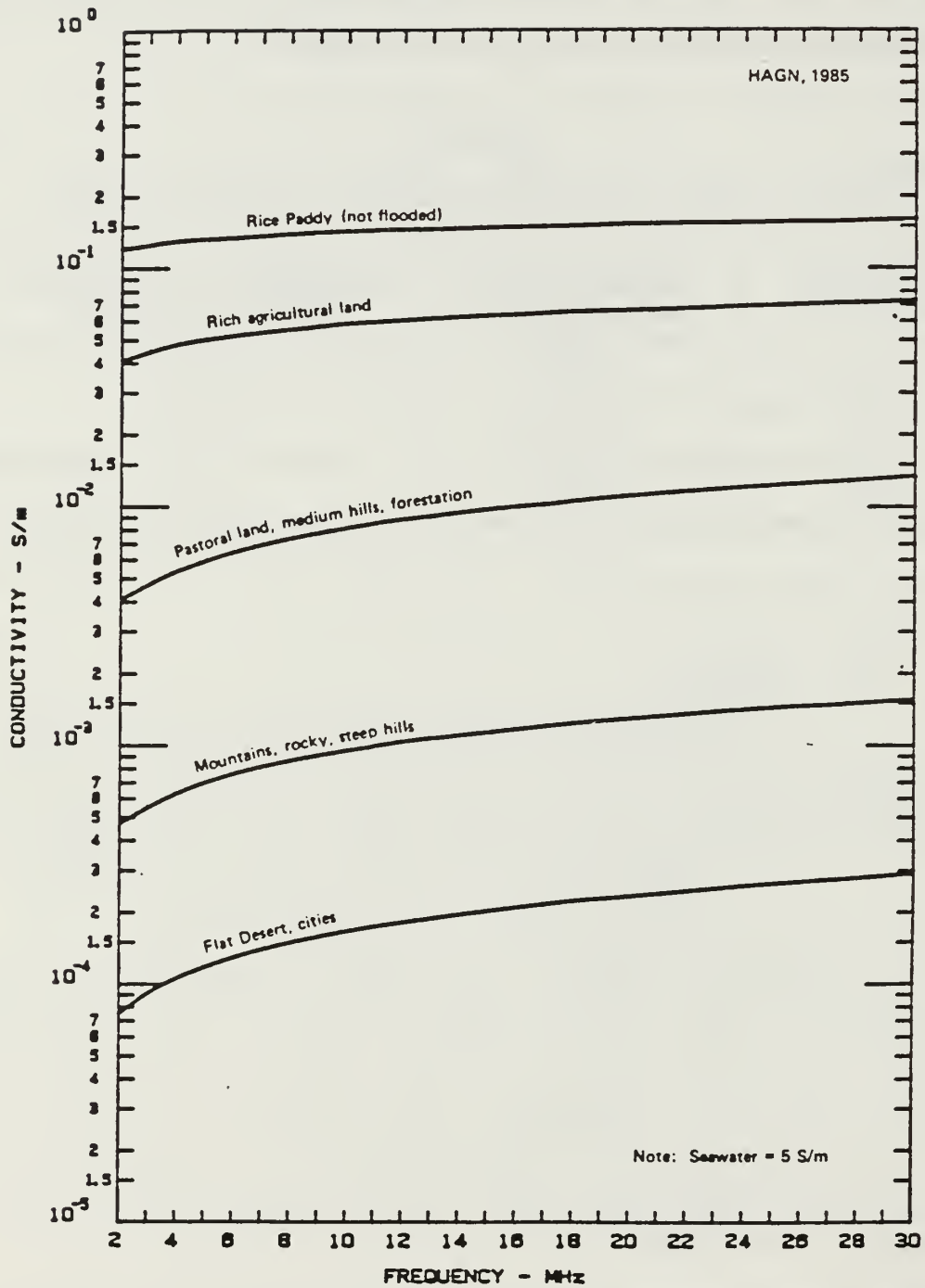

Figure 1.1 Conductivity as a Function of Frequency.

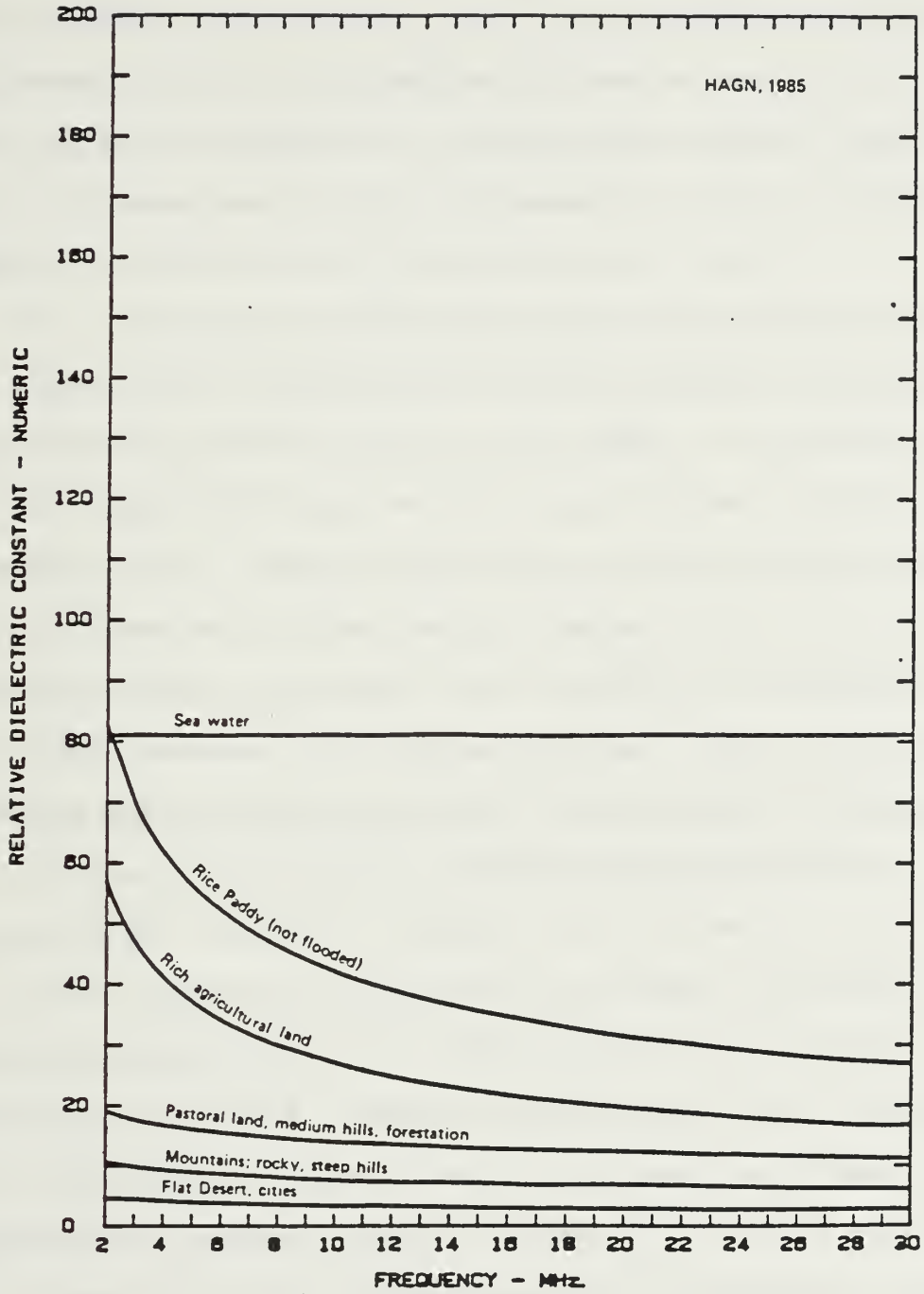

Figure 1.2 Dielectric Constant as a Function of Frequency.

was the case in the previous sections. As such, this may be considered the point of departure from the information that is available or can be derived from the literature, to the thrust of this investigation - the examination of the cumulative results of changes to the antenna geometry.

Several structures are to be introduced to the practical horizontally oriented long wire antenna. The voltage source, better known as the transmitter is the first constituent. The origin of the antenna and the use of isolation elements (i.e., baluns) will determine the transmitter's interaction with the antenna. This interaction can vary from transparent, as may be the case in a remote antenna configuration, to a small box, the box being the portable radio itself from which the antenna extends, to a large vehicle in which the transmitter is installed. Should the system take the form of the solitary portable radio, the transmitter will become a component of the antenna circuit by acting as an extremely small and irregularly shaped local 'ground plane'. As such, currents are induced over the transmitters surface. Similarly, if the system takes the form of a larger vehicle housing the transmitter, where both share a common ground, the vehicle becomes a component of the antenna circuit. In summary, the variability of the antenna's local ground plane may be altered considerably, and must be considered with the parameters affecting the antenna's measured performance.

The next constituent, the feed wire that is to run from the transmitter to the horizontal antenna which is displaced some finite distance above the ground, is fairly well confined to whether or not it is to radiate, and its physical orientation with respect to the ground and the antenna.

As discussed earlier, the long wire antenna may be terminated. A determination must therefore be made on whether the terminating lead is to radiate, its physical orientation with respect to the ground and the antenna, the placement of the terminating resistor, the resistance and type of resistor to be utilized, and the method of terminating the antenna current. Historically, termination has been accomplished by routing the current either directly into the ground via a ground rod, or through a feedback wire running the length of the antenna back to the transmitter.

Finally, variations that affect the characteristics of the ground plane as seen by the antenna may be considered. Typically these include laying radial wires or a ground screen, or grounding the transmitter structure with a grounding rod.

Specific combinations of these factors will dictate a unique configuration which in turn should produce unique input and/or output characteristics.

C. TRANSMISSION AND PROPAGATION CONSIDERATIONS

1. The Link Equation

There are several ways to approach an understanding of the significance of the transmit and receive antenna gains in the overall HF circuit configuration. An equation describing the circuit may first be stated in terms of the transmit and receive power requirements, and the system losses as follows:

$$P_t = P_r + L_s \quad (\text{dB}) \quad (1.1)$$

where:

P_t = transmitted power
 P_r = received power
 L_s = system losses

Equation 1.1 is further expanded into finer detail to include the variables describing the antenna gains in the circuit, as well as to expose the other variables that enter into the propagation / attenuation picture as follows:

$$P_t = (P_n + C/N) + (L_{bf} + L_i + L_g + Y_p - G_t - G_r) \quad (\text{dB}) \quad (1.2)$$

where:

P_n = received noise power (galactic, atmospheric, and man made)

C/N = required carrier to noise power at the receiver input
 L_{bf} = basic transmission spreading loss
 L_i = ionospheric absorption loss
 L_g = ground reflection loss
 Y_p = excess losses not directly attributable to sources just specified (focusing, multipath, polarization, etc.)
 G_t = transmitting antenna gain
 G_r = receiving antenna gain

From Equation 1.2, the following observations may be made concerning the effects of increasing the transmit or receive antenna gains:

1. An improvement in the quality of the channel which would be attributed to an improved signal to noise ratio, if all other parameters remain unchanged.
2. A decrease in the transmitter power requirements would be possible without degradation to the existing channel's quality.
3. An increase of the receiver tolerance to higher levels of signal to noise power would be realized if the transmitters power output is not altered.

In order to gain a better perspective of the variables related to antenna performance, it is advantageous at this point to better define what is meant or included when we speak of the 'transmitted power' and 'transmit antenna gain'. The transmitted power is the power developed at the transmitter (or its power amplifier) output terminals. Therefore, the transmit antenna gain term must encompass all gains and losses associated with transmitting the output power from the terminals into the atmosphere as electromagnetic radiation. The following considerations,

although not all inclusive, must be considered in this term:

1. Antenna gain (for a lossless antenna).
2. Transmission line ohmic losses.
3. Wire interface or connection losses.
4. Losses generated by impedance mismatches.
5. Losses associated with the use of impedance matching devices.
6. Variable losses generated by the ground soil conditions.
7. Losses generated by the use of a terminating resistor.

Although it may not be immediately apparent from Equation 1.2, several parameters of the communications channel depend on the medium through which the transmitter/receiver pair must continue to operate. A limited discussion of the dynamics of the most important part this medium, the ionosphere, will be discussed briefly in the next section.

2. The Ionosphere

Skywave propagation over long distances at HF is made possible by the existence of the ionosphere. Layers of plasma within the earth's atmosphere beginning at an altitude of about 50 Km and extending to a distance of several earth radii. The layer is formed by ionizing radiation primarily from the sun. Radio waves are refracted back toward the earth by the ionosphere.

To address the dynamics involved when dealing with the ionosphere, the following salient points are presented [Ref. 6]:

1. The ability of the ionosphere to return radio waves to earth depends on the ion density, the frequency of the radio wave, and the angle of transmission. The refractive ability of the ionosphere increases with ion density. Several significant periodic changes occur in the ionosphere affecting the ion density, including seasonal and diurnal changes due to the proximity of the earth to the sun, and the daily exposure of the earth's atmosphere to the sun, respectively.
2. The relative distribution of the ionospheric layers is shown in Figure 1.3(a). With the disappearance of the D and E layers at night, signals normally refracted by the E layer are refracted by the much higher layers resulting in greater skip distances at night, as depicted in Figure 1.3(b).
3. Layers which form the ionosphere undergo considerable variations in altitude, density, and thickness due primarily to solar activity. Sun spot activity which recurs in 11 year cycles has its greatest effect on the F layer(s). During periods of maximum sun spot activity, the F layer(s) become more dense and occur at higher altitudes.

Because of the ever changing ionospheric conditions, a greater degree of complexity is added to the communications scenario. As a result of the ionosphere's dynamic nature, it is conceivable that the high gain directional antenna that was extremely desirable in terms of optimizing the link equation parameters, could become a hindrance in terms of maintaining communications between two stations over a period of time. If the communications interval is to be of a shorter duration, this consideration

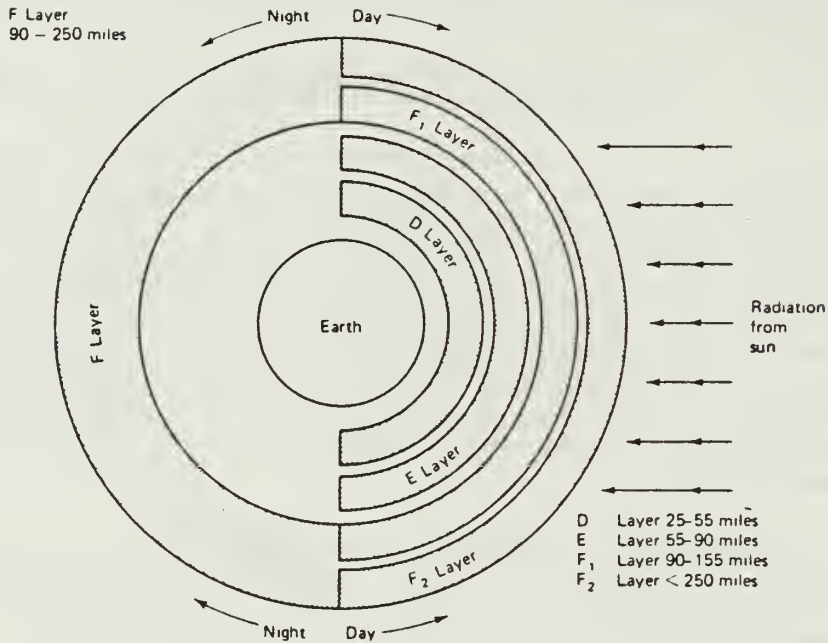

(a) Layers of the Ionosphere.

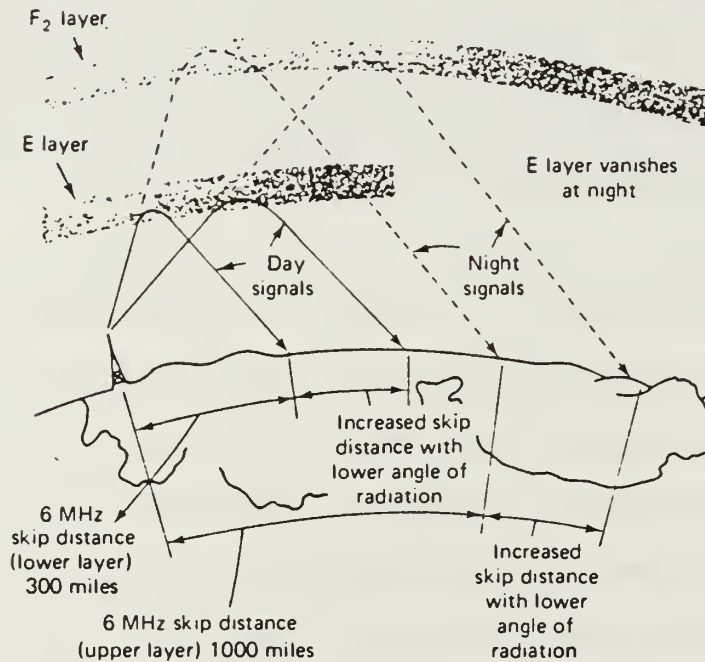

(b) Variations in Skip Distances.

Figure 1.3 Ionospheric Considerations.

may not be as crucial in weighing the pros and cons of the long wire antenna.

II. NATURE OF THE INVESTIGATION

A. BACKGROUND

There are several military publications in use today that address long wire antennas. A list is presented in Appendix A. While the extent of the material presented varies from publication to publication, all typify the long wire's radiation pattern as those encountered in free space. Although some mention is made of the effects that varying the finite ground conditions would have on the radiation patterns, the statements are very non-specific.

It is the intent of this investigation to seek a means of optimizing the radiation characteristics of the long wire antenna, and in doing so, add to the information base on long wire antennas by addressing the following:

1. The effects of a "fair" finite ground on the antenna. A conductivity of 0.003 mhos/meter and a dielectric constant of 10 farads/meter will be used. These parameters may be considered typical values for sandy soil (but not strictly sand) and mountainous rocky terrain.
2. The effects of changing the long wire antenna geometry, including:
 - a. Variations of the antenna's electrical height and length.
 - b. The effects of using ground radials or a grounding rod at the transmitter location.
 - c. The effects of using a terminating resistor and either a grounding rod or a return wire at the far end of the antenna.

- d. The effects of varying the physical size of the transmitter.
3. The characteristics of particular antenna configurations over a range of frequencies.

Although heights in excess of 40 feet are attainable in field expedient configurations, the maximum height of the antenna will be limited to 20 feet. It is anticipated that wooden lance poles will be used as the non-metallic support structures which, in turn, would be supported by non-metallic guy lines such as nylon or hemp rope; and that the configuration will allow for the unobstructed propagation of sky waves. It is further anticipated that the available terrain and the desired angle of propagation, or take off angle, of the sky wave will be the determining factors in the selection of the antenna dimensions.

B. ENVIRONMENTAL CONSIDERATIONS AND ANTENNA CONFIGURATIONS

In selecting antenna configurations to use to investigate the effects of geometrical variations on the far field radiation patterns, limited number of configurations with relatively large deviations in antenna lengths were chosen. The antenna lengths were further specified by restricting overall lengths to odd multiples of quarter wave sections at 17 MHz, to take advantage of the prospect of driving the antenna at a low impedance point as would be the case in transmission line theory. The configurations are listed at the end of this section.

The parameters adopted for use in this investigation include:

1. Ground constants for fair ground only: soil conductivity of 0.003 mhos/meter and dielectric constant of 10 farads/meter.
2. Radio systems that are 100% efficient (No losses occur in the radio or tuner).³
3. A frequency of design of 17 MHz - the logarithmic mean of frequencies used for longhaul HF skywave communication.
4. A radio measuring 11" x 12" x 4" (H x L x W) to be used as the generic standard for the transceiver in use.
5. The feed wire to the horizontal portion of the long wire antenna to be oriented at a 45 degree angle as measured in the vertical plane from the ground to the wire, in all configurations except Antenna #14. The feed wire will be a radiating element of the antenna for all antennas.
6. The use of a BNC adapter (UG-1441/G) for connecting the antenna wire to the antenna terminal of the man portable radio.

Running a long wire antenna directly from the rear of a vehicle in which the radio equipment could be mounted is the last configuration to be considered. The use of the Highly Mobile Multipurpose Wheeled Vehicle or HMMWV was selected in light of plans to phase in a large number of them over the coming years.

The specific antenna configurations are presented as follows:

³This parameter was instituted to accomodate a default option in the computer modeling code that will be used to model the antenna.

1. ANTENNA 1. Long wire antenna with a total length of $4 \frac{3}{4}$ wavelengths. Horizontal component $\frac{1}{2}$ wavelength above the ground.

VARIATIONS:

- (a) Feed directly by radio with no other connections. See Figure 2.1.

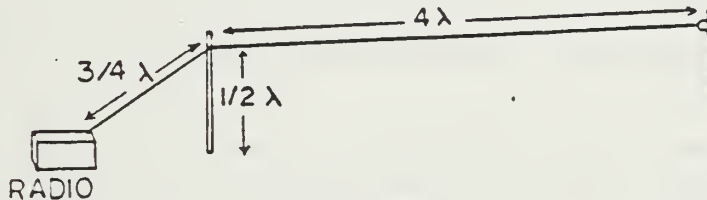

Figure 2.1 Antenna Configuration 1(a)

- (b) Maintain the overall length, but vary the height of the horizontal component from $\frac{1}{8}$ to $\frac{3}{8}$ wavelength.
- (c) Same as (a), but connect an 8 foot ground rod to the radio.
- (d) Connect 8 radials (each one $\frac{1}{8}$ wavelength long laid one inch below the ground) to the radio. See Figure 2.2.

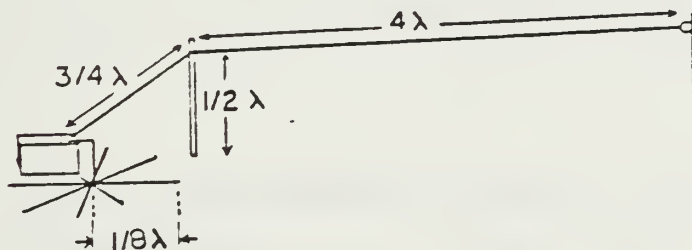

Figure 2.2 Antenna Configuration 1(d)

- (e) Feed directly by the radio with no other connections to the radio; connect the far end of the

antenna to a ground stake through a 400 ohm resistor. See Figure 2.3.

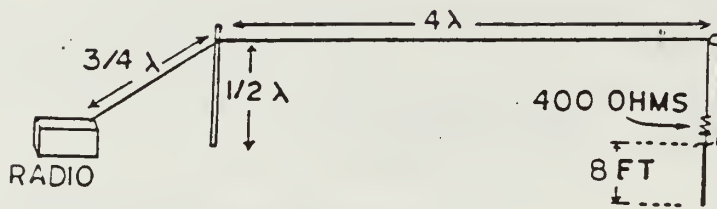

Figure 2.3 Antenna Configuration 1(e)

(f) Same as (e) but with 8 radials $1/8$ wavelength long, laid one inch below the ground, connected to the radio. See Figure 2.4.

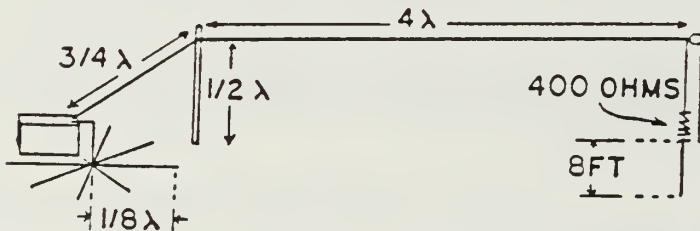

Figure 2.4 Antenna Configuration 1(f)

(g) Same as (e) but with a single ground return line connected between the radio case and the ground stake. See Figure 2.5.

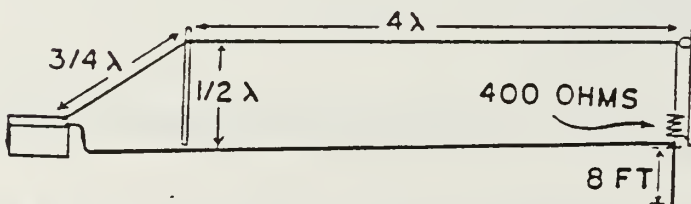

Figure 2.5 Antenna Configuration 1(g)

(h) Same as (g) but with the ground stake removed.

2. ANTENNA 2. Long wire antenna with a horizontal component 100 feet long, and 15 feet above the ground.

VARIATIONS:

- (a) Connect directly to the radio output connector through a single wire download. See Figure 2.6.

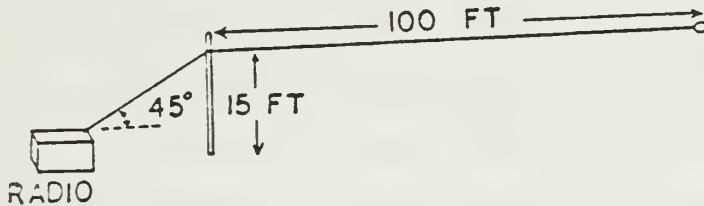

Figure 2.6 Antenna Configuration 2(a)

- (b) Same as (a), but terminated into a 400 ohm resistor connected to a ground stake planted 8 feet into the ground.
- (c) Same as (b), but with 8 radials, 1/8 wavelength long connected to the radio case and laid 1 inch below the ground.

3. ANTENNA 3. Long wire antenna with a horizontal component 100 feet long and 6 feet above the ground.

VARIATIONS:

- (a) Connect directly to the radio output connector through a single wire download. See Figure 2.7.

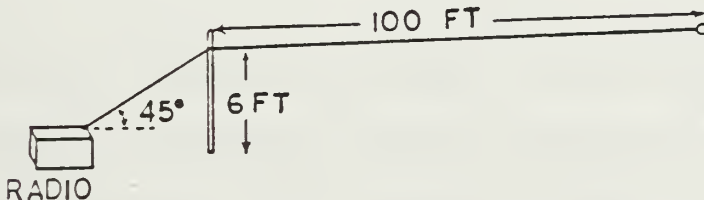

Figure 2.7 Antenna Configuration 3(a)

- (b) Same as (a), but terminated into a 400 ohm resistor connected to a ground stake planted 8 feet into the ground.

(c) Same as (b), but with 8 radials, $1/8$ wavelength long connected to the radio case and laid 1 inch below the ground.

4. ANTENNA 4. Long wire with an overall length of 234 feet.

VARIATIONS:

- (a) Located 6 feet above the ground.
(b) Located 15 feet above the ground.
(c) Located 20 feet above the ground.

5. ANTENNA 5. Long wire with an overall length of 564 feet.

VARIATIONS:

- (a) Located 6 feet above the ground.
(b) Located 15 feet above the ground.
(c) Located 20 feet above the ground.

C. INVESTIGATION CRITERIA

There are several available tools and terms that could be used to describe the performance characteristics of an antenna. Those utilized in this investigation, along with the criteria implemented are presented as follows.

1. Radiation Patterns

One of the more popular and readily understood techniques of conveying antenna performance is the far field radiation pattern display referenced to an isotropic radiator. This type of presentation is commonly used as an acceptable means of displaying the far field radiation patterns, and, as such, will place the results obtained into a

comparative posture with the published results of other antenna configurations. Furthermore, it is a tool that can be used directly by field Marines to select an optimum antenna configuration based on power gain in a given direction. It should be clarified however, that the displayed gain is not a direct measurement of the power transmitted in a given direction, but the relative distribution of power.

2. Take Off Angles and Frequencies

Long range (1000 to 1500 nautical miles) single hop HF communications will provide the greatest signal strengths at the receiving station as a result of minimizing signal energy loss by restricting the number of reflection points in the signal path, whether in the ionosphere or at the earth, to one point. In order to achieve these distances, a relatively small take off angle - angle at which the 'ray' of radiation leaves the transmitting antenna, must be attained. Based on the average virtual heights of the 110 km and 330 km for the E and F₂ layers of the ionosphere respectively, the E layer is of little use in achieving the desired range, while the F₂ layer is capable of covering this range with corresponding take off angles of approximately 15 to 7 degrees. [Ref. 4]

Because of the variety of ionospheric conditions encountered, the layers will certainly vary to other than average virtual heights. To realistically account for

this, the range of take off angles from 0 to 30 degrees will be investigated. Using these relatively low take off angles imparts a significant increase in the value of the maximum usable frequency, or MUF, which is expressed in terms of the secant law as follows:

$$f_{MUF} = f_c \sec (Z) \quad (\text{MHz}) \quad (2.1)$$

where:

- f_{MUF} = the new maximum usable frequency
- f_c = the critical frequency for vertical incident sky wave
- Z = (90) - (the take off angle in degrees)

Using a take off angle of 30 degrees gives the new MUF a two-fold increase over the critical frequency for the vertical incident sky wave. With this consideration in mind, the frequencies of 17 and 30 MHz at the upper end of the HF band will be used as the primary frequencies for the investigation.

III. DETAILS OF THE FAR FIELD PATTERN INVESTIGATION

A. THE NUMERICAL ELECTROMAGNETICS CODE (NEC)

NEC is a user oriented computer code for analyzing the electromagnetic response of an arbitrary structure consisting of wires and/or surfaces either in free space or over a ground plane. The technique used to analyze the antenna is the Method of Moments (MOM). In the program, the functional electromagnetic field equations are reduced to a set of equations that can be handled in a straight-forward fashion using matrix manipulation on a digital computer. This method is used for modeling the antenna and its immediate environment. First the input impedance and current distribution on the antenna are found. From this, the antenna gain and radiation pattern can be determined [Ref. 7].

Developed by Lawrence Livermore Laboratory in Livermore, California for the Naval Ocean Systems Center or NOSC, NEC is continuing to evolve as a highly successful tool for analyzing antenna structures. NEC3 was the version utilized in this investigation.

To contend with the close proximity of the antenna structure to a lossy ground, the NEC Sommerfeld-Norton ground option in double precision form (DSOMNTX) was invoked. This option enhances the accuracy of the solutions

for fields at the surface of a flat imperfectly conducting earth, and subsequently, the accuracy of NEC3 sky wave propagation results.

B. NEC COMPUTER MODEL DEVELOPMENT

Although there is no theoretical size limitation to the structure being modeled, the detail of the constructed transmitter models in terms of the number of wire segments used was purposely limited. The sum of the number of wire segments used for both the transmitter and the antenna could not exceed 300 wire segments in the version of NEC used--NEC3. Each segment was in turn limited in its electrical length in accordance with the NEC User Manual guidelines. The total number of segments utilized also determines the requirement on computer time for solving for the matrix structure of the currents on the segments, as well as file storage requirements. Consequently, it was both advantageous to simplify the geometric construction of the models to conserve computer resources, and necessary, in order to work within the established parameters of NEC3.

To exemplify the evolution of the more simplified models the specific case of the HMMWV model will be examined. A side view of the stick or segment models for the initial "HMMWV" and the final "BIG BOX HMMWV", as well as a picture of the vehicle which is being modeled are presented in Figures 3.1(a), (b) and (c). The model's respective input

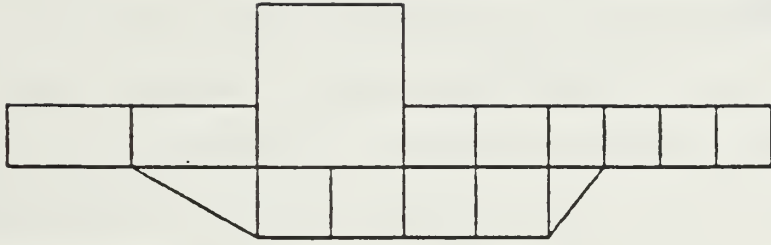

(a) Detailed HMMWV Segment Model.

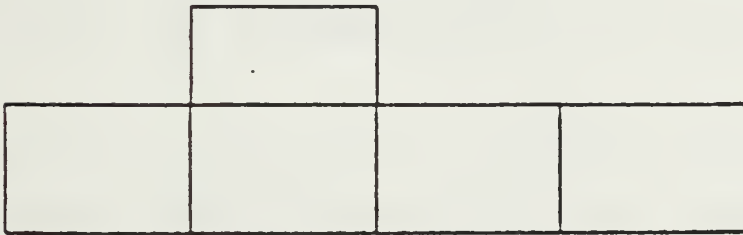

(b) Simplified BIG BOX HMMWV Segment Model.

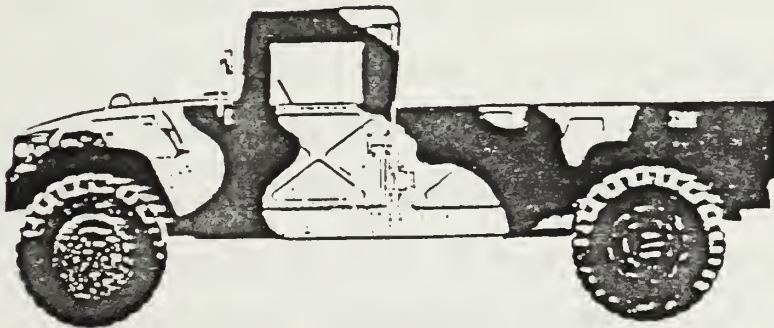

(c) The HMMWV.

Figure 3.1 A Side View of the HMMWV.

data sets are contained in Appendix B. An upper band frequency of 30 MHz was used for a comparison of the model performance which was evaluated only in terms of the model's effect on the far field radiation patterns. A particular antenna configuration, that of Antenna 1(a) was chosen as the test bed standard. A perspective of the vehicle with the long wire antenna attached is presented in Figure 3.2. When the simplified model had sufficiently reduced the computational and storage requirements to an acceptable level while retaining the composite far field radiation pattern, the model was considered acceptable, and no further steps were taken to pursue a more optimal solution.

The model for the generic transceiver was developed in a similar fashion. Its simplified form and a perspective of the long wire antenna attached to it is presented in Figures 3.3(a) and 3.3(b). The transceiver input data set is contained in Appendix B.

The specific antenna models did not undergo the scrutiny to simplify their design that the HMMWV and generic transceiver did, simply because their design translated to an acceptable computer model in terms of the number of segments they required. The guidance of the instructions set forth in Reference 7 was however, carefully followed in composing the antennas. The computer

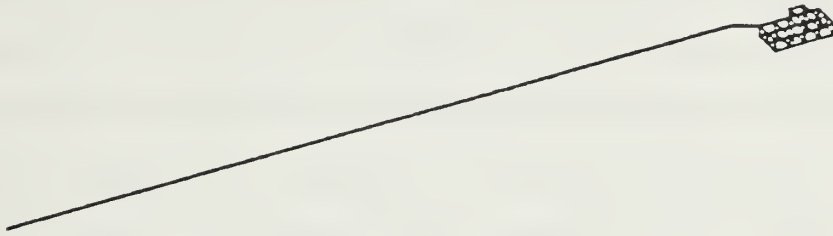

Figure 3.2 Big Box HMMWV with Antenna Attached.

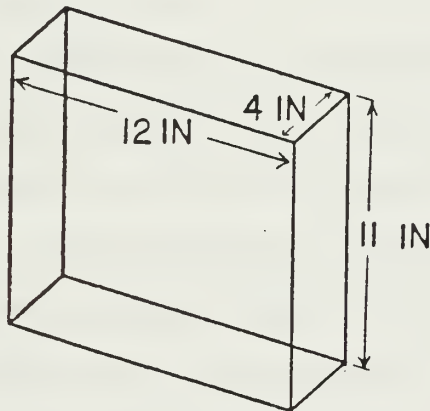

Figure 3.3(a) Simplified Transceiver.

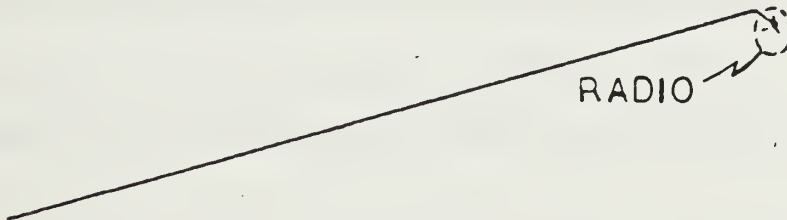

Figure 3.3(b) Transceiver with Antenna Attached.

code for antenna 1(a), and the subsequent appendages including the 8 foot ground rod that was attached to the radio, the ground radials, the terminating downlead with resistor and ground rod, and the return line are presented in a separate segments in Appendix B. They are included as a general representation of the geometry employed in modeling Antennas 1, 2, 3, 4 and 5 as detailed in the previous chapter.

C. RESULTS

The specific results of the individual NEC3 computer runs, broken down by antenna configuration, configuration variations and frequency are found in Appendix C through G, for Antennas 1 through 5 respectively. Appendix H contains the results of the HMMWV antenna configurations.

Some significant conclusions can be derived from the far field radiation patterns, although they are somewhat limited in numerical interpretation due to the large incremental changes that were imposed on the antenna geometries. Even further limitations were imposed by using only two frequencies, 17 and 30 MHz, for each particular antenna variation. Nonetheless, some very substantial insight has been gained.

Before addressing those results, the significance of the variations imposed on the antenna configurations will be considered. With the exception of Antenna 1 where all

measurements were expressed in terms of wavelengths, the antenna configurations of specified dimensions and varying excitation frequencies underwent significant modifications of both their electrical heights and lengths. Subsequently, their geometry changed significantly with respect to the lossy ground and source of excitation. An attempt to derive values for intermediate heights and lengths would result in an inordinate amount of interpolation and low confidence results.

1. General Observations

The long wire antenna in the presence of a lossy ground deviates significantly from its free space characteristics. Typically the main lobe that was described as being cone shaped about the antenna's axis loses a significant portion of the power radiated at the lower elevation angles. In the range of 0 to 5 degrees of elevation, predicted pattern intensities fell well below 0 dBi.

Two general symmetries of forward directed radiation patterns were encountered: those which formed relatively flat and almost concentric lobes of radiation as viewed in the vertical plane (See Figure 3.4(a)); and those that took on the general appearance of the cone shaped patterns previously discussed for the free space case, but with the lower lobes of radiation that would have appeared near the ground plane removed (See Figure 3.4(b)).

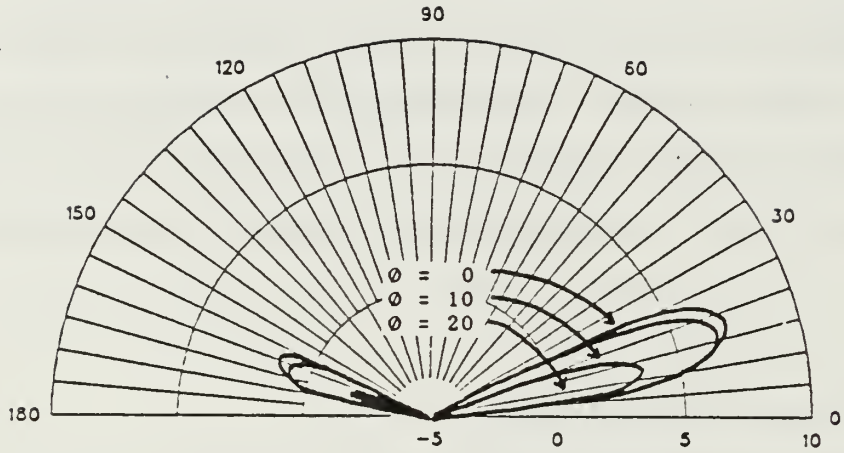

(a) Flat Concentric Lobes.

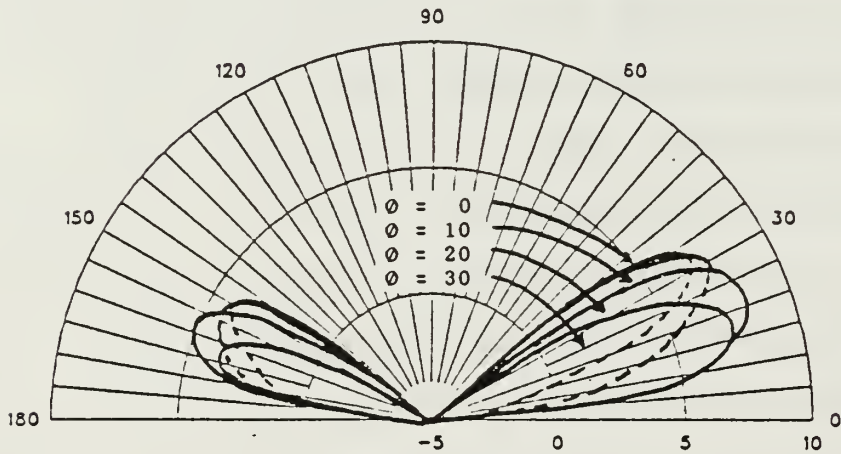

(b) Cone Shaped Patterns.

Figure 3.4 Radiation Pattern Symmetries

For most cases, this division of symmetry was observed for antennas located closer to the ground in the first case, and farther away from the ground in the later case.

Generally, both the height and length of the antenna contributed to the antenna's radiation characteristics. The closer the antenna was positioned to the ground, the lower the gain and the flatter the radiation pattern became. In terms of length, the longer the antenna, the lower and flatter the radiation pattern became, and the more the gain increased.

2. The Effects of Antenna Height

The results of antenna variations 1(a) and 1(b) which varied only the antenna's height while all other parameters remained fixed, were used to construct Table 2. The results generally indicate that as the height of the antenna is increased, the maximum gain of the antenna and the pattern's maximum elevation angle also increase. Additionally, the wave angle, or angle formed between the lobe of maximum radiation and the antenna axis, increases (i.e., moves away from the antenna axis), subsequently increasing the antenna offset angle required for maximum gain.

3. Sensitivity of the Antenna to Geometric Variations

In general, the closer the antenna was located to the ground, the less sensitive the antenna was to additional losses imposed by changes to its geometry. For example, using the results from Antennas 2 and 3, it was

found that the connection of the terminating downlead to a 400 ohm resistor and an 8 foot ground rod, and the subsequent connection of eight radial wires attached to the radio increased losses in the far field radiation patterns.

TABLE 2

MAXIMUM GAIN AND ELEVATION ANGLE AS A FUNCTION OF HEIGHT AND HORIZONTAL OFFSET ANGLE

Offset Angle	Height (Wavelengths)			
	1/8	1/4	3/8	1/2
0*	3.5 dBi 21*	5.2 dBi 25*	6.3 dBi 27*	7.0 dBi 28*
10*	3.2 dBi 20*	5.3 dBi 24*	6.7 dBi 25*	7.5 dBi 25*
20*	1.3 dBi 17*	4.8 dBi 18*	7.1 dBi 18*	8.6 dBi 17*
30*	< 0 dBi	0.3 dBi 13*	3.4 dBi 13*	5.6 dBi 13*
40*	< 0 dBi	< 0 dBi	< 0 dBi	< 0 dBi

* indicates measurements in degrees

As can be seen in Table 3, the impact of these modifications on Antenna 2 located 15 feet above the ground was significantly greater than that on Antenna 3 located 6 feet above the ground.

4. Effects Exclusive of Antenna Height and Length

The variations to Antenna 1 listed in Table 4, are exclusive of the antenna's height and length. These result

TABLE 3

SENSITIVITY TO GEOMETRICAL CHANGES AS A FUNCTION OF HEIGHT

Antenna Config.	Average Gain (dB)		Remarks
	17 MHz	30 MHz	
2(a)	0.0	0.0	Ht = 15 feet, no appendages
2(b)	-3.2	-3.0	400 ohm, 8 foot gnd rod termination
2(c)	-3.2	-3.0	2(b) plus 8 radial wires to radio
3(a)	0.0	0.0	Ht = 6 feet, no appendages
3(b)	-1.4	-1.6	400 ohm, 8 foot gnd rod termination
3(c)	-1.8	-2.0	3(b) plus 8 radial wires to radio

TABLE 4

THE EFFECTS OF ADDING THE APPENDAGES EXCLUSIVE OF
THE ANTENNA HEIGHT AND LENGTH

Antenna Config.	Remarks	Gain (dB)
1(a)	Radio without appendages	0.0
1(c)	Radio with 8 ft ground rod	-5.0 to -5.2
1(d)	Radio with radials	0.5 to 1.0
1(e)	Radio terminated to 400 ohm resistor and 8 ft ground	-2.0 to -3.2
1(f)	1(e) plus radio radials	-2.0 to -3.2
1(g)	1(e) plus return wire	-3.0 to -4.5
1(h)	1(g) without 8 ft ground	-3.0 to -4.5

form the basis of some interesting observations, including the significant losses encountered by employing some rather common field techniques such as grounding the radio equipment and terminating the long wire antenna.

What Table 4 does not address however, is the unidirectional propagation of the signal in an extension of the general direction traced from the transmitter to the terminating resistor. This directional characteristic is induced by the use of the terminating resistor which serves to dissipate any nonradiated power that reaches the far end of the antenna. The price paid for the directional capability is on the order of a 2 to 3 dB loss in signal strength in the direction of propagation.

5. The Composite Effect of Antenna Height and Length

Due to the interaction of the antenna's height and length on the results of the far field radiation patterns, a composite table based on these parameters was compiled. The results for all antenna configurations without appendages (i.e., ground rods, radial wires, etc.) were combined into the format of Table 5. The antenna dimensions were recalculated in terms of wavelengths. The minimum gain of the maximum lobe of radiation for the particular 5 degree range of elevation angles was recorded along with the required offset or wave angle at which the antenna would have to be oriented relative to the direction to the receiving station to achieve the stated gain.

TABLE 5

ANTENNA PERFORMANCE FOR HEIGHTS AND LENGTHS SPECIFIED

ANTENNA NUMBER	DIMENSIONS (WAVELENGTHS)	ELEVATION ANGLE (DEGREES)					
		0-5	5-10	10-15	15-20	20-25	25-30
1A	4.75 x 0.500 (*)	*	2.5dB/20	6.5dB/20	8.4dB/20	7.1dB/10	6.6dB/0
B	4.75 x 0.125 (*)	*	*	*	2.8dB/10	3.2dB/0	1.1dB/0
	4.75 x 0.250 (*)	*	*	2.4dB/20	4.5dB/20	5.1dB/10	4.5dB/0
	4.75 x 0.375 (*)	*	*	4.9dB/20	6.7dB/20	6.2dB/10	5.8dB/0
2A	2.09 x 0.259	*	*	*	2.4dB/30	3.9dB/30	4.8dB/30
	3.69 x 0.457	*	1.5dB/20	5.3dB/20	7.3dB/20	8.2dB/20	7.2dB/20
3A	1.87 x 0.103	*	*	*	*	*	*
	3.31 x 0.183	*	*	*	2.0dB/20	3.1dB/20	3.3dB/10
4A	4.04 x 0.103	*	*	0.3dB/0	2.2dB/0	3.3dB/0	2.1dB/0
	7.32 x 0.183	*	0.5dB/0	5.0dB/0	6.9dB/0	4.0dB/0	*
B	4.04 x 0.259	*	*	2.7dB/20	4.9dB/20	6.0dB/10	5.2dB/0
	7.32 x 0.457	*	3.5dB/10	8.2dB/20	9.3dB/10	7.8dB/0	0.5dB/0
C	4.04 x 0.345	*	0.2dB/20	4.1dB/20	6.3dB/20	6.8dB/20	6.3dB/10
	7.32 x 0.610	*	5.0dB/20	9.9dB/20	9.9dB/10	8.0dB/0	0.8dB/0
5A	9.47 x 0.103	*	0.3dB/0	4.7dB/0	4.0dB/0	*	*
	17.19 x 0.183	*	5.7dB/0	8.5dB/0	*	*	*
B	9.47 x 0.259	*	3.0dB/0	7.1dB/0	8.5dB/0	*	*
	17.19 x 0.457	*	9.5dB/10	11.0dB/0	*	*	*
C	9.47 x 0.345	*	5.1dB/10	8.5dB/10	7.9dB/0	1.0dB/0	*
	17.19 x 0.610	*	10.6dB/10	11.0dB/0	*	*	*

DOUBLET PERFORMANCE COMPARISON:

0.50 x 0.104	*	*	*	*	*	*
0.50 x 0.259	*	*	*	*	1.3dB	3.0dB
0.50 x 0.345	*	*	*	1.2dB	3.5dB	4.5dB
0.50 x 0.457	*	*	*	4.1dB	5.6dB	6.4dB
0.50 x 0.610	*	*	4.0dB	6.5dB	7.6dB	6.8dB

APPLICATION NOTE:

- The antenna dimensions above state the antennas full length first followed by its height above the ground. Measurements followed by an asterisk, "*", are constructed by using the first 0.75 wavelengths of wire as feedwire (i.e., located between the radio and the first antenna support). The remaining antenna wire is to form the horizontal element of the antenna. Measurements not followed by an asterisk are to have the antenna feedwire form an angle of 45 degrees with the ground up to the height specified.
- All antenna gains (in dB) are referenced to an isotropic radiator. An asterisk "*" in this portion of the table indicates values of gain which are less than 0.0 dBi. The term ".../XX" states the offset angle, or horizontal azimuthal displacement from the antenna axis at which the stated gain can be achieved.

To better address the significance of the results, the radiation patterns of a horizontally oriented half wave dipole at varying heights above the ground were also generated using the NEC3 code and the specified ground constants. This antenna configuration, better known as the doublet antenna, is typical of the antenna configurations currently utilized for HF teletype communications. A composite sketch of the doublet antenna's broadside far field radiation pattern is shown in Figure 3.5. It may be seen that as the height of the antenna increases, the take off angle decreases while, at the same time, the gain of

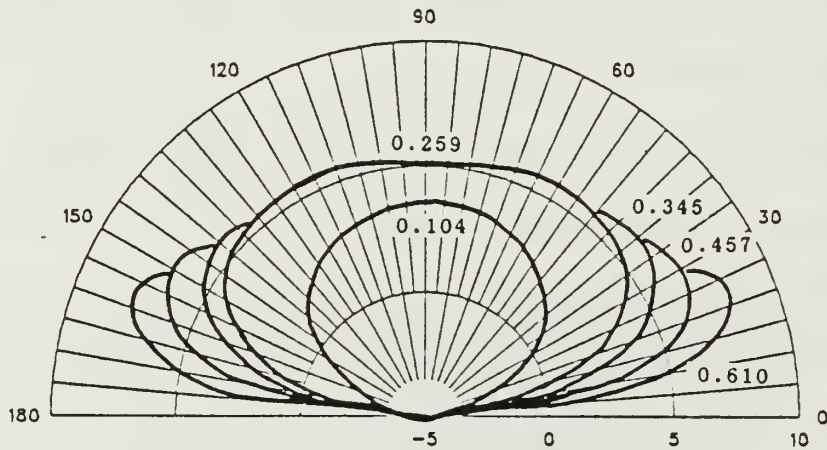

Figure 3.5 Doublet Radiation Pattern (dBi) as a Function of Height in Wavelengths

the lowest lobe of radiation increases rather significantly. It should be noted however, that the low take off angles occur for antenna configurations located a considerable distance above the ground. For example, to obtain the lowest take off angle pictured at an operating frequency of

17 MHz, the antenna would have to be placed at a height of approximately 30 feet.

As constructed, Table 5 provides an easily referenced comparison of relative antenna gains that were derived from the NEC3 antenna modeling runs. Although it does not conform to the usual progression or presentation of input parameters, it is, nonetheless, a viable interleaving of the height and length parameters along with an indication of their respective performance characteristics for the given ground conditions.

6. The HMMWV Mounted Radio Configuration

Antenna configurations 1(a) and 5, in which the HMMWV model was substituted for the generic radio, were used to determine the effects of a HMMWV mounted radio relative to the standard radio configuration. There was however a deviation in the geometry in which the feed wire formally attached to the radio was raised in an arc-like path to the height of the HMMWV feedpoint, without disturbing the remaining components of the antenna. This in effect reduced the angle that the feedwire formed with the ground to varying degrees, with the more pronounced deviations occurring at the lower antenna height of 6 feet.

The far field radiation patterns were similar to those of the box radio under the standard antenna configurations with the exception of an overall increase of gain of roughly 1 to 2 dBi over the entire HMMWV pattern. With

a lack of additional incremental changes to the antenna geometry, it cannot be determined whether the increase in gain was driven by the presence of the HMMWV, or whether it was due to the changes implemented in the antennas' geometry. Regardless of the cause of the pattern changes, it is reasonable to state that the HMMWV does not significantly change the comparative results of Table 5.

IV. SUMMARY AND APPLICATION OF THE FINDINGS

A. AN OVERVIEW

In general, the field expedient horizontal long wire antenna when used in a long range (1000 to 1500 nautical miles) communications circuit, has several inherent advantages as well as disadvantages.

The advantages include:

1. The construction of the horizontal long wire antenna is simple and straightforward requiring only wire, nonmetallic support poles and guys, and a terminating resistor and ground stake if unidirectional propagation is desired. A 12:1 transformer is required if coaxial line is used to feed the antenna.
2. The radio operator can transmit to and receive from different directions depending on the orientation of the antenna.
3. Lower radiation angle and significant increases in signal gain can be realized when compared with the conventional horizontal half wave dipole.

The disadvantages include:

1. The antenna's physical configuration and the manner in which it operates result in antenna characteristics which are quite sensitive to the electrical properties of the ground over which it operates.
2. A finite amount of time and materials are required to set up and retrieve the antenna from a field site.
3. The antenna may require a relatively large amount of open terrain in order to operate "as predicted without interference from obstructions lying in the path of propagation.
4. In open terrain, the antenna may present a fairly large and recognizable target to aerial observers.

In order to make a knowledgeable decision on the suitability of the antenna for a particular situation, the field communication personnel need to have an accurate perspective of the antenna's merits, as well as its weaknesses relative to those of other suitable antennas.

B. GENERAL CONSIDERATIONS

If the long wire antenna is to be employed over typically arid sandy soil or mountainous rocky terrain, its characteristics may vary significantly from the characteristics currently cited in numerous military publications. Adding to the publications' inaccuracies are the uncertainties associated with ionospheric interaction on the propagated wave. Even in the case of stable "quiet" ionospheric conditions, variations within the ionosphere itself may cause the path of the radiated waves to vary as much as 5 degrees in azimuth from the intended propagation path [Ref. 4].

C. FREQUENCIES OF OPERATION

The use of low take off angles in the range of 0 to 30 degrees, and the use of higher frequencies that will enable the sky wave to penetrate lower ionospheric layers during the daytime are two logical choices to achieve a satisfactory long range single hop communications link. An additional benefit that is derived from the use of the upper HF band is the reduced physical length and height of the

antenna for a particular antenna geometry and level of performance.

Although frequency assignments are typically directed by higher headquarters or issued from an applicable service instruction, a conscientious frequency planning and management effort may at some time present the opportunity to optimize long range communications circuits. As such, some basic considerations and guidelines should apply.

For low take off angles in the range of 0 to 30 degrees, a higher maximum usable frequency, or MUF, can be computed by multiplying the locally computed critical frequency of the vertical incident skywave by the scale factor listed in the Table 6 below, which is derived from the take off angle of the transmission.

$$f_{MUF} = (f_{CRIT}) \times (\text{frequency scale factor}) \quad (4.1)$$

where:

f_{MUF} = Maximum Usable Frequency for low angle propagation in MHz

f_{CRIT} = Critical frequency of the vertical incident sky wave in MHz

The 'frequency scale factor' is chosen from Table 6.

From this calculation, the highest frequency authorized that is equal to or less than the newly computed MUF should be used.

D. GEOMETRY SELECTION AND PERFORMANCE CHARACTERISTICS

The selection process by which a suitable long wire antenna configuration may be selected from a table of given

TABLE 6
FREQUENCY SCALE FACTORS

Maximum Desired Take Off Angle (degrees)	Scale Factor	Maximum Desired Take Off Angle (degrees)	Scale Factor
5	11.47	20	2.92
10	5.75	25	2.36
15	3.86	30	2.00

antenna geometries, knowing the required take off angle, is the methodology implemented for 'optimizing' the antenna's geometry and performance characteristics. If either the height or length of the antenna must be constrained, it will be necessary to perform some computations to determine the arguments for the table lookup.

Identical tables organized first by increasing antenna heights, and second, by increasing antenna lengths are presented as Tables 7 and 8 respectively.

Enter the table at the column which contains the range of values appropriate for the desired take off angle. The maximum value of gain in terms of dBi units (i.e., the

TABLE 7

ANTENNA PERFORMANCE WITH DIMENSIONS
ORDERED BY INCREASING HEIGHT

DIMENSIONS (WAVELENGTHS)	ELEVATION ANGLE (DEGREES)					
	0-5	5-10	10-15	15-20	20-25	25-30
1.87 x 0.103	*	*	*	*	*	*
4.04 x 0.103	*	*	0.3dB/ 0	2.2dB/ 0	3.3dB/ 0	2.1dB/ 0
9.47 x 0.103	*	0.3dB/ 0	4.7dB/ 0	4.0dB/ 0	*	*
4.75 x 0.125 (*)	*	*	*	2.8dB/10	3.2dB/ 0	1.1dB/ 0
3.31 x 0.183	*	*	*	2.0dB/20	3.1dB/20	3.3dB/10
7.32 x 0.183	*	0.5dB/ 0	5.0dB/ 0	6.9dB/ 0	4.0dB/ 0	*
17.19 x 0.183	*	5.7dB/ 0	8.5dB/ 0	*	*	*
4.75 x 0.250 (*)	*	*	2.4dB/20	4.5dB/20	5.1dB/10	4.5dB/ 0
2.09 x 0.259	*	*	*	2.4dB/30	3.9dB/30	4.8dB/30
4.04 x 0.259	*	*	2.7dB/20	4.9dB/20	5.0dB/10	5.2dB/0
9.47 x 0.259	*	3.0dB/ 0	7.1dB/ 0	8.5dB/ 0	*	*
4.04 x 0.345	*	0.2dB/20	4.1dB/20	6.3dB/20	6.8dB/20	6.3dB/10
9.47 x 0.345	*	5.1dB/10	8.5dB/10	7.9dB/ 0	1.0dB/ 0	*
4.75 x 0.375 (*)	*	*	4.9dB/20	6.7dB/20	6.2dB/10	5.8dB/ 0
3.69 x 0.457	*	1.5dB/20	5.3dB/20	7.3dB/20	8.2dB/20	7.2dB/20
7.32 x 0.457	*	3.5dB/10	8.2dB/20	9.3dB/10	7.8dB/ 0	0.5dB/0
17.19 x 0.457	*	9.5dB/10	11.0dB/ 0	*	*	*
4.75 x 0.500 (*)	*	2.5dB/20	6.5dB/20	8.4dB/20	7.1dB/10	6.6dB/ 0
7.32 x 0.610	*	5.0dB/20	9.9dB/20	9.9dB/10	8.0dB/ 0	0.8dB/0
17.19 x 0.610	*	10.6dB/10	11.0dB/ 0	*	*	*

DOUBLET PERFORMANCE COMPARISON:

0.50 x 0.104	*	*	*	*	*	*
0.50 x 0.259	*	*	*	*	1.3dB	3.0dB
0.50 x 0.345	*	*	*	1.2dB	3.5dB	4.5dB
0.50 x 0.457	*	*	*	4.1dB	5.6dB	6.4dB
0.50 x 0.610	*	*	4.0dB	6.5dB	7.6dB	6.8dB

APPLICATION NOTE:

1. The antenna dimensions above state the antennas full length first followed by its height above the ground. Measurements followed by an asterisk, "*", are constructed by using the first 0.75 wavelengths of wire as feedwire (i.e., located between the radio and the first antenna support). The remaining antenna wire is to form the horizontal element of the antenna. Measurements not followed by an asterisk are to have the antenna feedwire form an angle of 45 degrees with the ground up to the height specified.
2. All antenna gains (in dB) are referenced to an isotropic radiator. An asterisk "*" in this portion of the table indicates values of gain which are less than 0.0 dBi. The term "X/XX" states the offset angle, or horizontal azimuthal displacement from the antenna axis at which the stated gain can be achieved.

TABLE 8

ANTENNA PERFORMANCE WITH DIMENSIONS
ORDERED BY INCREASING LENGTH

DIMENSIONS (WAVELENGTHS)	ELEVATION ANGLE (DEGREES)					
	0-5	5-10	10-15	15-20	20-25	25-30
1.87 x 0.103	*	*	*	*	*	*
2.09 x 0.259	*	*	*	2.4dB/30	3.9dB/30	4.8dB/30
3.31 x 0.183	*	*	*	2.0dB/20	3.1dB/20	3.3dB/10
3.69 x 0.457	*	1.5dB/20	5.3dB/20	7.3dB/20	8.2dB/20	7.2dB/20
4.04 x 0.103	*	*	0.3dB/ 0	2.2dB/ 0	3.3dB/ 0	2.1dB/ 0
4.04 x 0.259	*	*	2.7dB/20	4.9dB/20	5.0dB/10	5.2dB/0
4.04 x 0.345	*	0.2dB/20	4.1dB/20	6.3dB/20	6.8dB/20	6.3dB/10
4.75 x 0.125 (*)	*	*	*	2.8dB/10	3.2dB/ 0	1.1dB/ 0
4.75 x 0.250 (*)	*	*	2.4dB/20	4.5dB/20	5.1dB/10	4.5dB/ 0
4.75 x 0.375 (*)	*	*	4.9dB/20	6.7dB/20	6.2dB/10	5.8dB/ 0
4.75 x 0.500 (*)	*	2.5dB/20	6.5dB/20	8.4dB/20	7.1dB/10	6.6dB/ 0
7.32 x 0.183	*	0.5dB/ 0	5.0dB/ 0	6.9dB/ 0	4.0dB/ 0	*
7.32 x 0.457	*	3.5dB/10	8.2dB/20	9.3dB/10	7.8dB/ 0	0.5dB/0
7.32 x 0.610	*	5.0dB/20	9.9dB/20	9.9dB/10	8.0dB/ 0	0.8dB/0
9.47 x 0.103	*	0.3dB/ 0	4.7dB/ 0	4.0dB/ 0	*	*
9.47 x 0.259	*	3.0dB/ 0	7.1dB/ 0	8.5dB/ 0	*	*
9.47 x 0.345	*	5.1dB/10	8.5dB/10	7.9dB/ 0	1.0dB/ 0	*
17.19 x 0.183	*	5.7dB/ 0	8.5dB/ 0	*	*	*
17.19 x 0.457	*	9.5dB/10	11.0dB/ 0	*	*	*
17.19 x 0.610	*	10.6dB/10	11.0dB/ 0	*	*	*

DOUBLET PERFORMANCE COMPARISON:

0.50 x 0.104	*	*	*	*	*	*
0.50 x 0.259	*	*	*	*	1.3dB	3.0dB
0.50 x 0.345	*	*	*	1.2dB	3.5dB	4.5dB
0.50 x 0.457	*	*	*	4.1dB	5.6dB	6.4dB
0.50 x 0.610	*	*	4.0dB	6.5dB	7.6dB	6.8dB

APPLICATION NOTE:

1. The antenna dimensions above state the antennas full length first followed by its height above the ground. Measurements followed by an asterisk, "*", are constructed by using the first 0.75 wavelengths of wire as feedwire (i.e., located between the radio and the first antenna support). The remaining antenna wire is to form the horizontal element of the antenna. Measurements not followed by an asterisk are to have the antenna feedwire form an angle of 45 degrees with the ground up to the height specified.
2. All antenna gains (in dB) are referenced to an isotropic radiator. An asterisk "*" in this portion of the table indicates values of gain which are less than 0.0 dBi. The term ".../XX" states the offset angle, or horizontal azimuthal displacement from the antenna axis at which the stated gain can be achieved.

highest dBi value) within the column is then chosen. Restrictions on antenna height/length parameters, if they do exist, can then be found in the left hand column, and the appropriate range of rows searched for the maximum value of gain. The antenna dimensions in the left hand column, and the offset angle accompanying the gain found within the appropriate table block would then be noted for construction of the antenna. When recording the antenna dimensions, it should also be noted if the dimensions are followed by an asterisk which indicates a different geometry.

While in the table, the performance of a horizontally oriented half wave dipole, or 'doublet', presented at the bottom of the table should be checked for comparative values and a decision made as to which antenna to select to perform the mission.

Table values must be converted for the type of the wire to be used in the construction of the antenna. For copper, phosphor bronze, or 'WD-1/TT' antenna wire, the conversion to be made is [Ref. 8]:

$$\begin{aligned} \text{Dimension in wavelengths} \times (\text{Y / Operating Freq in MHz}) \\ = \text{Antenna Dimension (ft)} \end{aligned} \quad (4.2)$$

where:

$$\begin{aligned} Y &= 984 \text{ for copper or phosphorous bronze wire} \\ &= 969 \text{ (approximately) for WD-1/TT} \end{aligned}$$

E. CONSTRUCTION CONSIDERATIONS

Construction of the antenna is accomplished by utilizing nonmetallic support structures--lance poles are ideal--and nonmetallic guys as appropriate to render adequate support. The antenna wire may be attached to the radio using a BNC adapter (UG-1441/U), or by using the short length of line with a thumbscrew attachment provided for exactly that purpose in the case of the AN/GRC 193 vehicular mounted transceiver.

The antenna wire leading from the radio to the first support will be oriented at a 45 degree angle relative to the ground, as pictured in Figure 4.1. For the antenna

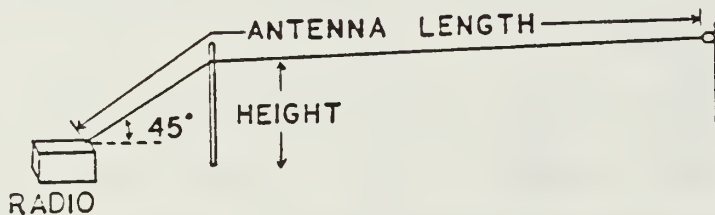

Figure 4.1 General Antenna Configuration

dimensions that were annotated with an asterisk, the first 3/4 wavelength section of the antenna will be used as the feed wire to the horizontal element, regardless of antenna height. This will form significantly smaller angles between the feed wire and ground.

Because a significant amount of tension must be placed on the wire to keep it from sagging excessively between supports, it is recommended that if a small radio is used, it be braced against a firmly planted wooden stake for support, as seen with the simulated radio in Figure 4.2. It is also necessary that the guys of the last support be properly positioned to maintain the appropriate amount of tension.

If desired, the radial wire ground screen may be formed by twisting and tying (and preferably soldering) the eight 1/8th wavelength wire ends together at the common junction and then connecting an uplead to the grounding terminal of the radio set. Typically the length of the radials should be approximately 1/8th of the free space wavelength, determined by the following formula:

$$\begin{aligned} \text{1/8th Wavelength (ft)} = \\ 123.03 / \text{Operating Freq (MHz)} \quad (4.3) \end{aligned}$$

Standard copper or iron 3 foot sectioned ground rods currently in use and available as SL-3 components should be used for grounding purposes. A terminating resistance on the order of 600 ohms may be fabricated using supply system components, and should be capable of absorbing at least one half of the transmitter power.

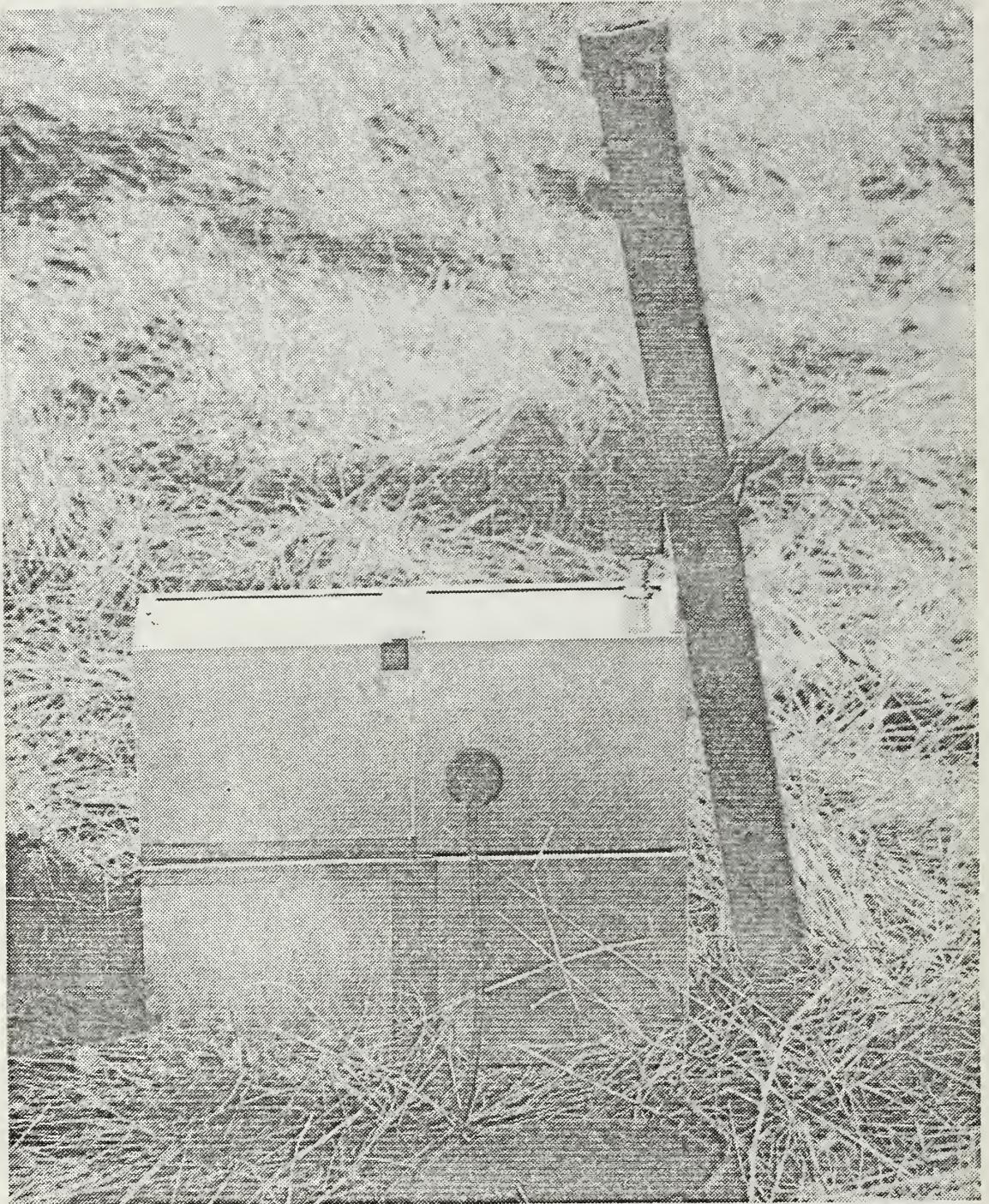

Figure 4.2 Supporting the Radio with a Wooden Stake

V. CONCLUSIONS

The insight gained through this investigation of the long wire antenna can only be expressed in relative terms. It presents itself as a step forward from the material currently appearing in the military publications, but only scratches the surface in a broader perspective of the number of antennas that appear military publications, whose information may be inaccurate in terms of real world applications and lossy grounds.

When configured and oriented properly, the long wire field expedient antenna can be a more effective configuration than a half wave horizontally oriented dipole for point to point longhaul communications (1000 to 1500 nautical miles). Since it is relatively easy to construct and does not have to be elevated to inordinate heights to be an effective radiator at low take off angles, the long wire antenna is a viable contender for timely, field expedient construction requiring little in the way of construction materials.

Both the height and length of the antenna share in creating the unique far field pattern in terms of gain, elevation and offset angle, and as such, they must be considered together when choosing an appropriate configuration.

Tables provided in this report contain computer generated results that are consequently referenced by both the height and length of the antenna.

Antenna appendages such as ground rods and radials generally tend to decrease antenna gain, but may also serve to reduce the input impedance of the antenna and therefore serve an important purpose in the antenna impedance matching scheme. Further testing of the antenna configurations is necessary however, to validate this assertion.

The far field radiation patterns did not show any significant deviations of the pattern geometry based on the characteristic shape of the transceiver. They did however, undergo a small but noticeable reduction of power gain over the entire pattern indicating that the general results could be scaled to account for variations to the size of the transceiver.

VI. RECOMMENDATIONS

It is recommended that the results contained herein be independently validated, preferably by 'field testing', and a subsequent appraisal made of the accuracy of these results as compared with currently published and utilized procedures.

It is further recommended that the results of this investigation be reviewed and incorporated into current military publications to update or correct inaccuracies in their presentations of long wire antennas, as appropriate. Additionally, it is recommended that related courses of instruction be modified to reflect the findings contained herein.

A number of other common antenna configurations should be investigated for use in the longhaul communications circuit in order to assemble a reliable comparative data base for that specific mission.

An aspect that was not covered in this investigation is the characteristics of the HF transceivers that interface with and drive the antennas, in particular, the PRC 104 and the AN/GRC 193. There is a need for better understanding of the fraction of available output power that is actually transferred to the antenna, and what trade-offs exist

between the transmitter's output circuitry or antenna matching unit, and the antenna's driving point impedance, in terms of useful radiated power. An investigation into this area is strongly recommended.

APPENDIX A

SERVICE PUBLICATIONS LIST

The applicable service publications that were reviewed for background to this investigation are listed by service as follows:

DEPARTMENT OF DEFENSE:

Field Antenna Handbook, ECAC-CR-83-200, Electromagnetic Compatability Analysis Center, Annapolis, MD.

DEPARTMENT OF THE ARMY:

Communications - Electronics Fundamental: Transmission Lines, Wave Propagation and Antennas [FM 11-64].

Conventvional and Field Expedient Antennas, Signal Center, Fort Gordon, GA.

DEPARTMENT OF THE AIR FORCE:

Antenna Theory and Practical Application, 7801-301, Innerservice Radio Frequency Management School, Keesler AFB, MS.

Common HF Antenna Vertical Radiation Patterns, 8009-311, Innerservice Radio Frequency Management School, Keesler AFB, MS.

MARINE CORPS:

Antennas, Conventional and Field Expedient, SM COS 5, Communications Officers School, MCDEC, Quantico, VA.

APPENDIX B

NUMERICAL ELECTROMAGNETICS CODE
DATA SETS

CM	*****	THE HMMWV MODEL	*****
CM		26 OCTOBER 1986	
CM		CAPT. R.J. GILLESPIE SP. USMC	
CM	*****		*****
GM	100,2,42,0,16,42,0,30,-.0625		FRONT: FORM BOX
GM	101,2,26,0,16,26,0,30,-.0625		VERT OPIENTED
GM	102,2,10,0,16,10,0,30,-.0625		I-Z PLANE
GM	103,2,42,0,16,42,0,16,-.0625		
GM	104,1,10,0,16,0,0,16,-.0625		
GM	2,1,0,0,0,0,0,14,103,104		
GM	8,2,0,0,0,0,0,29,0,100,106		DISP POP HOOD
GM	24,2,0,0,0,0,0,92,0,100,106		BOX TO REAR CAB
GM	150,2,0,0,16,10,58,16,-.0625		CONN HOOD BOXES
GM	2,2,0,0,0,16,0,0,150,150		FORM CAB FLOOR
GM	5,1,0,0,0,0,0,14,150,154		IE: LOWEST BOX
GM	160,4,0,10,58,16,0,10,126,0,-.0625		
GM	1,2,0,0,0,0,16,0,0,160,160		
GM	3,1,0,0,0,0,32,0,0,16,160,160		
GM	165,2,0,42,58,0,10,58,0,-.0625		CROSS PCS OF
GM	166,1,0,10,58,0,0,58,0,-.0625		CAB FLOOR
GM	2,4,1,0,0,0,0,17,0,165,166		
GM	9,1,0,0,0,0,0,68,16,165,166		CROSS PCS OF
GM	1,1,0,0,0,0,0,51,16,165,166		TRUCK BED
GM	180,1,0,10,58,0,10,58,16,-.0625		VERT PCS OF
GM	1,2,0,0,0,16,0,0,180,180		CAB FLOOR
GM	2,3,0,0,0,0,17,0,182,182		
GM	190,1,0,10,126,0,10,126,16,-.0625		
GM	200,1,0,10,92,0,10,92,16,-.0625		VERT PCS FOR
GM	2,1,0,0,0,16,0,0,200,200		REAR OF CAB
GM	204,1,0,26,126,0,26,126,16,-.0625		INNP WHEL WELL
GM	205,2,0,26,126,16,0,26,126,30,-.0625		
GM	2,1,0,0,0,16,0,0,204,205		CTR TRUCK BED
GM	210,2,0,10,92,16,10,126,16,-.0625		LONG PCS OF
GM	211,4,0,10,126,16,10,178,16,-.0625		TRUCK BED
GM	2,1,0,0,0,16,0,0,210,210		
GM	4,2,0,0,0,14,0,0,211,211		
GM	5,1,0,0,0,0,0,14,215,219		TOP OF WHEL WELL
GM	2,1,0,0,0,32,0,14,210,210		TOP OF CTR BED
GM	231,1,42,109,16,42,109,30,-.0625		VERT: CTR BED
GM	232,2,26,126,30,42,126,30,-.0625		CROSS: TOP FR W/W
GM	2,1,0,0,0,0,52,-14,232,232		BOT REAR W/W
GM	240,1,0,26,139,16,26,139,30,-.0625		FRAME WHEL WELL
GM	1,1,0,0,0,16,0,0,240,240		
GM	242,2,0,26,139,30,42,139,30,-.0625		
GM	3,3,0,0,0,0,13,0,240,242		
GM	255,1,0,26,139,16,0,10,139,16,-.0625		CROSS: BED BTWN
GM	256,1,0,10,139,16,0,139,16,-.0625		W/W
GM	2,3,0,0,0,0,0,13,0,255,256		
GM	8,1,0,0,0,0,39,14,255,256		CROSS: TOP TAIL G
GM	270,2,0,10,29,16,0,10,58,0,-.0625		OBLIQUE FRONT
GM	1,2,0,0,0,16,0,0,270,270		
GM	275,1,0,26,126,0,26,139,16,-.0625		OBLIQUE REAR
GM	1,1,0,0,0,16,0,0,275,275		
GM	280,1,0,42,58,30,42,58,53,-.0625		FR WINDSHIELD
GM	120,1,0,0,0,0,0,53,165,166		
GM	10,1,0,0,0,0,0,54,280,286		REAR WINDSHIELD
GM	298,2,42,58,53,42,92,53,-.0625		LONG WINDSHIELD
GX	300,100		TRANS THRU Y-Z
GM	599,4,34,126,30,34,178,30,-.0625		L/R FENDER
GM	600,2,34,178,30,34,178,16,-.0625		
GM	0,0,0,0,0,-34,-178,19,100,600		MOVE TO FEED PT

```

*****
CM THE BIG BOY HMMWV MODEL
CM 26 OCTOBER 1986
CM CAPT. R.J. GILLESPIE SP. USMC
*****
GM 100,1,0,0,0,0,0,0,30,0,0125 CREATE BOX ENDS
GM 1,2,0,0,0,0,42,0,0,100,100
GM 175,2,0,0,0,0,84,0,0,0125
GM 1,1,0,0,0,0,0,0,0,105,105
GM 10,1,0,0,0,0,0,0,176,0,100,107
GM 120,1,0,0,0,0,0,0,30,0,0125 FRONT AND BACK
GM 1,1,0,0,0,0,0,0,0,120,120
GM 123,1,0,0,44,0,0,44,30,0125
GM 1,2,0,0,0,0,0,44,0,123,123
GM 10,1,0,0,0,0,84,0,0,120,129
GM 20,1,0,0,0,0,42,0,0,120,120 TOP AND BOTTOM
GM 1,1,0,0,0,0,42,0,0,140,140
GM 4,1,0,0,0,0,0,44,0,125,105
GM 1,2,0,0,0,0,0,44,0,145,145
GM 15,1,0,0,0,0,0,0,-30,140,151
GM 170,1,0,0,44,30,0,44,53,0125 WINDSHIELD
GM 1,1,0,0,0,0,0,0,0,170,170
GM 173,1,0,0,44,53,0,44,53,0125
GM 5,1,0,0,0,0,0,44,0,170,173
GM 179,1,0,0,44,53,0,0,88,53,0125
GM 1,1,0,0,0,0,84,0,0,179,179
GM 0,0,0,0,0,0,-84,-176,19,100,180 MOVE TO FEED

```

```

*****
CM SIMPLIFIED BOX RADIO
CM *****
CE
GM 100,1,0,0,0,4,0,0,.0625 *** BOX RADIO ***
GM 101,1,4,0,0,4,0,11,.0625
GM 102,1,4,0,11,0,0,11,.0625
GM 103,1,0,0,11,0,0,0,.0625
GM 4,1,0,0,0,0,12,0,100,103
GM 110,1,0,0,0,0,12,0,.0625
GM 111,1,4,0,0,4,12,0,.0625
GM 2,1,0,0,0,0,0,11,110,111
GM 0,0,0,0,0,0,-12,1,100,115 MOVE TO FEED POINT

```

```

*****
CM      EIGHT 1/4 L RADIALS CONNECTED TO RADIO
CM      RADIALS PLACED 1 INCH BELOW THE GROUNDS SURFACE
CM      DESIGN FREQ =17.0 EPSILON = 10 SIGMA= 0.003
*****
CM
CE
GW 280,1, 0,0,12, 0,6,12, .0625          *FEED TO GND RADIALS*
GW 281,1, 0,6,12, 0,6,6, .0625
GW 282,1, 0,6,6, 0,6,3, .0625
GW 283,1, 0,6,3, 0,6,0, .0625
GW 284,1, 0,6,1, 0,6,0, .0625
GW 285,1, 0,6,0, 0,6,1, .0625
GW 286,1, 0,0,-1, 0,6,1, .0625          *GROUND RADIALS*
GW 287,2, 0,1,-1, 0,5,-1, .0625
GW 288,1, 0,5,-1, 0,9,-1, .0625
GW 289,1, 0,9,-1, 0,15,-1, .0625
GS 0,0, 0.083333
GW 290,6, 0,1.25,-.08333, 0,7.25,-0.08333, .0052  *CONVERT INCHES TO FT*
GM 10,7, 0,0,45, 0,0,0, 286.290          *RADIALS CONT*
GM 0,0, 0,0,0, 0,5,0, 286.400          *CREATE GND RADIAL GEOMETRY*
GM 0,0, 0,0,0, 0,5,0, 100.400          *MOVE RADIALS TO DOWNLEAD*
GS 1          *ROTATE TO -X AXIS*
          *CONVERT FEET TO METER*

```

```

*****
CM      DOWNLEAD INTO A 400 OHM TERM. RESISTOR AND 8 FT GROUND ROD
CM      DESIGN FREQ =17.0 EPSILON = 10 SIGMA = 0.003
*****
CM
CE
GW 260,9, 0,264.82,28.95, 0,264.82,3, .0052          *TERMINATION*
GW 261,1, 0,264.82,3, 0,264.82,1, .0052
GW 265,1, 0,264.82,1, 0,264.82,0, .0052          *RESISTANCE SEGMENT*
GW 270,8, 0,264.82,0, 0,254.82,-8, .0052          *GROUND ROD*
GM 0,0, 0,1,270, 0,0,0, 100.300          *ROTATE TO -X AXIS*
GS 1          *FEET TO METERS*
GE -1
LD 4,265,1,1, 400          ... 400 OHM RESISTANCE

```

```

*****
CM      8 FT GROUND ROD CONNECTED TO THE RADIO
CM      DESIGN FREQ =17.0 EPSILON = 10 SIGMA = 0.003
*****
CM
CE
GW 280,1, 0,0,12, 0,6,12, .0625          *FEED TO GND FOD*
GW 281,2, 0,6,12, 0,6,0, .0625
GW 282,2, 0,6,0, 0,6,-12, .0625
GS 0,0, 0.083333
GW 283,7, 0,0.5,-1, 0,0.5,-8, .0052          *SCALE INCHES TO FT*
GS 1          *GROUND FOD*
          *CONVERT FEET TO METER*

```

```

*****
CM      FEEDBACK LINE TO THE RADIO
CM      DESIGN FREQ =17.0 EPSILON = 10 SIGMA= 0.003
*****
CM
CE
GW 290,1, 0,0,12, 0,6,12, .0625          *FEED FROM RADIO TO FEEDBACK LINE*
GW 281,1, 0,6,12, 0,6,6, .0625
GS 0,0, 0.083333          *SCALE TO INCHES TO FEET*
GW 290,1, 0,1.5,5, 0,1.5,5, .0052          *FEEDBACK LINE*
GW 291,1, 0,1.5,5, 0,3.5,5, .0052
GW 292,1, 0,1.5,5, 0,7.5,5, .0052
GW 293,32, 0,7.5,5, 0,257.32,5, .0052
GW 294,1, 0,257.32,5, 0,261.32,5, .0052
GW 295,1, 0,261.32,5, 0,263.32,5, .0052
GW 296,1, 0,263.32,5, 0,264.32,5, .0052
GS 1          *TIE INTO DOWNLEAD*
          *CONVERT FEET TO METER*

```

```

*****
C  RADIO DRIVEN LONGWIRE
C  #14A, 4.75L X 0.50L, SP 40 D (NO RFKS)
C  DESIGN FREQ =17.0 PERMITSION = 1 SIGMA= 0.003
C  *****
C  *** INSERT THE STANDARD BOX RADIC HERE ***
C  GWS 200,2,0,0,12,0,12,27.6, .0625 *SLANT FEED TO HORIZ.*
C  GS 0,0,0,0,1833333 *SCALE TO FT*
C  GWS 255,1,0,0,1,2,3,0,2.15,3.27, .0052 *SLANT FEED CONT.*
C  GWS 255,1,0,0,1,2,3,0,2.15,3.27, .0052
C  GWS 255,1,0,0,1,2,3,0,2.15,3.27, .0052
C  GWS 255,1,0,0,1,2,3,0,2.15,3.27, .0052
C  GWS 255,1,0,0,1,2,3,0,2.15,3.27, .0052
C  GWS 255,1,0,0,1,2,3,0,2.15,3.27, .0052
C  GWS 255,1,0,0,1,2,3,0,2.15,3.27, .0052
C  GWS 255,1,0,0,1,2,3,0,2.15,3.27, .0052
C  GWS 255,1,0,0,1,2,3,0,2.15,3.27, .0052
C  GWS 255,1,0,0,1,2,3,0,2.15,3.27, .0052
C  GWS 255,1,0,0,1,2,3,0,2.15,3.27, .0052
C  GS 0,0,0,0,270,0,0,0,100.300
C  GE -1 *ROTATE TO -X AXIS*
C  FBS 0,0,0,0,17.0 *CONVERT FEET TO METER*
C  GMS 200,0,0,10, .003
C  GXS 0,200,1,0,1
C  GIL 0,0,0,4
C  RPL 0,181,1,1000, -90,0, 1,0
C  RPL 0,181,1,1000, -90,10, 1,0
C  RPL 0,181,1,1000, -90,20, 1,0
C  RPL 0,181,1,1000, -90,30, 1,0
C  RPL 0,181,1,1000, -90,40, 1,0
C  RPL 0,361,1,1000, 60,0, 0,1
C  RPL 0,361,1,1000, 65,0, 0,1
C  RPL 0,361,1,1000, 70,0, 0,1
C  RPL 0,361,1,1000, 75,0, 0,1
C  RPL 0,361,1,1000, 80,0, 0,1
C  GWS 0,1,361,1000, 80,0, 0,1
C  /*

```

ANTENNA 1A

4 3/4 X 1/2 LAMBDA FREQ=17 MHZ PHI=0

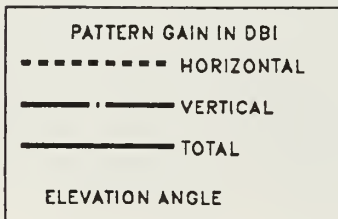
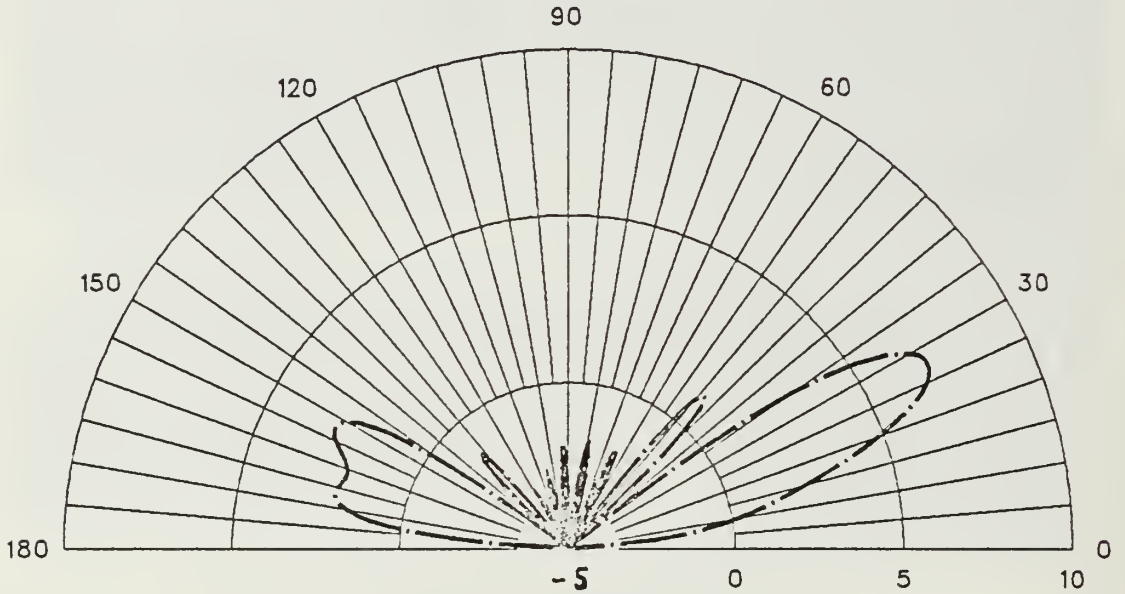

ANTENNA 1A

4 3/4 X 1/2 LAMBDA FREQ=17 MHZ PHI=10

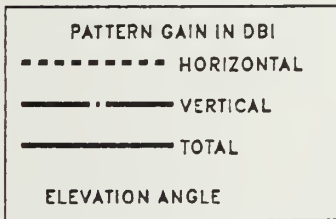
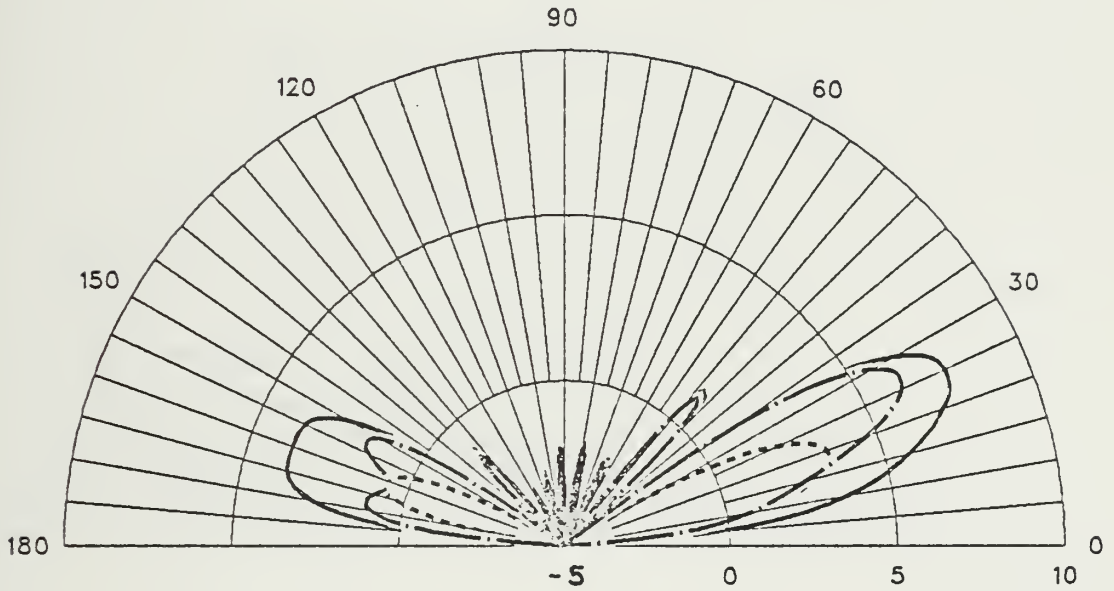

ANTENNA 1A

4 3/4 X 1/2 LAMBDA FREQ=17 MHZ PHI=20

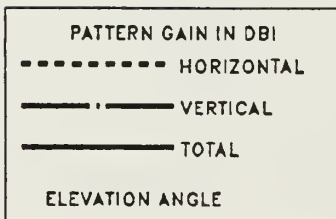
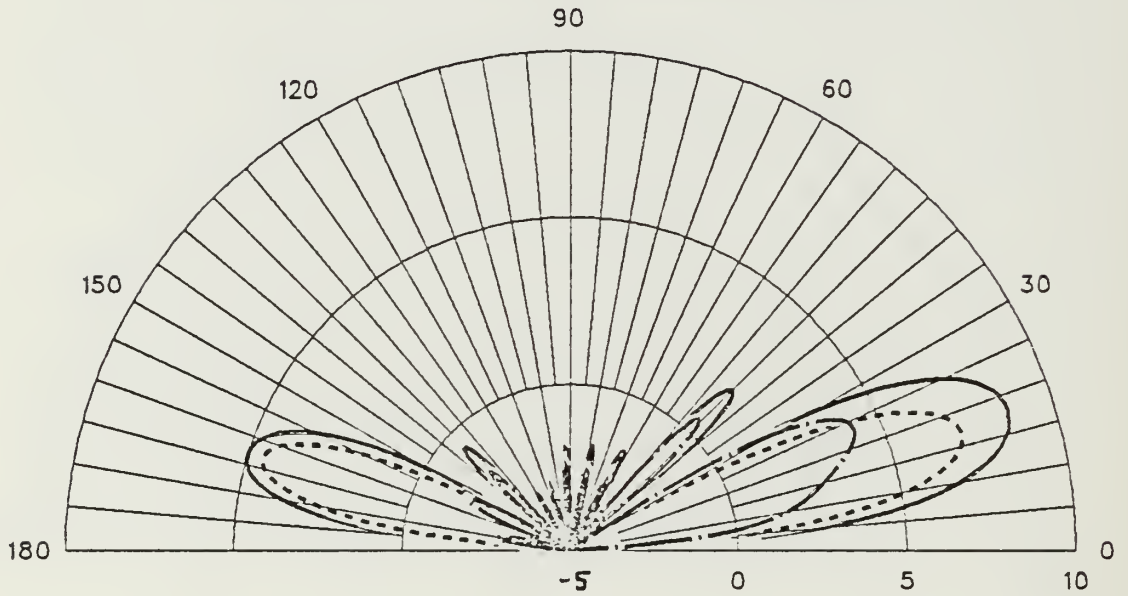

ANTENNA 1A

4 3/4 X 1/2 LAMBDA FREQ=17 MHZ PHI=30

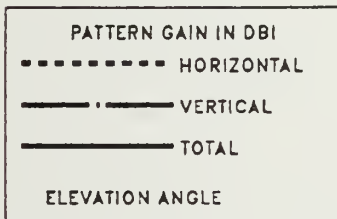
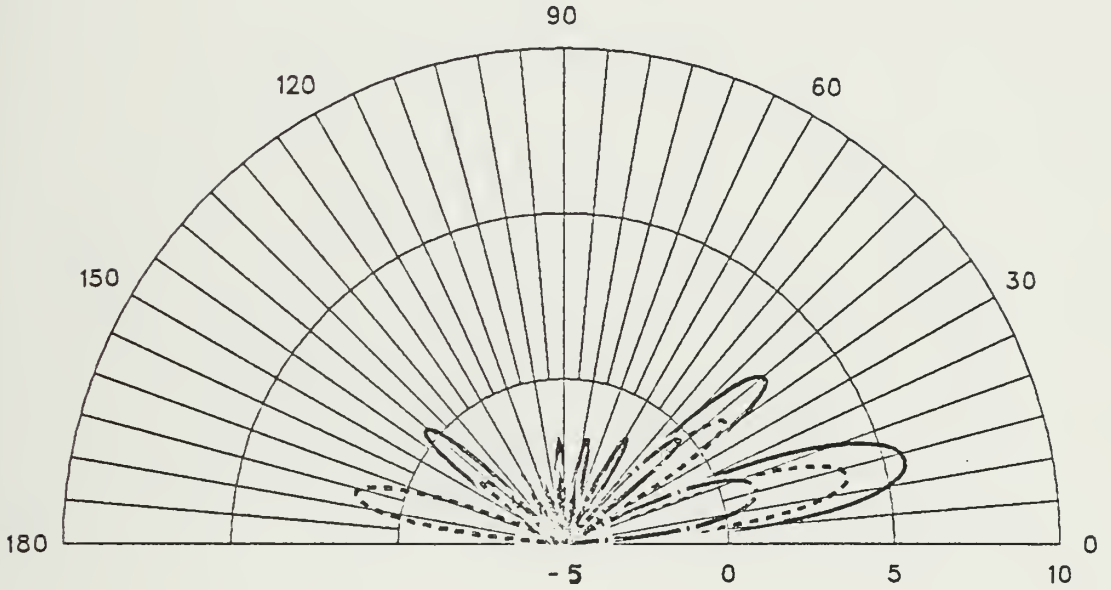

ANTENNA 1A

4 3/4 X 1/2 LAMBDA FREQ=17 MHZ PHI=40

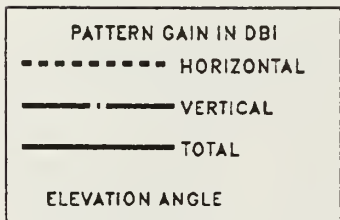
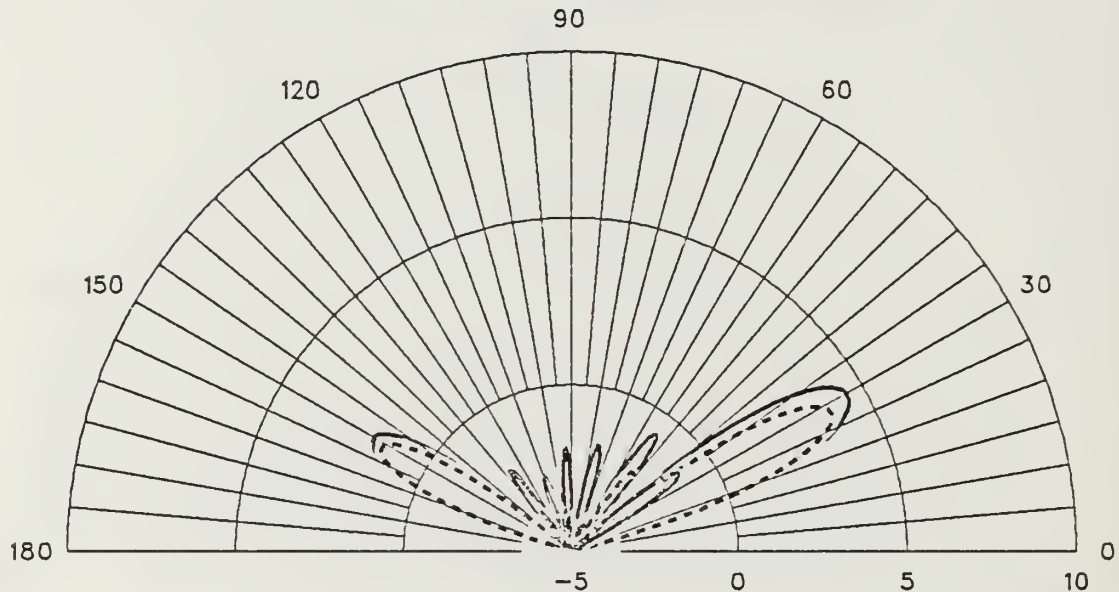

ANTENNA 1B

4 3/4 X 1/8 LAMBDA FREQ=17 MHZ PHI=0

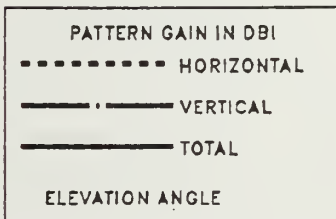
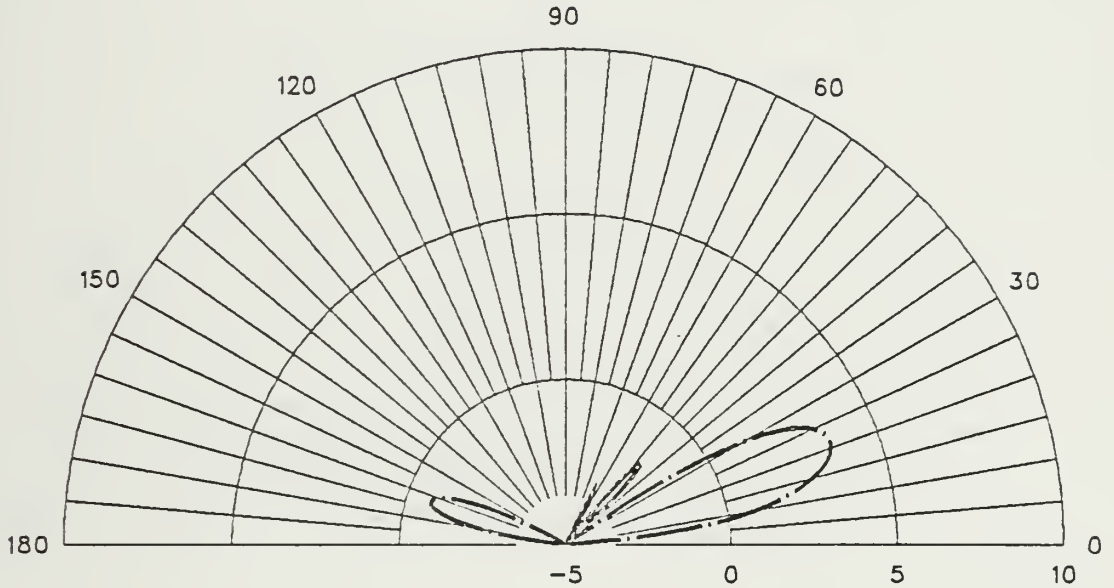

ANTENNA 1B

4 3/4 X 1/8 LAMBDA FREQ=17 MHZ PHI=10

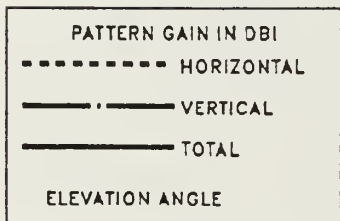
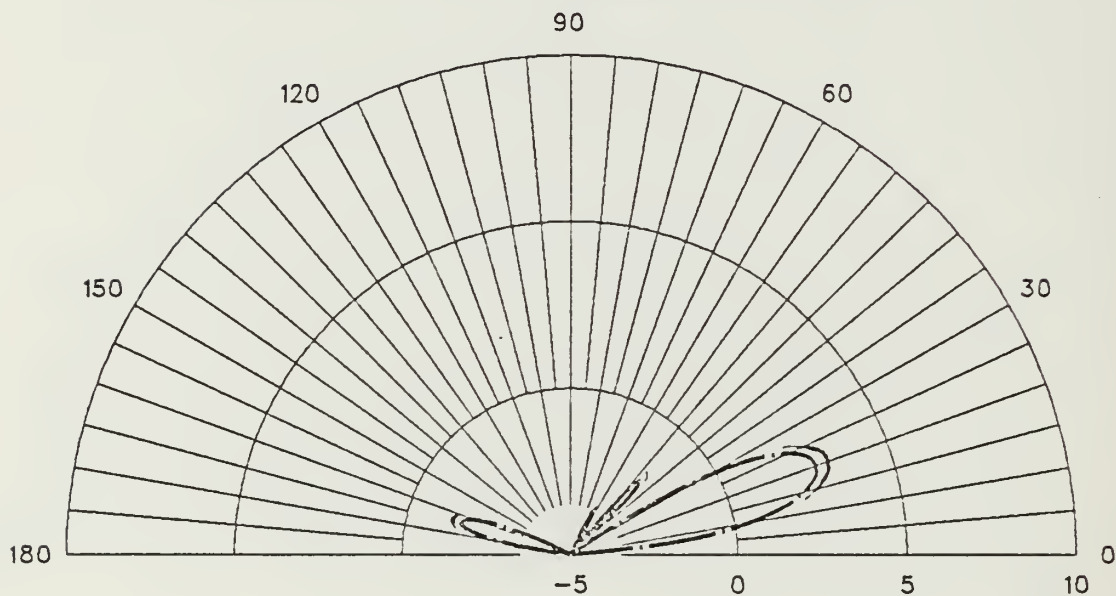

ANTENNA 1B

4 3/4 X 1/8 LAMBDA FREQ=17 MHZ PHI=20

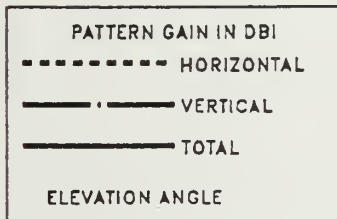
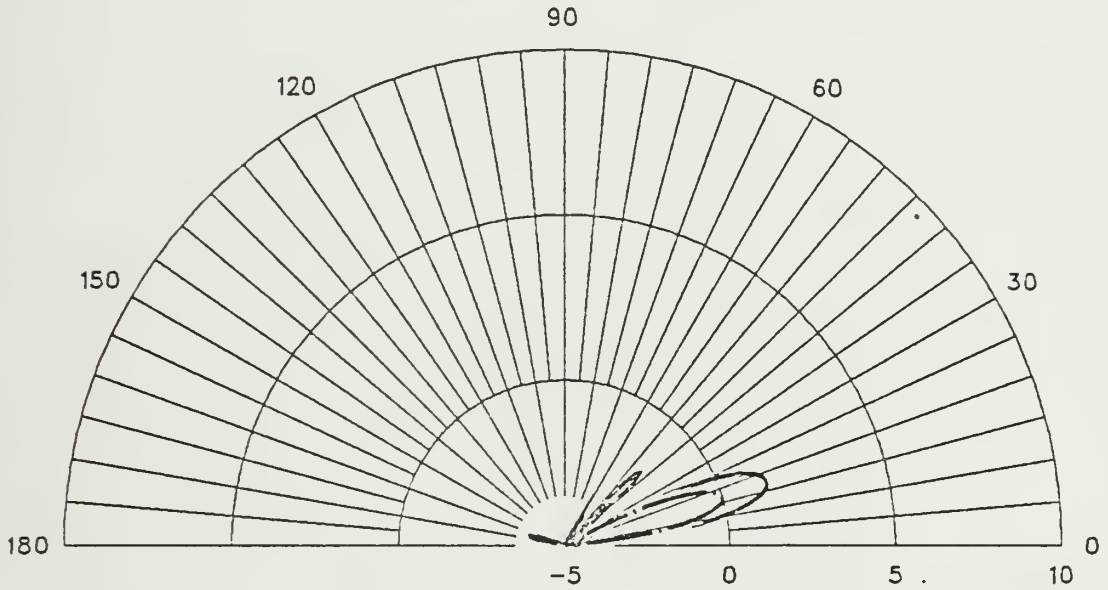

ANTENNA 1B

4 3/4 X 1/8 LAMBDA FREQ=17 MHZ PHI=30

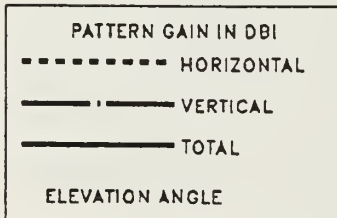
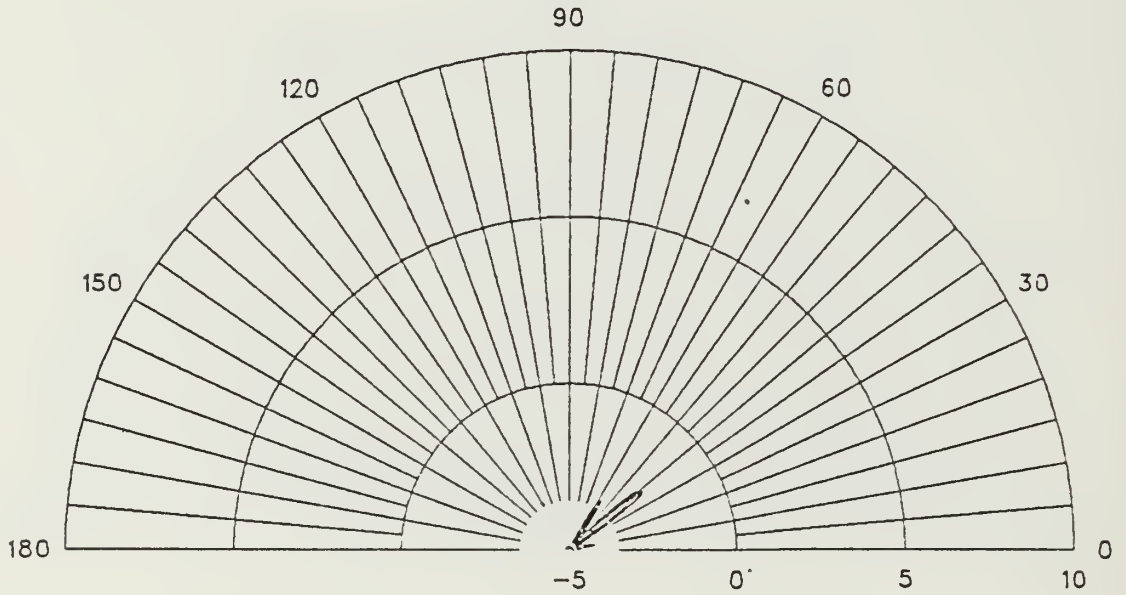

ANTENNA 1B

4 3/4 X 1/8 LAMBDA FREQ=17 MHZ THETA=70

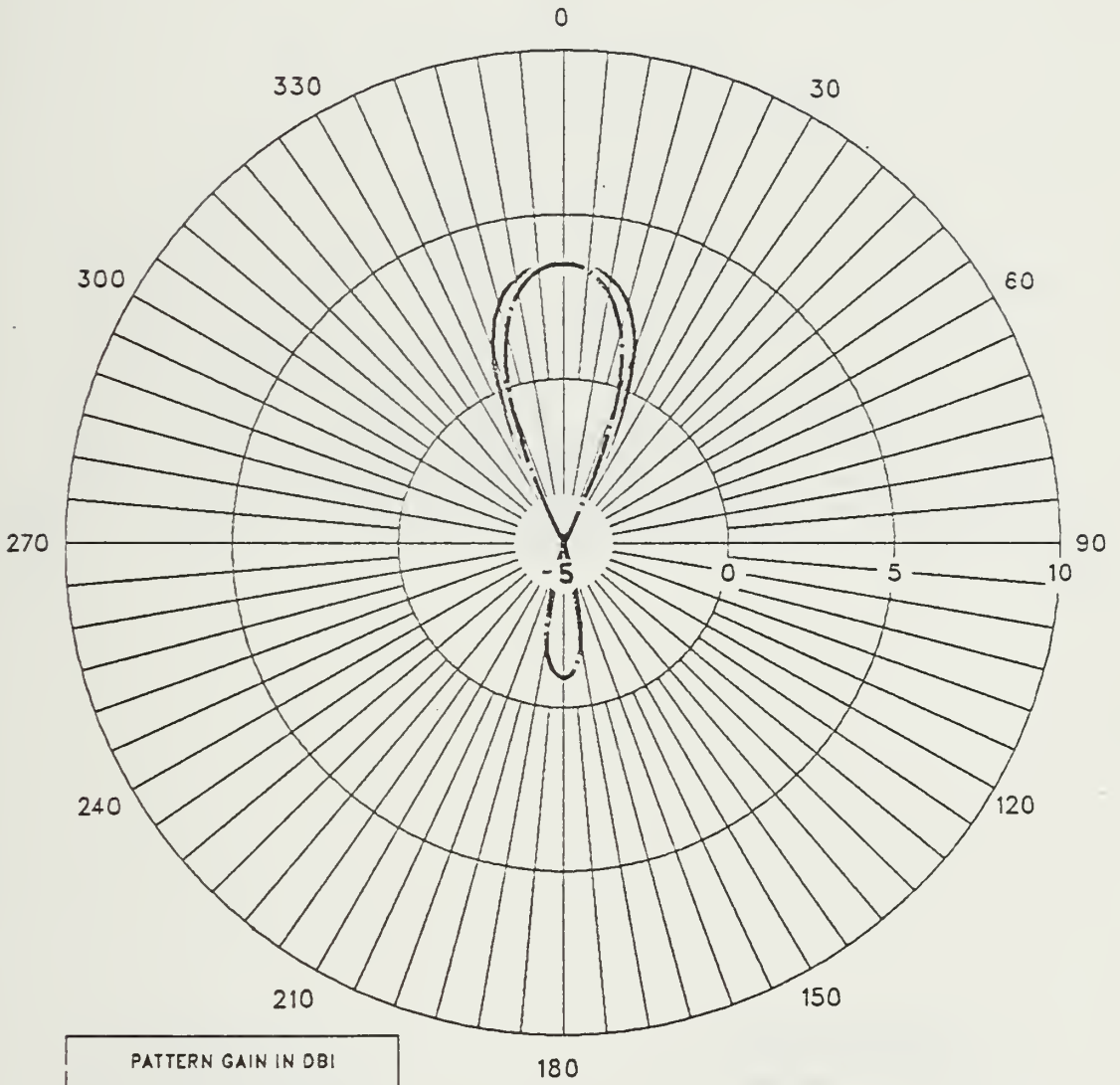

ANTENNA 1B

4 3/4 X 1/4 LAMBDA FREQ=17 MHZ PHI=0

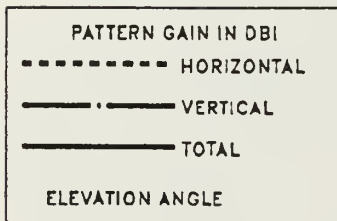
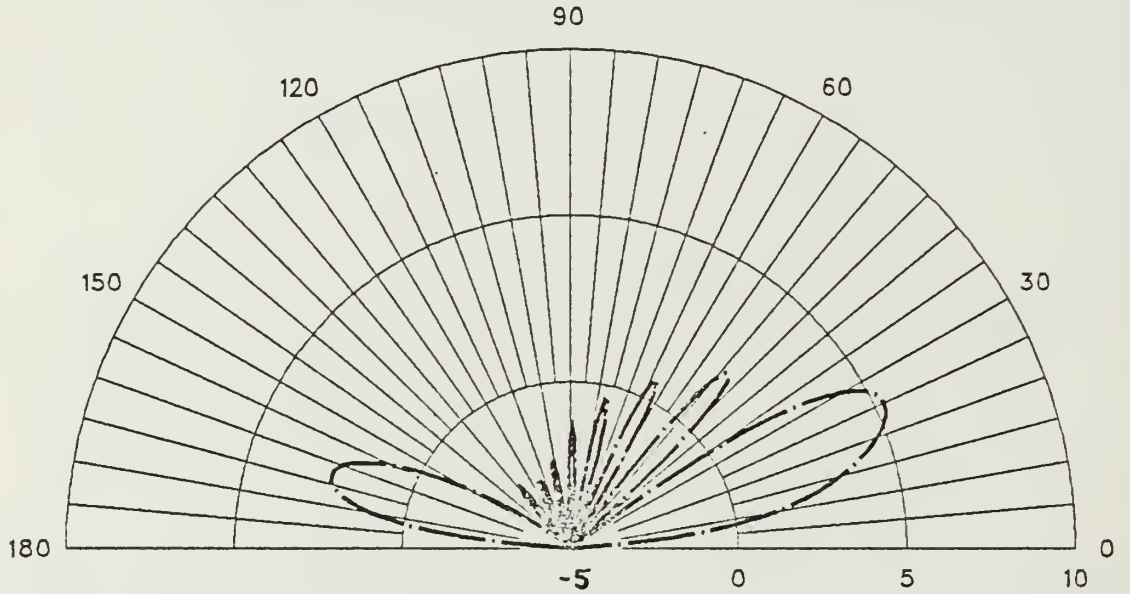

ANTENNA 1B

4 3/4 X 1/4 LAMBDA FREQ=17 MHZ PHI=10

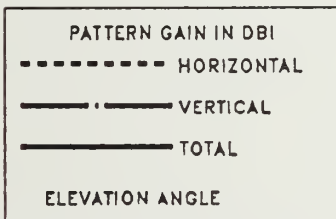
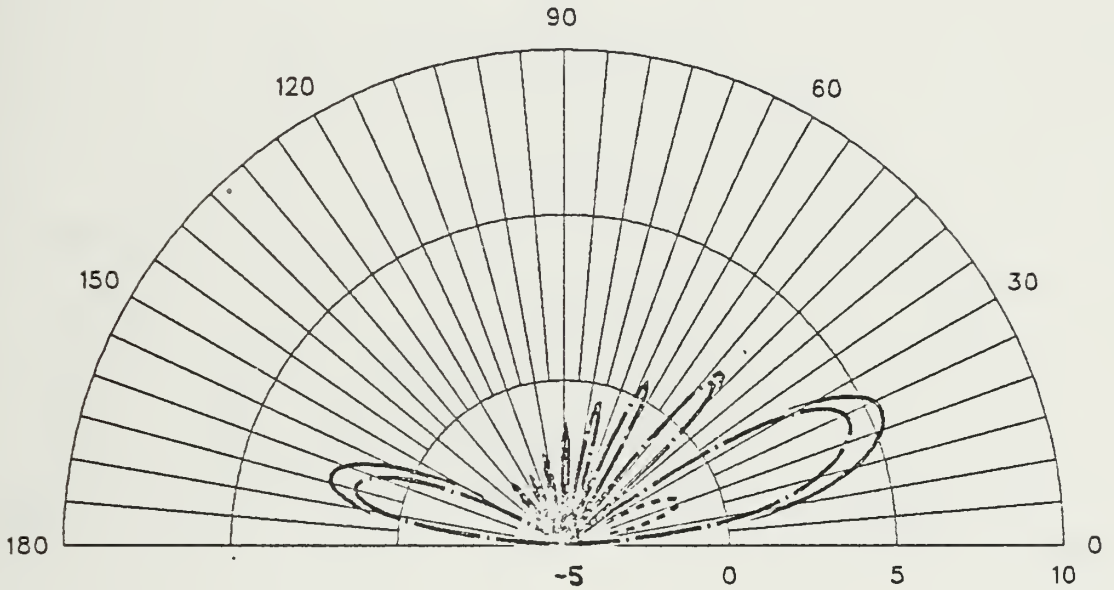

ANTENNA 1B

4 3/4 X 1/4 LAMBDA FREQ=17 MHZ PHI=20

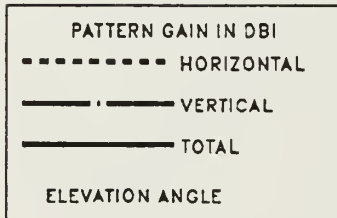
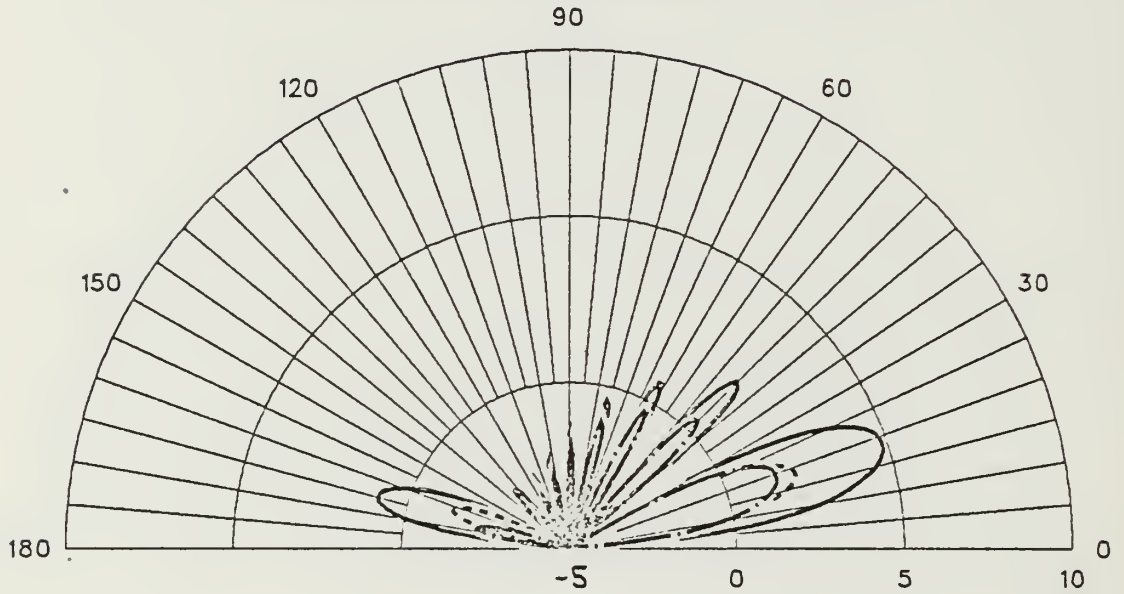

ANTENNA 1B

4 3/4 X 1/4 LAMBDA FREQ=17 MHZ PHI=30

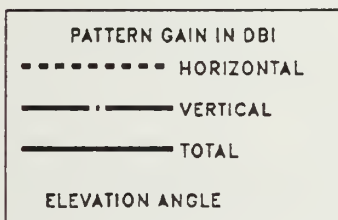
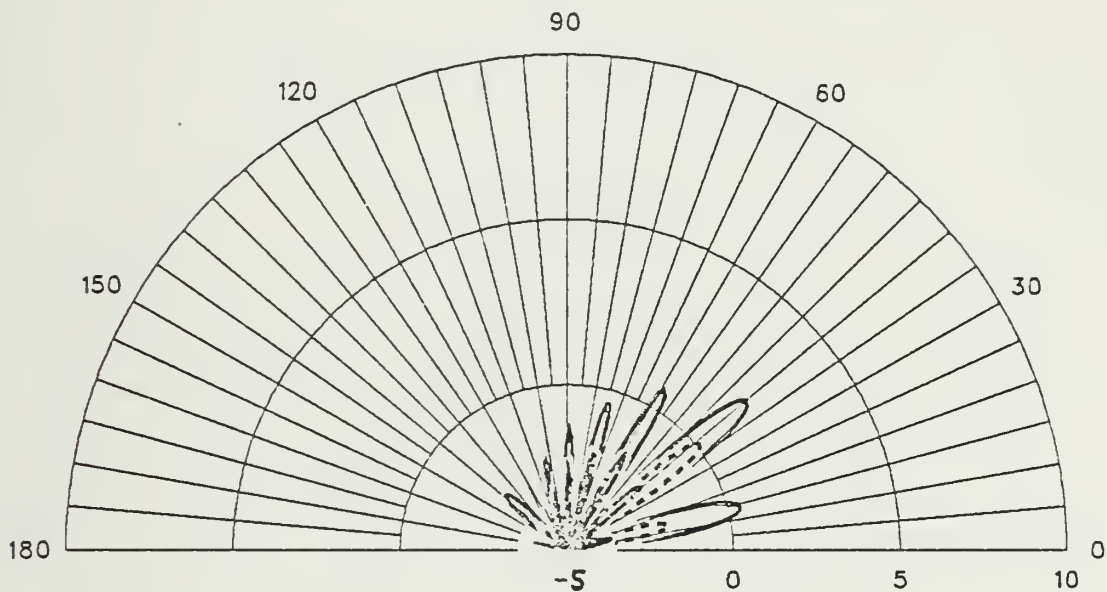

ANTENNA 1B

4 3/4 X 1/4 LAMBDA FREQ=17 MHZ PHI=40

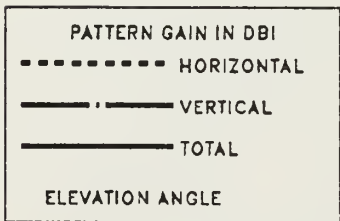
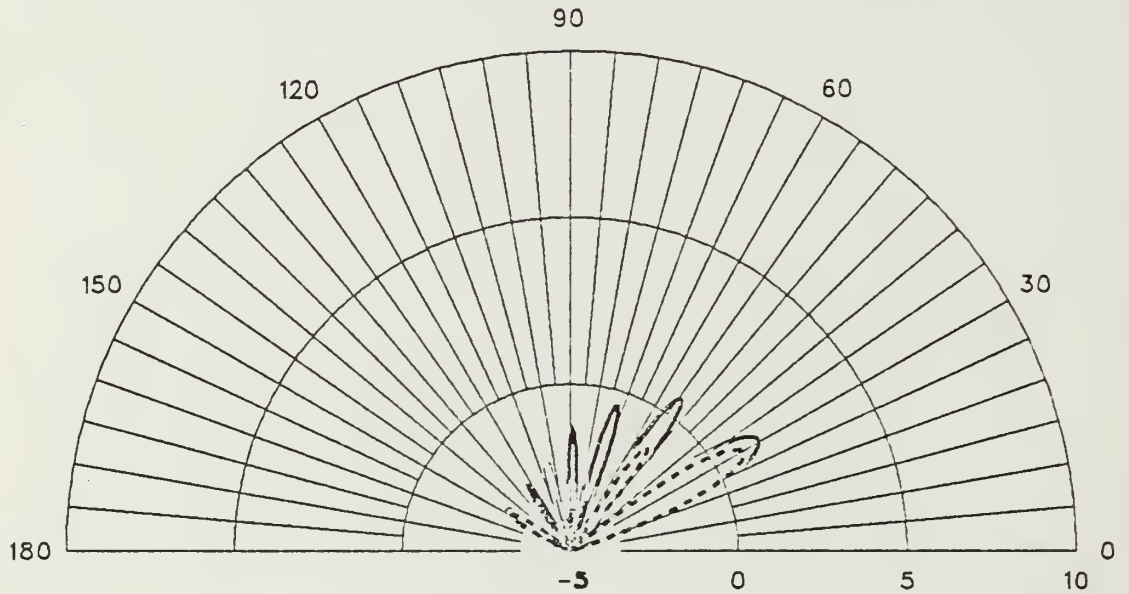

ANTENNA 1B

4 3/4 X 1/4 LAMBDA FREQ=17 MHZ THETA=65

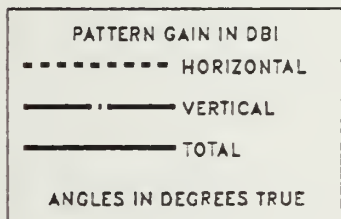
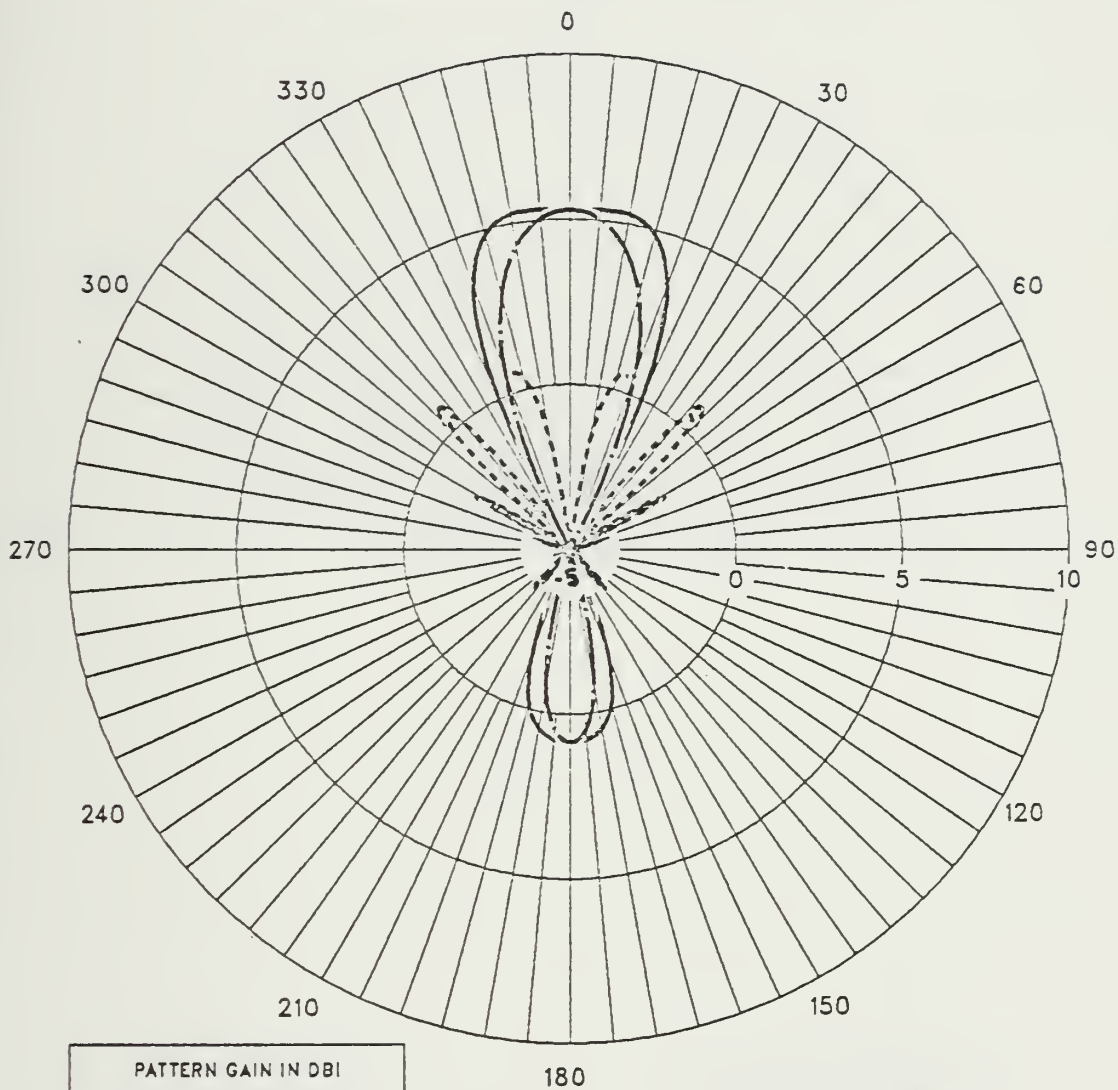

ANTENNA 1B

4 3/4 X 3/8 LAMBDA FREQ=17 MHZ PHI=0

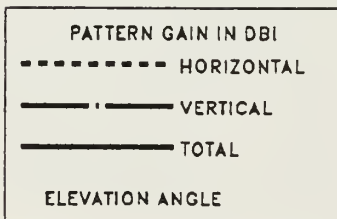
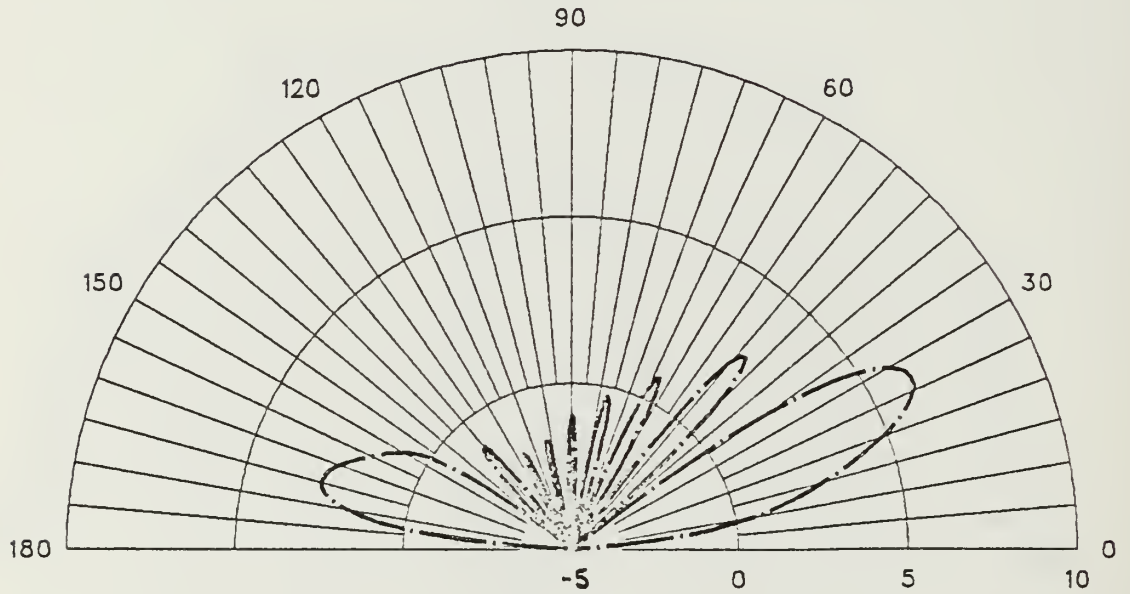

ANTENNA 1B

4 3/4 X 3/8 LAMBDA FREQ=17 MHZ PHI=10

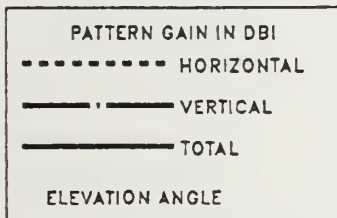
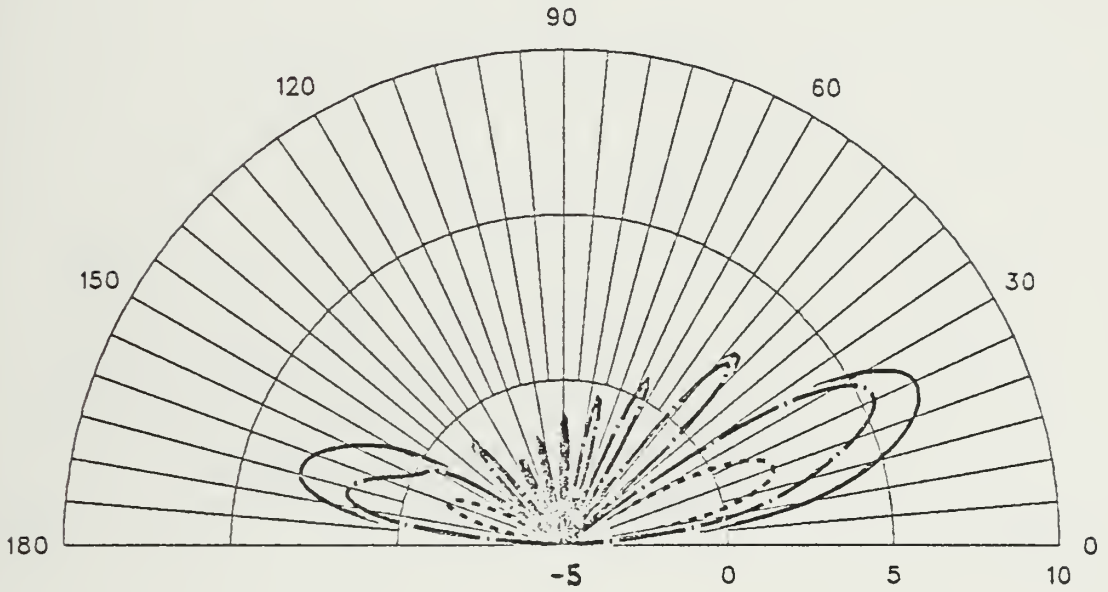

ANTENNA 1B

4 3/4 X 3/8 LAMBDA FREQ=17 MHZ PHI=20

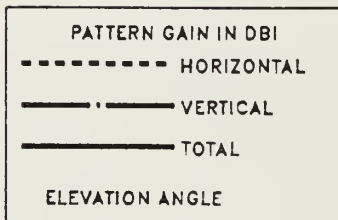
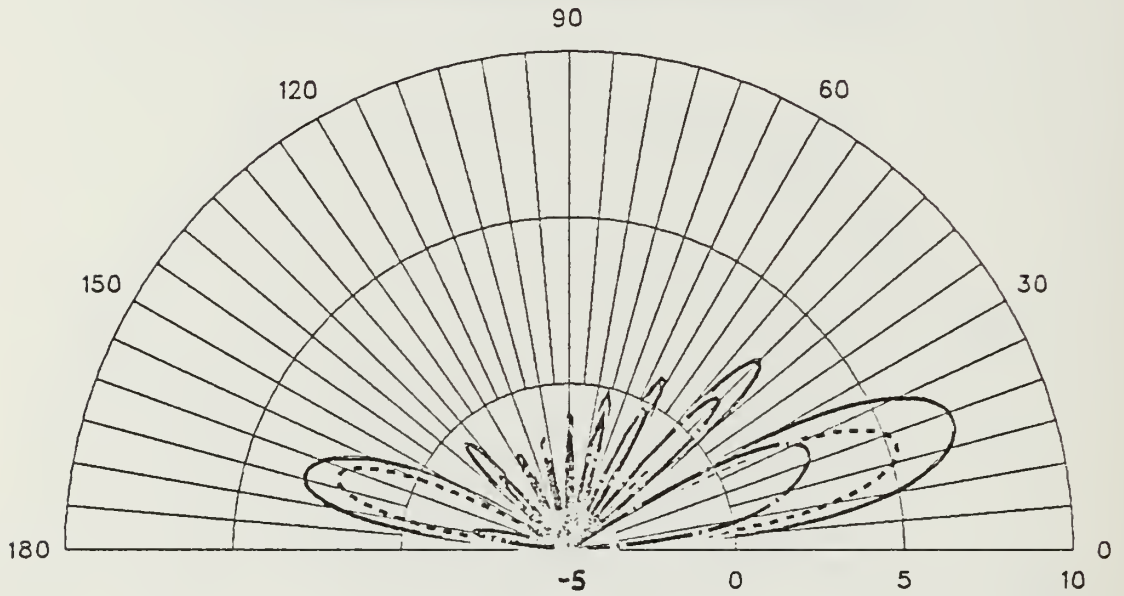

ANTENNA 1B

4 3/4 X 3/8 LAMBDA FREQ=17 MHZ PHI=30

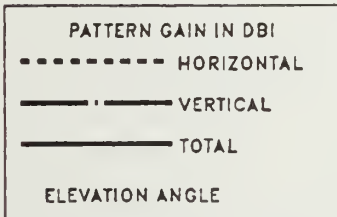
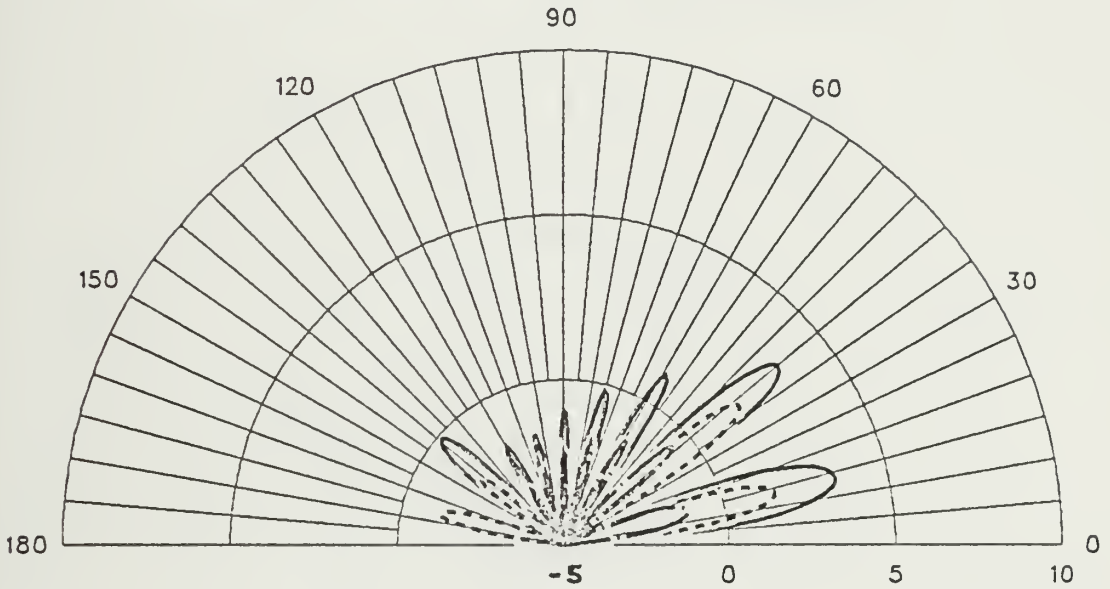

ANTENNA 1B

4 3/4 X 3/8 LAMBDA FREQ=17 MHZ PHI=40

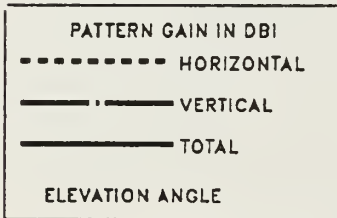
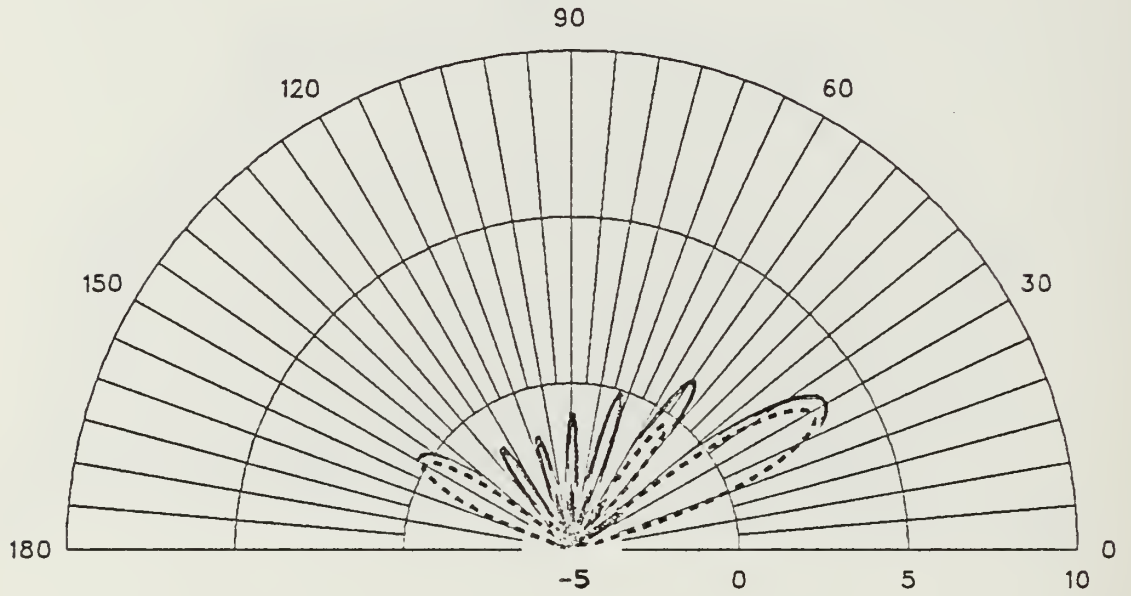

ANTENNA 1B

4 3/4 X 3/8 LAMBDA FREQ=17 MHZ THETA=70

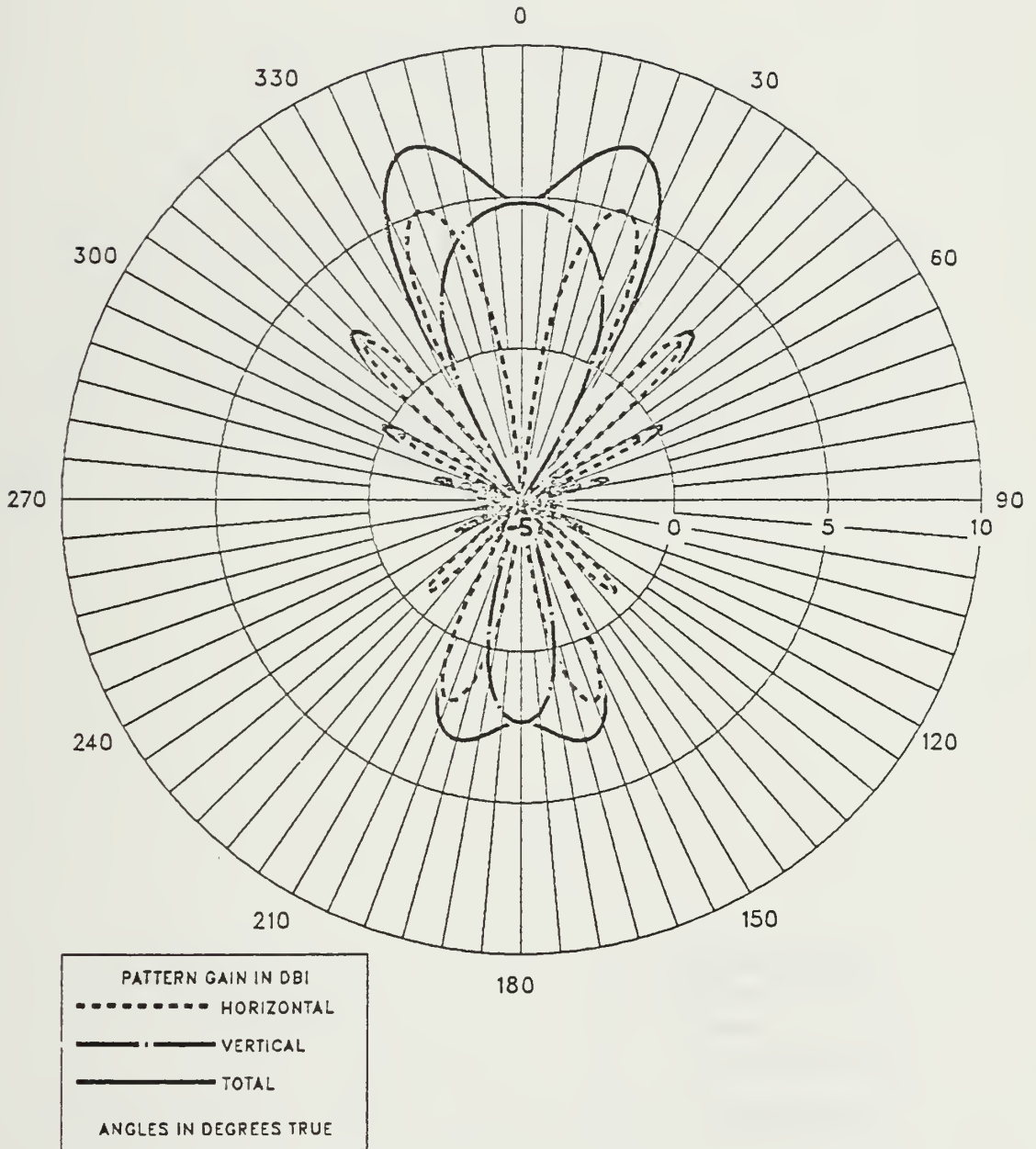

ANTENNA 1C

4 3/4 X 1/2 LAMBDA FREQ=17 MHZ PHI=0

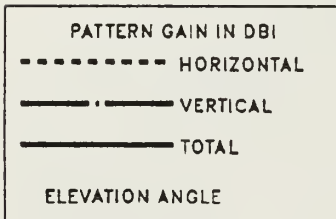
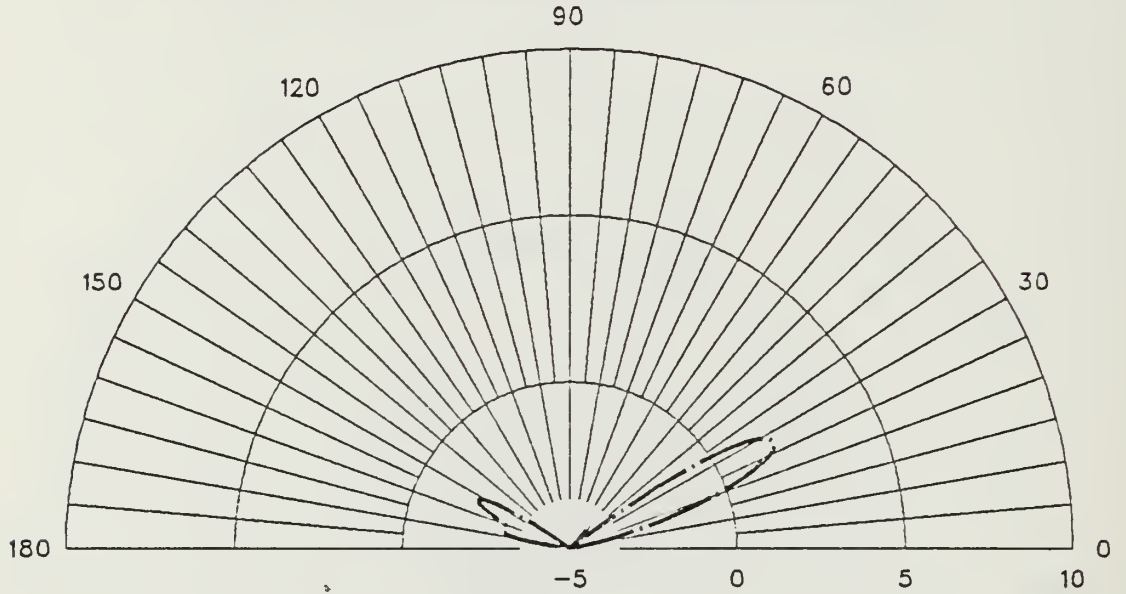

ANTENNA 1C

4 3/4 X 1/2 LAMBDA FREQ=17 MHZ PHI=10

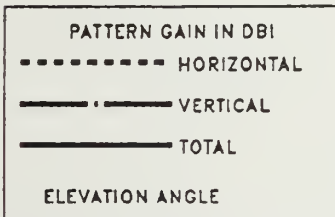
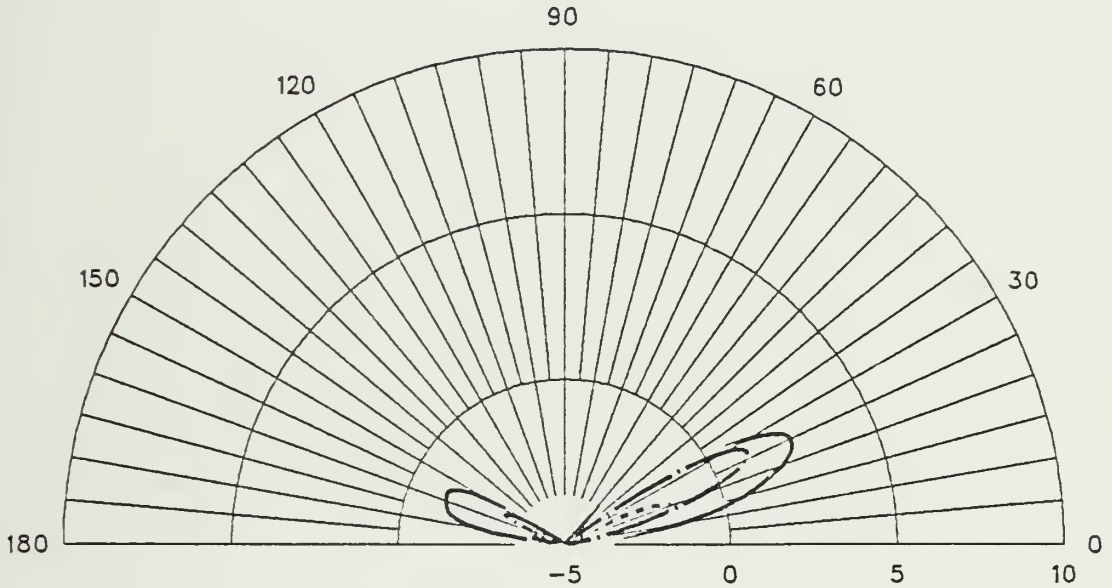

ANTENNA 1C

4 3/4 X 1/2 LAMBDA FREQ=17 MHZ PHI=20

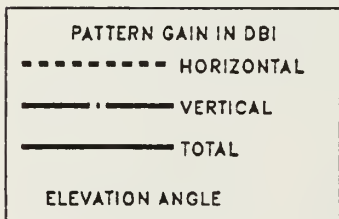
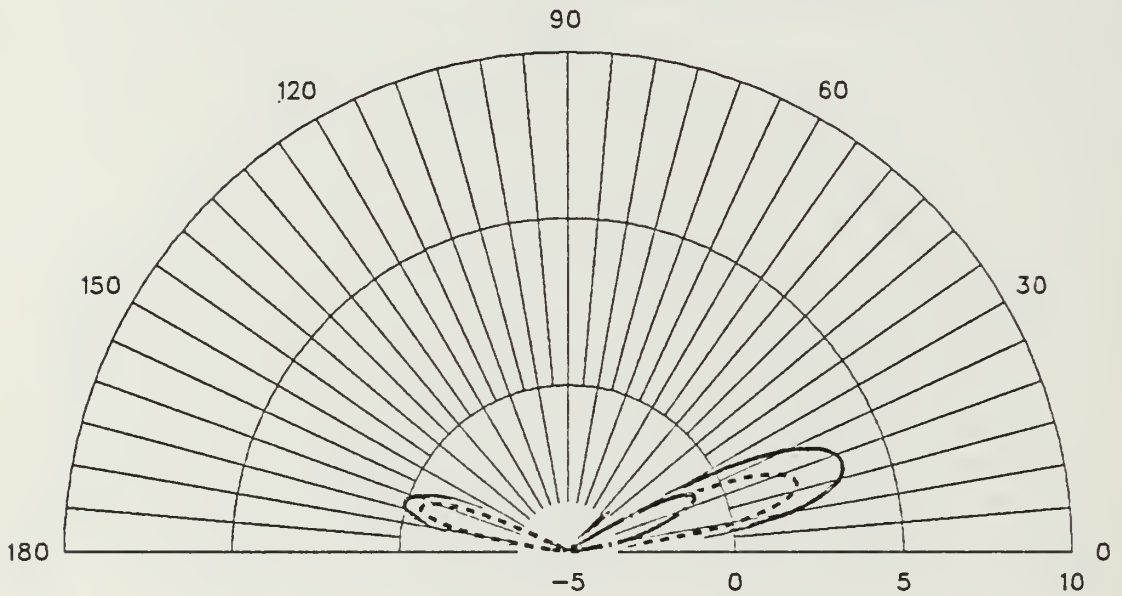

ANTENNA 1C

4 3/4 X 1/2 LAMBDA FREQ=17 MHZ PHI=30

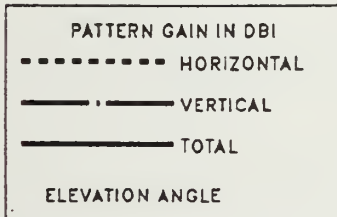
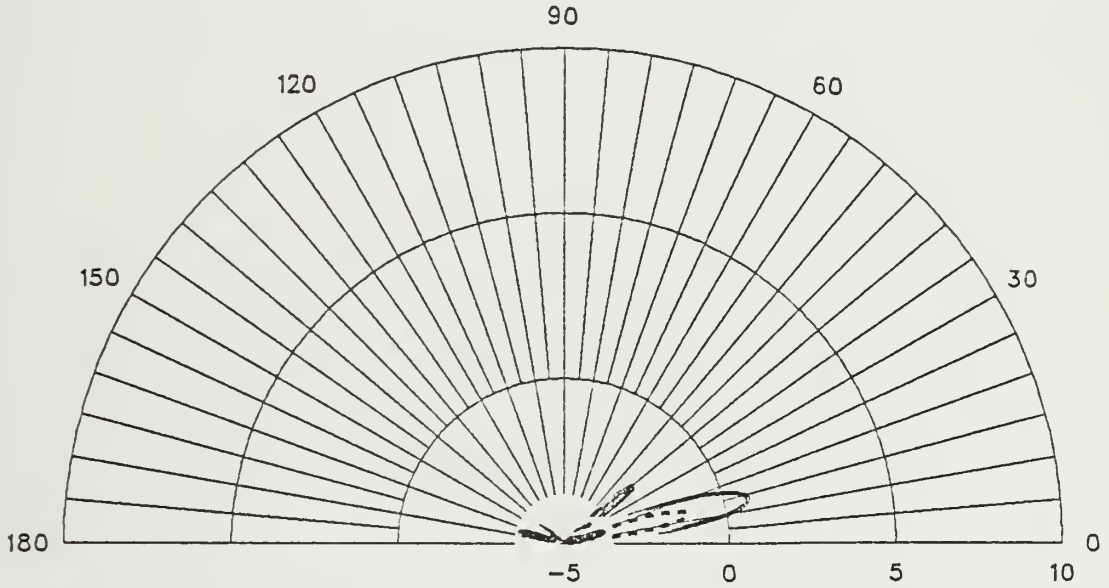

ANTENNA 1C

4 3/4 X 1/2 LAMBDA FREQ=17 MHZ PHI=40

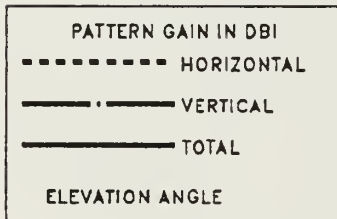
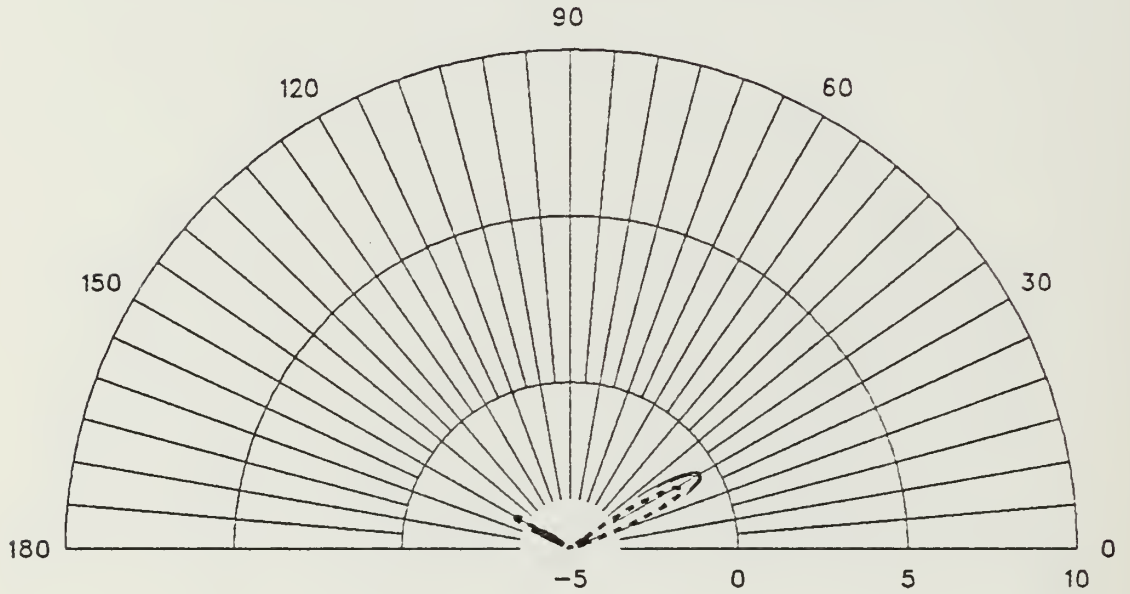

ANTENNA 1C

4 3/4 X 1/2 LAMBDA FREQ=17 MHZ THETA=75

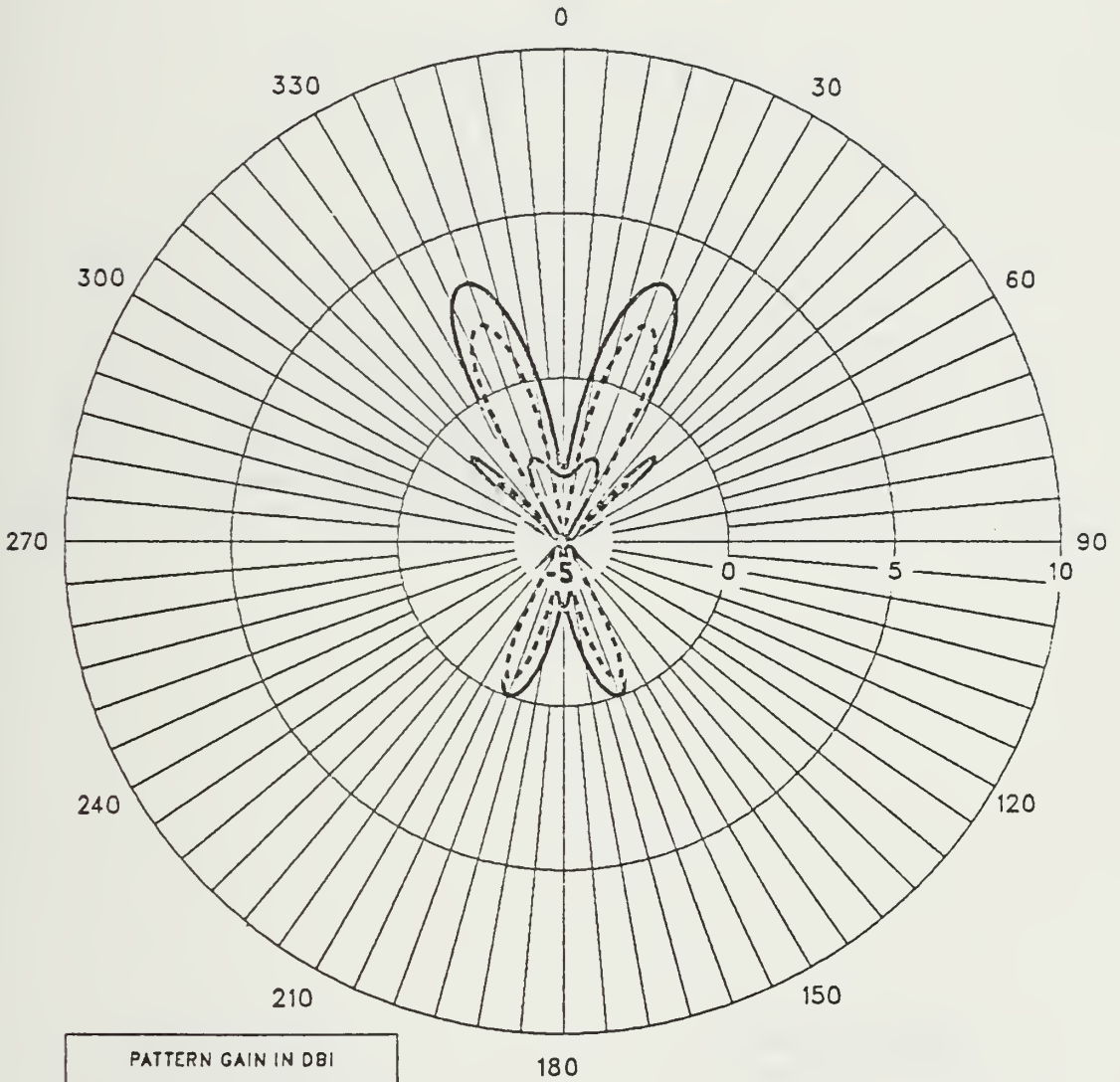

ANTENNA 1D

4 3/4 X 1/2 LAMBDA FREQ=17 MHZ PHI=0

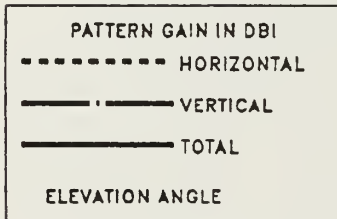
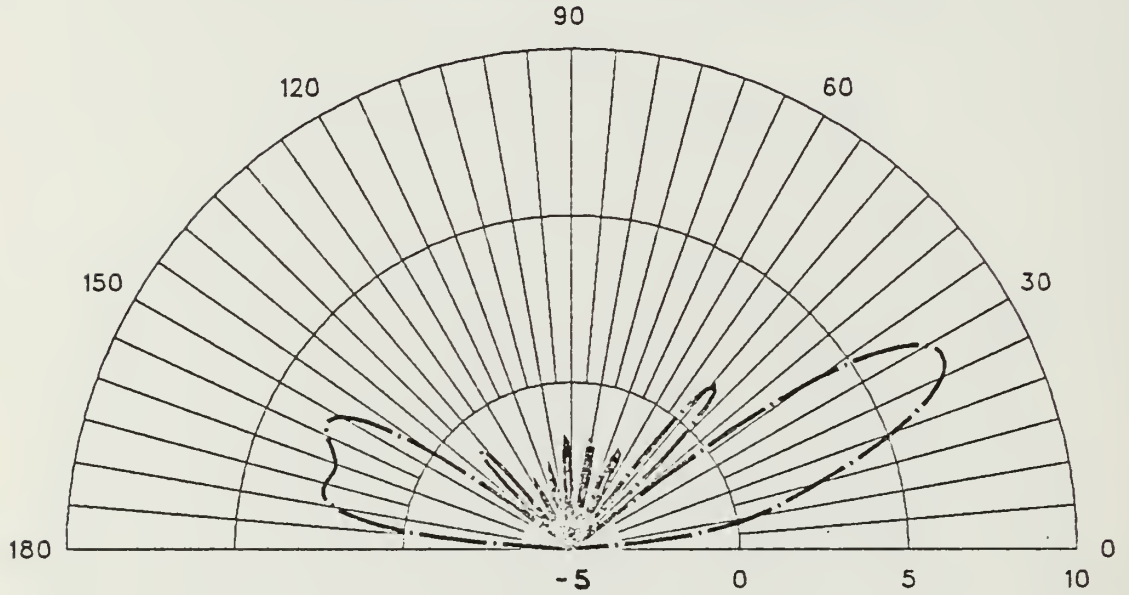

ANTENNA 1D

4 3/4 X 1/2 LAMBDA FREQ=17 MHZ PHI=10

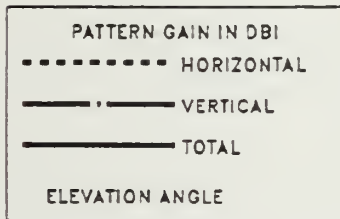
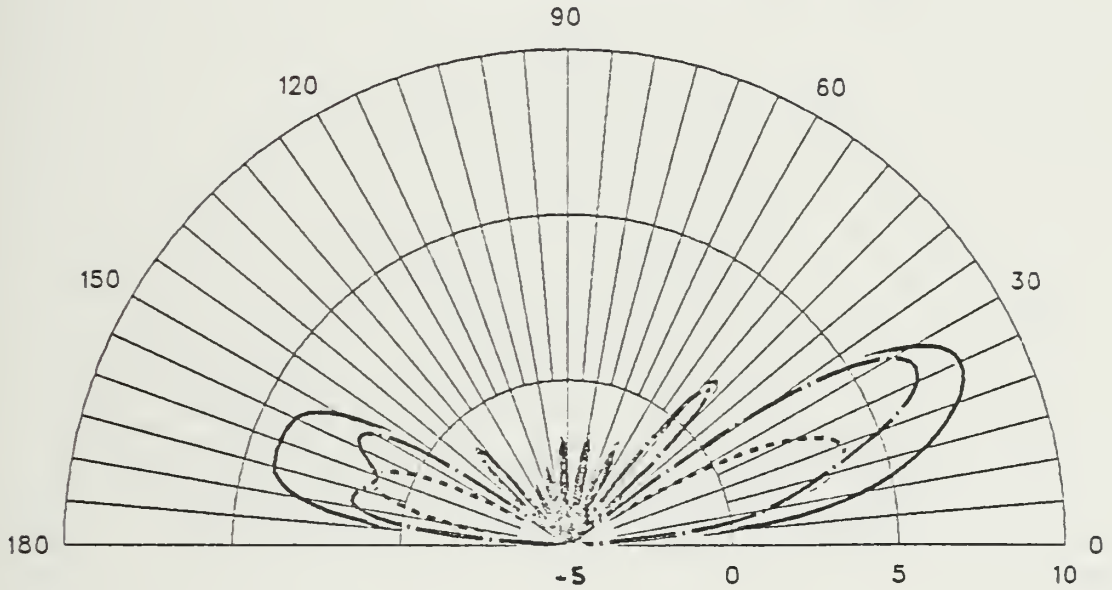

ANTENNA 1D

4 3/4 X 1/2 LAMBDA FREQ=17 MHZ PHI=20

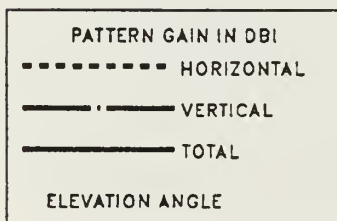
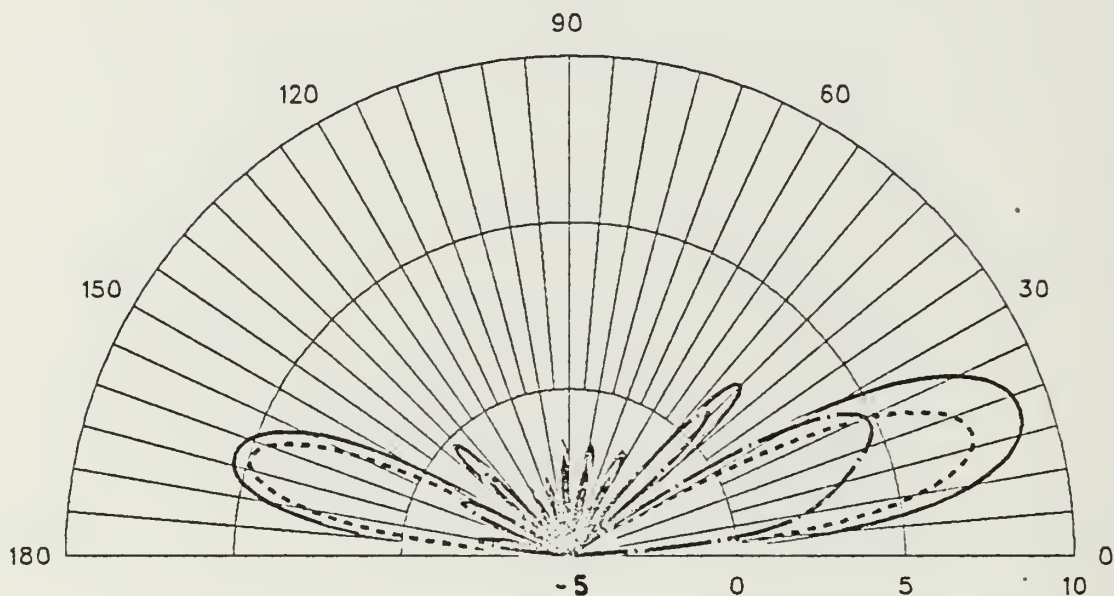

ANTENNA 1D

4 3/4 X 1/2 LAMBDA FREQ=17 MHZ PHI=30

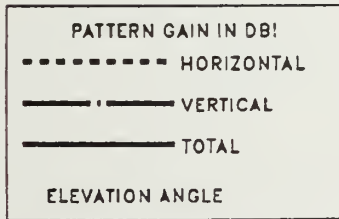
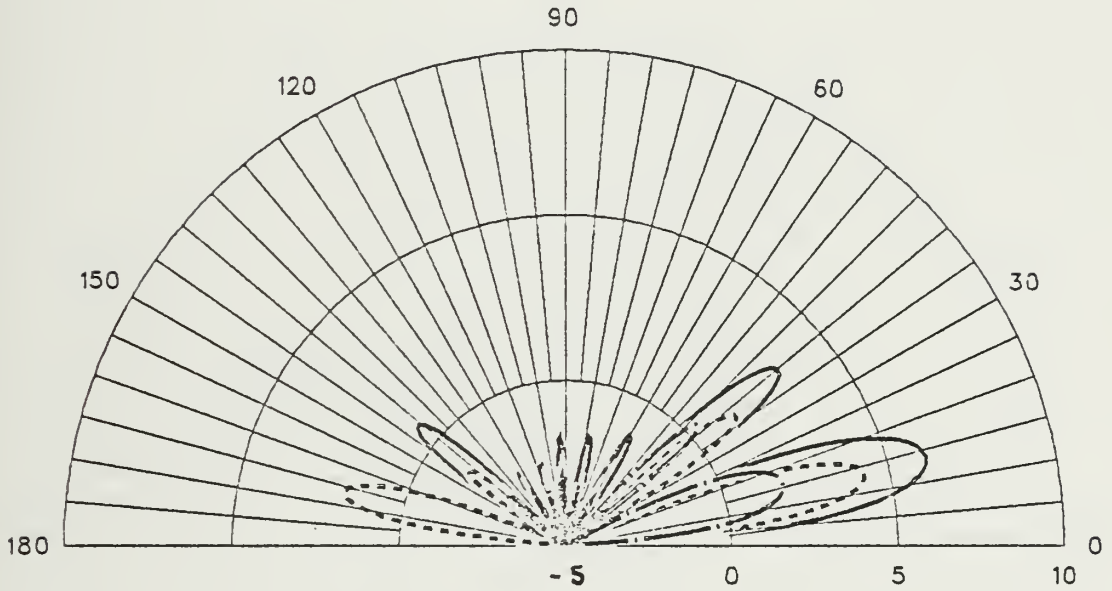

ANTENNA 1D

4 3/4 X 1/2 LAMBDA FREQ=17 MHZ PHI=40

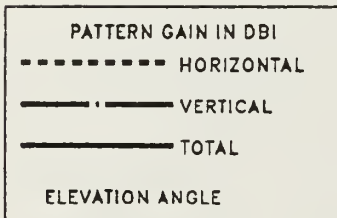
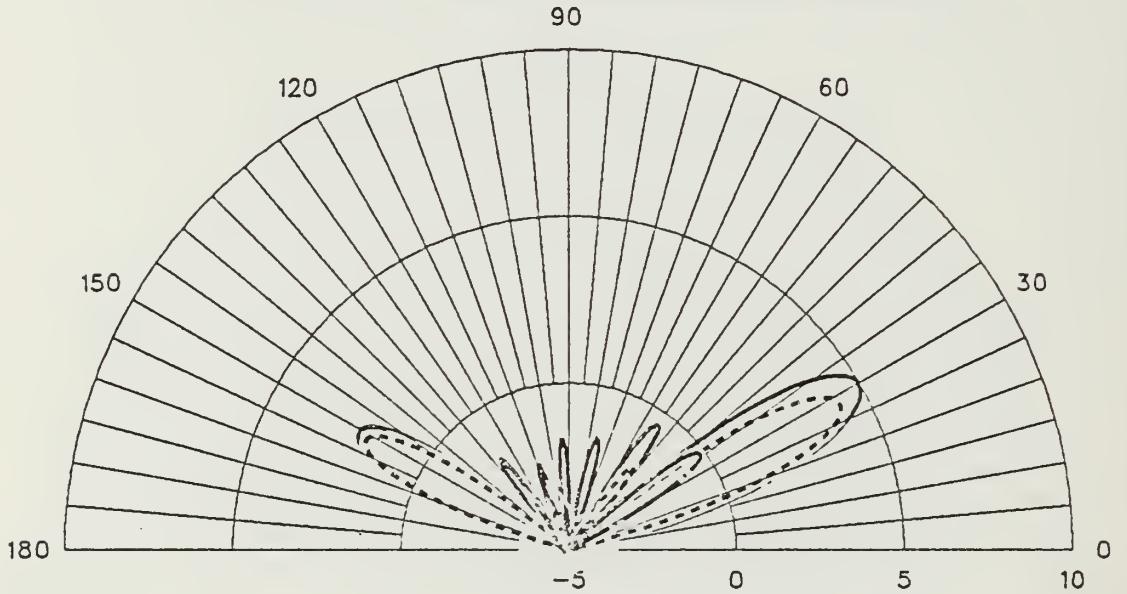

ANTENNA 1D

4 3/4 X 1/2 LAMBDA FREQ=17 MHZ THETA=75

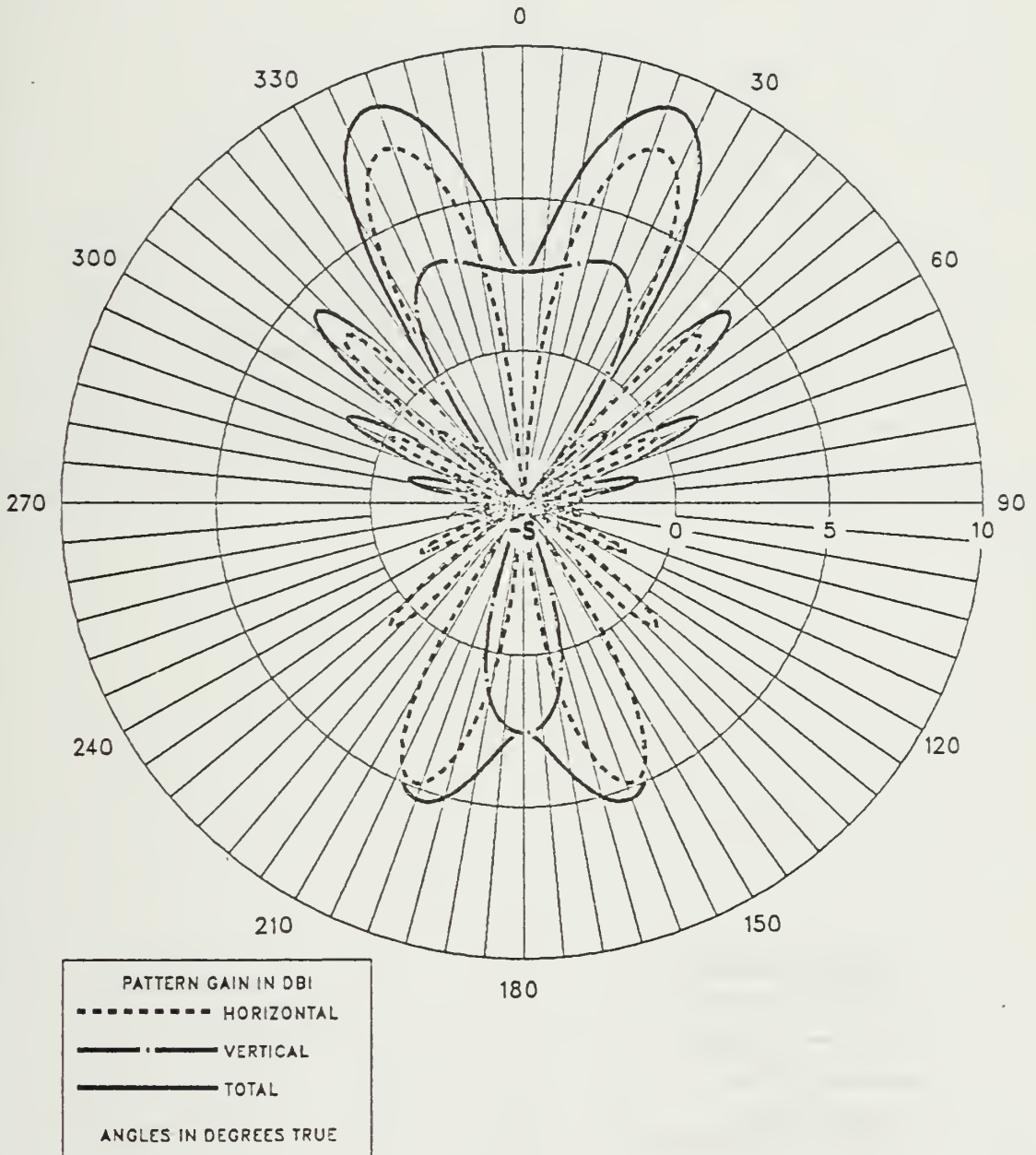

ANTENNA 1E

4 3/4 X 1/2 LAMBDA FREQ=17 MHZ PHI=10

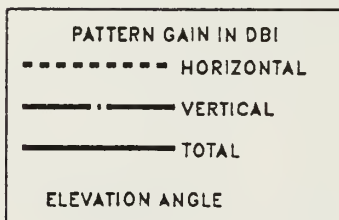
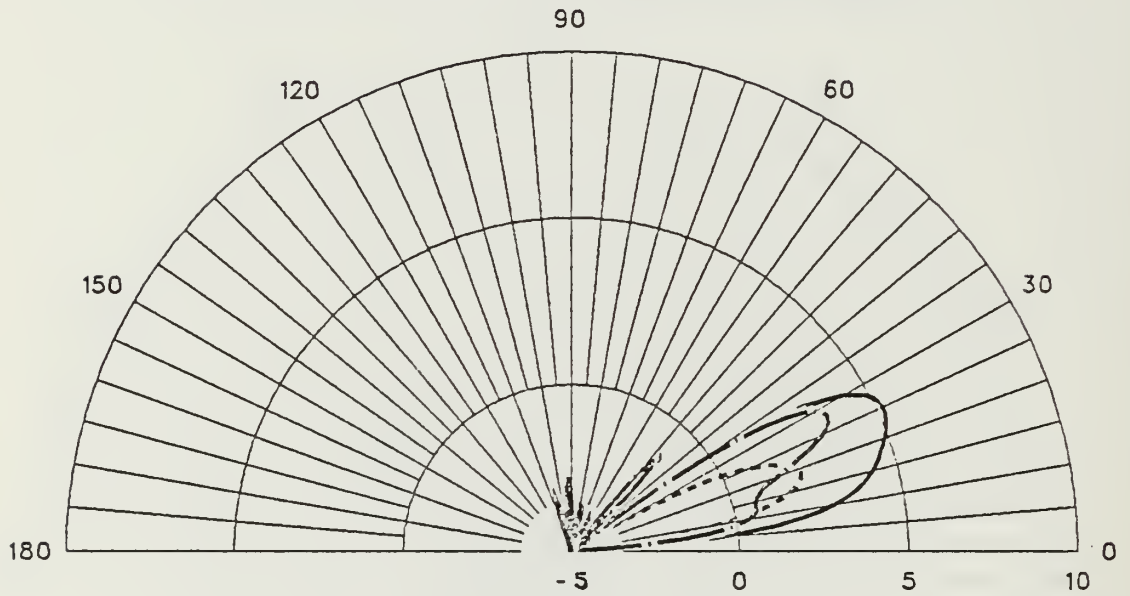

ANTENNA 1E

4 3/4 X 1/2 LAMBDA FREQ=17 MHZ PHI=0

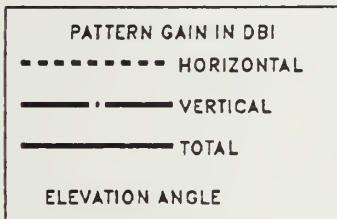
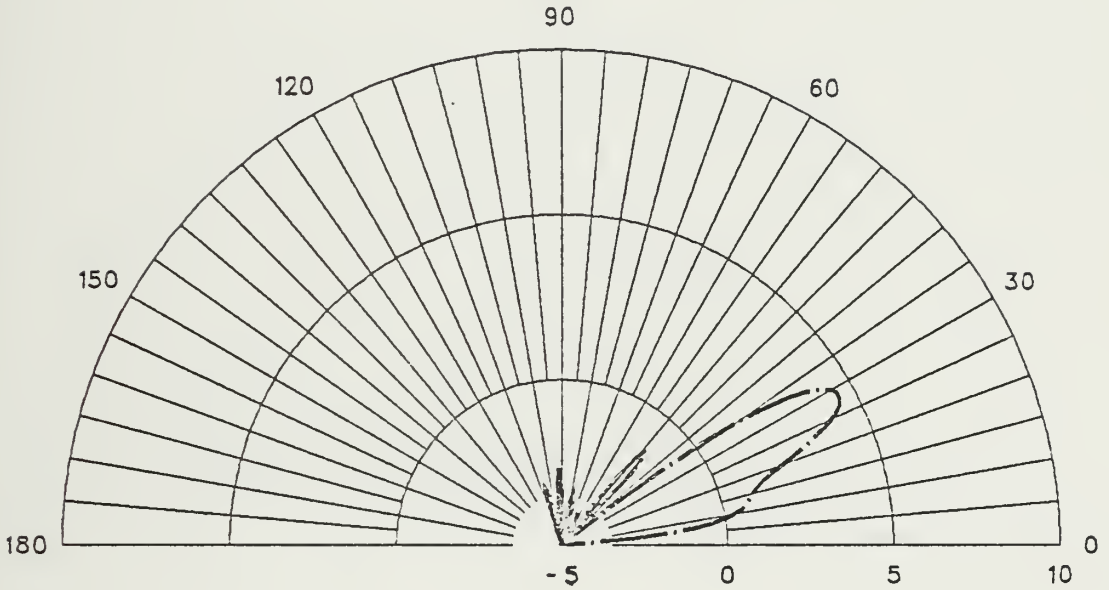

ANTENNA 1E

4 3/4 X 1/2 LAMBDA FREQ=17 MHZ PHI=20

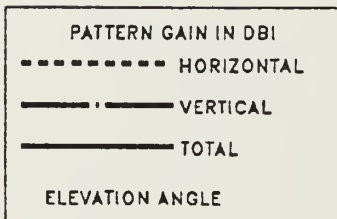
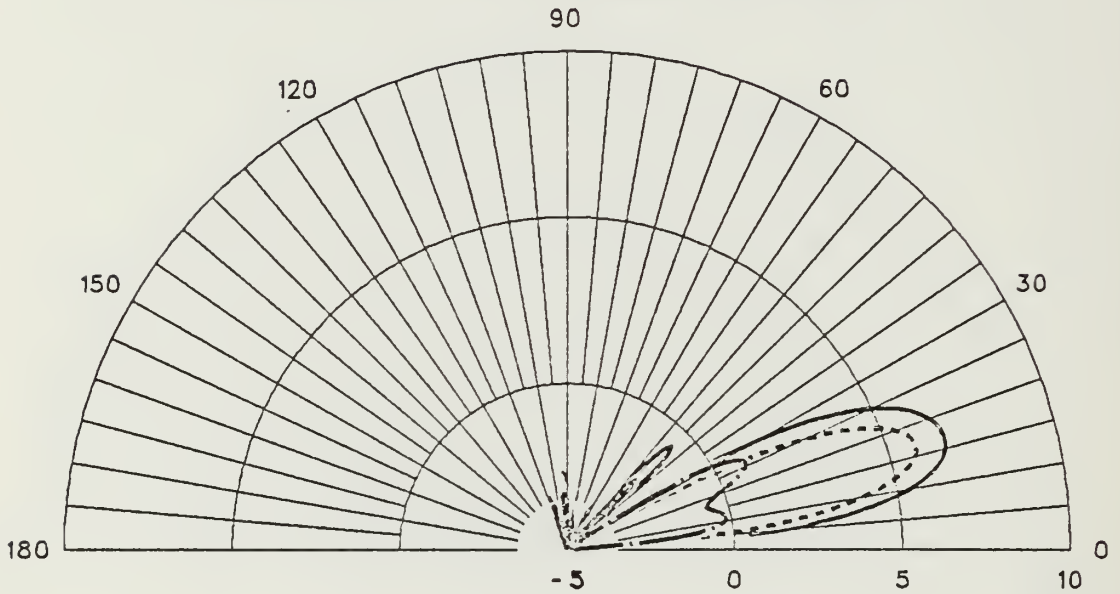

ANTENNA 1E

4 3/4 X 1/2 LAMBDA FREQ=17 MHZ PHI=30

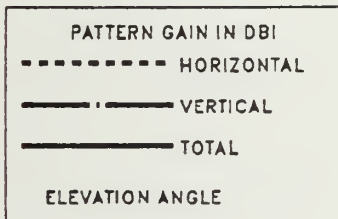
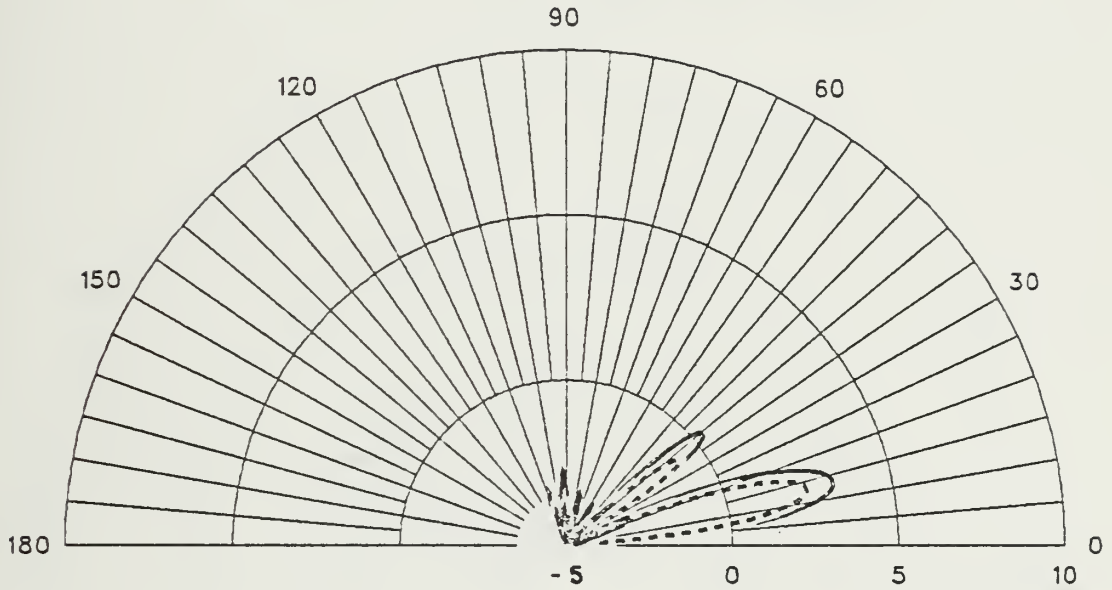

ANTENNA 1E

4 3/4 X 1/2 LAMBDA FREQ=17 MHZ PHI=40

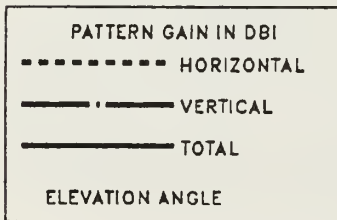
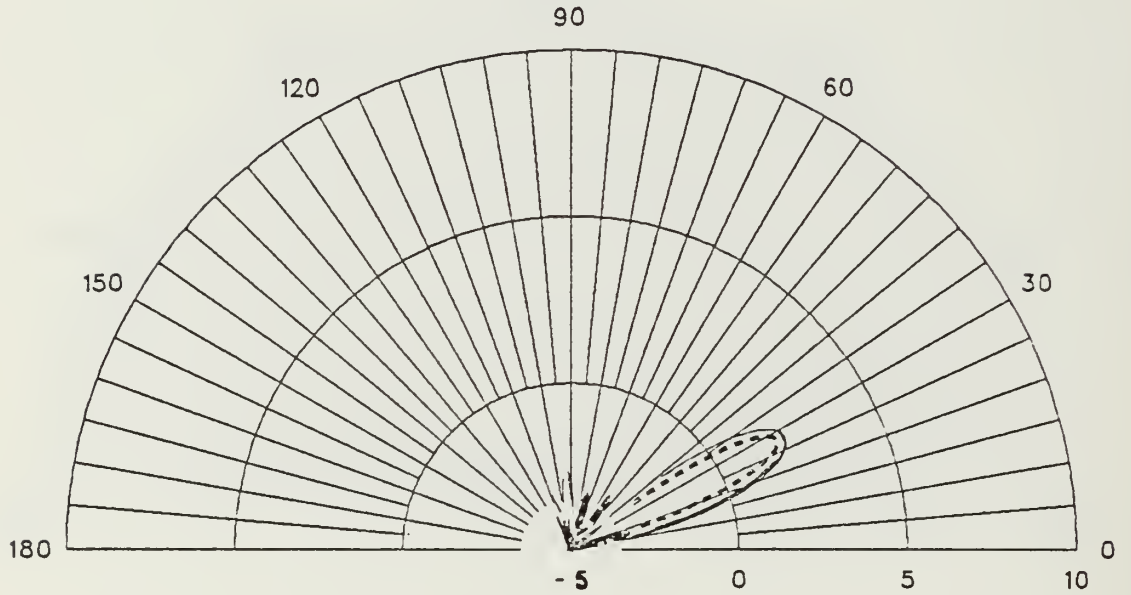

ANTENNA 1E

4 3/4 X 1/2 LAMBDA FREQ=17 MHZ THETA=75

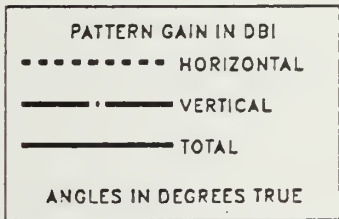
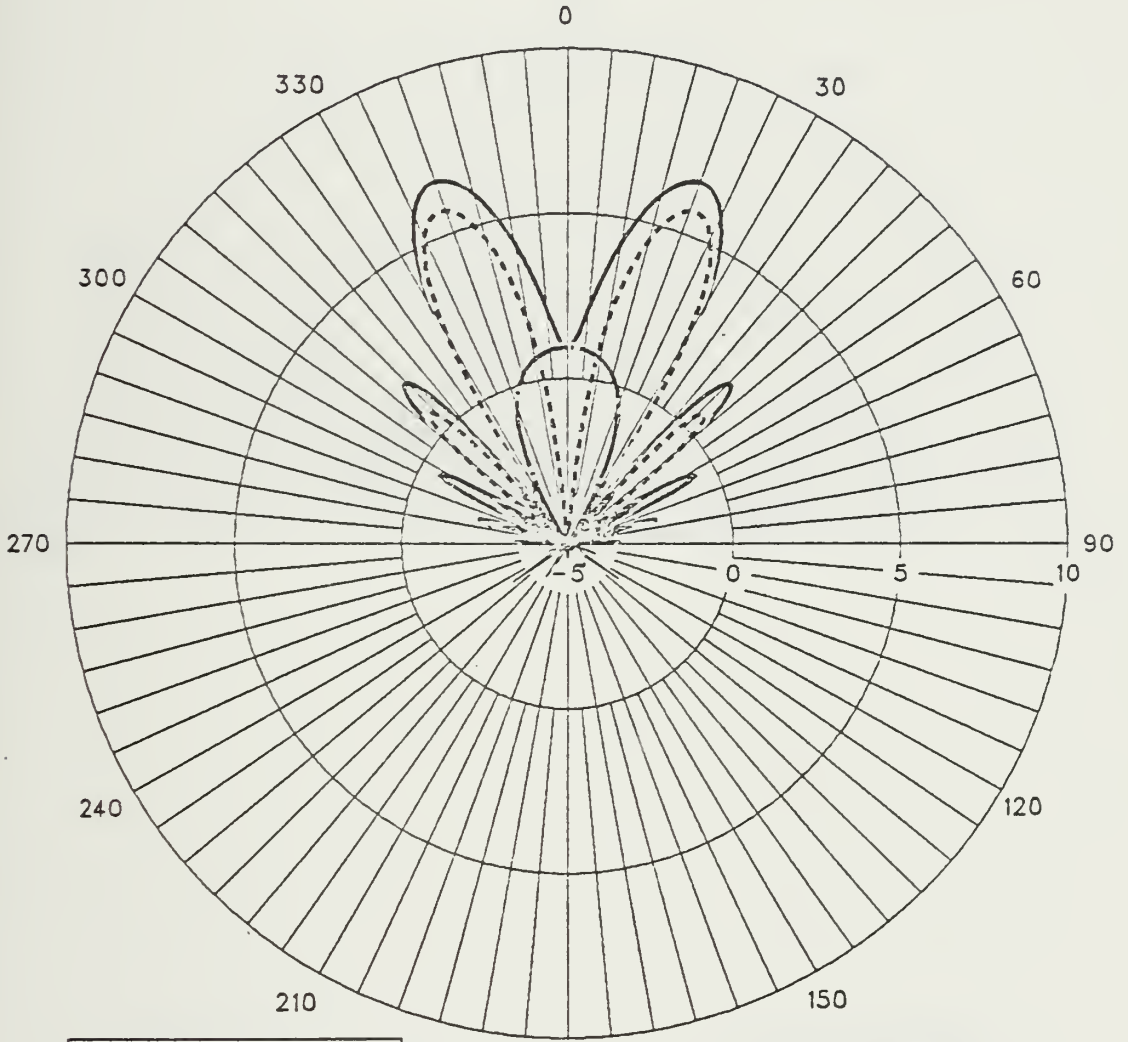

ANTENNA 1F

4 3/4 X 1/2 LAMBDA FREQ=17 MHZ PHI=0

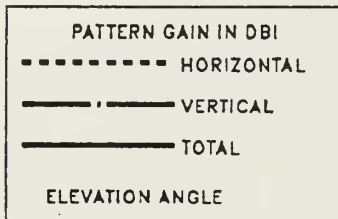
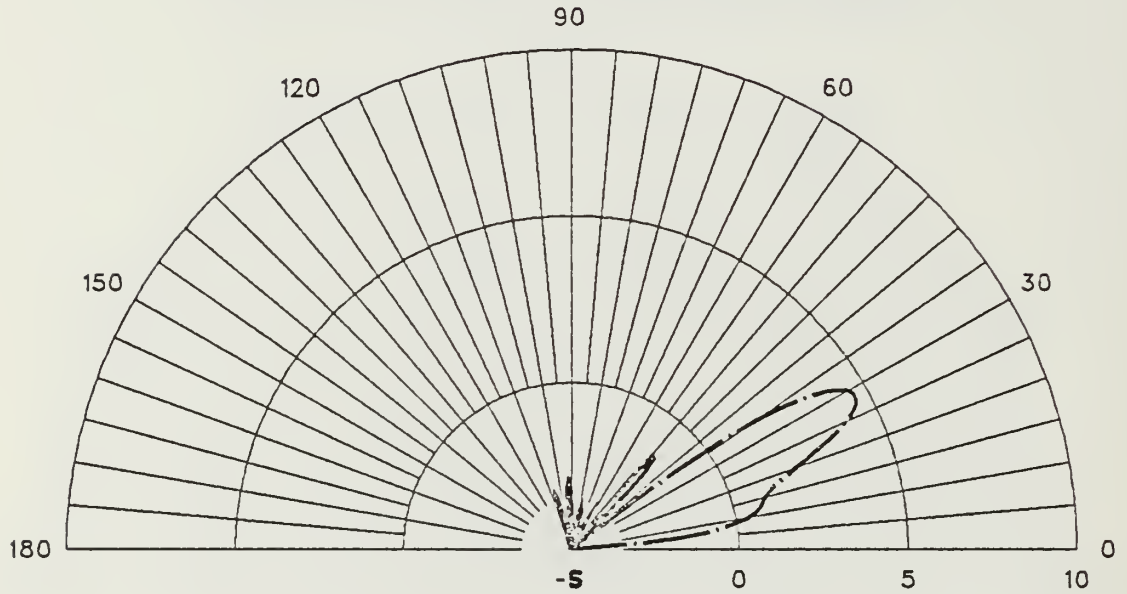

ANTENNA 1F

4 3/4 X 1/2 LAMBDA FREQ=17 MHZ PHI=10

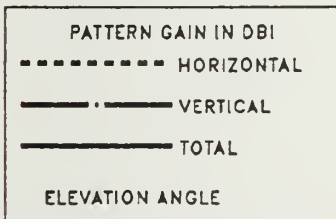
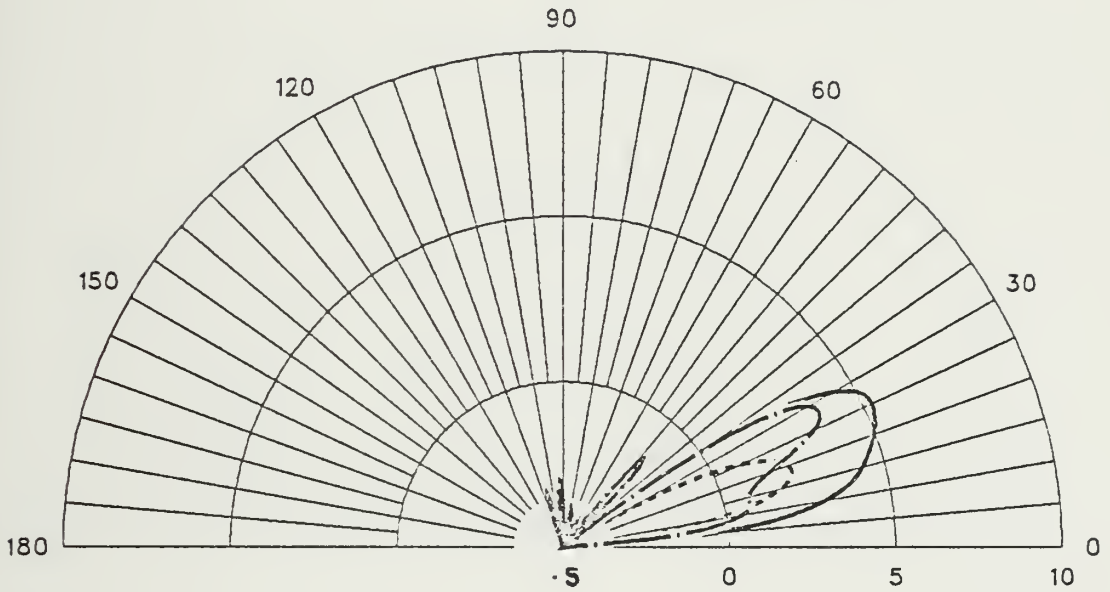

ANTENNA 1F

4 3/4 X 1/2 LAMBDA FREQ=17 MHZ PHI=20

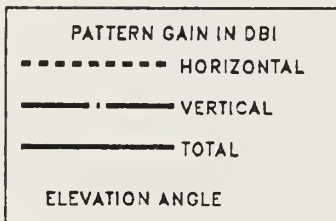
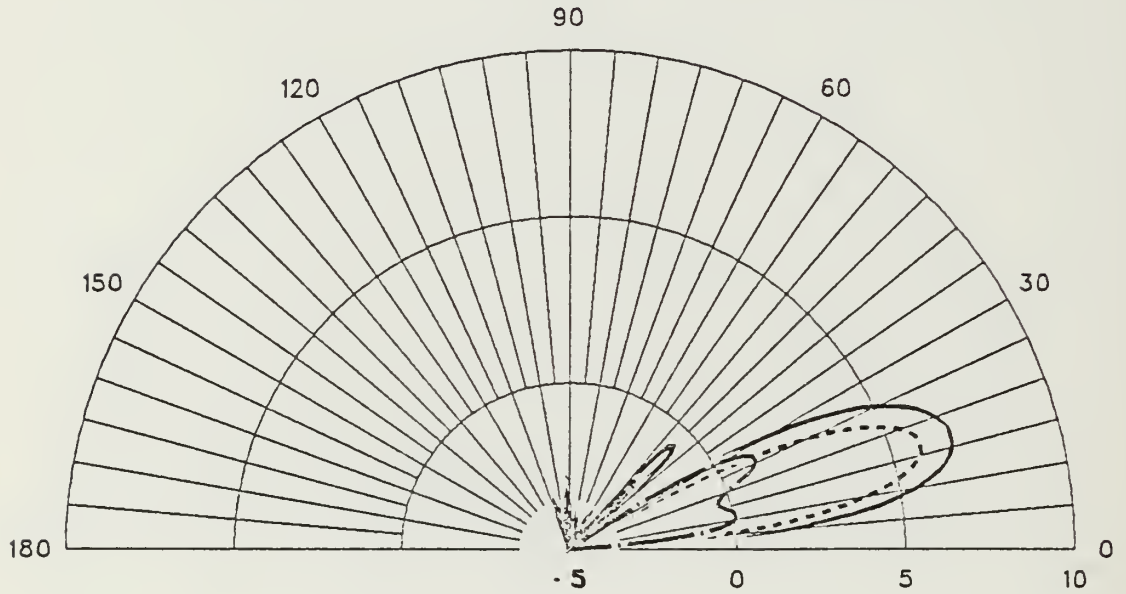

ANTENNA 1F

4 3/4 X 1/2 LAMBDA FREQ=17 MHZ PHI=30

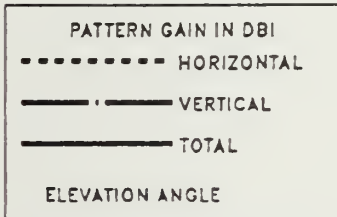
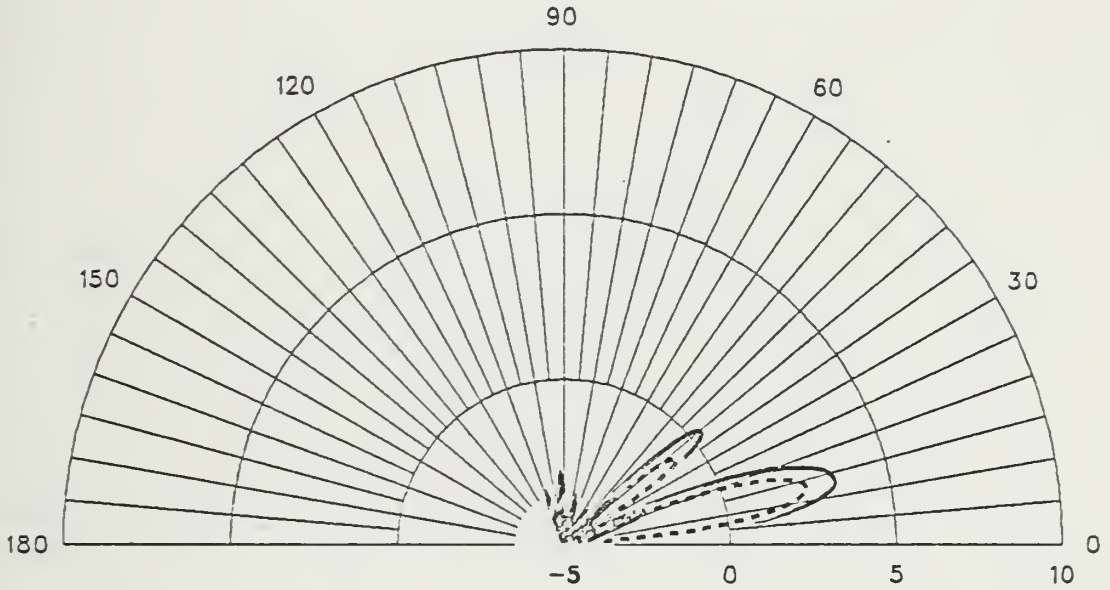

ANTENNA 1F

4 3/4 X 1/2 LAMBDA FREQ=17 MHZ THETA=75

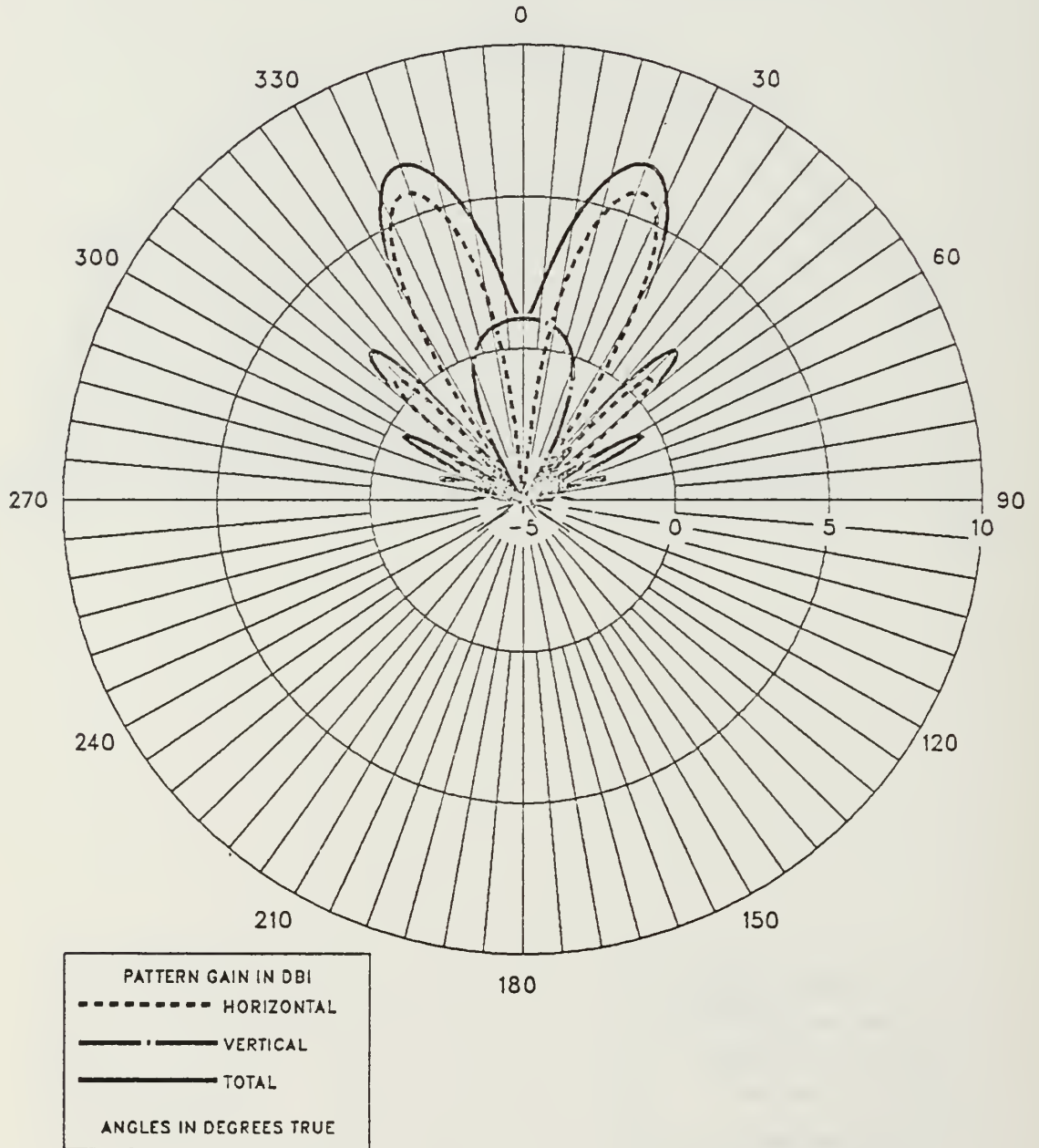

ANTENNA 1F

4 3/4 X 1/2 LAMBDA FREQ=17 MHZ PHI=40

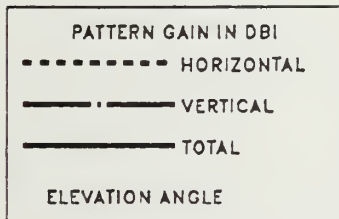
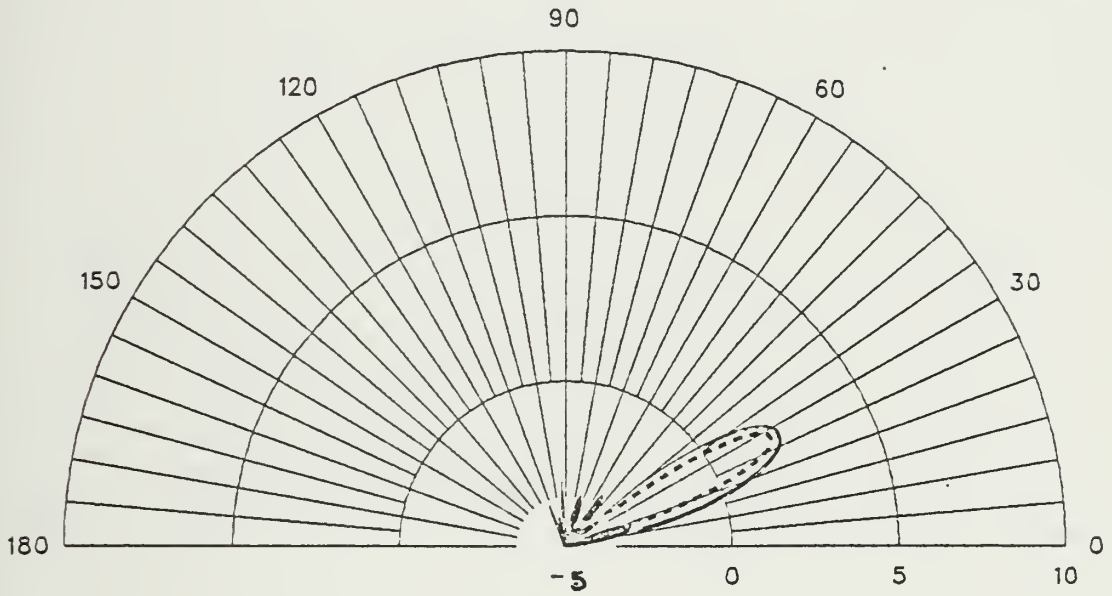

ANTENNA 1G

4 3/4 X 1/2 LAMBDA FREQ=17 MHZ PHI=0

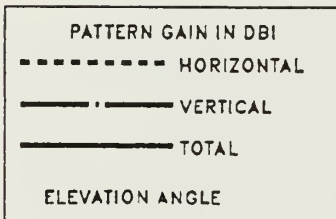
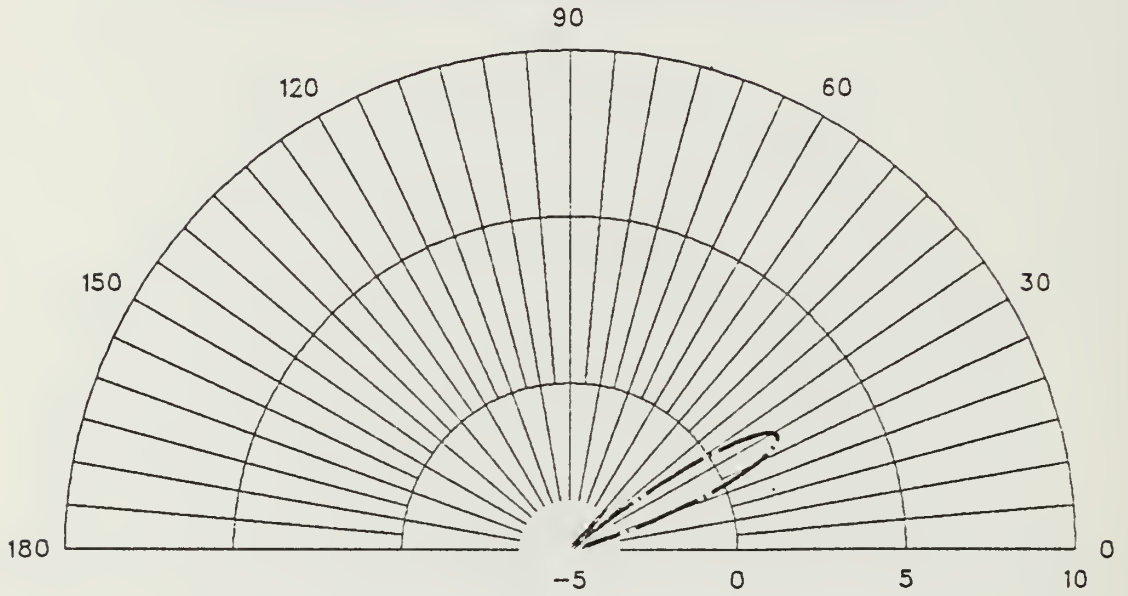

ANTENNA 1G

4 3/4 X 1/2 LAMBDA FREQ=17 MHZ PHI=10

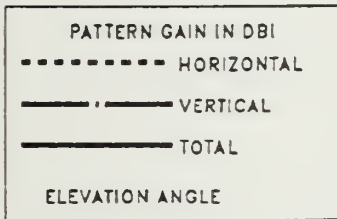
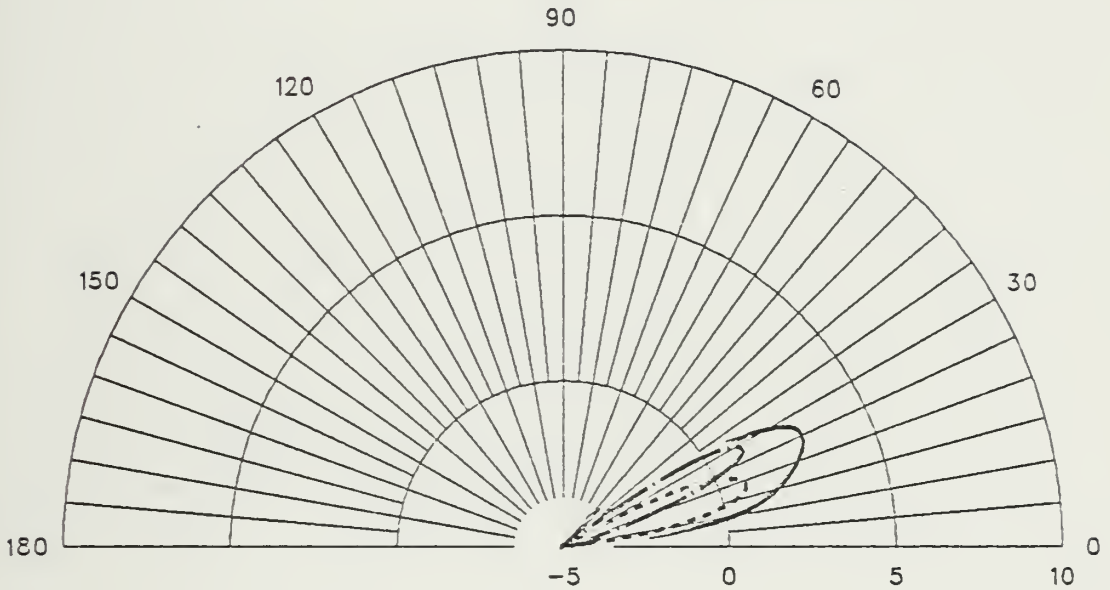

ANTENNA 1G

4 3/4 X 1/2 LAMBDA FREQ=17 MHZ PHI=20

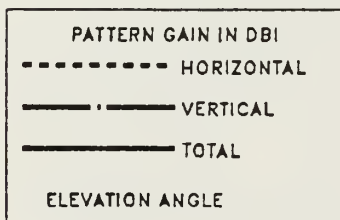
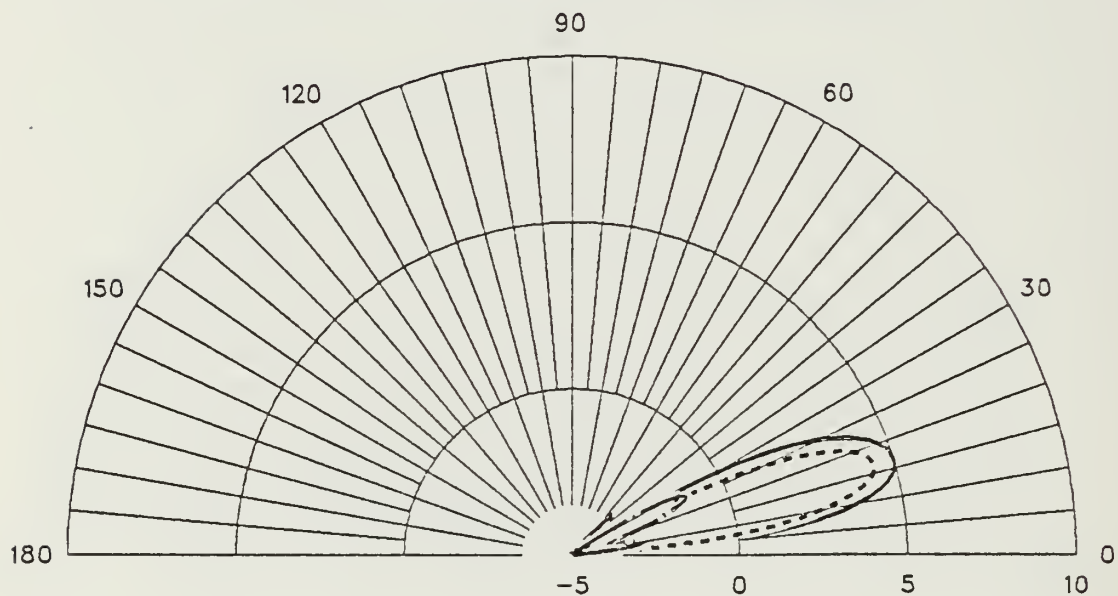

ANTENNA 1G

4 3/4 X 1/2 LAMBDA FREQ=17 MHZ PHI=30

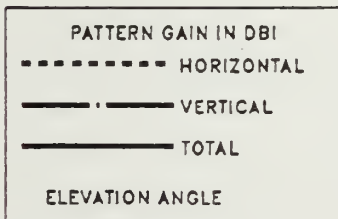
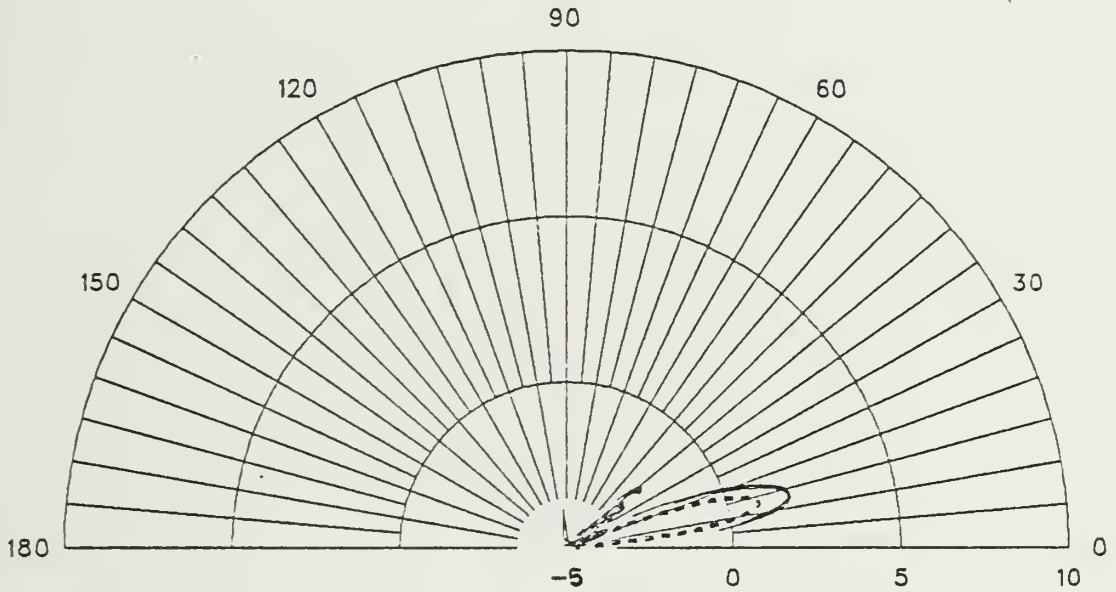

ANTENNA 1G

4 3/4 X 1/2 LAMBDA FREQ=17 MHZ PHI=40

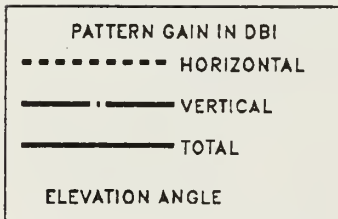
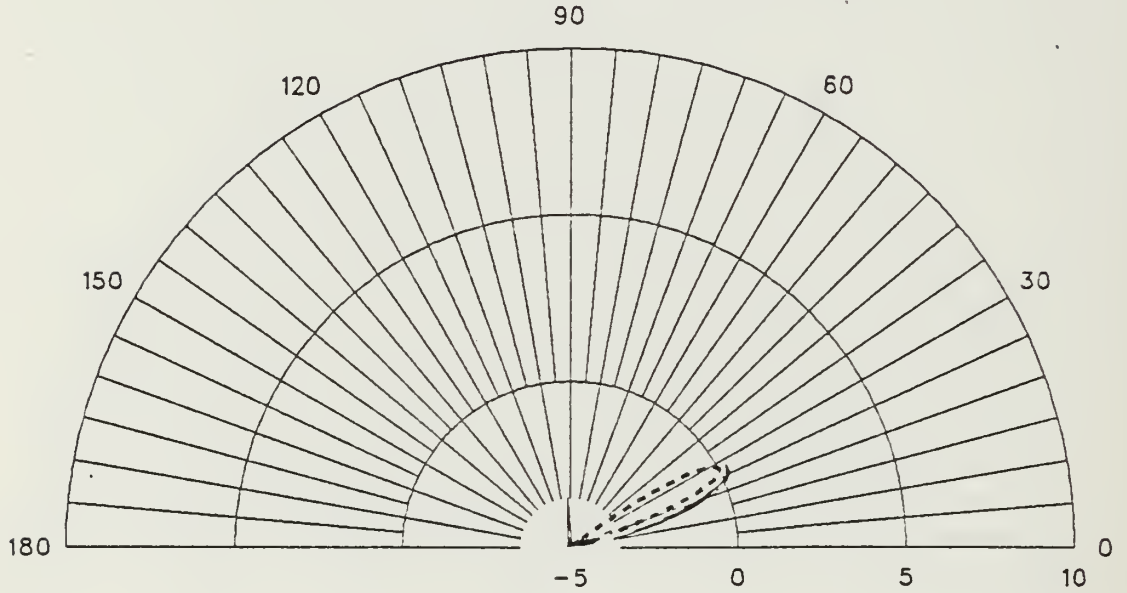

ANTENNA 1G

4 3/4 X 1/2 LAMBDA FREQ=17 MHZ THETA=75

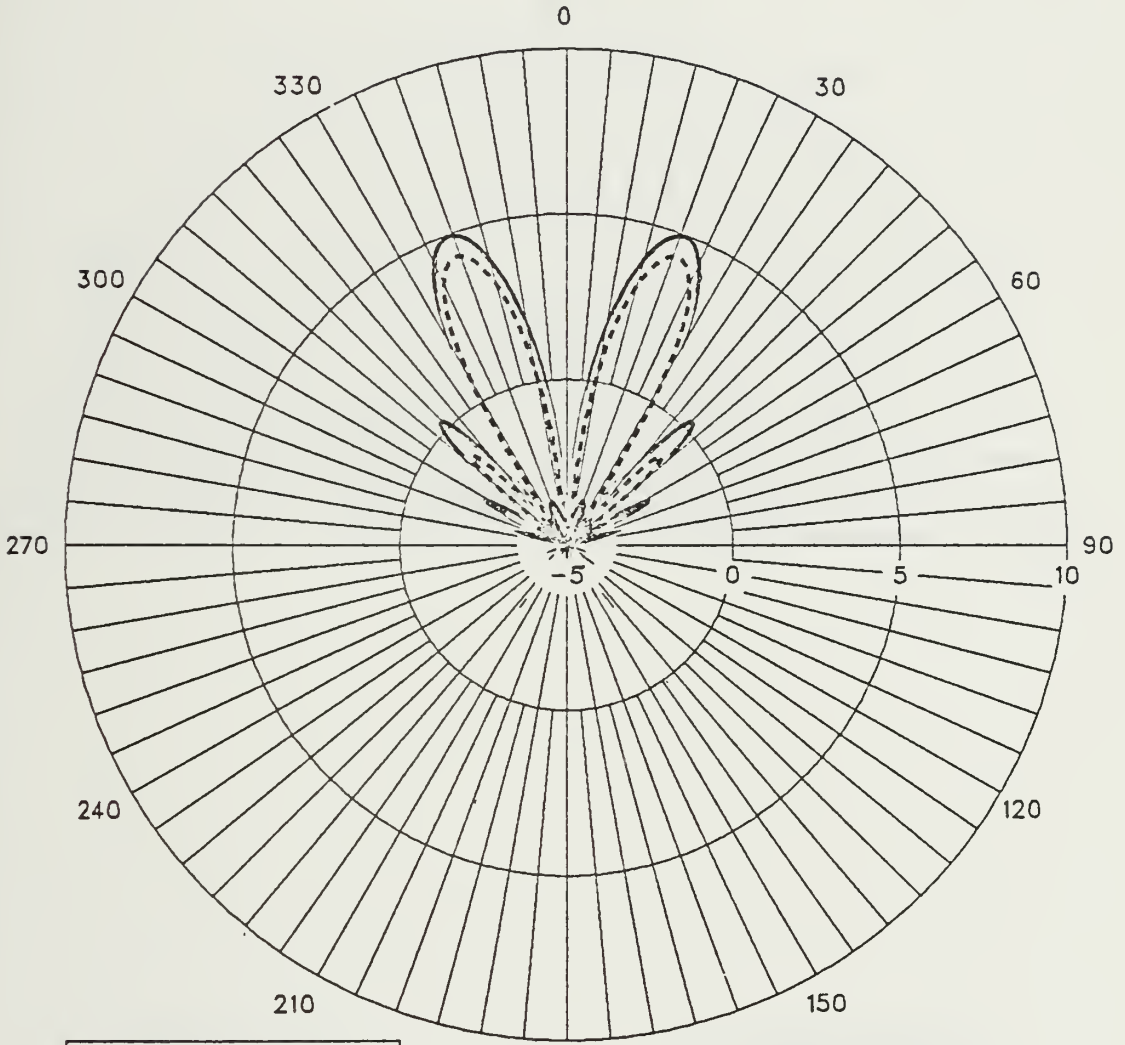

PATTERN GAIN IN DBI	
-----	HORIZONTAL
- · - · -	VERTICAL
—————	TOTAL
ANGLES IN DEGREES TRUE	

ANTENNA 1H

4 3/4 X 1/2 LAMBDA FREQ=17 MHZ PHI=0

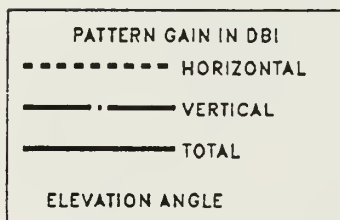
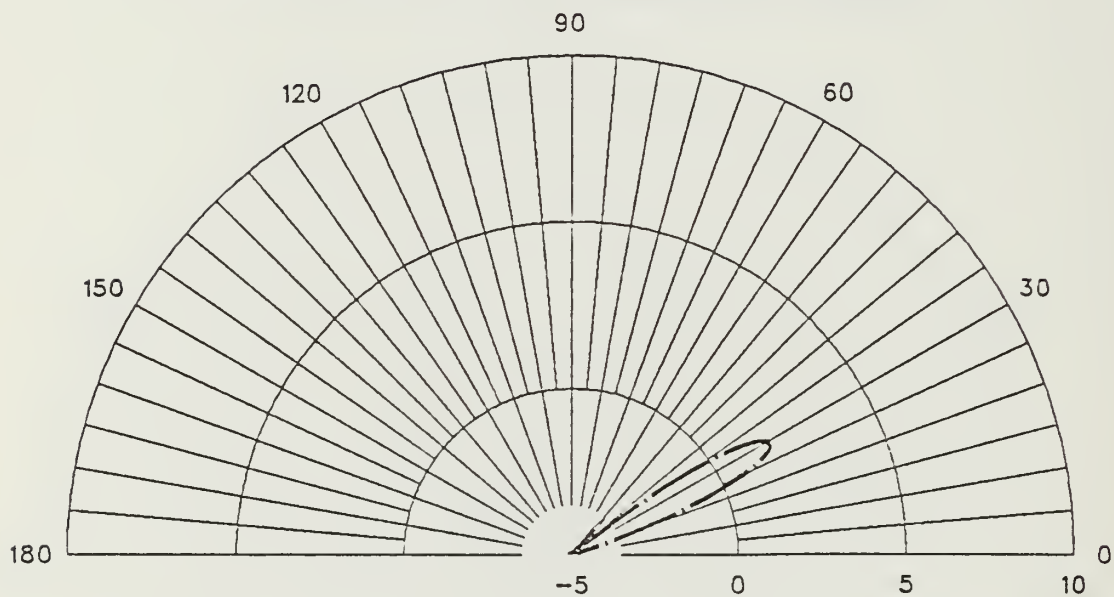

ANTENNA 1H

4 3/4 X 1/2 LAMBDA FREQ=17 MHZ PHI=10

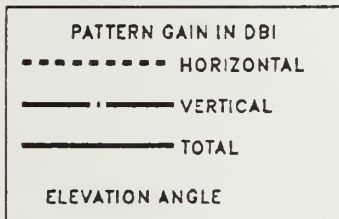
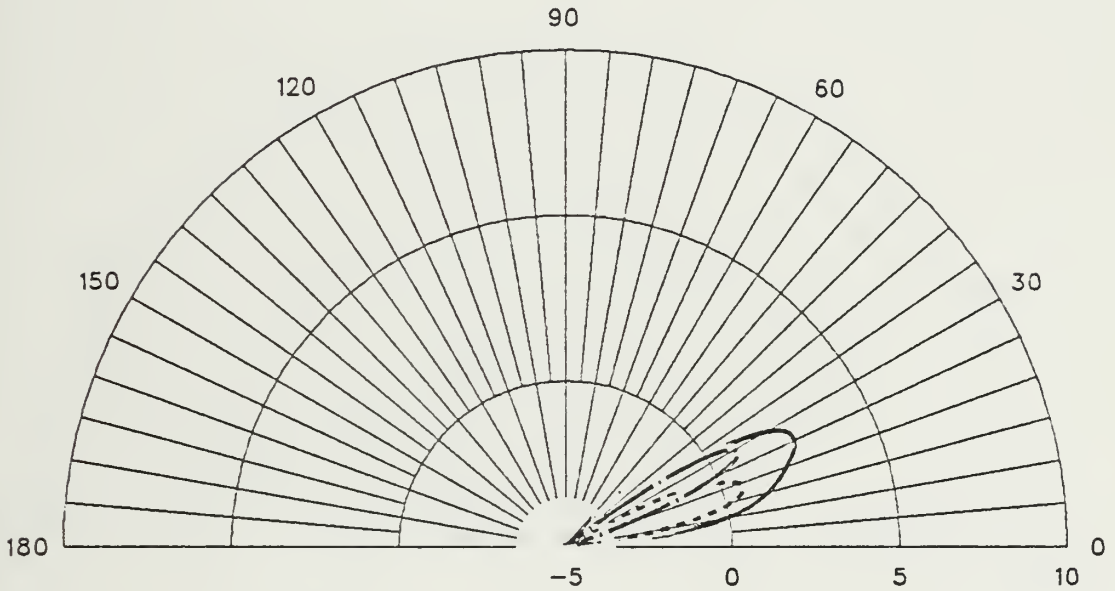

ANTENNA 1H

4 3/4 X 1/2 LAMBDA FREQ=17 MHZ PHI=20

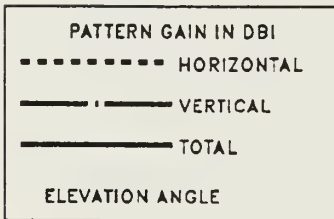
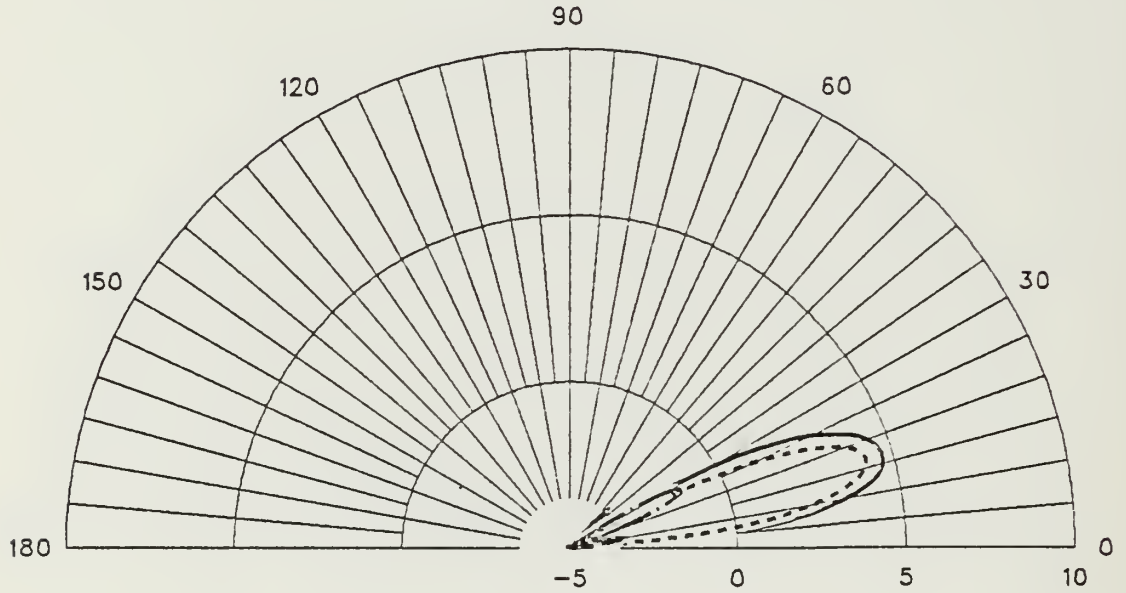

ANTENNA 1H

4 3/4 X 1/2 LAMBDA FREQ=17 MHZ PHI=30

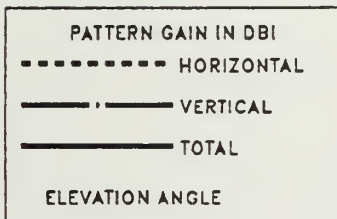
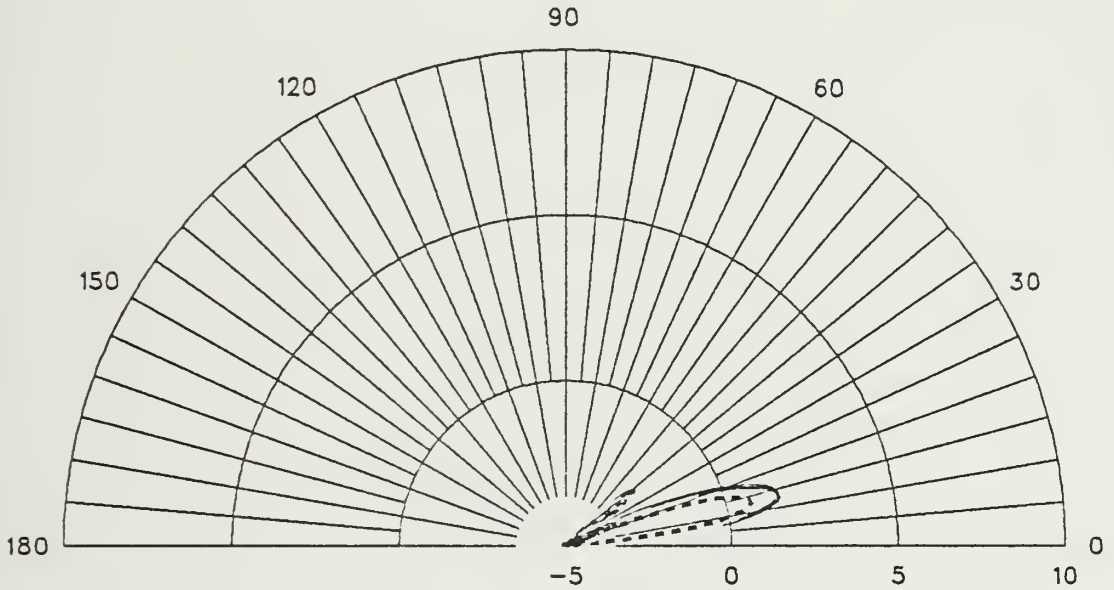

ANTENNA 1H

4 3/4 X 1/2 LAMBDA FREQ=17 MHZ PHI=40

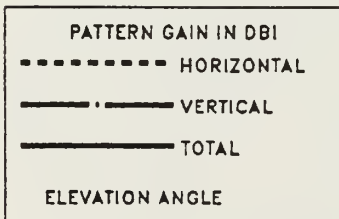
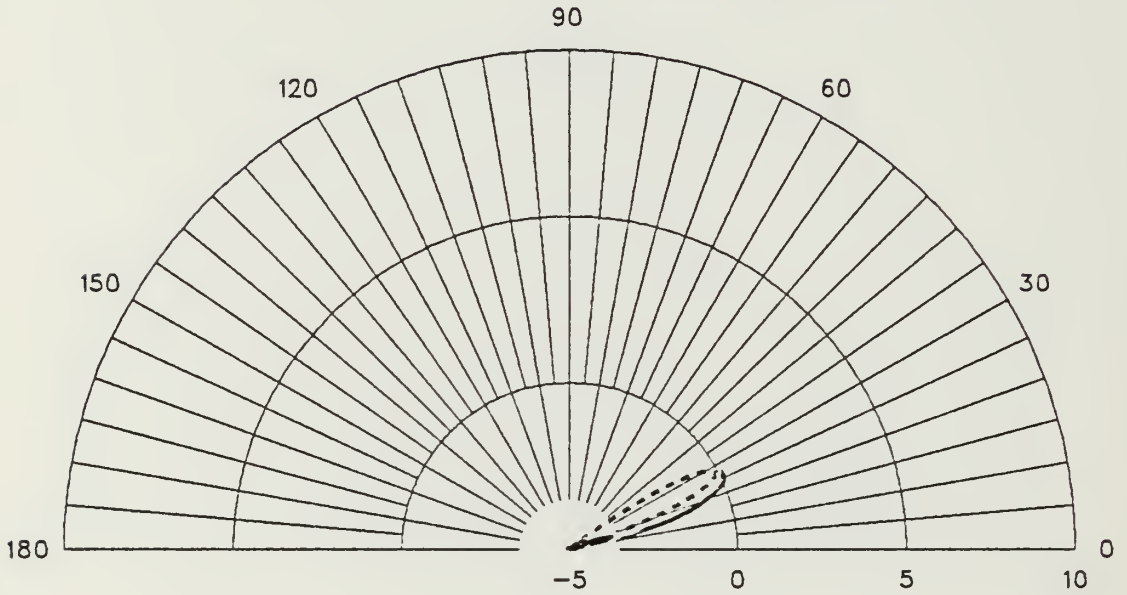

ANTENNA 1H

4 3/4 X 1/2 LAMBDA FREQ=17 MHZ THETA=75

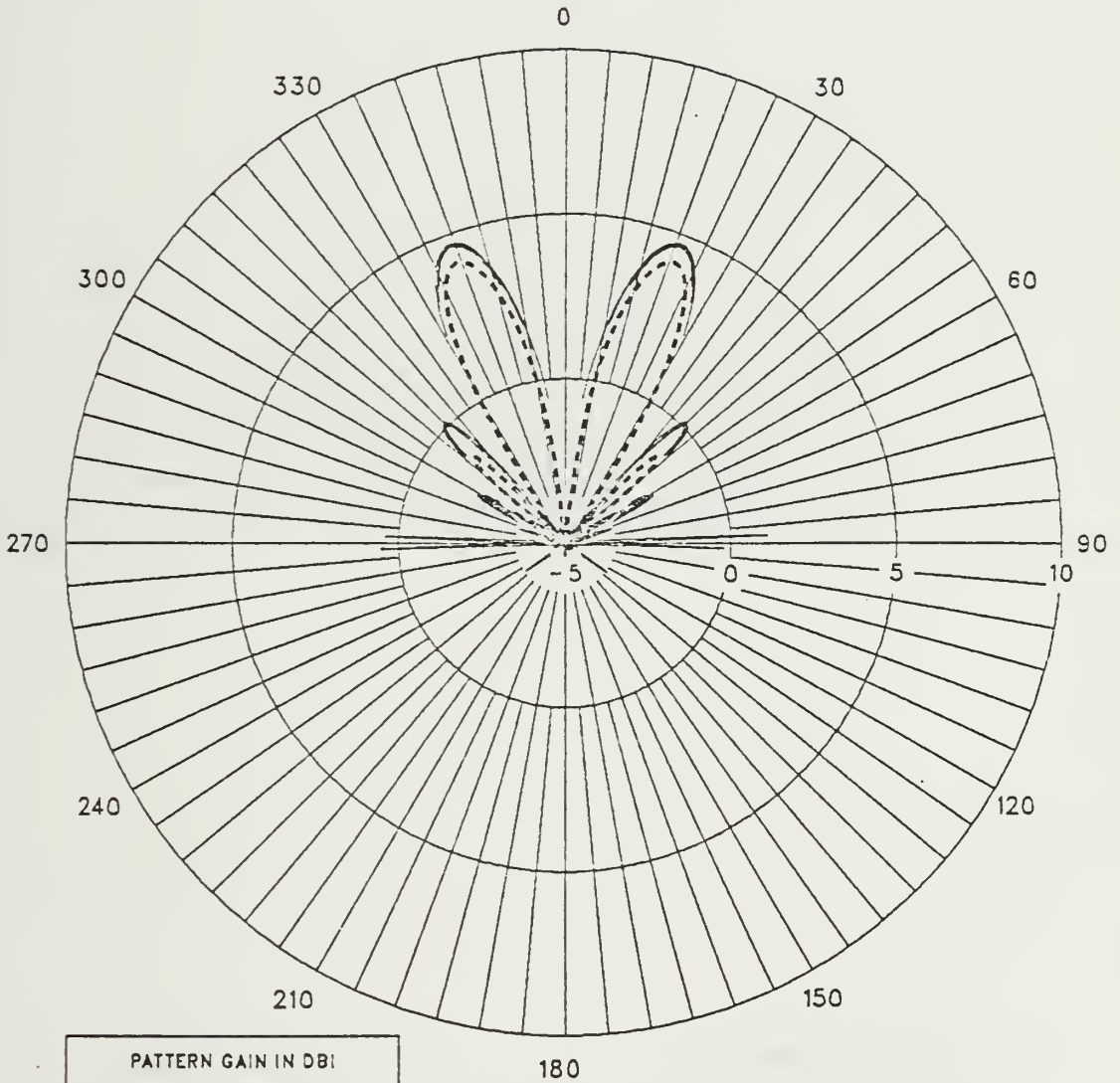

PATTERN GAIN IN DBI	
-----	HORIZONTAL
- . - . - .	VERTICAL
—————	TOTAL
ANGLES IN DEGREES TRUE	

ANTENNA 2A

100 X 15 FT FREQ=17 MHZ PHI=0

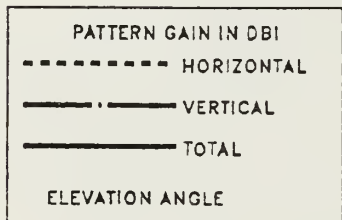
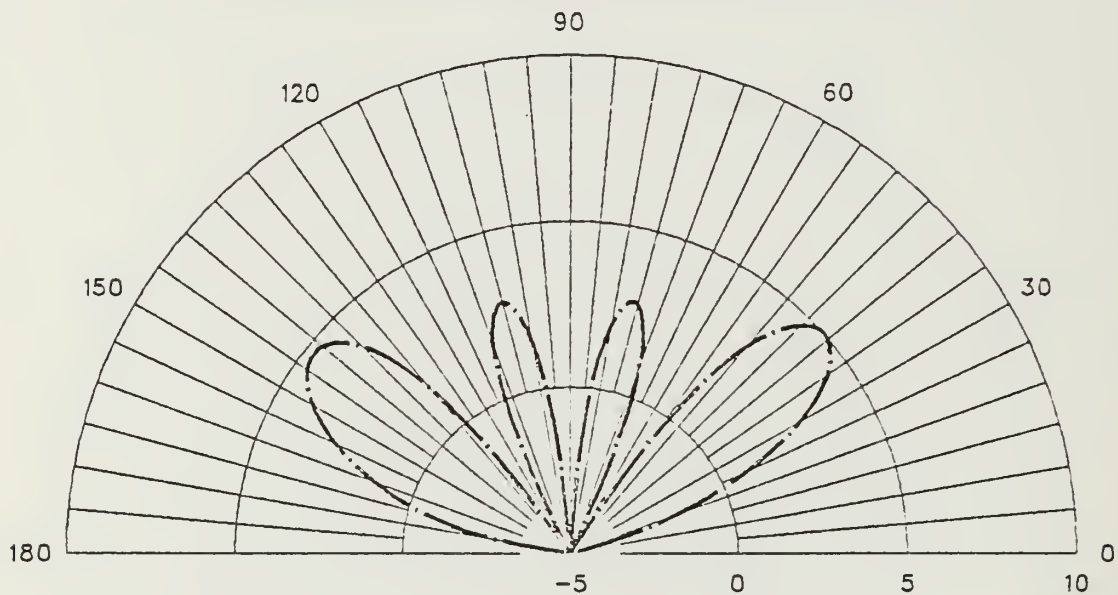

ANTENNA 2A

100 X 15 FT FREQ=17 MHZ PHI=10

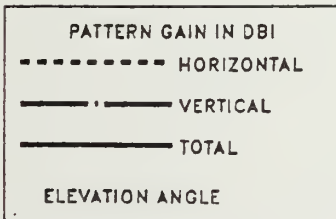
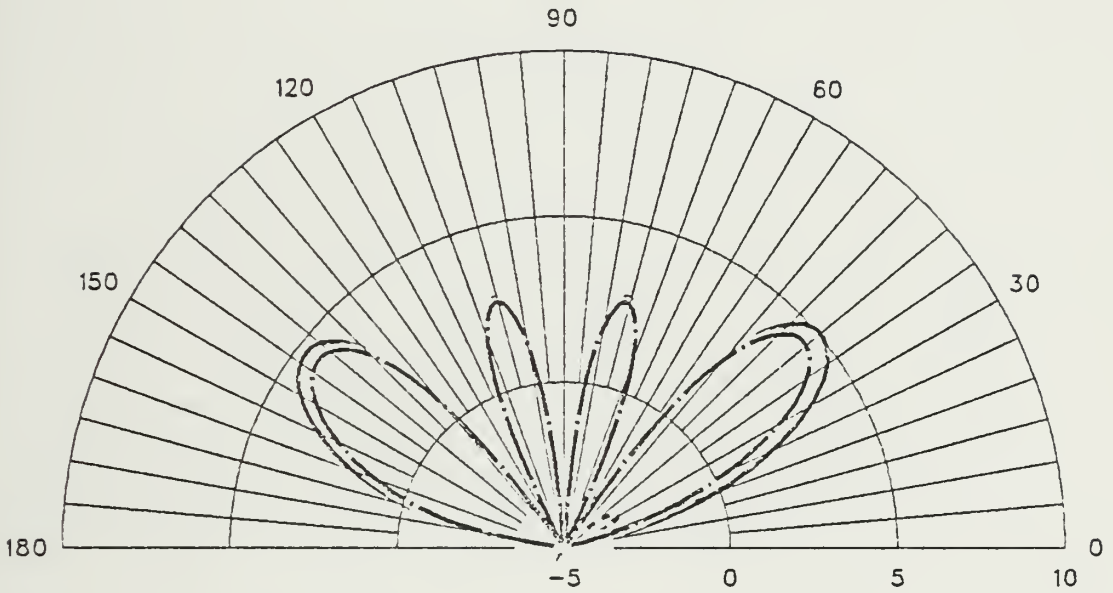

ANTENNA 2A

100 X 15 FT FREQ=17 MHZ PHI=20

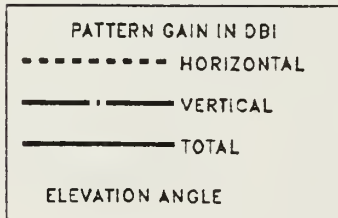
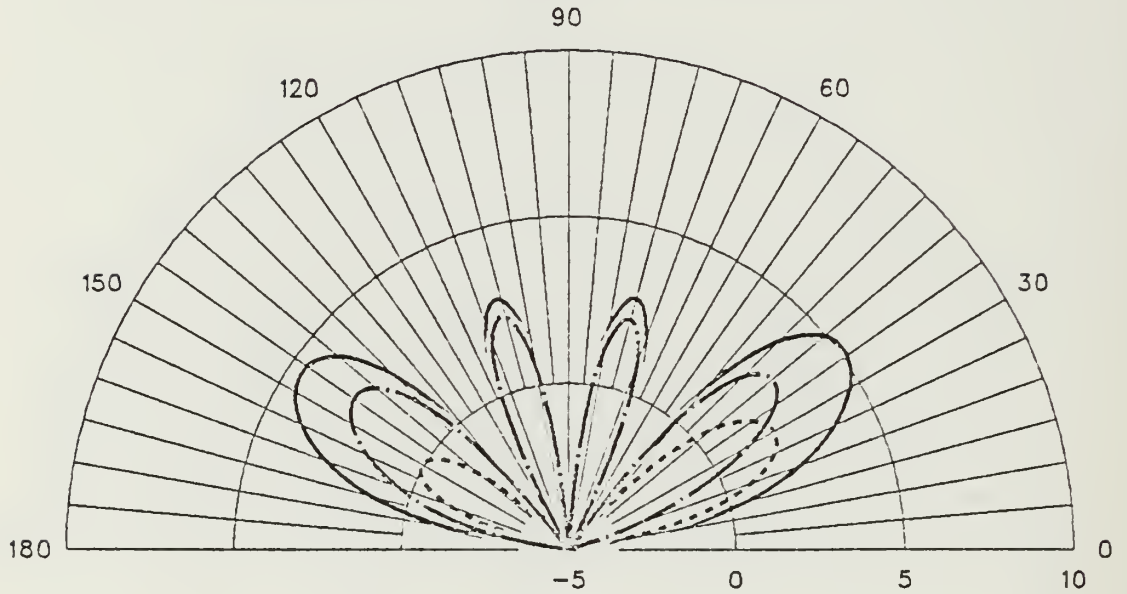

ANTENNA 2A

100 X 15 FT FREQ=17 MHZ PHI=30

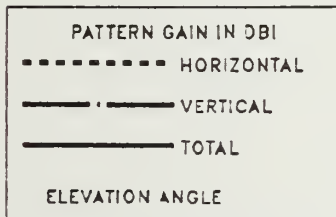
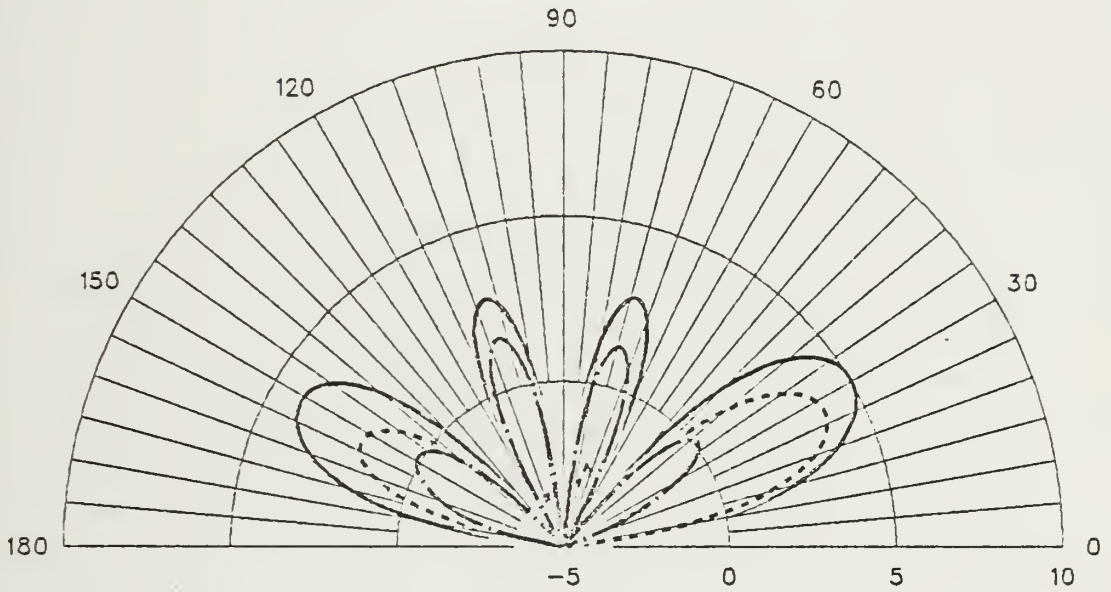

ANTENNA 2A

100 X 15 FT FREQ=17 MHZ PHI=40

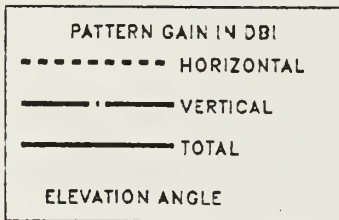
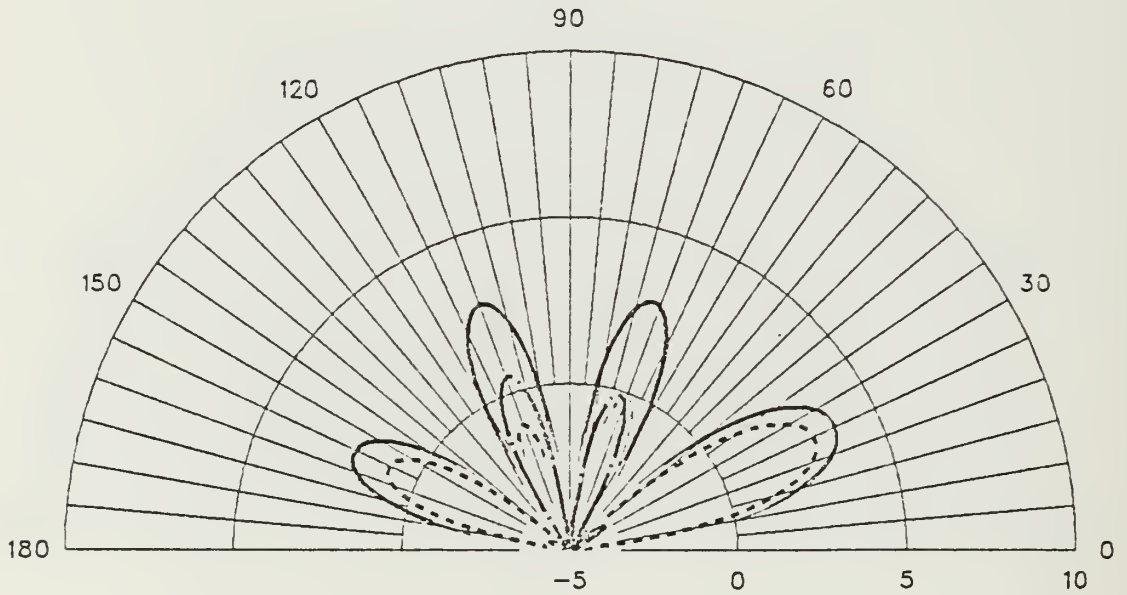

ANTENNA 2A

100 X 15 FT FREQ=17 MHZ THETA=60

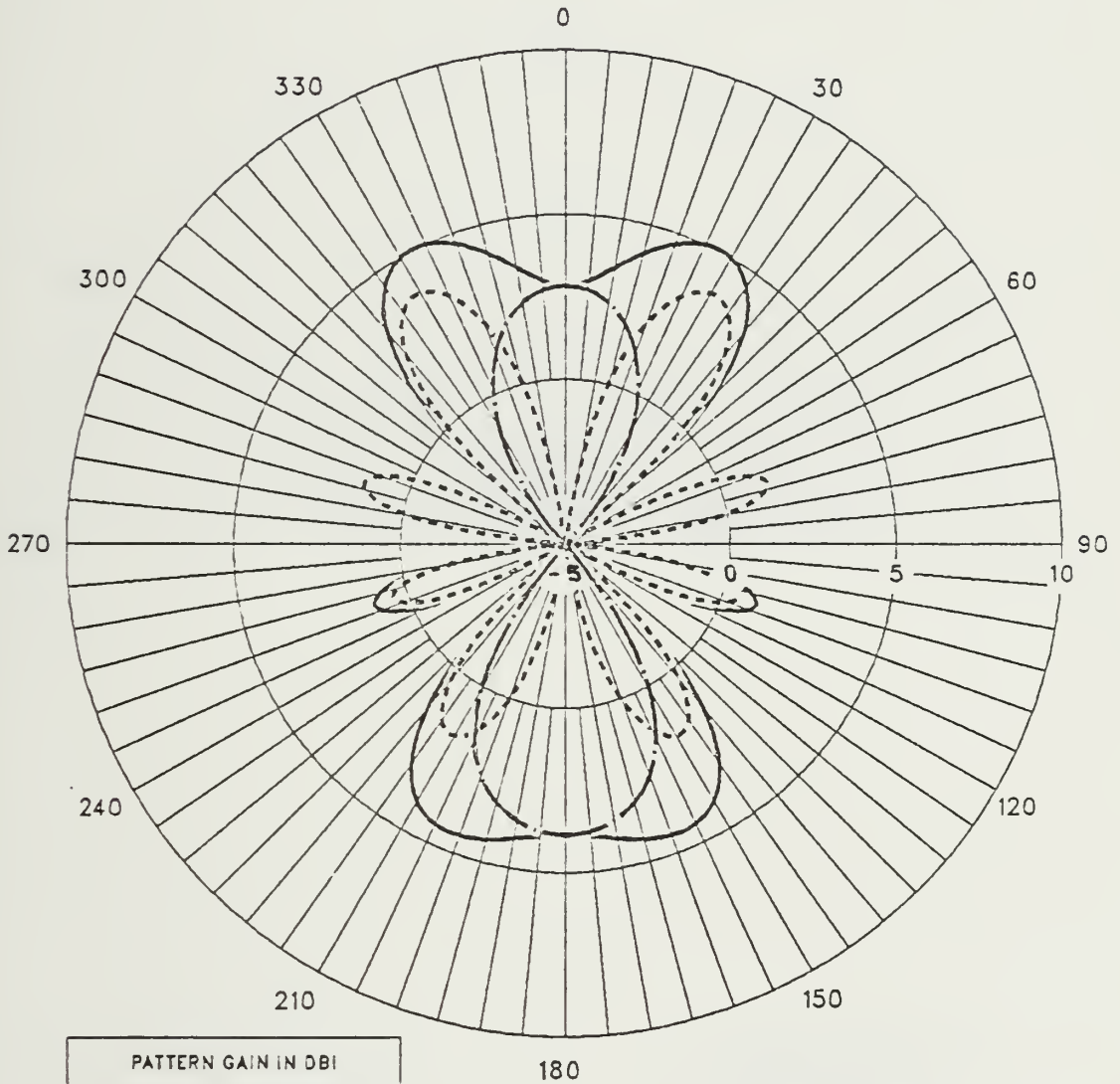

PATTERN GAIN IN DBI
----- HORIZONTAL
- · - · - VERTICAL
————— TOTAL
ANGLES IN DEGREES TRUE

ANTENNA 2A

100 X 15 FT FREQ=30 MHZ PHI=0

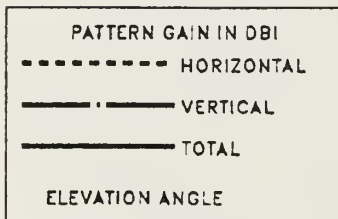
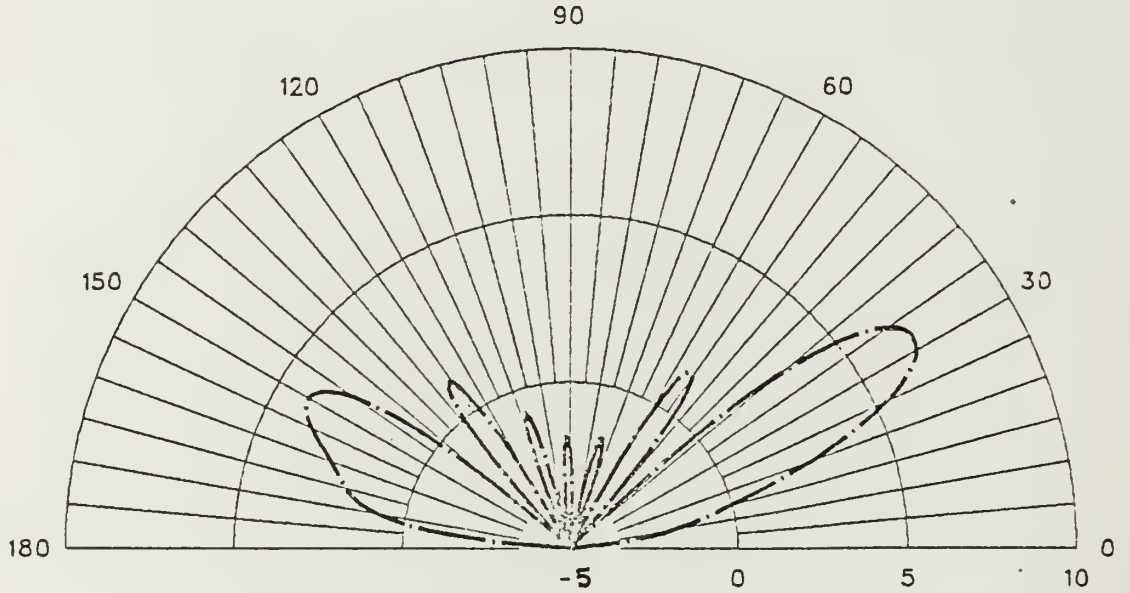

ANTENNA 2A

100 X 15 FT FREQ=30 MHZ PHI=10

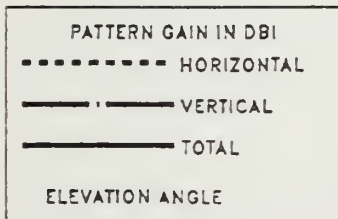
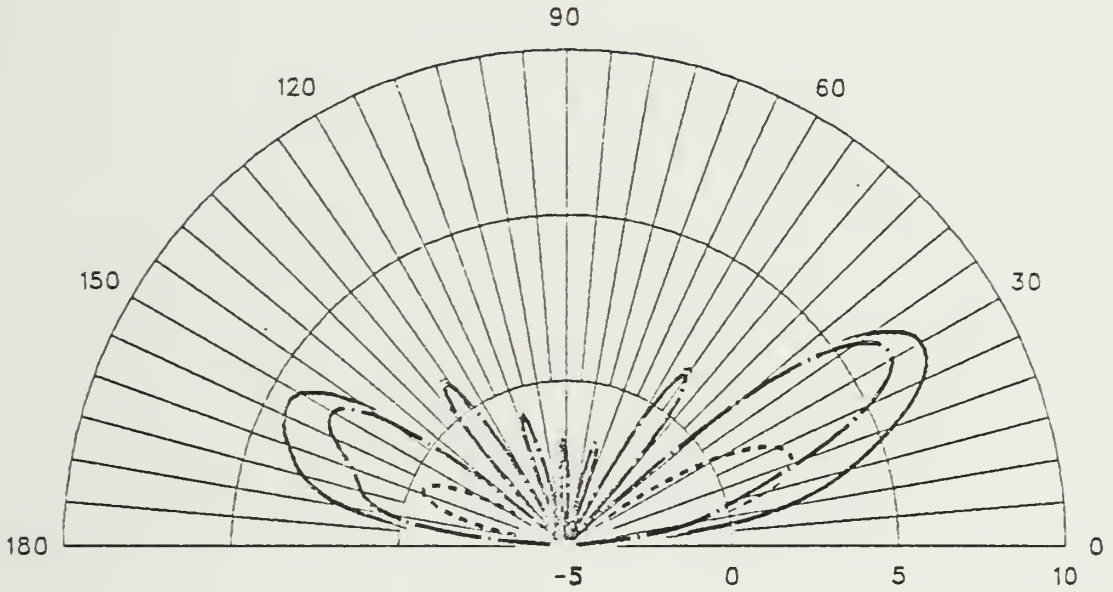

ANTENNA 2A

100 X 15 FT FREQ=30 MHZ PHI=20

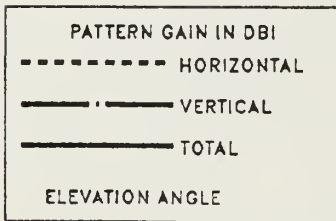
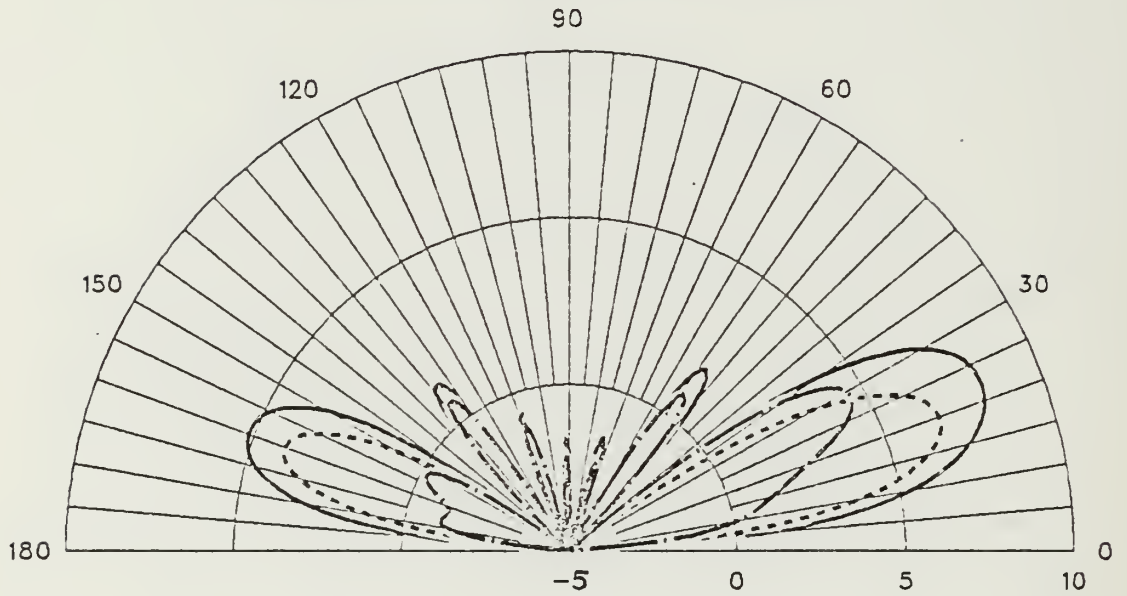

ANTENNA 2A

100 X 15 FT FREQ=30 MHZ PHI=30

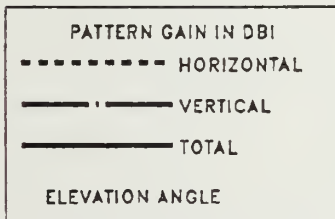
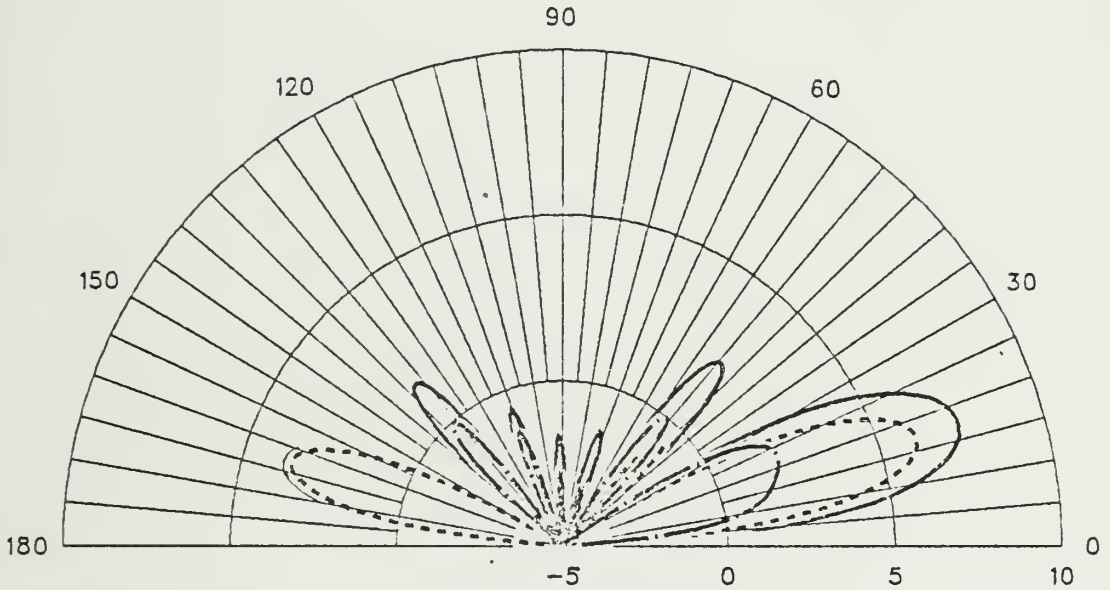

ANTENNA 2A

100 X 15 FT FREQ=30 MHZ PHI=40

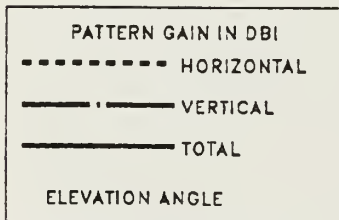
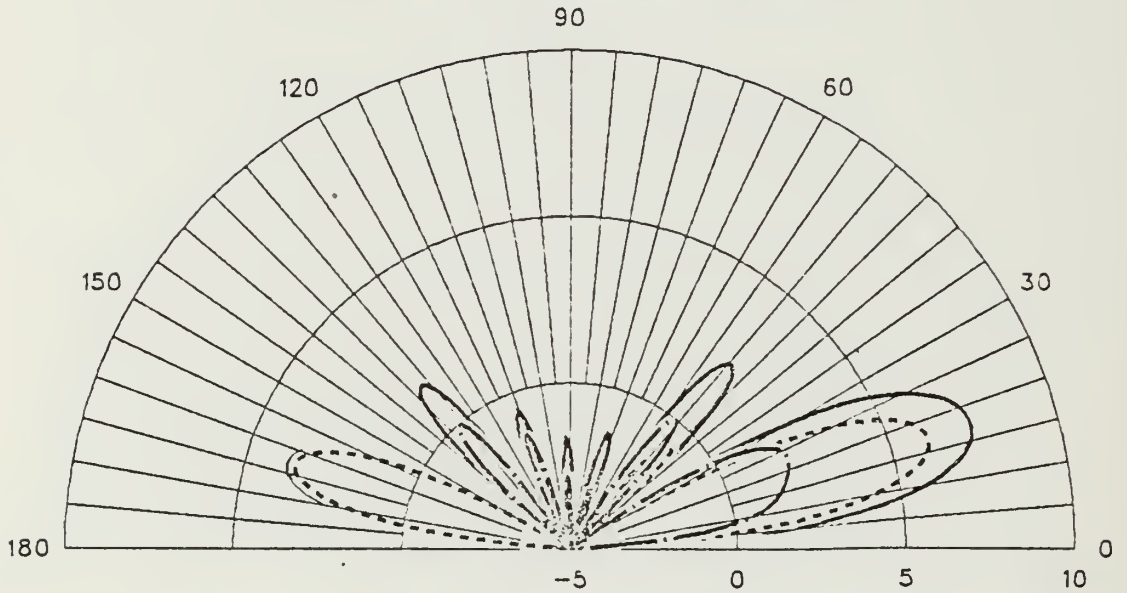

ANTENNA 2A

100 X 15 FT FREQ=30 MHZ THETA=65

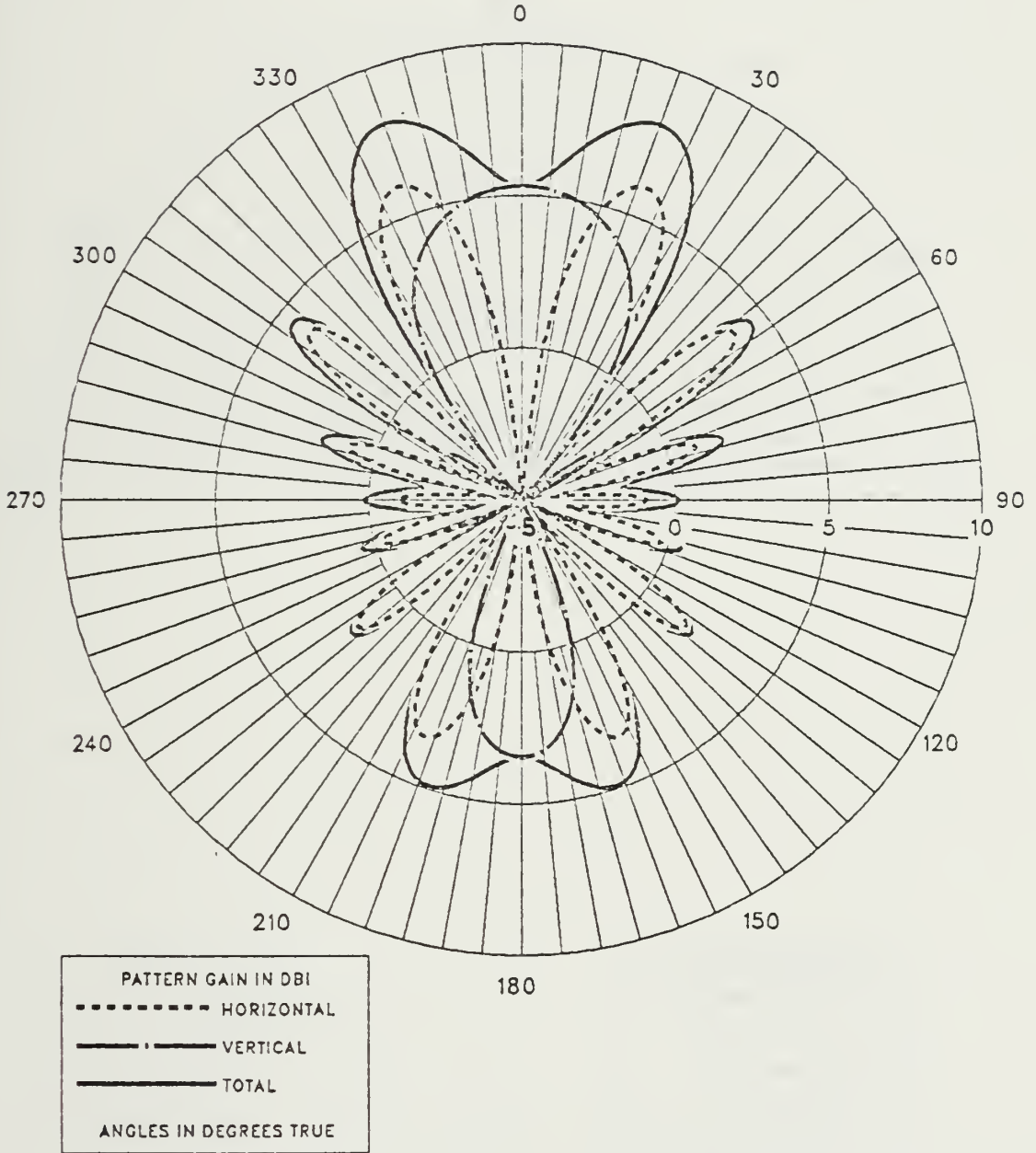

ANTENNA 2B

121 X 15 FT FREQ=17 MHZ PHI=0

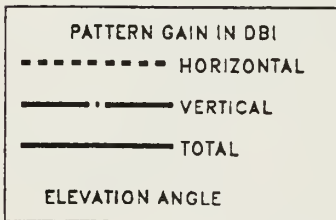
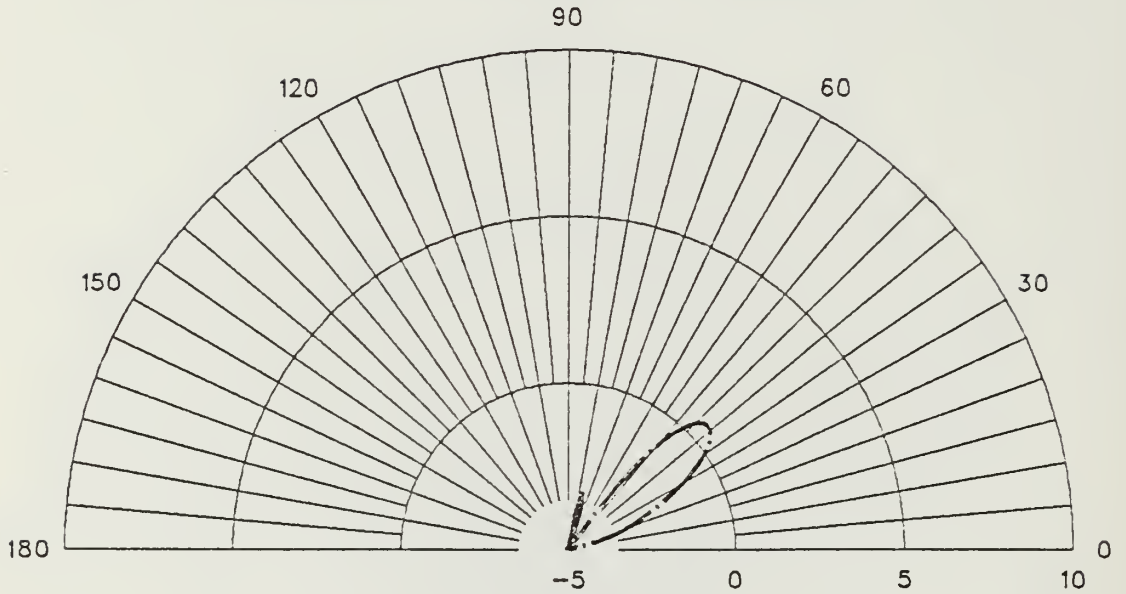

ANTENNA 2B

121 X 15 FT FREQ=17 MHZ PHI=10

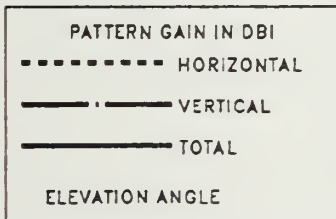
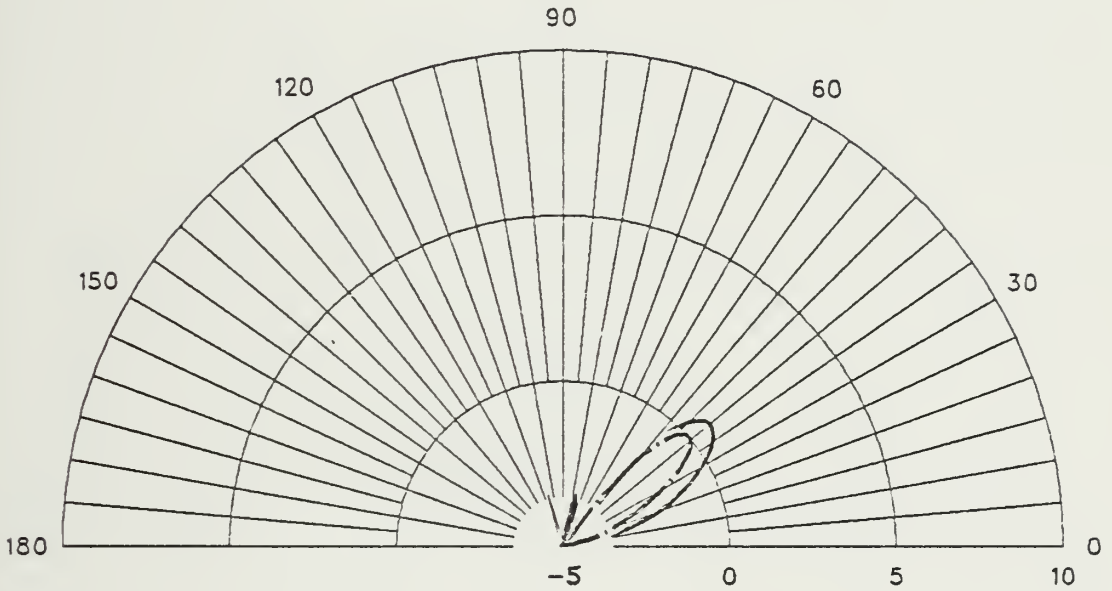

ANTENNA 2B

121 X 15 FT FREQ=17 MHZ PHI=20

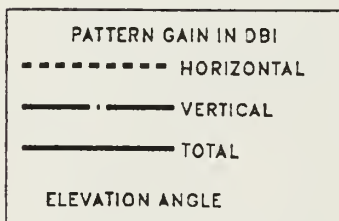
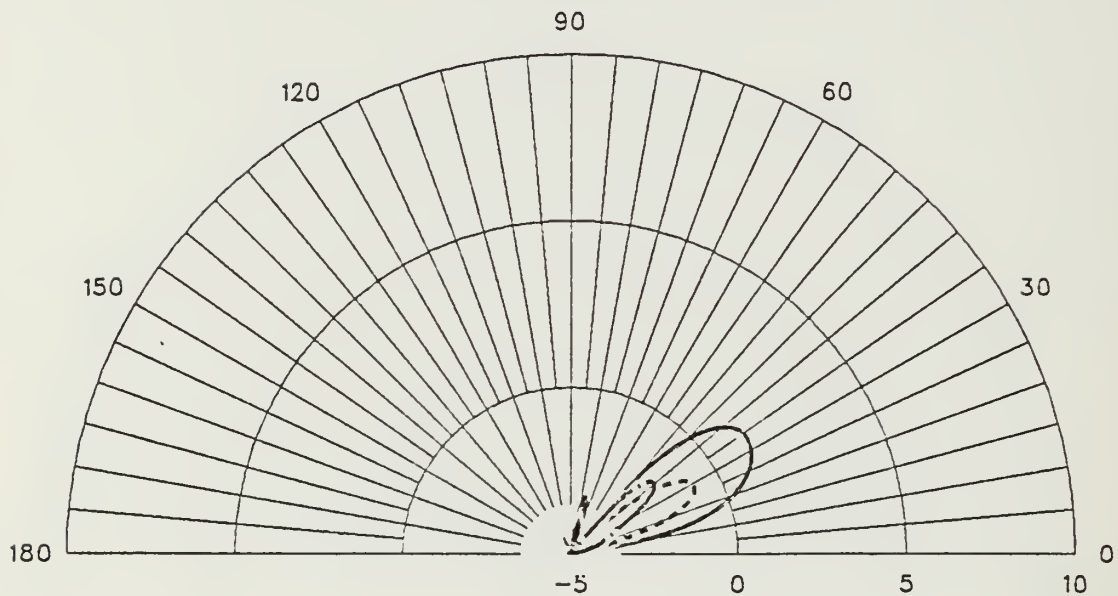

ANTENNA 2B

121 X 15 FT FREQ=17 MHZ PHI=30

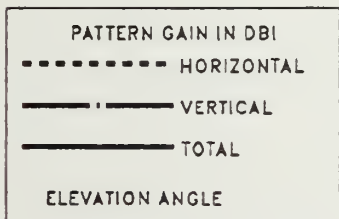
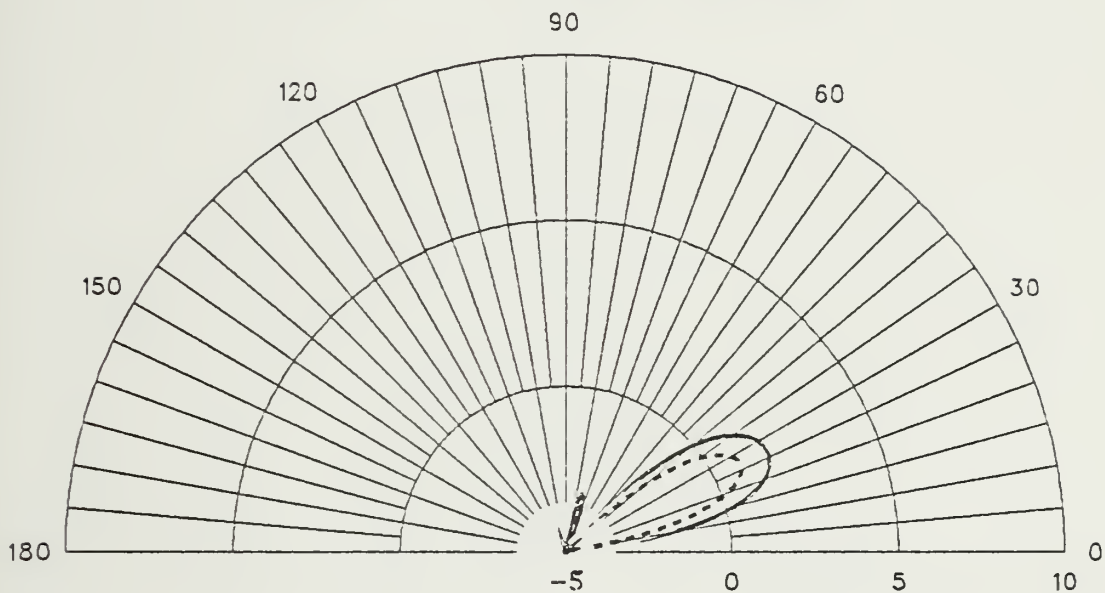

ANTENNA 2B

121 X 15 FT FREQ=17 MHZ PHI=40

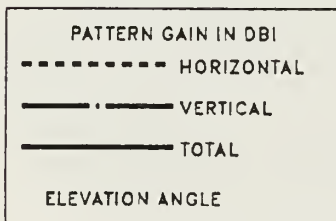
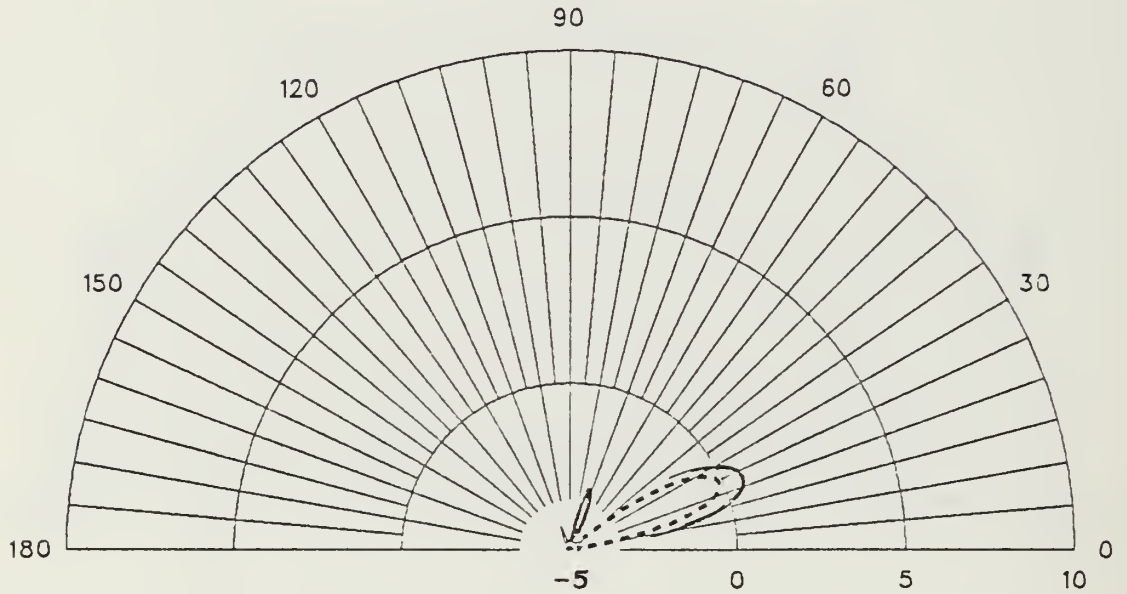

ANTENNA 2B

121 X 15 FT FREQ=17 MHZ THETA=65

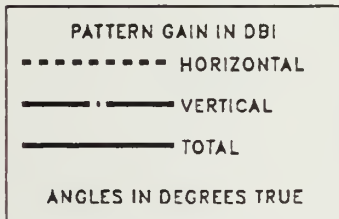
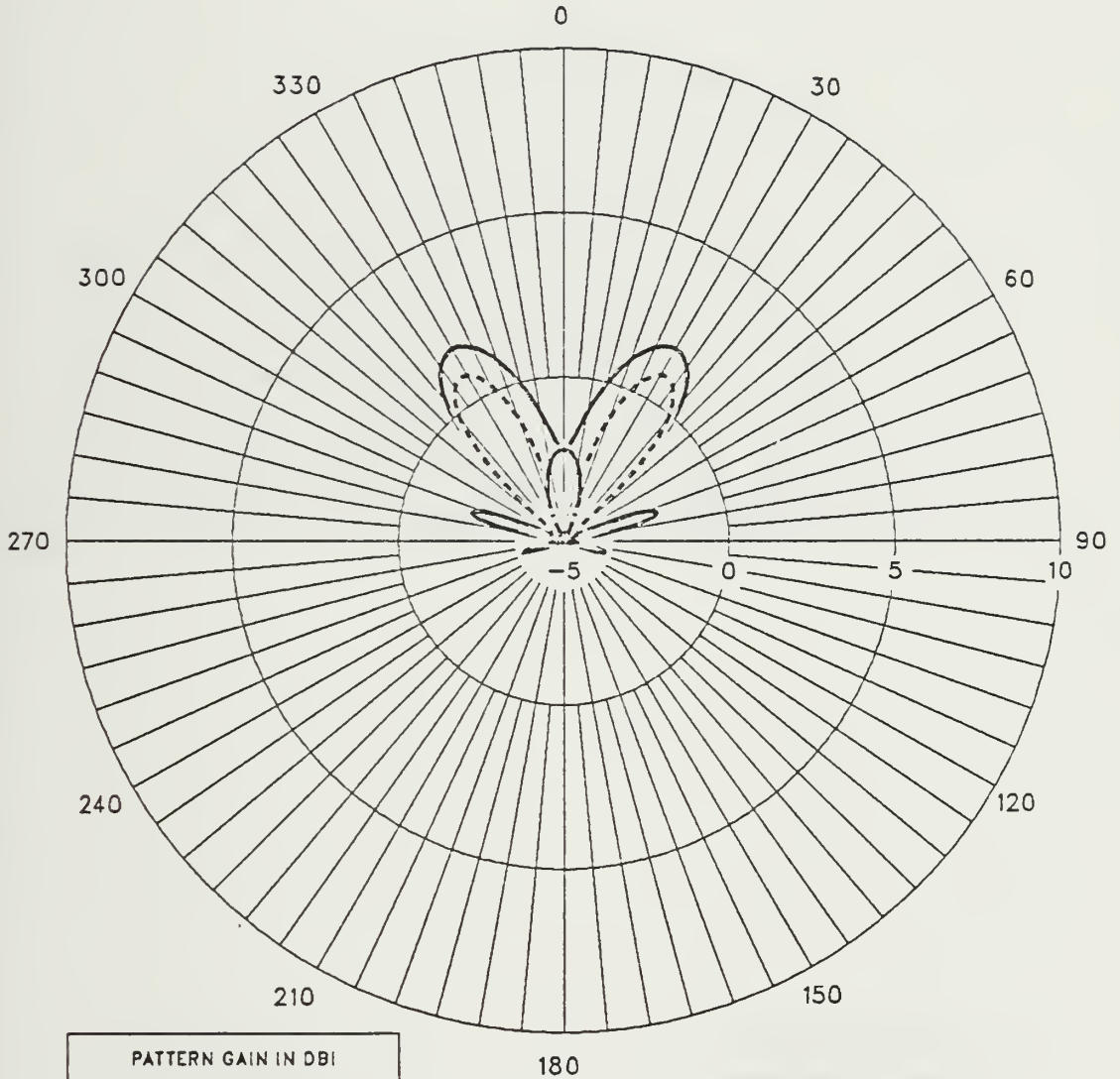

ANTENNA 2B

121 X 15 FT FREQ=30 MHZ PHI=0

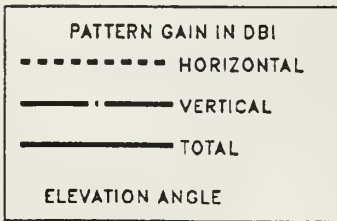
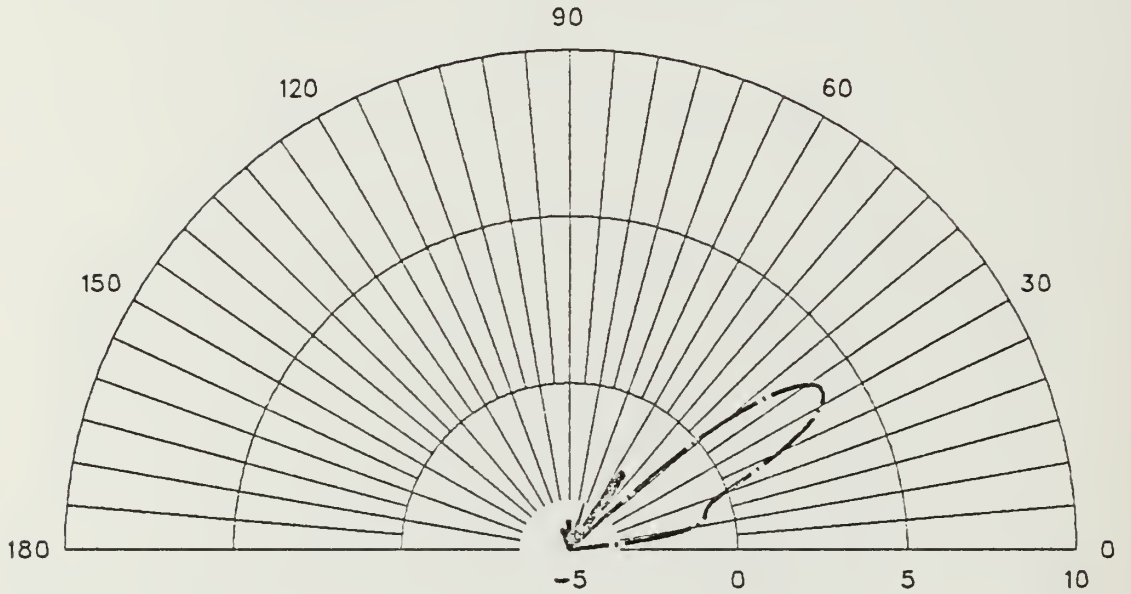

ANTENNA 2B

121 X 15 FT FREQ=30 MHZ PHI=10

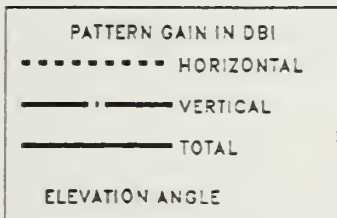
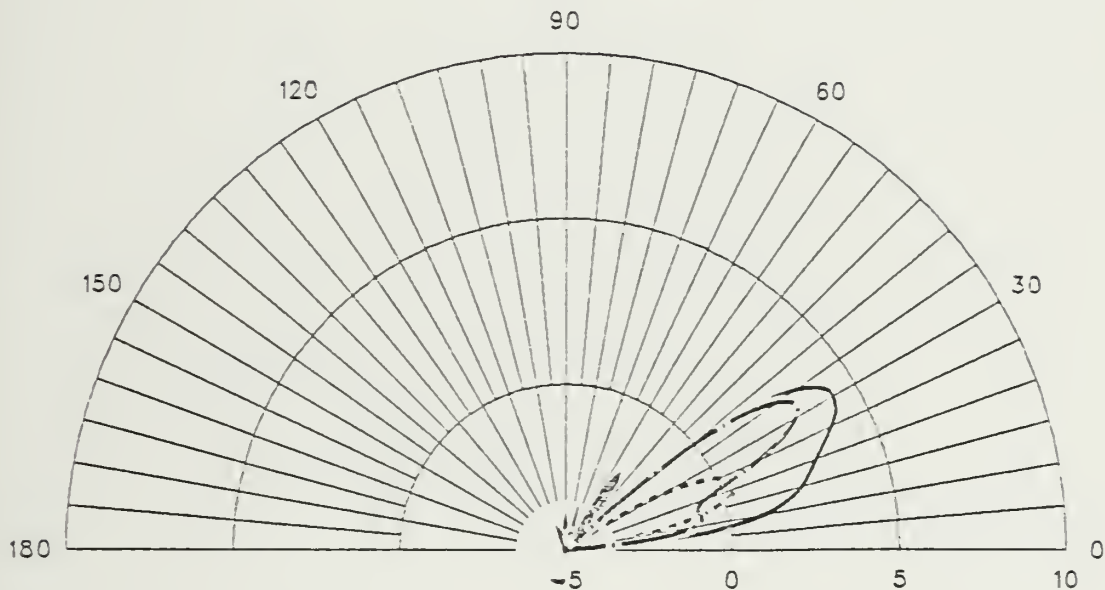

ANTENNA 2B

121 X 15 FT FREQ=30 MHZ PHI=20

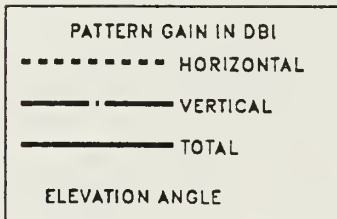
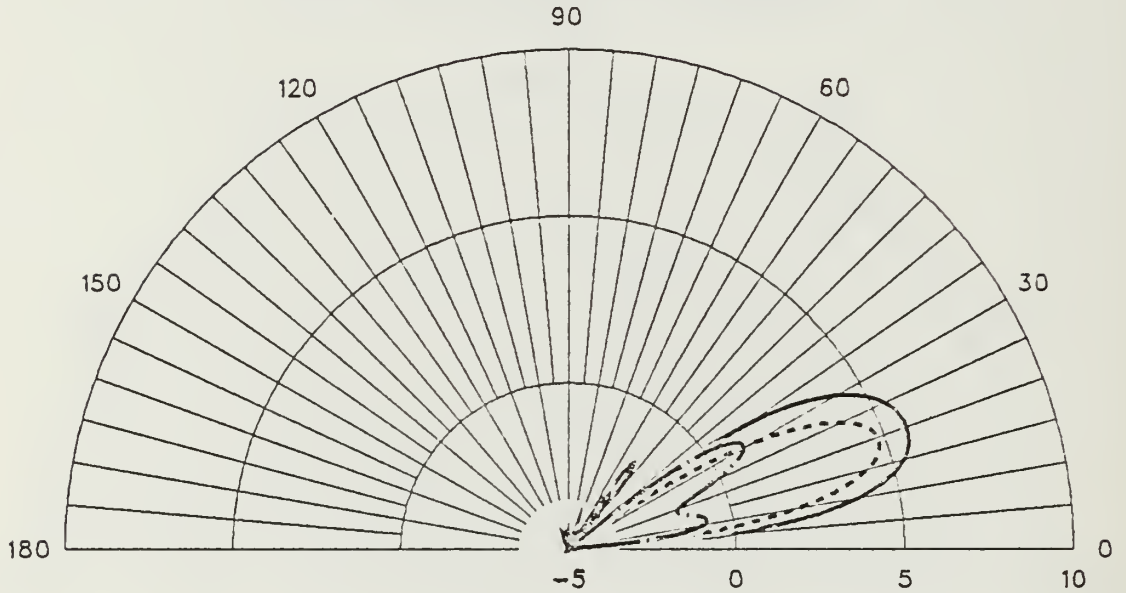

ANTENNA 2B

121 X 15 FT FREQ=30 MHZ PHI=30

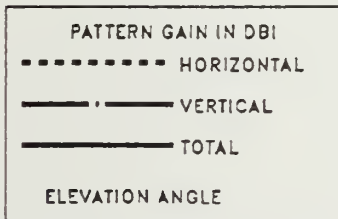
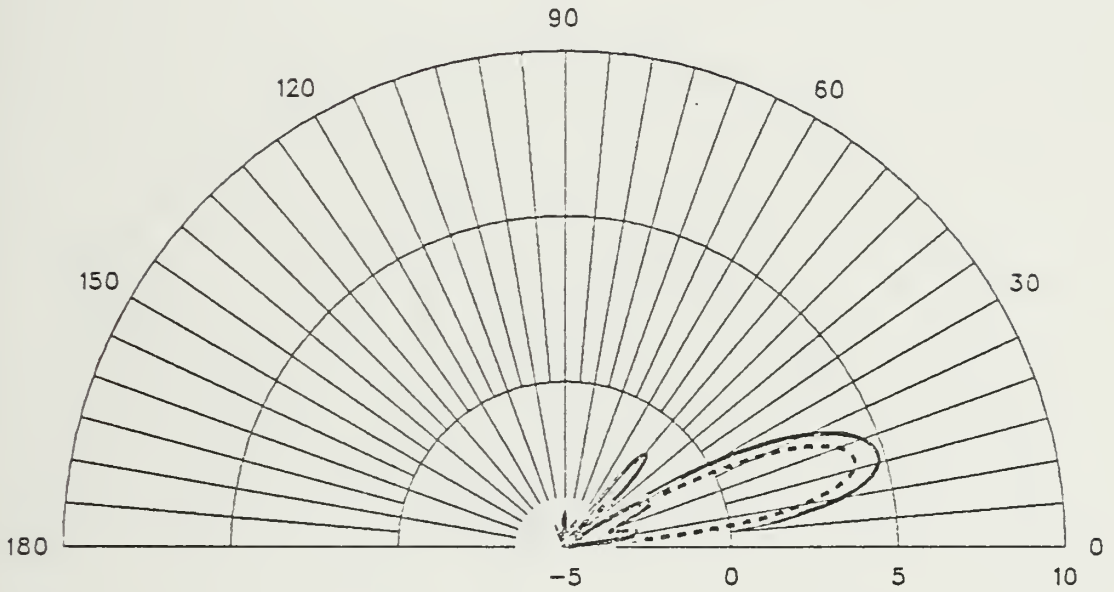

ANTENNA 2B

121 X 15 FT FREQ=30 MHZ THETA=70

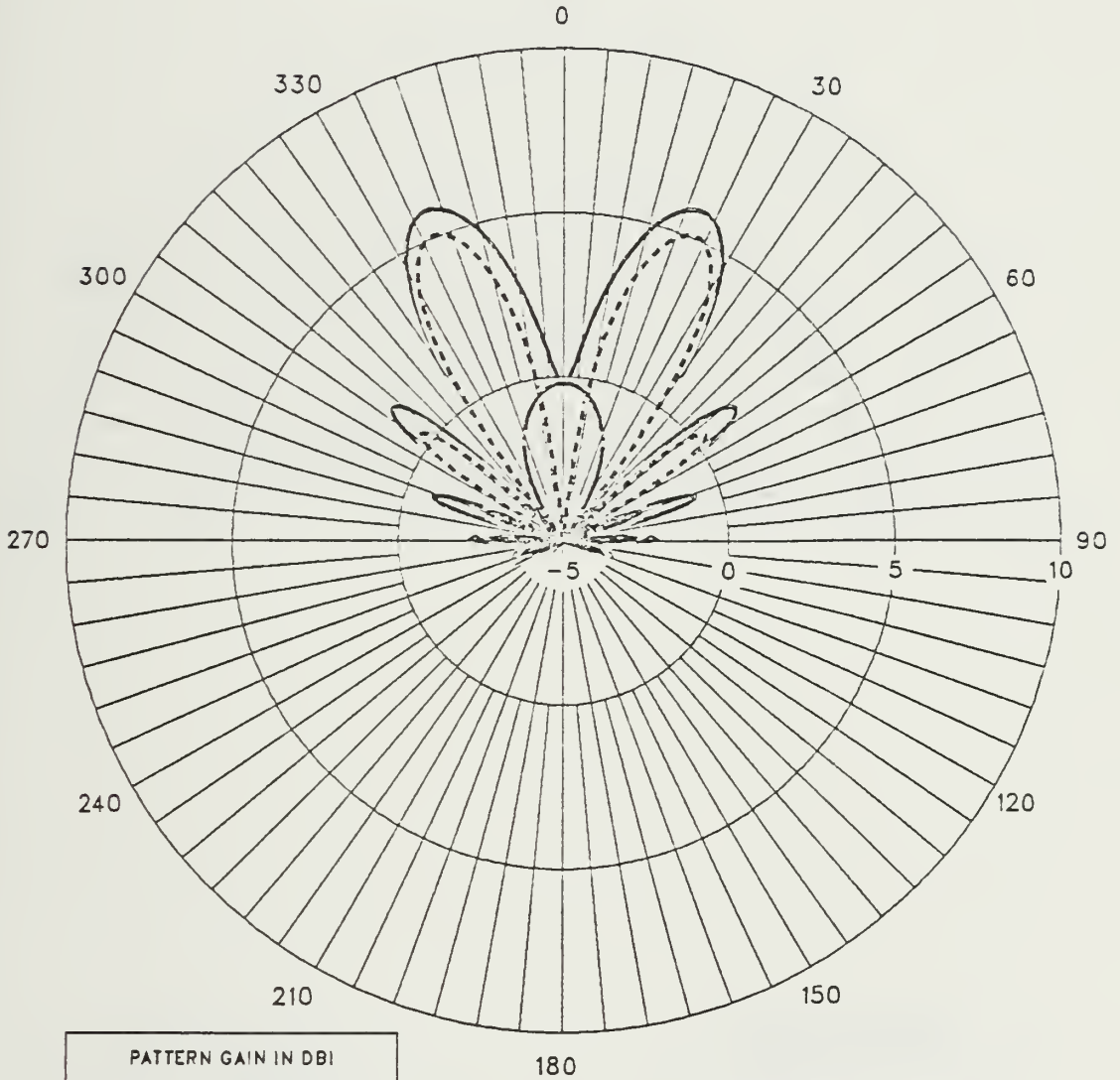

PATTERN GAIN IN DBI
- - - - - HORIZONTAL
————— VERTICAL
————— TOTAL
ANGLES IN DEGREES TRUE

ANTENNA 2C

121 X 6 FT FREQ=17 MHZ PHI=0

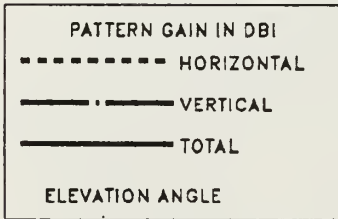
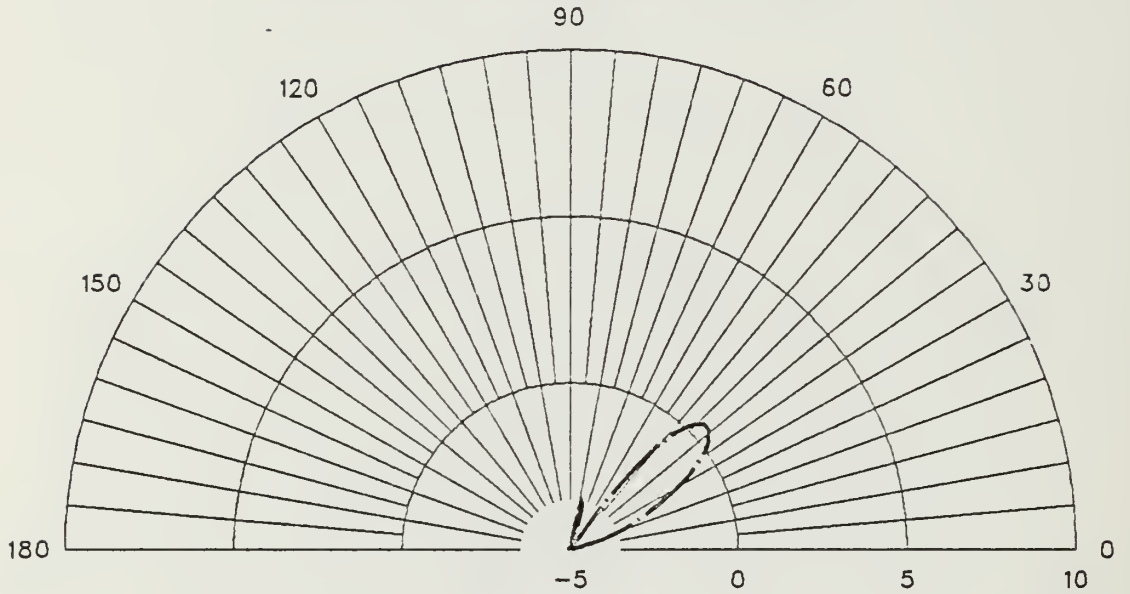

ANTENNA 2C

121 X 6 FT FREQ=17 MHZ PHI=10

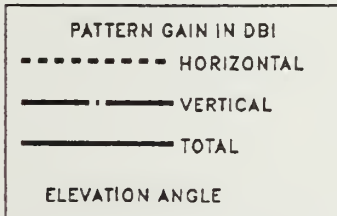
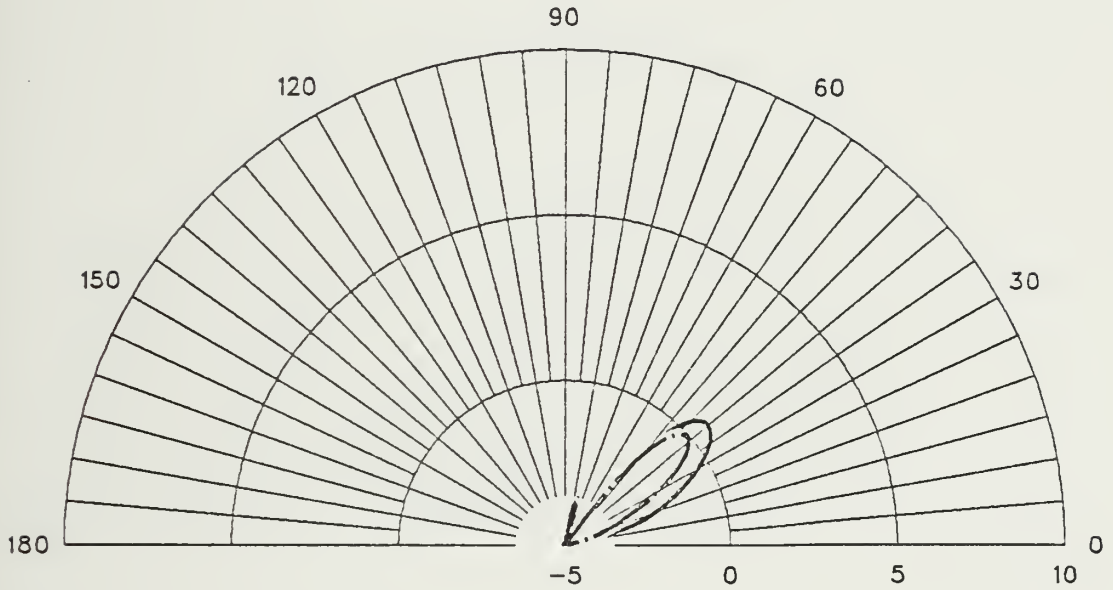

ANTENNA 2C

121 X 6 FT FREQ=17 MHZ PHI=20

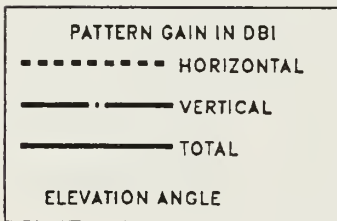
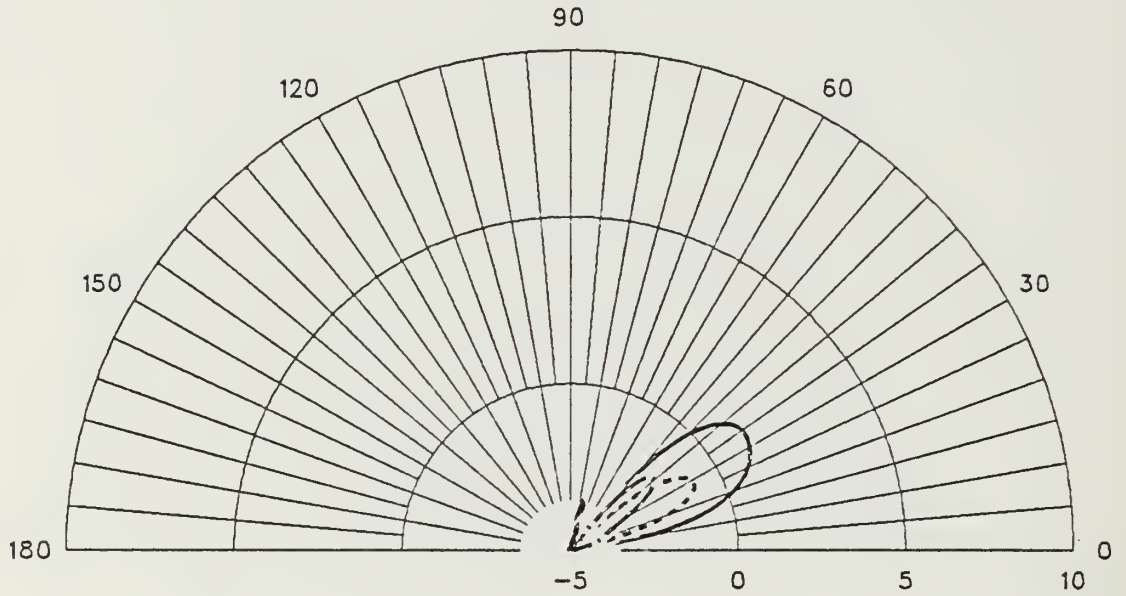

ANTENNA 2C

121 X 6 FT FREQ=17 MHZ PHI=30

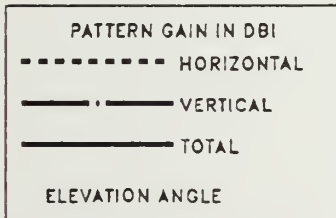
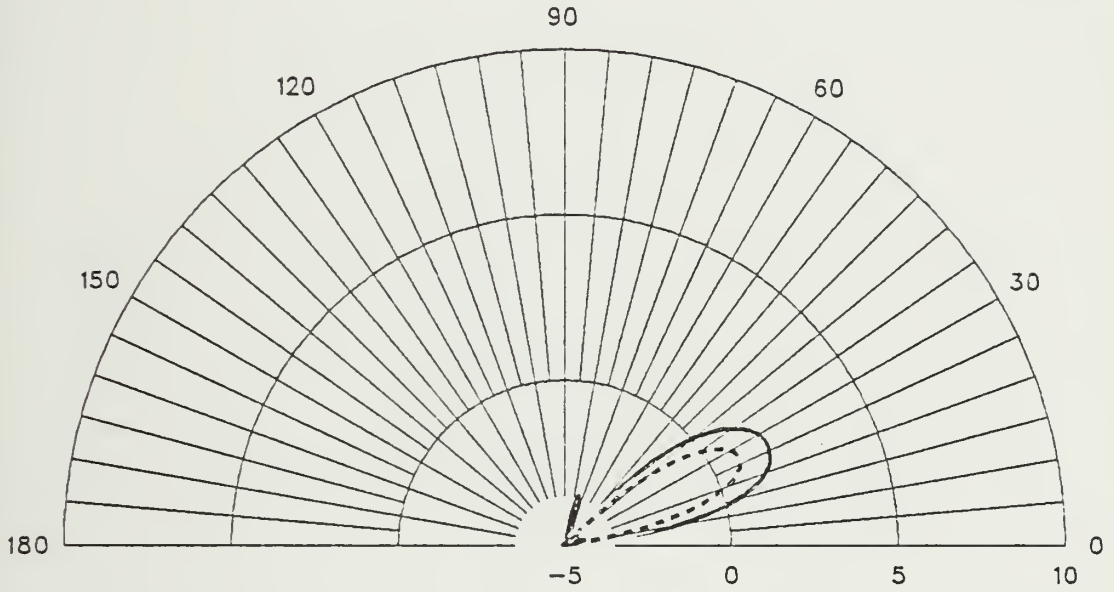

ANTENNA 2C

121 X 6 FT FREQ=17 MHZ PHI=40

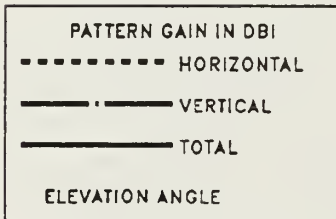
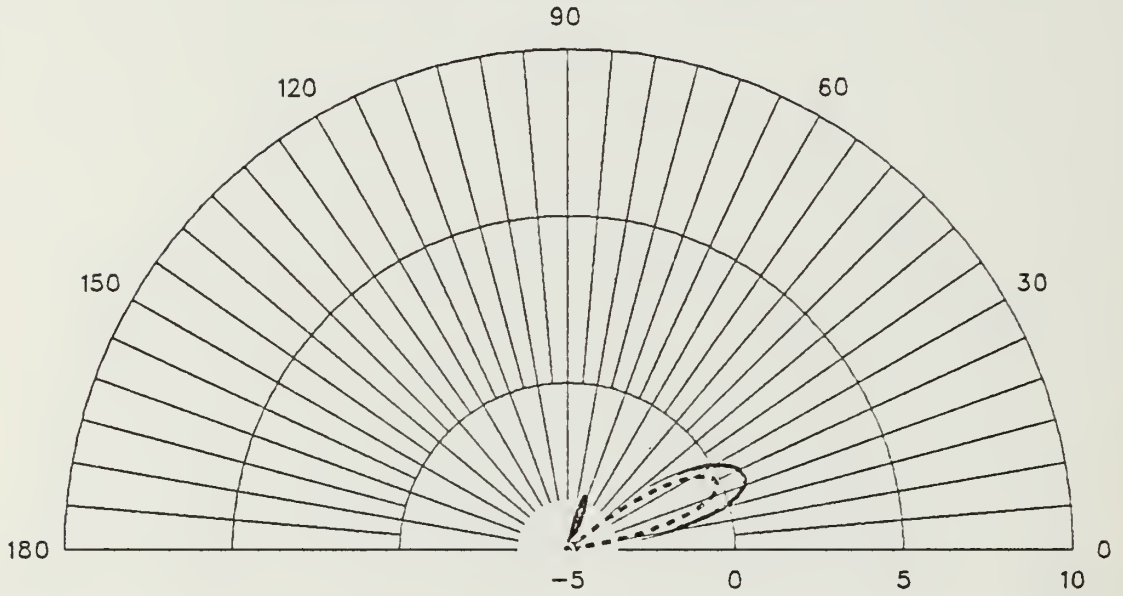

ANTENNA 2C

121 X 6 FT FREQ=17 MHZ THETA=65

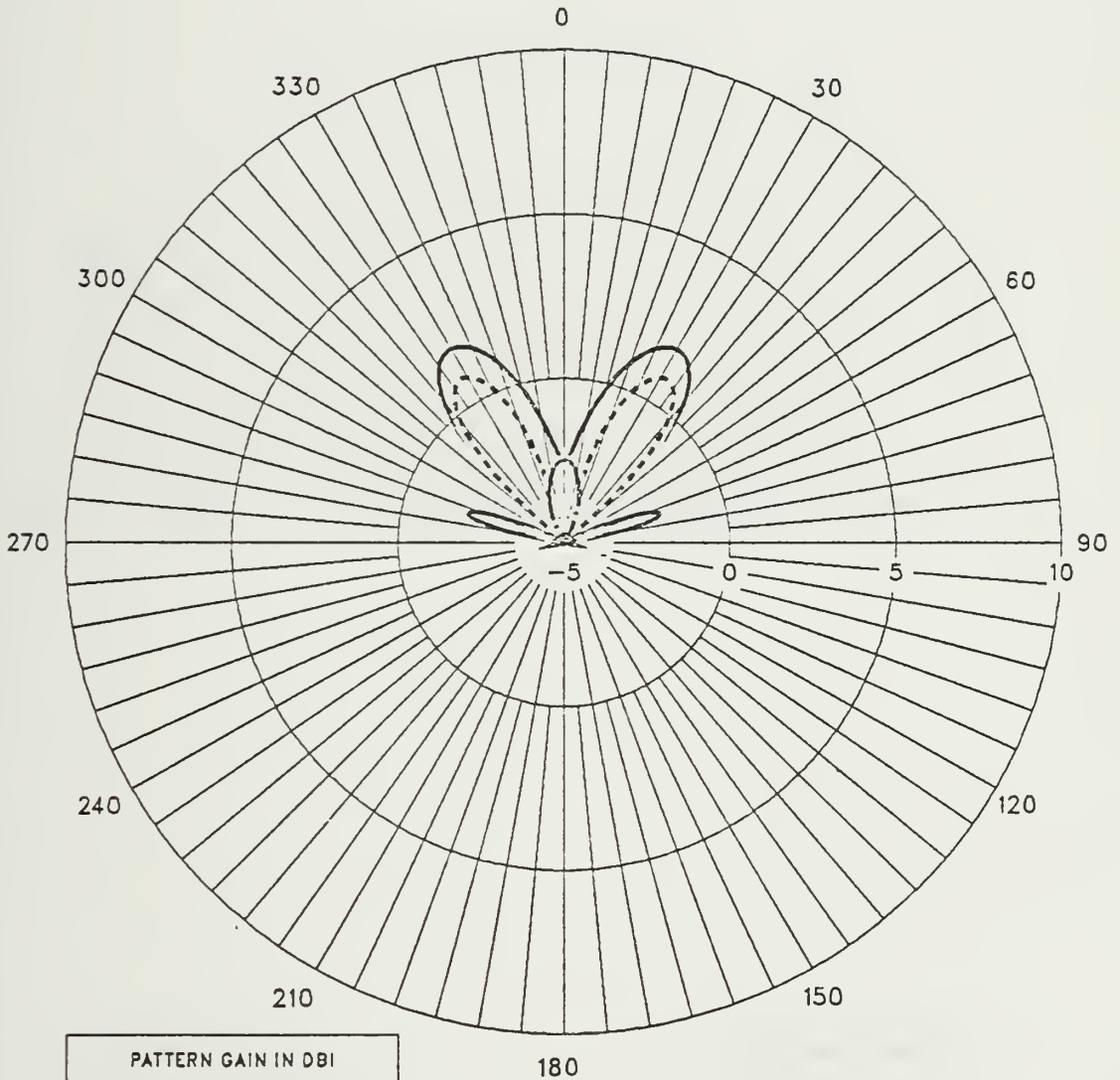

PATTERN GAIN IN DBI
----- HORIZONTAL
————— VERTICAL
————— TOTAL
ANGLES IN DEGREES TRUE

ANTENNA 2C

121 X 6 FT FREQ=30 MHZ PHI=0

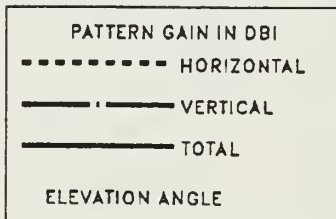
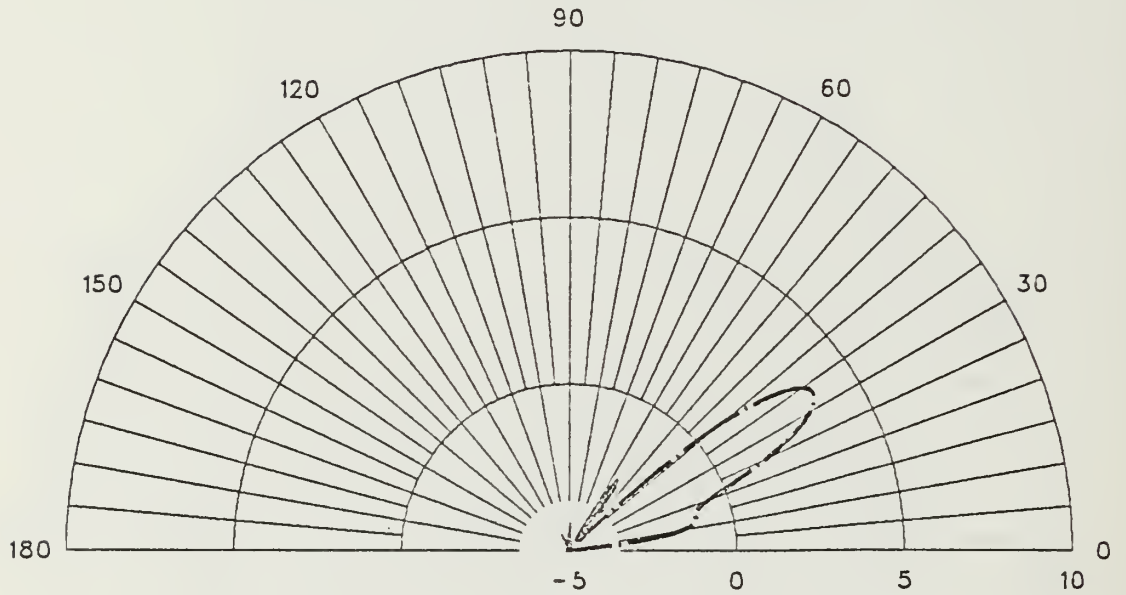

ANTENNA 2C

121 X 6 FT FREQ=30 MHZ PHI=10

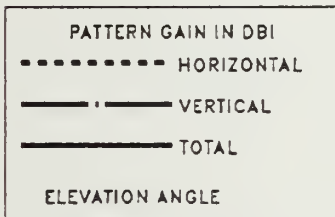
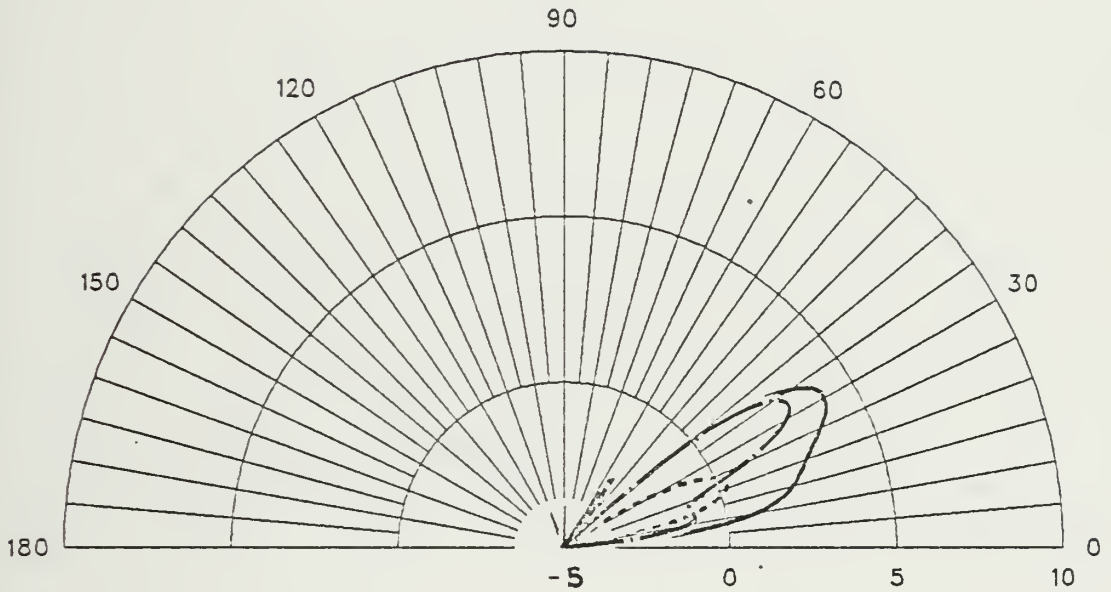

ANTENNA 2C

121 X 6 FT FREQ=30 MHZ PHI=20

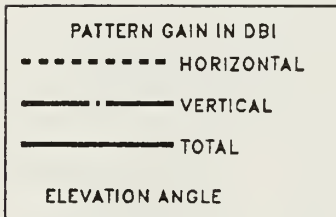
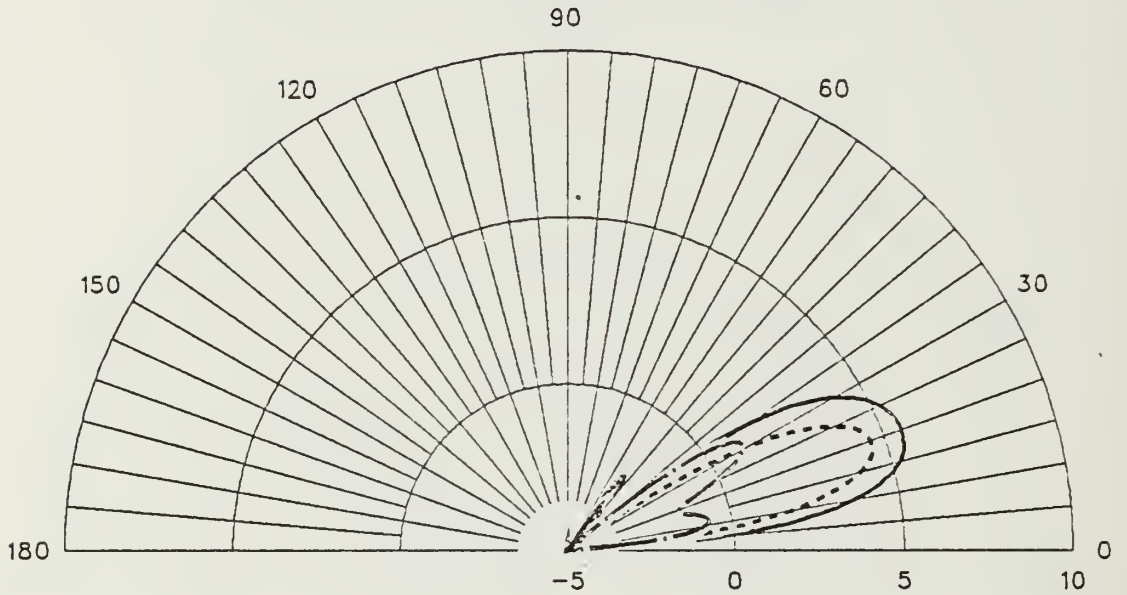

ANTENNA 2C

121 X 6 FT FREQ=30 MHZ PHI=30

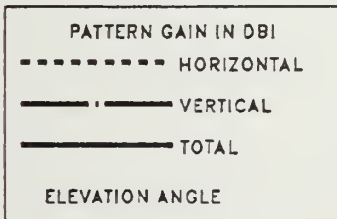
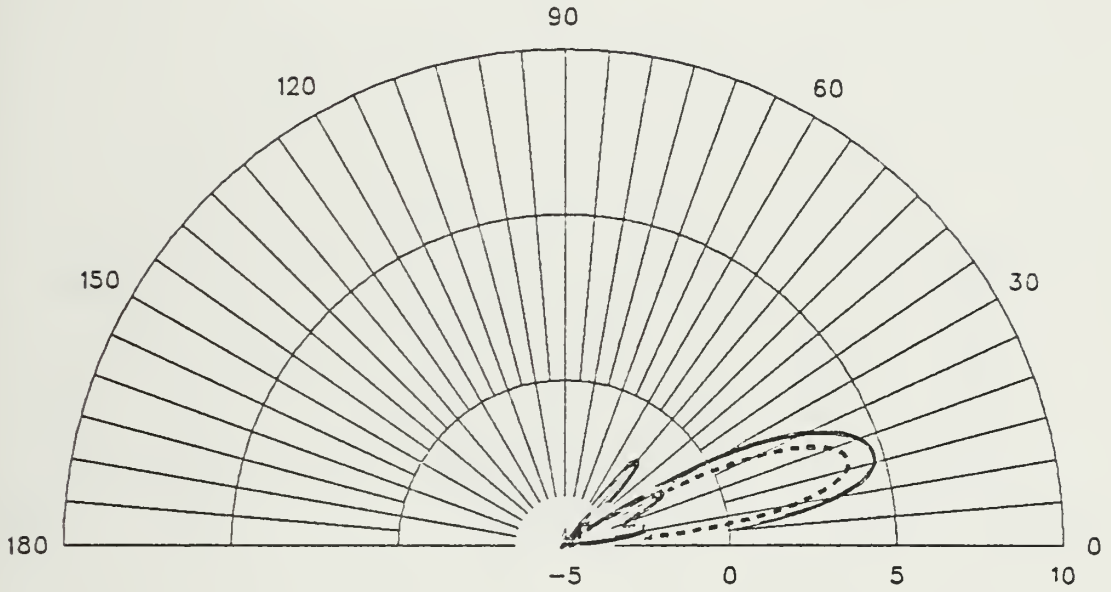

ANTENNA 2C

121 X 6 FT FREQ=30 MHZ PHI=40

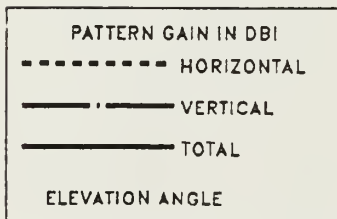
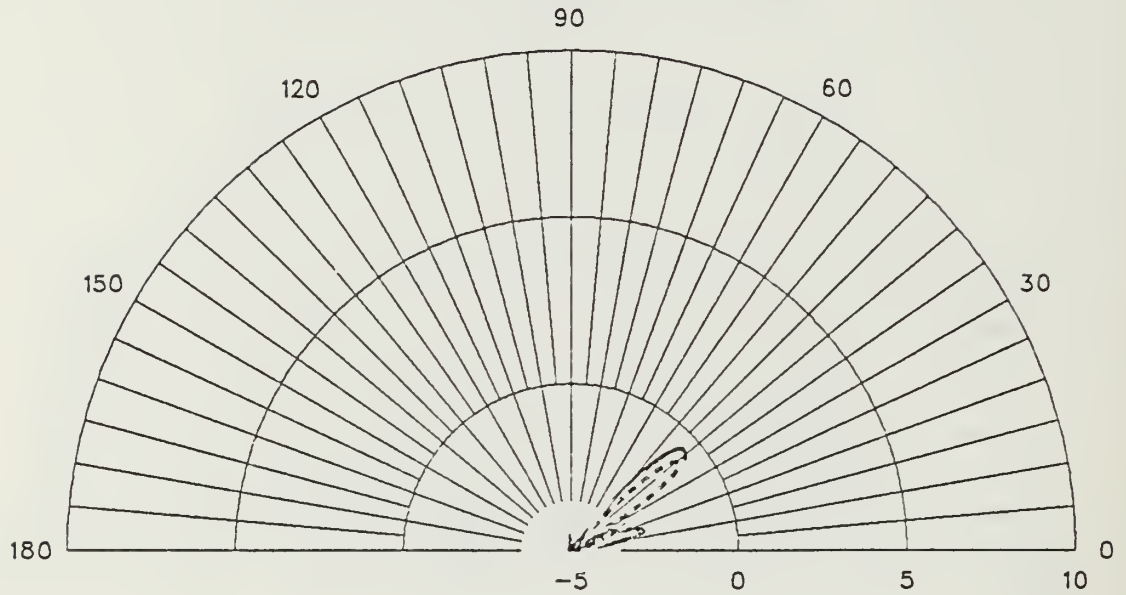

ANTENNA 2C

121 X 6 FT FREQ=30 MHZ THETA=70

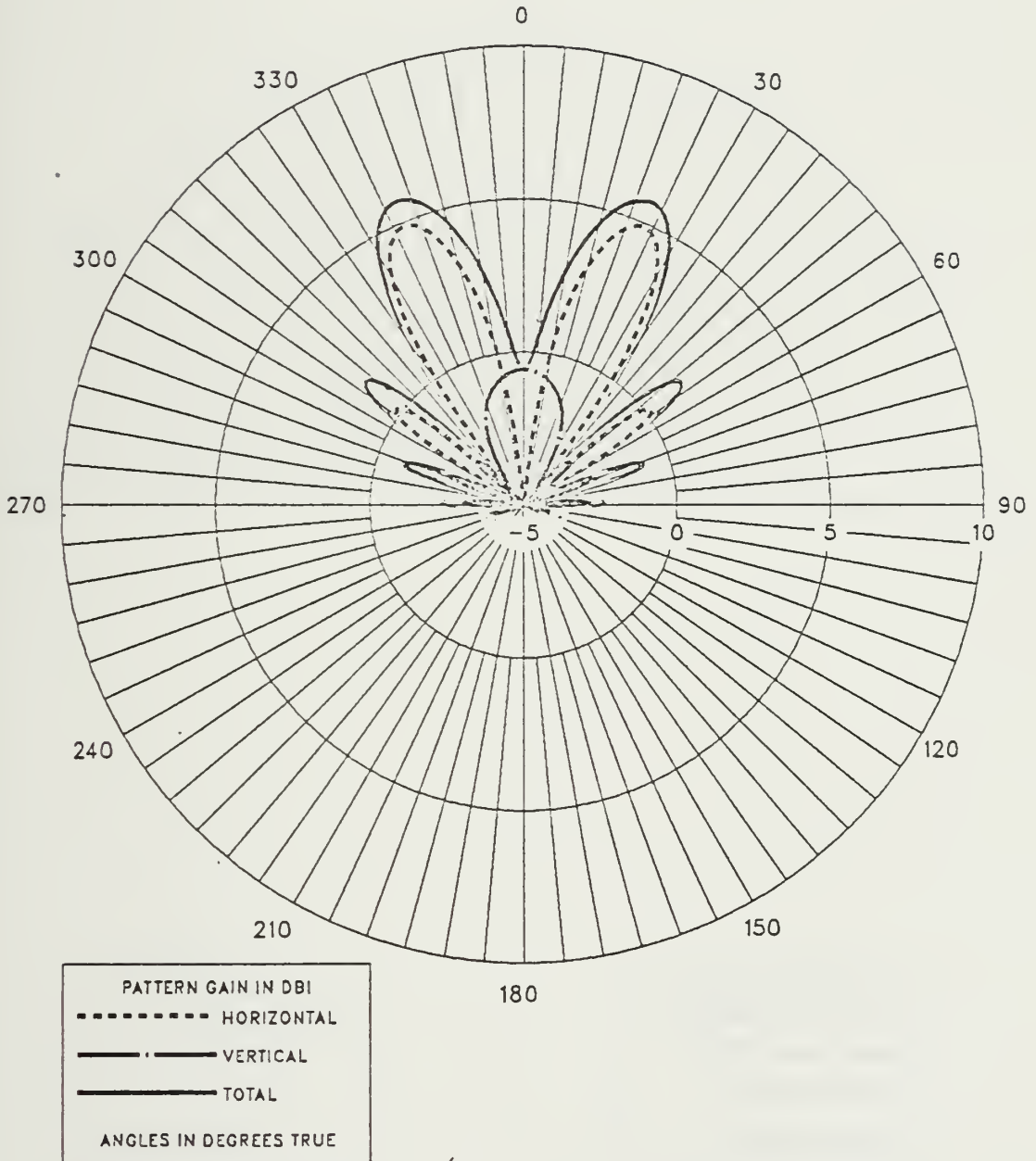

ANTENNA 3A

100 X 6 FT FREQ=17 MHZ PHI=0

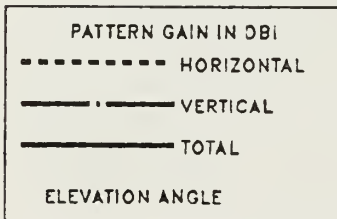
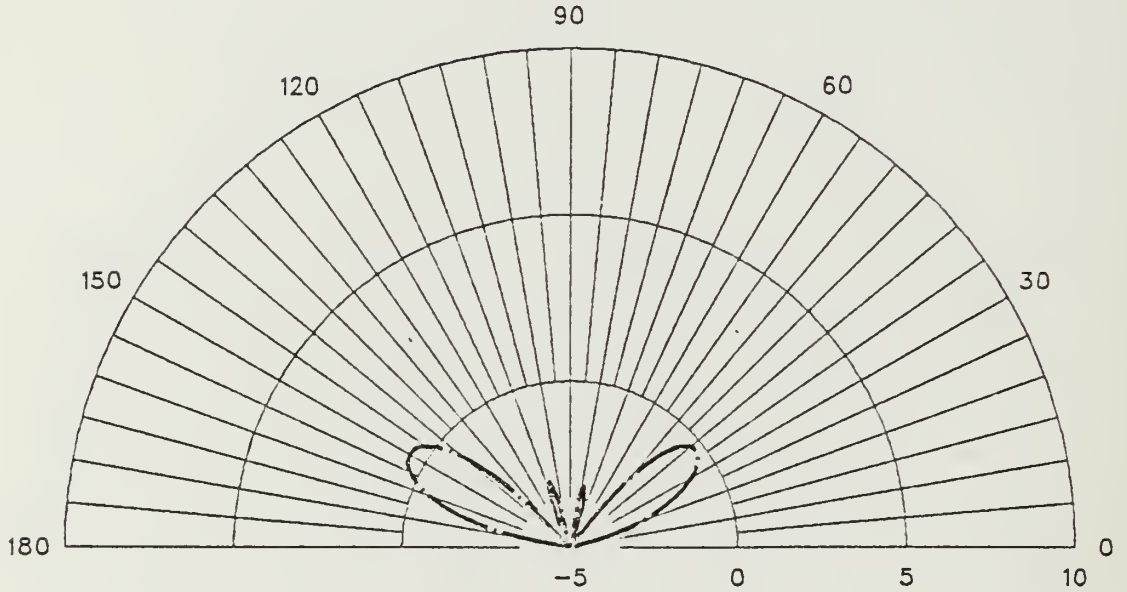

ANTENNA 3A

100 X 6 FT FREQ=17 MHZ PHI=10

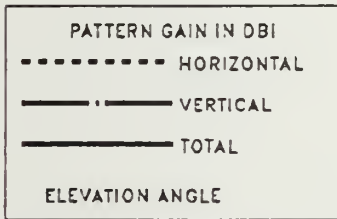
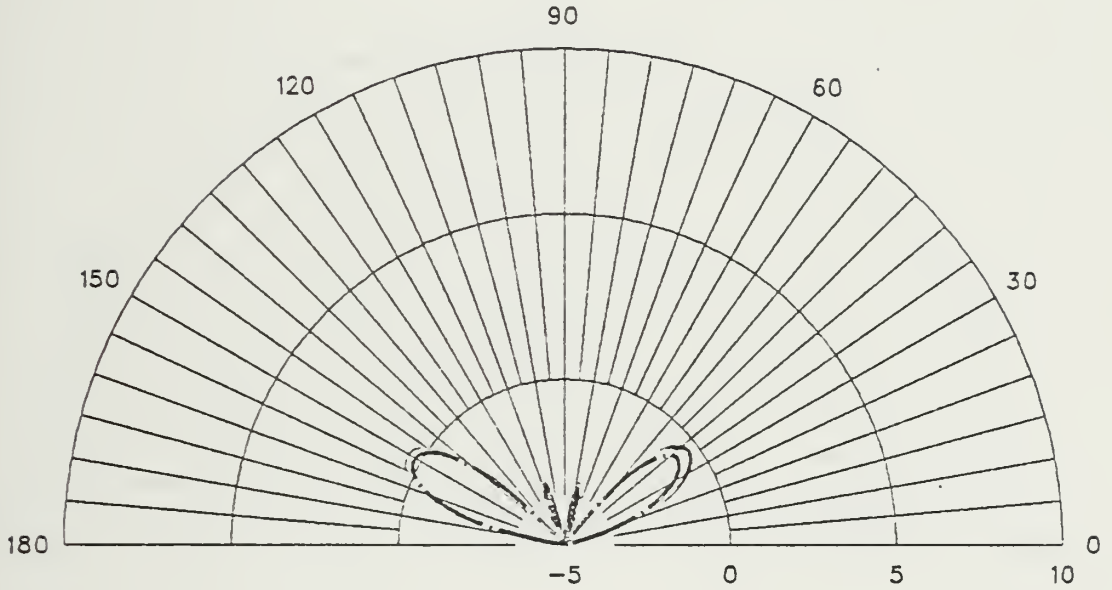

ANTENNA 3A

100 X 6 FT FREQ=17 MHZ PHI=20

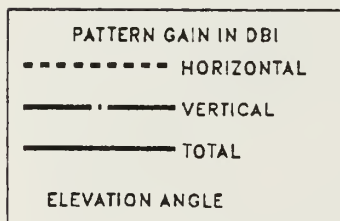
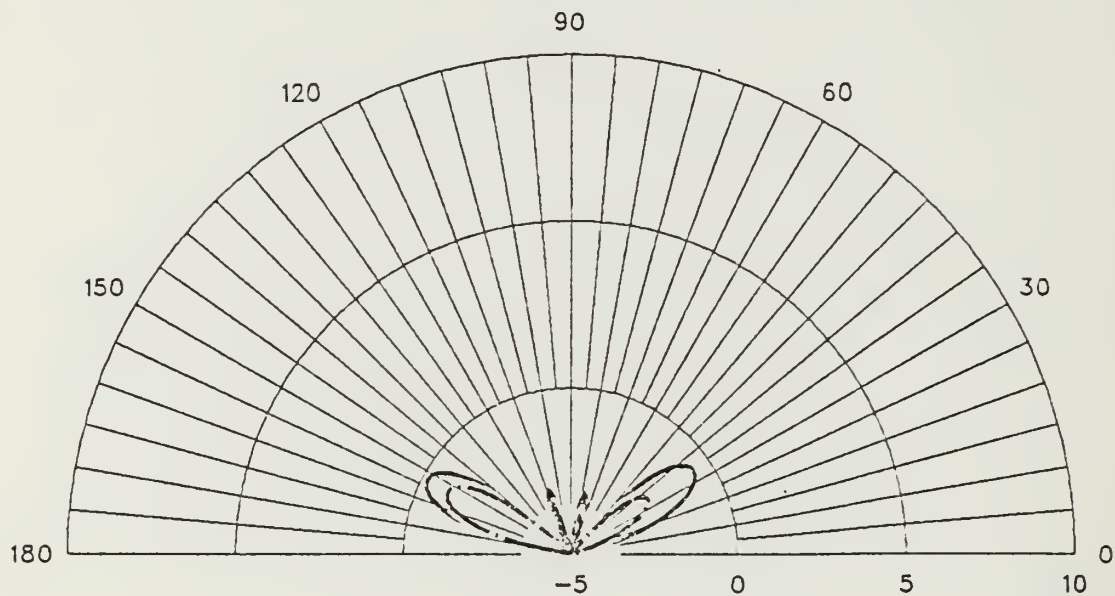

ANTENNA 3A

100 X 6 FT FREQ=17 MHZ PHI=30

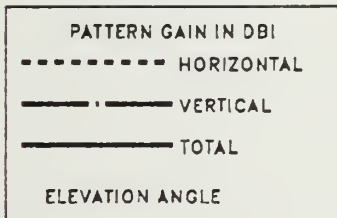
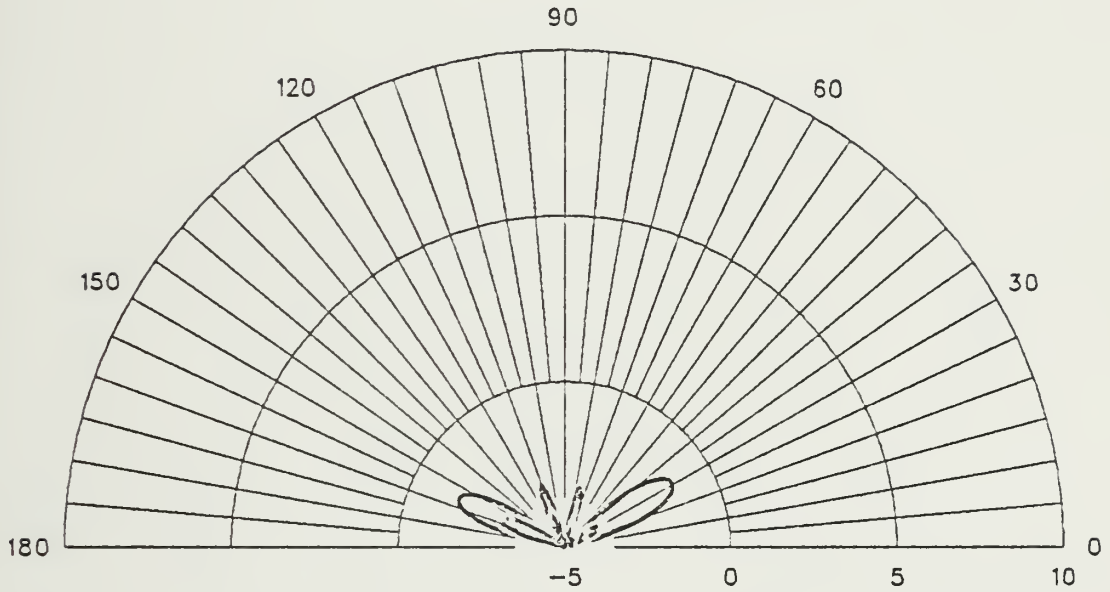

ANTENNA 3A

100 X 6 FT FREQ=17 MHZ PHI=40

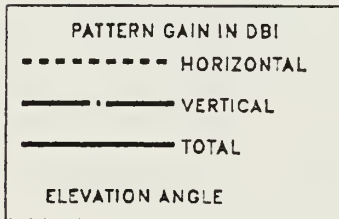
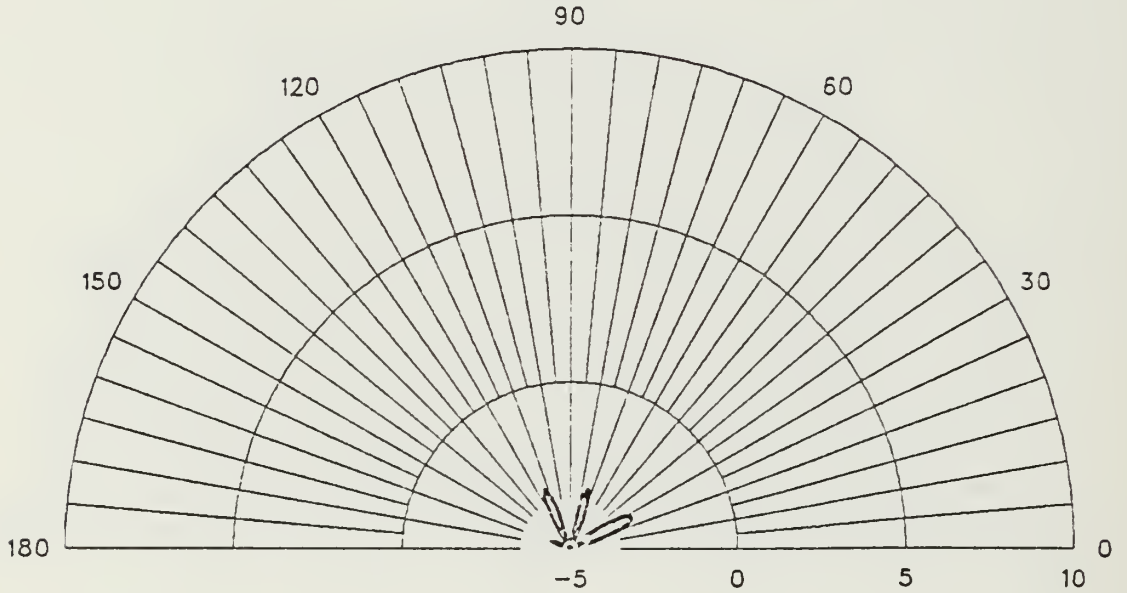

ANTENNA 3A

100 X 6 FT FREQ=17 MHZ THETA=60

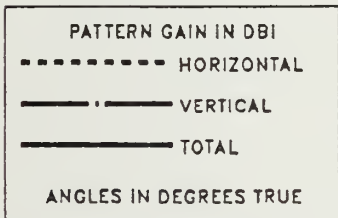
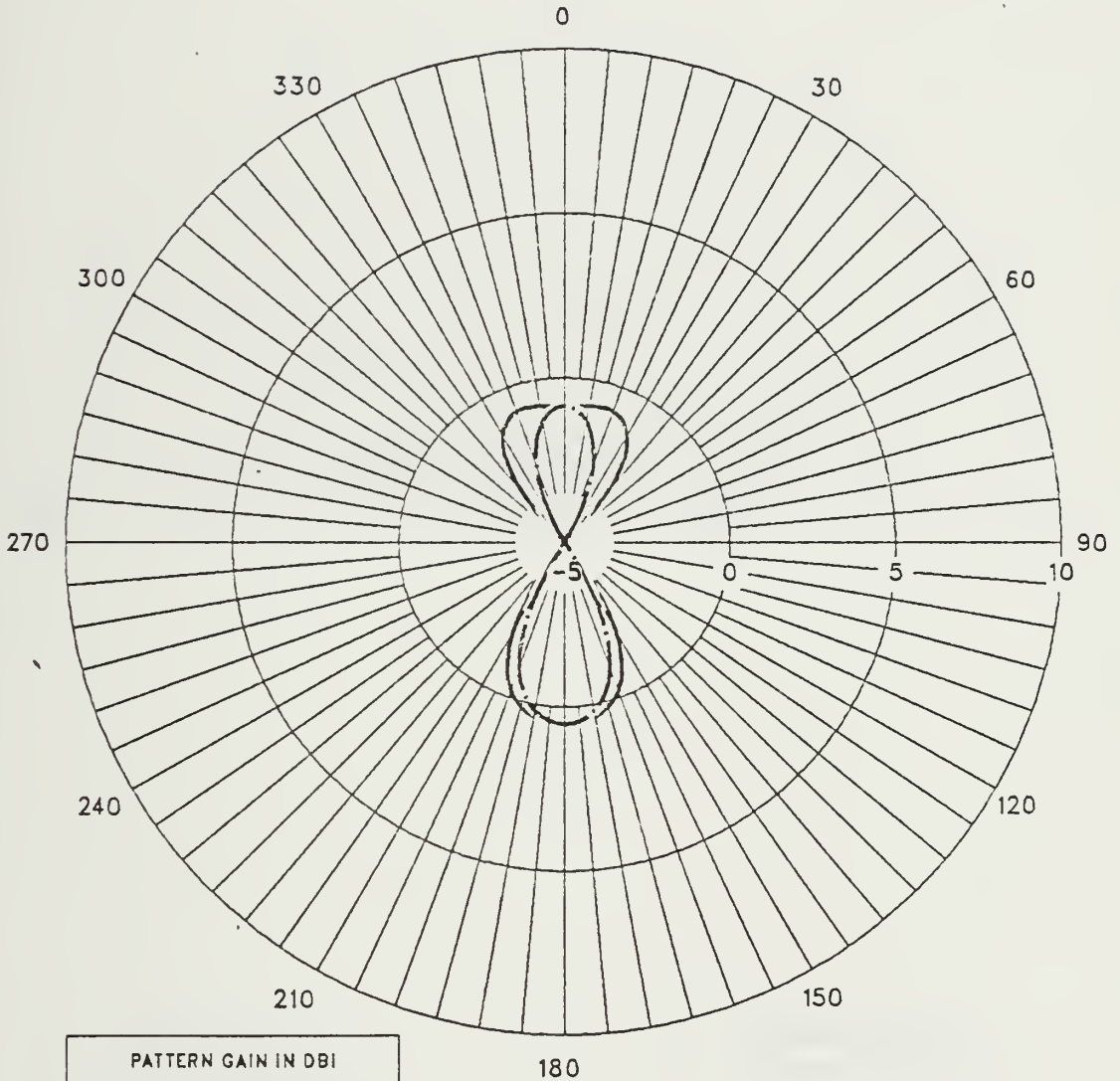

ANTENNA 3A

100 X 6 FT FREQ=30 MHZ PHI=0

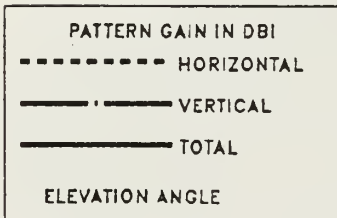
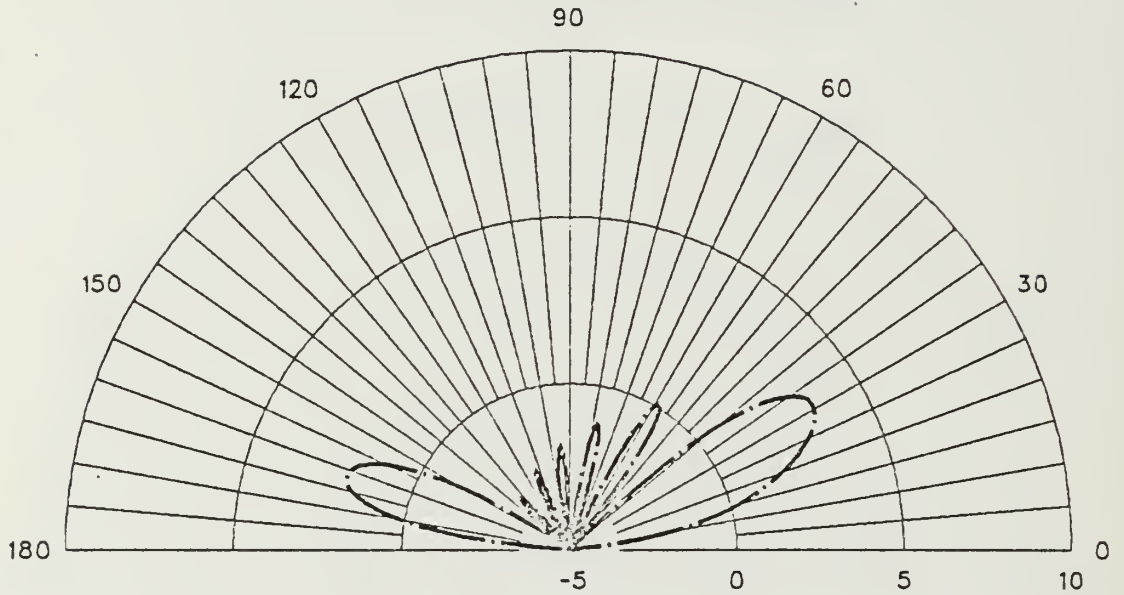

ANTENNA 3A

100 X 6 FT FREQ=30 MHZ PHI=10

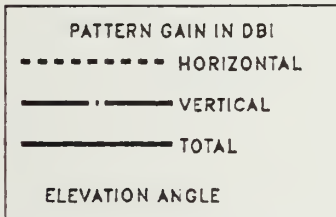
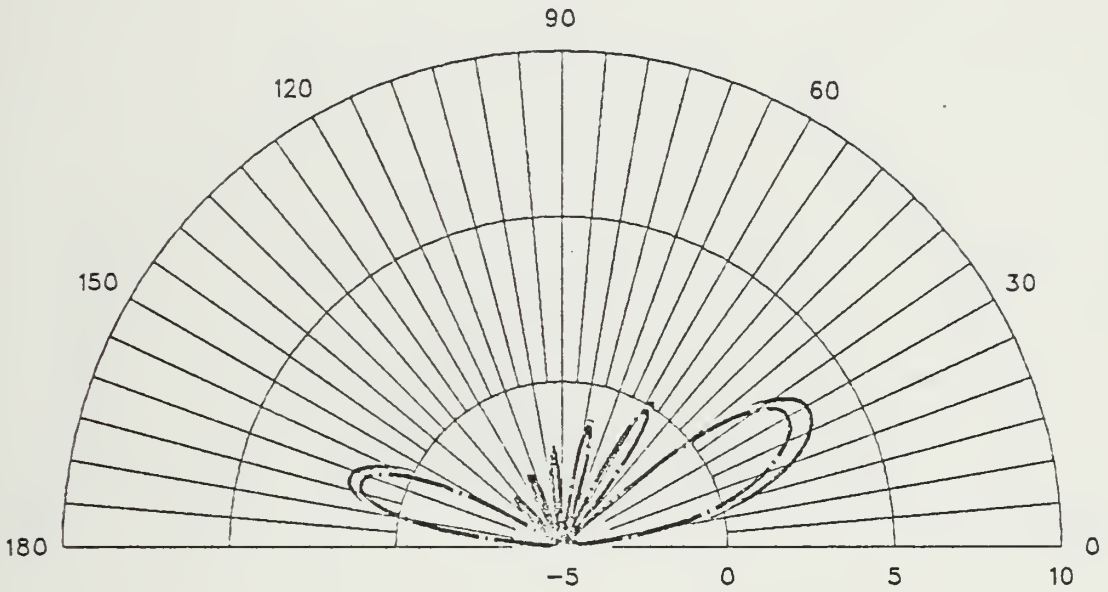

ANTENNA 3A

100 X 6 FT FREQ=30 MHZ PHI=20

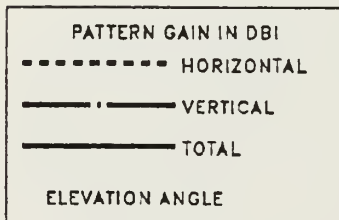
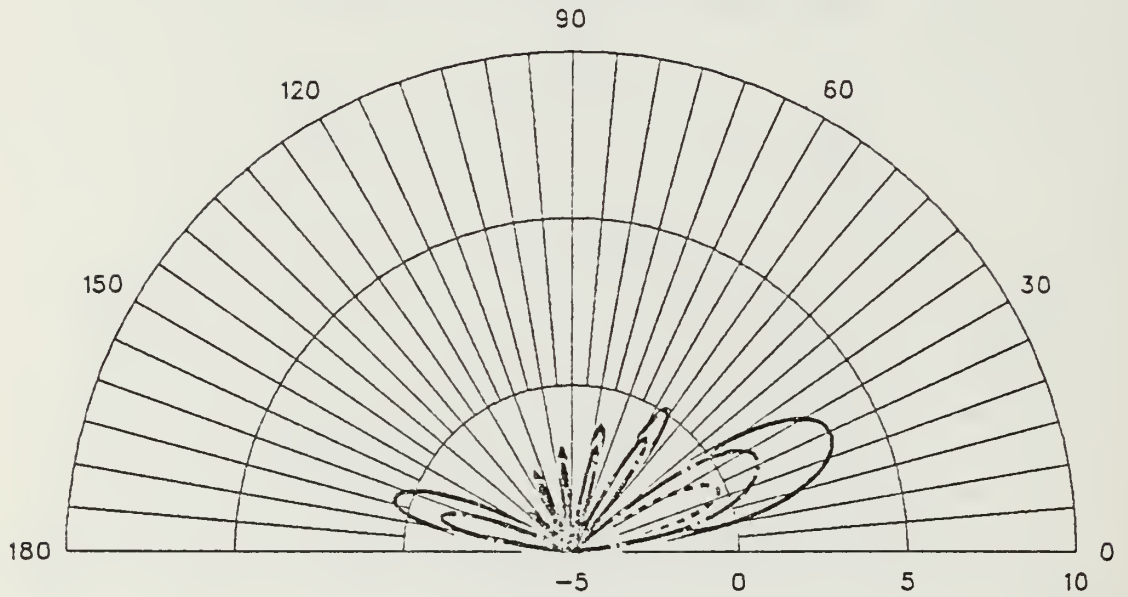

ANTENNA 3A

100 X 6 FT FREQ=30 MHZ PHI=30

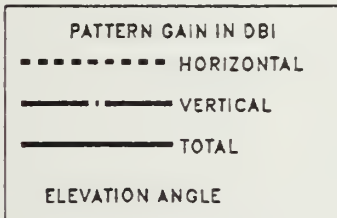
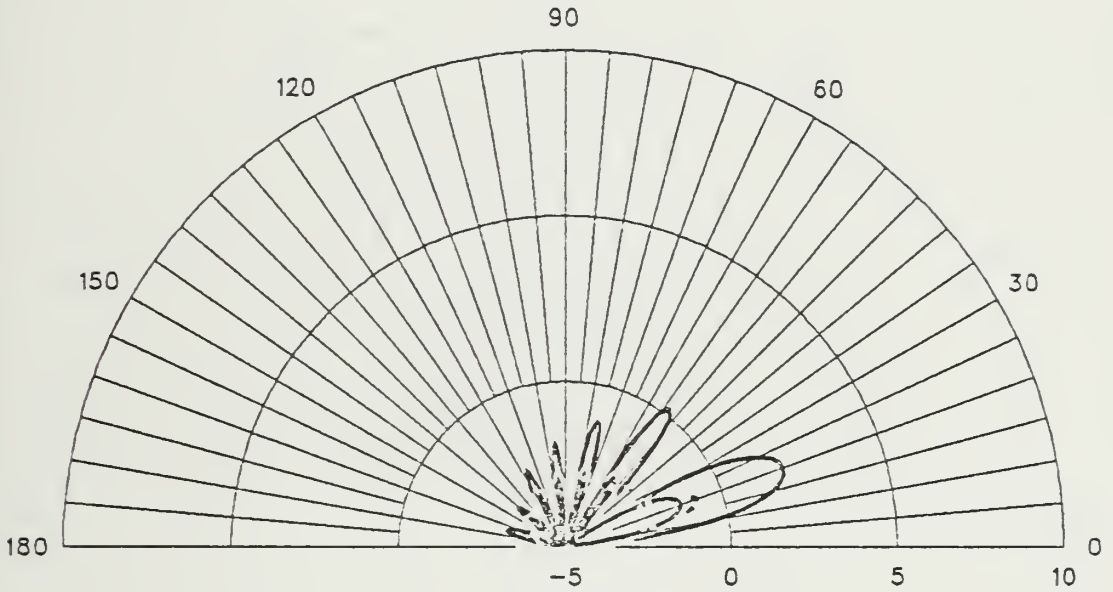

ANTENNA 3A

100 X 6 FT FREQ=30 MHZ PHI=40

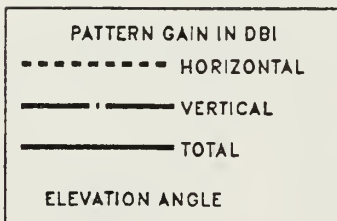
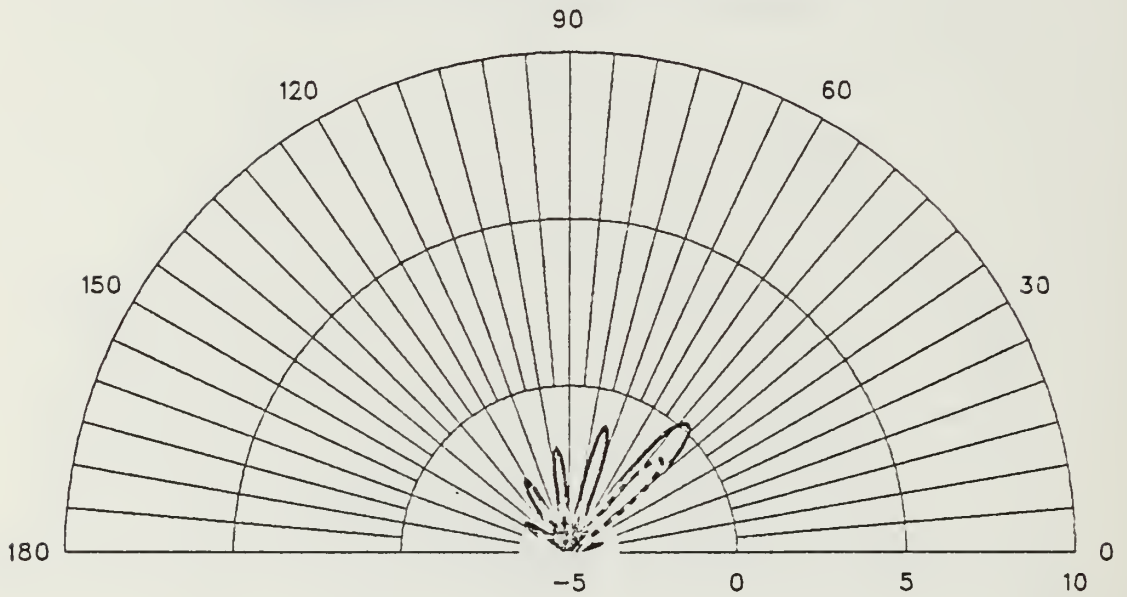

ANTENNA 3A

100 X 6 FT FREQ=30 MHZ THETA=65

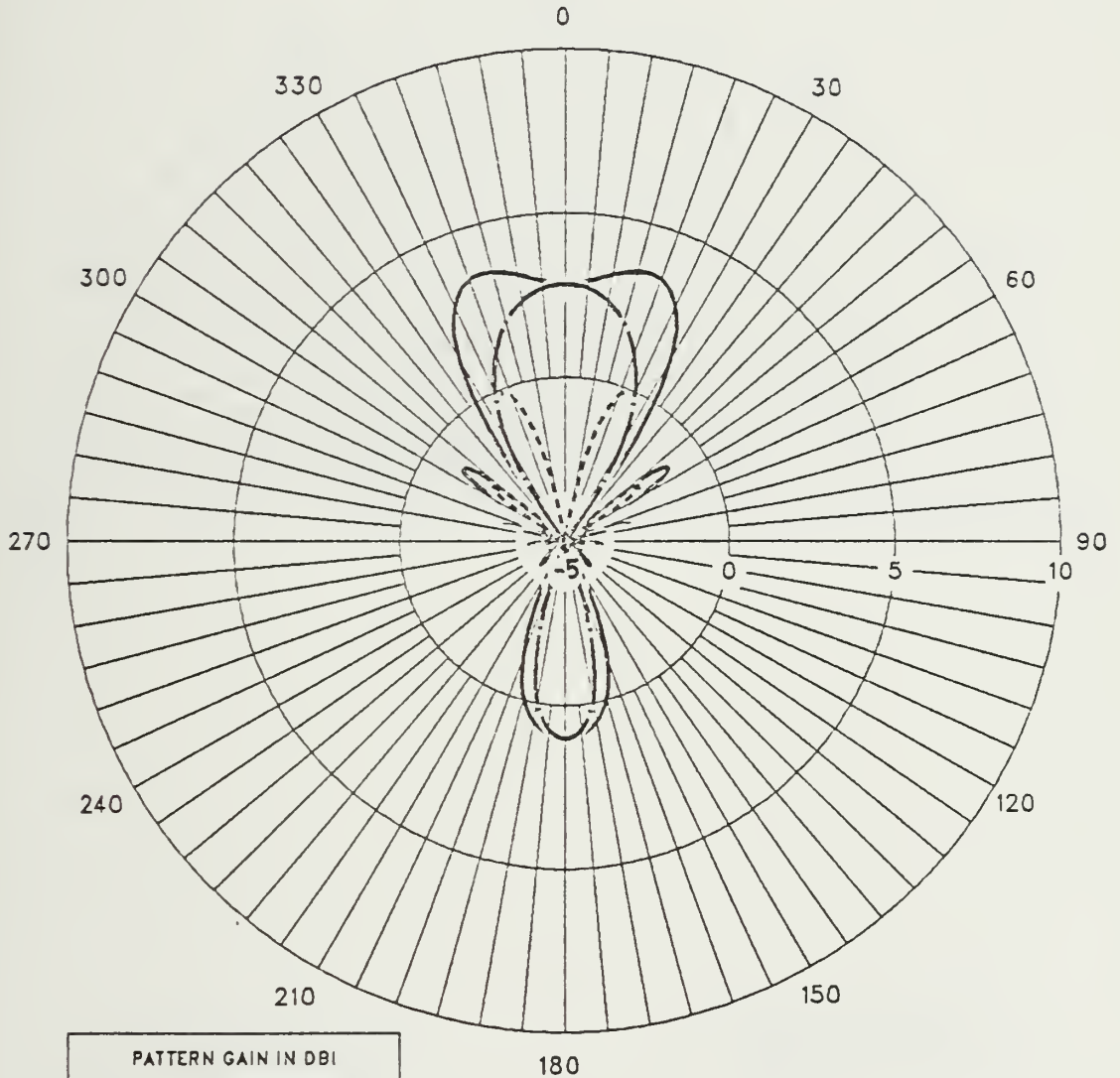

ANTENNA 3B

108 X 6 FT FREQ=17 MHZ PHI=0

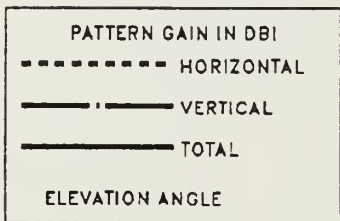
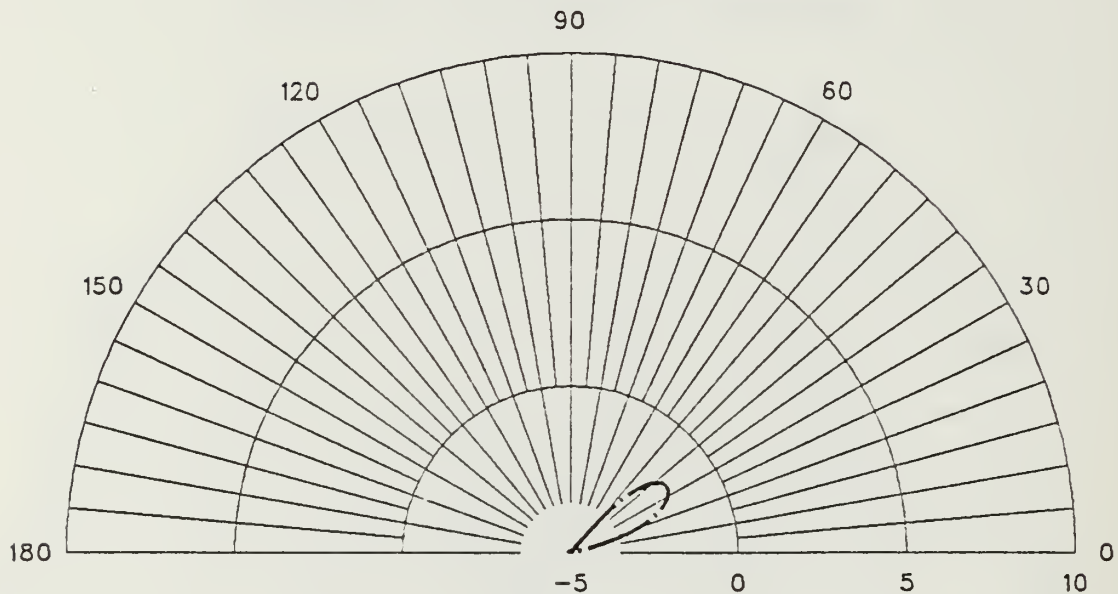

ANTENNA 3B

108 X 6 FT FREQ=17 MHZ PHI=10

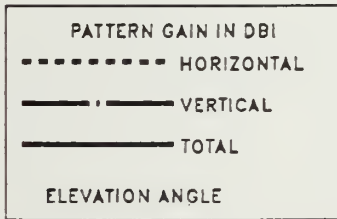
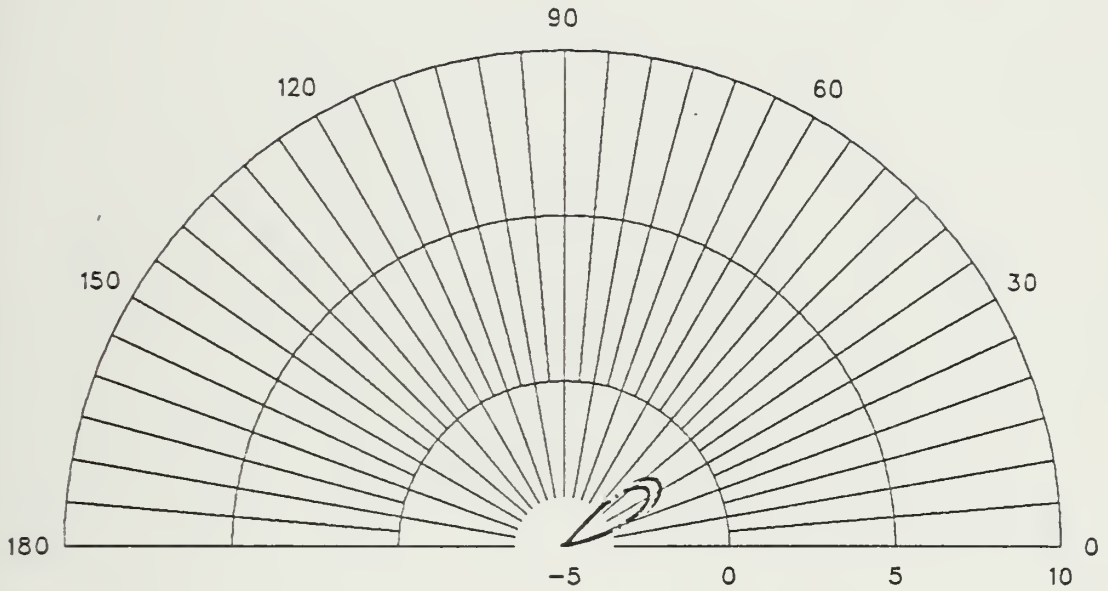

ANTENNA 3B

108 X 6 FT FREQ=17 MHZ PHI=20

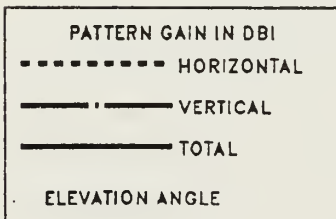
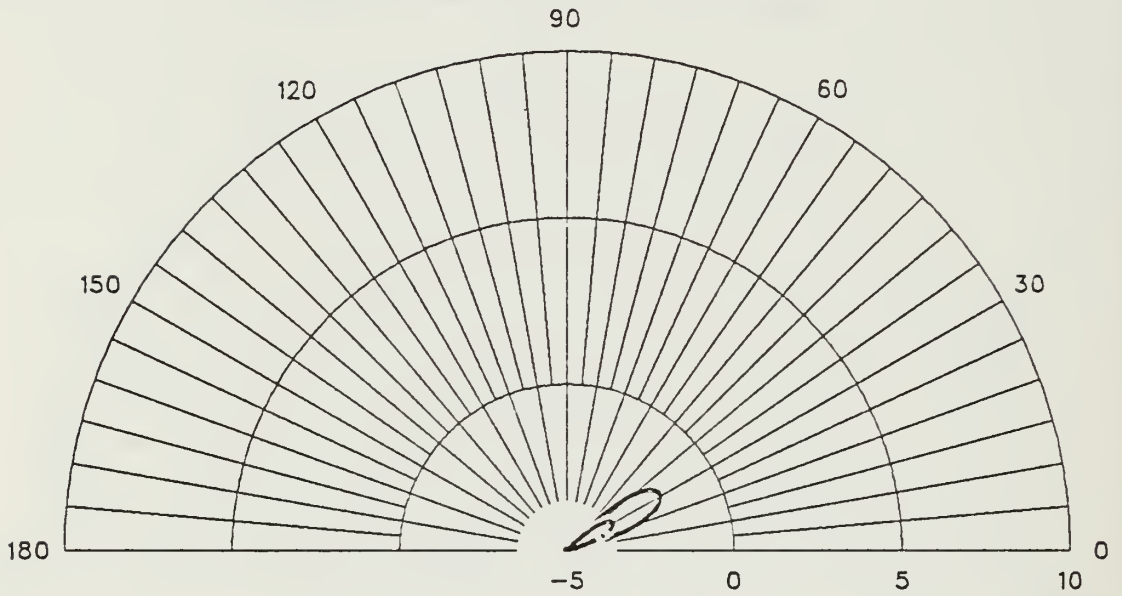

ANTENNA 3B

108 X 6 FT FREQ=17 MHZ PHI=30

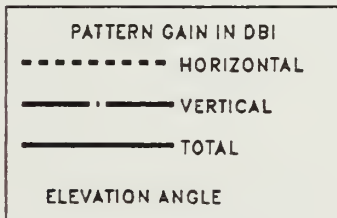
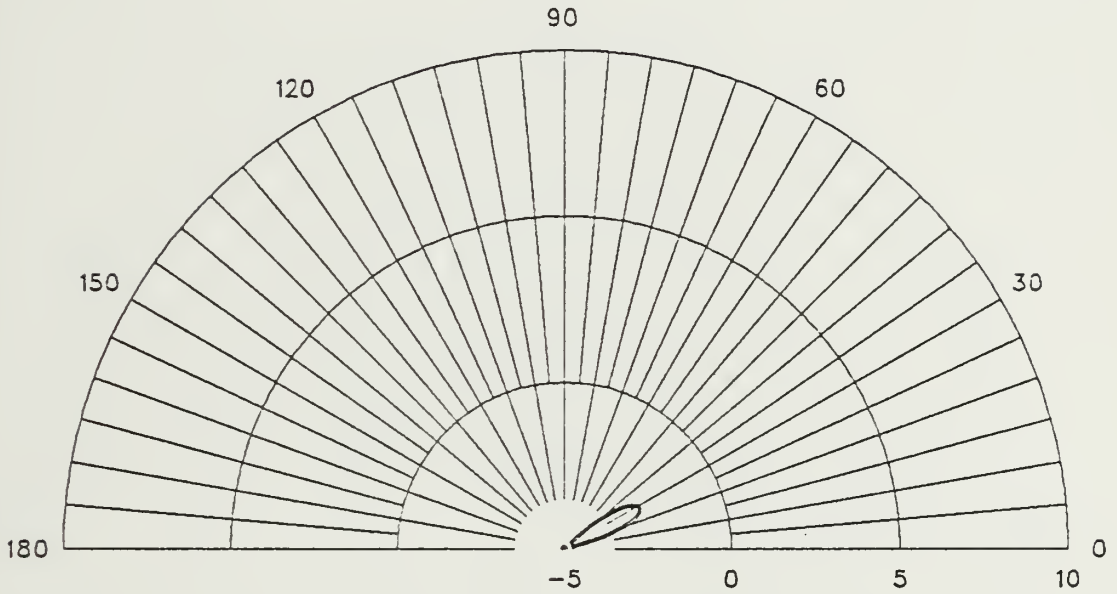

ANTENNA 3B

103 X 6 FT FREQ=17 MHZ PHI=40

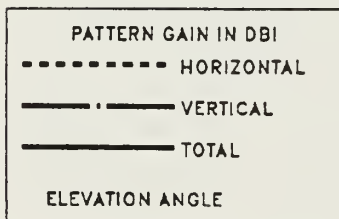
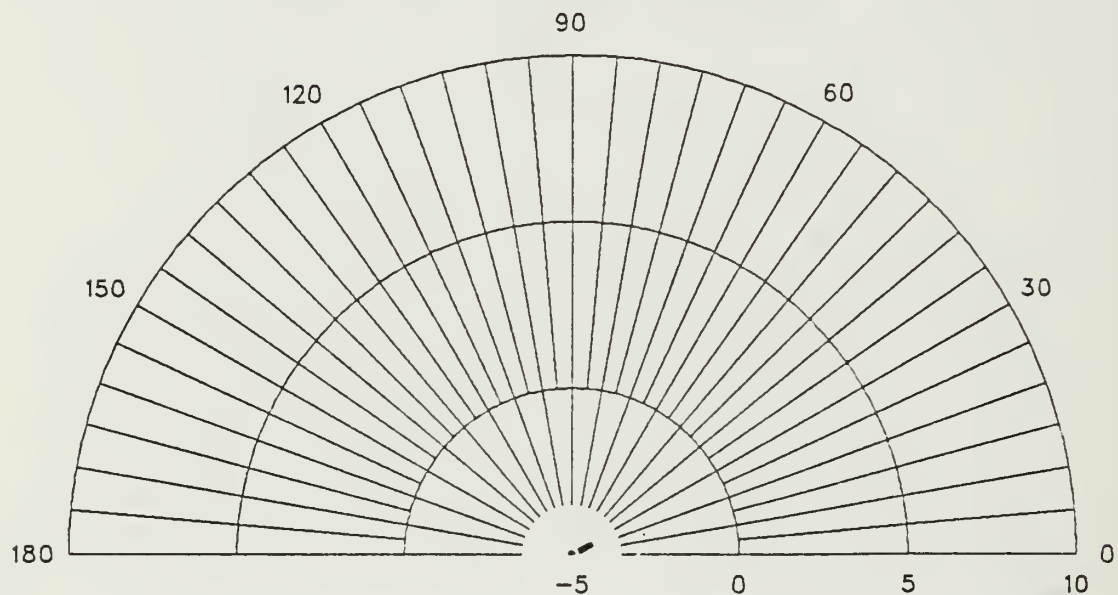

ANTENNA 3B

108 X 6 FT FREQ=17 MHZ THETA=60

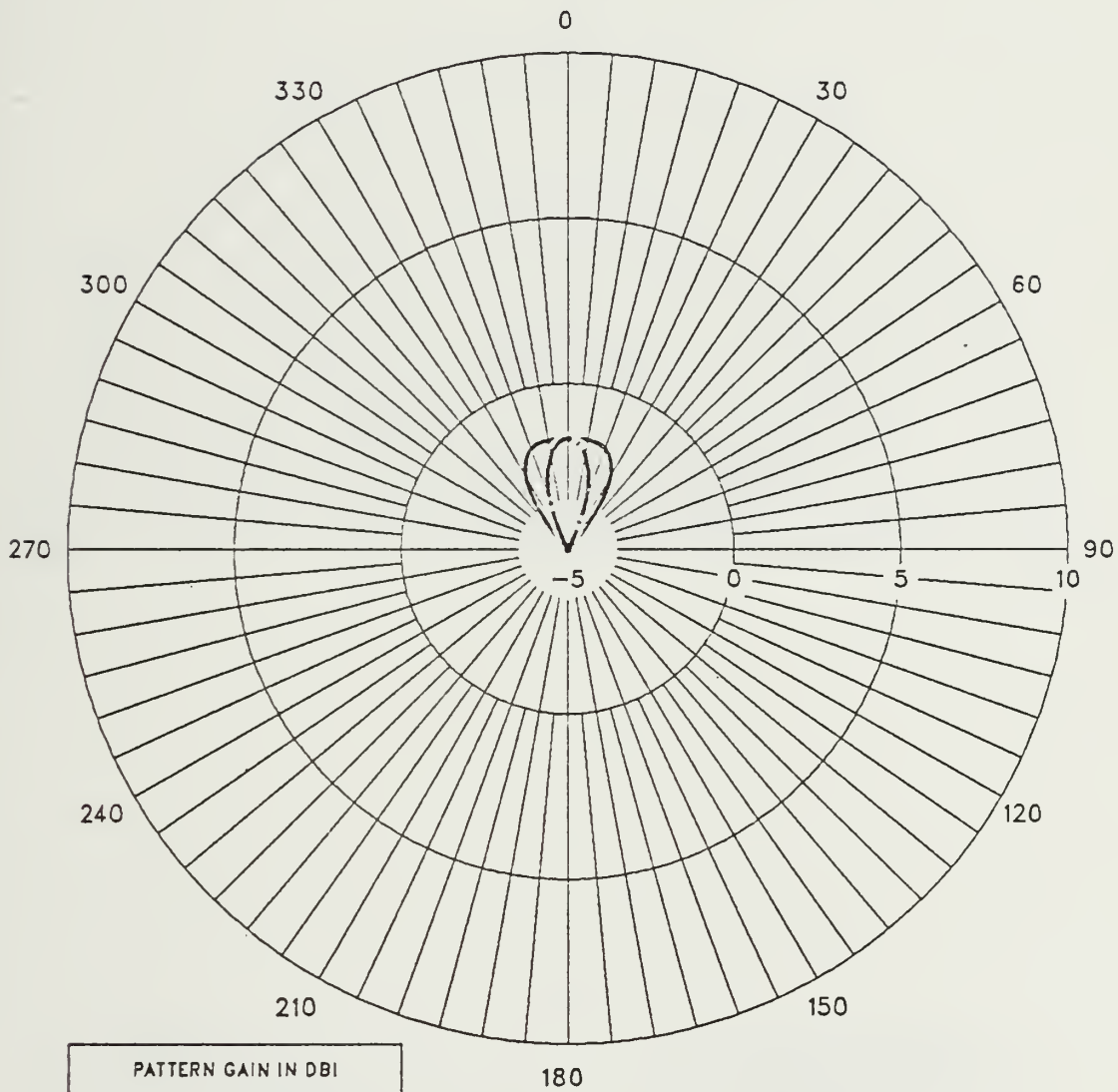

PATTERN GAIN IN DBI
----- HORIZONTAL
———— VERTICAL
———— TOTAL
ANGLES IN DEGREES TRUE

ANTENNA 3B

108 X 6 FT FREQ=30 MHZ PHI=0

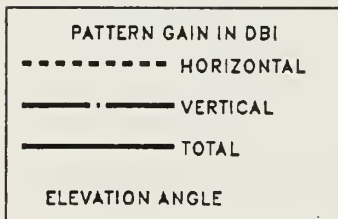
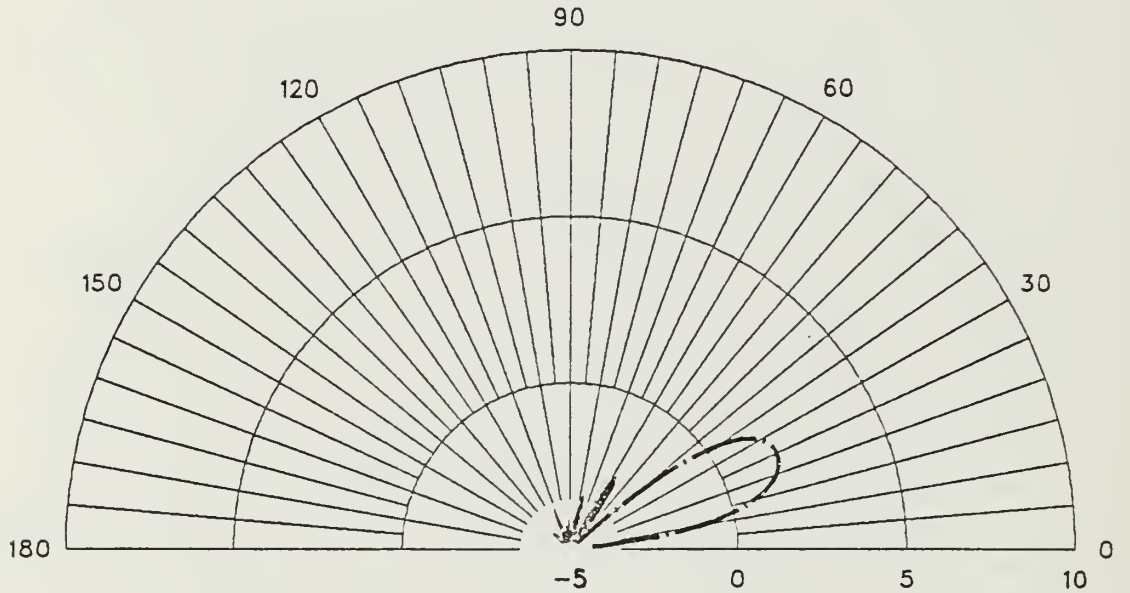

ANTENNA 3B

108 X 6 FT FREQ=30 MHZ PHI=10

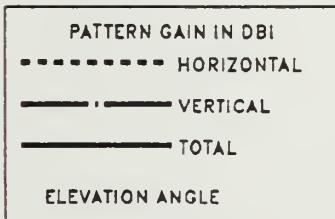
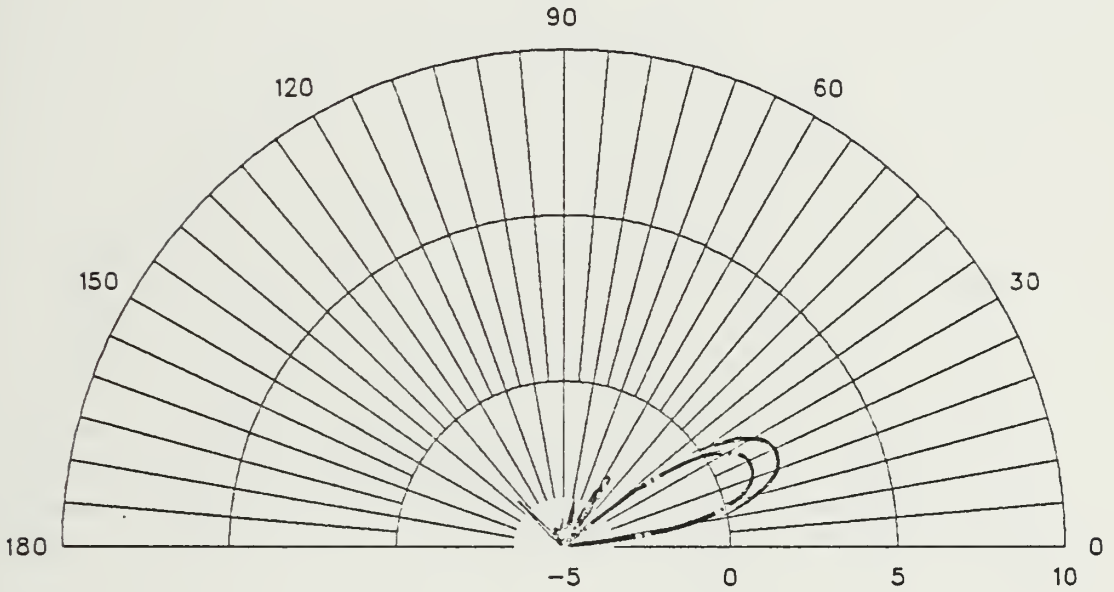

ANTENNA 3B

108 X 6 FT FREQ=30 MHZ PHI=20

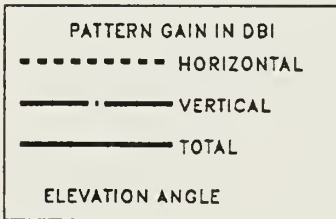
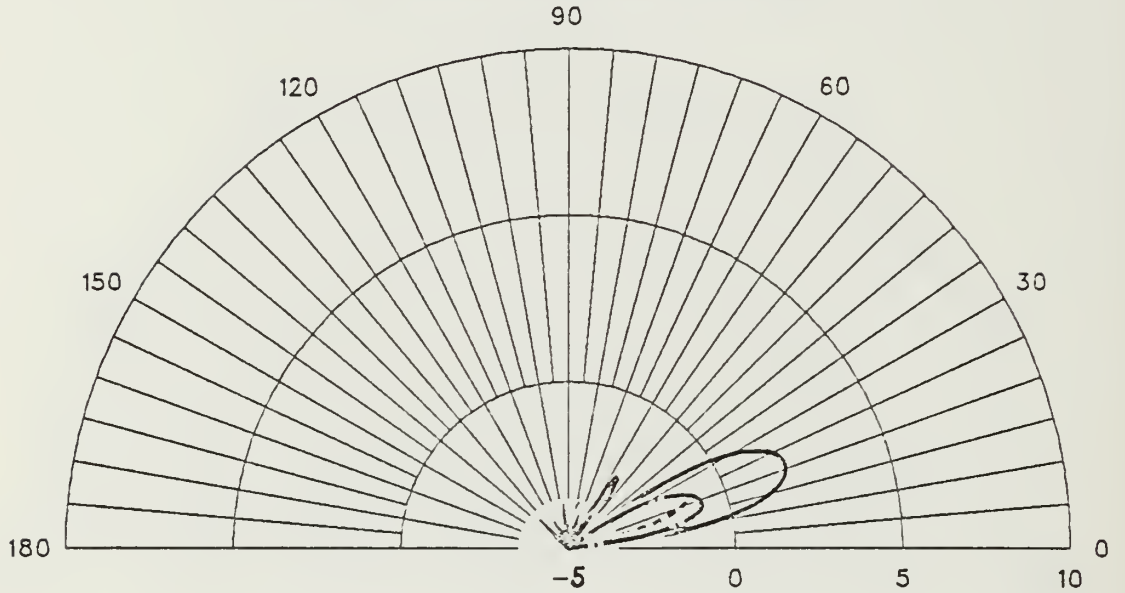

ANTENNA 3B

108 X 6 FT FREQ=30 MHZ PHI=30

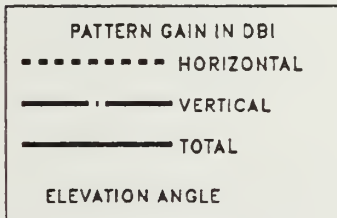
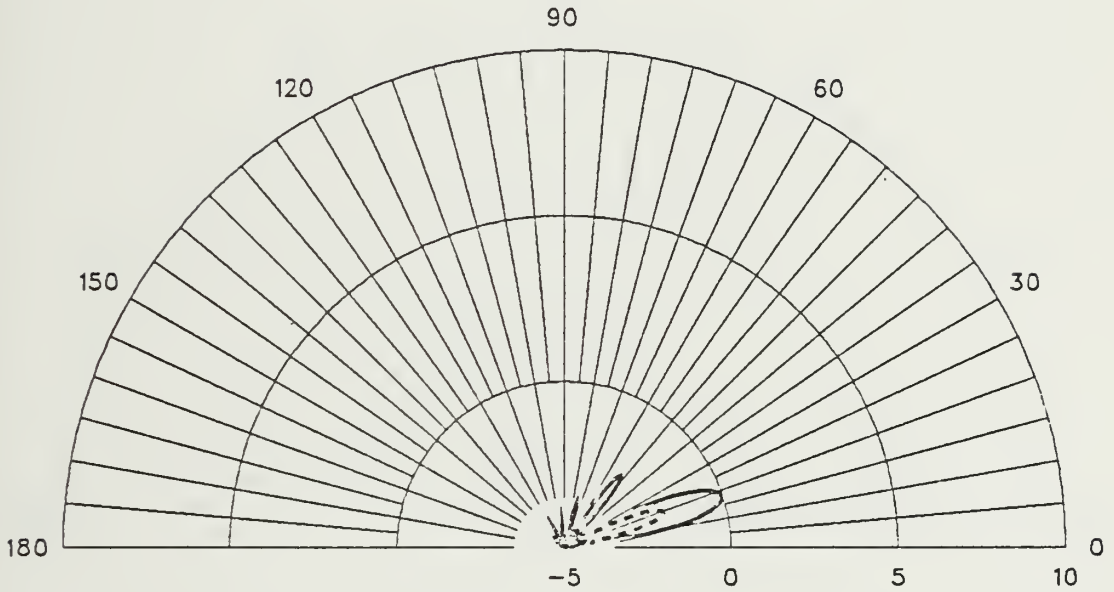

ANTENNA 3B

108 X 6 FT FREQ=30 MHZ PHI=40

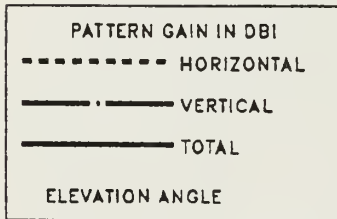
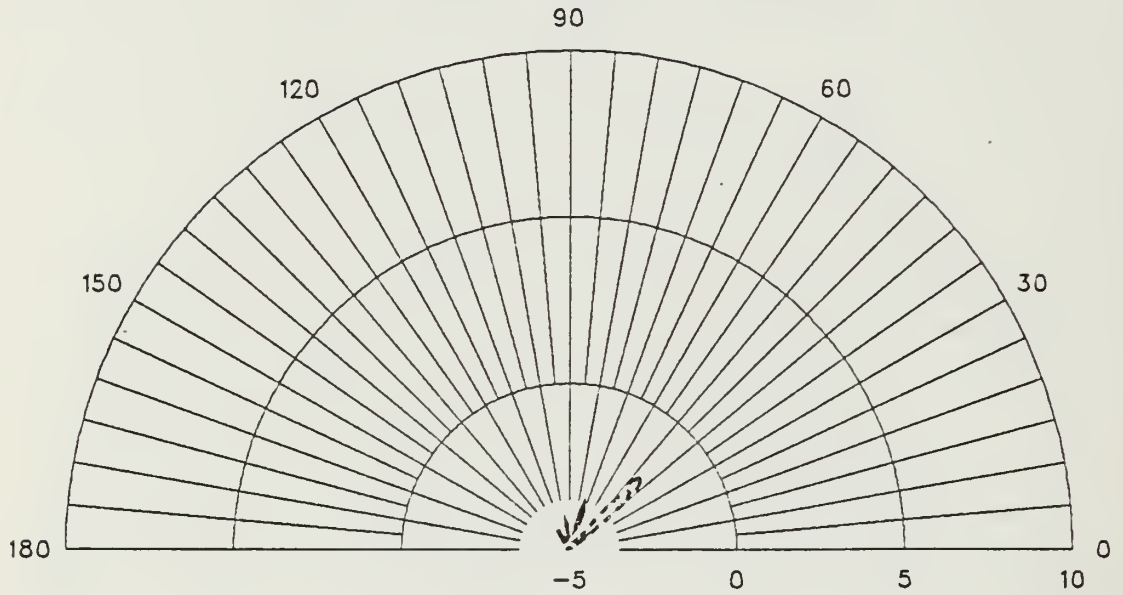

ANTENNA 3B

108 X 6 FT FREQ=30 MHZ THETA=70

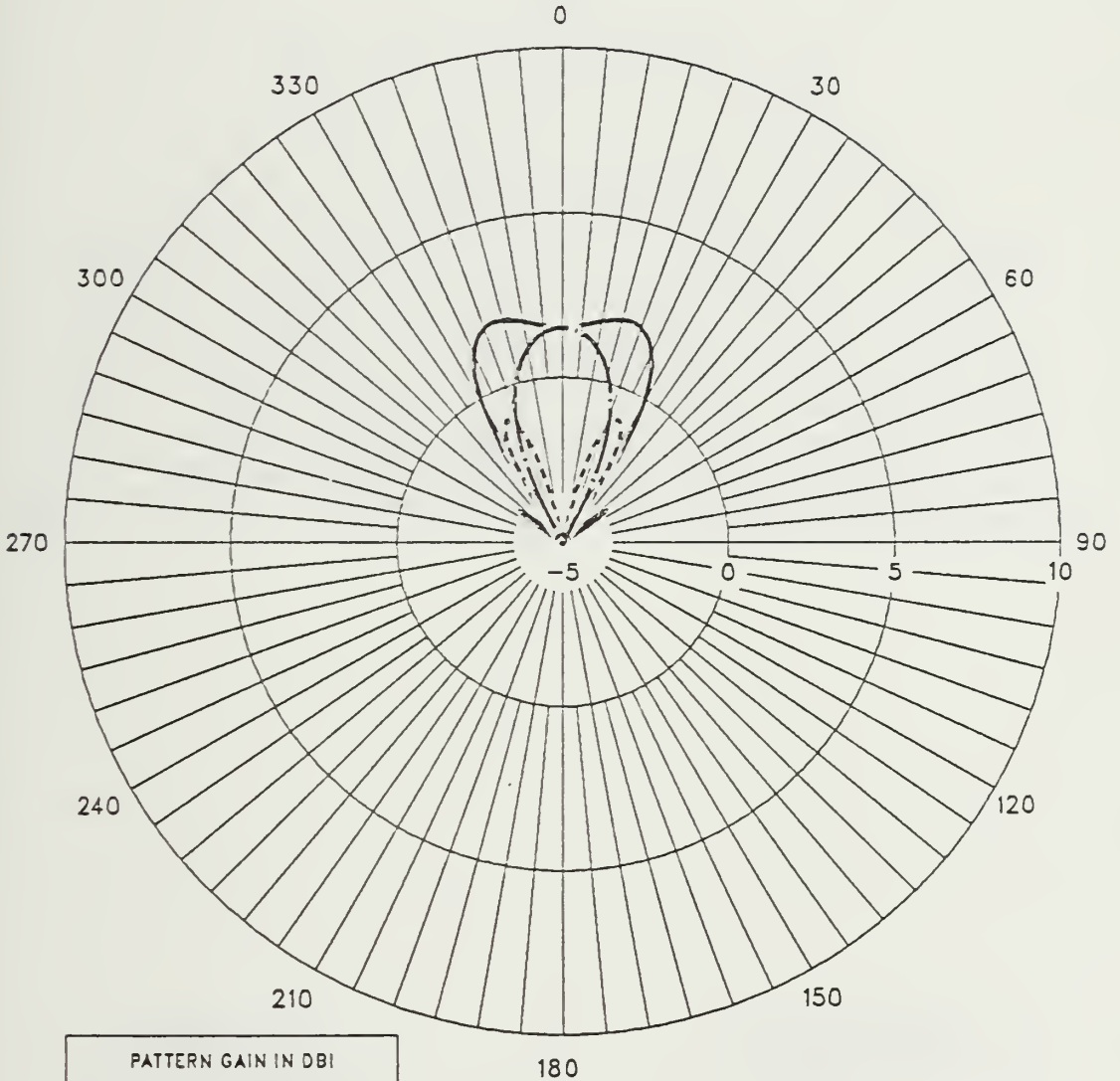

PATTERN GAIN IN DBI
- - - - - HORIZONTAL
- · - - - VERTICAL
- - - - - TOTAL
ANGLES IN DEGREES TRUE

ANTENNA 3C

108 X 6 FT FREQ=17 MHZ PHI=0

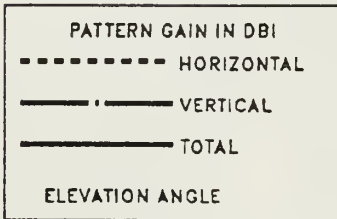
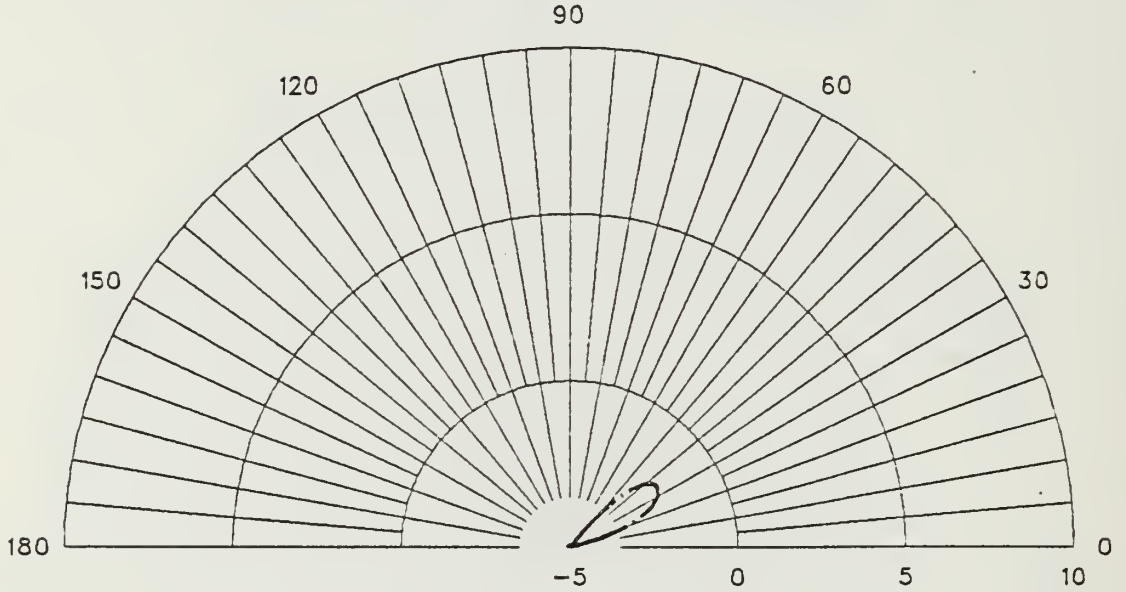

ANTENNA 3C

108 X 6 FT FREQ=17 MHZ PHI=10

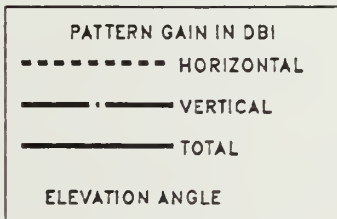
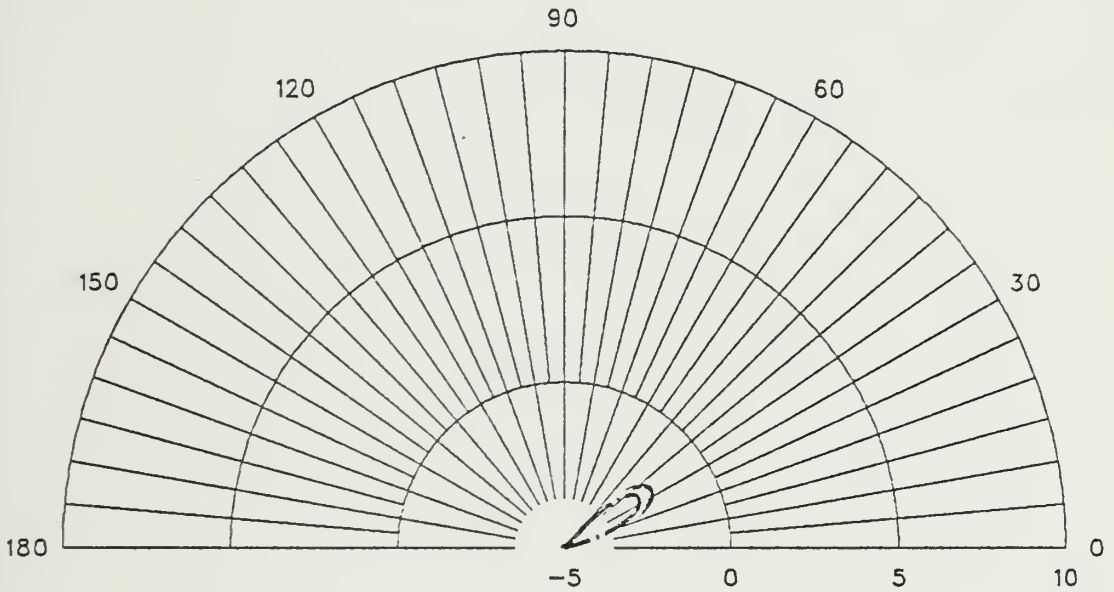

ANTENNA 3C

108 X 6 FT FREQ=17 MHZ PHI=20

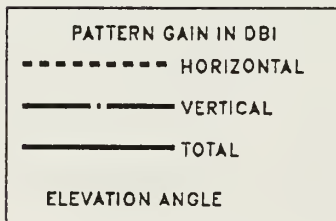
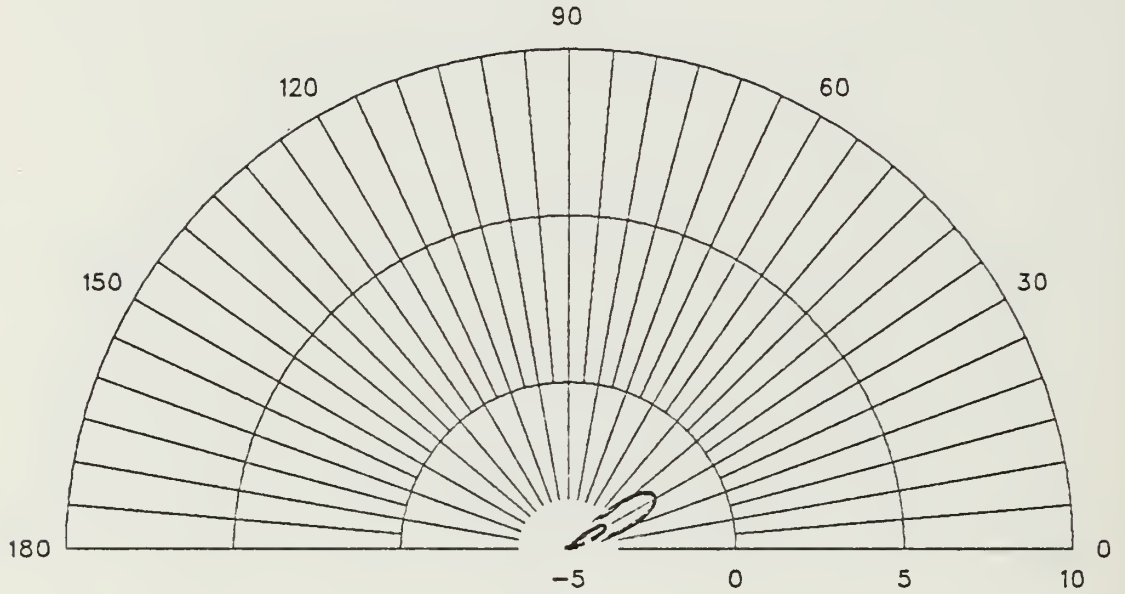

ANTENNA 3C

108 X 6 FT FREQ=17 MHZ PHI=30

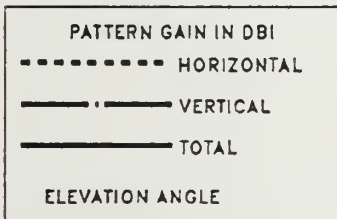
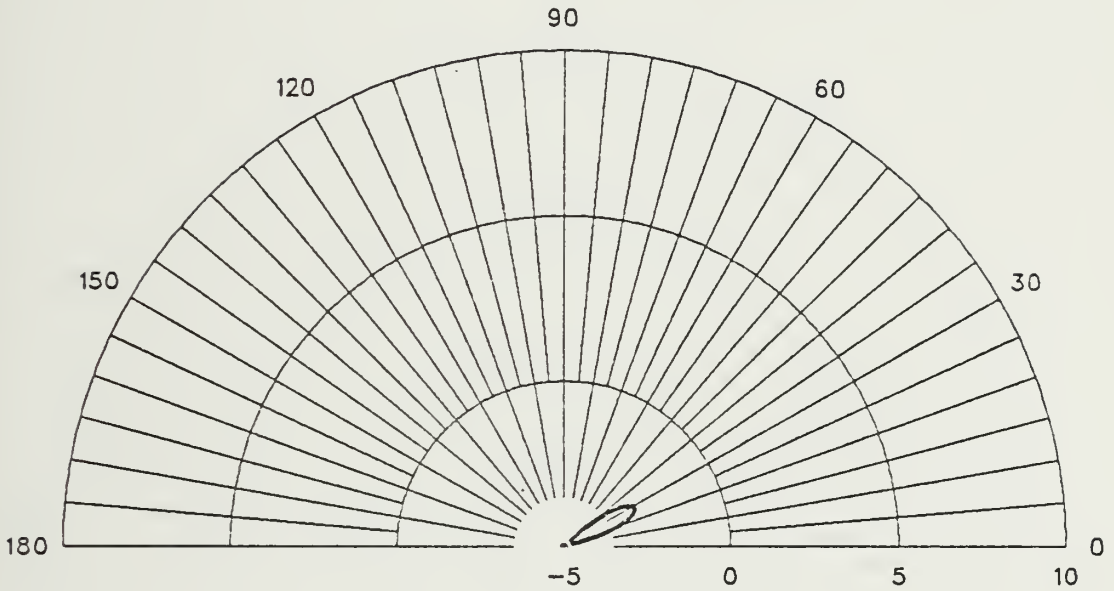

ANTENNA 3C

108 X 6 FT FREQ=17 MHZ PHI=40

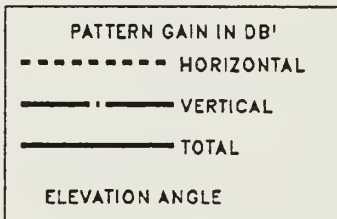
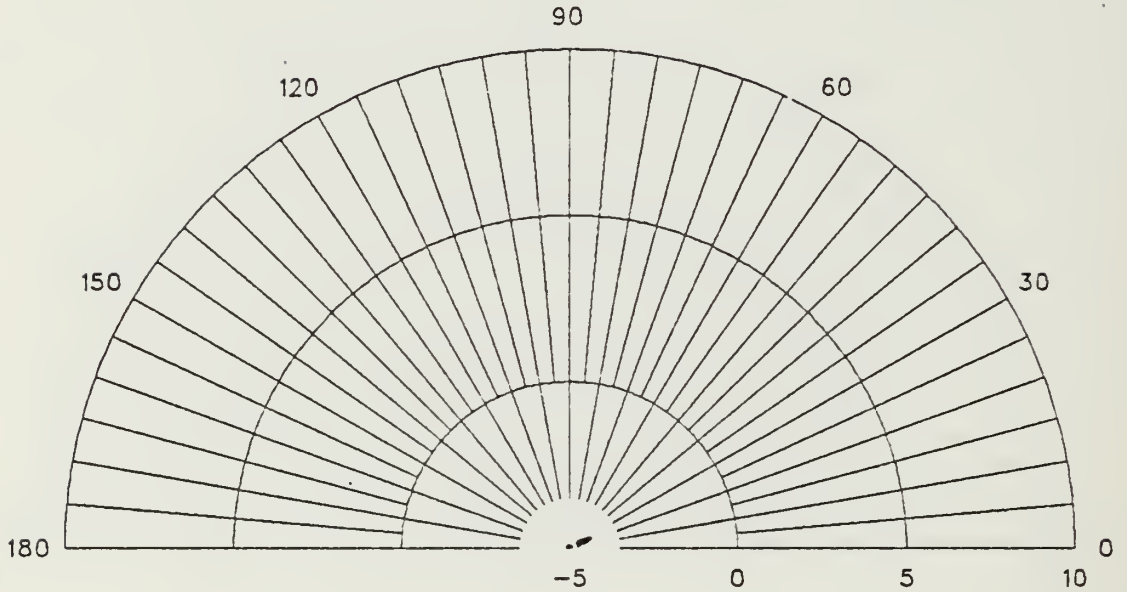

ANTENNA 3C

108 X 6 FT FREQ=17 MHZ THETA=60

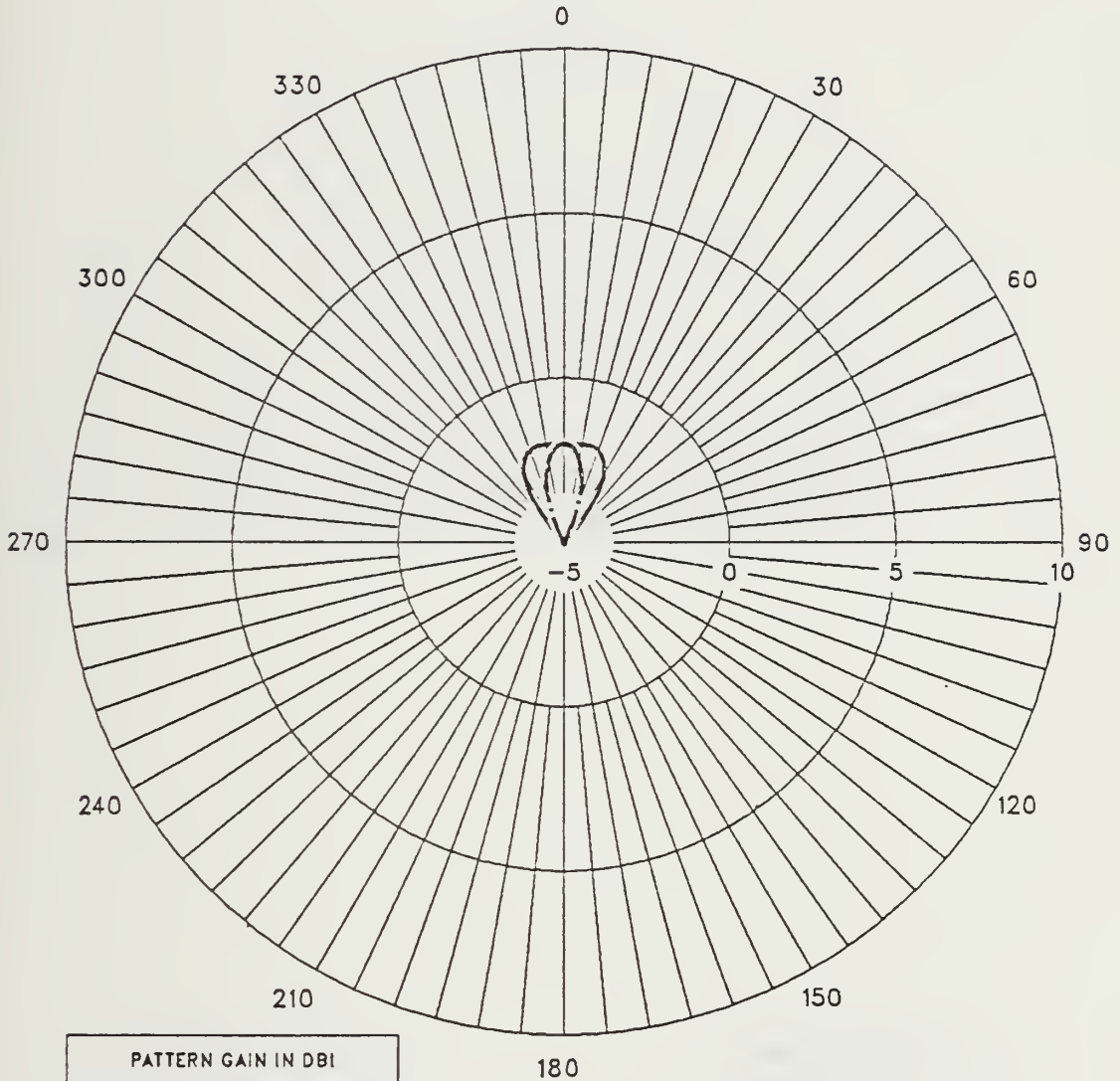

PATTERN GAIN IN DBI
----- HORIZONTAL
———— VERTICAL
———— TOTAL
ANGLES IN DEGREES TRUE

ANTENNA 3C

108 X 6 FT FREQ=30 MHZ PHI=10

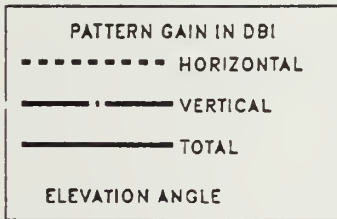
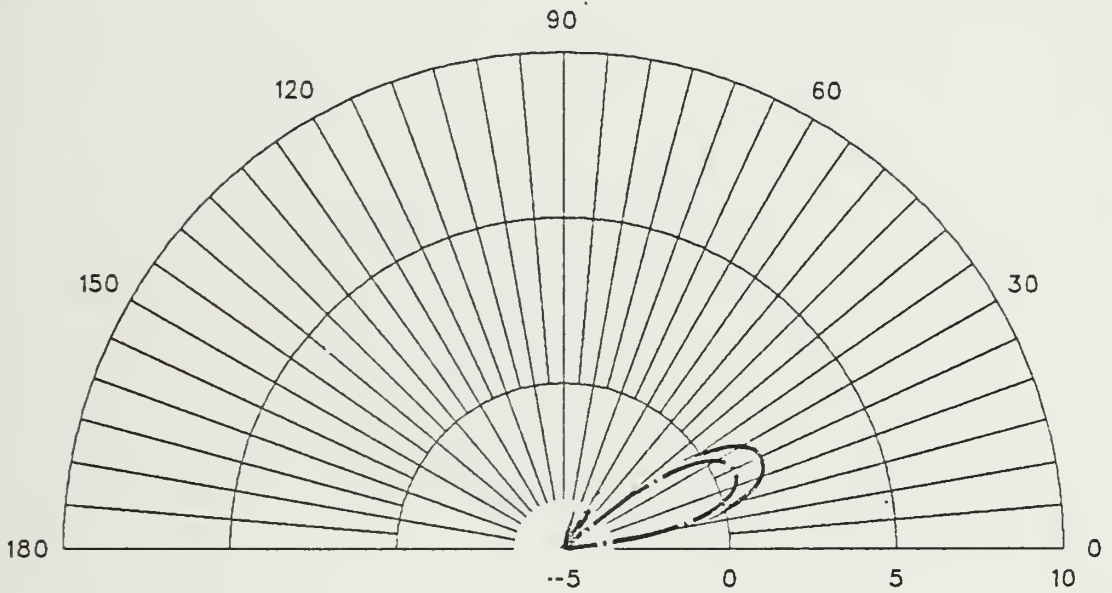

ANTENNA 3C

108 X 6 FT FREQ=30 MHZ PHI=20

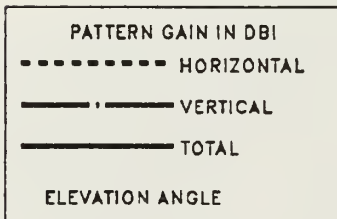
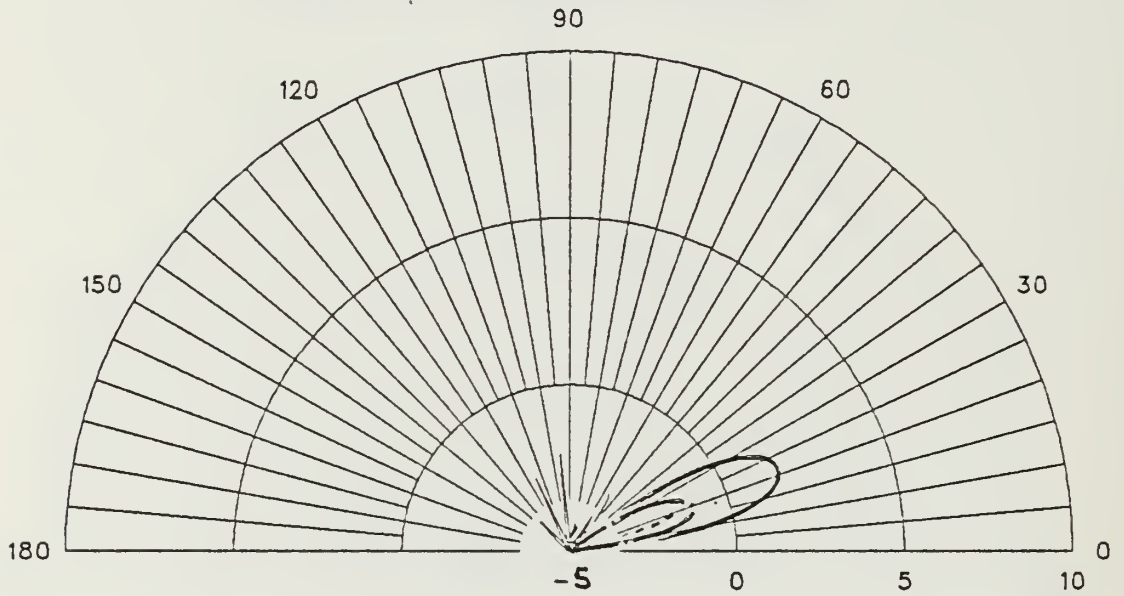

ANTENNA 3C

108 X 6 FT FREQ=30 MHZ PHI=30

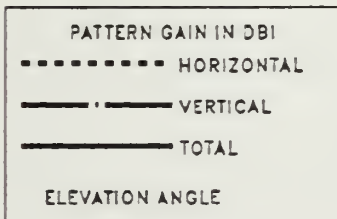
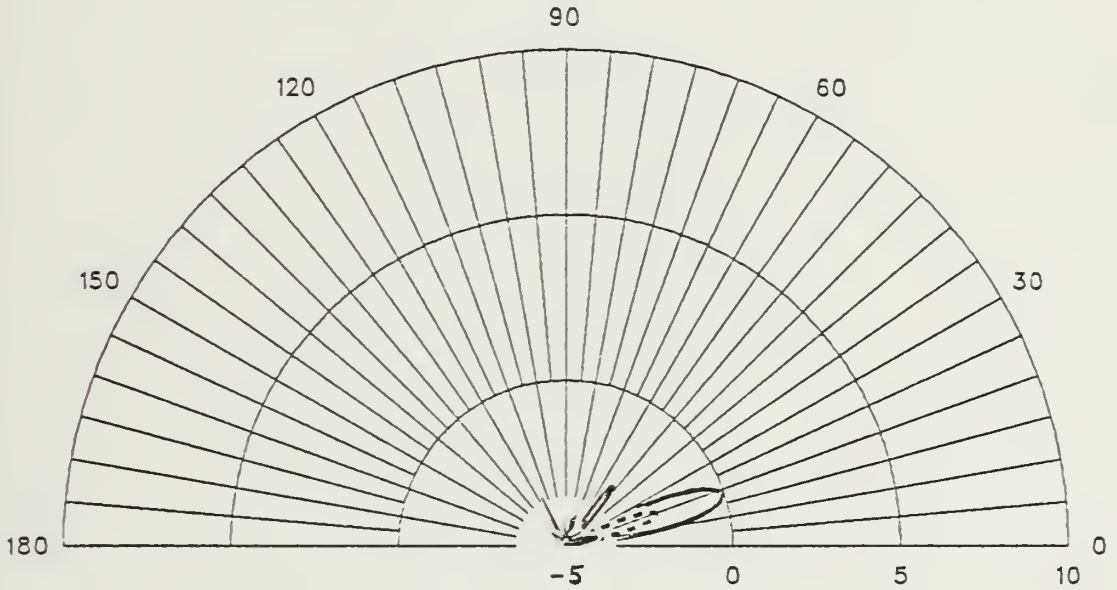

ANTENNA 3C

108 X 6 FT FREQ=30 MHZ PHI=40

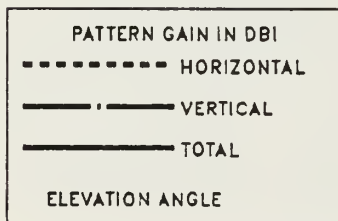
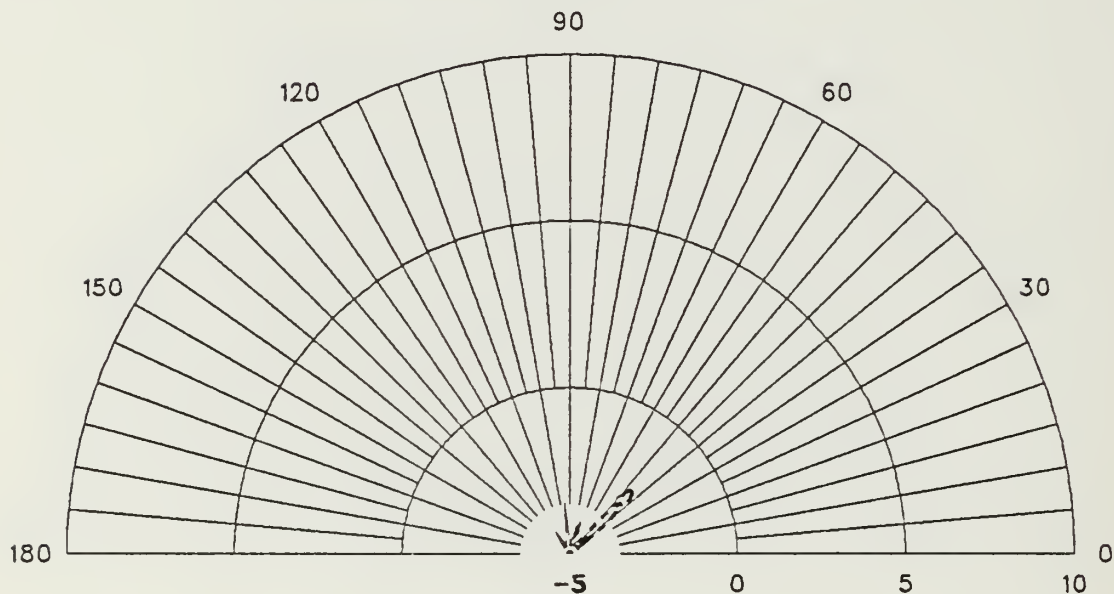

ANTENNA 3C

108 X 6 FT FREQ=30 MHZ THETA=70

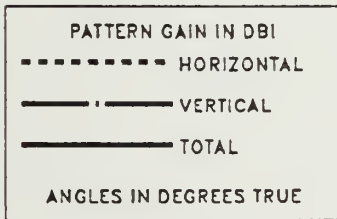
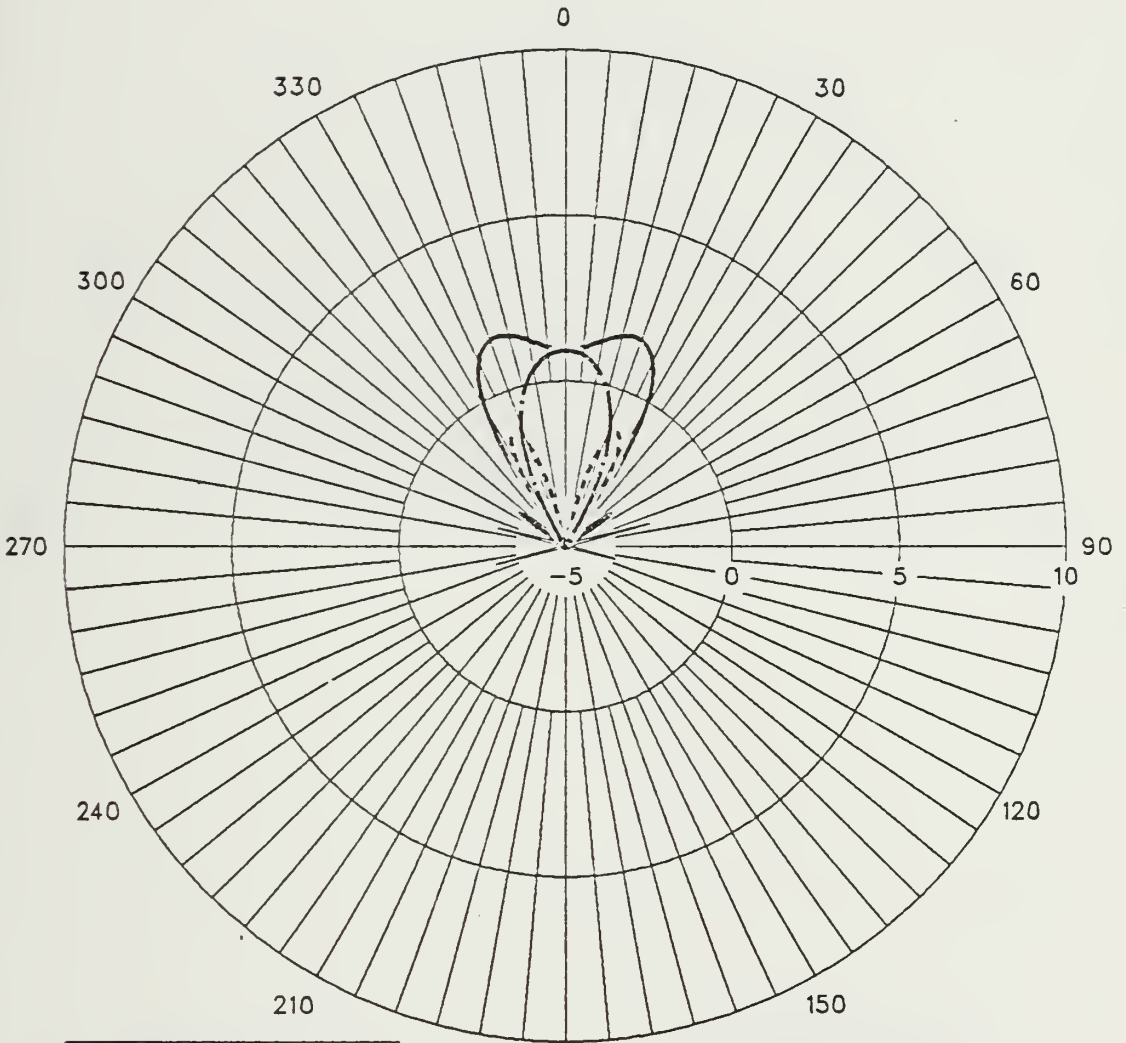

ANTENNA 4A

234 X 6 FT FREQ=17 MHZ PHI=0

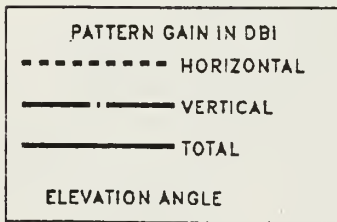
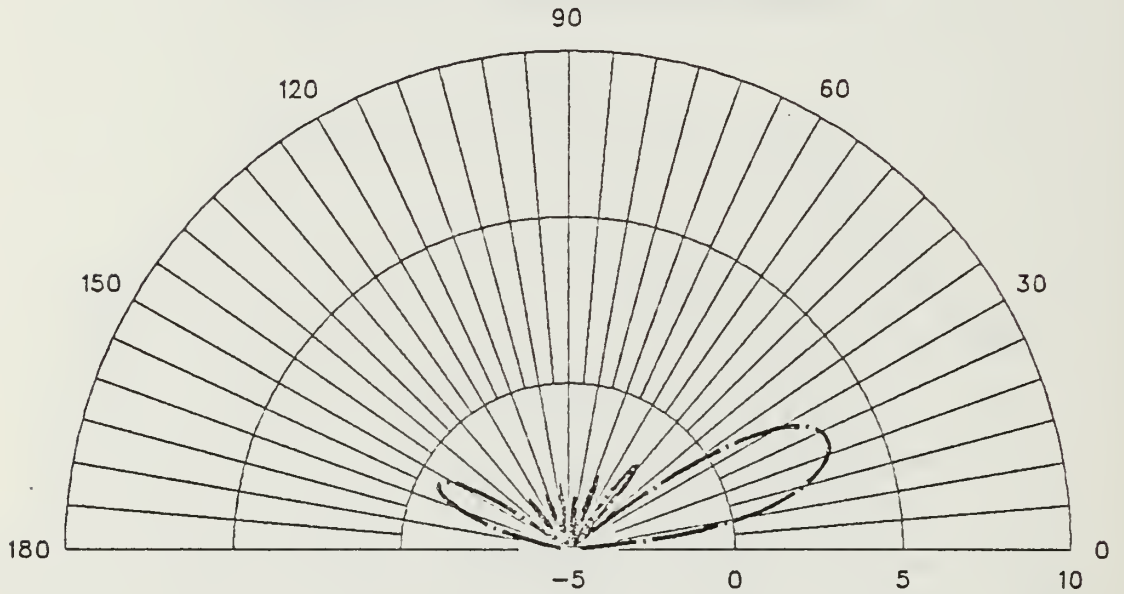

ANTENNA 4A

234 X 6 FT FREQ=17 MHZ PHI=10

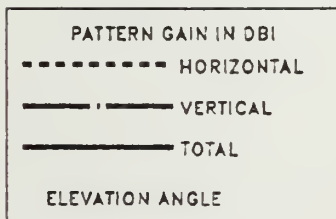
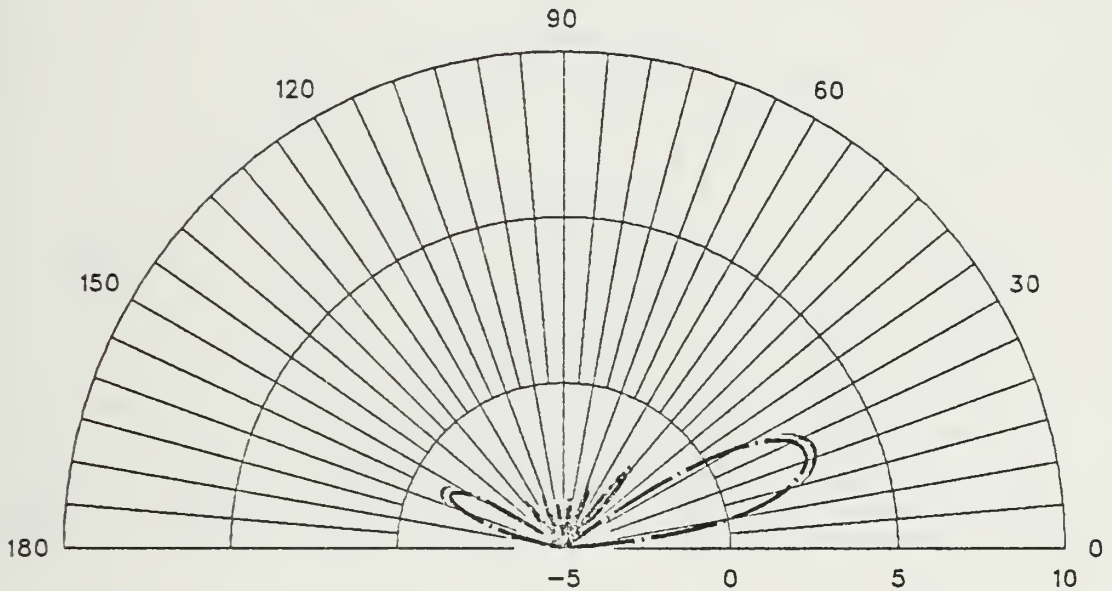

ANTENNA 4A

234 X 6 FT FREQ=17 MHZ PHI=20

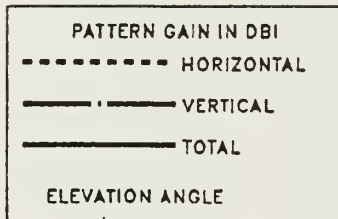
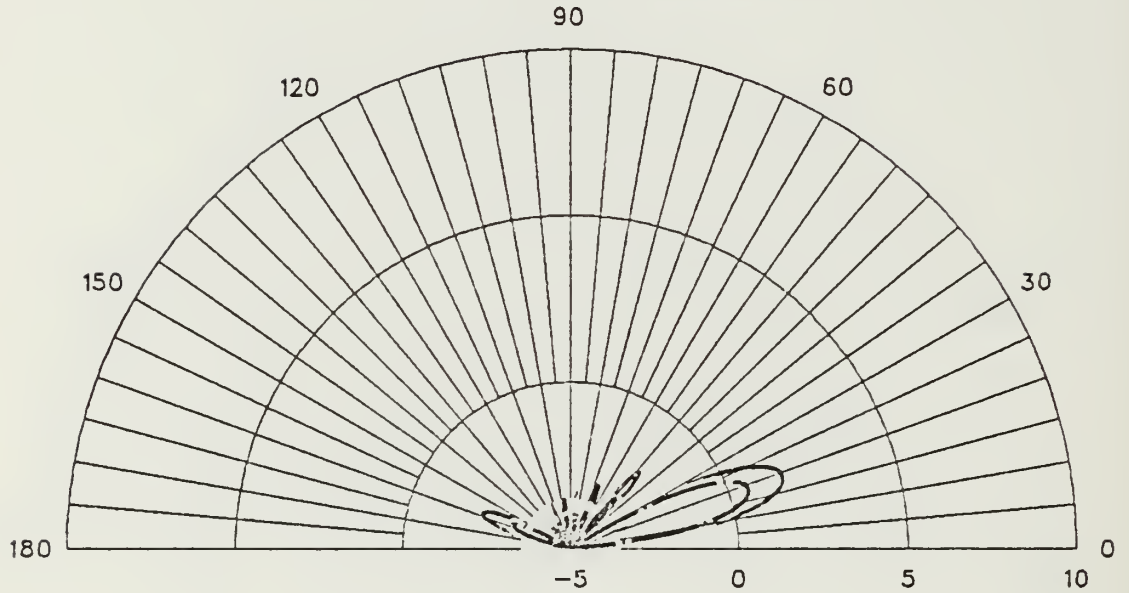

ANTENNA 4A

234 X 6 FT FREQ=17 MHZ PHI=30

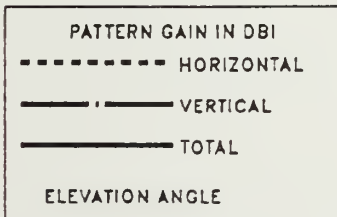
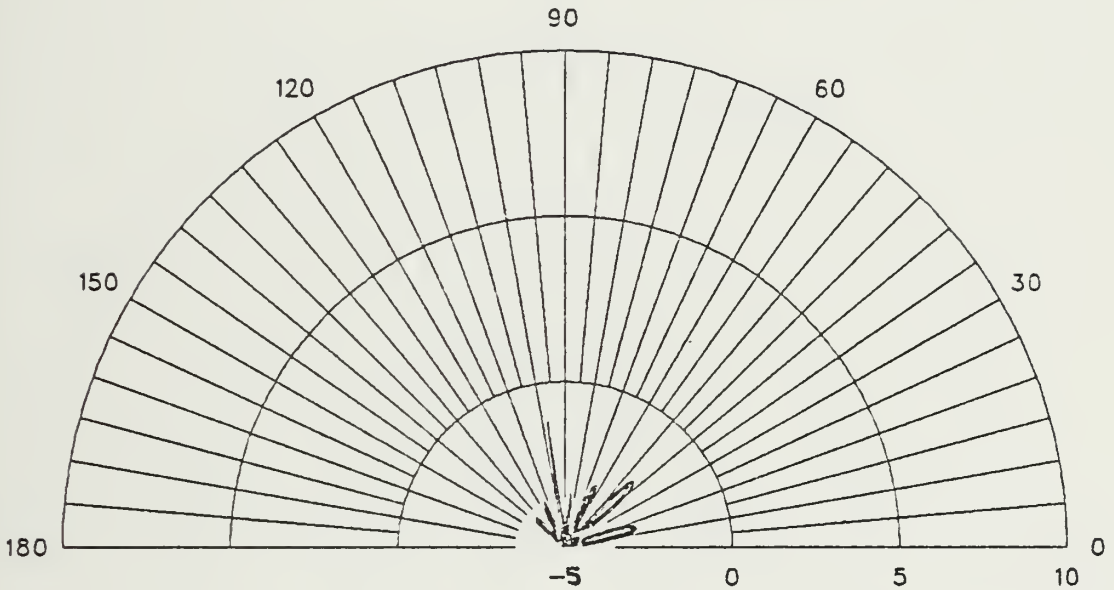

ANTENNA 4A

234 X 6 FT FREQ=17 MHZ PHI=40

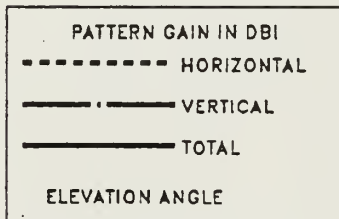
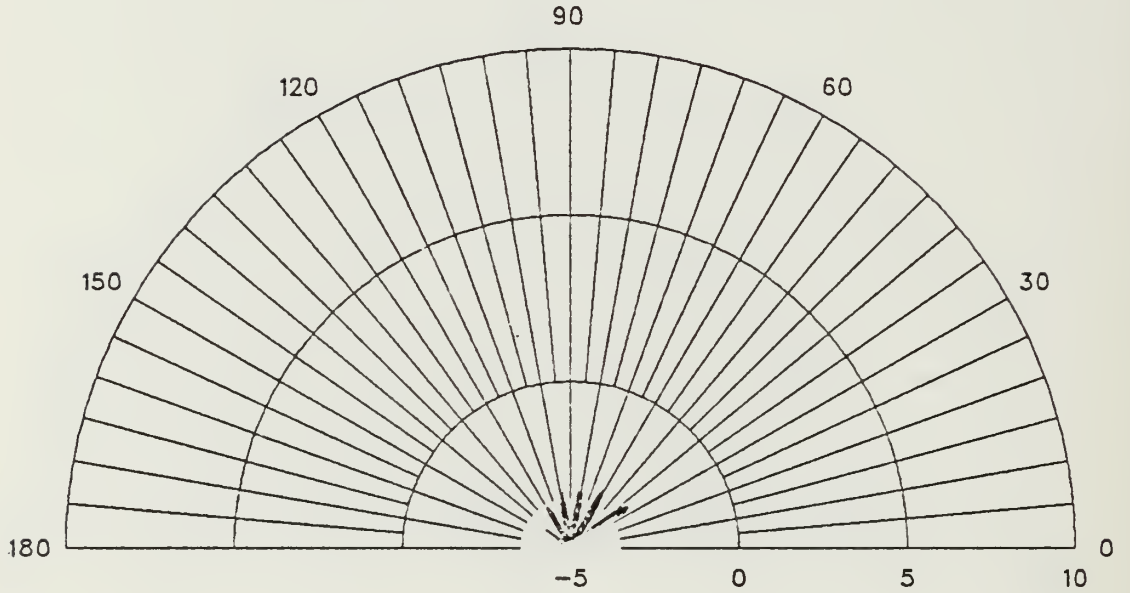

ANTENNA 4A

234 X 6 FT FREQ=17 MHZ THETA=70

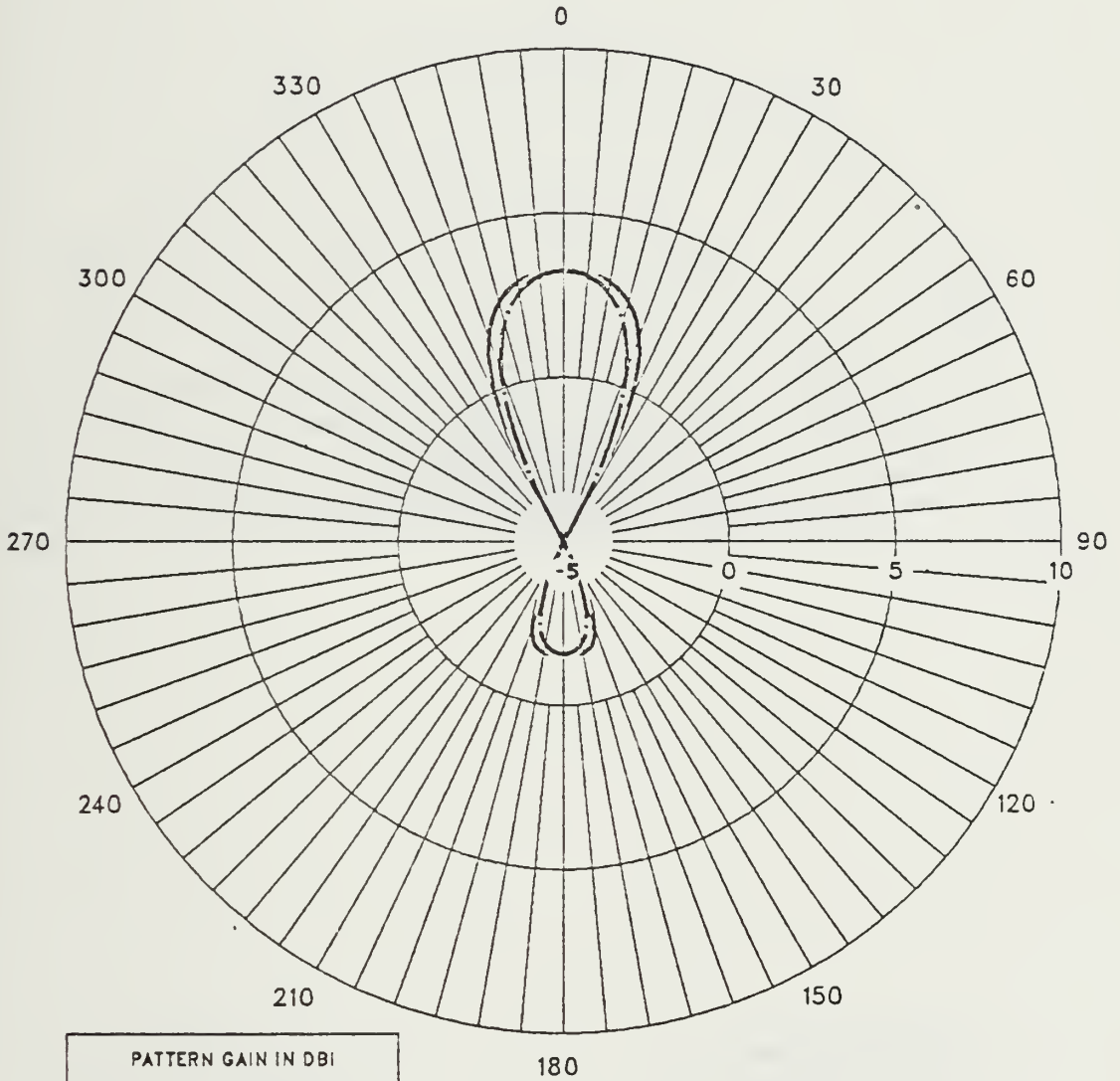

ANTENNA 4A

234 X 6 FT FREQ=30 MHZ PHI=0

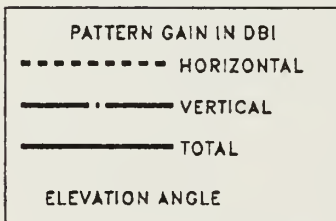
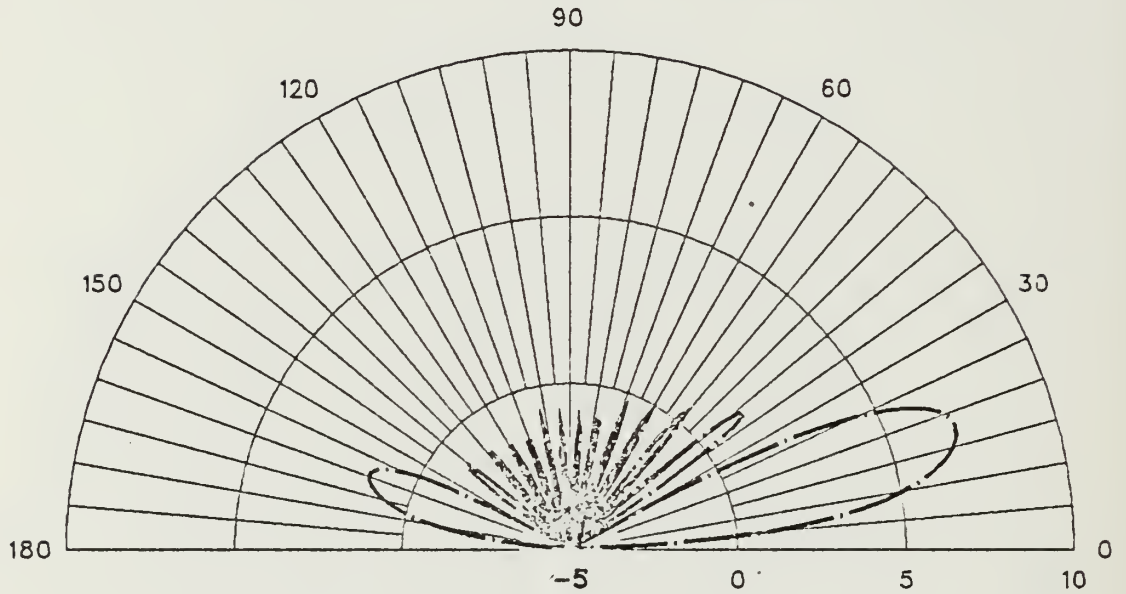

ANTENNA 4A

234 X 6 FT FREQ=30 MHZ PHI=10

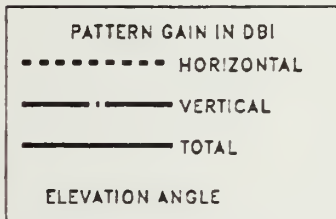
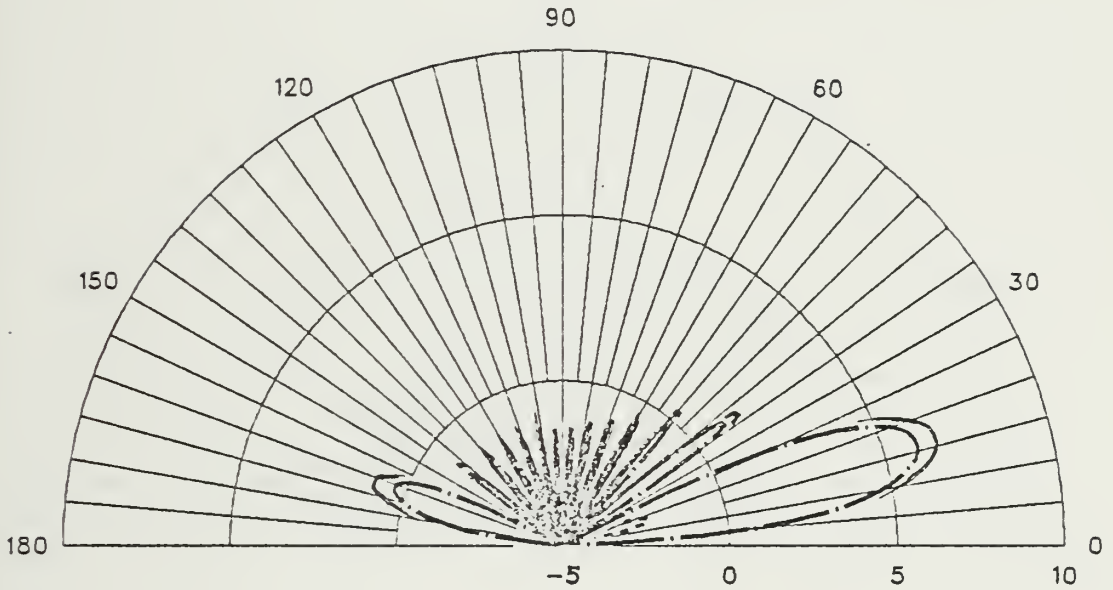

ANTENNA 4A

234 X 6 FT FREQ=30 MHZ PHI=20

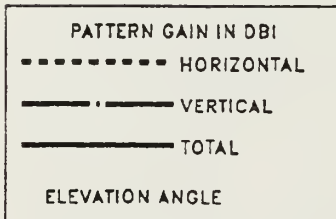
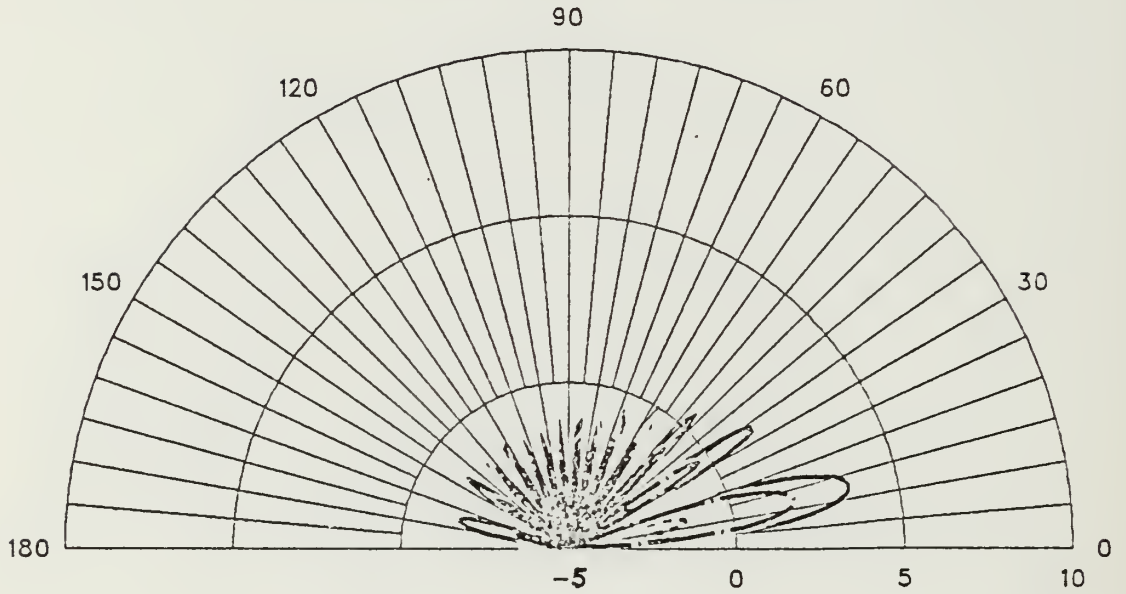

ANTENNA 4A

234 X 6 FT FREQ=30 MHZ PHI=30

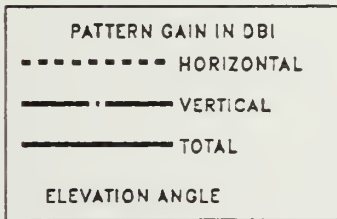
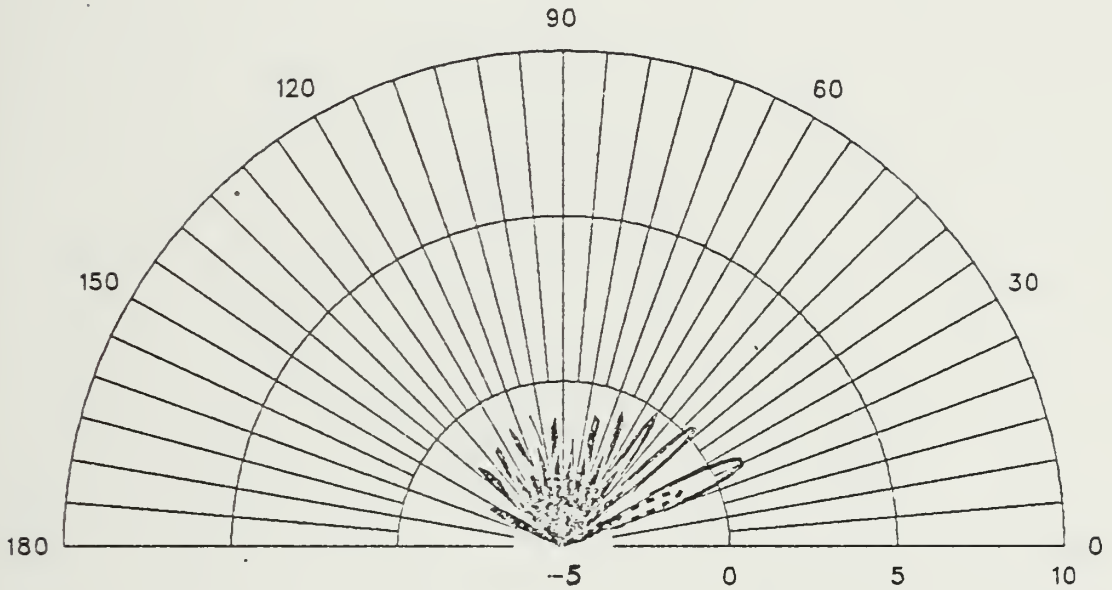

ANTENNA 4A

234 X 6 FT FREQ=30 MHZ PHI=40

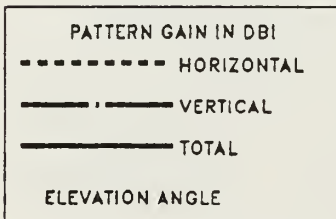
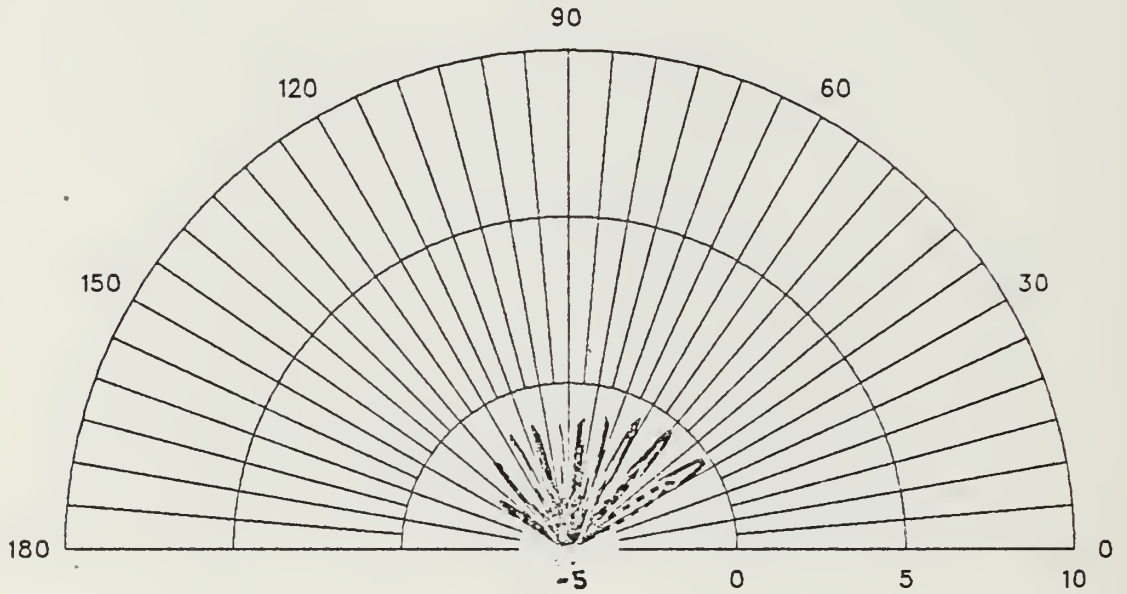

ANTENNA 4A

234 X 6 FT FREQ=30 MHZ THETA=75

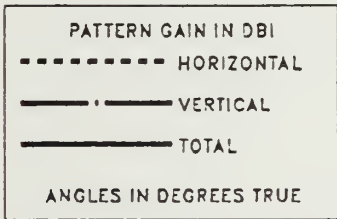
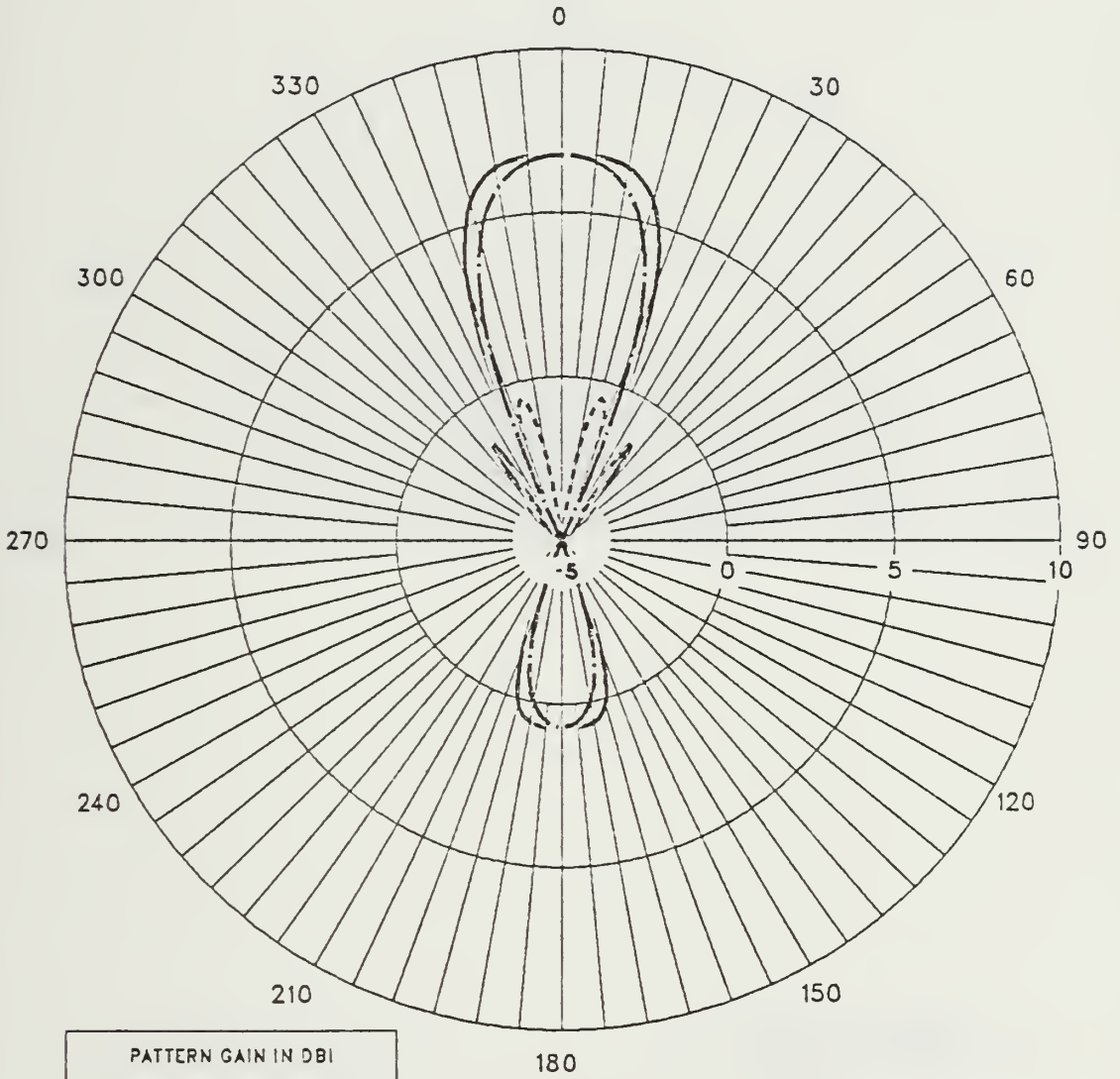

ANTENNA 4B

234 X 15 FT FREQ=17 MHZ PHI=0

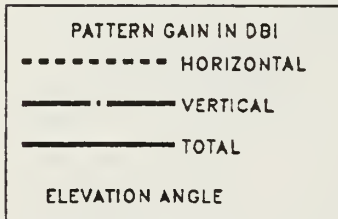
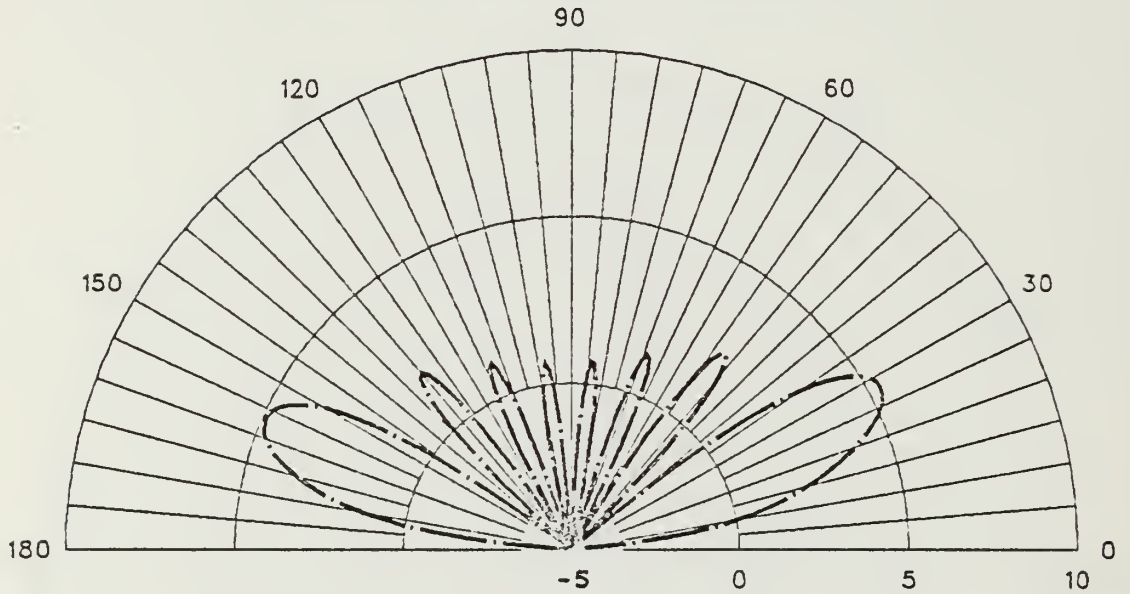

ANTENNA 4B

234 X 15 FT FREQ=17 MHZ PHI=10

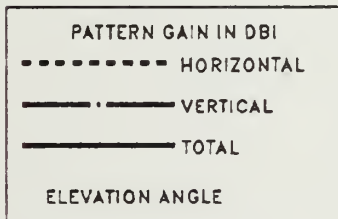
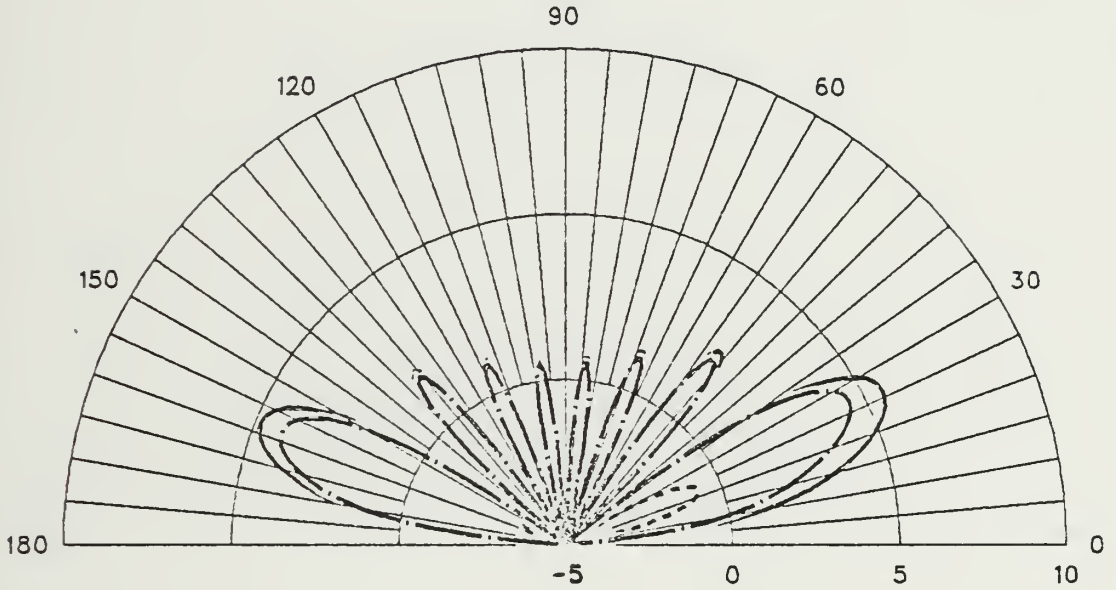

ANTENNA 4B

234 X 15 FT FREQ=17 MHZ PHI=20

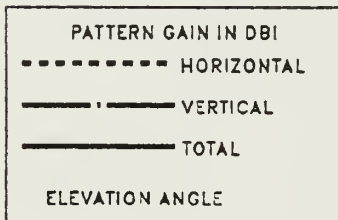
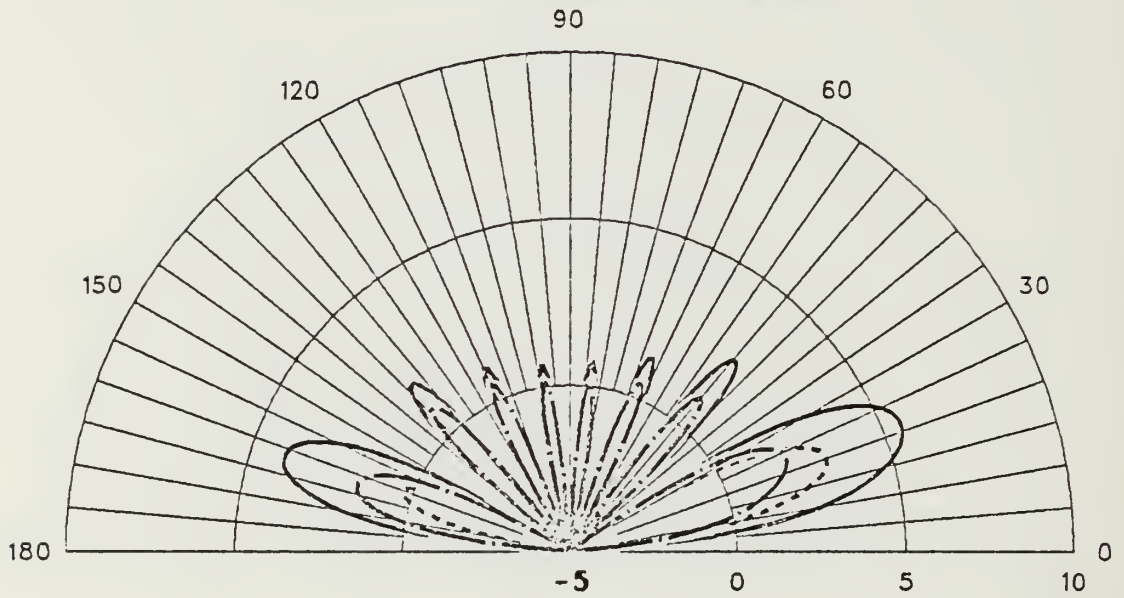

ANTENNA 4B

234 X 15 FT FREQ=17 MHZ PHI=30

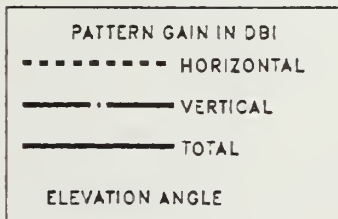
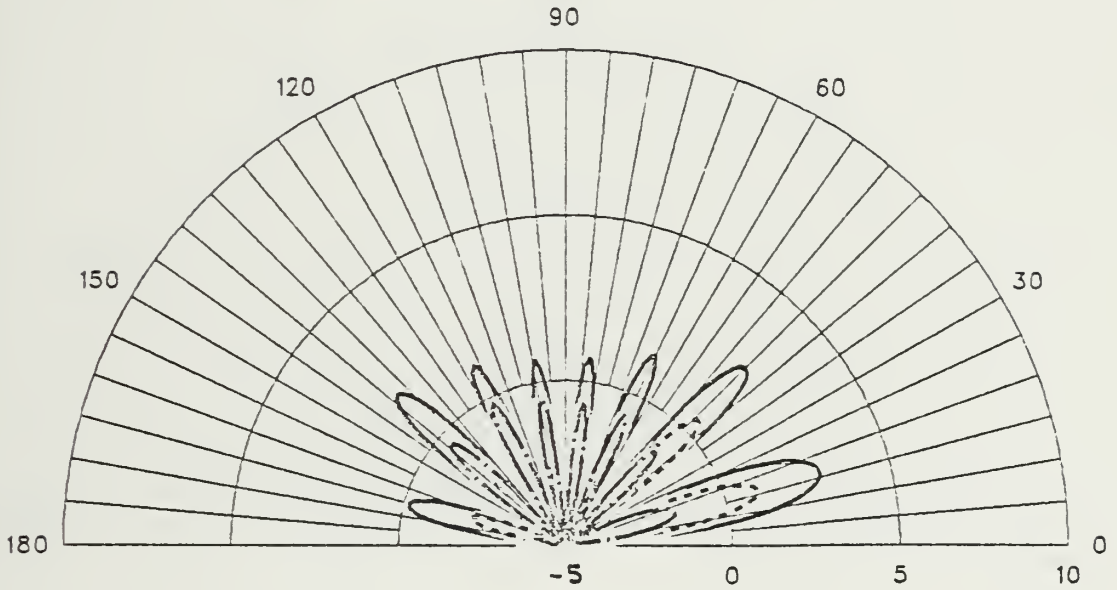

ANTENNA 4B

234 X 15 FT FREQ=17 MHZ PHI=30

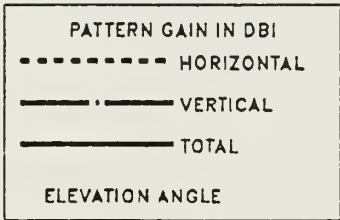
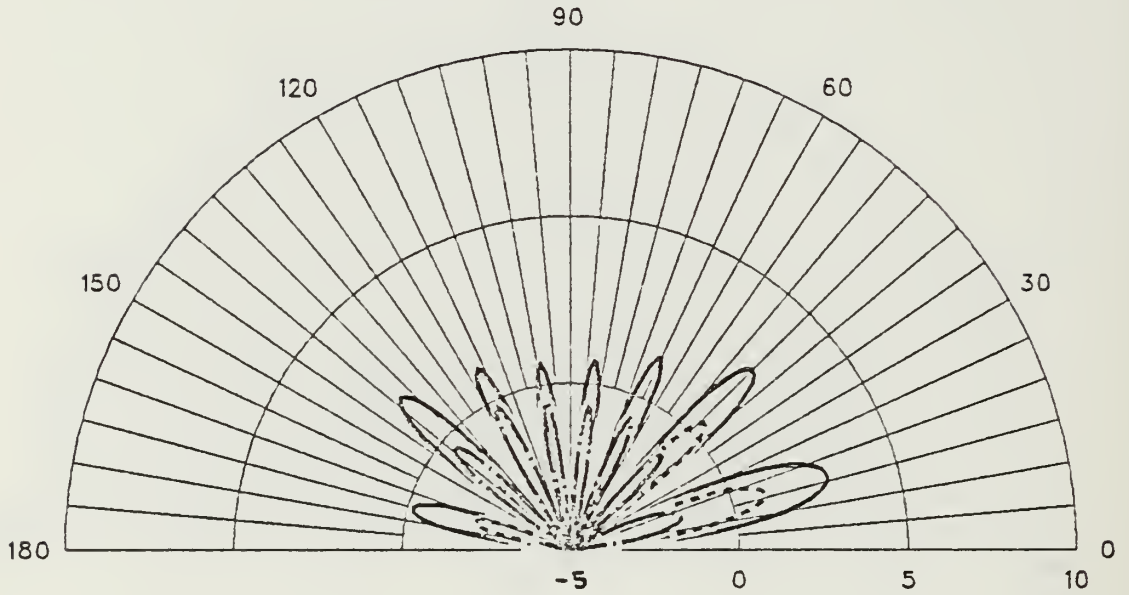

ANTENNA 4B

234 X 15 FT FREQ=17 MHZ PHI=40

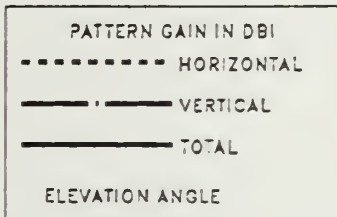
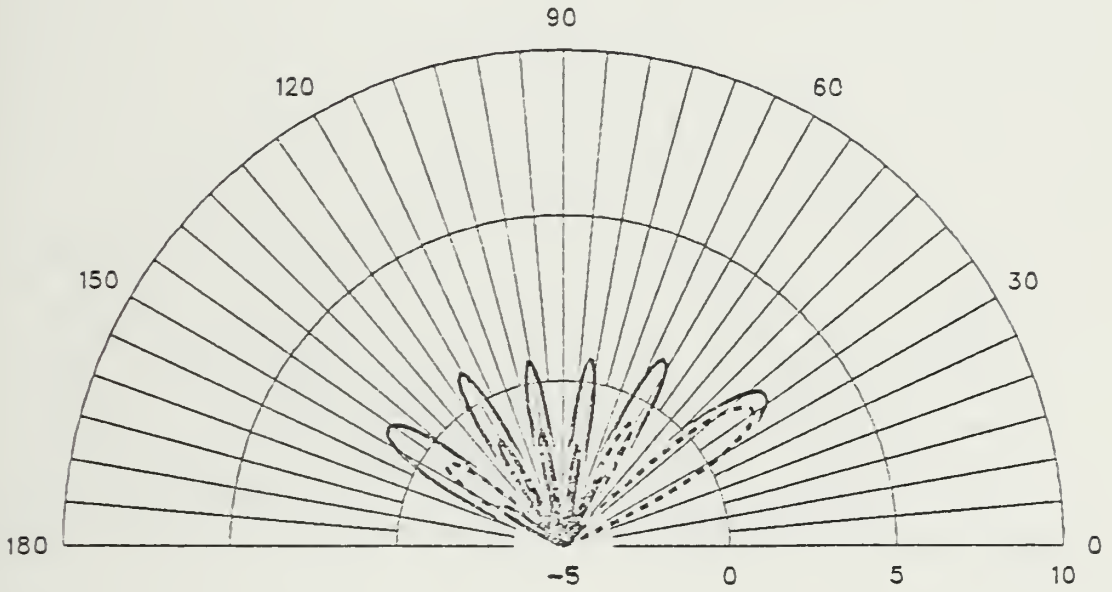

ANTENNA 4B

234 X 15 FT FREQ=30 MHZ PHI=0

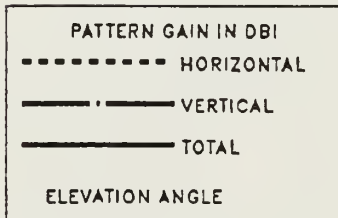
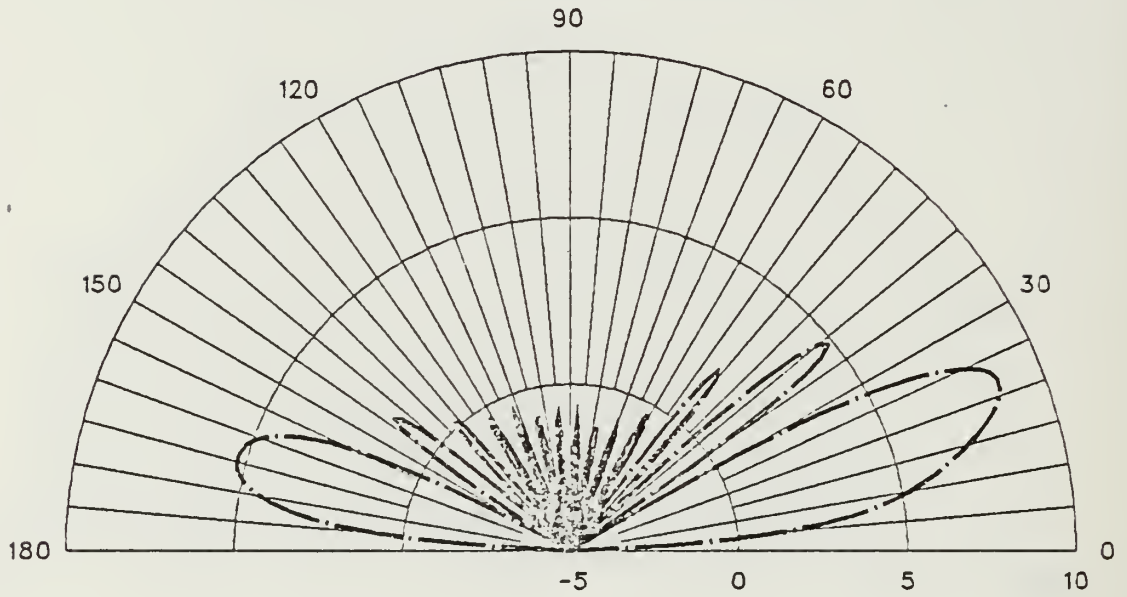

ANTENNA 4B

234 X 15 FT FREQ=30 MHZ PHI=10

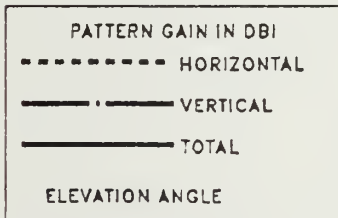
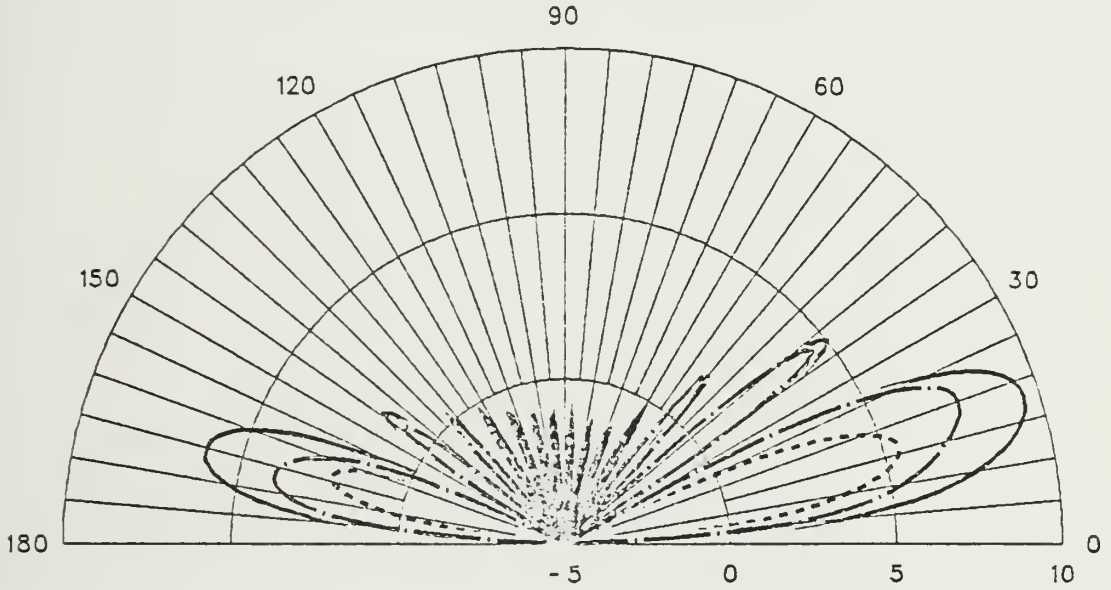

ANTENNA 4B

234 X 15 FT FREQ=30 MHZ PHI=30

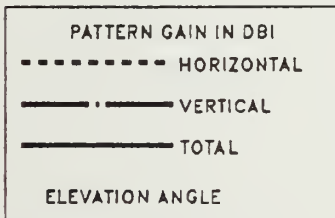
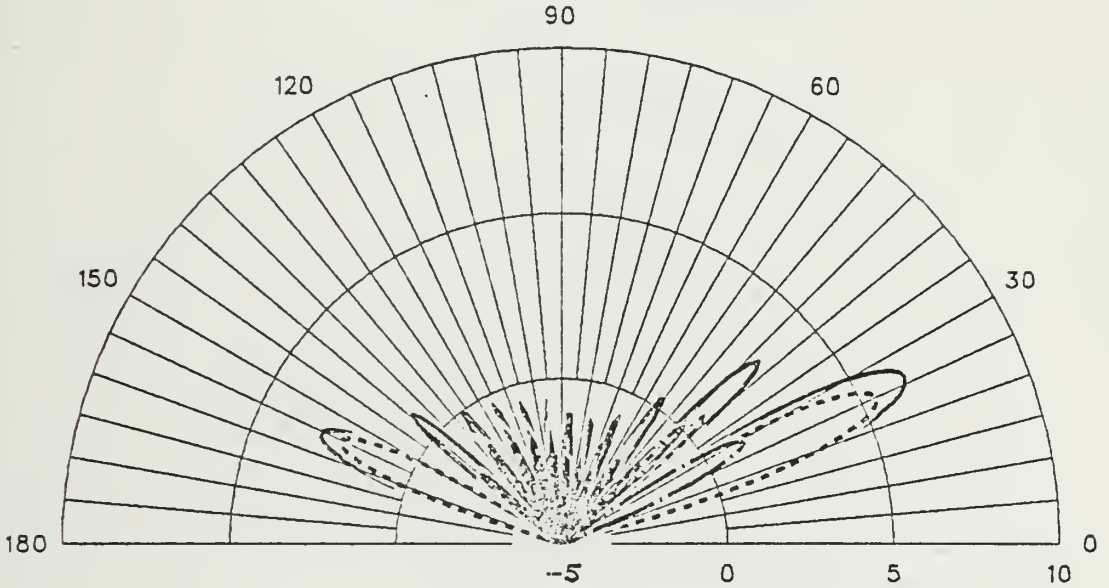

ANTENNA 4B

234 X 15 FT FREQ=30 MHZ PHI=40

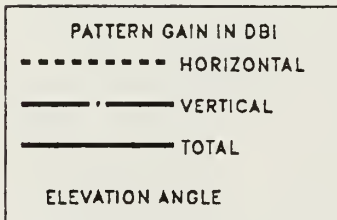
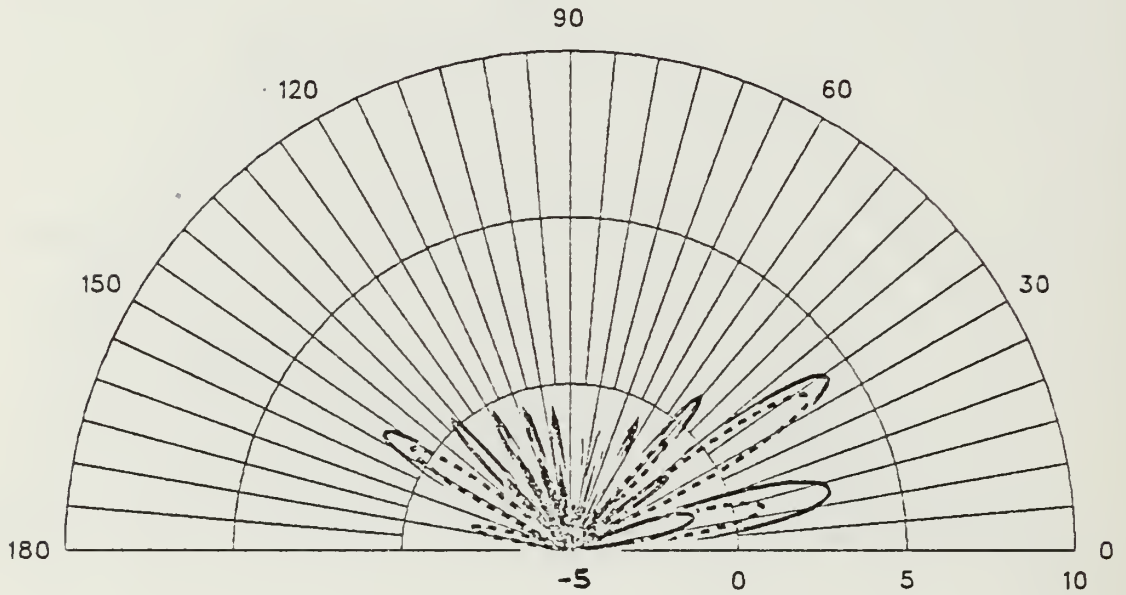

ANTENNA 4B

234 X 15 FT FREQ=17 MHZ THETA=65

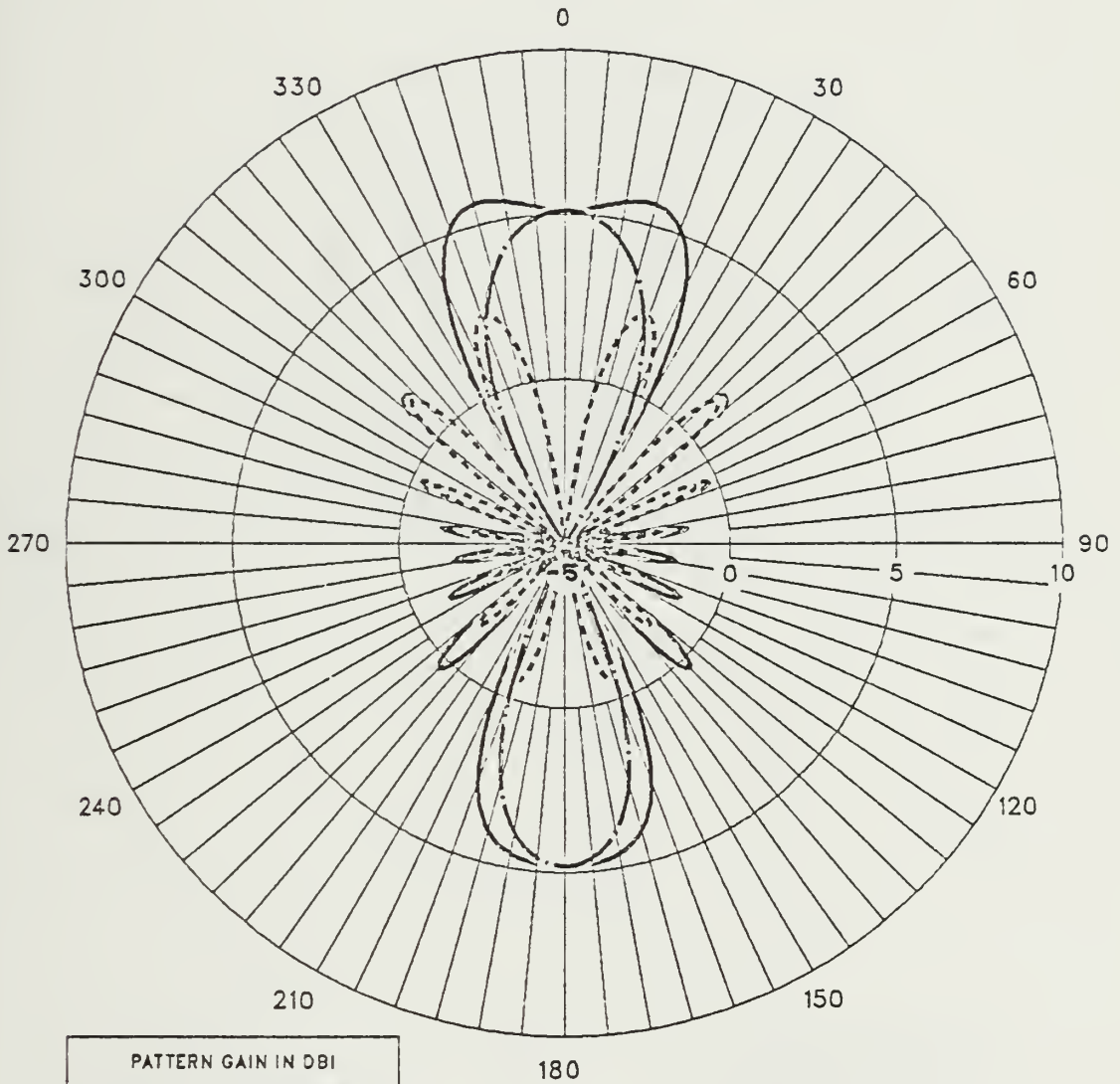

ANTENNA 4B

234 X 15 FT FREQ=30 MHZ THETA=75

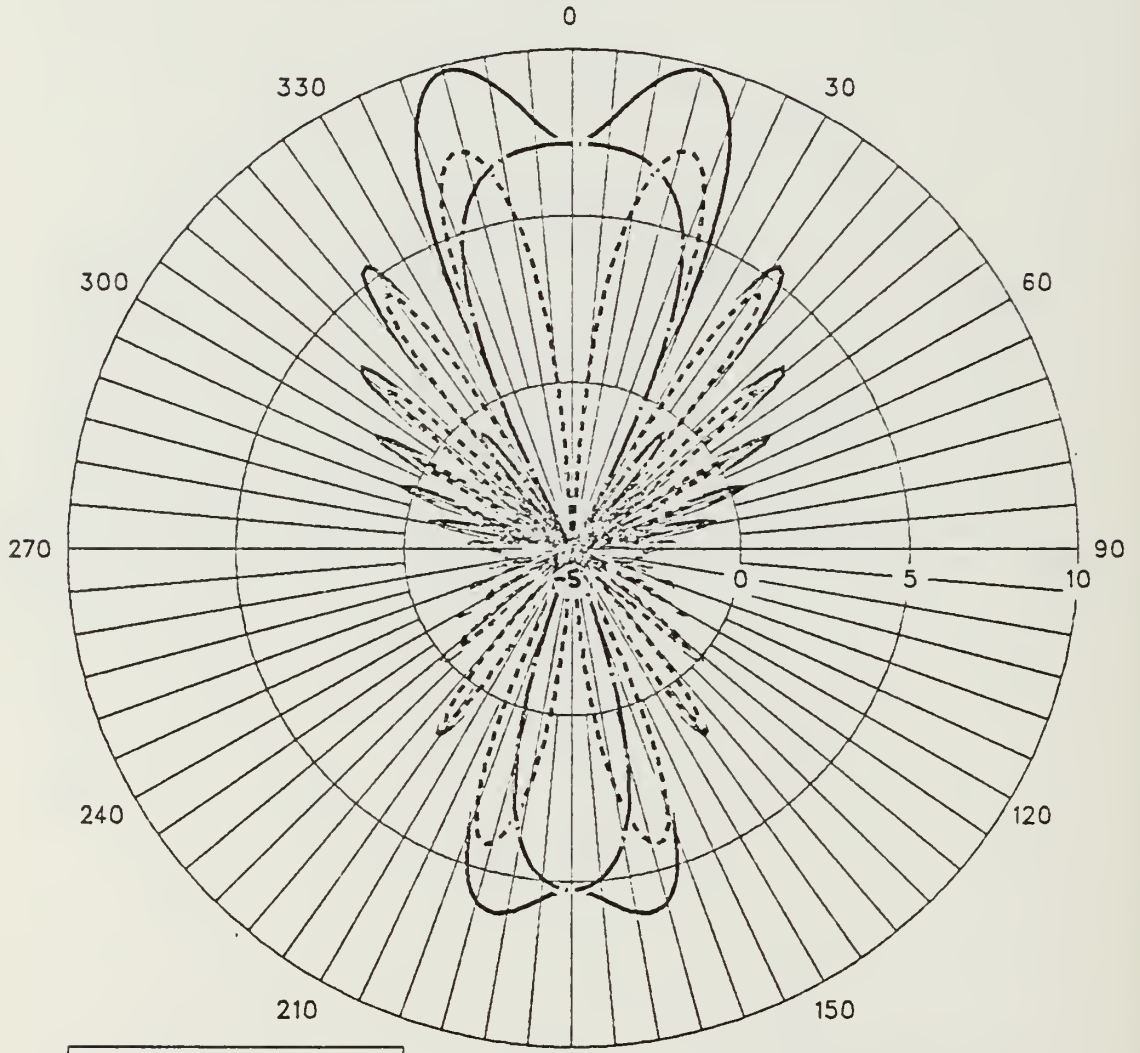

PATTERN GAIN IN DBI
----- HORIZONTAL
..... VERTICAL
————— TOTAL
ANGLES IN DEGREES TRUE

ANTENNA 4C

234 X 20 FT FREQ=17 MHZ PHI=0

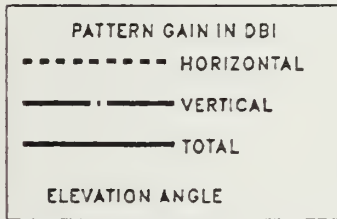
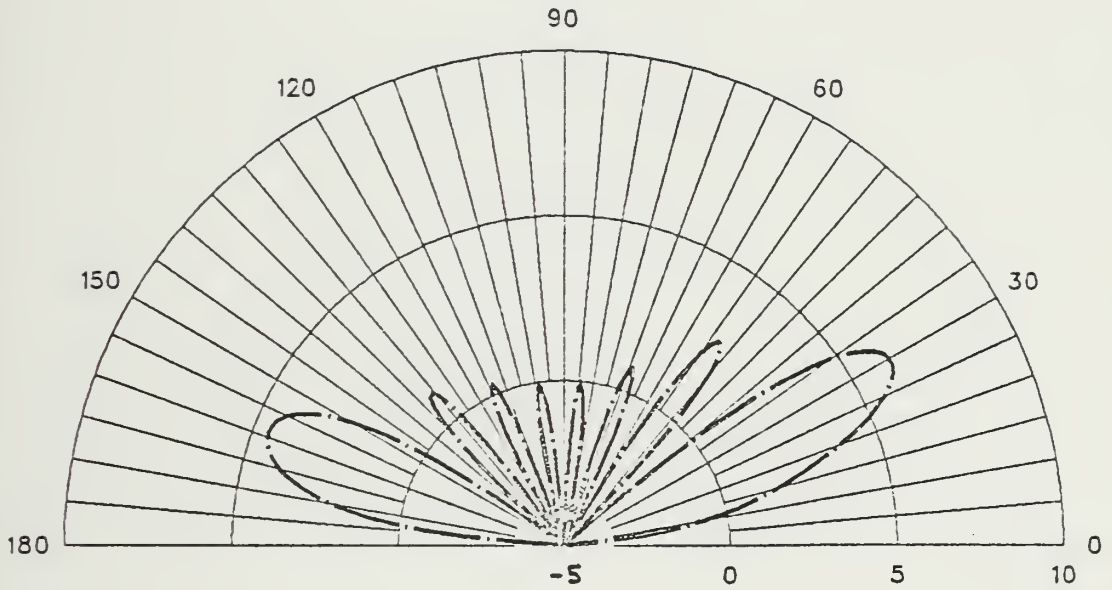

ANTENNA 4C

234 X 20 FT FREQ=17 MHZ PHI=10

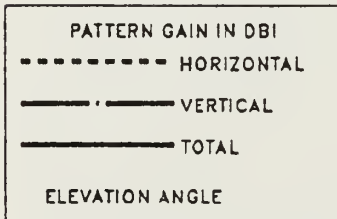
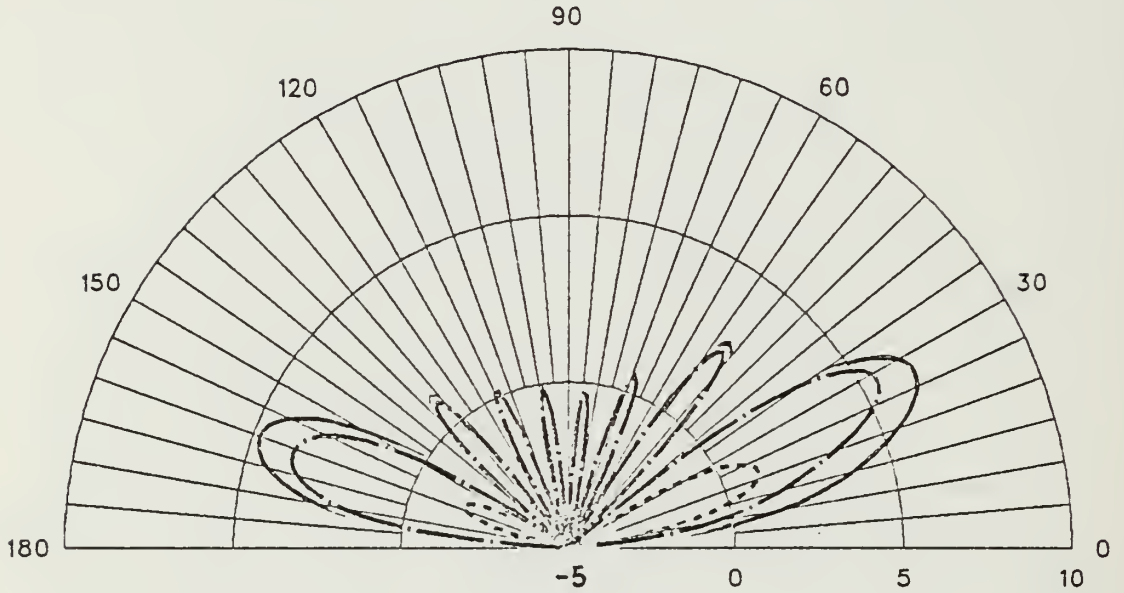

ANTENNA 4C

234 X 20 FT FREQ=17 MHZ PHI=20

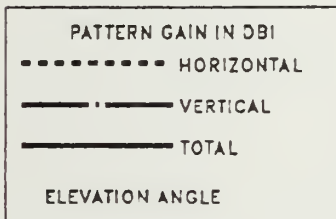
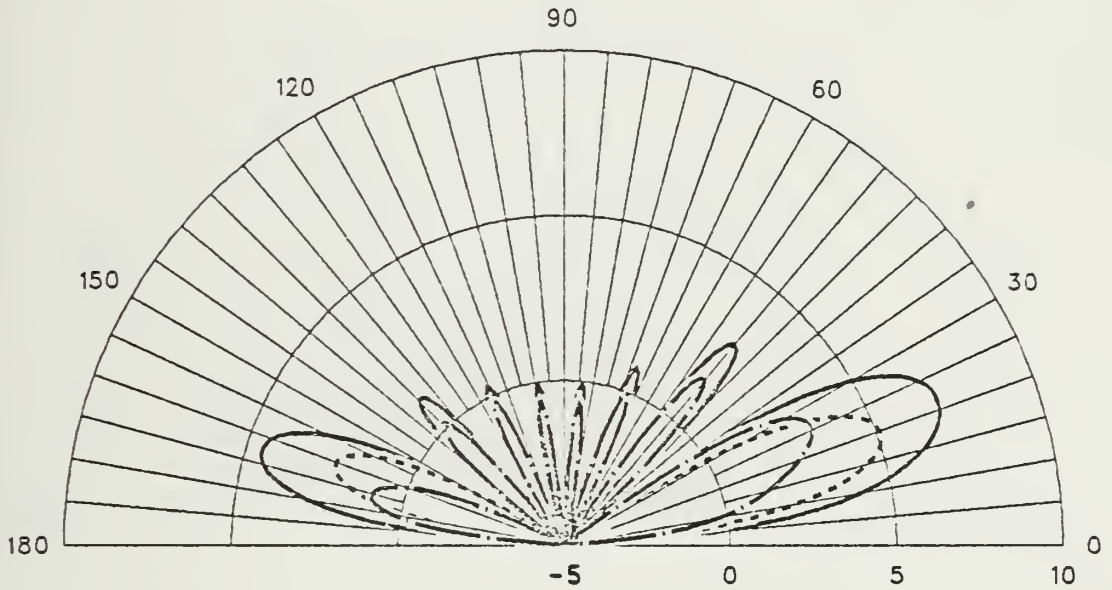

ANTENNA 4C

234 X 20 FT FREQ=17 MHZ PHI=30

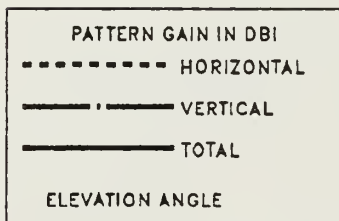
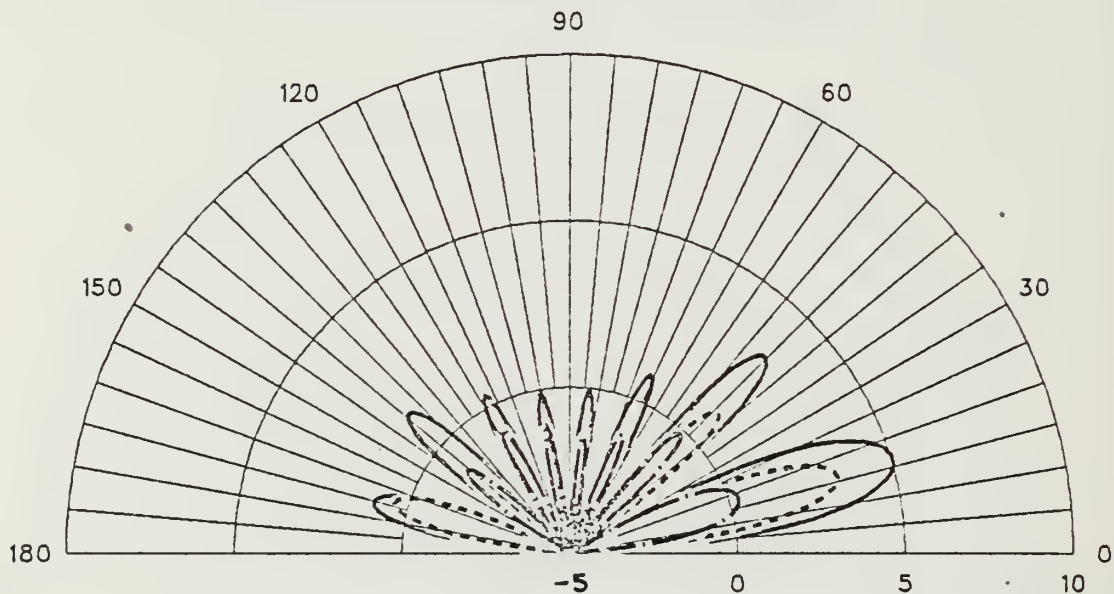

ANTENNA 4C

234 X 20 FT FREQ=17 MHZ PHI=40

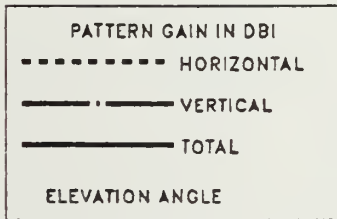
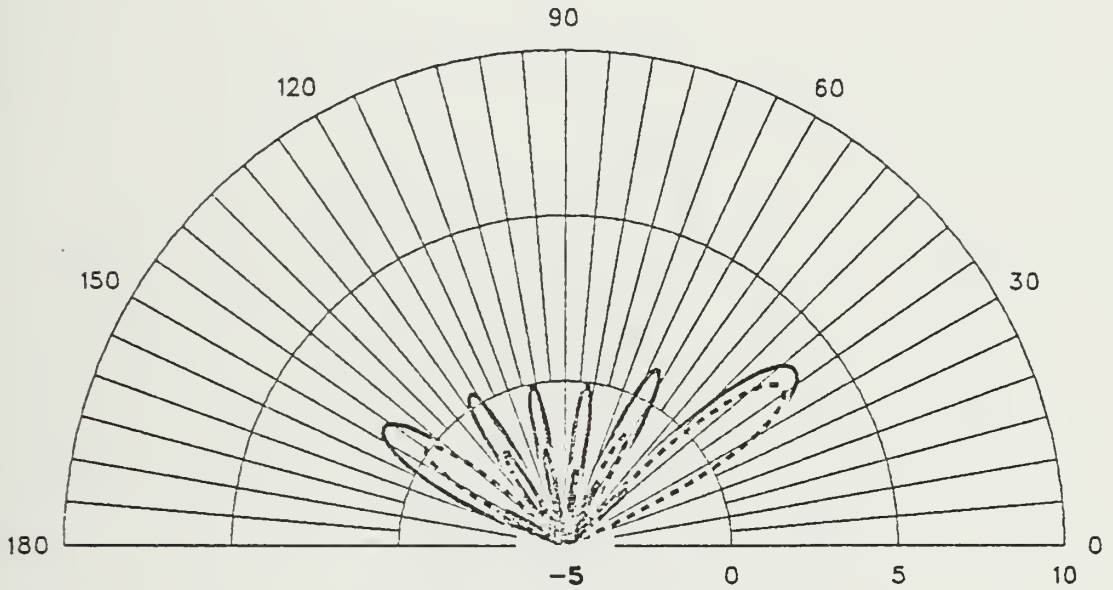

ANTENNA 4C

234 X 20 FT FREQ=17 MHZ THETA 70

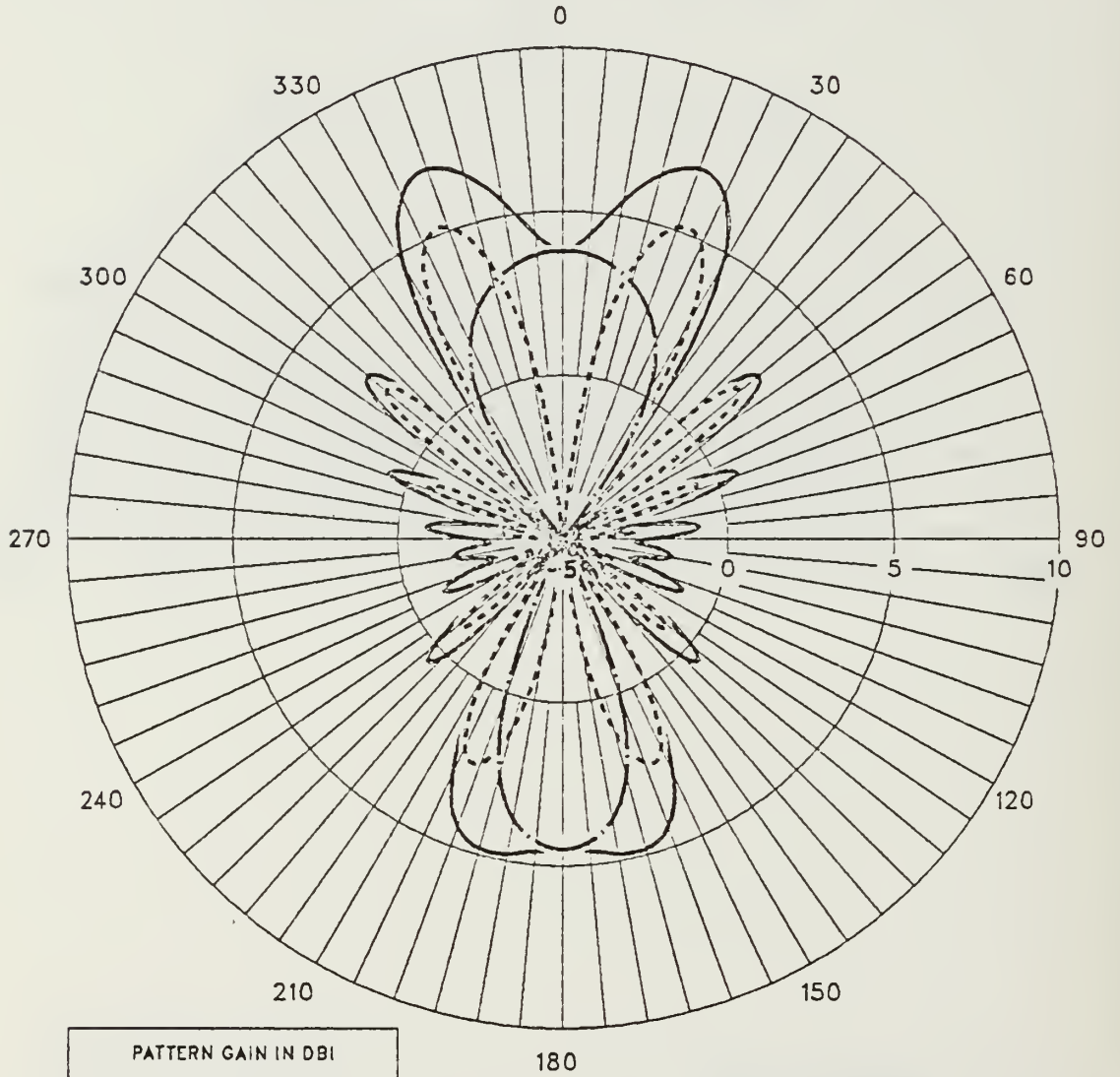

PATTERN GAIN IN DBI
----- HORIZONTAL
- · - · - VERTICAL
————— TOTAL
ANGLES IN DEGREES TRUE

ANTENNA 4C

234 X 20 FT FREQ=30 MHZ PHI=0

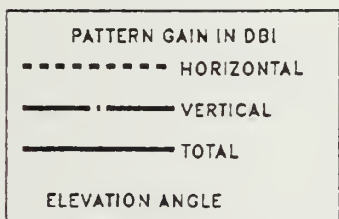
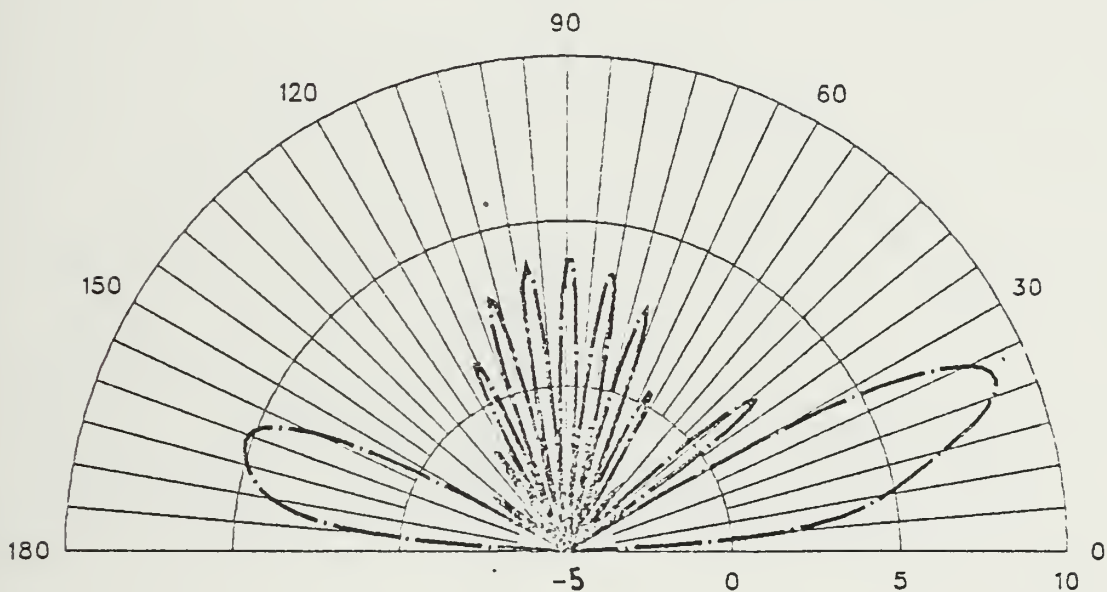

ANTENNA 4C

234 X 20 FT FREQ=30 MHZ PHI=10

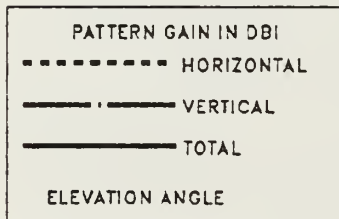
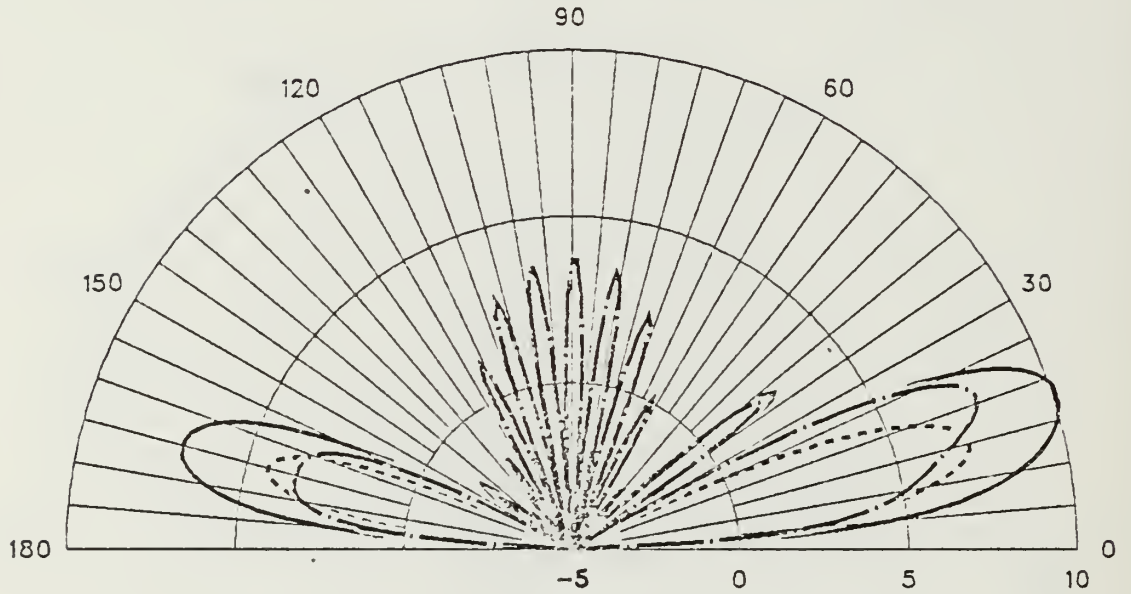

ANTENNA 4C

234 X 20 FT FREQ=30 MHZ PHI=20

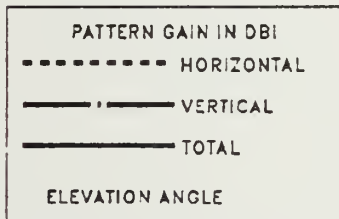
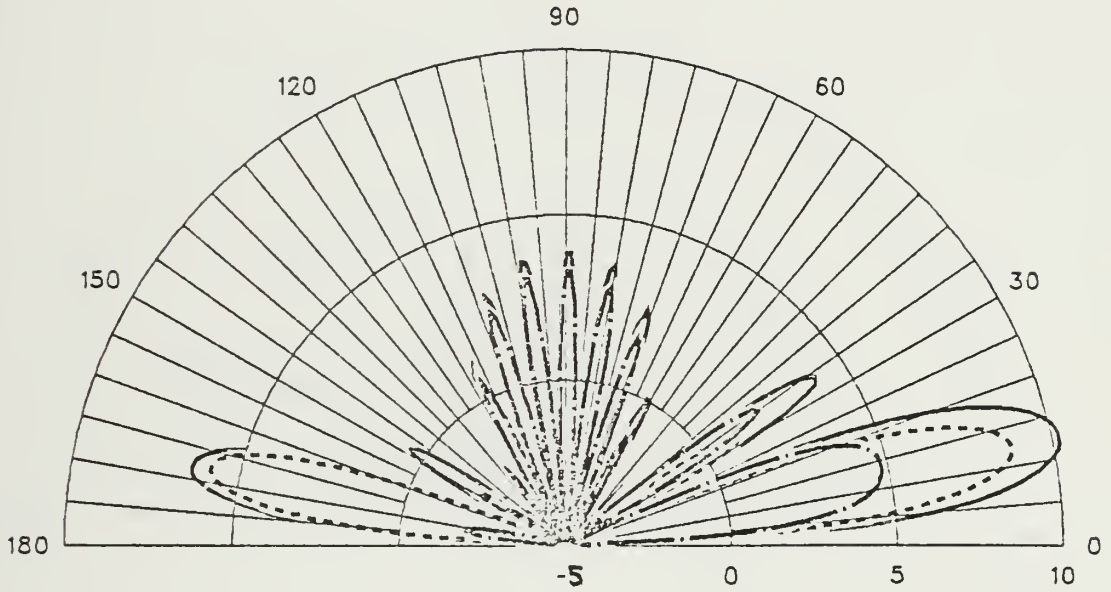

ANTENNA 4C

234 X 20 FT FREQ=30 MHZ PHI=30

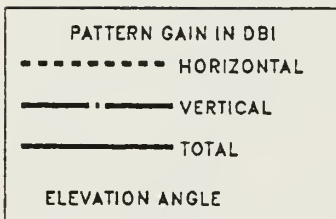
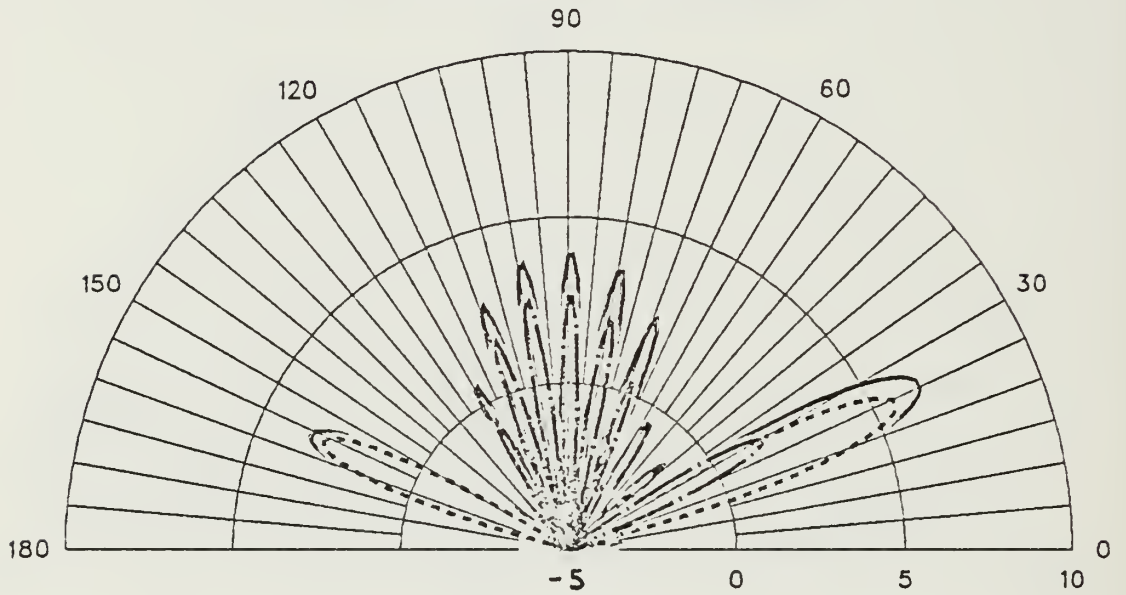

ANTENNA 4C

234 X 20 FT FREQ=30 MHZ PHI=40

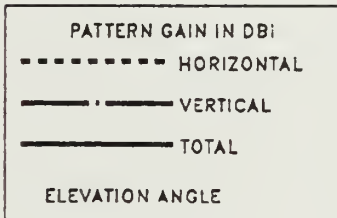
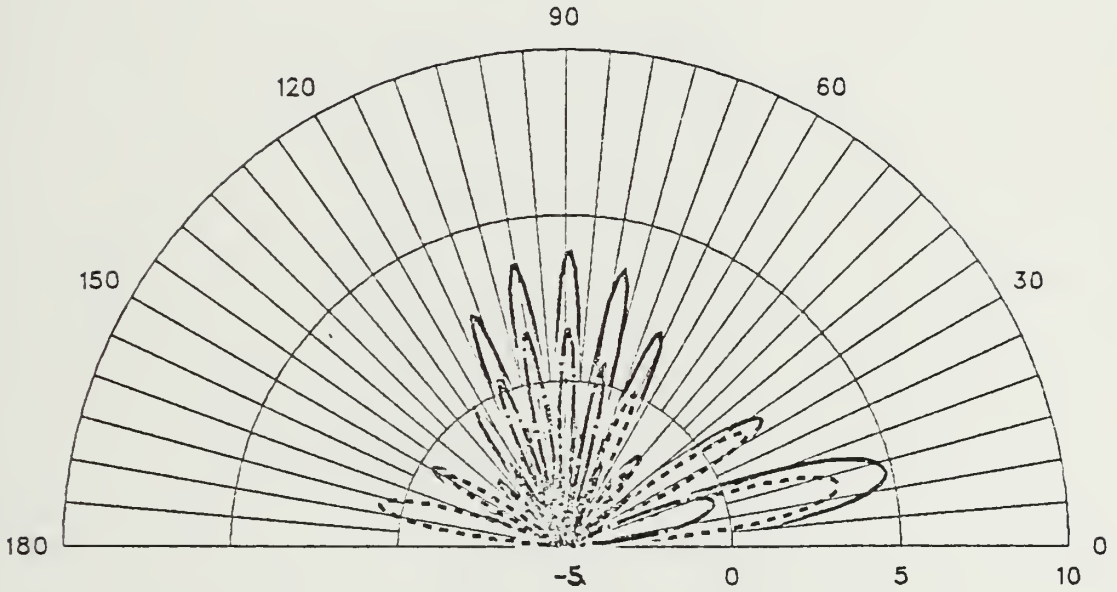

ANTENNA 4C

234 X 20 FT FREQ=30 MHZ THETA=80

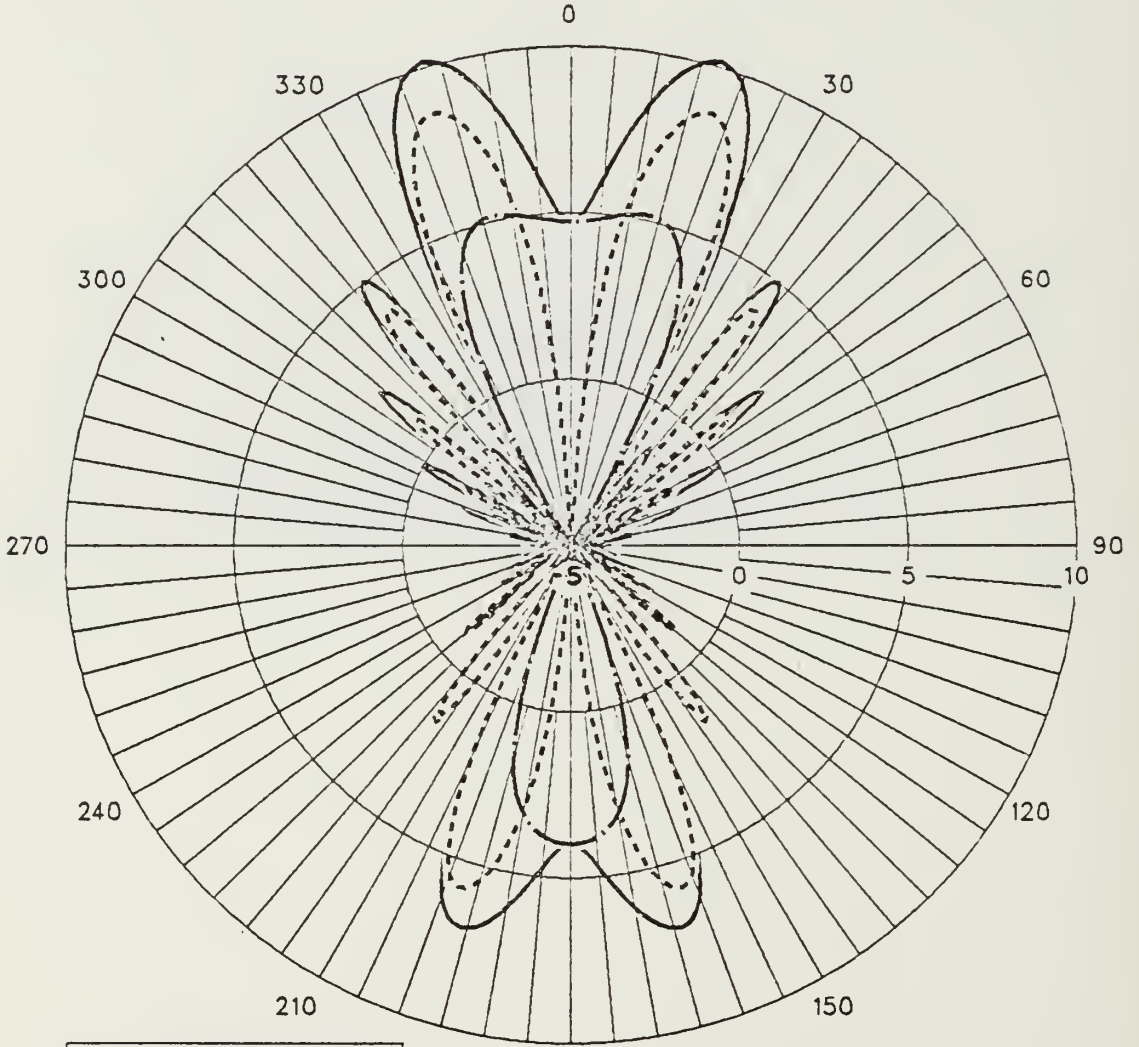

PATTERN GAIN IN DBI
- - - - - HORIZONTAL
————— VERTICAL
————— TOTAL
ANGLES IN DEGREES TRUE

ANTENNA 5A

564 X 6 FT FREQ=17 MHZ PHI=0

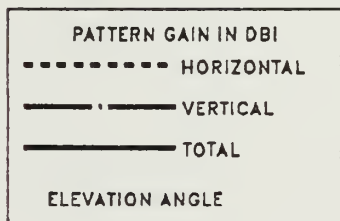
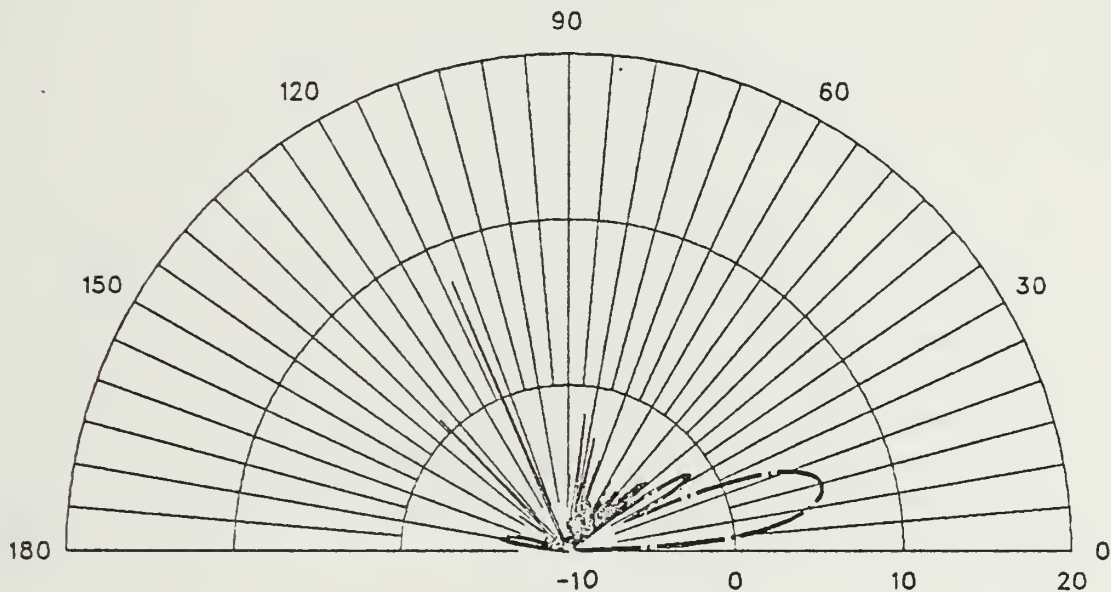

ANTENNA 5A

564 X 6 FT FREQ=17 MHZ PHI=10

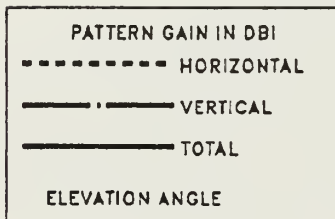
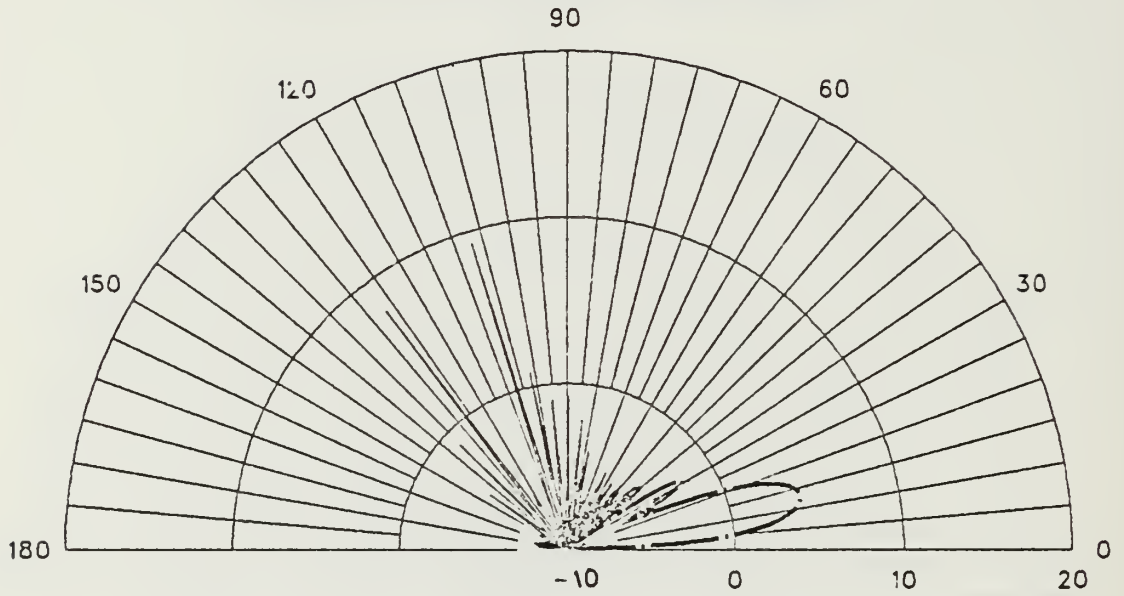

ANTENNA 5A

564 X 6 FT FREQ=17 MHZ PHI=20

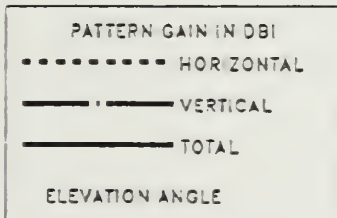
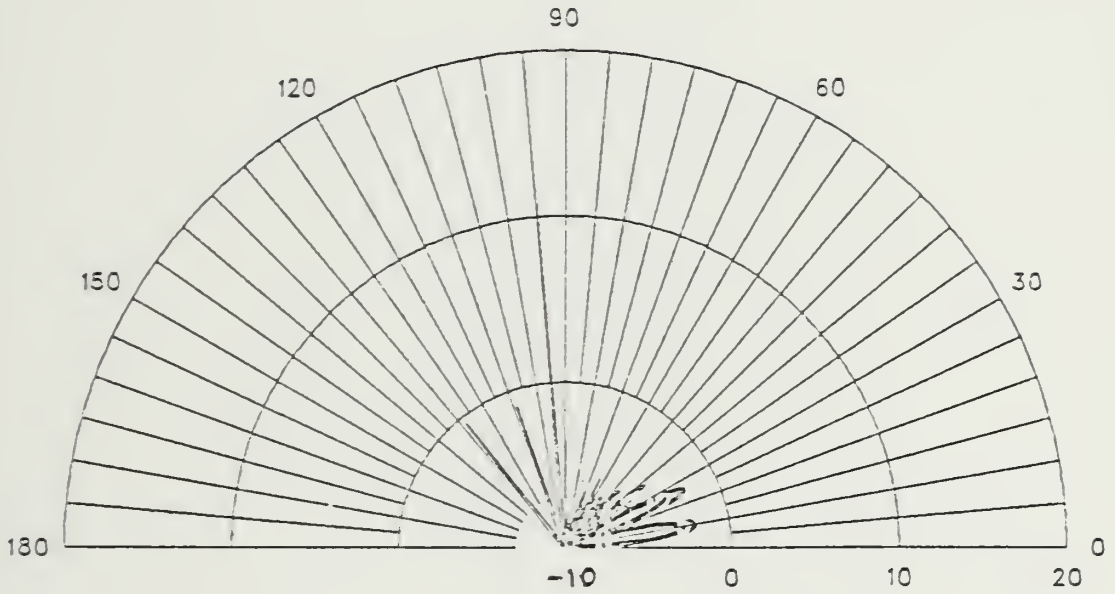

ANTENNA 5A

564 X 6 FT FREQ=17 MHZ PHI=30

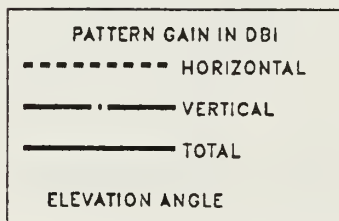
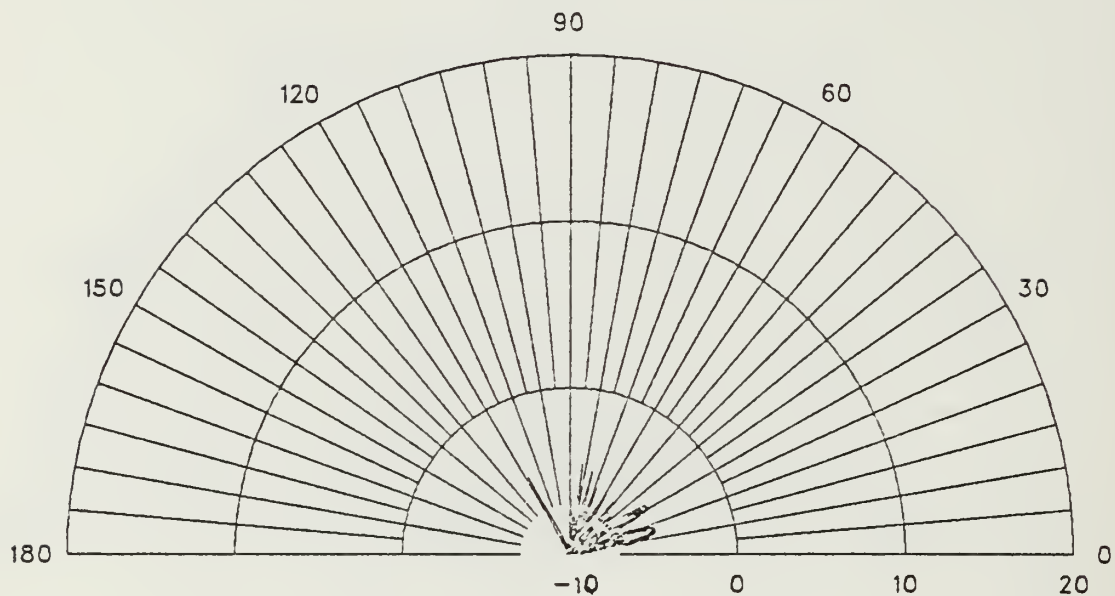

ANTENNA 5A

564 X 6 FT FREQ=17 MHZ PHI=40

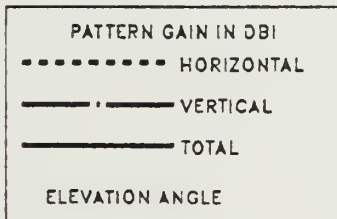
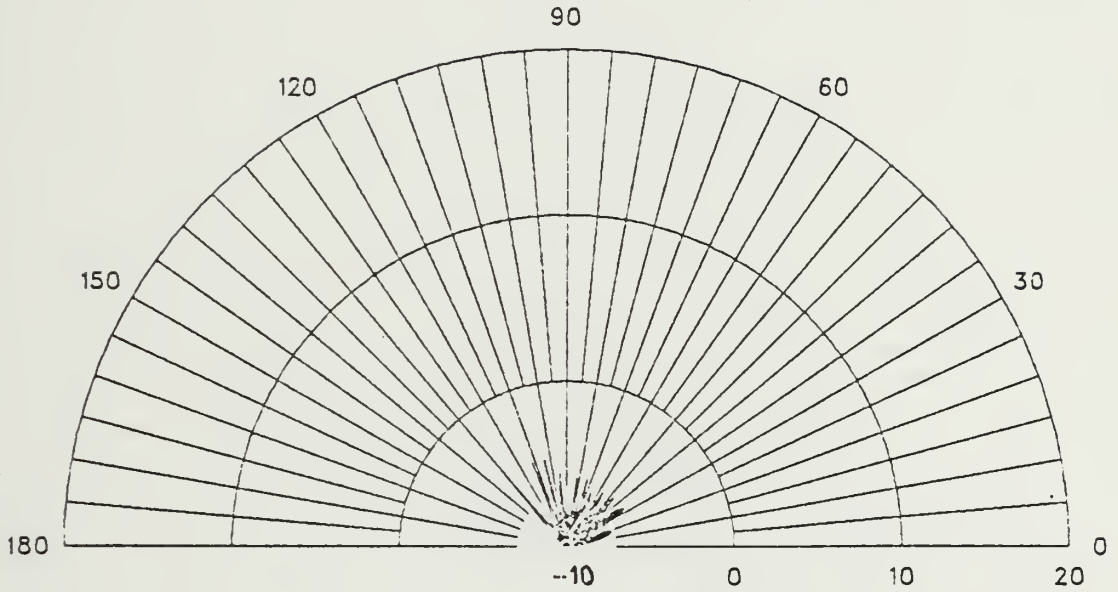

ANTENNA 5A

564 X 6 FT FREQ=17 MHZ THETA=75

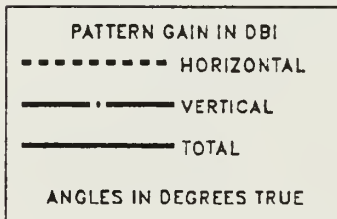
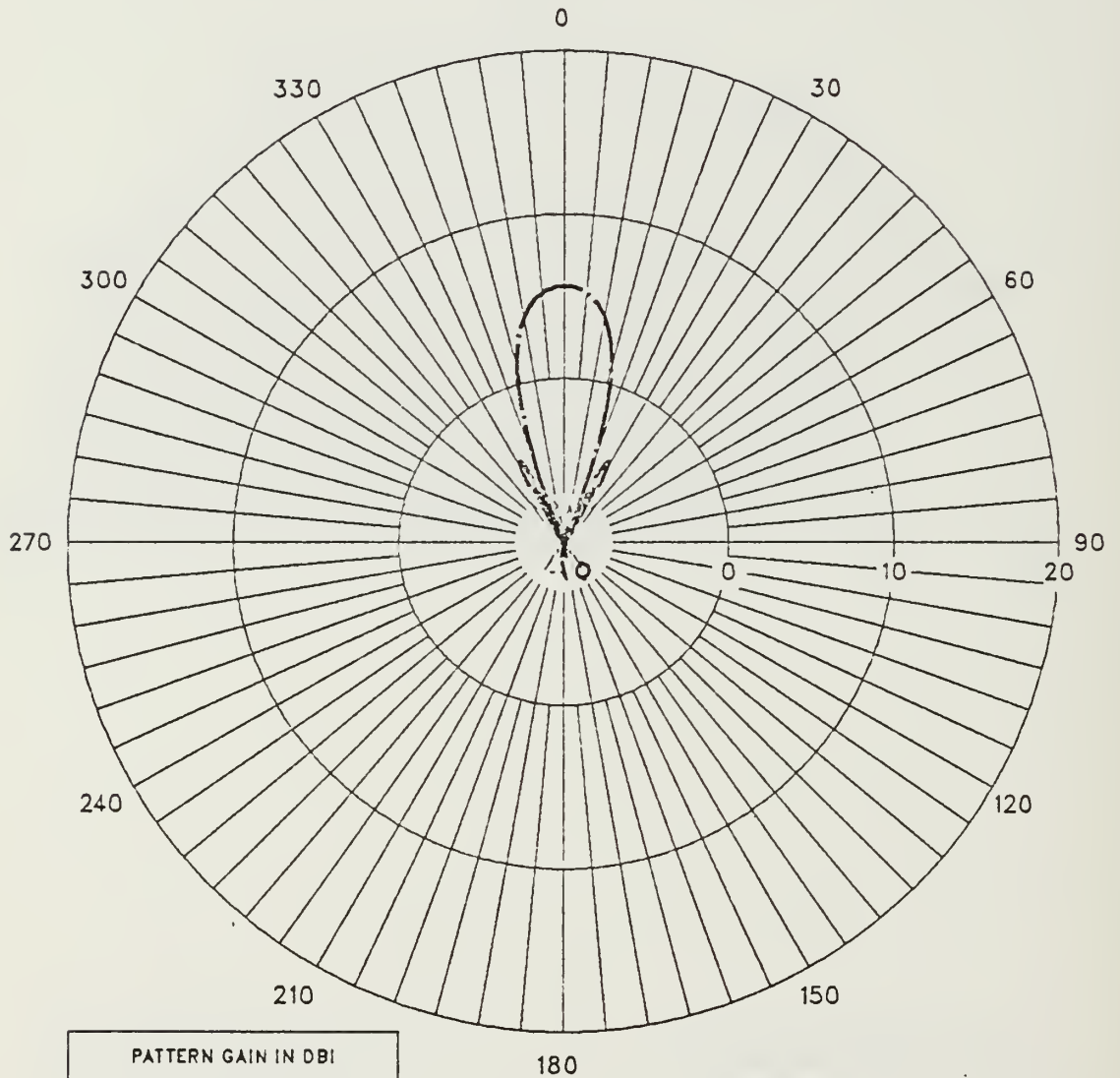

ANTENNA 5A

564 X 6 FT FREQ=30 MHZ PHI=10

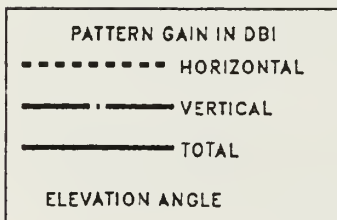
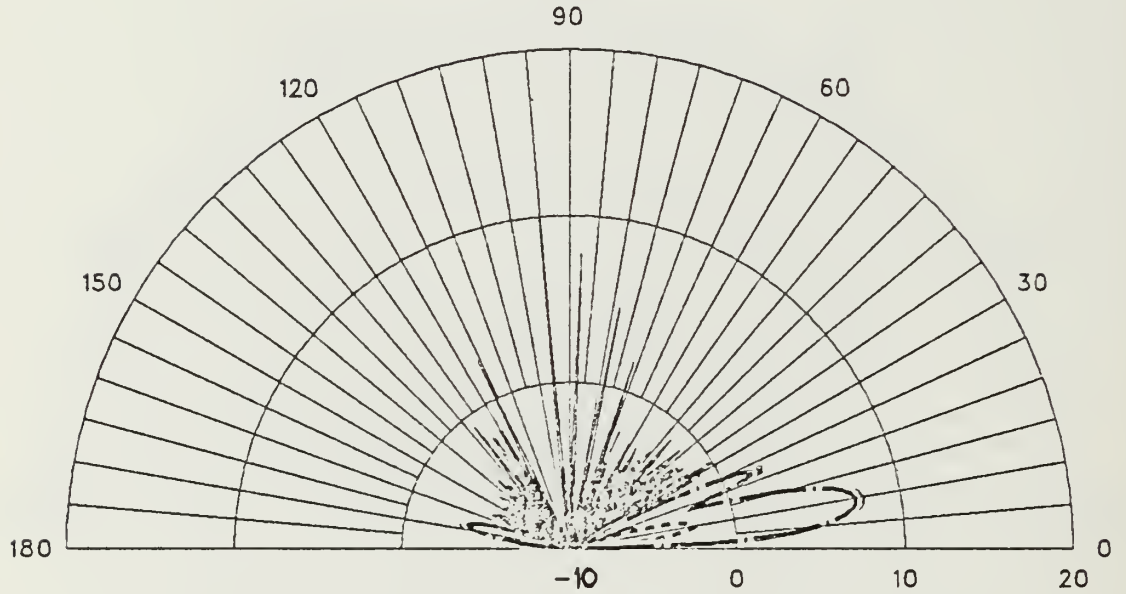

ANTENNA 5A

564 X 6 FT FREQ=30 MHZ PHI=30

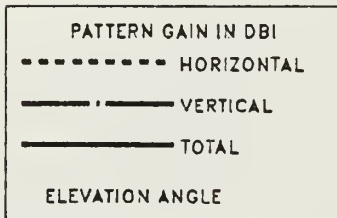
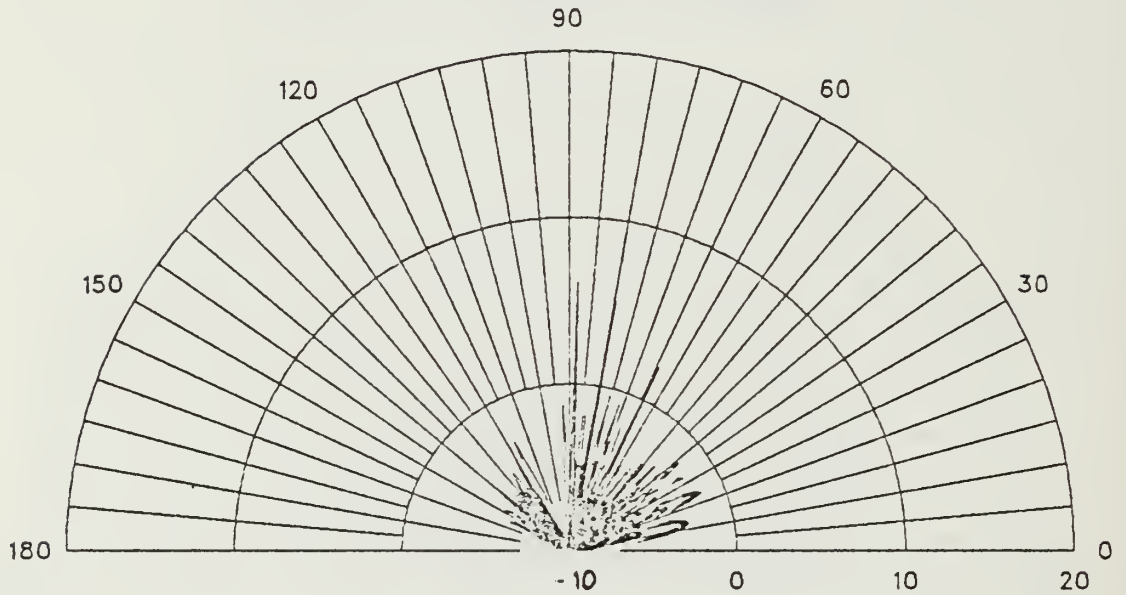

ANTENNA 5A

564 X 6 FT FREQ=30 MHZ PHI=40

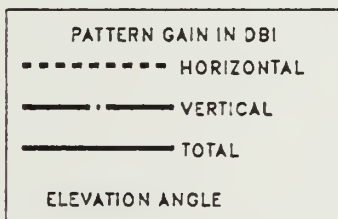
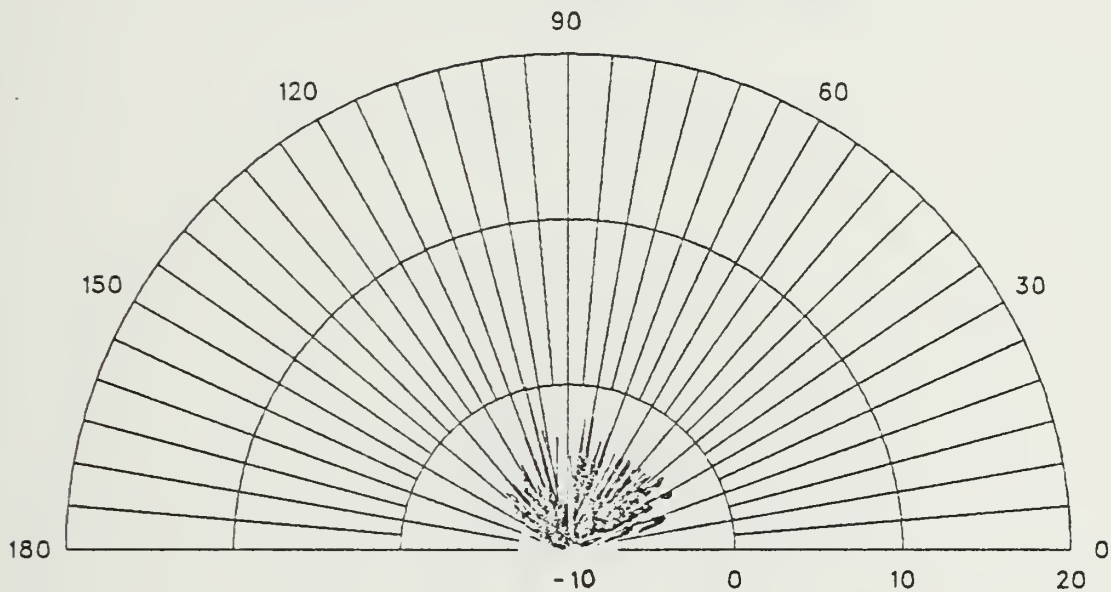

ANTENNA 5A

564 X 6 FT FREQ=30 MHZ THETA=80

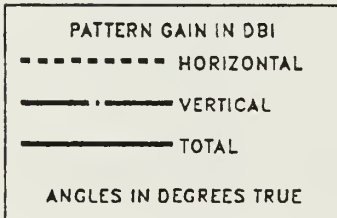
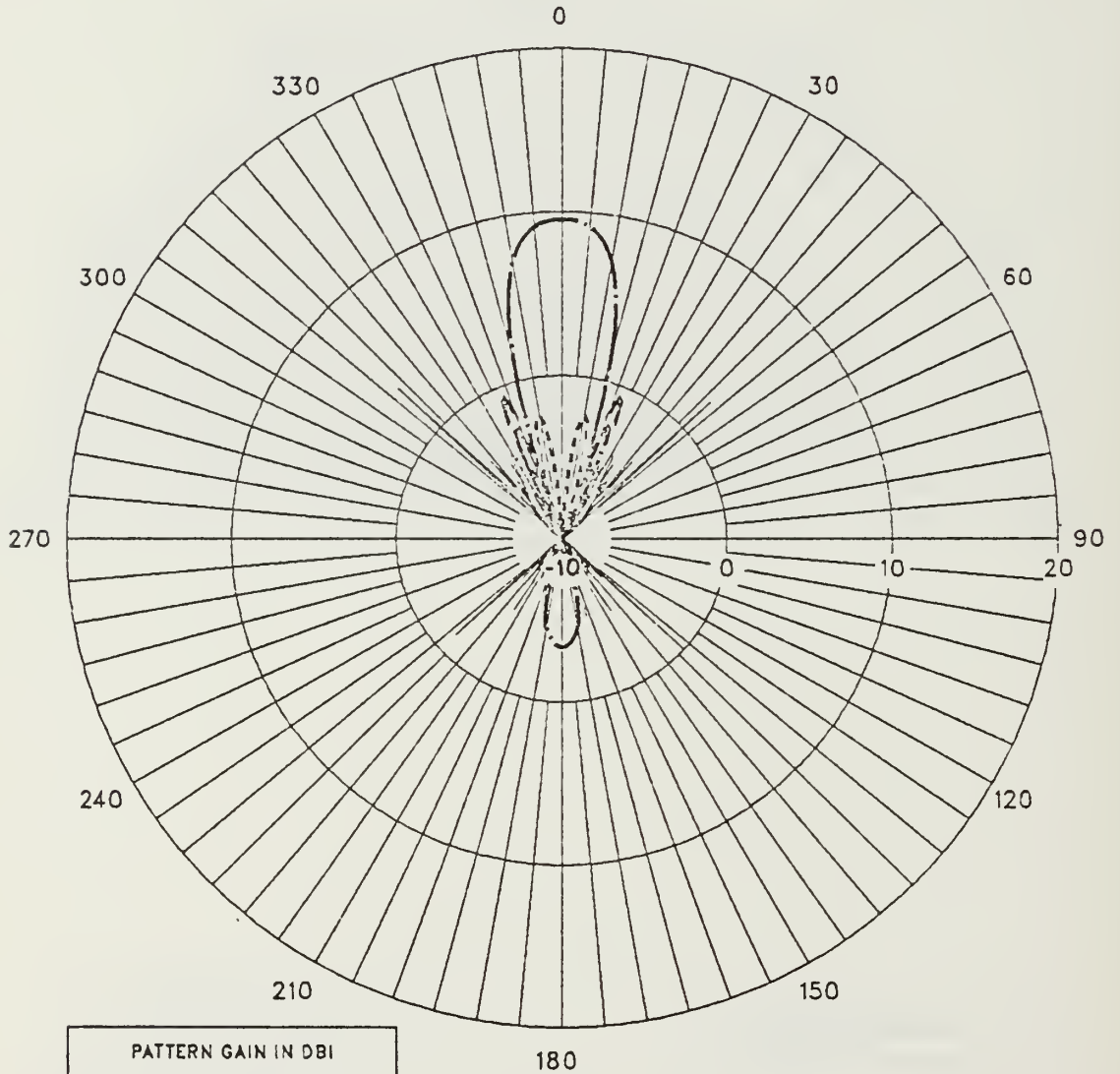

ANTENNA 5B

564 X 15 FT FREQ=17 MHZ PHI=0

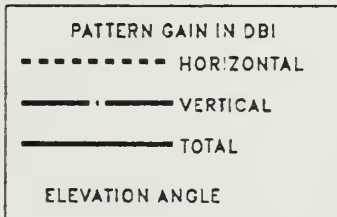
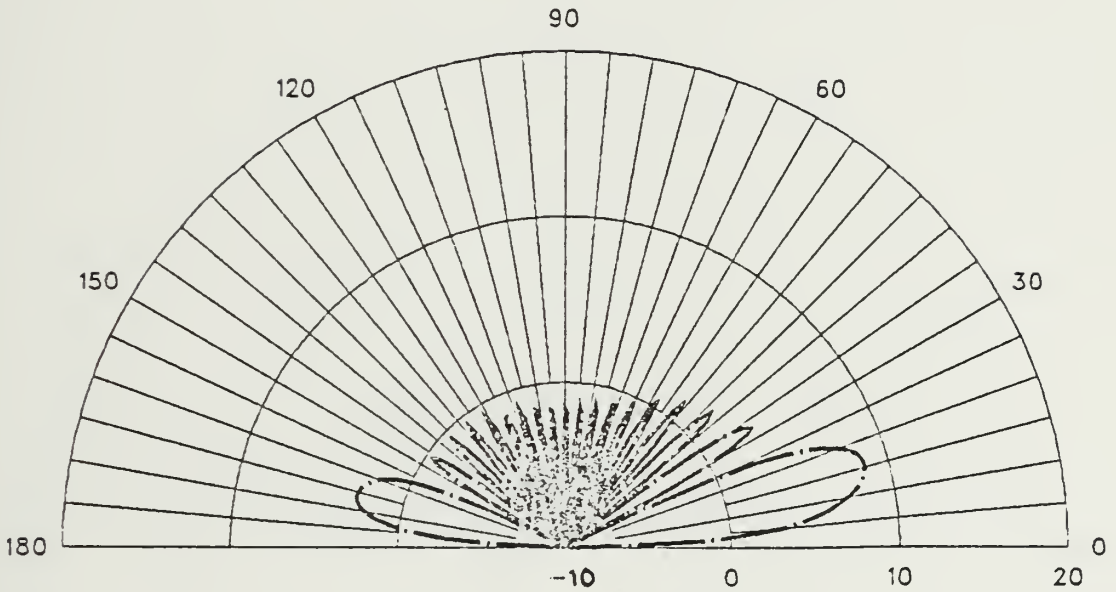

ANTENNA 5B

564 X 15 FT FREQ=17 MHZ PHI=10

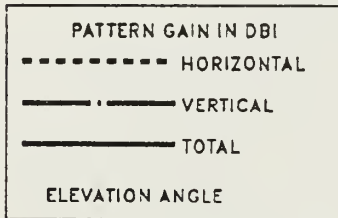
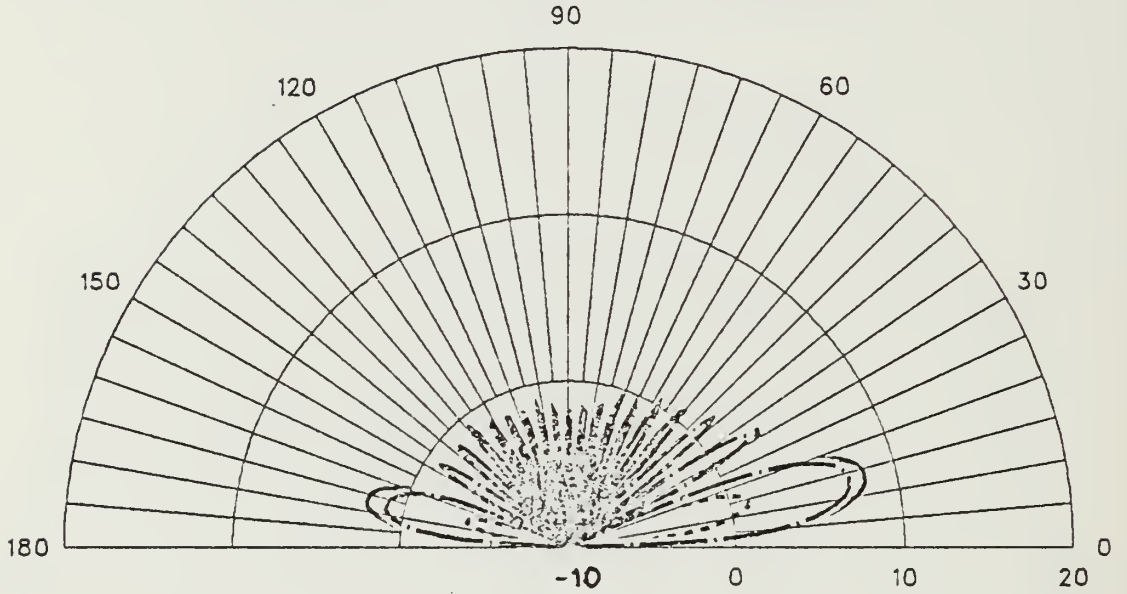

ANTENNA 5B

564 X 15 FT FREQ=17 MHZ PHI=20

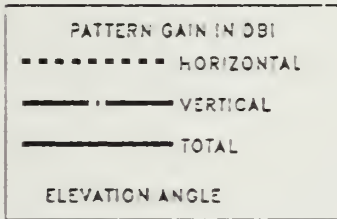
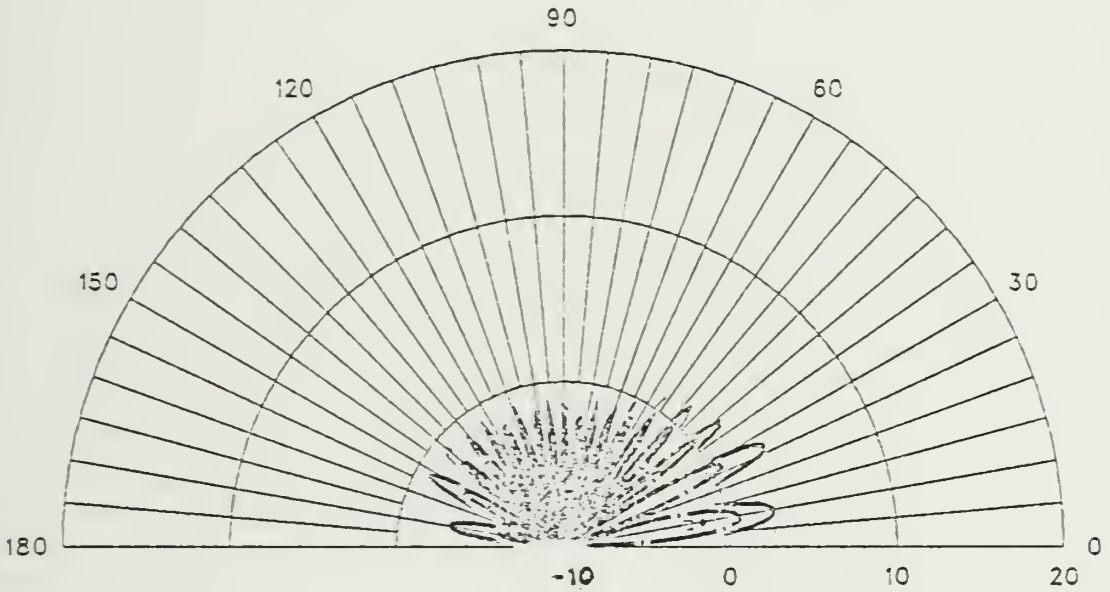

ANTENNA 5B

564 X 15 FT FREQ=17 MHZ PHI=30

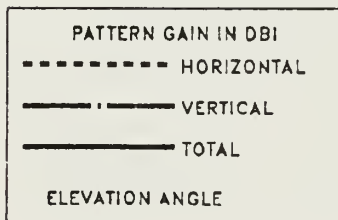
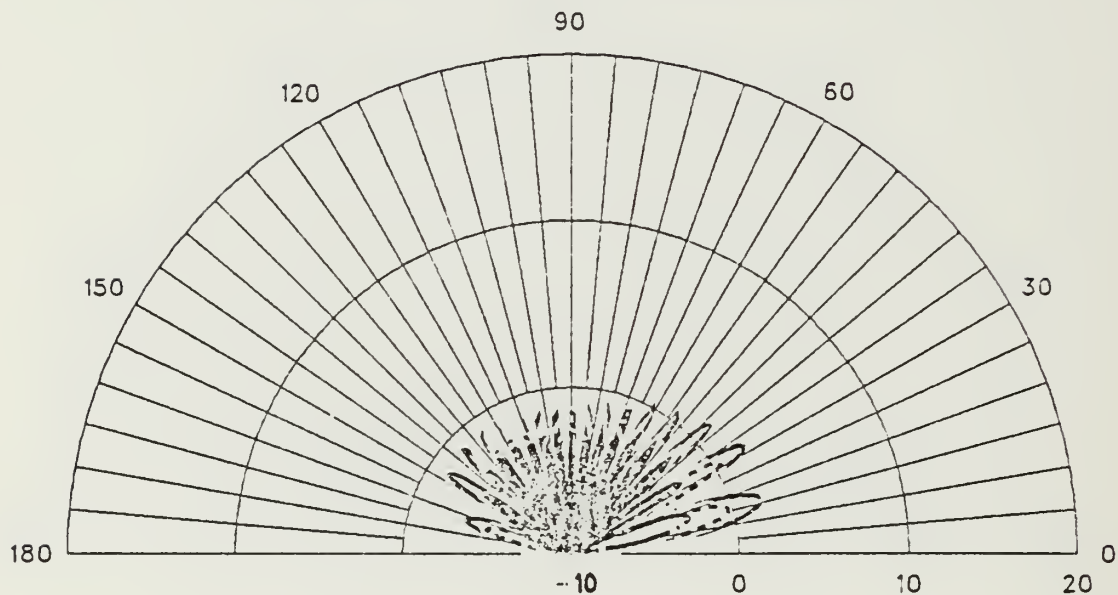

ANTENNA 5B

564 X 15 FT FREQ=17 MHZ PHI=40

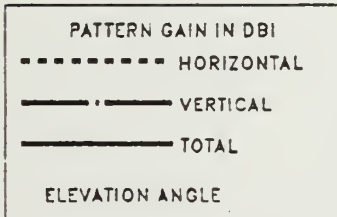
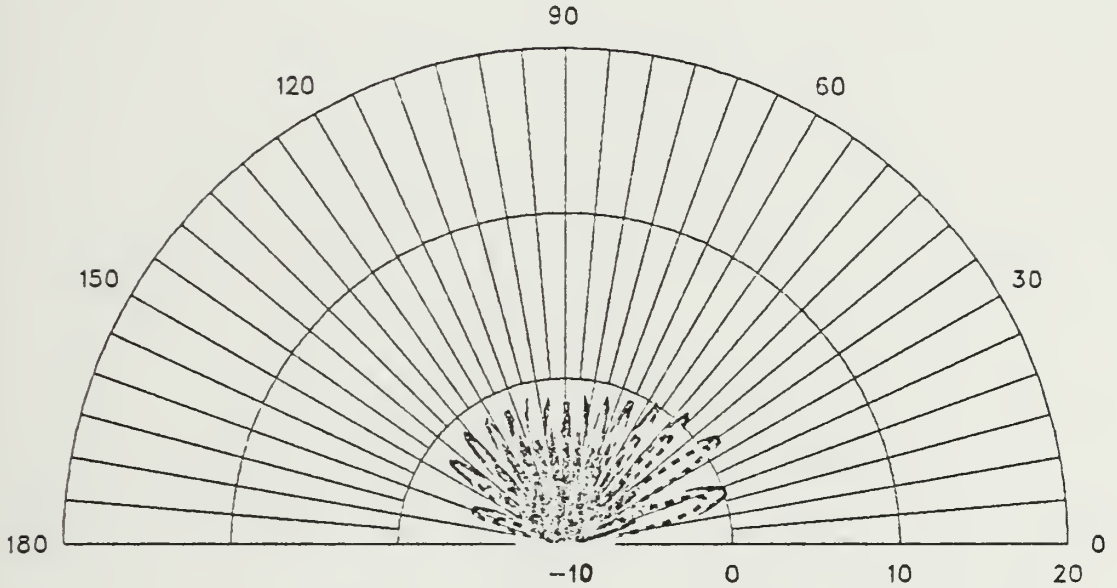

ANTENNA 5B

564 X 15 FT FREQ=17 MHZ THETA=75

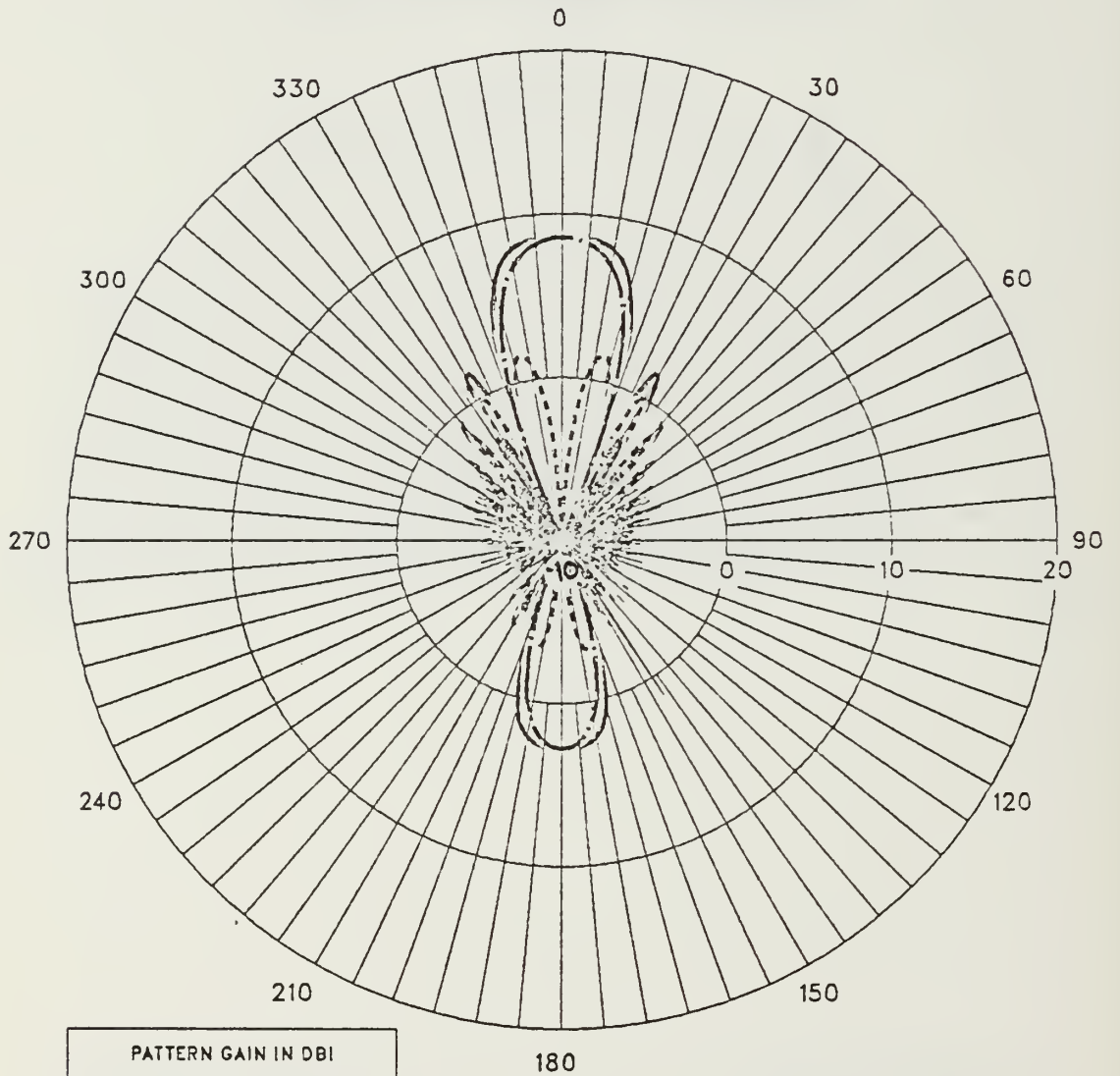

PATTERN GAIN IN DBI
- - - - - HORIZONTAL
- · - - - VERTICAL
- - - - - TOTAL
ANGLES IN DEGREES TRUE

ANTENNA 5B

564 X 15 FT FREQ=30 MHZ PHI=0

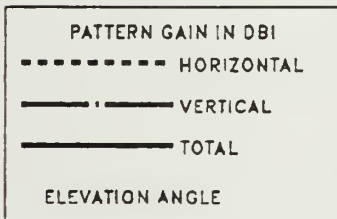
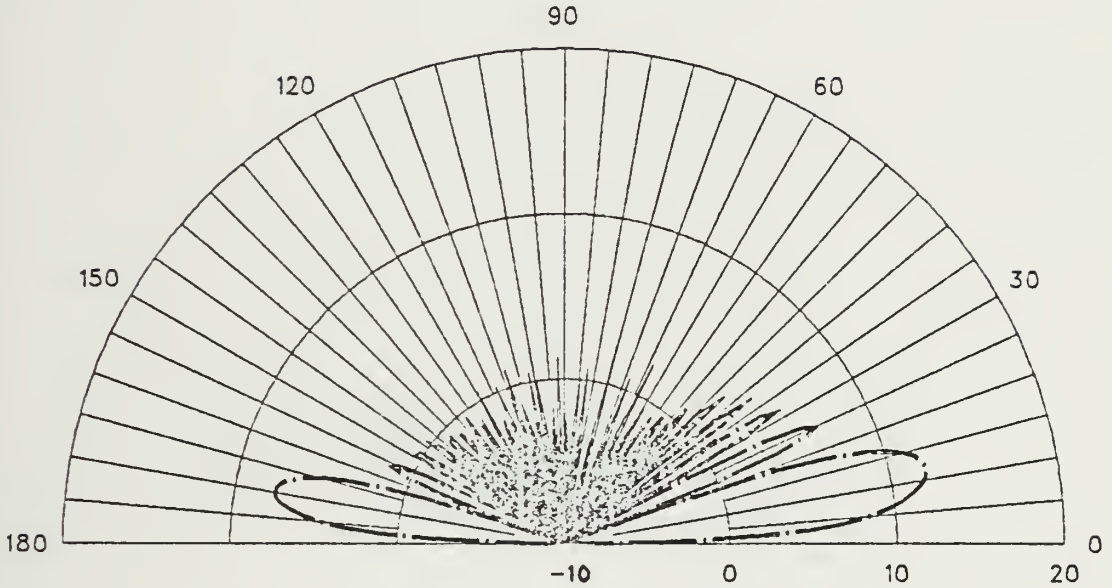

ANTENNA 5B

564 X 15 FT FREQ=30 MHZ PHI=10

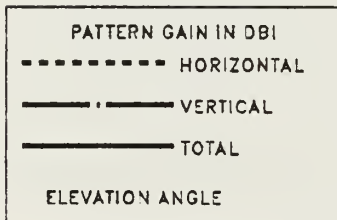
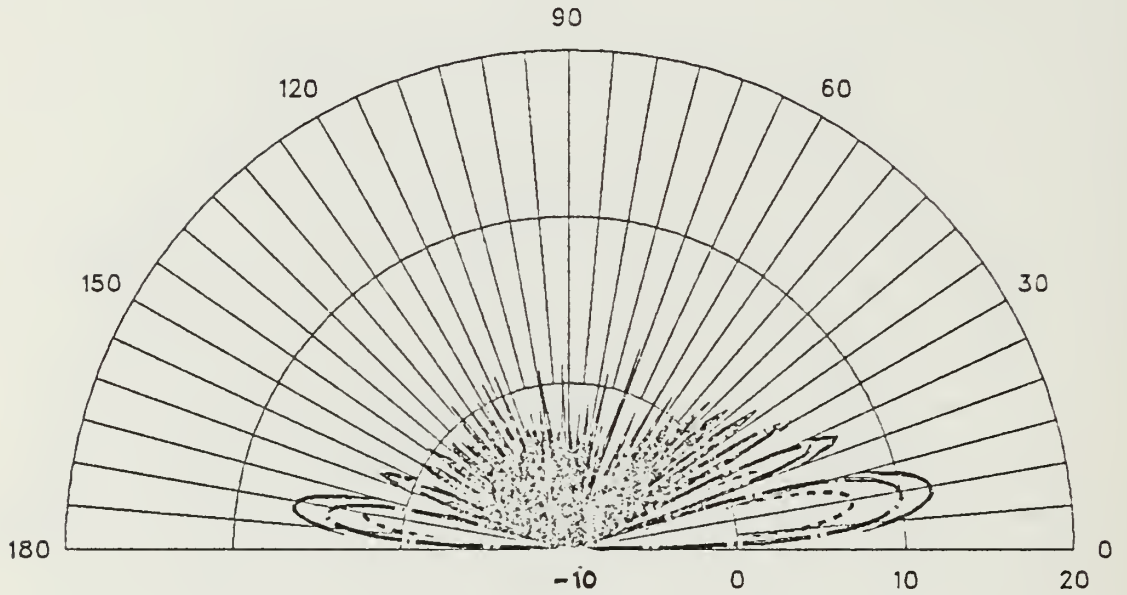

ANTENNA 5B

564 X 15 FT FREQ=30 MHZ PHI=20

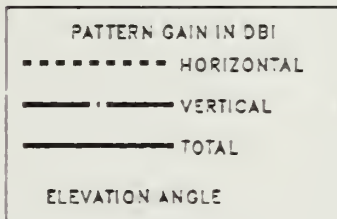
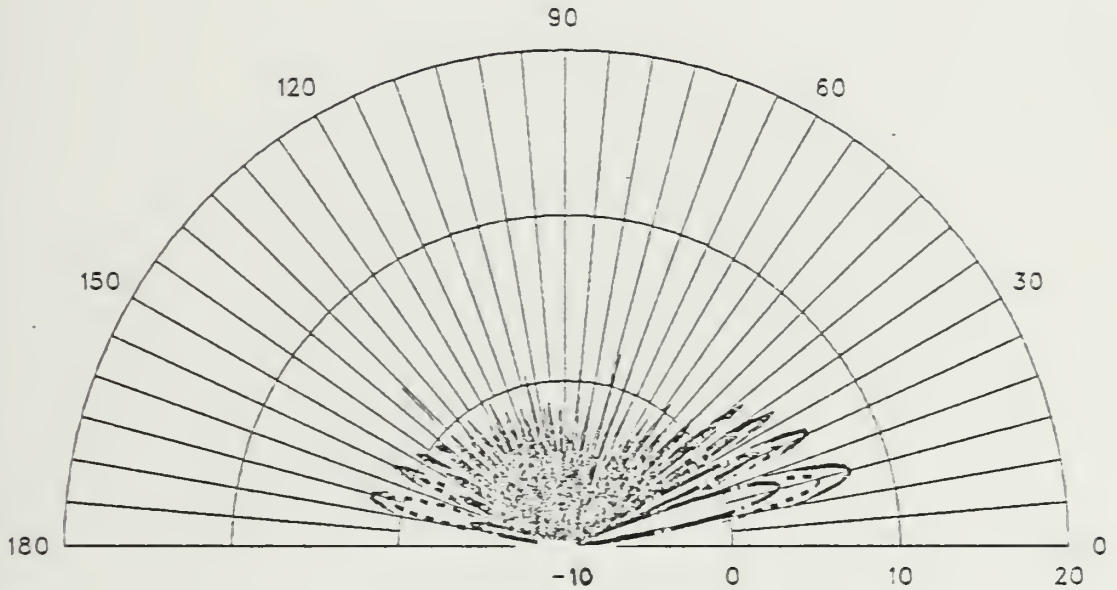

ANTENNA 5B

564 X 15 FT FREQ=30 MHZ PHI=30

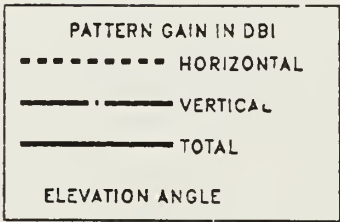
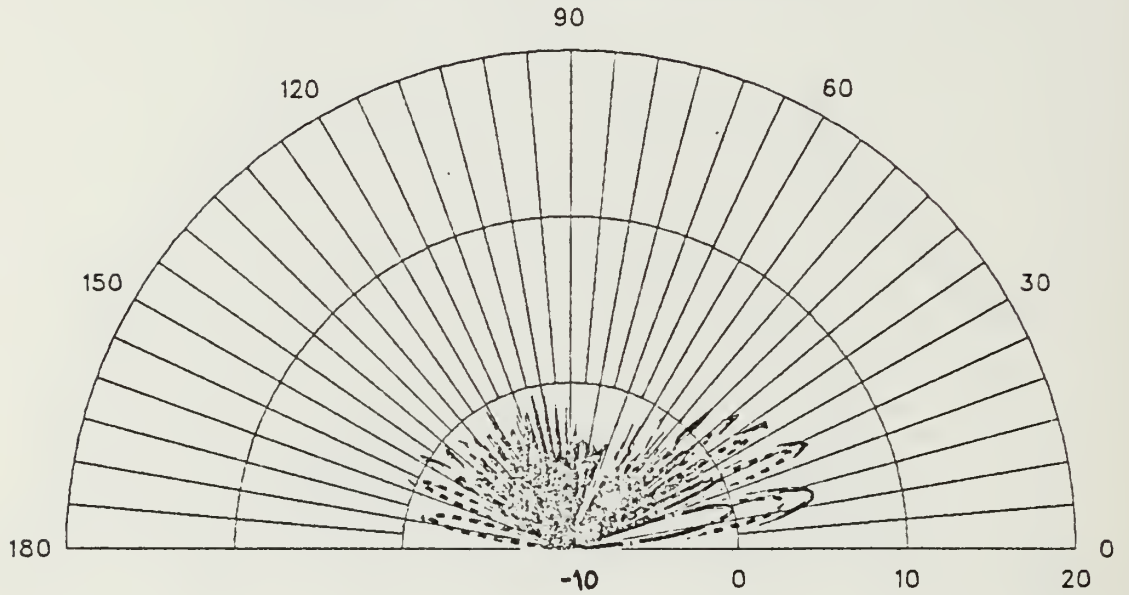

ANTENNA 5B

564 X 15 FT FREQ=30 MHZ PHI=40

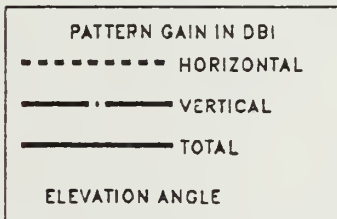
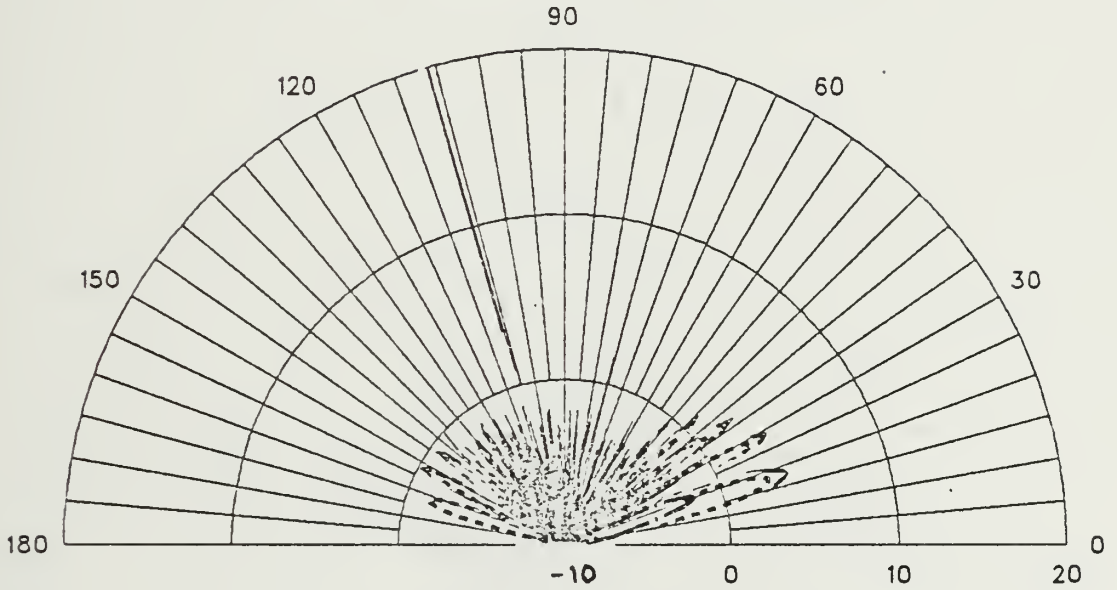

ANTENNA 5B

564 X 15 FT FREQ=30 MHZ THETA=80

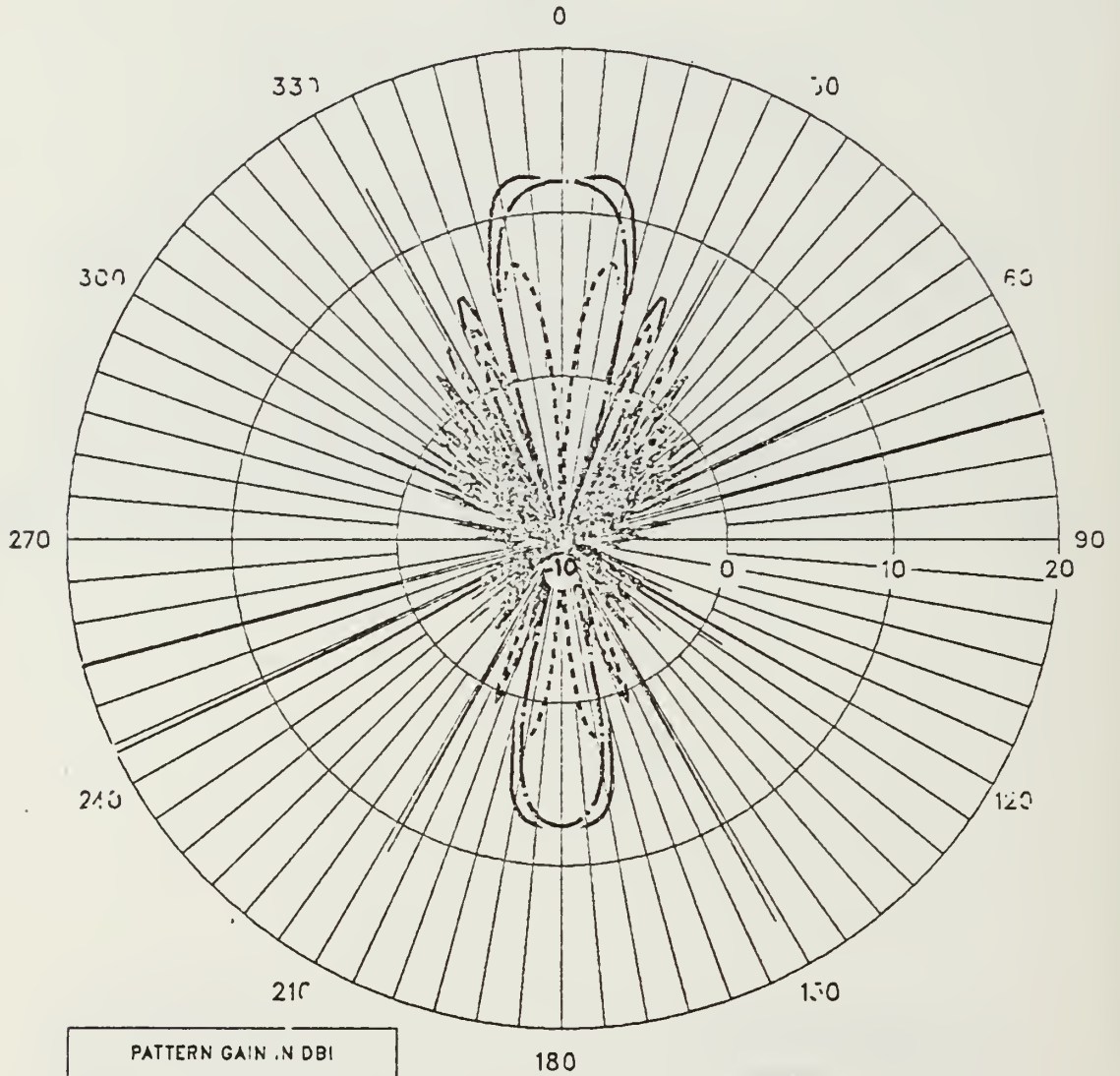

PATTERN GAIN IN DBI
----- HORIZONTAL
———— VERTICAL
- · - · - TOTAL
ANGLES IN DEGREES TRUE

ANTENNA 5C

564 X 20 FT FREQ=17 MHZ PHI=0

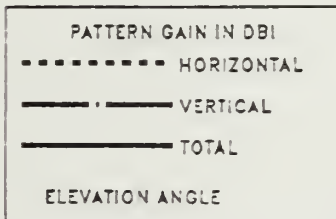
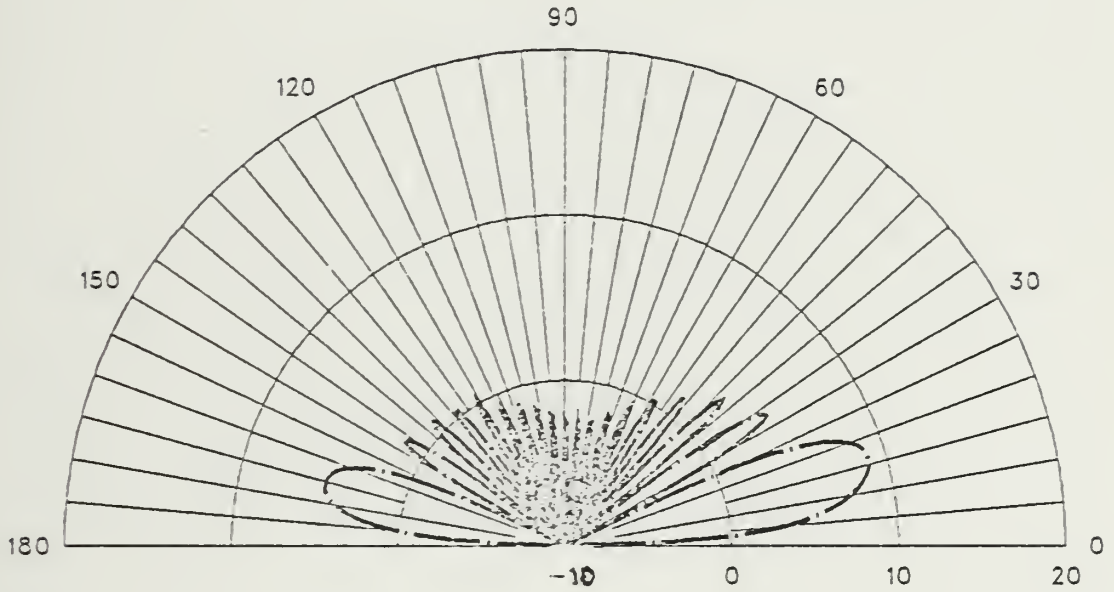

ANTENNA 5C

564 X 20 FT FREQ=17 MHZ PHI=10

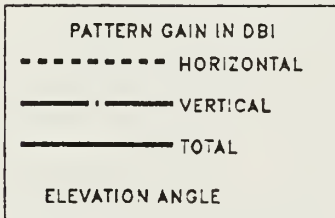
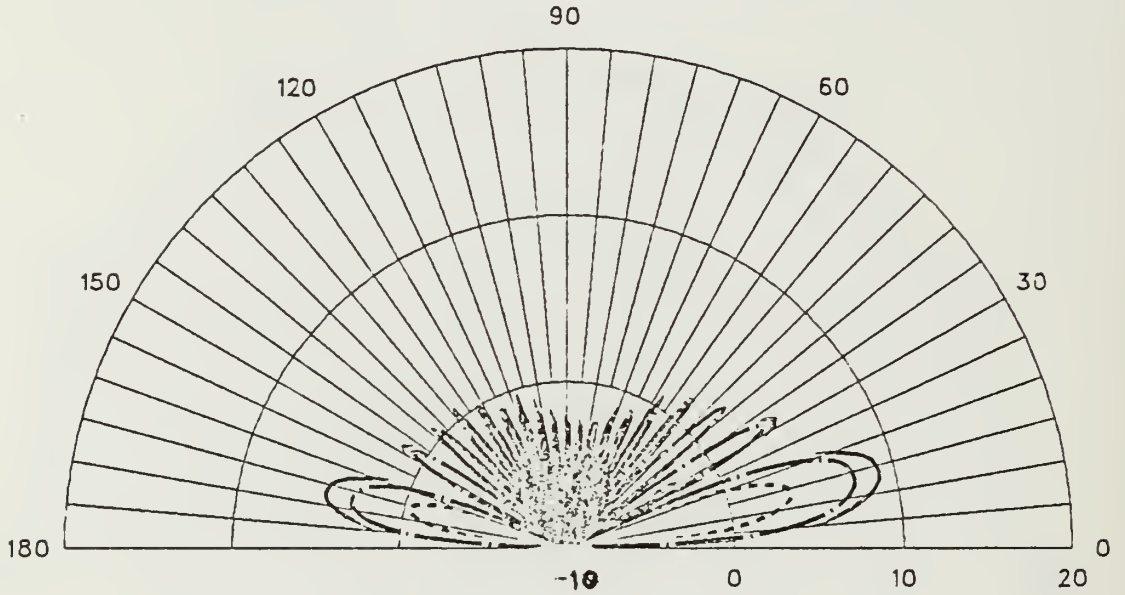

ANTENNA 5C

564 X 20 FT FREQ=17 MHZ PHI=30

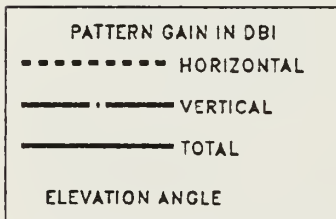
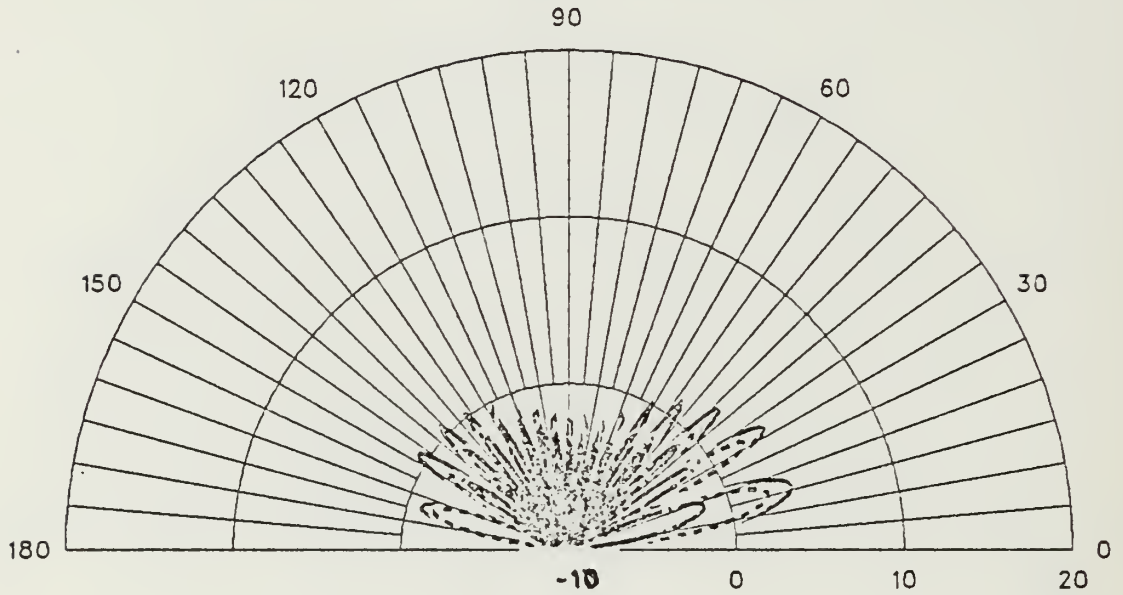

ANTENNA 5C

564 X 20 FT FREQ=17 MHZ PHI=40

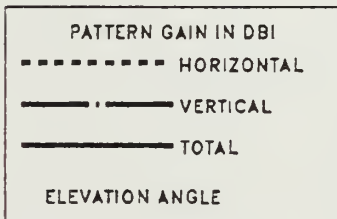
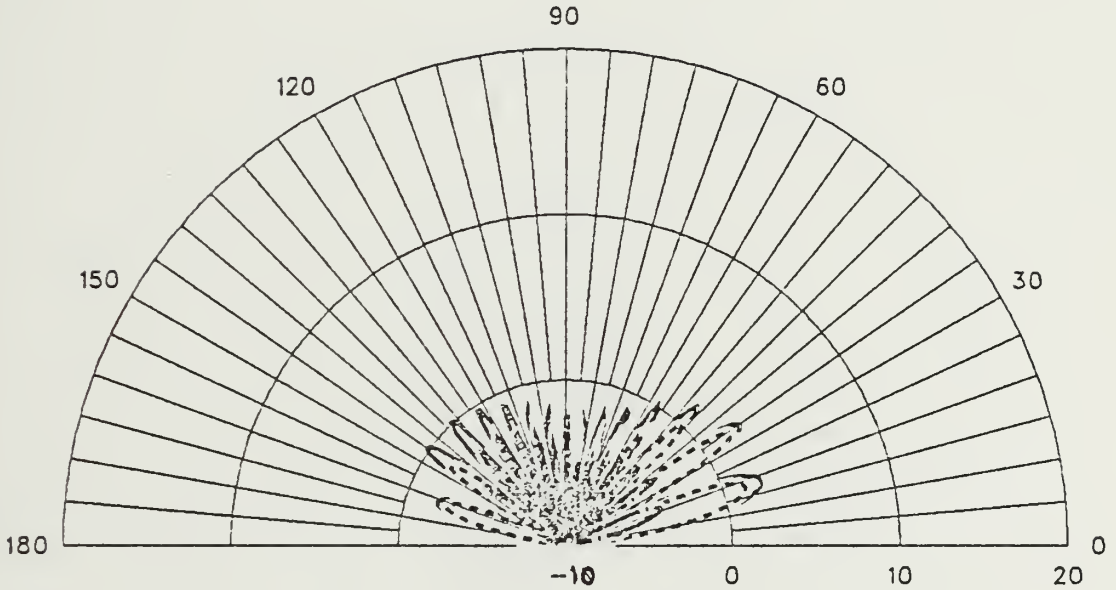

ANTENNA 5C

564 X 20 FT FREQ=17 MHZ THETA=75

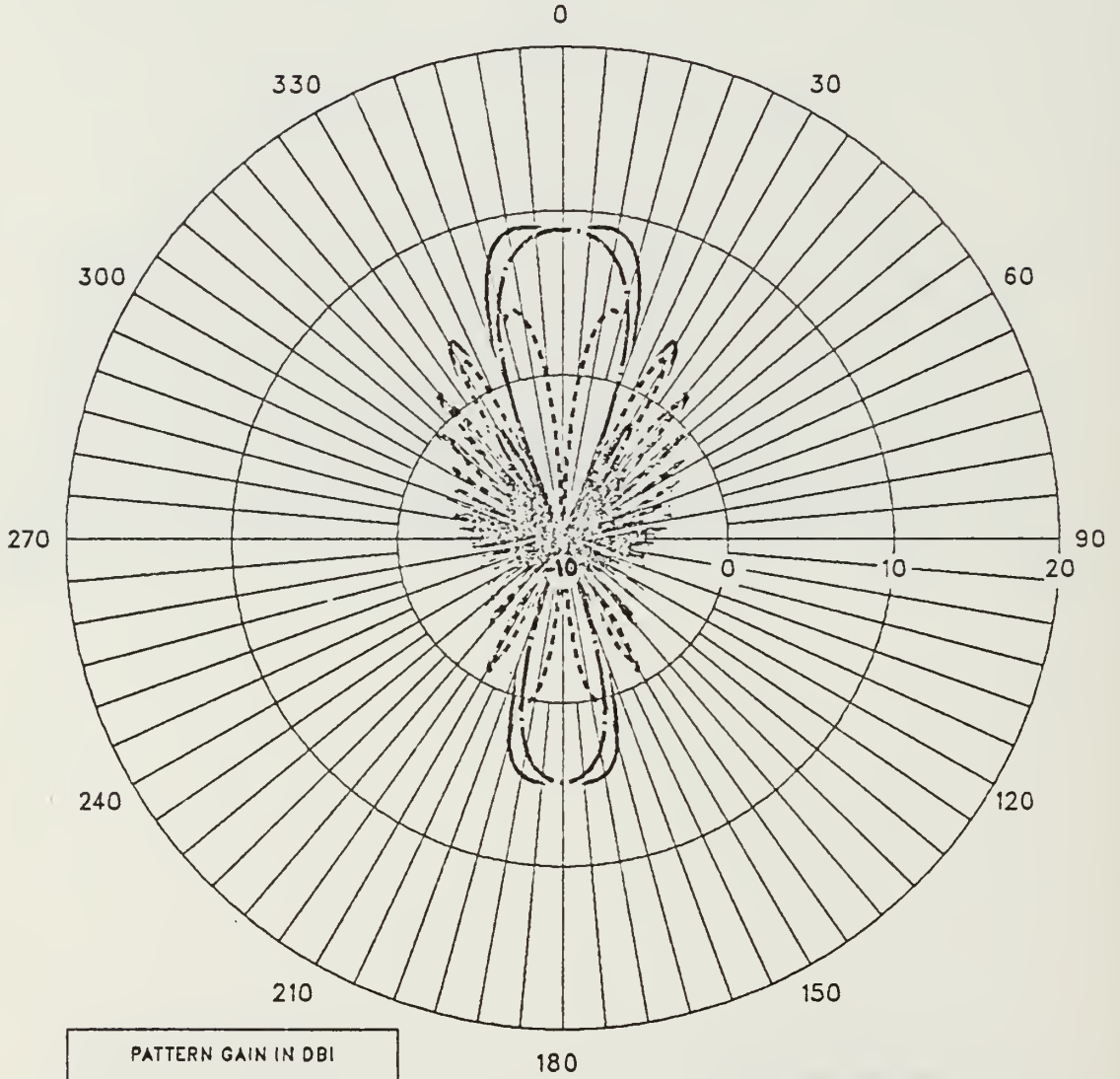

PATTERN GAIN IN DBI
- - - - - HORIZONTAL
- · - - - VERTICAL
- - - - - TOTAL
ANGLES IN DEGREES TRUE

ANTENNA 5C

564 X 20 FT FREQ=30 MHZ PHI=0

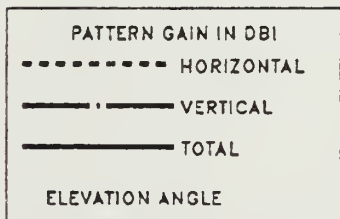
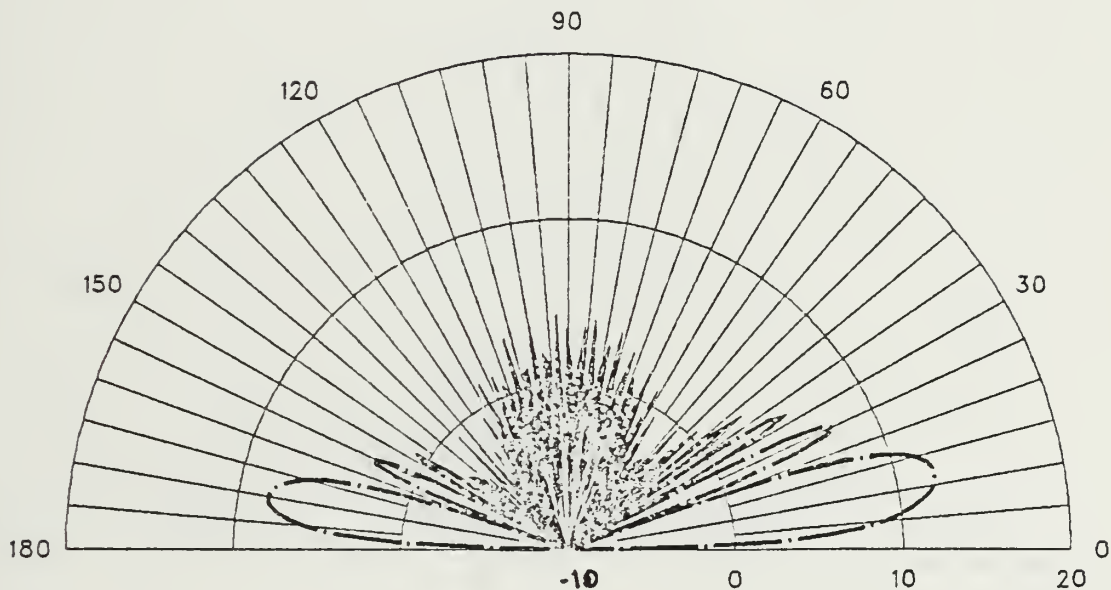

ANTENNA 5C

564 X 20 FT FREQ=30 MHZ PHI=10

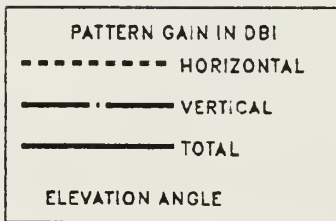
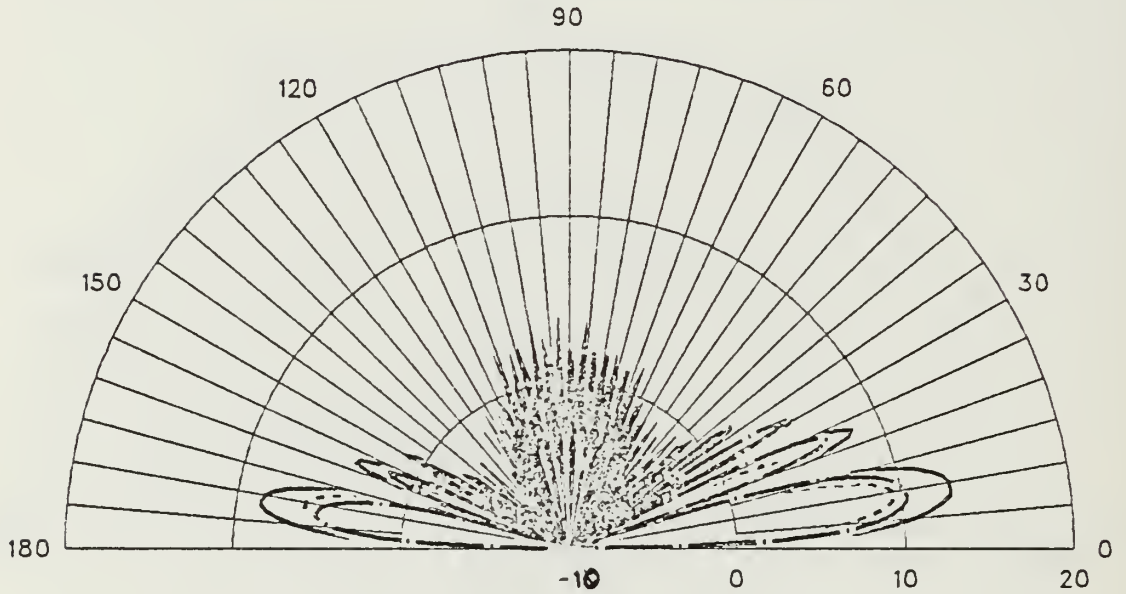

ANTENNA 5C

564 X 20 FT FREQ=30 MHZ PHI=20

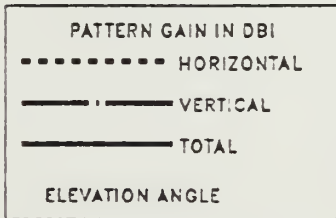
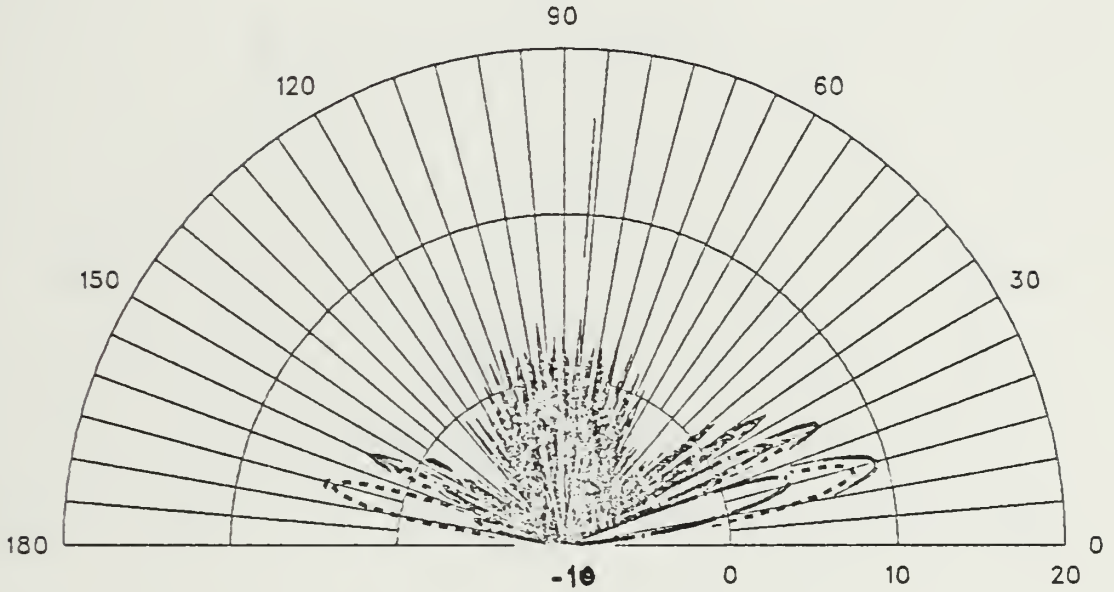

ANTENNA 5C

564 X 20 FT FREQ=30 MHZ PHI=30

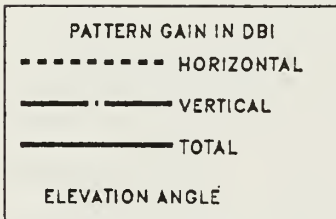
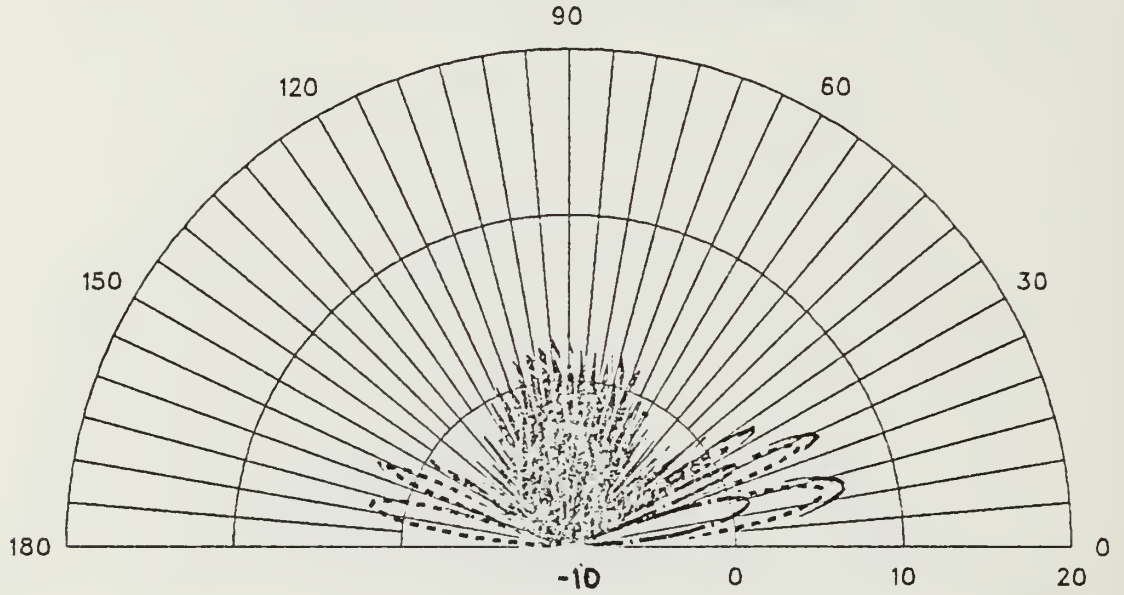

ANTENNA 5C

564 X 20 FT FREQ=30 MHZ PHI=40

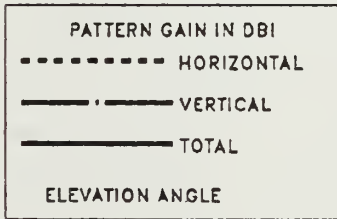
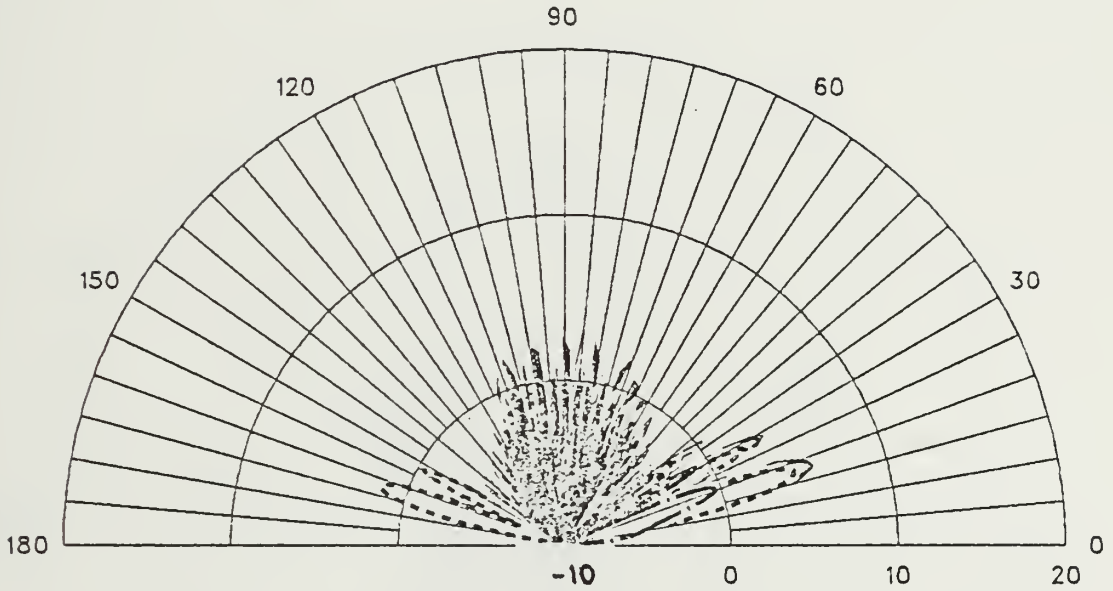

ANTENNA 5C

564 X 20 FT FREQ=30 MHZ THETA=80

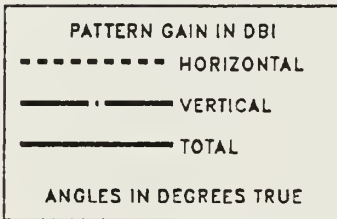
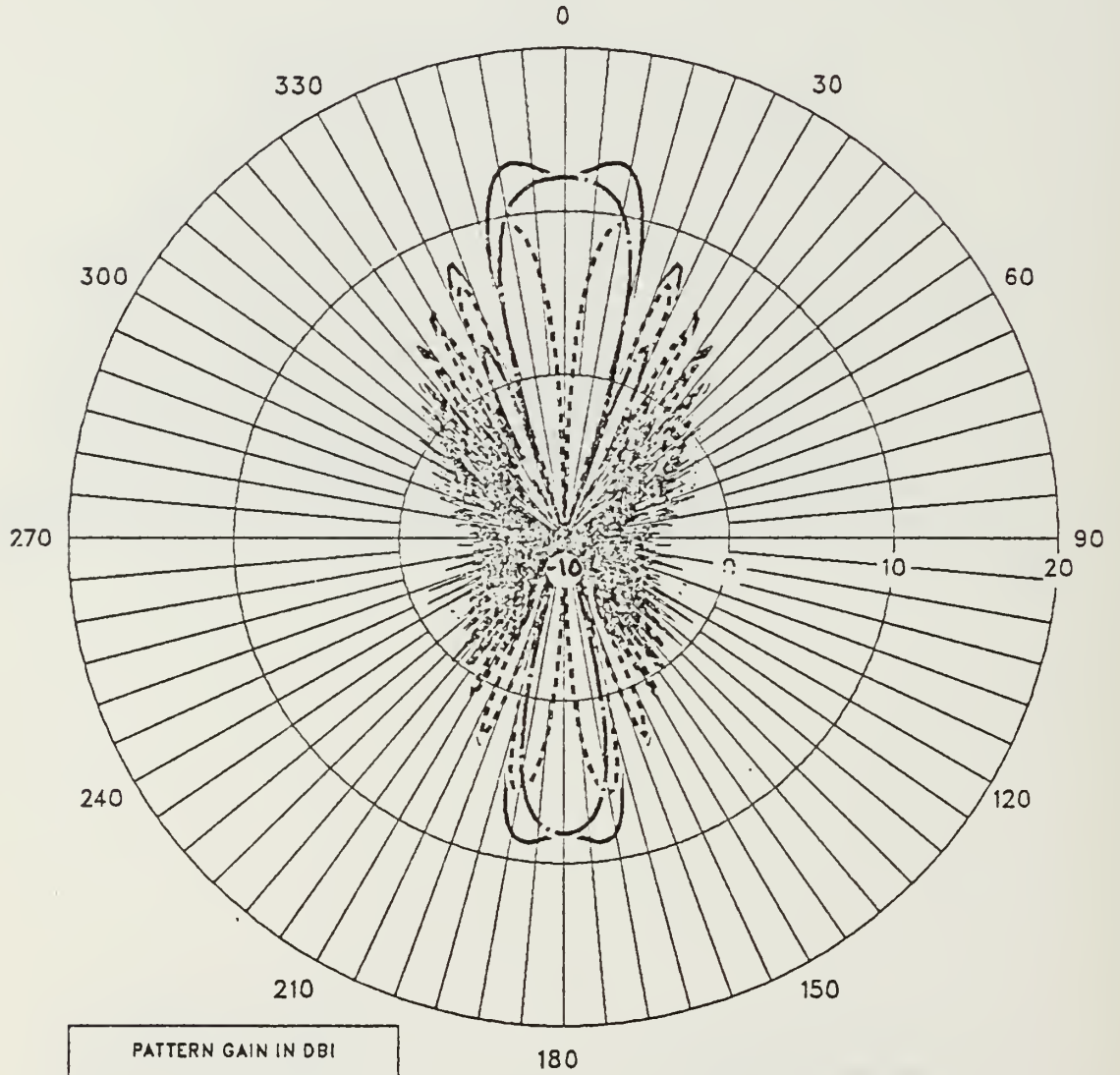

APPENDIX H RADIATION PATTERNS USING THE HMMWV

HMMWV DRIVEN 190 X 6 FT ANTENNA

FREQ=17 MHZ PHI=10 UNTERMINATED

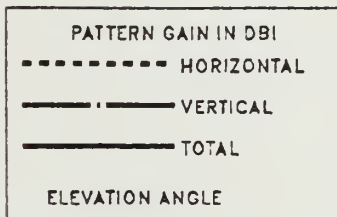
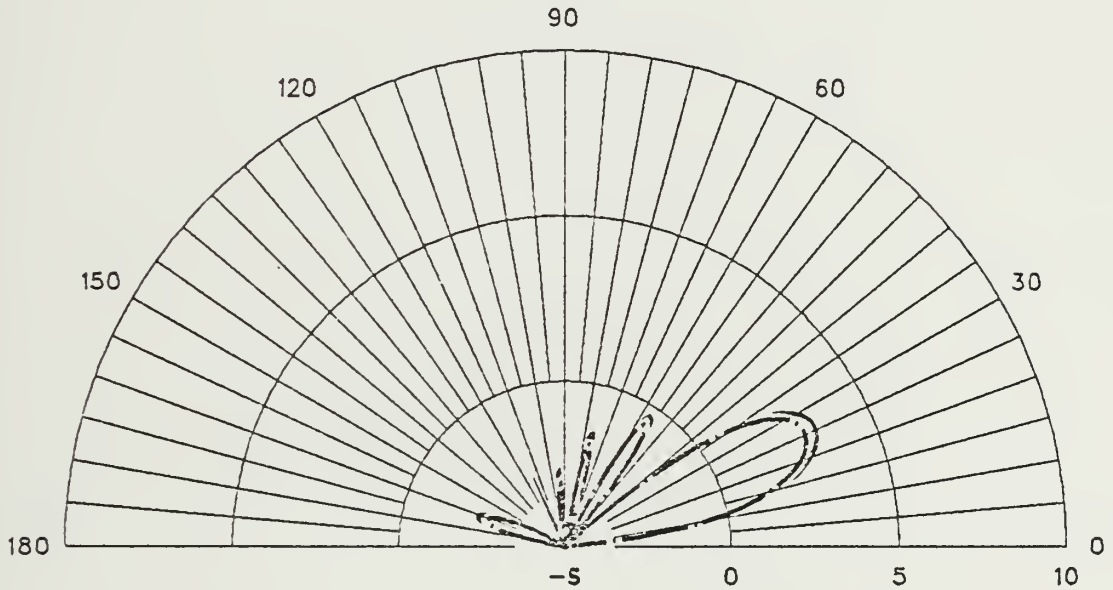

HMMWV DRIVEN 190 X 6 FT ANTENNA

FREQ=17 MHZ PHI=20 UNTERMINATED

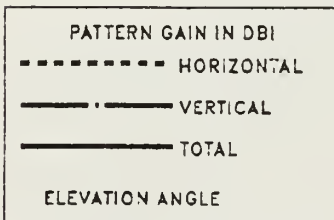
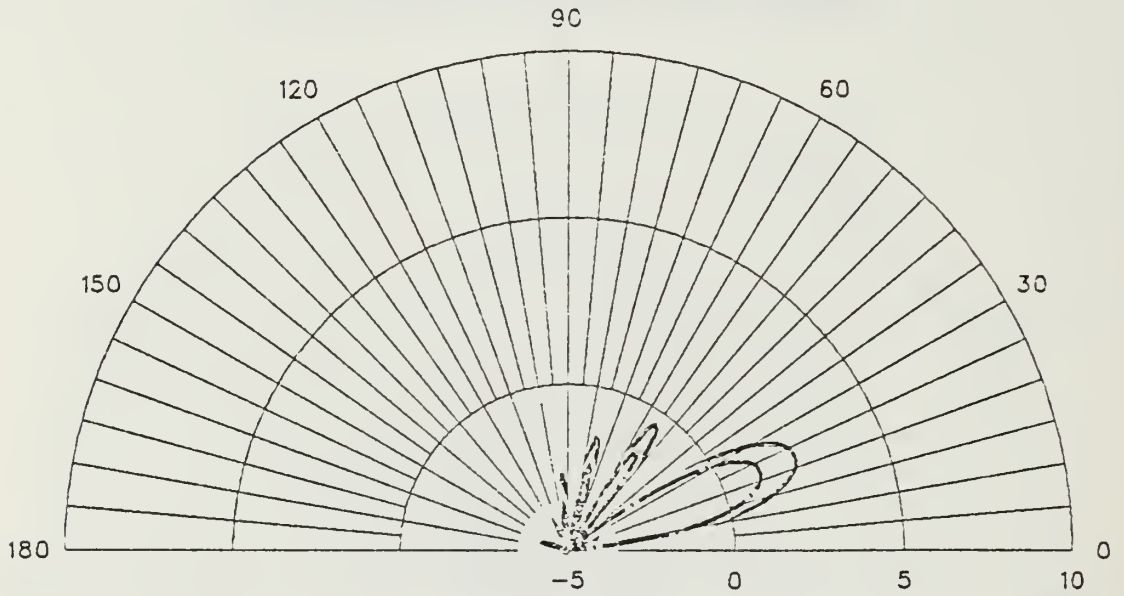

HMMWV DRIVEN 190 X 6 FT ANTENNA

FREQ=17 MHZ PHI=30 UNTERMINATED

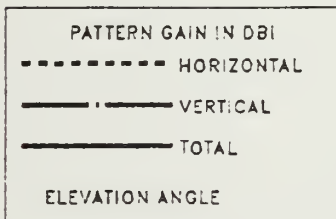
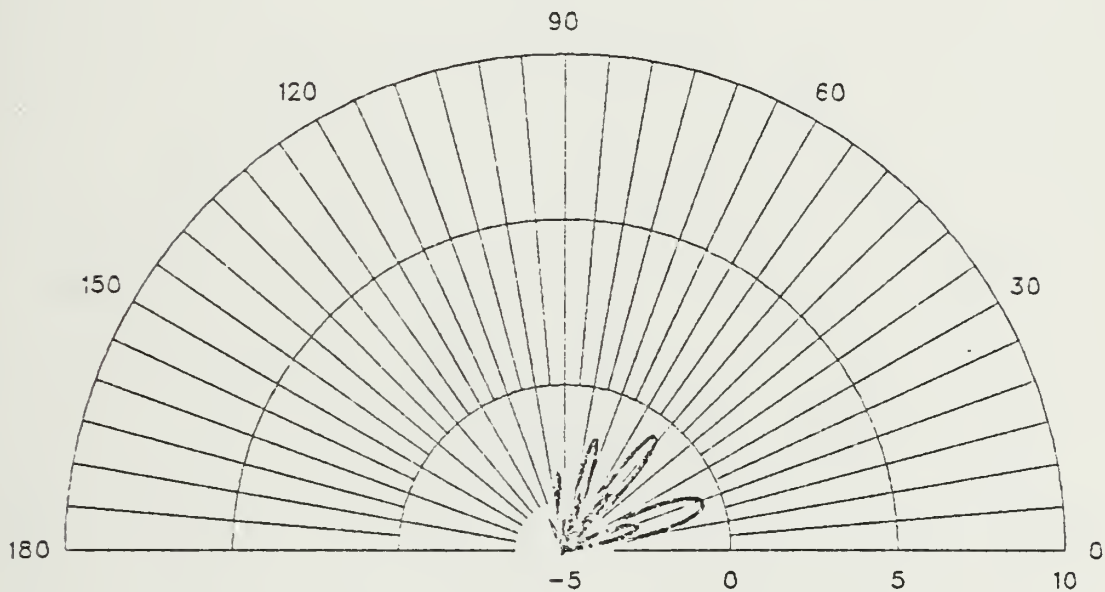

HMMWV DRIVEN 190 X 6 FT ANTENNA

FREQ=17 MHZ THETA=70 UNTERMINATED

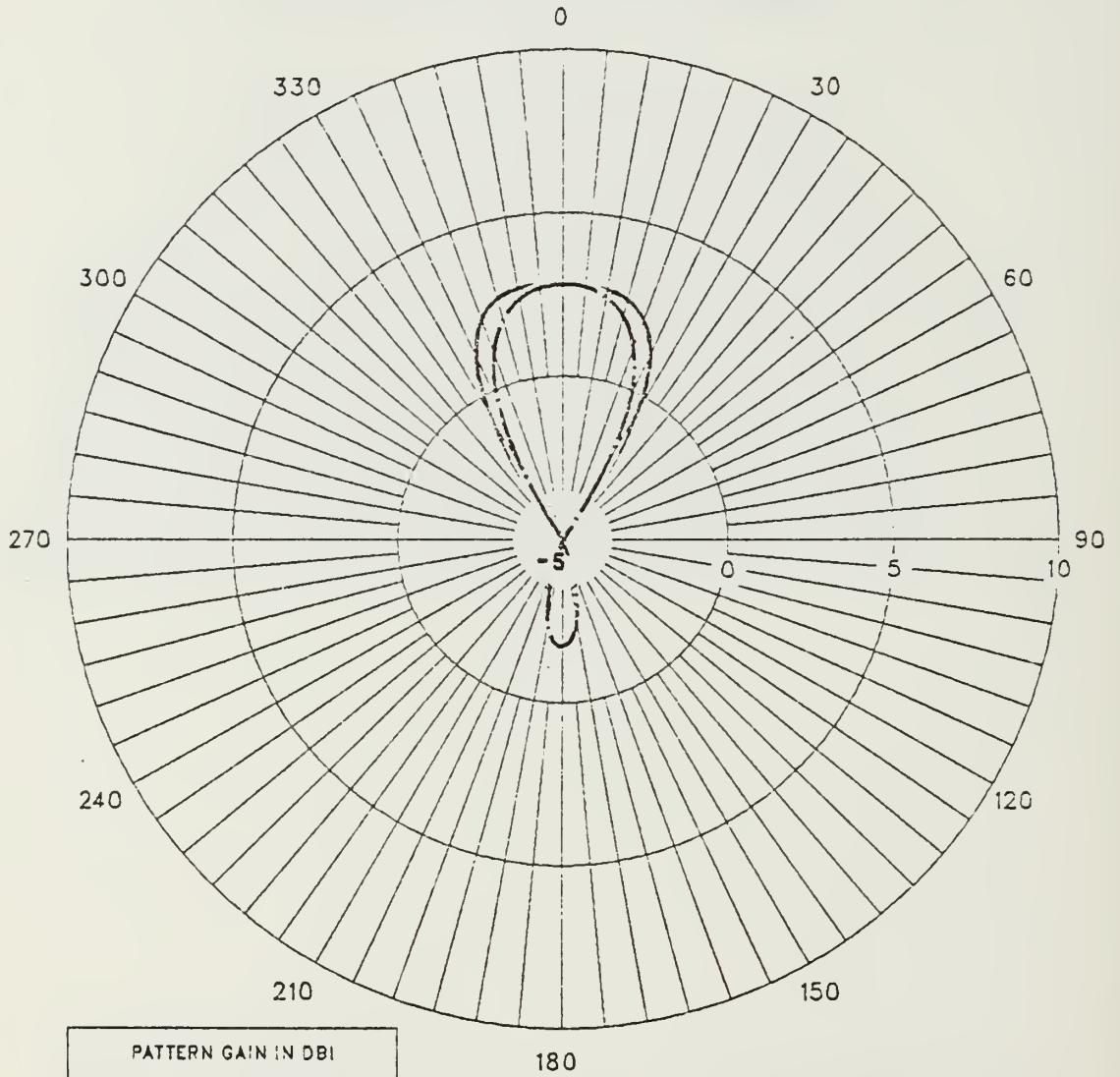

PATTERN GAIN IN DBI
----- HORIZONTAL
———— VERTICAL
———— TOTAL
ANGLES IN DEGREES TRUE

HMMWV DRIVEN 190 X 6 FT ANTENNA

FREQ=30 MHZ PHI=0 UNTERMINATED

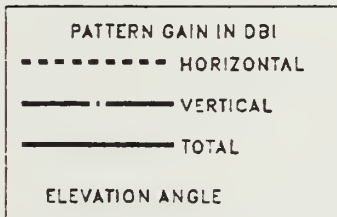
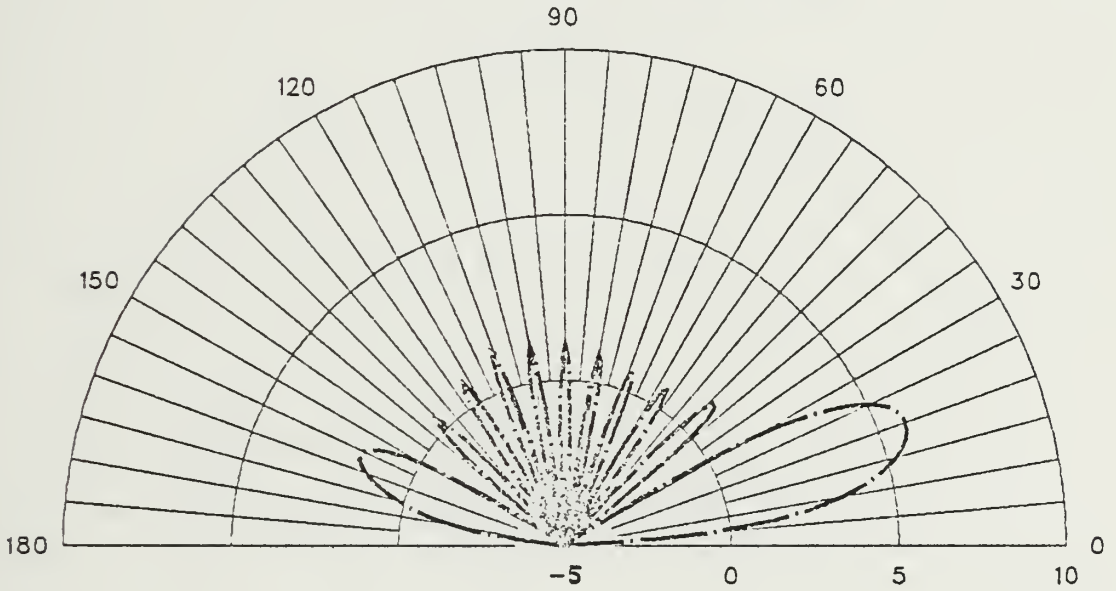

HMMWV DRIVEN 190 X 6 FT ANTENNA

FREQ=30 MHZ PHI=10 UNTERMINATED

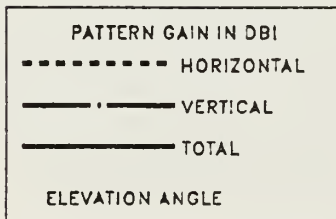
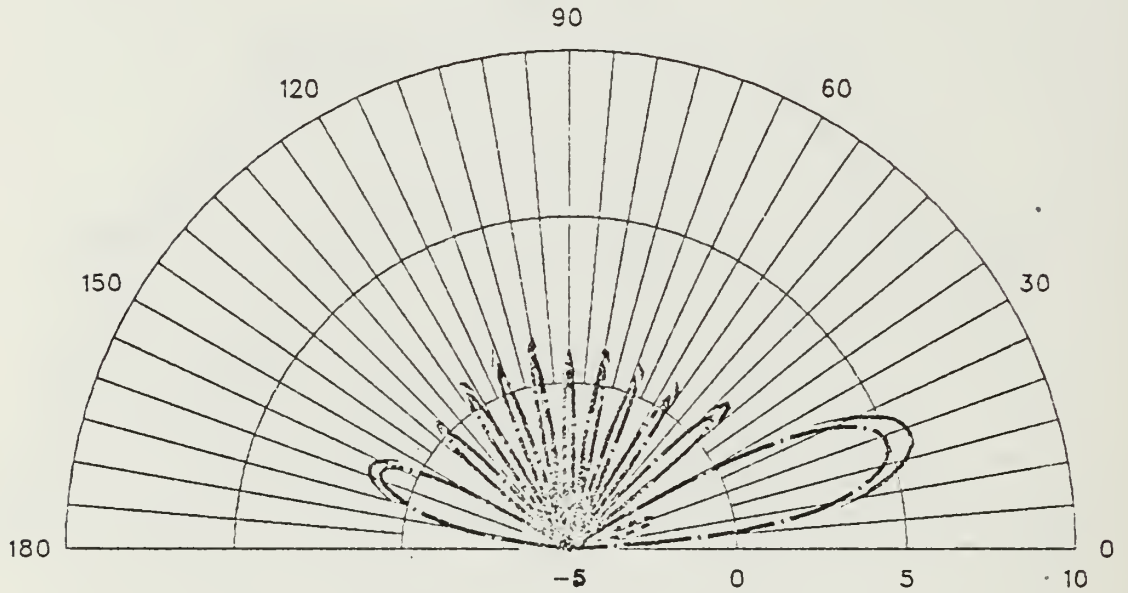

HMMWV DRIVEN 190 X 6 FT ANTENNA

FREQ=30 MHZ PHI=20 UNTERMINATED

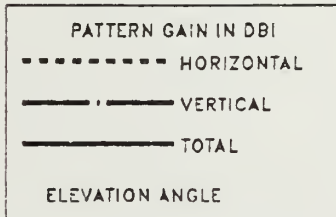
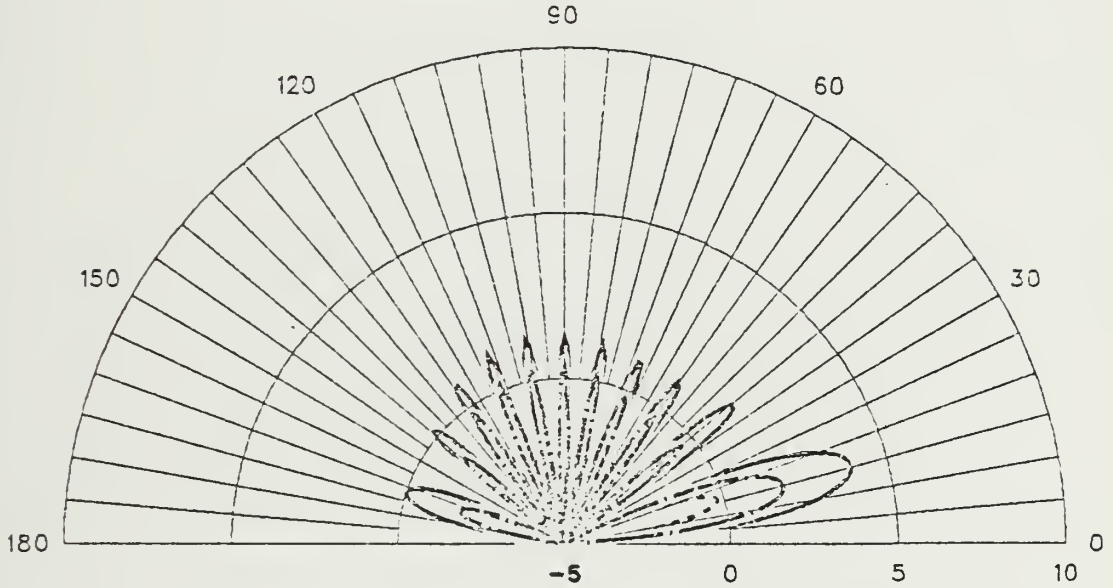

HMMWV DRIVEN 190 X 6 FT ANTENNA

FREQ = 30 MHZ UNTERMINATED

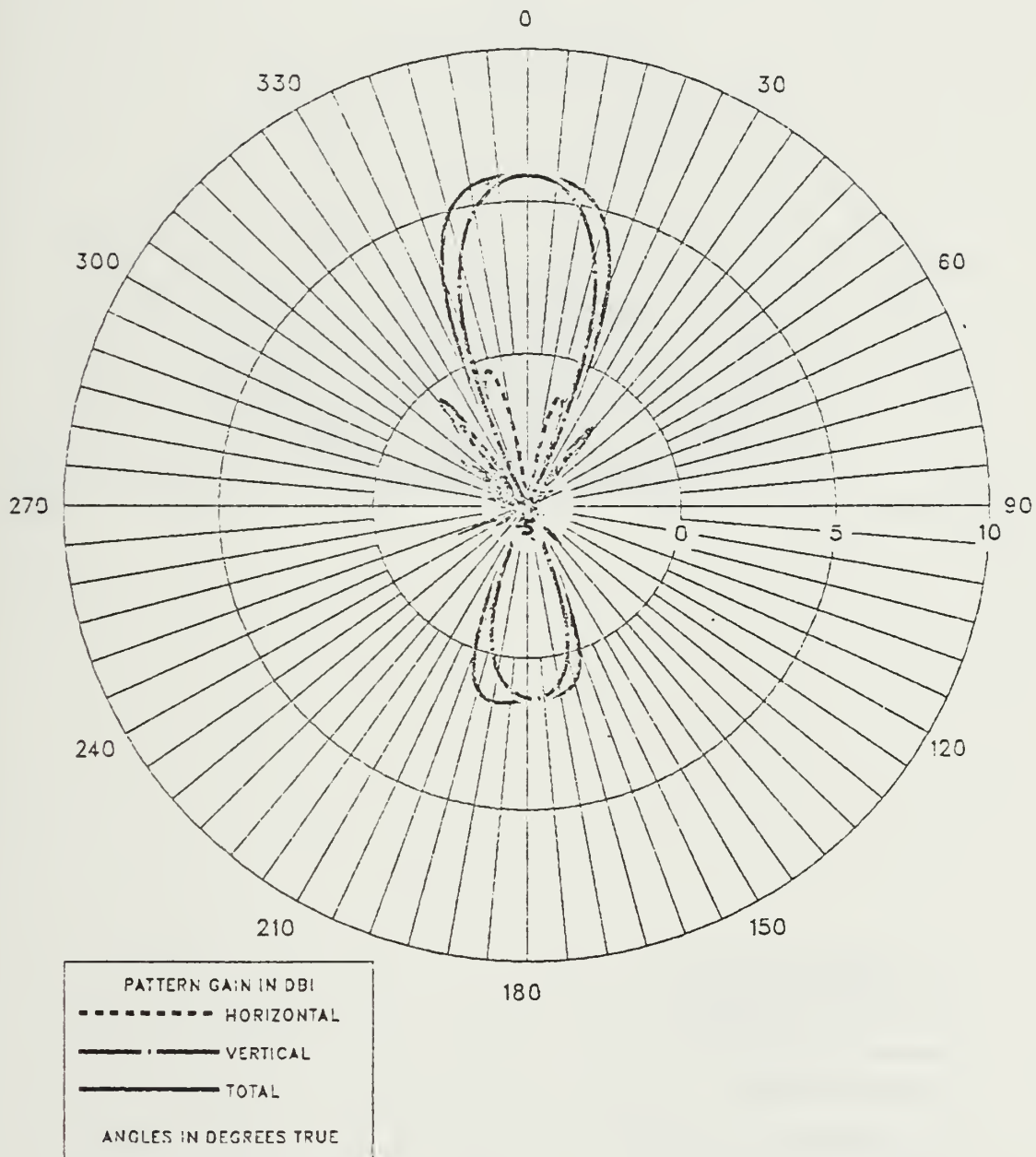

HMMWV DRIVEN 190 X 15 FT ANTENNA

FREQ=17 MHZ PHI= 0 UNTERMINATED

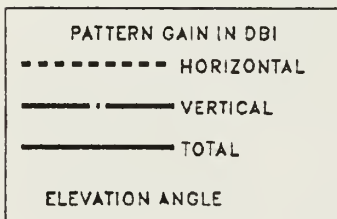
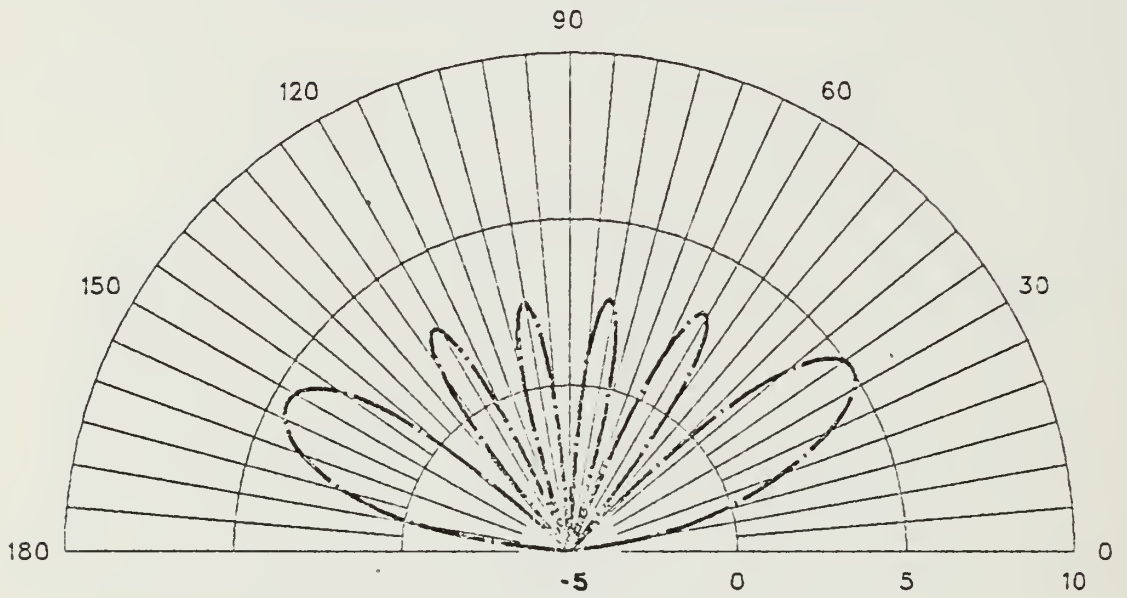

HMMWV DRIVEN 190 X 15 FT ANTENNA

FREQ=17 MHZ PHI=10 UNTERMINATED

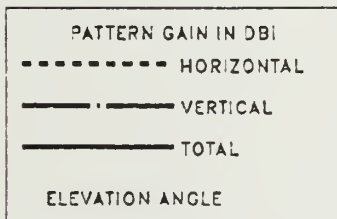
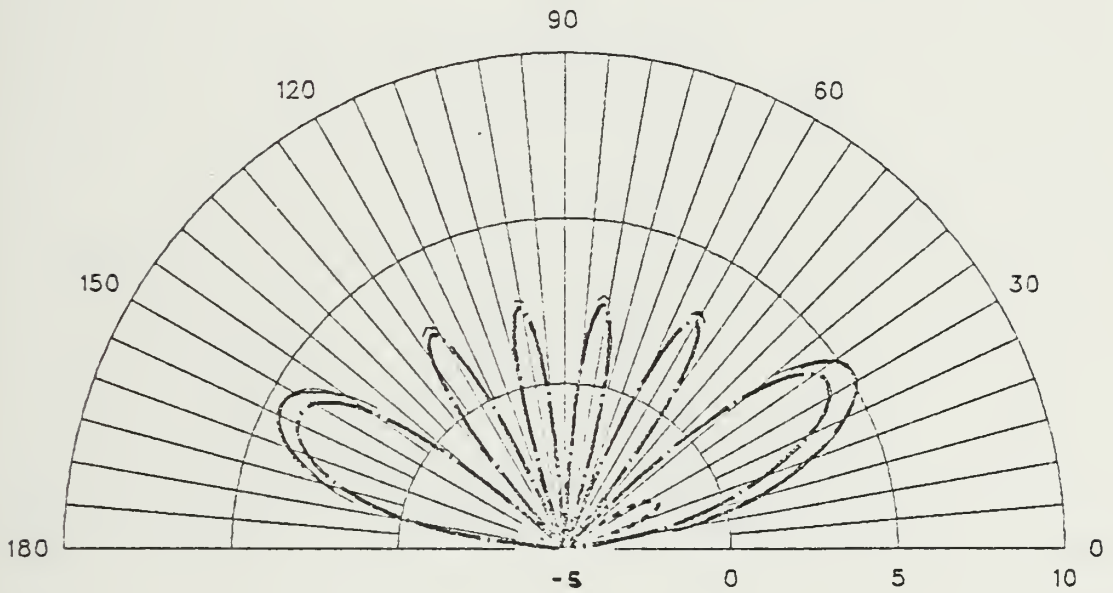

HMMWV DRIVEN 190 X 15 FT ANTENNA

FREQ=17 MHZ PHI=20 UNTERMINATED

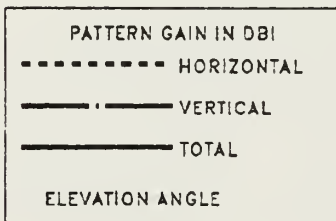
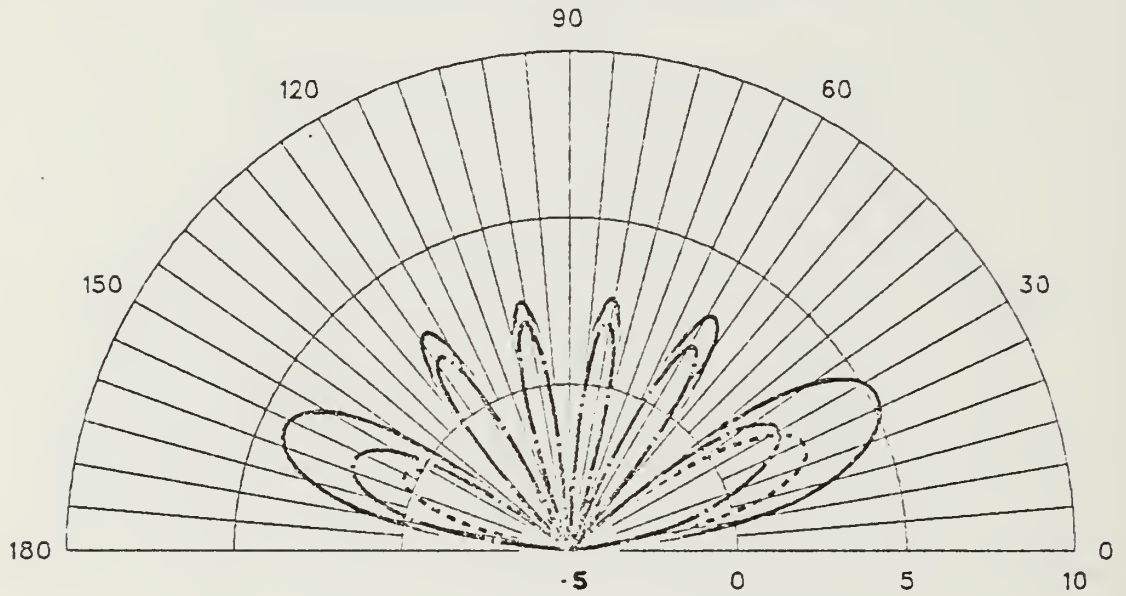

HMMWV DRIVEN 190 X 15 FT ANTENNA

FREQ=17 MHZ PHI=30 UNTERMINATED

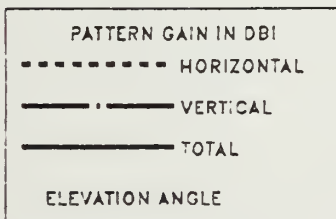
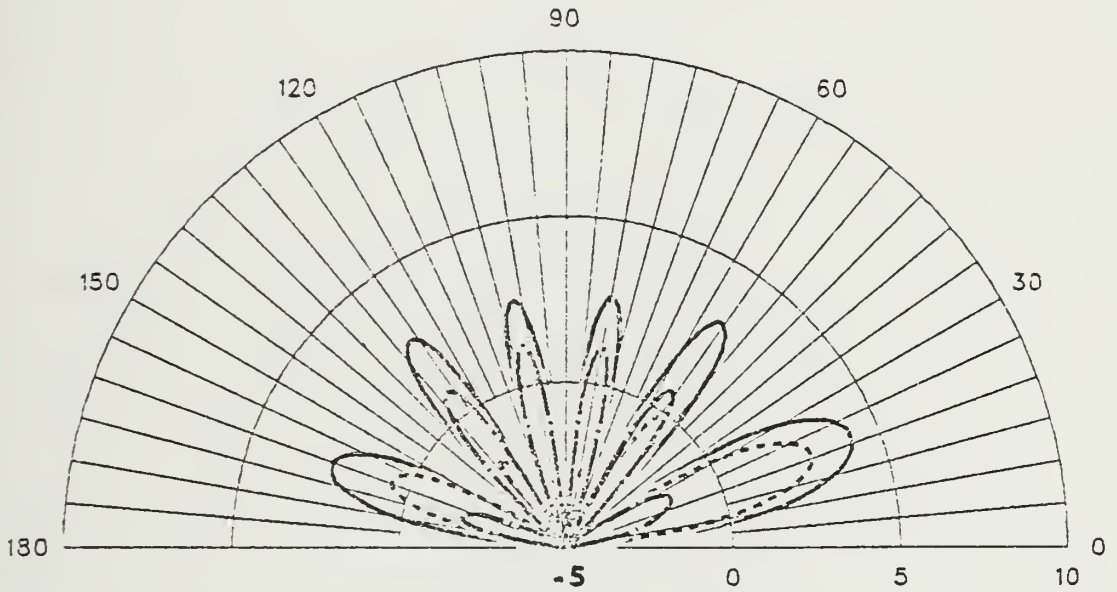

HMMWV DRIVEN 190 X 15 FT ANTENNA

FREQ=17 MHZ PHI=40 UNTERMINATED

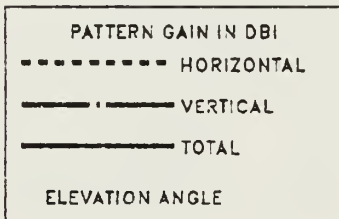
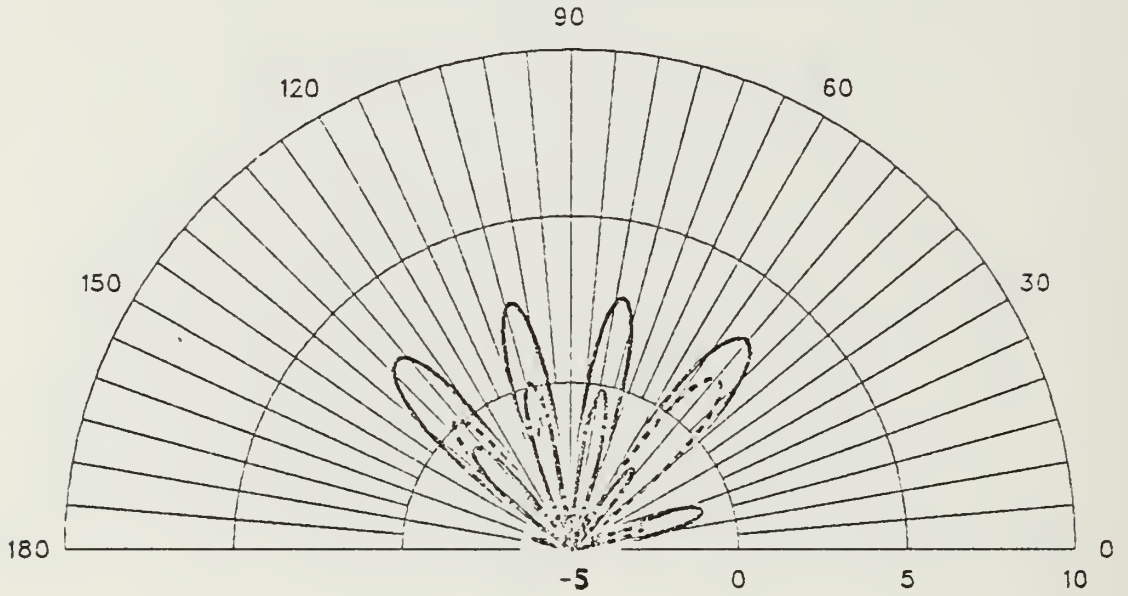

HMMWV DRIVEN 190 X 15 FT ANTENNA

FREQ=17 MHZ THETA=65 UNTERMINATED

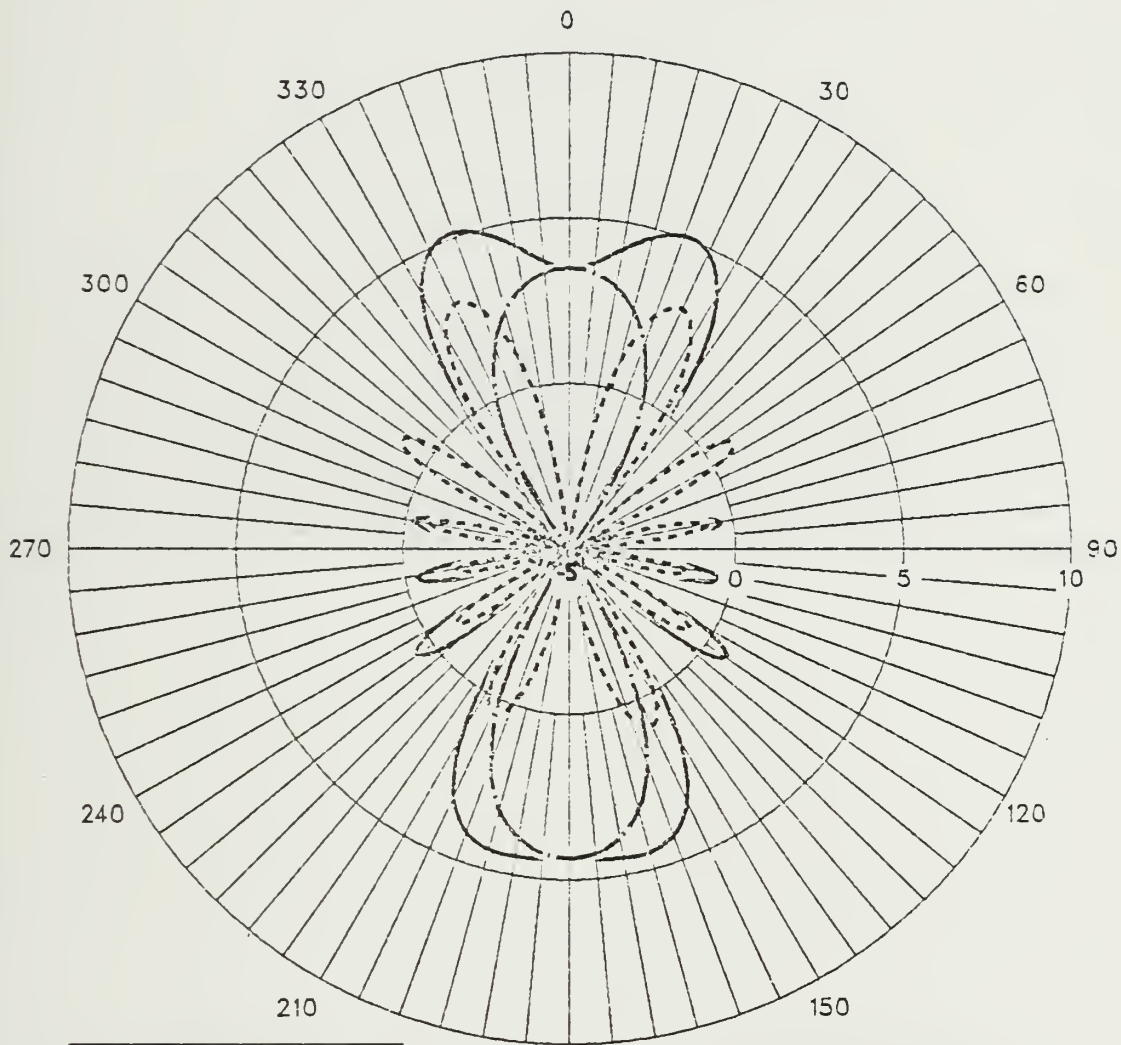

PATTERN GAIN IN DBI
----- HORIZONTAL
- · - · - VERTICAL
————— TOTAL
ANGLES IN DEGREES TRUE

HMMWV DRIVEN 190 X 6 FT ANTENNA

FREQ=17 MHZ PHI=0 UNTERMINATED

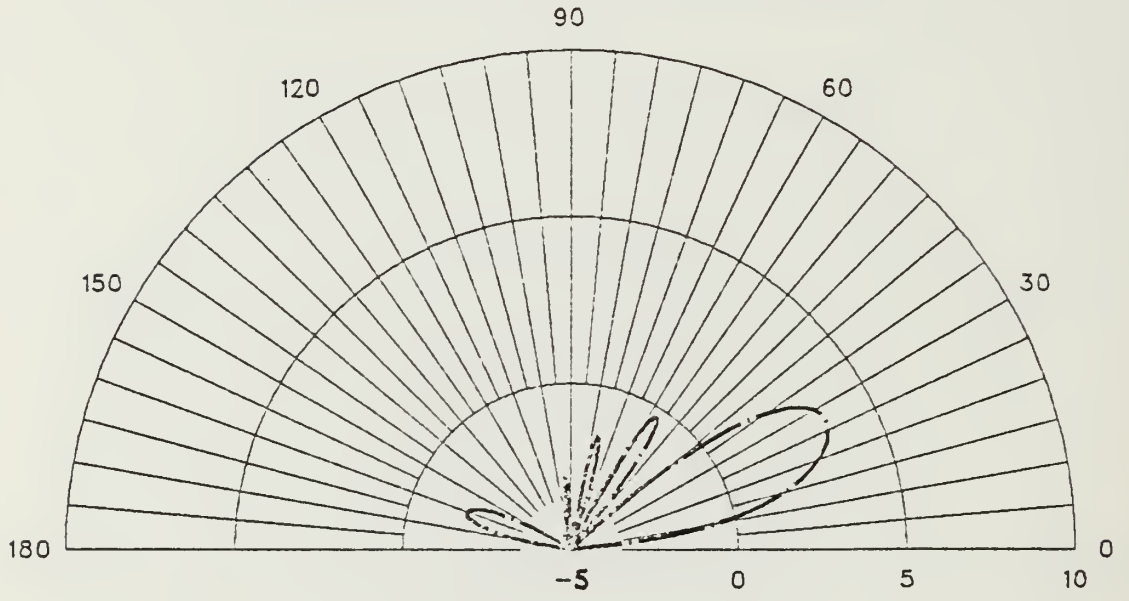

PATTERN GAIN IN DBI	
-----	HORIZONTAL
- - - - -	VERTICAL
—————	TOTAL
ELEVATION ANGLE	

HMMWV DRIVEN 190 X 15 FT ANTENNA

FREQ=30 MHZ PHI=0 UNTERMINATED

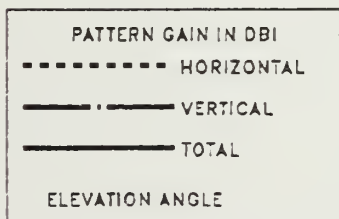
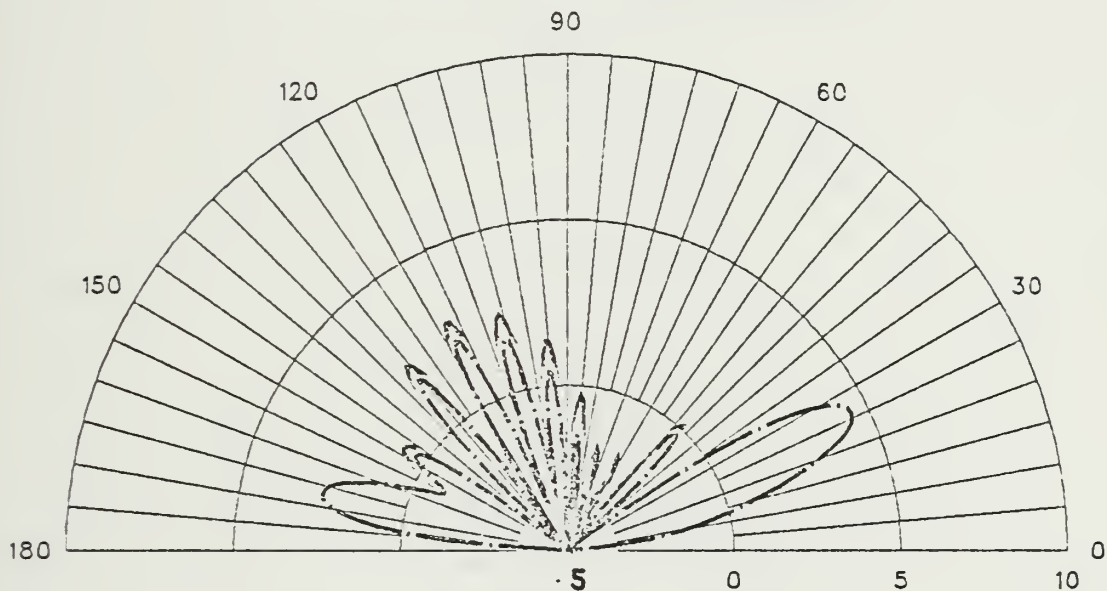

HMMWV DRIVEN 190 X 15 FT ANTENNA

FREQ=30 MHZ PHI=10 UNTERMINATED

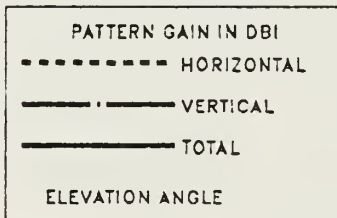
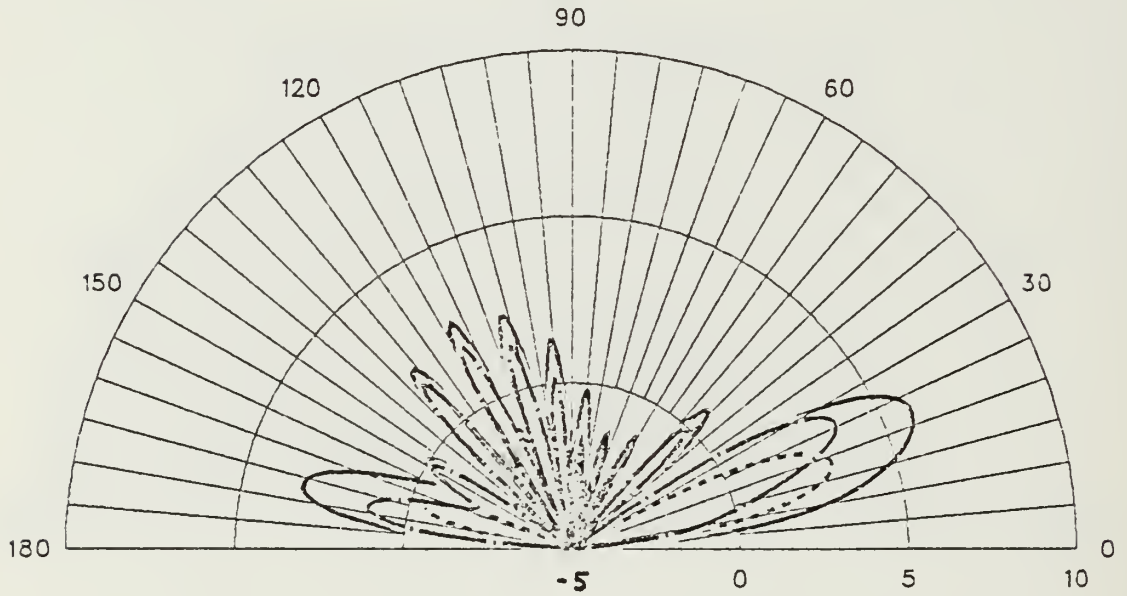

HMMWV DRIVEN 190 X 15 FT ANTENNA

FREQ=30 MHZ PHI=20 UNTERMINATED

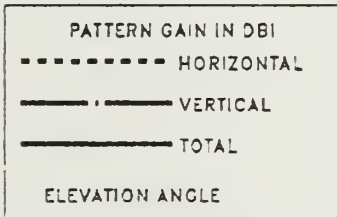
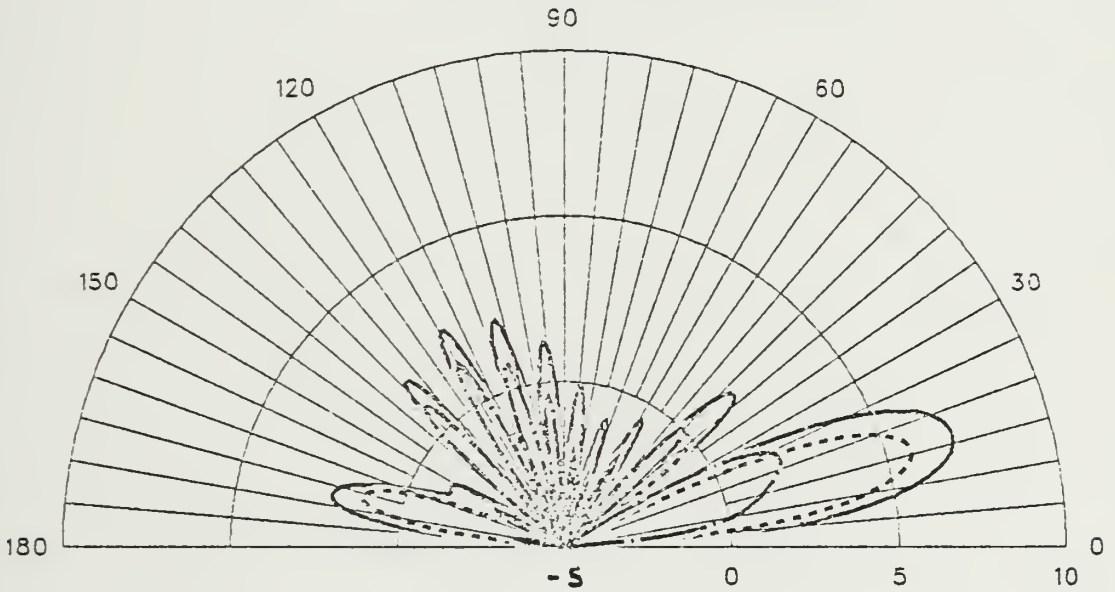

HMMWV DRIVEN 190 X 15 FT ANTENNA

FREQ=30 MHZ PHI=30 UNTERMINATED

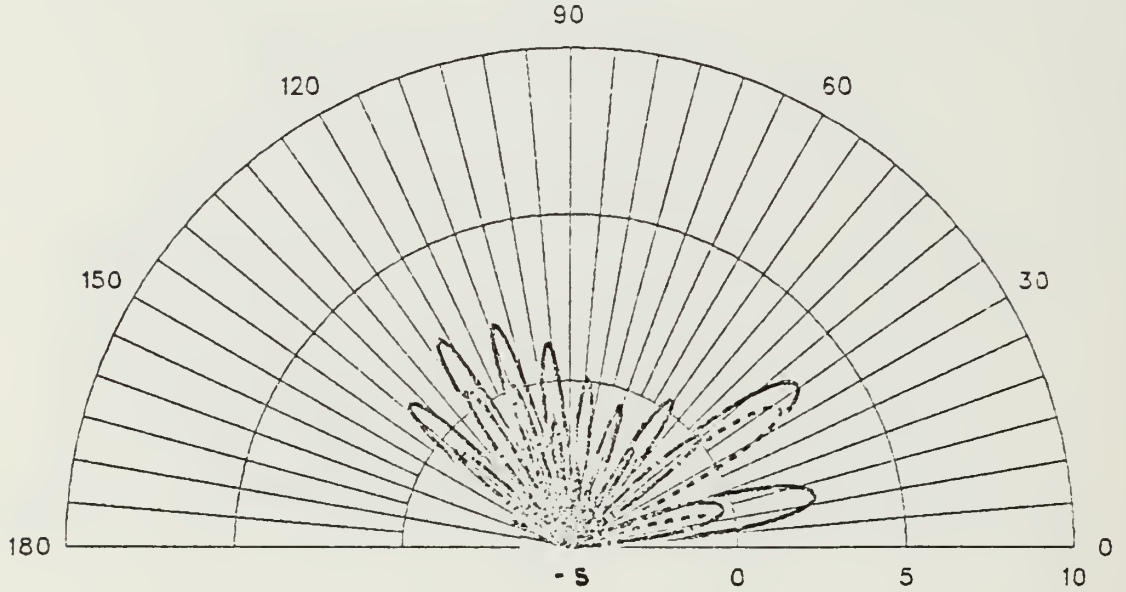

PATTERN GAIN IN DBI	
-----	HORIZONTAL
- . - . - .	VERTICAL
—————	TOTAL
ELEVATION ANGLE	

HMMWV DRIVEN 190 X 15 FT ANTENNA

FREQ=30 MHZ PHI=40 UNTERMINATED

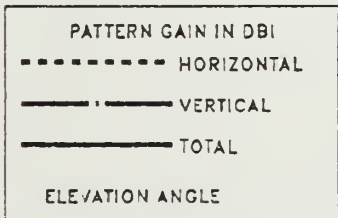
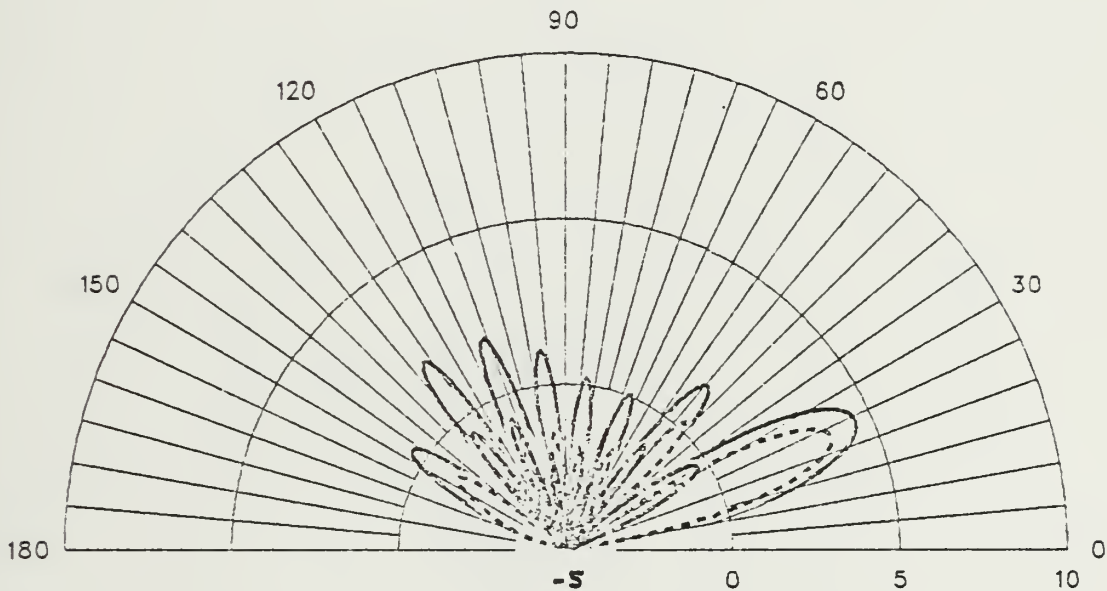

HMMWV DRIVEN 190 X 15 FT ANTENNA

FREQ=30 MHZ PHI=50 UNTERMINATED

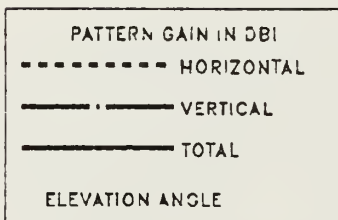
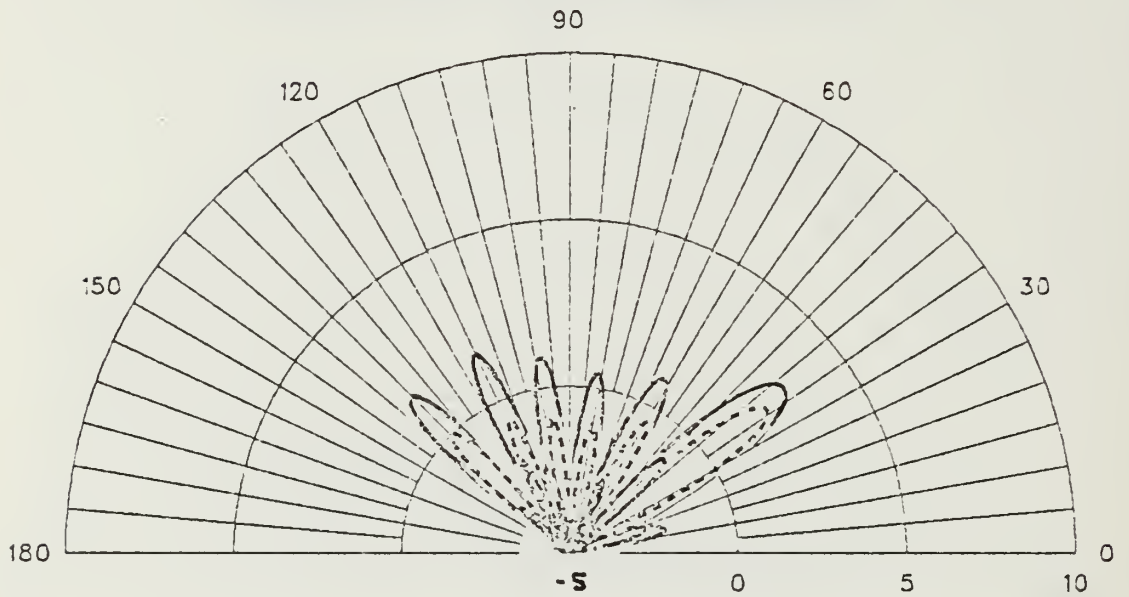

HMMWV DRIVEN 190 X 15 FT ANTENNA

FREQ=30 MHZ THETA=75 UNTERMINATED

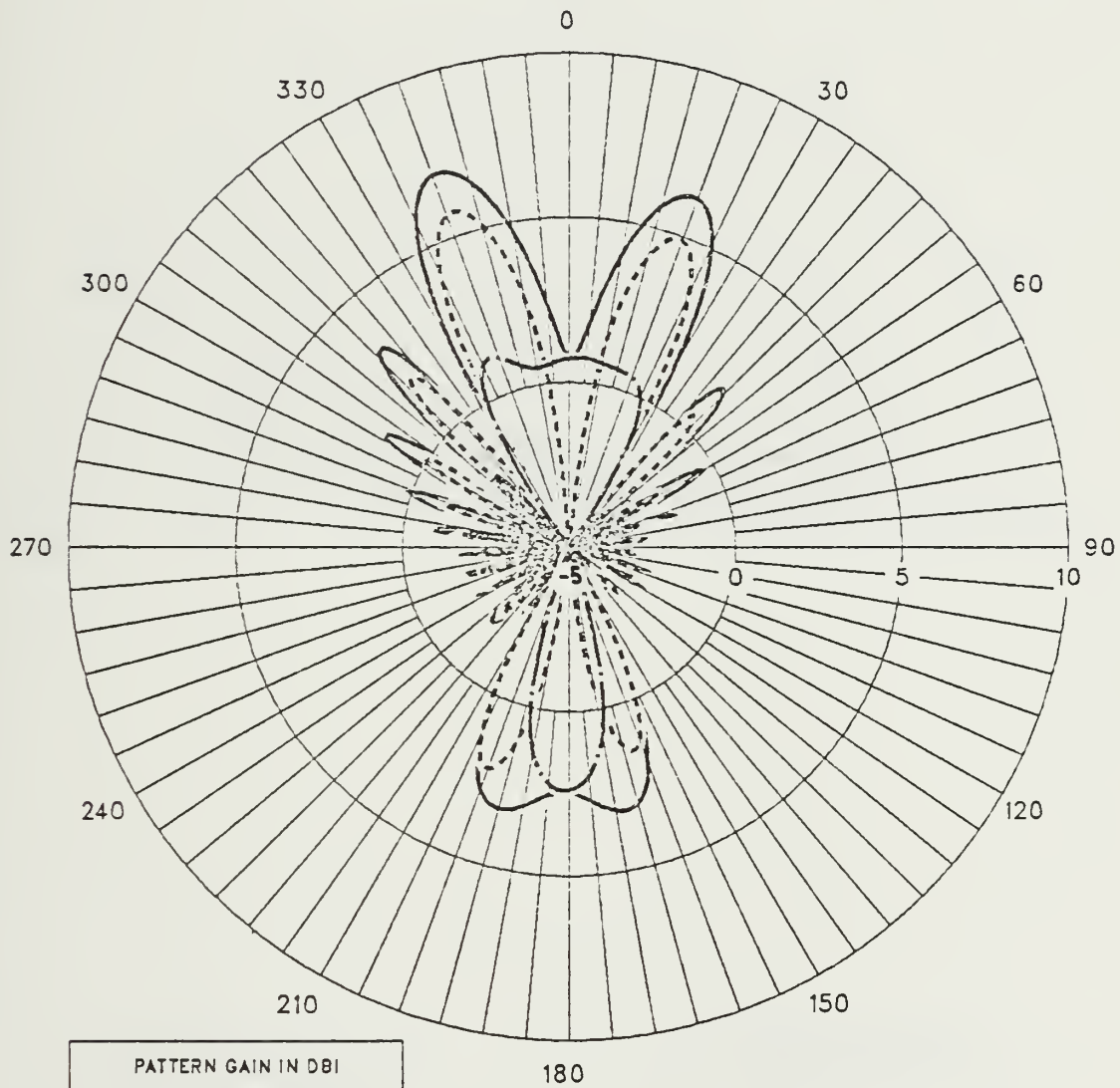

HMMWV DRIVEN 375 X 6 FT ANTENNA

FREQ=17 MHZ PHI=0 UNTERMINATED

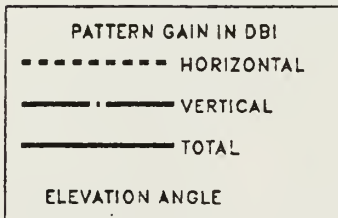
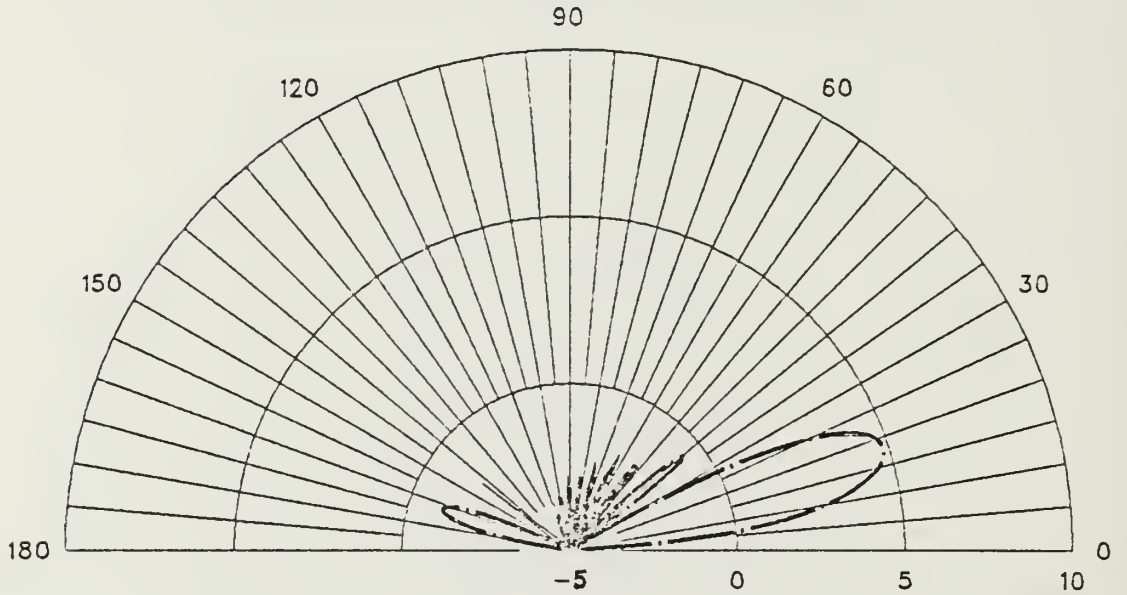

HMMWV DRIVEN 375 X 6 FT ANTENNA

FREQ=17 MHZ PHI=10 UNTERMINATED

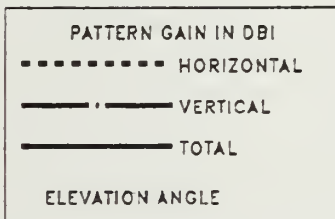
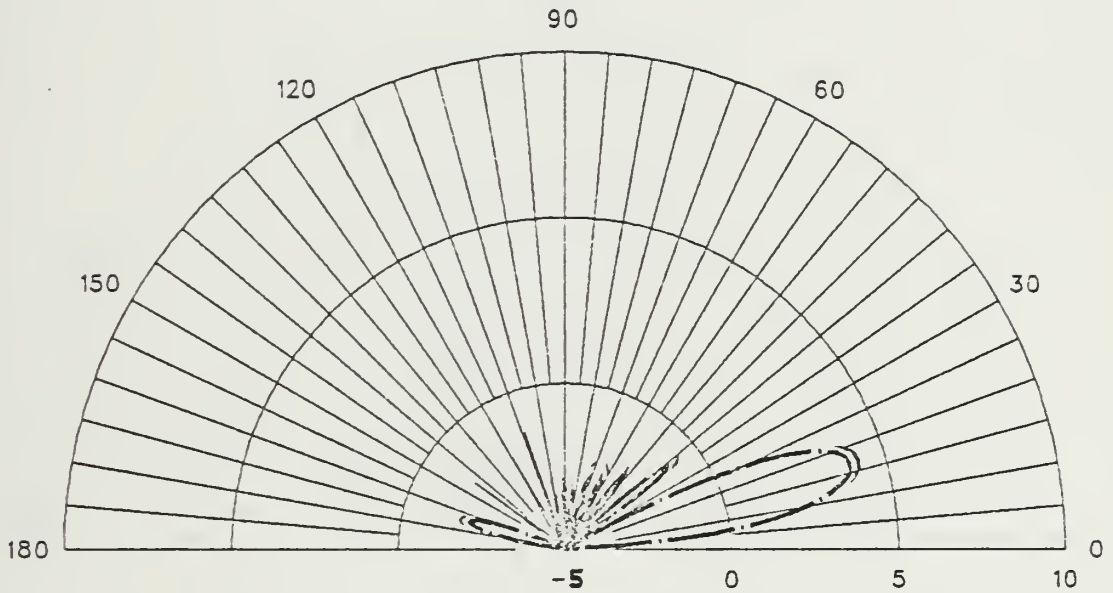

HMMWV DRIVEN 375 X 6 FT ANTENNA

FREQ=17 MHZ PHI=20 UNTERMINATED

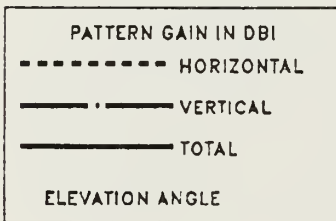
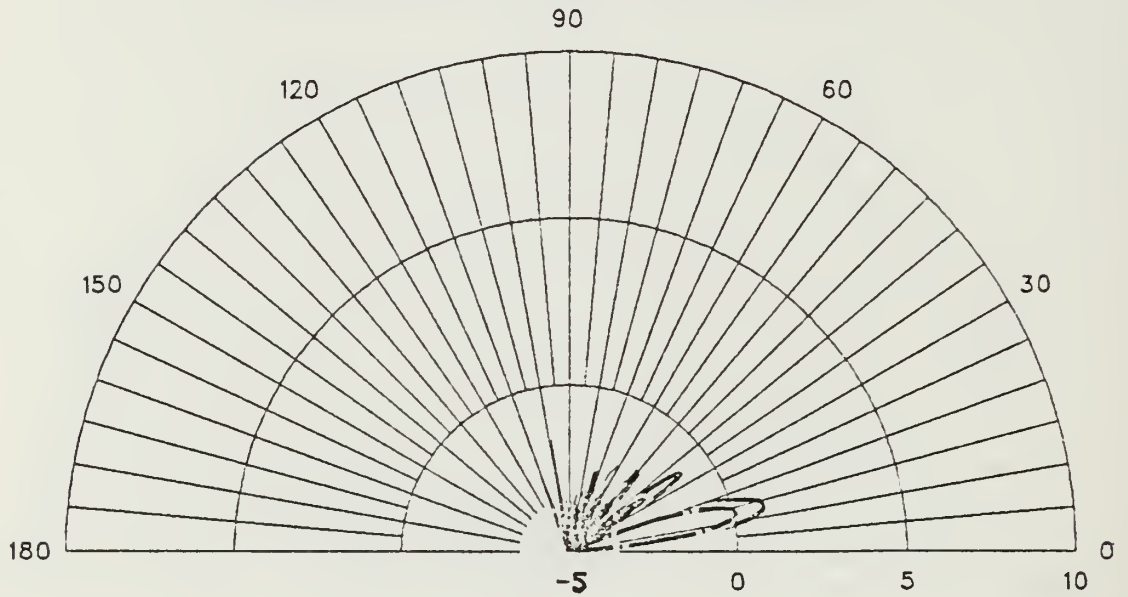

HMMWV DRIVEN 375 X 6 FT ANTENNA

FREQ=17 MHZ PHI=30 UNTERMINATED

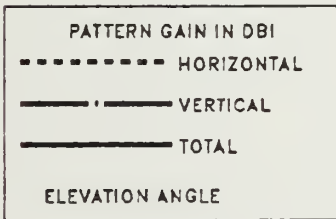
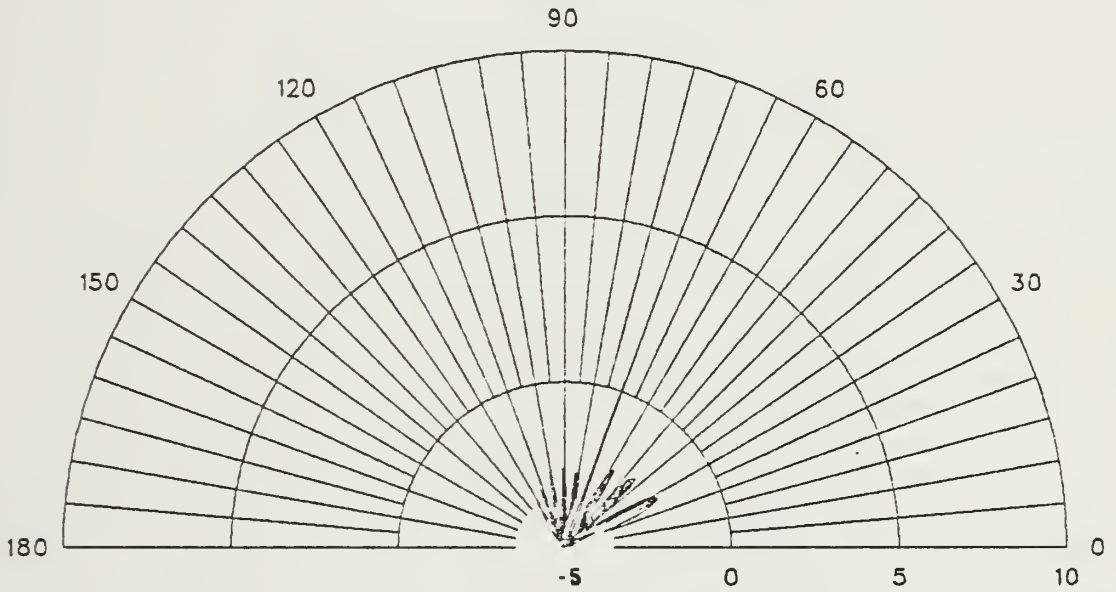

HMMWV DRIVEN 375 X 6 FT ANTENNA

FREQ=17 MHZ PHI=40 UNTERMINATED

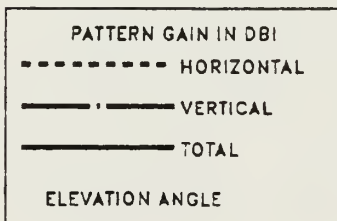
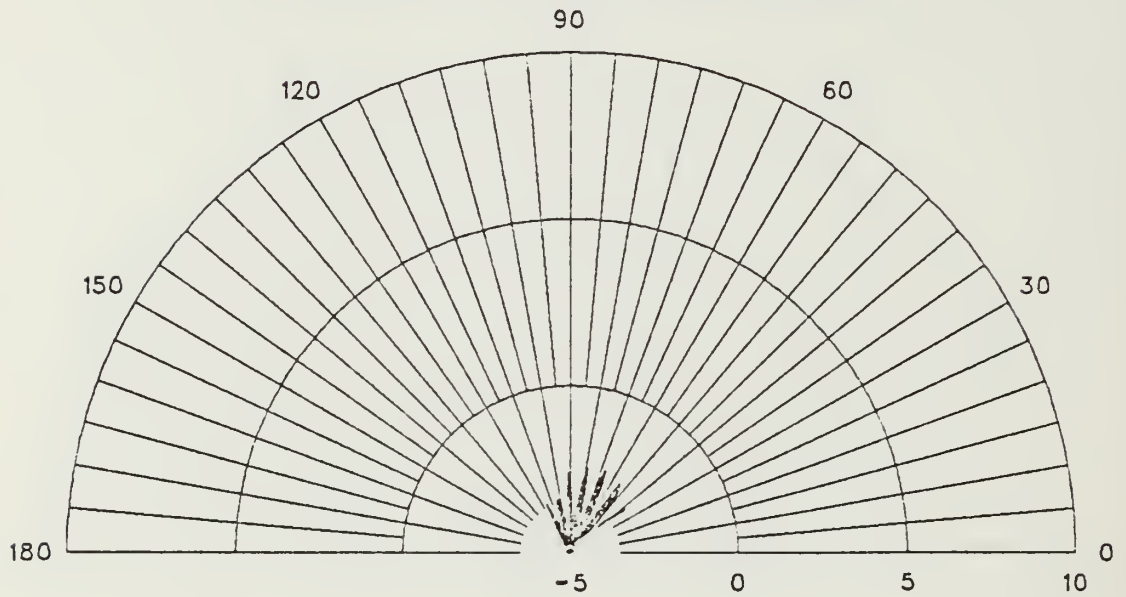

HMMWV DRIVEN 375 X 6 FT ANTENNA

FREQ=17 MHZ THETA=70 UNTERMINATED

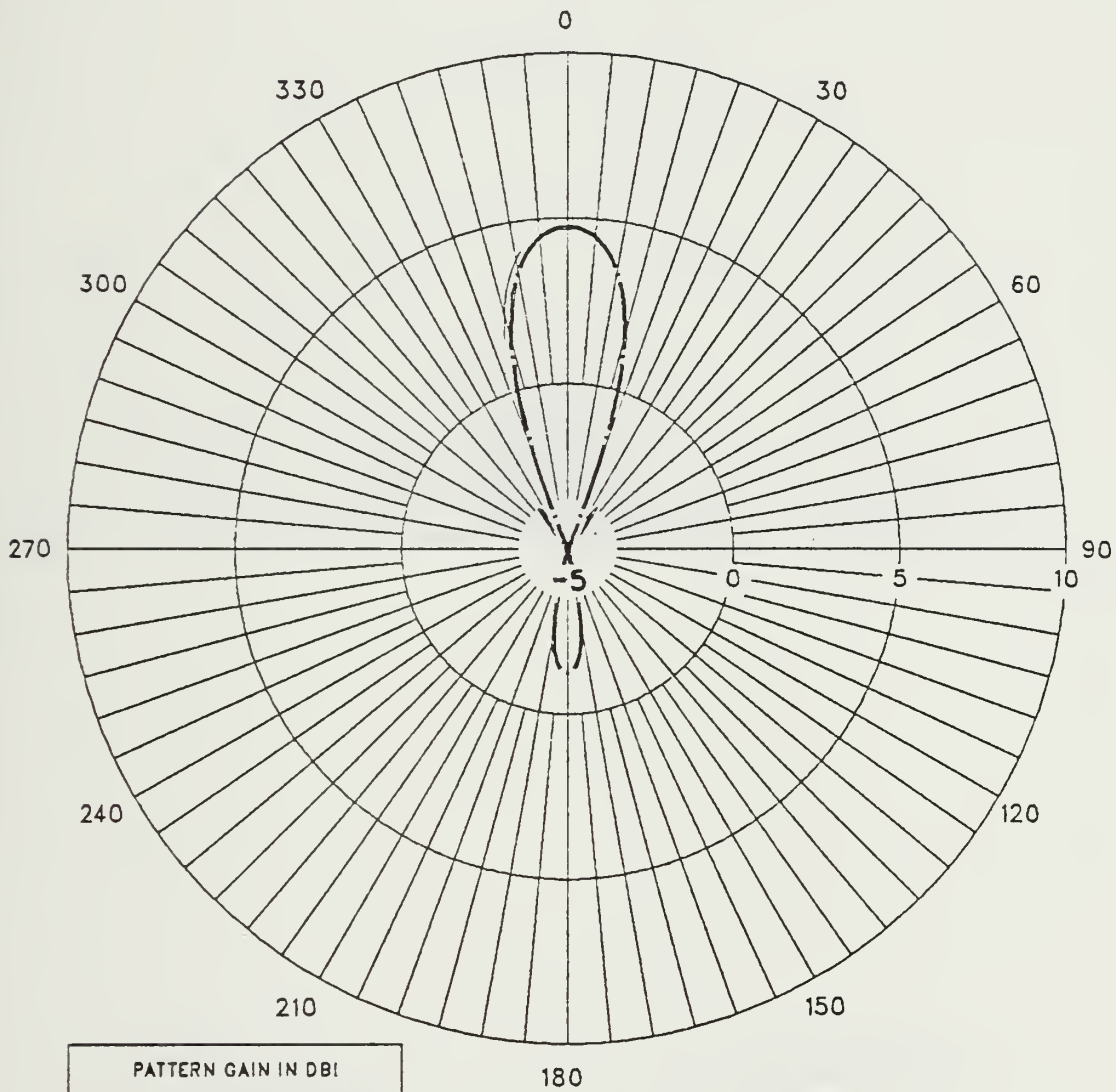

PATTERN GAIN IN DBI
- - - - - HORIZONTAL
- · - - - VERTICAL
- - - - - TOTAL
ANGLES IN DEGREES TRUE

HMMWV DRIVEN 375 X 6 FT ANTENNA

FREQ=30 MHZ PHI=0 UNTERMINATED

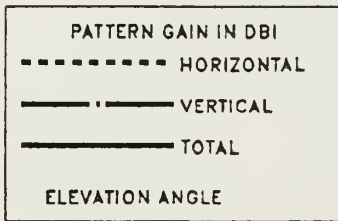
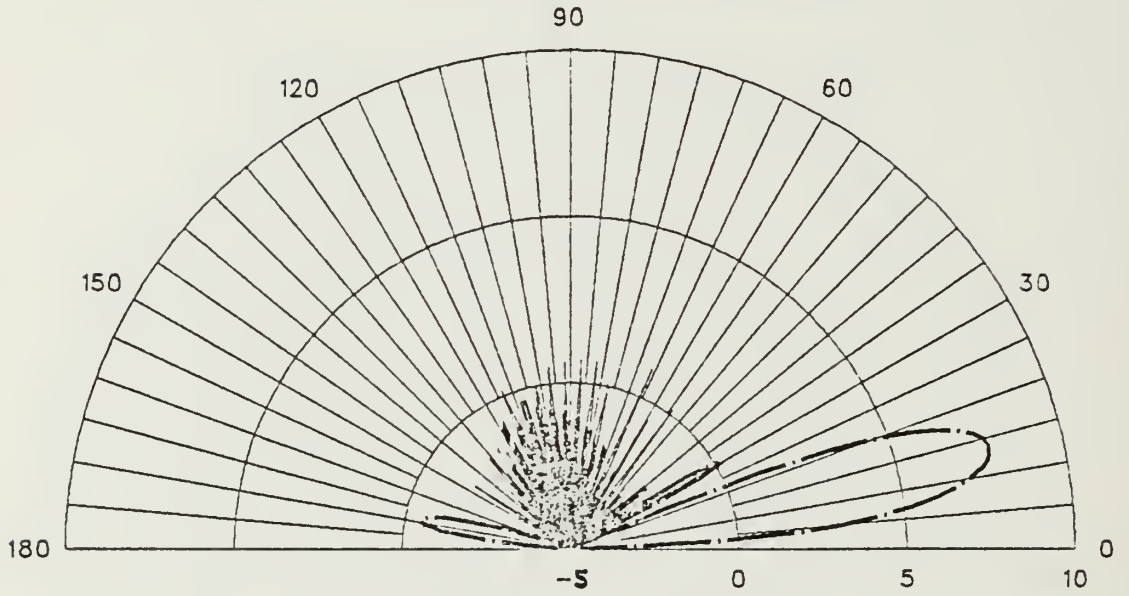

HMMWV DRIVEN 375 X 6 FT ANTENNA

FREQ=30 MHZ PHI=10 UNTERMINATED

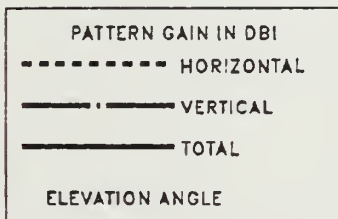
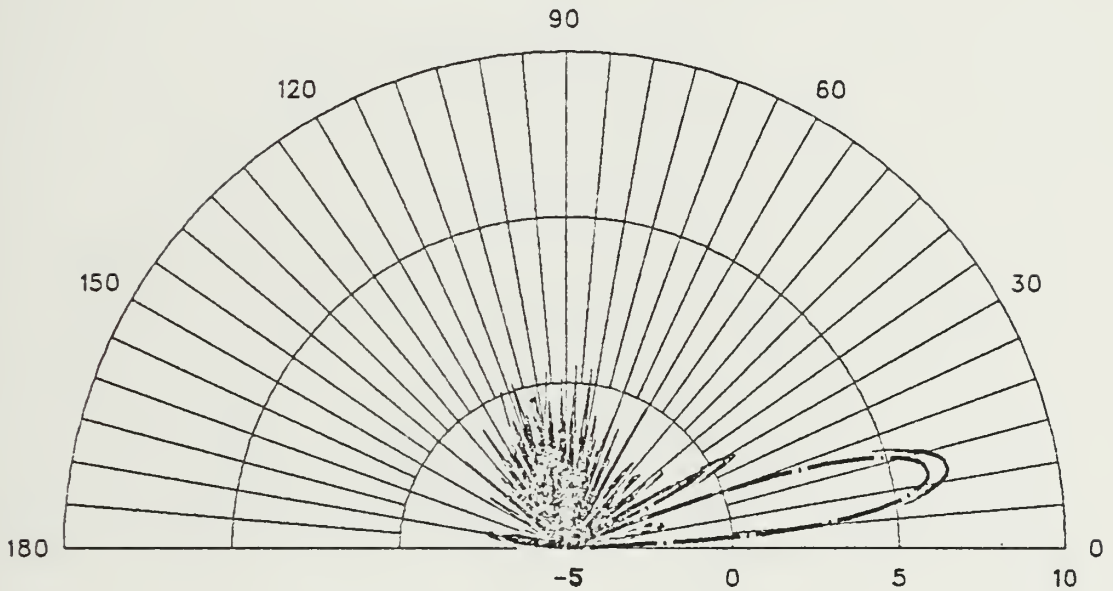

HMMWV DRIVEN 375 X 6 FT ANTENNA

FREQ=30 MHZ PHI=20 UNTERMINATED

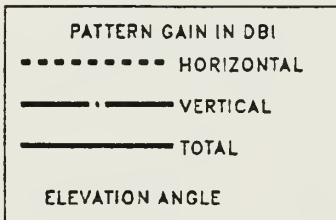
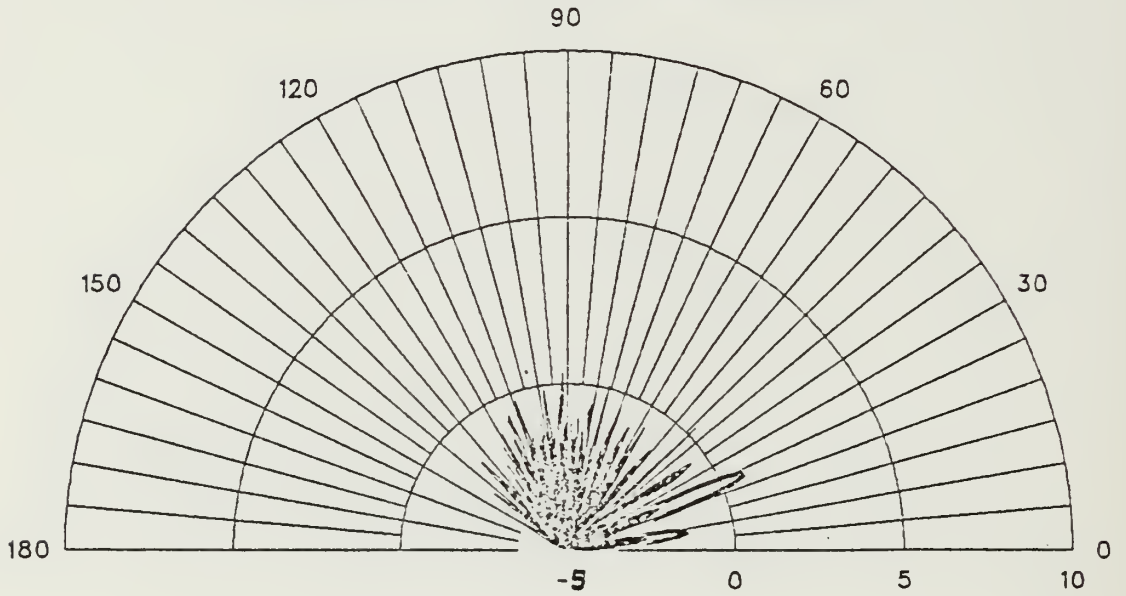

HMMWV DRIVEN 375 X 6 FT ANTENNA

FREQ=30 MHZ PHI=40 UNTERMINATED

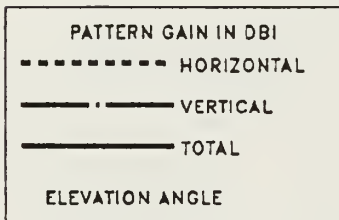
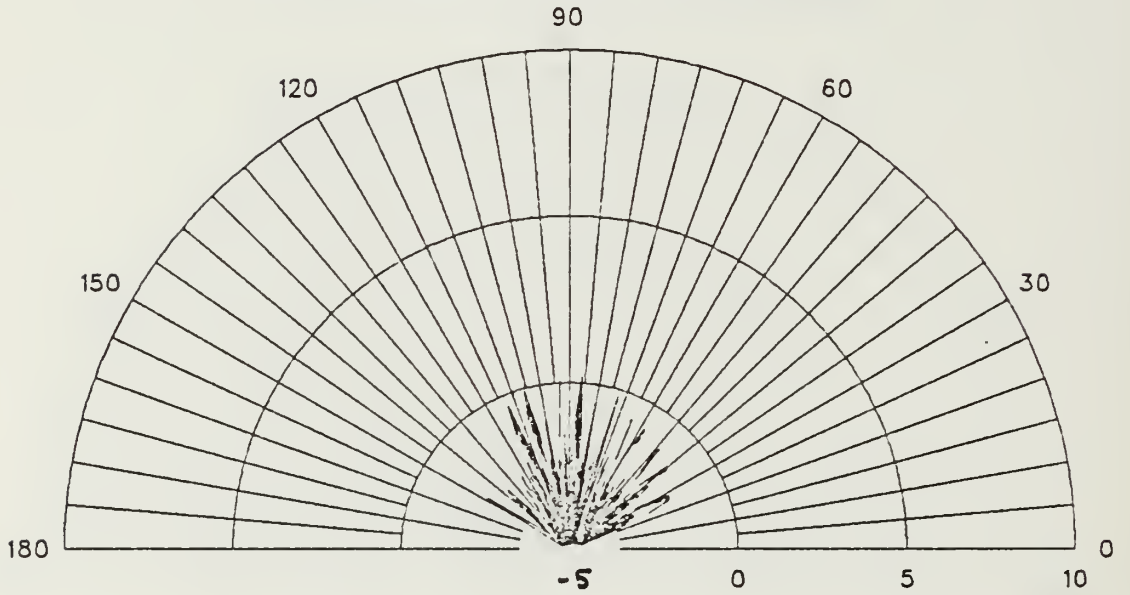

HMMWV DRIVEN 375 X 15 FT ANTENNA

FREQ=17 MHZ PHI=0 UNTERMINATED

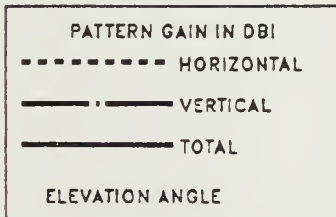
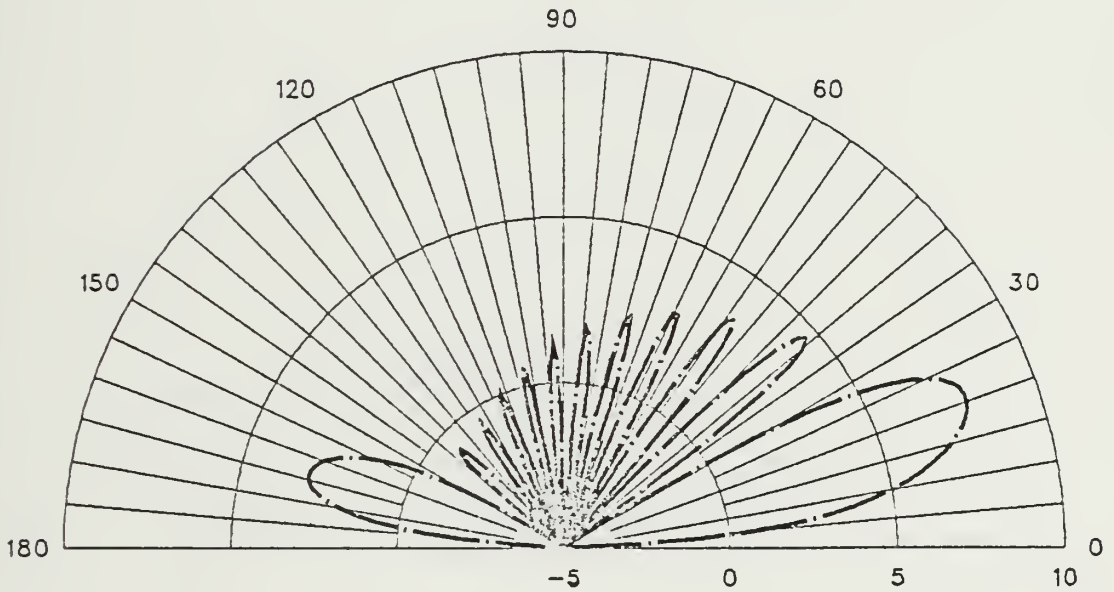

HMMWV DRIVEN 375 X 15 FT ANTENNA

FREQ=17 MHZ PHI=10 UNTERMINATED

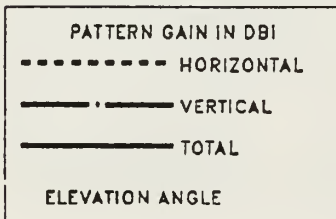
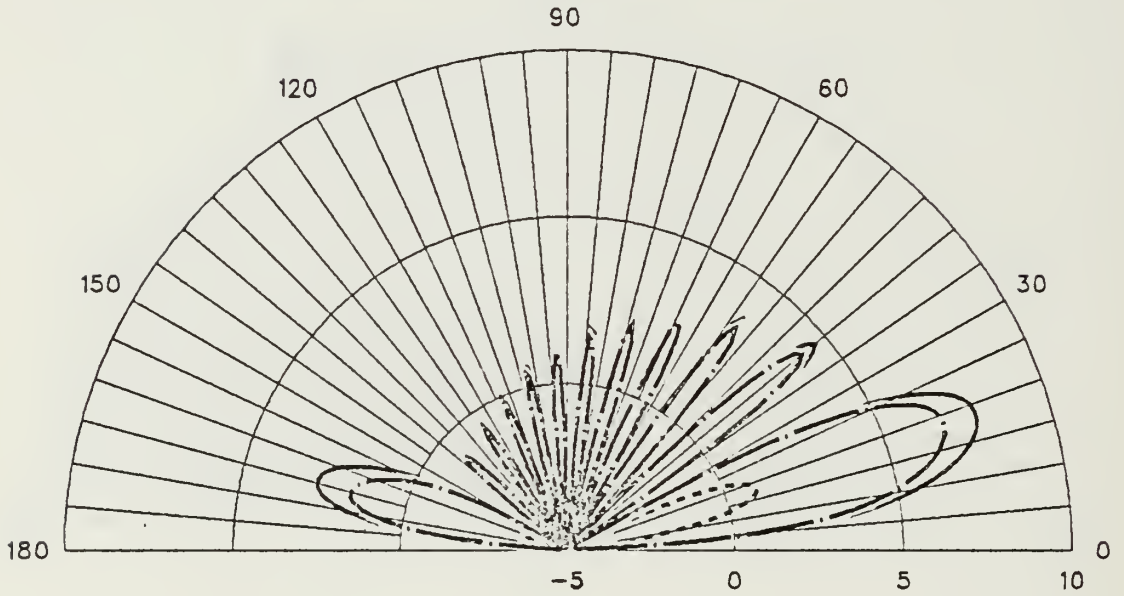

HMMWV DRIVEN 375 X 15 FT ANTENNA

FREQ=17 MHZ PHI=20 UNTERMINATED

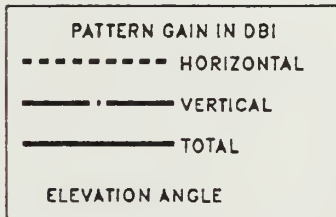
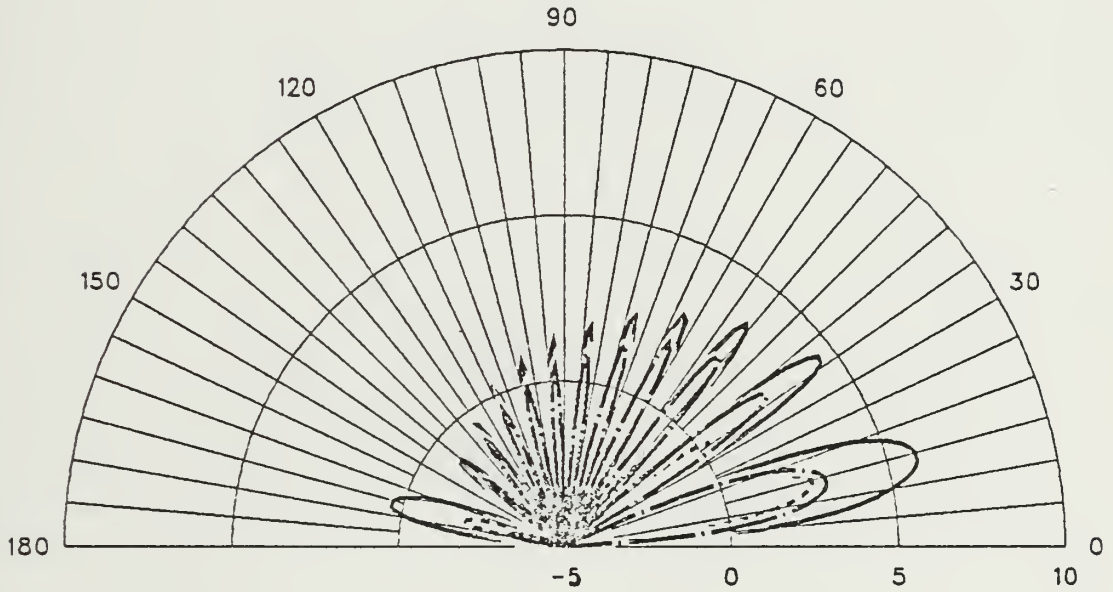

HMMWV DRIVEN 375 X 15 FT ANTENNA

FREQ=17 MHZ PHI=30 UNTERMINATED

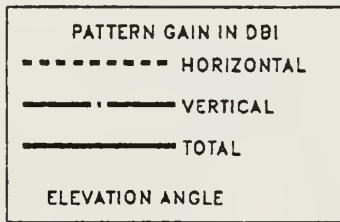
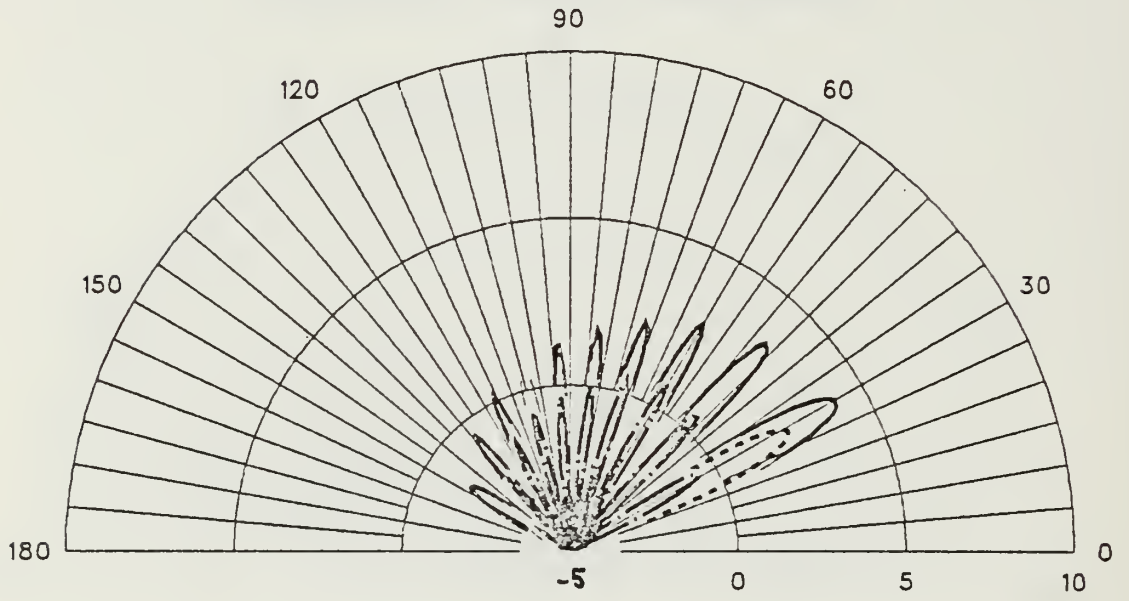

HMMWV DRIVEN 375 X 15 FT ANTENNA

FREQ=17 MHZ PHI=40 UNTERMINATED

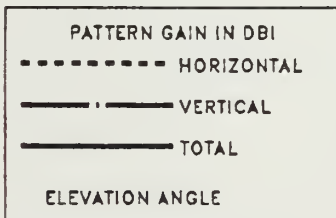
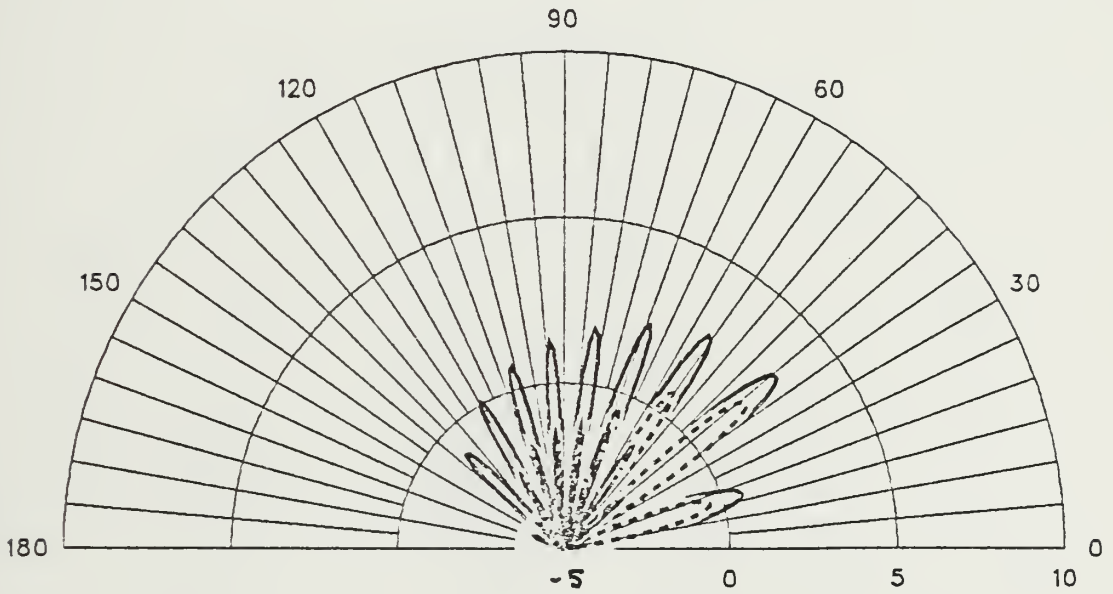

HMMWV DRIVEN 375 X 15 FT ANTENNA

FREQ=17 MHZ THETA=70 UNTERMINATED

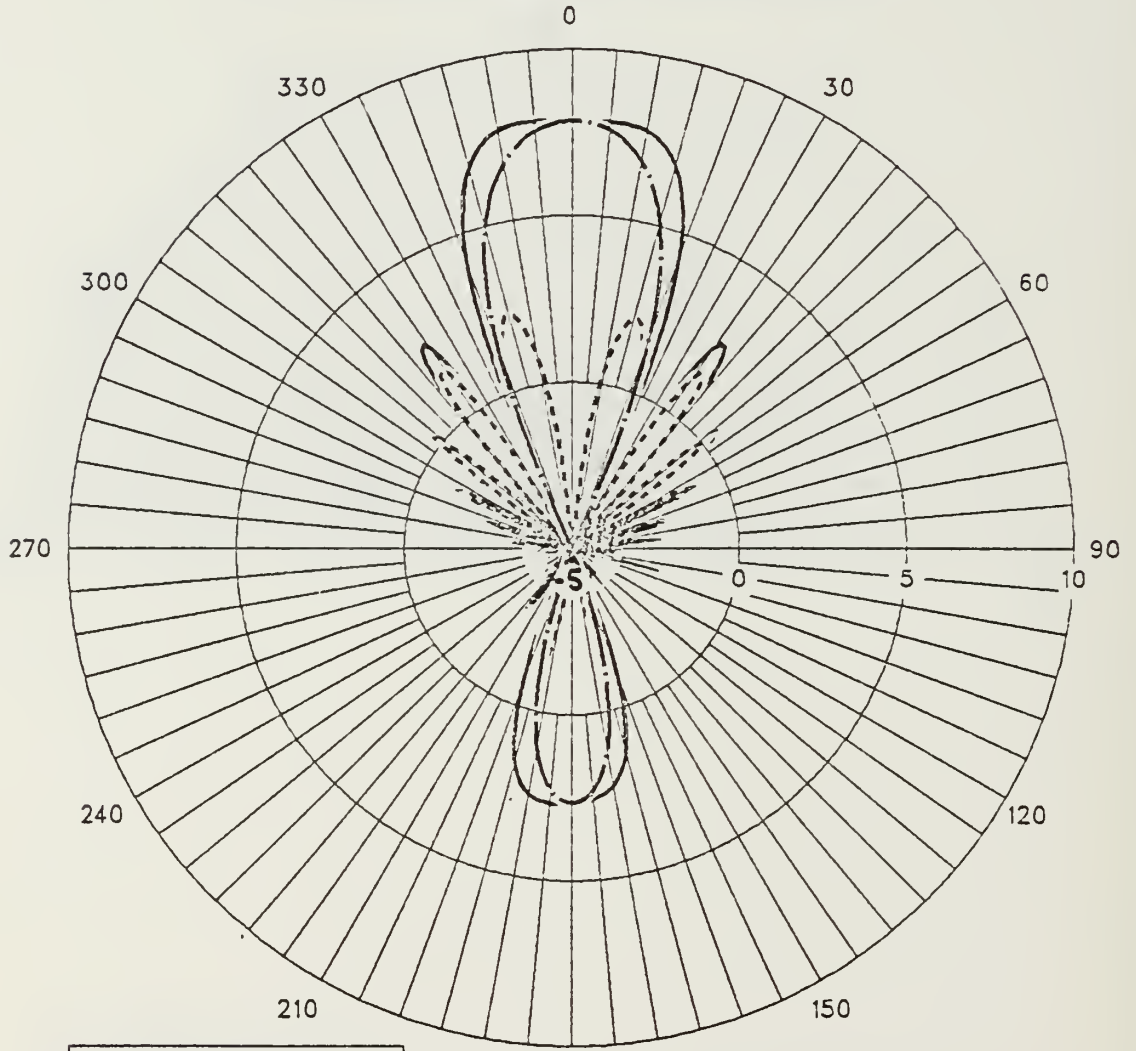

PATTERN GAIN IN DBI
- - - - - HORIZONTAL
———— VERTICAL
———— TOTAL
ANGLES IN DEGREES TRUE

HMMWV DRIVEN 375 X 15 FT ANTENNA

FREQ=30 MHZ PHI=0 UNTERMINATED

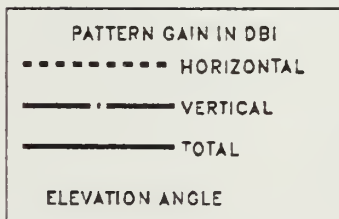
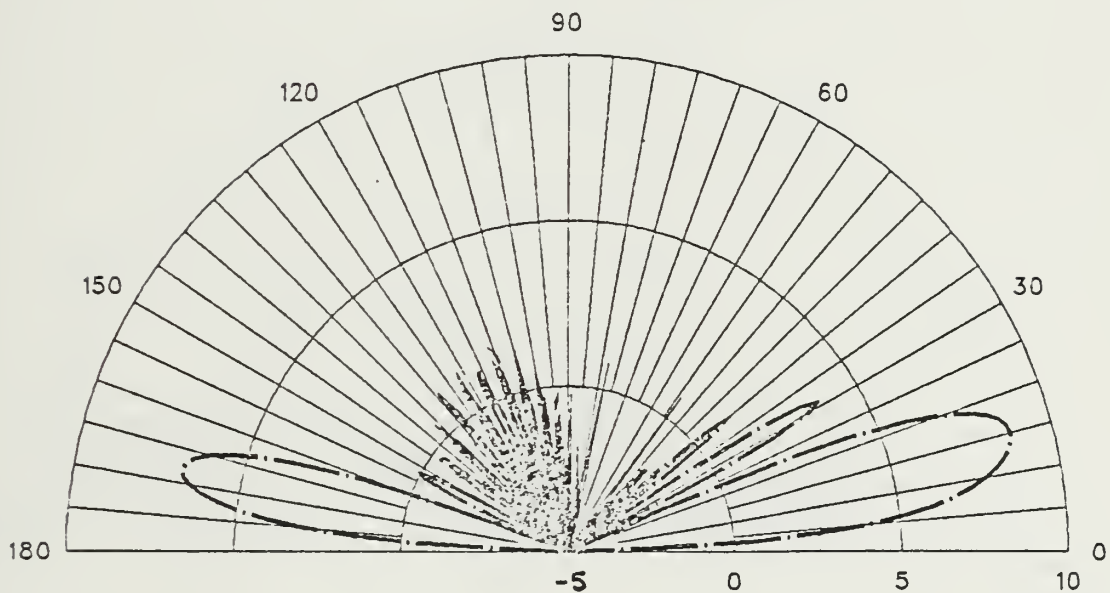

HMMWV DRIVEN 375 X 15 FT ANTENNA

FREQ=30 MHZ PHI=10 UNTERMINATED

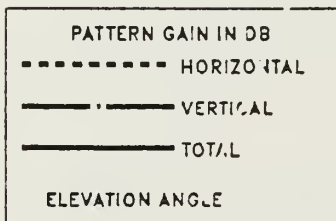
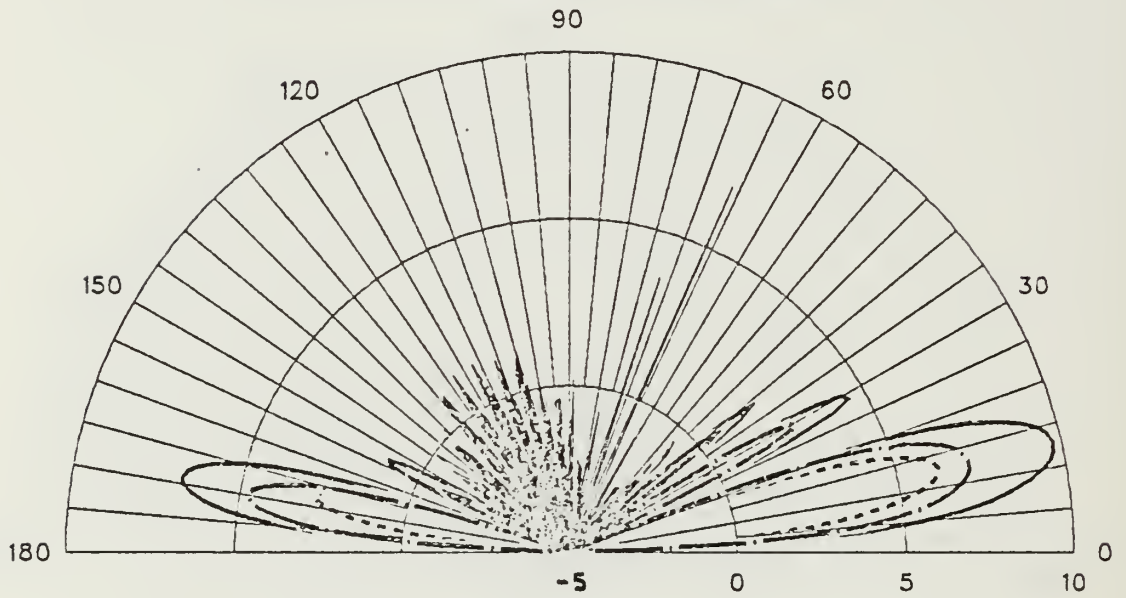

HMMWV DRIVEN 375 X 15 FT ANTENNA

FREQ=30 MHZ PHI=20 UNTERMINATED

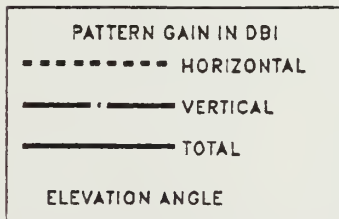
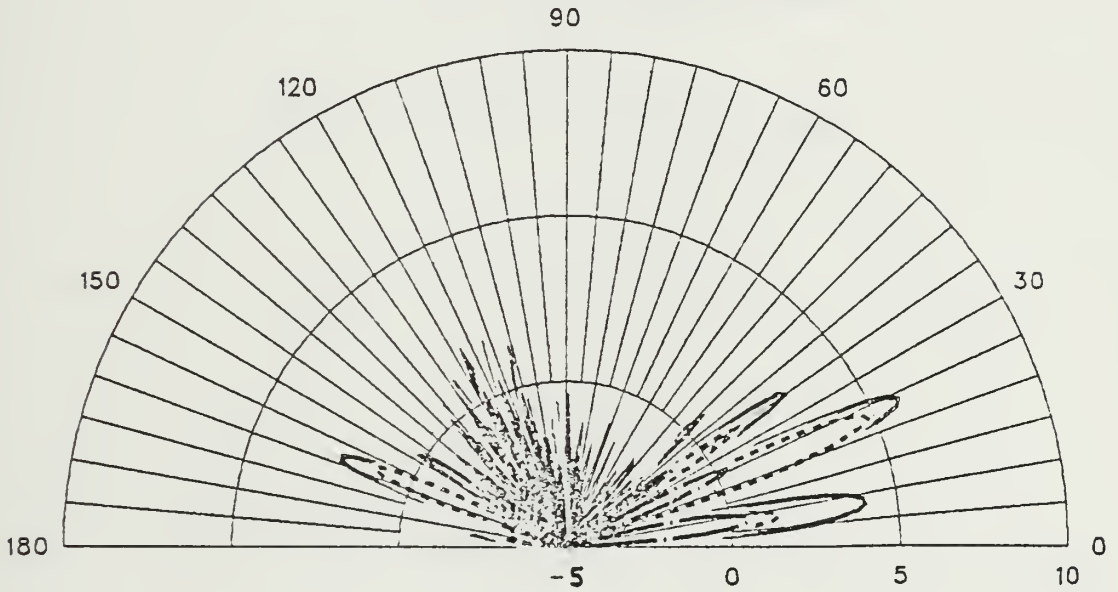

HMMWV DRIVEN 375 X 15 FT ANTENNA

FREQ=30 MHZ PHI=30 UNTERMINATED

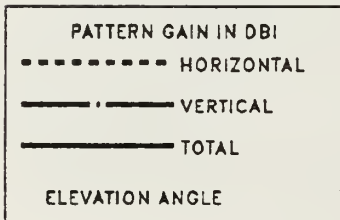
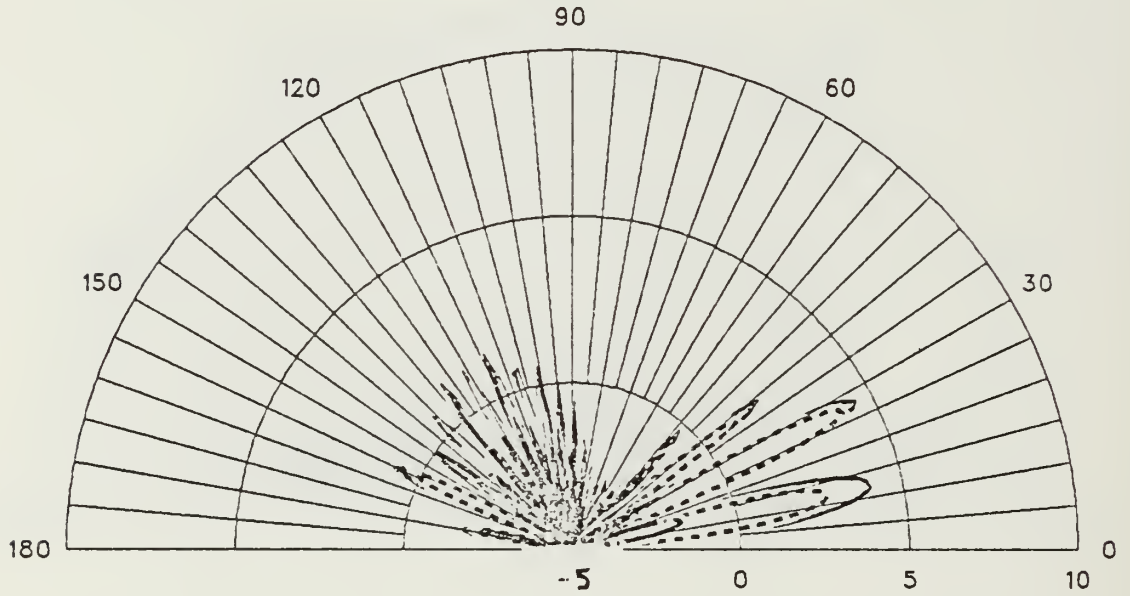

HMMWV DRIVEN 375 X 15 FT ANTENNA

FREQ=30 MHZ PHI=40 UNTERMINATED

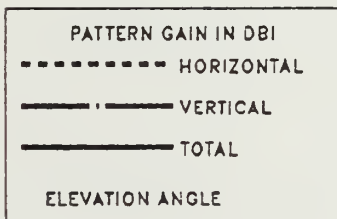
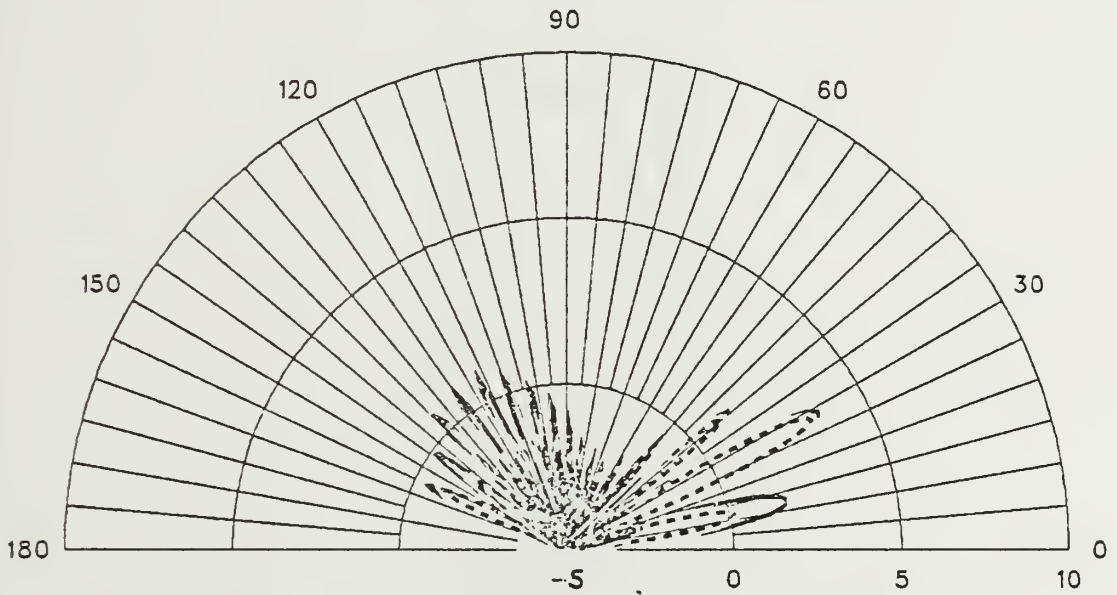

HMMWV DRIVEN 375 X 15 FT ANTENNA

FREQ=30 MHZ THETA=80 UNTERMINATED

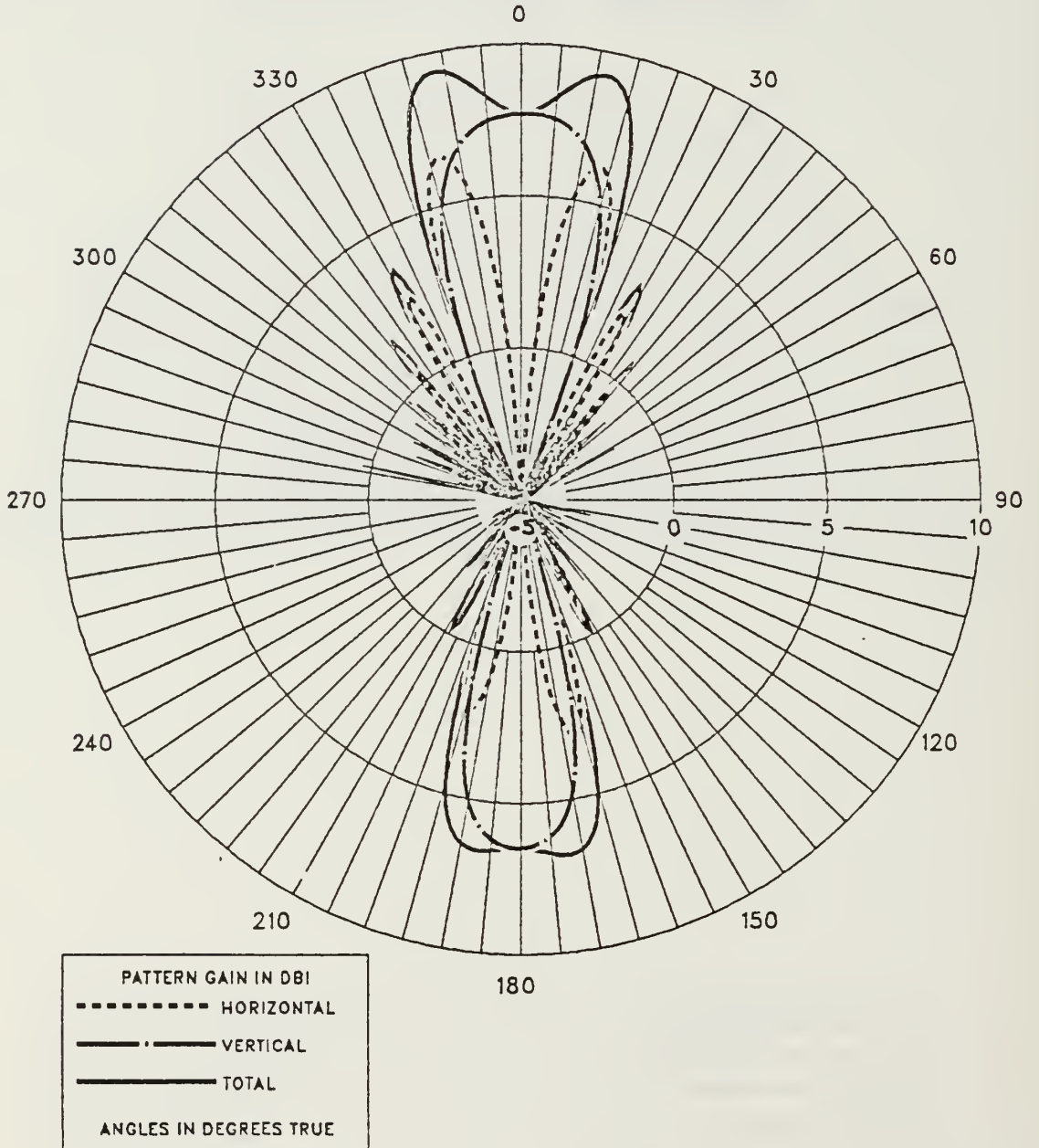

HMMWV DRIVEN 375 X 15 FT ANTENNA

FREQ=30 MHZ THETA=75 UNTERMINATED

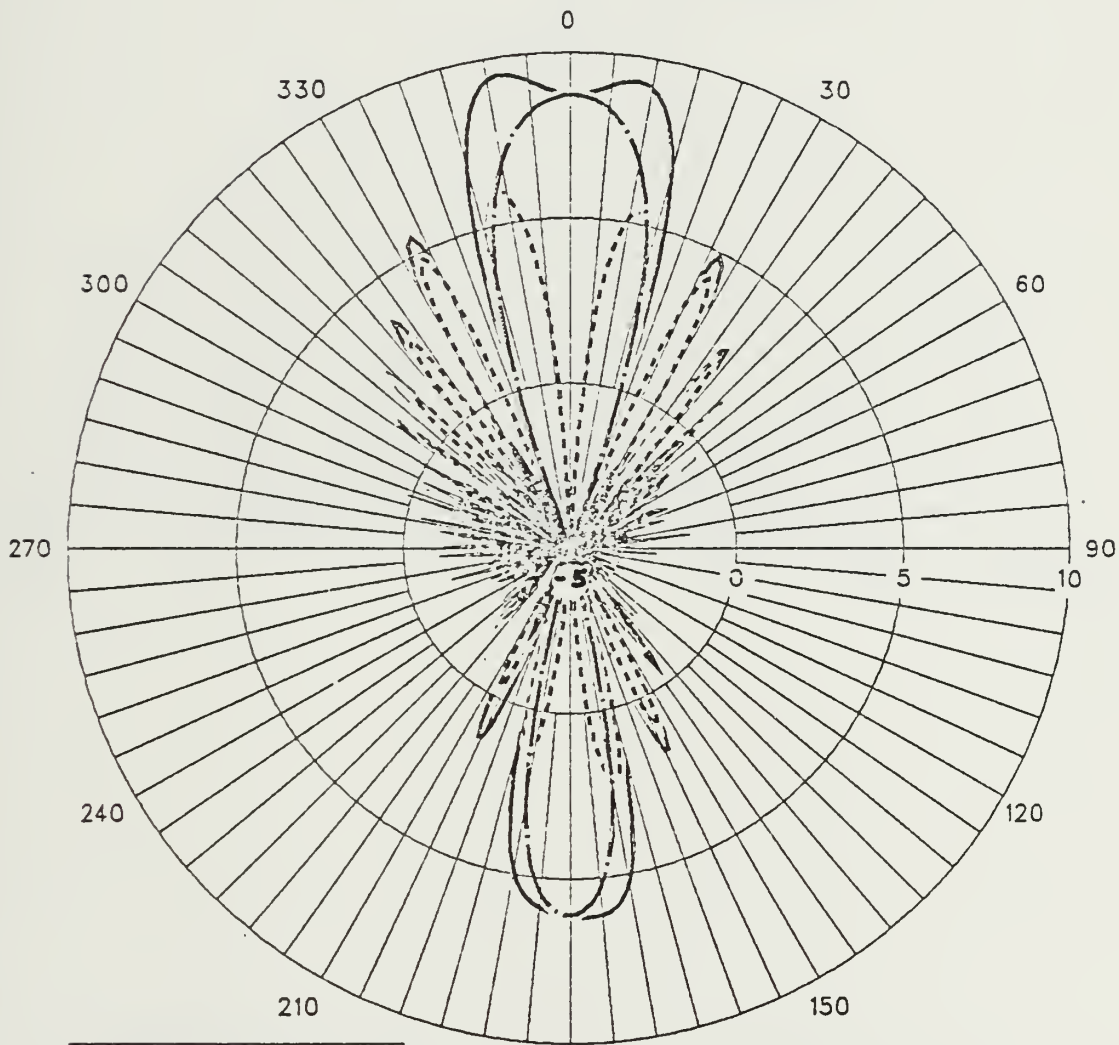

PATTERN GAIN IN DBI
----- HORIZONTAL
..... VERTICAL
————— TOTAL
ANGLES IN DEGREES TRUE

HMMWV DRIVEN 564 X 6 FT ANTENNA

FREQ=17 MHZ PHI=0 UNTERMINATED

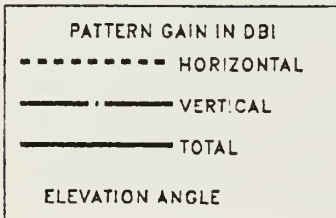
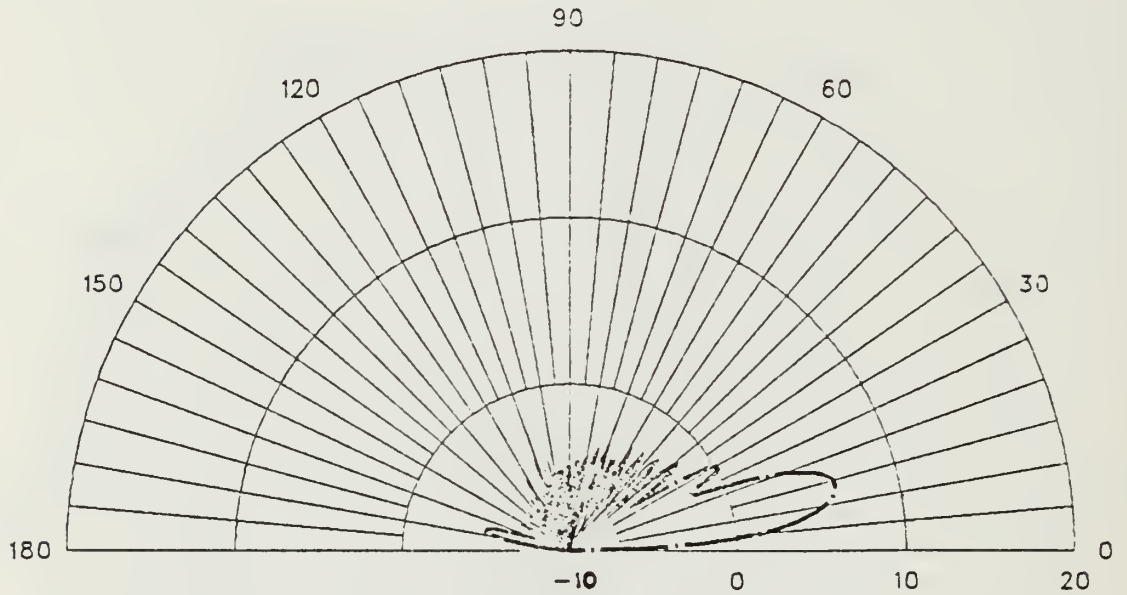

HMMWV DRIVEN 564 X 6 FT ANTENNA

FREQ=17 MHZ PHI=10 UNTERMINATED

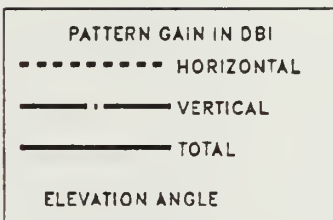
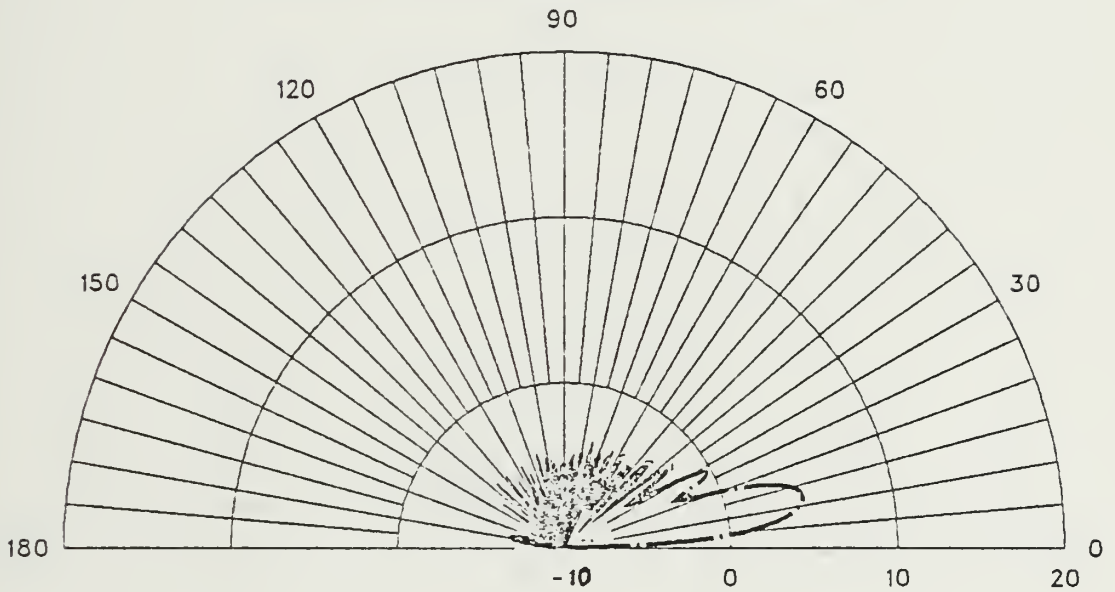

HMMWV DRIVEN 564 X 6 FT ANTENNA

FREQ=17 MHZ PHI=20 UNTERMINATED

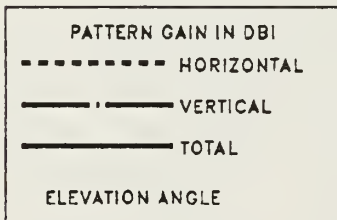
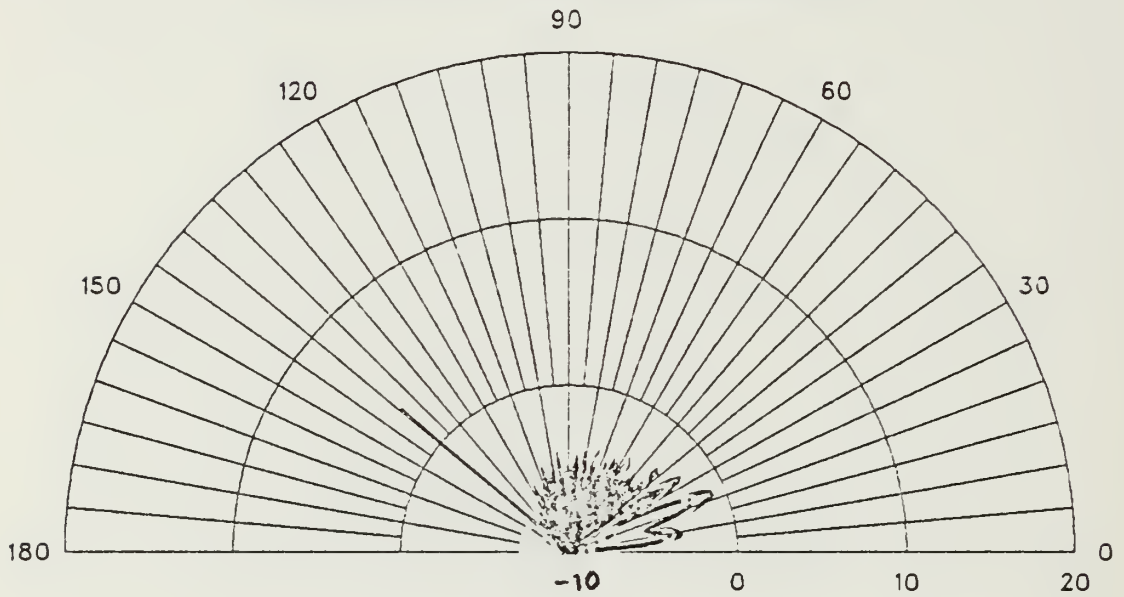

HMMWV DRIVEN 564 X 6 FT ANTENNA

FREQ=17 MHZ PHI=30 UNTERMINATED

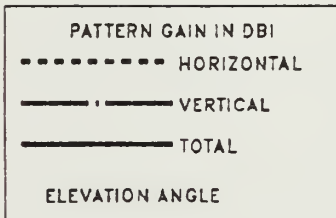
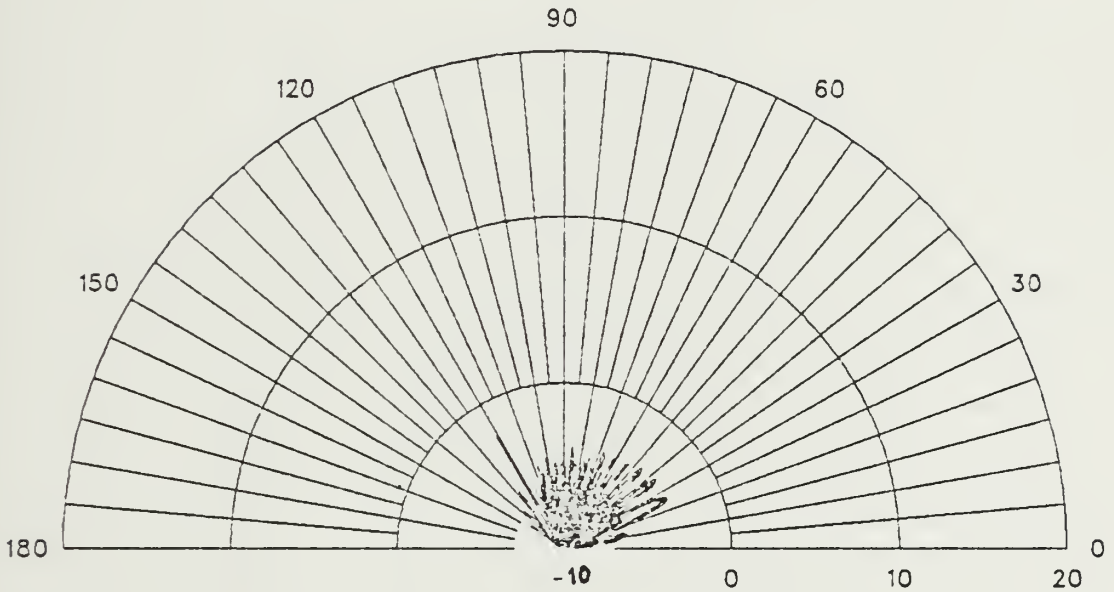

HMMWV DRIVEN 564 X 6 FT ANTENNA

FREQ=17 MHZ PHI=40 UNTERMINATED

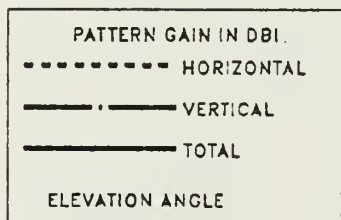
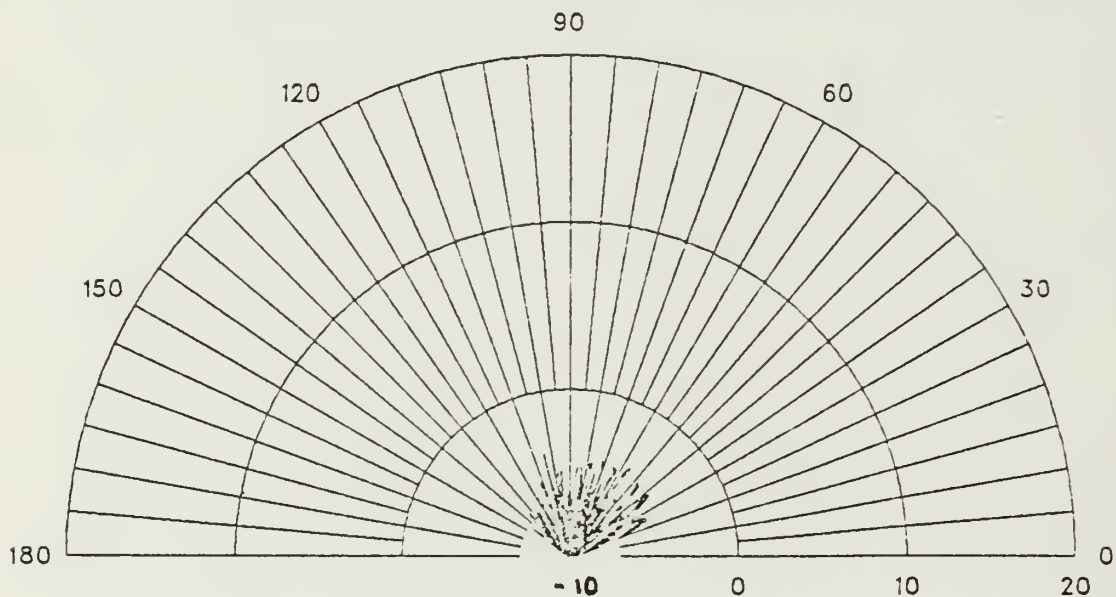

HMMWV DRIVEN 564 X 6 FT ANTENNA

FREQ=17 MHZ THETA=75 UNTERMINATED

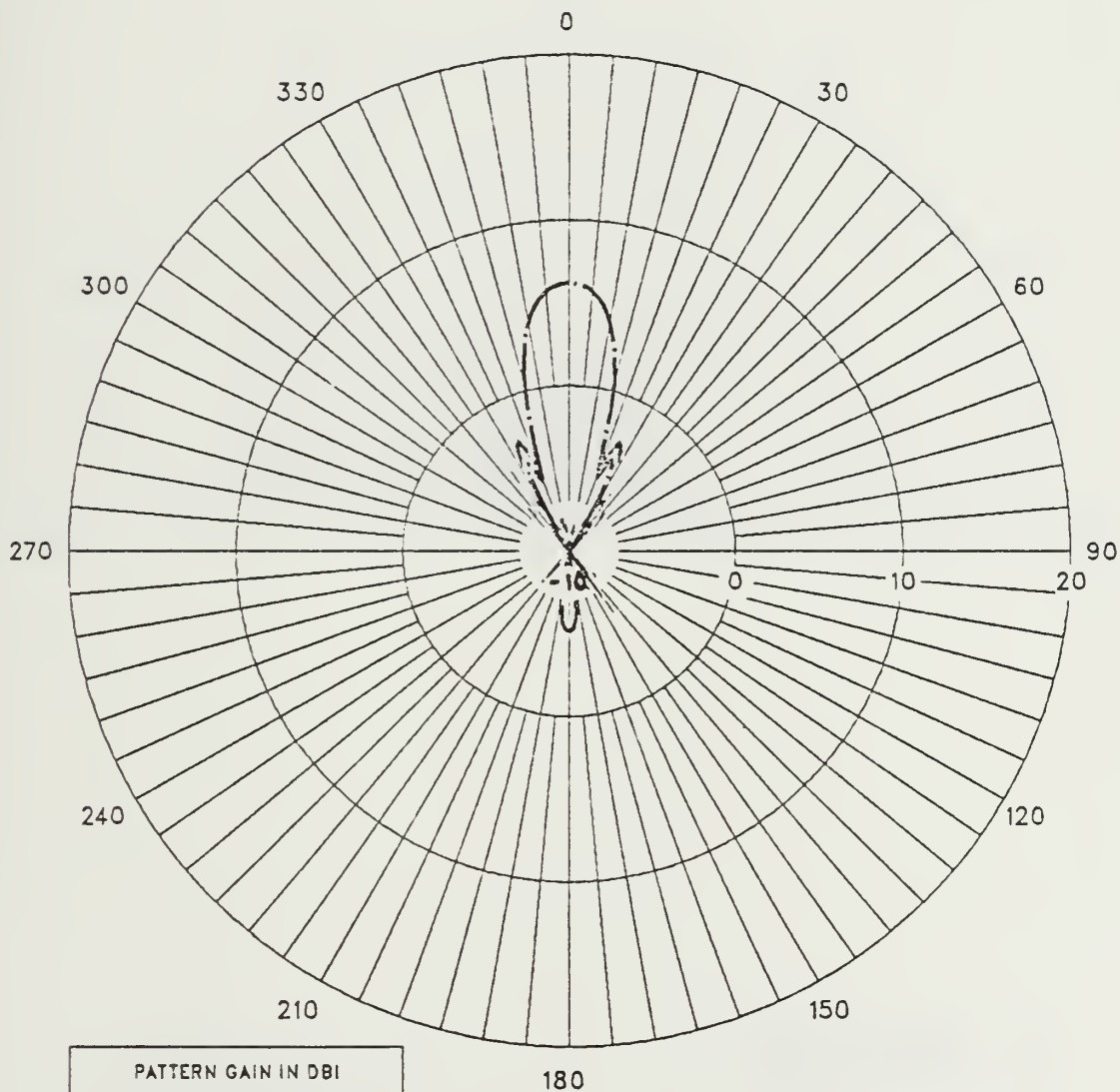

PATTERN GAIN IN DBI
- - - - - HORIZONTAL
————— VERTICAL
————— TOTAL
ANGLES IN DEGREES TRUE

HMMWV DRIVEN 564 X 06 FT ANTENNA

FREQ=30 MHZ PHI=0 UNTERMINATED

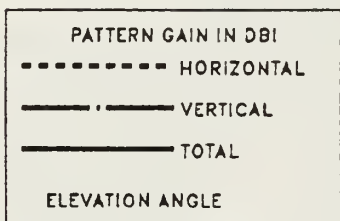
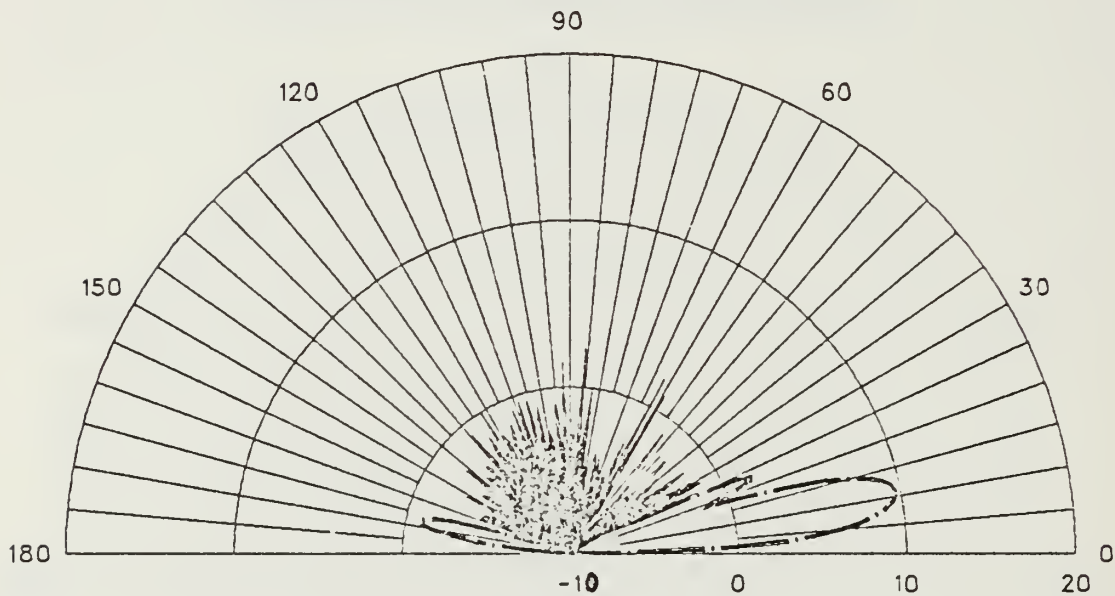

HMMWV DRIVEN 564 X 06 FT ANTENNA

FREQ=30 MHZ PHI=10 UNTERMINATED

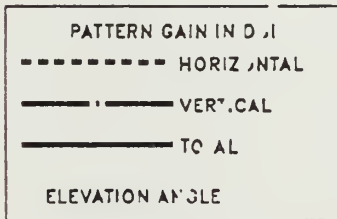
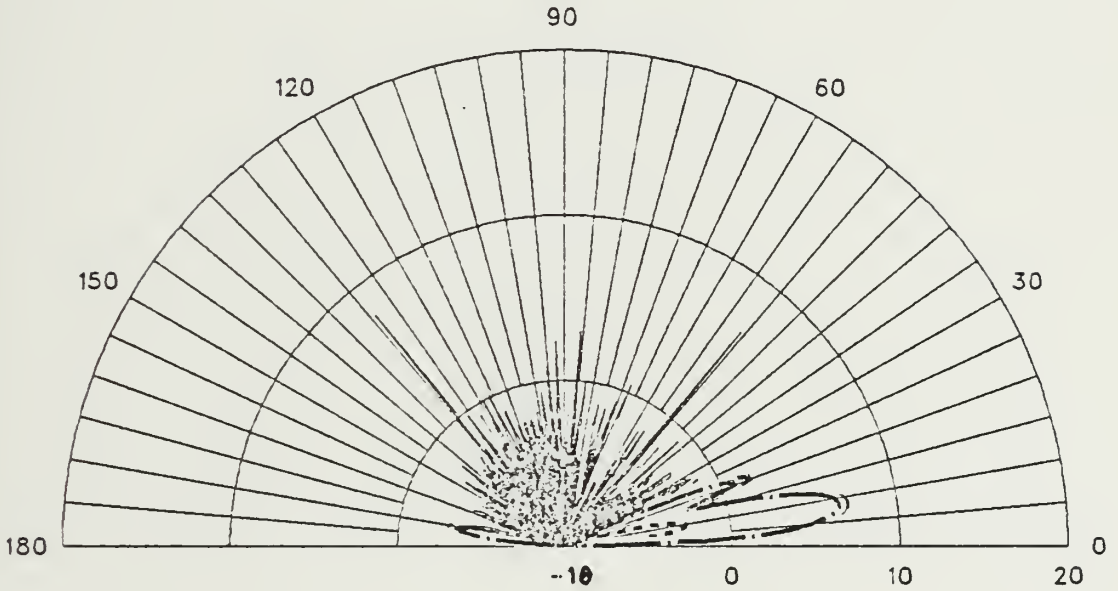

HMMWV DRIVEN 564 X 06 FT ANTENNA

FREQ=30 MHZ PHI=20 UNTERMINATED

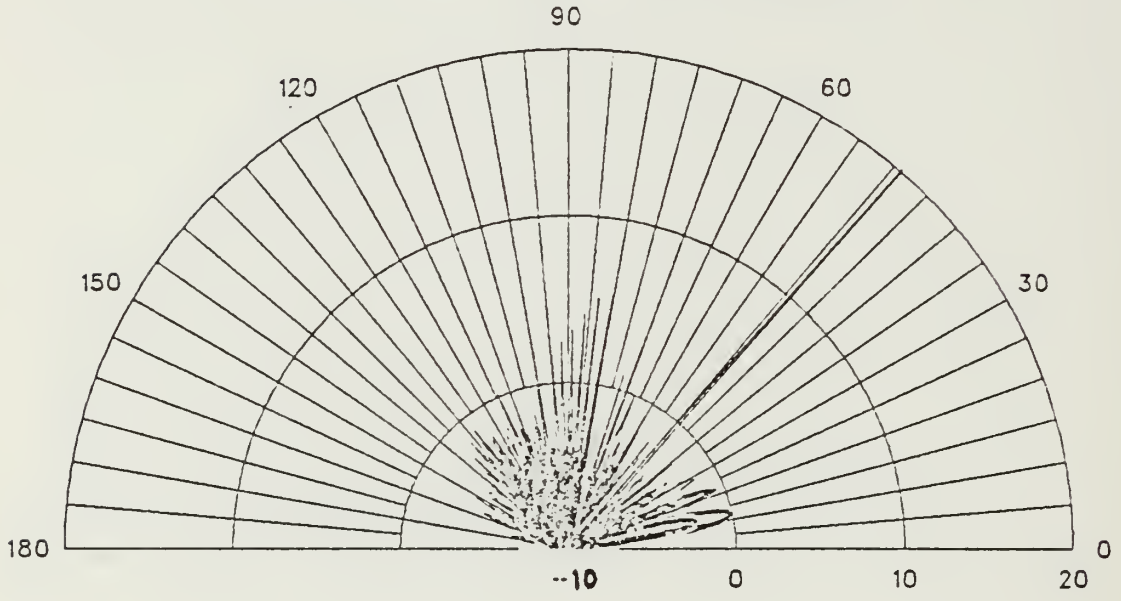

PATTERN GAIN IN DBI	
-----	HORIZONTAL
-----	VERTICAL
-----	TOTAL
ELEVATION ANGLE	

HMMWV DRIVEN 564 X 06 FT ANTENNA

FREQ=30 MHZ PHI=30 UNTERMINATED

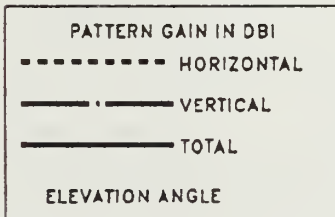
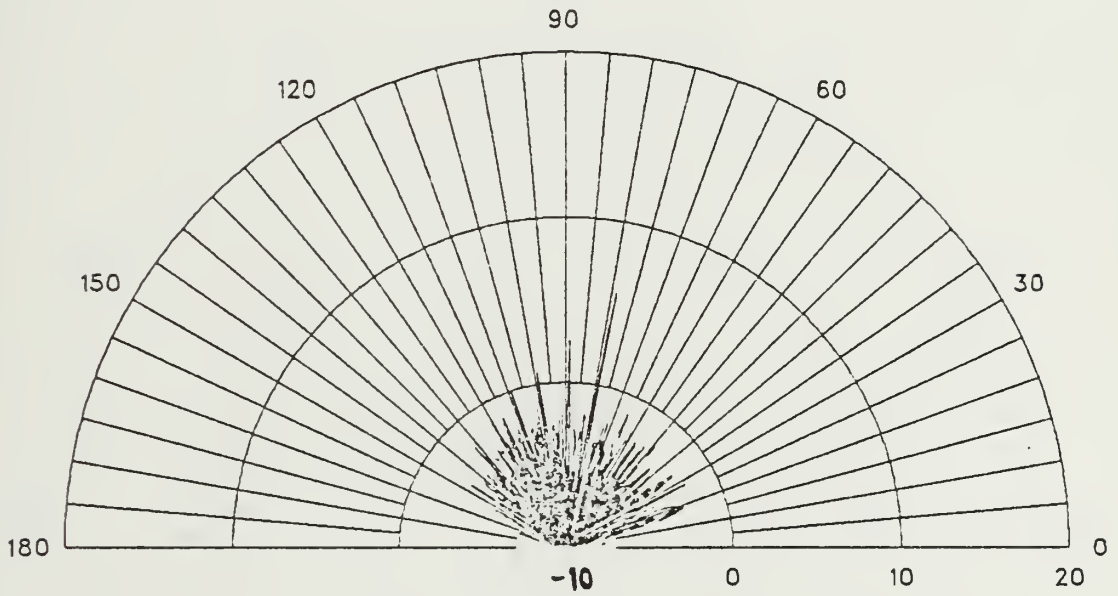

HMMWV DRIVEN 564 X 06 FT ANTENNA

FREQ=30 MHZ THETA=80 UNTERMINATED

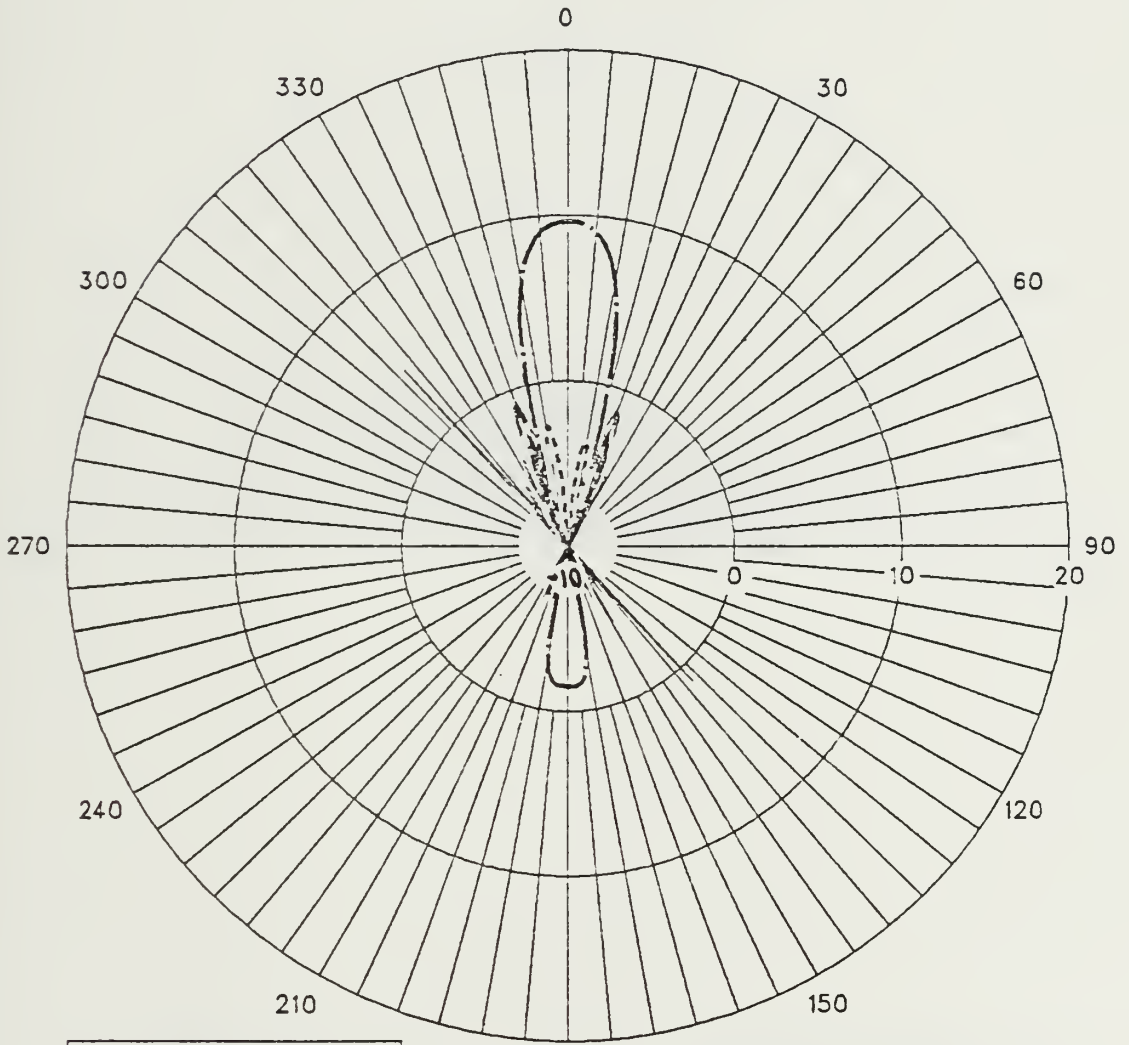

PATTERN GAIN IN DBI
----- HORIZONTAL
- - - - - VERTICAL
————— TOTAL
ANGLES IN DEGREES TRUE

HMMWV DRIVEN 564 X 15 FT ANTENNA

FREQ=17 MHZ PHI=0 UNTERMINATED

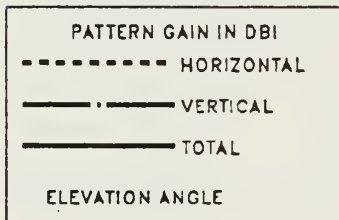
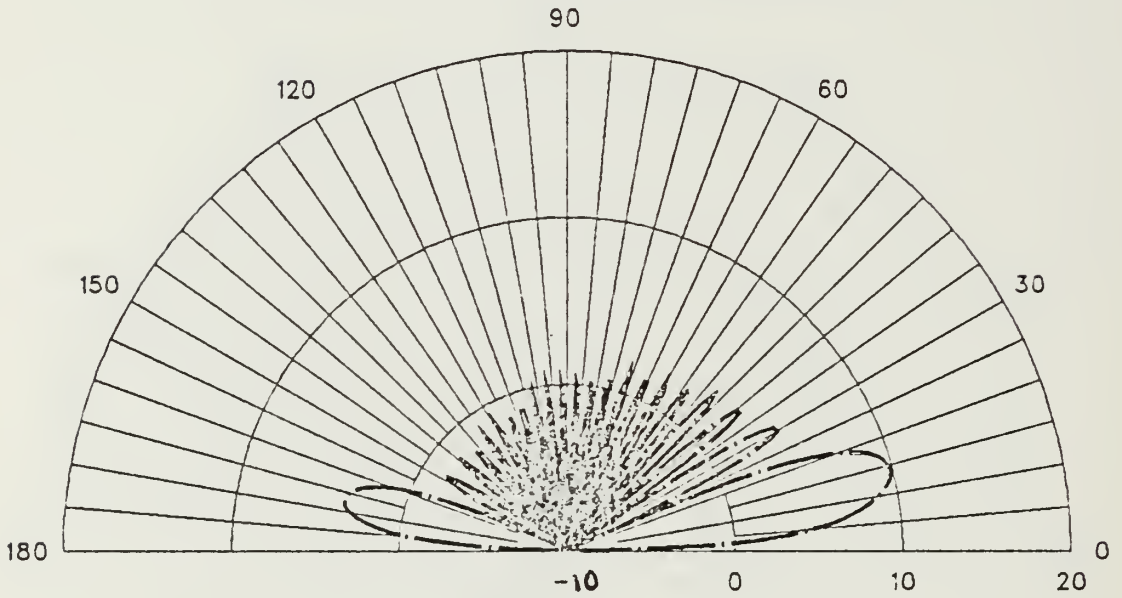

HMMWV DRIVEN 564 X 15 FT ANTENNA

FREQ=17 MHZ PHI=10 UNTERMINATED

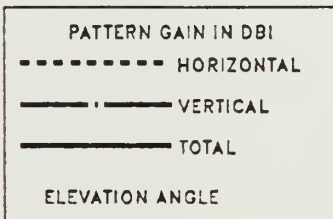
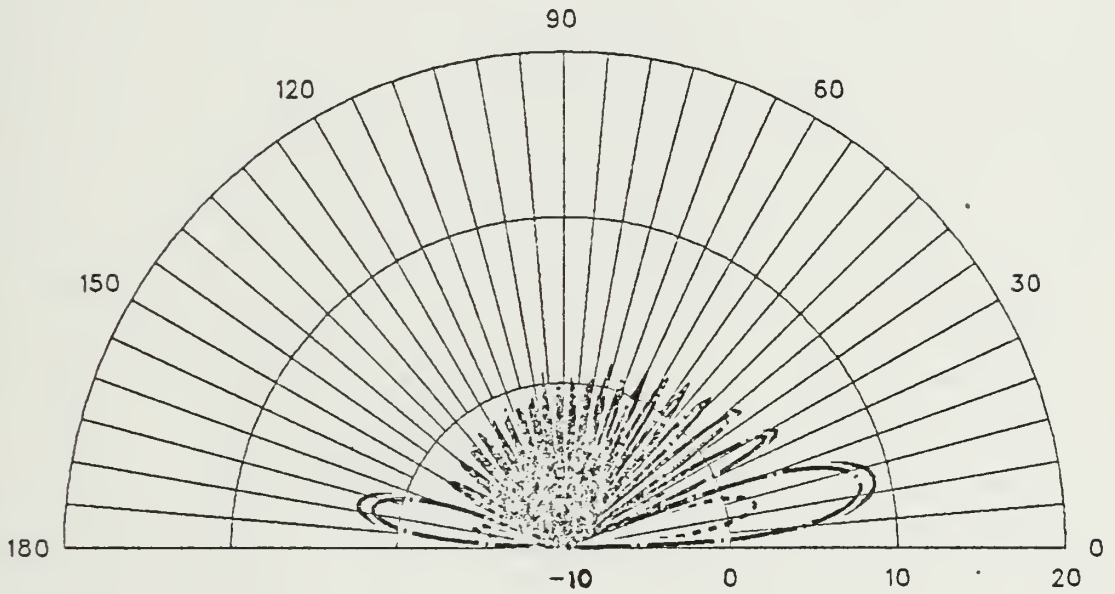

HMMWV DRIVEN 564 X 15 FT ANTENNA

FREQ=17 MHZ PHI=20 UNTERMINATED

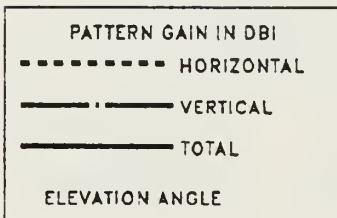
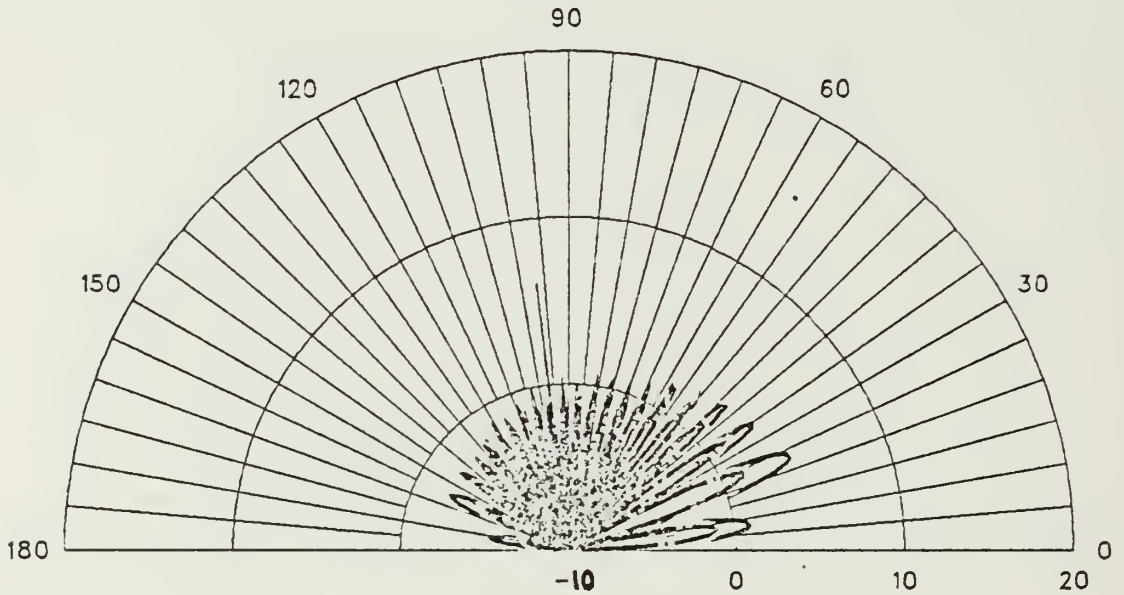

HMMWV DRIVEN 564 X 15 FT ANTENNA

FREQ=17 MHZ PHI=30 UNTERMINATED

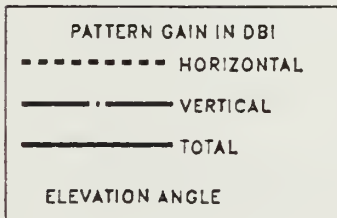
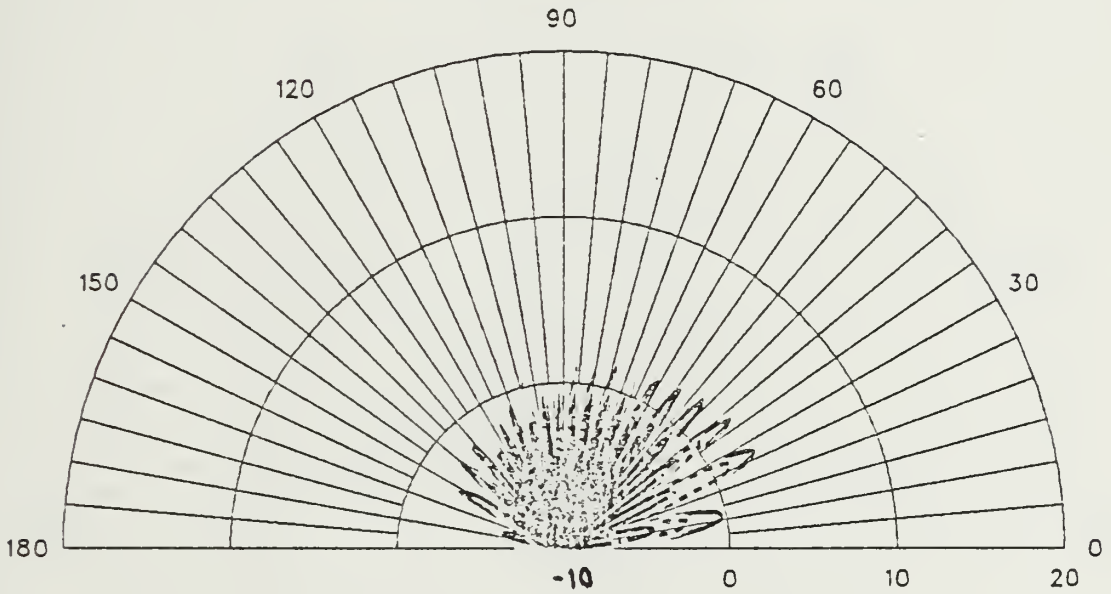

HMMWV DRIVEN 564 X 15 FT ANTENNA

FREQ=17 MHZ PHI=40 UNTERMINATED

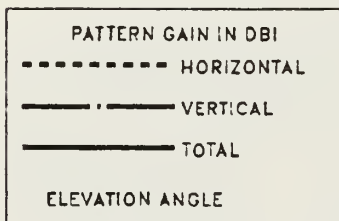
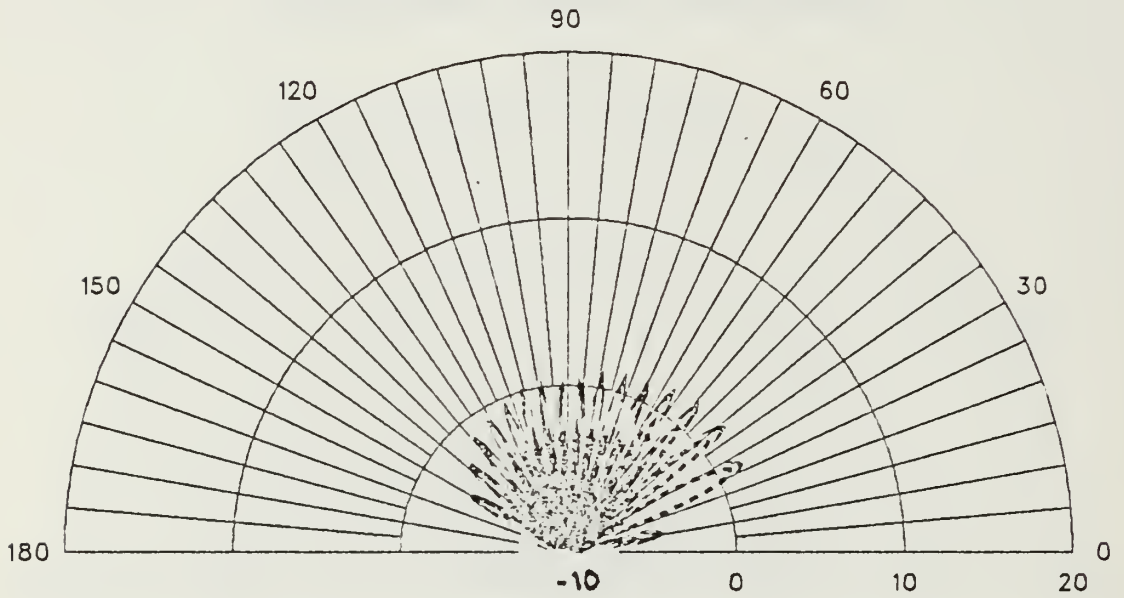

HMMWV DRIVEN 564 X 15 FT ANTENNA

FREQ=17 MHZ THETA=75 UNTERMINATED

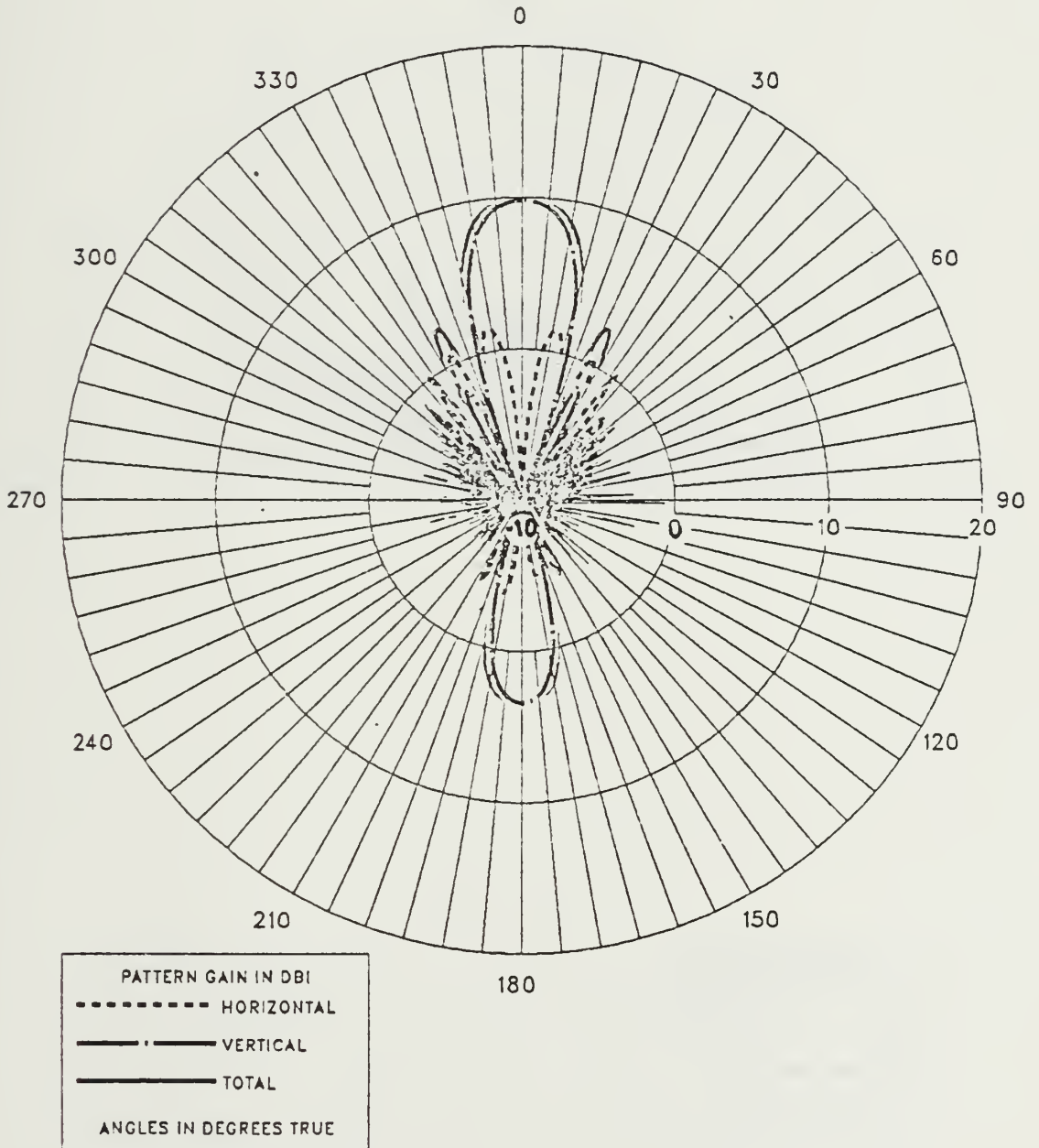

HMMWV DRIVEN 564 X 15 FT ANTENNA

FREQ=30 MHZ PHI=0 UNTERMINATED

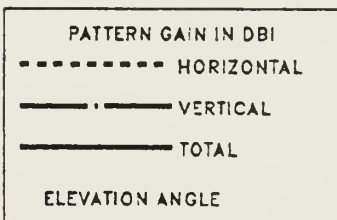
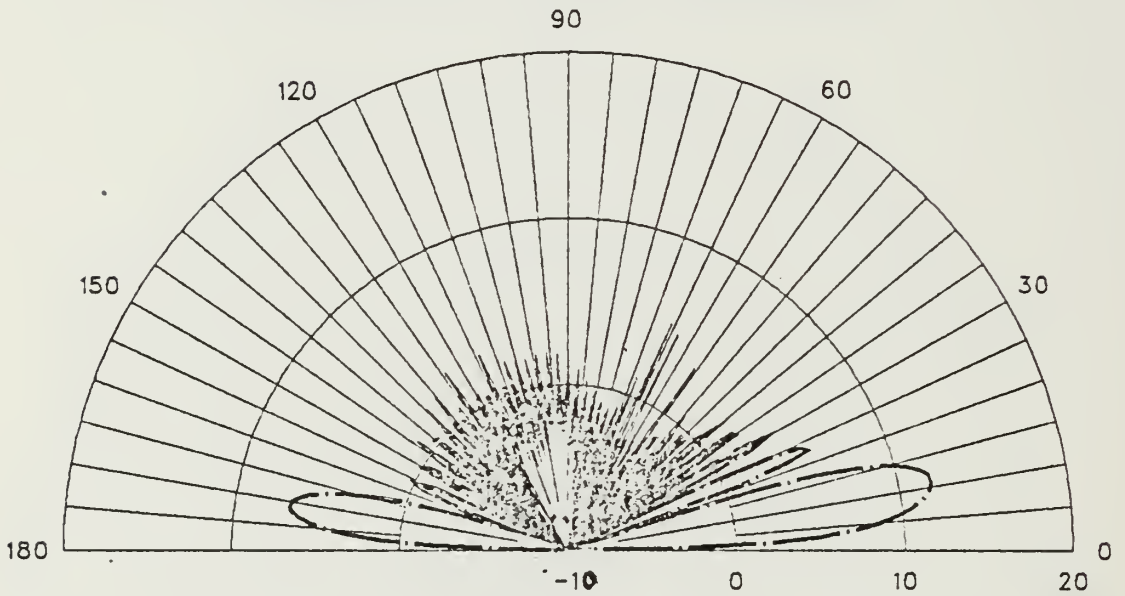

HMMWV DRIVEN 564 X 15 FT ANTENNA

FREQ=30 MHZ PHI=10 UNTERMINATED

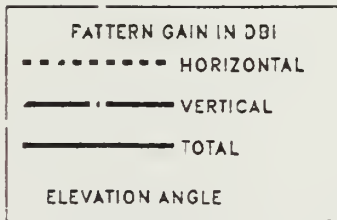
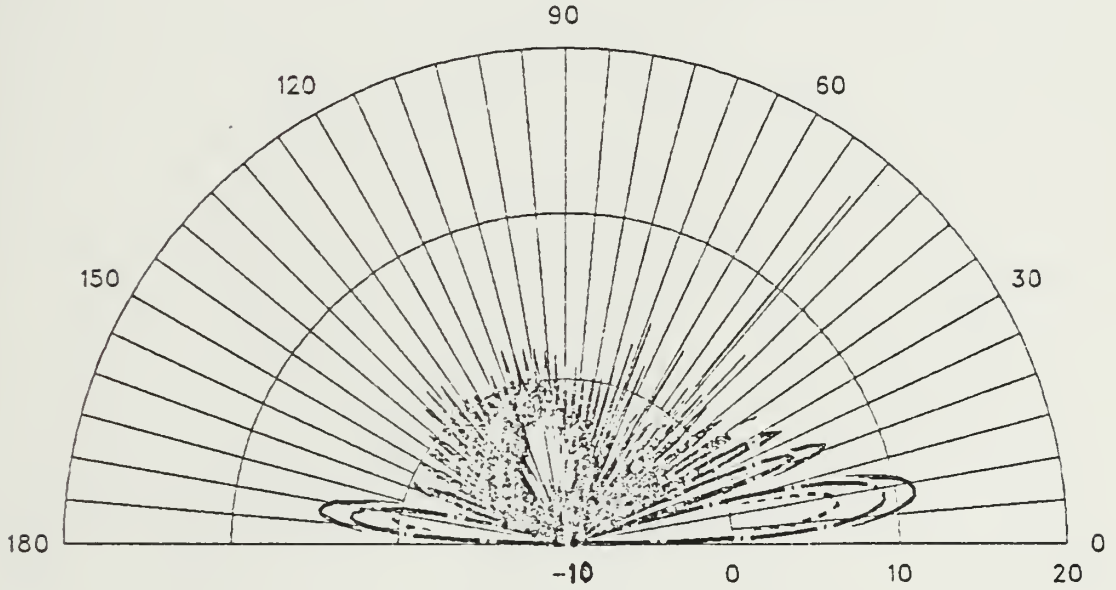

HMMWV DRIVEN 564 X 15 FT ANTENNA

FREQ=30 MHZ PHI=20 UNTERMINATED

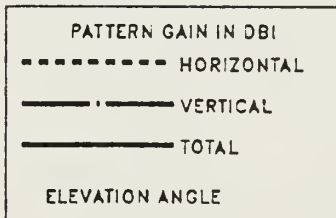
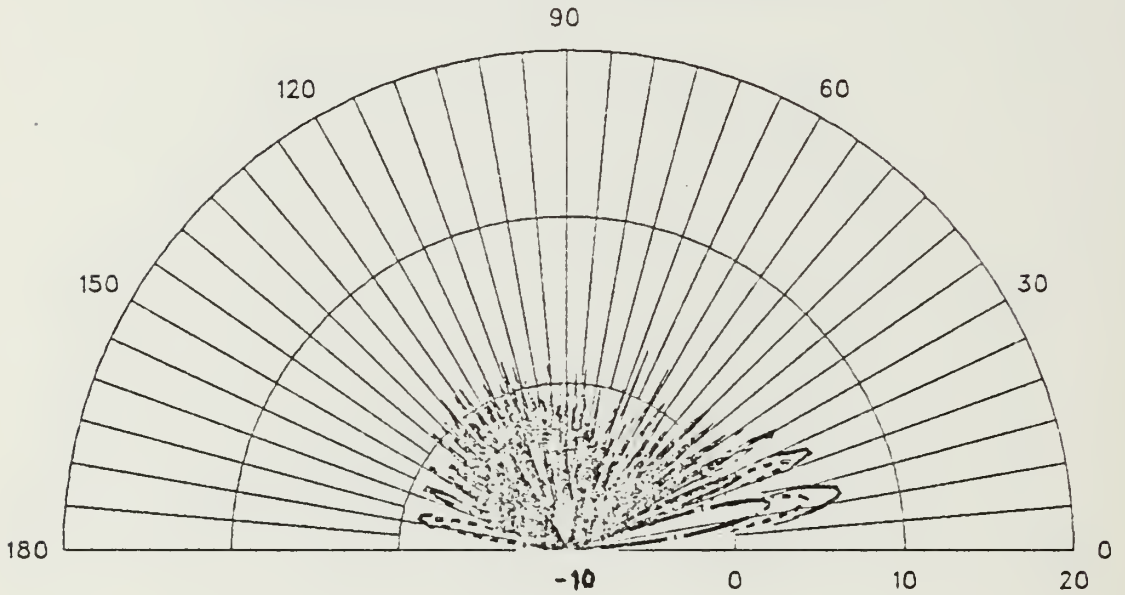

HMMWV DRIVEN 564 X 15 FT ANTENNA

FREQ=30 MHZ PHI=40 UNTERMINATED

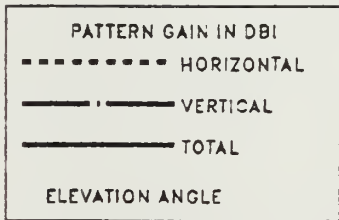
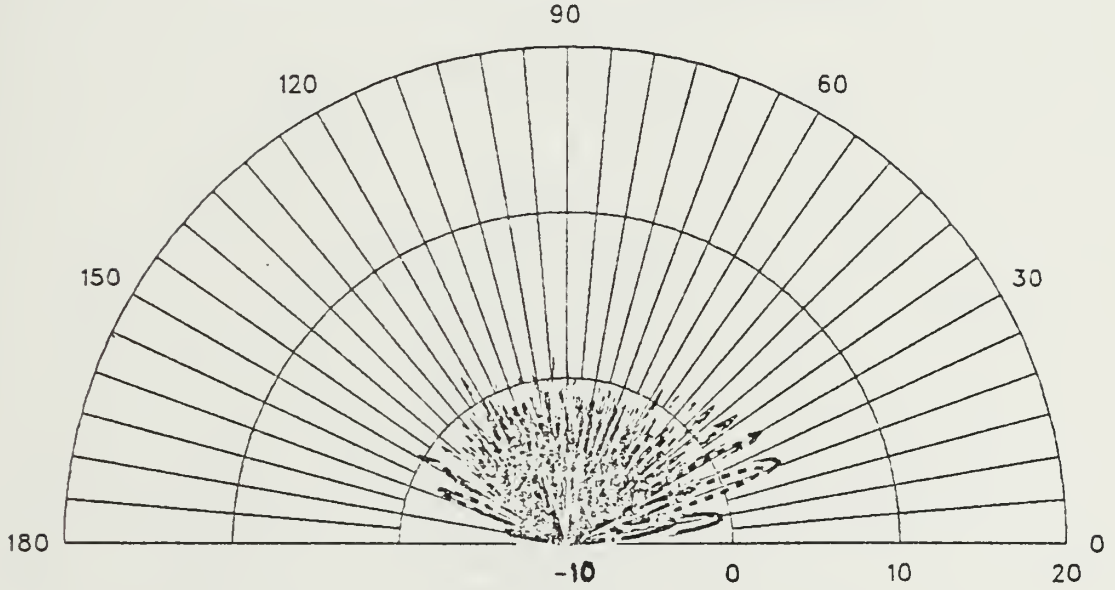

HMMWV DRIVEN 564 X 15 FT ANTENNA

FREQ=30 MHZ THETA=80 UNTERMINATED

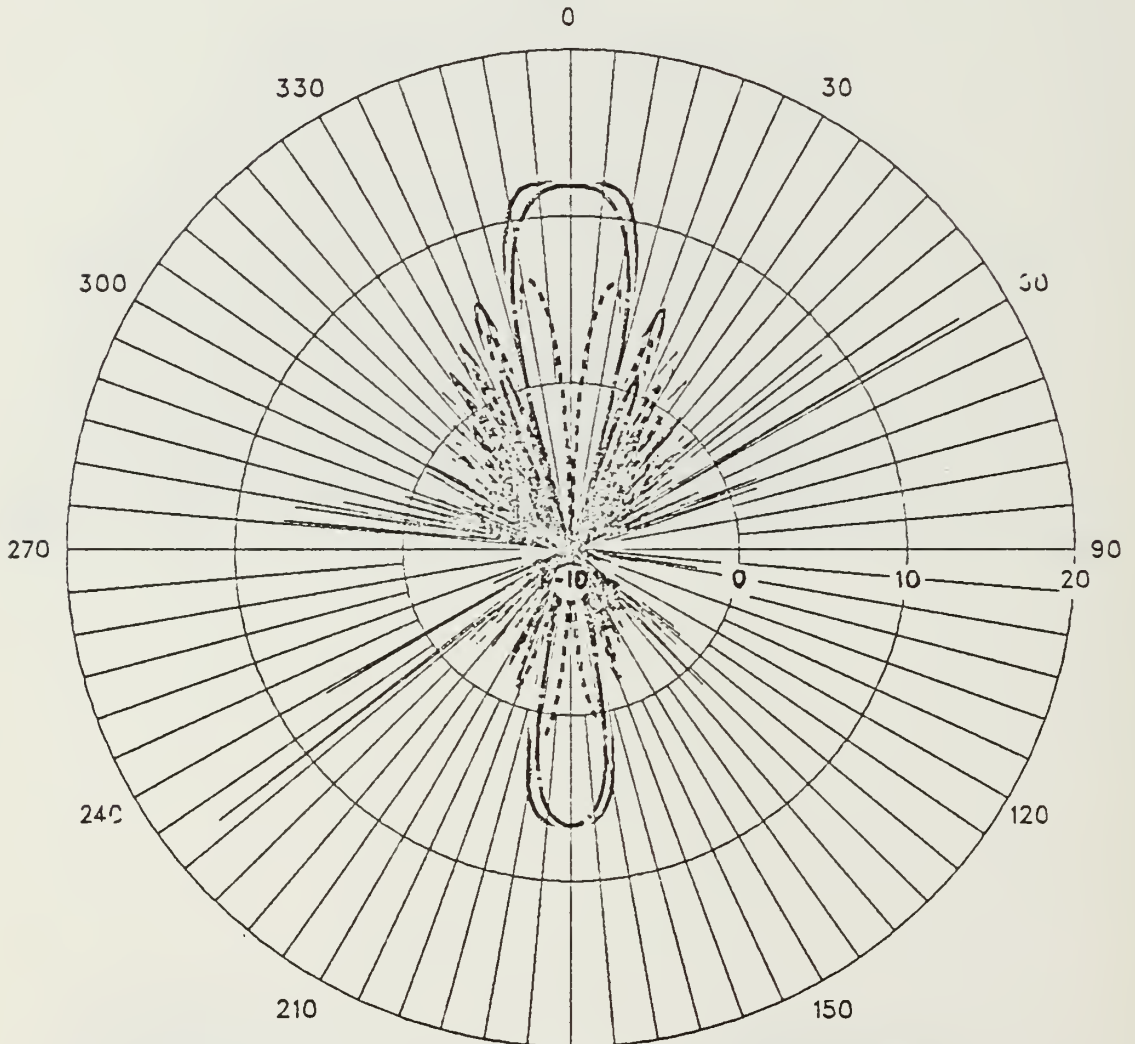

PATTERN GAIN IN DBI
- - - - - HORIZONTAL
- . - . - VERTICAL
- - - - - TOTAL
ANGLES IN DEGREES TRUE

HALF WAVE DOUBLET ANTENNA

HT= 6 FT FREQ=17 MHZ PHI=20

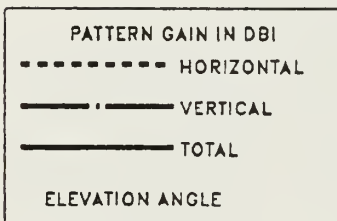
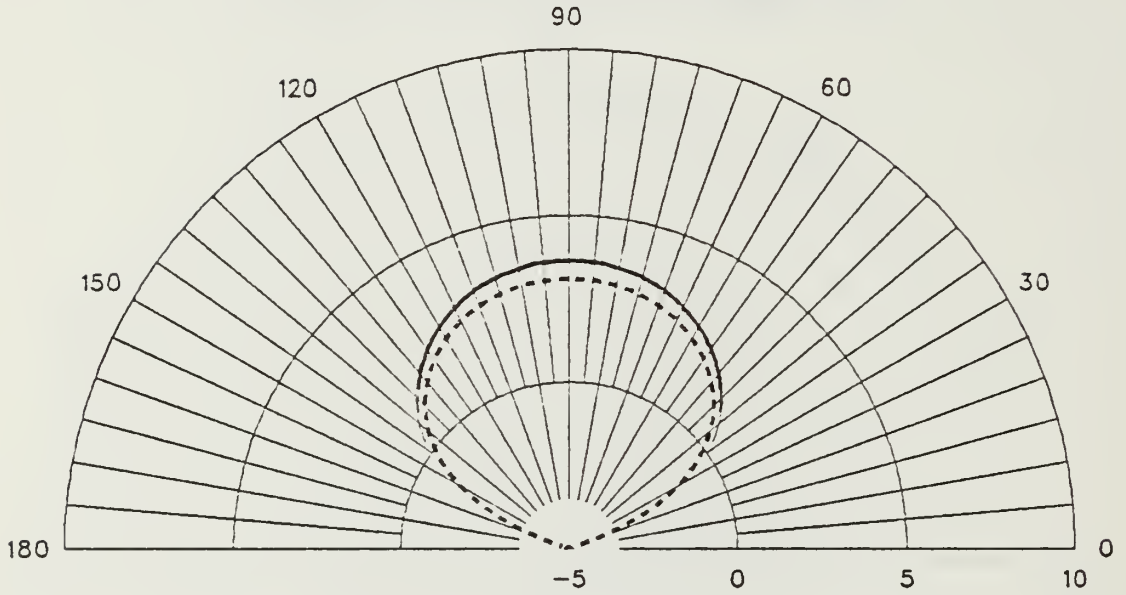

HALF WAVE DOUBLET ANTENNA

HT= 6 FT FREQ=17 MHZ PHI=40

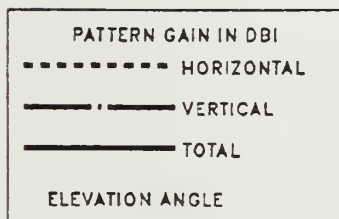
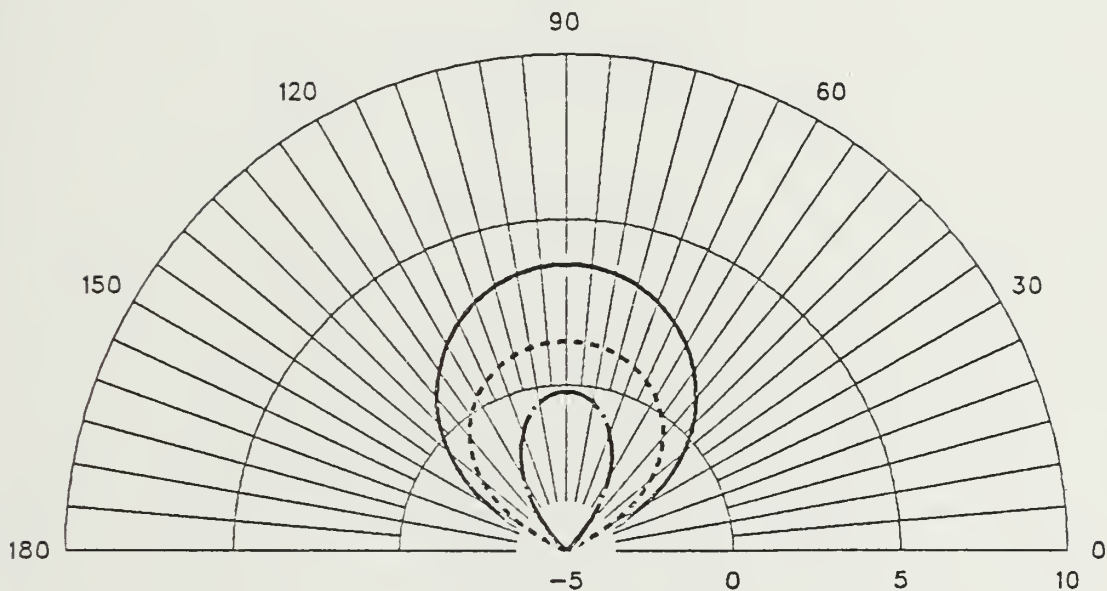

HALF WAVE DOUBLET ANTENNA

HT= 6 FT FREQ=17 MHZ THETA=70

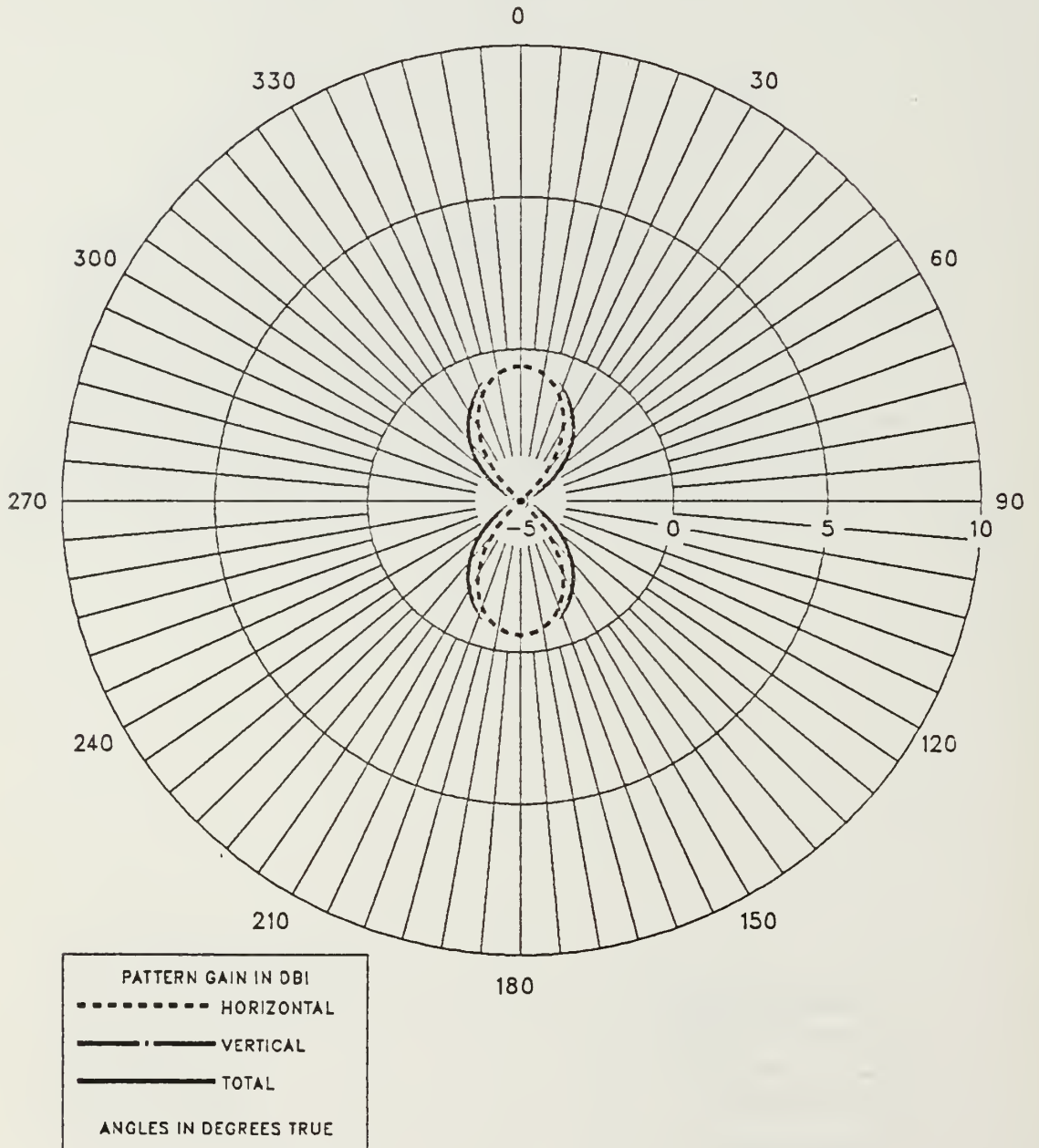

HALF WAVE DOUBLET ANTENNA

HT= 6 FT FREQ=30 MHZ PHI=0

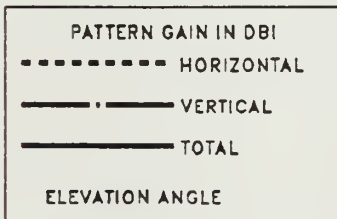
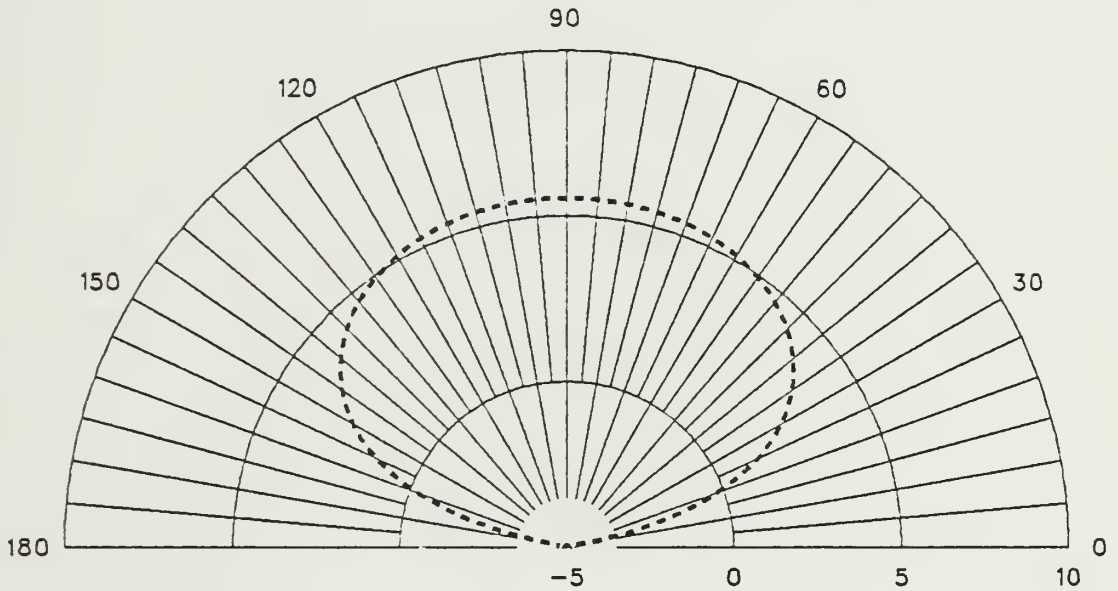

HALF WAVE DOUBLET ANTENNA

HT= 6 FT FREQ=30 MHZ PHI=20

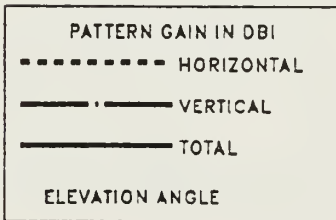
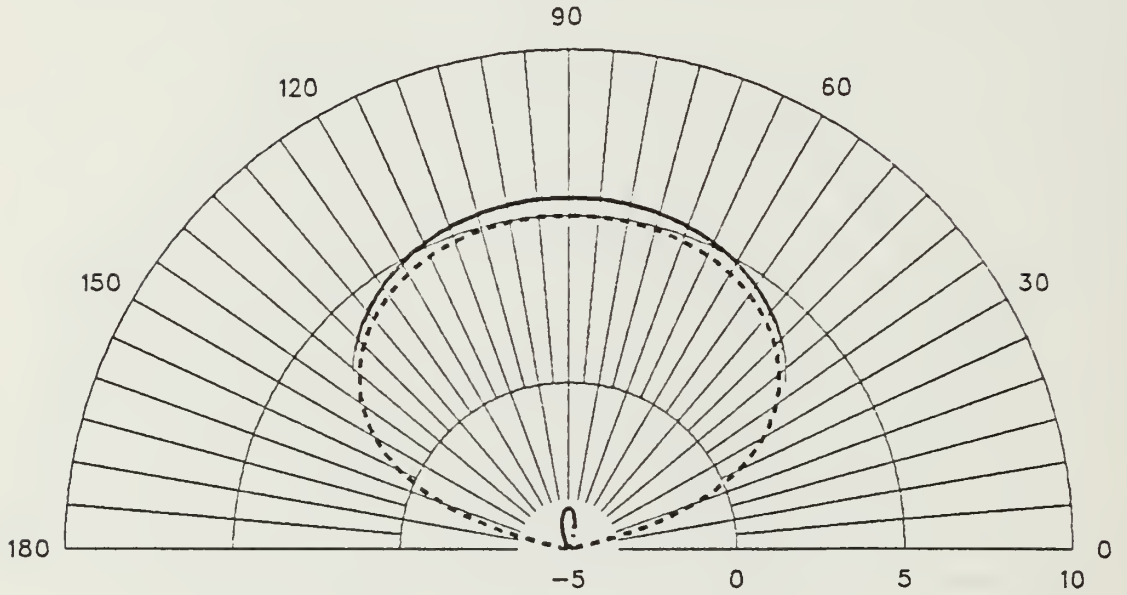

HALF WAVE DOUBLET ANTENNA

HT= 6 FT FREQ=30 MHZ PHI=40

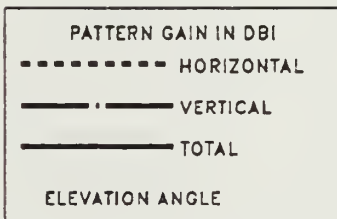
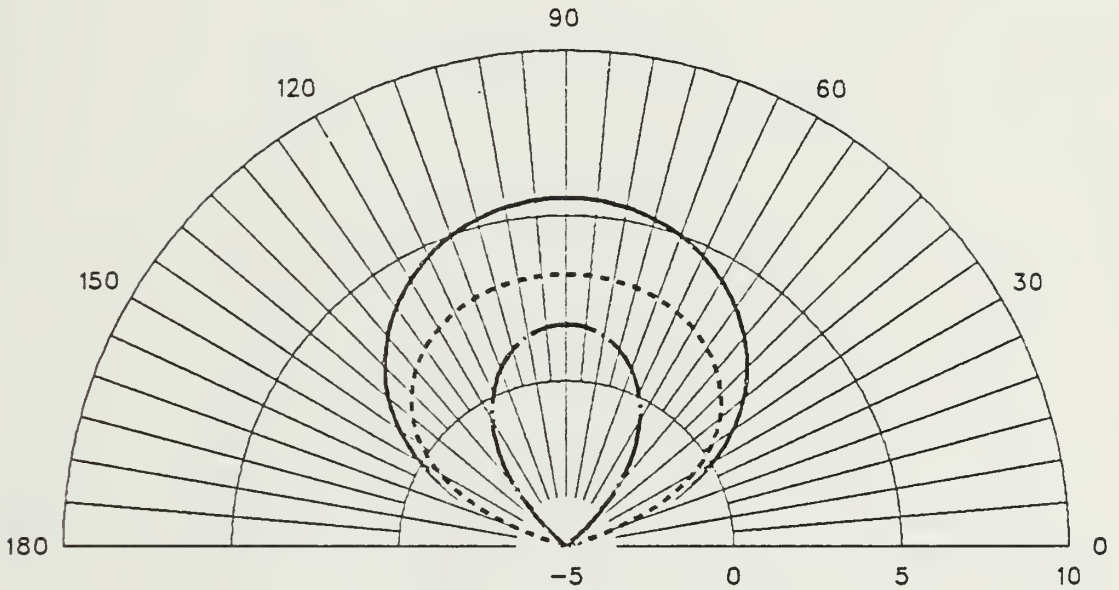

HALF WAVE DOUBLET ANTENNA

HT= 6 FT FREQ=30 MHZ THETA=60

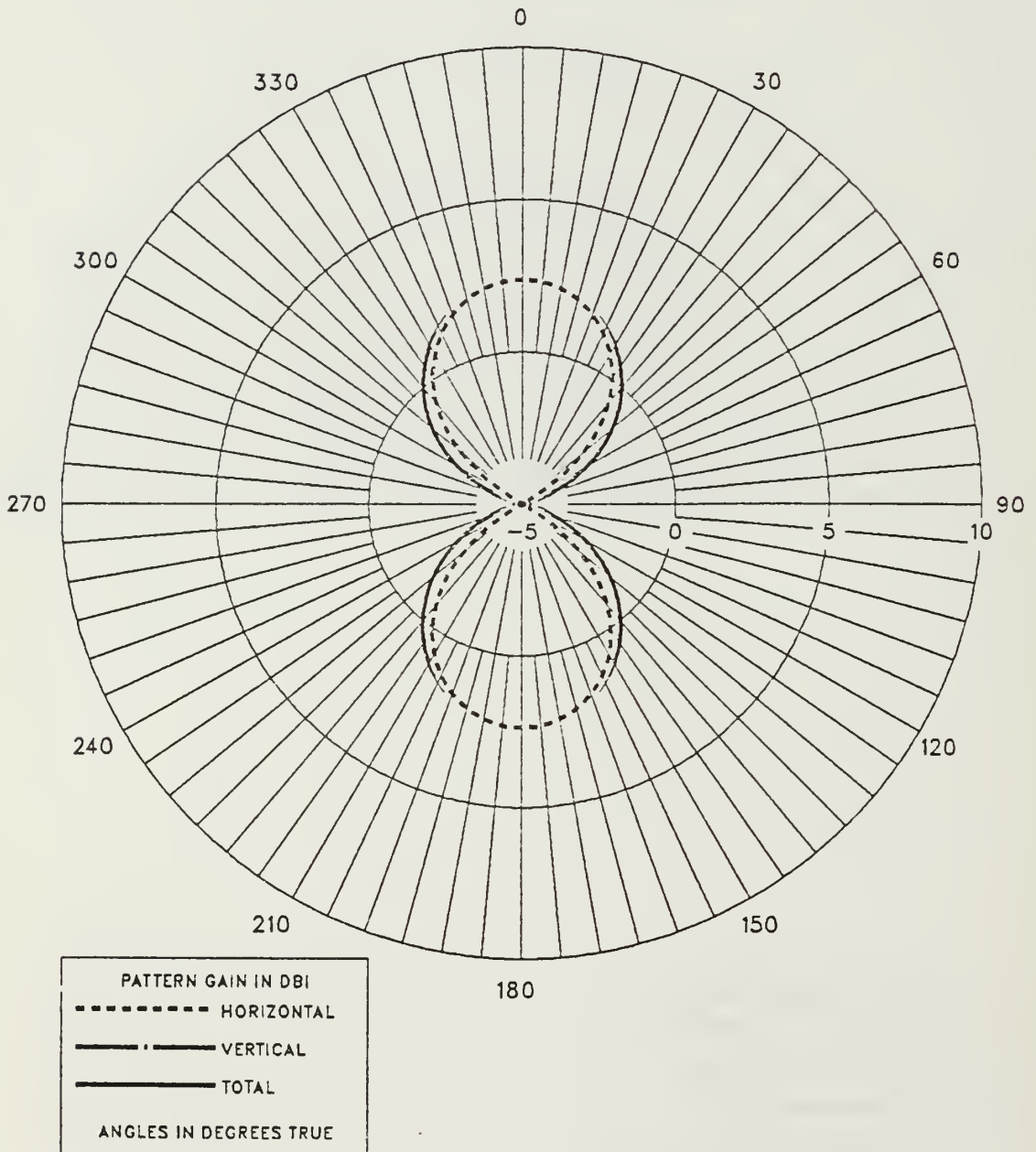

HALF WAVE DOUBLET ANTENNA

HT= 15 FT FREQ=17 MHZ PHI=0

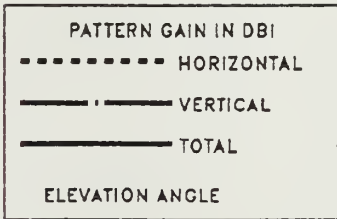
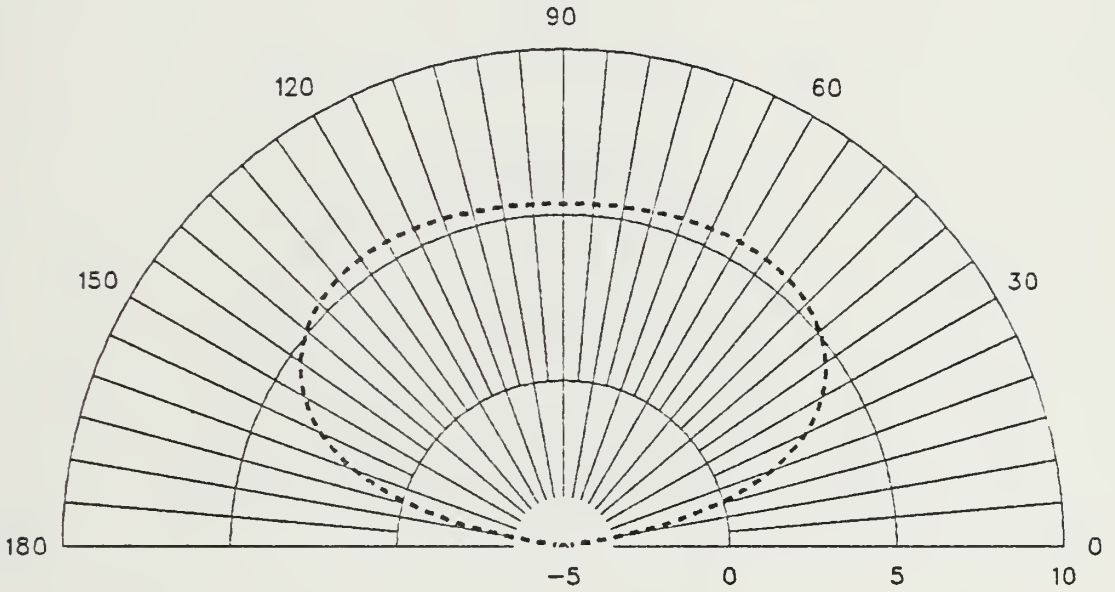

HALF WAVE DOUBLET ANTENNA

HT= 15 FT FREQ=17 MHZ PHI=20

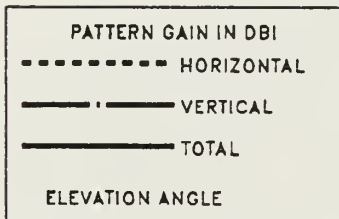
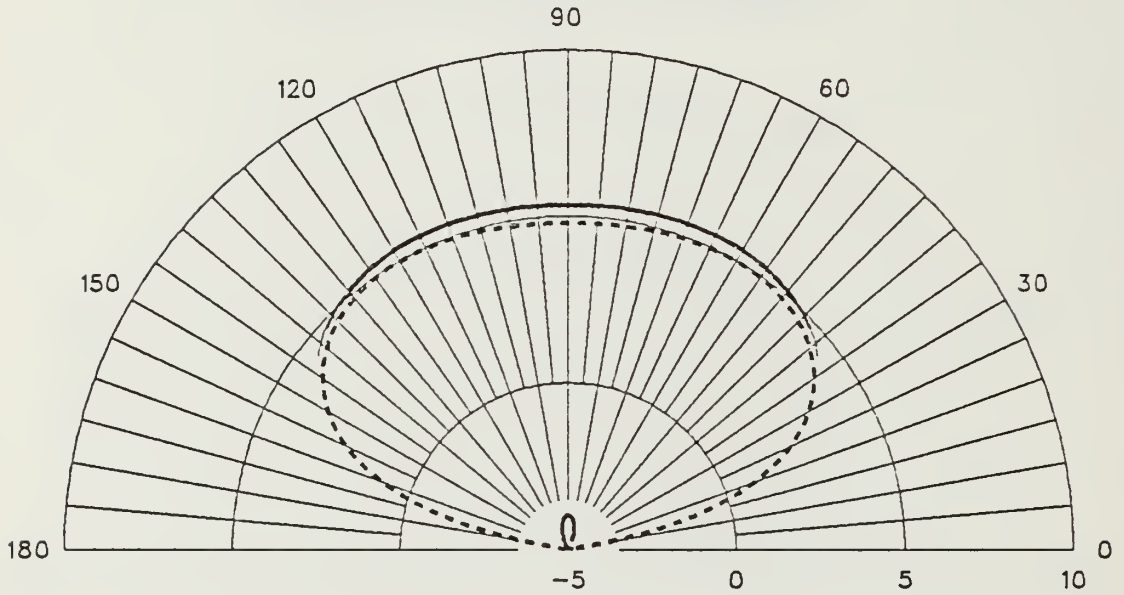

HALF WAVE DOUBLET ANTENNA

HT= 15 FT FREQ=17 MHZ PHI=40

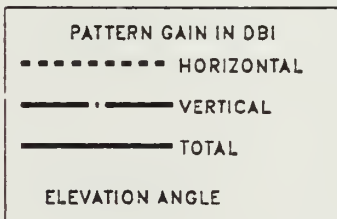
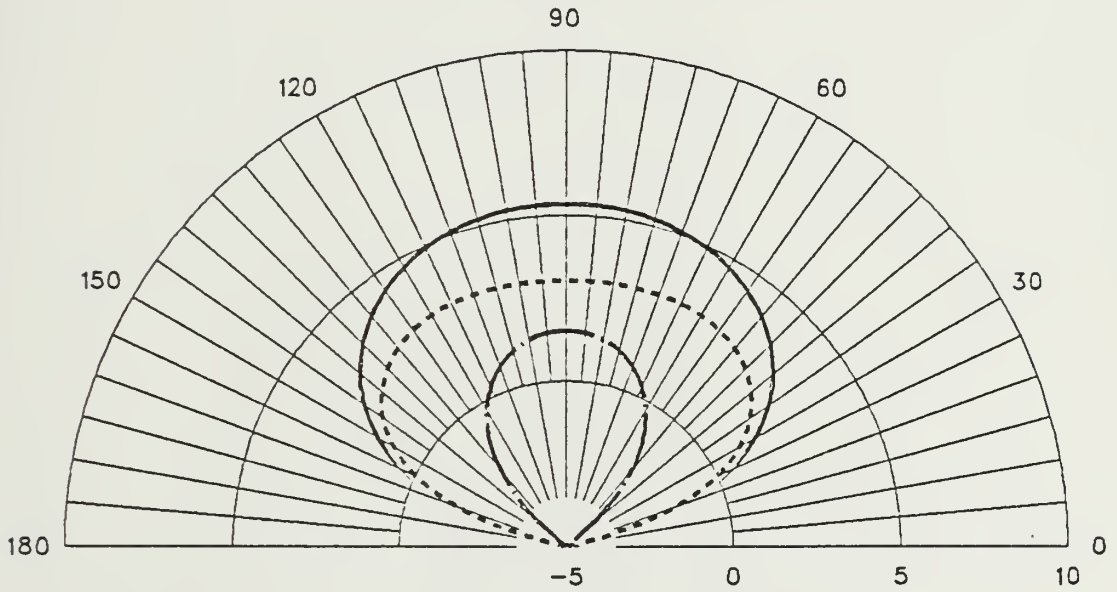

HALF WAVE DOUBLET ANTENNA

HT= 15 FT FREQ=17 MHZ THETA=60

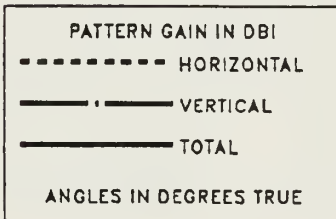
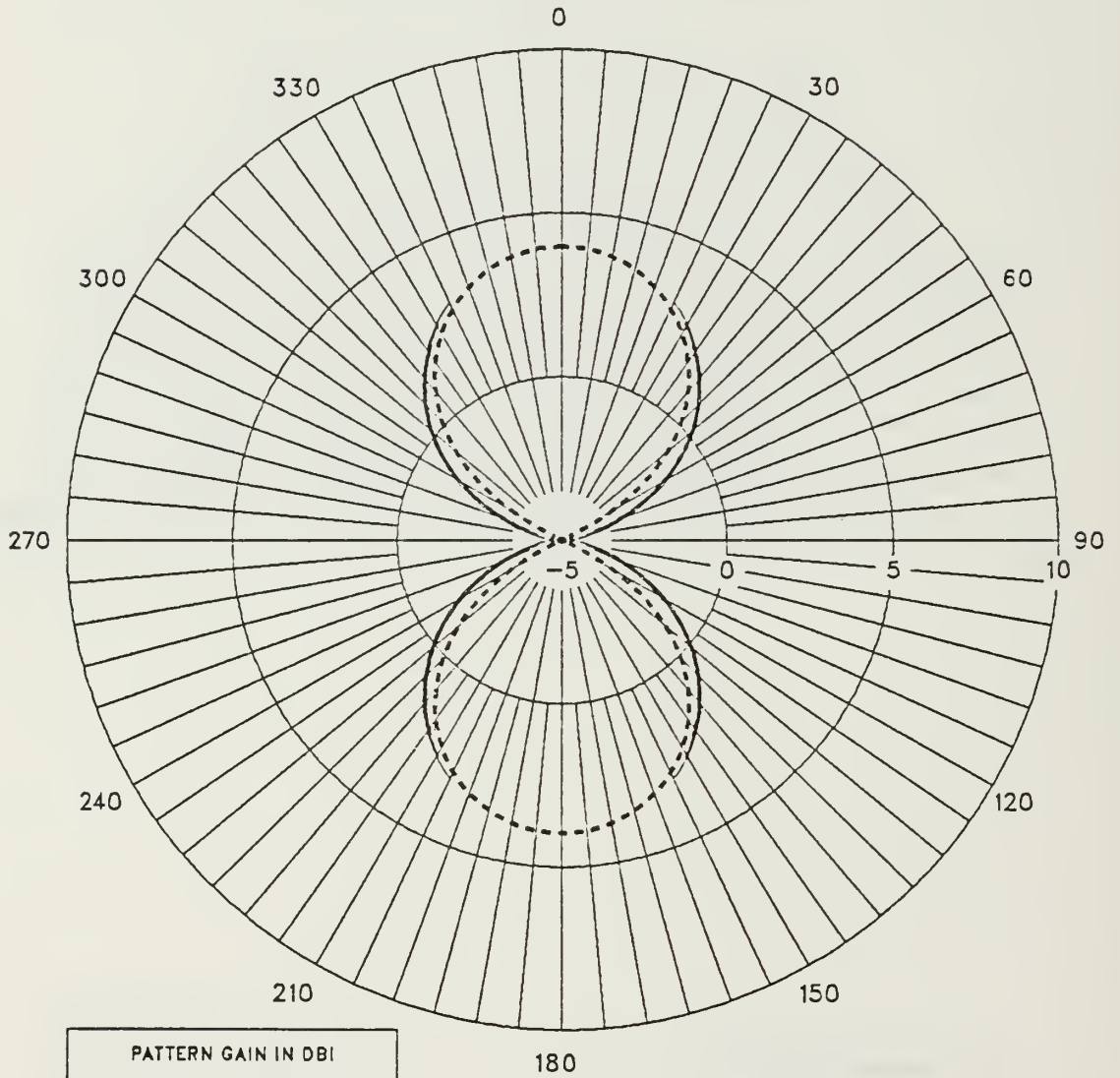

HALF WAVE DOUBLET ANTENNA

HT= 15 FT FREQ=30 MHZ PHI=0

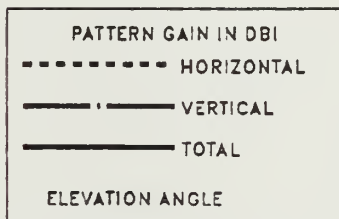
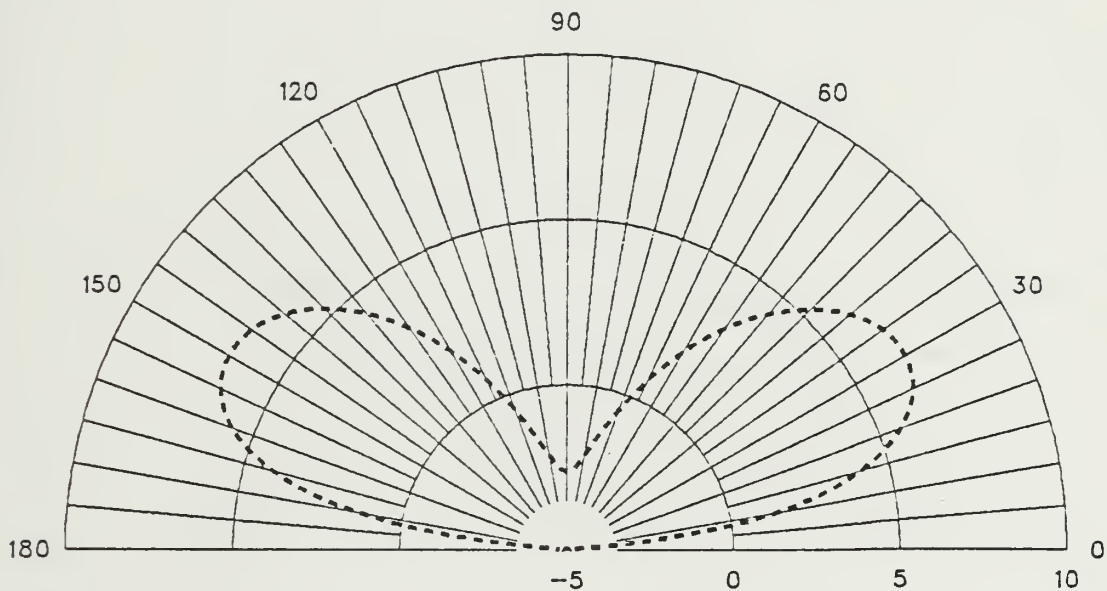

HALF WAVE DOUBLET ANTENNA

HT= 15 FT FREQ=30 MHZ PHI=20

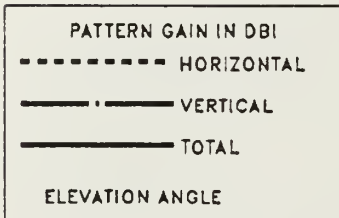
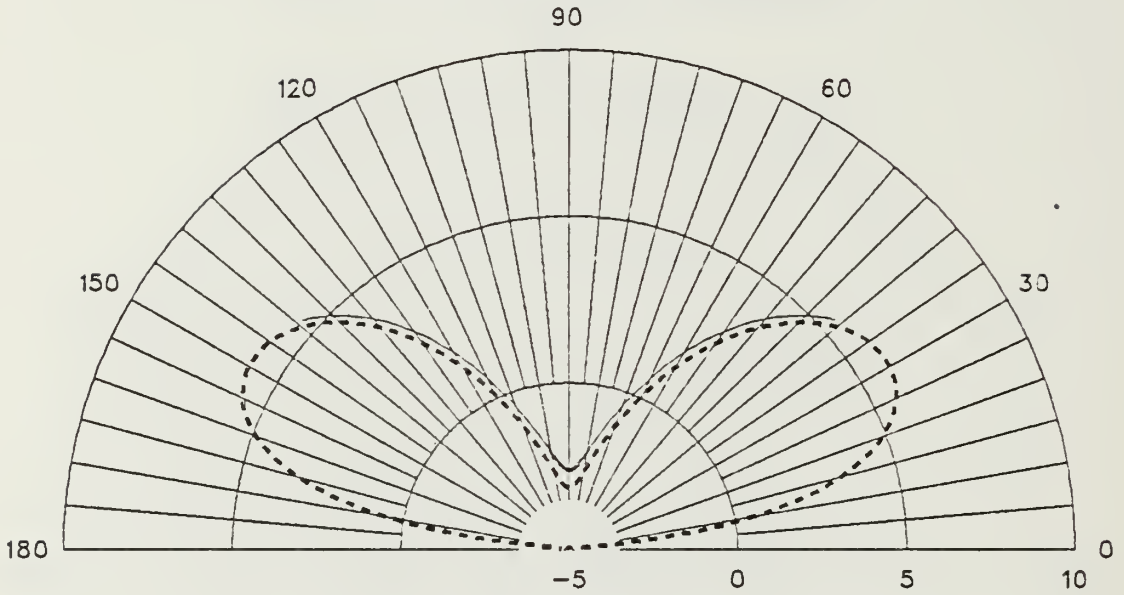

HALF WAVE DOUBLET ANTENNA

HT= 15 FT FREQ=30 MHZ PHI=40

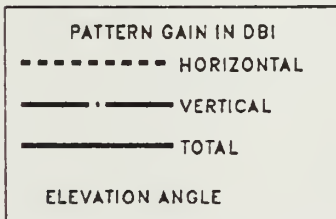
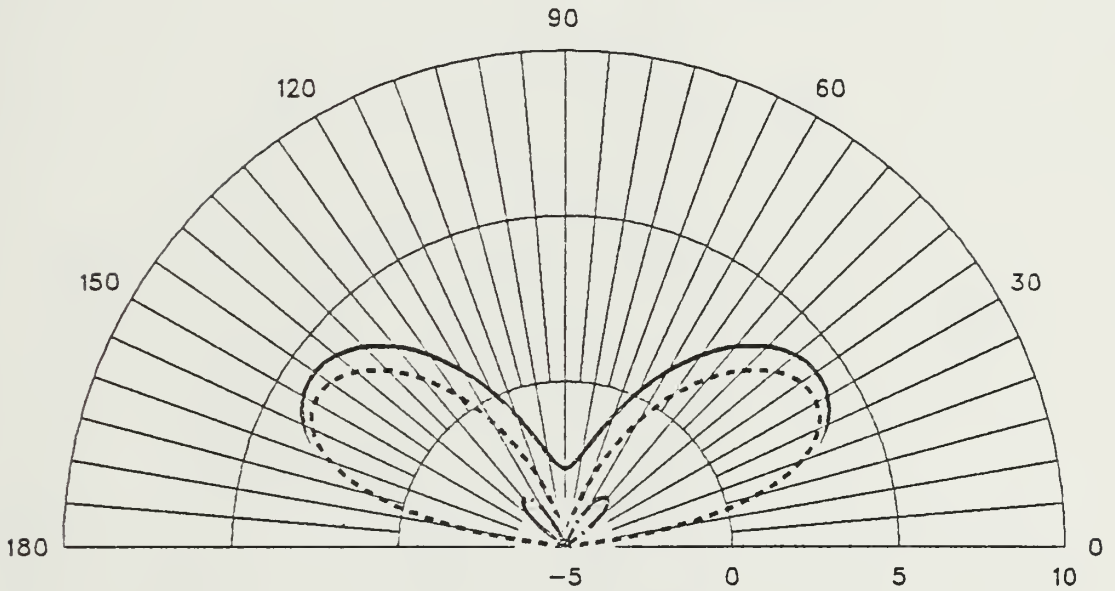

HALF WAVE DOUBLET ANTENNA

HT= 15 FT FREQ=30 MHZ THETA=60

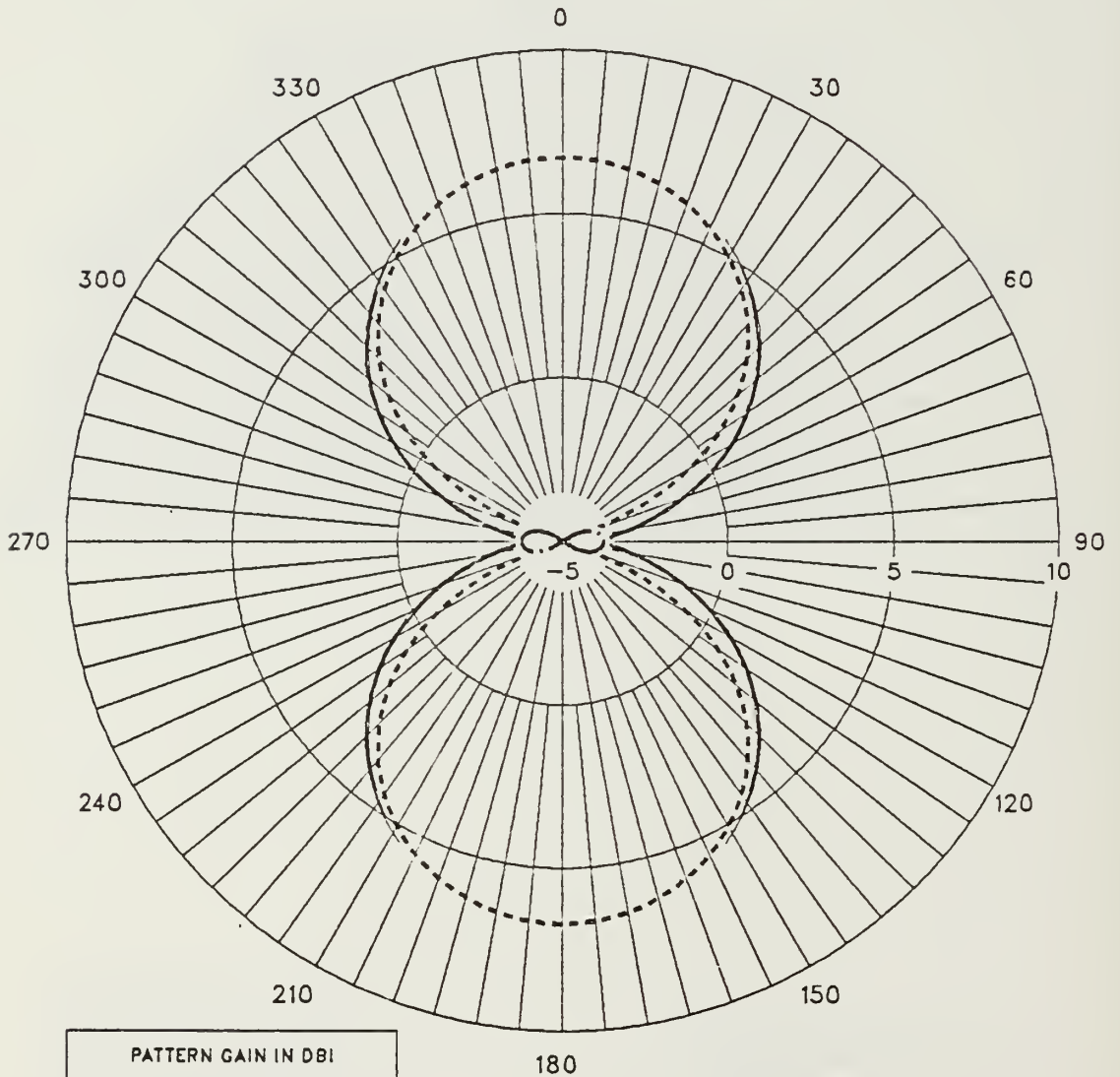

PATTERN GAIN IN DBI	
-----	HORIZONTAL
- · - · -	VERTICAL
—————	TOTAL
ANGLES IN DEGREES TRUE	

HALF WAVE DOUBLET ANTENNA

HT= 20 FT FREQ=17 MHZ PHI=0

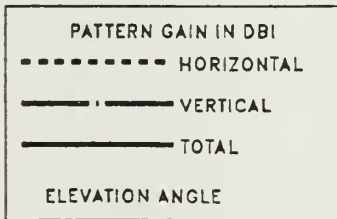
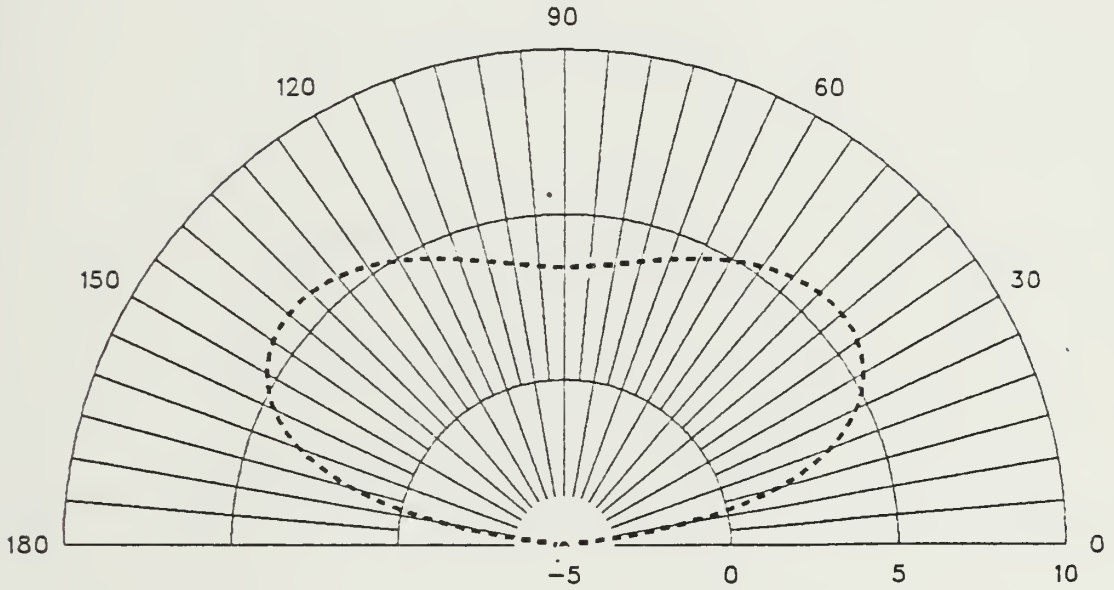

HALF WAVE DOUBLET ANTENNA

HT= 20 FT FREQ=17 MHZ PHI=20

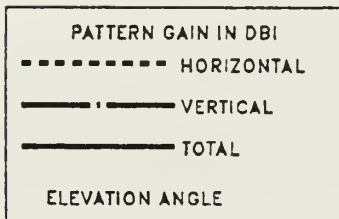
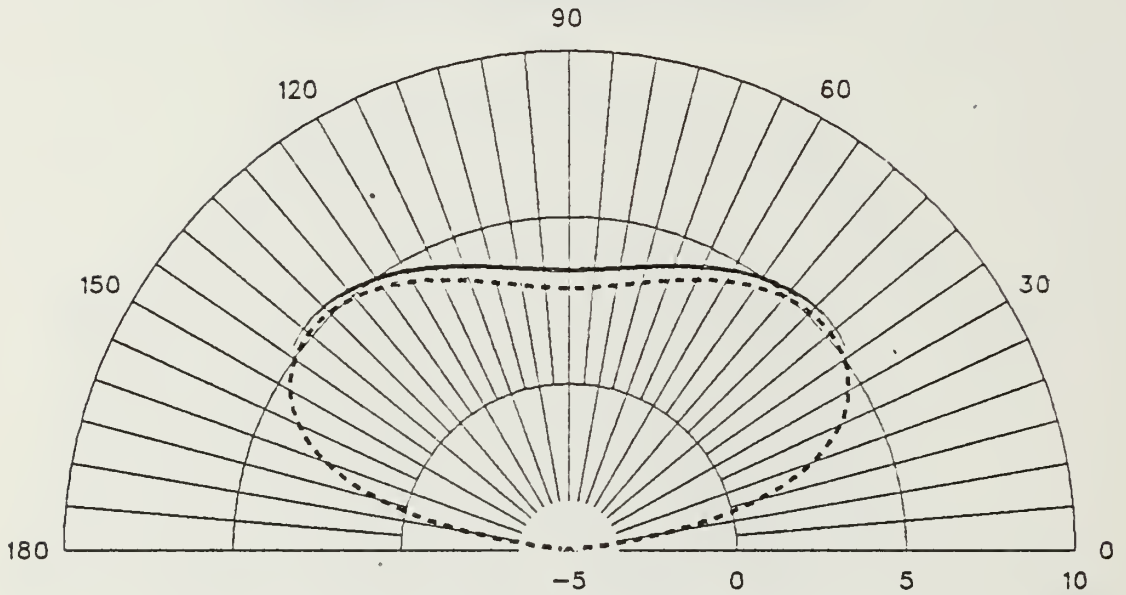

HALF WAVE DOUBLET ANTENNA

HT= 20 FT FREQ=17 MHZ PHI=40

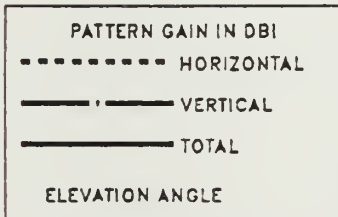
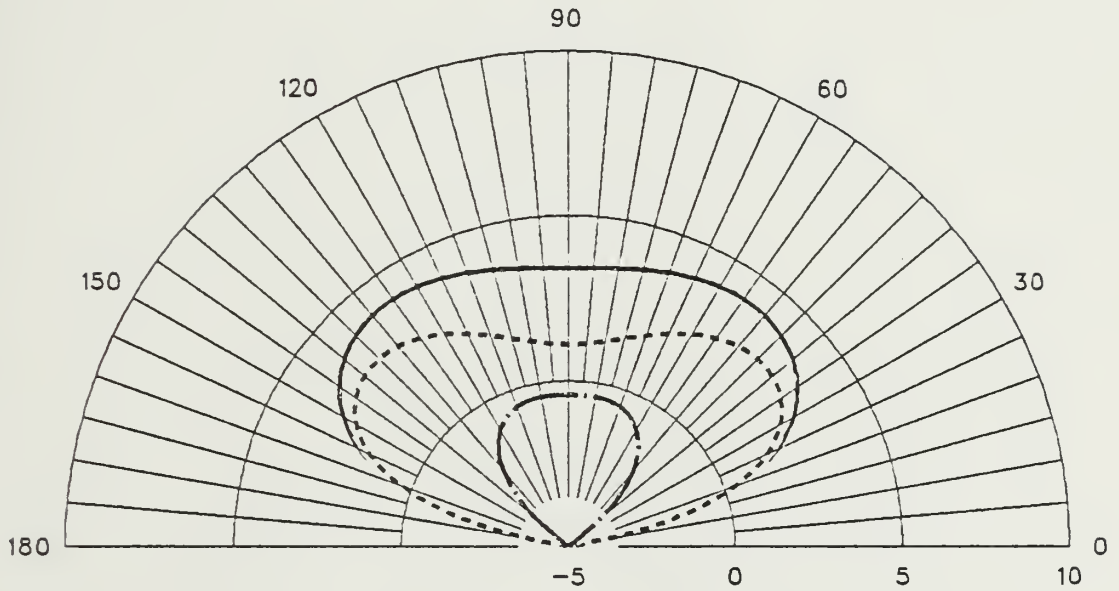

HALF WAVE DOUBLET ANTENNA

HT= 20 FT FREQ=17 MHZ THETA=60

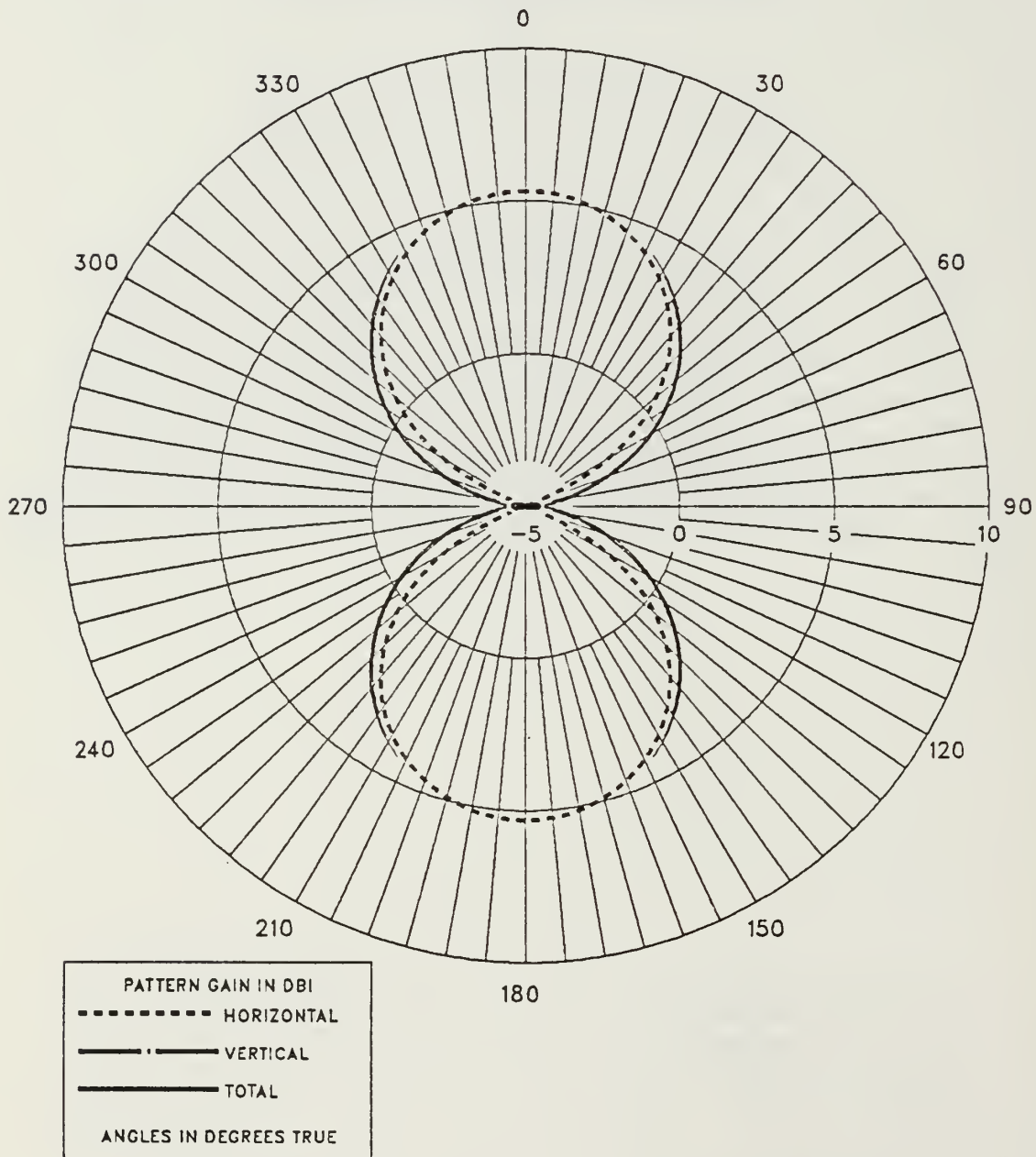

HALF WAVE DOUBLET ANTENNA

HT= 20 FT FREQ=30 MHZ PHI=0

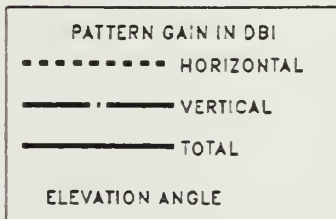
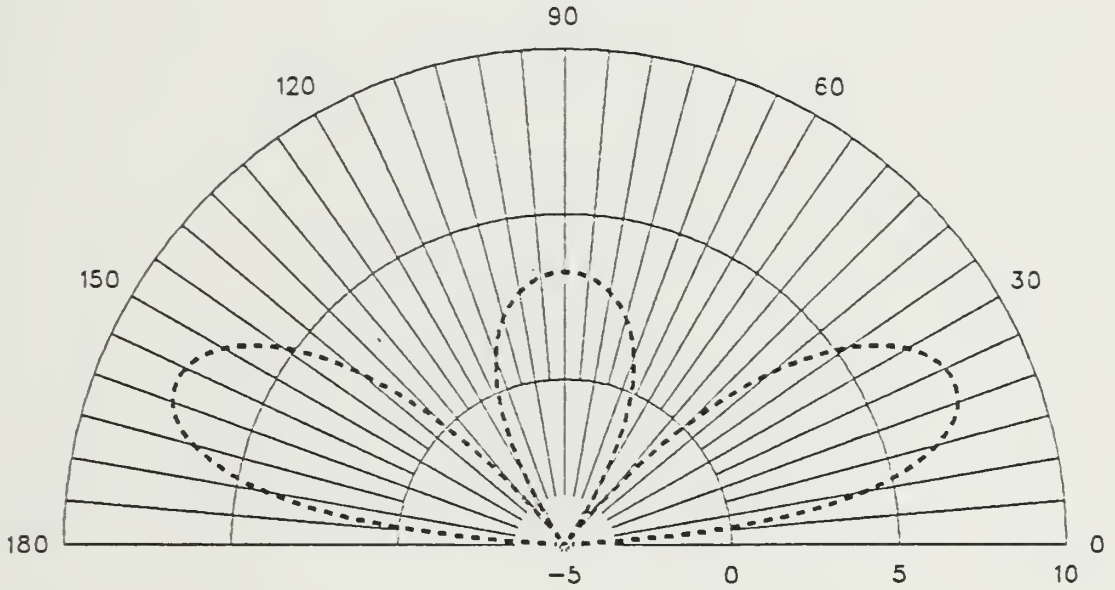

HALF WAVE DOUBLET ANTENNA

HT= 20 FT FREQ=30 MHZ PHI=20°

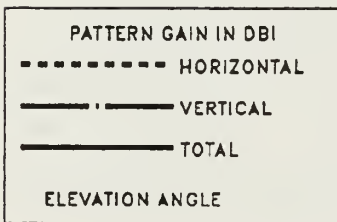
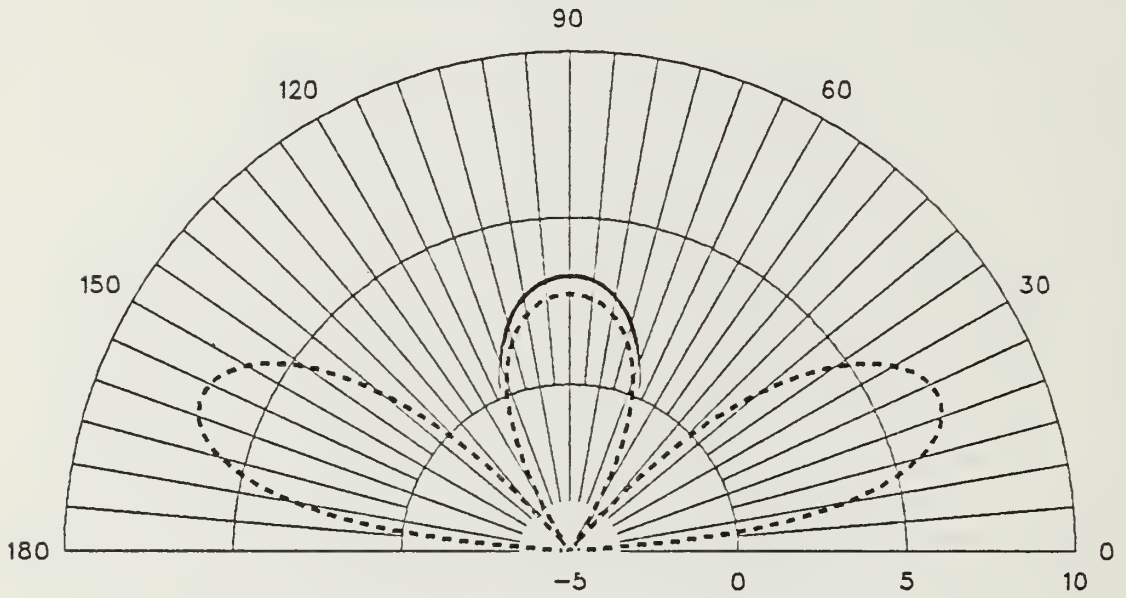

HALF WAVE DOUBLET ANTENNA

HT= 20 FT FREQ=30 MHZ PHI=40

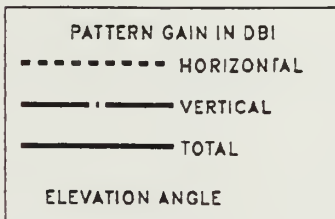
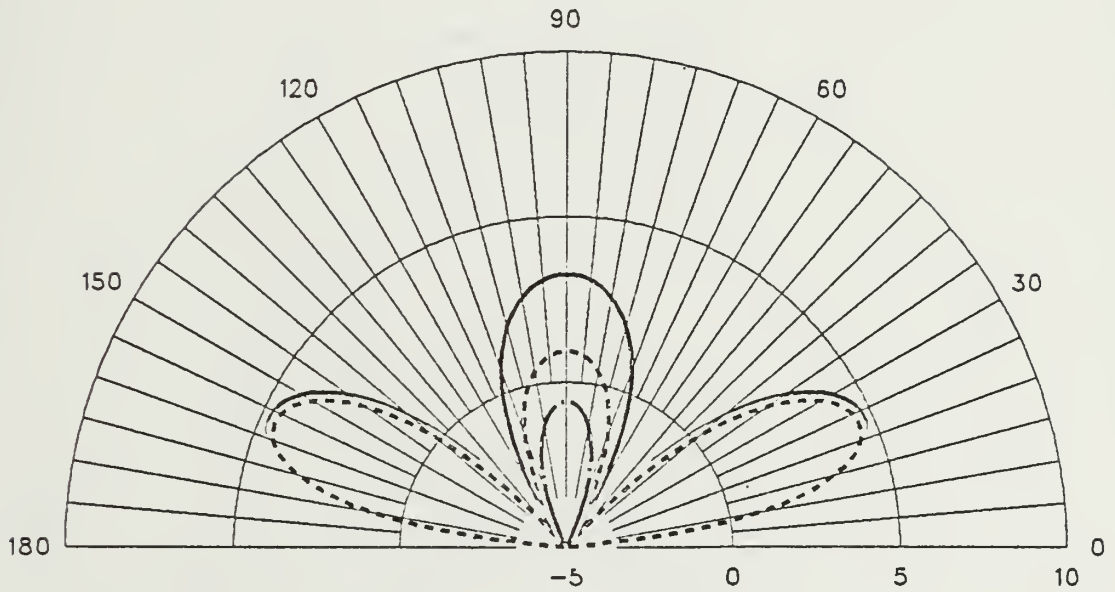

HALF WAVE DOUBLET ANTENNA

HT= 20 FT FREQ=30 MHZ THETA=65

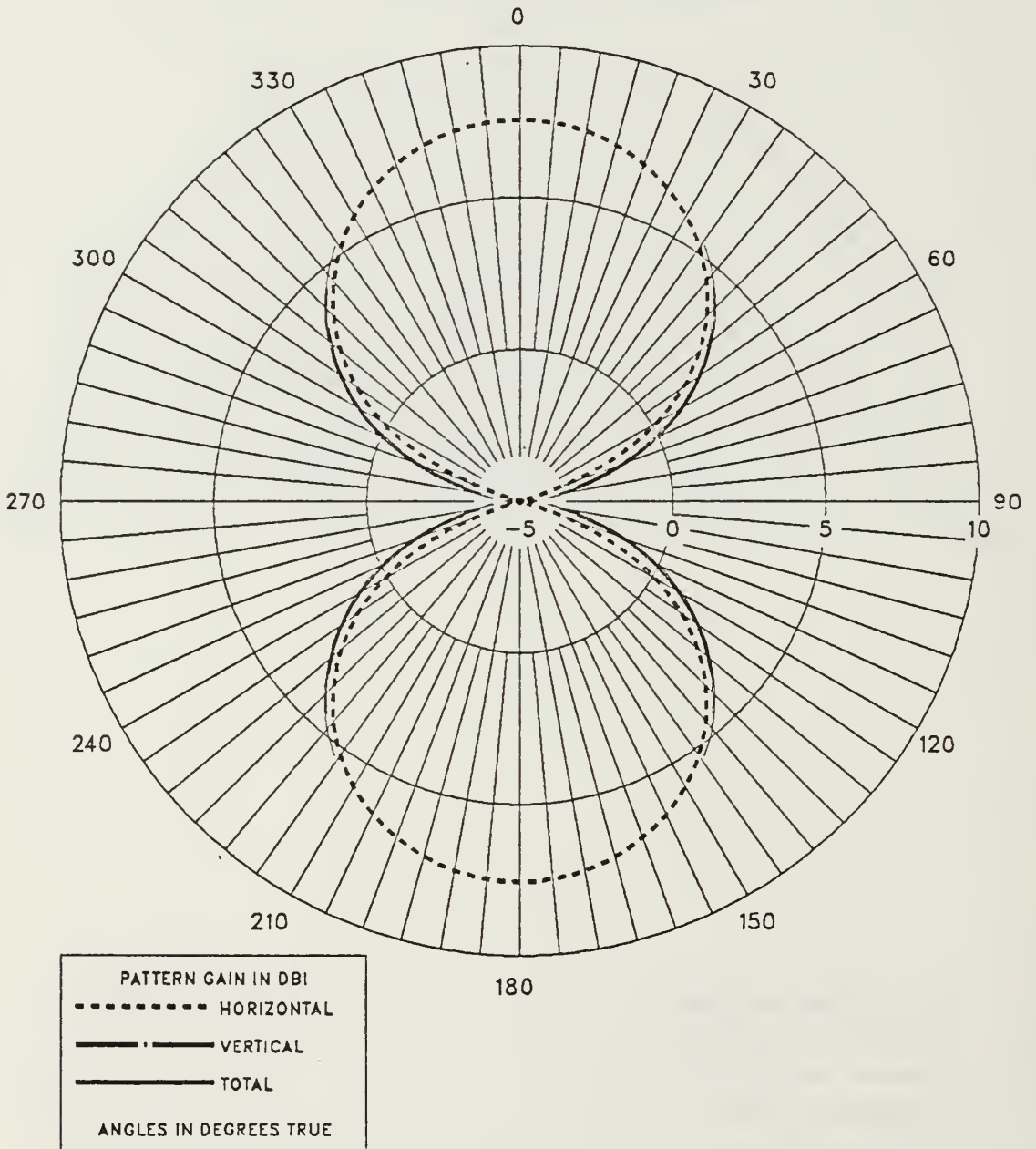

HALF WAVE DOUBLET ANTENNA

H=1/2 LAMBDA (29FT) FREQ=17 MHZ PHI=20

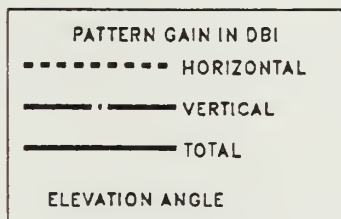
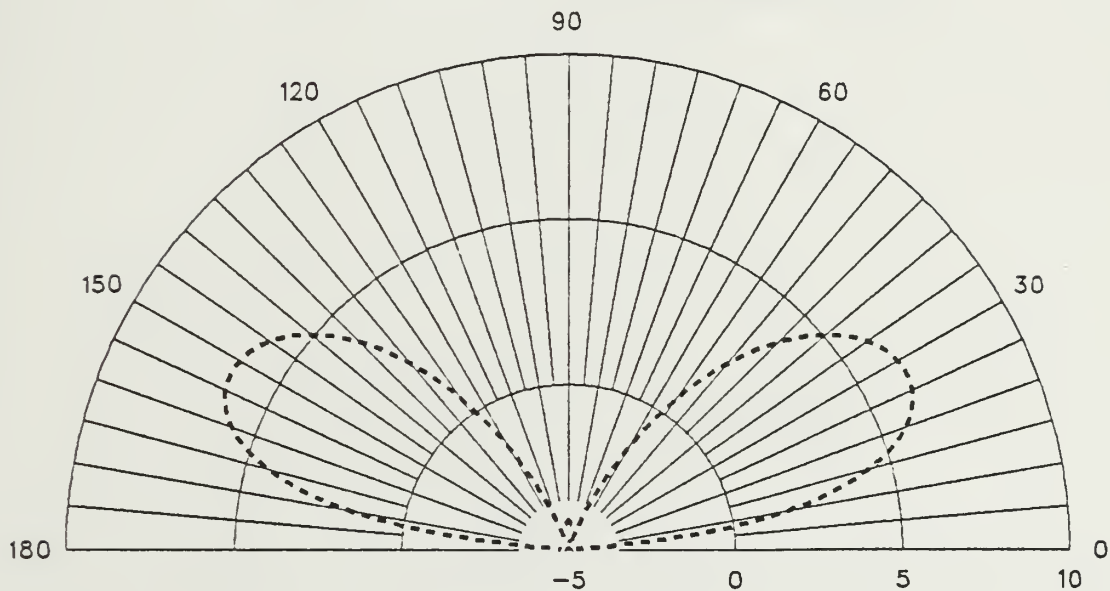

HALF WAVE DOUBLET ANTENNA

H=1/2 LAMBDA (29FT) FREQ=17MHZ THETA=60

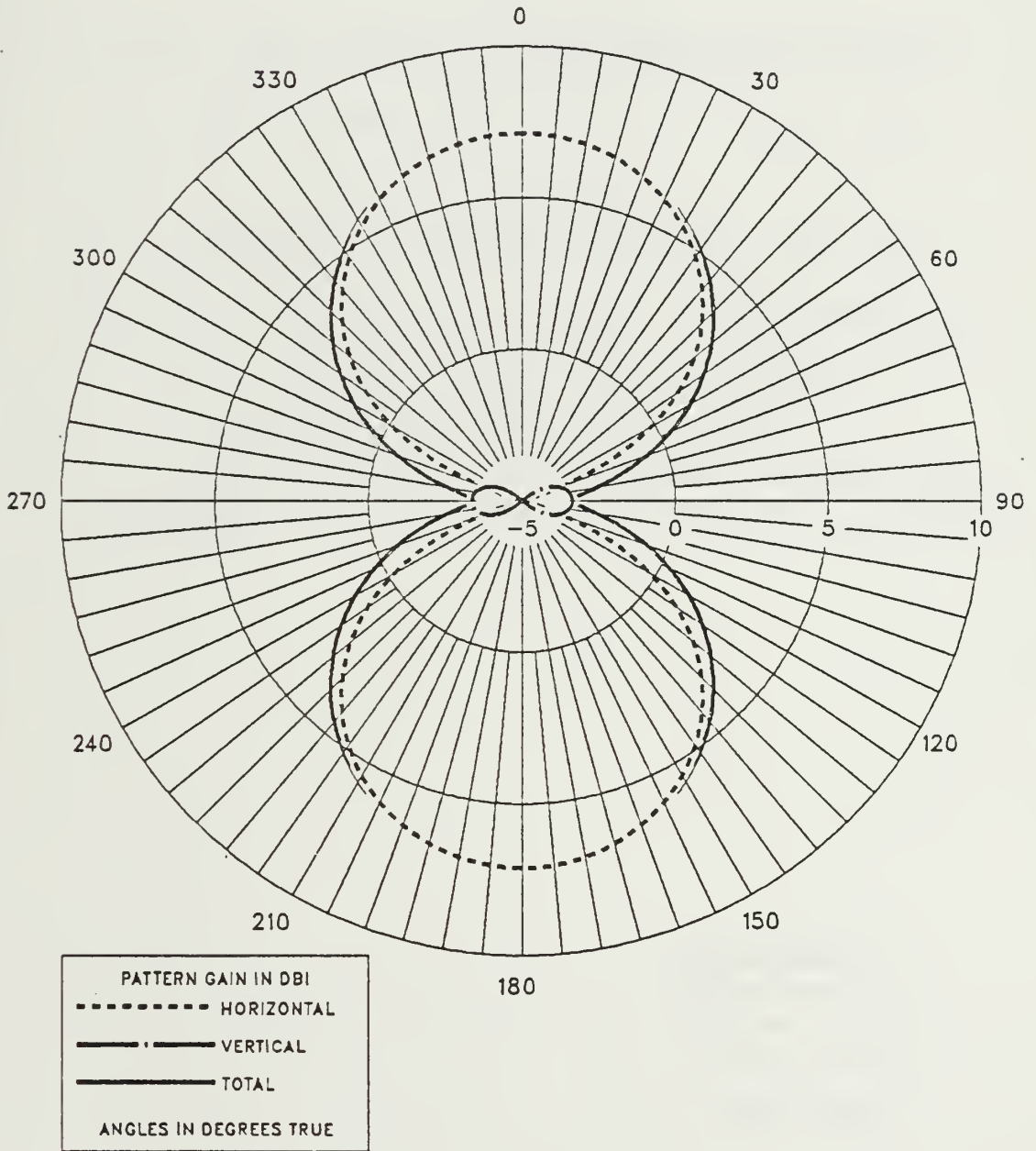

HALF WAVE DOUBLET ANTENNA

H=1/2 LAMBDA (29FT) FREQ=17 MHZ PHI=0

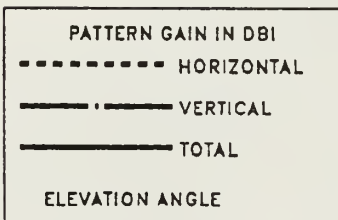
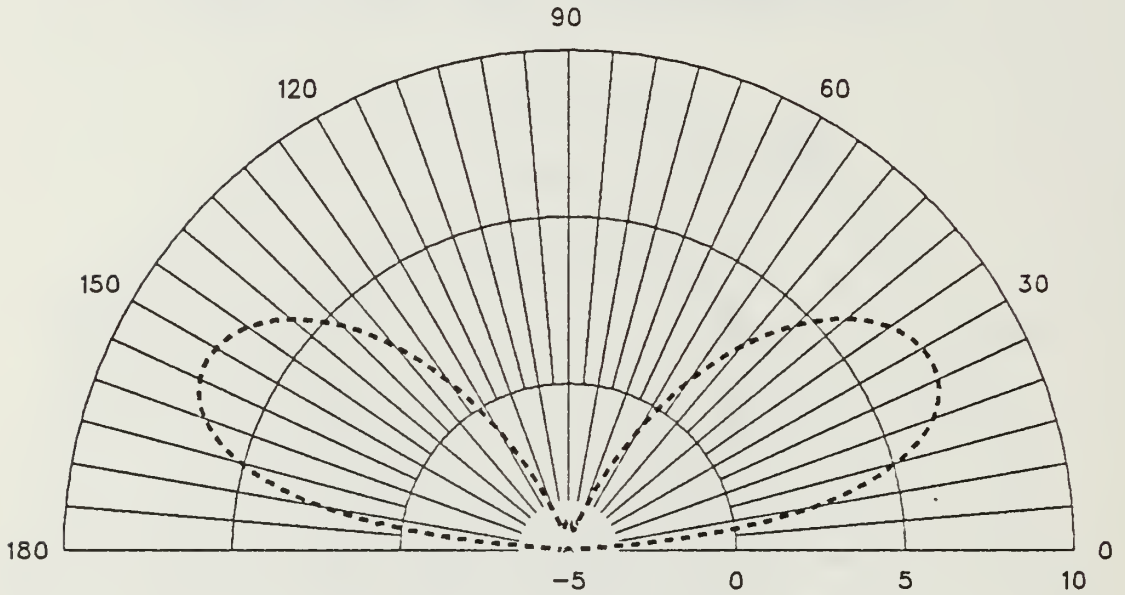

LIST OF REFERENCES

1. Johnson, R.C. and Jasik, H., Antenna Engineering Handbook, 2d ed., pp. 11.2-11.7, McGraw-Hill Book Co., 1984.
2. Balanis, C.A., Antenna Theory Analysis and Design, pp. 374-379, Harper & Row Publishers, Inc., 1982.
3. Blake, L.V., Antennas, p. 183, John Wiley & Sons, Inc., 1966.
4. The A.R.R.L. Antenna Book, Publication No. 15, pp. 9-57, American Radio Relay League, 1970.
5. Stutzman, W.L. and Theile, G.A., Antenna Theory and Design, pp. 229-238, John Wiley & Sons, Inc., 1981.
6. Miller, G.M., Modern Electronic Communication, pp. 439-453, Prentice-Hall, Inc., 1983.
7. Naval Oceans Systems Center Technical Document 116, v. 2, Numerical Electromagnetics Code (NEC) - A Method of Moments, by G.J. Burke and A.J. Poggio, January, 1981.

BIBLIOGRAPHY

Department of Defense Electromagnetic Compatibility Analysis Center Report ECAC-CR-83-200, Field Antenna Handbook, by James A. Kuch, June 1984.

Department of Defense Interservice Radio Frequency Management School Publication 7801-301, Antenna Theory and Practical Application, 1978.

Department of the Air Force Publication AFCC-CEMI 1300-1, Common HF Antenna Vertical Radiation Patterns, June 1982.

Department of the Army, Conventional and Field Expedient Antennas, United States Army Signal Center, Fort Gordon, GA, April 1985.

Department of the Army Field Manual 11-64, Communications-Electronics Fundamentals: Transmission Lines, Wave Propagation and Antennas, June 1985.

Marine Corps Development and Education Command Publication SM COS 5, Antennas, Conventional and Field Expedient, 2d ed., 1973.

INITIAL DISTRIBUTION LIST

	No. Copies
1. Director, Development Center ATTN: Major P. Dulin, 3-C Division MCDEC Quantico, VA 22134-5080	10
2. Professor R.W. Adler, Code 62AB Department of Electrical and Computer Engineering Naval Postgraduate School Monterey, CA 93943-5000	2
3. Professor H.M. Lee, Code 62LH Department of Electrical and Computer Engineering Naval Postgraduate School Monterey, CA 93943-5000	1
4. Professor H.B. Rigas, Code 62 Department of Electrical and Computer Engineering Naval Postgraduate School Monterey, CA 93943-5000	1
5. Defense Technical Information Center Cameron Station Alexandria, VA 22304-6145	2
6. Library, Code 0142 Naval Postgraduate School Monterey, CA 93943-5002	2
7. Captain R.J. Gillespie Sr. Development Center, C-3 Division MCDEC Quantico, VA 22134-5080	5
8. Naval Technical Training Det. ATTN: RCMC Ken Farwell Keesler AFB, MS 39354-5000	1
9. Commander 127th Signal Battalion ATTN: ADSO Fort Ord, CA 93941	2

10. Pete Cunningham 1
DRSEL-COM-RN-4
CENCOM-CENCOMS
Ft. Monmouth, NJ 07703-5202
11. Al Christman / Rodger Radcliff 2
Ohio University
Clippinger Research Laboratory
Athens, OH 45701
12. Ross Bell 1
DHV/Antenna Production Division
Box 520
Mineral Wells, TX 76067
13. W. P. Averill 1
Department of Electrical Engineering
U.S. Naval Academy
Annapolis, MD 21402
14. John Belrose 1
Communication Reseach Center
P.O. Box 11490, STN H
Ottawa, Ontario, Canada K2H8S2
15. Mr. Edwin Bramel 1
P.O. Box 722
Ft. Huachuca, AZ 85613
16. J. K. Breakall 1
Lawrence Livermore National Laboratory
P.O. Box 5504, L-156
Livermore, CA 94550
17. Donn Campbell 1
TRW MIL ELEX Division
RC2/266 7X
San Diego, CA 92128
18. DR Roger A. Cox 1
TELEX Communications, Inc.
8601 Northeast HWY 6
Lincoln, NE 68505
19. E. Domning 1
Lawrence Livermore National Laboratory
P.O. Box 5504, L-153
Livermore, CA 94550

20. Dave Faust 1
Eyring Research Institute
1455 W. 820 N.
Provo, UT 84601
21. G. H. Hagn 1
SRI International
1611 N. Kent Street
Arlington, VA 22209
22. Lawrence Harnish 1
SRI International
1611 N. Kent Street
Arlington, VA 22209
23. J. B. Hatfield 1
Hatfield & Dawson
4226 Sixth Avenue, N.W.
Seattle, WA 98107
24. Jackie Ervin Hipp 1
S W Research Institute/EMA
P.O. Drawer 28510
San Antonio, TX 78284
25. Howard Hochman/MS 4G12 1
GTE Sylvania
Box 7188
Mountain View, CA 94039
26. R. T. Hoverter 1
U.S. Army CECOM
AMSEL-COM-RN-R
Ft. Monmouth, NJ 07703
27. S.W. Kershner 1
Kershner & Wright
5730 Gen. Washington Drive
Alexandria, VA 22312
28. Moray King 1
Eyring Research Institute
1455 W. 820 N.
Provo, UT 84601
29. H. Kobayashi 1
1607 Cliff Drive
Edgewater, MD 21037

30. George Lane 1
Voice Of America/ESBA
601 D. Street, NW
Washington, DC 20547
31. Mr Jim Logan 1
NOSC Code 822 (T)
271 Catalina Blvd
San Diego, CA 92152
32. Janet McDonald 1
U.S. Army
USAISESA/ASBH-SET-P
Ft. Huachuca, AZ 85613-5300
33. David J. Pinion 1
74 Harper Street
San Francisco, CA 94131
34. J.J. Reaves, JR 1
Naval Elec. System Engineering Center
4600 Marriott Drive
N. Charleston, SC 29413
35. Alfred Resnick 1
Capitol Cities Communication / ABC Radio
1345 Ave of Americas, 26th Floor
NYC, NY 10705
36. R.B. Riegel 1
NSA
8806 Crandall Road
Lanham, MD 20801
37. Dr John W. Rockway 1
NOSC CODE 805 (T)
271 Catalina Blvd
San Diego, CA 92152
38. Joseph R. Romanosky 1
National Security Agency/R632
Electronic Engineer
Ft. Meade, MD 20755
39. R. Royce 1
Naval Research Laboratory
Washington, DC 20375

40. Dr Jacob Z. Schanker 1
Scientific Radio Systems
367 Orchard Street
Rochester, NY 14606
41. N. Skousen 1
Eyring Research Institute, Inc.
1455 W. 820 N.
Provo, UT 84601
42. W.D. Stuart 1
IIT Research Institute
185 Admiral Cochrane Drive
Annapolis, MD 21402
43. R. Tanner 1
Technology Communications Intl.
1625 Stierlin Road
Mountain View, CA 94043
44. E. Thowless 1
NOSC Code 822 (T)
271 Catalina Blvd.
San Diego, CA 92152
45. Research Administration (Code 012) 1
Naval Postgraduate School
Monterey, CA 93943

Radiation characteristics of selected lo



3 2768 000 71640 1

DUDLEY KNOX LIBRARY