

1-0

2-8

2-8

3-15

2-2

1-1

3-5

2-0

4-0

1-8

1-25

1-4

1-6

12

TECHNICAL REPORT CERC-86-12

REVIEW AND COMPARISON OF METHODS FOR ESTIMATING IRREGULAR WAVE OVERTOPPING RATES

by

Scott L. Douglass

Coastal Engineering Research Center

DEPARTMENT OF THE ARMY

Waterways Experiment Station, Corps of Engineers
PO Box 631, Vicksburg, Mississippi 39180-0631



US Army Corps of Engineers

AD-A178 346

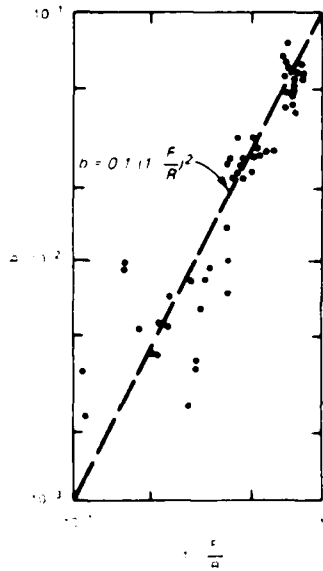
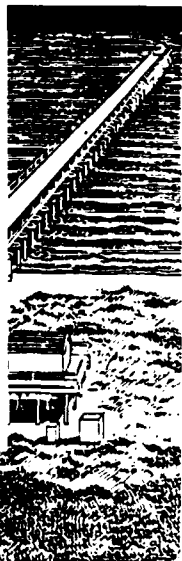

December 1986

Final Report

Approved For Public Release; Distribution Unlimited

DTC FILE COPY

MAR 30 1987



Prepared for DEPARTMENT OF THE ARMY
US Army Corps of Engineers
Washington, DC 20314-1000

87 3 30 008

Destroy this report when no longer needed. Do not return
it to the originator.

The findings in this report are not to be construed as an official
Department of the Army position unless so designated
by other authorized documents.

The contents of this report are not to be used for
advertising, publication, or promotional purposes.
Citation of trade names does not constitute an
official endorsement or approval of the use of
such commercial products.

Unclassified

SECURITY CLASSIFICATION OF THIS PAGE

REPORT DOCUMENTATION PAGE				Form Approved OMB No 0704-0188 Exp Date Jun 30 1986	
1a REPORT SECURITY CLASSIFICATION Unclassified		1b RESTRICTIVE MARKINGS			
2a SECURITY CLASSIFICATION AUTHORITY		3 DISTRIBUTION/AVAILABILITY OF REPORT Approved for public release; distribution unlimited			
2b DECLASSIFICATION/DOWNGRADING SCHEDULE					
4 PERFORMING ORGANIZATION REPORT NUMBER(S) Technical Report CERC-86-12		5 MONITORING ORGANIZATION REPORT NUMBER(S)			
6a NAME OF PERFORMING ORGANIZATION USAEWES, Coastal Engineering Research Center		6b OFFICE SYMBOL <i>(if applicable)</i>	7a NAME OF MONITORING ORGANIZATION		
6c ADDRESS (City, State, and ZIP Code) PO Box 631 Vicksburg, MS 39180-0631		7b ADDRESS (City, State, and ZIP Code)			
8a NAME OF FUNDING SPONSORING ORGANIZATION US Army Corps of Engineers		8b OFFICE SYMBOL <i>(if applicable)</i>	9 PROCUREMENT INSTRUMENT IDENTIFICATION NUMBER		
8c ADDRESS (City, State, and ZIP Code) Washington, DC 20314-1000		10 SOURCE OF FUNDING NUMBERS			
		PROGRAM ELEMENT NO	PROJECT NO	TASK NO	WORK UNIT ACCESSION NO
11 TITLE (Include Security Classification) Review and Comparison of Methods for Estimating Irregular Wave Overtopping Rates					
12 PERSONAL AUTHOR(S) Douglass, Scott L.					
13a TYPE OF REPORT Final report		13b TIME COVERED FROM _____ TO _____	14 DATE OF REPORT (Year, Month, Day) December 1986		15 PAGE COUNT 44
16 SUPPLEMENTARY NOTATION Available from National Technical Information Services, 5285 Port Royal Road, Springfield VA 22161.					
17 COSATI CODES			18 SUBJECT TERMS (Continue on reverse if necessary and identify by block number)		
FIELD	GROUP	SUB-GROUP	Coastal flooding	Overtopping	Wave runup
			Coastal structures	Seawalls	
			Irregular waves	Wave overtopping	
19 ABSTRACT (Continue on reverse if necessary and identify by block number)					
<p>Methods for estimating the volume rate of wave overtopping by irregular seas are reviewed. Four methods are discussed in detail: Shore Protection Manual (SPM 1984), Goda (1971), Battjes (1974), and Owen (1980). Each method is discussed adequately for engineering use, and an example using each method is given. The assumptions made in each method's derivation and the importance of these assumptions are discussed also. Since the four methods were derived for different situations, the methods' ranges of applicability are summarized.</p> <p>The different methods yield results which can vary by more than an order-of-magnitude. For vertical seawalls, the SPM method estimates more overtopping than Goda's method except in very shallow water. For steeply sloped structures, the SPM method estimates less overtopping than Owen's method. For mildly sloped structures, the SPM method estimates less overtopping than Battjes' method except for very low relative freeboards.</p> <p style="text-align: right;">(Continued)</p>					
20 DISTRIBUTION AVAILABILITY OF ABSTRACT <input checked="" type="checkbox"/> UNCLASSIFIED UNLIMITED <input type="checkbox"/> SAME AS RPT <input type="checkbox"/> DTIC USERS			21 ABSTRACT SECURITY CLASSIFICATION Unclassified		
22a NAME OF RESPONSIBLE INDIVIDUAL			22b TELEPHONE (Include Area Code)		22c OFFICE SYMBOL

19. ABSTRACT (Continued).

Published irregular-wave overtopping data are briefly reviewed and shown to be inadequate for evaluating the available methods. Until better data are available, estimates from these methods should be considered to be within a factor-of-three, and more conservatively, an order-of-magnitude of the actual overtopping rate.

PREFACE

This report is a product of the Wave Runup and Overtopping Work Unit, Coastal Structure Evaluation and Design Research Program, of the US Army Corps of Engineers. Mr. John H. Lockhart, Jr., Office, Chief of Engineers, was the Technical Monitor.

The report was written at the US Army Engineer Waterways Experiment Station (WES) by Mr. Scott L. Douglass, Hydraulic Engineer in the Coastal Structures and Evaluation Branch of the Engineering Development Division, Coastal Engineering Research Center (CERC). The work was directed by Mr. John Ahrens, Engineer, Wave Research Branch, Wave Dynamics Division, under the general supervision of Mr. D. D. Davidson, Chief, Wave Research Branch, and Dr. James R. Houston, Chief, CERC.

COL Allen F. Grum, USA, was the previous Director of WES. COL Dwayne G. Lee, CE, is the present Commander and Director. Dr. Robert W. Whalin is Technical Director.

Accession	
NTIS	<input checked="" type="checkbox"/>
DTIC	<input checked="" type="checkbox"/>
Unannounced	<input type="checkbox"/>
Justification	
By	
Date	
Approved	
Special Agent in Charge	
Director	

A-1

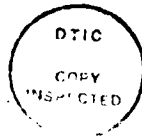

CONTENTS

	<u>Page</u>
PREFACE.....	1
CONVERSION FACTOR, NON-SI TO SI (METRIC) UNITS OF MEASUREMENT.....	3
PART I: INTRODUCTION.....	4
Background.....	4
Purpose and Scope.....	4
PART II: METHODS FOR ESTIMATING IRREGULAR WAVE OVERTOPPING RATES.....	6
Shore Protection Manual Method.....	6
Goda's Method.....	14
Battjes' Method.....	16
Owen's Method.....	21
Other Methods.....	25
PART III: COMPARISON OF METHODS.....	27
Summary of Regions of Applicability.....	27
Comparison of Results.....	28
Comparison with Data.....	32
PART IV: OTHER PARAMETERS THAT AFFECT OVERTOPPING.....	35
Onshore Winds.....	35
Angle of Wave Attack.....	35
Varying Water Level.....	35
PART V: SUMMARY AND CONCLUSIONS.....	37
REFERENCES.....	39

CONVERSION FACTORS, NON-SI TO SI (METRIC)
UNITS OF MEASUREMENT

Non-SI units of measurement used in this report can be converted to SI
(metric) units as follows:

<u>Multiply</u>	<u>By</u>	<u>To Obtain</u>
feet	0.3048	metres
cubic feet per second per foot	0.092903	cubic metres per second per metre
degrees (angle)	0.01745329	radians

REVIEW AND COMPARISON OF METHODS FOR ESTIMATING
IRREGULAR WAVE OVERTOPPING RATES

PART I: INTRODUCTION

Background

1. As waves of water hit a coastal structure, the water rushes up and sometimes over the structure. These closely related phenomena, wave runoff and wave overtopping, strongly influence the design (and the cost) of seawalls, breakwaters, revetments, etc. Accurately estimating the volume rate of overtopping can be vital to design engineers. For example, overtopping of the existing seawall causes flooding at Roughan's Point, Massachusetts, a coastal suburb of Boston. If the seawall were high enough to completely prevent overtopping, it would block the town's ocean view. An alternative which will reduce the flooding is a moderately higher seawall with improved backside drainage. In this situation, a reliable method for estimating overtopping rates for proposed seawall designs is imperative.

2. Several different aspects of overtopping are important to engineers designing coastal structures. For structures against the shoreline (seawalls or revetments), the amount of water which flows over the structure is important because of backside flooding. For breakwaters, wave regeneration on the leeward side is an important consideration in harbor design. For rubble-mound breakwaters, the stability of the backside of the breakwater is important. While the different aspects of overtopping are related, this report considers only the first--the amount of water which overtops coastal structures.

3. Wave overtopping is a complex phenomenon. It includes many of the complexities of both coastal wave transformations (how the waves change as they approach the shore) and wave runoff on structures. Even in a generalized case, many variables contribute to overtopping and the relationships between the variables are not well understood.

Purpose and Scope

4. This report discusses available methods for estimating overtopping

caused by irregular waves. However, several of these methods are based on regular (monochromatic) wave experiments and theory. In a monochromatic wave field, all waves have the same height and period. This is the type of wave train made by many laboratory wave generators and approximated in nature by swell from distant storms. An irregular wave field can be thought of as many waves of different heights and periods traveling in different directions on the same body of water. Coastal engineers often represent irregular seas with a significant wave height H_s or $H_{1/3}$, which is defined as the average of the one-third highest waves. Another definition of significant wave height is the spectral significant wave height H_{m0} (Shore Protection Manual (SPM) 1984). For engineering purposes, it is significant to know how much overtopping will be caused by an irregular sea with a given significant wave height (significant wave height is only one of the parameters used to describe an irregular sea).

5. Comparing the existing methods of estimating overtopping with laboratory or field data would be an optimal way to evaluate the methods. Unfortunately, no comprehensive data set of overtopping rates caused by realistic irregular waves has been published. Therefore, it cannot be confidently stated that one of the methods predicts wave overtopping quantities better than the others. However, this report will evaluate the assumptions made in the derivation of each method and examine the design situations for which each method was developed.

6. Part II of this report briefly describes four methods of estimating wave overtopping caused by irregular waves, presents an example of how to use each method, and discusses the effect of assumptions made in the derivation of each method. Since the estimation methods were not developed for identical situations, Part III of this report outlines which methods can be used for which design situations and compares the results of the methods when more than one method can be used. The methods are compared with the very limited, published laboratory and field data. Part IV briefly discusses the effects of wind speed and direction, angle of wave incidence, and varying still-water level (SWL) on wave overtopping.

7. This report does not explain to the design engineer how to choose all the parameters needed to apply these overtopping methods. The selection of water levels and wave characteristics for the design of coastal structures is beyond the scope of this study. These parameters will be considered as "known input parameters."

PART II: METHODS FOR ESTIMATING IRREGULAR WAVE OVERTOPPING RATES

Shore Protection Manual Method

Description

8. The Coastal Engineering Research Center's (CERC's) SPM (1984) possibly presents this country's best known method of estimating overtopping. This method is the result of three different CERC studies; the second two studies extended the method developed in the first study to more design situations.

9. Saville (1955) reports on overtopping studies conducted at the US Army Engineer Waterways Experiment Station (WES) by CERC in the 1950s. Saville studied overtopping of monochromatic waves by varying the wave characteristics, the structure geometry, and the model scale. Interestingly, these tests form the empirical basis for three of the methods discussed in this report.

10. Weggel (1976) reanalyzed Saville's results in dimensionless form. By looking at the relationships between his dimensionless variables, Weggel derived the following empirical equation for the monochromatic-wave overtopping rate:

$$Q_{\text{mono}} = \left(g Q_o^* H_o'^3 \right)^{1/2} \exp \left[- \frac{0.217}{\alpha} \tanh^{-1} \left(\frac{F}{R} \right) \right] \quad (1)$$

where

- Q_{mono} = volume rate of overtopping, L^2T
- g = acceleration due to gravity, L/T^2
- Q_o^* , α = dimensionless empirical coefficients
- H_o' = monochromatic deepwater wave height, L
- $F = h - d_s$ = freeboard above SWL, L
- h = height of structure, L
- d_s = depth of water at structure, L
- R = runup, L

An equivalent equation is

$$Q_{\text{mono}} = \left(g Q_o^* H_o'^3 \right)^{1/2} \left(\frac{R + F}{R - F} \right)^{- (0.1085/\alpha)} \quad (2)$$

11. In a design situation, H'_0 , F , and g are assumed or known, and R is the vertical distance the monochromatic wave would run up the structure if the slope were built high enough to prevent overtopping (Figure 1).

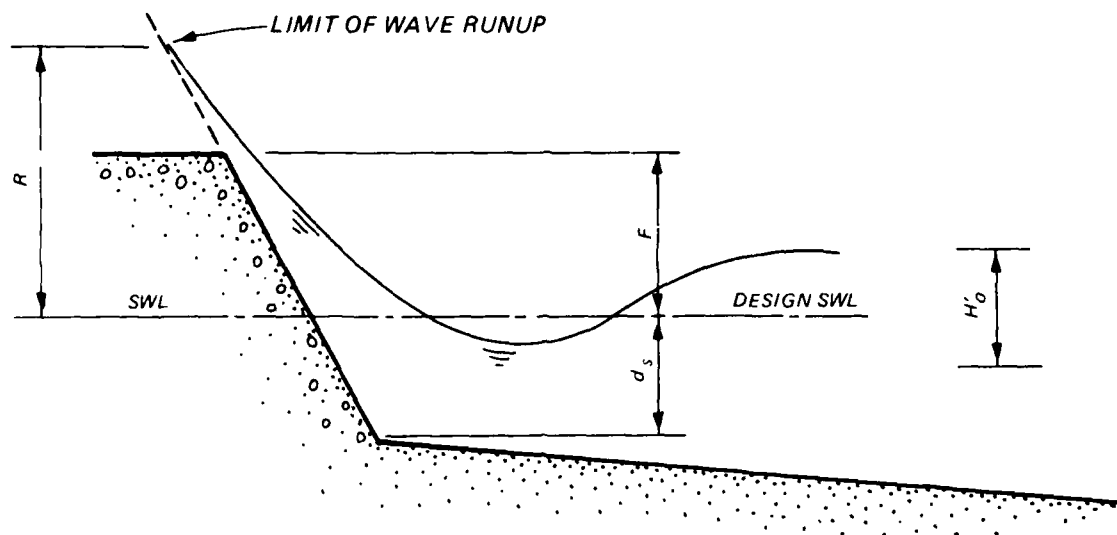

Figure 1. Wave runup definition sketch

Chapter 7 of the SPM describes how to estimate R . Weggel calculated the empirical coefficients, Q^*_0 and α , for the situations tested by Saville. These empirical coefficients are presented in the SPM (1984), Figures 7-24 through 7-32. The $Q^*_0 - \alpha$ figure for 1:3 smooth slopes is reproduced here in Figure 2.

12. To apply Weggel's equation to a sea of irregular waves, Ahrens (1977a) assumes that the distribution of runups (R 's) caused by an irregular sea will follow a Rayleigh distribution. Ahrens estimates the overtopping rate by summing the overtopping contributions from the individual runups,

$$Q_{SPM} = \frac{1}{199} \sum_{i=1}^{199} Q_i \quad (3)$$

where

Q_{SPM} = volume rate of overtopping caused by irregular waves, L^2/T

Q_i = volume rate of overtopping caused by one runup in the runup distribution, L^2/T , or

$$Q_i = \left[gQ^*_0 (H'_s)_0^3 \right]^{1/2} \exp \left[- \frac{0.217}{\alpha} \tanh^{-1} \left(\frac{F}{R_p} \right) \right] \quad (4)$$

where

$(H_s)_0$ = deepwater significant wave height

R_p = runup of probability of exceedance p

$$R_p = \left(\frac{\ln 1/p}{2} \right)^{1/2} R_s$$

$p = 0.005 \times i, i = 1, 2, 3, \dots, 199$

R_s = runup of monochromatic wave with the significant wave height and period

13. These equations can be considered to "correct" Weggel's monochromatic results for the effect of irregular waves (Ahrens 1977a). Figure 3 shows Ahrens' "correction factors" for freeboards, F , less than the runup of the significant wave, R_s . When the freeboard is greater than R_s , Weggel's equations yield no overtopping. However, larger runups in the runup distribution may still overtop the structure, and Equations 3 and 4 must be used. For these relatively high freeboards, the runup distribution should be

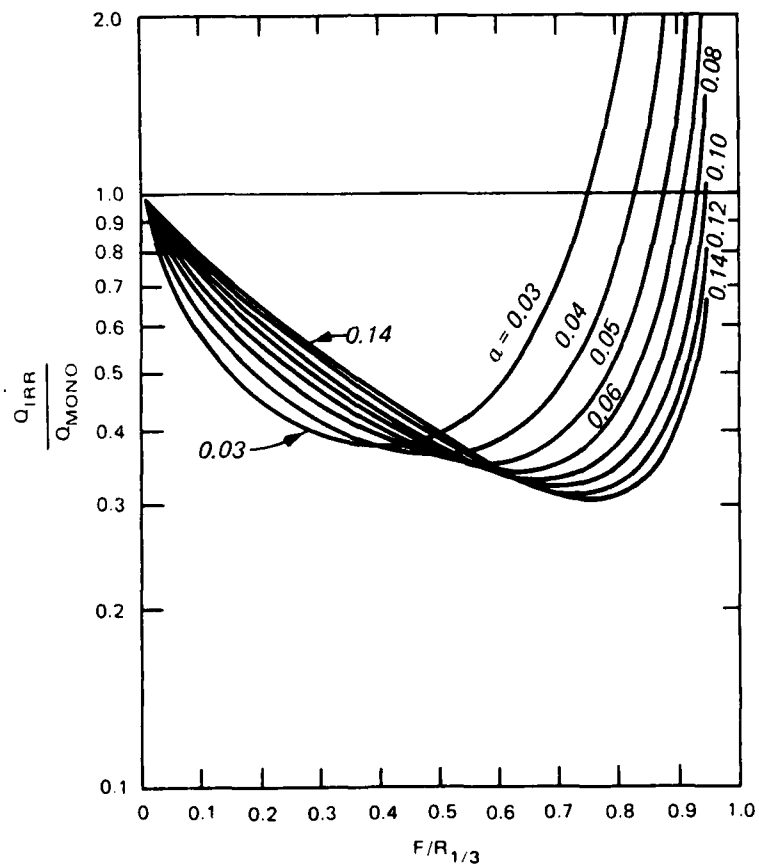

Figure 3. Ahrens' correction factors (from Ahrens 1977a)

broken into 999 runups, instead of 199, to properly account for the effect of the higher runups. Equation 3 becomes

$$Q_{SPM} = \frac{1}{999} \sum_{i=1}^{999} Q_i \quad (5)$$

where

$$p = 0.001 \times i, \quad i = 1, 2, \dots, 999$$

Example 1

14. Using the SPM method, an estimation can be made of the overtopping rate for a proposed 15-ft-high structure* (1:3 smooth slope) in 10 ft of water caused by waves with a significant wave height H_s of 5 ft and a design wave period T of 8 sec (Figure 4). To find R_s , runup of a

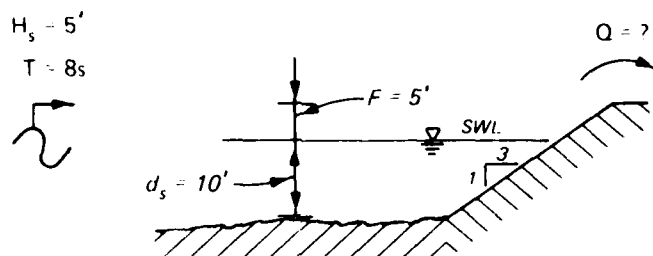

Figure 4. Definition sketch, Example 1

monochromatic wave of $H'_0 = 5$ ft and $T = 8$ sec:

$$\frac{H'_0}{gT^2} = \frac{5}{(32.2)(8)^2} = 0.0024 \quad \frac{d_s}{H'_0} = \frac{10}{5} = 2 \quad (6)$$

From SPM Figure 7-11, $R/H'_0 = 2.75$. From SPM Figure 7-13, scale effects correction factor, $k = 1.14$. Therefore,

$$R = \frac{R}{H'_0} (H'_0)(k) = (2.75)(5 \text{ ft})(1.14) = 15.7 \text{ ft} = R_s \quad (7)$$

To find Q^* and α , Figure 2 (SPM Figure 7-26), with $d_s/H'_0 = 2$, and $H'_0/gT^2 = 0.0024$, yields

* A table of factors for converting non-SI units of measurement to SI (metric) units is presented on page 3.

$$Q_o^* = 0.033 \text{ and } \alpha = 0.09$$

To calculate Q_{SPM} , and since $F < R_s$, there are two equivalent ways to calculate Q_{SPM} .

- a. Use "correction factor" applied to monochromatic result. Equation 1 for Q_{mono} becomes

$$Q_{mono} = \left[(32.2)(0.033)(5)^3 \right]^{1/2} \exp - \left[\frac{0.217}{0.09} \tanh^{-1} \left(\frac{5}{15.7} \right) \right] \quad (8)$$

$$= 5.2 \text{ ft}^3/\text{sec}/\text{ft of seawall}$$

From Figure 3 with $\frac{F}{R_s} = \frac{5}{15.7} = 0.32$:

$$\frac{Q_{irr}}{Q_{mono}} = 0.51 \quad (9)$$

Therefore

$$Q_{SPM} = Q_{irr} = (0.51)(5.2 \text{ ft}^3/\text{sec}/\text{ft})$$

$$= \underline{2.65 \text{ ft}^3/\text{sec}/\text{ft of structure}} \quad (10)$$

- b. Program Equations 3a, 4, and 5.

Interpolation for Q_o^* and α

15. In Example 1, the structure slope, wave steepness, and water depth were such that Figure 2 conveniently yielded a point for Q_o^* and α . In other words, this was one of the situations Saville tested and Weggel analyzed. If (as is inevitably the case) there is an interest in a situation which was not precisely modeled by Saville, where $H_s = 4$ ft and all the other variables in Example 1 remain the same, then $d_s/H_s = 2.5$, and $H_s/gT^2 = 4/[(32.2)(8)]^2 = 0.00194$. Figure 2 shows that there is no $Q_o^* - \alpha$ point for this situation. Interpolating between the surrounding points is difficult. To see this, it is assumed that if one of the existing points was missing, an interpolation for it would be necessary. A satisfactory general relationship between Q_o^* and α and the dimensionless variables d_s/H_s , H_s/gT^2 , and structure slope has not been found.

16. An alternative to interpolating between dimensionless parameters

and empirical coefficients, as in Figure 2, is interpolating between dimensional parameters.* For a given structure and water depth, each $Q_0^* - \alpha$ point in Figure 2 will yield a dimensional overtopping rate for a specific combination of H and T . This is because, for each $Q_0^* - \alpha$ point, the given water depth and d_s/H_0' determine H_0' , which determines T through H_0'/gT^2 . These results can be plotted on an $H - T$ plane, and overtopping rate contours can be interpolated. This procedure is outlined below and used in Example 2. Figure 4 is the dimensional overtopping plot from the example.

17. Seelig recommends the following design procedure for estimating wave overtopping for engineering design. This procedure can be used when interpolation for Q_0^* and α is necessary:

- a. Gather design data, H_s , T , d_s .
- b. Choose the most appropriate $Q_0^* - \alpha$ figure from the SPM (Figures 7-24 through 7-32).
- c. Convert the dimensionless data into dimensional overtopping rates. For the known d_s , each data point yields an overtopping rate Q for one H_s and T combination.
- d. Plot Q 's on an H_s versus T plane.
- e. Interpolate from the dimensional plot for the design H_s and T .

Example 2

18. Using the SPM method and the procedure outlined above, an estimation can be made of the volume rate of overtopping of a 1:3 smooth-slope structure in 10 ft of water with 5 ft of freeboard created by waves with a significant wave height H_s of 4 ft and a design wave period T of 8 sec.

Step 1 $H_s = 4$ ft
 $T = 8$ sec
 $d_s = 10$ ft
 $F = 5$ ft

Step 2 Figure 2 (SPM Figure 7-26) is the correct figure.

Step 3 Calculate an H_s , T , and Q for each $Q_0^* - \alpha$ point on Figure 2.

Step 4 See Figure 5.

Step 5 Interpolating in Figure 5 for the design variables $H_s = 4$ ft and $T = 8$ sec yields $Q_{SPM} = 0.5$ ft³/sec/ft of seawall.

* Personal Communication, Seelig 1983.

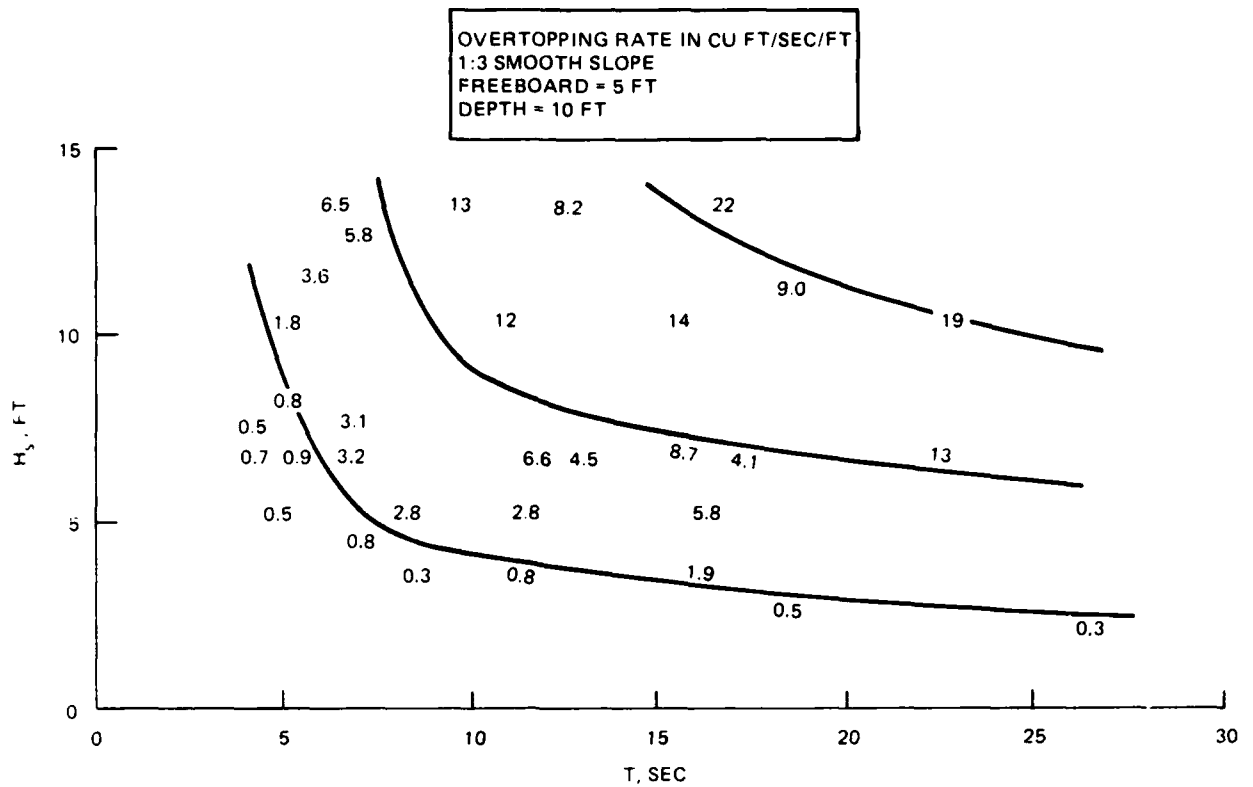

Figure 5. Dimensional overtopping rate plot, Example 2

Discussion

19. The SPM method for estimating overtopping created by monochromatic waves, Weggel's equation (Equation 1), agrees well with Saville's data. This is not surprising since Saville's data comprise the data set from which the equation was derived. Though Weggel's equation predicts monochromatic overtopping well, the assumptions made in extrapolating the equation to irregular seas should be examined.

20. Ahrens makes several assumptions when he applies Weggel's equation to irregular seas. His basic assumption is that runup is Rayleigh distributed (Ahrens 1977b). More recent results by Ahrens (1983) show runup to fit a Weibull distribution, of which a special case is a Rayleigh distribution. A Rayleigh distribution is a reasonable assumption for the purposes of the SPM overtopping-estimation method. A second assumption is that the significant deepwater wave $H_{1/3}$ causes the "significant" runup $R_{1/3}$. While Ahrens does not state that he made this assumption, he has to assume that some specific wave causes some specific runup in the runup distribution. This gives him a reference for his Rayleigh distribution of runups. That the $H_{1/3}$

causes the $R_{1/3}$ may be a reasonable assumption. Ahren's third assumption is that the α , Q_0^* , and H'_0 in Weggel's equation (Equation 1) remain constant as the overtopping contributions of the individual runups are summed. While this assumption may be necessary, it is far from true. However, since no satisfactory general expression for Q_0^* and α has been found, in order to apply Weggel's equation to irregular seas, Q_0^* and α are usually considered constant (Ahrens 1977a, Kobayashi and Reece 1983). Ahrens assumes that H'_0 can be held constant as $H'_0 = H_s$. Since, in the derivation of Equation 1, Weggel (1976) used H'_0 to nondimensionalize overtopping, perhaps irregular wave overtopping can be nondimensionalized with H_s . However, in the absence of experimental verification, any wave height parameter could be selected.

21. The trends shown by Ahrens' correction factors (Figure 3) appear to be reasonable. Ahrens (1977a) points out that the trends in the correction factors agree with trends in overtopping data from Tsuruta and Goda (1968). The correction factor is less than one for low relative freeboard F/H_s and greater than one for high relative freeboard.

22. A very important limitation of the SPM method is that it is based on the tests of Saville. In particular, most of the tests were done on smooth slopes. The only rubble slope tested was 0.1 on 1.5 riprap slope.

Goda's Method

Description

23. Tsuruta and Goda (1968) and Goda (1971) present a graphical method of estimating the rate of irregular wave overtopping over seawalls. This method is called Goda's method in this report. Goda reanalyzes Saville's monochromatic results for vertical walls along with the results of several Japanese monochromatic-wave overtopping studies. Goda presents curves which estimate the monochromatic-wave overtopping rate in terms of deepwater wave height, freeboard, and depth.

24. Goda extrapolates his monochromatic-wave overtopping curves to irregular wave overtopping by assuming that wave heights are Rayleigh distributed and adding together the overtopping contributions from each wave in an irregular sea. The result is presented in Figure 6. Goda duplicates his vertical seawall work for seawalls covered with concrete blocks; however, he does not define this situation well.

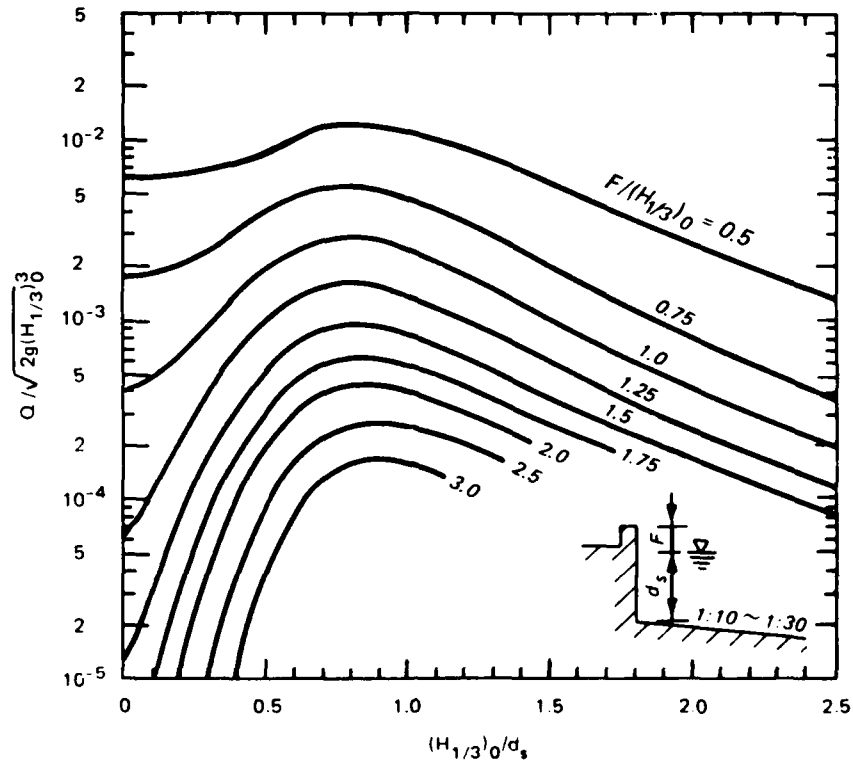

Figure 6. Goda's irregular-wave overtopping rate (from Goda 1971)

Example 3

25. Using Goda's method, overtopping over a vertical seawall with 5 ft of freeboard in 10 ft of water subject to the same wave conditions can be estimated as in Example 1 (Figure 7).

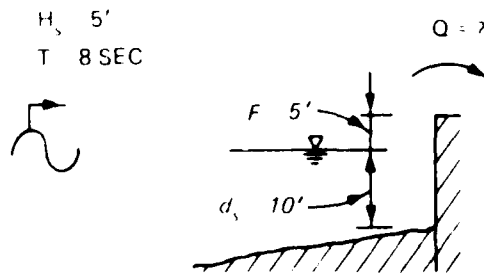

Figure 7. Definition sketch, Example 3

$$\frac{(H_s)_o}{d} = \frac{5 \text{ ft}}{10 \text{ ft}} = 0.5, \quad \frac{F}{(H_s)_o} = \frac{5 \text{ ft}}{5 \text{ ft}} = 1 \quad (11)$$

From Figure 6,

$$\frac{Q_{\text{Goda}}}{\sqrt{2g(H_s)_o^3}} = 2 \times 10^{-3} \quad (12)$$

Therefore,

$$Q_{\text{Goda}} = (2 \times 10^{-3}) \sqrt{(2)(32.2)(5)^3} = 0.18 \text{ ft}^3/\text{sec}/\text{ft of seawall} \quad (13)$$

Discussion

26. The data from which Goda derived his monochromatic-wave overtopping curves show much scatter around the curves. Goda says this scatter is caused by the effect of parameters he ignored (including wave period and beach slope). He believes that for a deepwater-wave steepness less than 0.01, the effect of wave period is not significant. In other words, Goda assumes the difference between overtopping caused by monochromatic waves and overtopping caused by irregular seas is mostly due to wave height variation in the irregular seas.

Battjes' Method

Description

27. The SPM method relates waves to runup and then runup to overtopping. A more direct approach is to relate wave characteristics directly to overtopping, as Goda does for vertical seawalls. Battjes (1974) does this for smooth, sloped structures. After deriving an expression for overtopping caused by monochromatic waves, he accounts for the irregularity of seas by assuming that deepwater wave height and wavelength are jointly Rayleigh distributed.

28. In deriving his monochromatic-overtopping equation, Battjes combines a monochromatic runup formula with laboratory results and then fits the equation to Saville's overtopping data to get

$$b = 0.1 \left(1 - \frac{F}{R}\right)^2 \quad (14)$$

where

$$b = \frac{B}{HL_o \sqrt{\tan \theta}}$$

b = Battjes' dimensionless overtopping for monochromatic waves

B = overtopping volume per wave

θ = structure slope

F = freeboard

R = runup as defined in Figure 1

29. The monochromatic-wave runup formula Battjes uses in his derivation of Equation 14 is from Hunt (1959). Battjes (1972) has shown that Hunt's formula well describes the runup created by breaking waves. The laboratory work Battjes uses is from Battjes and Roos (1975). They investigate the geometry of runup on smooth slopes and relate the volume of water on a structure slope at the instant of maximum runup to the incident monochromatic wave conditions. The coefficient 0.1 and the exponent 2 in Equation 6 are found by fitting the equation to Saville's data (Figure 8).

Figure 8. Battjes monochromatic-wave overtopping equation with Saville's data (from Battjes 1974)

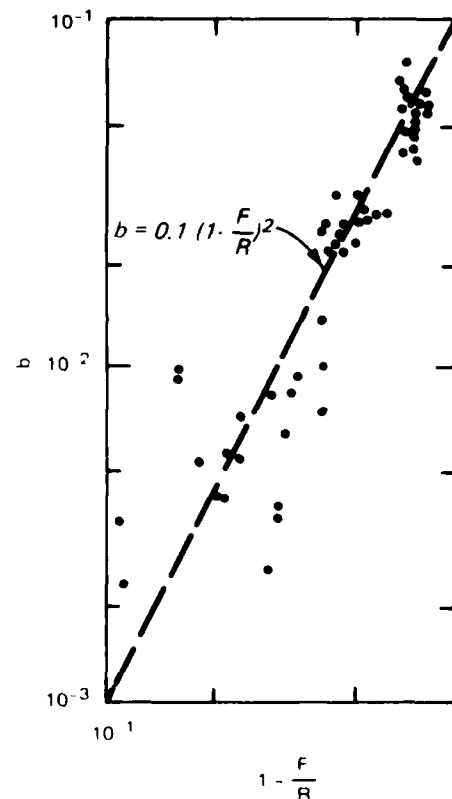

30. Substituting Hunt's formula into Equation 14 gives

$$B = 0.1 (\cot^{3/2} \theta) (R - F)^2 \quad (15)$$

The runup R is the only parameter on the right-hand side of this equation

which would vary in an irregular sea. By assuming that R can be approximated by Hunt's formula ($R = \sqrt{HL_0} \tan \theta$), and by assuming that both H and L_0 are jointly Rayleigh distributed in an irregular sea, Battjes analytically derives an expression for the average overtopping rate created by irregular waves,

$$\beta = \frac{(1 + \kappa)^{3/2}}{\sqrt{\kappa}} \left[\sqrt{\frac{1 + \kappa}{\pi}} \exp\left(-\frac{\pi}{2} \frac{\zeta^2}{1 + \kappa}\right) - \frac{1}{\sqrt{2}} \zeta \operatorname{erfc}\left(\frac{\pi}{2 + 2\kappa} \zeta\right) \right] \quad (16)$$

where

β = Battjes' dimensionless-overtopping volume per average wave period
 $= \bar{B} / (0.1 \bar{H} \bar{L}_0 \sqrt{\tan \theta})$

\bar{B} = average overtopping volume per average wave period

\bar{H} = average wave height

\bar{L}_0 = average deepwater wavelength

κ = statistical parameter which is directly related to λ ($0 < \kappa < 1$)

λ = the coefficient of linear correlation of H and L_0

ζ = dimensionless freeboard

$= F / (\sqrt{\bar{H} \bar{L}_0} \tan \theta)$

erfc = complementary error function (Abramowitz and Stegun 1965)

To calculate volumetric overtopping rate, \bar{B} is divided by the average wave period, \bar{T} ,

$$Q_{\text{Battjes}} = \frac{\bar{B}}{\bar{T}} = \frac{\beta (0.1 \bar{H} \bar{L}_0 \sqrt{\tan \theta})}{\bar{T}} \quad (17)$$

Equation 8 is shown graphically in Figure 9.

31. Battjes shows that his statistical parameter κ is a function of the linear correlation between H and L , λ . The relationship between λ and κ is shown graphically in Figure 10. When H and L_0 are completely uncorrelated, $\lambda = 0$ and $\kappa = 0$. When H and L_0 are perfectly correlated, $\lambda = 1$ and $\kappa = 1$.

Example 4

32. Using Battjes method, an estimation can be made of the volume rate of water which will overtop a smooth 1:6-slope sea dike with a 5-ft freeboard in 10 ft of water caused by waves with an average wave height of $\bar{H} = 3$ ft, and an average wave period of $\bar{T} = 8$ sec (Figure 11).

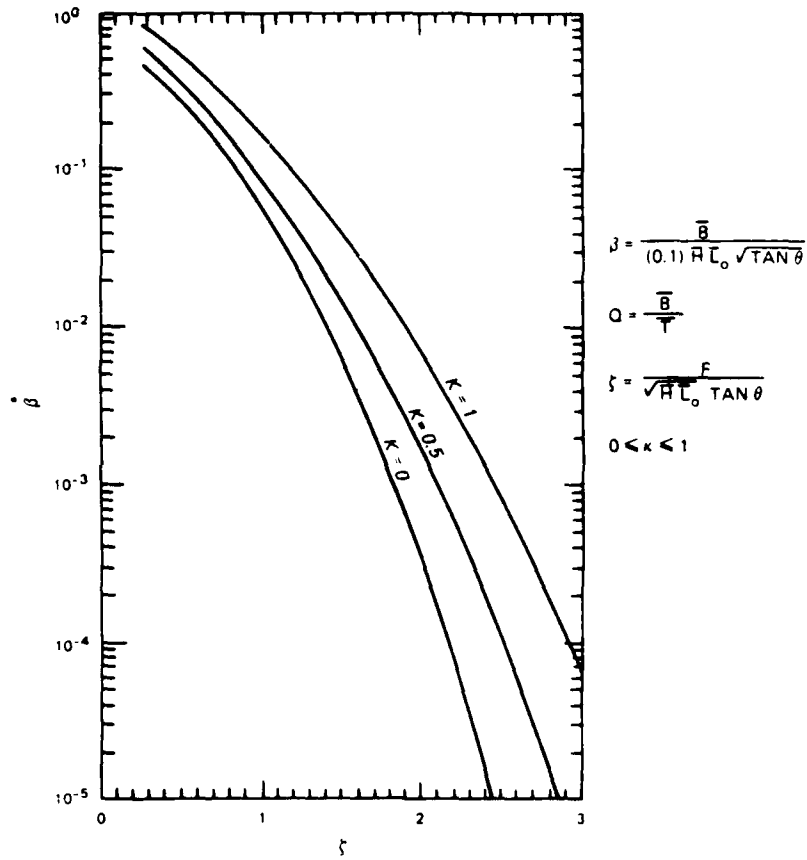

Figure 9. Battjes' irregular wave overtopping (from Battjes 1974)

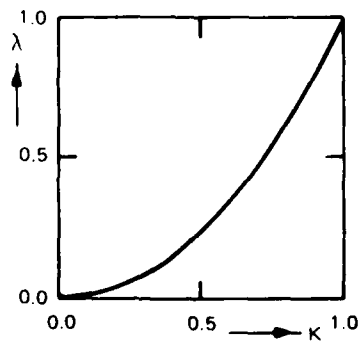

Figure 10. Relationship between Battjes' κ and λ (from Battjes 1974)

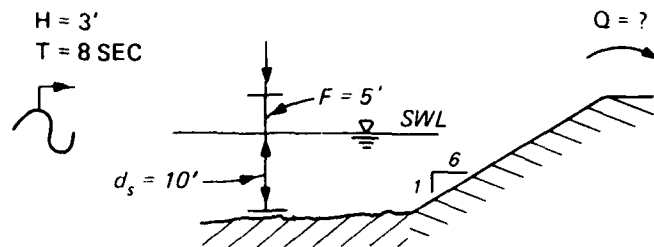

Figure 11. Definition sketch, Example 4

33. To calculate Battjes' dimensionless freeboard, ζ ,

$$\zeta = \frac{F}{\sqrt{\bar{H}\bar{L}_0} \tan \theta} = \frac{5}{\sqrt{(3)(5.12)(8)^2} \left(\frac{1}{6}\right)} = 0.96 \quad (18)$$

Figure 9 is then entered with ζ to find values of β for $\kappa = 0$, $\kappa = 0.5$, and $\kappa = 1.0$:

$$\beta = 0.06, 0.09, 0.2 \text{ as } \kappa = 0, 0.5, 1, \text{ respectively}$$

Equation 9 is used to calculate overtopping rate,

$$Q_{\text{Battjes}} = \frac{\beta(0.10 \bar{H} \bar{L}_0 \tan \theta)}{\bar{T}} = \frac{\beta(0.1)(3)(5.12 \times 8^2) \frac{1}{6}}{8} \quad (19)$$

Therefore,

$$Q = 0.30, 0.45, 1.0 \text{ ft}^3/\text{sec}/\text{ft of dike for } \kappa = 0, 0.5, 1.0, \text{ respectively}$$

Discussion

34. Battjes does not apply his method to rough slopes, i.e., rubble structures. The effective roughness of coastal structures of different materials is discussed in detail in Battjes (1972) and Section 7.2 of the SPM (1984).

35. Both Battjes' and Roos' geometric relation and Hunt's formula were derived for monochromatic waves, not irregular waves. Hunt's formula does not describe the runup of waves which do not break on the structure. Therefore, the more waves in a given spectrum that break, the more appropriate Battjes' method should be. Figure 12 can be used to get a rough estimate of the

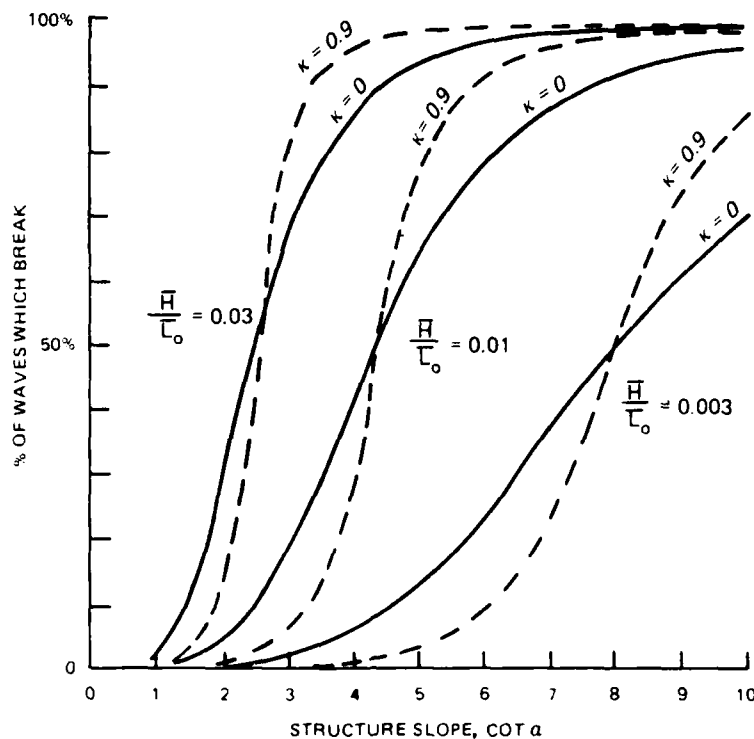

Figure 12. Rough estimate of the percentage of breaking waves

percentage of waves in a spectrum that will break. Figure 12 was generated by combining several equations discussed by Battjes (Battjes 1974; Equations 2.3.5--Iribarren and Nogales' breaking criterion, and 7.6.16--steepness distribution function). Note that for steeper structure slopes, fewer waves will break on the structure; therefore, Battjes' method will be less applicable.

36. Battjes' assumption of Rayleigh-distributed wave heights and wavelengths is commonly accepted as a reasonable approximation in deep water, but not in shallow water. For example, recent work by Ochi, Malakar, and Wang (1982) shows that shallow-water waves can be far from Rayleigh distributed. By making this assumption, Battjes' method may systematically overestimate or underestimate overtopping rate.

Owen's Method

37. Owen (1980) measured overtopping caused by irregular laboratory waves. Based on the results, an equation is presented for estimating irregular wave overtopping rates:

$$Q_* = Ae^{-BF_*} \quad (20)$$

where

Q_* = Owen's dimensionless overtopping

$$= Q/(\bar{T}gH_s)$$

Q = mean overtopping volume rate, L^2/T

\bar{T} = mean zero upcrossing wave period, T

F_* = Owen's dimensionless freeboard

$$= F/(\bar{T}\sqrt{gH_s})$$

F = freeboard, L

38. Values for A and B are presented in Table 1. The values for slopes of 1:1, 1:2, and 1:4 are from the experimental data. The others have been interpolated. Owen cautions against applying his method to situations other than those he tested. His experimental parameter ranges were as follows:

$$\begin{aligned} 0.05 < F_* < 0.30 \\ 10^{-6} < Q_* < 10^{-2} \\ 1.5 < d_s/H_s < 5.5 \\ 0.035 < H_s/\bar{L}_o < 0.055 \end{aligned}$$

Table 1
Empirical Coefficients for Owen's Overtopping
Equation (from Owen 1980)

<u>Seawall Slope</u>	<u>A</u>	<u>B</u>
1:1	7.94×10^{-3}	20.12
1:1.5	1.02×10^{-2}	20.12
1:2	1.25×10^{-2}	22.06
1:2.5	1.45×10^{-2}	26.1
1:3	1.63×10^{-2}	31.9
1:3.5	1.78×10^{-2}	38.9
1:4	1.92×10^{-2}	46.96
1:4.5	2.15×10^{-2}	55.7
1:5	2.5×10^{-2}	65.2

39. The values presented in Table 1 are for simple (plane in cross section) seawalls. Owen also investigated overtopping of seawalls with large berms. The SPM (1984) refers to this type of cross section as a composite slope. The results are presented in Owen (1980) in the form of different A and B values.

40. In order to interpolate between seawall slopes, Owen (1980) plots A and B values for all the situations investigated. Owen goes a step further and generates dimensionless design curves for each berm situation tested. Figure 13 is the design curve for simple seawalls.

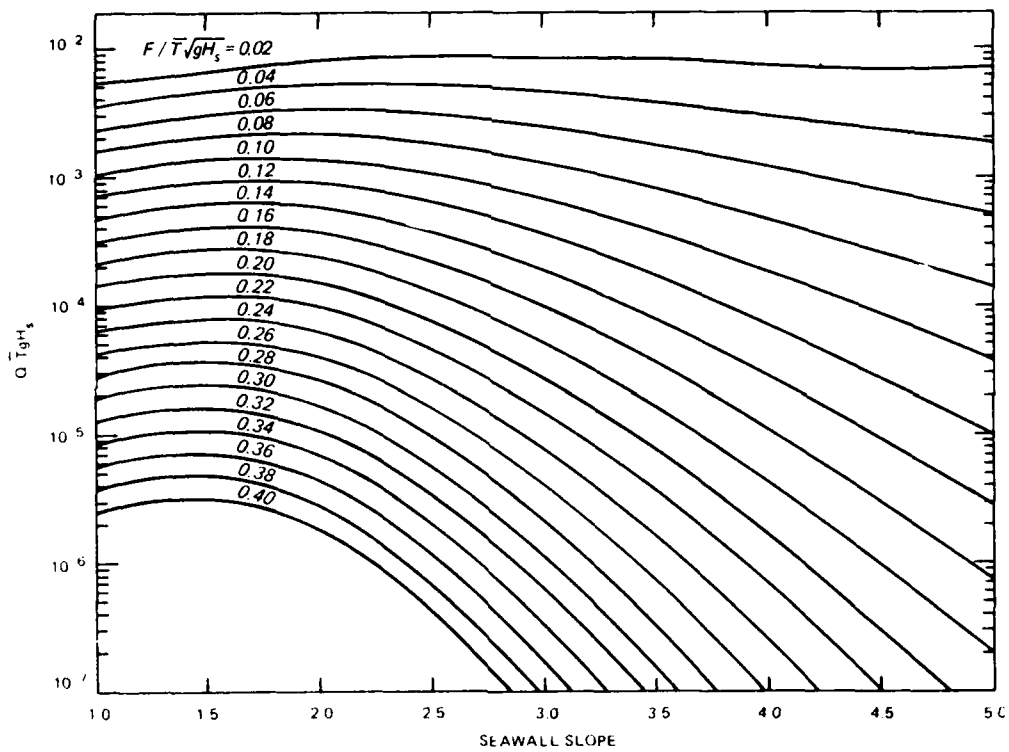

Figure 13. Owen's dimensionless overtopping for smooth, plane-sloped structures (from Owen 1980)

Example 5

41. Using Owen's method, an estimation can be made of the volume rate of water which will overtop a 15-ft-high, 1:3-slope, smooth seawall in 10 ft of water. Wave height and period are $H_s = 5$ ft and $\bar{T} = 8$ sec.

$$F_* = \frac{F}{\bar{T} \sqrt{gH_s}} = \frac{5}{[8 \sqrt{32.2(5)}]} = 0.049 \quad (21)$$

From Figure 13,

$$Q_{*} = 3 \times 10^{-3} \quad (22)$$

Therefore,

$$\begin{aligned} Q_{\text{Owen}} &= (3.5 \times 10^{-3}) \bar{T} g H_s = (3.5 \times 10^{-3})(8)(32.2)(5) \quad (23) \\ &= 4.5 \text{ ft}^3/\text{sec}/\text{ft of structure} \end{aligned}$$

42. Owen recommends an unverified correction to account for seawall roughness. He assumes the effect of roughness on overtopping can be accounted for by assuming the structure has a higher effective freeboard. This higher freeboard is estimated using the SPM (1984) roughness and porosity correction factor:

$$F_{\text{effective}} = \frac{F}{r} \quad (24)$$

where

$F_{\text{effective}}$ = Owen's effective freeboard for rough slopes, L

F = freeboard (see Figure 1), L

r = SPM roughness and porosity correction factor

The effective freeboard is used to determine F_{*} for Equation 20. However, because Owen's laboratory tests were done only for smooth slopes, this roughness correction is unverified.

Example 6

43. Using Owen's method, an estimation can be made of the volume rate of water which will overtop the seawall in Example 5 when made of typical rubble-mound construction. The SPM recommends $r = 0.5 - 0.55$ for two layers of rough, angular quarrystone. To be conservative, $r = 0.55$ is used:

$$\begin{aligned} F_{\text{effective}} &= \frac{F}{r} = \frac{5 \text{ ft}}{0.55} = 9.1 \text{ ft} \\ F_{*} &= \frac{F_{\text{effective}}}{\bar{T} \sqrt{g H_s}} = \frac{9.1}{[8 \sqrt{32.2 (5)}]} = 0.089 \quad (25) \end{aligned}$$

Using Equation 20 and Table 1 as an equivalent alternative to Figure 13,

$$Q_{*} = Ae^{-BF_{*}} = (1.63 \times 10^{-2}) \exp [(-31.9) (0.089)] = 9.5 \times 10^{-4} \quad (26)$$

Therefore

$$\begin{aligned} Q_{\text{Owen}} &= (9.5 \times 10^{-4})(\bar{T}gH_s) = (9.5 \times 10^{-4})(8)(32.2)(5) \\ &= 1.2 \text{ ft}^3/\text{sec}/\text{ft} \text{ of seawall} \end{aligned} \quad (27)$$

Discussion

44. Owen's method is the only method based on experiments with irregular waves. Analysis of the experiments has been presented in two papers, Owen (1980, 1982). However, the data have not been published.* Owen (1980, 1982) does not discuss possible scale effects in his small-scale (1:25) overtopping tests. Aaen's (1977) experimental work is discussed later in this report. It indicates that scale effects in overtopping may be very large.

45. The A and B coefficients in Table 1 are average values of five identical runs. The spread of the five runs allows Owen to determine confidence intervals for Equation 20. For an estimate of overtopping Q from Equation 20, the 95 percent confidence interval is from Q/3 to 3Q. Owen implies that this spread is entirely due to the irregularity of the waves. However, it can also be assumed that this spread is partly caused by the influence of other variables not explicitly considered in Equation 20. This confidence interval must be considered when using Owen's method.

Other Methods

46. Several methods of estimating overtopping have not been discussed. Cross and Sollitt (1970) derive an analytic expression for overtopping volumes caused by monochromatic waves, but they do not attempt to extrapolate to irregular waves. Kikkawa, Shi-Igai, and Kono (1968) treat monochromatic wave overtopping as a form of weir flow. Jensen and Sorensen (1979) present dimensionless equations and curves for estimating overtopping volumes, but do not clearly describe either the dimensionless variables or the empirical coefficients. Kobayashi and Reece (1983) use an assumed joint wave height and period distribution, a monochromatic-wave runup formula, and

* Personal Communication, Owen 1984.

Weggel's equation to derive an estimate of overtopping. The limitations of the assumptions made by Kobayashi and Reece (1983) are discussed in Douglass (1985).

PART III: COMPARISON OF METHODS

47. This section will compare the four methods of estimating irregular wave overtopping by (a) summarizing the methods' regions of applicability, (b) comparing the results of the methods, and (c) comparing the methods with the limited available data.

Summary of Regions of Applicability

48. Each of the four methods for estimating overtopping is applicable to specific design situations. The SPM method is limited by the range of structures which Saville tested: sloped, vertical, and recurved seawalls. The only quarrystone structure tested by Saville was a stone layer placed on an impermeable 1:1.5 slope. Also, since Saville only tested a small number of wave conditions for each structure, difficult interpolation is often necessary when using the SPM method. Owen's method is derived for smooth structures with slopes between 1:1 and 1:4. However, Owen's method should not be used when the experimental ranges on F_* , Q_* , d/H_s , and H_s/\bar{L}_0 are not met. In particular, Owen's range of wave steepnesses is narrow. Owen's method is the only method which specifically includes composite slope structures. Owen suggests an unverified way to extrapolate his smooth slope theory to rough, e.g. rubble-mound, structures. Battjes' method is applicable to gently sloped, smooth structures. Battjes (1974) did not attempt to apply his method to rough slopes. Goda's method is derived for vertical walls. These general regions of applicability of the methods are summarized in Figure 14.

49. The SPM method is the most cumbersome of the four methods. Using any of the other three methods requires only the application of one dimensionless figure or equation. The SPM method, because of its dependence on runup and $Q_0^* - \alpha$ figures, is a multiple-step procedure and is, therefore, more time-consuming.

50. The methods' estimates can be compared for design situations in which more than one method is applicable. Figure 14 and the discussion in the previous section show that for vertical seawalls the SPM method can be compared with Goda's method. For mildly sloped structures, i.e., when waves break on the structure (Figure 12), the SPM method and Battjes' method can be

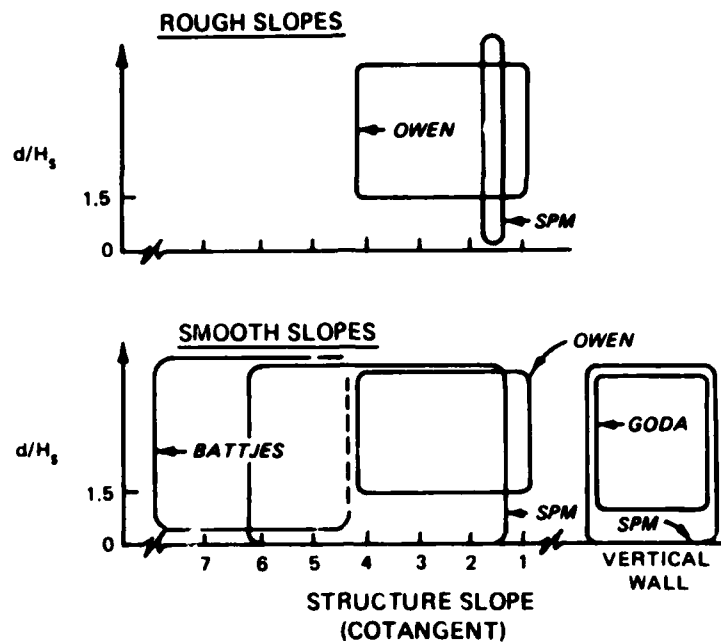

Figure 14. General regions of applicability of overtopping methods

compared. For smooth, steeply sloped structures the SPM method and Owen's method can be compared.

Comparison of Results

Goda and SPM--vertical walls

51. The SPM and Goda methods for vertical seawalls are compared in dimensionless form in Figure 15. The four d_s/H_s ratios correspond to the situations tested by Saville. The vertical spread of the SPM method is the effect of the variability of peak wave period, which Goda ignores. The SPM values shown in Figure 15 correspond to the range of wave steepnesses covered by the $Q_o^* - \alpha$ points in SPM Figure 7-24. This approach will also be used to compare the SPM method with Battjes' and Owen's methods. Figure 15 clearly shows the rapid decrease in overtopping with increasing structure height.

52. The relationship between SPM and Goda estimates is dependent on relative depth $d_s/(H_s)_o$. For $d_s/(H_s)_o = 3$ and 1.5 , the SPM method estimates more overtopping than Goda's method. For $d_s/(H_s)_o = 0.75$, the two methods yield comparable estimates. In very shallow water, $d_s/(H_s)_o = 0.4$, Goda's method estimates more overtopping than the SPM. This dependence on $d_s/(H_s)_o$ implies a dependence on wave breaking and appears to be a result of the different approaches used to extrapolate monochromatic-wave overtopping results to irregular waves.

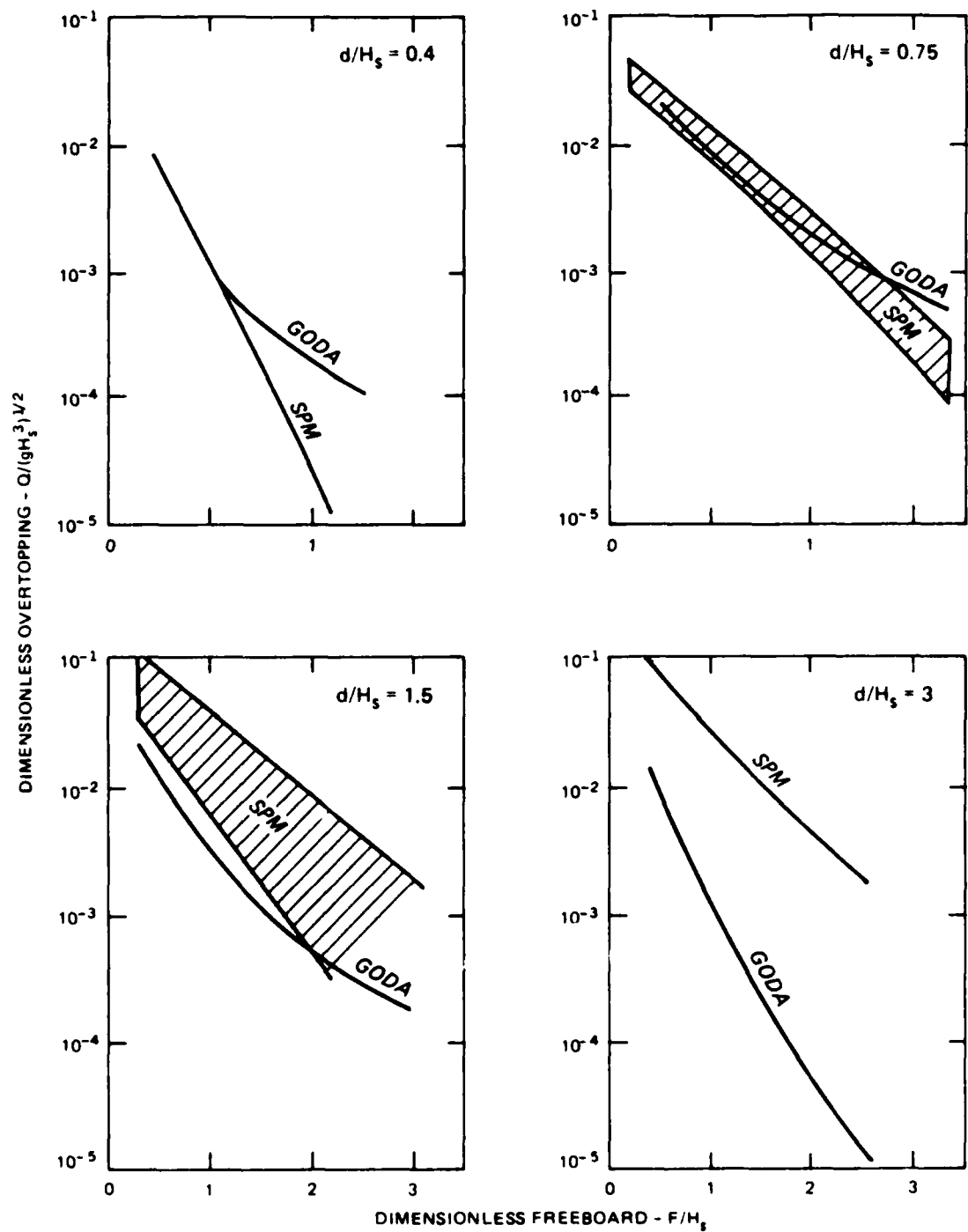

Figure 15. Comparison of Goda and SPM methods for estimating overtopping of a vertical wall

Battjes and SPM--mild slopes

53. Similar dimensionless comparison plots can be made for the SPM and Battjes' methods for mildly sloped structures. Figure 7-27 of the SPM (1984) has several $Q_0^* - \alpha$ points which have a corresponding wave steepness that meets Battjes' breaking criterion for a 1:6 smooth-slope structure. Figure 16 shows the SPM and Battjes' method estimates for a 1:6-slope structure. The total range of Battjes' κ values is considered.

54. Battjes' method estimates more overtopping than the SPM method,

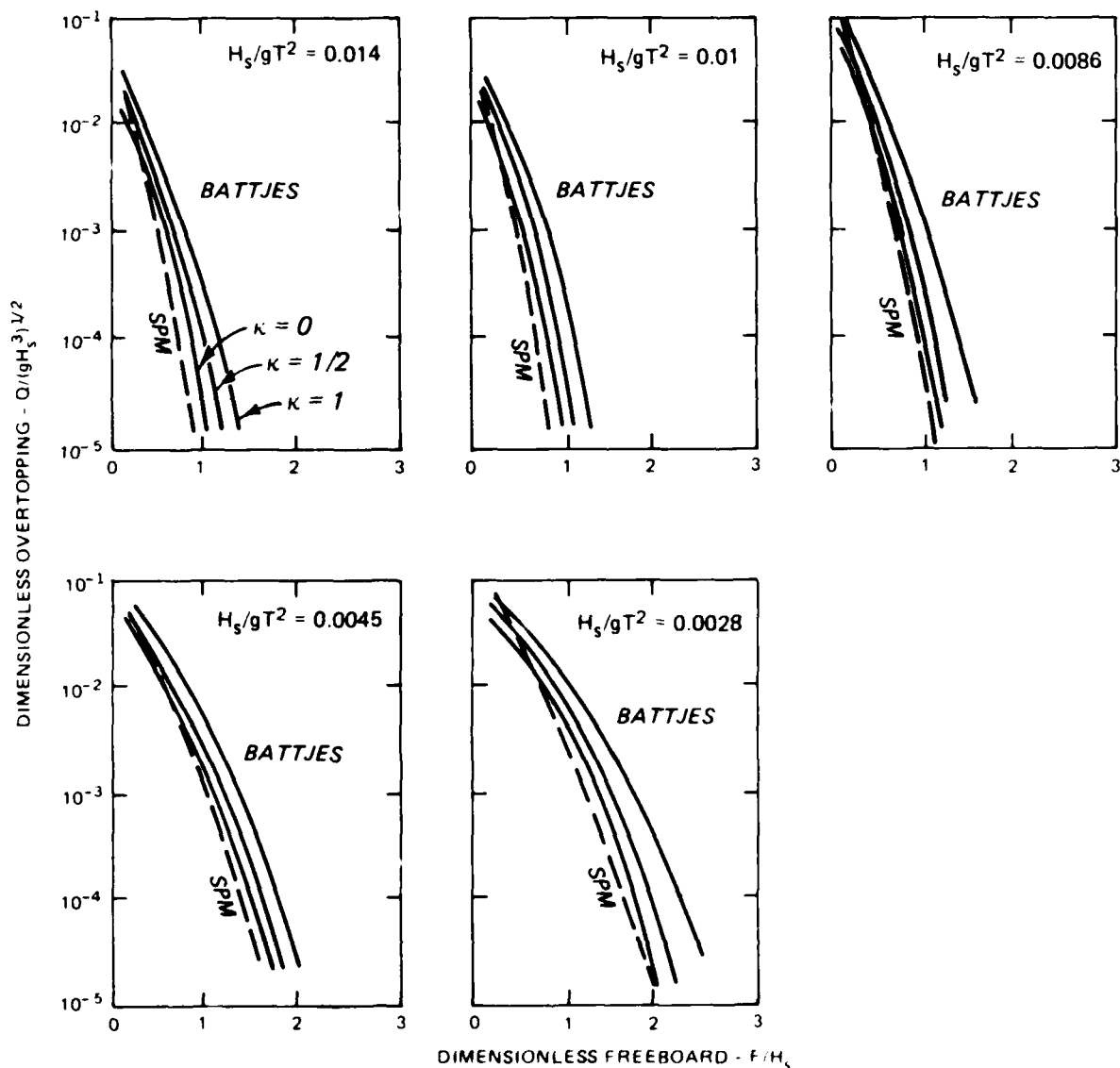

Figure 16. Comparison of Battjes' and SPM methods for estimating overtopping of a 1:6 smooth-slope structure

except for very low relative freeboards. The difference between the dimensionless estimates is greatest for small amounts of overtopping. The effect of slope cannot be checked because Saville did not test other mild slopes.

Owen and SPM--steep slopes

55. Figure 14 shows that Owen's method can be compared with the SPM method. Figures 7-25, 7-26, and 7-28 of the SPM (1984) present $Q_o^* - \alpha$ values for 1:1.5 and 1:3 smooth slopes and 1:1.5 rough slopes. The range of wave steepnesses and relative water depths tested by Owen limits the comparison to a few $Q_o^* - \alpha$ points in the SPM figures. The comparison for 1:3 smooth slopes is made in Figure 17 by plotting dimensionless overtopping versus dimensionless freeboard, as in Figures 15 and 16.

56. Owen's method estimates more overtopping than the SPM method. As the dimensionless freeboard increases and the overtopping decreases, the two estimates diverge. In other words, the difference between the two methods is greatest for very small amounts of overtopping. Similar results are found for both rough and smooth 1:1.5 slopes.

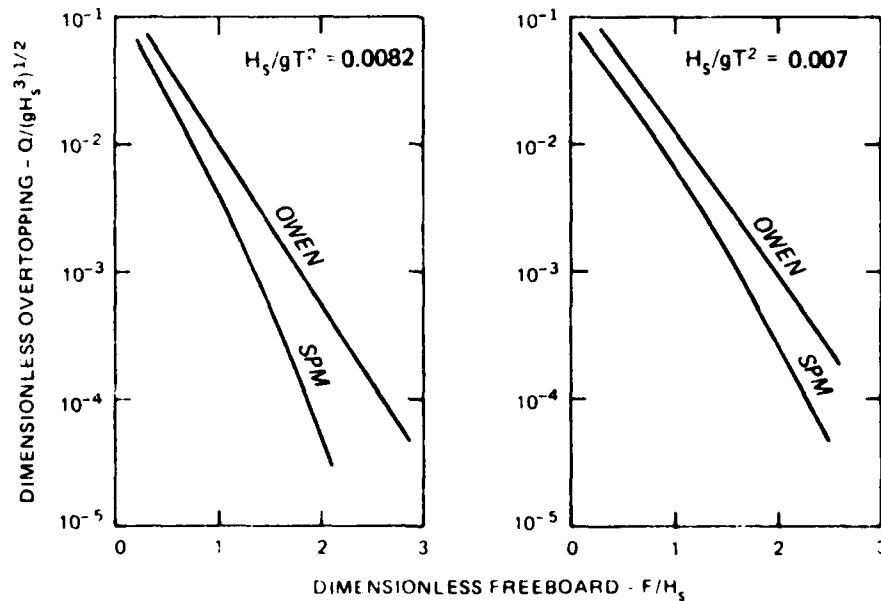

Figure 17. Comparison of Owen and SPM methods for estimating overtopping of a 1:3 smooth-slope structure

Comparison with Data

57. The four overtopping methods should be evaluated by comparing how they agree with laboratory and field data. Unfortunately, no conclusive, comprehensive set of overtopping volumes caused by irregular waves has been published. Paape (1960), Sibul and Tickner (1956), and Tsuruta and Goda (1968) conducted experiments before the present generation of laboratory irregular-wave generators was developed. Therefore, they could not generate a realistic, controlled irregular sea. Unfortunately, neither Jensen and Sorensen (1979) nor Owen (1980, 1982) published the data from which they derived their design curves.

58. Aaen (1977) measured overtopping in both the laboratory and the prototype to investigate scale effects in overtopping modeling. He measured actual overtopping over a breakwater at Hundested, Denmark, during six storms. He then reproduced the structure and storm conditions in the laboratory at two scales, 1:8 and 1:10. Since only one structure is considered, Aaen's data cannot be used to comprehensively evaluate the overtopping estimation methods. However, Aaen's data can be used as a rough "spot-check" verification of the methods for that specific structure and three specific wave conditions. The Hundested breakwater has a 1:2 slope of rounded sea stones.

59. Figure 14 shows that Owen's method is applicable and that the SPM method is nearly applicable. For the sake of an order-of-magnitude comparison, the SPM method will be compared with Aaen's data by ignoring the difference in slope (1:2 instead of 1:1.5) and the difference in armor layer (round sea stone instead of rough, angular quarystone). In calculating the overtopping estimates, a roughness and porosity correction factor r of 0.65 is assumed, and the methodology presented in the SPM for accounting for the effect of wind on overtopping is used (wind increases overtopping from 30 to 50 percent). The storm data are presented in Table 2 with the model data and estimates from both the SPM and Owen's methods. The results of the three largest storms are plotted in Figure 18.

60. The SPM method underpredicts Aaen's data while Owen's method predicts Aaen's data. The relationship between the two estimates agrees with the trend of Figure 17; that is, for low overtopping rates, Owen's method estimates much more overtopping than the SPM method.

61. Considering both the inherent assumptions of the SPM method and the

Table 2
Model Data and Estimates Using
SPM and Owen's Methods

Storm	Aaen's Measured Overtopping, $\text{ft}^3/\text{sec}/\text{ft}$			Estimated Overtopping	
	Prototype	1:8	1:10	SPM Method	Owen's Method
1	4×10^{-5}	9×10^{-5}	5×10^{-5}	$< 10^{-5}$	N/A
2	2×10^{-4}	5×10^{-5}	1×10^{-4}	$< 10^{-5}$	N/A
3	8×10^{-5}	1×10^{-4}	2×10^{-4}	$< 10^{-5}$	N/A
4	4×10^{-3}	4×10^{-3}	2×10^{-3}	2×10^{-3}	2×10^{-2}
5	4×10^{-4}	4×10^{-4}	4×10^{-4}	8×10^{-5}	6×10^{-3}
6	6×10^{-4}	6×10^{-4}	5×10^{-4}	1×10^{-4}	6×10^{-3}

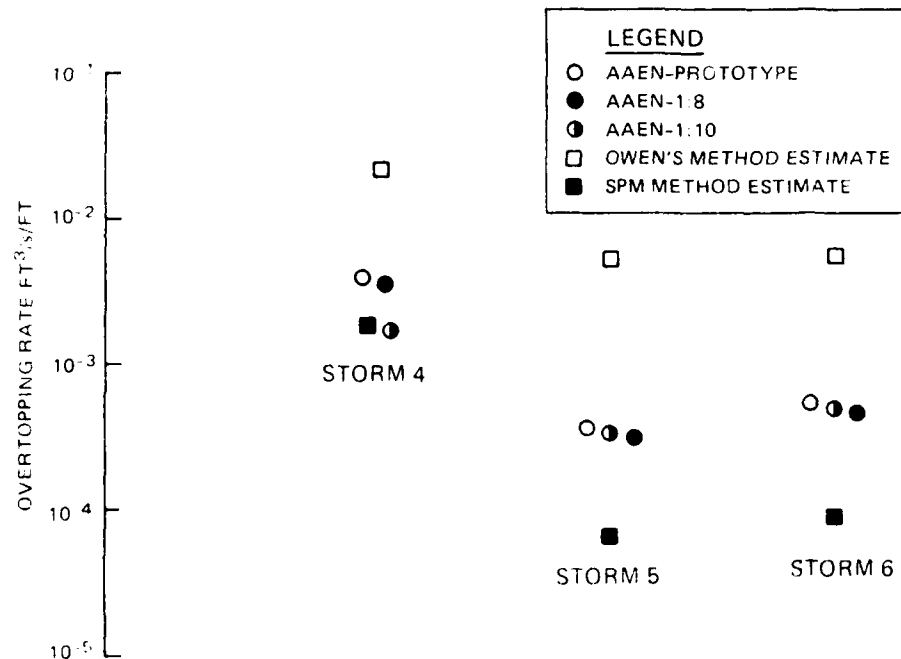

Figure 18. Aaen's (1977) overtopping data with estimates using Owen's method and the SPM method

ignored differences in structure slope and material, the agreement between Aaen's data and the SPM estimate is encouraging.

62. Owen's method estimates an order of magnitude more overtopping than Aaen measured. Since Owen's method is based on irregular wave tests on a 1:2 slope, the disagreement between Aaen's data and Owen's method is

surprising. Owen's unverified roughness correction factor may explain some of the difference between his estimate and Aaen's data.

63. Another explanation is that significant scale effects could have been present in Owen's 1:25-scale laboratory tests. Aaen (1977) found that the scale effect depends on the magnitude of overtopping; the model overestimates the prototype for very small amounts of overtopping. For three of Aaen's storms, the relatively high crest elevation F/H_s caused F_* to be outside of the range tested by Owen. For storms 5 and 6, F_* was at its upper limit. In fact, the high crest height allowed very little overtopping during any of the storms. Storm 4 had the most overtopping because it had the highest water level and largest wave height. Still, Aaen's overtopping rate of 4×10^{-3} ft³/sec/ft of breakwater is so small that it would take 30 sec to fill a gallon jug along each foot of breakwater. Further information is needed to ascertain the cause of the discrepancy between Aaen's data and Owen's method.

64. Fukuda, Uno, and Irie (1974) measured actual overtopping rates at a seawall fronted by artificial concrete blocks. They found that Goda's curves for seawalls covered with artificial blocks overpredicted their data by between one and two orders-of-magnitude. Fukuda, Uno, and Irie believe this drastic difference is caused by different offshore slopes. While Goda's method is derived for offshore slopes of 1:10 to 1:30, Fukuda's seawall had an offshore slope of 1:80. Fukuda, Uno, and Irie believe that their 1:80 slope caused significantly more energy loss than Goda's offshore slopes. Since the artificial-block seawall is not described in detail, these data are not compared with estimates from any of the other methods.

PART IV: OTHER PARAMETERS THAT AFFECT OVERTOPPING

Onshore Winds

65. Thus far, several parameters which affect overtopping have been ignored for the sake of simplicity. Onshore winds should increase the overtopping rate at a seawall. The SPM recommends an unverified wind correction. For onshore winds, the correction varies from 1 to 3.2 Owen (1980) uses the SPM wind correction factor; the other two methods do not address the problem. However, it must be realized that this equation is merely a rough engineering estimate of a very complex phenomenon. Gadd et al. (1984) discuss some qualitative trends in the wind effect and conclude that more data are needed to improve upon the SPM correction.

Angle of Wave Attack

66. Very little information exists concerning the effect that angle of wave attack has on overtopping. In the absence of data, engineers have usually assumed that overtopping is maximum when waves hit the structure head-on, i.e. perpendicularly, and tapers off to zero as the angle of attack lessens. However, Owen (1980) found that overtopping is maximum not when waves approach the structure perpendicularly, but at an angle of 15° . During his smooth-slope overtopping tests, Owen investigated angles of attack of 0° (perpendicular), 15° , 30° , 45° , and 60° . The effect of angle of attack for one structure slope is shown in Figure 19. The overtopping at 30° was similar to that at 0° . Figure 19 shows the results held for various freeboards. Owen (1980, 1982) has no explanation for the results shown in Figure 19. However, similar results have been seen by Tautenhain, Kohlhase, and Partenscky (1982) for monochromatic wave runup. Until more data are available to better define this phenomenon, care should be taken to not assume too much overtopping reduction for oblique angles of wave attack.

Varying Water Level

67. One of the most important parameters in overtopping estimation is the water depth at the structure. For a given structure, increasing the water

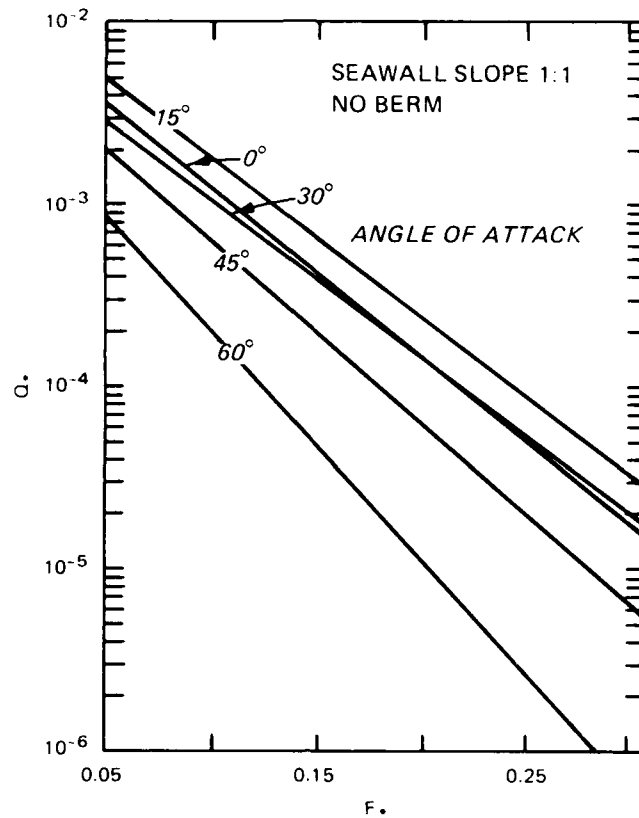

Figure 19. Effect of angle of wave attack (from Owen 1982)

depth decreases the relative freeboard F/H_s . Not only does a rise in water level decrease the freeboard F , but it also allows higher waves to reach the structure if the waves are depth limited. Figures 8, 11, 15, 16, and 17 all show the dramatic dependence of overtopping on relative freeboard F/H_s . Therefore, a varying water level, such as a tide or a storm surge, will cause the overtopping rate to vary significantly through time.

PART V: SUMMARY AND CONCLUSIONS

68. Four methods of estimating overtopping rates caused by irregular waves are briefly described in Part II. Three of the methods, SPM, Goda, and Battjes, extrapolate monochromatic laboratory results to irregular seas. The fourth method, Owen, is based on irregular-wave laboratory data.

69. The four methods were derived for different situations. The general ranges of applicability are summarized in Figure 14.

70. Comparison of the methods' results indicates that (a) for vertical seawalls, the SPM method estimates more overtopping than Goda's method except in very shallow water; and (b) for sloped structures, the SPM method generally estimates less overtopping than Battjes' method and Owen's method.

71. Data to adequately evaluate the methods have not been published. For one specific structure and very little overtopping, the SPM method agrees with the data, and Owen's method overestimates the data.

72. Available methods provide only a broad, general estimate of overtopping rates. The question "How well do the available methods estimate overtopping?" cannot be conclusively answered at this time. The methods discussed in this report provide the best available estimate. Until better data are available, these estimates should be considered to be within, at best, a factor-of-three, and conservatively, an order-of-magnitude of the actual overtopping rate. This conclusion is made considering:

- a. The lack of comprehensive, conclusive data and the discrepancies between the methods' estimates and the very limited published data.
- b. The assumptions made in the derivations of the methods.
- c. The factor-of-three confidence band that Owen claims for his method, which is the only method of the four based on irregular-wave overtopping data.
- d. The scale effects found by Aaen.
- e. The order-of-magnitude difference between estimates from different methods.

73. Model tests with irregular waves are recommended for a more precise, site-specific estimate of volume rate of overtopping.

74. More data are needed to improve the available methodology for estimating wave overtopping. Laboratory tests with irregular waves are needed. Prototype data are needed to determine scale effects in overtopping

modeling. Also, data are needed to better understand the effects of wind and angle of wave attack.

REFERENCES

- Aaen, S. 1977. "Oversprojt (Overtopping)," Bachelor Thesis, Danish Academy, Department of Civil Engineering, Copenhagen (in Danish).
- Abramowitz, M., and Stegun, I. A. 1965. Handbook of Mathematical Functions, Dover Publications, Inc., New York.
- Ahrens, J. 1977a. "Prediction of Irregular Wave Overtopping," CETA 77-7, US Army Engineer Waterways Experiment Station, Coastal Engineering Research Center, Vicksburg, Miss.
- _____. 1977b. "Prediction of Irregular Wave Runup," CETA 77-2, US Army Engineer Waterways Experiment Station, Coastal Engineering Research Center, Vicksburg, Miss.
- _____. 1983. "Wave Runup on Idealized Structures," Coastal Structures '83 Specialty Conference, Arlington, Va., pp 925-938.
- Battjes, J. A. 1972. "Wave Runup and Overtopping," Technical Advisory Committee on Protection Against Inundation, Rijkswaterstaat, The Hague, The Netherlands.
- _____. 1974. "Computation of Set-up, Longshore Currents, Run-up and Overtopping Due to Wind-Generated Waves," Report No. 74-2, Delft University of Technology, Department of Civil Engineering, Delft, Holland.
- Battjes, J. A., and Roos, A. 1975. "Characteristics of Flow in Runup of Periodic Waves," Report No. 75-3, Delft University of Technology, Department of Civil Engineering, Delft, Holland.
- Cross, R. H., and Sollitt, C. K. 1970. "Wave Transmission by Overtopping," Technical Report No. 15, Ralph M. Parson Laboratory, Department of Civil Engineering, Massachusetts Institute of Technology, Cambridge, Mass.
- Douglass, S. L. 1985. "Discussion of Irregular Wave Overtopping on Gravel Islands," Paper WW 18386 by Kobayashi and Reece, Journal of Waterways, Port, Coastal and Ocean Engineering, American Society of Civil Engineers, WWI, Vol 111, No. 1, pp 146-147.
- Fukuda, N., Uno, F., and Irie, S. 1974. "Field Observations of Wave Absorbing Revetment," Coastal Engineering in Japan, Vol 17.
- Gadd, P. E., et al. 1984. "Wave Runup and Overtopping: A Review and Recommendations," Proceedings of the 1984 Offshore Technology Conference, Houston, Tex.
- Goda, Y. 1971. "Expected Rate of Irregular Wave Overtopping of Seawalls," Coastal Engineering in Japan, Vol 14.
- Hunt, J. A. 1959. "Design of Seawalls and Breakwaters," Journal of Waterways and Harbors, American Society of Civil Engineers, WW3, pp 123-152.
- Jensen, O. J., and Sorensen, F. 1979. "Overspilling/Overtopping of Rubble-Mound Breakwaters," Coastal Engineering, Vol 3, No. 1.
- Kikkawa, H., Shi-Igai, A., and Kono, F. 1968. "Fundamental Study of Wave Overtopping on Levees," Coastal Engineering in Japan, Vol 11.

- Kobayashi N., and Reece, A. M. 1983. "Irregular Wave Overtopping on Gravel Islands," Journal of Waterway, Port, Coastal and Ocean Engineering, American Society of Civil Engineers, WW4, Vol 109, pp 429-444.
- Ochi, M. K., Malakar, S. B., and Wang, W. C. 1982. "Statistical Analysis of Coastal Waves Observed During the ARSLOE Project," Coastal and Oceanographic Engineering Department, University of Florida, Gainesville, Fla.
- Owen, M. W. 1980. "Design of Seawalls Allowing for Wave Overtopping," Report No. Ex 924, Hydraulics Research Station, Wallingford, England.
- _____. 1982. "Overtopping of Sea Defences," International Conference on the Hydraulic Modeling of Civil Engineering Structures, pp 469-480.
- Paape, A. 1960. "Experimental Data on the Overtopping of Seawalls by Waves," 7th Conference on Coastal Engineering, The Hague, The Netherlands, pp 674-681.
- Saville, T., Jr. 1955. "Laboratory Data on Wave Runup and Overtopping on Shore Structures," TM-64, US Army Corps of Engineers, Beach Erosion Board.
- Shore Protection Manual. 4th ed., 2 vols. 1984. US Army Corps of Engineers, US Government Printing Office, Washington, DC.
- Sibul, O. V., and Tickner, E. G. 1956. "Model Study of Overtopping of Wind-Generated Waves on Levees with Slopes of 1:3 and 1:6," TM-80, US Army Corps of Engineers, Beach Erosion Board.
- Tautenhain, E., Kohlhase, S., and Partenscky, H. W. 1982. "Wave Run-up at Sea Dikes Under Oblique Wave Approach," 18th International Conference on Coastal Engineering, Capetown, South Africa, pp 804-810.
- Tsuruta, S., and Goda Y. 1968. "Expected Discharge of Irregular Wave Overtopping," 11th Conference on Coastal Engineering, London, pp 833-852.
- Weggel, J. R. 1976. "Wave Overtopping Equation," Proceedings of the 15th Coastal Engineering Conference, Honolulu, pp 2737-2755.

END

4-87

DTIC