

AD-A185 812

DTIC FILE COPY



DEVELOPMENT OF MILESTONE SCHEDULES
FOR
SELECTED LOGISTICS SUPPORT DIRECTORATE PROGRAMS

APPENDIX C
HTPM SCHEDULES
(After Feasibility Assessment)



Science Applications International Corporation

DTIC
ELECTE
S OCT 07 1987 D
AD

DISTRIBUTION STATEMENT A

Approved for public release
Distribution Unlimited

87 10 1 490

1

DEVELOPMENT OF MILESTONE SCHEDULES
FOR
SELECTED LOGISTICS SUPPORT DIRECTORATE PROGRAMS

APPENDIX C
HTPM SCHEDULES
(After Feasibility Assessment)

15 SEPTEMBER 1987

BRUCE B. HALSTEAD
ARTHUR A. NARRO
THOMAS J. FIDD
KURT A. KLADIVKO
JERRI Y. GIST

DTIC
ELECTE
OCT 07 1987
S D D

Prepared for:
US Army
Belvoir Research, Development and Engineering Center

Under
Contract Number DAAK70-84-D-0053
Task Order 0033

"The views, opinions and/or findings contained in this report are those of the authors and should not be construed as an official Department of the Army position, policy or decision unless so designated by other documentation."

SCIENCE APPLICATIONS INTERNATIONAL CORPORATION
Military Operations Analysis Division
1710 Goodridge Drive, T-7-2
McLean, Virginia 22102

DISTRIBUTION STATEMENT A
Approved for public release;
Distribution Unlimited

R1

AD-A185 812

Form Approved
OMB No 0704-0188
Exp. Date Jun 30, 1986

1a. REPORT SECURITY CLASSIFICATION UNCLASSIFIED		1b. RESTRICTIVE MARKINGS NONE	
2a. SECURITY CLASSIFICATION AUTHORITY N/A		3. DISTRIBUTION / AVAILABILITY OF REPORT UNLIMITED	
2b. DECLASSIFICATION / DOWNGRADING SCHEDULE N/A		5. MONITORING ORGANIZATION REPORT NUMBER(S) TO BE ASSIGNED	
4. PERFORMING ORGANIZATION REPORT NUMBER(S) SAIC-87/1780		7a. NAME OF MONITORING ORGANIZATION US Army Belvoir Research, Development and Engineering Center	
6a. NAME OF PERFORMING ORGANIZATION Science Applications Int'l Corp	6b. OFFICE SYMBOL (If applicable) N/A	7b. ADDRESS (City, State, and ZIP Code) Commander Fort Belvoir, Virginia 22060-5606	
6c. ADDRESS (City, State, and ZIP Code) 1710 Goodridge Drive, T-7-2 McLean, Virginia 22102		9. PROCUREMENT INSTRUMENT IDENTIFICATION NUMBER DAAK70-84-D-0053	
8a. NAME OF FUNDING / SPONSORING ORGANIZATION US Army Belvoir Research, Dev. and Engineering Center	8b. OFFICE SYMBOL (If applicable) STRBE-HP	10. SOURCE OF FUNDING NUMBERS	
8c. ADDRESS (City, State, and ZIP Code) Fort Belvoir, Virginia 22060-5606		PROGRAM ELEMENT NO.	TASK NO. 0033
		PROJECT NO.	WORK UNIT ACCESSION NO.

11. TITLE (Include Security Classification) **APPENDIX C**
Development of Milestone Schedules for Selected Logistics Support Directorate Programs. (U)

12. PERSONAL AUTHOR(S)
Bruce B. Halstead, Arthur A. Narro, Thomas J. Fidd, Kurt A. Kladienko, Jerri Y. Gist

13a. TYPE OF REPORT Technical Report	13b. TIME COVERED FROM 12/86 TO 9/87	14. DATE OF REPORT (Year, Month, Day) 1987 September 15	15. PAGE COUNT 53
---	---	--	----------------------

16. SUPPLEMENTARY NOTATION

17. COSATI CODES			18. SUBJECT TERMS (Continue on reverse if necessary and identify by block number) Acquisition Milestone Schedules, Acquisition Management, Data Base Development
FIELD	GROUP	SUB-GROUP	

19. ABSTRACT (Continue on reverse if necessary and identify by block number)
The Logistics Support Directorate is responsible for numerous developmental programs requiring comprehensive milestone schedules to guide programs through the Army's extensive materiel acquisition cycle. Schedules are developed using micro-computers to assist Project Engineers with the management of key activities. The objective of this effort was to develop milestone schedules for selected developmental programs. Examples were generated for use by Project Engineers when they develop future milestone schedules. The document also includes examples of a data request form to extract data from Project Engineers and a user's manual for data base management.

20. DISTRIBUTION / AVAILABILITY OF ABSTRACT <input type="checkbox"/> UNCLASSIFIED/UNLIMITED <input checked="" type="checkbox"/> SAME AS RPT. <input type="checkbox"/> DTIC USERS		21. ABSTRACT SECURITY CLASSIFICATION UNCLASSIFIED	
22a. NAME OF RESPONSIBLE INDIVIDUAL Mr. James Stephens		22b. TELEPHONE (Include Area Code) 703-664-5092	22c. OFFICE SYMBOL STRBE-HP

APPENDIX C

HTPM SCHEDULES (After Feasibility Assessment)

TABLE OF CONTENTS

<u>SCHEDULE</u>	<u>PAGE</u>
2 KVA POWER CONDITIONER.....	C-1
15 AND 30 KW NOISE KITS.....	C-4
COMBAT VEHICLE ENVIRONMENTAL SUPPORT SYSTEM.....	C-13
DISTRIBUTION/ILLUMINATION SET, ELECTRICAL.....	C-23
FHUS.....	C-25
HIGH TECH REVERSE OSMOSIS WATER PURIFICATION UNIT.....	C-29
MODULAR BASE PETROLEUM LABORATORY.....	C-32
M113 ELECTRIC DRIVE PROJECT.....	C-35
REGENCY NET POWER UNIT PROGRAM SCHEDULE.....	C-38
PULSE POWER PROGRAM.....	C-41
TOTAL ENVIRONMENTAL CONTROL SYSTEM.....	C-45
TRIDENT II BOXCAR.....	C-48
UNIT BASIC LOAD - UPLOAD EQUIPMENT.....	C-52
UNIVERSAL SELF-DEPLOYABLE CARGO HANDLER.....	C-57

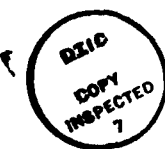

Accession For	
NTIS CRA&I	<input checked="" type="checkbox"/>
DTIC TAB	<input type="checkbox"/>
Unannounced	<input type="checkbox"/>
Justification	
By <i>per 1473</i>	
Distribution/	
Availability Codes	
Dist	Accession or Special
<i>A-1</i>	

24 : 000 1 2 3 4 5 6 7 8 9 10 11 12 13 14 15 16 17 18 19 20 21 22 23 24 25 26 27 28 29 30 31 32 33 34 35 36 37 38 39 40 41 42 43 44 45 46 47 48 49 50 51 52 53 54 55 56 57 58 59 60 61 62 63 64 65 66 67 68 69 70 71 72 73 74 75 76 77 78 79 80 81 82 83 84 85 86 87 88 89 90 91 92 93 94 95 96 97 98 99 100

2KVA POWER CONDITIONER
Project: 2KVAPC

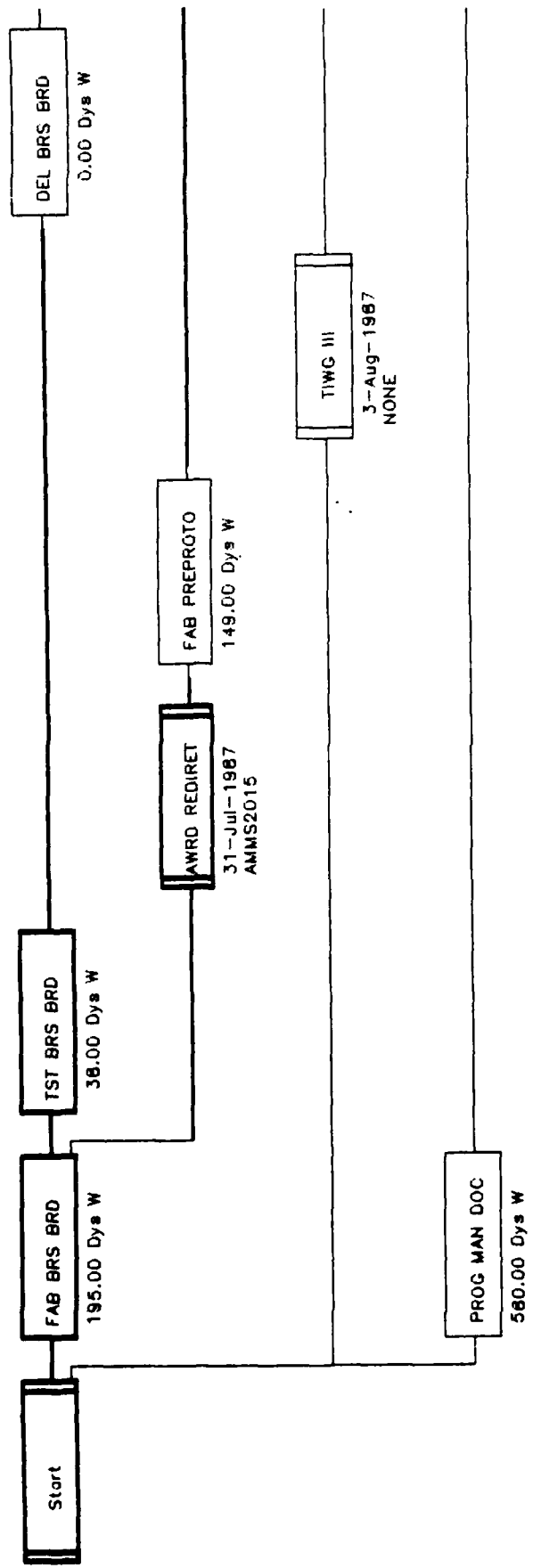

2 KVA POWER CONDITIONER
Project: 2KVAPC

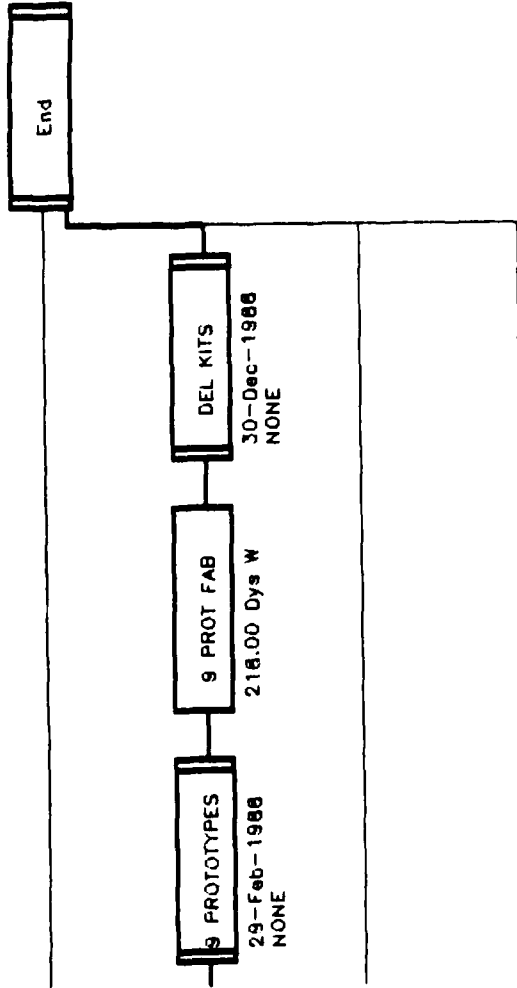

2KVA POWER CONDITIONER
Project: 2KVAPC

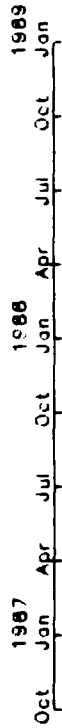

- Start
- TWIG III
- FAB BRS BRD
- PROG MAN DOC
- TST BRS BRD
- AWRD REDIRET
- FAB PREPROTO
- DEL BRS BRD
- 9 PROTOTYPES
- 9 PROT FAB
- DEL KITS
- End

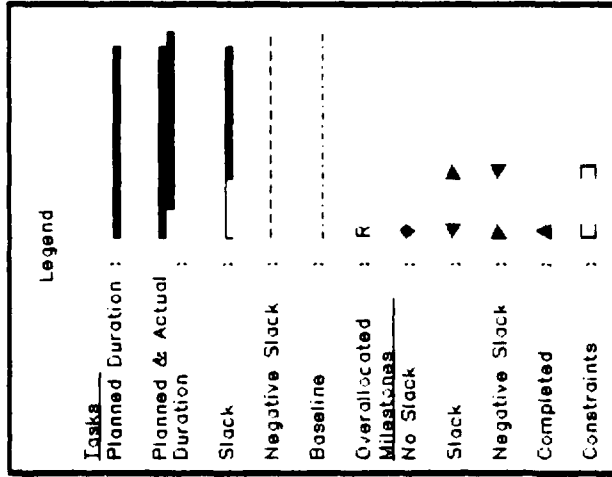

Legend

- Tasks : [Solid horizontal bar]
- Planned Duration : [Dashed horizontal bar]
- Planned & Actual Duration : [Thick solid horizontal bar]
- Slack : [Thin solid horizontal bar]
- Negative Slack : [Dashed horizontal bar]
- Baseline : [Dotted horizontal bar]
- Overallocated : R
- Milestones : ◆
- No Slack : ◆
- Slack : ▲
- Negative Slack : ▼
- Completed : ▲
- Constraints : [Square with diagonal line]

15 & 30 KW NOISE KITS
Project: ASK1

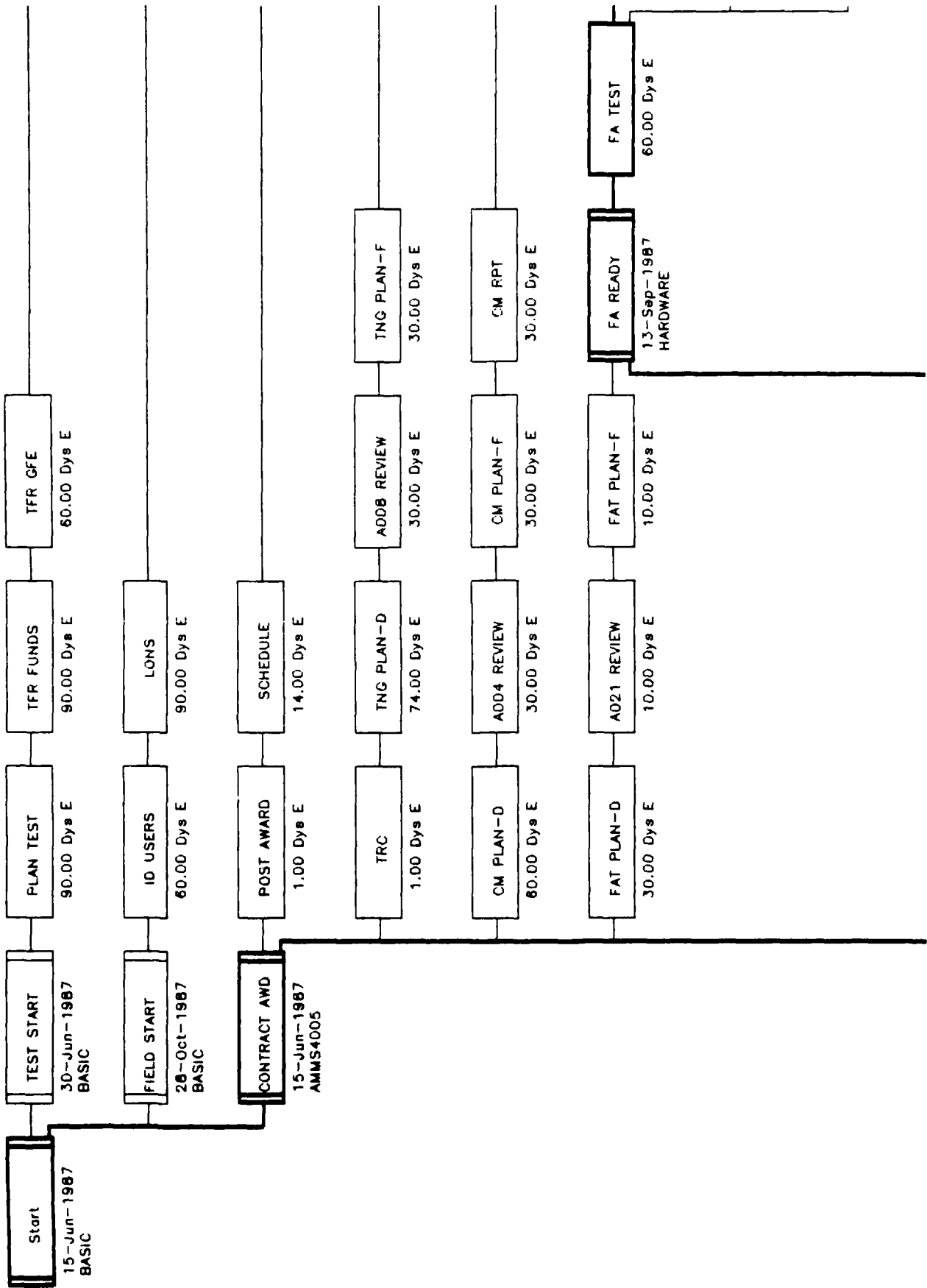

15 & 30 KW NOISE KITS
Project: ASK1

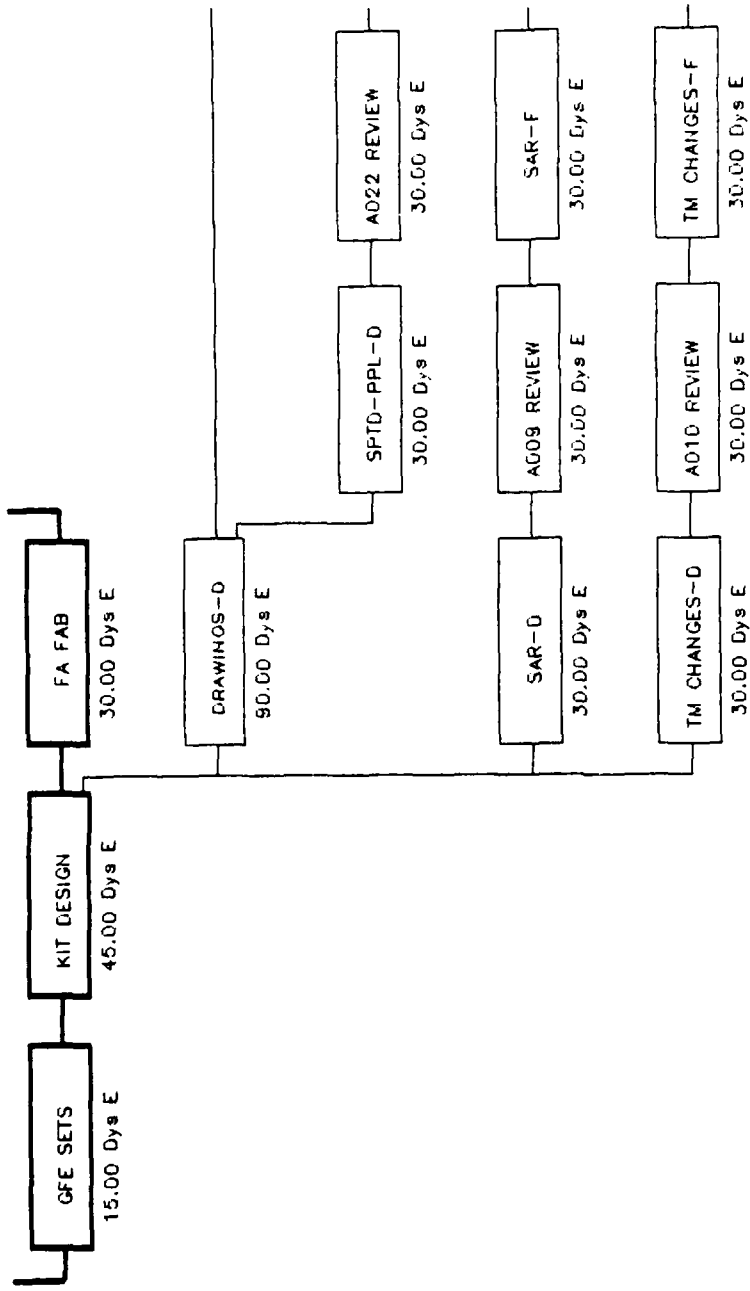

15 & 30 KW NOISE KITS
Project: ASK1

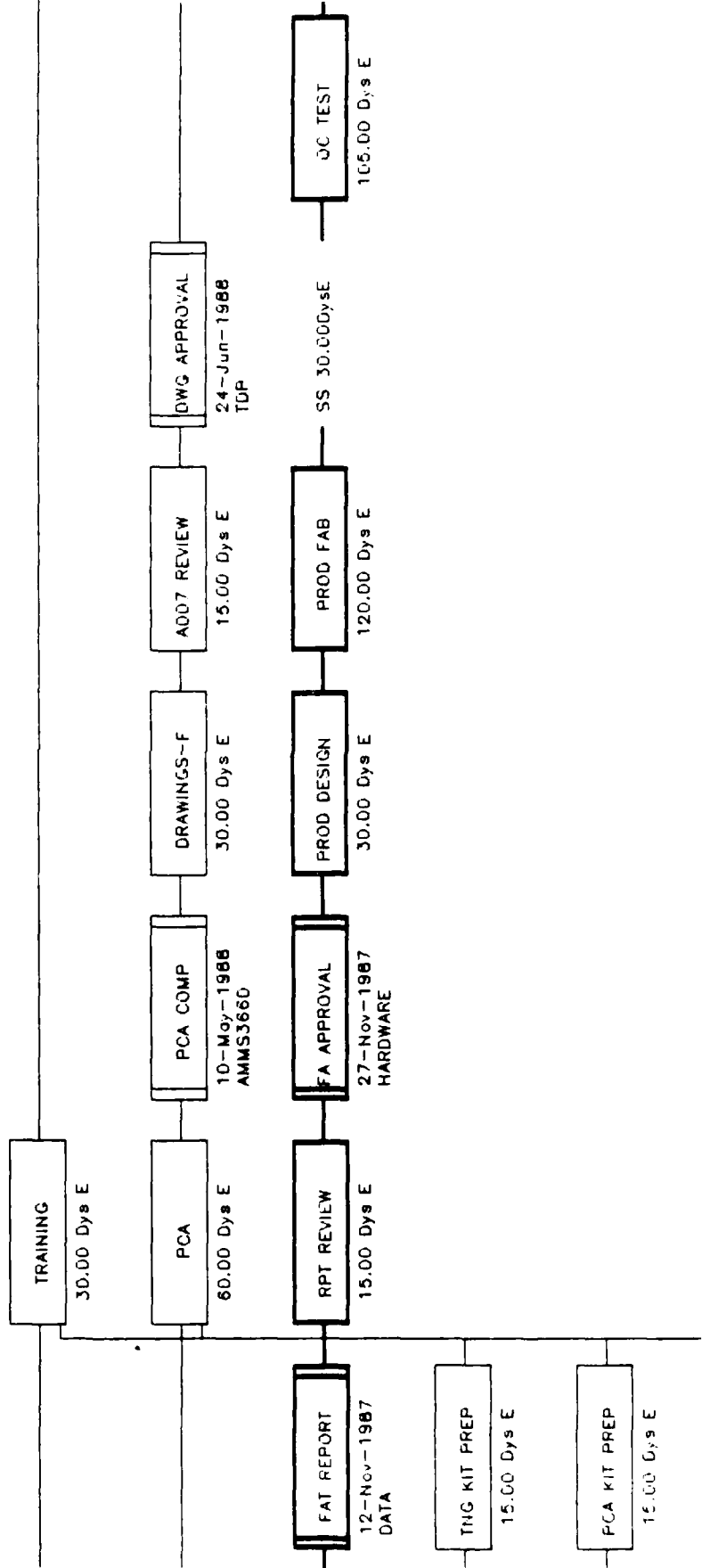

15 & 30 KW NOISE KITS
Project: ASK1

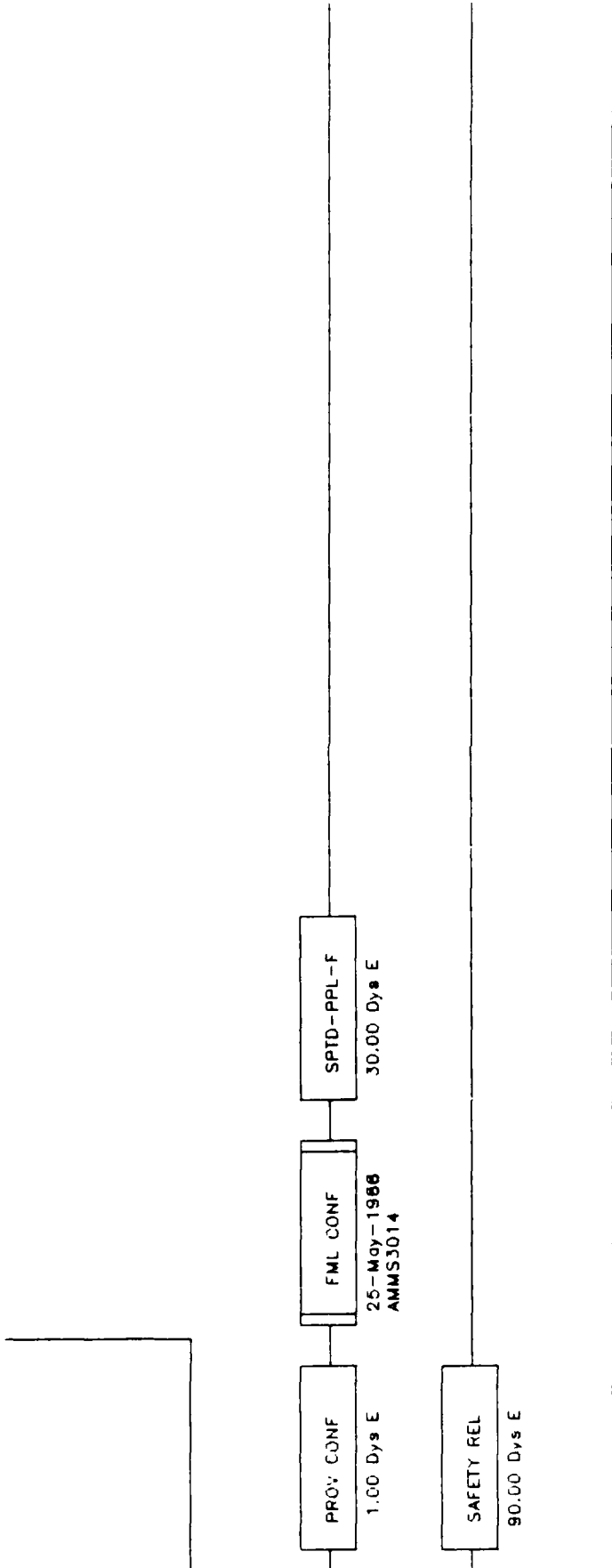

15 & 30 KW NOISE KITS
Project: ASK1

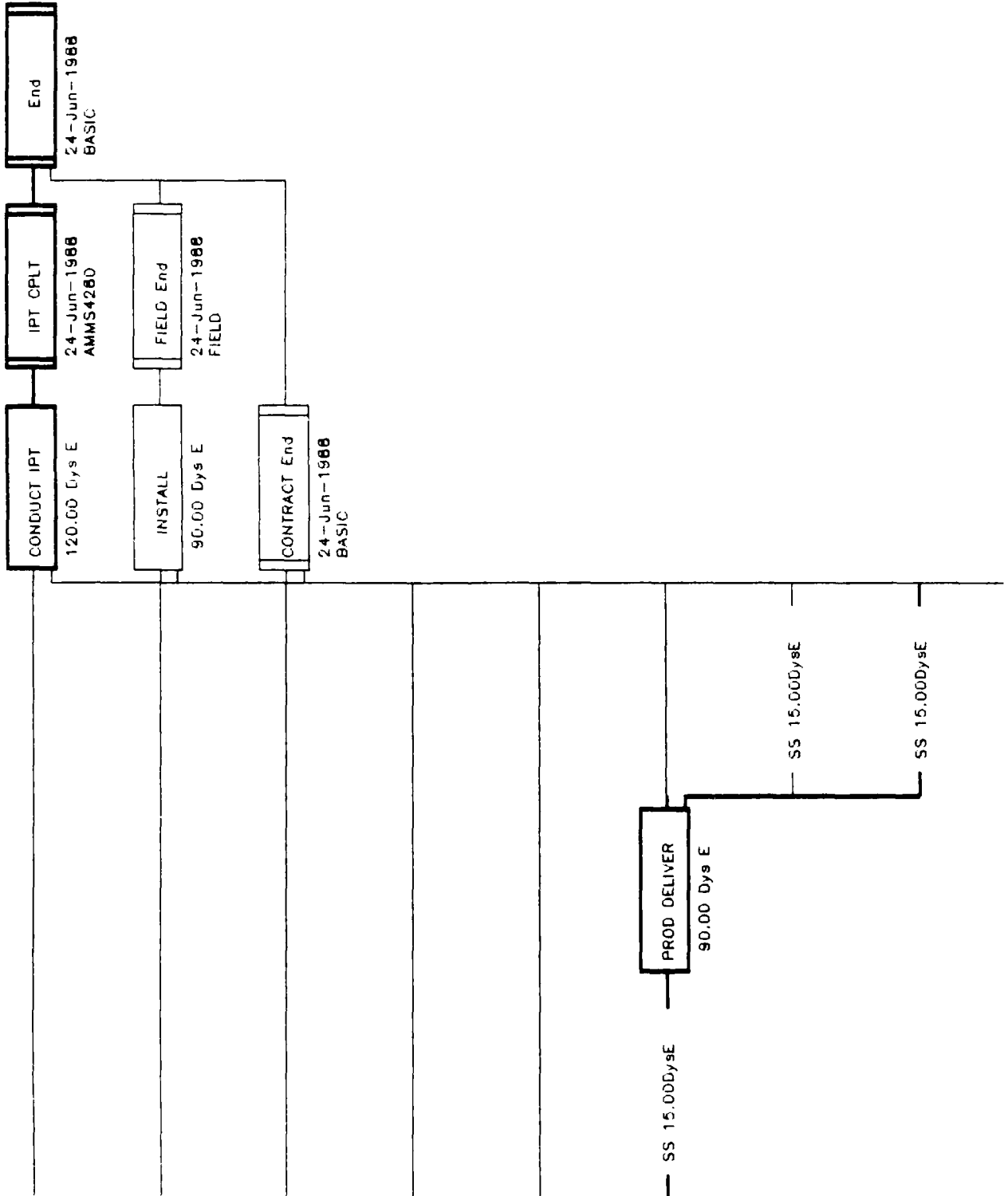

15 & 30 KW NOISE KITS
Project: ASK1

--	--	--

15 & 30 KW NOISE KITS
Project: ASK1

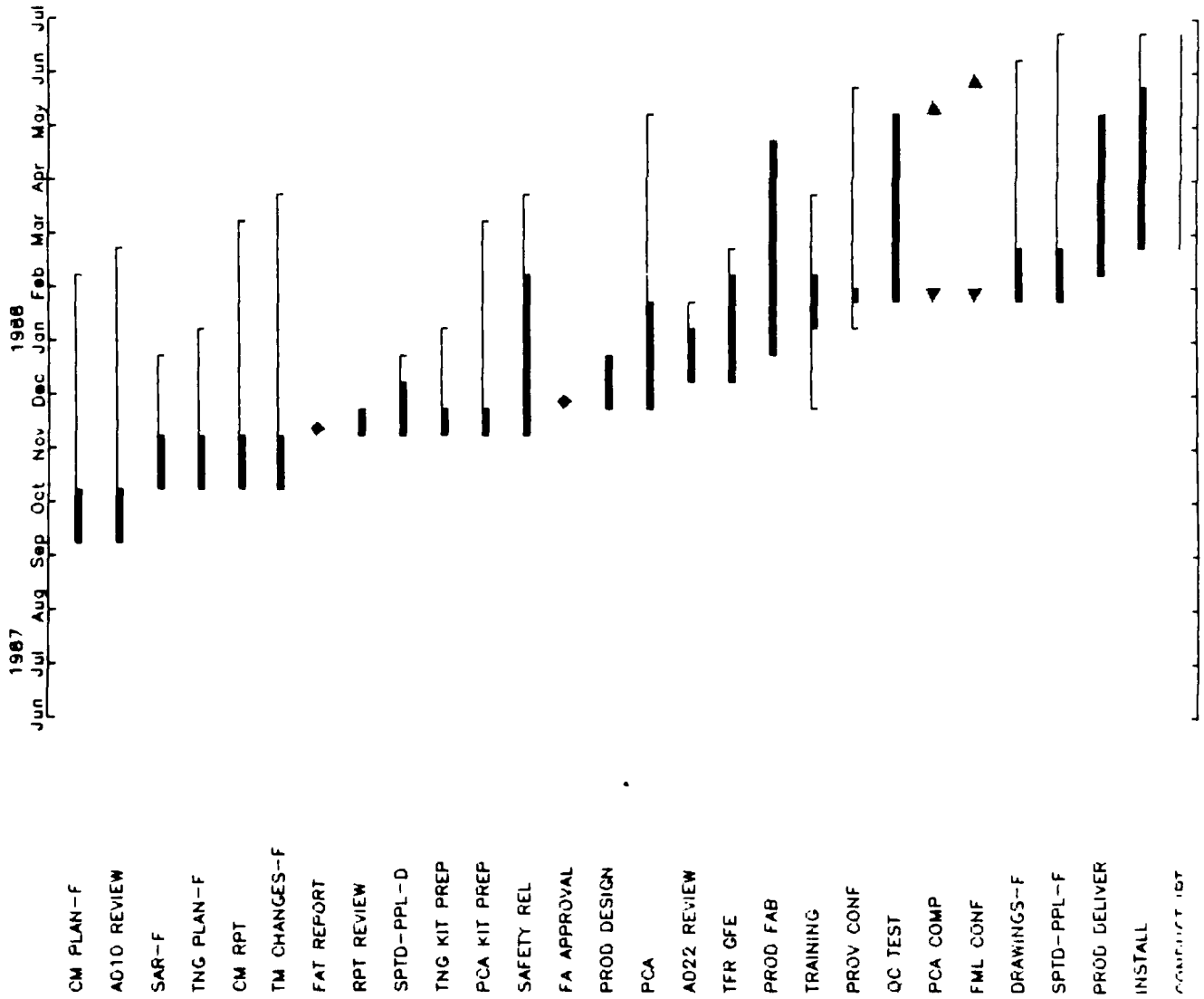

1987 Jun Jul Aug Sep Oct Nov Dec Jan Feb Mar Apr May Jun Jul
 1988

15 & 30 KW NOISE KITS
 Project: ASK1



COMBAT VEHICLE ENVIRONMENTAL SUPPORT SYSTEM
Project: CVES

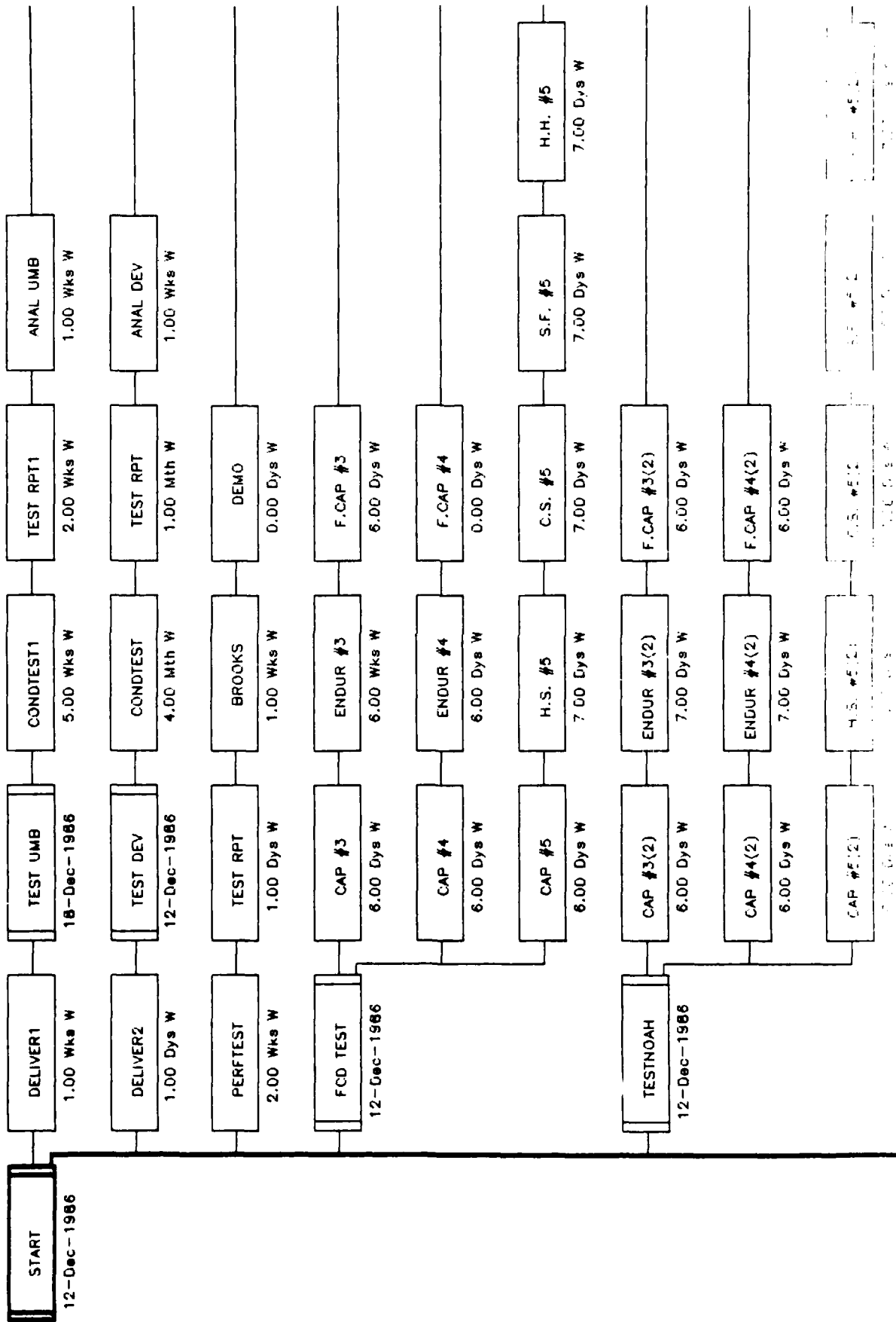

EMC-2 ENVIRONMENTAL SUPPORT SYSTEM
Project: CVSS

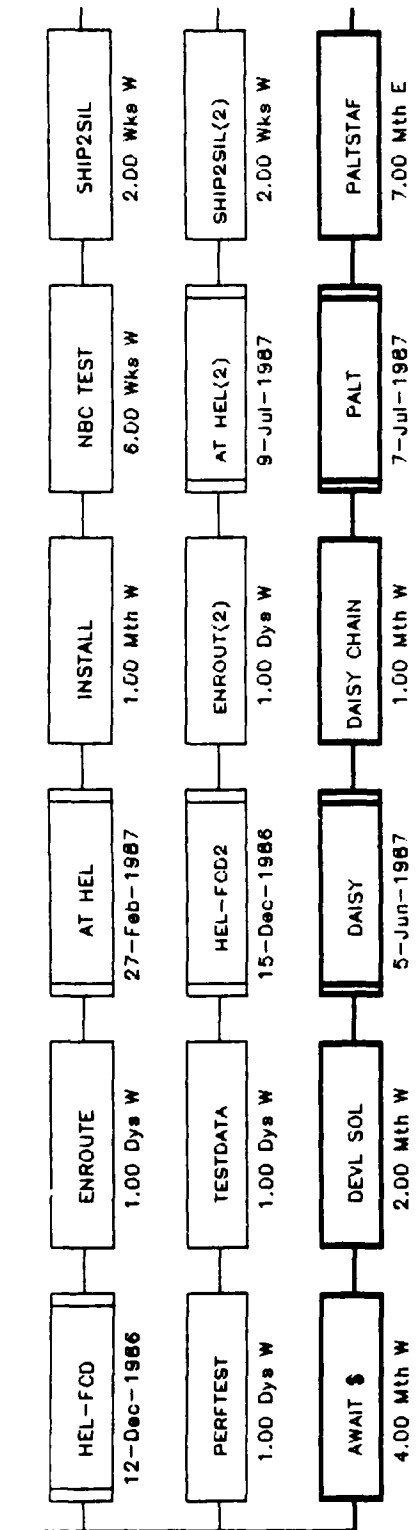

COMBAT VEHICLE ENVIRONMENTAL SUPPORT SYSTEM
Project: CVES

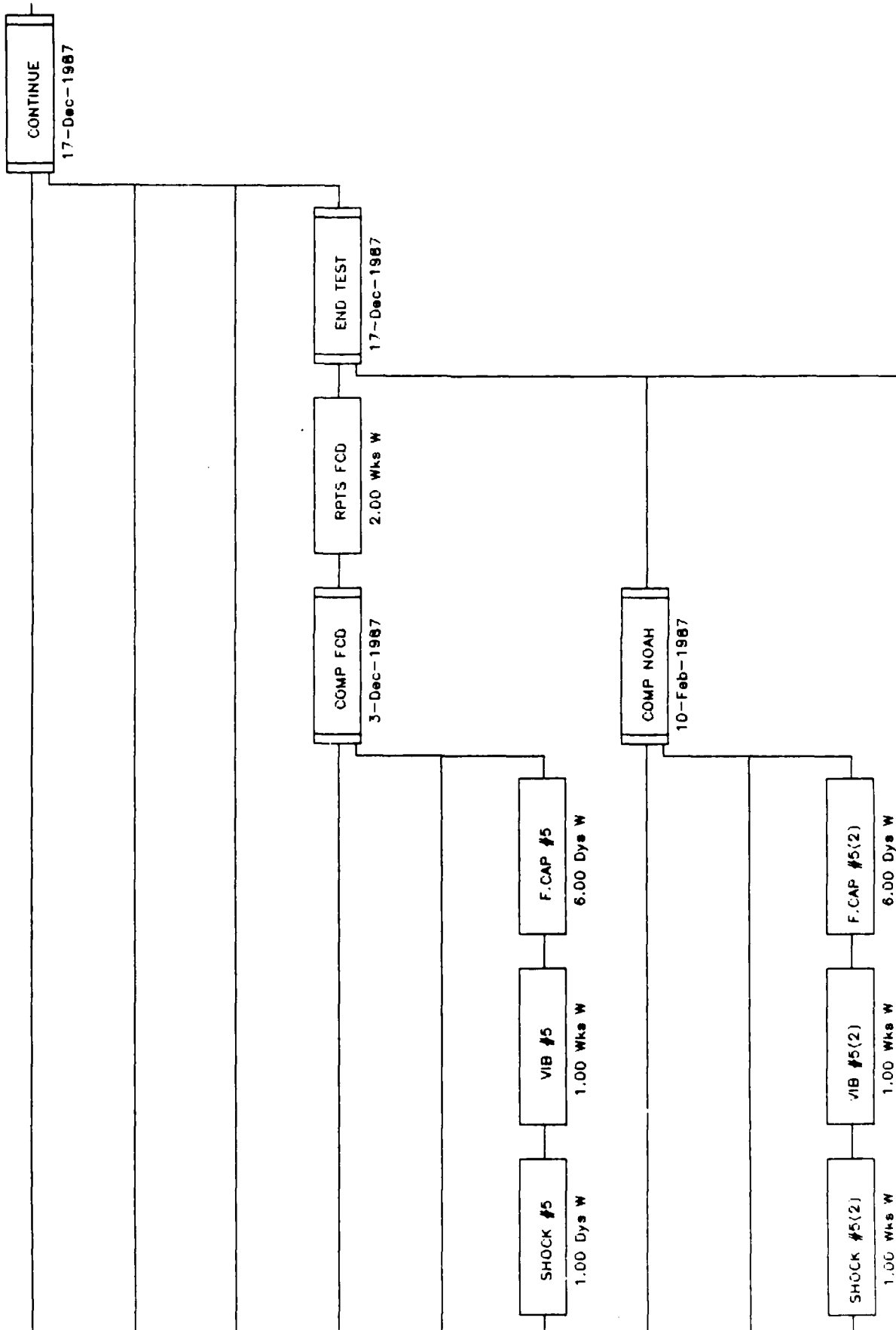

...AT VEHICLE ENVIRONMENTAL SUPPORT SYSTEM
Project: CVES

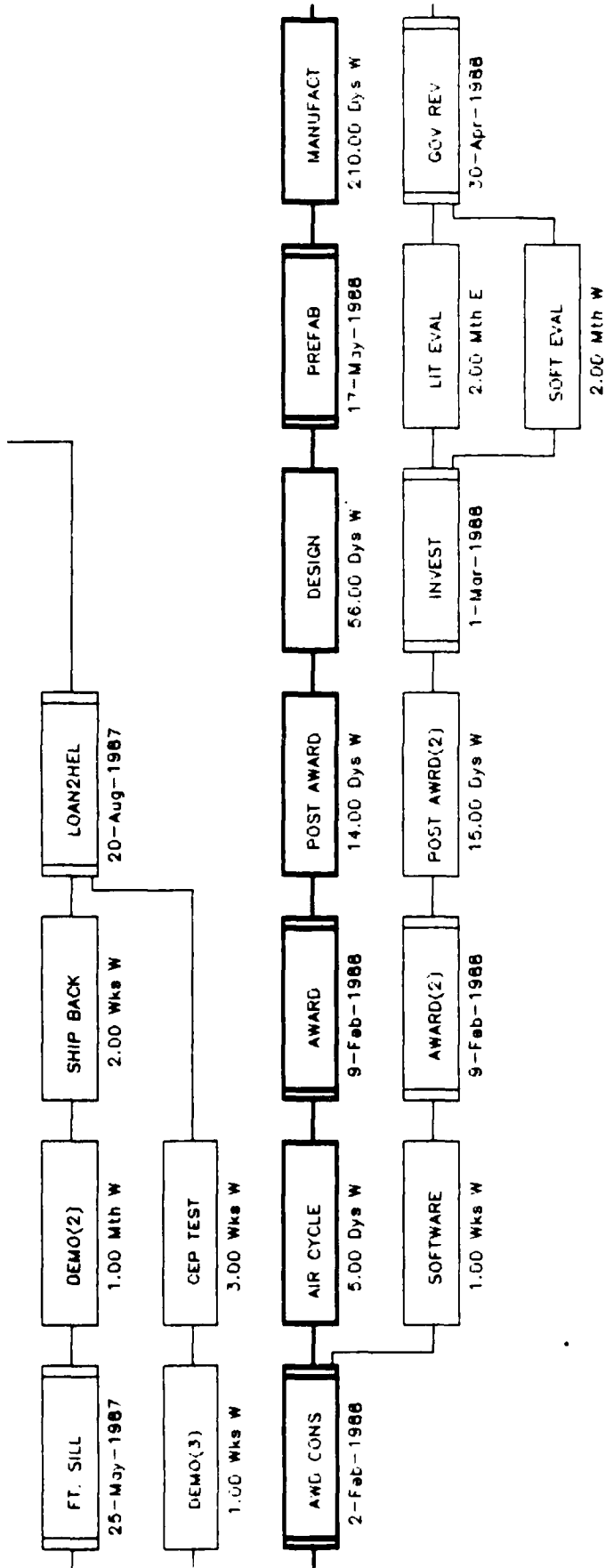

01 2000 1 2 3 4 5 6 7 8 9 10 11 12 13 14 15 16 17 18 19 20 21 22 23 24 25 26 27 28 29 30 31 32 33 34 35 36 37 38 39 40 41 42 43 44 45 46 47 48 49 50 51 52 53 54 55 56 57 58 59 60 61 62 63 64 65 66 67 68 69 70 71 72 73 74 75 76 77 78 79 80 81 82 83 84 85 86 87 88 89 90 91 92 93 94 95 96 97 98 99 100

COMBAT VEHICLE ENVIRONMENTAL SUPPORT SYSTEM
Project: CVES

END

30-Mar-1989

COMBAT VEHICLE ENVIRONMENTAL SUPPORT SYSTEM
Project: CVESS

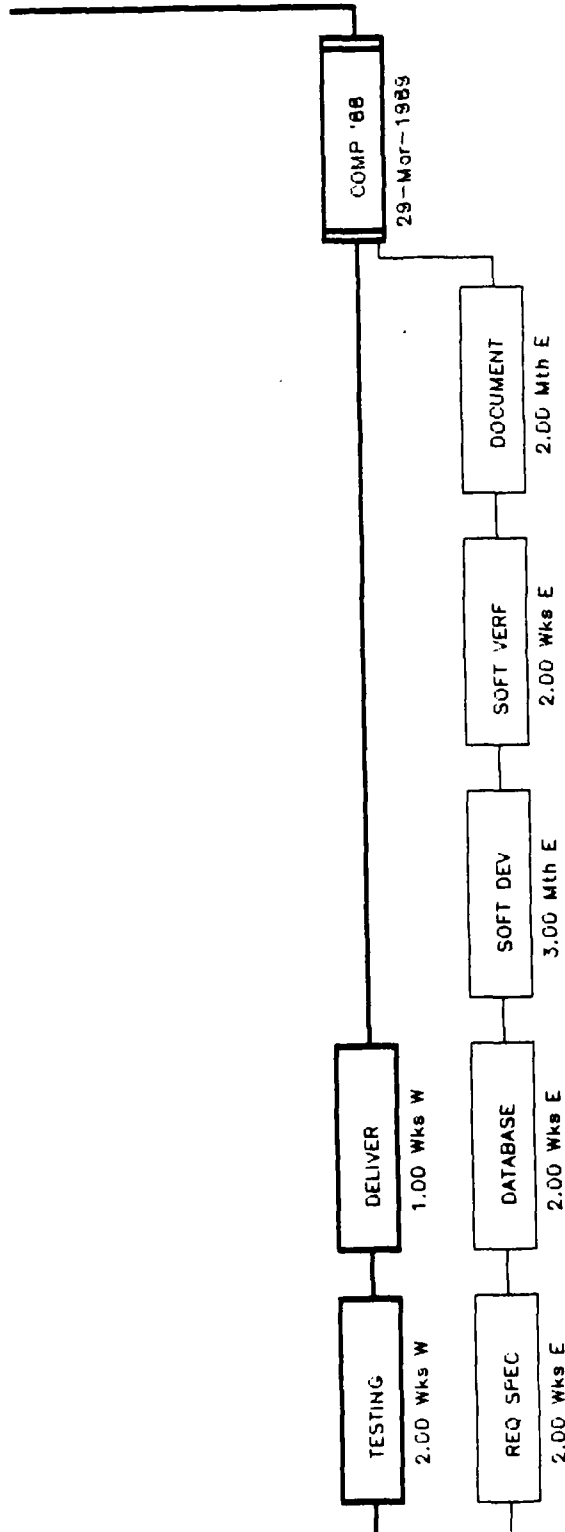

COMBAT VEHICLE ENVIRONMENTAL SUPPORT SYSTEM
Project: CVES

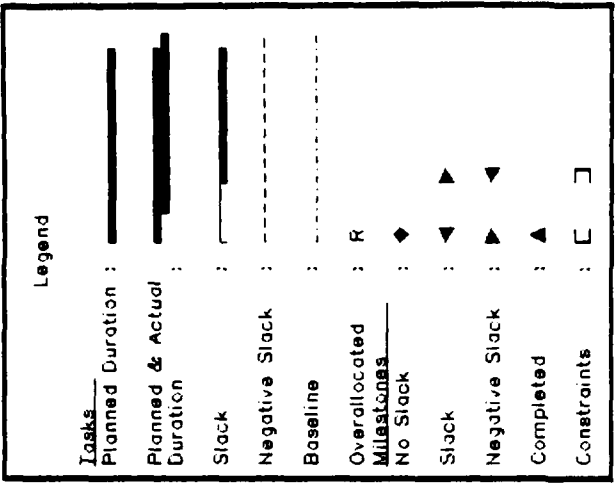
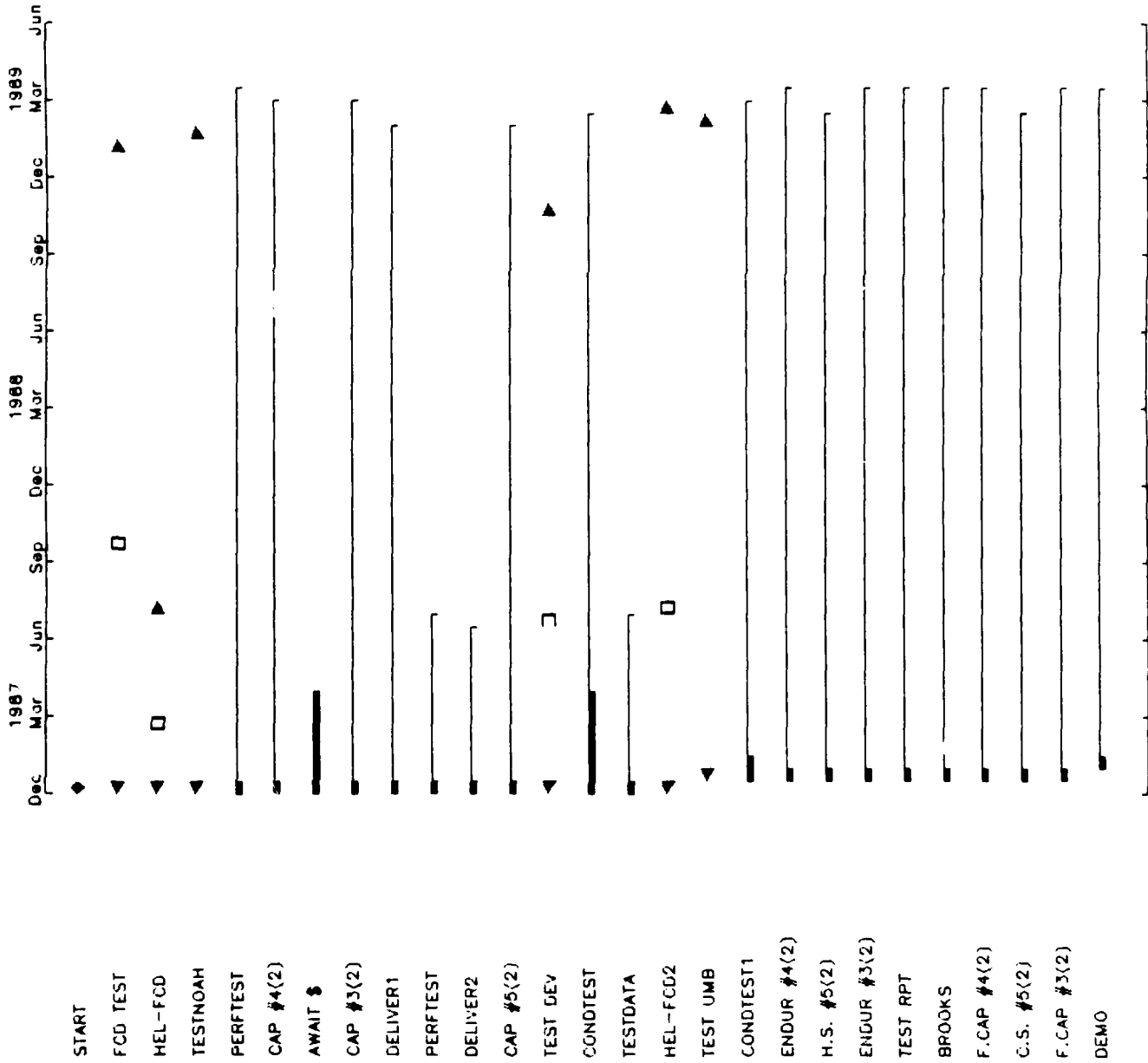

1987 1988 1989

COMBAT VEHICLE ENVIRONMENTAL SUPPORT SYSTEM
Project: CVES

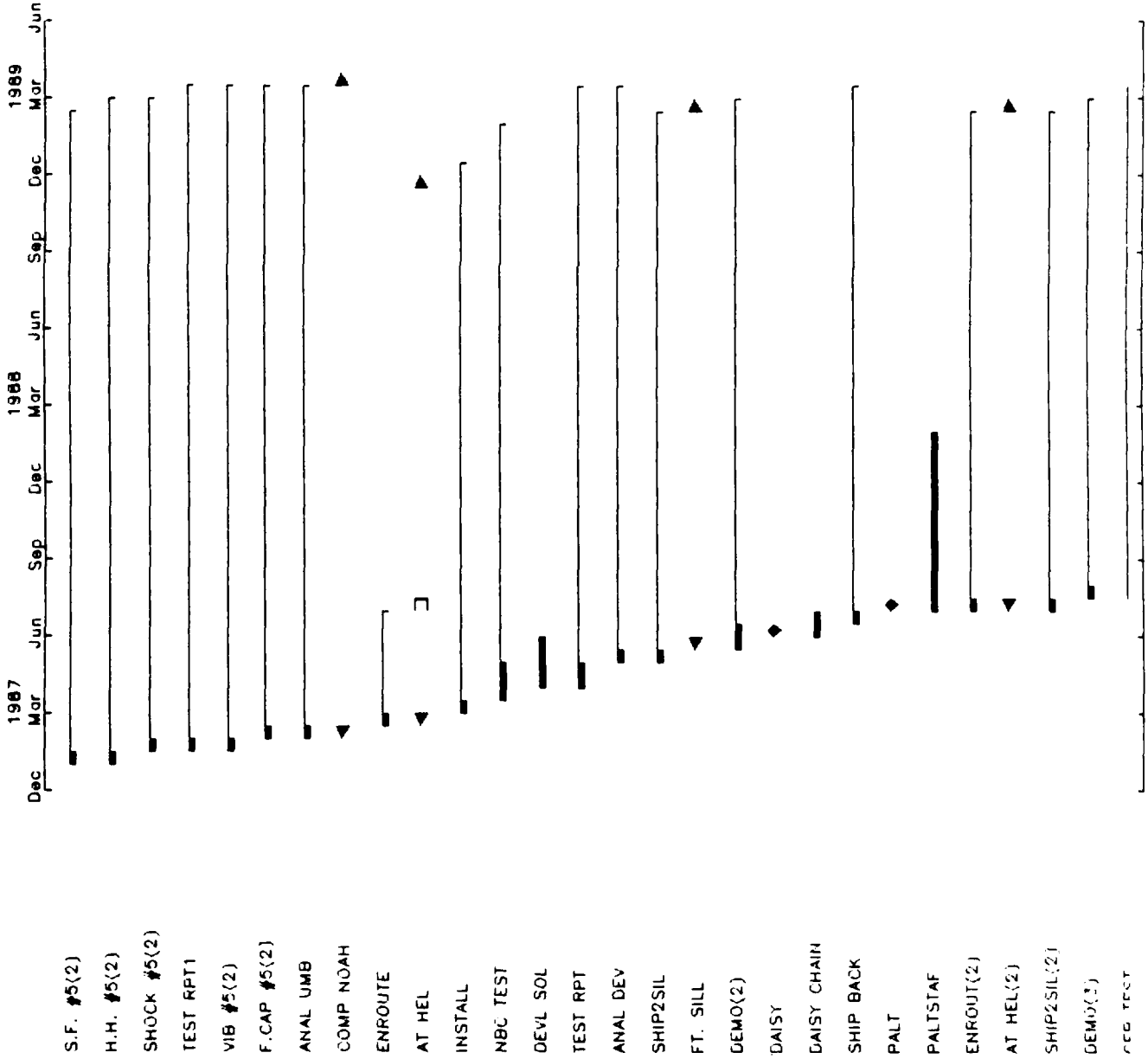

COMBAT VEHICLE ENVIRONMENTAL SUPPORT SYSTEM
Project: CVES

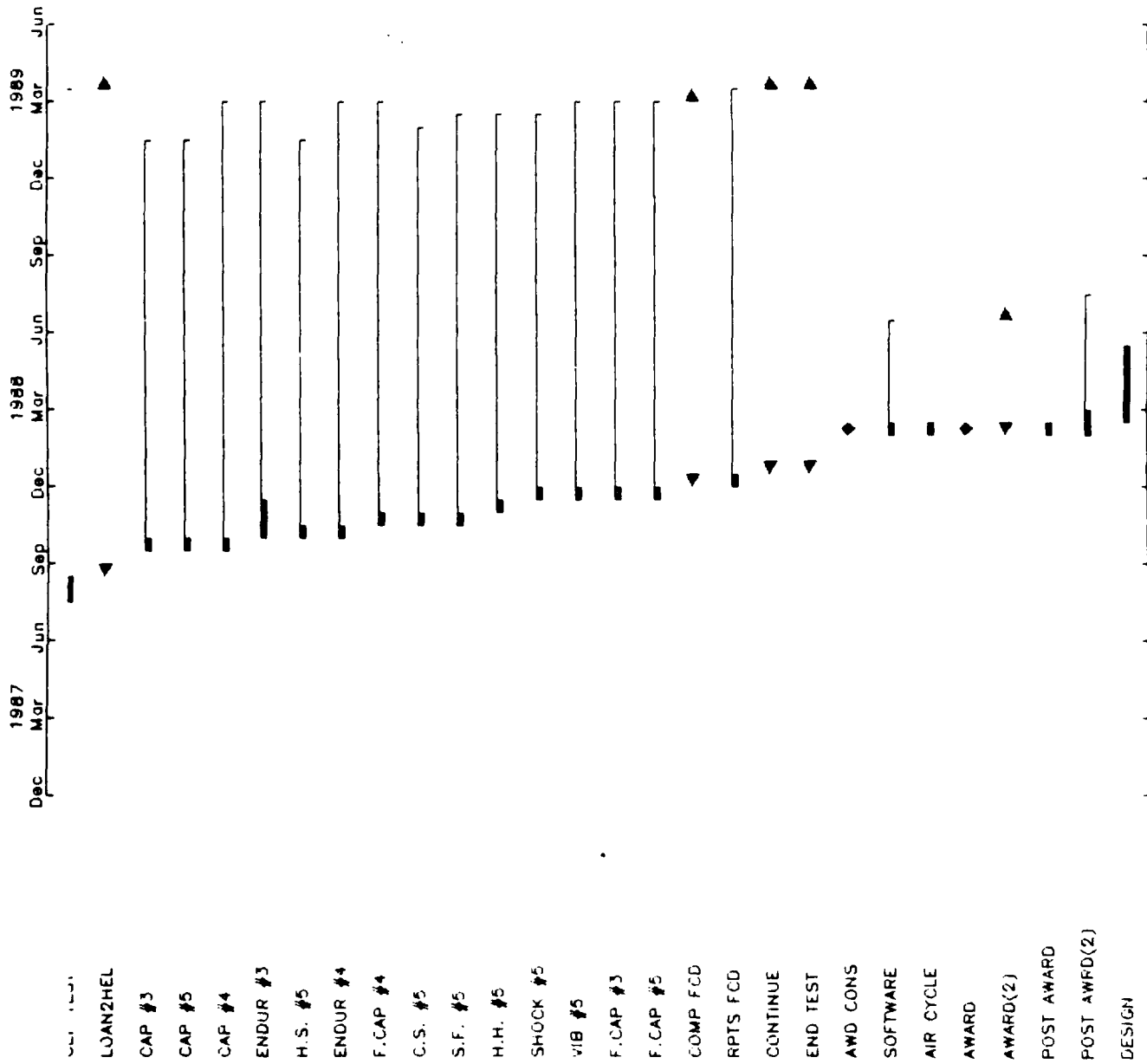

COMBAT VEHICLE ENVIRONMENTAL SUPPORT SYSTEM
Project: CVES

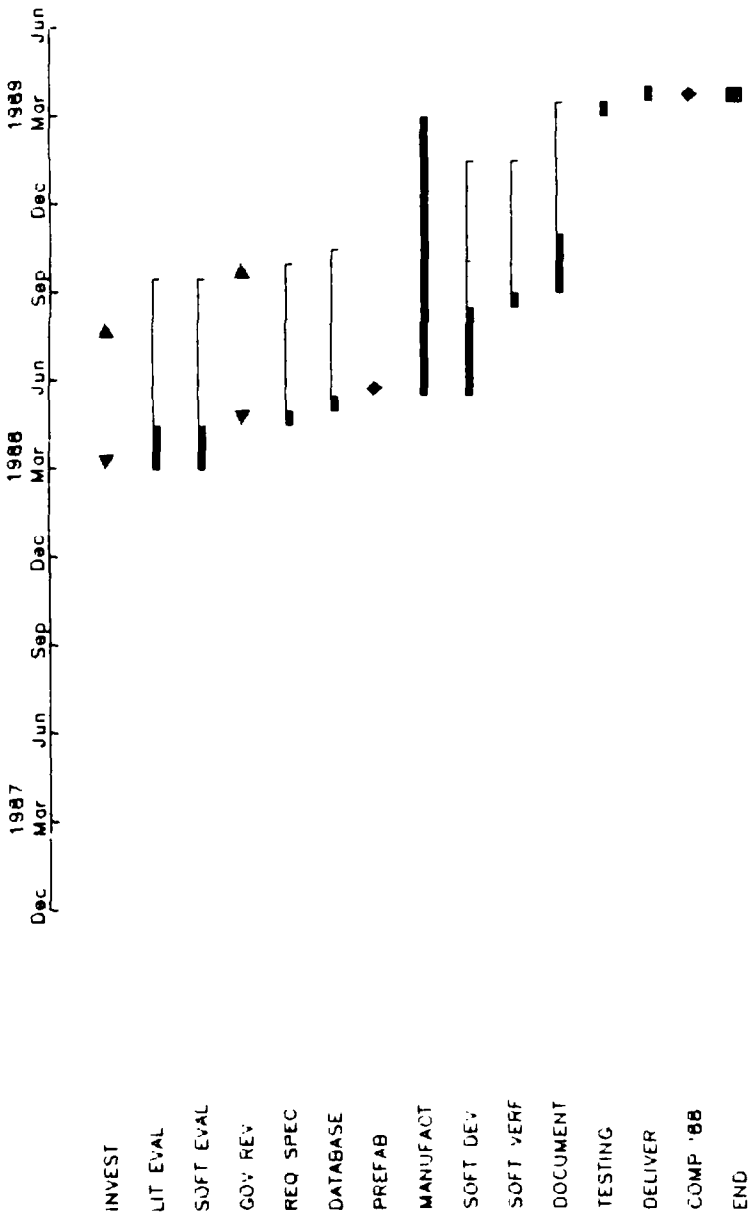

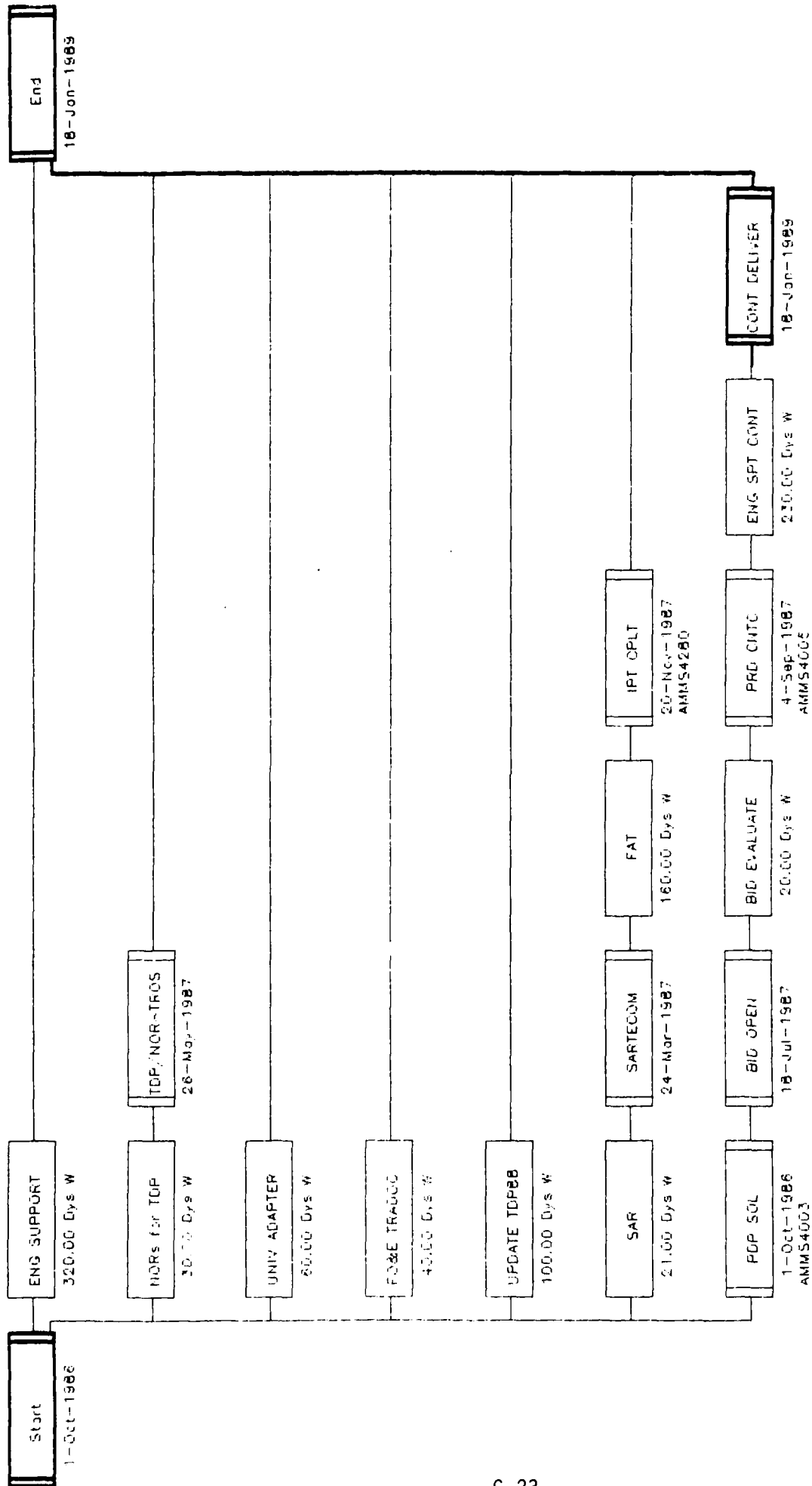

DISE PROGRAM
Project: DISE

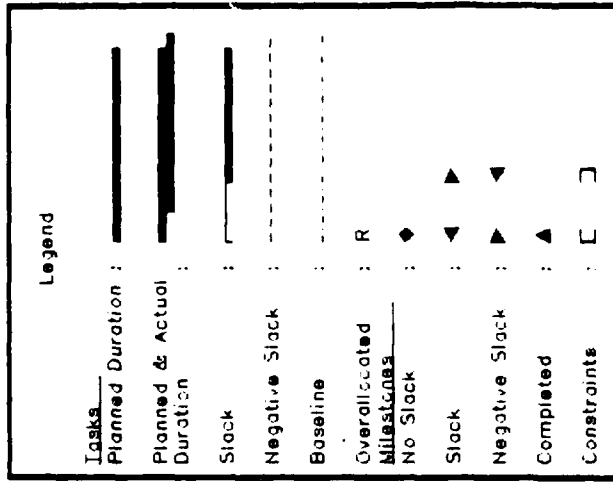
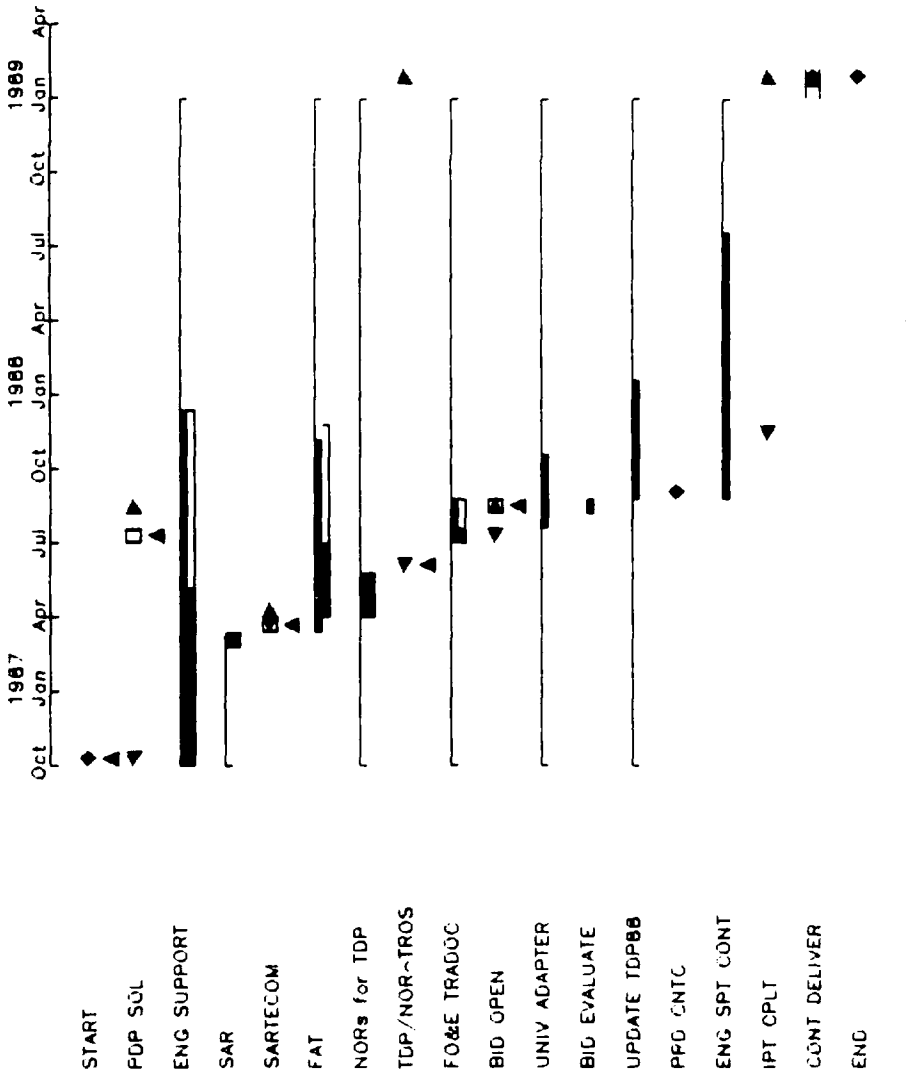

FHUS PROGRAM
Project: FHUS111

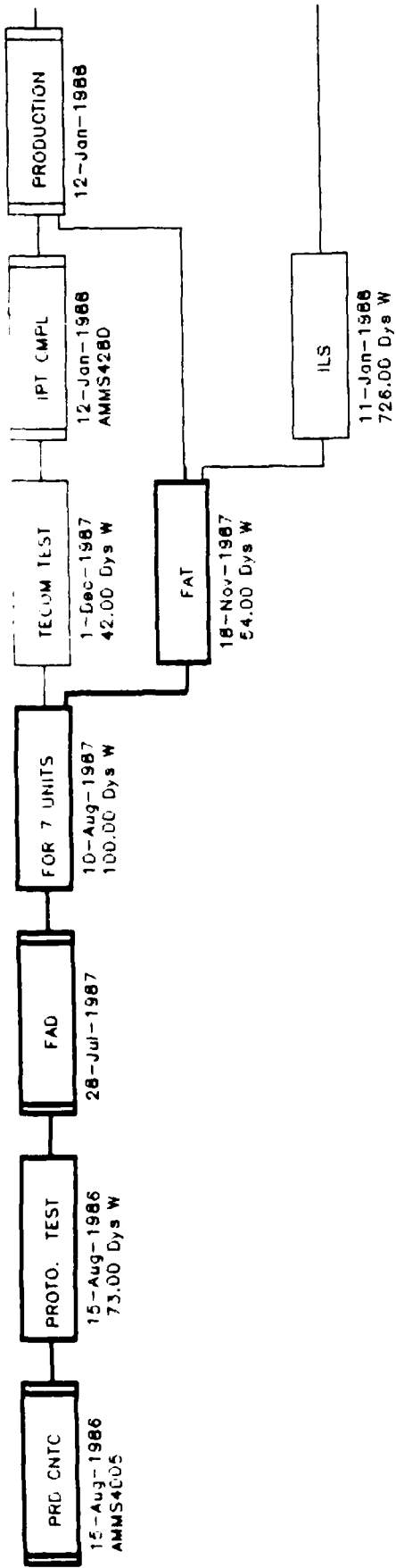



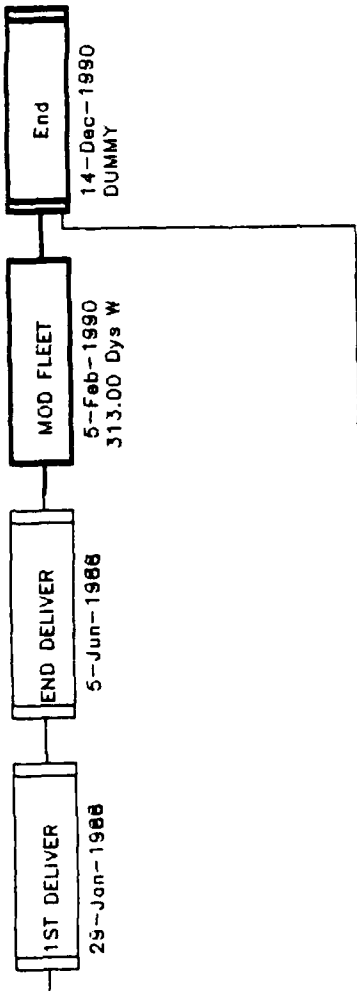





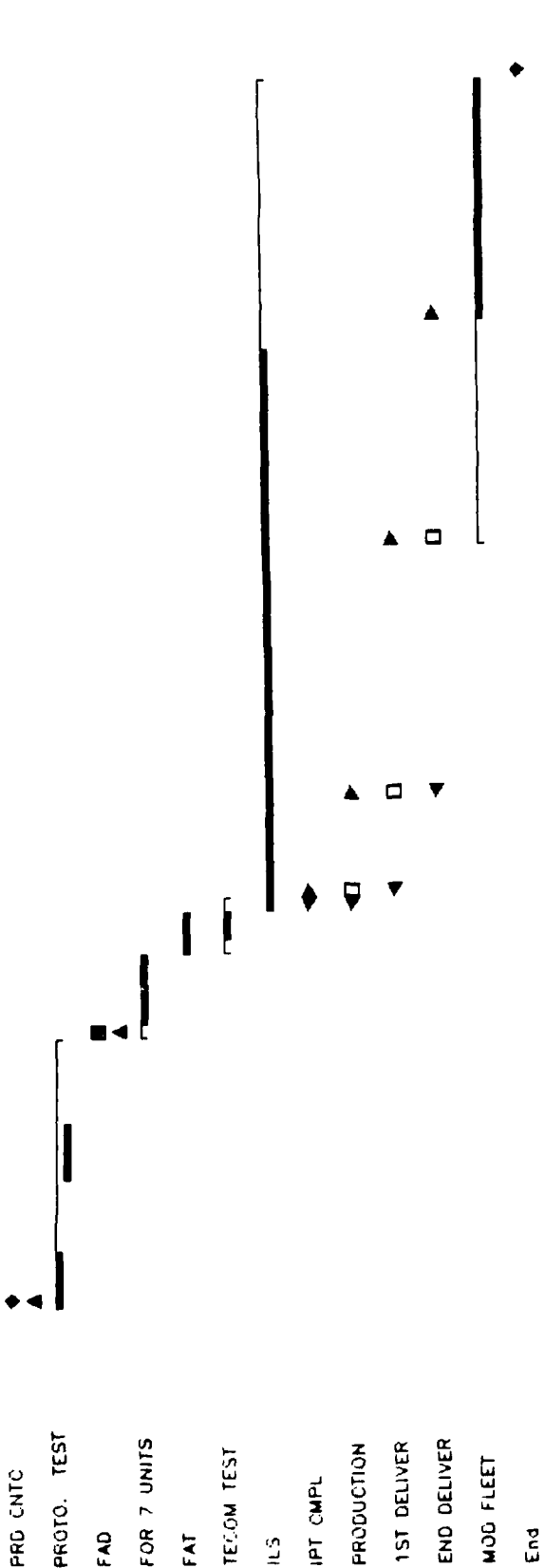





FHUS PROGRAM
Project: FHUS111



FHUS PROGRAM
Project: FHUS111

1986 1987 1988 1989 1990 1991
 Aug Nov Feb May Aug Nov Feb May Aug Nov Feb May Aug Nov Feb



Legend	
Tasks	
Planned Duration :	
Planned & Actual Duration :	
Slack :	
Negative Slack :	
Baseline :	
Overallocated Milestones	: R
No Slack	: 
Slack	:  
Negative Slack	:  
Completed	: 
Constraints	:  
Tags	: Code

HIGH TECH REVERSE OSMOSIS WATER PURIFICATION UNIT
 Project: HTROWPU

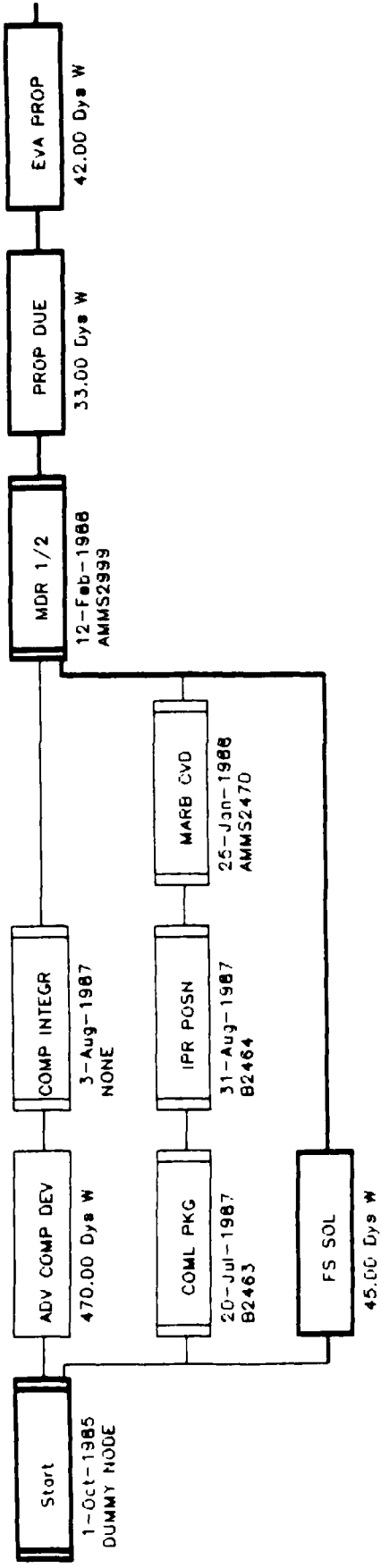

HIGH TECH REVERSE OSMOSIS WATER PURIFICATION UNIT
Project: HTRWFU

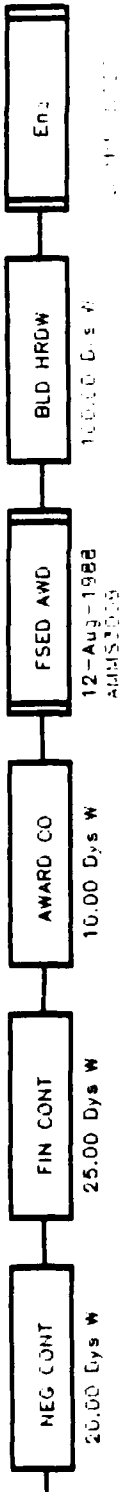

MODULAR BASE PETROLEUM LABORATORY
Project: MBPL

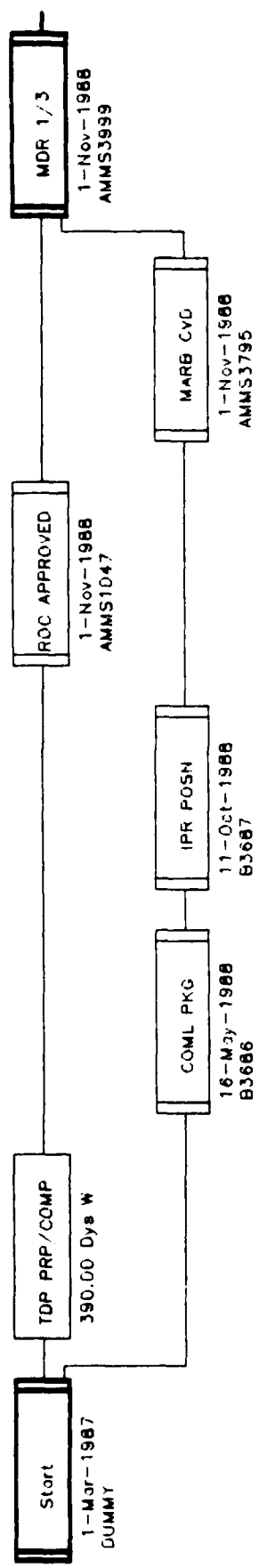

MODULAR BASE PETROLEUM LABORATORY
Project: MBPL

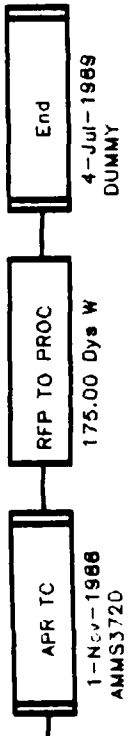

MODULAR BASE PETROLEUM LABORATORY
Project: MBFL

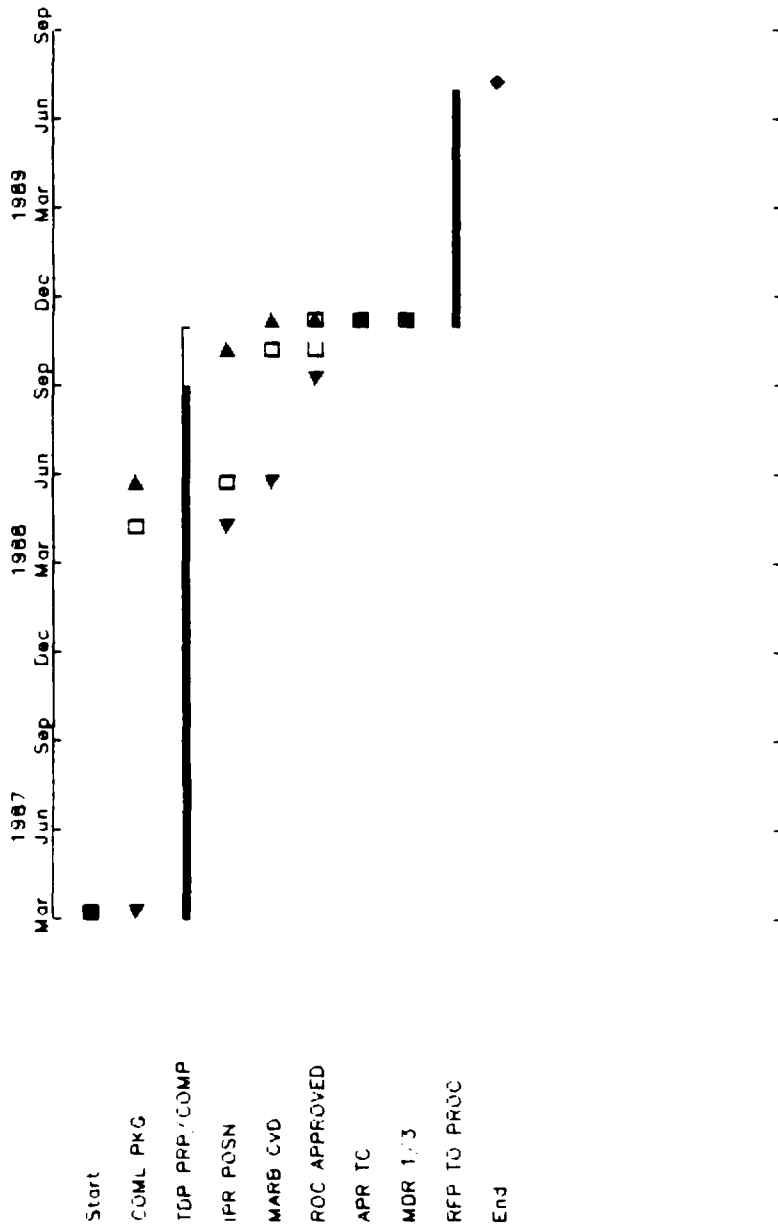

M113 ELECTRIC DRIVE PROJECT
Project: M113R

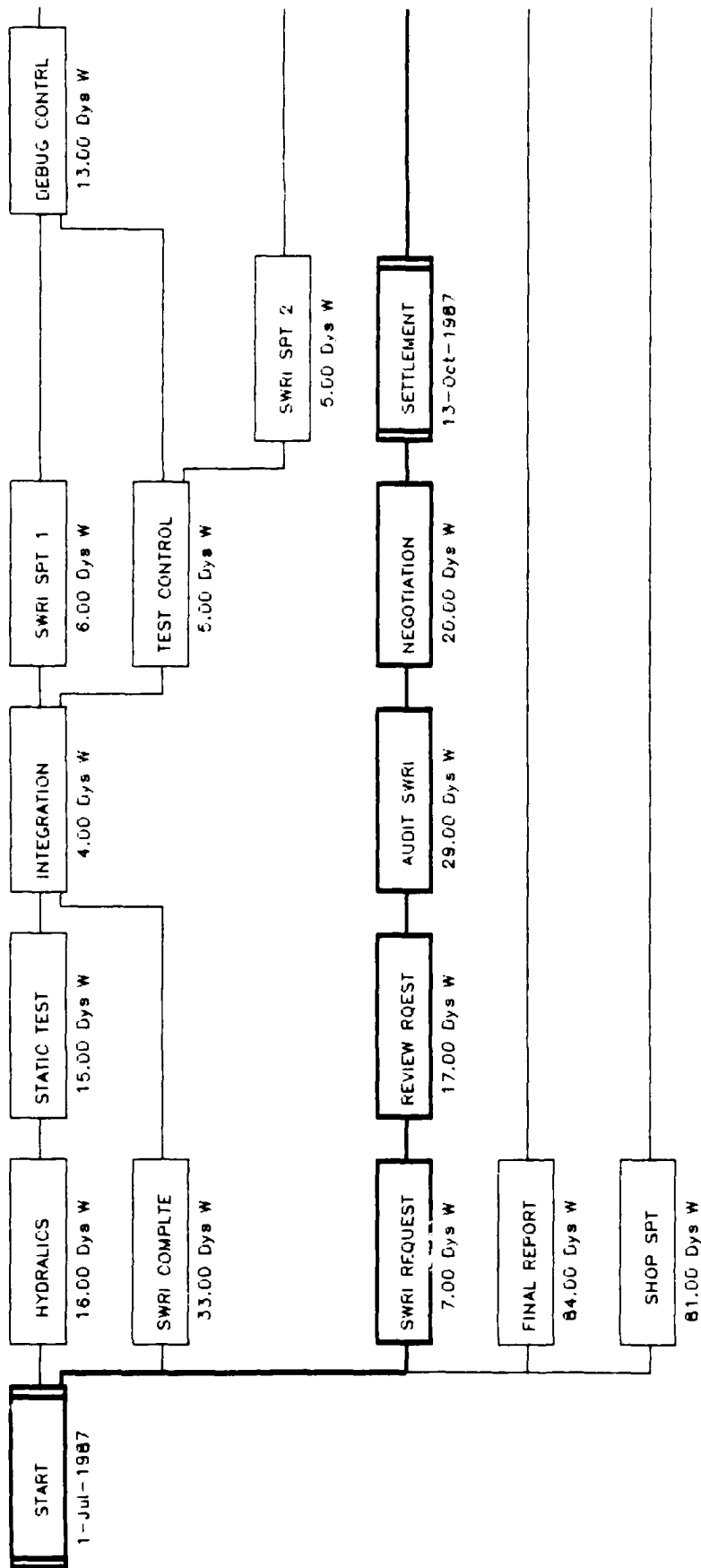

M113 ELECTRIC DRIVE PROJECT
Project: M113R

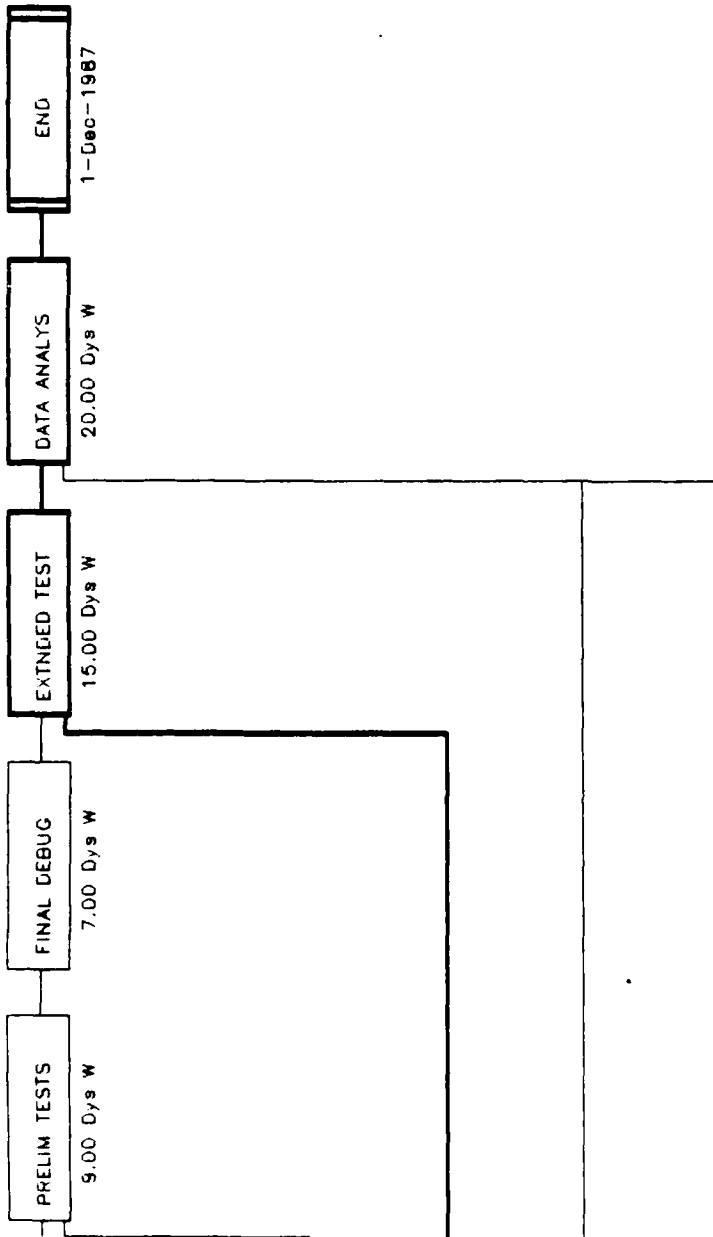

M113 ELECTRIC DRIVE PROJECT
Project: M113R

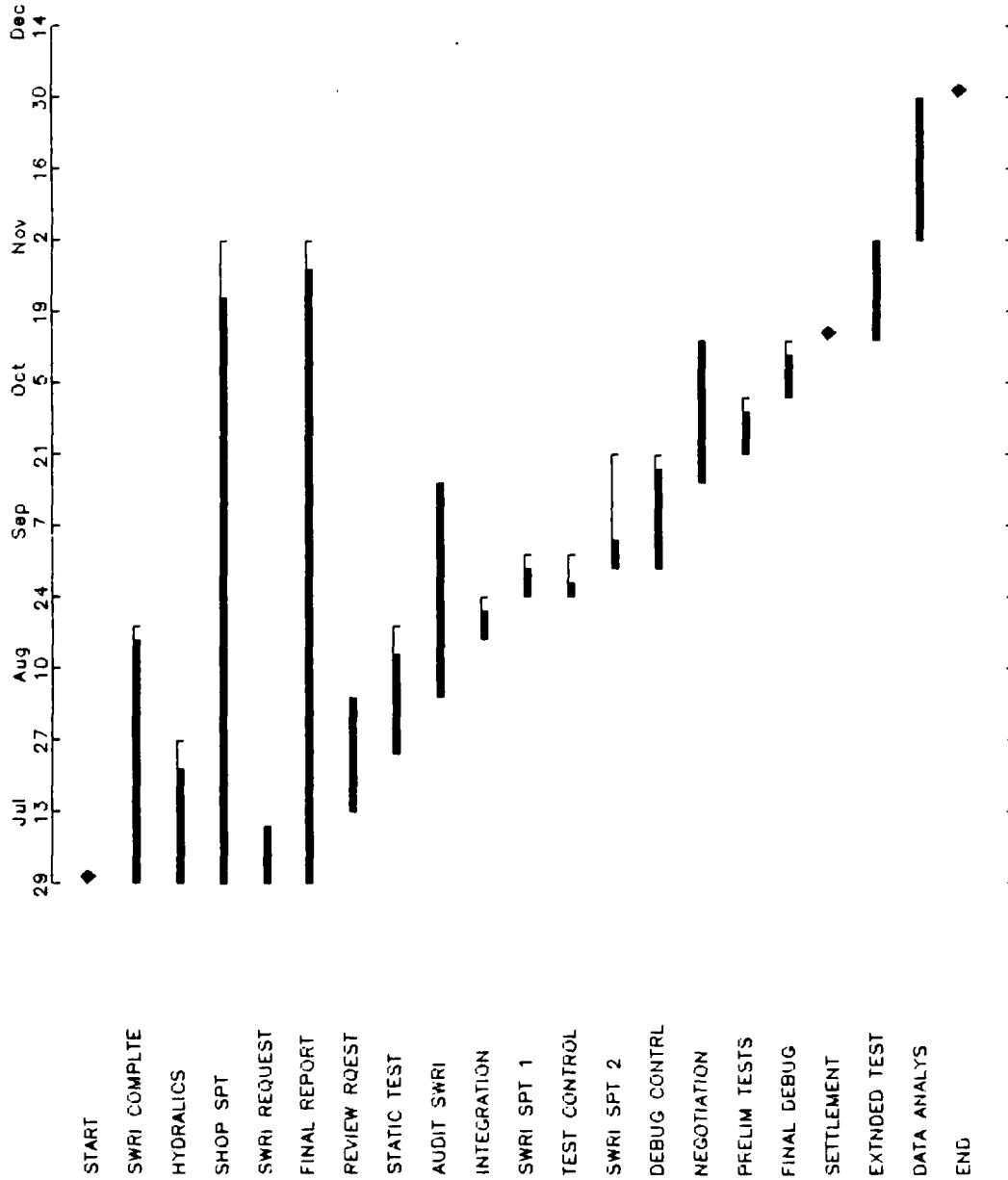

Legend

Tasks

Planned Duration : [Solid Bar]

Planned & Actual Duration : [Thick Solid Bar]

Slack : [Thin Solid Bar]

Negative Slack : [Dashed Bar]

Baseline : [Dotted Bar]

Overallocated : R

Milestones : [Diamond]

No Slack : [Thin Solid Bar]

Slack : [Thin Solid Bar]

Negative Slack : [Thin Solid Bar]

Completed : [Triangle]

Constraints : [Square]

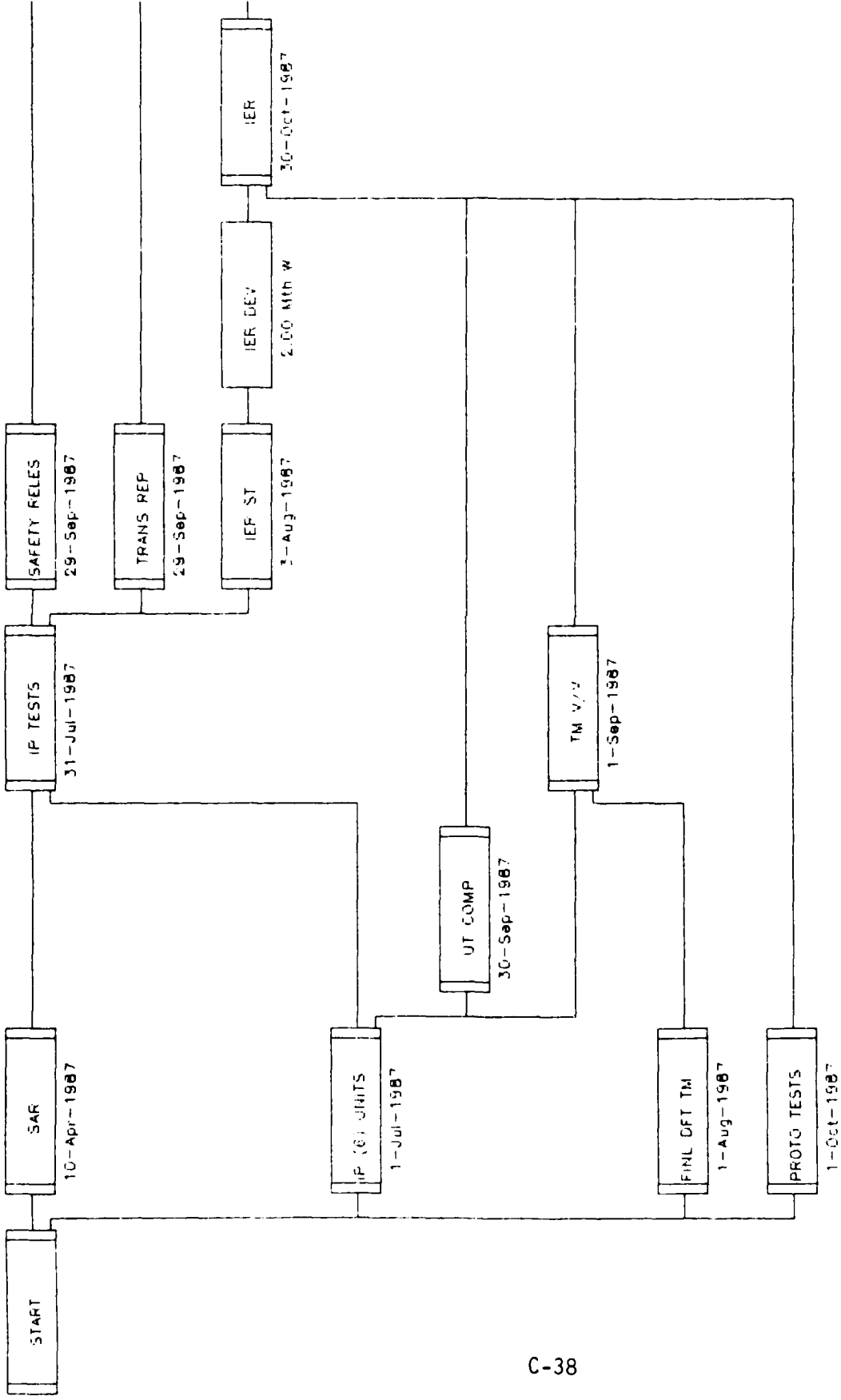

REGENCY NET POWER UNIT PROGRAM SCHEDULE
Project: REGENCY

1987 1988
Feb Mar Apr May Jun Jul Aug Sep Oct Nov Dec Jan Feb Mar

START
SAR
IP (6) UNITS
FINL DFT TM
PROTO TESTS
IP TESTS
UT COMP
IER ST
TRANS REP
SAFETY RELES
TM V/V
IER DEV
IER
MDR3
FULL REL
FUED
END

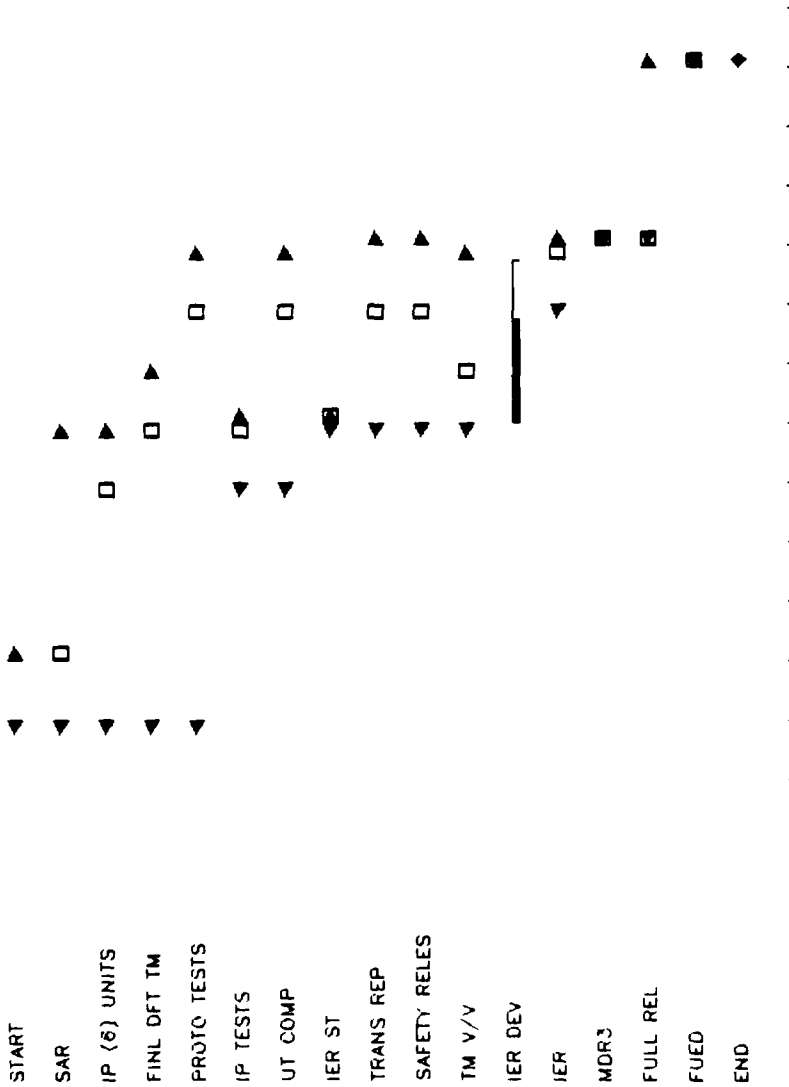
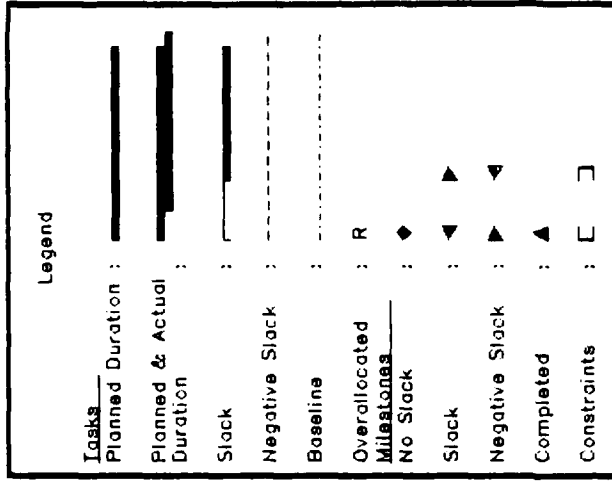

PULSE POWER PROGRAM
Project: PPOWER2

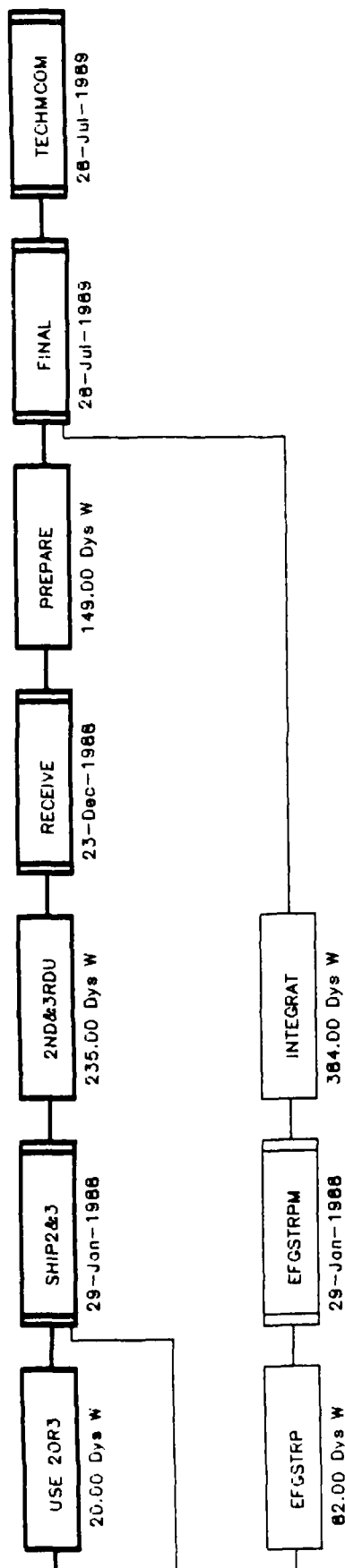

PULSE POWER PROGRAM
Project: PPOWER2

1986 1987 1988 1989
Jul Oct Jan Apr Jul Oct Jan Apr Jul Oct Jan Jul Oct

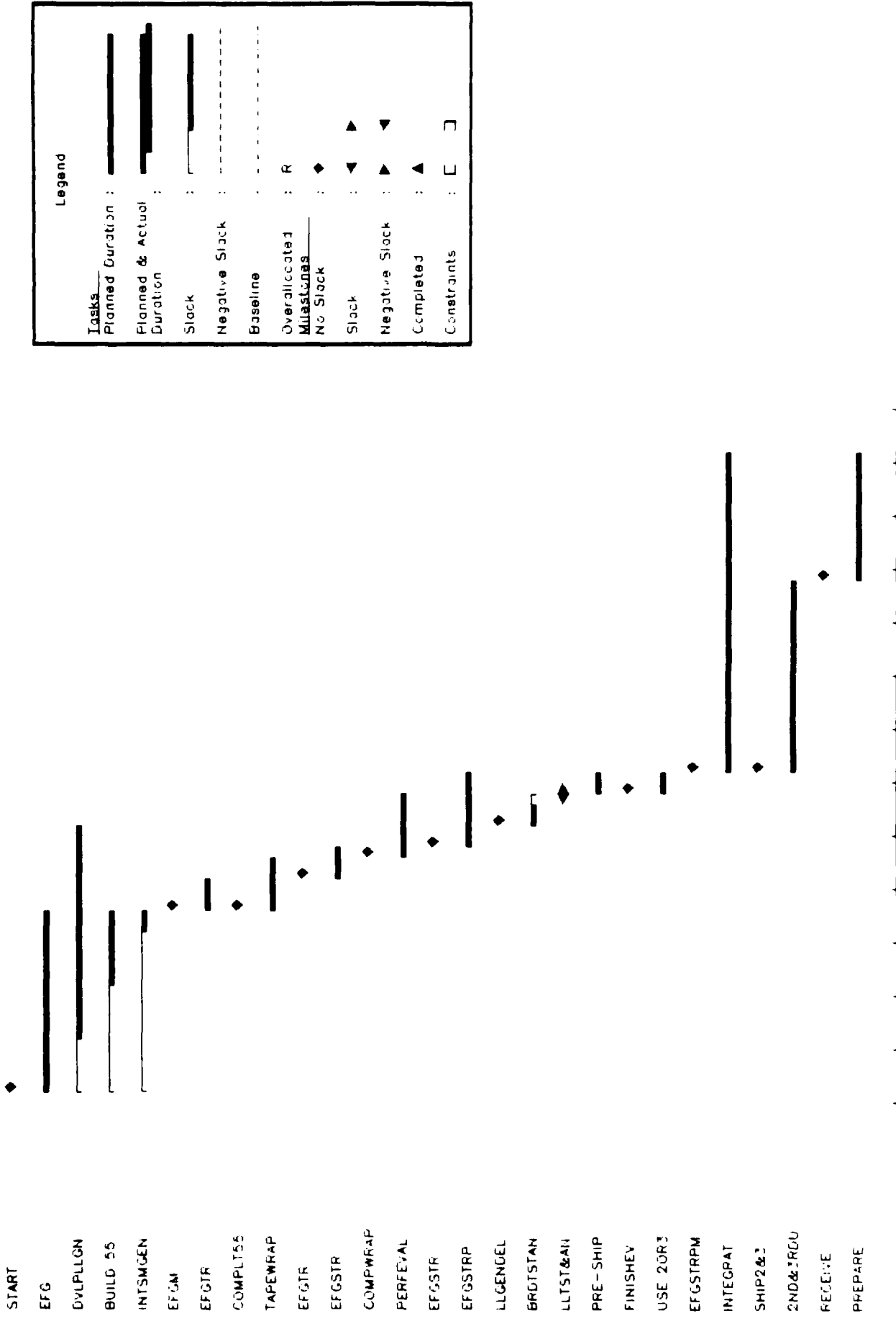

PULSE POWER PROGRAM
Project: PPOWER2



FINAL
TECHMCOM

◆ ◆

TOTAL ENVIRONMENTAL CONTROL SYSTEM
Project: TECS

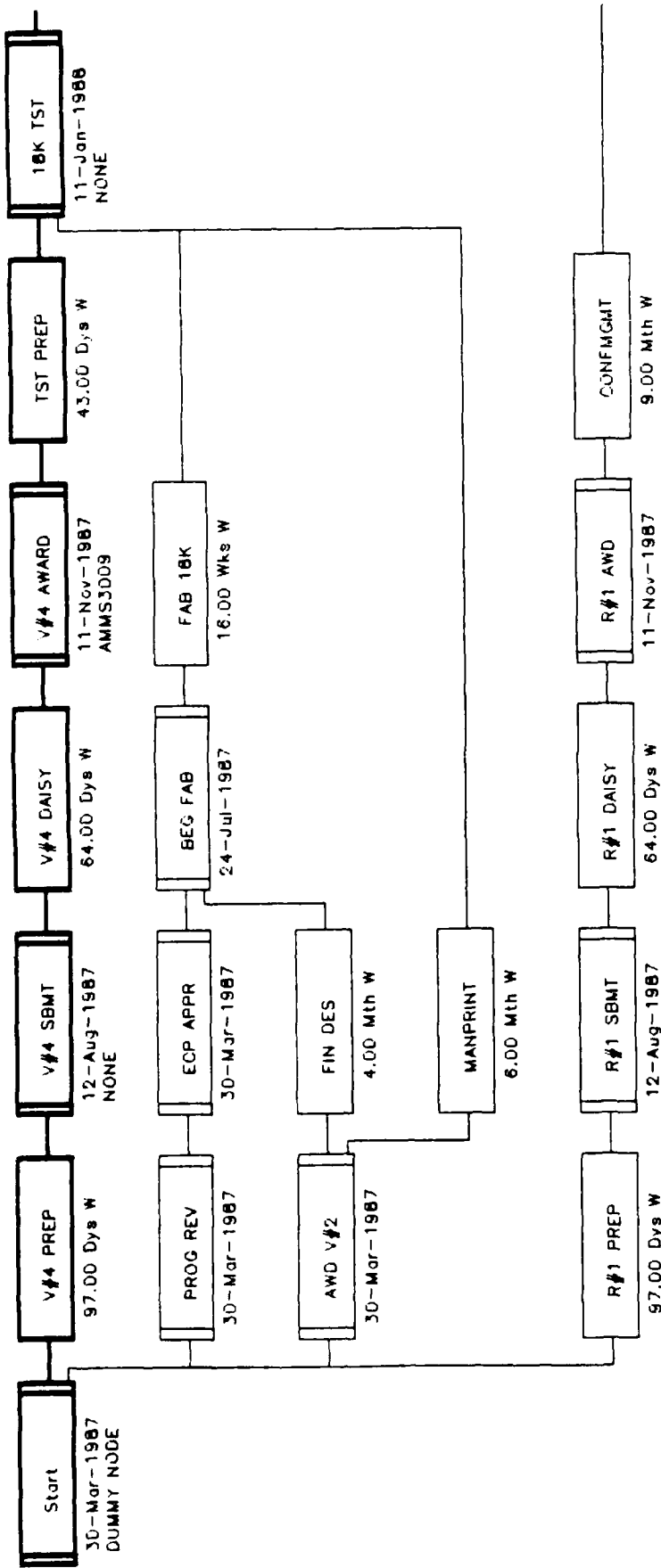

TOTAL ENVIRONMENTAL CONTROL SYSTEM

Project: TECS

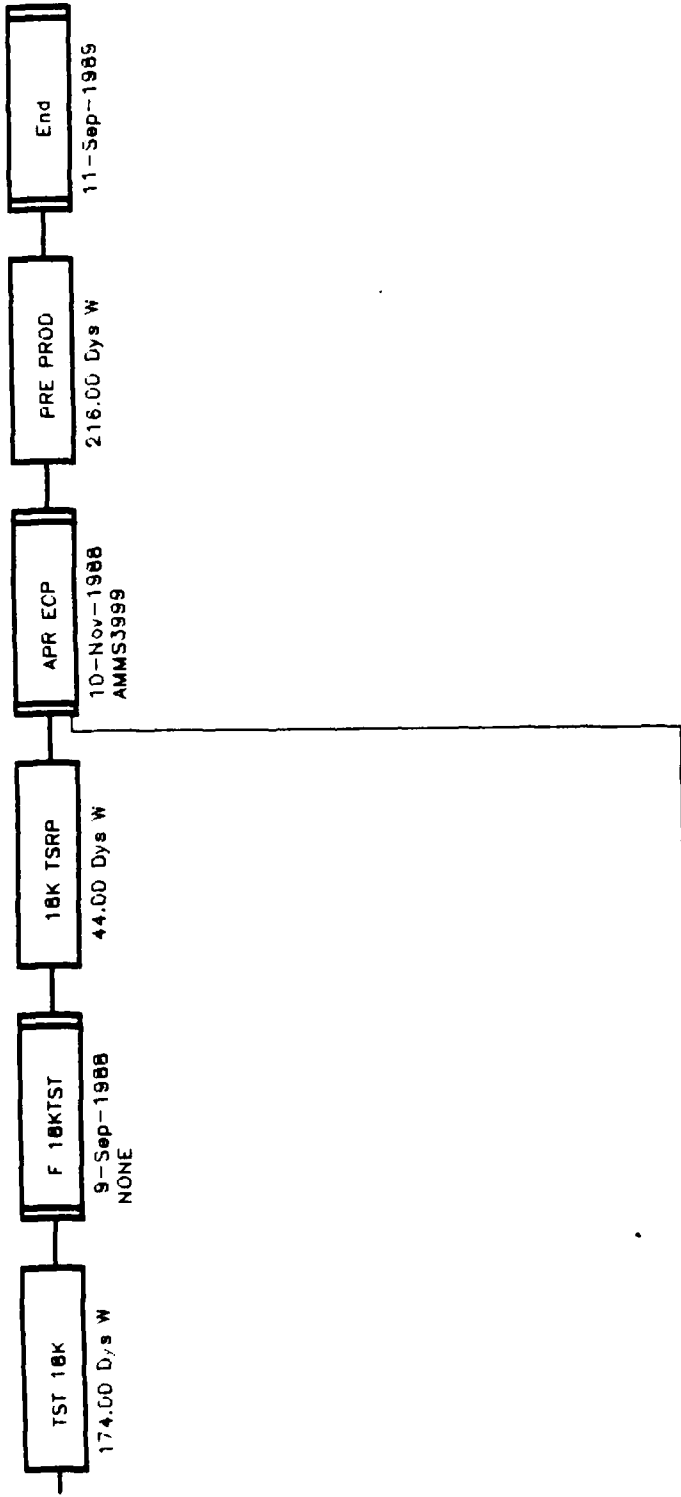

TOTAL ENVIRONMENTAL CONTROL SYSTEM
Project: TECS

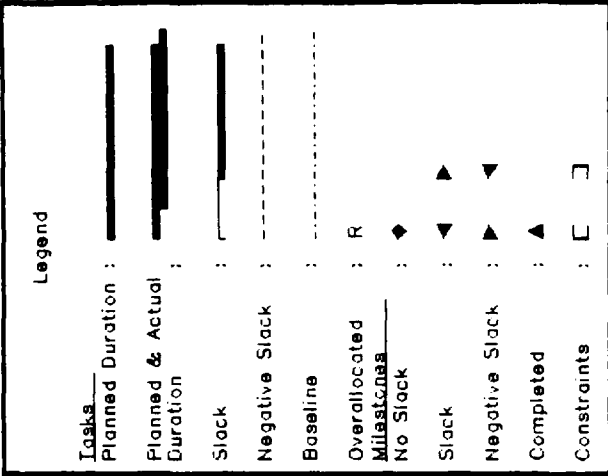
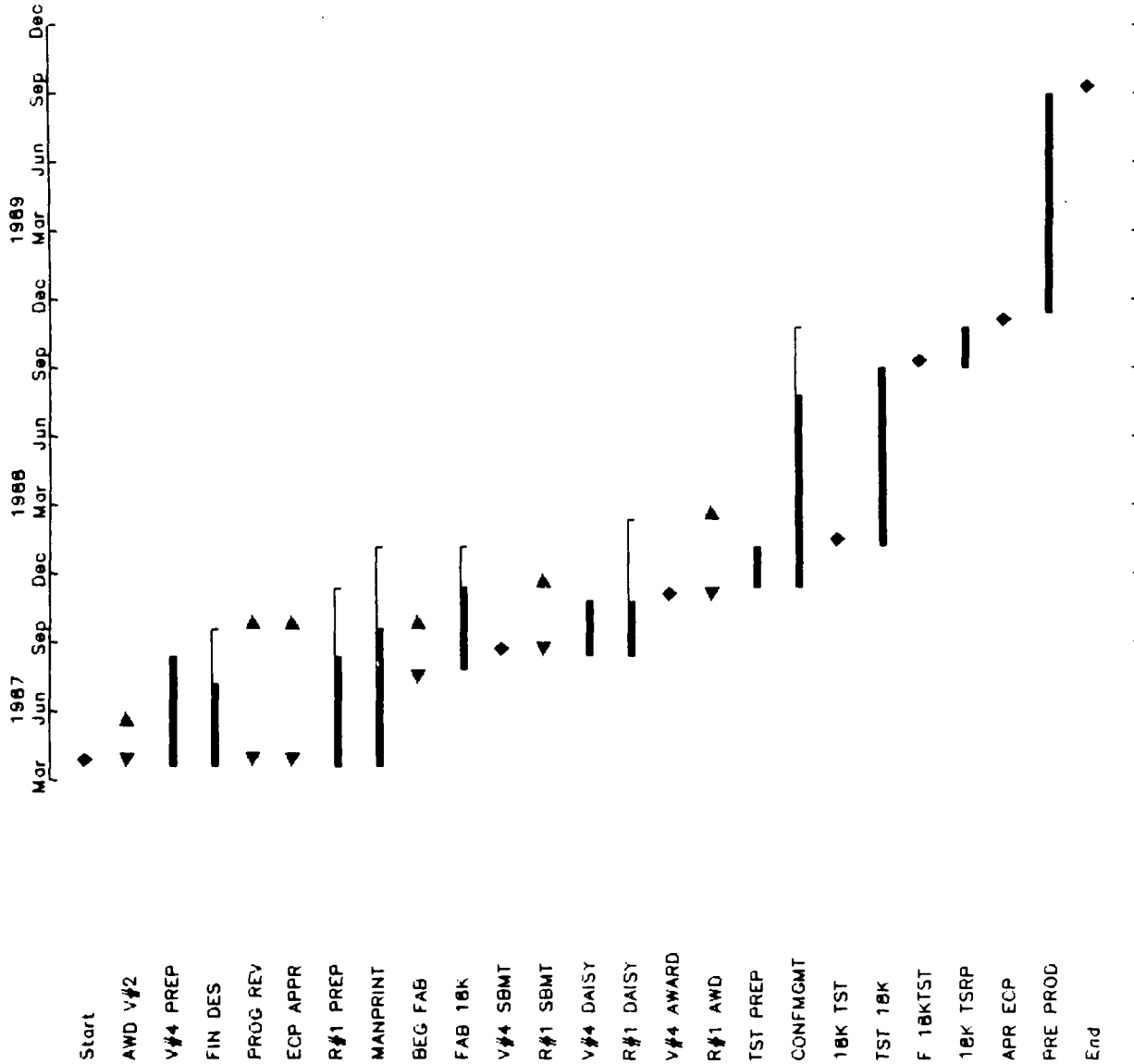

TRIDENT II BOACAR
Project: NAVY

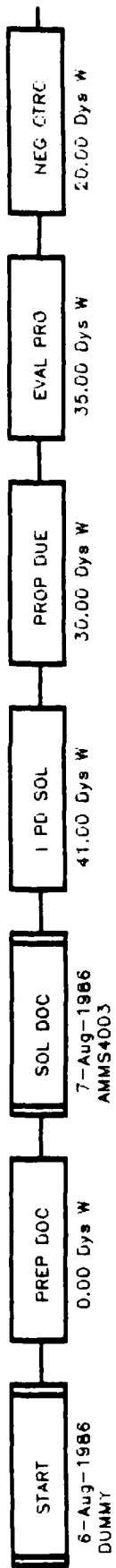

TRIDENT II BGA CAR
Project: NAVY

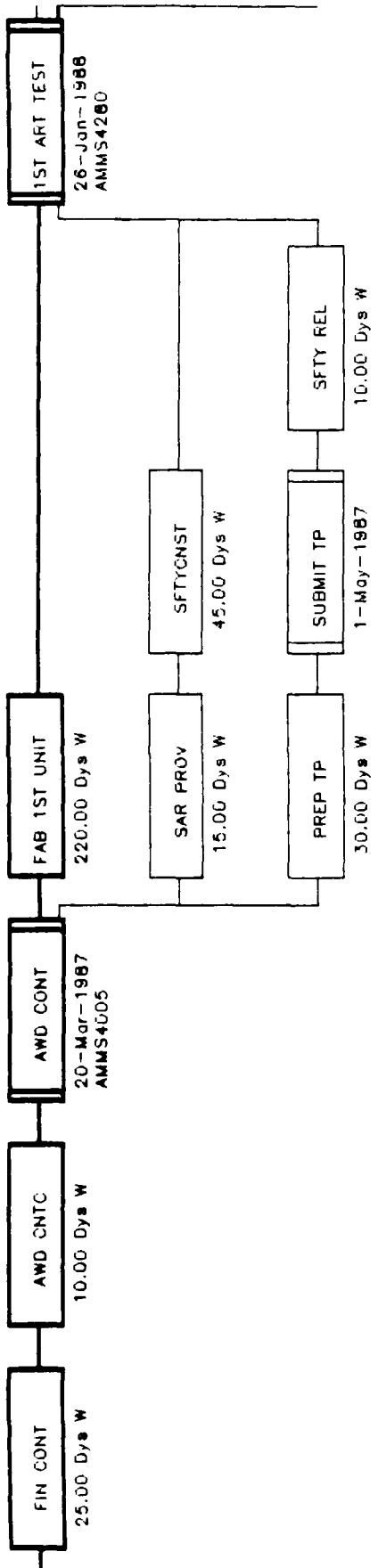

TRIDENT II BOACAR
Project: NAVI

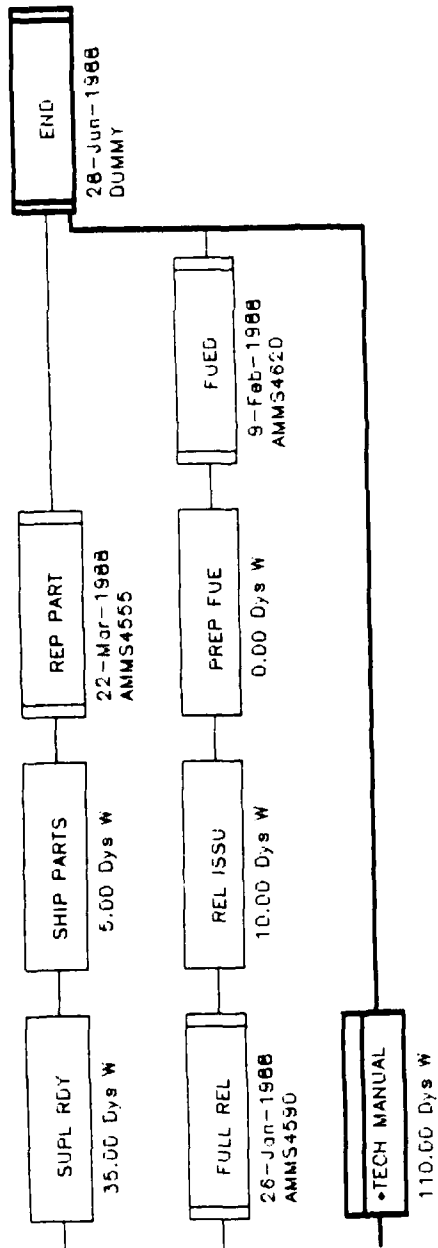

TRIDENT II BOXCAR
Project: NAVY

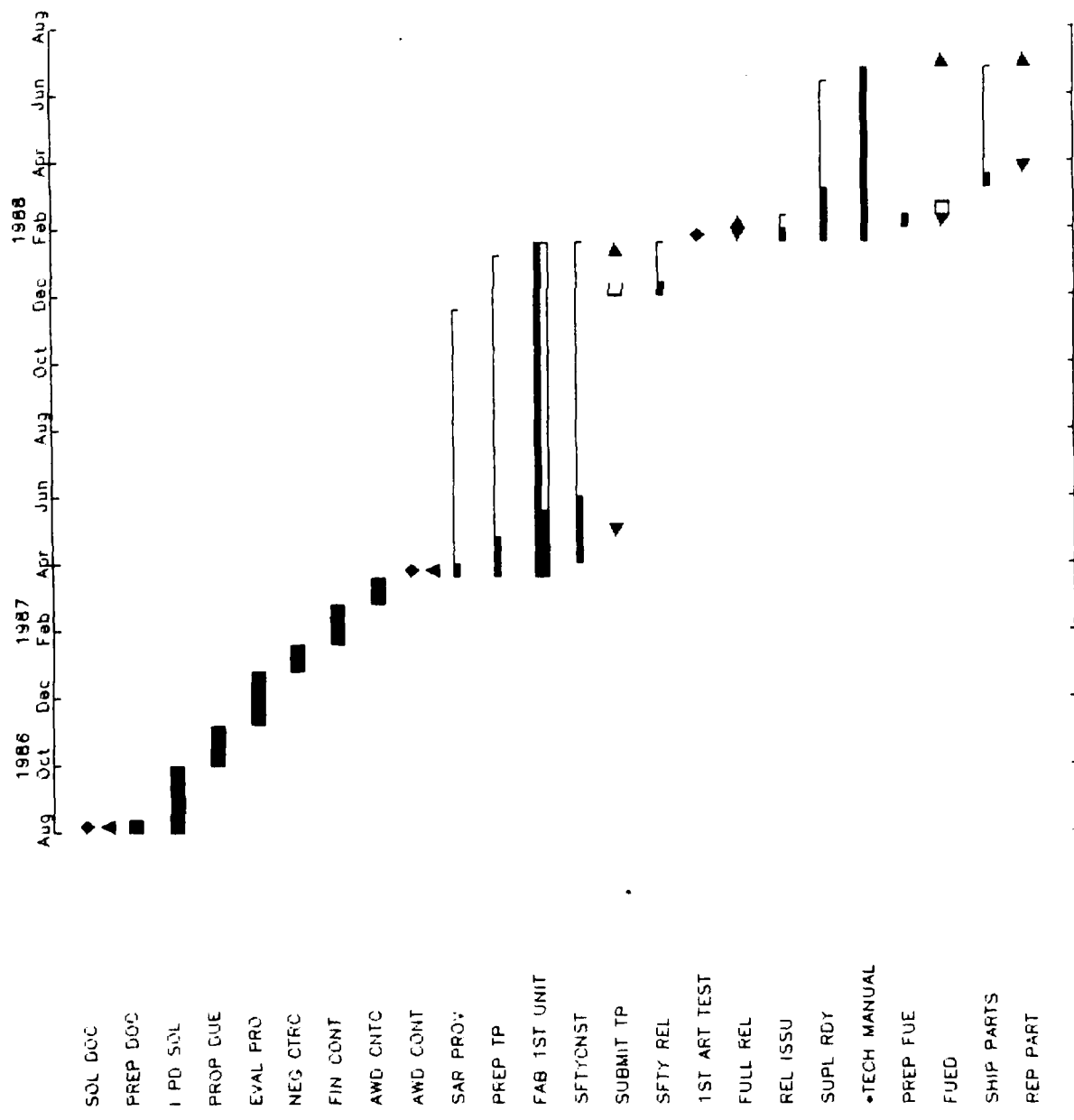

Legend

- Tasks
- Planned Duration : [Solid Bar]
- Planned & Actual Duration : [Thick Solid Bar]
- Slack : [Thin Solid Bar]
- Negative Slack : [Dashed Line]
- Baseline : [Dotted Line]
- Overallocated : R
- Milestones : ◆
- No. Slack : ◆
- Slack : ▲
- Negative Slack : ▼
- Completed : ▲
- Constraints : □

UNIT BASIC LOAD - UPLOAD EQUIPMENT
Project: UBLUE

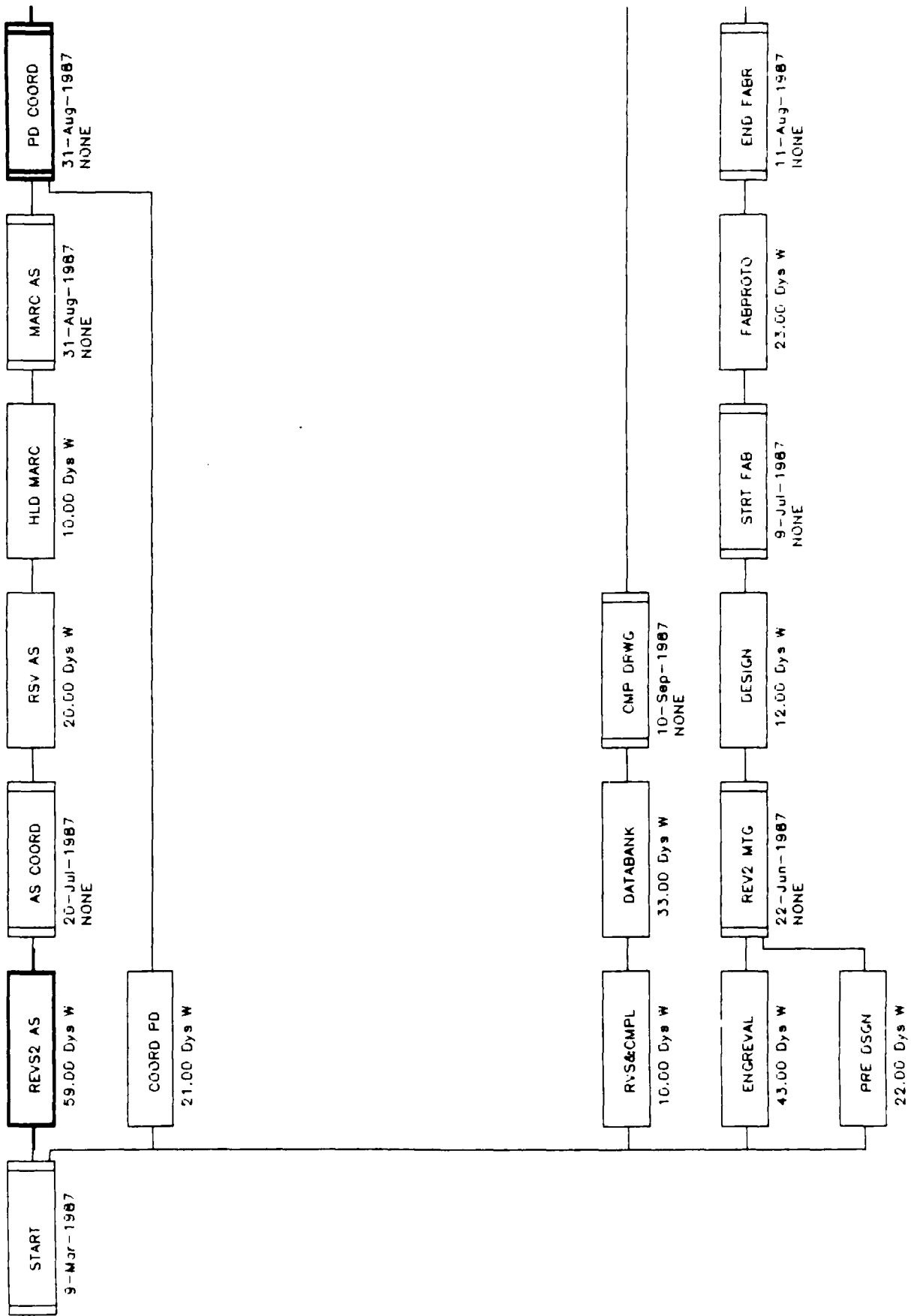

UNIT BASIC LOAD - UPLOAD EQUIPMENT
Project: UBLUE

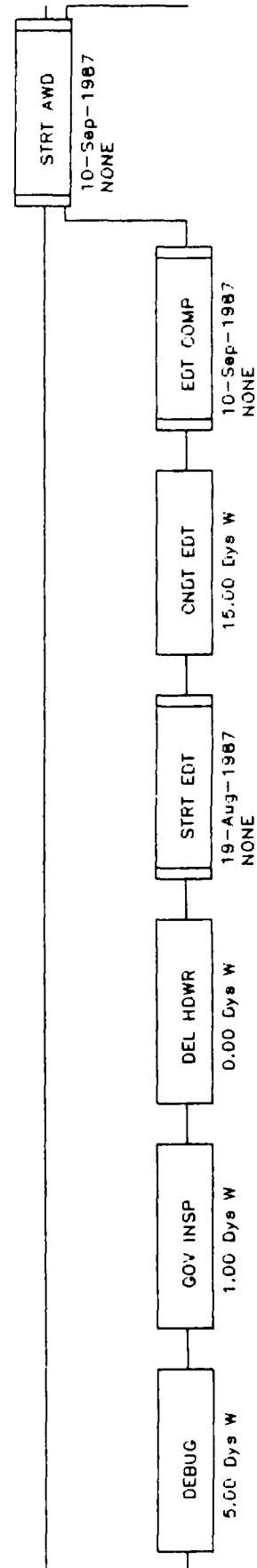
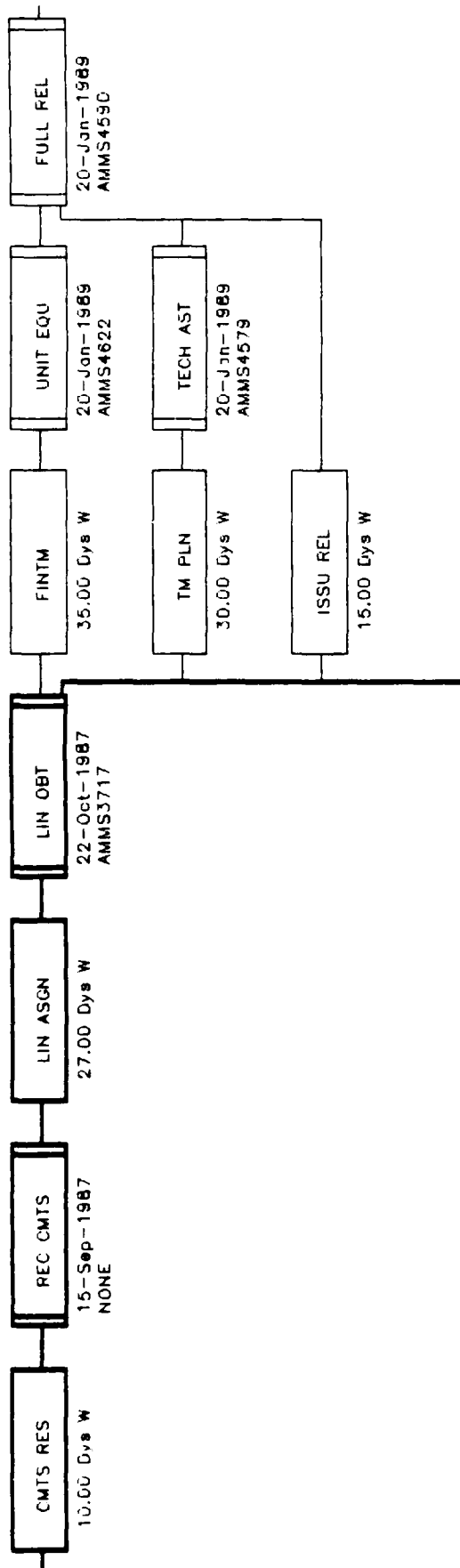

UNIT BASIC LOAD - UPLOAD EQUIPMENT
Project: UBLUE

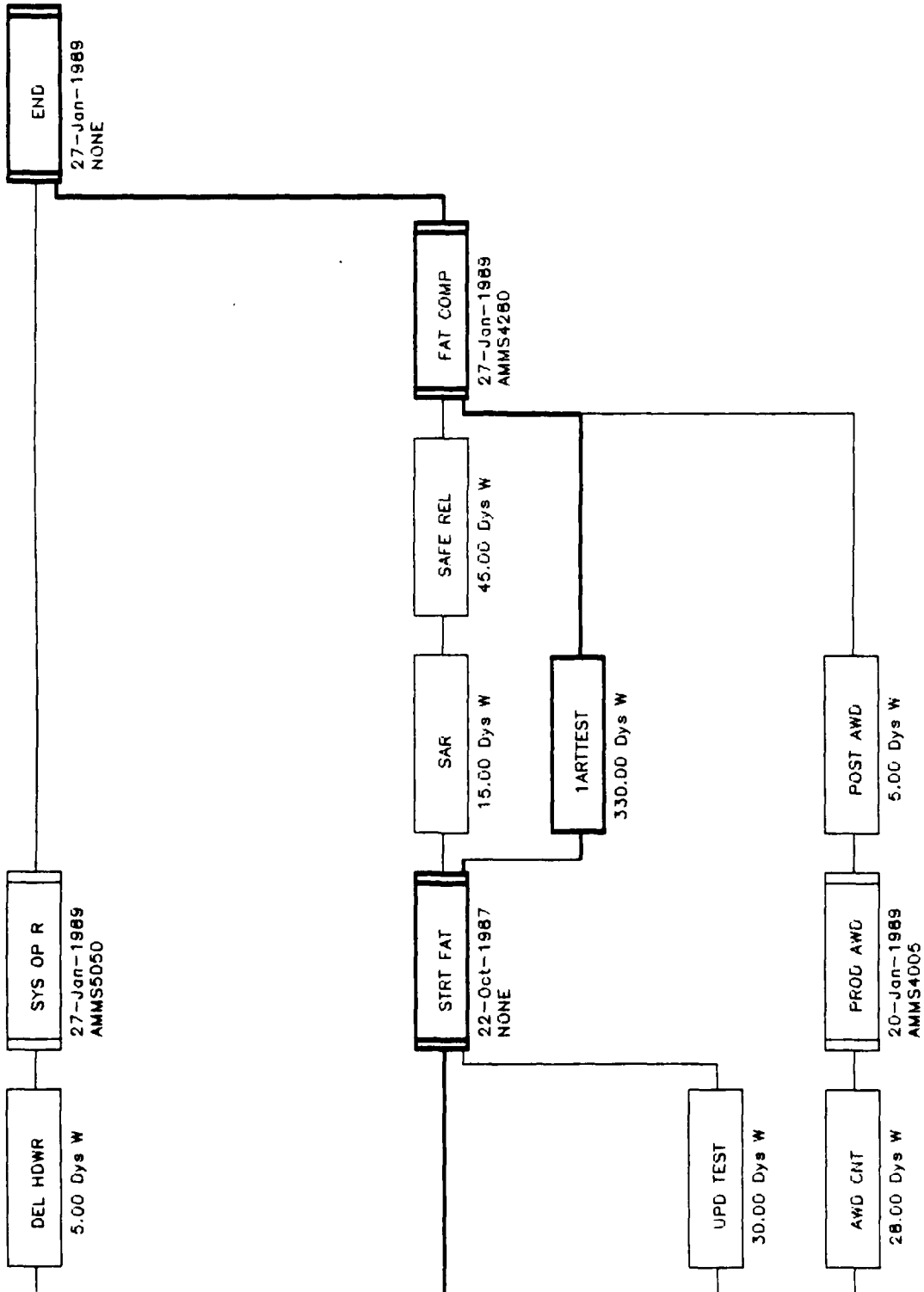

UNIT BASIC LOAD - UPLOAD EQUIPMENT
Project: UBLUE

1986 1987 1988 1989
Aug Nov Feb May Aug Nov Feb Aug Nov Feb

- START
- RVS&CMPL
- COORD PD
- DATABANK
- CMP DRWG
- REV'S2 AS
- ENGREVAL
- PRE DSGN
- REV2 MTC
- DESIGN
- STRT FAB
- FABPROTO
- AS COORD
- RSV AS
- HLG MARE
- ENG REPR
- SEBUC
- NOI MARE
- ST EDT
- DMGT EDT
- CEB MARE
- MARE AS
- EDT COMP
- AS COORD
- RSV AS
- HLG MARE
- ENG REPR
- SEBUC
- NOI MARE
- ST EDT
- DMGT EDT
- CEB MARE
- MARE AS
- EDT COMP
- AS COORD
- RSV AS
- HLG MARE
- ENG REPR
- SEBUC
- NOI MARE
- ST EDT
- DMGT EDT
- CEB MARE
- MARE AS
- EDT COMP
- AS COORD

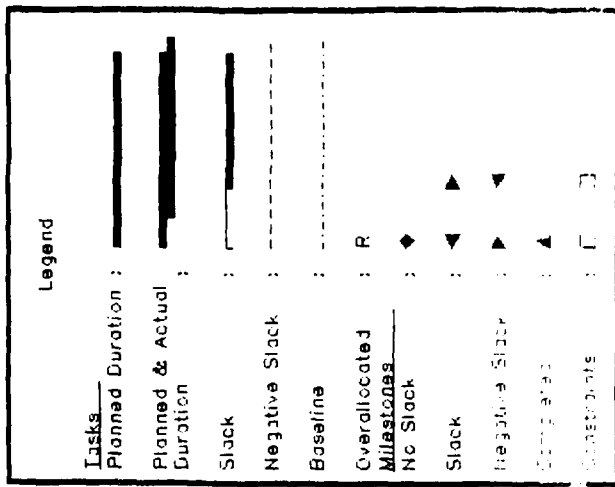

UNIT BASIC LOAD - UPLOAD EQUIPMENT
Project: UBLUE

1986 1987 1988 1989
 Aug Nov Feb May Aug Nov Feb May Aug Nov Feb

CMTS RES
 PROD AWD
 POST AWD
 REC CMTS
 LIN ASGN
 LIN OBT
 STRT FAT
 1ARTTEST
 SAR
 FINTRM
 TM PLN
 ISSU REL
 SAFE REL
 TECH AST
 FULL REL
 UNIT EQU
 DEL HDWR
 SYS CP R
 FAT COMP
 END

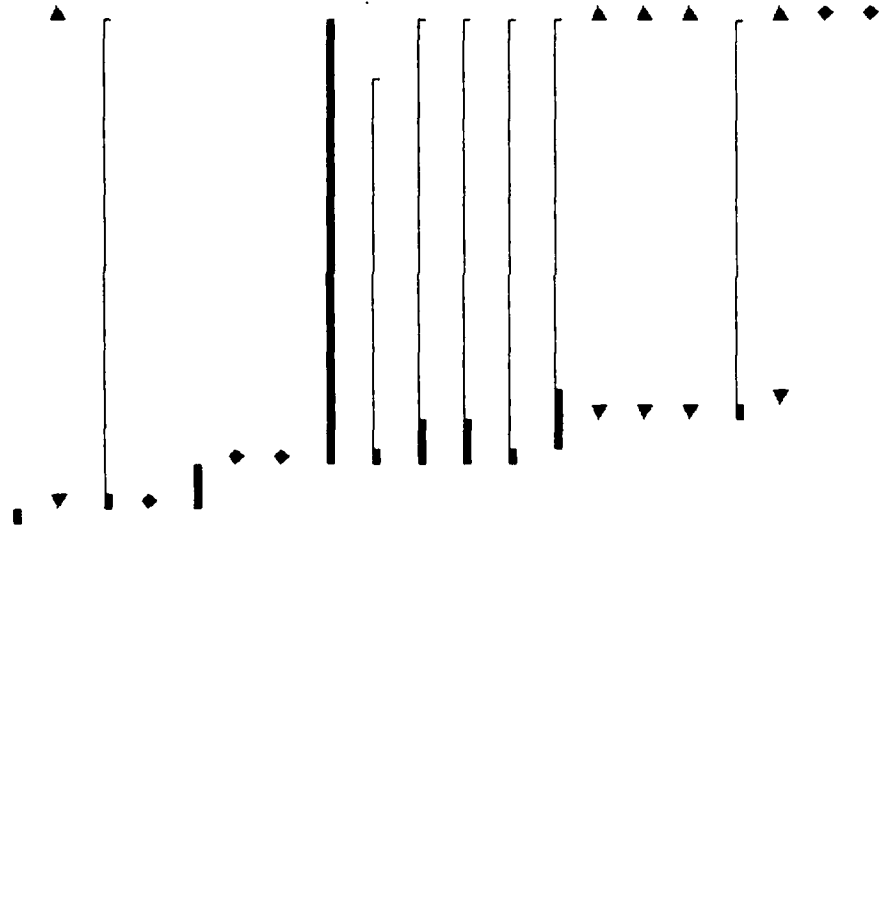

UNIVERSAL SELF-DEPLOYABLE CARGO HANDLER
Project: USDCHA2

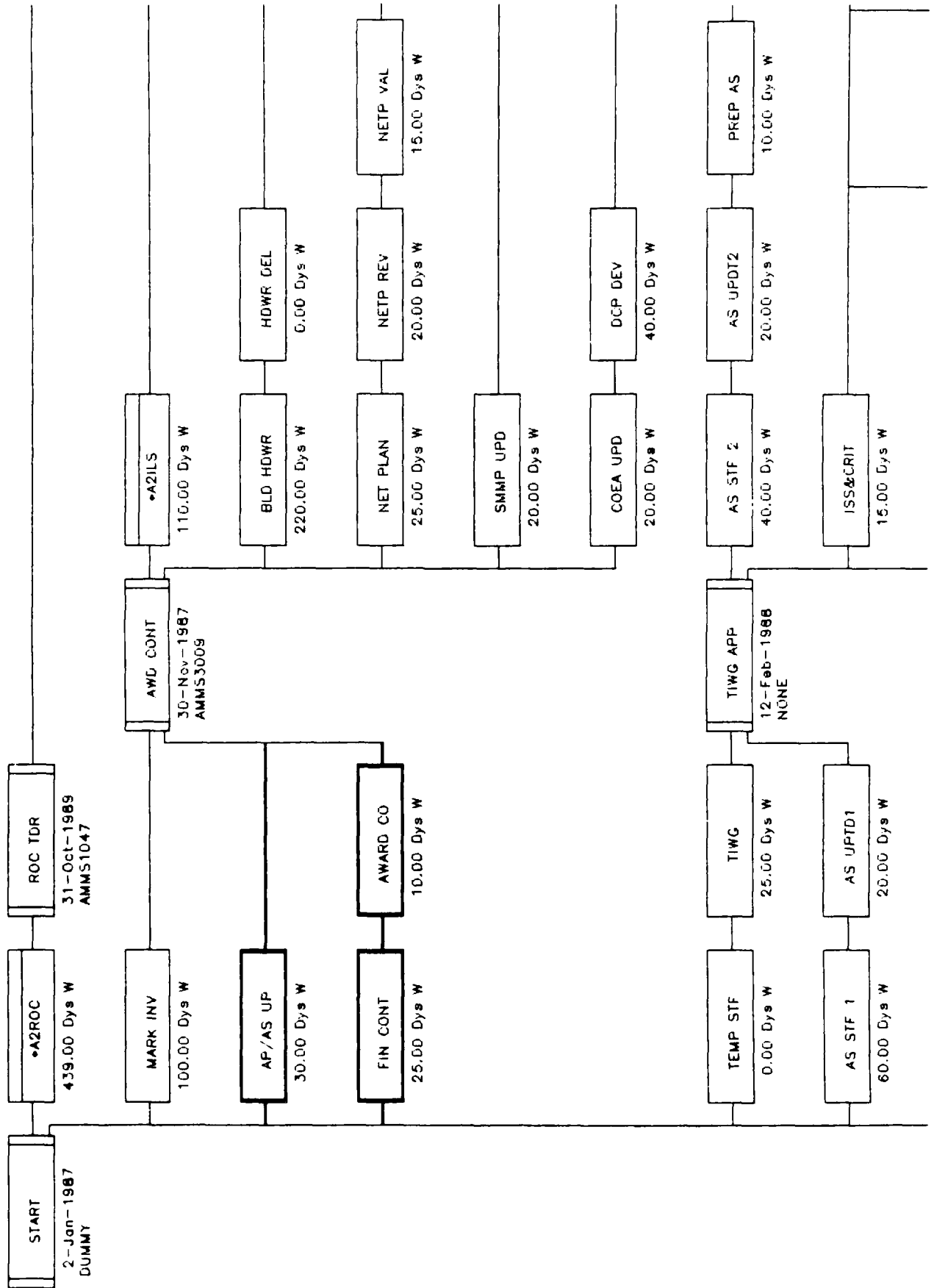

UNIVERSAL SELF-DEPLOYABLE CARGO HANDLER
 Project: USDCHA2

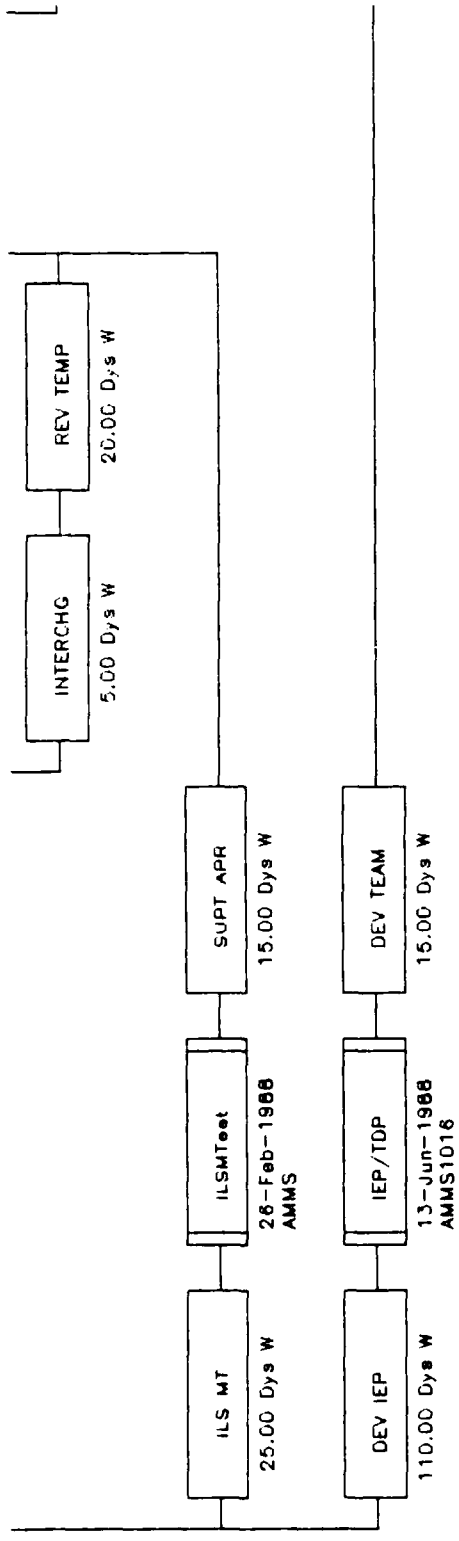

UNIVERSAL SELF-DEPLOYABLE CARGO HANDLER
 Project: USDCHA2

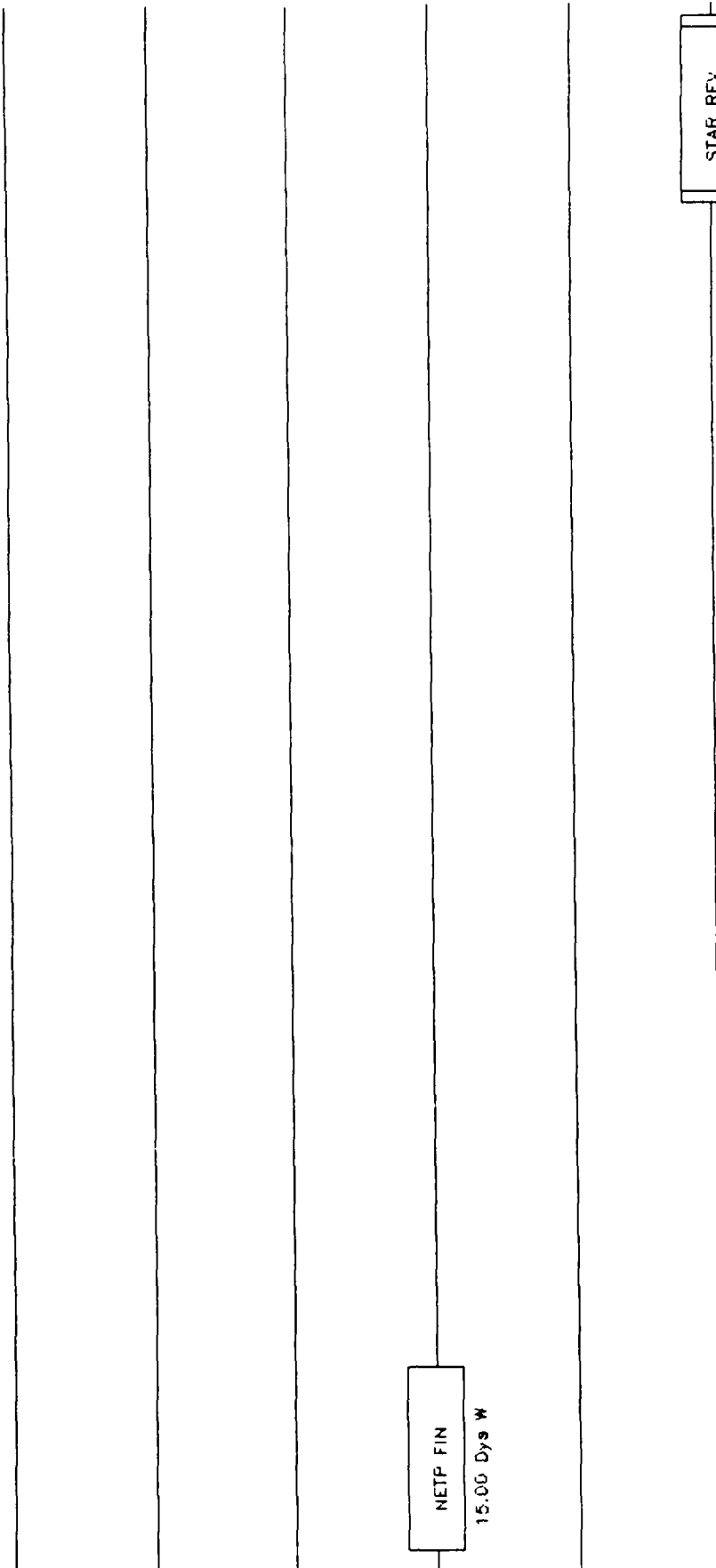

NETP FIN
 15.00 Dys W

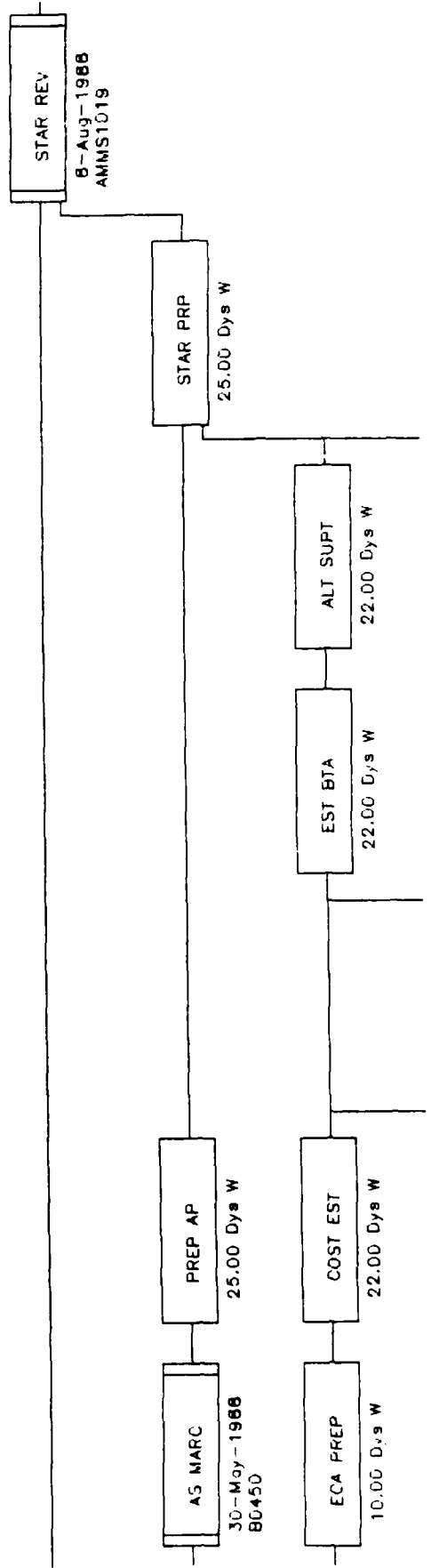

UNIVERSAL SELF-DEPLOYABLE CARGO HANDLER
Project: USDCHA2

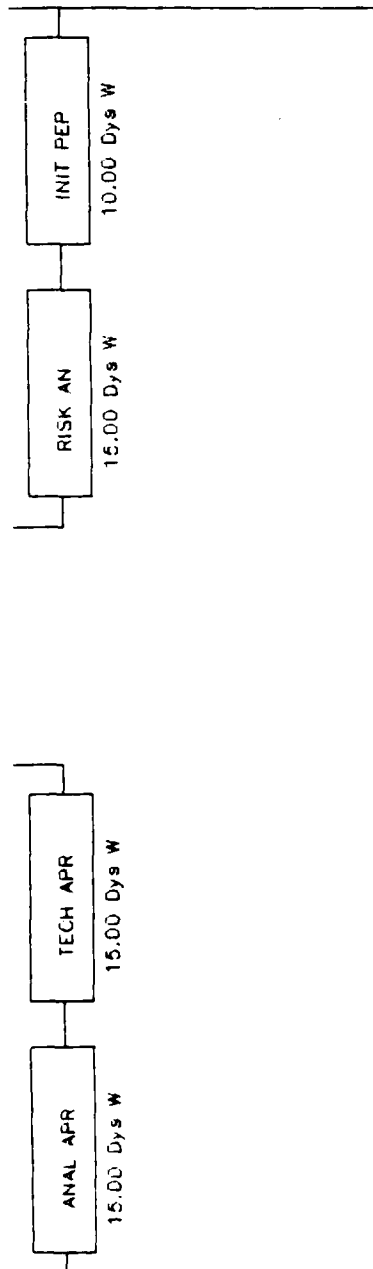

UNIVERSAL SELF-DEPLOYABLE CARGO HANDLER
Project: USDCHA2

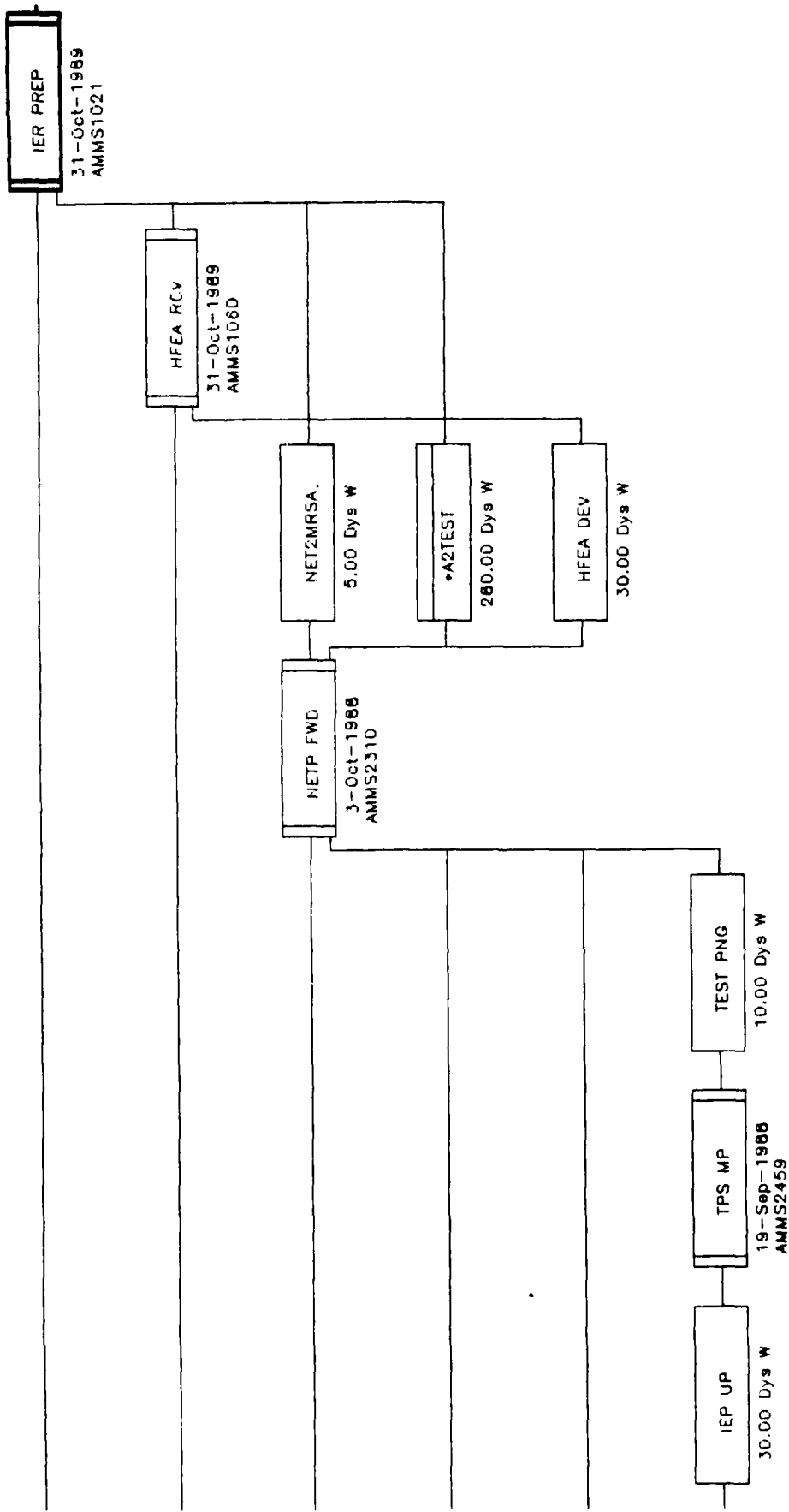

UNIVERSAL SELF-DEPLOYABLE CARGO HANDLER
Project: USDCHA2

END

31-Oct-1989

UNIVERSAL SELF-DEPLOYABLE CARGO HANDLER
Project: USOCHA2

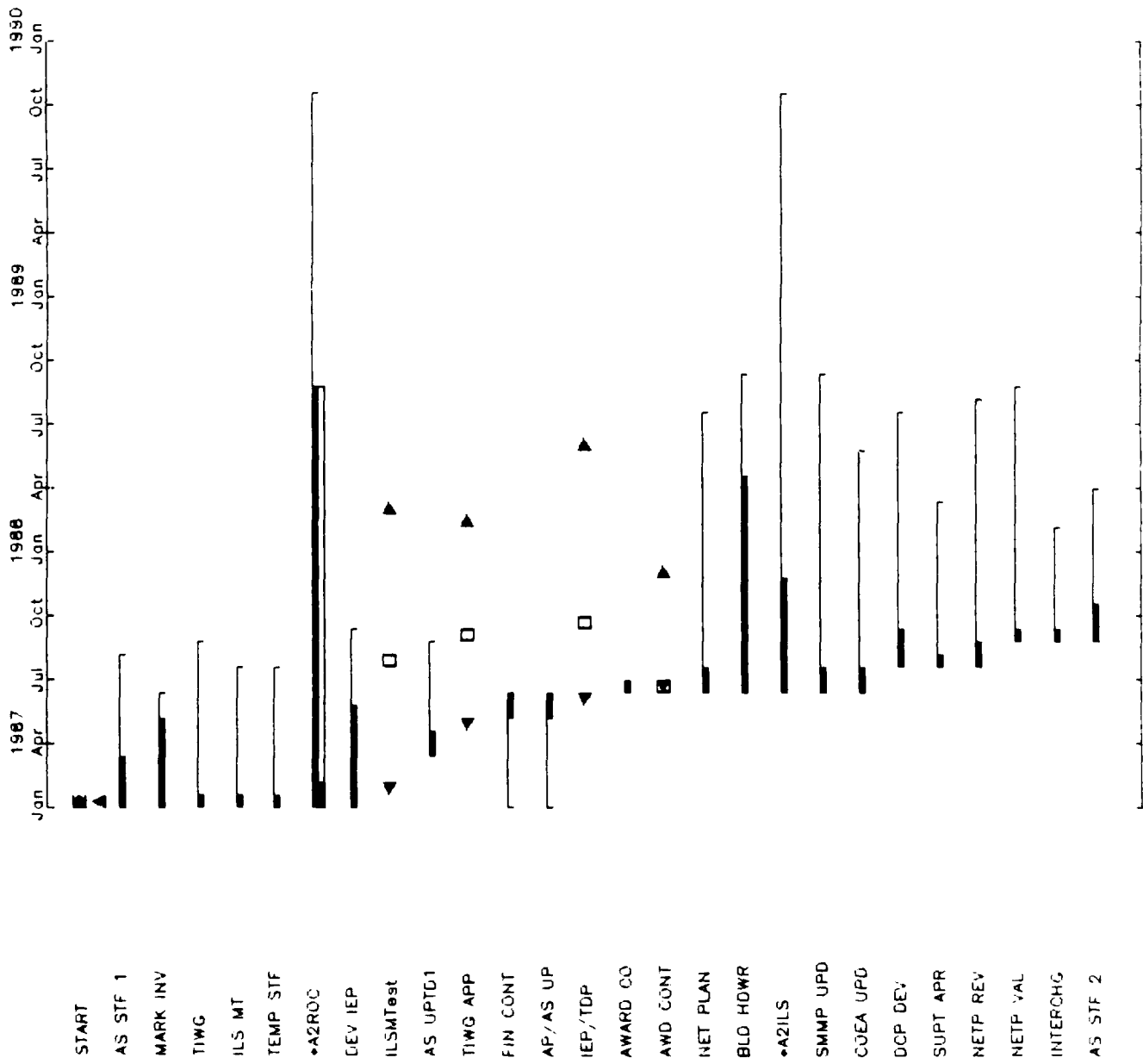

Legend

- Tasks
- Planned Duration : [Solid Bar]
- Planned & Actual Duration : [Thick Solid Bar]
- Slack : [Thin Solid Bar]
- Negative Slack : [Dashed Line]
- Baseline : [Dotted Line]
- Overallocated : R
- Milestones : ◆
- No Slack : ◆
- Slack : ▲
- Negative Slack : ▼
- Completed : ▲
- Constraints : □

UNIVERSAL SELF-DEPLOYABLE CARGO HANDLER
Project: USDCHA2

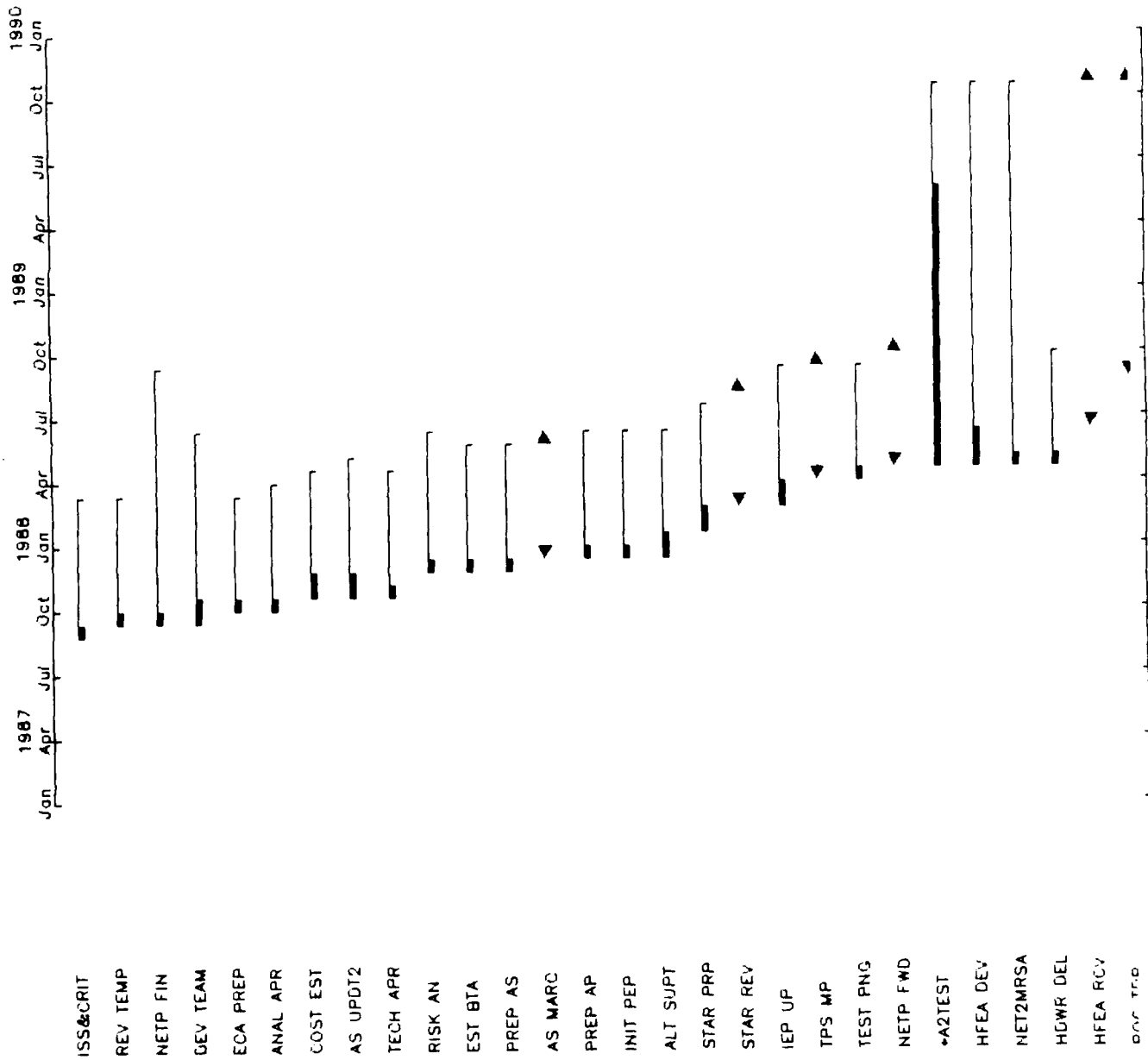

UNIVERSAL SELF-DEPLOYABLE CARGO HANDLER
Project: USDCHA2

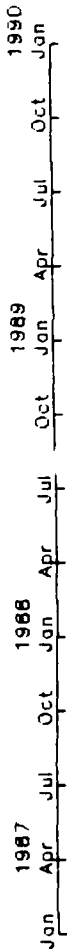

IER PREP
END

END

12-87

DTIC