

AD-A194 002

44/20 GHZ GROUND TERMINAL(U) COMMUNICATIONS RESEARCH  
CENTRE OTTAWA (ONTARIO) A H MCEMEN AUG 87 CRC-1428

1/1

UNCLASSIFIED

F/G 25/5

NL

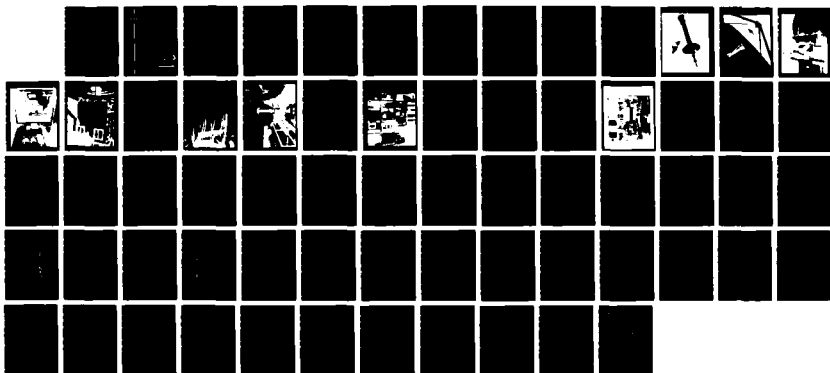

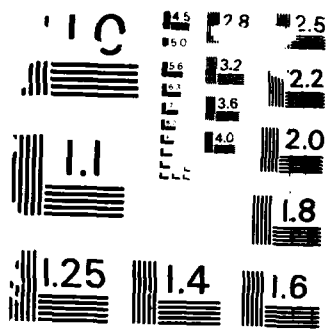

COPY RESOLUTION TEST CHART  
NATIONAL BUREAU OF STANDARDS-1963-A

①

# Communications Research Centre

DTIC FILE COPY

AD-A194 002

## 44/20 GHz GROUND TERMINAL

by

A.H. McEwen

This document was prepared for and is the property of the Department of National Defence,  
Research and Development Branch under Project No. 32A53.

DTIC  
ELECTE  
APR 27 1988  
S D  
dr H

CRC REPORT NO. 1428  
OTTAWA, AUGUST 1987

Government of Canada / Gouvernement du Canada  
Department of Communications / Ministère des Communications

**DISTRIBUTION STATEMENT A**  
Approved for public release  
Distribution Unlimited

Canada  
88 4 26 13 8

**COMMUNICATIONS RESEARCH CENTRE**

**DEPARTMENT OF COMMUNICATIONS  
CANADA**

**44/20 GHz GROUND TERMINAL**

by

**A.H. McEwen**

*(Space Technology and Applications Branch)*

**CRC REPORT NO. 1428**

**August 1987  
OTTAWA**

This document was prepared for and is the property of the Department of National Defence,  
Research and Development Branch under Project No. 32A53.

TABLE OF CONTENTS

	<u>Page No.</u>
List of Illustrations	i
List of Tables	iii
ABSTRACT	1
1. INTRODUCTION	1
1.1 Background	1
2. SYSTEM DESIGN	1
2.1 44/20 GHz Feed System	1
2.2 RF Package Design for EHF Pedestal	3
2.3 44/20 Configuration for Kingsmere	9
3. SYSTEM DESCRIPTION	9
3.1 Frequency Agility	9
3.2 Signal Routing	14
3.3 Component Coding and Identification	14
4. SIGNAL FLOW DESCRIPTION	15
4.1 Uplink Data Path	15
4.2 Uplink Local Oscillator Path	15
4.3 Downlink Data Path	15
5. SIGNAL CHARACTERIZATION	16
5.1 Local Oscillator Stability	16
5.2 Test Environment	16
5.3 Frequency Agile Local Osc. Chain	19
6. SYSTEM PERFORMANCE TESTS	25
6.1 TX 43.5 GHz Phase Noise	25
6.2 Kingsmere Experiments	25
7. CONCLUSIONS	37
8. ACKNOWLEDGEMENTS	37
9. REFERENCES	37
APPENDIX A - Primary Antenna Pattern	
Appendix B - 4' Diameter Antenna Patterns	

<b>Accession For</b>	
NTIS GRA&I	<input checked="" type="checkbox"/>
DTIC TAB	<input type="checkbox"/>
Unannounced	<input type="checkbox"/>
Justification	
By	
Distribution/	
Availability Codes	
Dist	Avail and/or Special
A-1	

(iii)



## LIST OF ILLUSTRATIONS

<u>Fig. No.</u>	<u>Page No.</u>
1. Andrew 44/20 GHz feed system design .....	02
2. Completed Andrew 44/20 GHz feed system .....	04
3. Andrew 44/20 GHz feed system in 6' Satcom Dish .....	05
4. 44/20 transceiver on Satcom pedestal .....	06
5. 44/20 Power Supply and Computer Shelf .....	07
6. Complete 44/20 GHz Satcom installation .....	08
7. 44/20 GHz system inside radome .....	10
8. Andrew 44/20 GHz antenna and pedestal .....	11
9. Schematic for the 44/20 GHz transceiver .....	12
10. Satellite control console .....	13
11. RF shelf assembly .....	17
12. Aventek amplifier UTO series frequency response .....	18
13. Varian amplifier VS47483CH9 frequency response .....	20
14. K&L filter 6FV-12650/1050 - Bandpass Response .....	21
15. K&L filter 6FV-12650/1050 - Bandpass Ripple .....	22
16. Freq. west oscillator MS54XEL-24 (ref. input ZETA) .....	23
17. Freq. west oscillator MS54XEL-24 (ref. input Fluke) .....	24
18. Mixer calibration WJM67C .....	26
19. Frequency Doubler Conversion Loss .....	27
20. Frequency Doubler Response .....	28
21. Frequency Doubler Output Spectrum .....	29
22. Mixer C38-25 Calibration .....	30
23. Local Oscillator Chain Freq. Response .....	31
24. Modem CW Signal Uplink .....	32
25. Modem CW Signal Downlink .....	33

	<u>Page No.</u>
26. Transmitter Output Normal Configuration .....	34
27. Transmitter Output Experimental Configuration.....	35
28. Receiver Calibration Curve .....	36
29. Rain Attenuation Plot .....	38

LIST OF TABLES

	<u>Page No.</u>
Table 1 - Antenna Feed System Specifications	3
Table 2 - Component Identification Code	14
Table 3 - List of Test Equipment	19

## 44/20 GHz GROUND TERMINAL

### ABSTRACT

The design and construction of an EHF SATCOM terminal to transmit in the mobile satellite (43.5 - 45.5) GHz band and receive in the fixed satellite space to earth (20.2 - 21.2) GHz band is described. Characterization plots for individual RF system components and test results of the complete terminal operating over a 16 km repeater range are shown.

### 1. INTRODUCTION

The design of a 44/20 GHz transceiver is described in this report. The design incorporates a retrofit for the existing C.R.C. Satcom Terminal, Ref. [1] and a stand alone system using a dual frequency feed and a 4' diameter fixed antenna. Provision has been made for broad band frequency agility in both the TX and RX signal paths. The component layout, packaging and signal characterization will be shown, along with the completed transceiver test results.

#### 1.1 BACKGROUND

The completion of the EHF Satcom Terminal and the successful trials using the LES 8 and LES 9 satellites proved the feasibility of EHF communication at (36/38) GHz. The second phase of the CRC Milsatcom program was the design and development of a terminal to operate in the Mobile-Satellite (43.5 - 45.5) GHz band and receive in the Fixed Satellite Space-to-Earth (20.2 - 21.2) band. Many of the modifications discussed here make reference to equipment discussed in Ref. [1], which is a necessary background document for this report.

### 2. SYSTEM DESIGN

#### 2.1 44/20 GHz FEED SYSTEM

The approach taken was to design an RF transceiver (44/20) GHz such that it could be used on the existing satcom terminal or operate with a fixed 4' diameter antenna over a 16 Km repeater range.

The first step was to design a new feed system which would meet the terminal transmit and receive specifications shown in Table 1.

The feed system was designed to be interchangeable with the original antenna feed on the (36/38) GHz system. A contract was awarded to Andrew Antenna Co., Whitby, Ontario to design and construct the (44/20) GHz feed system. The design (Fig. 1) also included the construction of a new subreflector; again this unit was to be interchangeable with the original subreflector.

20 / 44 GHz FEED ASSEMBLY

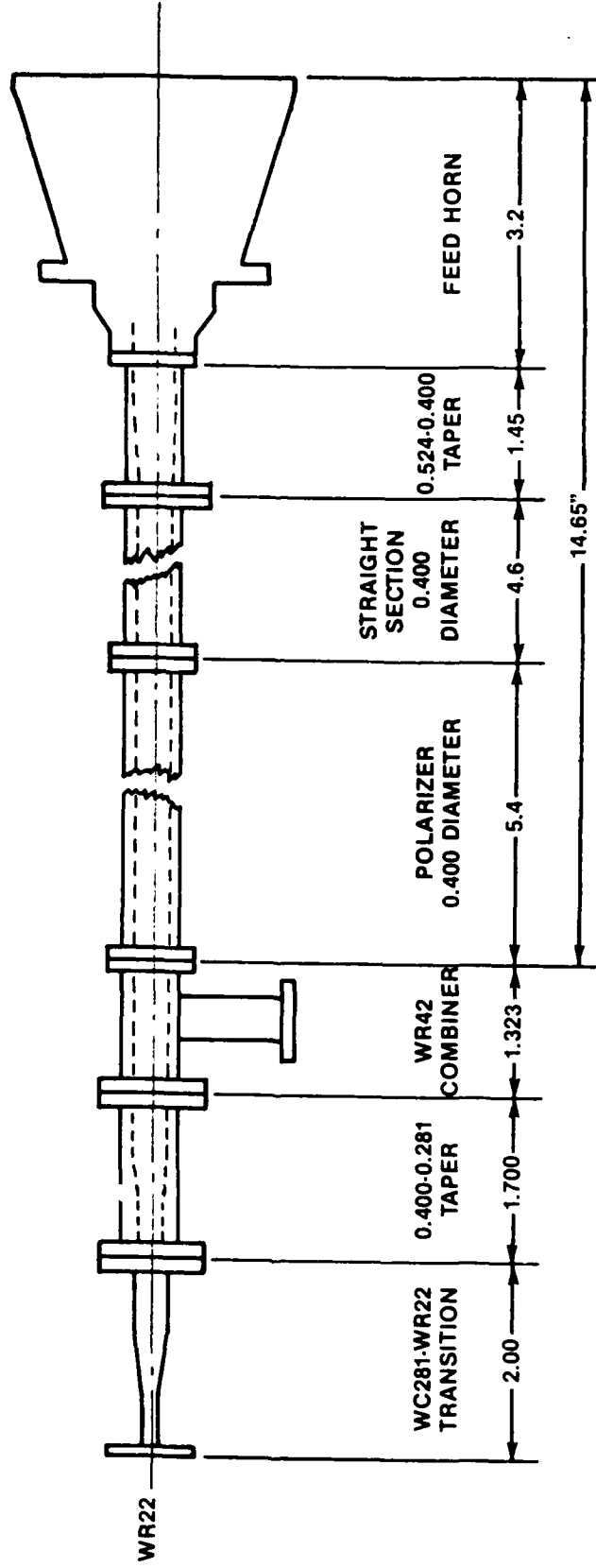

FIG. 1 44 / 20 GHz FEED SYSTEM DESIGN

TABLE 1		
ANTENNA FEED SYSTEM SPECIFICATIONS		
Frequency Range	Transmit	44.5 GHz $\pm$ 1 GHz
	Receive	20.7 GHz $\pm$ .5 GHz
Polarization	Transmit	R.H.C.P.
	Receive	L.H.C.P.
Axial Ratio	Transmit	2.0 dB max. typical 1.8 dB
	Receive	2.0 dB max. typical 1.5 dB
VSWR	Transmit	1.5 max.
	Receive	1.5 max.
Power Rating	(10 - 100) watts	

Axial ratios VSWR, and primary patterns (Appendix A) were measured at the Whitby Plant and supplied to CRC upon delivery of the unit. The completed feed and subreflector (Fig. 2) was installed in the satcom terminal and tested over the repeater link. Fig. 3 illustrates the feed system installed in the Satcom 6' dia. antenna.

## 2.2 RF PACKAGE DESIGN FOR EHF PEDESTAL

The RF transceiver was packaged in a shelf that could be mounted on the Satcom Terminal and fit on the shelf that originally held the (36/38) GHz HPA. This configuration (Fig. 4) kept the waveguide runs short thus reducing feed losses between the transmit and receive ports.

The second drawer (Fig. 5) of the (44/20) GHz system contains all the power supplies and a LSI 11-03 computer which monitors signal levels and transmits this information to the computer control console in room 203 three levels below the satcom installation [Ref. 1 for further details].

The power supply drawer is located beside and below the pedestal base and is fed the power and signal information through a cable installed inside the antenna pedestal.

The completed installation showing the waveguide runs to the antenna feed is illustrated in Fig. 6. The system was tested using the Kingsmere repeater range. This retrofit of the CRC satcom terminal will permit future testing over actual satellite links if available.

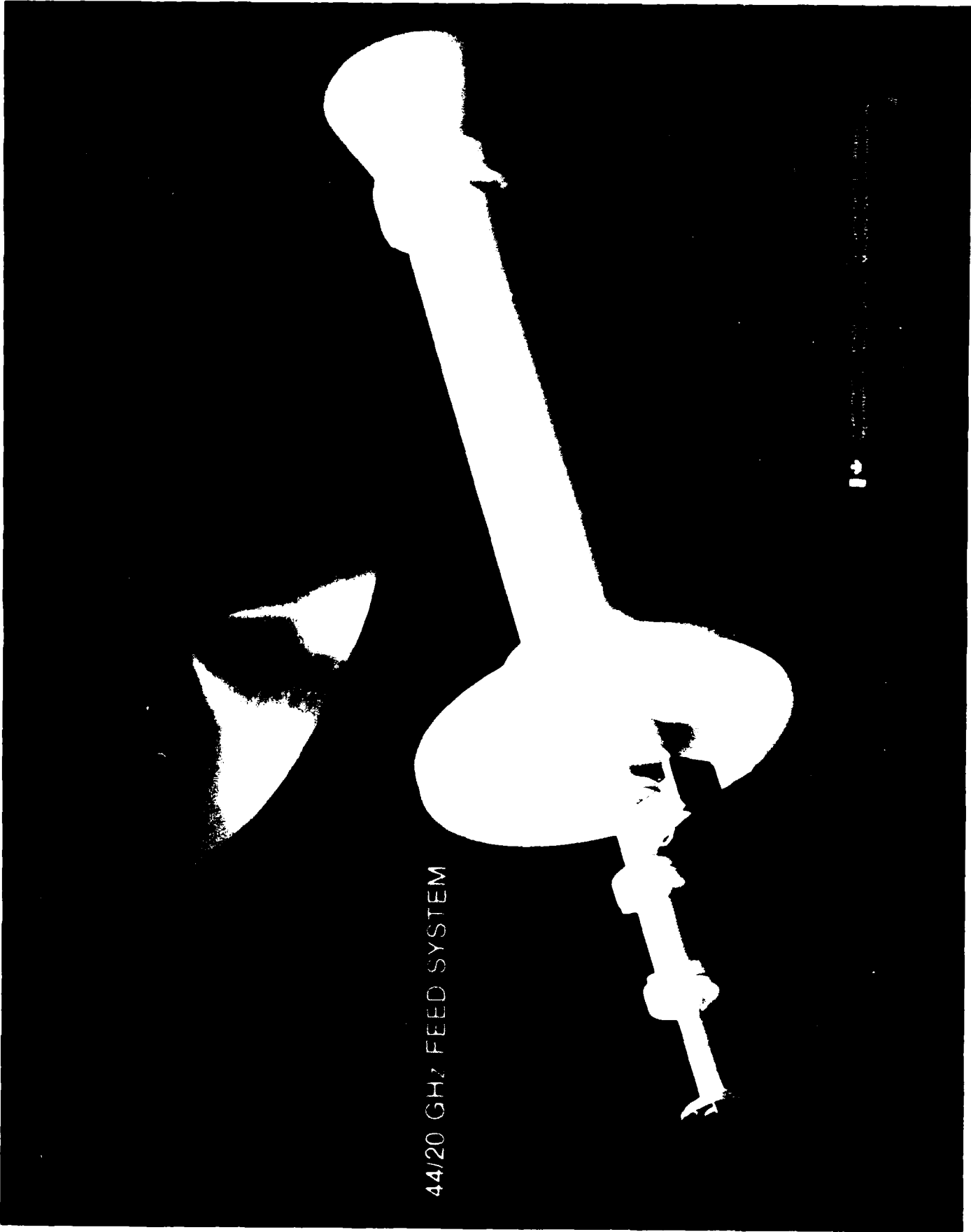

Figure 2 Completed Andrew 44/20 GHz feed system

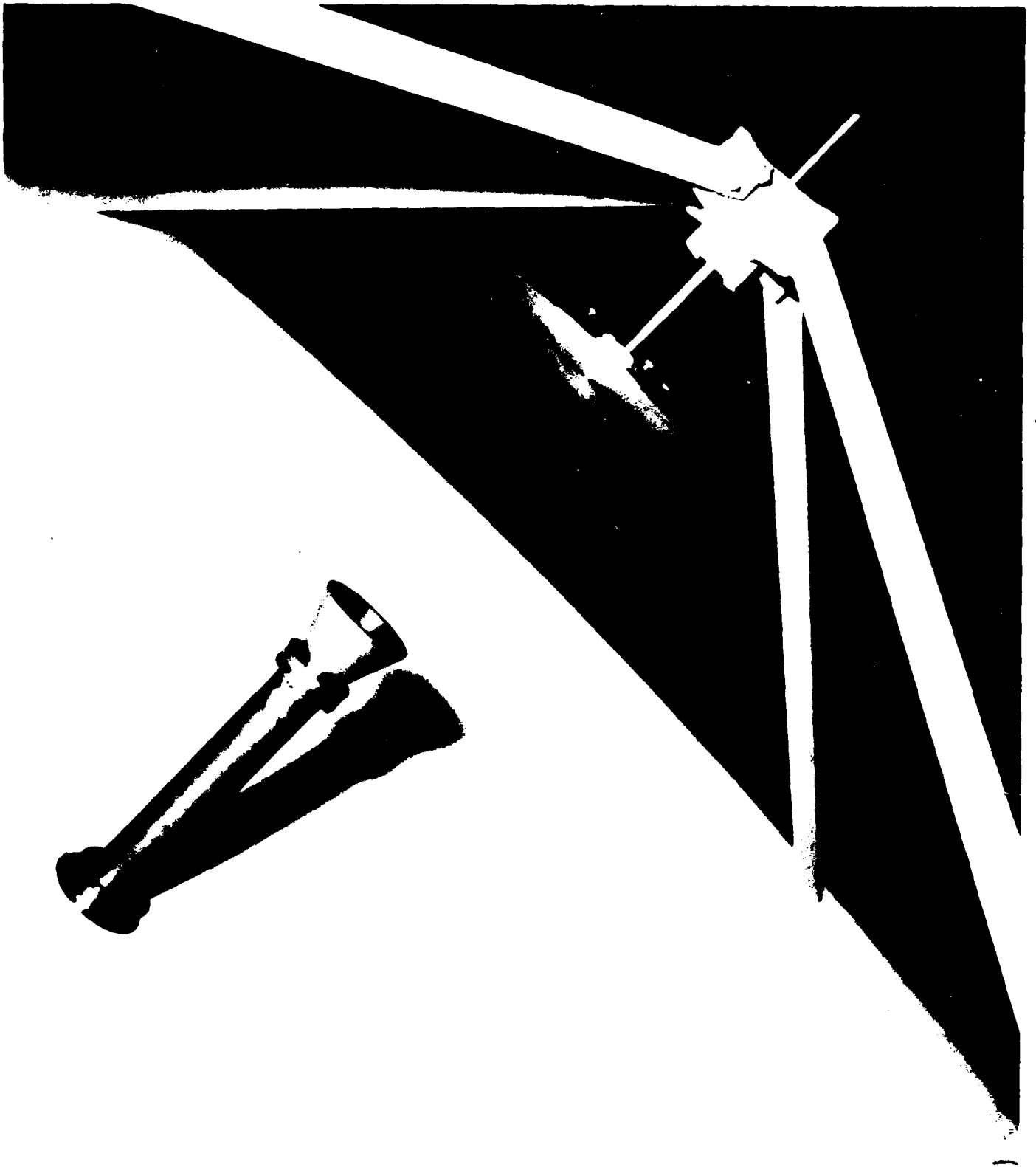

Figure 3 Andrew 44/20 GHz feed system in 6' Satcom Dish

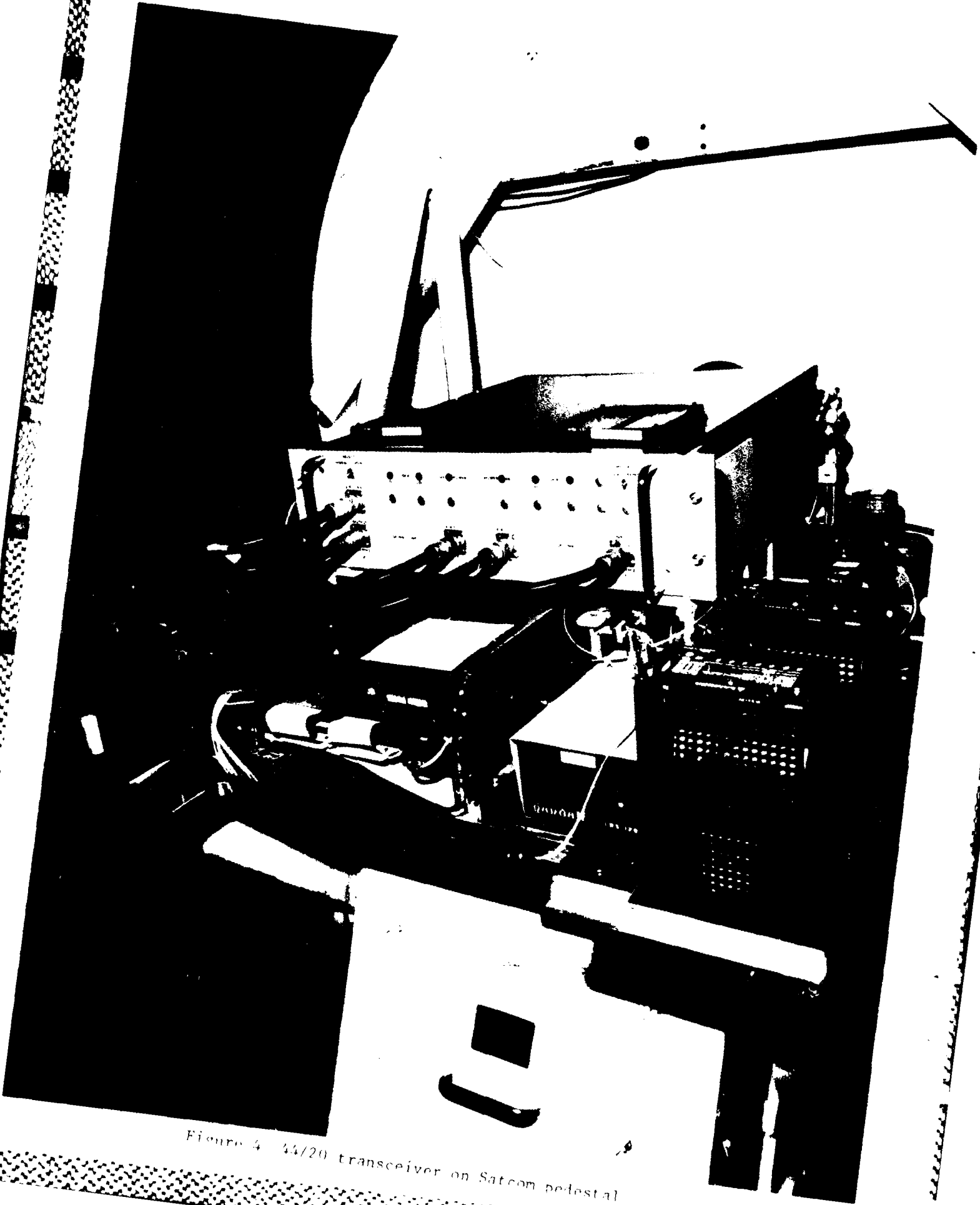

Figure 4 44/20 transceiver on Satcom pedestal

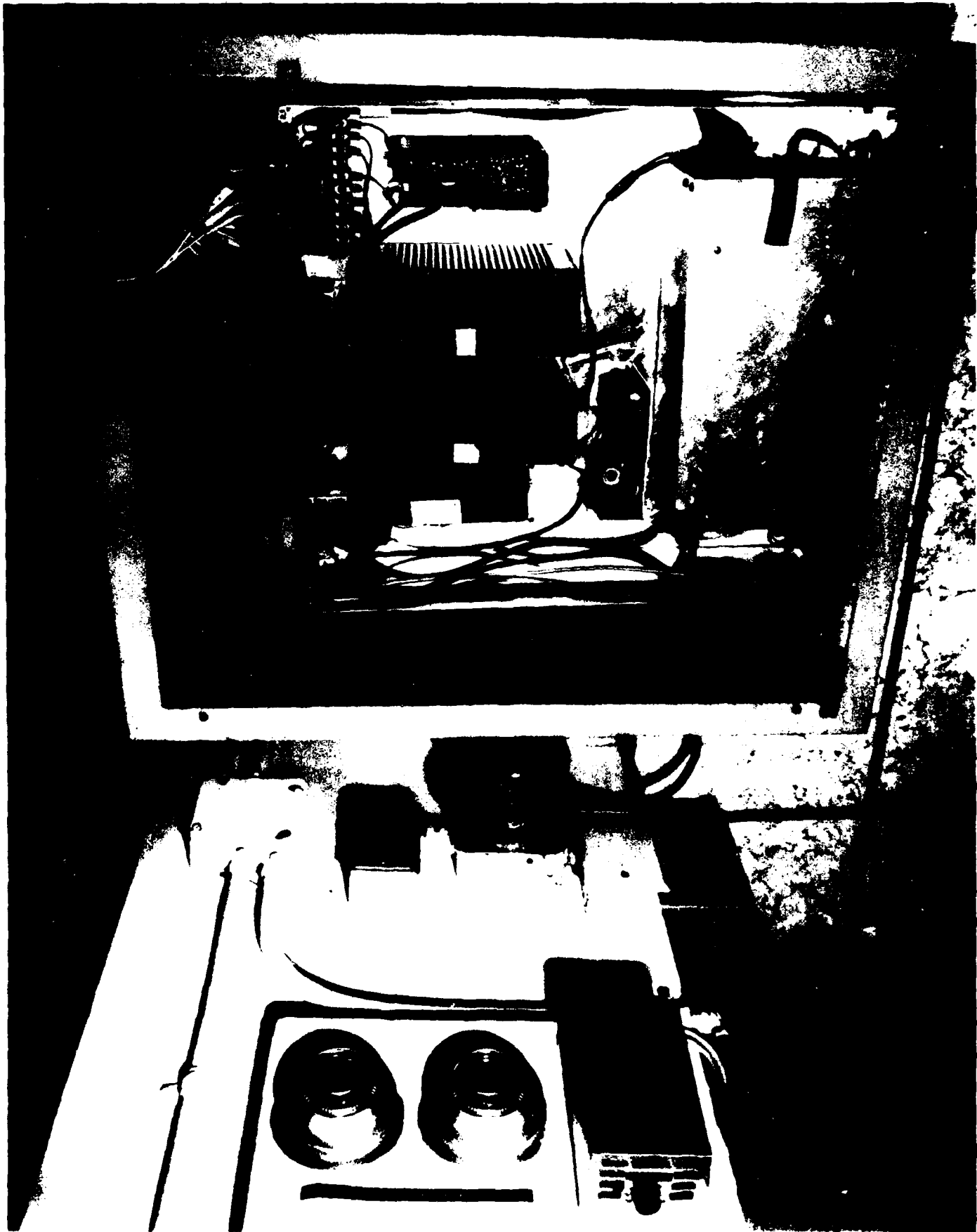

Figure 5 44/20 Power Supply and Computer Shelf

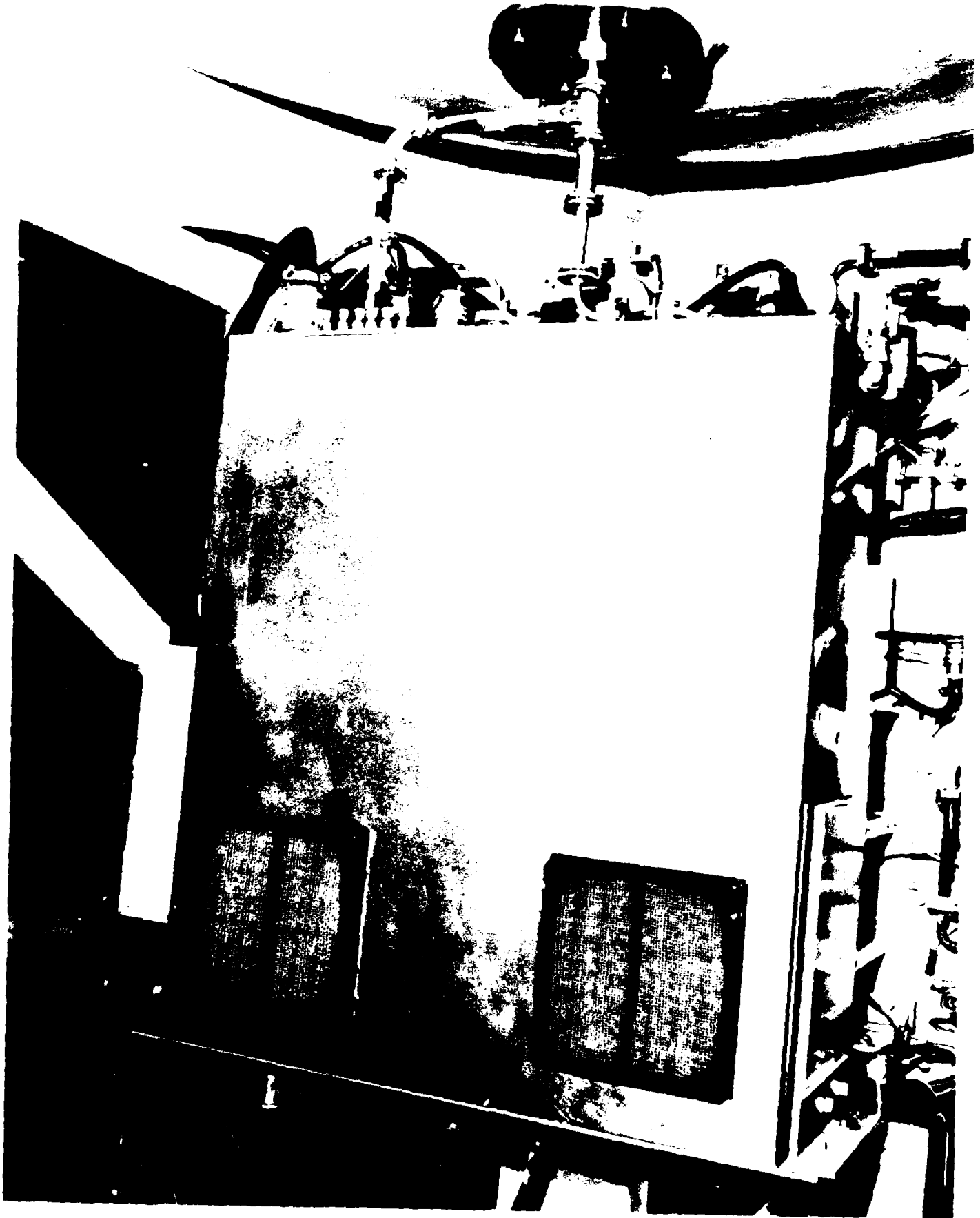

Figure 6 Complete 44/20 GHz Satcom installation

### 2.3 44/20 CONFIGURATION FOR KINGSMERE

The second part of the (44/20) GHz program calls for a fixed system which is to be dedicated to the Kingsmere repeater range. This system incorporates a separate antenna mounted outside the radome and aligned with the Kingsmere Tower.

A second contract was awarded to Andrew Antenna company to build a (44/20) GHz antenna and feed system with a 1 meter dish and fixed pedestal. After several discussions between Andrew and CRC it was agreed to use a 4' diameter spun aluminum production dish hand selected for minimum-surface distortion, and to integrate the dual frequency feed system into this antenna. Overall performance was to be equal or better than the 1 meter dish originally proposed by CRC.

The contract was issued on 14 November 1983 and the completed unit delivered on 31 March 1984. For this installation, the RF shelf and power supplies are mounted adjacent to the Radome wall (Fig. 7) and fed to the outside fixed antenna through the Radome panel. This configuration resulted in the lowest possible feed losses. The antenna installation is shown in Fig. 8. With this installation a series of experiments using frequency hopping and jamming techniques will be carried out over the Kingsmere repeater range.

## 3. SYSTEM DESCRIPTION

The 44/20 GHz circuit design is shown in Fig. 9. Components to the left of the dotted line are housed in the RF shelf mounted in the radome. Components to the right of this line are housed in the satellite console room 203 (Fig. 10).

Signals fed to the radome are amplified to overcome 200 ft of cable loss and then received by line receiver amplifiers. The signals are then level set to satisfy the RF mixer input requirements.

### 3.1 FREQUENCY AGILITY

The system allows for frequency agility in both the TX and RX signal paths. The transmitter has provision to radiate +17 dBm of RF power, in increments of 20 Hz steps from 43.5 GHz to 45.5 GHz into the 50 dB gain antenna.

The receiver has a similar 20 Hz incremental frequency agility across the 20.2 GHz to 21.2 GHz band.

The frequency agility will be provided through computer control of the highest frequency local oscillators, in both the transmit and receive signal paths. Both the transmit and receive chains use a double frequency conversion scheme with phase locked local oscillators.

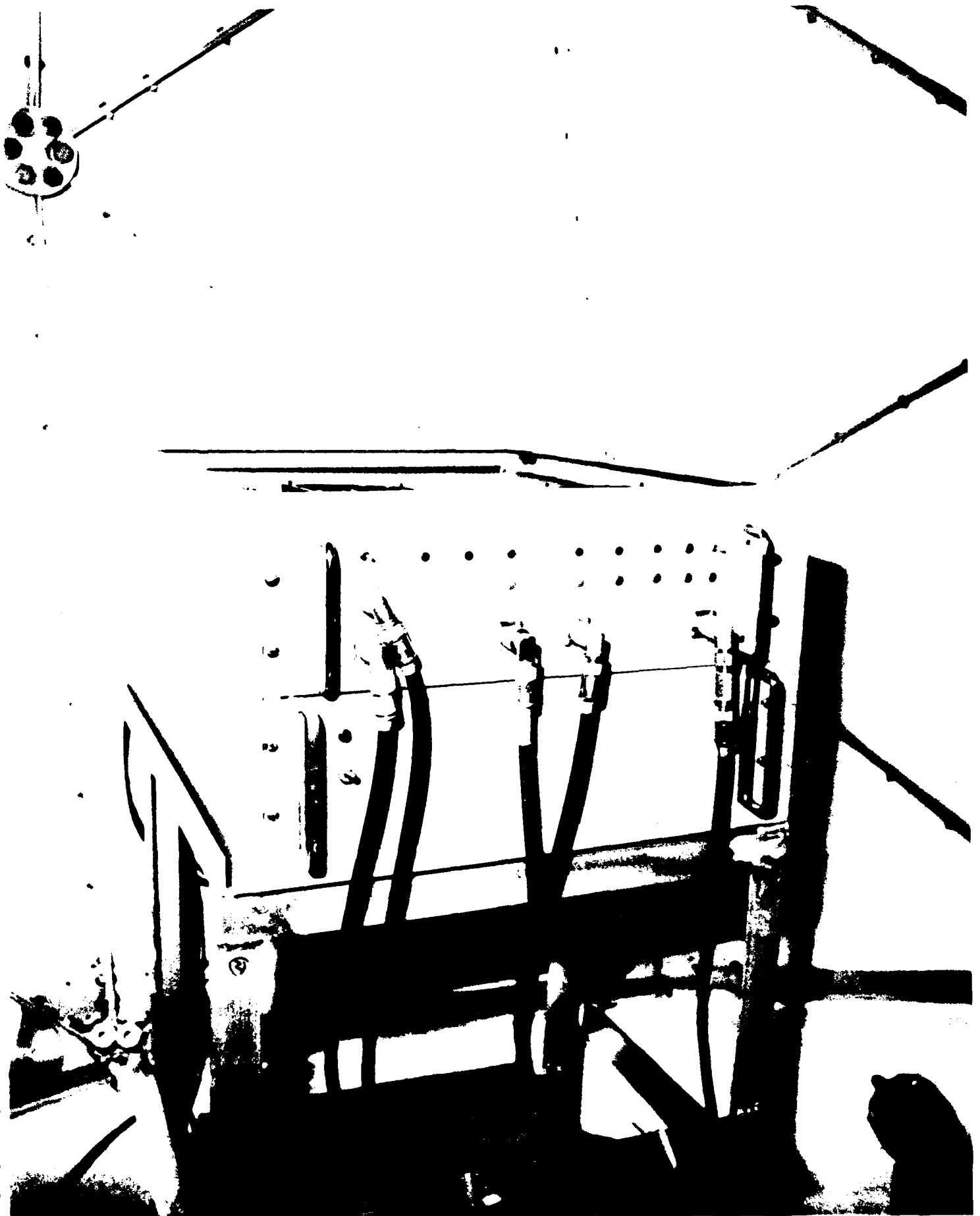

Figure 7 44/20 GHz system inside radome



Figure 8 Andrew 44/20 GHz antenna and pedestal

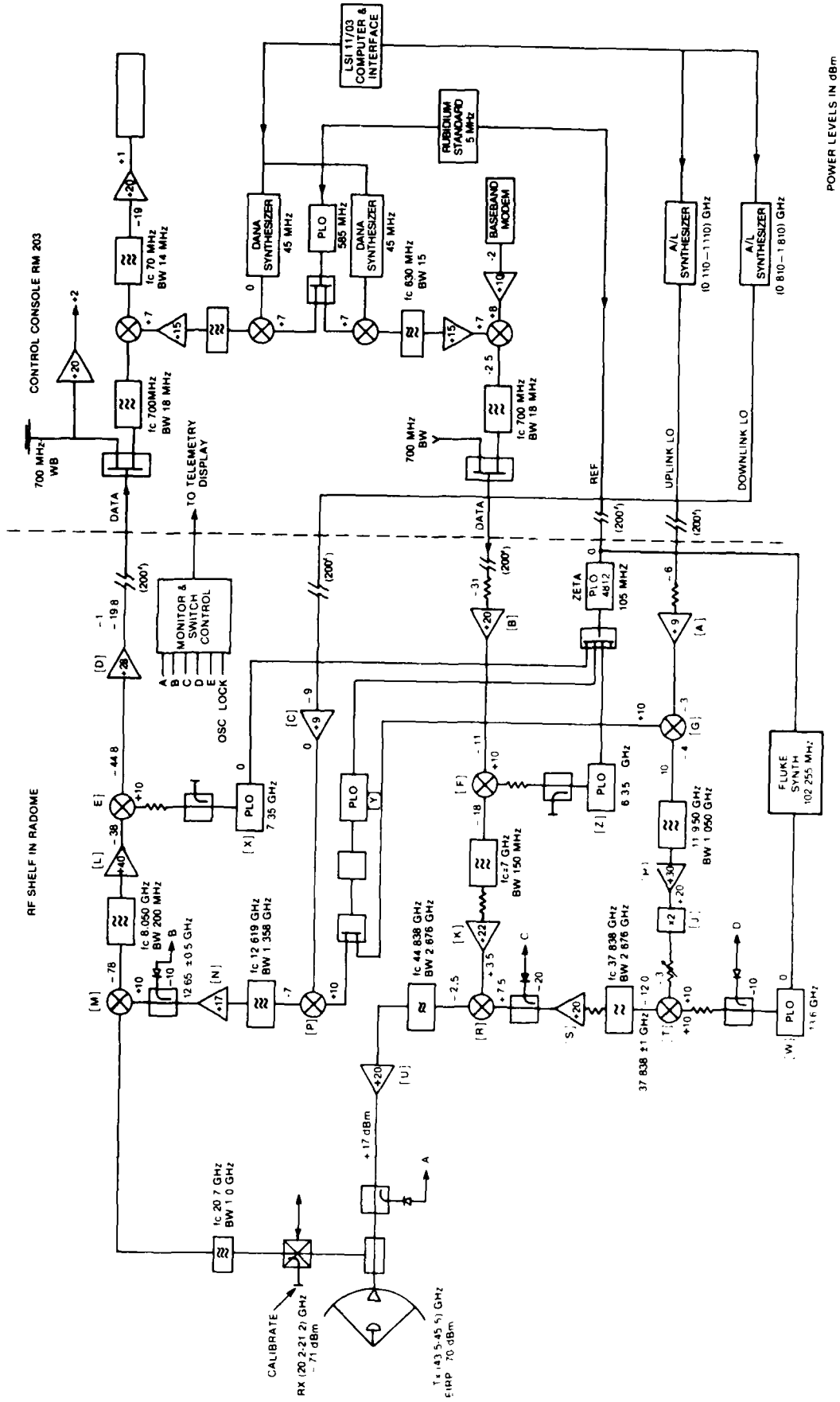

FIG. 9 SCHEMATIC FOR THE 44/20 GHz TRANSCIVER

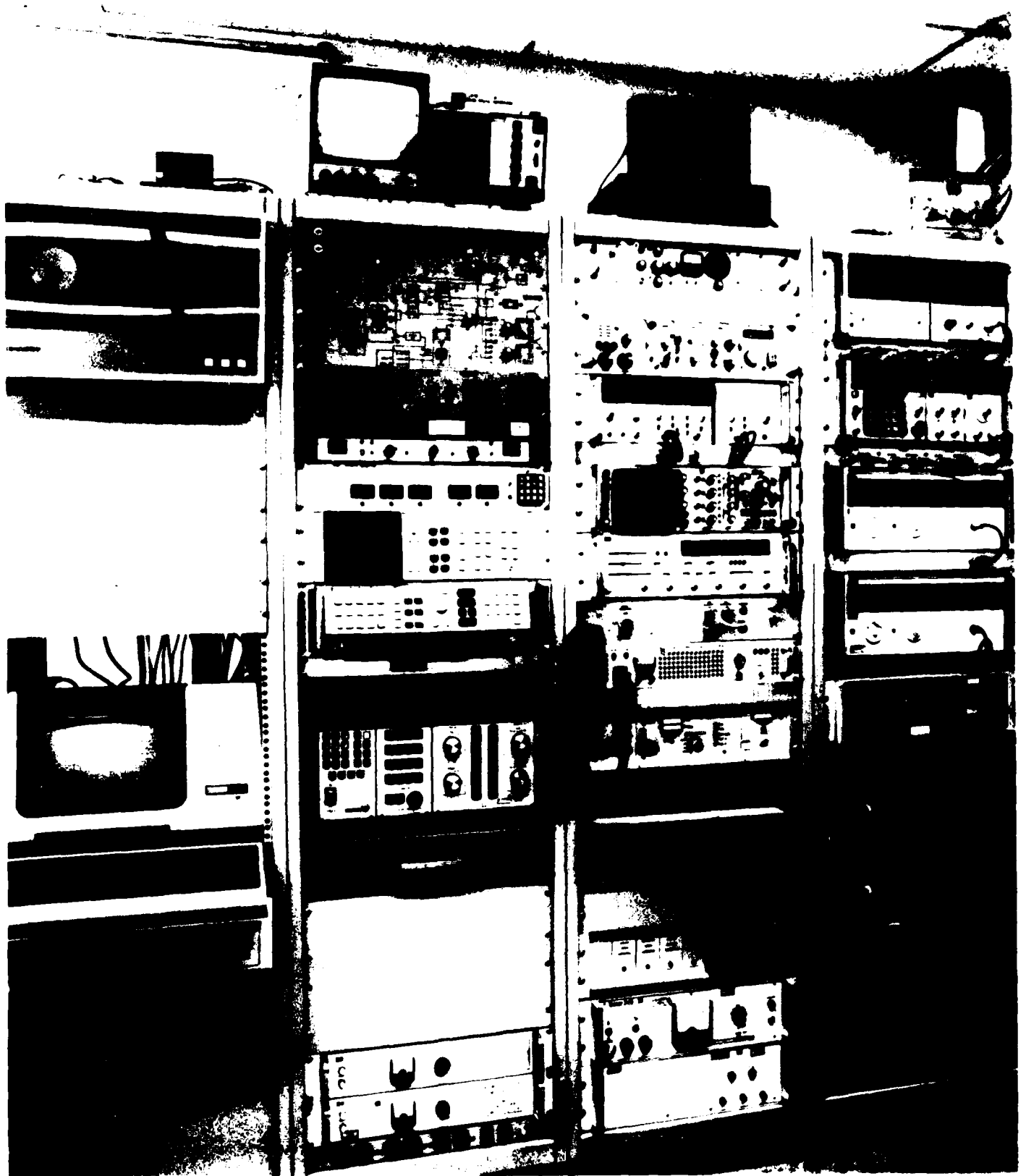

Figure 10 Satellite control console

### 3.2 SIGNAL ROUTING

Data signals, ref. signals and the local oscillator signals originate in the satellite console room (Fig. 10) and are fed to the RF shelf in the radome. Frequency agile local oscillator signals are upconverted to the Q band and KA band frequencies via mixers and phase locked local oscillators referenced to the 5 MHz frequency standard.

### 3.3 COMPONENT CODING FOR IDENTIFICATION

Major components are identified in Fig. 9 by a letter enclosed in square brackets [--]. A list of components with their identification code are tabulated in Table (2). The signal levels in dBm at the mixers and amplifiers in the transmit and receive chains are identified in Fig. 9. The detailed description of the system makes use of this labeling scheme.

TABLE 2	
COMPONENT IDENTIFICATION CODES	
[A]	AMPLIFIER UTO 2022
[B]	AMPLIFIER UTO 1002+1003
[C]	AMPLIFIER UTO 2022
[D]	AMPLIFIER UTO 1002+1002
[E]	MIXER HONEYWELL SPACEKOM MODEL SMC 0510
[F]	MIXER HONEYWELL SPACEKOM MODEL SMC 0408
[G]	MIXER WATKINS - JOHNSON MODEL WJ-M67C
[H]	AMPLIFIER VARIAN VSU7483CH
[J]	FREQUENCY DOUBLER HONEYWELL SPACEKOM DK-24-26
[K]	AMPLIFIER VAIRAN VSC-7463CR
[L]	AMPLIFIER VARIAN VSX-7473MC
[M]	MIXER HONEYWELL SPACEKOM MODEL C20-8
[N]	AMPLIFIER VARIAN MODEL VS4-7483CR
[P]	MIXER WATKINS-JOHNSON MODEL WJ-M67C
[R]	MIXER HONEYWELL SPACEKOM MODEL C45-7.5
[S]	AMPLIFIER VARIAN MODEL VSA-7405CC
[T]	MIXER HONEYWELL SPACEKOM MODEL C38-25
[U]	AMPLIFIER VARIAN MODEL VSQ-7407D
[W]	OSCILLATOR FREQUENCY-WEST MODEL MS800XEL-25
[X]	OSCILLATOR FREQUENCY-WEST MODEL MS600XEL-25
[Y]	OSCILLATOR FREQUENCY-WEST MODEL MS760XEL-25
[Z]	OSCILLATOR FREQUENCY-WEST MODEL MS54XEL-24
	FILTERS WAVEGUIDE GAMMA-F CORP.
	FILTERS BASEBAND TUBULAR K&L
	WAVEGUIDE COUPLERS BAYTRON
	XTAL DETECTORS TRG AND NARDA
	REF OSC (105 MHz) ZETA MODEL 4812
	WAVEGUIDE SWITCH MDL
	ANTENNA 6' DIA ALPHA TRG
	ANTENNA 4' DIA ANDREW ANTENNA
	DUAL FREQUENCY FEED SYSTEMS ANDREW ANTENNA
	POWER SUPPLIES LAMBDA

## 4. SIGNAL PATH DESCRIPTION

### 4.1 UPLINK DATA PATH

The 700 MHz uplink data signal is received at the RF shelf (Fig. 9) in the radome and level set to -31 dBm at the line receiver. The output of line receiver [B] feeds the first mixer [F] in the chain, here the signal is mixed with a 6.3 GHz phase locked signal [Z] to produce a 7 GHz data signal at -18 dBm. This signal is filtered and amplified [K] to set the input level for the final Q band mixer [R] at +3.5 dBm.

### 4.2 UPLINK LOCAL OSCILLATOR PATH

The local oscillator (LO) for mixer [R] provides the frequency agility for the transmitter, and is derived from a computer controlled synthesizer AIL model 360D11 housed in the satcom console rack. The AIL synthesizer output is transmitted to the radome and enters the RF shelf at -6 dBm. Amplifier [A] receives this signal and provides the drive level of -3 dBm to mixer [G]. The frequency agile LO signal is mixed with a 11.340 GHz phase locked source [Y] to generate the first upconversion in the LO chain (11.450 - 12.450) GHz. This signal is then filtered, amplified [H] and fed to a frequency doubler [J] at a +20 dBm level. The doubled output is attenuated to -3 dBm and applied to the second mixer [T] in the local oscillator chain. The local oscillator port of the mixer [T] is fed from a 13.6 GHz phase locked oscillator [W] at a +10 dBm level. The output of mixer [T] is then filtered and amplified [S] to +7 dBm to provide the final frequency agile signal for the Q band mixer [R].

The output of mixer [R] is filtered and applied to a solid state HPA [U] at an input level of -3 dBm. The amplifier output is fed to the antenna port of a 6 ft. dish (EHF satcom pedestal mode) or a 4' fixed antenna (Kingsmere repeater range mode). The EIRP is 42.5 dBm and 37 dBm respectively.

### 4.3 DOWN LINK DATA PATH

The received signal downlink data path is filtered and fed to a low noise mixer [M] at a nominal -71 dBm from the repeater range transmitter. The LO signal at mixer [M] provides frequency agility to de-hop the frequency hopped signals in the (20.2 - 21.2) GHz frequency range. The frequency agility is again provided by a second computer controlled synthesizer AIL model 360D11 housed in the satcom console rack. This signal is transmitted to the radome and is received at -9 dBm at the RF shelf.

The frequency agile signal (.810 - 1.810) is amplified [C] to 0 dBm and fed to mixer [P]. A fixed PLO [Y] at 11.340 GHz is shared by the

uplink and downlink chain through a power splitter providing a drive level of +10 dBm to mixer [P]. The output of mixer [P] is filter amplified [N] to provide a frequency agile. LO signal (12.150 - 13.150) GHz at +10 dBm at mixer [M].

The output of mixer [M] is a fixed IF signal of 8.050 GHz when synchronization of the received signal and the frequency agile LO is achieved at [M]. The 8.050 GHz IF signal is filtered amplified [L] to -38.0 dBm for the next down conversion at mixer [E].

The local oscillator port of mixer [E] is fed from a 7.350 GHz PLO [X] at +10 dBm. The 700 MHz output is amplified [D] and transmitted to the satcom console via a 200 ft. type N cable. The received signal is power split for wideband applications or filtered and demodulated to a 70 MHz IF signal for baseband demodulation and digital processing.

## 5. SIGNAL CHARACTERIZATION

### 5.1 LOCAL OSCILLATOR STABILITY

All local oscillators (Fig. 9) used in the upconversion and downconversion chains are phase locked to a 5 MHz frequency standard. This standard is housed in the satcom console rack and sent to the RF shelf in the radome. This 5 MHz reference is used to phase lock the ZETA oscillator model 4812. The output of the ZETA is 105 MHz and is used as the input reference signal for the 11.340 GHz PLO [Y], the 6.3 GHz PLO [Z] and the 7.350 GHz PLO [X]. The 13.6 GHz PLO [W] requires a separate reference signal (102.2255 MHz) due to a x133 multiplier ratio.

### 5.2 TEST ENVIRONMENT

The RF shelf assembly is shown in Fig. 11. Characterization of the amplifiers, filters, phase locked oscillators, and mixers was made during the assembly stage. The test equipment used is listed in Table 3. The RF shelf was placed in the radome and a link established from the satcom terminal through a simulated link using the Kingsmere repeater receiver (44 GHz) and transmitter (20 GHz) subassemblies.

Measurements of the overall system performance were recorded and some modifications made to improve the system phase noise.

One typical plot for each group of several identical components will be shown below. Signal characterization at critical monitor points in the uplink and downlink chain are presented along with input and output waveforms for the complete system.

A frequency response plot for the Aventek amplifiers [A] through [D] is shown in Fig. 12. These devices are the coaxial line receivers and drivers for the 200' cable runs between the satcom console and the radome.

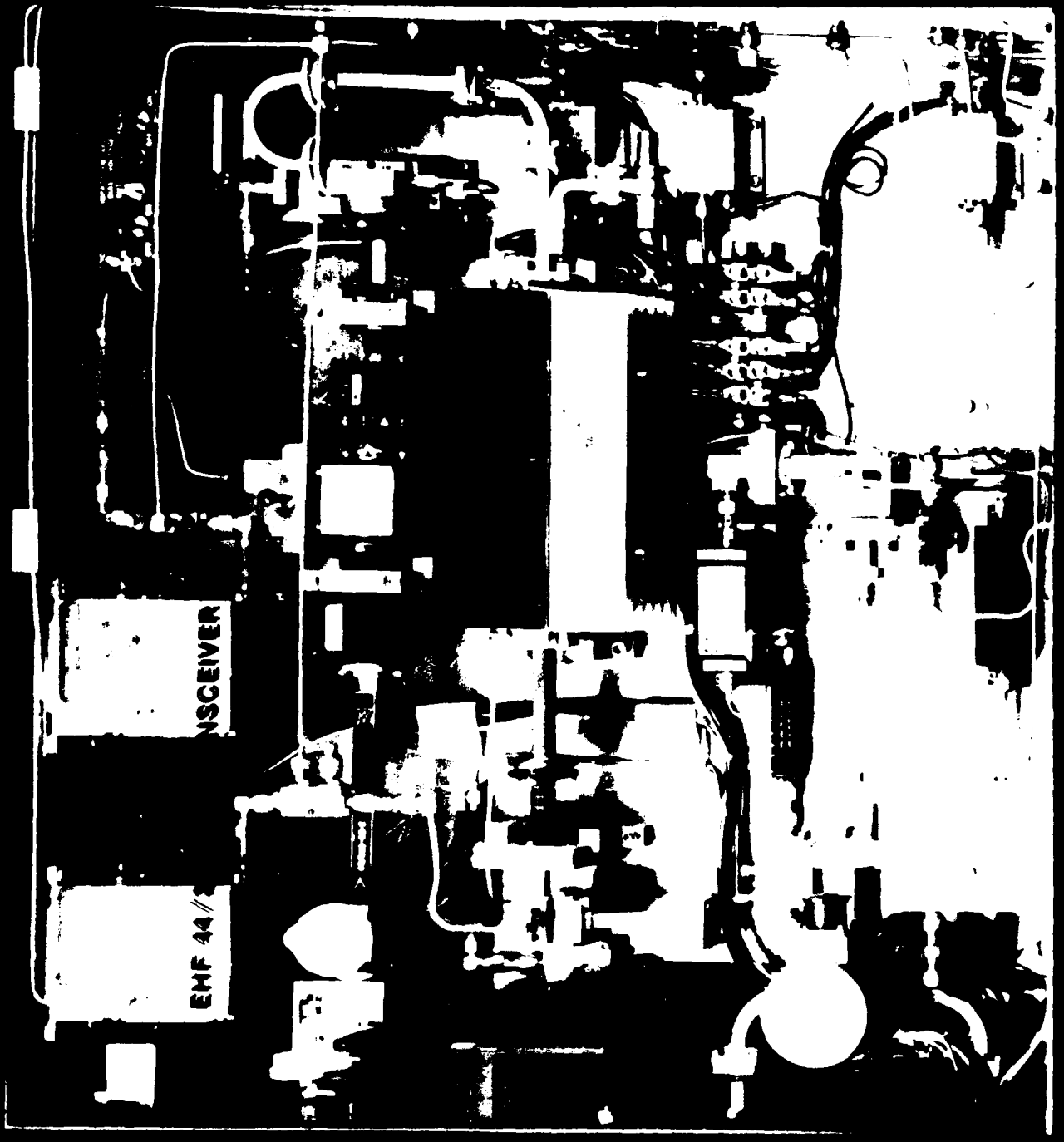
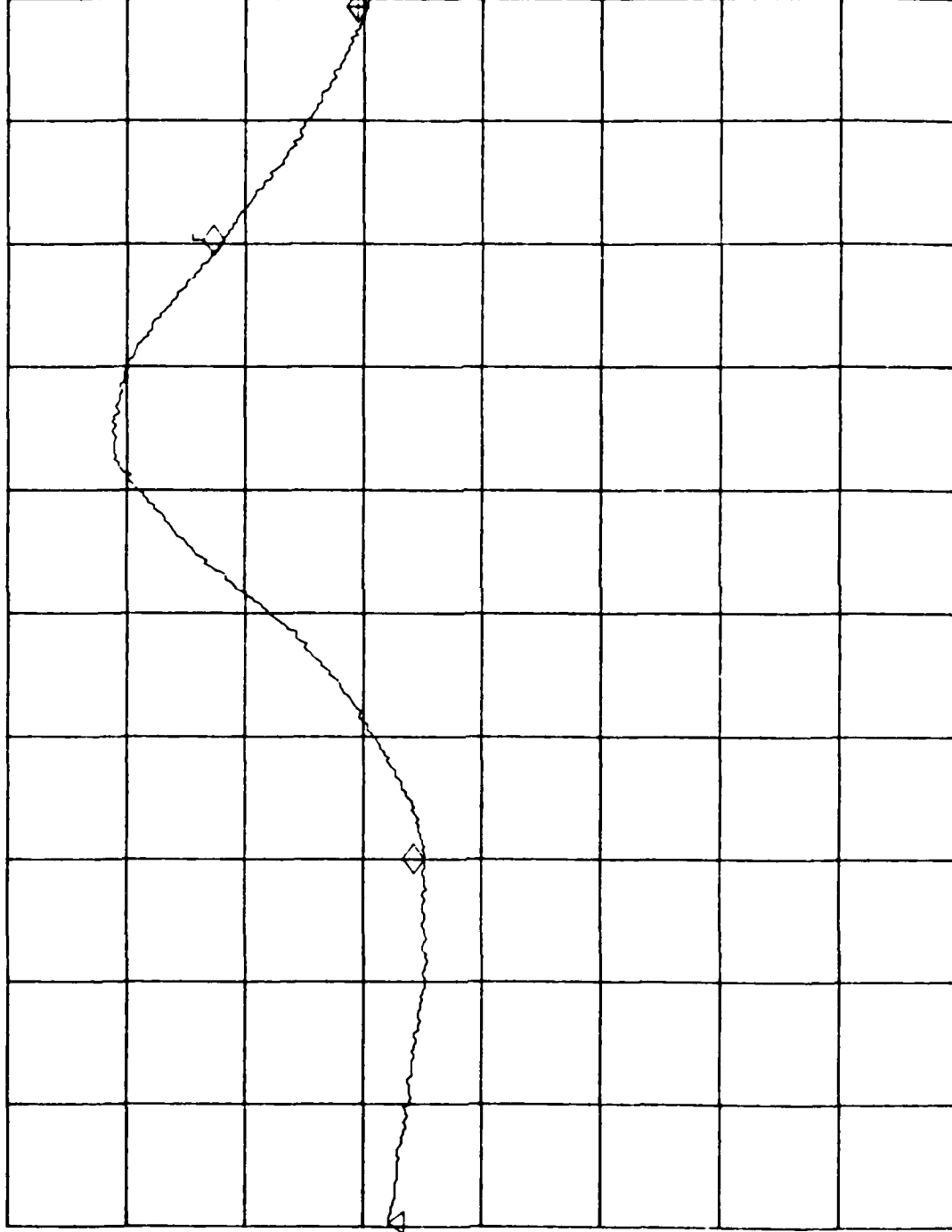

Figure 11 RF shelf assembly

CH2: B +.08 dB  
.5dB/ REF + 11.01 dB



REF 2

STRT + .0100GHZ CRSR + 1.9701GHZ STOP + 2.0000GHZ

Figure 12 Avtek amplifier U70 series frequency response

TABLE 3  
LIST OF TEST EQUIPMENT

1. Generator Sweep HP Model 8350  
RF Plug in 83570  
RF Plug in 83592A
2. Generator Synthesized HP Model 8673A
3. Frequency Extender WJ1204-42
4. Spectrum Analyzer HP 8566B
5. Power Meter HP 432A  
Power Meter HP 436A
6. Frequency Synthesizer Fluke 6160B
7. Network Analyzer HP 8756A  
HP Plotter 7470A

Amplification of signals in the 4 GHz to 14 GHz bands make use of Varian amplifiers [H] [K] [L] [N]. Frequency response of amplifier [H] model VSU7483CH is shown in Fig. 13.

A plot for the K&L filters used in the IF signal paths is presented in Fig. 14 and Fig. 15. The bandpass response (14) and bandpass ripple (15) is typical of all IF cavity type filters used in the shelf. The local oscillators [W] [X] [Y] [Z] are phase locked to a 5 MHz standard in the satcom console. Phase locking is achieved through the use of an intermediate phase locked oscillator ZETA (Model 4812) which supplies a 105 MHz reference for these oscillators.

The phase noise at the output of the oscillators can be shown to be directly related to the purity of the reference source. A 10 dB improvement in signal to noise was obtained for the output of oscillator [Z] 6.3 GHz simply by substituting a Fluke 1066B synthesizer to supply the reference frequency 105 MHz (Fig. 16) in lieu of the ZETA 4812 PLO (Fig. 17).

### 5.3 THE FREQUENCY AGILE LOCAL OSCILLATOR CHAIN

The uplink local oscillator chain generates the wideband frequency agility (2 GHz) required by the system design. The performance of this chain can be illustrated using the schematic diagram (Fig. 9) along with the individual component characterization plots.

AMP (VSU 7483 CHU) RESPONSE P OUT 19.44dBm MKR 12.446 GHz  
REF 21.7 dBm ATTN 40 dB 18.37 dBm

7/2

1 dB/

MARKER  
12.446 GHz  
18.37 dBm

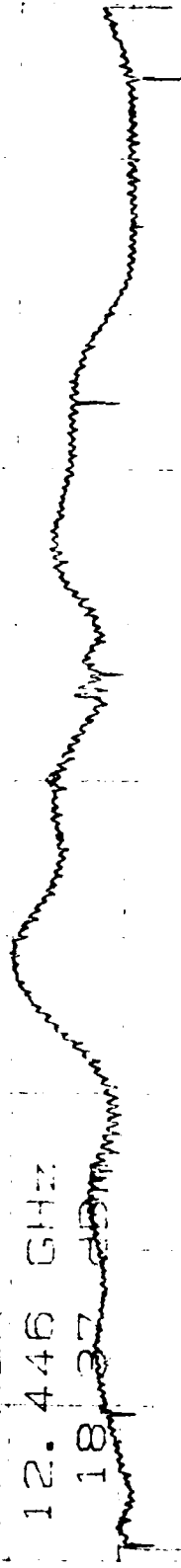

START 11.94 GHz  
RES BW 3 MHz

VBW 3 MHz

STOP 12.94 GHz  
SWP 25.0 msec

Figure 13 Varian amplifier VS47483CH9 frequency response

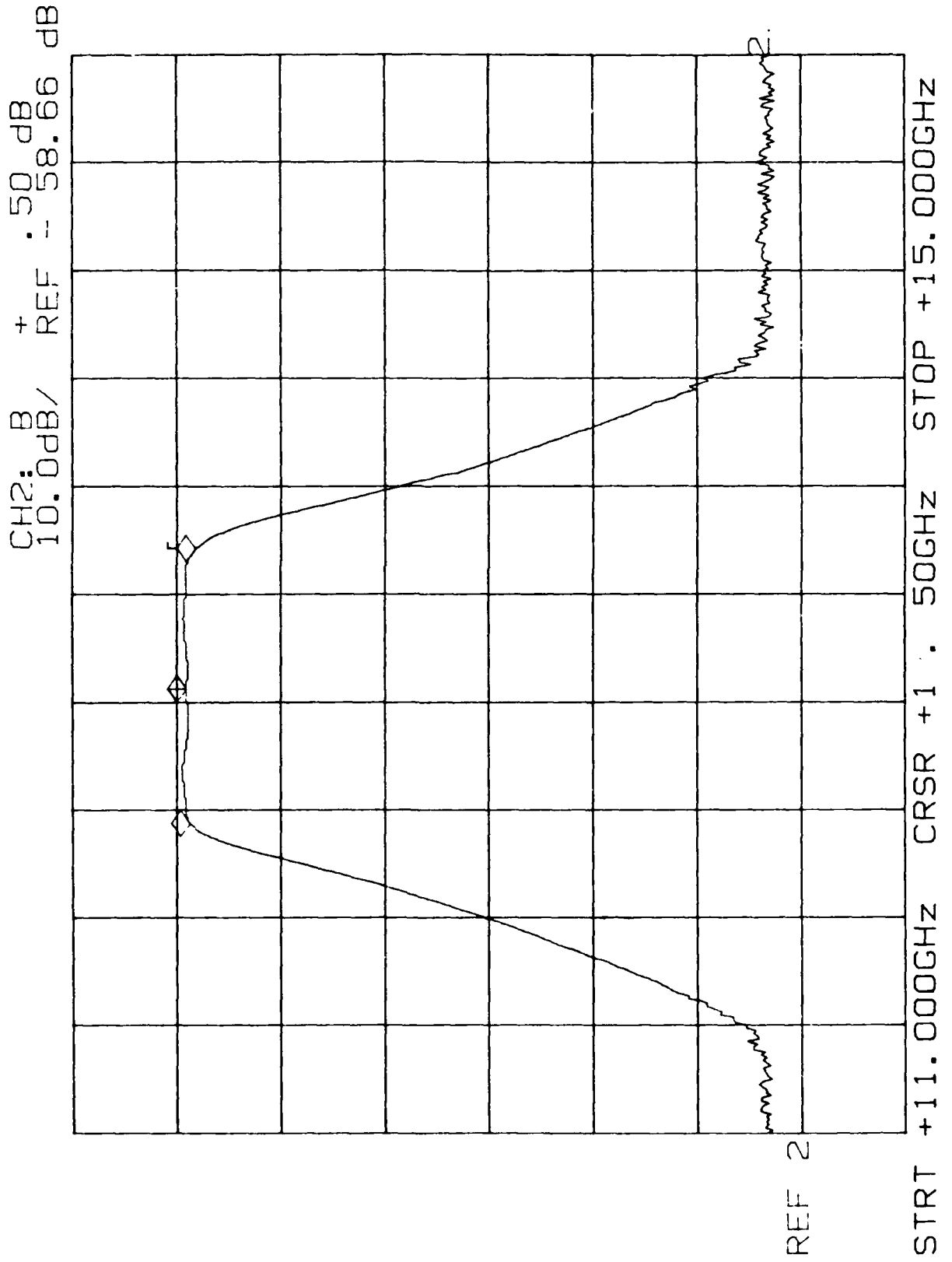
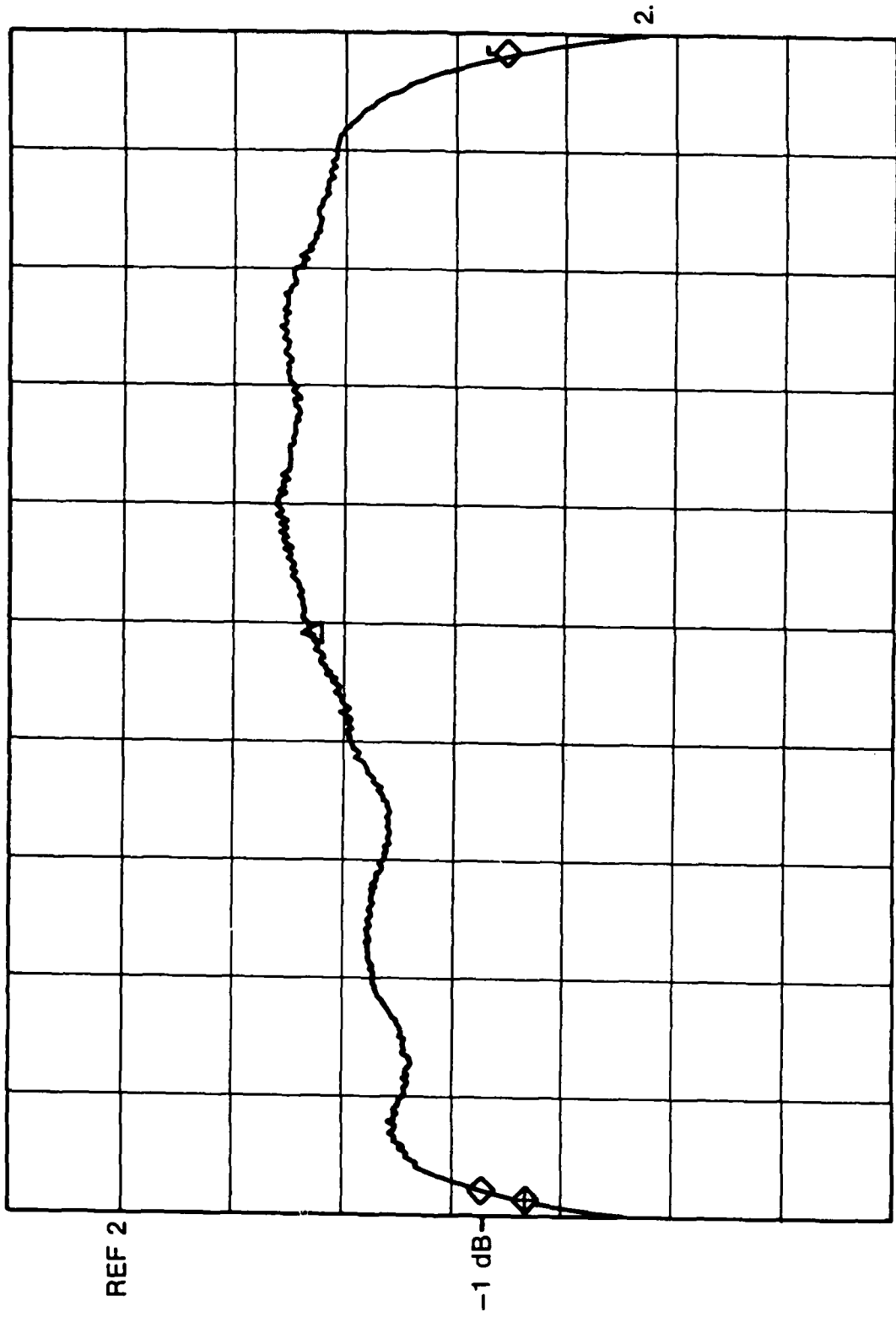

Figure 14 K&L filter 6FV-11.950/1050 - Band Pass Response

CH2: B — 1.05 dB  
.5 dB/ REF + .27 dB



STRT + 11.430 GHz CRSR + 511.20 MHz STOP + 12.470 GHz

FIG. 15 K & L FILTER 6 FV—11.950/1050 - BANDPASS RIPPLE

hp 6.3 GHz OSC./FLUKE 105 PWR SPLIT/4 MKR 6.300 000 084 GHz  
REF 10.0 dBm ATTEN 20 dB -3.00 dBm  
EXT REF

10 dB/

MARKER

6.300 000 084 GHz

-3.00 dBm

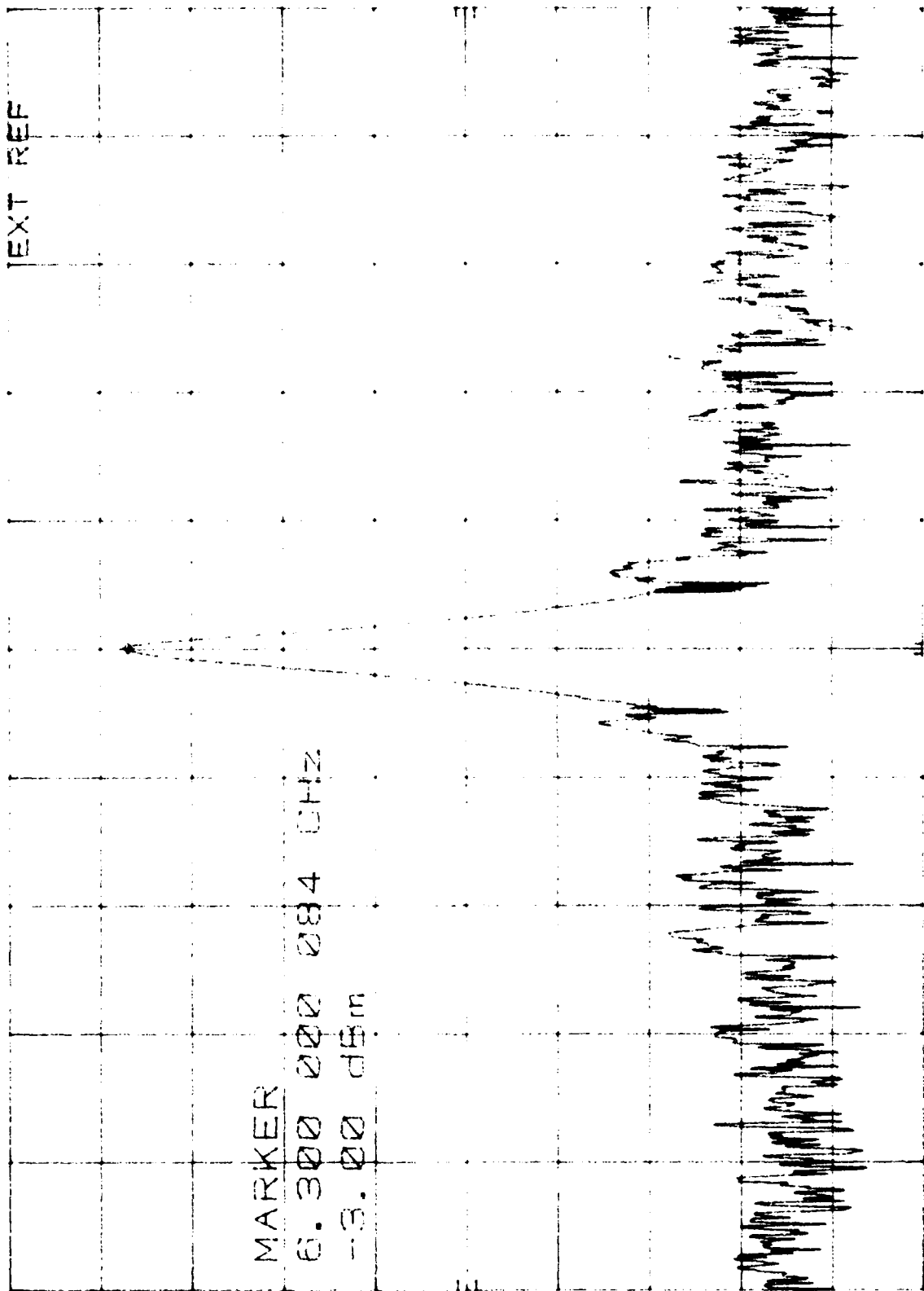

CENTER 6.300 000 084 GHz

RES BW 10 Hz

VBW 30 Hz

SPAN 1.00 KHZ

POWER 20.0 dBm

Figure 16 Frequency west oscillator MS54XEL-24 (ref. input FLUKE)

6.3 GHz OSC. / ZETA 105 PWR SPLIT / 4 MKR 6.300 000 079 GHz  
 REF 10.0 dBm ATTEN 20 dB -2.50 dBm  
 10 dB / EXT REF

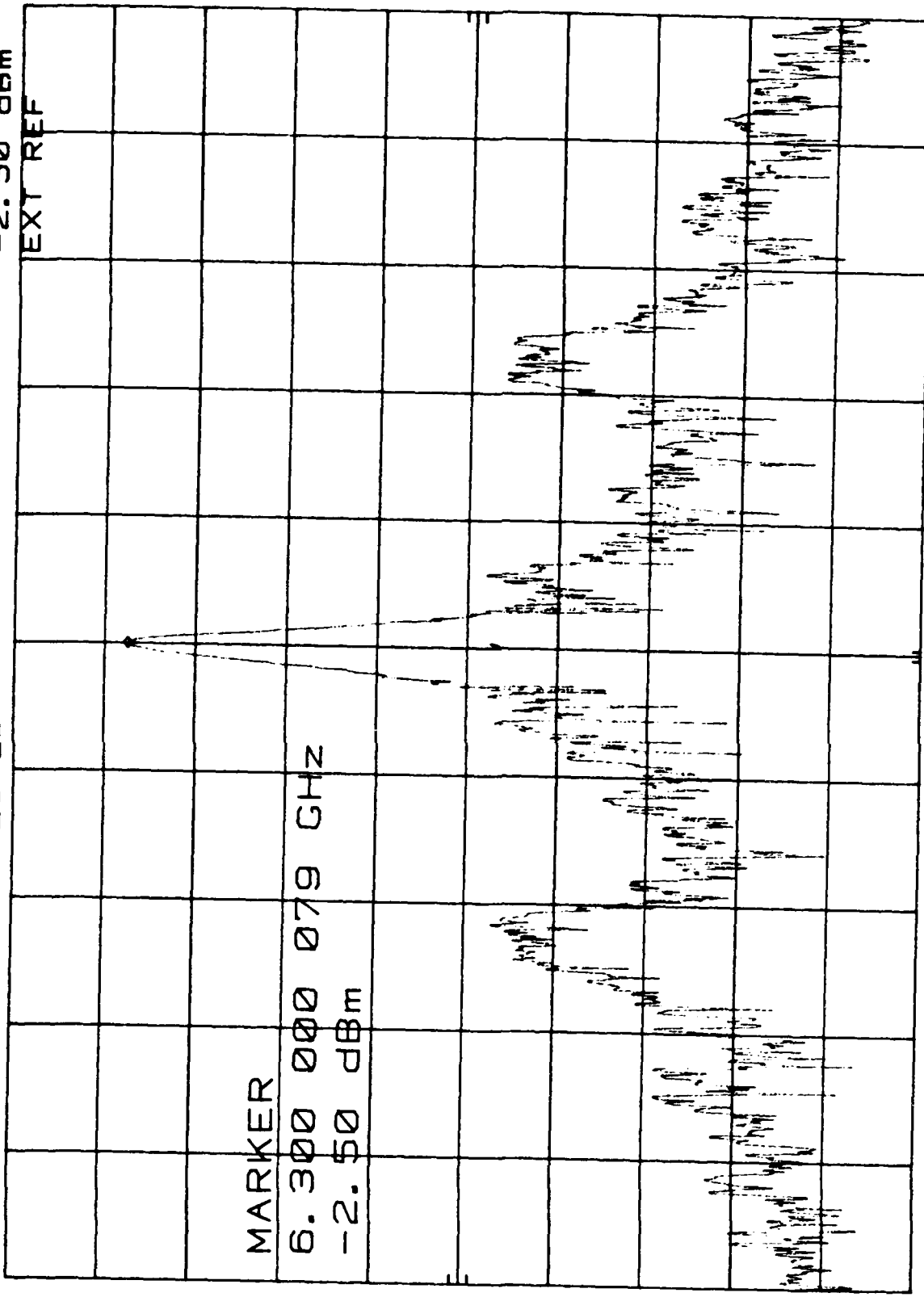

CENTER 6.300 000 07 GHz  
 RES BW 10 Hz  
 SPAN 1.00 KHZ  
 SWP 30.0 sec  
 VBW 30 Hz

Figure 17 Frequency west oscillator MS54XEL-24 (ref. input ZETA)

The calibration curve for mixer [G] (Fig. 18) show that an input of +3 dBm results in an output of -4 dBm. This signal is filtered, and amplified [H] to +20 dBm. From the frequency doubler curve (Fig. 19) an input of +22 dBm results in an output of +7.5 dBm. Thus the attenuator between doubler [J] and mixer [T] is set for a 10 dB signal reduction. The frequency response for doubler [J] is shown in Fig. 20 and the output spectrum (in Fig. 21) for a fixed frequency of 24.399 GHz.

The mixer plot C38-35 for mixer [T] (Fig. 22) shows an output of -12 dBm for an input of -6.5 dBm. This output level when applied to amplifier [S] gives an output of +7.5 dBm, which is the correct signal level for the LO port of mixer [R].

The frequency response of the frequency agile local oscillator chain is shown in Fig. 23.

## 6. SYSTEM PERFORMANCE TESTS

The system was checked in a simulated link made using the Kingsmere RX subassembly and the Kingsmere TX subassembly mounted in the Radome at CRC. This allowed a laboratory test of the 44/20 GHz link before installation of the subassemblies on the 80' tower at the repeater site 16 km from CRC.

The 700 MHz CW input signal derived from the satcom console is shown in Fig. 24. This input is attenuated to -31 dBm at the RF shelf in the radome. The recovered 700 MHz downlink signal (Fig. 25) was measured in the radome at the RF shelf IF output port.

### 6.1 Tx 43.5 GHz PHASE NOISE

The transmitter output of 43.5 GHz in the normal circuit configuration was plotted through a 20 dB coupler (Fig. 26). In an experiment to try to improve the 43.5 GHz transmit signal to noise ratio the modem 700 MHz IF signal and the ZETA 105 MHz reference locking signal were disconnected. Two separate Fluke synthesizers model 1066B were placed beside the equipment and used to generate the modem cw 700 MHz and the reference 105 MHz signals. A comparison of the transmitter outputs (Fig. 26) and (Fig. 27) shows a 12 dB improvement over the normal configuration.

The 20 GHz receiver has provision for injecting a calibration signal through a 3 port waveguide switch. A calibration curve for the receiver (Fig. 28) was made by injecting a 20.8 GHz signal into the receiver in the radome and measuring the output in the console room at 700 MHz.

### 6.2 KINGSMERE EXPERIMENTS

The 44/20 GHz system has been tested over the Kingsmere repeater range and error free data has been passed from data rates of 75 baud to 19.2 Kbps.

# MIXER CALIBRATION WJ M67C

LO at +10.0 dBm, 11.340 GHz

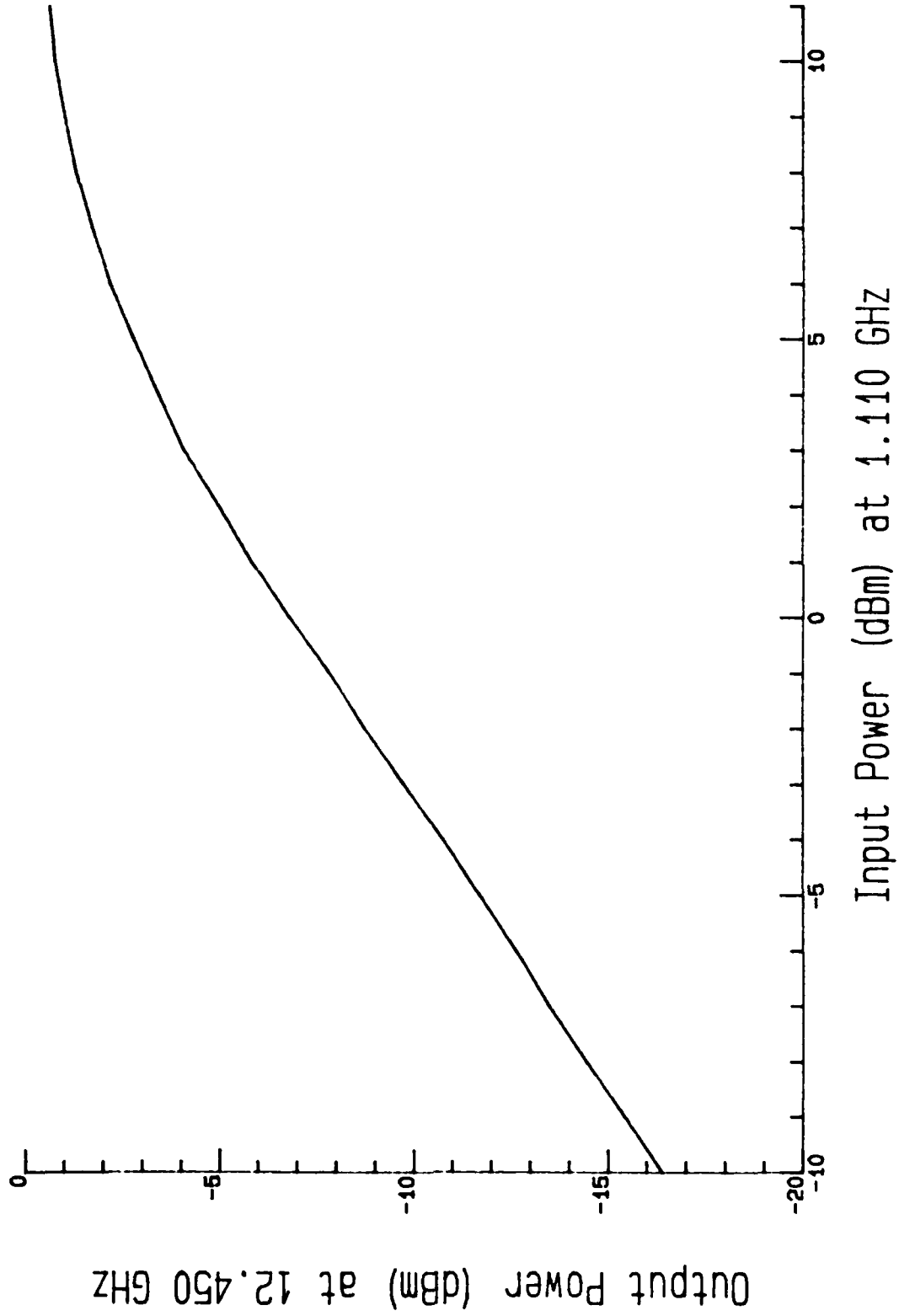

Figure 18 Mixer calibration WJM67C

# FREQUENCY DOUBLER CURVE

Conversion loss

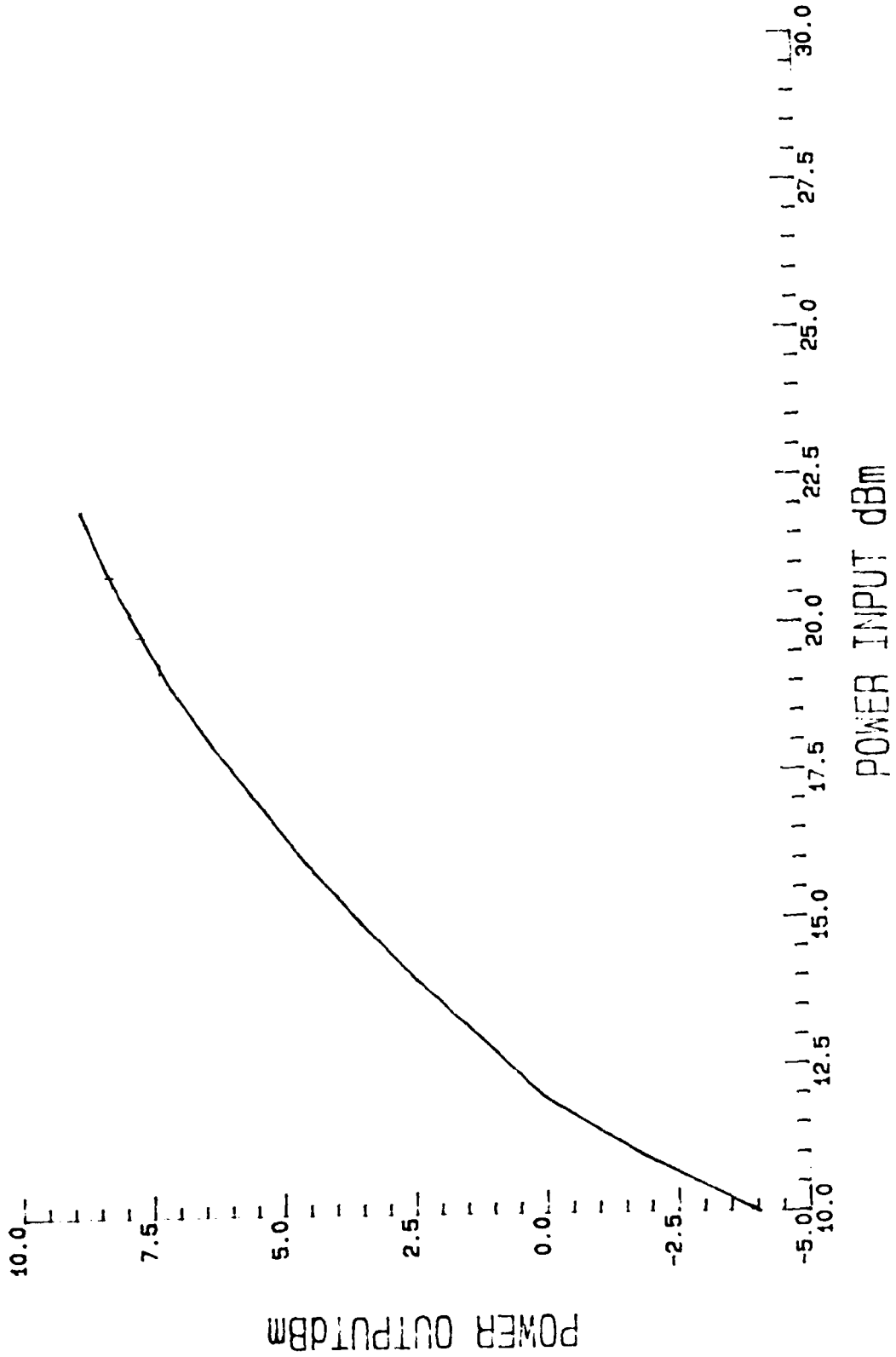

Figure 19 Frequency Doubler Conversion Loss

# KINGSMERE WIDE BAND SYSTEM

Frequency Doubler Response (18-JAN-85)

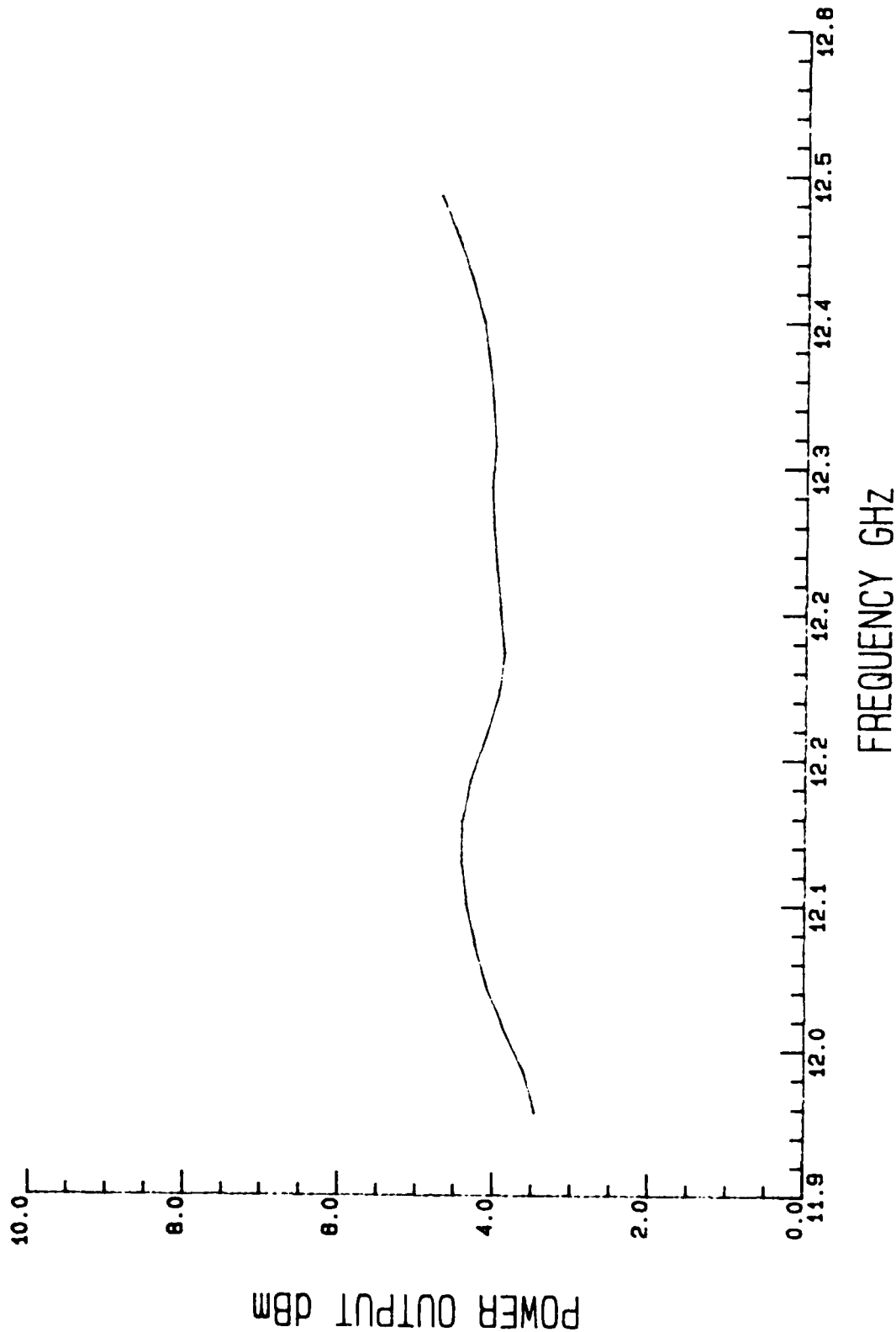

Figure 20 Frequency Doubler Response

FREQ DOUBLER OUTPUT 3.6dBm C/L12dB MKR 24.399 996 218 GHz  
REF -12.0 dBm HARMONIC 6 -35.80 dBm

47

10 dB/

CNVLOSS  
18.2  
dB

MARKER  
24.399 996 218 GHz  
-35.80 dBm

CENTER 24.399 996 21 GHz  
RES BW 10 HZ VBW 30 HZ  
SPAN 1.00 MHz  
SWP 20.0 sec

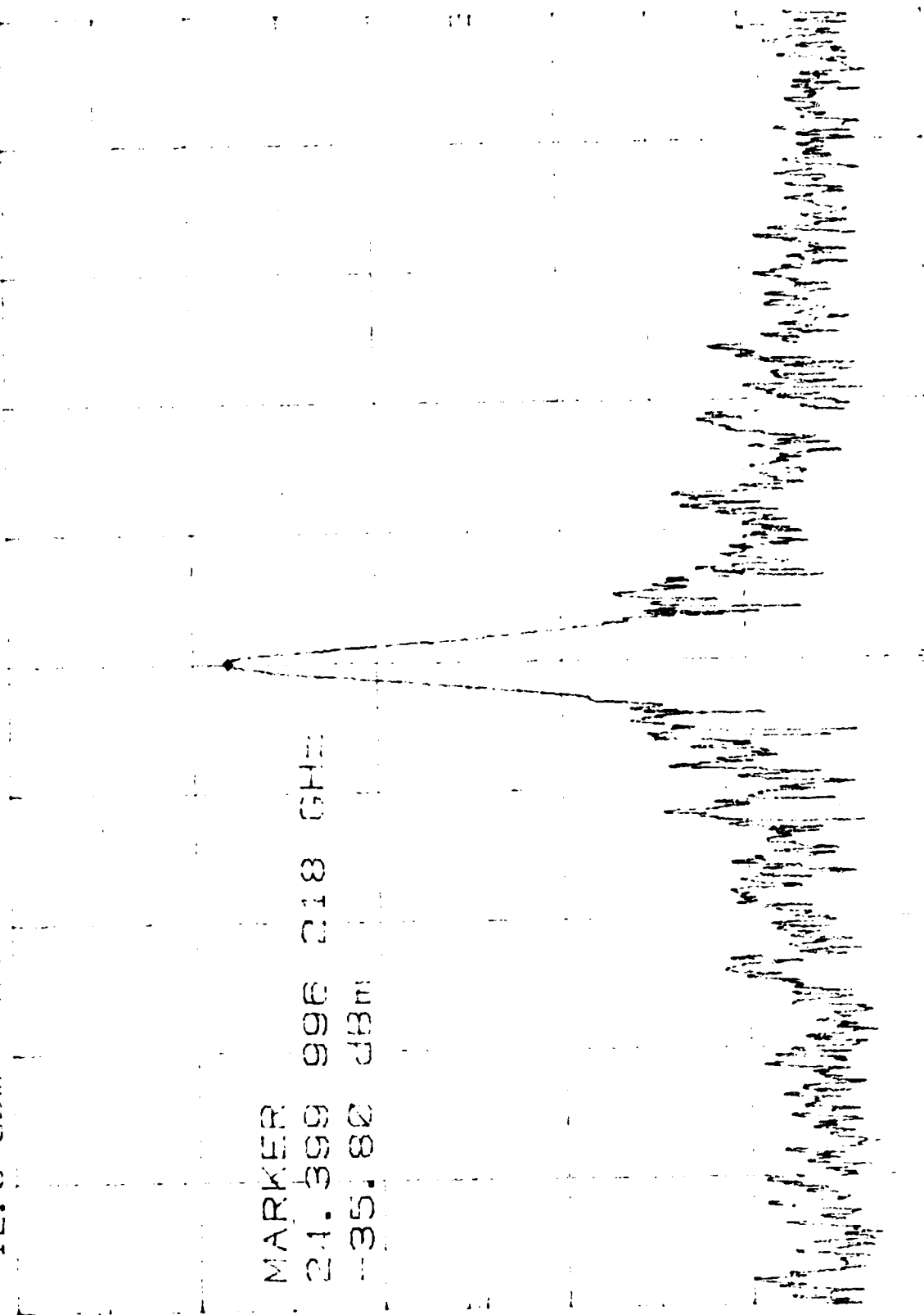

Figure 21 Frequency Doubler Output Spectrum

# MIXER C38-25

IF INPUT 24.5GHz (17-jan-85)

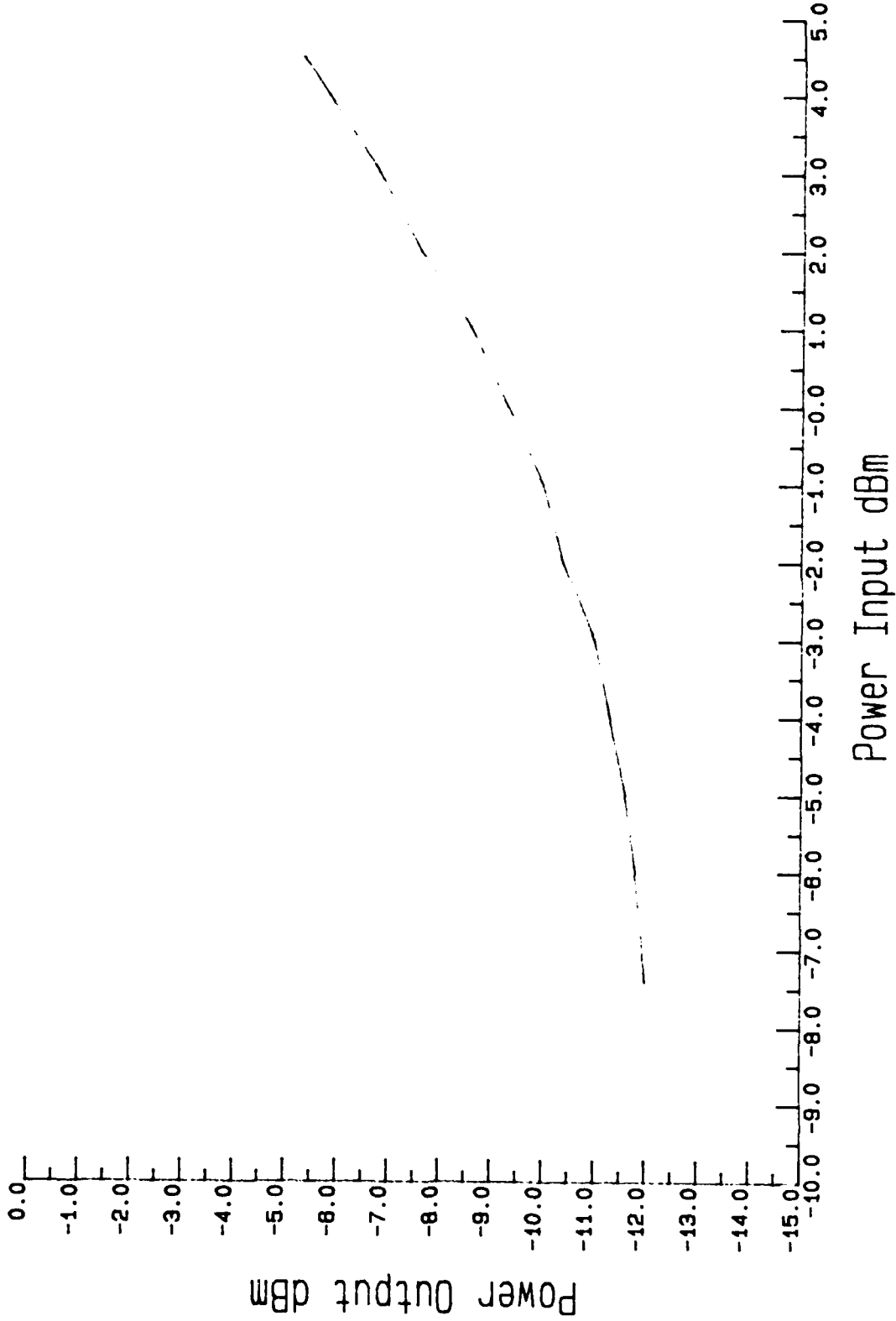

Figure 22 Mixer C38-25 Calibration

# LOCAL OSCILLATOR CHAIN

Frequency Agile 2GHz Band Width

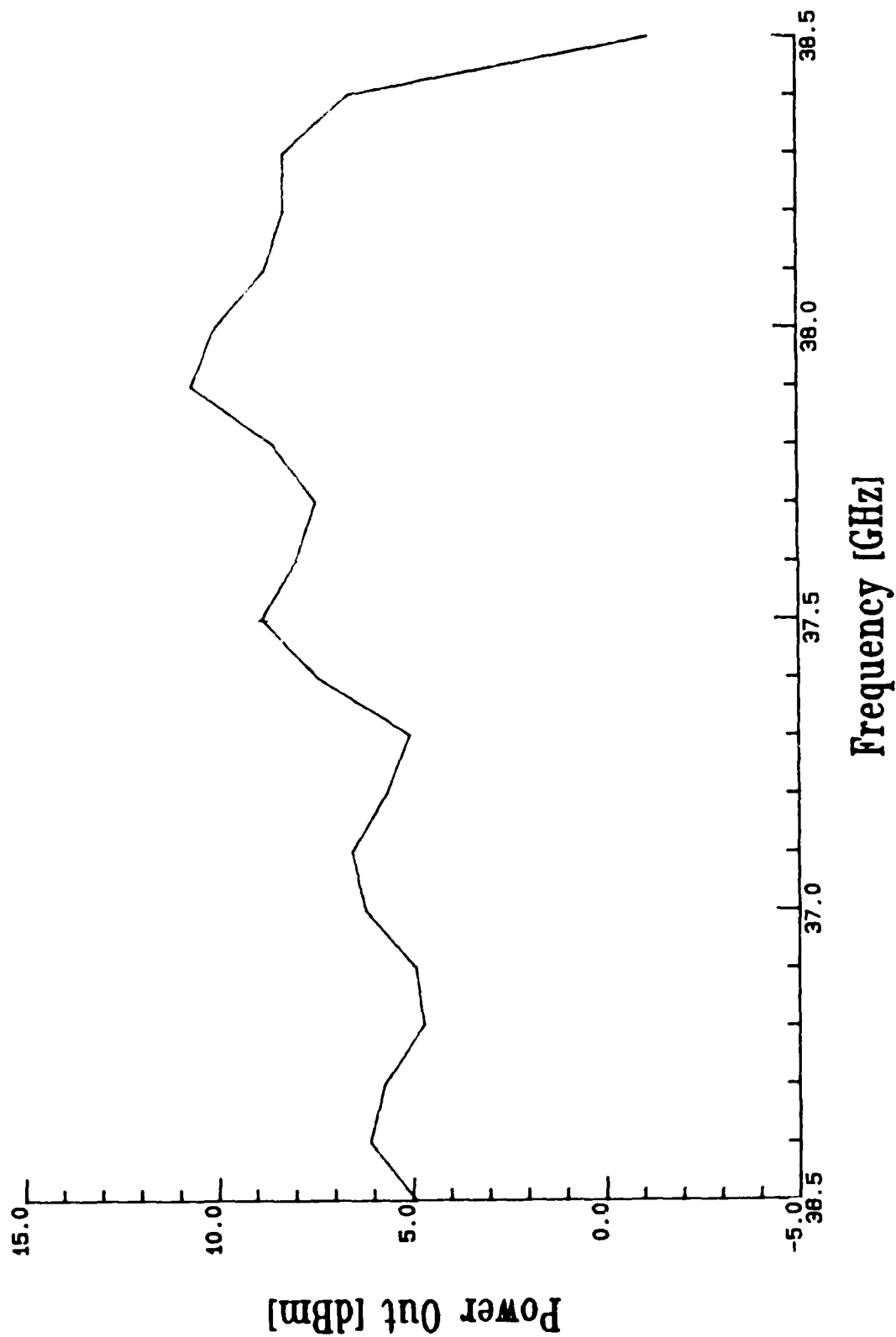

Figure 23 Local Oscillator Chain Freq. Response

MODEM CW IN DOME FROM RM203 84/11/23 MKR 699.999 875 MHz  
REF -30.0 dBm ATTEN 10 dB -29.70 dBm

hp

10 dB/

MARKER

699.999 875 MHz

-29.70 dBm

DL  
-83.0  
dBm

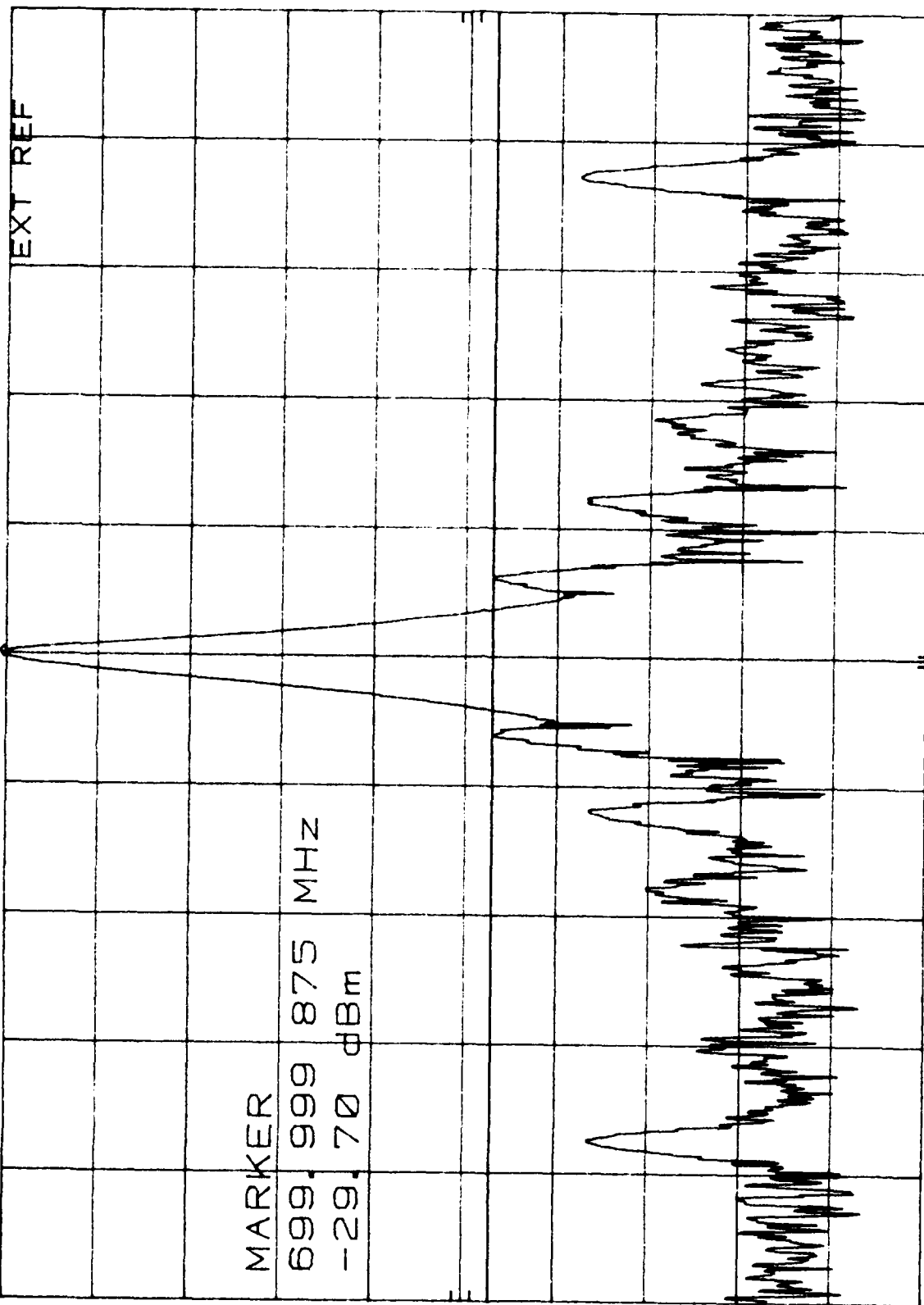

CENTER 699.999 87 MHz  
RES BW 10 Hz

VBW 30 Hz

SPAN 1.00 KHz  
SWP 30.0 sec

Figure 24 Modem CW Signal Uplink

MODEM CW THRU COMPLETE SYSTEM 84/11/26 MKR 699.999 995 MHZ  
REF 10.0 dBm ATTEN 20 dB  
-19.10 dBm

hp

10 dB/

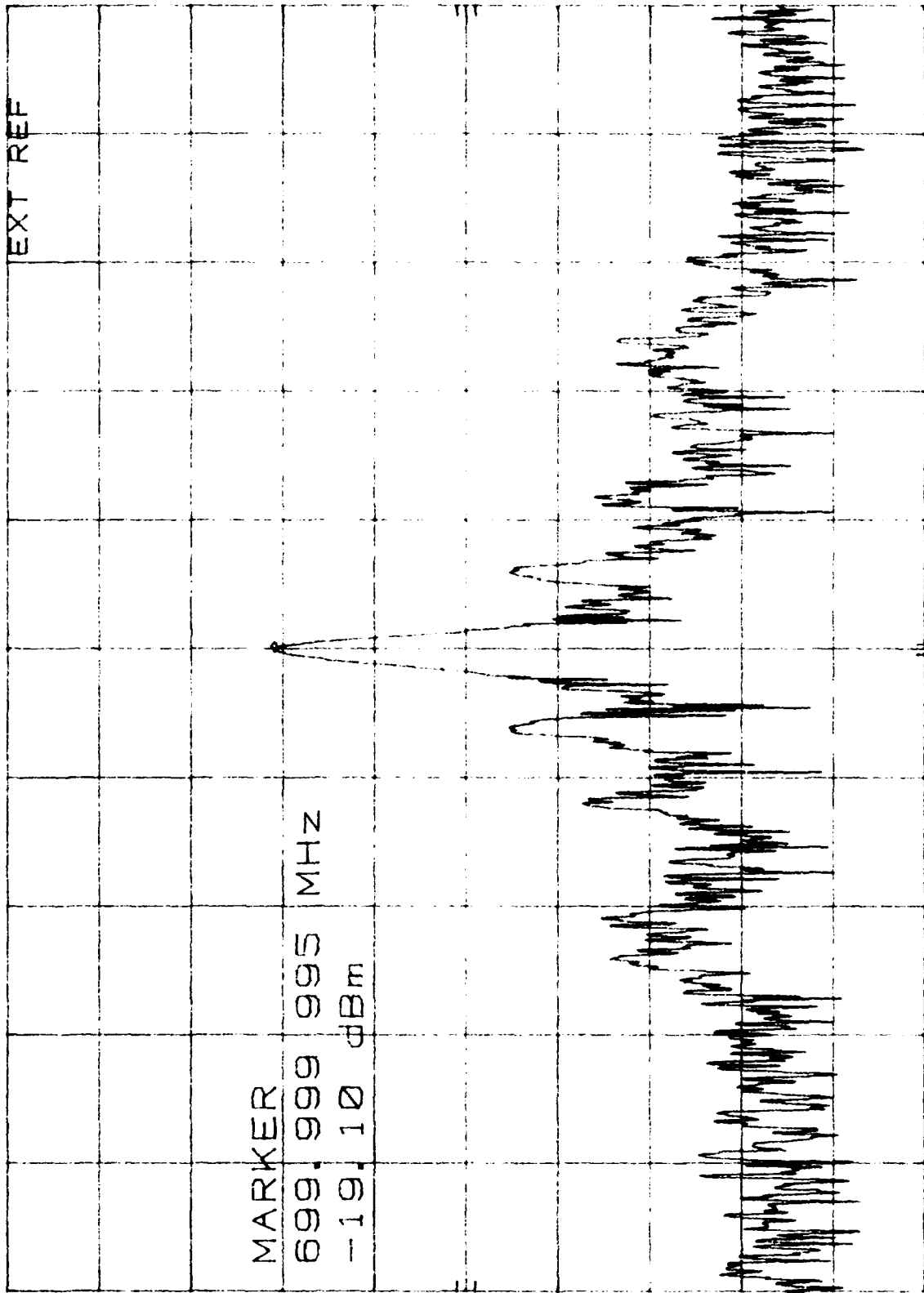

CENTER 699.999 995 MHZ  
RES BW 10 HZ

VBW 30 HZ

SPAN 1.00 KHZ  
SWP 30.0 sec

Figure 25 Modem CW Signal Downlink

ZETA 105, FLUKE 101, MODEM 700 -30dBm MKR 43.499 999 724 GHZ  
REF -8.0 dBm HARMONIC 10 -27.00 dBm

hp

10 dB/

CNVLOSS

22.0

dB

DL

-50.0

dBm

MARKER

43.499 999 724 GHZ

-27.00 dBm

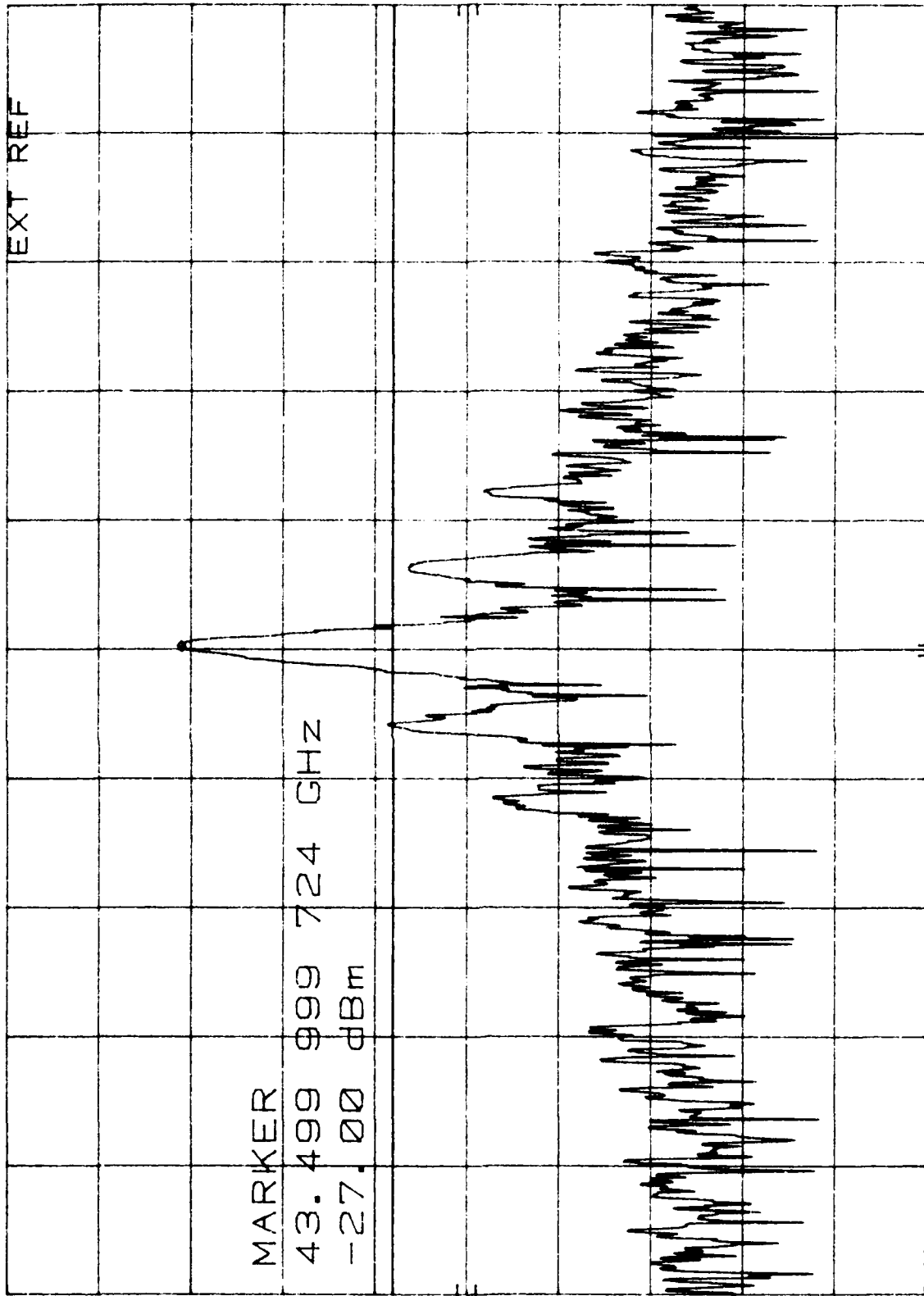

CENTER 43.499 999 72 GHZ

RES BW 10 Hz

VBW 30 Hz

SPAN 1.00 KHZ

SWP 30.0 sec

Figure 26 Transmitter Output Normal Configuration

ZETA 105. FLUKE 101. SYN 700 -30dBm MKR 43.499 999 766 GHz  
REF -8.0 dBm HARMONIC 10 -27.80 dBm

hp

10 dB/

CNVLOSS

22.0

dB

DL

-62.0

dBm

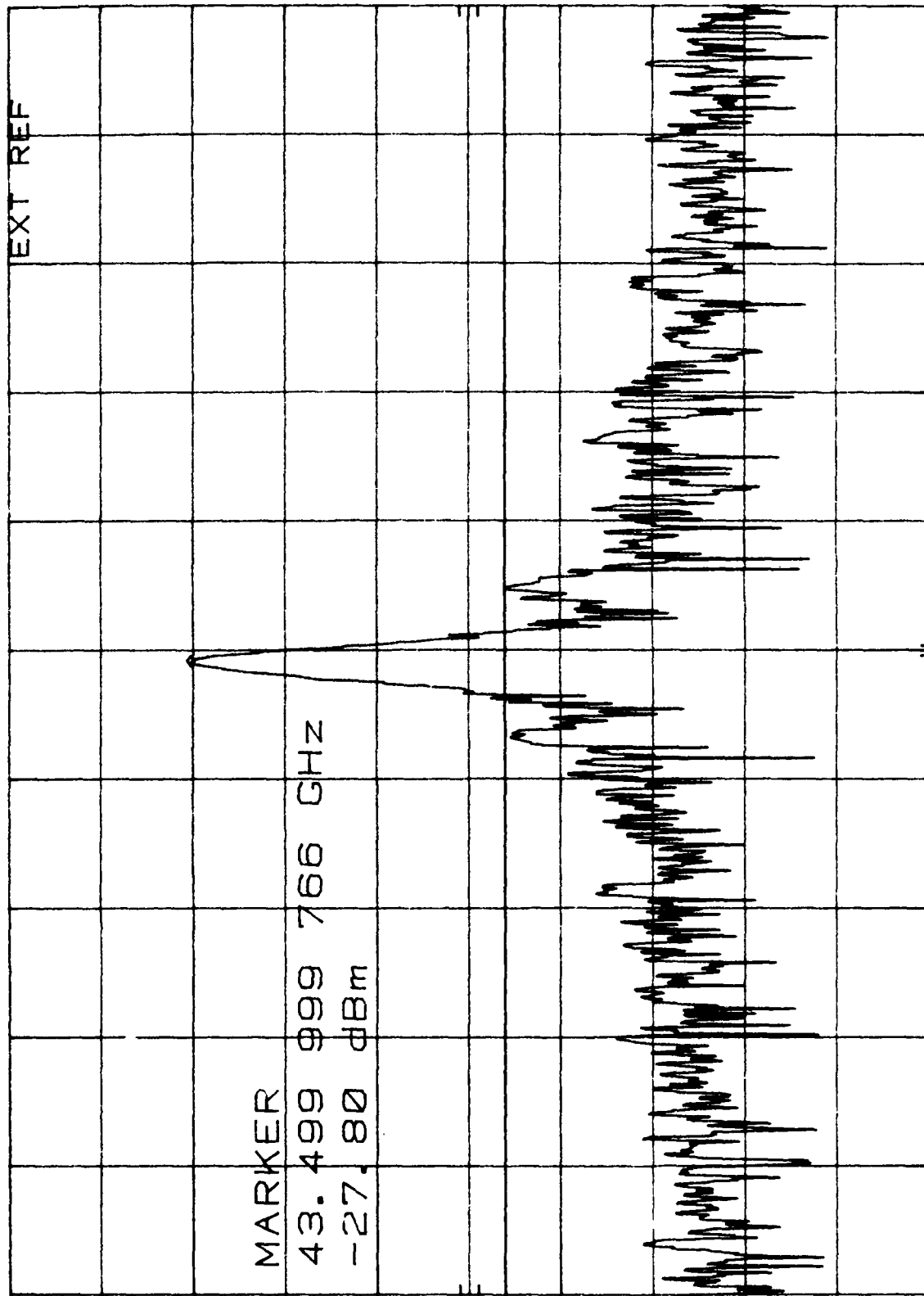

CENTER 43.499 999 77 GHz

RES BW 10 Hz

VBW 30 Hz

SPAN 1.03 KHz

SWP 30.0 sec

Figure 27 Transmitter Output Experimental Configuration

# Down Link shelf calibration

RF input at 20.84 GHz and IF output at 700 MHz

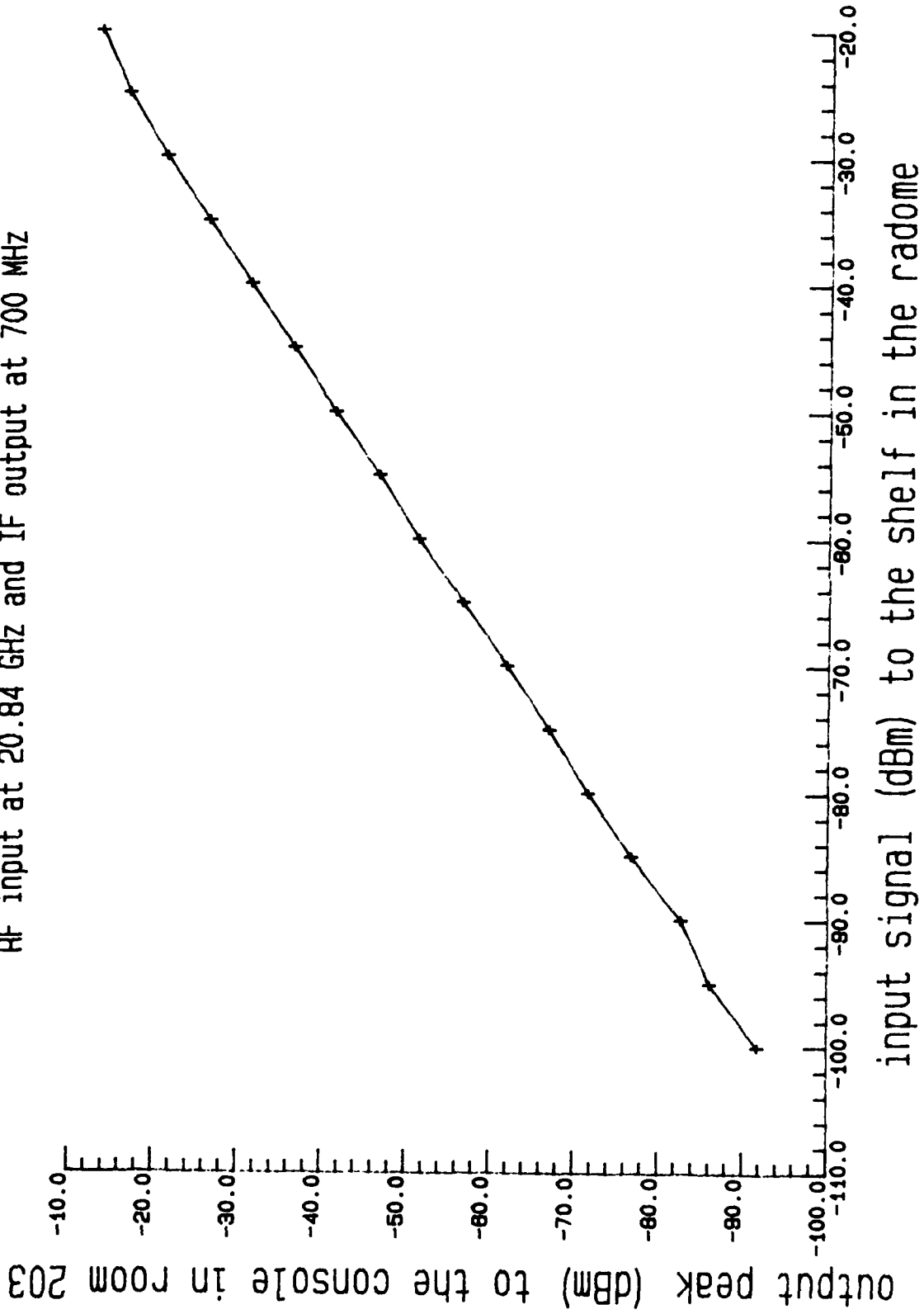

Figure 28 Receiver Calibration Curve

During the summer of 1984 some propagation experiments were carried out. Plots of attenuation for the 44 GHz TX path and the 20 GHz receive paths are shown in Fig. 29. Future experiments will include narrow band frequency hopping trials, signal jamming experiments and rain attenuation measurements.

## 7. CONCLUSIONS

7.1 The 44/20 GHz system has been successfully tested over the Kingsmere repeater link and some limited experiments conducted. The separation between baseband equipment and the RF shelf some 200 ft. will present some problems when wideband frequency hopping 2 GHz is implemented. The cable attenuation over the .610 to 1.610 GHz Hopping band will not be a constant and will affect the amplitude of the signal at the Q band mixer. To solve this problem, the fast hopping frequency synthesizer may have to be housed in the radome adjacent to the 44/20 GHz shelf. Improvements in signal to noise of the system could be made through the elimination of 200 ft. cable runs and placement of baseband signal processing equipment in the radome.

## 8. ACKNOWLEDGEMENTS

The author gratefully acknowledges the contributions and help given by Mr. J.D. Lambert, Mr. D. Sim, Mr. R. Addison and the model shop support at CRC. Mr. Addison was seconded to the Space Systems Directorate at CRC from the Defense Electronic Directorate, Defence Research Establishment Ottawa.

## 9. REFERENCES

1. LES 8/9-36/38 GHz Ground Terminal, A.H. McEwen and J.L. Pearce, CRC Report No. 1381, Ottawa, Sept. 1983, TRG

# Weather Attenuation

Rainy day, 22 Aug 84

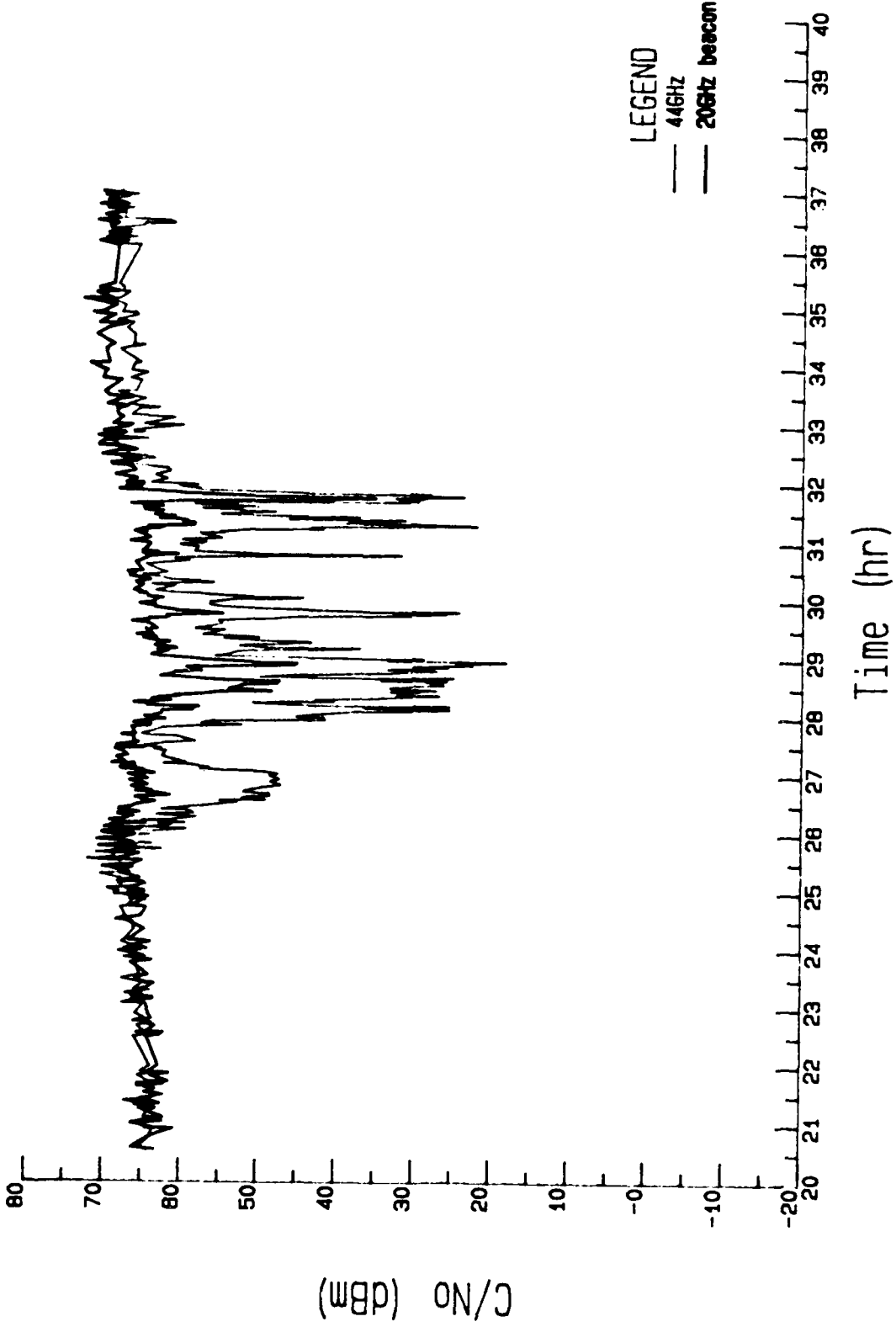

Figure 29 Rain Attenuation Plot

APPENDIX A

Primary Antenna Pattern

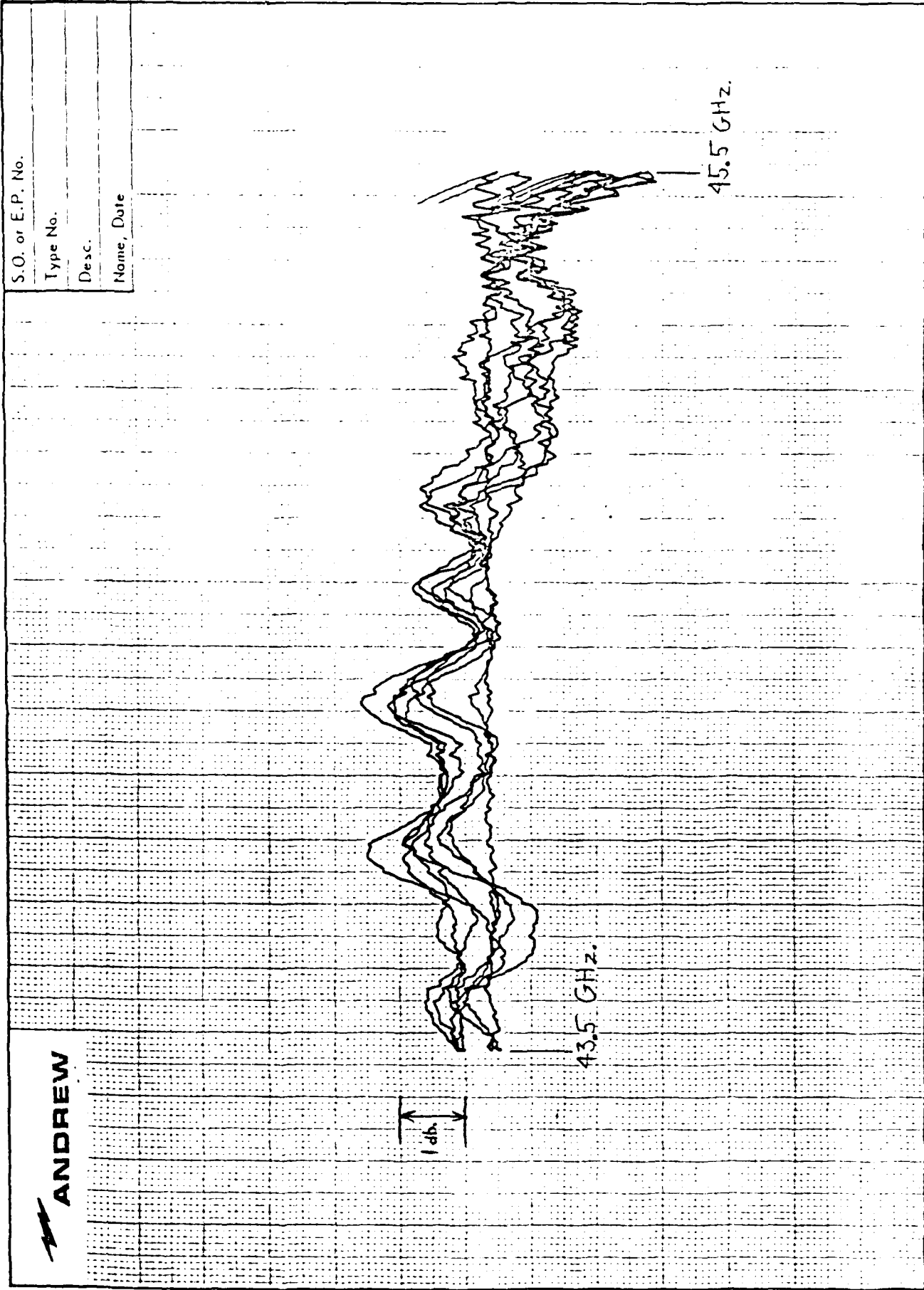

FIGURE A-1 TX AXIAL RATIO 43.5-45.5 GHz

S.O. or E.P. No.
Type No.
Desc.
Name, Date



Form C-07

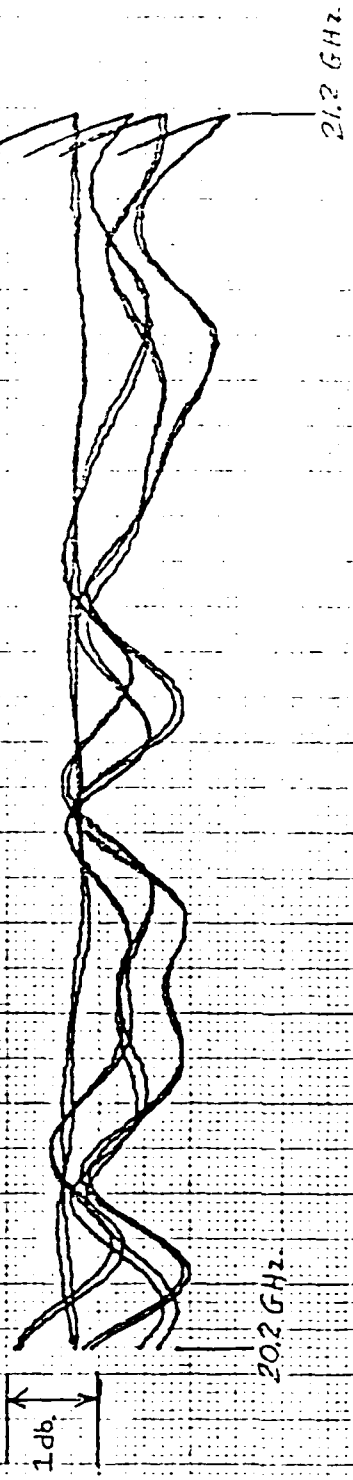

FIGURE A-2 TX AXIAL RATIO 20.2-21.2 GHz

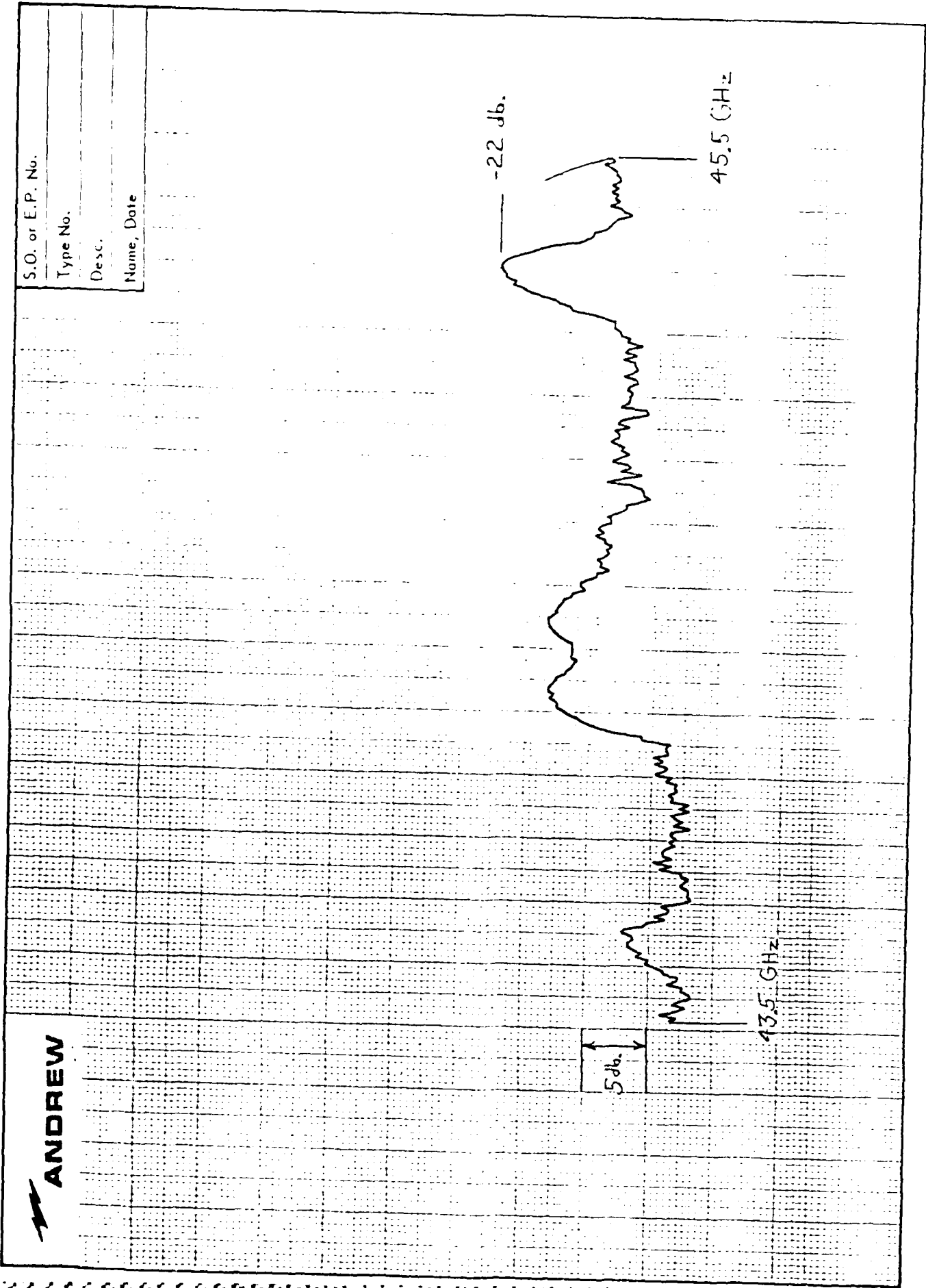

FIGURE A-3 TX V.S.W.R. 43.5-45.5 GHz

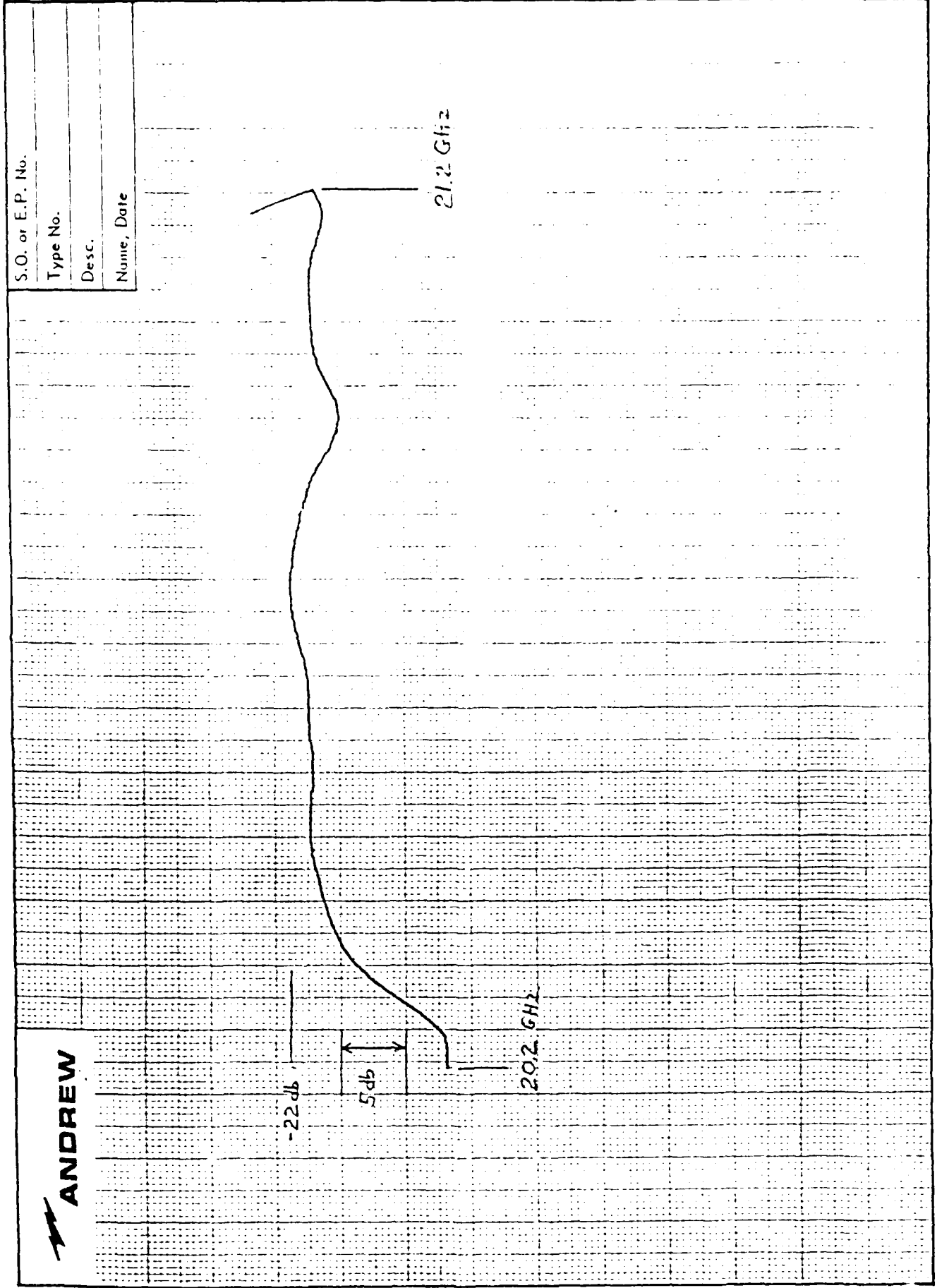

FIGURE A-4 RX V.S.W.R. 20.2-21.2 GHz

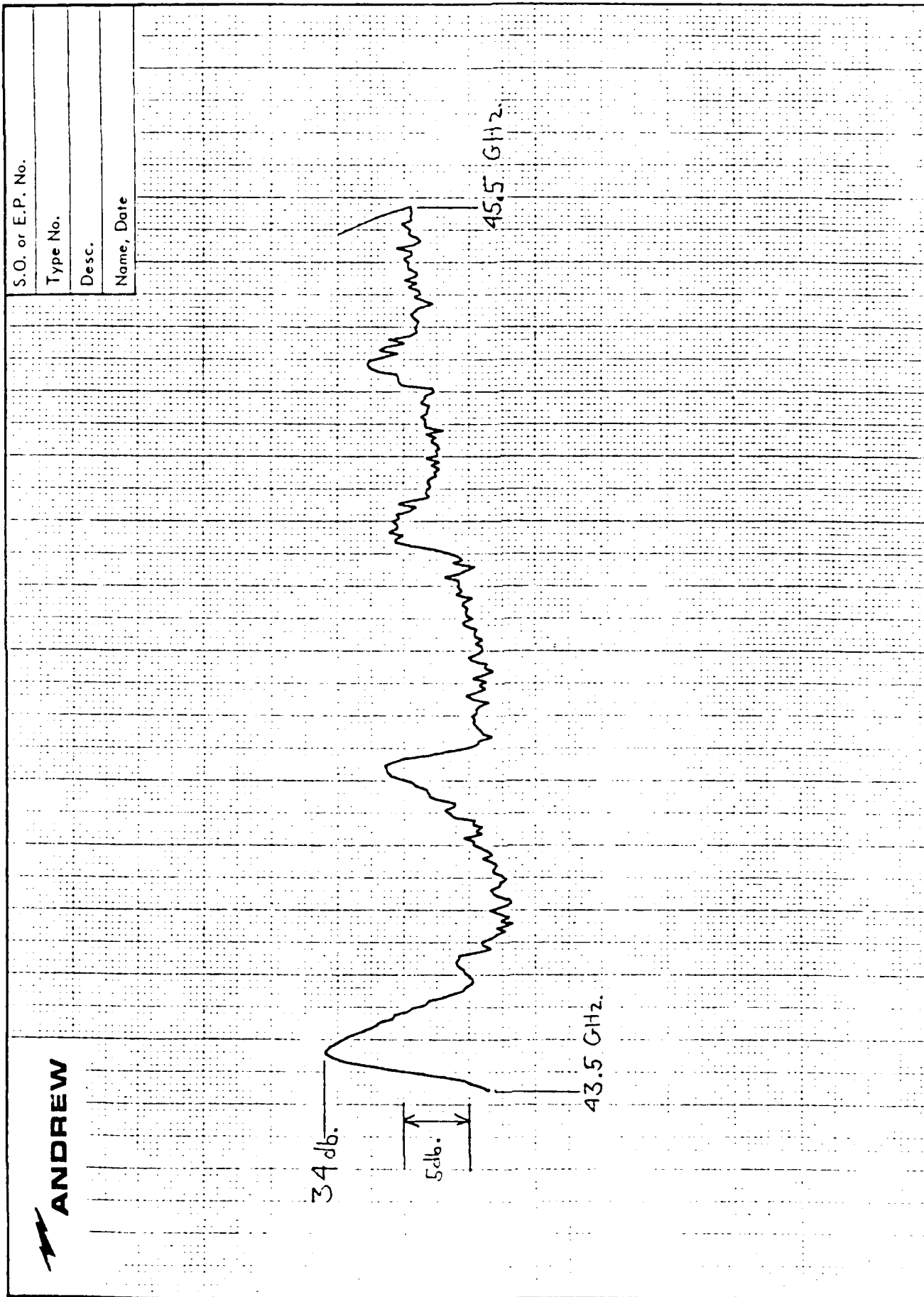

FIGURE A-5 ISOLATION TX/RX

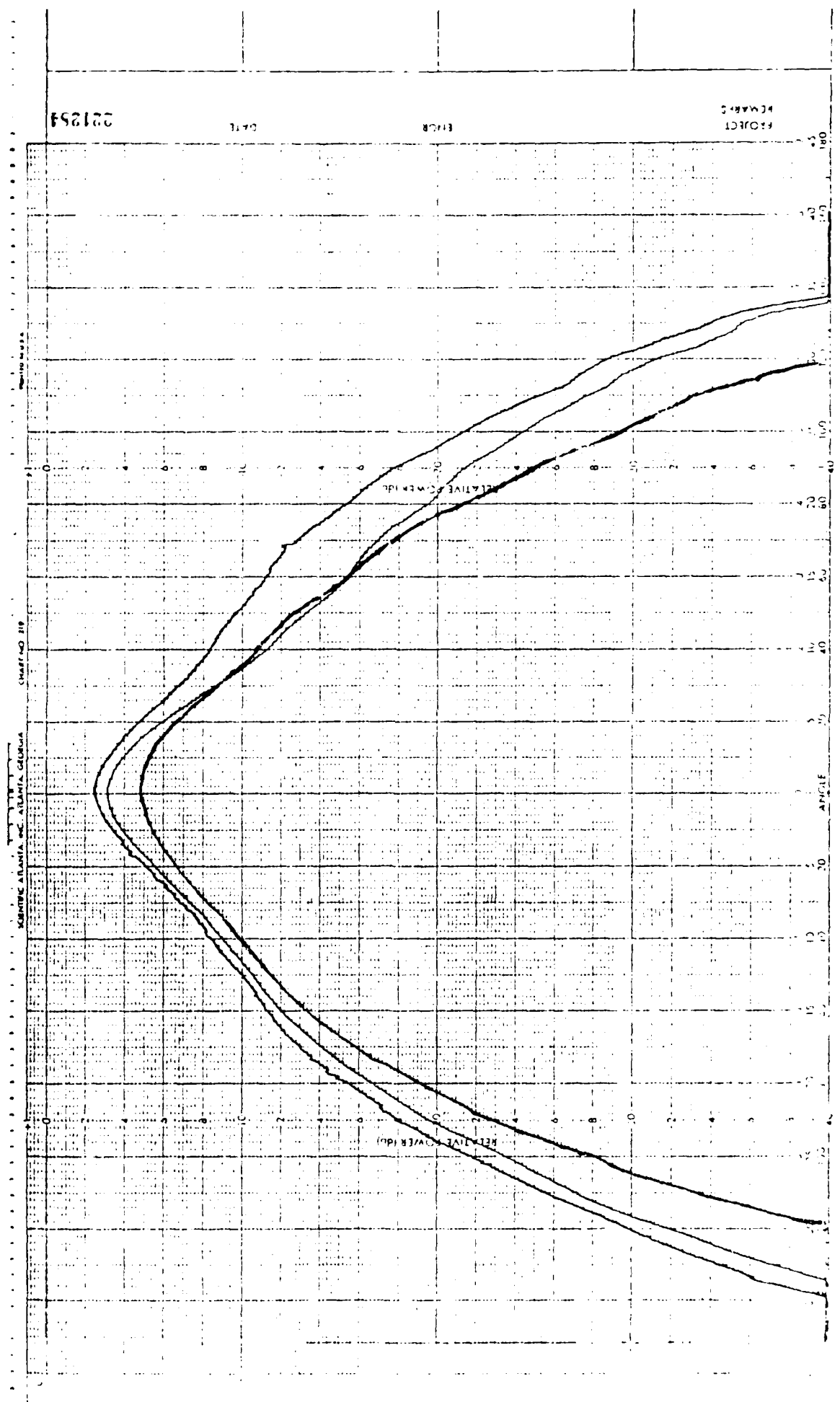

FIGURE A-6  
PRIMARY AMPLITUDE PATTERNS  
AZIMUTH: +45DEG. F=43.5 GHz

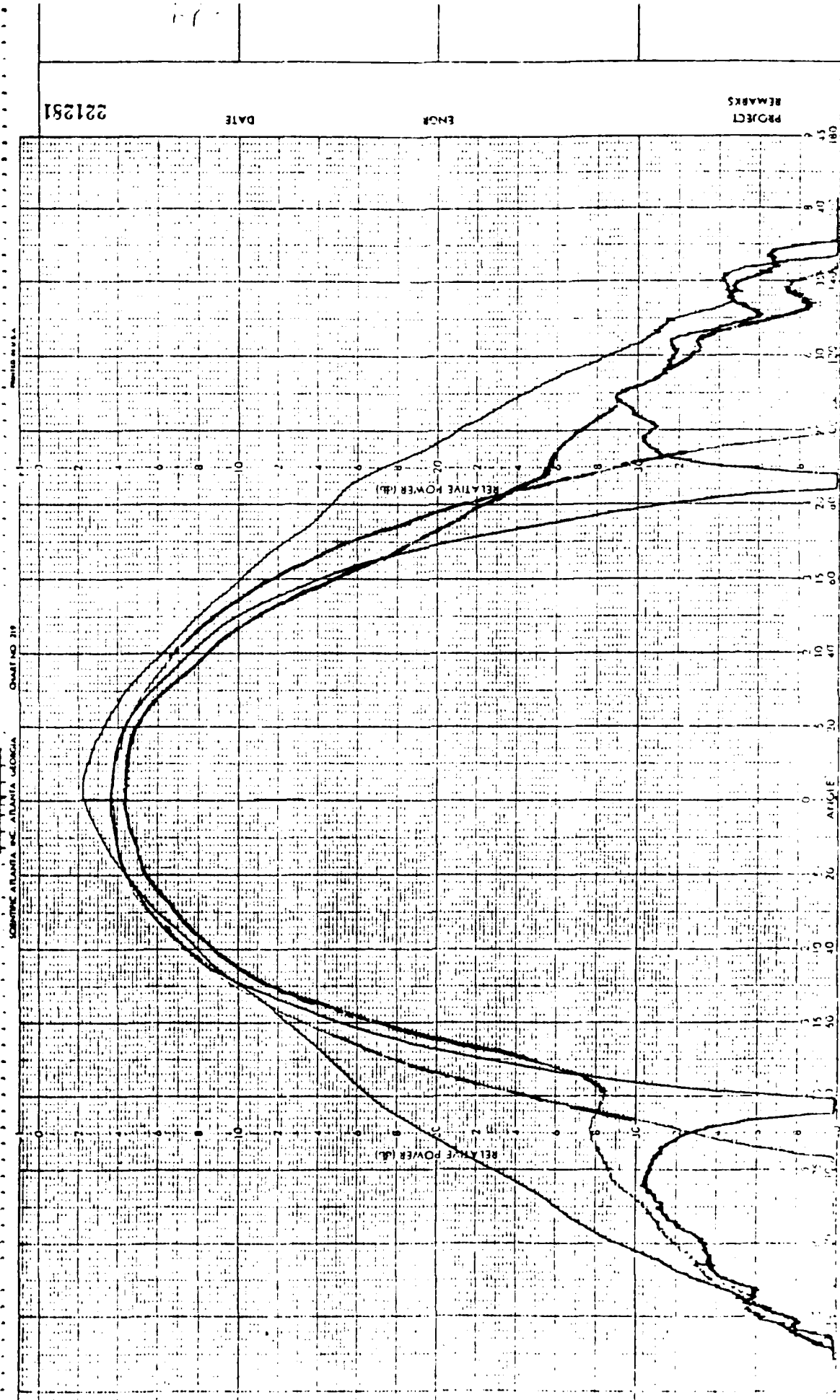

FIGURE A-7 PRIMARY AMPLITUDE PATTERNS  
AZIMUTH: +45 DEG. F=45.5 GHZ

COMMERCIAL ATLANTA INC. ATLANTA GEORGIA

CHART NO 319

REVISION 3/5/54

PROJECT 221281  
ENGR  
DATE 11  
REMARKS



FIGURE 8 PRIMARY PHASE PATTERNS  
AZIMUTH: +45 DEG. F=43.5GHZ  
PHASE: 1 DEG./DIV.

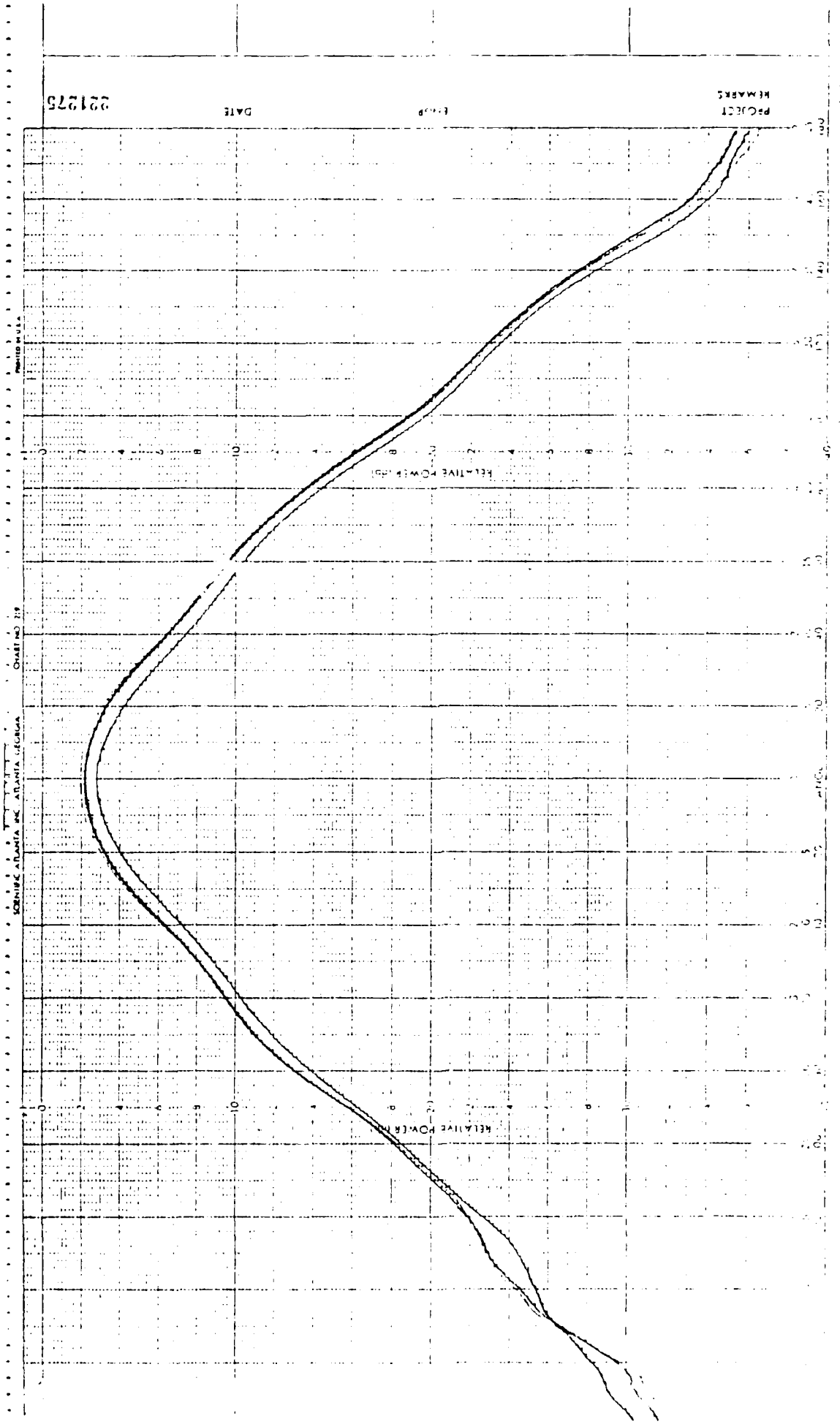

FIGURE A-9 PRIMARY AMPLITUDE PATTERNS  
AZIMUTH: +45 DEG. F=21.2GHZ.

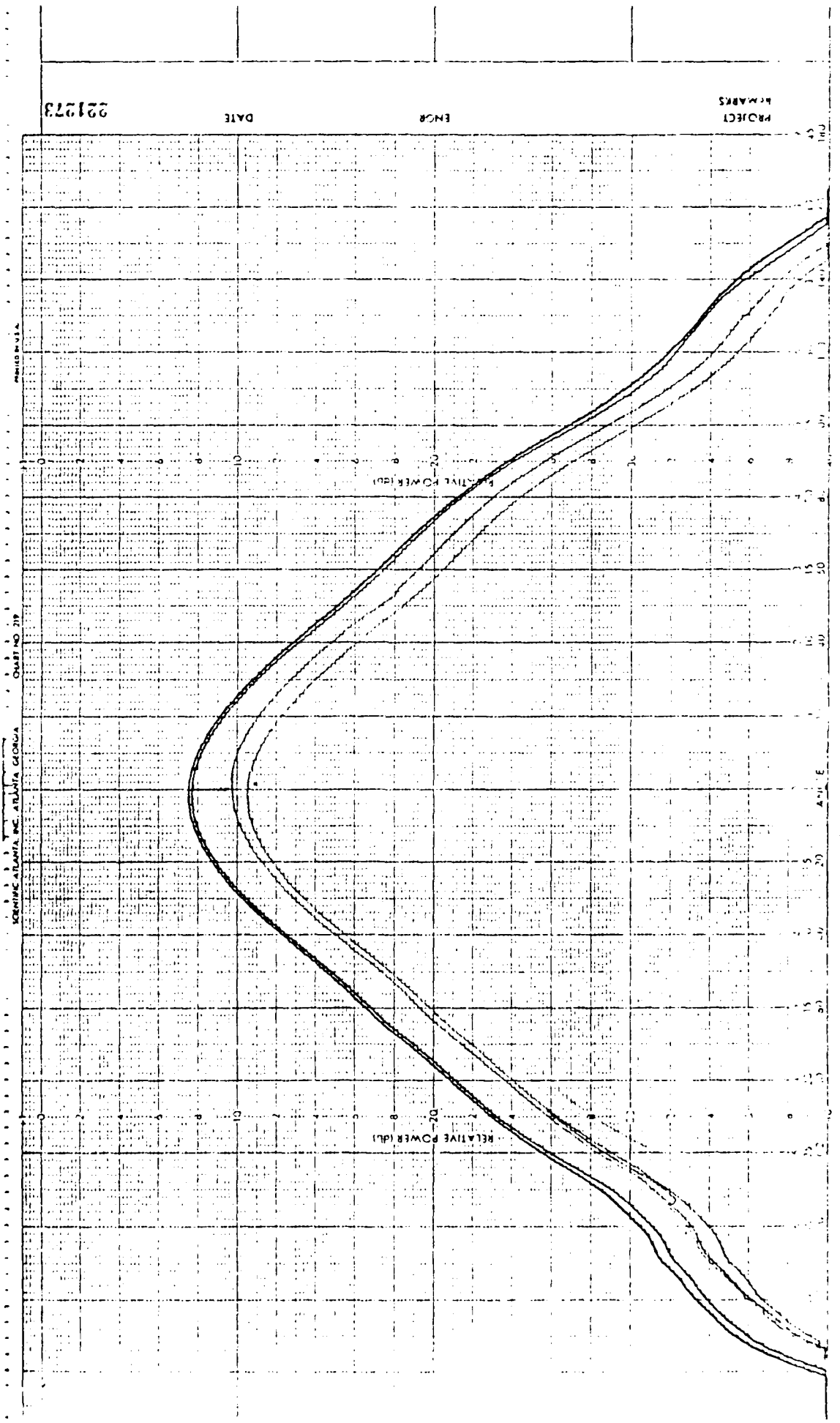

FIGURE A-10 PRIMARY AMPLITUDE PATTERNS  
 AZIMUTH: +45 DEG. F=20.2 GHZ.

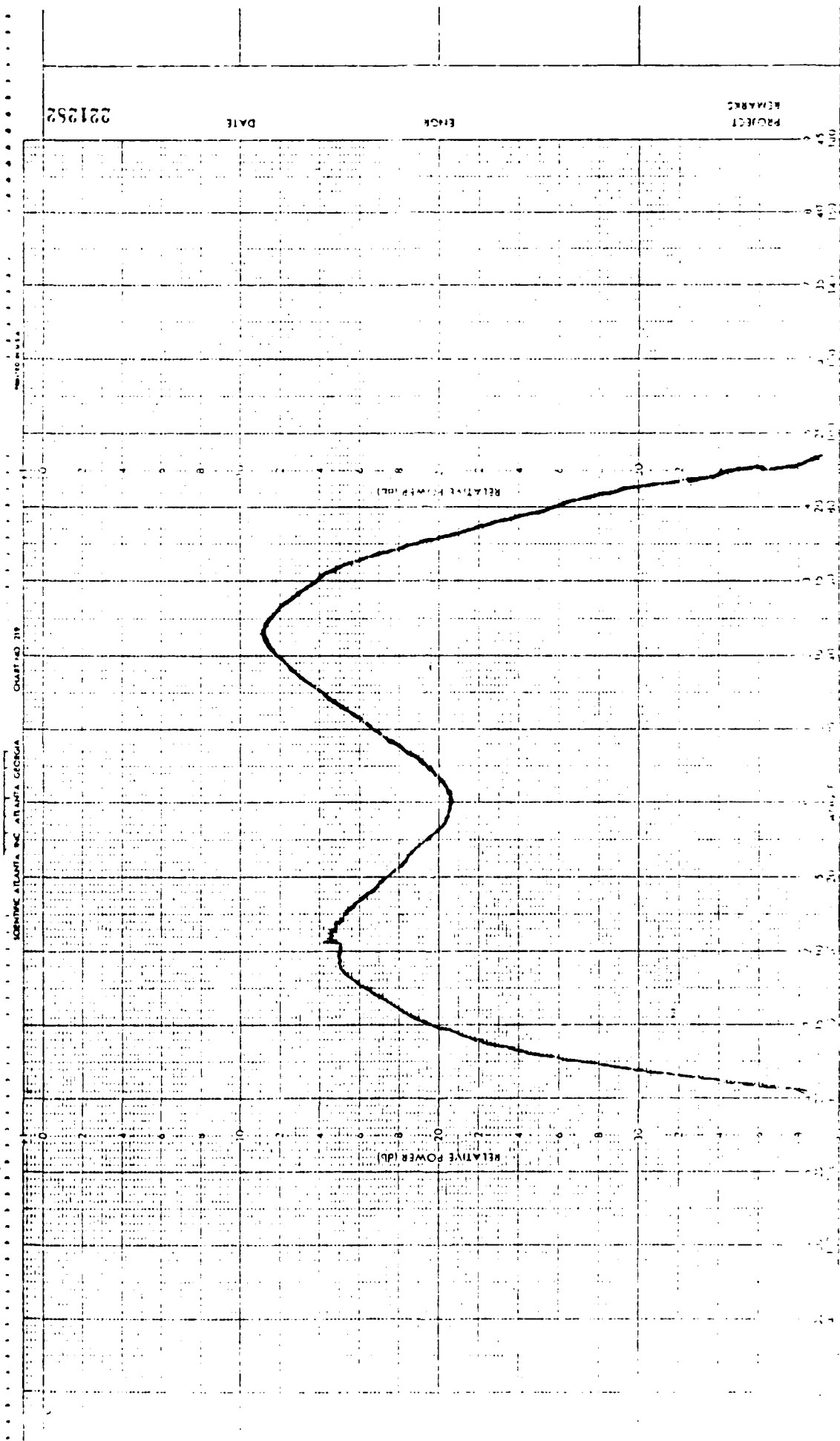

FIGURE A-11 PRIMARY PHASE PATTERNS  
AZIMUTH: +45 DEG F=45.5GHZ  
PHASE : I DEG./DIV.

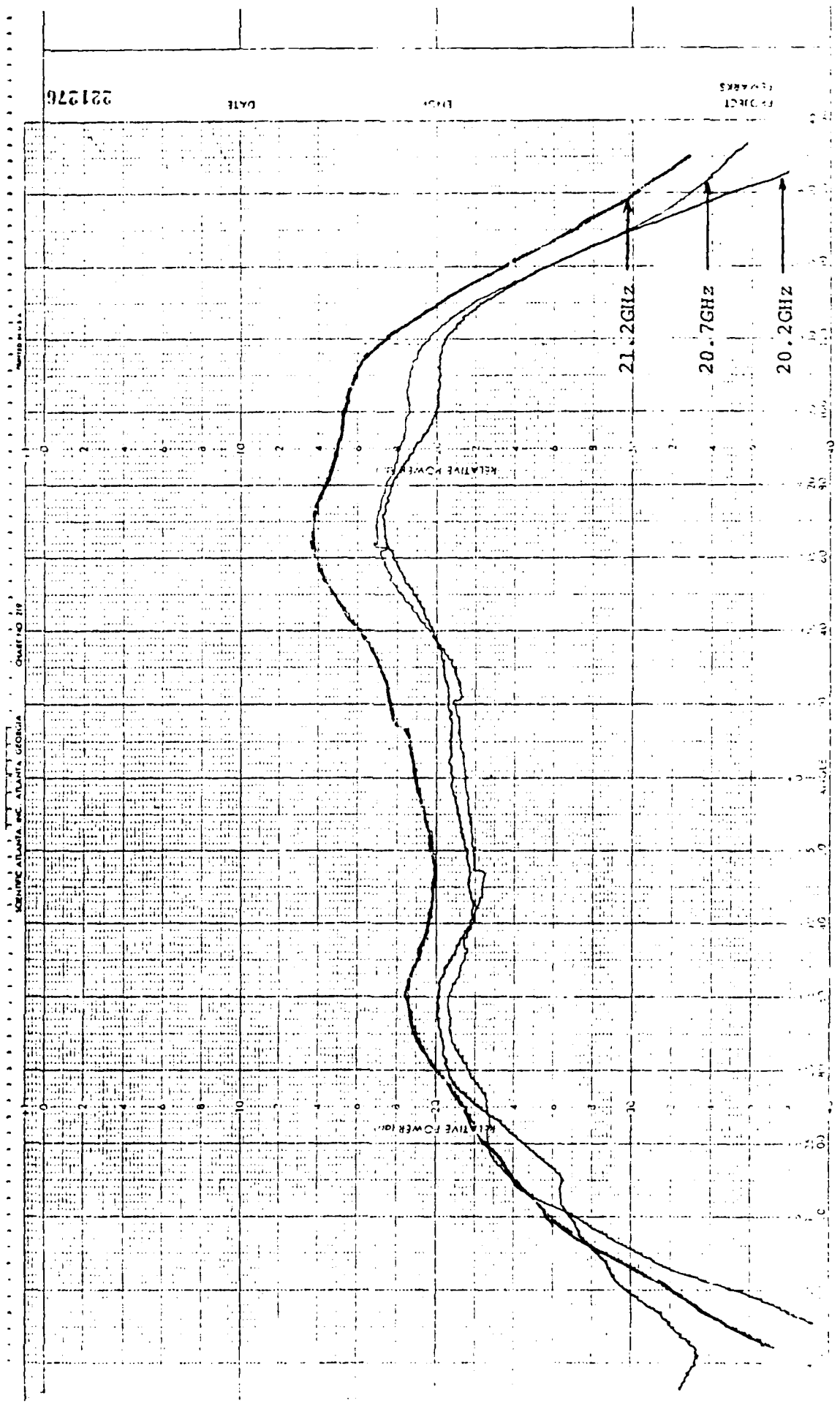
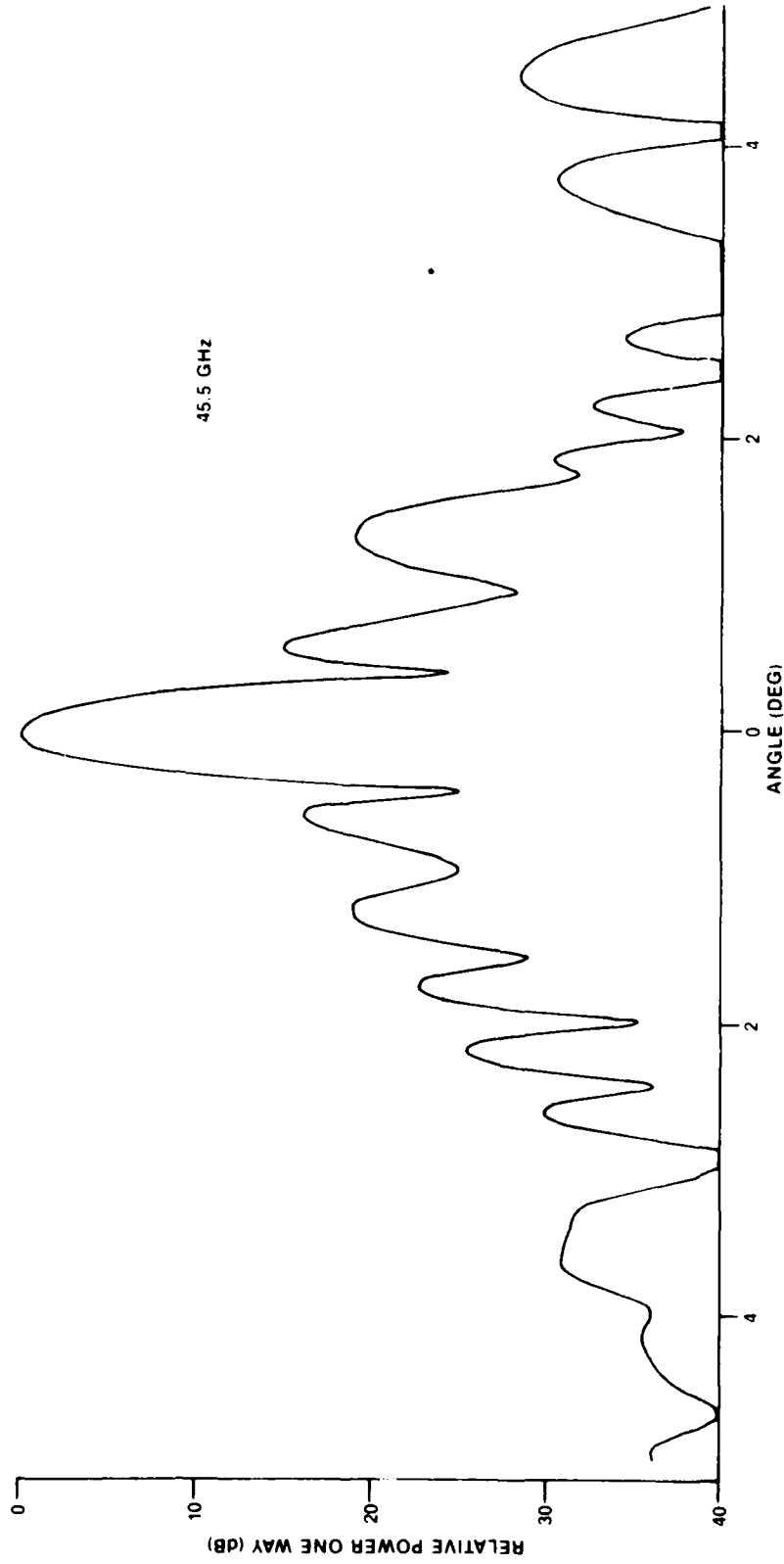

FIGURE A-12 PRIMARY PHASE PATTERNS  
 AZIMUTH: +45  
 PHASE : I DEG./DIV.

APPENDIX B

4' Diameter Antenna Patterns



4 ft. Diameter Pattern - Tx frequency

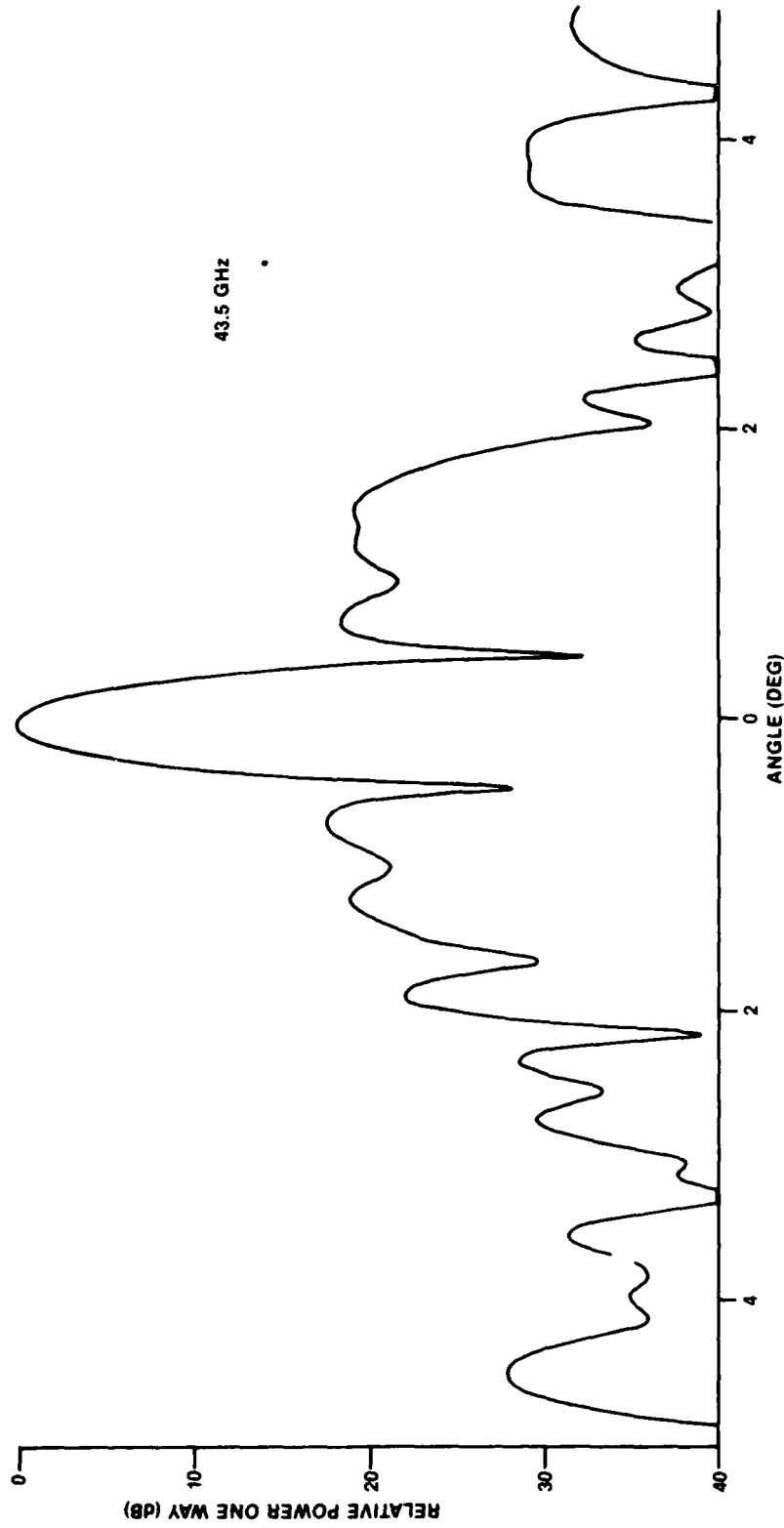

4 ft. Diameter Pattern - Tx frequency

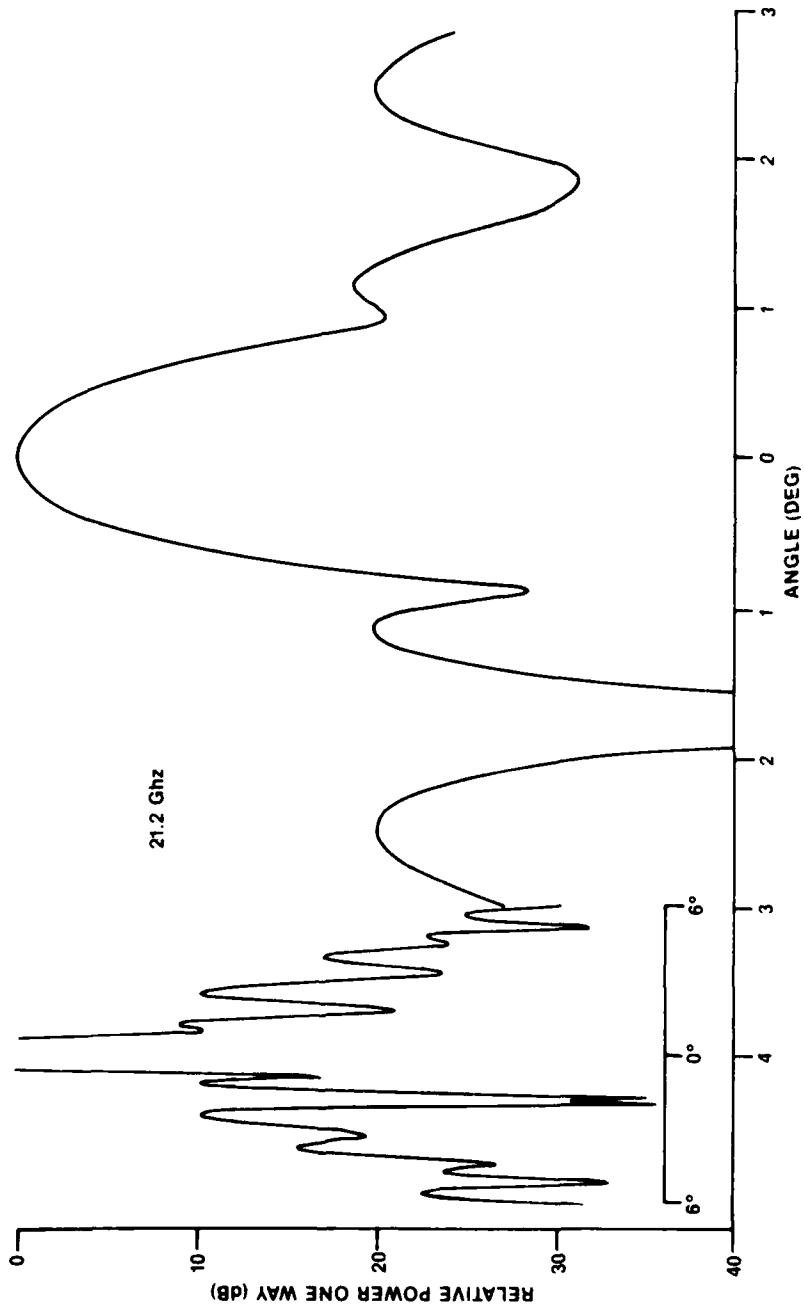

4 ft. Diameter Pattern - Rx frequency

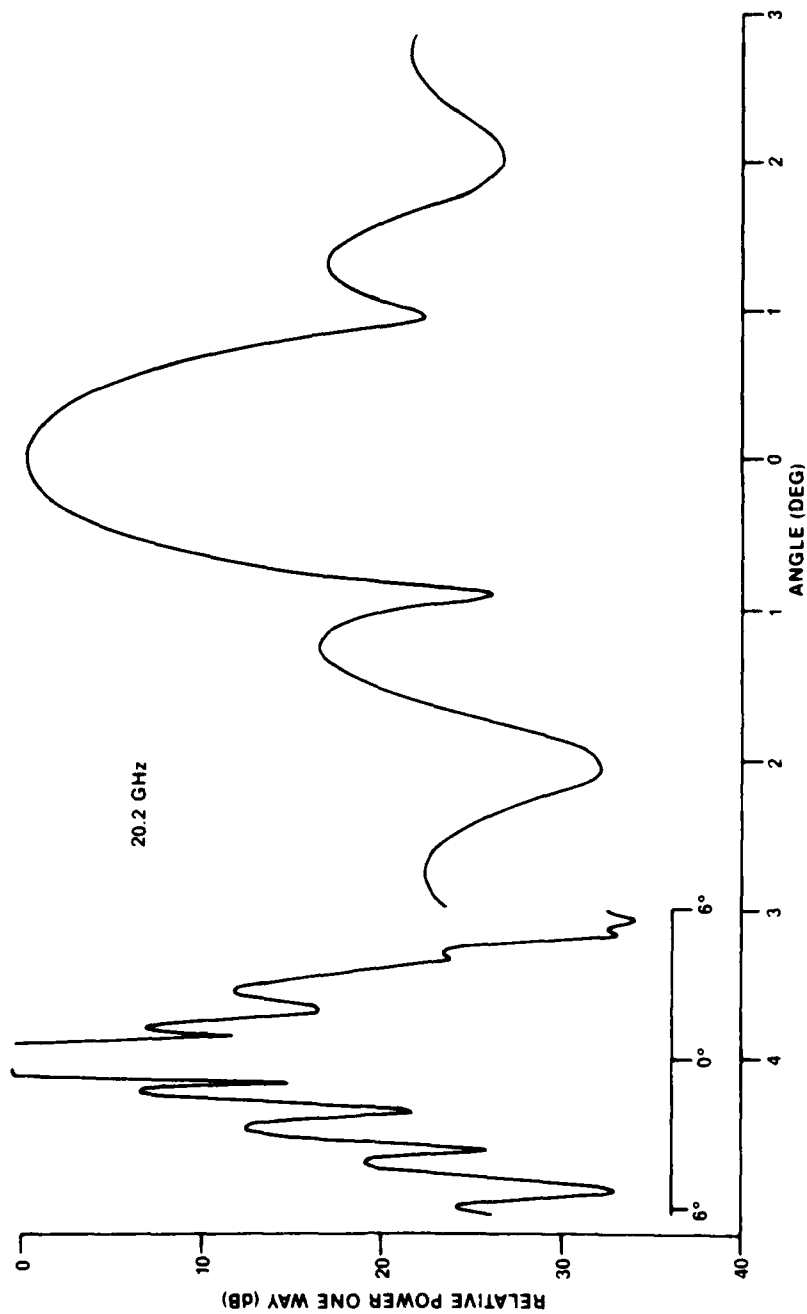

4 ft. Diameter Pattern - Rx frequency

SECURITY CLASSIFICATION OF FORM  
(highest classification of Title, Abstract, Keywords)

## DOCUMENT CONTROL DATA

(Security classification of title, body of abstract and indexing annotation must be entered when the overall document is classified)

1. ORIGINATOR (the name and address of the organization preparing the document. Organizations for whom the document was prepared, e.g. Establishment sponsoring a contractor's report, or tasking agency, are entered in section B.) Communications Research Center Satellite Communications Directorate 3701 Carling Avenue, Ottawa, Ontario, Canada		2. SECURITY CLASSIFICATION (overall security classification of the document, including special warning terms if applicable)  UNCLASSIFIED	
3. TITLE (the complete document title as indicated on the title page. Its classification should be indicated by the appropriate abbreviation (S,C,R or U) in parentheses after the title.)  44/20 GHz Ground Terminal			
4. AUTHORS (Last name, first name, middle initial. If military, show rank, e.g. Doe, Maj. John E.)  McEwen, A.H.			
5. DATE OF PUBLICATION (month and year of publication of document)  September 1987	6a. NO. OF PAGES (total containing information. Include Annexes, Appendices, etc.)  56	6b. NO. OF REFS (total cited in document)  1	
7. DESCRIPTIVE NOTES (the category of the document, e.g. technical report, technical note or memorandum. If appropriate, enter the type of report, e.g. interim, progress, summary, annual or final. Give the inclusive dates when a specific reporting period is covered.)  DREO Technical Report			
8. SPONSORING ACTIVITY (the name of the department project office or laboratory sponsoring the research and development. Include the address.)  DREO via CRC			
9a. PROJECT OR GRANT NO. (if appropriate, the applicable research and development project or grant number under which the document was written. Please specify whether project or grant)  32A53 0830 0000		9b. CONTRACT NO. (if appropriate, the applicable number under which the document was written)	
10a. ORIGINATOR'S DOCUMENT NUMBER (the official document number by which the document is identified by the originating activity. This number must be unique to this document.)  CRC REPORT 1428		10b. OTHER DOCUMENT NOS. (Any other numbers which may be assigned this document either by the originator or by the sponsor)	
11. DOCUMENT AVAILABILITY (any limitations on further dissemination of the document, other than those imposed by security classification)  <input checked="" type="checkbox"/> Unlimited distribution <input type="checkbox"/> Distribution limited to defence departments and defence contractors; further distribution only as approved <input type="checkbox"/> Distribution limited to defence departments and Canadian defence contractors; further distribution only as approved <input type="checkbox"/> Distribution limited to government departments and agencies; further distribution only as approved <input type="checkbox"/> Distribution limited to defence departments; further distribution only as approved <input type="checkbox"/> Other (please specify):			
12. DOCUMENT ANNOUNCEMENT (any limitation to the bibliographic announcement of this document. This will normally correspond to the Document Availability (11). However, where further distribution (beyond the audience specified in 11) is possible, a wider announcement audience may be selected.)  Same as 11.			

UNCLASSIFIED

SECURITY CLASSIFICATION OF FORM

13. ABSTRACT ( a brief and factual summary of the document. It may also appear elsewhere in the body of the document itself. It is highly desirable that the abstract of classified documents be unclassified. Each paragraph of the abstract shall begin with an indication of the security classification of the information in the paragraph (unless the document itself is unclassified) represented as (S), (C), (R), or (U). It is not necessary to include here abstracts in both official languages unless the text is bilingual).

The design and construction of an EHF SATCOM terminal to transmit in the mobile satellite (43.5 - 45.5) GHz band and receive in the fixed satellite space to earth (20.2 - 21.2) GHz band is described. Characterization plots for individual RF system components and test results of the complete terminal operating over a 16 km repeater range are shown.

14. KEYWORDS, DESCRIPTORS or IDENTIFIERS (technically meaningful terms or short phrases that characterize a document and could be helpful in cataloguing the document. They should be selected so that no security classification is required. Identifiers, such as equipment model designation, trade name, military project code name, geographic location may also be included. If possible, keywords should be selected from a published thesaurus, e.g. Thesaurus of Engineering and Scientific Terms (TEST) and that thesaurus identified. If it is not possible to select indexing terms which are Unclassified, the classification of each should be indicated as with the title.)

- spread spectrum
- digital satellite communications
- EHF satellites
- frequency hopping
- experimental satcom

END

DATE

FILMED

DTIC

JULY 88