

DTIC FILE COPY

USAARL Report No. 90-9

1

AD-A222 935



**Development of an Improved
SPH-4 Retention Assembly**

By

Robert H. Hines
 Ronald W. Palmer
 Joseph L. Haley, Jr.
 Ernest E. Hiltz

Biodynamics Research Division

April 1990

DTIC
 ELECTE
 JUN 19 1990
 S B D
 Co

Approved for public release; distribution unlimited.

90 06 18 336

United States Army Aeromedical Research Laboratory
 Fort Rucker, Alabama 36362-5292

Notice

Qualified requesters

Qualified requesters may obtain copies from the Defense Technical Information Center (DTIC), Cameron Station, Alexandria, Virginia 22314. Orders will be expedited if placed through the librarian or other person designated to request documents from DTIC.

Change of address

Organizations receiving reports from the U.S. Army Aeromedical Research Laboratory on automatic mailing lists should confirm correct address when corresponding about laboratory reports.

Disposition

Destroy this document when it is no longer needed. Do not return it to the originator.

Disclaimer

The views, opinions, and/or findings contained in this report are those of the author(s) and should not be construed as an official Department of the Army position, policy, or decision, unless so designated by other official documentation. Citation of trade names in this report does not constitute an official Department of the Army endorsement or approval of the use of such commercial items.

Human use

Human subjects participated in these studies after giving their free and informed voluntary consent. Investigators adhered to AR 70-25 and USAMRDC Reg 70-25 on Use of Volunteers in Research.

Reviewed:

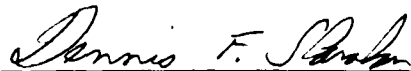

DENNIS F. SHANAHAN
LTC, MC
Director, Biodynamics
Research Division

Released for publication:



J. D. LaMOTHE, Ph.D.
Colonel, MS
Chairman, Scientific
Review Committee



DAVID H. KARNEY
Colonel, MC
Commanding

REPORT DOCUMENTATION PAGE				Form Approved OMB No. 0704-0188		
1a REPORT SECURITY CLASSIFICATION UNCLASSIFIED			1b RESTRICTIVE MARKINGS			
2a. SECURITY CLASSIFICATION AUTHORITY			3 DISTRIBUTION/AVAILABILITY OF REPORT Approved for public release, distribution unlimited			
2b. DECLASSIFICATION/DOWNGRADING SCHEDULE						
4. PERFORMING ORGANIZATION REPORT NUMBER(S) USAARL Report No. 90-9			5. MONITORING ORGANIZATION REPORT NUMBER(S)			
6a. NAME OF PERFORMING ORGANIZATION U.S. Army Aeromedical Research Laboratory		6b. OFFICE SYMBOL (If applicable)	7a NAME OF MONITORING ORGANIZATION U.S. Army Medical Research and Development Command			
6c. ADDRESS (City, State, and ZIP Code) P.O. Box 577 Fort Rucker, AL 36362-5292			7b. ADDRESS (City, State, and ZIP Code) Fort Detrick Frederick, MD 21701-5012			
8a. NAME OF FUNDING/SPONSORING ORGANIZATION		8b. OFFICE SYMBOL (If applicable)	9 PROCUREMENT INSTRUMENT IDENTIFICATION NUMBER			
8c. ADDRESS (City, State, and ZIP Code)			10. SOURCE OF FUNDING NUMBERS			
			PROGRAM ELEMENT NO. 62787A	PROJECT NO. 3M162787A878	TASK NO. AG	WORK UNIT ACCESSION NO. 131
11. TITLE (Include Security Classification) Development of an Improved SPH-4 Retention Assembly						
12. PERSONAL AUTHOR(S) Hines, Robert H., Palmer, Ronald W., Haley, J. L., Jr., and Hiltz, Ernest E.						
13a. TYPE OF REPORT Final		13b. TIME COVERED FROM _____ TO _____		14. DATE OF REPORT (Year, Month, Day) 1990 April	15 PAGE COUNT 19	
16. SUPPLEMENTARY NOTATION						
17. COSATI CODES			18. SUBJECT TERMS (Continue on reverse if necessary and identify by block number)			
FIELD	GROUP	SUB-GROUP	Impact protection, helmet, yoke harness, retention harness, retention assembly (SD)			
23	04					
19. ABSTRACT (Continue on reverse if necessary and identify by block number) Impact protection during a crash is one of the primary functions of a flight helmet. In order for the helmet to provide effective impact protection, the helmet must remain firmly secured on the head for the entire duration of the crash sequence. If the helmet is displaced on the head or comes off the head during the crash sequence, cranial exposure and subsequent head injury can occur. Previous research at USAARL has shown the retention assembly of the SPH-4 flight helmet often allows excessive helmet rotation or even helmet loss to occur during a crash. This report describes the construction and testing of a new SPH-4 retention assembly, the USAARL yoke harness, which will alleviate the helmet rotation/helmet loss problem. The load versus elongation under load and comfort of the USAARL yoke harness was compared to that of the currently used standard retention harness. The USAARL yoke harness was stronger, and stretched less under load than the standard retention harness. Comfort testing of the USAARL yoke harness showed the majority (72 percent) of those questioned preferred the USAARL yoke harness over the standard harness. <i>Kenneth</i>						
20. DISTRIBUTION/AVAILABILITY OF ABSTRACT <input checked="" type="checkbox"/> UNCLASSIFIED/UNLIMITED <input type="checkbox"/> SAME AS RPT <input type="checkbox"/> DTIC USERS			21 ABSTRACT SECURITY CLASSIFICATION UNCLASSIFIED			
22a. NAME OF RESPONSIBLE INDIVIDUAL Chief, Scientific Information Center			22b TELEPHONE (Include Area Code) (205) 255-6907	22c. OFFICE SYMBOL SGRD-UAX-SI		

Acknowledgments

It would be practically impossible to complete a publication from this Laboratory without the assistance of others whose names often go unmentioned. The authors would like to express special acknowledgment to SPC Charles Paschal and CW4 Larry Woodrum for their contributions to this effort.

Accession For	
NTIS GRA&I	<input checked="" type="checkbox"/>
DTIC TAB	<input type="checkbox"/>
Unannounced	<input type="checkbox"/>
Justification	
By _____	
Distribution/	
Availability Codes	
Dist	Avail and/or Special
A-1	

=====
This page intentionally left blank.
=====

Table of contents

	Page
List of figures.....	2
List of tables.....	2
Introduction.....	3
Materials.....	3
Methods.....	8
Results.....	13
Discussion.....	15
Conclusions.....	17
Recommendations.....	17
References.....	18
Appendix A. List of equipment manufacturers.....	19

List of tables

	Page
1. Pendulum tests results.....	15
2. Volunteer test results.....	15

List of figures

Figure

1. Final configuration of the USAARL yoke harness.....	5
2. The USAARL yoke harness mounted on headform.....	6
3. Photographs of Gentex swivel yoke harness.....	7
4. Right side view of the USAARL yoke harness in a skeletal helmet.....	8
5. Helmet retention harness pendulum tester.....	10
6. Typical pulse experienced by the "chest" of the pendulum tester.....	11
7. Typical helmet displacement on the Hybrid III headform in the pendulum tests.....	12
8. Chinstrap "pull" test on the standard, USAARL, and Gentex swivel yoke harnesses, all helmets equipped with a TPL™.....	13
9. Chinstrap "pull" test with standard, USAARL, and Gentex swivel yoke harnesses using a helmet liner without a TPL™.....	14

Introduction

Flight helmet stability and retention on the head during crashes have been, and continue to be, a source of concern for manufacturers and users of flight helmets. In use since 1970, the standard Sound Protective Helmet-4 (SPH-4) provides relatively good noise attenuation and impact protection, according to aircraft accident investigations. However, the retention assembly (integral napestrap and chinstrap) does not prevent the shell from undergoing excessive forward and rearward rotation when the head is exposed to crash induced acceleration(s) (Gruver and Haley, 1988) and, also, when visual enhancement devices are attached to the forward area of the helmet.

Previous work at the U.S. Army Aeromedical Research Laboratory (USAARL) has shown: (1) The double snap fasteners are inconsistent in attachment strength as determined by laboratory tests and actual failures in accidents (Vrynwy-Jones, Lanoue, and Pritts, 1988), (2) the cloth connection between the chinstrap/napestrap and shell permits excessive forward and rearward helmet displacement which may expose the cranium to impact, and (3) forward rotation of the shell has been identified as a concern when wearing night vision goggles due to the added weight and the forward position of the center-of-gravity (C.G.).

Palmer and Haley (1988) showed a simple modification of the current retention assembly significantly reduced elongation and increased the strength of the chinstrap. Recently, a new modified yoke harness incorporating the features described by Palmer and Haley (1988), was designed at USAARL and later constructed by Gentex Corporation. Gentex also designed a similar but different retention assembly having a swivel chinstrap. The objectives of this report were: (1) To compare the chinstrap strength and elongation of the USAARL yoke harness and the Gentex swivel yoke harness to that of the standard retention harness, (2) to compare the forward and rearward helmet rotation allowed by the two yoke harnesses to that allowed by the standard retention harness, and (3) to subjectively compare the wearing comfort of the USAARL yoke harness and the standard retention harness.

Materials

The final configuration of the USAARL yoke harness was obtained from the Gentex Corporation under the auspices of a written agreement dated 28 April 1989. It was constructed in a manner similar to a prototype assembly developed by Palmer and

Haley (1988). The Gentex swivel yoke harnesses* (Gentex Part no. 89D-7639) were provided by Gentex. The USAARL yoke harness shown in Figures 1 and 2 evolved from laboratory and field studies over a period of several months. The evaluation and testing of the USAARL yoke harness included a comfort wearing test in which pilots donned and doffed an SPH-4 with the USAARL yoke harness installed.

The USAARL yoke harness is a modified universal retention assembly with Gentex number 14AL crushable earcups* installed. The attachment points of the USAARL yoke harness are further apart than those of the current retention assembly and the Gentex swivel yoke harness (Figure 3) in order to increase the pitch rotational resistance of the assembly.

The forward mounting position of the USAARL yoke harness uses the lower visor hole (Figure 4) which is located 0.9 inches forward and 0.2 inches below the current harness attachment point. The rearward attachment point uses the headband clip hole located 1.1 inches rearward and 0.6 inches below the current rear attachment point.

The USAARL yoke harness was tied directly into the shell using 0.75-inch width tubular (existing chinstrap) webbing. Eyelets inserted into the tubular chinstrap webbing were reinforced with a stitch pattern as shown in Figure 1. Reinforcement of the eyelets in this fashion reduced deformation and allowed each attachment point to withstand loads of at least 150 pounds. This value is equal to the strength of the attachment points on motorcycle helmets. Also, it provides allowance for decrease of strength with age and usage. The chinstrap webbing was reinforced with 0.5-inch Kevlar™ tape which was added to minimize elongation of the chinstrap. A plastic (nylon) tab stiffener was sewn into the end of the chinstrap to ease the threading of the chinstrap through the double "D" ring release buckles. Diameter of the D-rings was 0.11 inches. A leather tab (1.75 inches x 0.19 inches, 50-lb strength) was affixed to the inner "D"-ring.

A shell-to-nape tie-down strap (1 inch wide x 5 inches long) was provided to limit the rotation of the shell away from the napestrap (see Figure 1). A 2-inch length of Velcro™ pile was sewn into the lower end of the tie-down strap so that it could be directly hooked into the Velcro™ of the adjustable napestrap. The tie-down strap concept was suggested and developed by Gentex Corporation development engineer Richard Long.

* See list of manufacturers

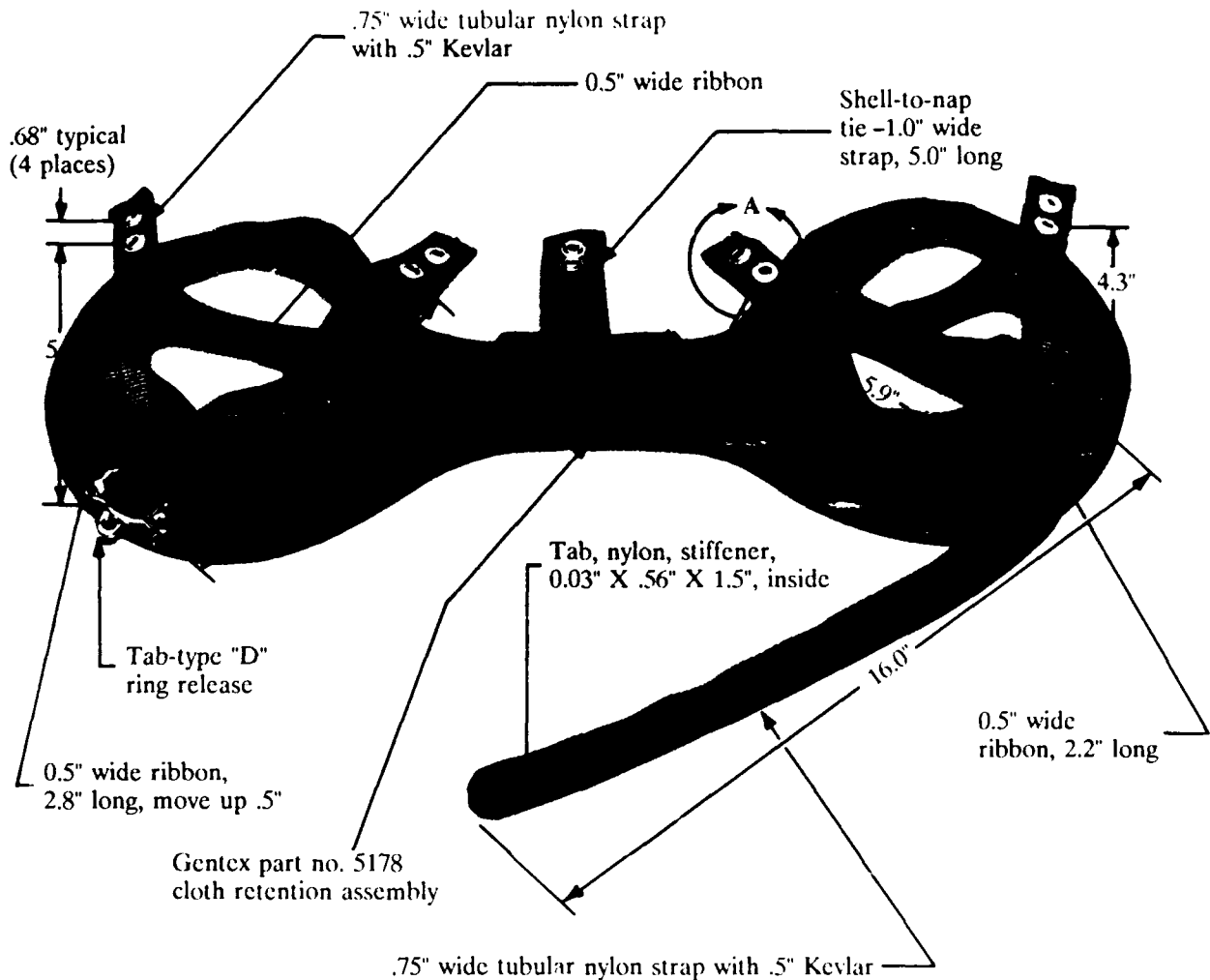

MIL-T-43636
 thread, nylon,
 FSN 8310-492-8397
 strength = 15 lb minimum

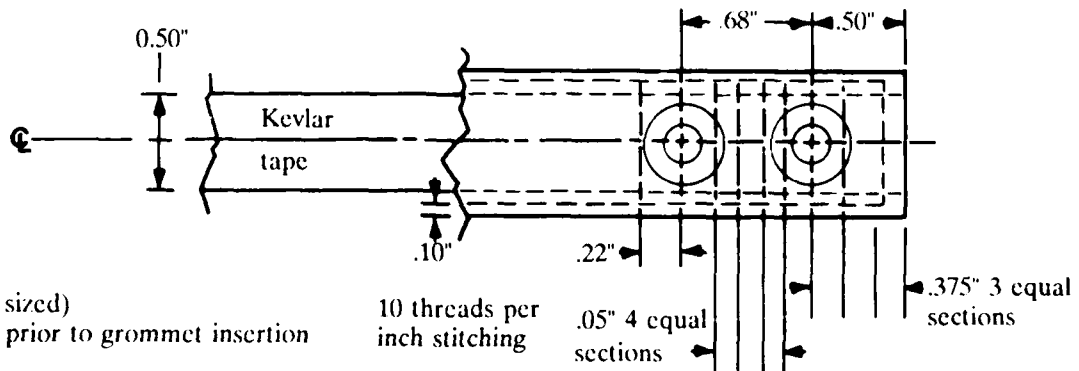
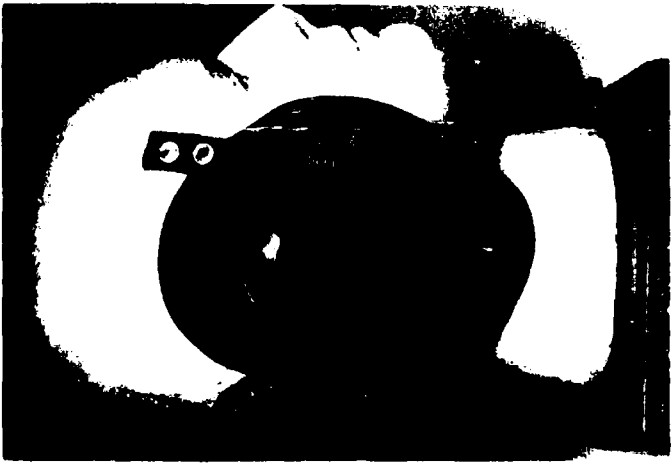

Figure 1. Final configuration of the USAARL yoke harness.



Right side view



Left side view

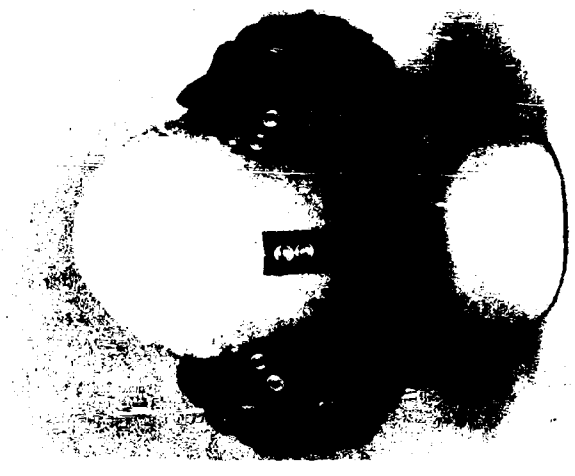

Rear view

Figure 2. The USAARL yoke harness mounted on headform.

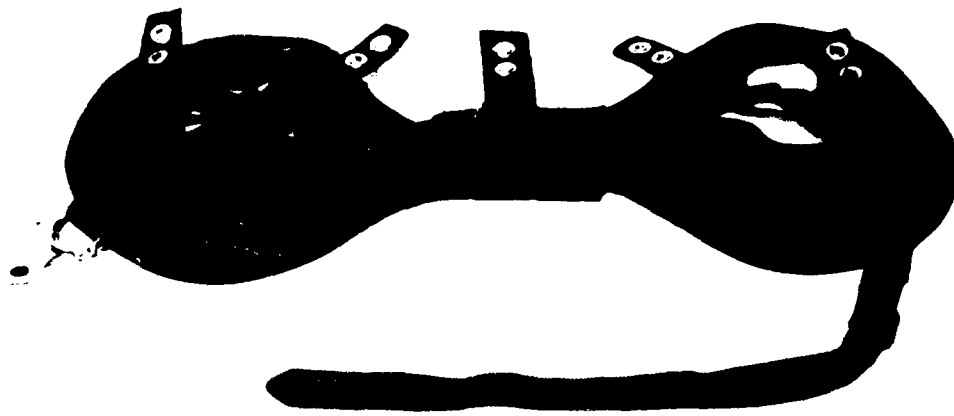

Figure 3. Photographs of Gentex swivel yoke harness.

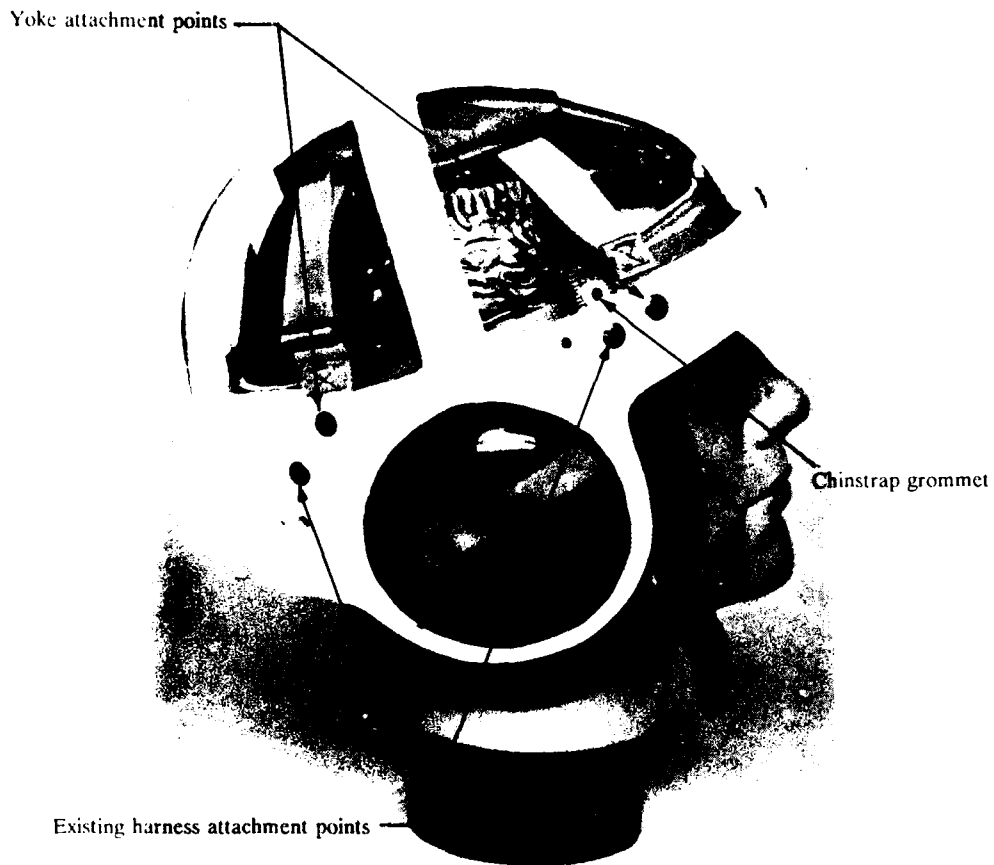

Figure 4. Right side view of the USAARL yoke harness in a skeletal helmet.

Methods

All testing was conducted with standard SPH-4 shells fitted with thermoplastic liners* (TPLTM). The USAARL yoke harness, Gentex swivel yoke harness, and the standard SPH-4 harness were tested for chinstrap strength, elongation, and helmet displacement using current USAARL testing methods. Only the standard harness and USAARL yoke harness were tested for wearer comfort.

The chinstrap tensile strength was measured according to MIL-H-43925 using a Tinius-Olson Locap testing machine*. A 600-lb Revere load cell* was used. Speed was 1.5 inches per minute.

A dynamic helmet retention harness testing device (Vyrnwy-Jones, Paschal, and Palmer, 1989) was used to measure helmet rotational displacement (Figure 5). This device consisted of a Hybrid III headform and neck assembly mounted on a pendulum beam. A simulated "crash" was created when the beam swung against a motion-arresting impact attenuator. The beam simulated an aviator's chest while the attenuator acted as the restraint harness. Upon impact, the "chest" velocity reduced to zero, but the head continued to move due to the humanoid (flexible) neck. The chest deceleration was provided by a 3-inch thick cardboard honeycomb pad and a 1-inch thick foam pad. The peak G provided by the honeycomb varied from 26 to 30 G. A typical example of deceleration experienced by the pendulum "chest" is shown in Figure 6 which shows a peak G value of 28 G. The approximate velocity was 16 fps at the headform C.G. Each test deceleration pulse was filtered at 1600 Hertz.

The simulated chest deceleration of 26-30 G peak is equal to the 95th percentile G level as stated in the Crash Survival Design Guide (Dynamic Science Engineering Corporation, 1971). However, the velocity of 16 fps is only the 10th percentile, a relatively short duration pulse, i.e., a moderate level "crash" pulse.

Helmets were fitted to the Hybrid III* headform and neck to simulate a "snug" fit on the wearer. Both the chin- and nape-straps were cinched to 10 lb to assure consistency. These values were reasonable, based on reported comfort from human trials. It should be emphasized that accident histories have shown that these straps frequently were worn more loosely than were tested.

The "chest" impact and resultant headform flail and helmet rotation were recorded by high speed video at 1,000 frames per second. Video data were digitized and reduced by computer. Mean values for forward and rearward rotational displacement were tested using one-way analysis of variance and the Student-Newman-Keuls multiple comparison test (Steel and Torrie, 1980).

Typical displacement of the standard SPH-4 helmet during a pendulum test is illustrated in Figure 7. Note the helmet displaced upward (lofted), then rotated forward and downward to the tip of the nose and rebounded enough to expose the frontal area of the head.

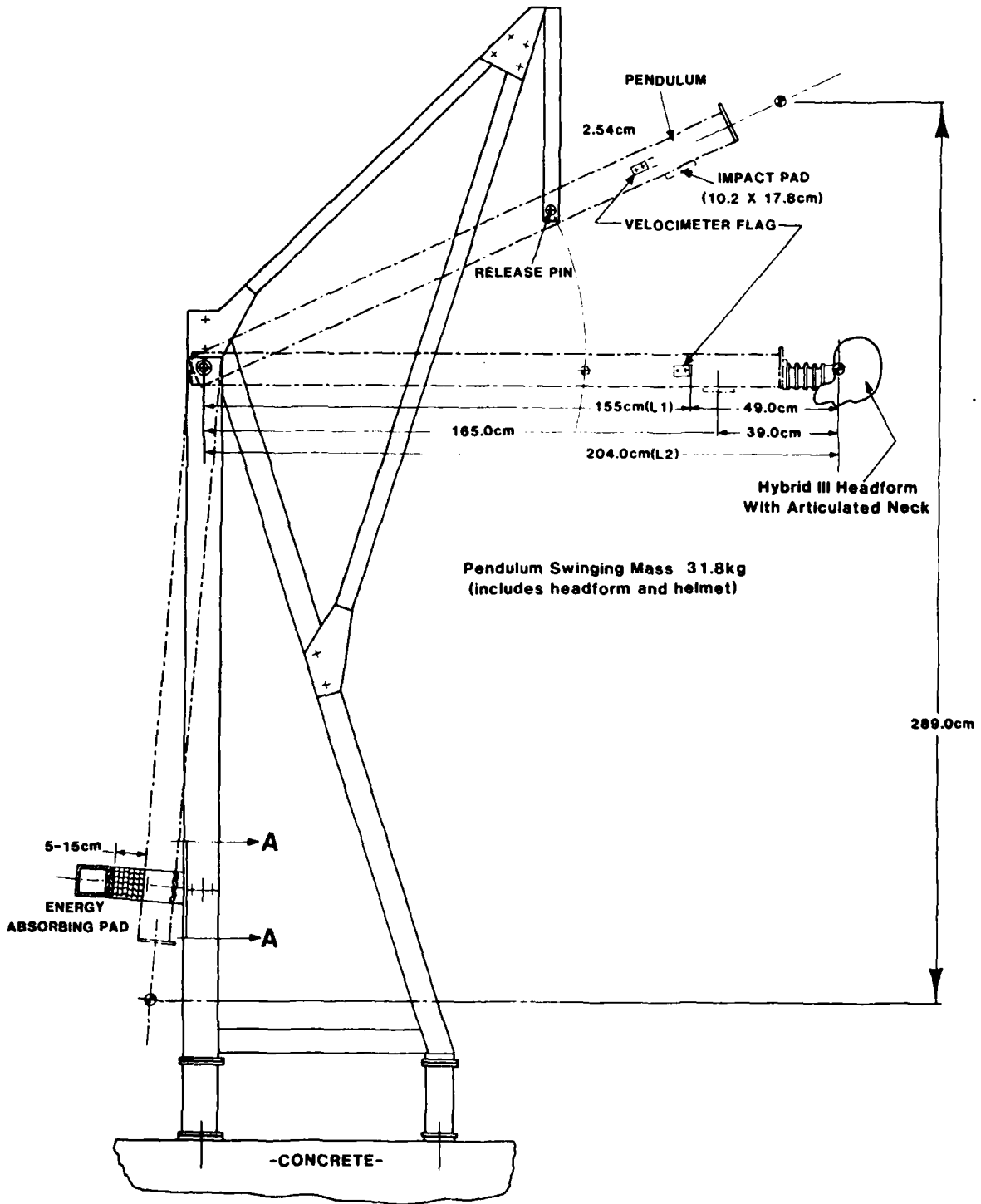

Figure 5. Helmet retention harness pendulum tester.

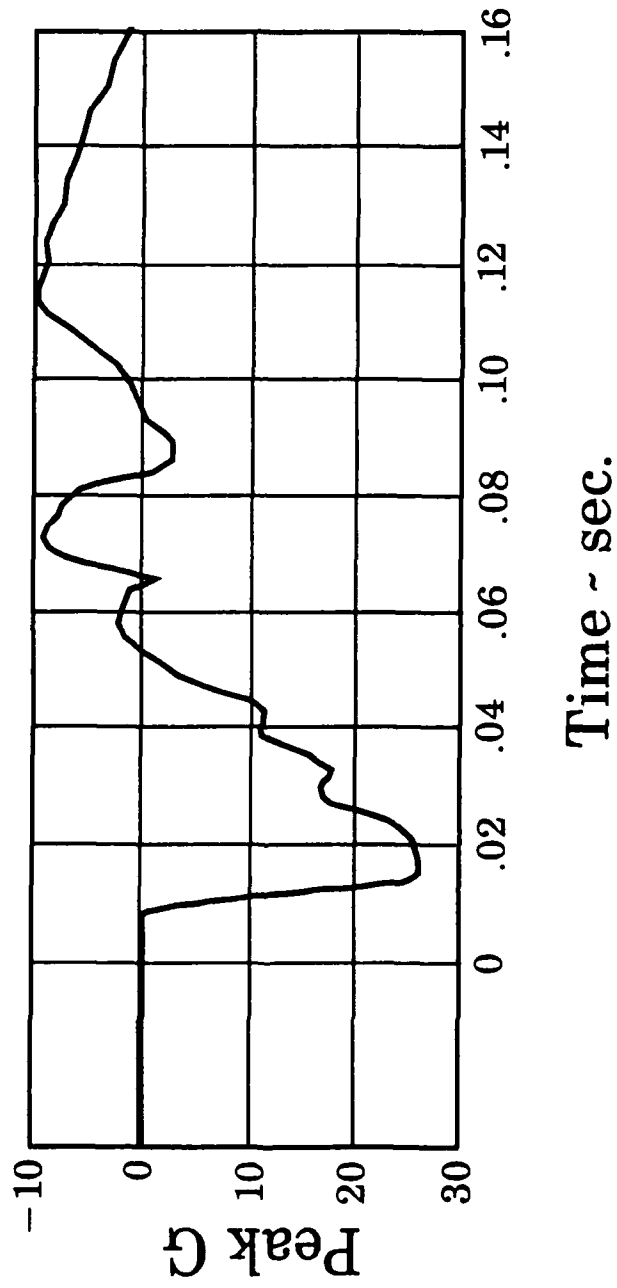

Figure 6. Typical pulse experienced by the "chest" of the pendulum tester.

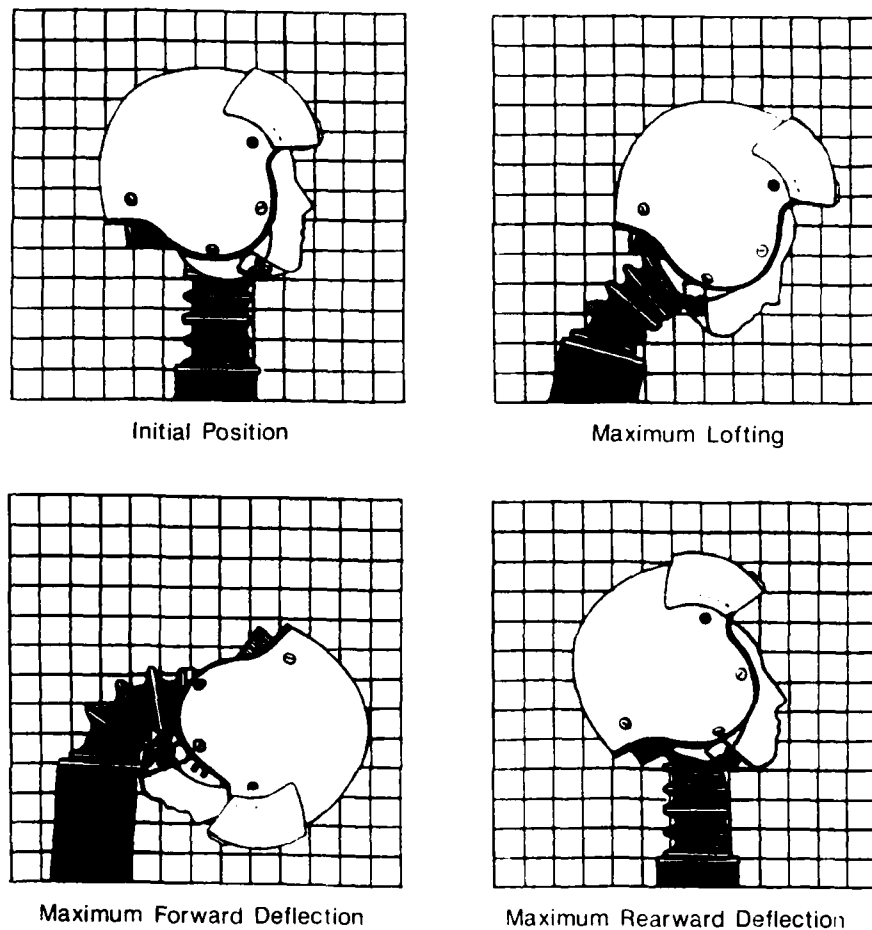

Figure 7. Typical helmet displacement on the Hybrid III headform in the pendulum tests.

To assess wearer comfort, a donning and doffing test was conducted using 29 aviators. This test compared two helmet configurations. The first helmet consisted of a TPL™ retrofit SPH-4 with a standard retention harness. (The TPL™ kit includes a 5/8-inch thick foam liner and the four-layer, pebbled plastic fitting pad). The second helmet consisted of a TPL™ retrofit SPH-4 with the USAARL yoke harness. The test subjects were instructed to don the helmet, wear it for 10 minutes, then remove the helmet. Immediately after removing the helmet, they answered a questionnaire relating to: (1) General overall comfort, (2) sound attenuation, (3) donning and doffing, (4) comfort of the double D-ring release buckle, and (5) preference.

Results

Chinstrap "pull test" results are shown in Figures 8 and 9. The USAARL yoke and the Gentex swivel yoke harnesses stretched less than the standard SPH-4 harness. The Gentex swivel yoke harness elongated more than the USAARL yoke harness when measured at the same load with or without the TPL™ installed. Both the USAARL yoke harness and the Gentex swivel yoke harness surpassed the HGU-56 strength requirement of 440 pounds.

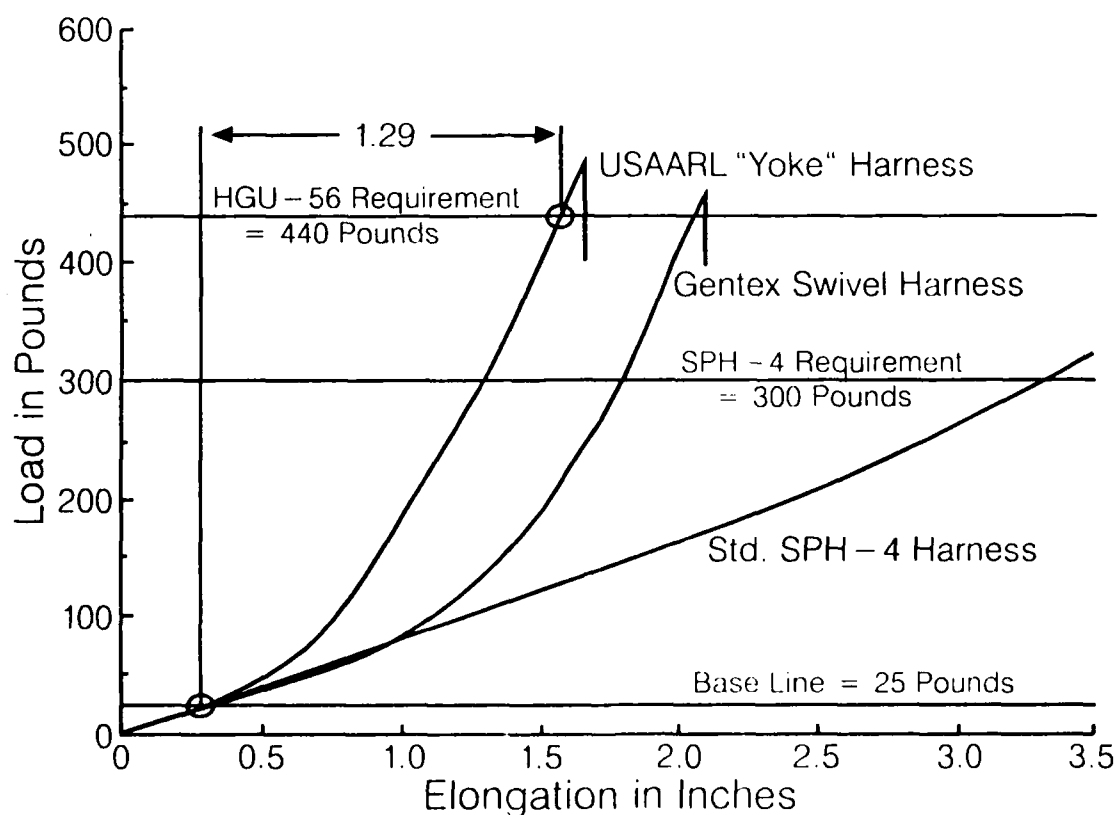

Figure 8. Chinstrap "pull" test on the standard, USAARL, and Gentex swivel yoke harnesses, all helmets equipped with a TPL™.

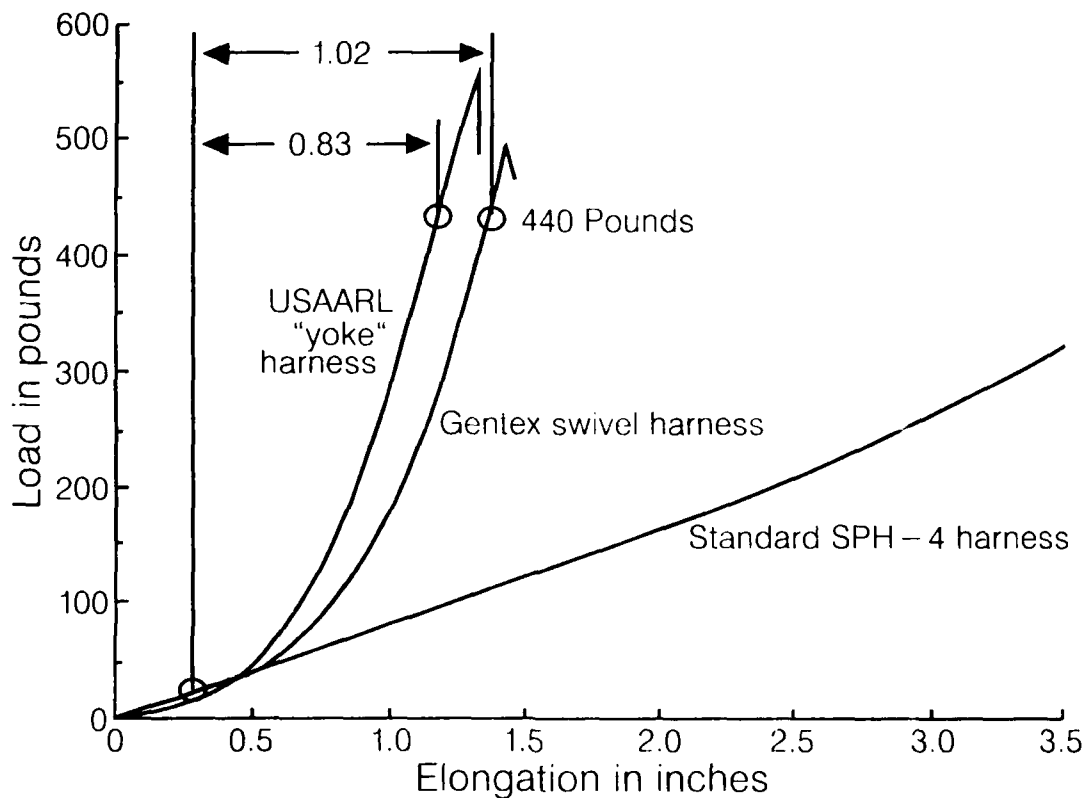

Figure 9. Chinstrap "pull" test with standard, USAARL, and Gentex swivel yoke harnesses using a helmet liner without a TPL™.

The pendulum test results are presented in Table 1. The standard retention assembly allowed more forward and rearward helmet rotation to occur than did either the USAARL yoke harness or the Gentex swivel yoke harness. Statistically, the USAARL yoke harness and the swivel yoke harness did not differ.

The results of the donning and doffing test with 29 aviators are shown in Table 2. Note a majority of the aviators critiqued the USAARL yoke harness as an improvement over the standard SPH-4 harness.

Table 1.

Forward and rearward rotations of the standard retention assembly, yoke retention assembly, and Gentex swivel yoke retention.

Assembly type	Number tests	Forward rotation (deg)	Rearward rotation (deg)
Standard SPH-4	8	16.3 ± 1.7 ^a	40.9 ± 3.3 ^a
USAARL yoke	8	9.0 ± 1.0 ^b	23.1 ± 3.3 ^b
Gentex swivel yoke	6	12.0 ± 1.3 ^b	19.3 ± 2.6 ^b

Note: Values are means ± standard error of mean (SEM). Different letters within a column indicate means differ (p=0.05).

Table 2.

Volunteer "don-doff" comparative critique of standard SPH-4 retention harness to the USAARL "yoke" retention harness.

	Improved	No difference	Decreased
Comfort	72.4%	17.2%	6.9%
Noise attenuation	79.3%	17.2%	3.5%
Ease of donning and doffing	0.0%	75.9%	24.1%
Comfort with D-ring	0.0%	86.2%	13.8%

Discussion

As mentioned in the introduction, the existing SPH-4 retention harness permits excessive helmet shell fore-aft rotation when the helmet is exposed to either operational torque caused by

visual enhancement devices or crash-induced inertial or tangential impact forces. Palmer and Haley theorized the rotational displacement could be reduced by reducing the chinstrap elongation and by providing a "yoke" shape chinstrap. The "yoke" shape, low elongation type retention harness was developed further in our laboratory trials to maximize its performance in the SPH-4 type helmet.

The preceding results have shown the USAARL yoke and the Gentex swivel yoke harnesses perform better than the standard SPH-4 harness because of the following: (1) The double snaps were replaced with tab-type "D" rings which provide higher strength and reliability ("D" rings have been used and proven effective in motorcycle helmets over the past 30 years), (2) the earcup retainer cloth was reinforced by a nylon-Kevlar™ "yoke" chinstrap which reduced the elongation of the assembly and reduced the rotational displacement of the helmet under inertial forces, (3) the current standard chinstrap sustained a load of 280 pounds, but the USAARL and Gentex yoke harnesses sustained 440 pounds (Figure 8) to ensure adequate resistance to asymmetric loads under tangential crash forces, (4) the USAARL yoke harness was judged by the 29 aviators to be slightly superior in sound attenuation because this type harness promotes a better earcup seal as the yoke chinstraps pull inward on the cups during tightening, and (5) the yoke harness offered enhanced stability and limited forward and rearward helmet displacement during normal wear in the cockpit.

When compared to the standard harness, both the USAARL and Gentex yoke harnesses stretched less than half as much. This stretch reduction is assumed to be the cause for the improved performance of the yoke harness over that of the standard harness on the pendulum device.

Although the Gentex swivel yoke harness and the USAARL yoke harness produced similar results in the pendulum tests, chinstrap pull tests definitely showed that less elongation occurred in the USAARL yoke harness than in the Gentex swivel yoke harness (Figures 8 and 9). Theoretically, the USAARL yoke should be superior to the Gentex swivel yoke because the lesser vertical displacement helped prevent forward or rearward rotation on the head.

Using the lowest visor hole for the forward attachment of the USAARL yoke to the shell requires a redesign of the TPL™ to include a depression in the foam liner to allow for the thickness of the anchor nut. The visor anchor nut should be increased in length by 0.10-in length to accommodate the addition of the 0.10-in thick chinstrap grommet (Figure 4). Insertion of the longer nut without causing damage to the TPL™ is a delicate task, but the procedure could be simplified by the use of a special anchor

nut gripping tool, or by the use of cement to hold the nut permanently.

The forward chinstrap anchorage point should be as far forward as is feasible, but if installation of the visor anchor nut simply is too tedious to consider for reasonably rapid production, the anchorage point can be moved rearward. For retrofit, the point can be the existing hole used for the forward anchor of the earcup cross strap; for new production SPH-4 helmets, the cross strap should be moved forward 0.4 inches and downward 0.2 inches. The new location would still function as the cross strap anchor hole, but provide the widest "yoke" possible for the chinstrap anchor point. Adequate flexibility exists in the yoke harness configuration to permit its usage in either location so that retrofit or production harnesses would be identical.

Conclusions

1. The USAARL yoke harness is stronger than the standard harness.
2. The USAARL yoke harness stretches less than the Gentex swivel yoke harness and the standard harness.
3. The USAARL yoke harness and the Gentex swivel yoke harness allow less helmet rotation than the standard harness.
4. The majority (72 percent) of aviators who wore the USAARL yoke harness preferred it over the standard harness.
5. The USAARL yoke harness easily sustains a 440-lb load (HGU-56 requirement).

Recommendations

1. Recommend replacing the standard SPH-4 harness with a "yoke" type harness as soon as possible.
2. The replacement yoke harness should be required to sustain a 440-lb load with less than 1.0-inch elongation between 25 and 440 pound loads.
3. Each of the four chinstrap attachments grommets should be tested to 150 pounds to ensure it does not loosen in the webbing after field use.

References

- Department of the Army. 1975. Helmet, flyers protection, SPH-4. Natick, MA: U.S. Army Natick Research and Development Command. MIL-H-43925.
- Dynamic Science Engineering Operations. 1971. Crash survival design guide. Fort Eustis, VA: U.S. Army Air Mobility Research and Development Laboratory. USAAMRDL Report No. 71-22.
- Gruver, D. M., and Haley, J. L. 1988. Development of a test method for evaluating the effectiveness of helmet retention systems. Fort Rucker, AL: U.S. Army Aeromedical Research Laboratory. USAARL LR-88-5-4-3.
- Palmer, R. W., and Haley, J. L. 1988. SPH-4 helmet retention assembly reinforcement. Fort Rucker, AL: U.S. Army Aeromedical Research Laboratory. USAARL LR-88-10.
- Steel, Robert G. D., and Torrie, James H. 1980. Principles and procedures of statistics. NY: McGraw-Hill, Inc.
- Vyrnwy-Jones, P., Paschal, C. R., and Palmer, R. W. 1989. Evaluation of helmet retention systems using a pendulum device. Fort Rucker, AL: U.S. Army Aeromedical Research Laboratory. USAARL Report No. 89-27.
- Vyrnwy-Jones, Peter, Lanoue, Bernard, and Pritts, Douglas. 1988. SPH-4 U.S. Army flight helmet performance 1983-1987. Fort Rucker, AL: U.S. Army Aeromedical Research Laboratory. USAARL Report No. 88-15.

Correspondence:

Cooperative Research Agreement between Gentex Corporation, Carbondale, PA, and U.S. Army Aeromedical Research Laboratory, Fort Rucker, AL, 28 April 1989.

Appendix A.

List of equipment manufacturers

Belding Corticelli Thread Company
1430 - T Broadway
New York, NY 10018

General Motors Corporation
3044-T West Grand Boulevard
Detroit, MI 48202

Gentex Corporation
P.O. Box 315
Carbondale, PA 18467

GHI Systems
Randros Palos Verdes, CA

Humanoid System
Division of Humanetics Corporation
17022 Montanero Street
Carson, CA 90746

John Chatillon and Sons
83-30 Kew Gardens Road
Kew Gardens, NY 11415

Kistler Instruments AAAG
Winterthur, Switzerland

Nicolet Instrument Corporation
Oscilloscope Division
5225 Verona Road
Madison, WI 53711

Spin Physics 2000, Kodak
3099 Science Park Road
San Diego, CA 92121-1011

Tinius-Olsen Testing Machine Company, Inc.
Easton Road, Box 429
Willow Grove, PA 19090

Initial distribution

Commander
U.S. Army Natick Research
and Development Center
ATTN: Documents Librarian
Natick, MA 01760

Naval Submarine Medical
Research Laboratory
Medical Library, Naval Sub Base
Box 900
Groton, CT 06340

Commander/Director
U.S. Army Combat Surveillance
& Target Acquisition Lab
ATTN: DELCS-D
Fort Monmouth, NJ 07703-5304

Commander
10th Medical Laboratory
ATTN: Audiologist
APO New York 09180

Commander
Naval Air Development Center
Biophysics Lab
ATTN: G. Kydd
Code 60B1
Warminster, PA 18974

Naval Air Development Center
Technical Information Division
Technical Support Detachment
Warminster, PA 18974

Commanding Officer
Naval Medical Research
and Development Command
National Naval Medical Center
Bethesda, MD 20014

Under Secretary of Defense
for Research and Engineering
ATTN: Military Assistant
for Medical and Life Sciences
Washington, DC 20301

Commander
U.S. Army Research Institute
of Environmental Medicine
Natick, MA 01760

U.S. Army Avionics Research
and Development Activity
ATTN: SAVAA-P-TP
Fort Monmouth, NJ 07703-5401

U.S. Army Research and Development
Support Activity
Fort Monmouth, NJ 07703

Chief, Benet Weapons Laboratory
LCWSL, USA ARRADCOM
ATTN: DRDAR-LCB-TL
Watervliet Arsenal, NY 12189

Commander
Man-Machine Integration System
Code 602
Naval Air Development Center
Warminster, PA 18974

Commander
Naval Air Development Center
ATTN: Code 6021 (Mr. Brindle)
Warminster, PA 18974

Commanding Officer
Harry G. Armstrong Aerospace
Medical Research Laboratory
Wright-Patterson
Air Force Base, OH 45433

Director
Army Audiology and Speech Center
Walter Reed Army Medical Center
Washington, DC 20307-5001

Director
Walter Reed Army Institute
of Research
Washington, DC 20307-5100

HQ DA (DASG-PSP-0)
5109 Leesburg Pike
Falls Church, VA 22041-3258

Naval Research
Laboratory Library
Code 1433
Washington, DC 20375

Harry Diamond Laboratories
ATTN: Technical Infor-
mation Branch
2800 Powder Mill Road
Adelphi, MD 20783-1197

U.S. Army Materiel Systems
Analysis Agency
ATTN: Reports Processing
Aberdeen proving Ground
MD 21005-5017

U.S. Army Ordnance Center
and School Library
Building 3071
Aberdeen Proving Ground,
MD 21005-5201

U.S. Army Environmental Hygiene
Agency
Building E2100
Aberdeen Proving Ground,
MD 21010

Technical Library
Chemical Research
and Development Center
Aberdeen Proving Ground,
MD 21010-5423

Commander
U.S. Army Institute
of Dental Research
Walter Reed Army Medical Center
Washington, DC 20307-5300

Naval Air Systems Command
Technical Air Library 950D
Rm 278, Jefferson Plaza II
Department of the Navy
Washington, DC 20361

Naval Research Laboratory Library
Shock and Vibration Infor-
mation Center, Code 5804
Washington, DC 20375

Director
U.S. Army Human Engineer-
ing Laboratory
ATTN: Technical Library
Aberdeen Proving Ground,
MD 21005-5001

Commander
U.S. Army Test
and Evaluation Command
ATTN: AMSTE-AD-H
Aberdeen Proving Ground,
MD 21005-5055

Director
U.S. Army Ballistic
Research Laboratory
ATTN: DRXBR-OD-ST Tech Reports
Aberdeen Proving Ground,
MD 21005-5066

Commander
U.S. Army Medical Research
Institute of Chemical Defense
ATTN: SGRD-UV-AO
Aberdeen Proving Ground,
MD 21010-5425

Commander
U.S. Army Medical Research
and Development Command
ATTN: SGRD-RMS (Ms. Madigan)
Fort Detrick, Frederick,
MD 21701

Commander
U.S. Army Medical Research
Institute of Infectious Diseases
Fort Detrick, Frederick,
MD 21701

Director, Biological
Sciences Division
Office of Naval Research
600 North Quincy Street
Arlington, VA 22217

Commander
U.S. Army Materiel Command
ATTN: AMCDE-XS
5001 Eisenhower Avenue
Alexandria, VA 22333

Commandant
U.S. Army Aviation
Logistics School
ATTN: ATSQ-TDN
Fort Eustis, VA 23604

U.S. Army Training
and Doctrine Command
ATTN: ATCD-ZX
Fort Monroe, VA 23651

Structures Laboratory Library
USARTL-AVSCOM
NASA Langley Research Center
Mail Stop 266
Hampton, VA 23665

Naval Aerospace Medical
Institute Library
Bldg 1953, Code 102
Pensacola, FL 32508

Command Surgeon
U.S. Central Command
MacDill Air Force Base
FL 33608

Air University Library
(AUL/LSE)
Maxwell AFB, AL 36112

Commander
U.S. Army Biomedical Research
and Development Laboratory
ATTN: SGRD-UBZ-I
Fort Detrick, Frederick,
MD 21701

Defense Technical
Information Center
Cameron Station
Alexandria, VA 22313

U.S. Army Foreign Science
and Technology Center
ATTN: MTZ
220 7th Street, NE
Charlottesville, VA 22901-5396

Director,
Applied Technology Laboratory
USARTL-AVSCOM
ATTN: Library, Building 401
Fort Eustis, VA 23604

U.S. Army Training
and Doctrine Command
ATTN: Surgeon
Fort Monroe, VA 23651-5000

Aviation Medicine Clinic
TMC #22, SAAF
Fort Bragg, NC 28305

U.S. Air Force Armament
Development and Test Center
Eglin Air Force Base, FL 32542

U.S. Army Missile Command
Redstone Scientific
Information Center
ATTN: Documents Section
Redstone Arsenal, AL 35898-5241

U.S. Army Research and Technology
Laboratories (AVSCOM)
Propulsion Laboratory MS 302-2
NASA Lewis Research Center
Cleveland, OH 44135

AFAMRL/HEX
Wright-Patterson AFB, OH 45433

University of Michigan
NASA Center of Excellence
in Man-Systems Research
ATTN: R. G. Snyder, Director
Ann Arbor, MI 48109

John A. Dellinger,
Southwest Research Institute
P. O. Box 28510
San Antonio, TX 78284

Product Manager
Aviation Life Support Equipment
ATTN: AMCPM-ALSE
4300 Goodfellow Blvd.
St. Louis, MO 63120-1798

Commander
U.S. Army Aviation
Systems Command
ATTN: AMSAV-ED
4300 Goodfellow Blvd
St. Louis, MO 63120

Commanding Officer
Naval Biodynamics Laboratory
P.O. Box 24907
New Orleans, LA 70189

U.S. Army Field Artillery School
ATTN: Library
Snow Hall, Room 14
Fort Sill, OK 73503

Commander
U.S. Army Health Services Command
ATTN: HSOP-SO
Fort Sam Houston, TX 78234-6000

U.S. Air Force Institute
of Technology (AFIT/LDEE)
Building 640, Area B
Wright-Patterson AFB, OH 45433

Henry L. Taylor
Director, Institute of Aviation
University of Illinois-
Willard Airport
Savoy, IL 61874

COL Craig L. Urbauer, Chief
Office of Army Surgeon General
National Guard Bureau
Washington, DC 50310-2500

Commander
U.S. Army Aviation
Systems Command
ATTN: SGRD-UAX-AL (MAJ Lacy)
4300 Goodfellow Blvd., Bldg 105
St. Louis, MO 63120

U.S. Army Aviation Systems Command
Library and Information
Center Branch
ATTN: AMSAV-DIL
4300 Goodfellow Blvd
St. Louis, MO 63120

Federal Aviation Administration
Civil Aeromedical Institute
CAMI Library AAC 64D1
P.O. Box 25082
Oklahoma City, OK 73125

Commander
U.S. Army Academy
of Health Sciences
ATTN: Library
Fort Sam Houston, TX 78234

Commander
U.S. Army Institute
of Surgical Research
ATTN: SGRD-USM (Jan Duke)
Fort Sam Houston, TX 78234-6200

Director of Professional Services
AFMSC/GSP
Brooks Air Force Base, TX 78235

U.S. Army Dugway Proving Ground
Technical Library
Bldg 5330
Dugway, UT 84022

U.S. Army Yuma Proving Ground
Technical Library
Yuma, AZ 85364

AFFTC Technical Library
6520 TESTG/ENXL
Edwards Air Force Base,
CAL 93523-5000

Commander
Code 3431
Naval Weapons Center
China Lake, CA 93555

Aeromechanics Laboratory
U.S. Army Research
and Technical Labs
Ames Research Center,
M/S 215-1
Moffett Field, CA 94035

Sixth U.S. Army
ATTN: SMA
Presidio of San Francisco,
CA 94129

Commander
U.S. Army Aeromedical Center
Fort Rucker, AL 36362

U.S. Air Force School
of Aerospace Medicine
Strughold Aeromedical Library
Documents Section, USAFSAM/TSK-4
Brooks Air Force Base, TX 78235

Dr. Diane Damos
Department of Human Factors
ISSM, USC
Los Angeles, CA 90089-0021

U.S. Army White Sands
Missile Range
Technical Library Division
White Sands Missile Range,
NM 88002

U.S. Army Aviation Engineering
Flight Activity
ATTN: SAVTE-M (Tech Lib)
Stop 217
Edwards Air Force Base,
CA 93523-5000

Ms. Sandra G. Hart
Ames Research Center
MS 239-5
Moffett Field, CA 94035

Commander
Letterman Army Institute
of Research
ATTN: Medical Research Library
Presidio of San Francisco,
CA 94129

Mr. Frank J. Stagnaro, ME
Rush Franklin Publishing
300 Orchard City Drive
Campbell, CA 95008

Commander
U.S. Army Medical Materiel
Development Activity
Fort Detrick, Frederick,
MD 21701-5009

Commander, U.S. Army
Aviation Center
Directorate
of Combat Developments
Bldg 507
Fort Rucker, AL 36362

Chief
Army Research Institute
Field Unit
Fort Rucker, AL 36362

Commander
U.S. Army Safety Center
Fort Rucker, AL 36362

U.S. Army Aircraft Development
Test Activity
ATTN: STEBG-MP-QA
Cairns AAF
Fort Rucker, AL 36362

Commander
U.S. Army Medical Research
and Development Command
ATTN: SGRD-PLC (COL Sedge)
Fort Detrick, Frederick
MD 21701

MAJ John Wilson
TRADOC Aviation LO
Embassy of the United States
APO New York 09777

Netherlands Army Liaison Office
Building 602
Fort Rucker, AL 36362

British Army Liaison Office
Building 602
Fort Rucker, AL 36362

Italian Army Liaison Office
Building 602
Fort Rucker, AL 36362

Directorate
of Training Development
Bldg 502
Fort Rucker, AL 36362

Chief
Human Engineering Laboratory
Field Unit
Fort Rucker, AL 36362

Commander
U.S. Army Aviation Center
and Fort Rucker
ATTN: ATZQ-T-ATL
Fort Rucker, AL 36362

President
U.S. Army Aviation Board
Cairns AAF
Fort Rucker, AL 36362

Dr. William E. McLean
Human Engineering Laboratory
ATTN: SLCHE-BR
Aberdeen Proving Ground,
MD 21005-5001

Canadian Army Liaison Office
Building 602
Fort Rucker, AL 36362

German Army Liaison Office
Building 602
Fort Rucker, AL 36362

French Army Liaison Office
Building 602
Fort Rucker, AL 36362

Brazilian Army Liaison Office
Building 602
Fort Rucker, AL 36362

Australian Army Liaison Office
Building 602
Fort Rucker, AL 36362

Dr. Garrison Rapmund
6 Burning Tree Court
Bethesda, MD 20817

Commandant
Royal Air Force Institute
of Aviation Medicine
Farnborough Hants UK GU14 6SZ

Dr. A. Kornfield, President
Biosearch Company
3016 Revere Road
Drexel Hill, PA 29026