

AD-A245 585

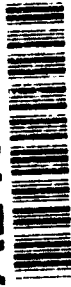

ATA

Applied
Technology
Associates, Inc.

STABILIZED SENSOR PLATFORM FOR MANNED SPACE OBSERVATION

DTIC
ELECTE
FEB 0 4 1992
S D

Phase I Results
SBIR AF90-140

Prepared for
Mission Planning Division
Space Test Program SSD/CLPD
Los Angeles AFB, CA

91-19096



by
Applied Technology Associates, Inc.

and

Rockwell International Space Systems Division

March 6, 1991

This document has been approved
for public release and sale; its
distribution is unlimited.

1

ATA

PRESENTATION PLAN

- Introduction
- Review of Project Plan and Technical Objectives
- Tasks 1 & 2 Results - System Requirements
- Task 3 Results - Stabilization Technology Concept
- Task 4 Results - SSPMSO Design & Verification
- Summary of Findings, Critical Questions, and Recommendations

Accession For	
NTIS CRA&I	<input checked="" type="checkbox"/>
DTIC TAB	<input type="checkbox"/>
Unannounced	<input type="checkbox"/>
Justification	
By <i>pm/ste</i>	
Dist. button /	
Availability Codes	
Dist	A-1
Avail and/or Spec	



ATA

INTRODUCTION

- **Purpose and Objective**
- **Problem Overview**
- **Key Thrusts**
- **SDIO/AF Starlab Replan**

ATA

PURPOSE AND OBJECTIVE

- **Purpose:**
 - **Present and Discuss the Phase I Findings, Results, and Recommendations**

- **Objective:**
 - **Establish Basis for Positive Decision on Proceeding Forward with Phase II**
 - **Create Foundation for Phase II Program Plan**

- **Man's Active Participation in Space Observation Experiments is Enhanced by:**
 - **High Magnification**
 - **Means to Capture Observations**
 - **Accurately Pointed and Stabilized Line-of-Sight**

- **Flexible, Effective Technology to Provide the Latter is the Primary Goal of This SBIR Project**

- **ATA/Rockwell Team Asserts That**
 - **Stabilization is Feasible by Integrating Several Innovative Components: Dynalens, MHD Inertial Angular Motion Sensor, and DSP-Based Digital Electronics**
 - **A Manual Gimbal Enhances Operations**

- **Understand Full Requirements Set for Crew Cabin Experiment Equipment**
 - **Performance**
 - **Operations**
 - **User Interactions**

- **Identify/Select Stabilization Concept That Addresses Performance Requirements**

- **Plan and Prioritize Phase II to Achieve Development and Demonstration of Critical Technology for SSPMSO**

ATA

STARLAB REPLAN

- **ATA/Rockwell Envisioned a First SSPMSO Flight with Starlab, But**
 - **SDIO Directed That Starlab as STS Mission Required Change**
 - **SDIO's ATP Experiment is Now a Freeflyer**

- **Joint SSPMSO/Starlab Experiment No Longer Valid Plan**

- **Identify and Document Technical Performance and Operational Requirements**
- **Identify and Interpret Design Constraints and Environments Which Must Be Recognized**
- **Select Technology/Configuration Which Fulfills Requirements Within Constraints**
- **Complete Design Documentation and Breadboard Validations**
- **Prepare/Present Phase II Plan to Accomplish On-Orbit Demonstration of Prototype**
- **Document Phase I Results**

REVIEW OF PROJECT PLAN AND TASKS AND SCHEDULE - PHASE I

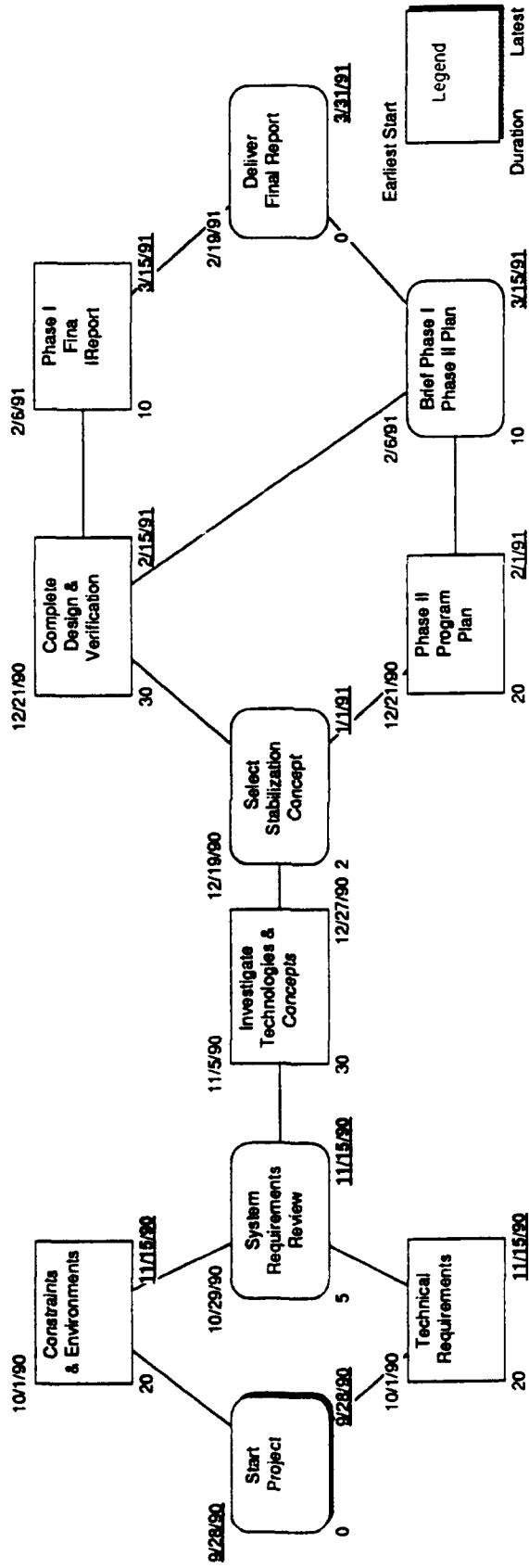

- **Overview of Task 1 and Task 2 Approaches**
- **SSPMO System Requirements Document**
- **Critical Requirements/Priorities**
- **Discussion of Selected Critical Requirements**

- **Baseline Typical STS Manned Observation Mission Parameters**
- **Baseline Typical Optical Payload**
- **Identify STS Crew Cabin Experiment Constraints and Environments**
- **Collect Information, Review, and Understand Implications**
- **Compile List of Requirements**

- 1) **Field of Regard of the Two Gimbal Axes**
- 2) **Accuracy of Gimbal Pointing**
- 3) **Allowable Residual Jitter of the Stabilized Line-of-Sight (LOS)**
- 4) **Slew Rate to Maintain the LOS on a Viewed Object**
- 5) **Range of Attached Optical Payload Mass Properties and Size Envelopes**
- 6) **Search and Acquisition Time to Center on Desired Object**
- 7) **Attachment Method for Optical Payload**
- 8) **User Interface Features**
- 9) **STS Interfaces**
- 10) **Optical Characteristics of Elements (If Any) Placed in the Viewing Path**
- 11) **Electrical Power**
- 12) **Environment**
- 13) **Thermal**
- 14) **Safety**
- 15) **Flammability, Odor, and Offgassing**
- 16) **Materials**
- 17) **Conducted and Radiated EMI Emissions**
- 18) **Electrical Isolation and Bonding**
- 19) **On-Orbit Setup, Temporary Stowage, and Stowage**
- 20) **Checkout and Operations**

- 1) **SBIR Problem Description, AF90-140**
- 2) **Quick Response Shuttle Payload for Department of Defense Space Test Program**
- 3) **Shuttle Orbiter/Cargo Standard Interfaces, ICD-2-19002**
- 4) **Shuttle/Payload Interface Definition Document for Middeck Accommodations, NSTS 21000 IDD MDK**
- 5) **Summary of DOD Secondary Payload Optical Systems for SSPMSO Study**
- 6) **Overhead Window Mounting Techniques**
- 7) **Proposal for the Design, Fabrication and Test of a 12-Inch Dynalens**
- 8) **Proposal for the Design and Fabrication of IMAX Image Motion Stabilizer**
- 9) **Optical V/H Image Motion Compensation System**
- 10) **Wideband Angular Vibration Experiment Quick-Look Reports Nos. 1 and 2**
- 11) **Beam Control System Modeling and Simulation - Interim Subtask Report for Subtask 03-06, Section 3.0 Remote Sensing System and Appendices A and B**
- 12) **Notes, Informal Communications, and Telephone Conferences**
- 13) **SDIO Space Shuttle Based Experiments for Acquisition, Tracking and Pointing (Definition of Space Shuttle Operational Environment)**
- 14) **Basic Theory of Window Degradation on an Optical System**
- 15) **Crew System Design Requirements, NASA Document XXXX**
- 16) **Payload Integration Plan, Annex 2, Flight Planning Services Black Book**

Parameters for Typical Orbits and Significant to Sensor Platform Design

<u>Parameter</u>	<u>Case 1</u>	<u>Case 2</u>
Orbit Altitude (km)	259	398
(Nautical Miles)	(140)	(215)
Earth Radius (km)	6,376	6,376
Orbit Radius (km)	6,636	6,774
STS Velocity (km/s)	7.75	7.67
Circular Distance (km)	41,693	42,566
Orbit Period (min)	89.6	92.5
Earth Pt Velocity (km/s)	0.46	0.46
STS to Earth Pt Ang Rate (rad/s)	0.028	0.018
Max Slant Range (STS to Earth Pt) (km)*	1,837	2,288
Viewing Half Angle(deg)*	16.1	19.7
Viewing Time (min)*	8.0	10.1

*The range of viewing angles from the orbiter to the earth target is influenced by atmospheric obfuscation. The tangential distance is an upper bound at which target search can be started. Considering the time to locate the target and the degradation caused by atmosphere, the maximum high quality viewing time is 4 minutes less than the listed values.

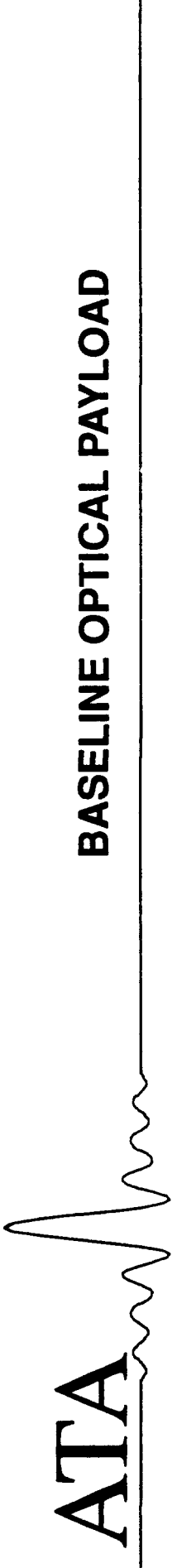

BASELINE OPTICAL PAYLOAD

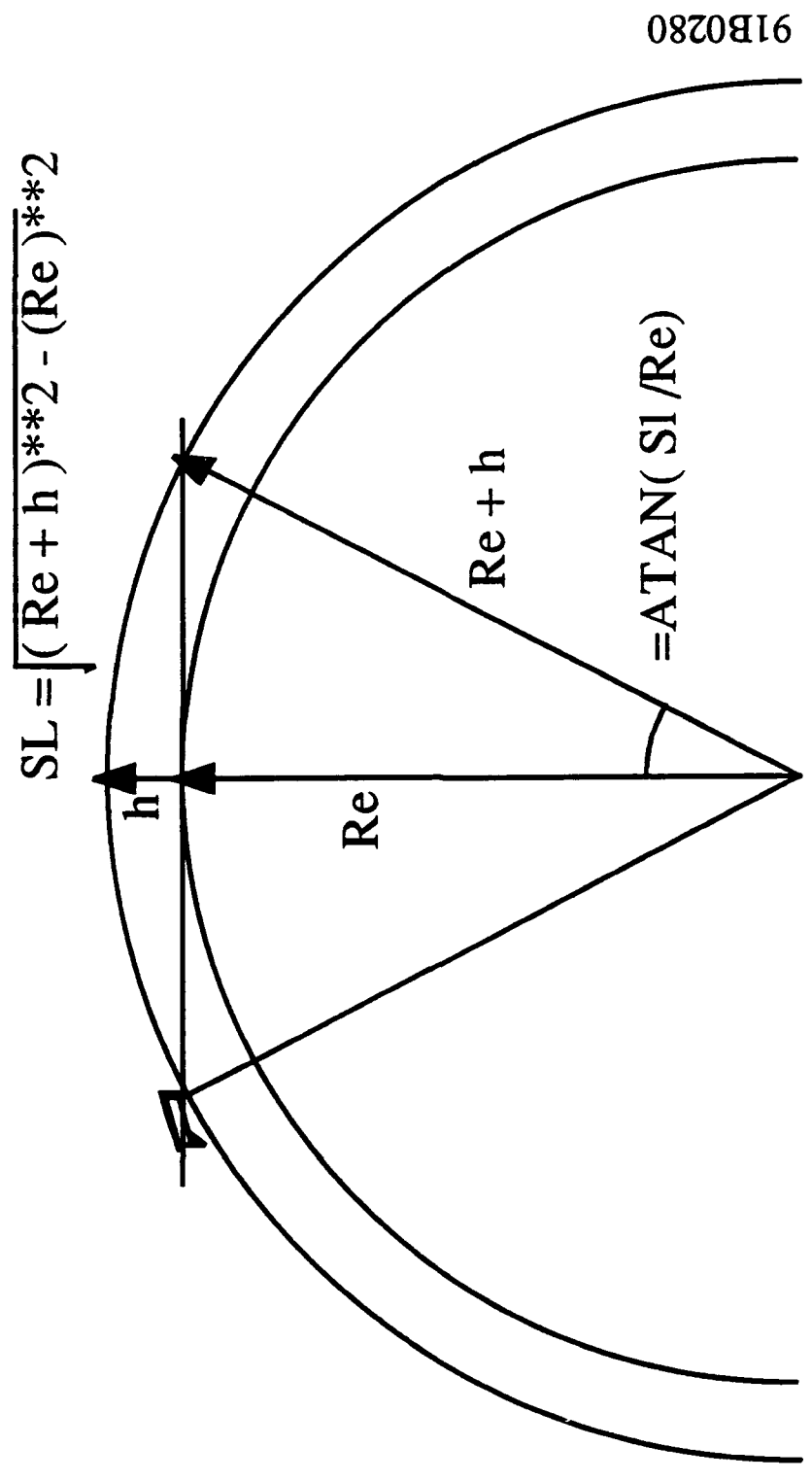

91B0280

Geometrical Relations for Calculating Viewing Parameters

- **Large Magnification Telescope**
 - Aperture 8" (203 mm) - FOV 0.6° (10 mrad)
 - Focal Length 90" (2032 mm) - Resolution 0.57 sec (2.7 μrad)
 - Focal Ratio 8/10 - Telescope Length 18.5" (470 mm)
 - Std Eyepiece 25 mm, Kelner, 81x - Telescope Weight 9.6 lb

- **Observation Recording Device (Camera/CCD)**

	<u>Dimensions (Inches)</u> <u>(L x W x D)</u>	<u>Typical</u> <u>Weight (lbs)</u>
- Camera and/or CCD	3 x 6 x 7	4
- Teleconverter	6 x 5.5 x 2.5	3.3
- Miscellaneous	4 x 2.5	0.25
	6 x 2.5 (Envelope)	1.0

- **Factors Which Govern Stabilization**
 - **Image Does Not Move Significantly in Relation to Resolution Diameter**
 - **8" Aperture Case Implies Resolution of 2.7 μ rad Diameter**
 - **Jitter (1- σ) \leq Resolution Radius**

- **Single "Snapshot" Observation Require Stabilization Only During Exposure Time Interval**
 - **Continuous Observation Implies "Snapshot" Stabilization Plus Subresolution Image Motion Between Observations**

- **SSPMO Stabilization Goal: Jitter \leq 1.0 μ rad (1- σ), All Frequencies Above 1 Hz**

- **Factors Which Govern**
 - **It Must Be Possible to Place and Hold a Viewed Object at a Location Withing the FOV, Say $\leq 10\%$ of FOV**
 - **FOV of 8" Aperture Celestron is 0.6° (10 mrad)**
 - **Drifts of Viewed Object During Observation Interval Should Be Correctable Within Capability of Manual Actions**

- **SSPMO Accuracy Goal: Position and Hold LOS Within 1 mrad of Designated Location**

- **Factors Which Govern**
 - **Provides Required Angular Degrees of Freedom for STS MSO Missions (>40° Along Track, >20° Cross Track)**
 - **Interfaces with STS Window Structures**
 - **Compatible with Middeck Locker Storage**
 - **Establishes and Maintains Alignment of Payload in Relation to Orbiter Reference System**
 - **Accommodates Attachment of SSPMSO Jitter Suppression and Digital Signal Processor Assemblies**
 - **Satisfies Applicable Requirements for Safety, Materials, and Operations**
 - **Low Risk to Manufacture**

- **Configuration Goal: Functional and Low Cost Manual Gimbal System Which Provides Upgrade Path for Future Fully Automated System**

ATA

MECHANICAL CONFIGURATION

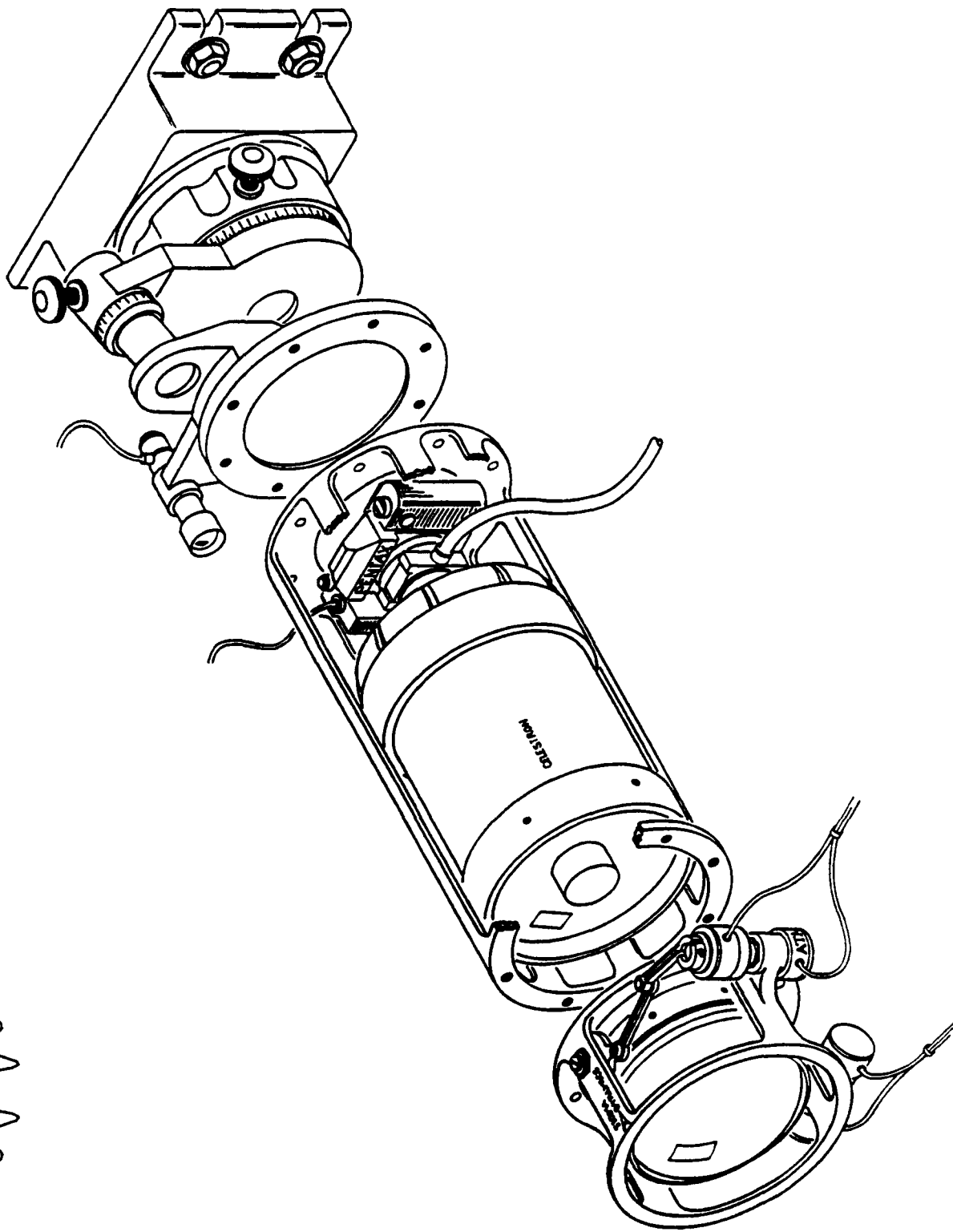

ATA

PAYLOAD FLEXIBILITY

- **SSPMO Mechanical Assembly is Modular**
- **Standardized Payload Carrier Facilitates Changeout of Payload/Carrier Assembly**
- **SSPMO Accommodates a Suite of Several Payloads by Making Carriers with a Variety of Internal Structures and Adaptors**
- **Several Payloads May Be Taken to Orbit Each in an Experiment Ready Carrier Assembly**

ATA

OPERATOR FRIENDLINESS

- **Assembly is Simple**
- **Adjustments to Establish Correct Boresight Alignment**
- **Electronic Control of Fine Pointing and Jitter Suppression**
- **Video Monitor Display of Observed Images in WFOV and NFOV**

ATA

**TASK 3 RESULTS - STABILIZATION
TECHNOLOGY CONCEPT**

- **Overview of LOS Stabilization/Pointing**
- **Control System Concepts/Technologies**
- **Critical Components**

- **LOS Pointing and Stabilization System Definition**

"electro-mechanical assembly that is capable of rejecting and responding to effects of environments, target maneuvers, and host vehicle maneuvers and disturbances so that the payload LOS is maintained on the target with sufficient accuracy and without jitter."

- **Pointing and LOS Stabilization Controls are Separate Functions**
 - **Stabilization Control Isolates Payload from Host Vehicle Operational Disturbance**
 - **Pointing Control Established LOS of Payload**
 - **By Measuring Target Location in Tracking Sensor FOV, or**
 - **By Measuring Payload Orientation Relative to Host Vehicle**

- **Several Technologies Have Been Developed for Precision* Stabilization and Pointing**
 - **Nested Gimbals Systems Use a "Fine" Gimbal to Carry Payload and a "Coarse" Gimbal to Carry Fine Gimbal**
 - **Fast Steering Mirror (FSM) Assemblies are Used to Correct for LOS Pointing/Stabilization Errors by Adjusting LOS Relative to the LOS of Coarse Gimbal LOS Reflected on FSM**
 - **Dynalens Works to Correct LOS Direction (Like FSM), But is Transmissive in Contrast to Reflective**
- **Angle Range of Precision Elements are Limited and Must Be Configured With "Coarse" Pointing Assembly**
- * **Order of Microradians or Less**

ATA

NESTED GIMBAL ASSEMBLY

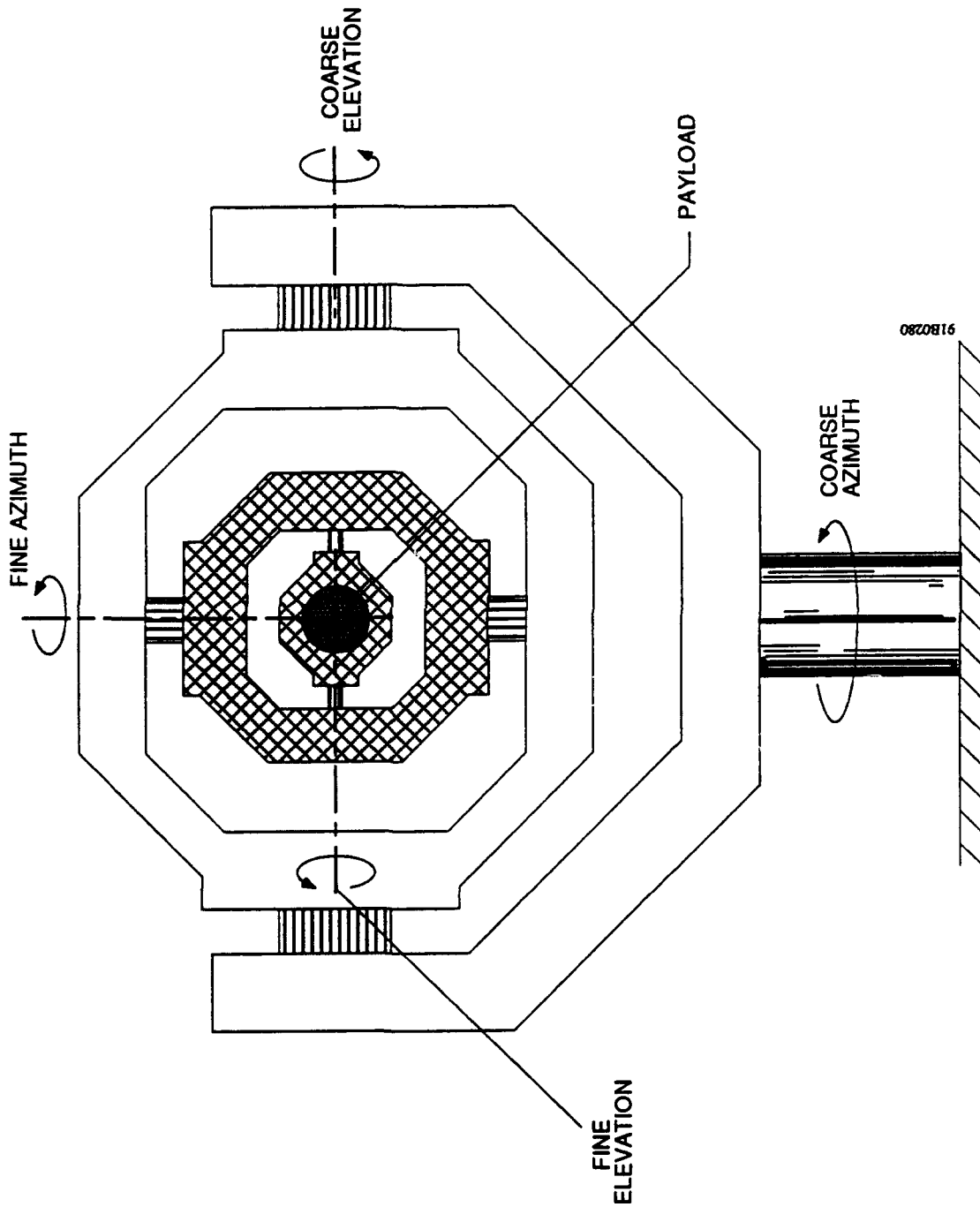

ATA

DYNALENS

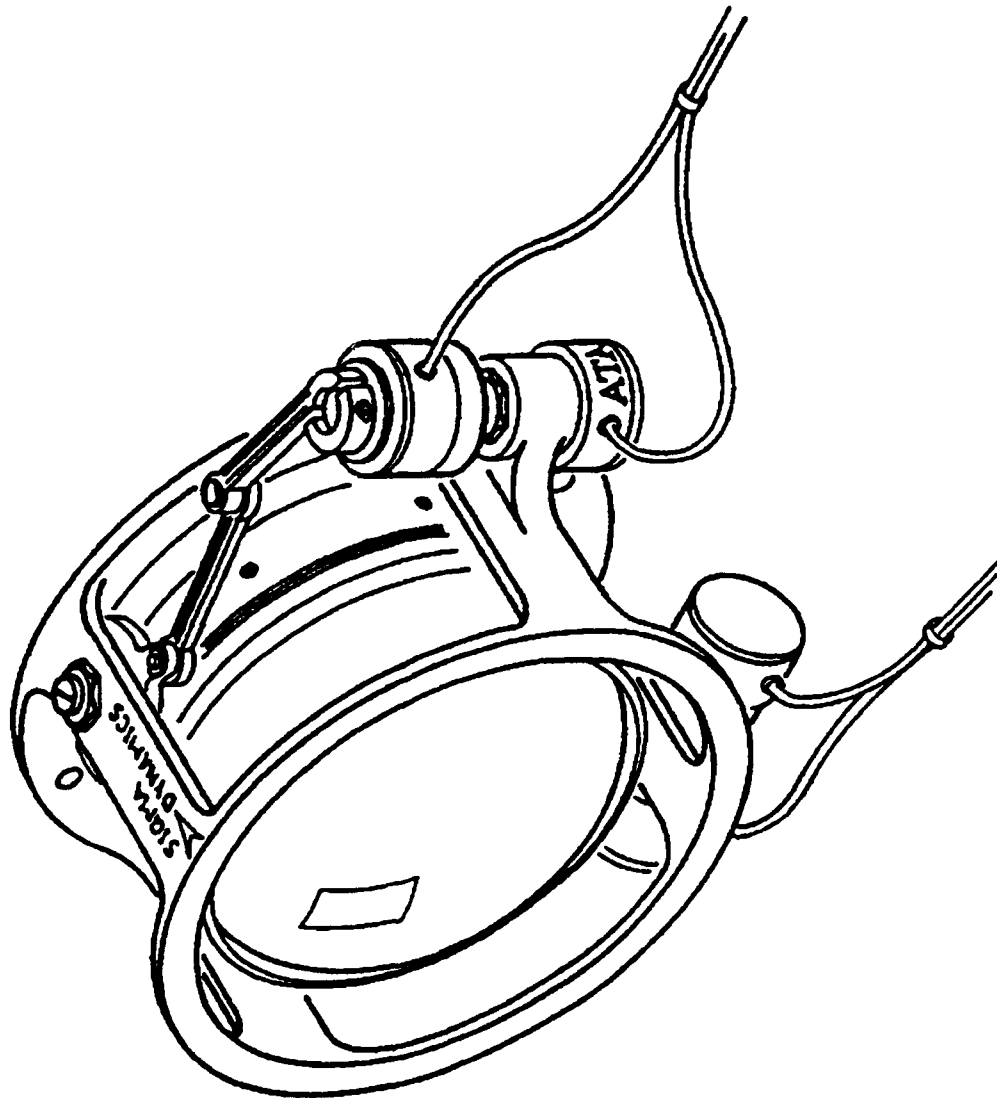

- **Disturbance Which Influences LOS STAB/PTC Performance Include:**
 - **Host Vehicle Vibrations (Angular and Linear) and the Coupling of These Disturbances to the LOS - Bearing/Support Design Schemes Try to Minimize the Coupling**
 - **Measurement Noise of the Control Loop Sensors**
 - **Control System Electronics Noise**
 - **Noise of Actuators to Move Payload**

ATA

CONTROL SYSTEM CONCEPTS/TECHNOLOGIES

- **Classical Servo Loops**
- **Disturbance Cancellation Enhancements**
- **Adaptive Disturbance Cancellation Schemes**

- **Purpose: Keep Measured Errors Near Zero**
- **Stabilization Control Loop**
 - **Employs Inertial Sensor to Measure Payload Jitter**
 - **Rate Gyros Measure Angular Rate of Payload**
 - **Rate Integrating Gyros Measure Angular Position**
 - **Commands Actuators to Hold Payload Against Disturbances**
 - **Responds to Commands from the Pointing Loop**
 - **Sensor Quality, Disturbance Spectra, and Loop Design Establish Performance**
 - **Low Noise Gyros are Expensive**
- **Pointing Control Loop**
 - **Employs Tracking Sensor or Angle Encoder to Measure Pointing Errors**
 - **Generates Commands Which Cause Changes in Payload Pointing**
 - **Very Precise Pointing Requires High Cost Sensors**
 - **Pointing Loop Bandwidth Needs to Be Compatible with Relative Kinematics of Target LOS - Typically Much Less Than Stabilization Loop**

- **Purpose: Sense Disturbances and Keep LOS from Responding (Resulting in Non-Zero Errors)**
- **Identify That Part of the System Output Which is Coherent with the Disturbance**
- **Apply Appropriate Signal to Actuator So That It Responds to Cancel Effects of Disturbance**
- **Disturbance Cancellation is an Enhancement to Classical Servo Loop**
- **Typically is Employed in "Open Loop Feed Forward" Implementation Such That Corrective Commands are Injected into a Classical Servo Loop from Outside the Loop**
- **Requires Accurate Measurement of Disturbances and Scaling of Commands**

- **Purpose: Sense Disturbances and LOS Stabilization and Pointing Errors; Apply Cancellation Signals to Actuators Which Are Computed to "Minimize" Correlation Between Residual Errors and Sensed Disturbances**
- **Disturbances Cancellation Signals are Proportional to Disturbance Measurements But the Gain and Phase Relations are Continuously Adjusted (Adapted)**
- **Implementation of Adaptive Process is With Digital Processor Hardware and Software**

ATA

ANC CONSTRUCT FOR CLOSED-LOOP CONTROL SYSTEMS

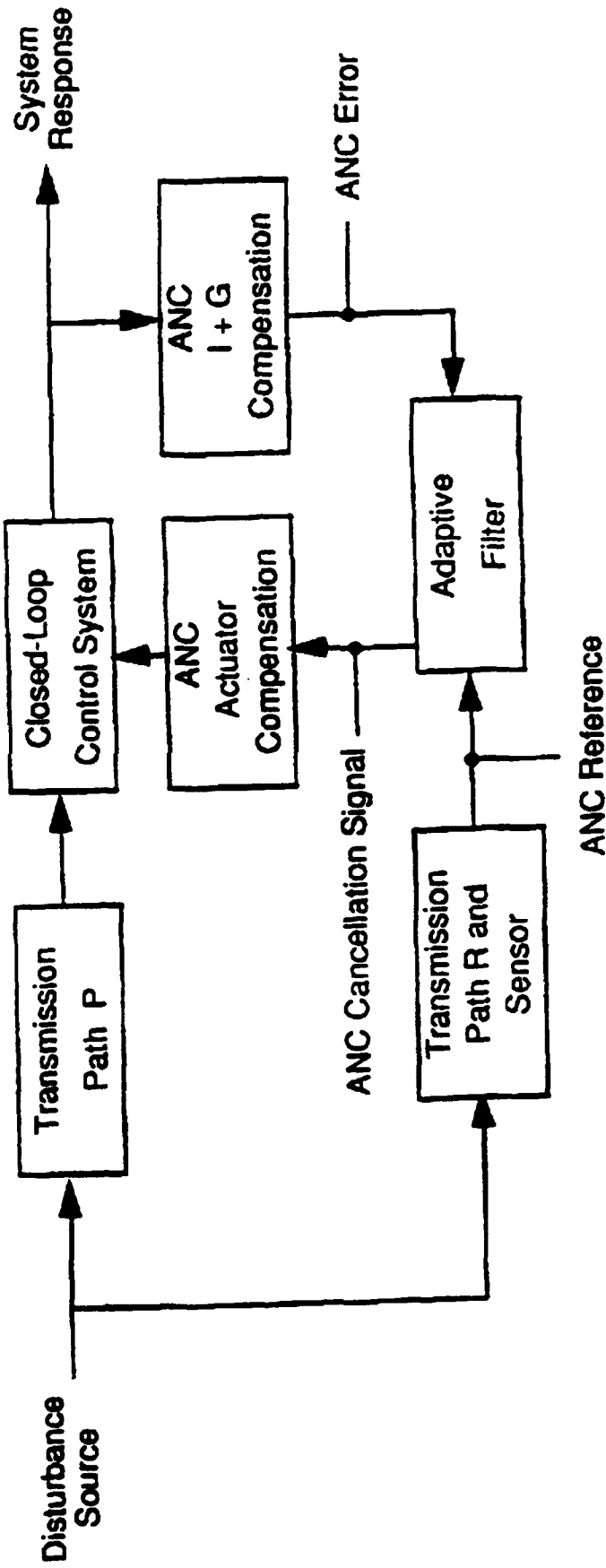

- Adaptive Filter is Same as ANC Signal Processing Filters
- Single Disturbance Case Studied in Earlier Work

ATA

CRITICAL PRECISION POINTING SYSTEM COMPONENTS

- **Inertial Angular Motion Sensor**
- **Relative Angle Sensor**
- **Actuators and Devices for LOS Adjustment**
- **Gimbal Assembly**
- **DSP/Computer System**

ATA

INERTIAL ANGULAR MOTION SENSORS

- **Senses Angular Motion of Payload**
- **Sensor's Angle Noise Equivalent Governs Performance of LOS Stabilization**
- **Sensor Quality as Indicated by Drift Rate and Angle Noise Equivalent are Reflected in Cost**
- **A Variety of Sensor Principles and Vendors From Which To Choose**
- **Gyros Respond to Constant Rate Motion (DC-Response)**
- **ATA's MHD and Systron Donner's IAS Have 1 - 2 Hz Low Frequency Cutoff**

- Gyros
 - Phillips Lab and ATA Tested 8 Gyros From 7 Vendors
 - Candidates Were Compatible with Precision Pointing and Stabilization Requirements ($< 1 \mu\text{rad}$ Noise)
 - Technologies Included Floated Gyros, Dynamically Tuned Gyros, and Ring Laser Gyros
 - Vendors Who Supplied Gyros Included Draper Lab, Singer Kearfott, Teledyne, Bendix, Ferranti, Litton, and Rockwell

- ATA MHD and Systron Donner IAS
 - 1 - 1,000 Hz Response Bandwidth
 - 1 μrad Angle Noise Used in RME Spacecraft Precision Pointing Experiment

ATA

RELATIVE ANGLE SENSOR

- **SSPM SO Will Be Pointed Using Sensors to Measure Orientation of LOS Relative to Shuttle's Structure (Attached to STS Window)**
- **Accuracy of Relative Angle Sensor Influences LOS Pointing Accuracy**
- **Dynamic Range to Handle Full Range of Pointing Angle to Smallest Value of Pointing Angle Correction**
- **Optical Disk Encoder Provides Direct Digital Readout**
- **Resolving Potentiometer Provides Analog Output**

- **For Small Angles - Linear Disp/Radius Yields Angles**
- **Differential Impedance Transducers (DITs) Measure Small Relative Positions**
- **Linear Variable Differential Transformer (LVDTs) Measure Small Relative Positions**

- **As Noted Previously; Gimbals, Fast Steering Mirrors, and Dynalens May be Used to Point/Stabilize the LOS**
- **Actuators Apply Torques and/or Forces to Change LOS Direction**
- **Torque Motors and Linear Electromagnetic Actuators Create the Torques and Forces**
- **LOS Pointing/Stabilization Performance Will Be Influenced by Torque Force "Noise" of the Actuators and the Spectral Character of Noise**
- **Sometimes this Noise is Referred to as Force/Torque "Ripple"**

- **Unique Patented Gimbal Design by Tom Applebury of Rockwell**
- **Rotation About Center Remote From Gimbal Mechanism**
- **Provides Optical Geometry Advantage for Viewing Through Window**
- **Increased Pointing Precision - Gimbal Arms Move More than Payload**
- **Gimbal Stiffness Advantages Over Conventional Gimbals**
- **Previous Work Provides Analytical Tools to Treat Exocentric Gimbal Dynamics and Control**

- **Control Systems for Pointing and Stabilization May Be Implemented in Analog or Digital Electronics**
- **Processing Capacity of Off-the-Shelf Digital Signal Processors (DSPs) are Compatible with Requirements for SSP Pointing/Stabilization Control Implementation**
- **Multi-Degree of Freedom Active Motion Control Systems Have Been Implemented at ATA**
 - **NASA Microgravity Isolation Test Bed**
 - **DARPA Vibration Isolation for X-Ray Lithography Apparatus**
- **DSPs Have Been Used to Implement Adaptive Disturbance Cancellation Sample Rates of 10 kHz and Up**

- **Technology Approaches Are Available to Address Key SSPMSO Pointing and Stabilization Requirements**
- **Several Concepts Exist for Precision Stabilization**
- **Results of Several Different Experiments Will Serve As Basis for SSPMSO Design**

- **Approach**
 - **Develop Simulation Models of Stabilization Servo (Jitter Suppression) with Dynalens and MHD**
 - **Confirm Reasonable Disturbance Rejection Frequency Response**
 - **Verify That Pointing Loop May Be Added to Stabilization Loop Without Degrading Its Performance**
 - **Utilize Prior Experiences with LOS Stabilization Control to Verify Credibility of Approach**
 - **RME**
 - **DAMPER**
 - **SSP**
 - **STARLAB**

JITTER SUPPRESSION DESIGN AND REQUIREMENTS VERIFICATION (Cont)

Analysis Model

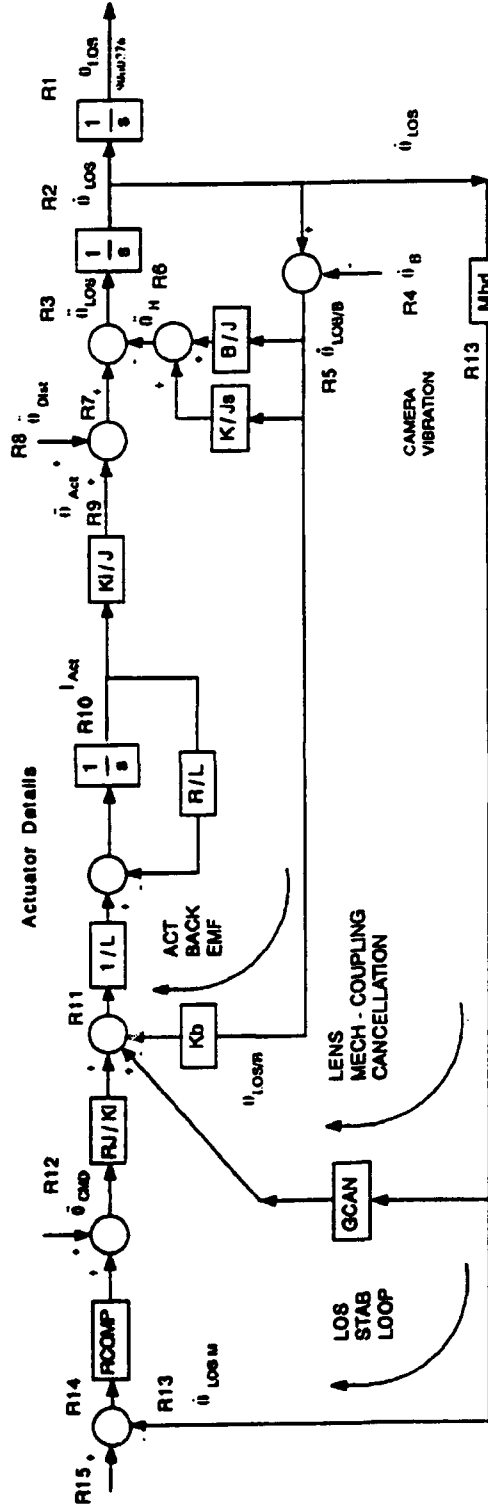

PARAMETER SIMULATION VALUE DESCRIPTION

PARAMETER	SIMULATION	VALUE	DESCRIPTION
R1	P1	1.0	Resistance of Actuator Coil, Ohm
R2	P2	1.0	Inertia of Controlled Element, oz-in-sec**2
R3	P3	1.0	Actuator Torque Coefficient, oz-in/amp
R4	P4	0.001	Inductance of Actuator Coil, Henries
R5	P5	0.0	Back Emf Coefficient, V/rad/s
R6	P6	31.459	Coefficient of Viscous Torque Coupling, oz-in/rad/s
R7	P7	24.742	Spring Coefficient, oz-in/rad
R8	P8	350	Stabilization Loop Gain Parameter, volt/volt
R9	P9	0.159	Stab Loop Comp Numerator Coef
R10	P10	0.159	Stab Loop Comp Denominator Coef
R11	P11	0.0	Stab Loop Comp Denominator Coef
R12	P12	31.42	Natural Frequency For Load After Tuning, rad/sec
R13	P13	0.707	Damping Ratio for Load After Tuning
R14	P14	0.0072	Mhd Sensor Model - Numerator s**2 Coef, volt/rad/s
R15	P15	1.5125E-12	Mhd Sensor Model - Denominator s**4 Coef
R16	P16	1.2513E-8	Mhd Sensor Model - Denominator s**3 Coef
R17	P17	5.0100E-5	Mhd Sensor Model - Denominator s**2 Coef
R18	P18	4.0163E-4	Mhd Sensor Model - Denominator s**1 Coef
R19	P19	7.7285E-4	Mhd Sensor Model - Denominator s**0 Coef

$$R_{COMP} = \frac{K_c (1.0 + N1s)}{D0 + D1s}$$

MECHANICAL COUPLING CANCELLATION

where

$$K_c = \frac{R1/K3}{Mhd}$$

$$\dot{K} = J Wc^{-2}$$

$$\dot{b} = 2 J Zc Wc$$

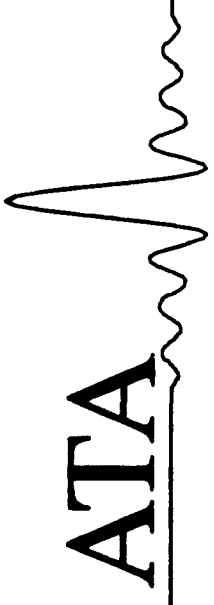

JITTER SUPPRESSION DESIGN AND REQUIREMENTS VERIFICATION (Cont)

- Design Predictions

FRQRSP --- Signal ID: R13/R14
ERQRSP --- Signal ID: B13/RJQ
ERQRSP --- Signal ID: B14/RJ5

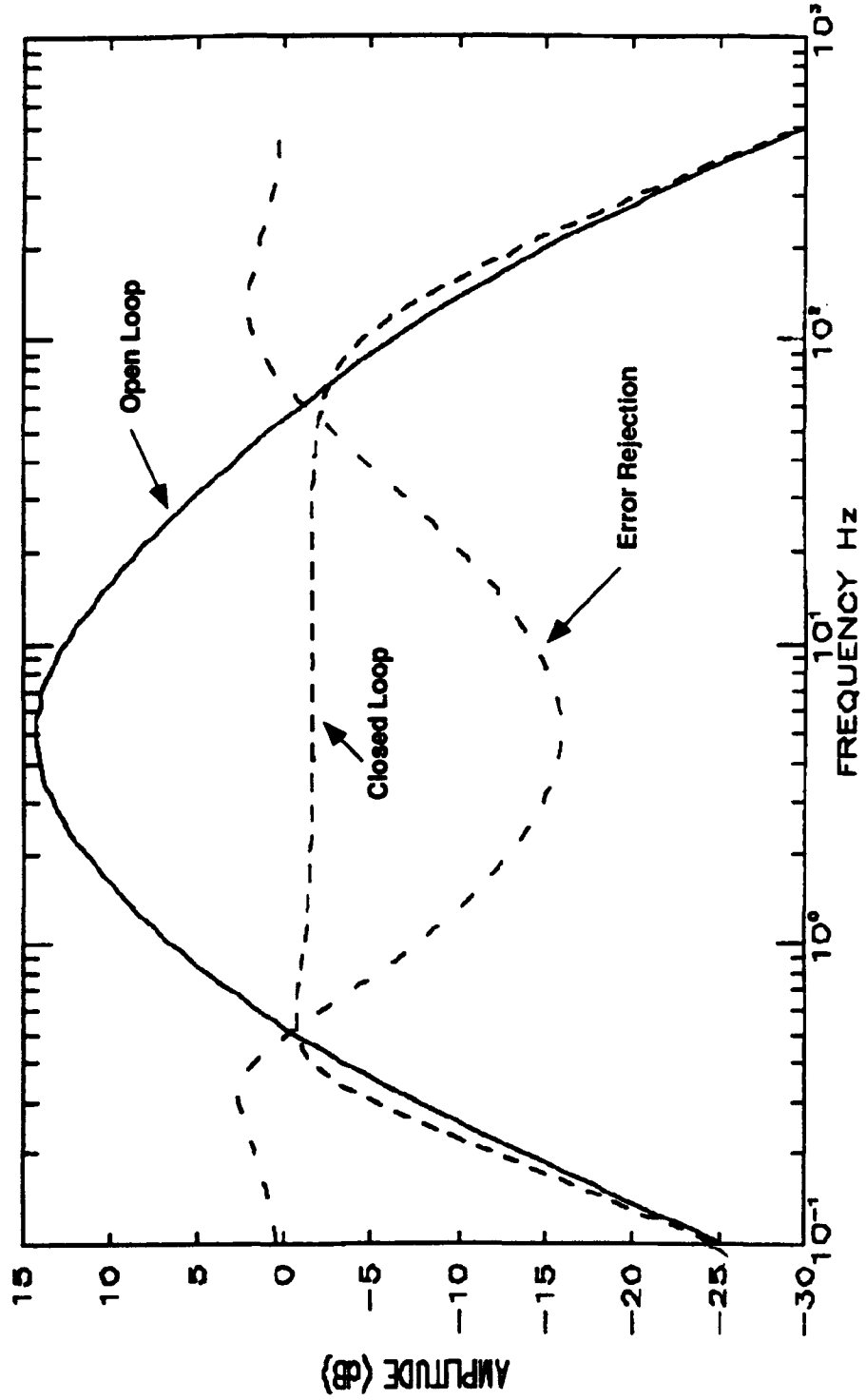

- **Design Verification**
 - **Dynalens and MHD Sensor May Be Used in One or More Servo Configurations to Perform LOS Stabilization to SSPMSP Requirements Level**
 - **Performance Achieved Will Depend on Disturbance Levels and Spectra**
 - **Data Describing Angular Vibration of Window Not Yet Found**
 - **Accurate Measurements of Disturbances Not Known**
 - **Existing Data Exhibits Frequency Characteristics Which Can Be Handled by Dynalens/MHD LOS Stabilization Concepts**
 - **Jitter Suppression Assembly Fits into Locker**

- **Approach**
 - **Seek Information on Existing Small Gimbals**
 - **Contact Vendors for Related Applications**
 - **Theodolites**
 - **Telescope Pointers**
 - **Evaluate/Analyze Exocentric Gimbal Concept**
 - **Define Design Concept to Fulfill Pointing Geometry Requirements**
 - **Payload Flexibility Imposed**

- **Design Verification**
- **Manual Gimbal Design Concept Selected**
- **Geometry Requirements Must Be Satisfied**
 - **Pointing Cone of $>40^\circ$**
 - **Two Degrees of Freedom Adequate**
 - **Roll Axis May Be Added Easily**
- **Center of Rotation at Window (or at Dynalens)**
- **Concepts for Attachment to Window Evaluated and Confirmed**
- **Gimbal Design Size is Compatible with Locker**

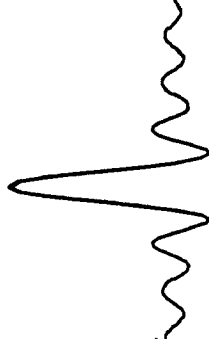

- **Approach**
 - **Review Existing MHD Sensor Designs for Compatibility with Requirements**
 - **IET-1.8 Most Closely Fits**
 - **Safety and Space Qualification Testing Issues Addressed**
 - **Noise/Sensitivity Performance OK**
 - **Bandwidth OK**
 - **IET-1.8 Modified for Installation in Dynalens Stabilization Control Loop**
 - **Perform Laboratory Characterization of Modified MHD**

- Requirements Verification

Noise RMS

1 - 1000 Hz	0.37 μ rad
1 - 10 Hz	0.36 μ rad
10 - 100 Hz	0.05 μ rad
100 - 1000 Hz	0.02 μ rad

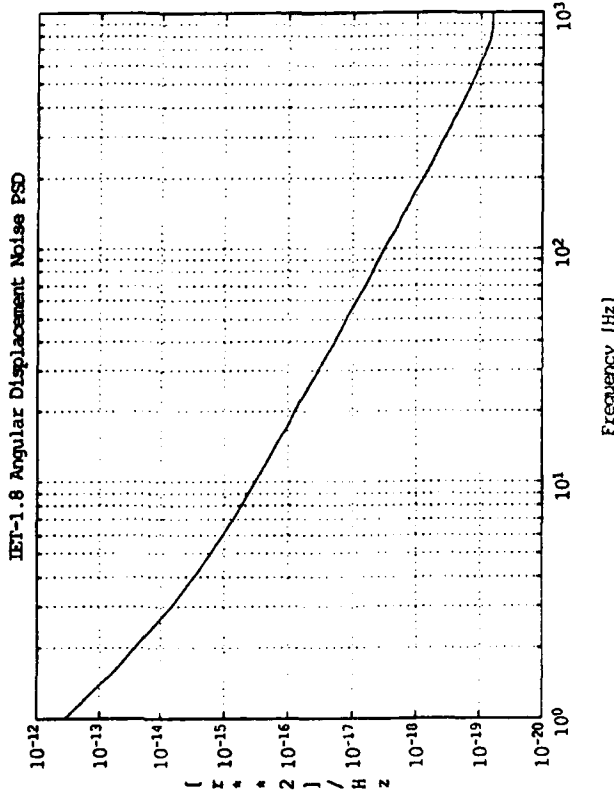
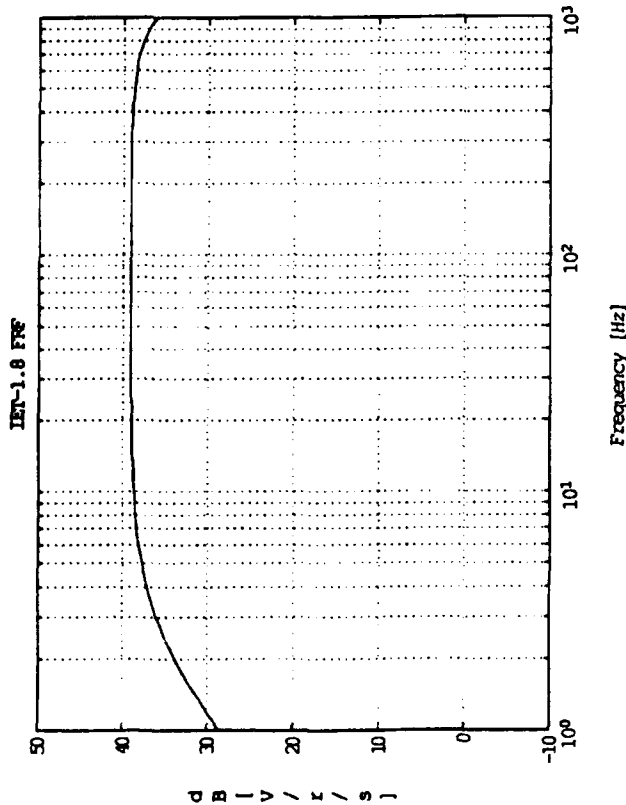

Bandwidth Spans Requirements for SSPMSO

Measurement Noise Level is Low Enough

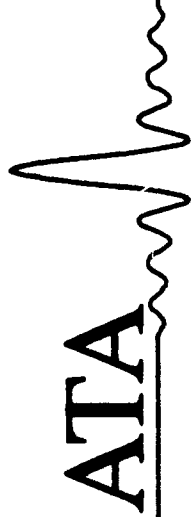

SSPMO-TYPE MHD SENSOR (ASSEMBLED)

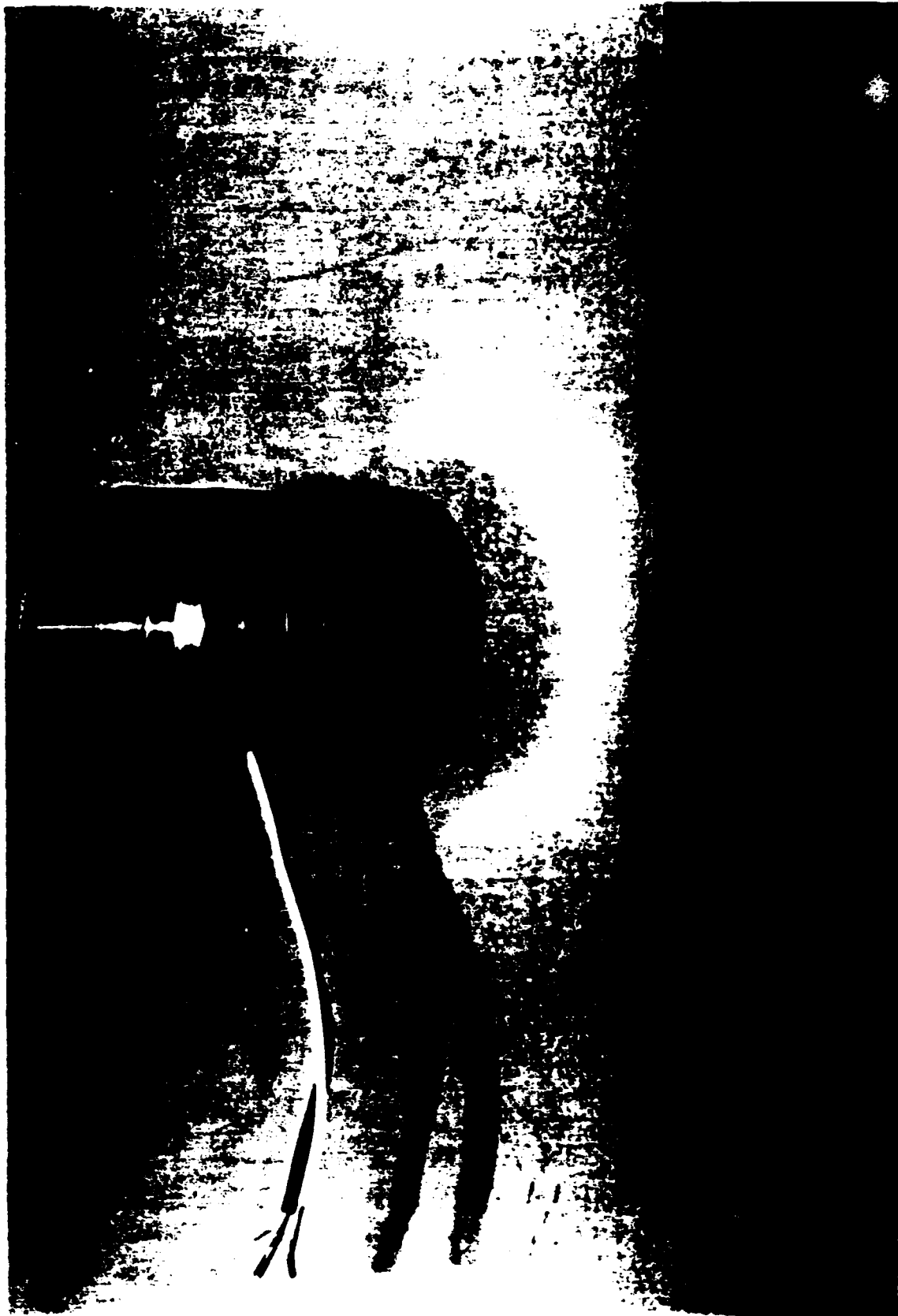

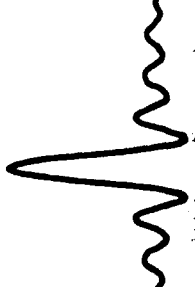
ATA 

SSPMO-TYPE MHD SENSOR (EXPLODED VIEW)

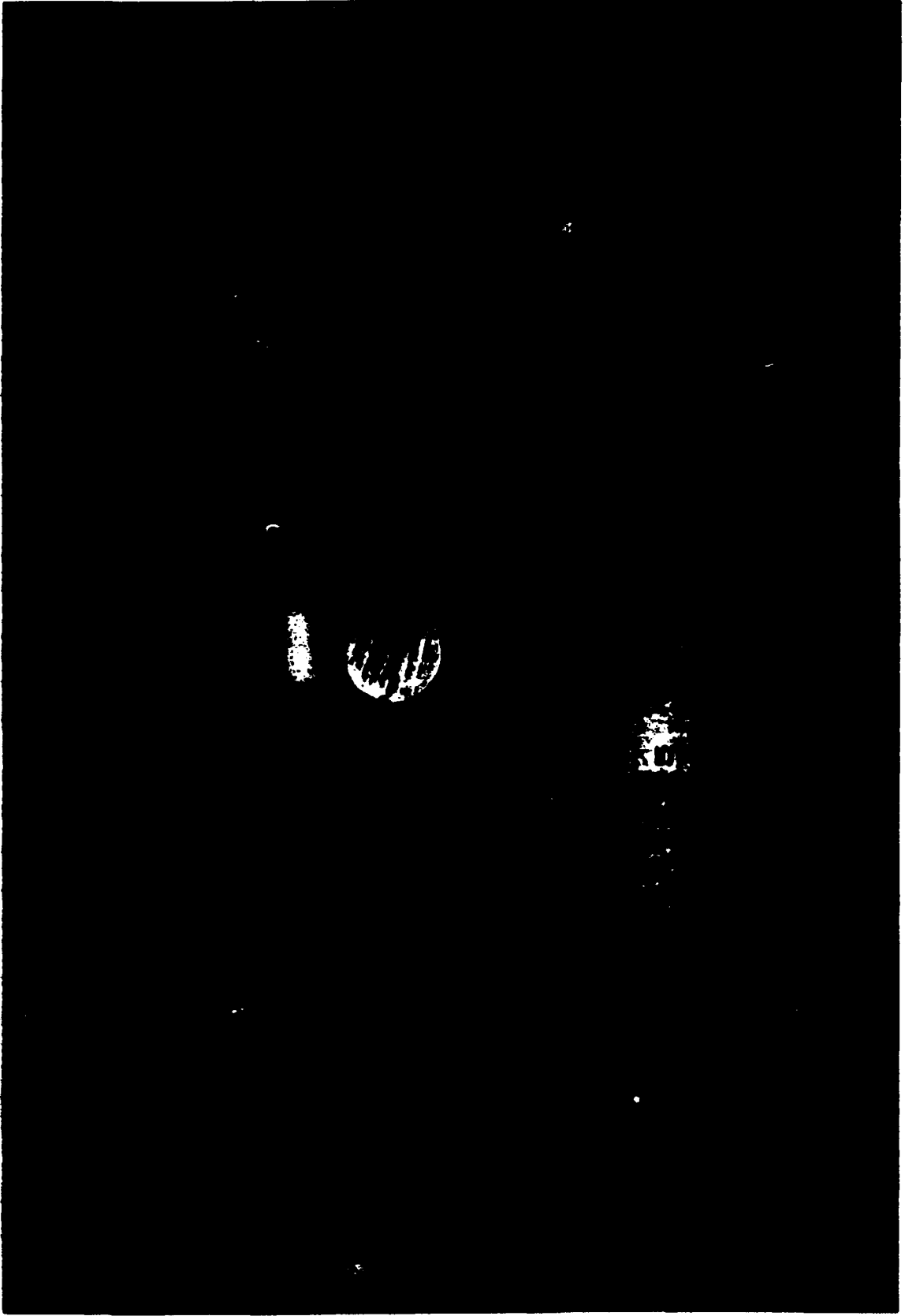

- **Approach**
 - **Utilize Design Based on NASA-Funded SBIR Phase II Project (DAMPER)**
 - **Confirm DAMPER DSP Control System Fulfills Requirements**
 - **Stabilization Control Loop**
 - **Pointing Control Loop**
 - **Assess Capability for Future SSPMSO Enhancements**
 - **Assess Its Capability as Data Collection Element for SSPMSO Demonstration Experiment**

- Requirements Verification
 - SSPMSO Requirements Less Strict Than Those Imposed on DAMPER
 - Digital Processor Design Concept Fulfills Requirement
 - Flight Qualification Compatibility is TBD
 - Assembly Compatible with Locker Storage
 - Size and Weight Reasonable

ATA

DARPA-SPONSORED ISOLATION PROJECT



- DSP Provides Lithography Apparatus Isolation

ATA

SPACE-BASED MATERIALS PROCESSING PLATFORM

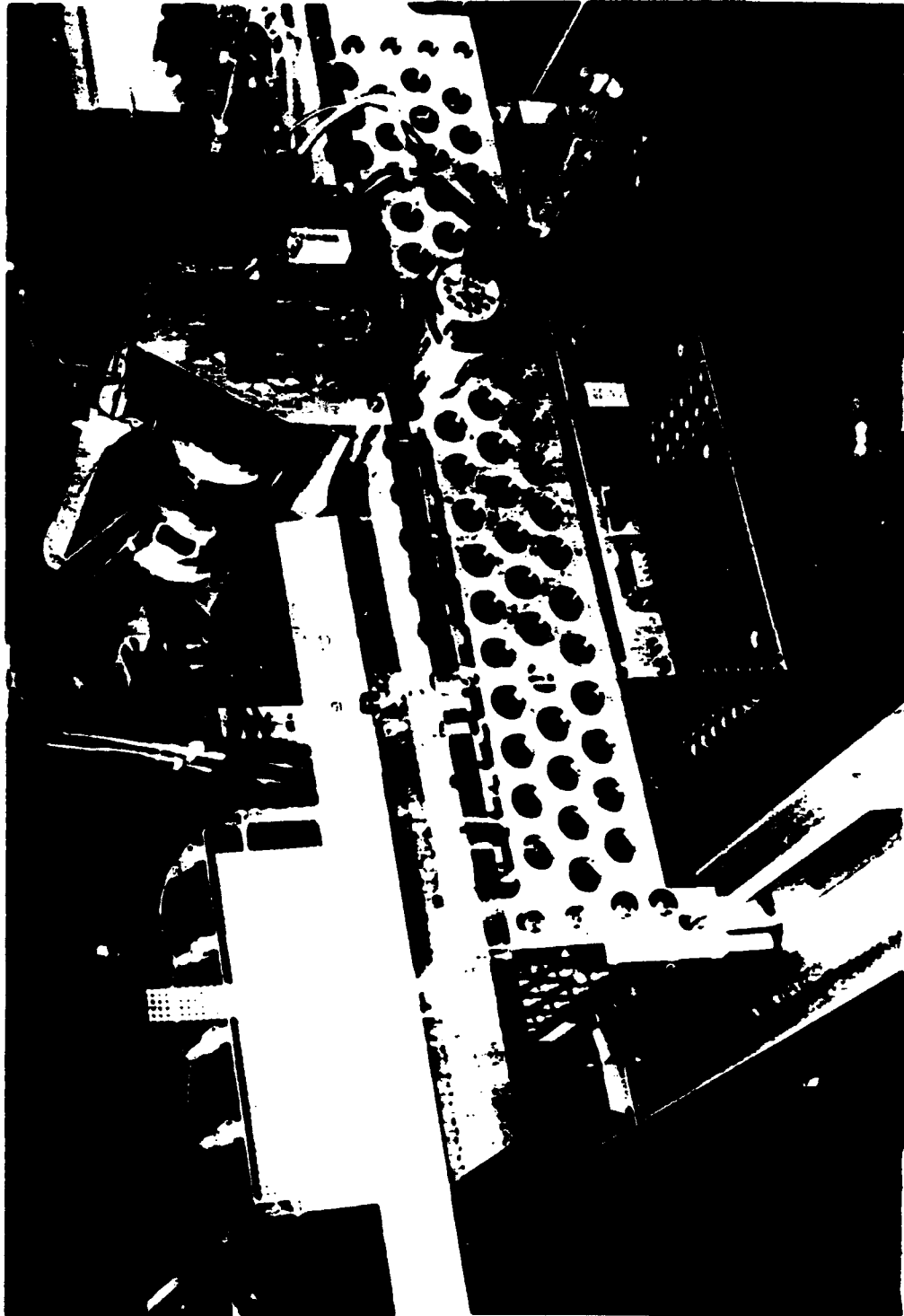

- NASA Phase II SBIR Implements Active Controller for Micro-g Level Isolation

ATA

**ADAPTIVE DISTURBANCE CANCELLATION DESIGN
AND REQUIREMENTS VERIFICATION**

- **Approach**
 - **Assess RME's Adaptive Disturbance Cancellation Design Application to SSPMSO**
 - **Confirm Validity of Concept for SSP**

- **Requirements Verification**
 - **Experiment Implanted on RME's Satellite Tracking Equipment**
 - **Vibration of Mirrors in Gimbal Optics Causes LOS Jitter**
 - **Transducers Which Measure Vibrations Show Signals that Correlate with LOS Jitter**
 - **Results are Encouraging - Jitter Reduced by Factor of 4**
 - **RME Requirements are Similar to SSPMSO**
 - **Concept is Valid for LOS Jitter Suppression in SSPMSO**

- **Key Requirements**
- **Design Concepts**
- **Critical Technical Questions**
- **Recommendations for Phase II**

- **Pointing and Stabilization Compatible with Baseline Optical Payload**
 - **Pointing Accuracy < 1 mrad (0.06 deg)**
 - **LOS Jitter < 1.0 μ rad (1 σ , 1-axis)**
 - **Acquisition Device Has FOV > 8 deg**
- **Modular Design Accommodates Typical Optical Payloads**
- **Does Not Degrade Optical Viewing (Visible)**
- **Fits Mid-Deck Locker**
- **Compatible with Aft Deck Window Viewing Experiments**
- **No STS Requirements Incompatibilities**
- **"Friendly" to Crew**

- **MHD Inertial Sensor's Noise and Bandwidth**
- **Dynalens Optics**
- **Stabilization Loop Performance (Disturbances Not Very Well Known)**
- **Digital Signal Processor Implements Control Loops**
 - **MHD Sensor/Dynalens Performs LOS Stabilization**
 - **Dynalens with LVDT or DIT Performs Small Angle Pointing**
- **Adaptive Disturbance Cancellation an Option for Digital Processor**
- **Exocentric Gimbal Provides Pointing Angle Coverage**
 - **Manual Initially**
 - **Flight Payload Automated in Future Upgrades**
- **Carrier Assembly Accommodates Wide Range of Payloads**

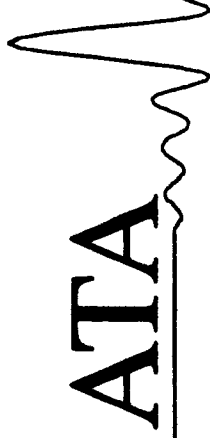

CRITICAL TECHNICAL QUESTIONS

- **On-Orbit Flight Performance of Dynalens-MHD-DSP
LOS Stabilization**
- **Operation of Equipment in STS Environment**
- **Disturbances to System During STS Viewing Experiments**

••••

ATA

RECOMMENDATION

- **ATA and Rockwell Recommend Proceeding to Phase II**
 - **Phase I Objectives Have Been Achieved**
 - **Requirements Clear**
 - **Design Concept Meets Requirements**
 - **Innovative Advances Solve the Key Problems of Manned Space Observation**