

AD-A246 018



AD

2



US ARMY  
LABORATORY COMMAND  
MATERIALS TECHNOLOGY LABORATORY

MTL TR 91-49

# INNOVATIVE LIFE CYCLE MANAGEMENT SYSTEMS FOR COMPOSITES

December 1991

FRANCIS D. GUTOWSKI

The Analytix Group  
P.O. Box 925954  
Houston, TX 77292

SB

DTIC  
SELECTE  
FEB 05 1992  
S B D

FINAL REPORT

Contract DAAL04-91-C-0013

Approved for public release; distribution unlimited.

Prepared for

U.S. ARMY MATERIALS TECHNOLOGY LABORATORY  
Watertown, Massachusetts 02172-0001

92-02720



The findings in this report are not to be construed as an official Department of the Army position, unless so designated by other authorized documents.

Mention of any trade names or manufacturers in this report shall not be construed as advertising nor as an official indorsement or approval of such products or companies by the United States Government.

**DISPOSITION INSTRUCTIONS**

Destroy this report when it is no longer needed.  
Do not return it to the originator.

Unclassified

SECURITY CLASSIFICATION OF THIS PAGE

REPORT DOCUMENTATION PAGE				Form Approved OMB No 0704-0188	
1a REPORT SECURITY CLASSIFICATION <b>Unclassified</b>		1b RESTRICTIVE MARKINGS			
2a SECURITY CLASSIFICATION AUTHORITY		3 DISTRIBUTION/AVAILABILITY OF REPORT Approved for public release; distribution is unlimited.			
2b DECLASSIFICATION/DOWNGRADING SCHEDULE					
4 PERFORMING ORGANIZATION REPORT NUMBER(S) <b>AMTL FR 12.91</b>		5 MONITORING ORGANIZATION REPORT NUMBER(S) <b>MTL TR 91-49</b>			
6a NAME OF PERFORMING ORGANIZATION <b>The Analytix Group</b>		6b OFFICE SYMBOL <i>(if applicable)</i>	7a NAME OF MONITORING ORGANIZATION <b>U.S. Army Materials Technology Laboratory</b>		
6c ADDRESS (City, State, and ZIP Code) <b>P.O. Box 925954 Houston, Texas 77292</b>		7b ADDRESS (City, State, and ZIP Code) <b>405 Arsenal Street Watertown, MA 02172-0001</b>			
8a NAME OF FUNDING/SPONSORING ORGANIZATION <b>U.S. Army Materials Technology Laboratory</b>		8b OFFICE SYMBOL <i>(if applicable)</i> <b>SLCMT-MEC</b>	9 PROCUREMENT INSTRUMENT IDENTIFICATION NUMBER <b>DAAL04-91-C-0013 SBIR PHASE I</b>		
8c ADDRESS (City, State, and ZIP Code) <b>405 Arsenal Street Watertown, MA 02172-0001</b>		10 SOURCE OF FUNDING NUMBERS			
		PROGRAM ELEMENT NO	PROJECT NO	TASK NO	WORK UNIT ACCESSION NO
11 TITLE (Include Security Classification) <b>INNOVATIVE LIFE CYCLE MANAGEMENT SYSTEMS FOR COMPOSITES</b>					
12 PERSONAL AUTHOR(S) <b>Gutowski, Francis David</b>					
13a TYPE OF REPORT <b>Final</b>		13b TIME COVERED FROM <b>1/9/91</b> TO <b>7/12/91</b>		14. DATE OF REPORT (Year, Month, Day) <b>December, 1991</b>	15 PAGE COUNT <b>74</b>
16 SUPPLEMENTARY NOTATION <b>The views expressed in this report are those of the author and do not reflect the official policy or position of the Department of Defense or the U.S. Government.</b>					
17 COSATI CODES		18 SUBJECT TERMS (Continue on reverse if necessary and identify by block number)			
FIELD	GROUP	SUB-GROUP	<b>Composites, life cycle management, quality management, real-time expert systems, knowledge-based systems, process control, G2.</b>		
19 ABSTRACT (Continue on reverse if necessary and identify by block number) <p>The production of advanced composite structures proceeds through a sequence of stages (design, processing, quality control, etc.), each linked to preceding and following functions by material and data flows in the form of inputs, outputs and constraining factors. The integrity of a composite structure depends on a variety of reactive materials with limited shelf lives, complex production and test equipment, and exacting processes and procedures. In this environment, accurate, systematic and complete documentation of material identities is mandatory. Significant technical challenges arise in the design and implementation of an intelligent, interactive quality management system for advanced composites which is cost-effective, user-friendly, and well-adapted to both R&amp;D-intensive and large-scale, production-oriented composites fabrication environments.</p> <p>Rapid prototyping was used to test the feasibility of developing an integrated, user-friendly, knowledge-based life cycle management system (LCMS) to provide comprehensive material traceability and quality management support in R&amp;D and production environments. At the outset, prototypes coded in Lisp using Symbolics' Genera™ develop-</p> <p style="text-align: right;"><i>(continued on reverse side)</i></p>					
20 DISTRIBUTION/AVAILABILITY OF ABSTRACT <input checked="" type="checkbox"/> UNCLASSIFIED/UNLIMITED <input type="checkbox"/> SAME AS RPT <input type="checkbox"/> DTIC USERS			21 ABSTRACT SECURITY CLASSIFICATION <b>Unclassified</b>		
22a NAME OF RESPONSIBLE INDIVIDUAL <b>Dr. Richard Shuford</b>		22b TELEPHONE (Include Area Code) <b>617-923-5572</b>		22c OFFICE SYMBOL <b>SLCMT-MEC</b>	

19 ABSTRACT (Continue on reverse if necessary and identify by block number)

(continued from reverse side)

ment environment were used to refine preliminary material-tracking and user-interface concepts. These were followed by prototypes developed with G2™, a real-time expert system shell whose object-oriented design, user-interface tools, framework for knowledge representation, software interfaces and portability contributed to its superiority for development and delivery. To leverage the functionality, productivity, and value of the LCMS, the investigators proposed that it be coupled to a subsystem of software modules for autonomous, real-time optimization and control of pultrusion, autoclave curing and press curing. These would capitalize on the synergistic reuse and extension of the LCMS knowledge base of materials, their physical and chemical properties, and processing requirements.

Further development involving extensive field testing of working prototypes at government, academic and commercial sites was recommended to ensure a smooth transition to broad Phase III commercial deployment, which would enable the DoD to realize lower-cost, higher-quality procurements of advanced materials.

**ABSTRACT**

The production of advanced composite structures proceeds through a sequence of stages (design, processing, quality control, etc.), each linked to preceding and following functions by material and data flows in the form of inputs, outputs and constraining factors. The integrity of a composite structure depends on a variety of reactive materials with limited shelf lives, complex production and test equipment, and exacting processes and procedures. In this environment, accurate, systematic and complete documentation of material identities is mandatory. Significant technical challenges arise in the design and implementation of an intelligent, interactive quality management system for advanced composites which is cost-effective, user-friendly, and well-adapted to both R&D-intensive and large-scale, production-oriented composites fabrication environments.

Rapid prototyping was used to test the feasibility of developing an integrated, user-friendly, knowledge-based life cycle management system (LCMS) to provide comprehensive material traceability and quality management support in R&D and production environments. At the outset, prototypes coded in Lisp using Symbolics' Genera™ development environment were used to refine preliminary material-tracking and user-interface concepts. These were followed by prototypes developed with G2™, a real-time expert system shell whose object-oriented design, user-interface tools, framework for knowledge representation, software interfaces and portability contributed to its superiority for development and delivery. To leverage the functionality, productivity, and value of the LCMS, the investigators proposed that it be coupled to a subsystem of software modules for autonomous, real-time optimization and control of pultrusion, autoclave curing and press curing. These would capitalize on the synergistic reuse and extension of the LCMS knowledge base of materials, their physical and chemical properties, and processing requirements.

Further development involving extensive field testing of working prototypes at government, academic and commercial sites was recommended to ensure a smooth transition to broad Phase III commercial deployment, which would enable the DoD to realize lower-cost, higher-quality procurements of advanced materials.



<b>Accession For</b>		
NTIS GRA&I	<input checked="" type="checkbox"/>	
DTIC TAB	<input type="checkbox"/>	
Unannounced	<input type="checkbox"/>	
Justification		
By _____		
Distribution/ _____		
<b>Availability Codes</b>		
Dist	Avail	and/or Special
A-1		

**Contents**

**ABSTRACT** ..... 1

**LIST OF ILLUSTRATIONS** ..... 4

**LIST OF TABLES** ..... 4

**INTRODUCTION** ..... 5

    Phase I Objectives ..... 5

    Methodology ..... 5

**DISCUSSION** ..... 8

    Scope of Life Cycle Management ..... 8

        Planning and Scheduling ..... 8

        Project Execution ..... 9

        Data Collection/Validation ..... 9

        Post Mortem Data Retrieval and Reporting ..... 9

        Data Analysis ..... 9

    Overview of Material Tracking System Functionality ..... 9

    Scenario for LCMS Expert System-based Advisory Support ..... 10

    SOP Control Panels as Active Documents ..... 11

    Batch Records ..... 13

    Rapid Prototyping Methodology ..... 14

    Prototype Development ..... 15

        User Interface Design Considerations ..... 16

        Material Identities ..... 16

        Additional Data Types ..... 16

        Storage and Batch-splitting Processes ..... 17

        Available Inventory ..... 18

        Planning and Scheduling ..... 20

        Symbolics Lisp Prototypes ..... 21

            Prototype 1: The Box Editor ..... 21

            Prototype 2: The Process/Material Editor ..... 22

            Integration of "as planned" and "as executed" structures ..... 23

        G2 Prototype ..... 28

            User Interface for Materials ..... 28

            'As-Planned' Process Flow Diagram ..... 31

            Material Tracking ..... 38

**STATUS OF ACCOMPLISHMENTS** ..... 39

**TESTS** ..... 40

**SUMMARY** ..... 40

**CONCLUSION** ..... 42

**RECOMMENDATIONS** ..... 43

    Objectives for Full-Scale Development and Implementation ..... 43

Functional Requirements ..... 43

Overview of Expert Systems ..... 44

    Introduction ..... 44

    LCMS Knowledge Acquisition and Representation ..... 45

    Overview of G2 for Full-scale Development and Delivery ..... 45

        Knowledge Representation ..... 46

        Time ..... 46

        Knowledge Building Tools ..... 46

        Knowledge Management ..... 46

        Knowledge Debugging ..... 46

        Knowledge Validation ..... 46

        Explanations of Reasoning ..... 46

        Truth Maintenance ..... 46

        Focus ..... 46

        End-user Interface ..... 47

        On-line Data ..... 47

        Networking ..... 47

    Creating LCMS Knowledge Bases with G2 ..... 47

System Architecture ..... 49

Announced Release of G2 Version 3.0 ..... 49

GSI ..... 49

Oracle™ RDBMS ..... 51

GSI-Oracle Bridge™ ..... 52

Bar code scanning ..... 52

Real-time Optimization and Control of Composites Processing ..... 53

    Requirements of Real-time, Knowledge-based Process Control Applications ..... 55

    Published Example of G2-based Real-time Control of Compression Press Curing ..... 55

    Autoclave Curing ..... 56

    Pultrusion ..... 57

Field Testing and Development ..... 57

Use by the Federal Government ..... 58

Commercial Deployment and Other Potential Commercial Applications ..... 59

    Knowledge-based Infrastructure ..... 59

    Foundation for Concurrent Engineering and CIM ..... 59

**BIBLIOGRAPHY ..... 61**

**APPENDIX ..... 62**

    ASTM D30 Standards for Composite Materials ..... 63

    SBIR Guidance Information ..... 64

    Use of G2 for Real-Time Control of Composite Press Curing ..... 69

**LIST OF ILLUSTRATIONS**

Figure 1. Overview of Polymer Composites Processing. .... 6

Figure 2. Scope of Life Cycle Management. .... 8

Figure 3. SOPs as Active Documents. .... 12

Figure 4. Database Snapshots of the Domain. .... 14

Figure 5. Traditional and Object-oriented Development Cycles. .... 15

Figure 6. System-level Details for Complete Material Traceability. .... 16

Figure 7. Details at System and User Interface Levels. .... 17

Figure 8. As-Planned, As-Executed Flow Diagrams. .... 19

Figure 9. Relationship of Material/Process Flow and CPM Diagrams. .... 20

Figure 10. Symbolics Prototype 1: The Box Editor. .... 21

Figure 11. Symbolics Prototype 2: The Process/Material Editor. .... 22

Figure 12. Symbolics Prototype 2: Process/Material Editor. .... 24

Figure 13. Symbolics Prototype 2: Process/Material Editor. .... 25

Figure 14. Symbolics Prototype 2: Process/Material Editor. .... 26

Figure 15. Symbolics Prototype 2: Process/Material Editor. .... 27

Figure 16. G2 Prototype: Main-menu Console. .... 28

Figure 17. G2 Prototype: Raw Material Inventory Window. .... 28

Figure 18. Table of Material Attributes. .... 29

Figure 19. Class Hierarchy of Materials. .... 30

Figure 20. Warning of Shelf-life Expiration. .... 30

Figure 21. Process Library Window. .... 31

Figure 22. Pop-up Menu for a Process. .... 31

Figure 23. Blank Process Flow Template. .... 32

Figure 24. Library of Process Instances. .... 32

Figure 25. Partially Completed Flow Diagram for Processing of a Composite. .... 33

Figure 26. Raw Material Inventory Control Panel. .... 34

Figure 27. Pop-up Windows for Material and Process Icons. .... 34

Figure 28. Material Editor and Subordinate Control Panels. .... 35

Figure 29. Control Panel for ASTM Test Procedure and Message Board. .... 36

Figure 30. Extended Workspace Using Connector Posts. .... 37

Figure 31. Parent-Child Table. .... 38

Figure 32. Parent-Child Nested Hierarchy. .... 38

Figure 33. Control Panel for Press Curing. .... 39

Figure 34. Functional Requirements of Life Cycle Management System. .... 44

Figure 35. Iterative Knowledge Engineering Process. .... 45

Figure 36. LCMS System Architecture. .... 50

Figure 37. Videx Time Wand II. .... 53

Figure 38. Candidates for Real-time Optimization and Control. .... 54

Figure 39. Modular Concurrent Engineering Environment. .... 60

**LIST OF TABLES**

Table 1. Major Components of a Knowledge Base. .... 47

Table 2. Commercially Available LCMS Software Components. .... 49

## **INTRODUCTION**

### **Phase I Objectives**

The principal technical objective of Phase I was to deliver a fully documented, working prototype of an integrated bar code database system for composites life-cycle tracking. The Phase I proposal submitted in response to DoD solicitation A90-375 stated that two prototypes would be developed which would demonstrate:

- A database containing 1) an inventory of raw materials (appropriately identified with respect to supplier lot number, internally assigned fabricator lot number, shelf life, storage requirements, etc.) and 2) historical data (captured through simulated bar code scanning) which includes the relationship of a component or assembly to all material antecedents, as detailed in its batch record.
- Libraries of reusable material specifications, production equipment and process parameters which the user can access and modify as needed.
- A graphic user interface which a user — with no formal training in programming — can interact with to configure the system and document the production of a particular composite structure.
- A graphical interface which will enable the user to browse the database to identify and examine all antecedents and descendants of a particular raw material, intermediate or composite structure. This feature can be extended in Phase II to incorporate traceability based on process, facility or QC parameters.

Although it was assumed in the proposal that the LCMS would be modelled on a typical composites production environment, the contractor and AMTL agreed instead to focus Phase I prototyping on AMTL's R&D environment. (The flow chart on the following page summarizes materials and processes in the AMTL domain.) The rationale was that a tracking system which satisfied the requirements of an R&D-intensive environment would need to be robust, flexible, intelligent and user-friendly. Such a system could be adapted more easily to highly structured, high-volume production environments than one based on a production environment, which subsequently would be adapted for use in R&D. This approach also supported the Phase III objective of fielding commercial life cycle management systems for production- and research-oriented environments.

### **Methodology**

Phase I was guided by the need to align an ongoing analysis of the requirements for the LCMS with an exploration of the best technical solution(s). The vehicle used to map the real-world problem onto potential system-based solutions was rapid prototyping. This methodology requires that small, working software prototypes be created and presented to users to evoke feedback, which, in turn, is fed into the next prototype iteration.

Prototyping proved to be invaluable for both users and developer. For example, the objective of the first prototype, which was written in Lisp, was to operationalize the seemingly simple notion of on-screen flow-diagramming of material and process flows. The process of developing that prototype revealed that physically connecting material and process icons with lines could have several logical interpretations and consequences at the system level. As the flow-diagramming interface was being designed, it became apparent that presenting too much system-level detail to users would not be advisable. In response, the interface was designed to hide the complexity of the system-level data representations. The first prototype iteration surfaced issues that were not fully recognized, nor could they have been, before undertaking the task of programming. Though it was not elaborated further, this prototype served as a sensitive and instructive technical probe.

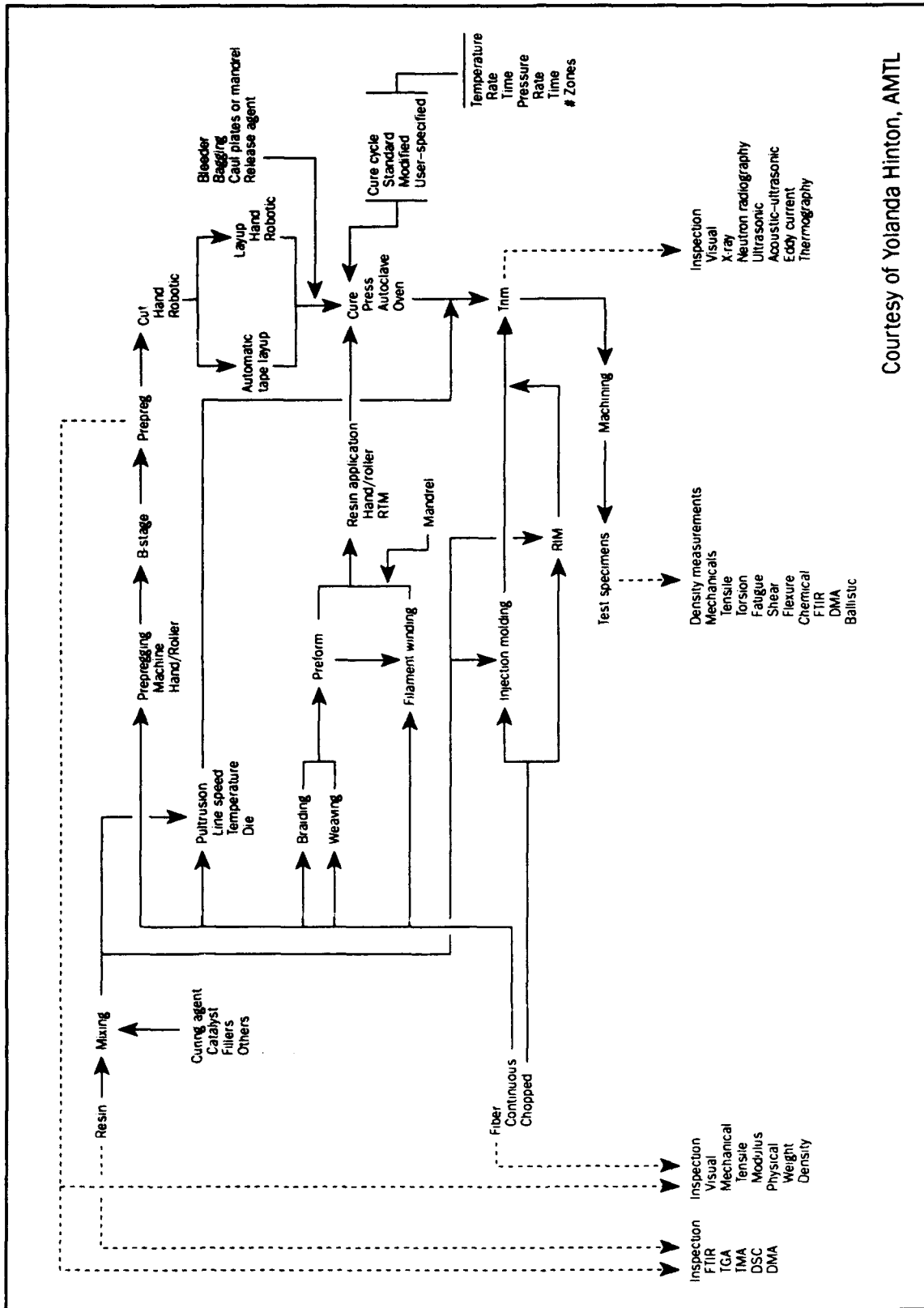

Courtesy of Yolanda Hinton, AMTL

Figure 1. Overview of Polymer Composites Processing.

The implication at the midpoint of Phase I was that the LCMS would need a sophisticated awareness of the context(s) in which the user was attempting to connect icons of processes and materials. If the system understood the context of the user's actions, it could hide the underlying complexity, while preserving the logical relationships it required and the user probably intended (but may not have even realized). It would, therefore, take on some of the roles of an intelligent assistant.

The search for a more robust solution led to the evaluation of a commercially available expert system shell which, among a host of other features, offered the tools needed to build interactive, intelligent user interfaces. This software development environment, G2™ from Gensym Corporation, is object-oriented, as was the Symbolics Genera™ environment used in the first prototype iteration, which greatly simplified the mid-project transition. Real-time, knowledge-based reasoning originally was not considered essential to the LCMS; however, the combination of object orientation, tools for building graphical user interfaces, knowledge-based expert system development tools, portability and the ability to reason in real time made G2 an attractive candidate. (G2 was designed for real-time, knowledge-based process control applications, and has become well established in that field, although it is being used for a variety of other applications.) As a result, it was decided to apply what had been learned in the first half of Phase I to a continuation of rapid prototyping using G2 rather than Lisp. The Symbolics and G2 prototypes are described in detail in the Discussion section of the report.

The work described in the report was carried out under contract #DAAL04-91-C-0013 SBIR PHASE I. Software development was performed in Houston, Texas. Prototype demonstrations were conducted for the Army at the U.S. Army Materials Laboratory, Watertown, MA and at the offices of Symbolics Inc., Burlington, MA.

In the remainder of this report, we first examine what life cycle management is and what it implies for users' interactions with the system and its design and implementation. We then turn to discussions of the prototypes developed during Phase I. Lastly, we outline recommendations for full-scale development and subsequent government and commercial deployment.

**DISCUSSION**

**Scope of Life Cycle Management**

To better understand the implications of life cycle management for system design, it was desirable to divide life cycle management into a sequence of steps. Each step was evaluated separately. The following illustration summarizes this sequential view of the components of life cycle management. Prototype development focused on the planning segment. Project execution, data collection/validation and data analysis were then simulated using the prototypes.

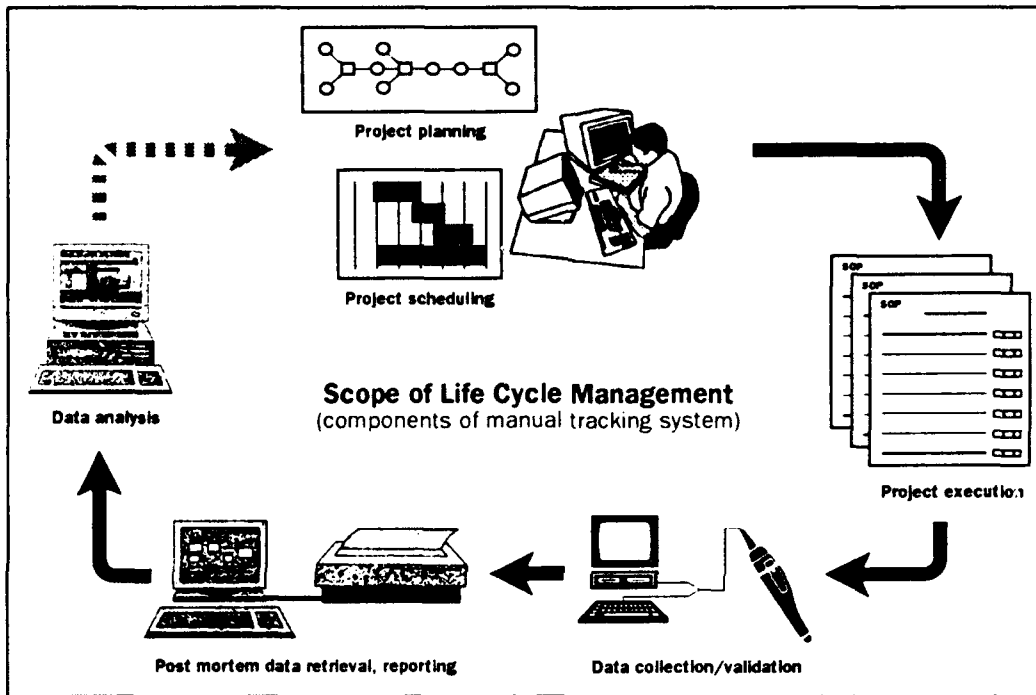

Figure 2. Scope of Life Cycle Management.

Planning and Scheduling

Planning is the process of defining future tasks using material/process flow diagrams created by the user. The implementation of the flow diagramming paradigm will be described in detail later in this report. Scheduling is the sequencing and timed execution of tasks as defined by users' flow diagrams. Planning and scheduling are not only associated with longer-range project planning, as was presumed early in Phase I. Planning and scheduling capabilities came to be recognized as essential for routine operation of the LCMS in composites R&D and production environments. With multiple users setting up any number of as-planned projects while other as-planned projects were executing on the shop floor and in the laboratory, the LCMS would need to evaluate the availability of materials and process resources as they were selected and connected to the material/process flow diagram.

A process will almost never be executed as originally planned. The LCMS must accommodate delayed, long-duration transactions and make resource allocation decisions in the background as data arrive from bar code scanners and other data entry devices. The LCMS also must alert users to conflicts that it could not resolve by adjusting the scheduled execution of one or more as-planned processes within the bounds of available slack. Furthermore, when the scheduled execution of a process slips, the LCMS must adjust the as-planned execution of subsequent processes in that user's flow diagram as well as every other as-planned project which uses the same resources. Although these scheduling considerations were recognized, they were not evaluated explicitly in the proto-

types. However, G2 is well suited to heuristic scheduling optimization; in fact, The Johnson Group, a Phase I subcontractor, has developed a scheduling optimization toolkit which runs within G2. This toolkit was demonstrated at AMTL during Phase I.

#### Project Execution

In this step of the cycle, the expert system component of the LCMS translates the user's flow diagrams into syntactically correct, bar-coded work orders, which may also contain illustrations. The LCMS can also generate prompt files for downloading to hand-held bar code scanners. It also enables users to set up real-time data acquisition and control schemes for on-line instruments and processing equipment.

#### Data Collection/Validation

Data collected from bar code scanning of work orders, materials and other resources can be uploaded instantaneously or batch-wise, depending on the requirement. Some bar code scanners can issue data-entry prompts and immediately validate scanned-in data. The LCMS can simply log data from on-line instruments and processing equipment, provide real-time advisory support or provide autonomous process control. All incoming, as-executed data are validated by the expert system component of the LCMS. A variety of standard reports may be included by the user in material/process flow diagrams. These would be generated by the LCMS as soon as the required data were available.

#### Post Mortem Data Retrieval and Reporting

As-planned and as-executed flow diagrams are stored temporarily in the expert system component of the LCMS while projects remain active. Once validated, those data are swept into a relational, E49-compatible material-property database. Objects originally created in the G2 component of the LCMS are mirrored in the relational database. Acting as an intelligent front end to this archival database, the expert system supports *ad hoc* queries and standard report writing. Custom reports can be generated by the user via SQL calls to the database component. Both the LCMS expert system shell (G2™) and the relational database (Oracle™) support multi-user, distributed computer environments.

#### Data Analysis

Users carrying out statistical quality control or engineering analyses can transfer data from the archival database to dedicated statistics, graphics presentation and other software packages.

#### Overview of Material Tracking System Functionality

The LCMS will maintain an inventory of materials, and, at the user's discretion, store in the material's batch record associated scanned-in shipping documents, manufacturer's QA certification sheets, product data sheets, MSDS sheets, cure cycle data and relevant ASTM testing procedures. Unique serial identifiers will be maintained by the system internally and will be printed on bar-coded labels for raw materials, intermediates, composite end items (formatted according to SACMA SRP 1-90 for external transfers), processing equipment, test equipment and other resources critical to maintaining high quality standards of production.

Forward and backward traceability will be maintained via system-administered batch records for every uniquely identifiable raw material, intermediate, test sample and end item. There are no theoretical limits to the overall number of ancestors and descendants a material may have or the branching within the material's parent-child hierarchy.

As a specific material (uniquely identified by lot number) is entered into the system, it will inherit behaviors characteristic of that material's class. For example, all prepregs will inherit the behavior of monitoring and accumulating room temperature time and adjusting their remaining shelf lives

accordingly. From the user's vantage, these behaviors will be controlled by Standard Operating Procedures (SOPs). Shelf life parameters recommended by the manufacturer will be set by the user in an SOP control panel. Unless the manufacturer amends those recommendations, other lots of that material entering the system in the future will automatically inherit identical shelf-life parameters and behaviors.

SOPs governing shelf-life expiration will generate advisory messages in anticipation of a material's shelf life expiration. The user can then activate an SOP to recertify the material, or, at the user's discretion, the system can do so automatically. Materials whose shelf life has expired and which have not been recertified will be blocked from being selected for use pending successful completion of the recertification SOP. Once activated, other SOPs will monitor instrument calibration schedules and other time-dependent resource requirements.

### **Scenario for LCMS Expert System-based Advisory Support**

A frequently overlooked, but nevertheless critical, requirement of any database system centers on the mechanism(s) by which data are identified, collected, validated and entered. No database, however intelligent, fast, user-friendly and well-designed can be expected to perform any useful function if relevant data are not captured in a cost-effective, timely and consistent manner.

This raises the question, "How can the benefits of a LCMS be realized in R&D-intensive environments such as AMTL without imposing an onerous administrative burden or disrupting normal work practices?" The solution proposed in Phase I was to embed in the LCMS expert-system-based reasoning to enable it to support users in the following ways:

- Assist in the definition of data capture requirements by making it possible to communicate with the system through a graphical, icon- and menu-based, flow-diagramming interface.
- Enable users to select standard processing and test procedures from comprehensive, built-in libraries.
- Oversee specification of what materials should be used, what tasks need to be performed, and what data should be collected.
- Alert the user to any anomalies that would (or could) violate the user's specifications or intent, such as material availability, impending shelf-life expiration, scheduling conflicts, applicability of the intended procedure, etc.
- Automatically configure the system's internal data representations to accommodate routine and specialized data collection requirements.
- Based on user-specified tasks and data capture requirements, automate the generation of bar-coded, SOP work orders.
- Generate a list of expected scanned-in bar codes and any messages that should appear on the display of the bar code scanner.
- Make this list available for downloading to a portable bar code scanner.

As tasks described in the LCMS-generated work order are executed, technicians scan the corresponding bar-coded work order instruction and materials, equipment or other resource influencing the execution of the work order. If written comments are made on the form, scans of bar codes corresponding to that part of the work order are made and the comments entered manually. When the scanner is returned to its uploading module, the time-stamped bar code data are uploaded automatically to the LCMS from the scanner port. Uploaded bar code scans are then validated, the user is alerted to any discrepancies, and, if accepted by the user, the data are archived.

This scenario would be impractical, if not impossible, without expert-system assistance. Far too much training, time, effort and dedication would be required of users. As a consequence, the flow of data into the system would become increasingly sporadic and the value and relevancy of the LCMS in subsequent database queries would decline. As the LCMS continued its descent, efforts to add new data to the system would be regarded as fruitless. Ultimately, the system would likely be forgotten, perhaps to be re-invented when the problems it was supposed to solve became more acute.

Ultimately, it is human nature, not technology, that determines the acceptance and successful application of tools like the LCMS. If technology can be applied in ways that favorably affect the work habits of users, then the technology will be accepted and behaviors will adjust accordingly. Well-designed expert systems can provide significant labor-saving advantages, but users must first see the benefits of working with the system. How, and at what level(s) of abstraction expert system technology is applied is secondary to what it accomplishes. Large doses advisory support for a variety of low-level tasks can outweigh the benefits of high-level support for a handful of more complex, narrowly defined tasks.

When considering the ergonomics of users' interactions with the system, there are several aspects that should be recognized as potential problem areas. Systems which attempt to dictate behavior under the guise of assisting people often fail because technicians resist using them. In many instances, rejection is understandable: any man-machine interface that hinders their sometimes irregular work patterns will be regarded as an obstruction. For example, a terminal that requires someone to be constantly walking from one area of a room to the opposite end, or one that requires that the operator be prompted through even the most mundane tasks will not increase productivity. If it is not used for these reasons, then such a system will not satisfy the materials traceability requirements for which it was designed. We address this particular ergonomic issue with small, pocket-sized portable bar code scanners which can be programmed to display prompts for input, but which do so in a supportive, unobtrusive manner.

An intelligent system can anticipate users' needs and offer coherent explanations of its actions and decisions. Furthermore, it needs to be flexible enough to allow users to modify its behavior while it preserves its internal requirements for data integrity. This level of user friendliness represents a paradigm shift — from database systems as inflexible data repositories, to intelligent assistants which help users to achieve their mutual objectives. The requirements of R&D-oriented users for flexibility, user-friendliness, intelligent assistance and good ergonomic design represent, in a very real sense, a worst-case scenario. If this class of users can be won over, then the system can be integrated more easily into more structured work environments.

In summary, the strategy for the applying expert system technology to the manual SOP tracking component of the LCMS is predicated on saturating users with labor-saving features to win them over to new ways of planning and organizing their projects, having work assignments carried out, recording and reporting the results of their efforts. The goal of the LCMS is not to supplant the need for thought, or to absolve users from being intelligent, but to leverage their productivity and that of resources under their control. This can be achieved through the intelligent management and application of both generic and highly specific knowledge about their environment. By alleviating users' need to be responsible for routine details, the system will be embraced as a welcomed intelligent assistant, rather than be rejected as an unyielding taskmaster.

### **SOP Control Panels as Active Documents**

It is convenient to think of materials, processes and facilities as governed by a system of Standard Operating Procedures (SOPs). These contain rules which govern events such as the certification and receipt of raw materials, their storage, removal from storage, recertification, processing, testing, final disposition, obsolescence and disposal. They also govern equipment and facilities maintenance

including instrument calibration. Essentially, everything that the system knows about the behaviors of objects in its domain can be viewed as controlled by SOPs.

The concept underlying active documents is that basic intelligence, in the form of expert-system rules, can perform services for the user during a document's creation or editing. An active document, in effect, knows what it must do, how it must be structured and where it must extract or deposit data. It can perform those functions without specific user intervention.

The on-screen control panels we propose for specifying ASTM-based SOPs are active document templates. When a user connects the icon for a particular ASTM test procedure to a material icon in a process flow diagram, the active-document intelligence of the test procedure object would validate 1) whether the test was applicable to that material type; 2) whether the context in which the user wished to apply the test was reasonable (e.g., does the test require special preparation, one or more specimens or the entire part?); and, 3) whether the resources needed to carry out the test were available, needed calibration, etc. Even a simple task, such as checking the inventory of any required reagents and alerting the user to those that needed to be resupplied, would be a welcomed labor-saving function.

Active document intelligence can aid ease of use by automatically filling in selected data-entry fields. The fields will depend, of course, on the particular SOP. User-specified fields would be validated as data were entered. Erroneous or suspect entries would trigger the appropriate warning message(s). Assignment of batch record identifiers to intermediates or products of a material-transforming process is performed automatically by the system. Control panels also can be used to access and control instruments interfaced through LabVIEW 2™.

Another behavior of control panels as active documents is the intelligent creation of bar-code-labelled SOP work orders and, optionally, bar-coded specimen ID tags. Work orders serve several purposes: they contain stepwise instructions for performing a test procedure, they provide a means of documenting what was done, by whom, when, and under what circumstances. They also provide a consistent format for capturing test data. Based on its knowledge of a test procedure, the material being tested, and entries made by the user, the active document intelligence within a control panel would, for some SOPs, generate a work order containing a syntactically correct sequence of instructions with adjacent bar-coded data entry points; for others, it would generate a table or form-like work order.

When data from the SOP work order are uploaded, the control panel object would recognize the identity of the incoming data. It then would validate that those data satisfied default or user-specified criteria and would alert the user automatically to exceptions, omissions or irregularities by logging its objections to a message board. Messages are stored by the system in a log book. Following acknowledgment by

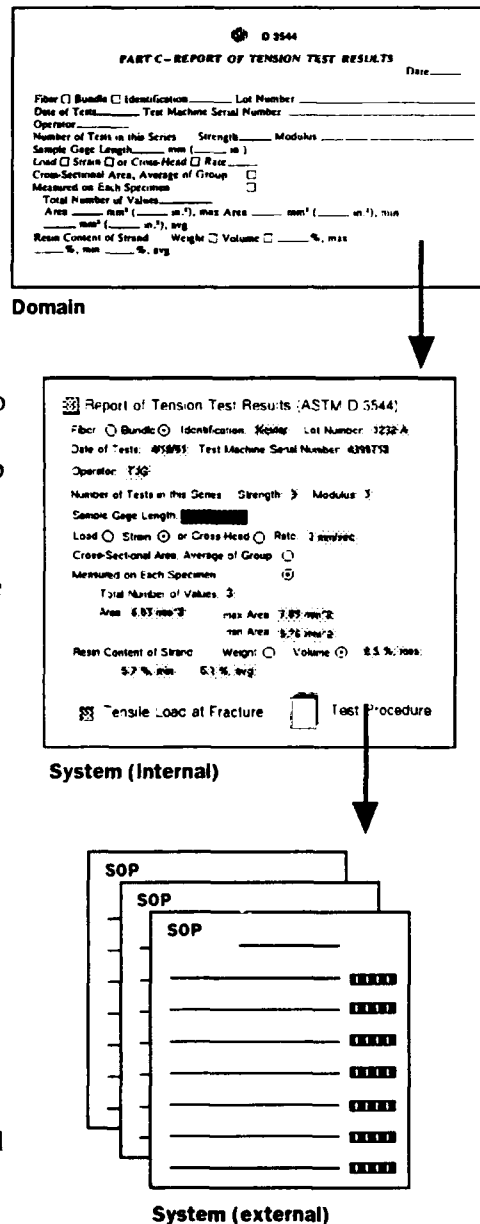

Figure 3. SOPs as Active Documents.

the user, the control panel object would complete its task by storing the results in the system's archival database.

### **Batch Records**

As the user specifies a sequence of production and testing procedures in a flow diagram, the system builds an as-planned master batch record containing slots for each uniquely identifiable material in the sequence and the SOPs to be applied. Pointers to the E49 material property database are also established. Once data generated about the material and SOPs enter the system, material property data are processed and stored in the archival E49 material property database.

Additional slots in the batch record provide a means for documenting the status of objects in the domain that influence a material's processing and testing history. Much of this metadata (data about data) is specified by the E49 material property database standard. Metadata which are not already included, but which may be relevant to the life cycle history of the material, can be appended to the material's batch record.

One can envision each slot in a batch record containing a "snapshot" of the state of relevant aspects of the domain at the time data about the material were captured. As materials traverse the domain (see illustration on the following page), they interact with objects (processing and testing equipment, other materials, human operators, etc.). Each SOP defines objects within a process which potentially can influence a material's properties.

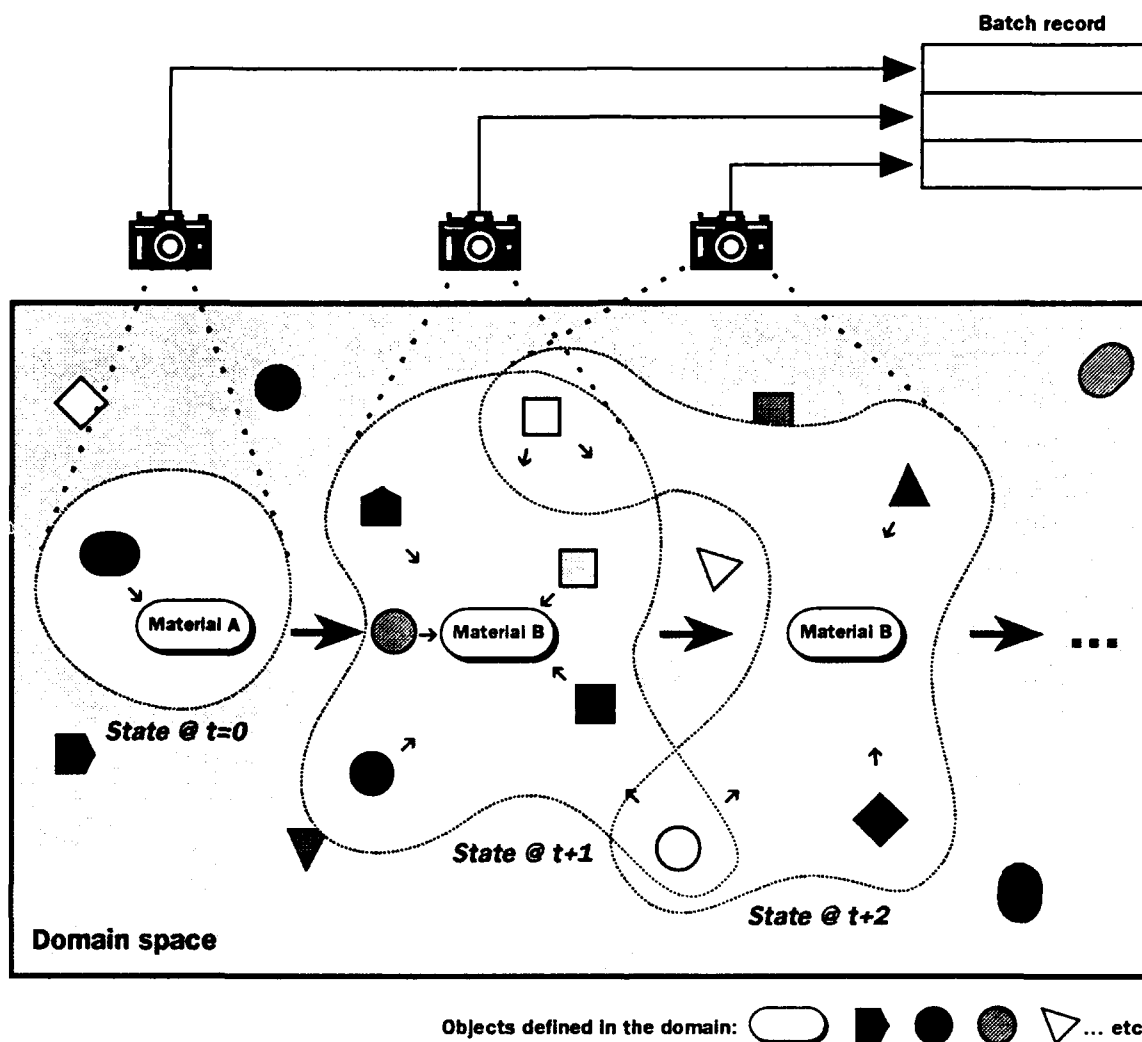

Figure 4. Database Snapshots of the Domain.

Execution of an SOP generates data relevant to a material's unique identity. These data are not generated by the material but by other objects which interact with the material. Therefore, it makes sense to record the status of those objects (metadata) in addition to the data they generate about the material. These batch record snapshots describe selected objects whose state when an SOP was executed can influence a material's physical properties. Capturing the status of all domain objects in the material's batch record would unnecessarily result in staggering data storage requirements and corresponding penalties in system performance.

**Rapid Prototyping Methodology**

By setting aside notions of absolute predictability and quickly converting an imaginative understanding of users' needs into working models, a series of increasingly refined prototypes can drive the process of discovery, synthesis and innovation. Prototype-driven innovation tends to blur distinctions between designers, programmers, engineers, managers and end users, and allows these diverse groups to contribute their unique insights. Prototypes must, therefore, be seen as community property, not just the property of the developer. Users must have opportunities to interact with, and relate to, prototypes as they evolve. Prototyping can then become a common language between

developers and end users, who evolve a unique design vocabulary as they grapple with new ways of expressing their points of view.

Rapid prototyping makes it possible to elicit ideas from individuals with diverse needs and perspectives. Users who become deeply involved in the prototype design cycle ultimately shape not only the product itself, but also the *relationship* between product and user. Collaboration between users and developers ensures that fundamental, yet often subtle, issues of functionality, performance, user-friendliness and completeness are resolved at low cost early in the development of the system. By imposing a rigorous, ongoing "dress rehearsal" that would be impossible to simulate, prototyping also provides an inexpensive way to manage development risk.

The traditional software development cycle is useful for static problems, for which an algorithm is known. Systems designed this way are not usable until they are completed, and if the problem changes, they must be revised or even scrapped. For an expert system application such as the LCMS, for which no discrete algorithmic solution exists, the development cycle must be one in which

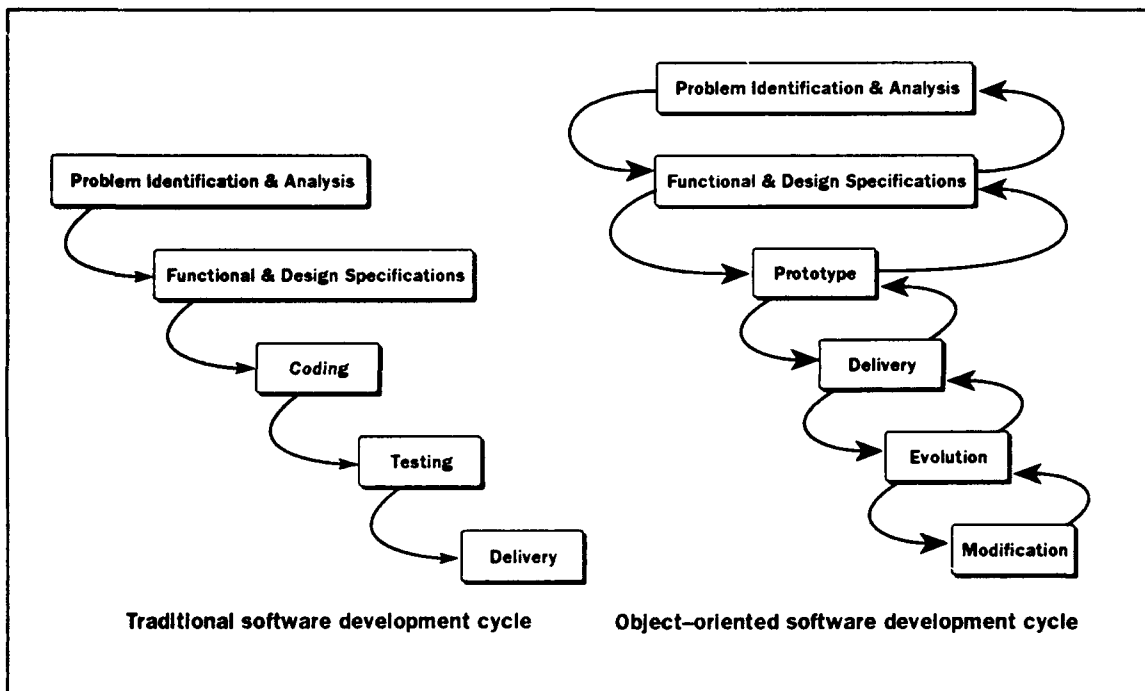

Figure 5. Traditional and Object-oriented Development Cycles.

parallel refinement of the requirements, design, and implementation occur in an iterative, incremental fashion using working prototypes and user feedback to help guide the development.

**Prototype Development**

Approaching the problem at the outset with no *a priori* application-specific examples, constraints or off-the-shelf tools (except Lisp), we needed to define what material traceability meant and should be handled by the application. As soon as the design and coding of the flow diagramming interface began, several issues relating to the manner in which low-level data representations needed to be handled immediately came to light. This was to be expected: one of the advantages of rapid prototyping is that it reveals design and implementation issues early in the development cycle. In the course of reconciling the design of the user interface with system-level data representations, we discovered ways to enhance the prototype's functionality.

User Interface Design Considerations

Our first realization stemmed from conflicting design goals: by presenting on screen the level of detail needed by the system to establish a comprehensive life cycle history of a material, we realized that users would be burdened by more detail than ordinarily would be needed or desired. This prompted us to temporarily redirect our attention to lower-level data representations — and their relationship to the on-screen behavior of graphics in the user interface — before returning to the development of a simple flow-diagramming interface. At this stage, we also began to develop a concept for tying the flow-diagramming interface to shop floor and laboratory documents.

Material Identities

Our concept for complete material traceability did not allow a material to exist outside a process. Some process, including the state of being ambient, would always be acting on a material. This requirement ensures that the system always contains a complete, continuous history of an end-product. To accomplish this, the system would need information describing the environment of all of the material's ancestors during any interval in their life cycles. Under normal circumstances, users would not record information on every temporary state of a material; however, if the temporary state were to become extended, it might become significant. For instance, a material accidentally left out for 12 hours when it was to be returned to cold storage after 10 minutes would represent an anomaly that the LCMS should be designed to capture automatically. The rationale at this stage of the project was that unless we planned to record the existence of all states, we might miss significant anomalies.

The following screen mock-up illustrates by example the level of detail we believed was necessary for the system to record, but not necessarily display.

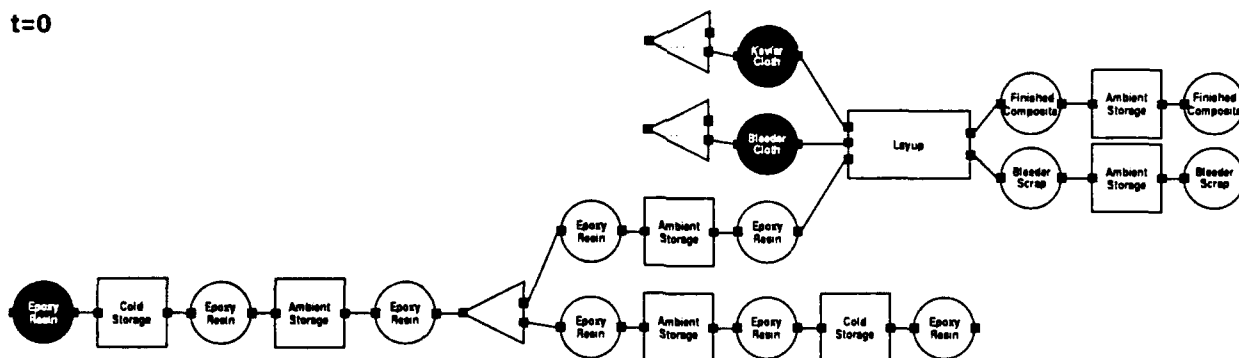

Figure 6. System-level Details for Complete Material Traceability.

Additional Data Types

Our original concept provided for only two data types: materials and processes. We discovered that only two basic types by themselves were not as useful as they might be for tracking undistinguished materials. The lowest-level database representation needed to accommodate four data types: material batches, storage processes (ambient and controlled), batch-splitting processes and laboratory processes. Specializations of material and process data types were to be added incrementally during Phase I, extending the system's understanding of the interactions of particular types of materials and processes. We believed it would be advantageous to preserve the substrate material and process capabilities to allow the system to handle generic materials and processes. That capability would allow new materials and processes to be added and tracked, even in the absence of specific information about their material and process classes.

Storage and Batch-splitting Processes

Please note that in the following discussion, we use the terms “batch,” “material” and “material batch” interchangeably. As was mentioned earlier, we believed that it was important for the system to track ambient storage as well as cold storage. At this juncture, we assumed that a single ambient process existed. The ultimate intent was for the program to infer, from the material’s location, the process a material was undergoing. The system would automatically place the material in the ambient process upon exiting a cold storage process or a process such as layup. In the future, an entire lab might be instrumented to record temperature and humidity. The system would be able to infer changes in the material’s ambient condition based on changes in its location.

Batch-splitting processes, which are represented by the triangular symbol in the preceding flow diagram, are quite basic. Most materials must be subdivided at some time. The behavior of this process was to automatically infer the properties and identities of the resultant batches from the input batch when a batch-split occurred.

Clearly, a balance needed to be reached between the level of detail tracked by the system and its intuitiveness and ease of use. In the lower half of the following illustration, we condense the upper flow diagram, which contains all the process and material blocks the system needs to establish a complete tracking history of the material, to one that we felt would be more in line with the way users normally would think about this series of material and process steps. As the prototype evolved, we planned to use filters to conceal some of this extraneous detail from the user. This would allow all of the information in the top half of the illustration on the following page to be tracked, but only the lower half to be displayed. The condensed level of detail would be set as the system default.

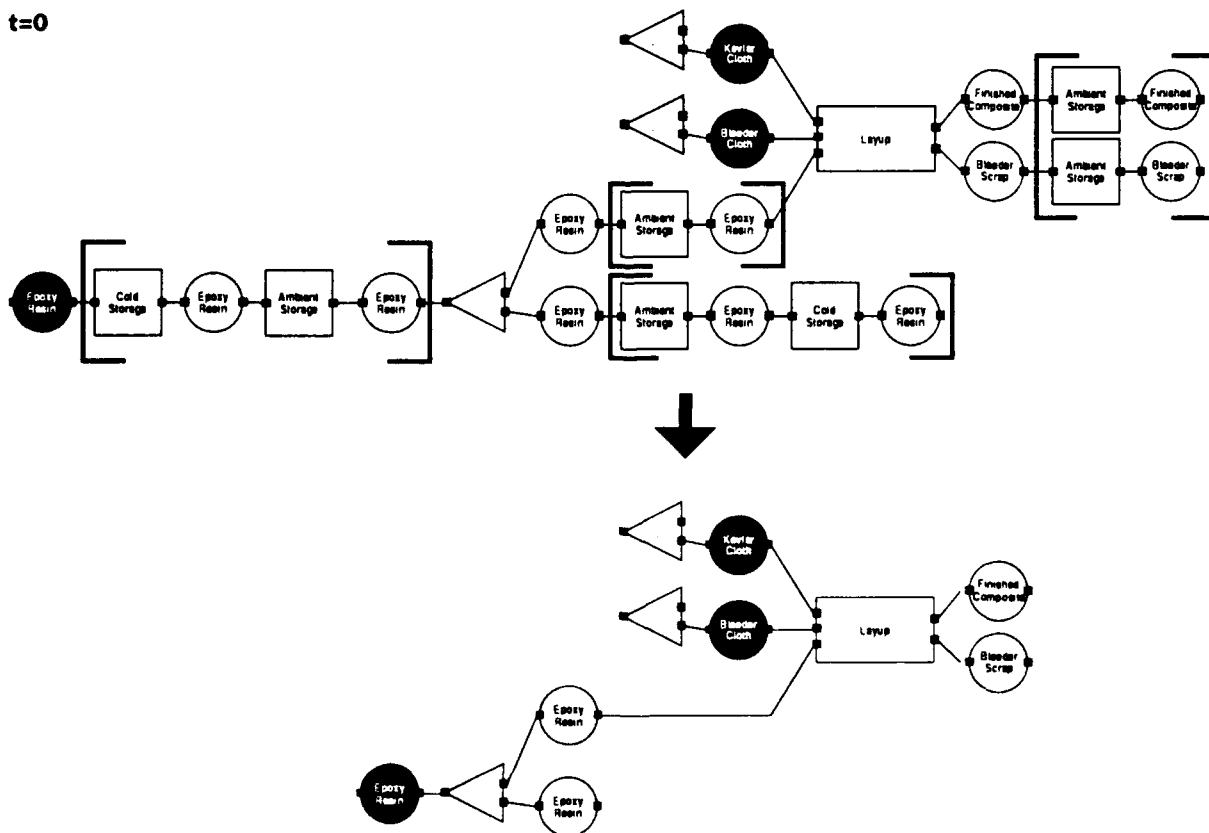

Figure 7. Details at System and User Interface Levels.

### Available Inventory

At this stage, we modified our concept of generalized inventory, which we began calling "available inventory." We discovered that subtle distinctions needed to be made between the "as-planned" and "as-executed" segments of the flow diagram. These distinctions, in turn, had implications for how material batches were handled internally and presented to the user on screen.

In the sequence of flow diagrams labelled  $t=0$  to  $t=4$  in the illustration on the following page, material batches we termed "available inventory" are represented by filled-in circles. As we step forward in time, as-planned segments of the flow diagram are executed and are transformed incrementally to as-executed segments. The as-planned segments may or might not be executed as indicated; hence, they remained editable. Once executed, material and process symbols, which contained information about the materials' history, could no longer be edited, though they could be examined. As new material batches came into existence, they became available inventory and were denoted as such by filled-in circles. Available inventory material batches might subsequently enter, and be consumed by, future as-planned processes.

The system's internal representations of material batches stemmed from a need to distinguish as-planned and as-executed segments of the flow diagram and to provide the flexibility to create a flow-diagram containing materials, which, though chemically equivalent, might be from different lots. When a circle, representing a material, was withdrawn (symbolically) from an inventory storage process and placed in the flow diagram, it was a virtual batch. A unique ID could not assigned at that time. Its identity was established via a pointer to a template of the material type, epoxy resin, which was stored in the system's library. When the user "opened" a storage process symbol and selected the type of epoxy resin to be withdrawn, as for example, from the cold-storage inventory process, the material represented by the symbol became an unbound batch. The batch was unbound at that point to accommodate, in part, the likelihood that different lots of that particular type of epoxy resin might be available for use. When setting up the flow diagram, the user might or might not wish to specify which lot was to be withdrawn. If the user didn't select a particular lot, the system needed to be able to recognize that different lots of the same material were equally acceptable. If instead, the user specified that a particular lot was to be withdrawn, then, when the material was physically removed and the specific lot number recorded (via bar coding or manually), the system would confirm that the material's as-planned and as-executed attributes satisfied the criteria set by the user (any lot of that material type or a specific lot of that material type). At that point, the system could assign a unique batch identifier to the material based on a confirmed lot number. The greater specificity of that batch's identifier corresponded to its transformation from an as-planned to an as-executed batch.

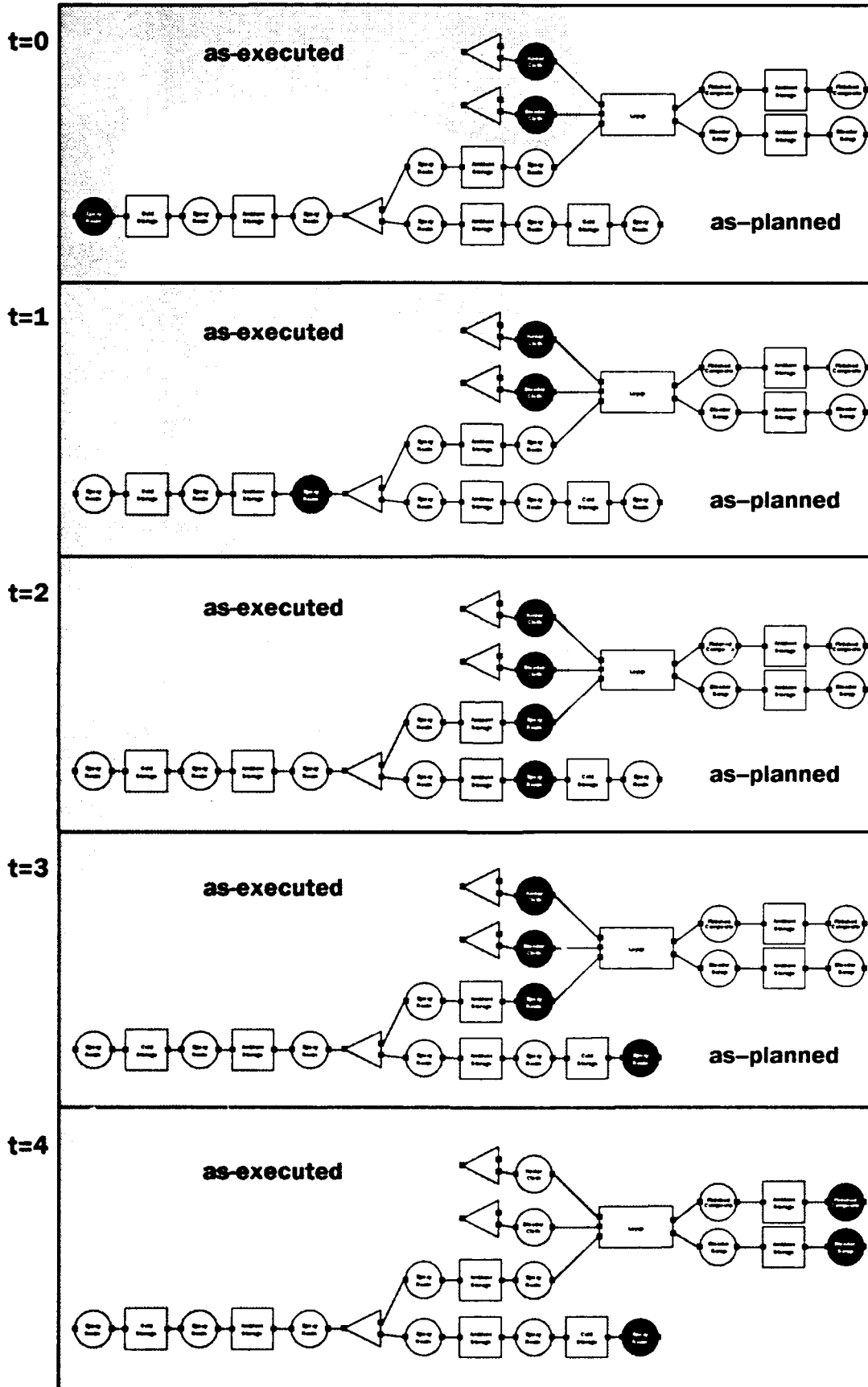
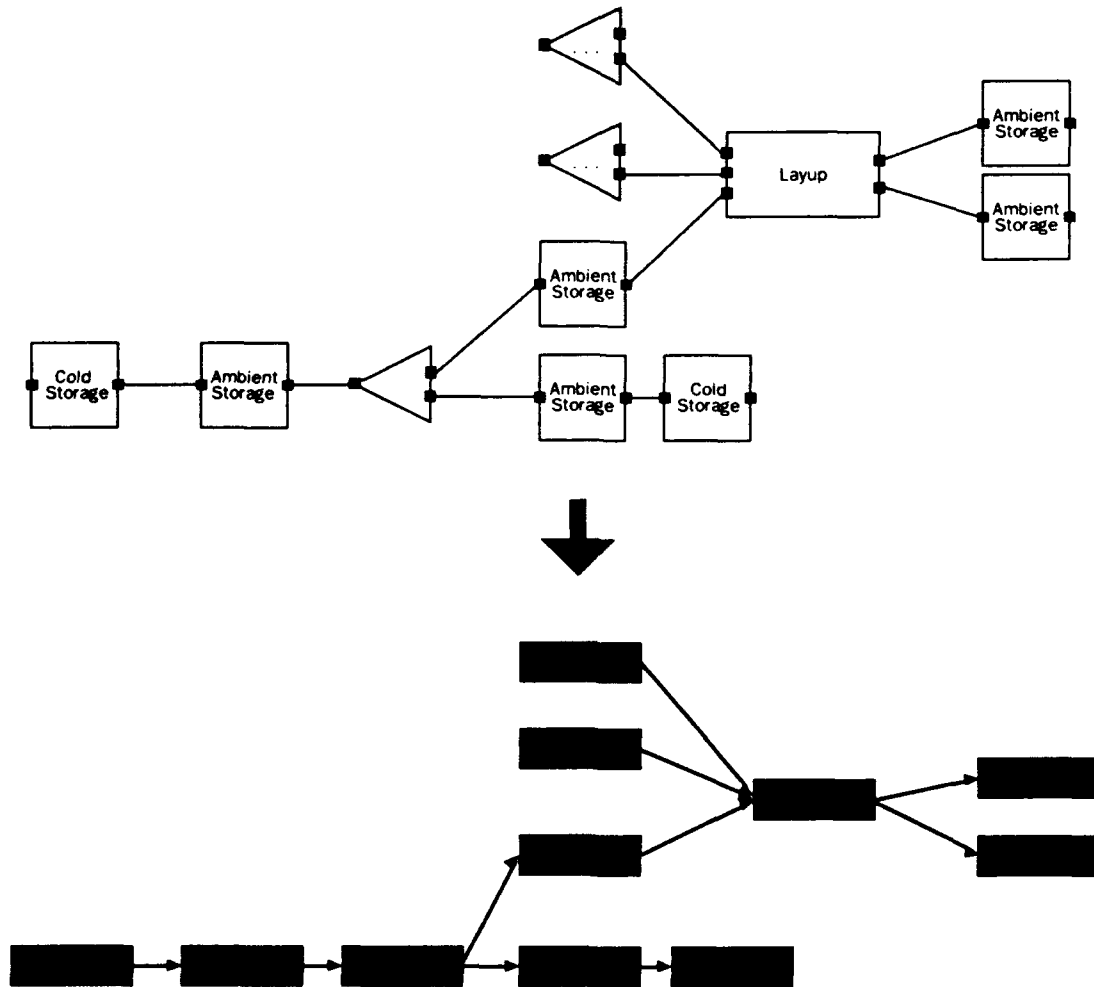

Figure 8. As-Planned, As-Executed Flow Diagrams.

Planning and Scheduling

We alluded earlier to the potential for extending the LCMS to support project planning and resource and task scheduling. In the following illustration we establish a conceptual recognition of the relationship between the process/material flow diagram and a conventional CPM chart. When materials are removed from the diagram, only a sequence of linked processes remains. Like any other objects in the system, processes can contain attributes of time, which can be viewed in a CPM format.



*Figure 9. Relationship of Material/Process Flow and CPM Diagrams.*

Symbolics Lisp Prototypes

Two working prototypes were created using Symbolics' Genera object-oriented development environment. The first was a simple graphic editor designed to demonstrate an interactive flow-diagramming user interface. In the second, intelligent behaviors were added to materials and processes.

Prototype 1: The Box Editor

The first prototype demonstrated to AMTL was a "Box Editor." This interface enabled the user to create boxes of various shapes and connect them with flow arrows. More than just a graphic drawing tool, the editor "understood" what it meant for an arrow to be connected to a box. When the box moved, arrows connected to it moved with it. When a box was deleted, its arrows were deleted automatically.

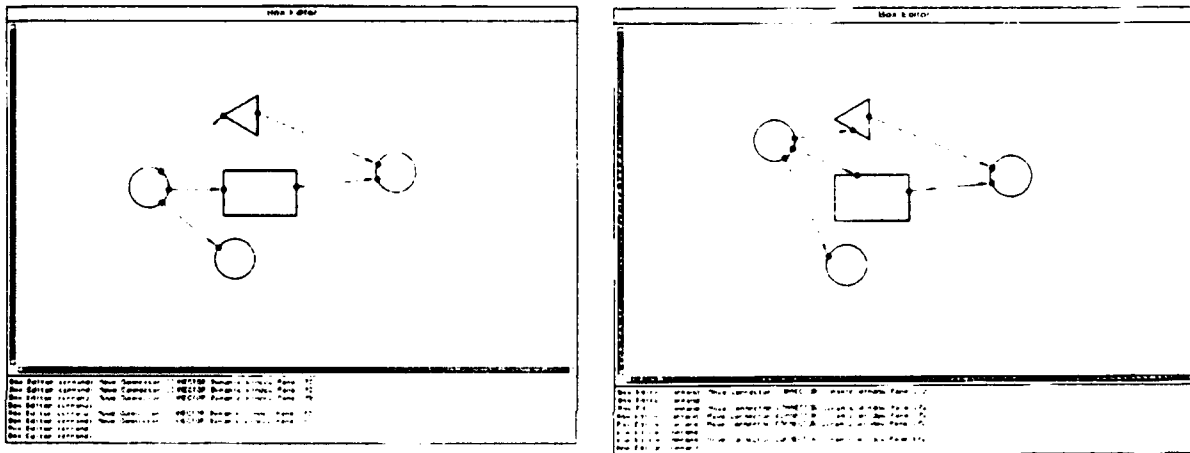

*Figure 10. Symbolics Prototype 1: The Box Editor.*

Care was taken during the design of this prototype's underlying structure to enable it to be readily extended by adding intelligent behaviors to the boxes and arrows. While not actually necessary for the Box Editor, Connectors were implemented as well. These were small tabs on the perimeter of the boxes to which lines must be connected. In the Box Editor, an arbitrary number of connectors could be created on any box, and these could be moved anywhere on the perimeter of the box.

Prototype 2: The Process/Material Editor

The Process/Material Editor was built on top of the Box Editor. The oval boxes represented materials, rectangular boxes were general processes, square boxes were storage processes, and triangular boxes were batch-splitting processes. When the user created a material box or a storage box, the box had one "input" connector and one "output" connector: these could be moved or deleted, and new connectors could not be added. Any number of connectors could be added to a general-process box or a batch-splitter box, and these connectors could be moved and deleted. A distinction was made between materials boxes and all other process boxes: a material could be connected to a process, or vice versa, but the interface did not permit the user to connect a material to a material, or a process to a process.

The oval-shaped material batches could be edited in the lower-left window to change their material type, lot number, amount, and units. Material type could be chosen from the expandable materials hierarchy, which the Box Editor displayed in the lower-right window. All windows in both editors were scrollable.

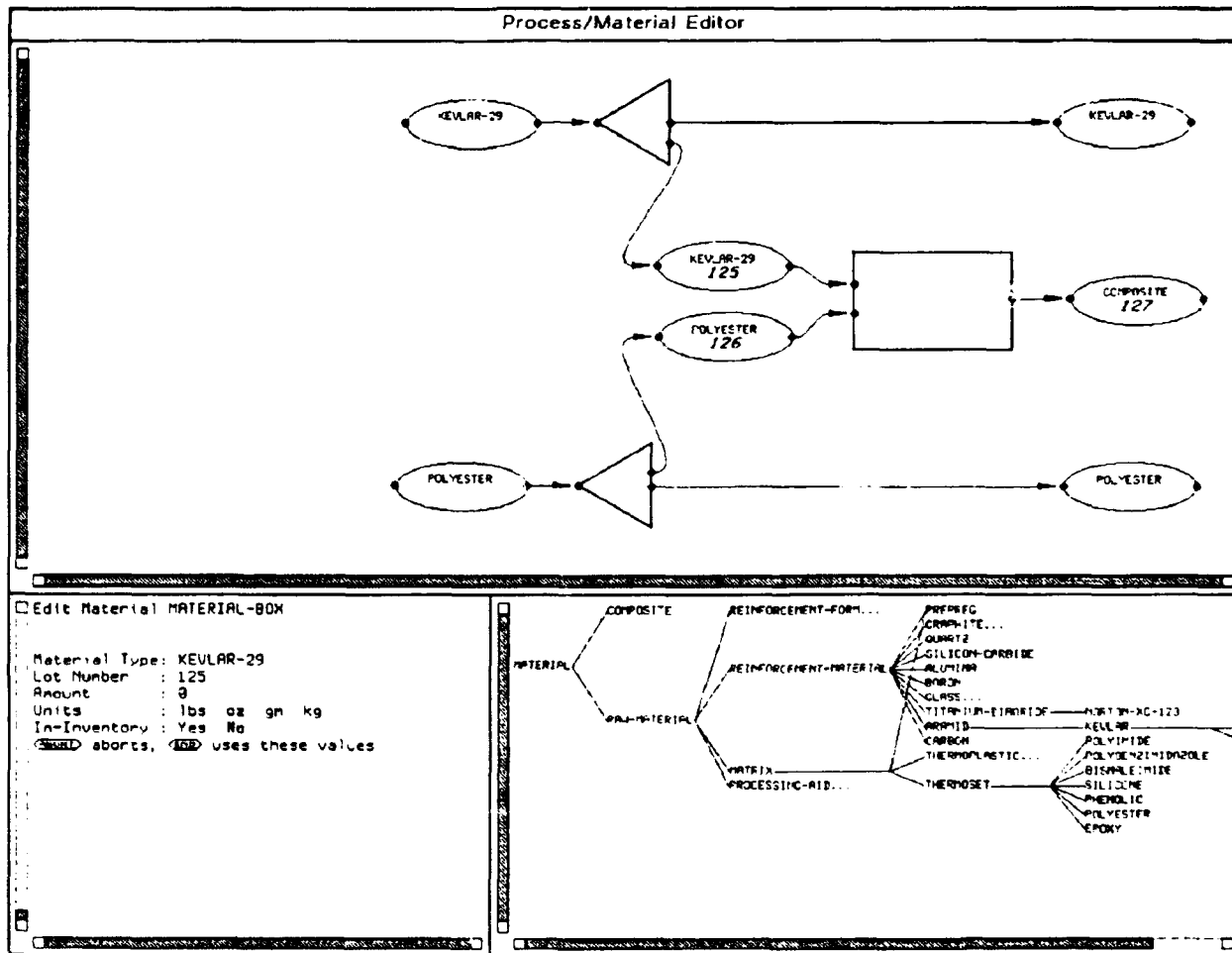

Figure 11. Symbolics Prototype 2: The Process/Material Editor.

Integration of "as planned" and "as executed" structures

The concepts of *Unbound Batch* and *Virtual Batch* were briefly introduced and then abandoned in favor of *Bound Batch* and *Inventory Batch*. These merely represented a means by which the "as planned" and "as executed" structures would be integrated into a single structure.

An oval in Prototype 2 represented the state of a batch at a particular point in time. (From now on, we will refer to an oval as a Batch Snapshot.) A batch may have any number of batch snapshots, as it passes into and out of storage, or has pieces removed in a batch-splitting process. A finished composite would have one snapshot for each testing/characterization process through which it passed.

The preceding Figure displayed an as-planned structure. Three ovals near the middle of the window are labeled 125, 126, and 127; these are the bar code IDs that would be affixed to the material batches as soon as they came into existence. The ovals at the top and bottom of the window were not yet identified with a particular batch, but we knew that they would be required to be Kevlar-29 and Polyester. From this plan, Standard Operating Procedure work orders would be printed with instructions and bar-coded data entry points for each batch snapshot. The actual bar-code number of the two input batches was not important, since it was simply used as a temporary identifier until the actual batch bar-code number was known.

In the illustration below, two batches have been retrieved from inventory. The black background of those ovals represents the fact that the two batches existed at this point in time and were not conceptual placeholders, as were the white ovals.

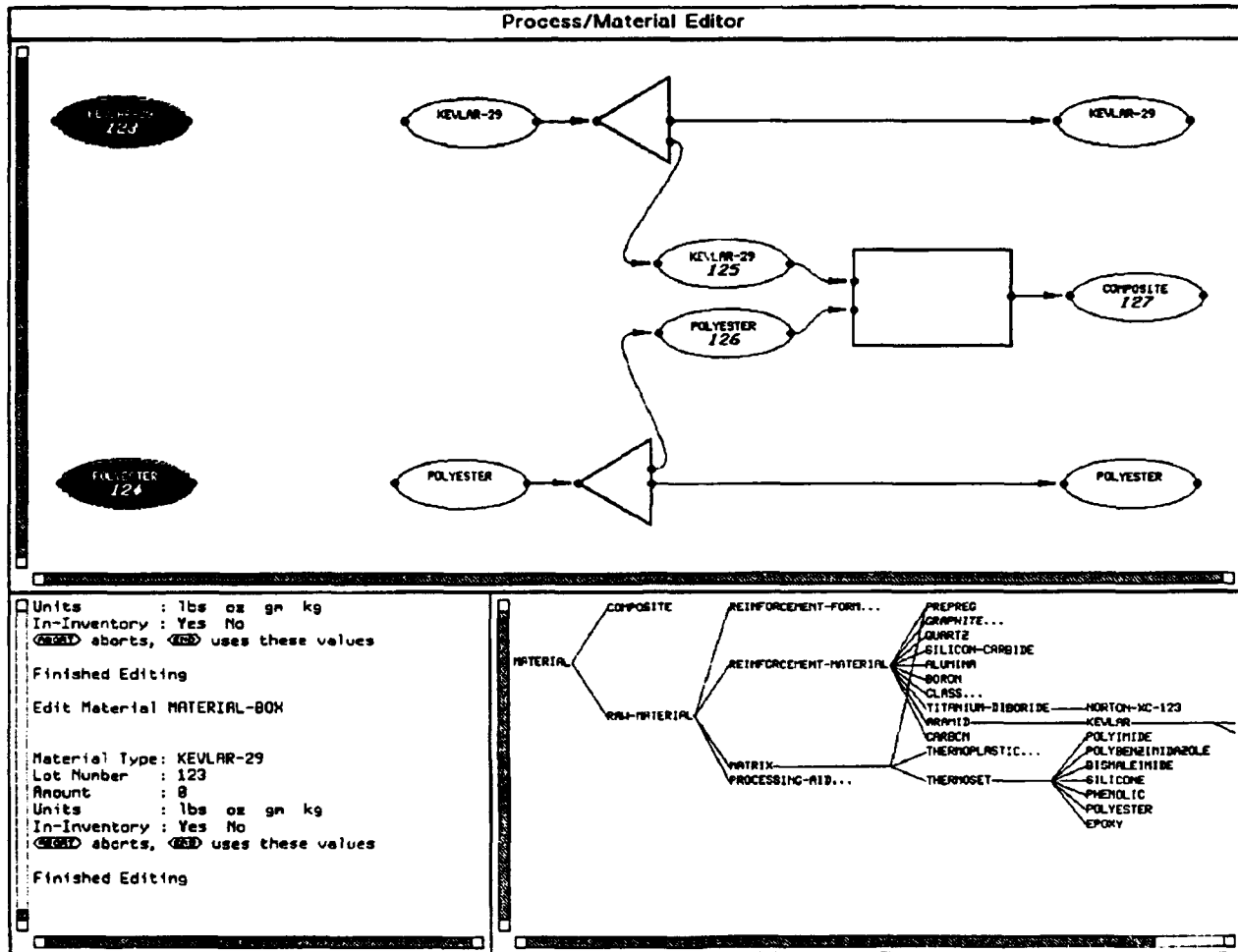

Figure 12. Symbolics Prototype 2: Process/Material Editor.

In the next illustration, the user has scanned the bar code on each batch and the corresponding temporary bar code identifier on the Standard Operating Procedure work order. The two input batch snapshots become bound with batches 123 and 124, respectively. In each case, a temporary ambient storage process is inserted by the program. The batch snapshots of batches 123 and 124 have changed to black ovals, representing the fact that the batches have been "aged" by the ambient storage process.

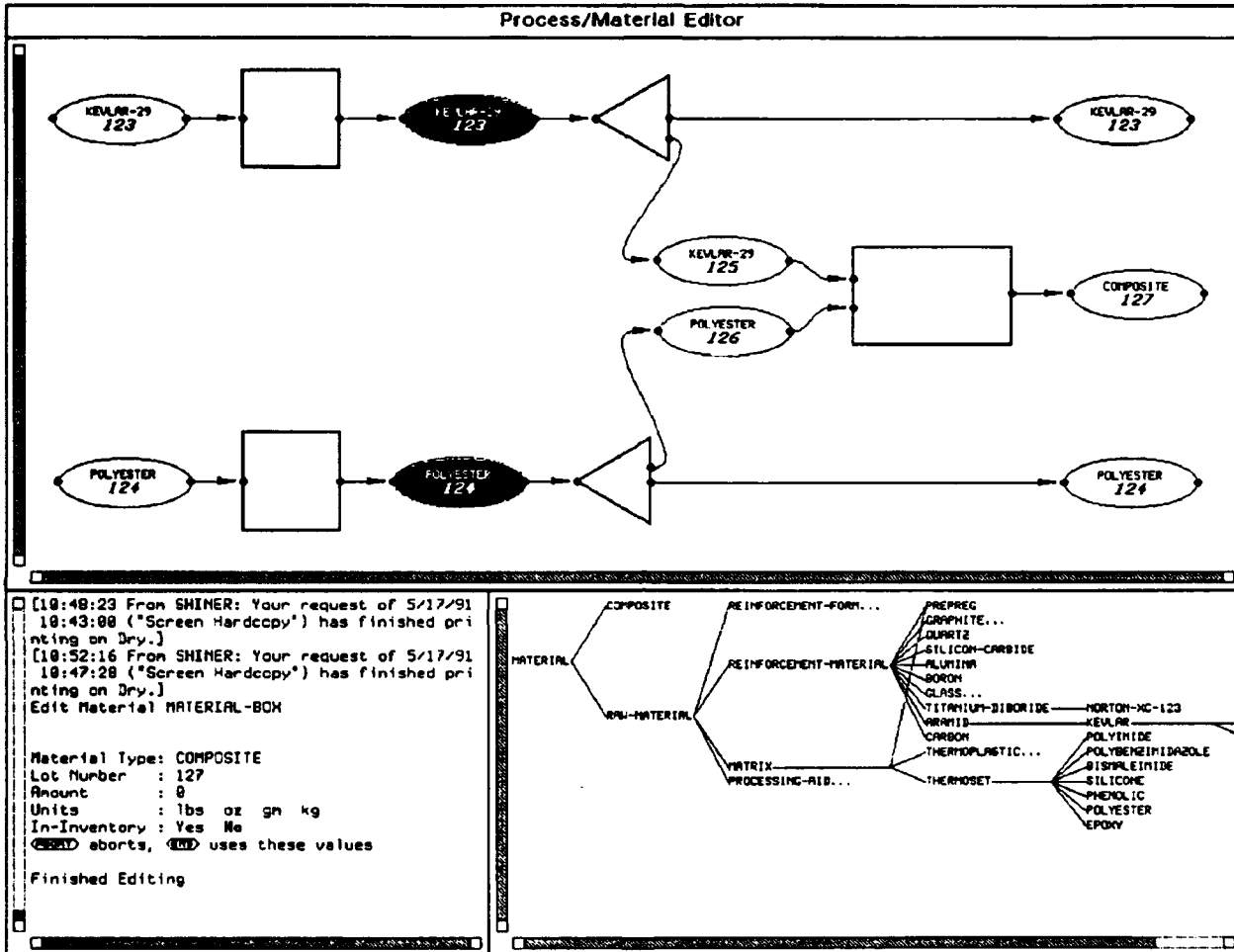

Figure 13. Symbolics Prototype 2: Process/Material Editor.

This Figure displays the state of the database after the user has scanned the bar code on the Operating Procedure that represents completion of the splitting processes.

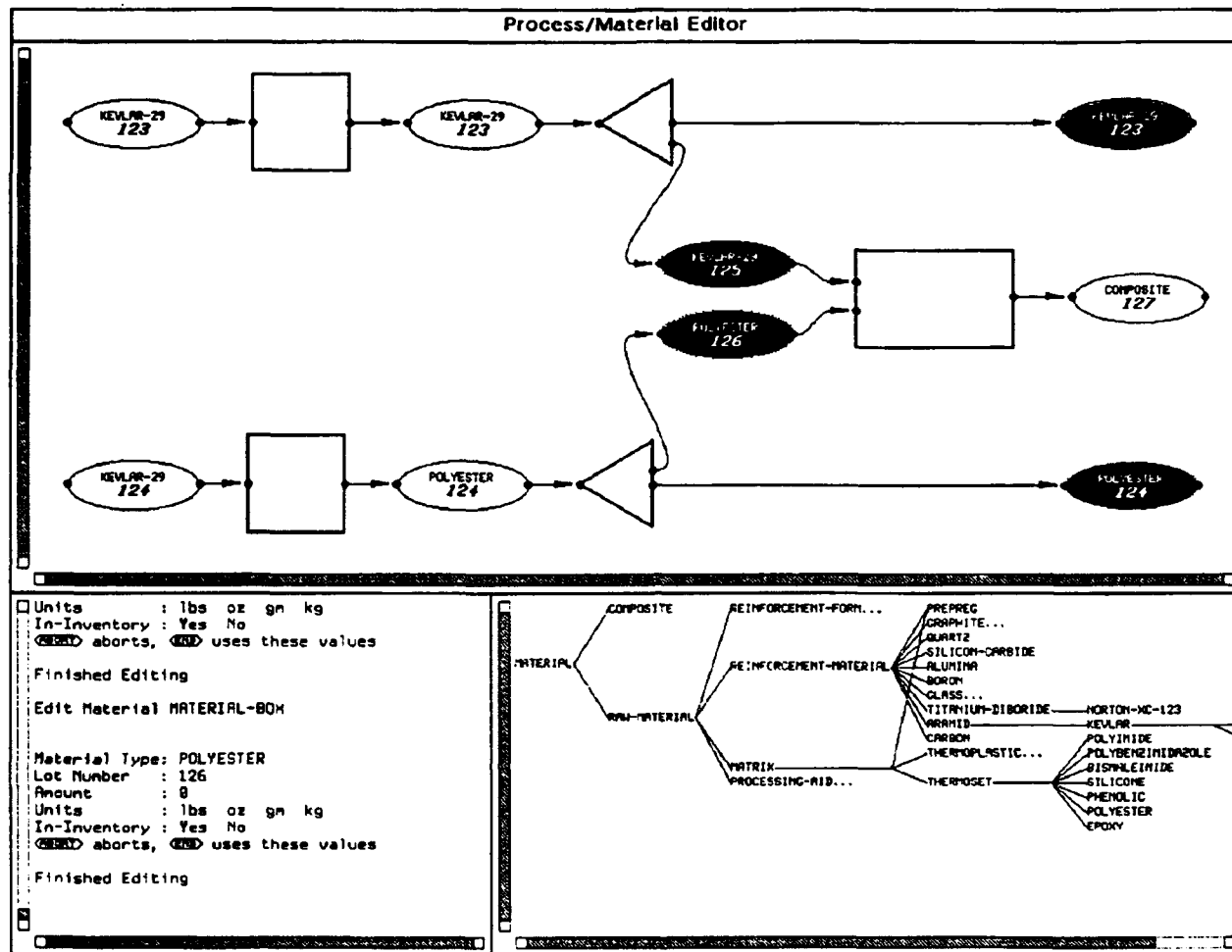

Figure 14. Symbolics Prototype 2: Process/Material Editor.

Finally, the user has scanned the bar code on the Operating Procedure that represents completion of the main layup process. At this point, the final composite comes into existence.

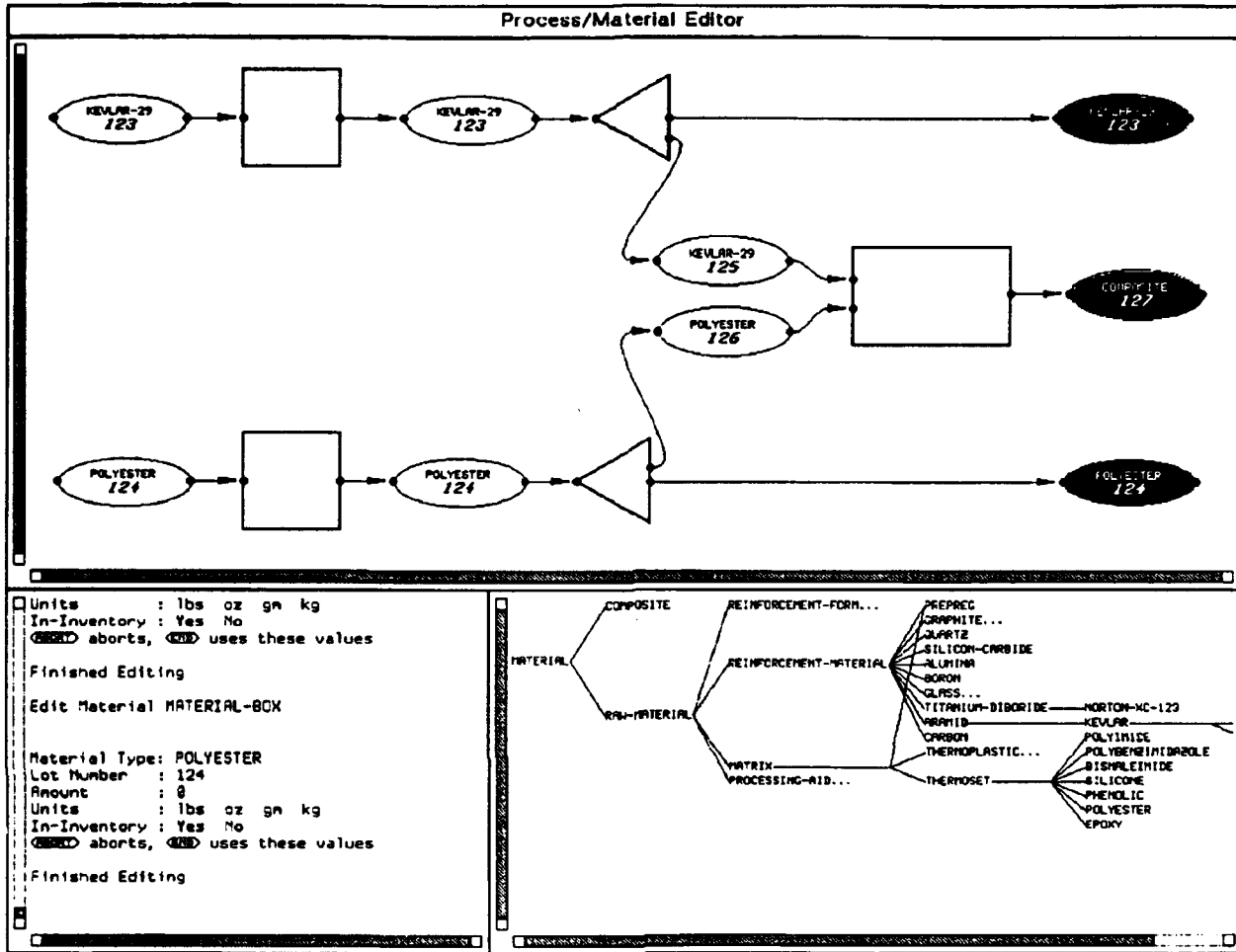

Figure 15. Symbolics Prototype 2: Process/Material Editor.

One simplification has been made for purpose of this example: batches 123 and 124 would normally go straight into an ambient process after each batch-splitting process. Rapid prototyping in Lisp aided in understanding these low-level data representations, laying the groundwork for the G2-based generation of prototypes described in the following section.

G2 Prototype

To achieve the level of functionality required of a full-scale Life Cycle Management System (LCMS), a commercially available, real-time expert system shell, G2™, was evaluated and found to be well-suited not only to the original objectives of Phase I, but also to a much more ambitious set of objectives. The final G2-based prototype incorporated an intelligent, graphical user interface; interactive flow diagramming for planning, specifying and scheduling project activities; a library of process templates to aid project planning; automatic creation and management of batch records; automatic assignment of unique material identifiers; continuous monitoring of prepreg shelf life; message-board notification of shelf-life expiration; and, interactive control panels for user specification of Standard Operating Procedures (SOPs). The final prototype also demonstrated the potential for integrating within the LCMS a modular subsystem for real-time, knowledge-based process control of press curing and other composites processes.

User Interface for Materials

The following main-menu console appears automatically when the workspace is opened. It provides a point of departure for this demonstration of the prototype.

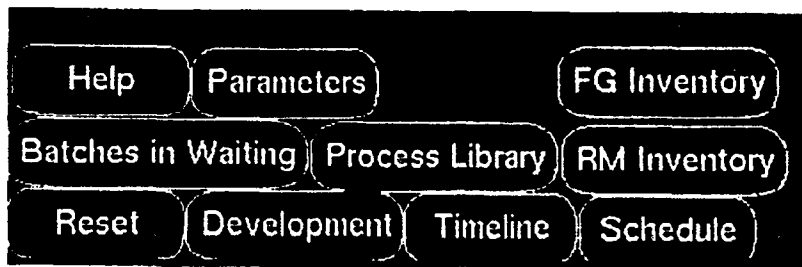
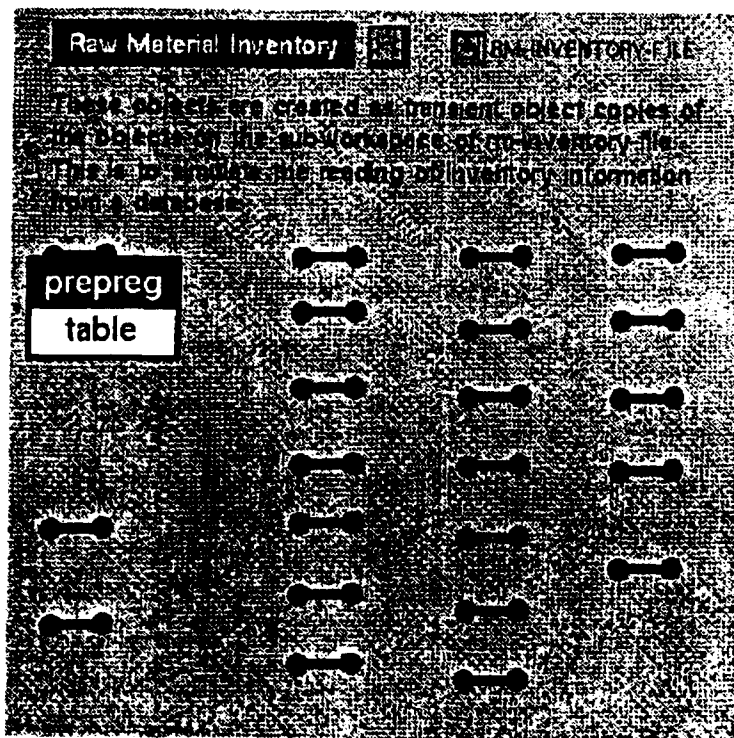

Figure 16. G2 Prototype: Main-menu Console.



In this session, the user clicked the mouse on "RM Inventory," opening the following window. The main-menu console remained on screen during the session to facilitate navigation to other parts in the application. The raw material window contains icons representing raw inventory objects (resins, prepreps, reinforcements, fillers, release agents, etc.), which are stored in the prototype's rm-inventory file.

In a full-scale implementation, the application would be interfaced to, and communicate transparently

Figure 17. G2 Prototype: Raw Material Inventory Window.

with, an archival, relational database. In that configuration, G2 would access inventory and other data as needed through GSI, G2's communications interface to sensors, controllers, external databases, and other software. The interface for browsing RM inventory could easily be organized by category, with each raw material category appearing in a separate subworkspace window. Inventory objects were not labelled in this prototype, but would be in subsequent versions. Names with icons suggestive of the type of material could be presented.

The user could query items in the prototype's raw material file by clicking on an icon. Doing so produced the pop-up window in the previous illustration. Clicking on "table" opened the accompanying pop-up table which containing attributes of the raw material. In this example, the user was

logged on as an "operator," which limited the information presented. "Supervisor" mode, for example, might reveal additional details. Other user types can be authorized, allowing discretionary control over which attributes are visible to different types of users.

a prepreg	
Batch number	122
Status	inventory
Material type	'Graphite Fiberprepreg'
Mfr tradename	'Hercules, Magnamite Graphite Fibers Type AS4/3501-6'
Date of mfr	27 Dec 90 10:52:53 p.m.
Po #	'DAAD0589P2396'
Lot number	6149-3
Areal wt	146 GM-PER-M2
Resin content	32
Shelf life	1 hour
Expiration date	19 Jun 91 2:33:53 p.m.

Figure 18. Table of Material Attributes.

The accompanying screen shot is a portion of the material hierarchy which underlies this knowledge base. Normally, the hierarchy would be neither visible nor of interest to typical end users. Assignment of a material to a class is established using an object's attribute table in developer mode.

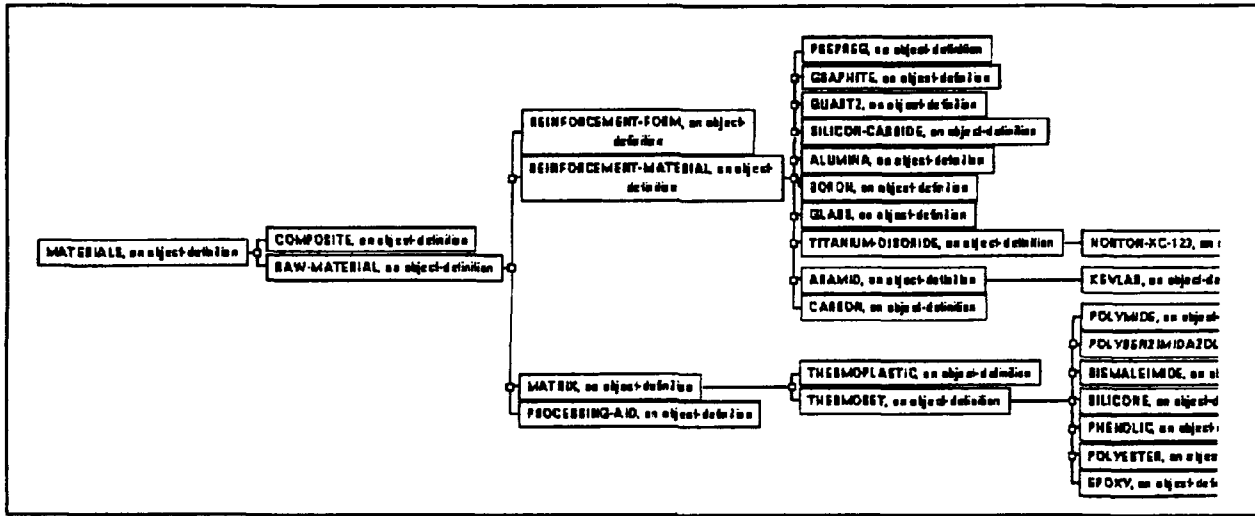

Figure 19. Class Hierarchy of Materials.

During this session, the shelf life of several materials expired. When this occurred, an icon was automatically superimposed over that of the expired material in the raw material inventory window.

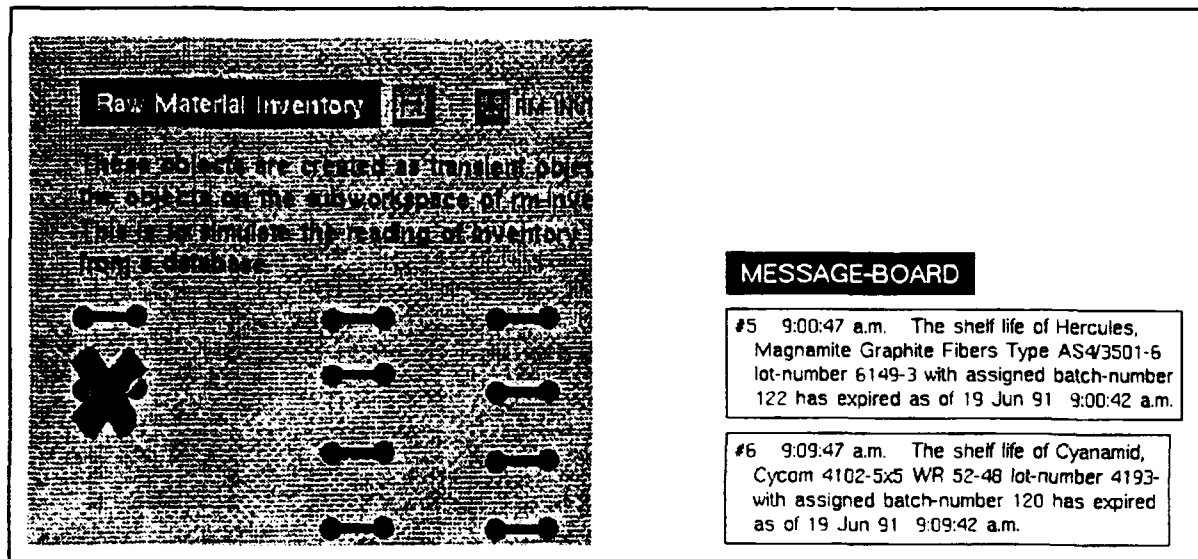

Figure 20. Warning of Shelf-life Expiration.

Simultaneously, a pop-up Message-Board appeared, with a text message alerting the user to the event. The Message Board would alert the user to this and other events whether the corresponding window was open or not. This example provided a simple demonstration of G2's real-time expert system capabilities applied to the firing of shelf-life expiration rules, which were inherited when designated materials entered the system. Shelf-life is an attribute of a prepreg which can be inherited at the class level.

'As-Planned' Process Flow Diagram

A "Process Library" was included in the G2 prototype. The accompanying window appeared in response to clicking on "Process Library" in the main control console.

Rather than require users to painstakingly create process/material flow diagrams from individual

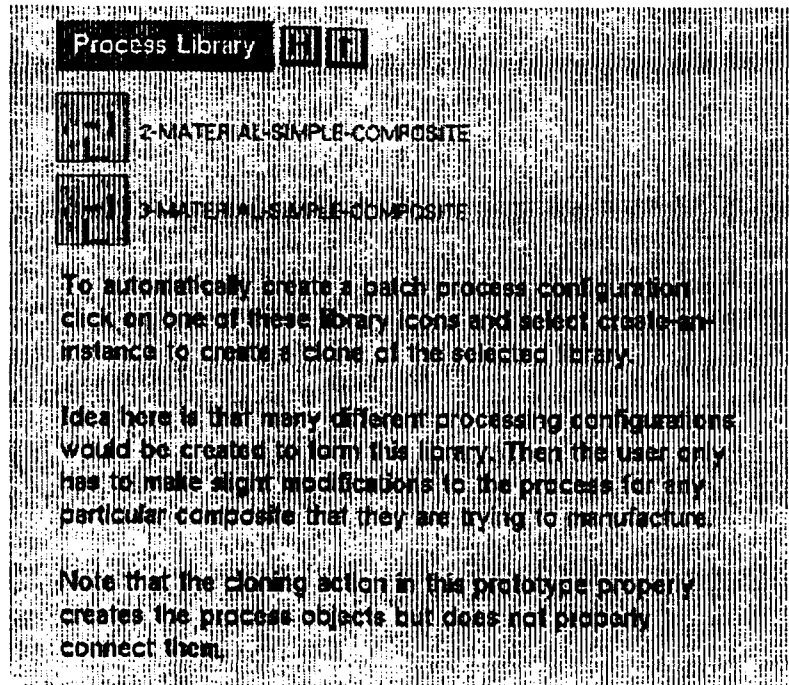

Figure 21. Process Library Window.

components when planning a project, we proposed instead that users be able to access a library of templates of process diagrams, selecting one that corresponds most closely to the planned project. The library would contain templates for layup and curing, pultrusion, filament winding, RTM, etc., in addition to those for standard characterization and testing procedures.

The two icons in the portion of the process library window shown below provided access to sub-workspaces containing 2- and 3-component-material flow diagrams. Selecting a template with a mouse click produced a pop-up menu with options for either inspecting the template or creating an instance of it, which corresponded to checking out of

the library a fresh copy for the user's project. These were intended to demonstrate the process of documenting the production scheme for a composite.

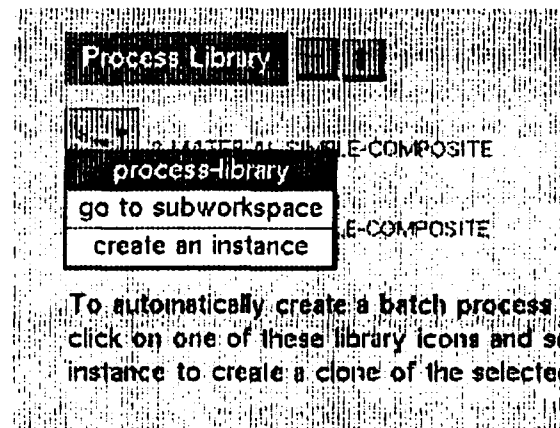

Figure 22. Pop-up Menu for a Process.

A blank, ready-to-specify, process flow diagram immediately appeared in a new workspace window. This prototype did not include rules which automatically established connections between materials and process icons, although future versions could. Ovals represent materials, rectangles are processes and triangles are batch-splitting operations.

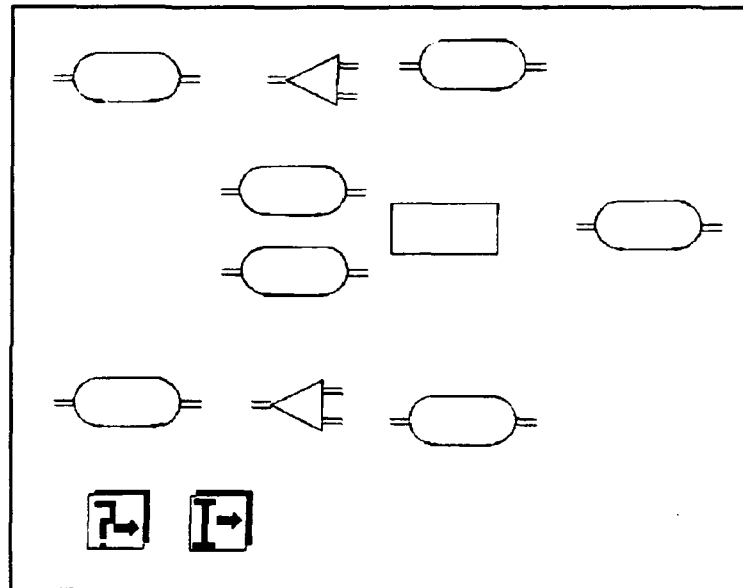

Figure 23. Blank Process Flow Template.

The accompanying window contains a collection of process flow diagrams which were previously checked out of the process library by other users and customized by them for specific projects. These could be viewed by process type (transforming, destructive and nondestructive test), by date, user, product type, etc.

In G2, connections are objects, which can be defined hierarchically at the developer level with the table editor shown earlier for materials. Their behaviors also can be controlled with rules. In this prototype, drawing connections manually enables us to demonstrate the intelligent on-screen behaviors of material and process icons.

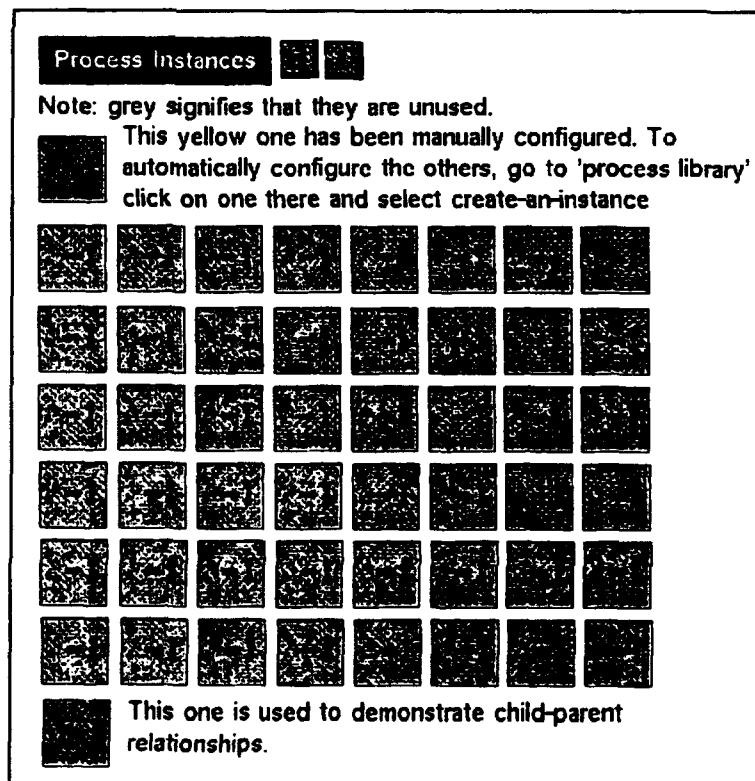

Figure 24. Library of Process Instances.

Here, the user has drawn connections between materials and processes and has selected Kevlar batch #139 as one of the starting materials. (Kevlar was chosen as the only material in this example to better illustrate the system's parent/child tracking capabilities, which follows later in this section.) Ovals are materials, rectangles are processes and triangles are batch-splitting operations. The user could start material selection anywhere. The system reasoned about, and filled in the remaining nodes.

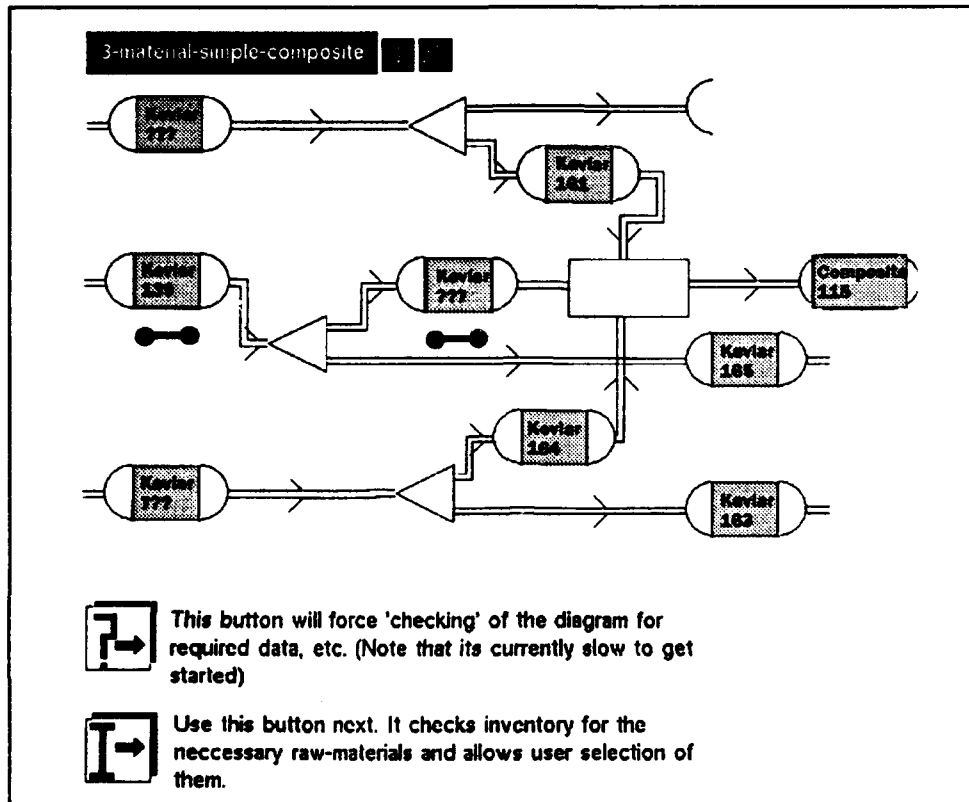

Figure 25. Partially Completed Flow Diagram for Processing of a Composite.

Batch numbers and names for the descendants of the parent raw materials were assigned automatically when the user established connections by dragging the cursor between icons. The system precluded erroneous connections from being made, e.g., between materials. In G2, connections are objects and can be defined hierarchically at the developer level. Their behaviors also can be controlled with rules. In this prototype, drawing connections manually enabled us to demonstrate the intelligent on-screen behaviors of material and process icons.

The functions performed by the "?" and "I" buttons were carried out manually in this prototype. They would be performed automatically in Phase II versions. The "?" button searched for missing data, placing its icon over empty raw material blocks. The user then clicked on the "I" button to search available inventory and select the desired materials.

Materials also could be assigned to the flow diagram by clicking on a material icon. The accompanying control panel allowed the user to inspect the batches of Kevlar in inventory while altering the user to other batches currently in use. The table could easily be enhanced to show the amounts available.

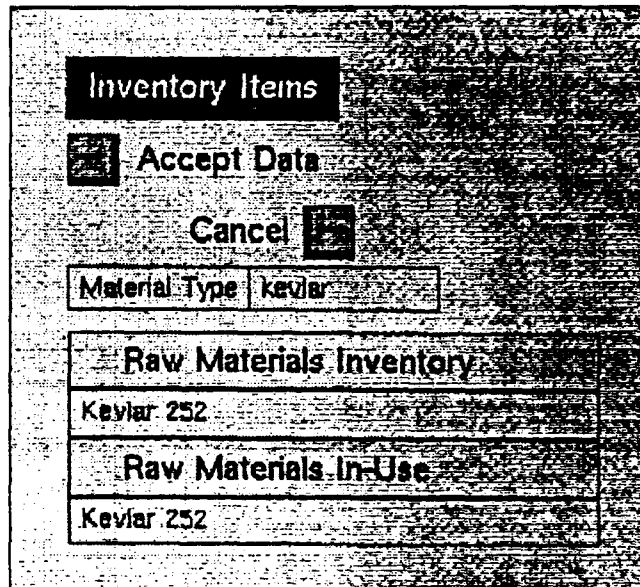

Figure 26. Raw Material Inventory Control Panel.

Material- and process-specific information could be inspected with pop up windows that open when clicking on icons in the flow diagram. The windows available to this user, who was logged on as an operator, are abbreviated. They enabled the user to inspect the attributes of a material, the results of tests performed on it and its lineage. For process blocks, the user could examine SOPs and, for a simple process like batch splitting, could specify the amount entering the process.

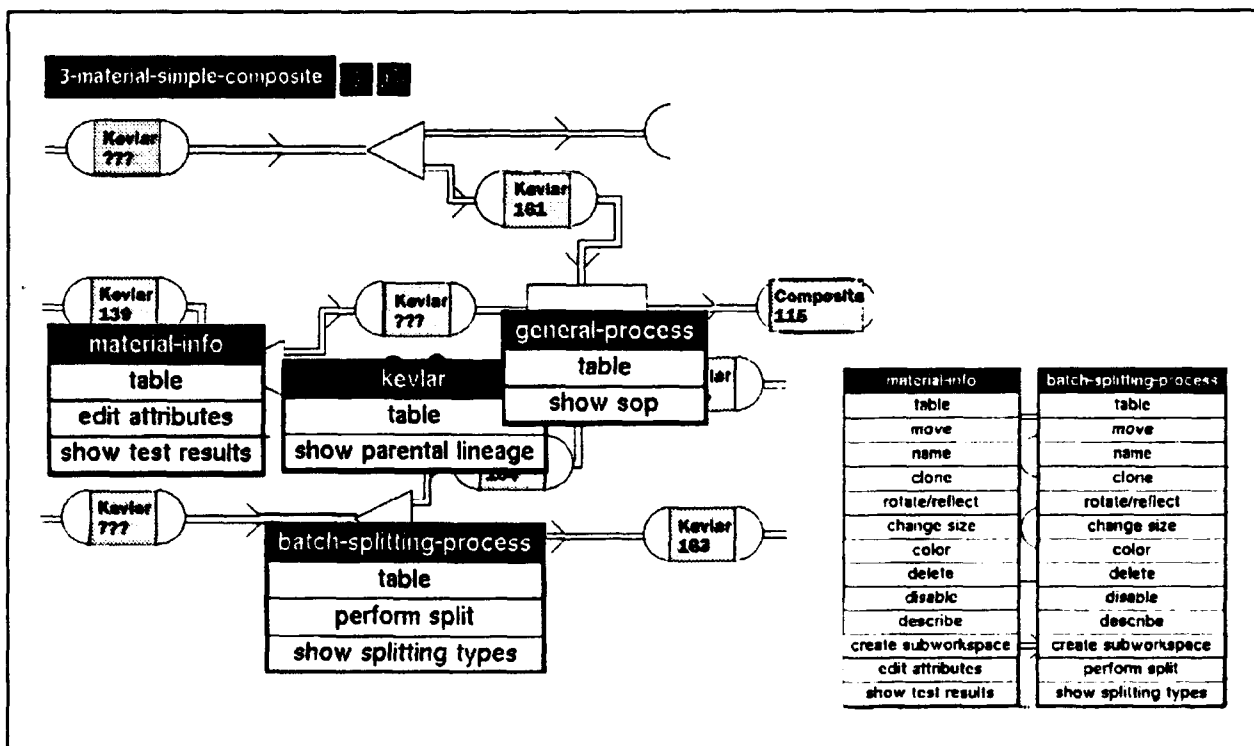

Figure 27. Pop-up Windows for Material and Process Icons.

Developer mode permits additional menu choices, control of object definitions and the ability to tailor the user interface to satisfy the needs of different categories of users.

These control panels were used in the course of performing a batch-splitting operation, signified by the triangular icons in the preceding flow diagram. They also serve to demonstrate the implementation of context-sensitive help and data-entry error trapping, both of which capitalize on G2's rule-based expert system capabilities. Units in the Material Editor control panel adjust to the type of material (liquid, powder, fabric, tow, etc.). Depending on the flow diagram selected from the Process Library, a host of process-specific rules and pre-set parameters could be applied automatically, alleviating the need for the user to manually specify many of the details.

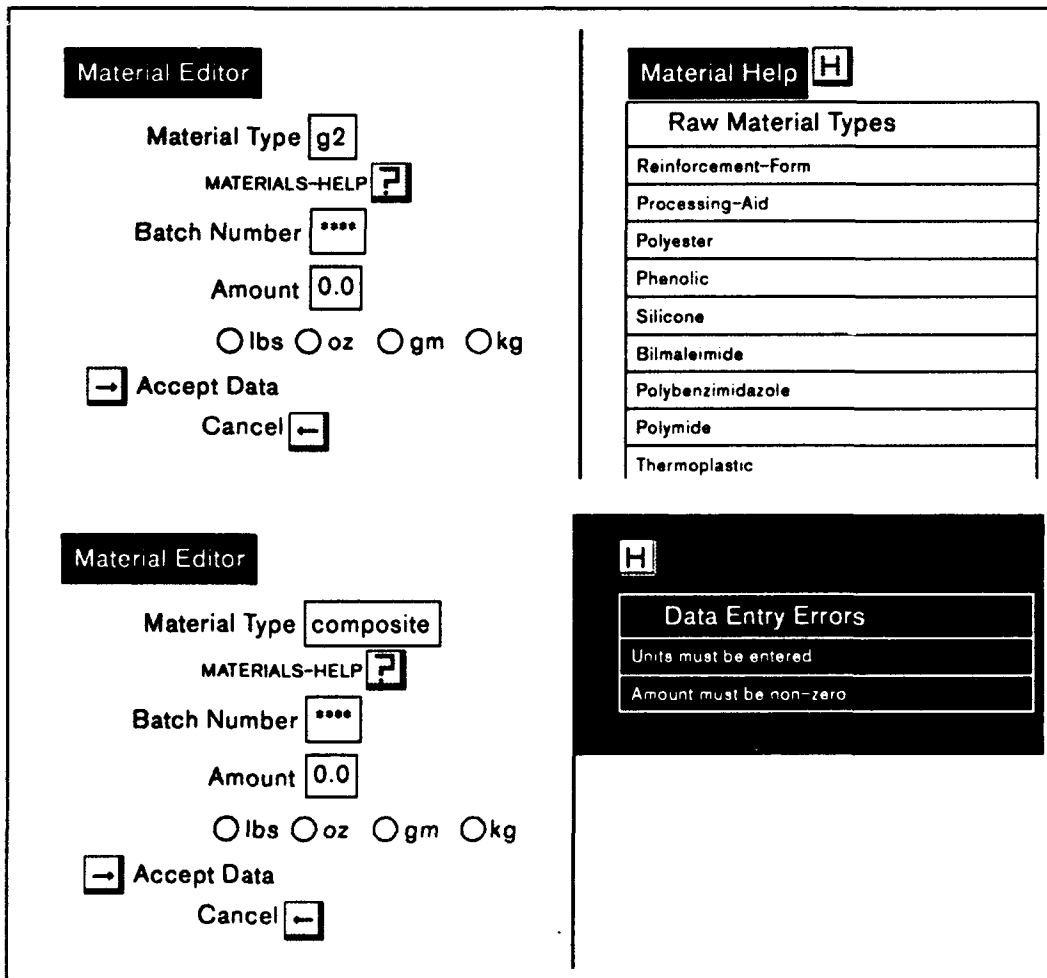

Figure 28. Material Editor and Subordinate Control Panels.

The user could inspect the test results for a material or specify the details of a test procedure and append it to the flow diagram and hence, the material's batch record. The interface was configured as a control panel, which is the on-screen representation of, and basis for, the corresponding printed SOP work order. Editing the parameters of a test procedure in the control panel would simultaneously update the SOP work order document for that test.

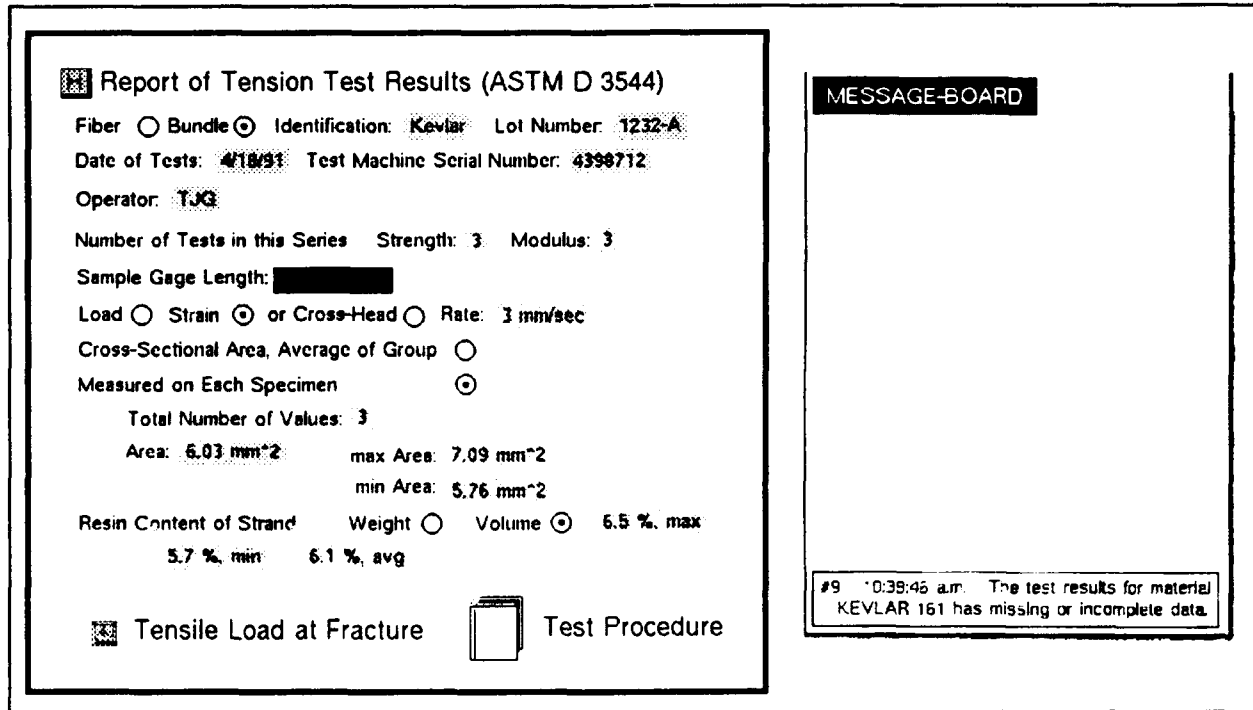

Figure 29. Control Panel for ASTM Test Procedure and Message Board.

Because one of the parameters violated rules associated with elements in the diagram, another warning message appeared on the Message-Board.

A G2 workspace containing a process flow diagram can be extended with a feature known as a connection post. A pair of TO-BATCH/FROM-BATCH posts can link a batch in one subworkspace with the same batch in another. The sequence can be continued indefinitely, creating a single, large material/process flow diagram. Connection posts can be placed anywhere in a flow diagram. They can be used to attach test procedures that may not be contained in a particular process library template.

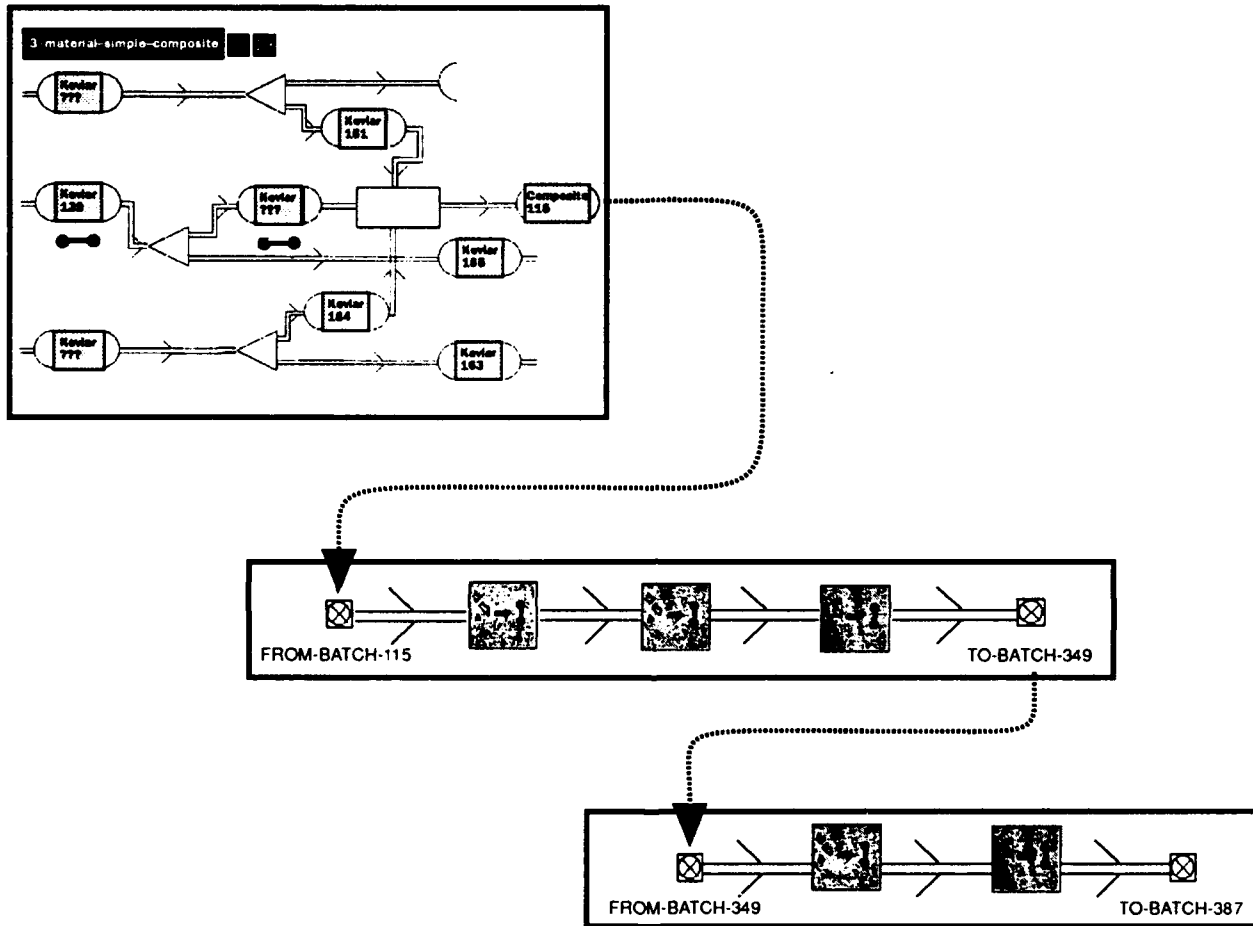

Figure 30. Extended Workspace Using Connector Posts.

Material Tracking

Parent/child relationships were established automatically by the system as it monitored the user's activities. Batch numbers were assigned to uniquely identifiable materials where necessary. A material's ancestors and descendants and their status could be inspected in a pop-up window.

The table automatically extends to include all the batch's parents and children. In this example, Kevlar batches 165 and 139 are the parents of Kevlar 163, which appeared in the earlier flow diagram. Similarly, the children of Kevlar batch 163 were assigned batch numbers 161 and 162 by the application. Other methods of presenting parent/child relationships are with the nested hierarchy shown in the accompanying illustration and with the expandable network tree. The latter was demonstrated in an earlier Symbolics prototype.

<b>H</b>	
Parents of KEVLAR 163	
KEVLAR 165	Status: USED-UP
KEVLAR 139	Status: USED-UP
<b>H</b>	
Children of KEVLAR 163	
KEVLAR 161	Status: IN-USE
KEVLAR 162	Status: IN-USE

Figure 31. Parent-Child Table.

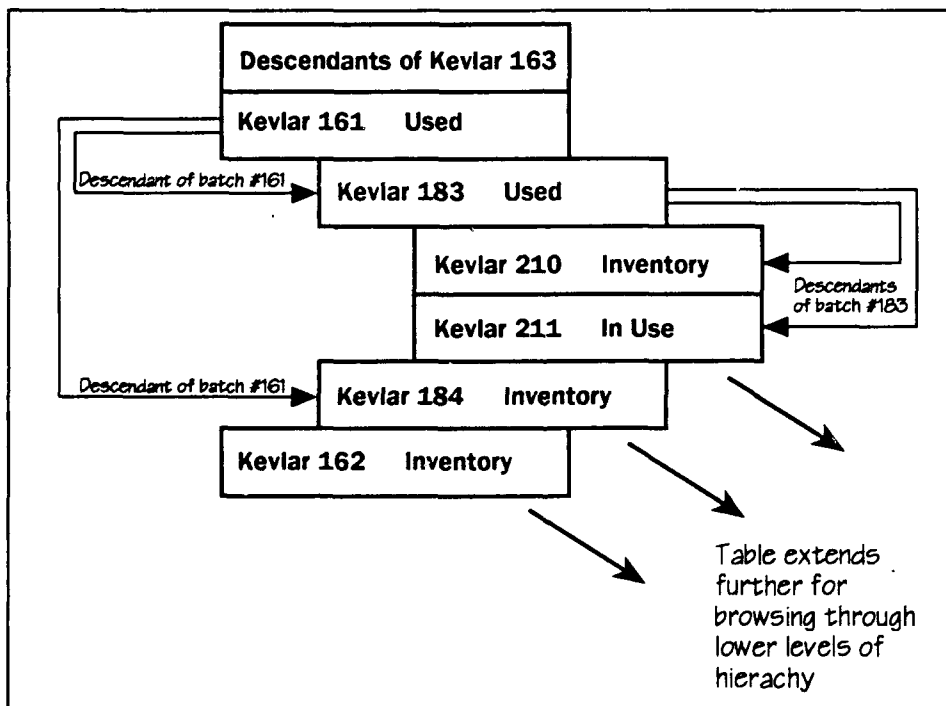

Figure 32. Parent-Child Nested Hierarchy.

To provide a simple demonstration of a user interface for real-time control of press curing, the prototype was extended with a press curing control panel. After setting the target temperature, ramp rate and soak time, the user started the press with the control panel. The prototype simulated data logging from temperature sensors by presenting the incoming data in real time on a scrolling graph. The icon of Press-1 was animated to provide an indication of the operating status of the press. The use of G2 for real-time control of composites processing is discussed in greater detail in the Recommendations section of this report.

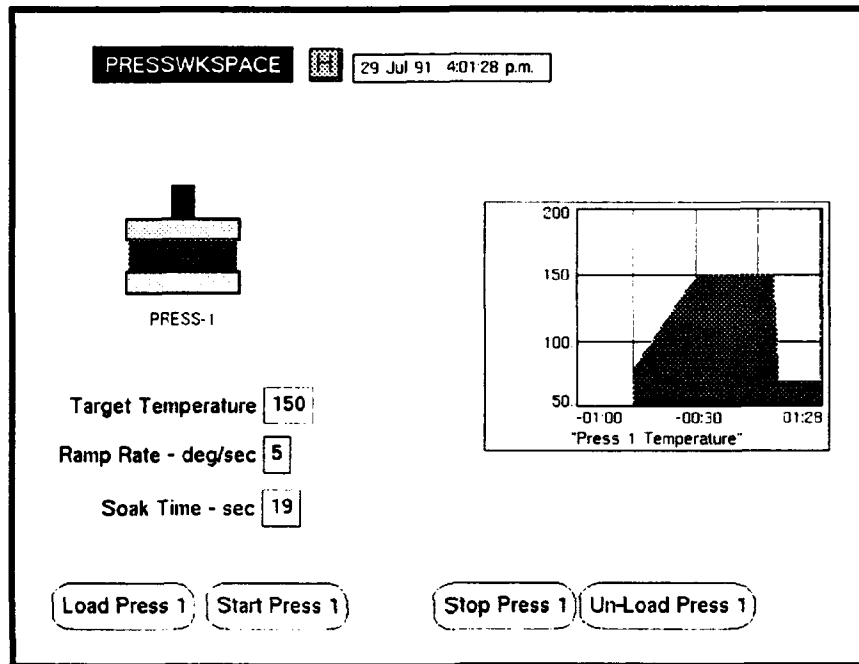

Figure 33. Control Panel for Press Curing.

### **STATUS OF ACCOMPLISHMENTS**

Phase I proof-of-feasibility was established through delivery of the prototypes described in the Discussion section of this report. The achievement of the technical objectives of Phase I can be attributed to:

- Ongoing analysis of the requirements throughout Phase I.

This process benefited from site visits to AMTL, from the proactive participation of AMTL staff in defining their requirements, and from feedback provided by AMTL in response to the Symbolics and G2 prototypes delivered during Phase I.

- The Lisp-based prototypes demonstrated at mid-project.

These prototypes implemented the concepts of an intelligent, flow-diagramming user interface and of batch record tracking. They aided in understanding the problem and facilitated the transition to the second-generation, G2-based prototypes.

- Selection and application of G2.

Phase I evaluation of G2 was a departure from the original work plan, which called for prototypes to be programmed *de novo* in Lisp. It became clear that G2 provided the functionality needed to develop and deliver a full-scale LCMS. G2 also makes it possible to extend

the functionality of the LCMS to real-time, autonomous, expert-system-based process control for composites processing.

Having established the technical superiority of G2 for development and delivery, full-scale development can focus from the outset on substantive issues of knowledge engineering, integration with external data sources and repositories, user-interface ergonomics, sophisticated data retrieval and reporting capabilities, and development of knowledge bases for real-time process control of composites processing.

In addition to significantly reducing the development risk and time associated with a *de novo* programming effort, features inherent in G2 also resolved several implementation issues which were identified during Phase I:

- *Portability.* G2 has been ported to a variety of popular hardware platforms, ranging from PC's to mainframes.
- *Multi-user access.* G2 provides multi-user access through its version of X-Windows when running under UNIX.
- *Interfacing to other applications.* Through GSITM, Gensym Corporation's communications interface for G2, applications developed in G2 can exchange data with external databases, sensors and controllers, simulation models, etc.

## **TESTS**

Rapid prototyping made possible hands-on evaluations of the applicability and feasibility of important design concepts, including elements of the graphical user interface, SOPs, material traceability, and expert system-based advisory support features. These prototypes were described in the Discussion section of this report. The feasibility of full-scale development and deployment was evaluated during Phase I and in conjunction with the preparation of a Phase II proposal. A discussion of these development issues is presented in the Recommendations section of this report.

## **SUMMARY**

The principal technical objective of Phase I was to deliver a fully documented, working prototype of an integrated bar code database system for composites life-cycle tracking. It was assumed initially that the LCMS would be modelled on a typical composites production environments. At the outset however, it was decided instead to attempt to satisfy the requirements of R&D environments such as AMTL's. The rationale was that a tracking system for R&D-intensive environments would raise more challenging design issues and could later be readily adapted to more highly structured, high-volume production environments.

To better understand the implications and scope of life cycle management for system design, life cycle management was divided into the following steps: planning and scheduling, project execution, data collection/validation, post mortem data retrieval and reporting, and data analysis. Emphasis during Phase I was placed on user interaction with the planning interface, which was based on an intelligent flow diagramming paradigm. Materials, processes and other resources were objects which appeared on-screen as icons. Relationships between objects could be described explicitly, both logically and graphically, by connecting them with line segments.

The LCMS maintains an inventory of materials, and, at the user's discretion, stores in the material's batch record associated scanned-in shipping documents, manufacturer's QA certification sheets, product data sheets, MSDS sheets, cure cycle data and the results of ASTM testing procedures. Unique serial identifiers maintained by the system can be printed on bar-coded labels for raw materials, intermediates, composite end items, processing equipment, test equipment and other resources critical to maintaining high quality standards of production. Forward and backward

traceability are maintained via system-administered batch records for every uniquely identifiable raw material, intermediate, test sample and end item.

As a material enters the system, it inherits behaviors characteristic of the material's class. For example, all prepregs monitor and accumulate room temperature time and adjust their remaining shelf lives accordingly. From the user's vantage, these behaviors are controlled by Standard Operating Procedures (SOPs). SOPs governing shelf-life expiration, for example, generates advisory messages in anticipation of a material's shelf life expiration. Users can then activate a recertification SOP, or, at the user's discretion, the system can do so automatically. Materials whose shelf life has expired and which have not been recertified will be blocked from being selected for use pending successful completion of the recertification SOP. Other SOPs monitor instrument calibration schedules and other time-dependent resource requirements.

A crucial requirement of any database system centers on the mechanism(s) by which real-world data are identified, collected, validated, entered and stored. To minimize time-consuming, administrative tasks associated with documenting composites processing and testing, expert-system-based reasoning was applied. Bar-coded work orders generated by the system would serve as the link between the user's material/process flow diagrams and shop-floor and laboratory execution of SOP work orders. On-line data from instruments and process sensors would be captured by the system, validated and stored in a relational material property/batch record database. The expert system would serve as an intelligent assistant and a graphical front-end to the integrated archival database.

The strategy for applying expert system technology to the manual SOP tracking component of the LCMS was predicated on saturating users with labor-saving features to win them over to new ways of planning and organizing their projects, having work assignments executed, recording and reporting results. The goal was not to supplant the need for thought, or to absolve users from being intelligent, but to leverage their productivity and that of the resources they used.

On-screen SOP control panels provide a convenient means of specifying the parameters of ASTM-based test procedures. When a user connected the icon for a particular ASTM test procedure to a material icon in a process flow diagram, the active-document intelligence of the test procedure control panel object would validate, among other requirements, 1) whether the test was applicable to that material type; 2) whether the context in which the user wished to apply the test was reasonable; and, 3) whether the resources needed to carry out the test were available or needed calibration. As the user specified a sequence of production and testing procedures in a flow diagram, the LCMS would create an as-planned master batch record containing slots for each uniquely identifiable material consumed or created and the applicable SOPs.

Each SOP defines objects within a process which potentially can influence a material's properties. Once data about the material and the SOPs entered the system, the material property data would be processed and stored in an integrated archival E49 material property database. Additional slots in the batch record would provide a means of documenting the status of objects in the domain that may have some influence a material's processing and testing history. Batch records, therefore, contain "snapshots" of the state of relevant objects in the domain at the time data about the material were collected.

The first working prototypes, whose purpose was to elicit user feedback regarding the graphical flow-diagramming interface and the behaviors of materials and process objects, were created in Lisp. These prototype revealed that physically connecting material and process icons with lines could have several logical interpretations and consequences. It became apparent that presenting too much system-level detail to users would not be advisable. In response, the interface was designed to hide the complexity of the system-level data representations.

The implication at the midpoint of Phase I was that the LCMS would need a sophisticated awareness of the context(s) in which the user was attempting to connect icons of processes and materials. If the

system understood the context of the user's actions, it could hide the underlying complexity, while preserving the logical relationships it required and the user probably intended (but may not have fully realized).

The search for a more immediate solution led to the evaluation of a commercially available expert system shell which, among a host of other features, offered the tools needed to build interactive, intelligent user interfaces. This software development environment, G2™ from Gensym Corporation, is object-oriented, as was the Symbolics Genera™ environment used in the initial, Lisp-based prototypes, which greatly simplified the mid-project transition. Real-time, knowledge-based reasoning was not considered essential for the LCMS at the outset of Phase I; however, the combination of object orientation, tools for building graphical user interfaces, knowledge-based expert system development tools, portability and the ability to reason in real time made G2 an attractive development shell. As a result, rapid prototyping was continued in the second half of the project with G2.

The final G2-based prototype incorporated an intelligent, graphical user interface; interactive flow diagramming for planning, specifying and scheduling project activities; a library of process templates to simplify project planning; automatic creation and management of batch records; automatic assignment of unique material identifiers; continuous monitoring of prepreg shelf life; message-board notification of shelf-life expiration; and, interactive control panels for user specification of Standard Operating Procedures (SOPs). The final prototype also demonstrated the potential for integrating within the LCMS a modular subsystem for real-time, knowledge-based process control of press curing and other composites processes.

## **CONCLUSION**

The prototypes developed with G2 established the technical superiority of G2 for development and delivery of the LCMS. The choice of G2 also resolved technical uncertainties associated with portability, multi-user access and integration with external databases. The consequences of the shift in development environments from Lisp to G2 extend well beyond the demonstration of technical feasibility, however. Development of the LCMS using G2 will make it possible to:

- Deliver a much higher level of functionality and added value via the integration of material tracking, quality management and real-time process control capabilities in a single application;
- More easily capture and incorporate during development the knowledge of collaborating organizations having extensive composites processing expertise;
- Share and reuse existing knowledge bases to leverage the development of extended capabilities;
- Field test incremental prototypes of the LCMS using existing computer hardware at field test sites;
- Simulate process control scenarios within the application before field testing;
- Interface the real-time process control portions of the application to existing sensors and controllers;
- Dramatically reduce development time and cost despite a much higher overall level of functionality;
- Begin applying the system's functionality to support the broader objectives of concurrent engineering and Computer Integrated Manufacturing.

These opportunities for full-scale development were unthinkable at the outset of Phase I and would remain so in the absence of the evaluation of G2 made during Phase I.

It should be noted that at the outset of Phase I it was not evident that an expert system-based approach was appropriate, nor was real-time control of composites processing considered within the scope of a LCMS. However, in the context of G2's framework for knowledge representation and

reasoning, the material tracking component of the LCMS now can be viewed as a slower-moving subset of a more encompassing, real-time, knowledge-based application.

## **RECOMMENDATIONS**

### **Objectives for Full-Scale Development and Implementation**

Full-scale development and implementation are predicated on the following two broad, complementary technical objectives:

1. Delivery of a unified, user-friendly, knowledge-based advanced composites life cycle management system that provides comprehensive material traceability and quality management support for both R&D-intensive and high-volume production environments;
2. Leveraging the system's knowledge base of materials, their physical and chemical properties and processing requirements by developing software modules for real-time, autonomous control of composites processing, specifically, for pultrusion, autoclave curing and compression press curing.

Distinctive advantages of G2 are its modular, knowledge-based architecture, real-time inferencing and graphical user interfaces. Full-scale development would capitalize on the synergistic reuse of one knowledge base to create others, thereby making it possible to extend the system's functionality, value and cost effectiveness beyond what could be accomplished in separate, uncoordinated development efforts. Full-scale development would also benefit from the rapid prototyping approach employed in Phase I. To gain further advantage from the collaborative advantages of rapid prototyping, hands-on field testing at government, academic institutions and commercial enterprises should be an integral part of any full-scale development effort. This would ensure satisfaction of Army and supplier requirements and also would facilitate the transition to broad commercial deployment.

### **Functional Requirements**

Functional requirements for the LCMS were described in the Discussion section of this report and are summarized in the illustration on the following page. A full-scale LCMS also would provide a framework for quality management, supporting contractually required inspection records of product acceptance under MIL-Q-9858A and MIL-I-45208. Documents complying with these quality management standards are labor intensive to create, use in process analysis, store and retrieve. They can be lost, damaged and otherwise rendered illegible. The LCMS would satisfy the compelling need to replace shop-floor paper documents with a flexible, easily maintainable computer-aided quality management system.

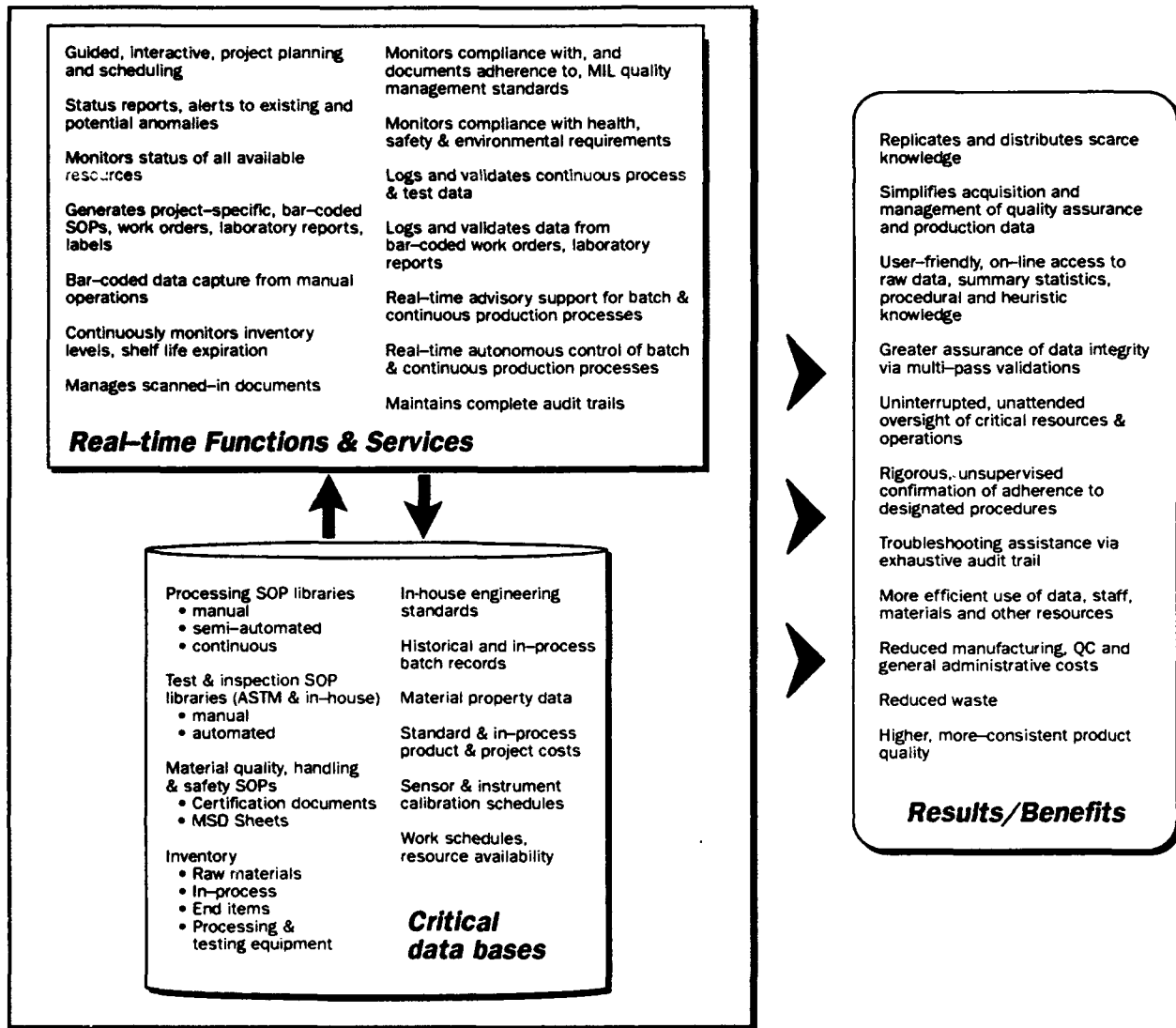

**Life Cycle Management System**

*Figure 34. Functional Requirements of Life Cycle Management System.*

**Overview of Expert Systems**

Introduction

Expert systems like G2 use a symbolic computational approach to automating intelligence. Rule-based expert systems consist of three key parts: an inference engine; a collection of IF...THEN... production rules, called a rule base; and a collection of known facts and beliefs about the world, called a knowledge base.

The IF...THEN... rules provide an expert system with a set of actions to take when the perceived state of the world matches the conditional clause of the rules. The knowledge base contains the facts about the world as they are known to the system. Not all facts are absolutely true: most have a belief or certainty factor associated with them. The inference engine is the heart of the production-rule system. Its primary task is to match the conditional clauses of the rules with the known state of the world in the knowledge base. From the collection of matching rules, a single rule is chosen, and the

system executes that rule. This action probably changes the state of the world, so a new set of matching rules must be developed. The operational cycle of a rule-based system is one of *match-select-fire* and not the *fetch-execute-store* cycle of a conventional procedural program.

LCMS Knowledge Acquisition and Representation

Knowledge acquisition is the process of extracting and formalizing knowledge for use by an expert system. This knowledge can be acquired from human experts and from published sources. Examples of knowledge are descriptions of objects, identifications of relationships, and explanations of procedures. A substantial, well-organized body of knowledge about composites testing and characterization is already contained in the ASTM D-30

Standards. A list of those which will be encoded as SOPs in the LCMS appears in the Appendix. Another source is MIL-HDBK-17. These and other published sources will be used to build the LCMS knowledge base.

Knowledge representation will include the use of production ("IF...THEN...") rules and frames. "IF...THEN..." rules lend themselves to the representation of deductive knowledge — situation/action, premise/conclusion, antecedent/consequent, and cause/effect knowledge, such as "If the temperature exceeds 90 degrees Fahrenheit, then alert the operator." Frames

are well suited to representing descriptive and relational knowledge that clusters or that conforms somewhat to stereotypes, such as the behaviors of similar materials. Of these knowledge representation forms, production rules are the most widely used for commercial applications. In the LCMS, knowledge would be compartmentalized (for the convenience of users) in larger units called SOPs.

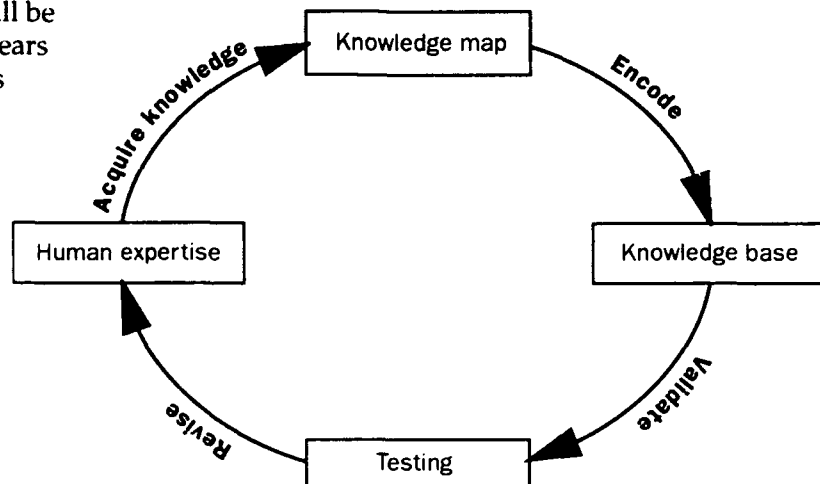

Figure 35. Iterative Knowledge Engineering Process.

Overview of G2 for Full-scale Development and Delivery

G2 is a software environment for developing real-time expert systems for applications that require continuous, intelligent monitoring, diagnosis and control. It is designed for, and has been successfully applied in, a wide range of real-time applications in process control, manufacturing, aerospace, robotics, finance, medicine and telecommunications.

G2 makes it possible to:

- Express and make use of complex relationships between objects.
- Represent the permanent and transient aspects of an application.
- Reason about and control events in a continuously changing environment.
- Respond to events when they occur without continuously having to poll sensors.
- Scan an application and focus on key areas when potential problems or opportunities are detected.
- Apply procedural knowledge and rule-based heuristics.
- Acquire information from any number of local and remote data sources.
- Provide information to, and respond to requests from, local and remote users.

- Communicate with other applications (e.g., simulation programs, external databases, and communications programs).

Application development within G2 is simplified through the use of structured, natural language programming tools and a high-level, intuitive, graphic-oriented environment. These features will enable a series of prototypes of the LCMS to be developed rapidly, tested by users, and incrementally evolved into a complete system. The following characteristics of G2 are relevant to the development of the LCMS.

#### Knowledge Representation

The object and frame representation of knowledge in G2 is augmented by representation of deep structure, object interactions and models of behavior. Objects may interact through connectivity or proximity. Interactions may be analytic or heuristic. Knowledge is represented in generic form and inherited across classes of objects.

#### Time

The ability to reason about time is a critical requirement for the LCMS. Human experts naturally express knowledge in terms of behavior over time. Conventional expert systems do not provide this reasoning ability. G2 allows heuristics and dynamic models to refer to behavior over time.

#### Knowledge Building Tools

Knowledge base development in G2 is facilitated by a natural language interface that human experts can easily understand and use directly.

#### Knowledge Management

G2 allows knowledge to be organized in workspaces, which can be independently controlled and secured. A knowledge-base retrieval facility allows browsing through knowledge, editing and other knowledge management tasks.

#### Knowledge Debugging

G2 includes facilities for tracing the use of rules and other forms of knowledge at selectable levels of detail to assist in debugging the knowledge.

#### Knowledge Validation

When developing complex, real-time applications, it is not practical to wait for an event to occur to test the correctness of the knowledge base. G2 provides a built-in simulation capability that represents dynamic behavior and fault conditions, so the knowledge base can be tested and validated before it is used on-line.

#### Explanations of Reasoning

As it runs on-line, G2 generates explanatory messages. Rules can provide explanations in natural language, and the values of variables can be shown in trend plots.

#### Truth Maintenance

The validity of conclusions must be maintained in large applications with rapidly changing data. This is accomplished built-in mechanisms that dynamically update the chain of inference, both backward and forward.

#### Focus

Humans have the ability to focus on several problems while maintaining general awareness of their surroundings. G2 mimics this behavior by priority invocation of the knowledge needed to deal with

a particular set of circumstances—while still monitoring for other situations that may require attention.

End-user Interface

G2 provides all the tools needed to create interfaces for communicating with end users and controlling access to G2. Custom end-user interfaces can display real-time data through graphs, meters, dials, readout tables and message boxes. Operators can enter information using type-in boxes, check boxes, action buttons, radio buttons, attribute tables and sliders. In addition, G2 can animate and change the color of objects dynamically to call attention to changing conditions in the application's domain.

On-line Data

Through GSI, the G2 Standard Interface, G2 can receive data from and send messages to data acquisition equipment, data bases and other data sources.

Networking

G2, through its Intelligent Communications Protocol, can communicate over conventional networks to remote terminals running X-Windows. Multiple G2's can be networked as well.

**Creating LCMS Knowledge Bases with G2**

The first step in developing the LCMS application with G2 will be to define each class (or type) of object in the application, including its screen icon, its attributes, special characteristics and how objects of that class will be connected to other objects. Every object in G2 belongs to a class, and all classes are arranged hierarchically so that subclasses can inherit the attributes and icons of their superior classes. An example of a class hierarchy for materials was presented in the Discussion section of this report for the G2 prototype.

The hierarchical arrangement simplifies the task of defining the classes of objects for a complex application like the LCMS. Attributes that apply to a number of different classes of objects can be defined once, in a common parent class. Those attributes will automatically be inherited by the subclasses. This eliminates the need to repeatedly assign the same attributes or icons to a number of related classes. Similarly, rules can be applied to classes of items at any level within the hierarchy.

This makes it possible to write a few powerful rules that apply across the application to many different types of items. The results is a well-structured knowledge base that contains fewer rules than otherwise might be expected.

Having defined classes of objects, the next task will be to create a model of the permanent parts of application by placing objects on a workspace and

<b>Major Components of a Knowledge Base</b>	
<b>Objects</b>	Articles of interest in the application
<b>Attribute tables</b>	Tables that list the described characteristics of objects, connections and other items.
<b>Object definitions</b>	Definitions of the classes of objects that exist within the knowledge base.
<b>Variables and parameters</b>	Objects that have numbers, symbols, text, or truth values as values.
<b>Connections and relations</b>	Representations of the physical, logical, temporal, and other relationships between items.
<b>Rules</b>	Statements that indicate how to respond and what to conclude from conditions in the application.
<b>Procedures</b>	Sequentially executable sets of statements.
<b>Functions</b>	Arithmetic operations, either built-in or user-defined.

*Table 1. Major Components of a Knowledge Base.*

connecting them to show their relationships. The result is a top-level schematic diagram of the application, much like the flow diagram on the second page of the Introduction. Associated with each object in the diagram is a table that describes the object. G2 automatically creates this table from the definition of the object's class. These tables were mentioned in the discussion of the G2 Phase I prototype.

After constructing the schematic, the source of values for each variable is indicated. Possible data sources include the G2 real-time inference engine, the G2 simulator, and other data sources such as real sensors. Those which are valid for limited periods are represented with variables. Data values which need to remain valid indefinitely are represented with parameters.

Some variables and parameters receive values from G2's real-time inference engine. If...then... rules tell G2 how to conclude values for those objects. Other rules may indicate how to respond, and what to conclude, from changing conditions within the application. Rules and all other statements in G2 are entered in structured, natural language using a context-sensitive editor that provides guidance through each part of writing the statement, making it impossible to write a syntactically incorrect rule. When the application is running, G2's real-time inference engine uses these rules, together with data it receives from other data sources, to infer how to respond to conditions. Rules will be as generic as possible, i.e., so that they apply to a whole class of items, because having one rule that applies to many items is better than many rules which accomplish the same result.

Many of the objects and relationships in the LCMS will be permanent, while some may be transient, i.e., they may be created and deleted by actions that G2 executes as it runs. Within rules and procedures, objects can be created, manipulated and deleted. Objects created in this manner are transient objects because they are not saved as part of the knowledge base; however, they can be worked with while the knowledge base is running. Actions can also establish or remove relations between items. G2 can reason about relations in the same way that it can reason based on graphical connections between objects. Like transient objects, relations are not saved as permanent parts of the knowledge base.

When the LCMS is running, users must be able to interact with information from the application. A library of end-user controls, such as check boxes, radio buttons, action buttons, and type-in boxes will be created for entering values or giving instructions. A number of these interface features were used in the Phase I G2 prototype. Various displays will also be required, including graphs, dials, meters and readouts to show the state of the system and its components. Another means of communicating conforming and non-conforming events is through messages, which will be written to an on-screen message board and accumulated in the system's log book.

The knowledge base of the LCMS will contain the class definitions, objects, connections, rules, formulas, procedures, end-user controls, etc. Components of this knowledge base will be organized in subworkspaces. Each ASTM D-30 SOP control panel, for example, will appear in a separate workspace, called up from a menu tied to a library of all ASTM SOPs in another workspace. Other objects will be contained in workspace, supporting a hierarchical, modular organization of knowledge.

Development of the LCMS knowledge base can proceed incrementally, with each prototype iteration adding new components to the knowledge base. Even before the knowledge base is completed, however, field testing can begin. The application also can be connected through GSI, G2's communication's interface, with external data sources using off-the-shelf or custom-programmed data interfaces. Therefore, field testing of the process control subsystems of the LCMS can also commence early in the full-scale development cycle.

**System Architecture**

The architecture of a full-scale LCMS is illustrated on the following page. Note that the design is modular, yet highly integrated. Key software components are discussed in this section.

A full-scale LCMS would contain the following commercially available software products, which are described in detail in this section of the report:

Product	Vendor	Purpose
G2™	Gensym Corporation	Real-time expert system shell
GSI™	Gensym Corporation	Communications interface for G2
G2 Interface Bridges	Gensym Corporation	Interface to sensors and controllers
Oracle™RDBMS	Oracle Corporation	Archival, relational, material property database
Oracle Bridge	Gensym Corporation	Interface G2 to Oracle
LabVIEW2™	National Instruments	Interfacing to laboratory instruments

*Table 2. Commercially Available LCMS Software Components.*

**Announced Release of G2 Version 3.0**

Coinciding with the conclusion of Phase I in July, 1991, the Gensym Corporation announced a new release of G2. Version 3.0 incorporates enhancements which have favorable implications for enhancing the functionality of the LCMS.

The processing speed of G2 has been increased through use of an incremental compiler. Version 3.0 up to 10 times faster than previous versions. G2-based applications like the LCMS will now be able to process several thousand rules per second, up from several hundred. This improves the price/performance ratio for large-scale applications, such as a LCMS deployed enterprise-wide in a high-volume production environment. The amount of memory needed to run G2 has been reduced. RAM required to run G2 and its applications on a conventional UNIX workstation has been reduced by more than 50%. These two enhancements — greater speed and reduced memory size — bode well for Phase III delivery on low-cost workstations or high-end PC's, thereby making the LCMS even more accessible and economically acceptable to smaller composites fabricators. Embeddable, run-time versions were announced as well. These can be made part of other systems, such as process control systems, robots and other closed-loop control systems. The embeddable version of G2 and a typical application will fit in 8 megabytes of memory. In the event of a system shutdown caused, for example, by a power failure, a new "warm boot" facility will restore the run-time environment and resume operations at the point of shutdown. Without this automatic restoration feature, a LCMS based on the previous version of G2 would require a costly workaround.

In addition, the user interface has been enhanced with facilities to print reports and hard copy documents through PostScript™-compatible files. Bar, column line and scatter charts are also included in Version 3.0. Tables, a facility for creating compact and highly-configurable data displays, has been added. Version 3.0 also has more editor controls, enhancements to the inspect facility, and new tools for searching and modifying knowledge bases.

**GSI**

GSI, the G2 Standard Interface, is a toolkit for building interfaces between G2 and external data sources such as a data acquisition or control system, remote databases, or non-G2 operator displays. GSI allows G2 to:

- Obtain values from external sources;

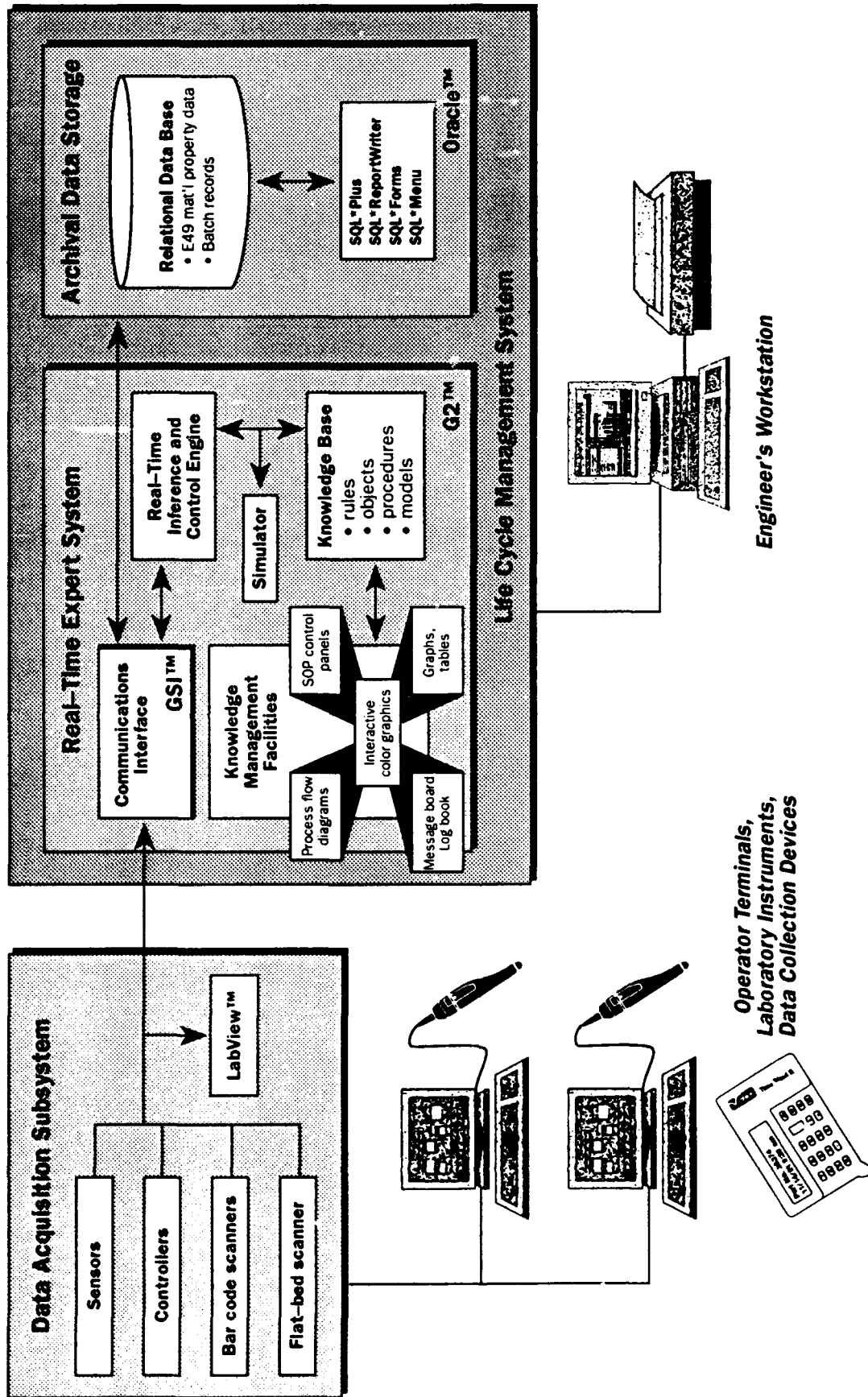

Figure 36. LCMS System Architecture.

- Set values in external applications;
- Send text messages and receive acknowledgments;
- Receive unsolicited input from external data servers;
- Invoke C functions and optionally receive return values;
- Have G2 procedures invoked by a C program.

GSI acts as a data server for variables in G2 like the inference engine or the G2 simulator. It makes it possible to establish a correspondence between external data points and special G2 variables. When the value of such a variable is needed, it will be obtained by GSI from the external data point. When such a variable is set, the value will be sent to the external data point by GSI.

GSI addresses the following issues in a platform–and network–independent manner, without any need for user involvement:

- synchronizing processing tasks
- interfacing with a network
- recovering from network or node failure
- dealing with multiple data sources
- grouping data
- receiving unsolicited data and messages
- exchanging error messages
- exchanging status reports
- buffering data
- converting data formats
- dealing with variable–length data
- handling system start–up and shut–down
- handling pausing and resuming operation
- handling buffer panics
- allocating resources
- recovering resources
- minimizing processing overload
- detecting failure.

### **Oracle™ RDBMS**

The LCMS includes an E49–compatible relational database system for materials property data and for meta data contained in batch records. In a relational system, data are stored as rows and columns in table, which allows rapid access to data in response to query operations that ask for information about materials having certain properties. Material data can be and are measured in different ways. Unless the user knows the test method, it is very difficult to know if the data apply to the application. The proposed E49 standard provides a format for storing this meta data with the material property data.

Oracle is a widely used relational database. It is available on a large number of platforms, as is the case with G2, eliminating portability as a technical impediment to Phase II development and Phase III deployment. The product contains a relational database management system (rdbms) and other add–on tools as part of the full development license. Additional tools are also available. Those which are applicable to the development of a data retrieval and report–writing functionality in the LCMS have been included in the cost proposal and are summarized in the accompanying figure.

Oracle will be interfaced to G2 and used to store archival batch records and material property data compatible with the proposed E49 standard. A database containing data gathered from bar code scanning of manual SOPs and from on–line production processes and instruments would quickly exceed G2's internal storage capabilities. Therefore, incorporating an external, archival database in

the LCMS is imperative. Furthermore, in light of trends toward material property data standardization, it is advisable at the outset to integrate a relational, E49-compatible database with the LCMS. Graphic images will be stored as well as textual and numeric data.

In the past three years there has been a gradual merging of expert systems and database packages. Databases are beginning to provide AI capabilities and expert system shells now provide links to databases. G2 is one of the latter. Users of the LCMS will perceive a seamless integration of the supporting knowledge bases and archival data base. An integrated solution environment is technically feasible and desirable for tasks that involve configuring the system to capture data, defining and inspecting as-planned project scenarios or controlling continuous processes. On the other hand, access to archival material property and batch record data, particularly when nonroutine queries are involved, is likely to be carried out directly via SQL calls to Oracle. The proposal includes the appropriate Oracle tools for building query and report-writing user interfaces to the Oracle data base.

### **GSI-Oracle Bridge™**

The GSI-Oracle Bridge is an off-the-shelf software utility developed by the Gensym Corporation which allows G2 to act as a front end to Oracle databases and to access existing data. The bridge makes it possible to store G2-generated batch record and associated material property data for future retrieval and analysis. Archival storage is a critical requirement of the LCMS. The GSI-Oracle Bridge has been used on-line since February, 1991 in Biosphere II, where Oracle is used with G2, which controls the project's environmental systems.

The GSI-Oracle Bridge™ runs as a stand-alone process that allows data exchange between G2 and an Oracle database. One of the add-on tools supplied with Oracle that does not require a full development license is the Oracle Call Interface (OCI). The Oracle Bridge code is based on OCI. Classes of Oracle-objects can be defined in G2 that match corresponding tables in the rdbms, i.e., attribute names in G2 match column names in the database. Consequently, selected objects appearing in G2 can be mirrored by an Oracle record. The bridge optionally caches database record cursor definitions for greater efficiency during repeated fetches to the database.

GSI-Oracle Bridge provides:

- record selection using standard SQL (Standard Query Language) statements;
- selective control for continuous updating;
- additional access to the database via remote procedure calls from G2;
- sample interactive SQL dialog;
- pre-packaged record manipulation procedures;
- connection of multiple G2's to a single bridge.

### **Bar code scanning**

The Videx TimeWand II® is a small, portable, highly programmable bar code scanner. The operation of the TimeWand II is controlled by programs which are loaded in the wand's RAM, which is used for both data and program storage. TimeWand II programs are stored in files on the host computer and are uploaded to the device through a recharger/downloader unit using communications software. The scanner is programmable in C, providing complete control over the wand's operation. Two types of programmability are possible: symbology programs enable the device to read and store bar codes, including Code 3 of 9, which will be used in the LCMS; and, application programs, which control the sequence of data entry and the messages that appear on the Time Wand's display. Cross references, such as a list of material ID numbers and their descriptions, can be included for point-of-use validation of data input.

When integrated with the LCMS's SOP control panel work order generator, G2 would create display prompts and a list of the scans expected for the bar-coded manual operations designated in the

work order. These would then be downloaded to the scanner when it was placed in its recharger/downloader. When one or more SOP work orders were completed, the user would return the device to the recharger/downloader, where G2, sensing its presence, would automatically upload scanned-in bar codes and any data entered via the keypad. G2 would then process, validate, store and report the execution of the work order. No further documentation of performance on the work order would be necessary in most cases. All scanned-in bar codes are automatically time-stamped; therefore, whenever extremely time-critical operations need to be monitored, G2 can determine whether they were carried out in accord within the prescribed amount of time.



Figure 37. Videx Time Wand II.

This approach extends the expert system's vigilance to the point of use in a unobtrusive, constructive manner, while still allowing users complete freedom of movement to do their jobs. Users can still make invalid entries, but a combination of a message on the scanner's display and an audio response will alert them to doing so. For time-dependent procedures, the scanner can also issue beeps and advisory messages when specific tasks need to be performed. This model can store approximately 2,000 scans in addition to the device's operating system and application programs.

#### **Real-time Optimization and Control of Composites Processing**

Significant economic returns can be realized from the application of real-time, expert-system-based control of important composites processes such as autoclave curing, RTM, pultrusion, filament winding and press curing:

- Mistakes are costly in terms of material cost and lost development time.
- The composites community needs a better understanding of these processes, which are complex and sensitive to many process parameters. A coherent set of algorithms and heuristics needs to be developed.
- Trial & error is often used to establish a working set of variables.
- Development of an expert system is a process of assembling, validating and codifying diverse knowledge. The expert system allows that knowledge to be replicated and distributed cost effectively.
- Sufficient expertise is available to benefit from the development of a real-time expert system.
- Results can be readily evaluated, i.e., the quality of the parts fabricated under expert-system control can be evaluated unambiguously.

The schematic on the following page appeared earlier in this report. Shading is used to highlight processes in which a combination of real-time advisory support and/or autonomous optimization and control either have been demonstrated or can be applied.

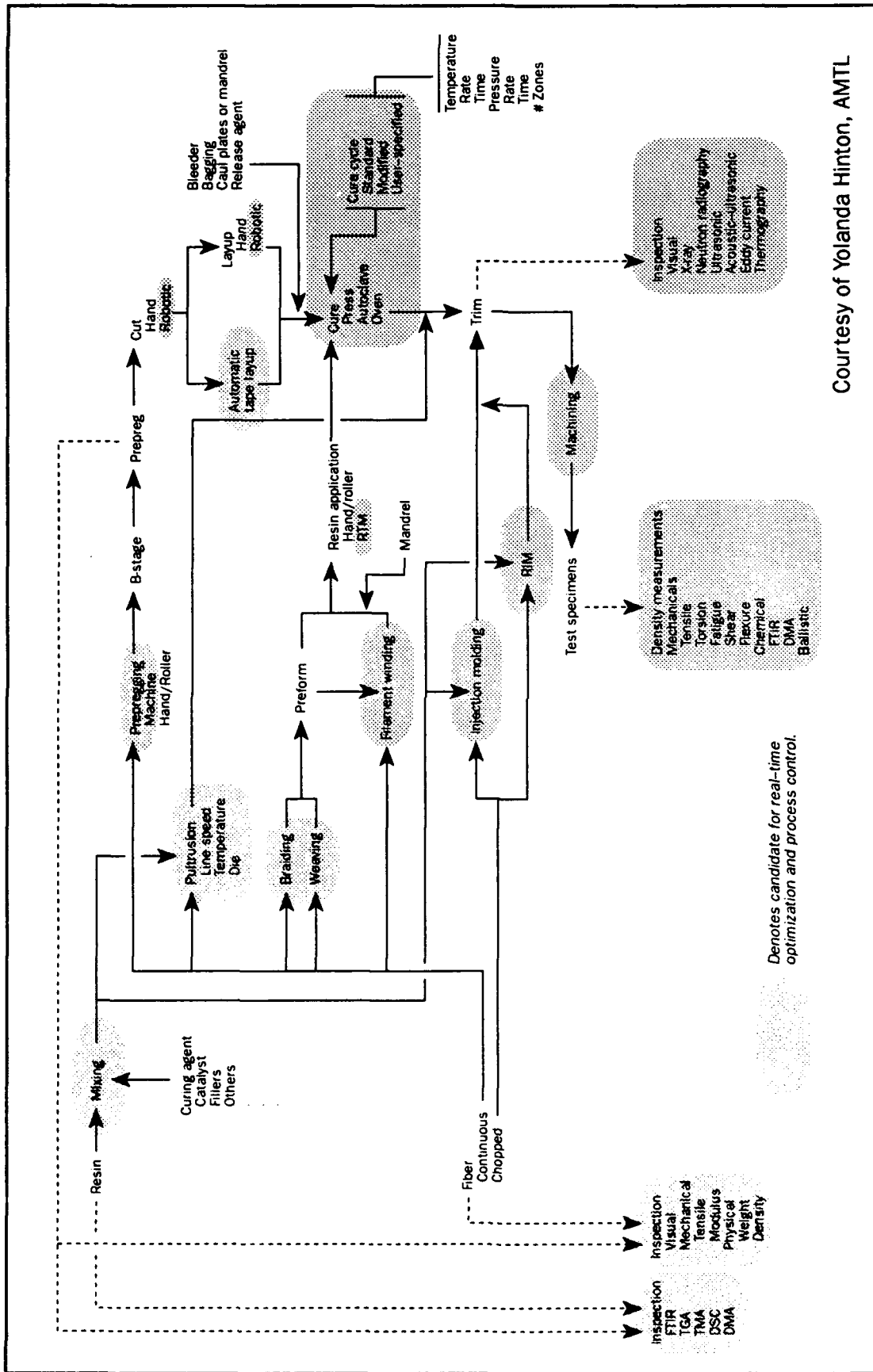

Courtesy of Yolanda Hinton, AMTL

Figure 38. Candidates for Real-time Optimization and Control.

G2 is ideally suited for developing real-time expert systems that require continuous and intelligent monitoring, diagnosis and control. G2 makes it possible to:

- Express and make use of complex relationships between objects.
- Represent the permanent and transient aspects of an application.
- Reason about and control events in a continuously changing environment.
- Respond to events when they occur without continuously having to poll sensors.
- Scan an application and focus on key areas when potential problems or opportunities are detected.
- Apply procedural knowledge and rule-based heuristics.
- Acquire information from any number of local and remote data sources.
- Provide information to, and respond to requests from, local and remote users.
- Communicate with other applications (e.g., simulation programs, external databases, and communications programs).

#### Requirements of Real-time, Knowledge-based Process Control Applications

*They involve objects that can be viewed in a hierarchy.* Broad classes can have behaviors associated with all members of the class, while more specific sub-classes or instances can have behaviors associated only with the sub-class or instance. This allows greater efficiency in knowledge representation, not only when expressing rules, but also when expressing dynamic behavior and other analytic knowledge. Rules and dynamic models that refer to broad classes are expressed generically, to apply to all members of the class, a great efficiency in implementing the system.

*Similar types of problems recur.* Rules, objects and dynamic models developed for one application scenario may be adapted to similar problems, enabling existing knowledge to be reused to create a new solution.

*Many applications have fast changing data.* G2, because it is designed for real-time applications, greatly reduces the prototyping time for such applications. G2 allows a simulation to provide values for prototyping and development, supplanted by sensor-based data at installation. At that time, data servers can provide interfaces to other systems with a minimum of user work, so the prototype can evolve into the working application more quickly.

*They require knowledge management facilities.* Large applications may include thousands of object, rules, formulas, dynamic models, and other items. The techniques of relational data base retrieval can be extended to knowledge bases, to allow the user to browse through objects, rules, models and other forms of knowledge, editing and augmenting them in an interactive manner.

G2's real-time expert system features are well suited to these kinds of applications. G2 makes it possible to combine analytic modeling and heuristic reasoning in an object-oriented representation of the problem domain. G2 knowledge bases can be modified and debugged while running, further speeding up debugging.

#### Published Example of G2-based Real-time Control of Compression Press Curing

A rule-based expert system implemented in G2 for control of organic matrix composites curing has demonstrated the ability to process a part according to the specific requirements of a part's materials and geometry (Manzini and Roehl, 1990), whose work was motivated by earlier research in self-directed control (Abrams, Lagnese, LeClair and Park, 1987) at Wright-Patterson AFB. These examples led to the recommendation that a subsystem of process control modules for compression press curing, pultrusion, and autoclave curing be integrated with the full-scale LCMS. The following discussion summarizes the article by Manzini and Roehl.

Manufacture of graphite fiber-reinforced organic thermoset composites typically involves the creation of a part by laminating into a mold resin-impregnated sheets of woven graphite fibers.

Epoxides are the most commonly used resins in the organic matrix compound. The mold is heated using a heatable pressure vessel (autoclave) or a compression press. An adjustable force is applied to vertically opposed heatable platens of the press. Pressure is increased during processing to expel entrapped air, moisture, excess resin and volatiles, thereby reducing voids. As the temperature increases, the viscosity of the resin first becomes very low before undergoing an exothermic polymerization reaction. After the resin has hardened, the part is cooled, removed from the mold, trimmed and machined.

The cure state of a part can be inferred during processing from in-situ sensor measurement of temperature, pressure and resin viscosity. The pressure on a part in a compression press is the result of a contacting, rather than hydrostatic, force of an autoclave. Vacuum typically is not applied. Therefore, thermal and resin flows are markedly different from those encountered in autoclave curing.

Thick laminates develop significant thermal gradients across their thicknesses during heating. Traditional processing strategies employ ramp-soak periods to compensate for different heat transfer rates between the surface and centerline of the part. Uniform heating is also complicated by the exothermic reaction of the epoxy resin. Nonuniform curing can result in residual stresses that adversely affect quality.

As the resin cures, it proceeds through a sequence of states. Real-time optimization of these state transitions implies a need for analysis of sensor values and their derivatives.

Simultaneous goals of a real-time control strategy for press curing are to:

1. Maintain uniform temperature distribution throughout the part.
2. Drive the average part temperature to the target temperature as soon as possible.
3. Reach a final degree of cure consistent with good part quality.
4. Obtain the desired resin-to-fiber ratio.
5. Prevent exotherm-induced overheating.
6. Continue operation in the presence of sensor failures.

The article proceeds to describe the detailed implementation of object hierarchies for materials, equipment, sensors, and part sites process rules. G2's ability to reason about the on-screen proximity of objects and connections between objects facilitates adaptation of the knowledge base to various processing scenarios.

In summary, the object-oriented, hierarchical design of G2 is a natural modeling environment for mapping the components of the press curing process to an expert-system-based representation. The sheer variety of processing scenarios faced by a composites production facility makes an object-oriented expert system very attractive for a process control system. The behavior of sensors and process equipment and the physical relationships between objects in a production scenario can be defined explicitly, including the processing requirements of different sites on the same part. As was demonstrated in a very limited way during Phase I, rules are used to start up, run and shutdown the process. Other control system rules reason about the states of the objects present in a given processing scenario. Different categories of rules will represent the behavior of process equipment (e.g. sensors and controllers), resin classes and specific resin types. Conflict resolution rules arbitrate conflicts arising from the needs of different part sites. The knowledge base for the manual tracking functions of the LCMS can be reused and extended in the pultrusion and autoclave curing process control modules, saving development time and cost. Heuristic reasoning would be combined where appropriate with analytic models.

#### Autoclave Curing

Autoclave curing is another advanced composites process that would benefit from a real-time knowledge-based control system flexible enough to accommodate changes in materials and process-

ing conditions. A process control module for autoclave curing would share knowledge representations with the core LCMS and other process control modules. Wu and Joseph (1990) have reported on the feasibility of applying knowledge-based control based on simulations of autoclave curing.

### Pultrusion

Of all the commercially viable composite manufacturing methods, pultrusion offers the greatest cost reduction potential, is the most in need of an advancement of scientific understanding and could benefit most from the application of knowledge-based systems techniques to maintain consistently high quality. The goal of this portion of a full-scale development effort would be the creation of a real-time, knowledge-based subsystem for autonomous control of pultrusion processing. Recognition of the advantages of this objective have been noted in a recent publication by the Composites Development Branch of AMTL (Jacklitsch and Bostic, 1991).

Pultrusion is a low cost, high quality, automated manufacturing method for continuously producing advanced composite material structures. Pultrusion offers the potential to reduce the cost of advanced composite parts by a factor of 2 to 5 compared to the price of conventionally-autoclaved composite structures made from prepreg materials. Pultrusion has been receiving increasingly widespread interest from the defense community because of its ability to satisfy the low cost and high quality goals of manufacturers and users of advanced structural composites.

The low cost of pultruded composite components can be attributed to a variety of factors. The process requires little operator input other than to maintain the material supply. Therefore, labor costs are low compared to other alternatives for moderate production runs. Pultrusion machinery is relatively inexpensive when compared to other automated composite production hardware, and tooling costs are also low. Pultrusion generally employs the least costly forms of the constituent matrix and reinforcing materials, and very little raw material is wasted. Except for pultrusion, all advanced composite production techniques make components one at a time. The cost of repetitive operations greatly increases the price of finished components. Only pultrusion produces completely cured composite parts on a continuous basis. Cured structures of any length may be fabricated at rates 15 to 40 times faster than alternative methods.

Pultrusion is one of the most challenging candidates for process control and optimization. Rapidly changing temperatures and pressures and a moving reference point inside the closed die are a few factors complicating sensing, reasoning, optimization and control of the process. The development of an intelligent control system for automated process monitoring and control is essential for achieving the consistent quality required in high performance composite structures. As with the process control subsystems for compression press curing and autoclave curing, a hybrid system combining analytic modeling and heuristic reasoning would be required.

### Field Testing and Development

As an integral component of full-scale development, field test sites would provide real-world exposure to production, quality assurance, scheduling and related manufacturing issues. They would contribute expertise in production, testing and characterization processes where real-time, expert-system-based advisory support and process control would have the most favorable implications for productivity, quality and cost reduction.

We anticipate that a number of iterations would be necessary when proceeding through the stepwise approach to field testing described below. Some features would need to await the implementation of others. Early designs would need to be refined in response to user feedback and as other enhancements were added to the system. G2 supports, and indeed, encourages, this iterative approach.

1. Deploy a rudimentary tracking system as soon as possible in a full-scale development effort. In addition to the flow-diagramming user interface, the first-generation system would need to incorporate bar-code printing and scanning, batch record keeping, a batch record query

facility and the infrastructure of a material/process knowledge base. Field testers would be asked to organize a small project team to coordinate their in-house use of the prototypes in part of their operation on a stand-alone, experimental basis. Several iterations of this first-pass system would be needed to refine the interface and underlying knowledge representations.

2. Add to the tracking system SOPs for ASTM test and characterization procedures, manual fabrication procedures and other tasks for which routine documentation is required. At this stage, SOPs would be represented as on-screen control panels. The technical challenge is translating ASTM and other procedures into intelligent, ergonomic, active documents, supported by an expert system rule base. The tracking system also would be interfaced to an archival, relational database (Oracle™), where material property and batch record data would be stored. The objectives of step 2 are intuitive ease of use, explanatory features, and consistency among a growing number of SOPs.
3. Generate bar-coded work orders from control-panel SOPs. Data captured from the shop floor or the laboratory via bar-coded SOP work order documents would be uploaded, validated and appended to a materials' batch record. A good deal of overlap is inevitable between steps 2 & 3 as refinements are made with respect to how these SOPs are handled internally and externally. Feedback from field test sites would be based on actual or anticipated integration of these SOPs in their routine operations. Scheduling and standard costing modules could be added at this time in response to suggestions by field test sites, as would routine database query and report-writing features. The knowledge base would continue to be enhanced in line with the need to support the system's growing complexity.

Steps 1-3 would essentially complete the system's manual information-tracking capabilities. At that point, all field test sites would, of necessity, be using the same system.

4. Incorporate easily configurable modules for real-time data acquisition and knowledge-based process control of autoclave curing, pultrusion, and press curing, in addition to interfaces for real-time acquisition of data from selected laboratory instruments (*via* LabVIEW 2). Advisory-level support modules for controlling composites processing would be developed initially. These would provide much of the infrastructure needed for the subsequent extensions to autonomous process control.

Step 4 could be initiated before Steps 2 and 3 are completed. The LCMS would be designed as a modular system with lower-level sharing of object definitions and behaviors. This will enable any process control modules developed in the future to be grafted seamlessly to the core application.

### **Use by the Federal Government**

These recommendations are designed to ensure that the LCMS meets the Army's requirements for an integrated, user-friendly, knowledge-based life cycle management system which can easily accommodate the continuously changing scenarios for material traceability and quality management typified by research-intensive organizations such as AMTL.

The Army is engaged in a variety of applications of advanced polymer composite materials. These materials are used in air and ground vehicles, bridges, shelters, weapons, missiles, ballistic armor, etc. Typically, end-item requirements, which may or may not specify the type of material(s) to be used, are furnished by the government to commercial contractors who develop the engineering designs. Interaction of government agency and contractor is one means by which material quality and performance problems are identified. These then become the subject of future Army R&D efforts. A LCMS would facilitate this and other types of government-contractor interactions. It would increase R&D productivity, shorten development times, and facilitate R&D planning, project scheduling and budgeting. One of many desirable services provided by a full-scale LCMS would be

the ability to retrieve from its database materials used for a specific application and/or environment. This is of particular interest to the Army because it would facilitate correlations of materials' life-cycle histories with material properties, processing conditions and other pertinent information. Real-time process control modules for press curing and autoclave curing could be custom-tailored for, and interfaced to, existing AMTL processing equipment. AMTL would also benefit from a generic knowledge-based process control module for pultrusion. In addition to having a practical solution to composites life cycle management, the LCMS would provide a knowledge-based infrastructure which could be extended in future Army R&D efforts to develop more sophisticated process control capabilities for the production of advanced composites.

### **Commercial Deployment and Other Potential Commercial Applications**

Rapid prototyping and extensive field testing at government, academic and commercial sites would help to identify subtle life cycle management issues and ensure a smooth transition to broad commercial deployment. The new capabilities provided by the system would contribute to lower-cost, higher-quality procurements of advanced materials by the DoD.

The LCMS described in this report would replicate and distribute scarce knowledge, simplify acquisition and management of manufacturing and quality assurance data, provide unattended, uninterrupted oversight of critical resources and operations, ensure high quality, reduce development time and manufacturing costs, and increase operational efficiency. Stringent standards for materials traceability and life cycle management also exist in biotechnology, pharmaceuticals, medical diagnostics and devices, clinical laboratories, military and commercial aviation and nuclear power systems.

### **Knowledge-based Infrastructure**

The LCMS would provide a unified software infrastructure for fast delivery and commercial deployment of technology developed by research centers. The knowledge-based infrastructure of the LCMS can facilitate the evolutionary development, integration and widespread deployment of increasingly sophisticated knowledge in the form of new, special-purpose software modules.

### **Foundation for Concurrent Engineering and CIM**

The need to work concurrently in the design, analysis and manufacturing of products using composite materials is prompting the integration of computerized material property data with CAD, CAM and CAE systems. The potential exists to integrate the LCMS with design engineering software. Doing so would represent a bottom-up approach to the creation of a modular concurrent engineering environment. Subsequent integration with financial accounting and database systems would lead to a unified system for Computer Integrated Manufacturing (CIM) of composites, as shown in the following illustration.

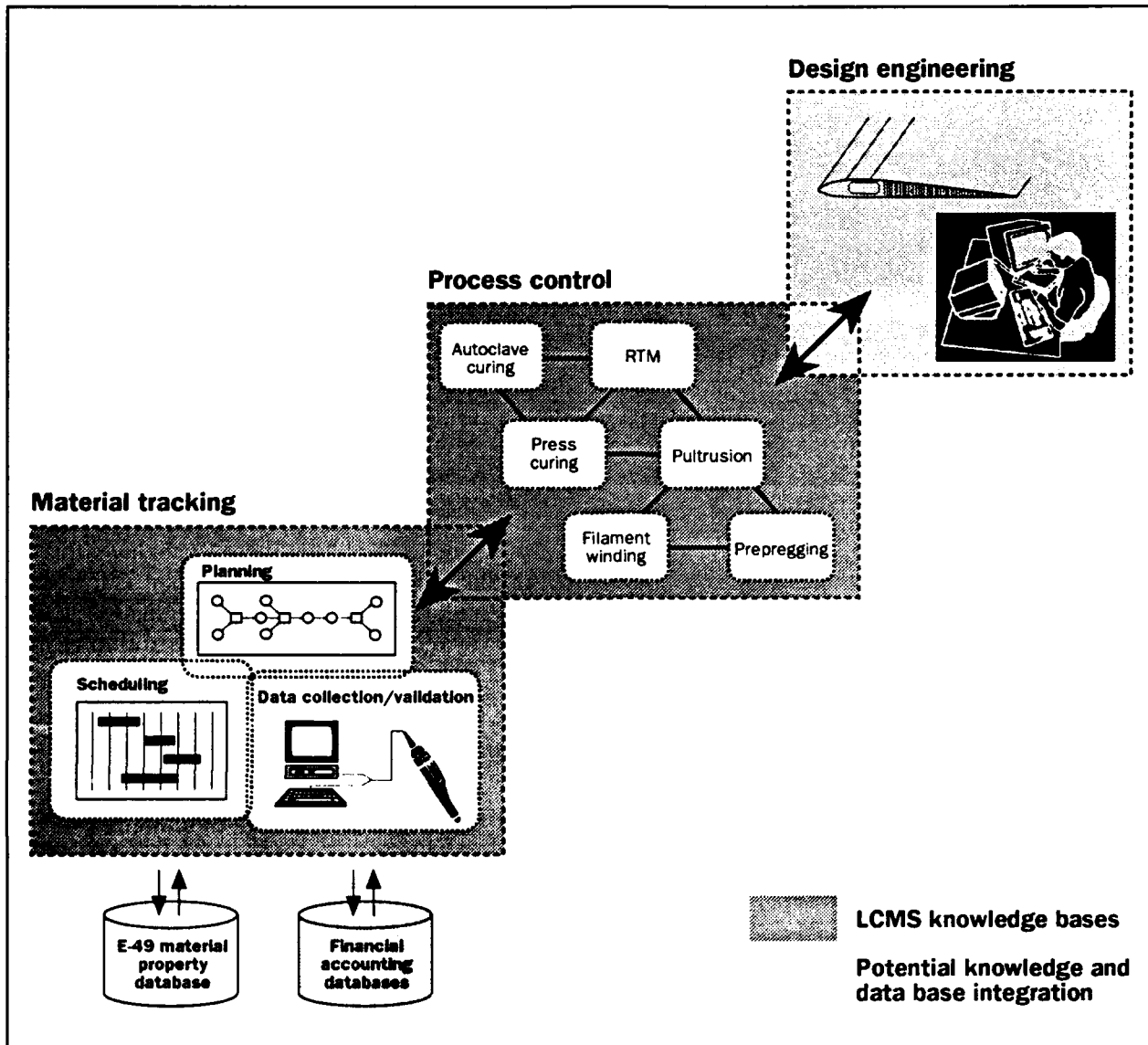

Figure 39. Modular Concurrent Engineering Environment.

## Bibliography

Abrams, F.L., Lagnese, T.L., LeClair, S.R. and Park, J.B., "Qualitative Process Automation for Autoclave Curing of Composites," *Air Force Wright Aeronautical Laboratories Technical Report 87-4083*, November, 1987.

Gensym Corporation, *Introduction to G2*, 1990.

Gensym Corporation, *Object Oriented Rapid Prototyping with G2*, January, 1989.

Gensym Corporation, *G2 Real-Time Expert System in Process Control Applications*, February, 1989.

Gensym Corporation, *GSI User's Manual*, 1989.

Gutowski, F.D., *Innovative Life Cycle Management Systems for Composites*, Department of Defense Phase II SBIR Proposal, September, 1991.

Joseph, B. and Wu, H-T., "Knowledge-based Control of Autoclave Curing of Composites," *SAMPE Journal*, 26 (6), 39, 1990.

Joseph, B. and Wu, H-T., "Knowledge-based Control of Pultrusion Processes," *SAMPE Journal*, 26 (6), 59, 1990.

Jacklitsch, D. J. and Mostic, M. T., "An Analysis of Three Pultrusion Models Proposed for Use in a Pultrusion Control System," Composites Development Branch, U.S. Army Materials Technology Laboratory, *MTL TR 91-12*, April 1991.

Mazini, R.A. and Roehl, E.A., "Flexible Control of an Organic Matrix Composite Cure Process Using Object-Oriented Control Concepts," *ACC '90, 1980*, 1990.

**Appendix**



ASTM D30 Standards for Composite Materials

ASTM Standards for Composite Materials June 1986		ASTM Standards for Composite Materials June 1986	
Standards under the jurisdiction of D30		page 2	
No.	Title	No.	Title
C 613	Resin Content of Carbon and Graphite Prepregs by Solvent Extraction	D618	Conditioning Plastics and Electrical Insulating Materials for Testing
D2290	Apparent Tensile Strength of Ring of Tubular Plastics and Reinforced Plastics by Split Disk Method	D636	Test for Tensile Properties of Plastics
D2291	Fabrication of Ring Test Specimens for Glass-Resin Composites	D648	Deflection Temperature of Plastics Under Flexural Load
D2344	Apparent Interlaminar Shear Strength of Parallel Fiber Composites by Short Beam Method	D671	Flexural Fatigue of Plastics by Constant-Amplitude-of-Force
D2585	Preparation and Tension Testing of Filament-Wound Vessels	D695	Compressive Properties of Rigid Plastics
D2586	Hydrostatic Compressive Strength of Glass-Reinforced Plastic Cylinders	D696	Coefficient of Linear Thermal Expansion of Plastics
D3039	Tensile Properties of Fiber-Resin Composites	D756	Practice for Determination of Weight and Shape Changes Under Accelerated Service Conditions
D3171	Fiber Content of Resin-Matrix Composites by Matrix Digestion	D790	Flexural Properties of Unreinforced and Reinforced Plastics and Electrical Insulating Materials
D3355	Fiber Content of Unidirectional Fiber-Resin Composites by Electrical Resistivity	D792	Tests for Specific Gravity and Density of Plastics by Displacement
D3379	Tensile Strength and Young's Modulus for High-Modulus Single Filament Materials	D891	Tests for Specific Gravity of Industrial Aromatic Hydrocarbons and Related Materials
D3410	Compressive Properties of Unidirectional or Crossply Fiber-Resin Composites	D1423	Test for Twist in Yarns by the Direct Counting Method
D3479	Tension-Tension Fatigue of Oriented Fiber Resin Matrix Composites	D1505	Test for Density of Plastics by the Density-Gradient Technique
D3518	In-Plane Shear Stress-Strain Response of Unidirectional Reinforced Plastics	D1822	Tensile-Impact Energy to Break Plastics and Electrical Insulating Materials
D3529	Resin Solids Content of Carbon Fiber-Epoxy Prepreg	D2736	Dynamic Mechanical Properties of Plastics by Means of a Torsional Pendulum
D3530	Volatiles Content of Carbon Fiber-Epoxy Prepreg	D2829	Tensile Properties of Plastics at High Speeds
D3531	Resin Flow of Carbon Fiber-Epoxy Prepreg	D2943	Test for Tensile Properties of Glass Fiber Strands, Yarns, and Roving for Reinforced Plastics
D3532	Gel Time of Carbon Fiber-Epoxy Prepreg	D2584	Ignition Loss of Cured Reinforced Resins
D3544	Reporting Test Results on High Modulus Fibers	D2567	Acetone Extraction and Ignition of Glass Fiber Strands, Yarns, and Roving for Reinforced Plastics
D3552	Tensile Properties of Fiber-Reinforced Metal Matrix Composites	D2724	Void Content of Reinforced Plastics
D3553	Fiber Content by Digestion of Reinforced Metal Matrix Composites	D2990	Test for Tensile, Compressive, and Flexural Creep and Creep Rupture of Plastics
D3800	Density of High-Modulus Fibers	D3029	Test for Impact Resistance of Rigid Plastic Sheet or Parts by Means of a Tup (Falling Weight)
D3874	Definitions of Terms Relating to High-Modulus Reinforcing Fibers and Their Composites	D3163	Strength of Adhesively Bonded Rigid Plastic Lap-Shear Joints in Shear by Tension Loading
D4018	Tensile Properties of Continuous Filament Carbon and Graphite Yarns, Strands, Rovings, and Tows	D3418	Transition Temperatures of Polymers by Thermal Analysis
D4107	Thermal Oxidative Resistance of Carbon Fibers	D3647	Classifying Reinforced Plastic Pultruded Shapes According to Composition
D4255	In-plane Shear Properties of Composite Laminates	D3846	In-Plane Shear Strength of Reinforced Plastics
Other Composite Material Standards and Applicable Documents for D30 Standards		E4	Load Verification of Testing Machines
B193	Test for Resistivity of Electrical Conductor Materials	E6	Definitions of Terms Relating to Methods of Mechanical Testing
C581	Chemical Resistance of Thermosetting Resins Used in Glass Fiber Reinforced Structures	E12	Definitions of Terms Relating to Density and Specific Gravity of Solids, Liquids and Gases
D123	Definition of Terms Relating to Textiles	E18	Tests for Rockwell Hardness and Rockwell Superficial Hardness of Metallic Materials
D256	Impact Resistance of Plastics and Electrical Insulating Materials	E83	Verification and Classification of Extensometers
D543	Resistance of Plastics to Chemical Reagents	E467	Recommended Practice for Verification of Constant Amplitude Dynamic Loads in an Axial Load Fatigue Testing Machine

**SBIR Guidance Information****Element 5: Fabrication and Processing**

- A. Materials procurement and manufacturer's product data
  - 1. Shipping and receiving documents
  - 2. Manufacturer's QA certification sheet
  - 3. Product data sheet
  - 4. Material safety data sheet (MSDA)
  - 5. Cure cycle data
  - 6. ASTM testing procedures
  - 7. Materials supplies testing characterization procedures
  - 8. Method and form of computer data input, e.g., manufacturer's bar code info
- B. Processing methods
  - 1. Type of processing
    - a. Autoclave
    - b. Compression press
    - c. Oven
    - d. Hot table
    - e. Pultrusion
    - f. Filament winding
    - g. Resin transfer molding
    - h. Other
  - 2. Type, description and number of monitoring sensors
    - a. Vacuum
    - b. Pressure
    - c. Time/temp cycle
    - d. Temperature and humidity data during out-time
  - 3. Data relevant to processing
    - a. Cure cycle
    - b. Methods for monitoring or determining state of cure
      - (1) dielectric techniques
      - (2) FTIR
      - (3) acoustic
    - b. Sensor data records
- C. Fabrication of part
  - 1. Types of tooling used
    - a. Description of tooling
      - (1) call plate
      - (2) vacuum bagging materials
      - (3) geometric configuration of tooling
    - b. Ancillary release, mold release spray, film
    - c. Bleeder cloth, surface roughness requirements
  - 2. Raw material QA characterization and testing
    - a. Determine amount of prepreg required for manufactured part
    - b. (Prepreg storage log-out)
    - c. QA for prepreg fiber resin content (see element 6.A.1)
      - (1) Procedure for specimens sampling and handling
      - (3) temp/humid tracking record of out-time of prepreg
      - (5) implement characterization. Selected from element 6)

e.g.:

(a) Prepreg

[1]chemical

HPLC: *High Performance Liquid Chromatography*

FTIR: *Fourier Transform Infrared*,

DSC: *Differential Scanning Calorimetry*

[2]Tack, acid digestion/resin burn-out

(b) fiber/spool

[1]fiber density, filament/tow strength

3. Staging requirements

4. Implementation; ply lay-up, procedure selected from element 4, B

a. (Prepreg storage log-in) for unused portion of prepreg

5. Processing implementation, selected from element 5, B, C.

a. Selection of cure cycle

b. Recording processing data

6. Post processing procedures

a. Bag tear down

b. Part removal

(1) record part orientation and position in relation to tooling

(2) label part (ID. & Orientation)

c. Tool cleanup

d. Inspection of part; select and implement tests

(1) good-bad criteria based on following tests

(a) thickness magnitude and variability

(b) visual cracks

(c) microhardness

(d) degree of cure test (FFT-IR (*Fast Fourier Transform Infrared*)) using trim scrap

••••• decision branch •••••

(2) if reject then determine cause and remedy (establish AI/ES symptom, cause, remedy); go to element 5, B, 3

(3) if OK then go to next step (i.e. Element 5, D immediately below)

D. Machining of part (e.g. whole panel or end item) & relabel

1. Safety considerations (MSDA, personal protection requirements)

2. Trim part, establish new part dimensions

3. Machining procedure (e.g. lathe, diamond wheel, routing, drilling, composite expert system, etc.)

4. Machining prep requirements (type of tool used, special fixtures, wheel dressing, lubricant)

5. Record of scrap

E. Implement end-item or panel characterization

(Selected characterization methods from element 6, A.) e.g.:

1. Nondestructive testing & evaluation (NDT/NDE):

a. Ultrasonic C-scan

b. Eddy current

c. X-ray

d. Radiography

2. Panel thickness and thickness variability (auto scan with x-y coordinate ID relatable to thickness).

F. Machining test specimens from panel or end item (see element C, E)

1. Select from element 5, D for cutting & machining

2. Selected from element 4, B, 3 for cutting orientation requirements

3. Implement CAD/CAM procedures for mapping and labeling requirements for test coupons. Mapping must be overlay correlatable with mappings associated with element 5, E

G. Select types of testing and characterization of coupons from element 6.

#### Element 6: Menu of Characterization and Testing Methods (partial list)

An expert system could be developed to provide the selection of the most significant or cost effective set of characterization and testing for a specific application.

##### A. Quality control methods.

###### 1. Prepreg

- a. Fiber content,
  - (1) acid digestion
  - (2) resin burn-out
- b. Primary chemical composition analysis methods.
  - (1) High performance liquid chromatography (HPLC)
  - (2) infrared spectroscopy: FTIR
- c. Primary methods related to resin processability
  - (1) thermal analysis:
    - (a) DSC: *Differential Scanning Calorimetry*
    - (b) TGA: *Thermal Gravimetric Analysis*
    - (c) DTA: *Differential Thermal Analysis*
    - (d) TMA: *Thermal Mechanical Analysis*
    - (e) DMA: *Dynamic Mechanical Analysis*
  - (2) tack

###### 2. Polymer matrix, batch quantities, (resin, epoxy etc.)

- (1) HPLC: *High Performance Liquid Chromatography*
- (2) FTIR: *Fourier Transform Infrared*
- (3) thermal analysis (same as c. (1) immediately above)

###### 3. Fiber/spool (continuous or chopped)

- a. Fiber density,
- b. Filament strength
- c. Yarn tow strength

###### 4. Cured laminate test coupons

- a. Fiber and % fiber content (acid digestion or resin burn-out)
- b. Degree of cure,
  - (1) Fourier Transform Infrared (FTIR)
  - (2) Differential Scanning Calorimetry (DSC)
  - (3) Dynamic Mechanical Analysis (DMA)

###### e. Composite density

###### f. Composite thickness

###### g. Microhardness

###### 5. End item or panel characterization

- a. NDE; C-scan
- b. Eddy current
- c. X-ray
- d. Radiography
- e. Panel thickness and thickness variability (auto scan with x-y coordinate ID correlatable to thickness).

##### B. Test and characterization related to engineering application properties

The selection of the types of tests, characterizations, and conditions are dependent on the design application

1. Mechanical testing (e.g.)  
(Filament, neat polymer, composite)
  - a. Tensile, 0°, 90°, ± 45°, 5° off axis
  - b. Compression, specify orientation
  - c. Short beam shear, impact, fatigue tension/torsion
  - d. ASTM, MIL Handbook 17, standards
  - e. Other test methods (next menu)
2. Test monitoring methods
  - a. Acoustic emission
  - b. Thermography
3. Mechanical environmental test conditions (MIL-17, S.O.P.)
  - a. Wet/dry
  - b. Humidity/temperature
4. Environmental exposure (S.O.P.)
  - a. Weathering (temp/humidity/biological)
  - b. Abrasion
- C. Other testing of end item or panel (S.O.P.)
  1. Weathering
  2. Ballistic
  3. Wear
  4. Field evaluation
- D. Test specimen sample preparation and handling methods (S.O.P.)
  1. Fiber (filaments & tows)
  2. Prepreg
  3. Coupons
  4. Laminate panels
  5. Filament wounded
  6. Prototype
- E. Specimen cutting procedures
  1. Coupon dimensions (ASTM/MIL-Handbook 17 standards)
  2. Panel mapping for test coupons
    - (a) statistical design, number of test specimens per type of characterization (trimmed panel size requirement)
    - (b) CAD/CAM lay-out for all types of specimens with labeling
    - (c) labeling info: panel I.D., CAD code for coupon orientation and position relative to panel.

#### **Element 7: Data Analysis**

- A. Material labeling and recording system
  1. Types of labeling (internal/external to AMTL routing, tracking and computer input procedures)
    - a. Auto label
      - (1) bar coding, compatible with SACMA
      - (2) alphanumeric (scanner)
      - (3) rf coding
    - b. Manual/audio
      - (1) keyboard
      - (2) vocal
  2. Utilization of label information
    - a. Database storage and retrieval

- b. Tracking and routing (characterization, testing, in/out storage data)
  - c. Labeling information requirements for documents, raw materials, laminate panels, test coupons.
  - d. Need to relate to one or more documents or databases
- B. Statistical design
- 1. Sample size
  - 2. Model

**Element 8: Field Evaluation**

- A. In-service use field report
- 1. History tracking
    - a. Record performance
      - (1) down time
      - (2) failure record (symptom, cause, remedy)
      - (3) environment record

Use of G2 for Real-Time Control of Composite Press Curing

FLEXIBLE CONTROL OF AN ORGANIC MATRIX  
COMPOSITE CURE PROCESS USING OBJECT-ORIENTED  
CONTROL CONCEPTS

Richard A. Manzini\* and Edwin A. Roehl\*\*

Process Control and Manufacturing Technology Division\*  
Applied Mathematics and Computer Technology Division\*\*  
Alcoa Laboratories, Alcoa Center, PA 15069

ABSTRACT

Rule-based expert systems for controlling the curing of organic matrix composites have demonstrated the ability to process a part according to the specific requirements of a part's materials and geometry. This paper describes an extension to this methodology using an object-oriented approach to develop a highly flexible, on-line control strategy which can be quickly configured to accommodate a variety of production loads.

INTRODUCTION

Real-time knowledge-based systems have been applied to a broad spectrum of command and decision systems problems, but their use in traditional manufacturing process control applications has been more limited. The Qualitative Process Automation (QPA) program at the Air Force Aeronautical Laboratory [1,2] (AFWAL) has attempted to demonstrate the viability of this approach for materials manufacturing applications which are either newly emerging or have resisted traditional approaches to process automation. The work described in this paper builds upon this experience by bringing to bear improved software techniques which result in a control system that is architecturally simple, readily extensible, and very flexible in the processing scenarios that it can accommodate.

THE COMPOSITES CURING APPLICATION

The manufacture of graphite fiber reinforced organic thermoset composites typically involves the creation of a part by curing and laminating into a mold resin impregnated sheets (plies) of woven graphite fibers. Various types of epoxies are the most commonly used resins in the organic matrix compound. The mold is then heated using either a heatable pressure vessel called an *autoclave*, or a *press*. A press is comprised of two vertically opposed heatable platens with an adjustable force applied between the platens. As the part is heated, the resin undergoes a chemical reaction (curing) in which its viscosity will for a time become very low before ultimately hardening. After the part is fully cured, it is cooled, removed from the mold, and undergoes final trimming and machining. Press processing is the subject process for the work described in this paper.

Pressure is increased during processing to reduce the amount of voids present in the final part and to express excess resin in order to obtain a resin to fiber ratio needed to achieve the desired part characteristics. Gases present due to entrapped air, moisture, or a resin's volatile components, are the major causes of voids. In an autoclave, hydrostatic pressure reduces gas emission and compresses voids. Resin flow disperses or expels voids.

The cure state of a given part can be inferred from sensor measurements made in-situ during processing. The critical measured parameters are temperature, pressure, and resin viscosity. Part temperature is measured by thermocouple, and pressure on the press is supplied by a load cell. Unlike an autoclave, the load on a part in a press is a contacting rather than hydrostatic force and vacuum is typically not applied. The part in a press is in physical contact with the heat source that controls curing. Therefore, the thermal and resin flow behaviors of press processing are markedly different from that of an autoclave.

Viscosity, being a mechanical property, cannot be measured in-situ but can be inferred from in-situ measurements of a resin's dielectric properties [3,5]. These properties are obtained using microdielectric analysis (MDA). Information that is inferred about viscosity from resin ionic conductivity is adequate for controlling the process [4,5]. The idealized curves in Figure 1 depict a graphite-epoxy laminate undergoing changes in chemical structure upon heating. Initially, as the temperature rises, the resin viscosity decreases (viscosity is roughly inversely proportional to the ionic conductivity). At some point the resin begins cross-linking and the viscosity rises until reaching a maximum final viscosity, whereupon the curing is complete.

During heating, thick laminates (~256 plies) will develop significant thermal gradients across their thicknesses. This is due to lower heat transfer rates between a part's surface and centerline than between the press platen and part surface. Consequently, a resin such as an epoxy that undergoes an exothermic reaction tends to contain the heat generated within the part. Conversely, while increases in platen temperature are quickly matched at the surface of a part, the thermal mass of the part causes the center to lag behind.

Traditional open-loop processing strategies employ ramp-soak periods to compensate for the lag. Nonuniform curing can result in residual stresses that adversely affect quality.

As a resin cures, it transits through a sequence of states that correspond to regions in which the cure control strategy evolves. Figure 1 depicts these process states in terms of idealized sensor data. Clearly, detecting state transitions requires analyzing not only sensor values, but also their derivatives.

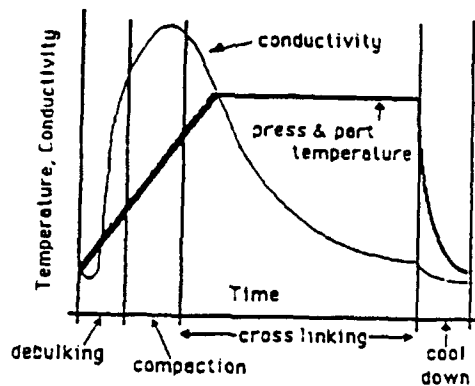

Figure 1: Idealized Process States of An Epoxy Cure Cycle

In summary, the goals of a control strategy for curing a part are:

1. Maintain a uniform temperature distribution throughout the part while driving the average part temperature to the target processing temperature in minimum time.
2. Reach a final degree of cure that insures good quality.
3. Minimize the number and size of voids.
4. Obtain the desired resin to fiber ratio.
5. Prevent performance degradation by exothermic reaction induced overheating.
6. Continue operation in the presence of sensor failures.

SOFTWARE DESIGN

Much work has been done to develop composite cure process models, but a continued dependence on conservative approaches to processing (long cure cycles) exists. With an infinite number of combinations of part shapes, process equipment and resin characteristics, the models that are currently available do not possess the generality and accessibility needed for production use.

The use of a knowledge-based system approach in combination with a sensed part has been shown to be an economical mechanism for generating cure cycles tailored to a given situation [2]. The expert system is a collection of disparate forms of expertise, such as models, data and heuristics, which collectively applies a general solution method to a very specific set of circumstances.

Object-oriented design (OOD) provides a natural way for representing physical situations in data structures that describe the characteristics of the entities (objects) of interest [6,7]. A given part may have a variety of features, i.e., thick and thin sections (*part sites*), which have different processing requirements. Each part site is represented as an instance of a prototype part site object that, during processing, has the ability to evaluate its progress and recommend changes to the process setpoints. Analogously, a given piece of process equipment may have a production load consisting of more than one part. Each part and its needs are denoted by the part sites which comprise it.

The sheer variety in processing scenarios faced by a composites production facility makes OOD very attractive for a control system. Objects are used to describe not only parts and the status of their constituent part sites, but also the process requirements and behaviors of resin systems. The object-oriented metaphor can also be used to explicitly define the behavior of sensors and process equipment and the physical relationships between the objects that represent a specific production scenario, e.g., which thermocouple is located at a given part site's centerline. A working object hierarchy for a composite's cure control system is depicted in Figures 2 through 6. The fundamental object types are *process equipment*, *connections*, *sensors*, *resins*, and *part sites*. Generic objects are depicted in boxes and specific instances of an object are shown in balloons. A lower level object (*child*) inherits the *attributes* (listed below the object name) of the higher level object (*parents*) from which it descends, e.g., a MPT-24 press has both a load setpoint inherited from PRESS and a Pressure setpoint inherited from PROCESS EQUIPMENT (Figure 2).

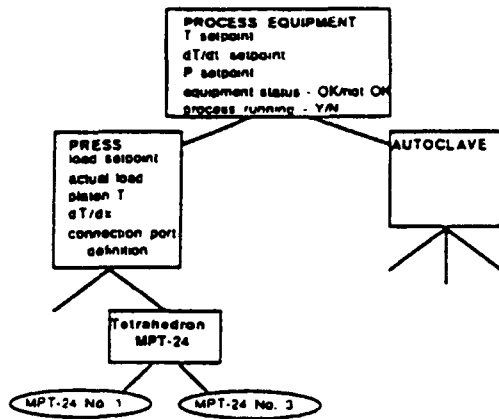

Figure 2: Partial Object Hierarchy for Composites Curing Process Equipment

The equipment status attribute of process equipment objects is used to signal when equipment problems arise during a process run, e.g., large temperature variations in the press platen zones. The process running attribute is the main on/off switch of the control system. It is used to automatically invoke shut down procedures when the control system is unable to accommodate a detected equipment problem or at the completion of a normal cycle. The connection port definition permits process equipment to be interactively connected to part sites so that when operating, the control system knows which equipment and part sites are to be monitored and controlled. Process equipment instances not connected to a part site are ignored.

Figure 3 illustrates the usefulness of connections, depicted by the heavy black lines. Part Sites 1-3 are connected to each other and to Press 2. The part sites can have varying ply thickness which can significantly influence the cure cycle that is generated by the control system. When the control system is configured prior to a run, information about the part, such as resin system type and plan area need only be input into the primary part site's (designated by P) attributes. The non-primary part sites connected to the primary part site will inherit the attribute values required for control system operation. In addition, the press can examine connected part sites to determine information that it needs, e.g., calculating a load setpoint from a target process pressure and plan area.

Connections are also used to link sensor measurements to part site attribute values. For example, the centerline temperature of Part Site 3 is the measure of the thermocouple, TC 2, located at its right center sensor connection site. In addition, if a sensor failure is detected, the control system can look at measurements

from another connected part site to obtain an approximate value.

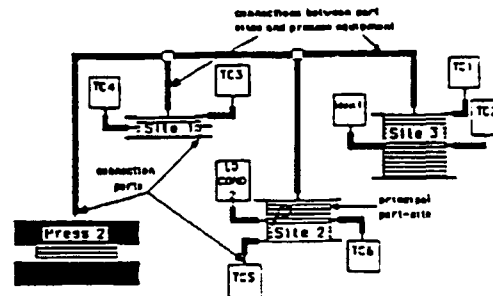

Figure 3: How Connection Objects are Used. Connections are Shown With Heavy Lines

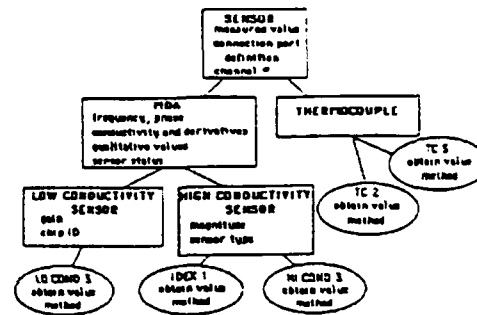

Figure 4: Object Hierarchy for Sensors

The sensor objects depicted in Figure 4 show that the authors have experimented with three types of Micromet MDA devices of varying sensitivities. Index are used as a reasonable compromise between sensitivity and reliability. Like process equipment objects, sensors also have a connection port to allow connections to part sites. Procedures (methods) used to obtain values from sensors are given as attributes of the objects that represent them.

Figure 5 shows the hierarchy for resin objects. The control system is designed to be readily extensible to accommodate new resin types. Basic process objectives for target pressures and temperatures will vary for each instance of a resin. A resin instance such as Hercules 3501-6 descends from a general resin class like epoxy. Most epoxy resins exhibit the same general thermochemical behavior during processing, which is markedly different from that of bismaleimides and polyimides; however, actual process parameters will vary among the many different epoxies from which composites are made.

Resins transit through several states during curing that can be distinguished using sensor data. A primary goal of the control system is to recognize transitions between cure states so that the appropriate control actions can be taken.

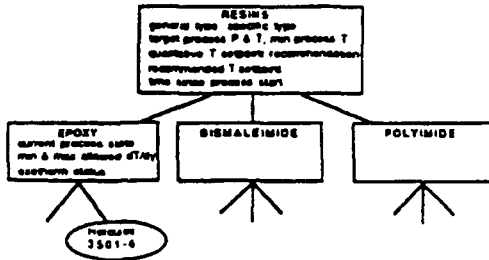

Figure 5: Partial Object Hierarchy for Resin Systems Used in Composites Manufacture

A collection of connected part site objects (Figure 6) describe the processing requirements of the production load to the control system. The production load can be composed of one or more parts, each having one or more part sites. The description includes the plan area, values of sensors connected to constituent part sites, and the type of resin/resins used. To the control system, a production load comprised of three parts, each having a single part site, is logically equivalent to a production load with one part having three part sites. Understandably, when different resin systems are employed in a production load, it is necessary that they have similar processing requirements.

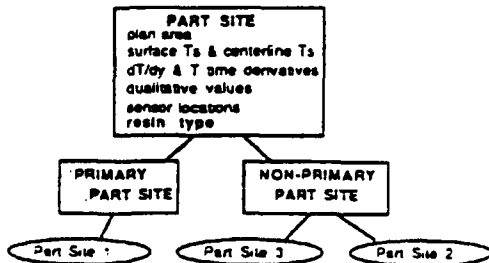

Figure 6: Partial Object Hierarchy for Part Sites Process Rules and Conflict Resolution

The resin type attribute of a part site is occupied by a resin instance that brings with it all of the information required by the control system. During processing, the appropriate control rules are applied to each part site by identifying the resin type. Each part site is examined independently of all others and its specific control needs are ascertained by rule inferences and posted to the recommended-setpoint attributes of its resin type. Periodically, a poll is taken of the setpoint

recommendations of all part sites and actions are taken according to results obtained from the application of conflict resolution rules.

The control system uses rules to reason about the states of the objects present in a given production scenario. Rules are written to be as generic as possible so that a single rule may be applied repetitively to many different object instances, e.g., the rules used to process epoxy resins can be applied to any epoxy part site, however, rules specific to Hercules 3501-6 are only applied to part sites with that specific resin.

The three categories of rules used to start up, run and shutdown the process are *process equipment rules*, *resin class rules* and *resin type rules*. Process equipment rules are employed for any process configuration (any combination of part sites and resin types) on a given piece of process equipment, and are used principally to sequence startup and shutdown procedures, and monitor equipment status. An example process equipment rule is:

*FOR any MPT-24 press P,  
IF the heating zones of the press platens vary by more than 15°F  
THEN set the equipment status of P to not OK and notify the operator that P is not OK.*

For a given resin class, i.e., epoxy, resin class rules are applied to each epoxy part site to evaluate its status and make recommended setpoint changes. Also included in this category are the conflict resolution rules which determine what control actions are to be taken when a poll of the part sites shows that their needs are in conflict. An example resin class rule is:

*For any part site S,  
IF the general type of the resin of S is epoxy AND the exotherm status of S is epoxy AND the centerline temperature of S is >= the target process temperature  
THEN set the recommended temperature setpoint status of S to decrease.*

For a specific resin type, such as Hercules 3501-6, resin type rules are typically used to establish control system targets prior to initiation of process startup. An example resin type rule is:

*For any part site S,  
IF the specific type of the resin of S is Hercules 3501-6  
THEN set the target process temperature of the resin of S to 350°F.*

Due to variations in curing rates, conflicting setpoint recommendations occur regularly when processing multiple part sites simultaneously. In a sense, one part site is competing with all others to have process equipment setpoints adjusted to meet its needs.



## ACKNOWLEDGEMENTS

The authors would like to thank Dan Bergstrom, Ruth Roberts, Janet Hammill and Jonell Kerkhoff at Alcoa Technical Center for their kind assistance and invaluable suggestions during this project.

## REFERENCES

- [1] "Qualitative Process Automation for Autoclave Curing of Composites," AFWAL-TR-87-4083 (May 15, 1987).
- [2] LeClair, S. E., Arbams, F. L. and Matejka, R. F., "Qualitative Process Automation: Self-Directed Manufacture of Composite Materials," *Artificial Intelligence for Engineering Design, Analysis and Manufacturing*, Vol. 3, No. 2 (1989), pp. 125-136.
- [3] Bidstrup, S. A. and Simpson, J. O., "Correlation of Viscosity and Conductivity Using a Free Volume Model," to be published, *Georgia Institute of Technology* (1989).
- [4] Ciriscioli, P. R. and Springer, G. S., "Dielectric Cure Monitoring - A Critical Review," *SAMPE Journal*, Vol. 25, No. 3 (May/June 1989), pp. 35-42.
- [5] Yokota, M. J., "In Process Controlled Curing of Resin Matrix Composites," *SAMPE Journal*, Vol. 22, 1977, pp. 416-429.
- [6] Cox, B., "Message/Object Programming: An Evolutionary Change in Programming Technology," *IEEE Software* (January 1984), pp. 50-61.
- [7] Meyer, B., "Object-Oriented Software Construction," Prentice-Hall, New York, 1988.

DISTRIBUTION LIST

No. of Copies	To
1	Office of the Under Secretary of Defense for Research and Engineering, The Pentagon, Washington, DC 20301
	Commander, U.S. Army Laboratory Command, 2800 Powder Mill Road, Adelphi, MD 20783-1145
1	ATTN: AMSLC-IM-TL
1	AMSLC-CT
	Commander, Defense Technical Information Center, Cameron Station, Building 5, 5010 Duke Street, Alexandria, VA 22304-6145
2	ATTN: DTIC-FDAC
1	MIAC/CINDAS, Purdue University, 2595 Yeager Road, West Lafayette, IN 47905
	Commander, Army Research Office, P.O. Box 12211, Research Triangle Park, NC 27709-2211
1	ATTN: Information Processing Office
	Commander, U.S. Army Materiel Command, 5001 Eisenhower Avenue, Alexandria, VA 22333
1	ATTN: AMCSCI
	Commander, U.S. Army Materiel Systems Analysis Activity, Aberdeen Proving Ground, MD 21005
1	ATTN: AMXSY-MP, H. Cohen
	Commander, U.S. Army Missile Command, Redstone Scientific Information Center, Redstone Arsenal, AL 35898-5241
1	ATTN: AMSMI-RD-CS-R/Doc
1	AMSMI-RLM
	Commander, U.S. Army Armament, Munitions and Chemical Command, Dover, NJ 07801
2	ATTN: Technical Library
1	AMDAR-LCA, Mr. Harry E. Pebly, Jr., PLASTECH, Director
	Commander, U.S. Army Natick Research, Development and Engineering Center, Natick, MA 01760-5010
1	ATTN: Technical Library
	Commander, U.S. Army Satellite Communications Agency, Fort Monmouth, NJ 07703
1	ATTN: Technical Document Center
	Commander, U.S. Army Tank-Automotive Command, Warren, MI 48397-5000
1	ATTN: AMSTA-ZSK
2	AMSTA-TSL, Technical Library
	Commander, White Sands Missile Range, NM 88002
1	ATTN: STEWS-WS-VT
	President, Airborne, Electronics and Special Warfare Board, Fort Bragg, NC 28307
1	ATTN: Library
	Director, U.S. Army Ballistic Research Laboratory, Aberdeen Proving Ground, MD 21005
1	ATTN: SLCBR-TSB-S (STINFO)
	Commander, Dugway Proving Ground, Dugway, UT 84022
1	ATTN: Technical Library, Technical Information Division
	Commander, Harry Diamond Laboratories, 2800 Powder Mill Road, Adelphi, MD 20783
1	ATTN: Technical Information Office
	Director, Benet Weapons Laboratory, LCWSL, USA AMCCOM, Watervliet, NY 12189
1	ATTN: AMSMC-LCB-TL
1	AMSMC-LCB-R
1	AMSMC-LCB-RM
1	AMSMC-LCB-RP
	Commander, U.S. Army Foreign Science and Technology Center, 220 7th Street, N.E., Charlottesville, VA 22901-5396
3	ATTN: AIFRTC, Applied Technologies Branch, Gerald Schlesinger

No. of Copies	To
1	Commander, U.S. Army Aeromedical Research Unit, P.O. Box 577, Fort Rucker, AL 36360 ATTN: Technical Library
1	Commander, U.S. Army Aviation Systems Command, Aviation Research and Technology Activity, Aviation Applied Technology Directorate, Fort Eustis, VA 23604-5577 ATTN: SAVDL-E-MOS
1	U.S. Army Aviation Training Library, Fort Rucker, AL 36360 ATTN: Building 5906-5907
1	Commander, U.S. Army Agency for Aviation Safety, Fort Rucker, AL 36362 ATTN: Technical Library
1	Commander, USACDC Air Defense Agency, Fort Bliss, TX 79916 ATTN: Technical Library
1	Commander, U.S. Army Engineer School, Fort Belvoir, VA 22060 ATTN: Library
1	Commander, U.S. Army Engineer Waterways Experiment Station, P. O. Box 631, Vicksburg, MS 39180 ATTN: Research Center Library
1	Commandant, U.S. Army Quartermaster School, Fort Lee, VA 23801 ATTN: Quartermaster School Library
1	Naval Research Laboratory, Washington, DC 20375 ATTN: Code 5830
2	Dr. G. R. Yoder - Code 6384
1	Chief of Naval Research, Arlington, VA 22217 ATTN: Code 471
1	Edward J. Morrissey, WRDC/MLTE, Wright-Patterson Air Force, Base, OH 45433-6523
1	Commander, U.S. Air Force Wright Research & Development Center, Wright-Patterson Air Force Base, OH 45433-6523 ATTN: WRDC/MLLP, M. Forney, Jr.
1	WRDC/MLBC, Mr. Stanley Schulman
1	WL/MLBC, Dr. Charles E. Browning
1	NASA - Marshall Space Flight Center, MSFC, AL 35812 ATTN: Mr. Paul Schuerer/EH01
1	U.S. Department of Commerce, National Institute of Standards and Technology, Gaithersburg, MD 20899 ATTN: Stephen M. Hsu, Chief, Ceramics Division, Institute for Materials Science and Engineering
1	Committee on Marine Structures, Marine Board, National Research Council, 2101 Constitution Ave., N.W., Washington, DC 20418
1	Librarian, Materials Sciences Corporation, 930 Harvest Drive, Suite 300, Blue Bell, PA 19422
1	The Charles Stark Draper Laboratory, 68 Albany Street, Cambridge, MA 02139
1	Wyman-Gordon Company, Worcester, MA 01601 ATTN: Technical Library
1	General Dynamics, Convair Aerospace Division, P.O. Box 748, Fort Worth, TX 76101 ATTN: Mfg. Engineering Technical Library
2	Director, U.S. Army Materials Technology Laboratory, Watertown, MA 02172-0001 ATTN: SLCMT-TM
1	SLCMT-IMA-V
1	SLCMT-PR
25	SCLMT-MEC
1	Laboratory for Manufacturing and Productivity, MIT - Room 35-132, Cambridge, MA 02139-4307 ATTN: Dr. Timothy W. Gutowski, Director

No. of Copies	To
1	Bell Helicopter, Mail Stop 01458R, PO Box 482, Fort Worth, TX 76101 ATTN: E. E. Blake
1	Advanced Composite Products, Inc., PO Box 288, North Branford, CT 05471 ATTN: Mr. David Maas
1	Department of Chemical Engineering, University of Delaware, Newark, Delaware 19716 ATTN: Dr. Prasad Dhurjati
1	Center for Composite Materials, University of Delaware, Newark, Delaware 19716 ATTN: Dr. Roy L. McCullough
1	Textron Specialty Materials Division, 2 Industrial Avenue, Lowell, MA 01851 ATTN: Mr. Mike Dorf
1	McDonnell Douglas Helicopter Co., 5000 E. McDowell Rd., Mesa, AZ 85205 ATTN: Mr. Jim Ratliff
1	Fiber Materials, Inc., 5 Morin Street, Biddeford, ME 04005-4497 ATTN: Dr. Shirley Darrah
1	American Composite Technology, Inc., 306 Northern Avenue, Boston, MA 02210 ATTN: Dr. Jerome Fanucci
1	SunRez Corp., 1374 Merritt Dr., El Cajon, CA 92020 ATTN: Mr. Mark Livesay
1	Kaman Aerospace, 8101, Old Windsor Road, Bloomfield, CT 06002 ATTN: Mr. David Barnes
1	Space Industries International, Inc., 711 W. Bay Area Blvd., Suite 320, Webster, TX 77598-4001 ATTN: Dr. Clifford R. Kurtzman
1	Gensym Corporation, 125 CambridgePark Drive, Cambridge, MA 02140 ATTN: Mr. Roland Jones
1	Tennessee Technological University, Department of Industrial Engineering, P.O. Box 5011, Cookeville, TN 38505 ATTN: Dr. Kenneth Currie
1	Vista Biologicals Corporation, 2120-C Las Palmas Drive - Suite C, Carlsbad, CA 92009 ATTN: Dr. Robert Fleischaker, Jr.

U.S. Army Materials Technology Laboratory  
Watertown, Massachusetts 02172-0001  
INNOVATIVE LIFE CYCLE MANAGEMENT SYSTEMS  
FOR COMPOSITES

Key Words

AD  
UNCLASSIFIED  
UNLIMITED DISTRIBUTION

Composites  
Expert Systems  
Quality Management

Francis D. Gutowski  
Technical Report MTL TR 91-49, December 1991.  
74 pp—illus—tables.

The production of advanced composite structures proceeds through a sequence of stages (design, processing, quality control, etc.), each linked to preceding and following functions by material and data flows in the form of inputs, outputs and constraining factors. The integrity of a composite structure depends on a variety of reactive materials with limited shelf lives, complex production and test equipment, and exacting processes and procedures. In this environment, accurate, systematic and complete documentation of material identities is mandatory. Significant technical challenges arise in the design and implementation of an intelligent, interactive quality management system for advanced composites which is cost-effective, user-friendly, and well-adapted to both R&D-intensive and large-scale, production-oriented composites fabrication environments.

Rapid prototyping was used to test the feasibility of developing an integrated, user-friendly, knowledge-based life cycle management system (LCMS) to provide comprehensive material traceability and quality management support in R&D and production environments. At the outset, prototypes coded in Lisp using Symbolics' Genera™ development environment were used to refine preliminary material-tracking and user-interface concepts. These were followed by prototypes developed with G2™, a real-time expert system shell whose object-oriented design, user-interface tools, framework for knowledge representation, software interfaces and portability contributed to its superiority for development and delivery. To leverage the functionality, productivity, and value of the LCMS, the investigators proposed that it be coupled to a subsystem of software modules for autonomous, real-time optimization and control of pultrusion, autoclave curing and press curing. These would capitalize on the synergistic reuse and extension of the LCMS knowledge base of materials, their physical and chemical properties, and processing requirements. Further development involving extensive field testing of working prototypes at government, academic and commercial sites was recommended to ensure a smooth transition to broad Phase III commercial deployment, which would enable the DoD to realize lower-cost, higher-quality procurements of advanced materials.

U.S. Army Materials Technology Laboratory  
Watertown, Massachusetts 02172-0001  
INNOVATIVE LIFE CYCLE MANAGEMENT SYSTEMS  
FOR COMPOSITES

Key Words

AD  
UNCLASSIFIED  
UNLIMITED DISTRIBUTION

Composites  
Expert Systems  
Quality Management

Francis D. Gutowski  
Technical Report MTL TR 91-49, December 1991.  
74 pp—illus—tables.

The production of advanced composite structures proceeds through a sequence of stages (design, processing, quality control, etc.), each linked to preceding and following functions by material and data flows in the form of inputs, outputs and constraining factors. The integrity of a composite structure depends on a variety of reactive materials with limited shelf lives, complex production and test equipment, and exacting processes and procedures. In this environment, accurate, systematic and complete documentation of material identities is mandatory. Significant technical challenges arise in the design and implementation of an intelligent, interactive quality management system for advanced composites which is cost-effective, user-friendly, and well-adapted to both R&D-intensive and large-scale, production-oriented composites fabrication environments.

Rapid prototyping was used to test the feasibility of developing an integrated, user-friendly, knowledge-based life cycle management system (LCMS) to provide comprehensive material traceability and quality management support in R&D and production environments. At the outset, prototypes coded in Lisp using Symbolics' Genera™ development environment were used to refine preliminary material-tracking and user-interface concepts. These were followed by prototypes developed with G2™, a real-time expert system shell whose object-oriented design, user-interface tools, framework for knowledge representation, software interfaces and portability contributed to its superiority for development and delivery. To leverage the functionality, productivity, and value of the LCMS, the investigators proposed that it be coupled to a subsystem of software modules for autonomous, real-time optimization and control of pultrusion, autoclave curing and press curing. These would capitalize on the synergistic reuse and extension of the LCMS knowledge base of materials, their physical and chemical properties, and processing requirements. Further development involving extensive field testing of working prototypes at government, academic and commercial sites was recommended to ensure a smooth transition to broad Phase III commercial deployment, which would enable the DoD to realize lower-cost, higher-quality procurements of advanced materials.

U.S. Army Materials Technology Laboratory  
Watertown, Massachusetts 02172-0001  
INNOVATIVE LIFE CYCLE MANAGEMENT SYSTEMS  
FOR COMPOSITES

Key Words

AD  
UNCLASSIFIED  
UNLIMITED DISTRIBUTION

Composites  
Expert Systems  
Quality Management

Francis D. Gutowski  
Technical Report MTL TR 91-49, December 1991.  
74 pp—illus—tables.

The production of advanced composite structures proceeds through a sequence of stages (design, processing, quality control, etc.), each linked to preceding and following functions by material and data flows in the form of inputs, outputs and constraining factors. The integrity of a composite structure depends on a variety of reactive materials with limited shelf lives, complex production and test equipment, and exacting processes and procedures. In this environment, accurate, systematic and complete documentation of material identities is mandatory. Significant technical challenges arise in the design and implementation of an intelligent, interactive quality management system for advanced composites which is cost-effective, user-friendly, and well-adapted to both R&D-intensive and large-scale, production-oriented composites fabrication environments.

Rapid prototyping was used to test the feasibility of developing an integrated, user-friendly, knowledge-based life cycle management system (LCMS) to provide comprehensive material traceability and quality management support in R&D and production environments. At the outset, prototypes coded in Lisp using Symbolics' Genera™ development environment were used to refine preliminary material-tracking and user-interface concepts. These were followed by prototypes developed with G2™, a real-time expert system shell whose object-oriented design, user-interface tools, framework for knowledge representation, software interfaces and portability contributed to its superiority for development and delivery. To leverage the functionality, productivity, and value of the LCMS, the investigators proposed that it be coupled to a subsystem of software modules for autonomous, real-time optimization and control of pultrusion, autoclave curing and press curing. These would capitalize on the synergistic reuse and extension of the LCMS knowledge base of materials, their physical and chemical properties, and processing requirements. Further development involving extensive field testing of working prototypes at government, academic and commercial sites was recommended to ensure a smooth transition to broad Phase III commercial deployment, which would enable the DoD to realize lower-cost, higher-quality procurements of advanced materials.

U.S. Army Materials Technology Laboratory  
Watertown, Massachusetts 02172-0001  
INNOVATIVE LIFE CYCLE MANAGEMENT SYSTEMS  
FOR COMPOSITES

Key Words

AD  
UNCLASSIFIED  
UNLIMITED DISTRIBUTION

Composites  
Expert Systems  
Quality Management

Francis D. Gutowski  
Technical Report MTL TR 91-49, December 1991.  
74 pp—illus—tables.

The production of advanced composite structures proceeds through a sequence of stages (design, processing, quality control, etc.), each linked to preceding and following functions by material and data flows in the form of inputs, outputs and constraining factors. The integrity of a composite structure depends on a variety of reactive materials with limited shelf lives, complex production and test equipment, and exacting processes and procedures. In this environment, accurate, systematic and complete documentation of material identities is mandatory. Significant technical challenges arise in the design and implementation of an intelligent, interactive quality management system for advanced composites which is cost-effective, user-friendly, and well-adapted to both R&D-intensive and large-scale, production-oriented composites fabrication environments.

Rapid prototyping was used to test the feasibility of developing an integrated, user-friendly, knowledge-based life cycle management system (LCMS) to provide comprehensive material traceability and quality management support in R&D and production environments. At the outset, prototypes coded in Lisp using Symbolics' Genera™ development environment were used to refine preliminary material-tracking and user-interface concepts. These were followed by prototypes developed with G2™, a real-time expert system shell whose object-oriented design, user-interface tools, framework for knowledge representation, software interfaces and portability contributed to its superiority for development and delivery. To leverage the functionality, productivity, and value of the LCMS, the investigators proposed that it be coupled to a subsystem of software modules for autonomous, real-time optimization and control of pultrusion, autoclave curing and press curing. These would capitalize on the synergistic reuse and extension of the LCMS knowledge base of materials, their physical and chemical properties, and processing requirements. Further development involving extensive field testing of working prototypes at government, academic and commercial sites was recommended to ensure a smooth transition to broad Phase III commercial deployment, which would enable the DoD to realize lower-cost, higher-quality procurements of advanced materials.