

9

UNCLASSIFIED

AD-A267 537



MARITIME PATROL AVIATION-BLUEPRINT FOR THE FUTURE

by

Howard C. Norton
Commander, U.S. Naval Reserve

and

Riley J. Gladden
Commander, U.S. Naval Reserve

June 1992

DTIC
ELECTE
AUG 10 1993
S E D

~~RESTRICTED STATE~~
Approved for public release
Distribution Unlimited

UNCLASSIFIED

93-18287



9 3 1 8 2 8 7

002

REPORT DOCUMENTATION PAGE

1a REPORT SECURITY CLASSIFICATION Unclassified			1b RESTRICTIVE MARKINGS N/A			
2a. SECURITY CLASSIFICATION AUTHORITY			3 DISTRIBUTION / AVAILABILITY OF REPORT Unlimited			
2b. DECLASSIFICATION / DOWNGRADING SCHEDULE						
4. PERFORMING ORGANIZATION REPORT NUMBER(S)			5 MONITORING ORGANIZATION REPORT NUMBER(S)			
6a. NAME OF PERFORMING ORGANIZATION U.S. Naval War College		6b OFFICE SYMBOL <i>(if applicable)</i>	7a. NAME OF MONITORING ORGANIZATION			
6c. ADDRESS (City, State, and ZIP Code) Newport, RI 02840-5010			7b. ADDRESS (City, State, and ZIP Code)			
8a. NAME OF FUNDING / SPONSORING ORGANIZATION Advanced Research Department		8b. OFFICE SYMBOL <i>(if applicable)</i>	9. PROCUREMENT INSTRUMENT IDENTIFICATION NUMBER			
8c. ADDRESS (City, State, and ZIP Code) U. S. Naval War College Newport, RI 02840-5010			10 SOURCE OF FUNDING NUMBERS			
			PROGRAM ELEMENT NO	PROJECT NO	TASK NO	WORK UNIT ACCESSION NO
11. TITLE (Include Security Classification) " Maritime Patrol ^{airborne} Blueprint for the Future"						
PERSONAL AUTHOR(S) Norton, H. C. CDR / Gladden, R. J. CDR						
13a TYPE OF REPORT		13b TIME COVERED FROM _____ TO _____		14 DATE OF REPORT (Year, Month, Day) 1992 May 29		
15 PAGE COUNT 100						
16 SUPPLEMENTARY NOTATION						
17 COSATI CODES			18 SUBJECT TERMS (Continue on reverse if necessary and identify by block number)			
FIELD	GROUP	SUB-GROUP				
19 ABSTRACT (Continue on reverse if necessary and identify by block number) (U) With the downfall of the Soviet Union and the decreased optempo of their submarine fleet, the Navy's MPA community has been underemployed in its traditional role, ASW. This paper examines the role of MPA in today's Navy and focuses on mission analysis, aircraft requirements and the necessary force structure for both the present and the future. It also examines how the MPA community fits within the new National Military Strategy and offers several key recommendations to improve readiness.						
20 DISTRIBUTION / AVAILABILITY OF ABSTRACT <input checked="" type="checkbox"/> UNCLASSIFIED/UNLIMITED <input type="checkbox"/> SAME AS RPT <input type="checkbox"/> DTIC USERS			21 ABSTRACT SECURITY CLASSIFICATION Unclassified			
NAME OF RESPONSIBLE INDIVIDUAL CDR C. Benigno, ASST DIR, ARP			22b TELEPHONE (Include Area Code) (401)-841-3304		22c OFFICE SYMBOL	

NAVAL WAR COLLEGE
Newport, R. I.

MARITIME PATROL AVIATION-BLUEPRINT FOR THE FUTURE

by

Howard C. Norton
Commander USNR
and
Riley J. Gladden
Commander USNR

A paper submitted to the Faculty of the Naval War College in partial satisfaction of the requirements of the Department of Operations.

The contents of this paper reflect our own personal views and are not necessarily endorsed by the Naval War College or the Department of the Navy.

Signature: 

Signature: 

19 June 1992

Paper directed by
Mel G. Chaloupka, Commander, USNR
Director, Naval Reserve Project

Approved by: _____

Faculty Research Advisor Date

Abstract of
MARITIME PATROL AVIATION-BLUEPRINT FOR THE FUTURE

This paper addresses the future of the MPA community within the context of the current national military strategy. The purpose of this research is to determine the optimum mix of future missions, the necessary aircraft enhancements, and appropriate force structure to maximize the MPA community's contributions to forward presence and crisis response. It examines the Reserve role in the MPA community and develops an extensive two-Medium Regional Crises case study to arrive at conclusions and recommendations including a minimum total MPA force level. The paper offers extensive recommendations concerning mission mix, aircraft enhancements, and force mix. It specifically recommends an optimum active / reserve mix, a method of improving reservists ability to respond to crises through establishment of a voluntary data base, and an active / reserve executive steering committee to establish direction and guidance for the community.

Accession For	
NTIS CRA&I	<input checked="" type="checkbox"/>
DTIC TAB	<input type="checkbox"/>
Unannounced	<input type="checkbox"/>
Justification	
By	
Distribution /	
Availability Codes	
Dist	Avail and/or Special
A-1	

DTIC QUALITY INSPECTED 3

EXECUTIVE SUMMARY

purpose of this research paper is to examine the role of the Maritime Patrol Aviation (MPA) community in the context of the national military strategy with specific focus on the elements of forward presence and crisis response. The four primary research questions below guided our research:

A. WHAT IS THE APPROPRIATE FUTURE MISSION MIX FOR THE MPA COMMUNITY WITHIN THE CONTEXT OF THE NATIONAL MILITARY STRATEGY?

B. WHAT AIRCRAFT ENHANCEMENTS ARE NECESSARY TO ACCOMPLISH THE PRESENT AND FUTURE MISSIONS?

C. WHAT IS THE ROLE OF RESERVE MPA WITHIN THE CONTEXT OF THE NATIONAL MILITARY STRATEGY?

D. WHAT IS THE APPROPRIATE FLEET TO RESERVE SQUADRON RATIO TO ENSURE ADEQUATE RESERVE MPA MANNING? WHAT ARE THE IMPLICATIONS OF TOO LOW A RATIO?

2. In the absence of the Unified Commander-in-Chiefs' (CINCs) MPA missions requirements, we reviewed all traditional missions including ASW, ASUW, surveillance and counter narcotics, mining, and search and rescue. We examined several potential missions including amphibious readiness group

support (ARG), the anti-SCUD mission, early warning (AEW), and tanking.

3. Following our recommendation for a future mission mix, we conducted an analysis of the necessary capabilities to perform these missions. Where necessary, we recommended and prioritized aircraft enhancements to accomplish the missions. Among the enhancements evaluated, were ISAR, active detection and tracking capability, P-3 survival package, tanking, Cluster Ranger, and weapons.

4. In the absence of the Unified CINCs' wartime MPA force level requirements, we derived the requirements by analyzing two regional scenarios from the Naval War College 1991 Global War Games. This was followed by discussions of the relative costs of active and reserve squadrons and an analysis of the reserve role in the national military strategy. We then compared the force level derived from the scenarios to the various proposals for force mix from DON, JCS, CNO, and Congress. Each proposal was assessed based on relative cost, war time risks and peace time capabilities. Finally, in the absence of sufficient empirical data to answer the ratio question, we constructed a model to predict the appropriate ratio and recommended an appropriate force level and mix.

5. The following are our answers to the primary research questions:

A. WHAT IS THE APPROPRIATE FUTURE MISSION MIX FOR THE MPA

**COMMUNITY WITHIN THE CONTEXT OF THE NATIONAL MILITARY
STRATEGY?**

We recommend that the missions retained or added to the MPA community be as follows:

1. Retain ASW with a focus on third world/shallow water ASW.
2. Retain and increase emphasis on ASUW capabilities and readiness.
3. Retain and increase emphasis on surveillance and counter narcotics capabilities and readiness.
4. Retain mining mission and recommend that the P3 be used only in a non-AAW environment.
5. Assume adjunct tanking mission for CVBG by retrofitting six to ten heavyweight P3Bs or P3Cs (SLEP as necessary-aircraft to have no other significant major capabilities). Aircraft should be stationed at VP forward deployed bases and operated and maintained by VP personnel. Do not retrofit any other existing active or reserve aircraft. Defer decision on tanking capability for production aircraft (Orion II or follow on P3) pending evaluation of how effectively the capability is integrated by the CVBG.
6. Assume the ARG support mission. Begin tactics development immediately.
7. Continue development of anti-SCUD tactics.
8. Reject the AEW mission. It is not a mission readily adaptable to the patrol community. Training to this mission

would degrade/dilute the community's ability to perform other missions.

B. WHAT AIRCRAFT ENHANCEMENTS ARE NECESSARY TO ACCOMPLISH THE PRESENT AND FUTURE MISSIONS?

We recommend the following priority for procurement of aircraft enhancements to accomplish the recommended mission mix (all active and reserve aircraft should be homogeneous):

1. **ISAR**-absolutely essential to effective ASW against diesel submarines and surveillance/ASUW missions. Should be purchased independently from Update IV to avoid delays.

2. **Improved active detection and tracking capability**-essential to effective ASW against third-world diesel submarines.

3. **Improved ESM system** for P3Cs (and P3Bs if they are not retired in the near future) is critical for ASUW operations.

4. **Update IV**-(includes ISAR but we should not delay an immediate ISAR capability. Also includes an improved ESM system.)

5. **Survivability package**-for all P-3 aircraft.

6. **CLUSTER RANGER system**.

C. WHAT IS THE ROLE OF RESERVE MPA WITHIN THE CONTEXT OF THE NATIONAL MILITARY STRATEGY?

Our conclusion is that the reserve MPA has and can

continue to provide contributory support and forward presence. While Reserve MPA forces are available through the presidential callup of the selected reserves, we believe their ability to respond to crisis can be enhanced by the following recommendations: (Some of the following may have reserve wide application.)

1. That contributory support become a major MPA Reserve priority at the expense of traditional readiness. This should include revision of the Reserve readiness equation to emphasize actual readiness prior to the annual training period instead of total year readiness.

2. That each reserve MPA squadron poll their personnel (aircrew and ground support) to determine who are available for immediate recall (48 hours) for a minimum time period of one month.

3. If initial feedback is sufficient to justify further effort, that the existing RSTARS data base system be modified to code those reservists available by NEC.

4. That the data base be updated monthly by the squadrons and that their aircrew availability be reported in the remarks section of the monthly readiness report.

5. That COMNAVAIRESFOR code 513 manage ADT (active duty for training) funds to support crisis response requests.

6. That the functional wings identify a "first in the barrel" squadron monthly (or for some specified period) to provide a full mission capable aircraft and aircrew for launch

within 48 hours. (This crew would not necessarily be an intact crew nucleus but rather a makeup crew capable of surveillance/ASUW for fleet backfill/augment). By accessing the data base, functional wings could fill any known personnel shortages from other squadrons with compatible aircraft.

7. That following activation of the first aircraft/crew, another "first in the barrel" squadron/aircrew be identified.

We propose that these assets be used only for crisis response to backfill or augment the active component. They should not be used to mask funding shortfalls.

D. WHAT IS THE APPROPRIATE FLEET TO RESERVE SQUADRON RATIO TO ENSURE ADEQUATE RESERVE MPA MANNING? WHAT ARE THE IMPLICATIONS OF TOO LOW A RATIO?

1. Based on our analysis of the scenarios, we recommend a force level of 31 squadrons. Based on our analysis of cost factors, reserve capabilities, and ratio prediction model, we recommend that a minimum of 18 squadrons be retained in the active component and 13 squadrons be retained in the reserve component.

Throughout the entirety of our research we continually observed a lack of communication between the active and reserve MPA communities. Generally, we believe that the lack of a unified effort from both components sends confusing signals to Congress and could affect the image and funding of the community as a whole. Our final recommendation is:

**THE FORMATION OF AN MPA EXECUTIVE STEERING GROUP (FLAG LEVEL)
COMPOSED OF SENIOR ACTIVE AND RESERVE MPA LEADERS TO MEET
SEMI-ANNUALLY TO STUDY AND PROVIDE RECOMMENDATIONS ON THE
DIRECTION AND NEEDS OF THE COMMUNITY.**

PREFACE

Conducting this advanced research project at the Naval War College gave us the opportunity to assimilate and apply concepts from the total Naval War College Curriculum to our community in which we have combined a total of 35 years of service. The conclusions we reached in the course of our research varied significantly with our initial notions of the direction our community should take. We feel fortunate to have had this opportunity and hope that in some way our work will benefit our nation, Navy, and the dedicated professionals at all levels in the Maritime Patrol Aviation community.

We wish to thank Rear Admiral Tom F. Hall, for his support of our project and invaluable insight to the challenges that face our community. We also thank our academic advisors, Captain (select) Mel Chaloupka, and Lieutenant Commander Chris Benigno for their tremendous support and enthusiasm for our project. Without question, the assistance of Ms. Barbara Prisk, of the Naval War College Advanced Research staff was indispensable to our effort.

We also sincerely appreciate the time and interest of the numerous community leaders who contributed their collective wisdom, experience and insight through interviews.

The opinions expressed herein are solely those of the authors.

TABLE OF CONTENTS

	PAGE
ABSTRACT	
EXECUTIVE SUMMARY	i
PREFACE	ii
LIST OF ILLUSTRATIONS	iii
LIST OF TABLES	iv
LIST OF ABBREVIATIONS	v
GLOSSARY	vi
EPIGRAPH	
I. INTRODUCTION	1
II. BACKGROUND	7
III. CINC MPA REQUIREMENTS	16
IV. ROLES AND MISSIONS ANALYSIS	18
V. AIRCRAFT AGING ANALYSIS	45
VI. AIRCRAFT ENHANCEMENT ANALYSIS	48
VII. CASE STUDY-TWO MEDIUM REGIONAL CRISES SCENARIO	54
VIII. FORCE MIX ANALYSIS	66
IX. ACTIVE / RESERVE FORCE MIX	78
X. MISSION SPECIALTY SQUADRON ANALYSIS	86
XI. SUMMARY OF CONCLUSIONS AND RECOMMENDATIONS . .	91

APPENDIX	I--THIRD WORLD / SHALLOW	
	WATER ASW THREAT	103
APPENDIX	II--REFUELING DATA	104
APPENDIX	III--ENHANCEMENTS	105
APPENDIX	IV--CASE STUDY DATA	106
SOURCES	CONSULTED	107

LIST OF ILLUSTRATIONS

FIGURE	PAGE
1. Map of Reserve MPA Squadron Locations	13
2. Proliferation of Submarines in the Third World	28
3. Proliferation of Modern Submarines into Third World Arsenals	29
4. Threat Assumptions	31

LIST OF TABLES

TABLE	PAGE
I. Proposed DON FY 93 MPA Force Location	10
II. P3 Models Flown by RESFORONs Today	13
III. Countries Possessing P3 Aircraft	19
IV. Summary of CIS Submarines	31
V. Active / Reserve Cost Comparison Summary	70
VI. Level of Reserve MPA Contributory Support (CS)	73
VII. Active / Reserve Force Mix Matrix	85
VIII. Comparison of Full VS Specialty Mission Squadrons	90
IX. Potential Schedule of Required P3 Enhancements	97

LIST OF ABBREVIATIONS

AAW - Anti-Air Warfare
ADT - Active Duty for Training
AEW - Airborne Early Warning
AOR - Area of Responsibility
ARG - Amphibious Readiness Group
ASUW - Anti Surface Warfare
ASW - Anti Submarine Warfare
AT - Annual Training
AUX - Auxiliary vessel
C3I -Command, Control, Communication and Intelligence
CAP - Combat Air Patrol
CINC - Commander - in - Chief
CINCLANTFLT - Commander - in - Chief Atlantic Fleet
CIS - Commonwealth of Independent States
CN - Counter Narcotics
CNA - Center for Naval Analysis
CNO - Chief of Naval Operations
COMINWARCOM - Commander Mine Warfare Command
COMNAVAIRESFOR - Commander Naval Air Reserve Force
COMPATWINGSPAC - Commander Patrol Wings Pacific
CTF - Commander Task Force
CVBG - Carrier Battle Group
DIFAR - Directional Finding Acoustic Receiver
DMZ - Demilitarized Zone

DON - Department of the Navy
DPRK - Democratic Peoples Republic of Korea
ESL - Engineered Service Life
ESM - Electronic Signal Measurement
GCC - Gulf Cooperation Council
GPS - Global Positioning System
IPADS - Improved Processing and Display System
IPL - Integrated Priority List
ISAR - Inverse Synthetic Aperture Radar
JCS - Joint Chiefs of Staff
MAU - Master Augment Unit
MPA - Maritime Patrol Aviation
MRC - Medium Regional Conflict
NAS - Naval Air Station
NATO - North Atlantic Treaty Organization
NAVAIR - Naval Aviation
NAVET - Navy Veteran
NEC - Navy Enlisted Classification Code
NFO - Naval Flight Officer
NOBC - Navy Officer Billet Code
NPG - Naval Post Graduate School
NRA - Naval Reserve Association
OPLAN - Operational Plan
OPTEMPO - Operational Tempo
OTH-T - Over the Horizon Targeting
P3B TACNAVMOD - P3B Tactical Navigation Modification

PAA - Primary Aircraft Allowance
PCSR - Presidential Call Up of Selected Reservists
PERSTEMPO - Personnel Tempo
POL - Petroleum, Oil and Lubrication
POM - Program Objective Memorandum
PRC - Peoples Republic of China
RESFORON - Reserve Force Squadron
RIMPAC - Rim of the Pacific
ROA - Reserve Officers Association
SAM - Surface to Air Missile
SAR - Search and Rescue
SATCOMM - Satellite Communication
SAU - Squadron Augment Unit
SELRES - Selected Reservist
SIGINT -Signal Intelligence
SLEP - Service Life Extension Program
SLOC - Sea Lane of Communication
SRP - Sustained Readiness Program
SS - Conventionally powered (diesel - electric) Submarine
SSBN - Ballistic Missile Submarine
SSGN -Nuclear Powered Guided Missile Submarine
SSN - Nuclear Powered Submarine
TACAIR - Tactical Aviation
TAR - Training and Administration of the Reserve
USCINCPAC - US Commander - in - Chief Pacific

GLOSSARY

CLUSTER RANGER - name given to a new long range, electro-optical, video data collection system.

Crisis Response - the ability to respond to crises as they occur, with the goal of deterring conflicts or if necessary - resolving them by force.

Engineered Service Life - theoretical design service life for the P3.

Fleet Support - missions performed in support of US naval operations.

Forward Presence - the visible presence of the US military forces in regions vital to national interests. Considered key to averting crises, preventing wars and demonstrating American participation in global affairs.

Integrated Priority List - primary means for unified CINCs to identify their highest needs to CJCS and SECDEF.

ORION II - proposed follow on aircraft to the P3C.

POSSE HUNTER - name given to CINCLANTFLT initiative to outfit several P3s with special equipment for the counter narcotics role.

Reconstitution - the ability to activate contingency war equipment, mobilizing new and reserve manpower, to re-expand the military industrial base and to bring shelved technological innovations quickly into operation.

RSTARS / RTSS - Data Bases for Reserve Management

SCUD - Name given to Soviet or Chinese made surface to surface ballistic missile.

Service Life Extension Program - a more extensive P3 inspection and repair program designed to extend the engineered service life by 18 years.

Sustained Readiness Program - program designed to extend the engineered service life by approximately 8 years.

UPDATE IV - enhanced acoustic / non-acoustic /

navigation and tactical systems upgrade to the P3C.

EPIGRAPH

A look at...Desert Shield / Storm in which MPA performed extensive ASUW, and performed it well...gives insight into that mission area...In 219 {combat} missions during Desert Storm...P3s provided identification and targeting in 31 engagements leading to destruction of over 50% of all Iraqi surface vessels...Response-P3s were the first US Navy forces on the scene. A full squadron was operating around the clock within two days. ¹

The navy has recognized the threat posed by the proliferation of submarines in the third world...

The loss of a single capital vessel would have serious consequences in any show-of-force operation by the U. S. Navy...the sinking of a U. S. capital ship would have precisely the same effect on the U. S. national will as the bombing of the marine billeting area in Lebanon did in 1983...²

¹Rear Admiral W. L. Vincent, USN, "MPA-Responses to Changing Threats," Maritime Patrol Aviation, March 1992. Page 36.

²Representative Dave McCurdy (D-OK), "The Way Ahead," U. S. Naval Institute Proceedings, September 1991. Page 18-23.

CHAPTER I

INTRODUCTION

On December 25, 1991, when the "Hammer and Sickle" was retired from over the Kremlin for the last time, the world entered a new era of uncertainty and adjustment to life with only one superpower. For the United States this required defining our role in "The New World Order" as well as an overhaul of our national goals and objectives, economic, political and military strategies. With a growing budget deficit, defense expenditures quickly became a highly vulnerable target for other national programs competing for scarce resources. Within DOD, the services were forced to face tough decisions concerning traditional missions versus interoperability, force structure, personnel level adjustments, and equipment procurement. Additionally, the Total Force concept required new emphasis to ensure the most cost effective use of both the active and reserve components.

The National Military Strategy (NMS) established the guidance for how future military resources would be distributed. Based on the four pillars of *forward presence, crisis response, strategic deterrence, and reconstitution*, the

iterative process of designing the post-Cold War military is ongoing.

The Secretary of the Navy has further refined the direction

for the Department of the Navy:

They {the U. S. Navy} will continue, however to be the strongest naval forces in the world, and they will do so by concentrating their resources on force quality and readiness--even over force structure....

As the likelihood of full mobilization decreases, the Naval Reserve is being reoriented and equipped for crisis response. In addition, naval reservists will make greater contributions to peace time operations and contingency support.¹

Within the context of the National Military Strategy and Secretary of the Navy guidance, it is the purpose of this research paper to examine the role of the Maritime Patrol Community (active and reserve) in the evolving force structure.

Methodology

In this chapter, we will establish the framework and methodology for our research.

In the chapter entitled "Roles and Missions Analysis," we analyze the traditional roles and missions of the MPA community for relevance to the current national military

¹H. Lawrence Garrett, III, Secretary of the Navy, et. al. Department of the Navy 1992 Posture Statement February-March, 1992.

strategy elements of forward presence and crisis response. Two elements of the national security strategy are purposely not discussed in this research paper. The first, strategic deterrence, is normally associated with strategic nuclear capabilities and therefore not relevant to the community, while the second, reconstitution is beyond the scope of our research.

Due to the unique versatility of the platform, a number of missions are discussed. In order to bound the scope of our research, missions such as cargo / personnel transport, signal intelligence (SIGINT), and weather research were reviewed and eliminated as too diverse for consideration.

The objective of the "Roles and Missions Analysis" chapter is to answer one of four primary research questions:

WHAT IS THE APPROPRIATE FUTURE MISSION MIX FOR THE MPA COMMUNITY WITHIN THE CONTEXT OF THE NATIONAL MILITARY STRATEGY?²

Our mission mix recommendation takes into consideration training requirements (the ability to train aircrews to an

²Ideally the MPA missions requirements and force levels would be determined based on the Unified Commander-in-Chiefs (CINCS) Integrated Priority List to the Joint Chiefs of Staff. Since the last input from the CINCs preceded the current NMS, we have derived the community missions in the section entitled "Roles and Missions" and the force levels from the section entitled "Case Study."

acceptable level of proficiency in multiple missions), and redundancy with similarly capable platforms.

Once the appropriate missions mix was established, we focused on the second primary research question in the chapter entitled "Aircraft Enhancements:"

WHAT AIRCRAFT ENHANCEMENTS ARE NECESSARY TO ACCOMPLISH THE PRESENT AND FUTURE MISSIONS?

It is clear that future military procurement will be budget constrained. In the final chapter, we will prioritize the need for the enhancements.

The third primary research question is:

WHAT IS THE ROLE OF RESERVE MPA WITHIN THE CONTEXT OF THE NATIONAL MILITARY STRATEGY?

In order to address this question, we developed two regional crises scenarios (in chapter VII, entitled "Case Study-Two Medium Regional Conflict Scenarios") to predict the Unified CINCs' total MPA wartime mission and force level requirements. These scenarios, based on regional crises in Korea and Southwest Asia, were taken from the 1991 Naval War College Global War Games.³ At this juncture it was necessary

³New York Times. 17, 23 February 1992, In a report of seven Pentagon derived scenarios, both scenarios used in this study appeared as a possible simultaneous occurrences. Likewise, in the February 23rd edition, Representative Les Aspin reports that his staff also considered these scenarios as a part of an

to establish the relative costs of active and reserve squadrons and to discuss availability issues of reserve squadrons.

To address the cost issue, we reviewed two studies specifically on the subject of active and reserve MPA relative costs. This discussion was followed by an analysis of the reserve MPA community's ability to contribute to the forward presence and crisis response elements of the national military strategy. Since our nation is normally in a peace time condition, a discussion of reserve MPA ability to provide contributory support for peace time operations was addressed as a major factor for cost considerations.

We then constructed a model that compared the existing force mix proposals, including some from within the Department of the Navy, JCS, and the political position of Congress to our prediction for the CINCs' wartime requirements (derived from the Two Medium Regional Crises Scenarios case studies). Each proposal was analyzed for the relative costs, wartime risks, the ability to contribute to the peace time mission (forward presence), and sustainability of reserve manpower.⁴ This synthesis enabled us to answer the question of reserve

independent study.

⁴By sustainability of reserve manpower, we mean the degree to which each proposal provides a flow of NAVETs (fleet trained MPA personnel) to the Reserve from the active component due to normal attrition.

MPA's role in the national military strategy.

Our final primary research question was:

WHAT IS THE APPROPRIATE FLEET TO RESERVE SQUADRON RATIO TO ENSURE ADEQUATE RESERVE MPA MANNING?

Sufficient empirical data is not available to accurately derive a ratio of active / reserve MPA squadrons to ensure an adequate flow of NAVETs to the VP reserve force squadrons (RESFORONS). Based on historical reserve retention rates, we developed a model of a mid-grade (MPA pilot / NFO) NAVET lieutenant's progression to Commander (O-5) in a RESFORON to predict manning shortfalls in MPA RESFORONS .

CHAPTER II

BACKGROUND

The history of the Maritime Patrol Aviation community (MPA) pre-dates the P3 Orion platform by more than 40 years. Although the community's mission has included surface surveillance, mining, search and rescue (SAR), and anti-surface warfare (ASUW), the P3 has been normally associated with anti-submarine warfare (ASW) and its Cold War mission of tracking Soviet ballistic and fast attack submarines. Introduced into the fleet in 1962 as a replacement for the Lockheed P2 Neptune, the P3 was specifically designed as a multi-mission aircraft adaptable to modular electronic modifications enabling it to keep pace with technological advancements necessary for varied platform missions. To be sure, countering the rapidly emerging Soviet submarine threat was of the utmost concern at the platform's inception. To date, the original platform design has housed eight generations of modular ASW improvements with a ninth, the Update IV, pending funding decisions.

Over the years, the community and platform played a key

role in the defense against the Soviet strategic SSBN fleet and was a highly valued asset working in concert with other platforms for defense of the CVBGs against the potent Soviet attack submarine fleet. The community's success in the ASW arena became the MPA community trademark often overshadowing the numerous contributions in the surveillance and ASUW missions. Although unheralded, the P-3 platform was indispensable in numerous crises/conflicts over the last three decades in the more traditional maritime patrol role.

It is premature to dismiss or even diminish the ASW role of the platform. Although the threat from the Commonwealth of Independent States (CIS) appears relatively benign compared to the Soviet threat of the last 40 years, the ballistic and fast attack fleets still exist (though likely in a lower state of readiness) and represent a potential threat under a more belligerent evolution of the new government or if transferred in a "guns for butter" trade to unpredictable nations such as Libya, Iran or Iraq. Until final disposition of the hardware is determined, the fast attack fleet remains the most serious threat to US maritime forces operating world wide. The SSBN force remains the most versatile strategic option available for either first strike or counterstrike capability by the CIS and will likely be one of the last cards dealt away in arms negotiations. The CIS submarine capability notwithstanding, at least 41 countries currently possess at least 408

submarines⁵ including China's SSBN capability.⁶

The following quote summarizes the dangers posed by two diesel/electric submarines to a surface battle group during a regional conflict (Falkland War):

...we had a 'probable submarine' on the loose, in the middle of the group, in pitch black conditions, with no navigation lights, burning, and with ships all over the place...it was nothing short of a melee...⁷

The British experience with shallow water submarine threats during the Falkland War should cause us to consider the sobering possibilities of how one diesel submarine in Iraq's possession could have affected our maritime operations during the Gulf War.

Active MPA Component

Until 1990, the active MPA component consisted of 24 squadrons comprised of approximately 350 people and nine aircraft each. Deploying to various overseas sites, active squadrons would be under the operational control of the various numbered fleet commanders for approximately six months in support of theater operations.

⁵J. Benedict, "Third World Submarines and ASW Implication," (source of data-OP-714, ASW Plans brief, 9 January 1992)

⁶J. R. Hill, Anti-Submarine Warfare (U. S. Second Edition, Annapolis MY, U. S. Naval Institute Press, 1991). Page 41-42.

⁷Admiral Sandy Woodward, RN, One Hundred Days (Naval Institute Press, 118 Maryland Avenue, Annapolis, MD), 1992. Page 105.

Recent budget cuts eliminated six active squadrons and reduced the primary aircraft allowance per squadron (PAA) to eight. The proposed FY 93 budget will eliminate four reserve squadrons in addition to closing a VP home site, NAS Moffett Field, and VP deployed site, NAS Cubi Point, RP. Table I shows the DON proposed realignment following execution of the FY 93 budget.

TABLE I

PROPOSED DON FY 93 ACTIVE MPA FORCE LOCATION

<u>Jacksonville, Fl</u>	<u>Brunswick, Me</u>	<u>Barbers Pt, Hi.</u>
6 Sqdns-P3C III and FRS ⁸	6 Sqdns-P3C II.5	6 Sqdns-P3C III

Throughout the community's history, the active MPA has been a responsive, flexible, and inexpensive method of filling forward presence requirements when compared to surface alternatives. In a matter of hours, our nation can demonstrate resolve and provide moral support for an ally through deployment of P3 assets worldwide. In addition to maintaining a large, longstanding presence in such strategic areas as Japan and Europe, MPA has routinely been used to "show the flag" in numerous countries around the world.

⁸ Data source: OP-503C brief(March 1992). Assumes a final active force level of 18 active squadrons. FRS is the fleet replacement squadron.

Recently, the Secretary of the Navy stressed the importance of multi-national exercises to forward presence.

Friendly and cooperative ties with naval services of other countries have long been a source of diplomatic and operational benefit...1991 was no exception. Navy ships and Marine Corps units participated in 288 exercises involving 60 countries around the world. As navies become smaller and international security interests become more integrated, such exercises are likely to become even more important.

MPA participates in virtually all maritime, multi-national exercises including Team Spirit, RIMPAC, UNITAS, NATO and numerous lesser exercises.

The ability of the active MPA community to respond to a crisis is well established. By strategic forward deployed basing and availability of ready alert crews, there are very few places on the globe that cannot be reached by a P3 within hours. For example, among the more recent crises over the last three decades that involved the MPA community, P3 aircraft were used extensively during the KAL-007 incident as well as to track the Soviet Yankee class submarine that eventually sank due to a reactor casualty.

The aggregate of the proposed active MPA cutbacks of between 25% and 50%, will profoundly affect the traditional active force deployment methods. The typical six month full-squadron deployment cycle to six forward deployed sites, has been mostly replaced by rotating detachments. This adjustment

⁹H. Garrett, et. al., Department of the Navy 1992 Posture Statement, 10

was made due to funding constraints, reduced operational tempo (OPTEMPO), and a desire to maintain a reasonable personnel tempo (PERSTEMPO). This trend will make it difficult for the active MPA component to contribute the same level of forward presence and crisis response in the future.

Reserve MPA Component

Reserve MPA squadrons were established in 1970 to create a trained, viable force for mobilization to augment the active component in a global war with the Soviet Union. Consisting of thirteen VP RESFORONS (reserve squadrons) located throughout the country for demographic as well as political considerations, (see illustration 1), each RESFORON was designed to be a mirror image of an active VP squadron.

ILLUSTRATION I

RESERVE VP SQUADRON LOCATION

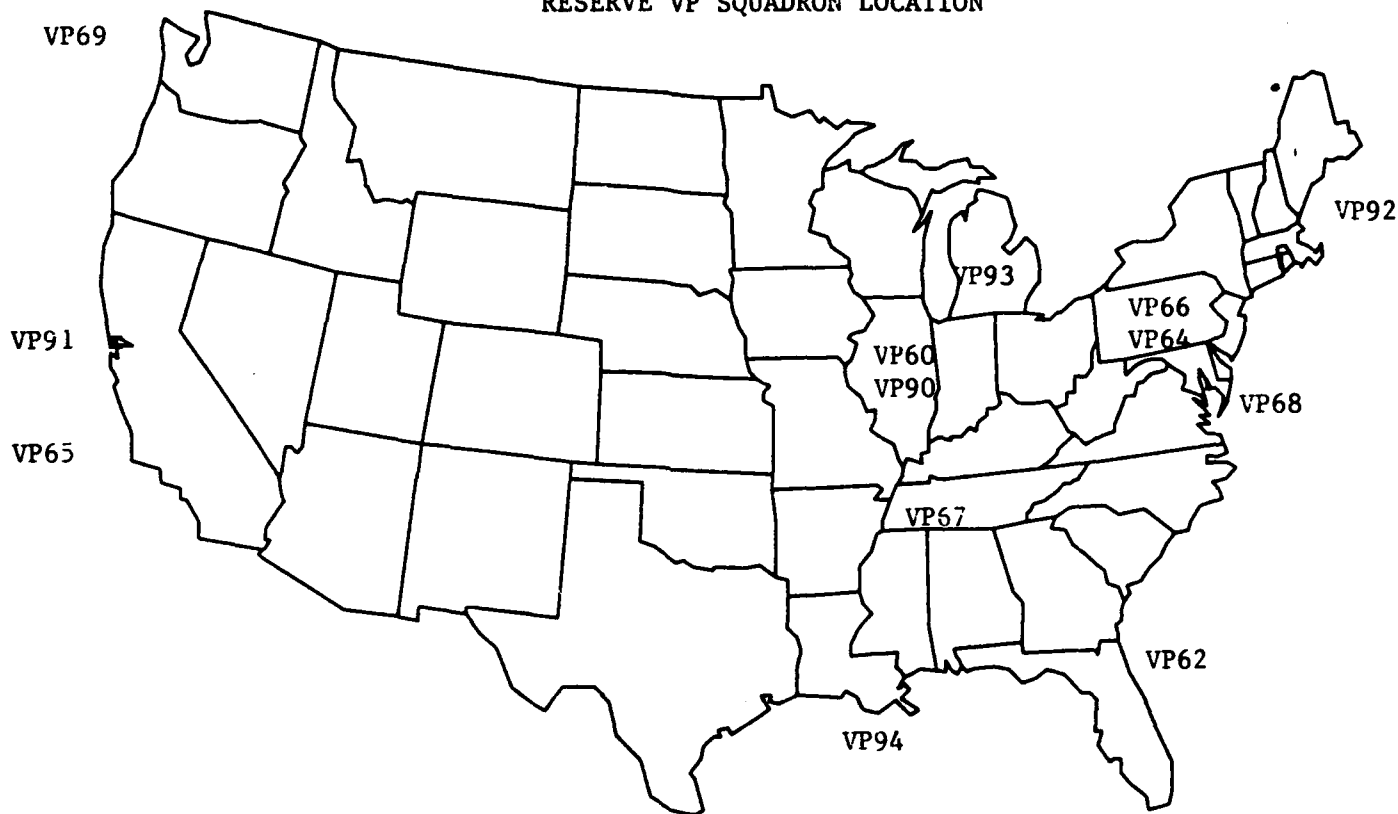

Initially operating the P2V, all RESFORONS ultimately transitioned to the version of the P3 they operate today as shown in Table II

TABLE II

P3 MODELS FLOWN BY RESFORONS TODAY

<u>P3B (Mod)</u>	<u>P3C</u>	<u>I</u>	<u>P3C II</u>	<u>P3C III</u>
8 SQDNS	1 SQND	1 SQND	1 SQND	2 SQDNS ¹⁰

¹⁰ Data source: brief from OP-505I (March 1992).

RESFORON manning closely resembles an active squadron when fully mobilized. However, RESFORONS are manned with only 115 (average) full time personnel (TARS), the balance being drilling Selected Reservists. Traditionally, each RESFORON conducted their required annual training periods (AT) for one month each year, usually at the same locations as the forward deployed active squadrons. The primary purpose of these training periods was to upgrade their readiness for mobilization by gaining ASW related qualifications. Although contributory support of fleet operations was not the primary focus of these training periods, it was routinely provided and coincidental with training missions.

Since most reserve aircrewmembers are previously fleet qualified, Reserve aircrews on the average enjoy a significant experience advantage. With few exceptions, reserve pilots have completed at least one active MPA tour and a high percentage have furthered their overall aviation skills in their civilian employment with an airline. It is not unusual for a Reserve pilot to have twice as many P3 flight hours as his active counterpart. Reserve crewmembers previously qualified in the same version of the P3 in the fleet, can be re-qualified in a relatively short time whereas an active crewmember may require initially up to two of the normal three year tour to qualify in position. Reserve aircrews normally fly together for longer periods of time (sometimes for 8-10 years) than active duty

aircrews (at the most three years) leading to increased crew stability, and ASW expertise. Despite this, tactical crew proficiency is always a challenge facing Reserve aircrews.

While Reserve MPA assets have always supported the fleet their role in the NMS has recently been questioned. Their AT periods and ADT opportunities make them quite suitable for a forward presence role as in the past. In a crisis response short of a PCSR, the Reserves have a limited capacity to respond. Later in this paper, we present a solution to this concern.

CHAPTER III

CINC MPA MISSION REQUIREMENTS

Periodically, the CINCs submit a fiscally unconstrained wish list to the JCS staff of mission and force level warfare requirements for review.¹¹ This list is designed to give them the resources to accomplish their OPLANS as well as cover other responsibilities in their AOR. JCS prioritizes the various lists with regard to a fixed budget and tasks the service chiefs with providing the various resources. This list then becomes a factor driving the respective service's POM. In summary, the CINC determine the mission and force level requirements while the service chiefs provide the mission capability and resolve such issues as OPS TEMPO and PERS TEMPO.

The most current CINC MPA requirements were submitted in 1990 when USCINCPAC requested 10 VP squadrons to cover their AOR needs. This was prior to publication of the current national military strategy which changed from global to

¹¹. Integrated Priority List (IPL) - primary means for the CINCs to identify their highest priority needs to CJCS and SECDEF.

regional in scope. CINC MPA mission requirements for regional crises and peacetime operations under current NMS are unknown.

In the absence of definitive CINC requirements, JCS and DON have developed their own positions that are discussed in later chapters.

For the purpose of this research paper, we have developed the required MPA missions, force level requirements and active / reserve mix in later chapters based on a case study involving a two medium regional crises scenario.

IV. ROLES AND MISSIONS ANALYSIS

How can the MPA community contribute to the forward presence element of the national military strategy? As defined in the 1992 DON Posture statement,

Forward presence is the visible presence of United States military forces in regions vital to national interests and is key to averting crisis, preventing wars, and demonstrating American participation in global affairs. United States forces deployed overseas show American commitment, lend weight to its alliances, enhance regional stability, and provide a rapid crisis-response capability. They also provide a means of friendly, nation-to-nation contact and promote United States influence and access. Naval forces have long been a natural means of forward presence, and they will become even more important in that role as the Nation reduces the number of its permanent overseas bases.¹²

The amount of forward presence desired may vary from a complete carrier battle group to a single aircraft or surface ship depending on circumstances. The P3 aircraft has been used extremely effectively in this role through normal deployments and minor detachments as routine participants in virtually all major exercises such as Team Spirit, UNITAS, PACEX, RIMPAC, NATO and other fleet exercises. They have frequently been employed to provide responsive, inexpensive

¹²Garrett, et.al., Department of the Navy 1992 Posture Statement. Page 4-5.

(single aircraft as compared to a single surface ship) forward presence even in the absence of a pressing mission. Examples of this are UNITAS (an annual South American exercise), periodic flights to the Mariana Islands, Micronesia, Australia and African coastal countries where the mere presence of an aircraft and aircrew produces the desired presence defined above.

The utility of this relatively inexpensive means of forward presence has not been lost on other countries with smaller navies. Table III suggests that foreign countries with smaller defense budgets and military forces recognize the P3 as a cost effective, forward presence multiplier, as well as a versatile, multi-mission platform.

TABLE III
COUNTRIES POSSESSING P3s

<u>CURRENTLY POSSESSING P-3</u>		<u>CONTEMPLATING P3 PURCHASES</u>	
Canada	New Zealand	Germany	United Kingdom
Portugal	Iran		
Spain	South Korea		
Australia	Japan		
Netherlands	Norway		

With the drawdown of the surface navy to the base force

of less than 450 ships, it may be economically advantageous to apportion a larger share of the forward presence role to the MPA community.

Does the MPA community contribute to the crisis response element of the National Military Strategy? As defined in the 1992 DON Posture Statement,

Crisis Response- ...the {ability} to respond to crises as they occur, with the goal of deterring conflicts or-if necessary-resolving them by force.¹³

The MPA community is a proven tool in numerous crises. Included in these operations were: the 1961 Berlin crisis¹⁴, the Cuban Missile crisis in 1962, Market Time patrols in southeast Asia during the Vietnam War, and rescue of the Vietnamese "boat people" after the fall of Saigon.

Of particular note was the employment of maritime patrol assets in the 1991 Gulf War (including two Reserve P3 crews voluntarily recalled to active duty). The first U. S. forces on the scene, MPA assets were responsible for 53 of the 103

¹³Garrett, et. al., Department of the Navy 1992 Posture Statement. Page 5.

¹⁴During this crisis, five VP squadrons were recalled to active duty for patrol of the Caribbean. James L. Lacy, Naval Reserve Forces: The Historical Experience With Involuntary Recalls, (Center For Naval Analyses, 4401 Ford Avenue, Alexandria, Virginia 22302-0268), April 1986.

Iraqi vessels destroyed or disabled during the conflict. Over 9500 hours and 950 sorties were flown by MPA assets in support of the war during which over 6300 ships were intercepted.¹⁵ P3 crews are still operating in the Gulf today as part of the effort to enforce the post-War settlement.

WHAT ARE THE APPROPRIATE FUTURE MISSIONS FOR THE MPA COMMUNITY WITHIN THE CONTEXT OF THE NEW NATIONAL MILITARY STRATEGY?

The remainder of this section is dedicated to analyzing the a variety of present and proposed future missions of the MPA community. Consideration has been given where appropriate to redundancy with other platforms' capabilities. Much of the discussion below is based on interviews with MPA leaders and other experts within the community.

Anti-Surface Warfare (ASUW) MPA Mission

The ASUW mission of the P3 has been growing in importance over the past decade. The community has responded to the growing demands for ASUW services by the CVBGs (and to some extent the ARGs) by providing increased surveillance, OTH-T, ISAR imaging, C3I and strike coordination. The Harpoon

¹⁵Rear Admiral W. L. Vincent, USN, "MPA-Responses to Changing Threats," Maritime Patrol Aviation, March 1992. Page 35-38.

missile also gives the P3 an ASUW capability that can extend the Task Group's defense zone. In our research, we could find no aircraft in the Navy or Air Force inventory that combines the range, speed and endurance with the integrated sensor package and weapons delivery capabilities into one platform as effectively as the P3. As noted in the quote by Rear Admiral W. L. Vincent in the epigraph of this paper, MPA clearly passed the test in the Gulf War. Rear Admiral Vincent went on to say:

...over the past 15 years, the Navy has played a major role in 77 incidents. Of these, carriers have participated in 55 and MPA in 53. Of these 53 incidents in which MPA forces played significant roles, missions spanned the spectrum of P3 capabilities including fleet support, independent search and surveillance, combat SAR and independent ASW. The following breakdown applies:¹⁶

Fleet Support.....	68%
Independent Search and Surveillance.....	25%
Independent ASW.....	2%
Combat SAR.....	4%

...Looking at fleet support, we see the following:¹⁷

ASW.....	50%	ASUW.....	94%
----------	-----	-----------	-----

The above data highlights two important points central to this analysis:

(1) That MPA is normally involved in the same crises as

¹⁶ William L. Vincent, RADM, USN. "MPA Responses to Changing Threats". Maritime Patrol Aviation Magazine, March 1992. Page 36.

¹⁷ Ibid. Page 35, 36. RADM Vincent explains that the numbers do not total 100% because numerous missions were tasked for both ASW and ASUW. In our opinion this underscores the multi-mission role and versatility expected from this platform.

the CVBGs.

(2) That fleet support missions frequently require both ASW and ASUW capabilities and that they are complementary rather than mutually exclusive. The two missions are likely to remain inter-related as the third world ASW threat continues to grow along with the increased need for ASUW.

Surface Surveillance Mission of the P3

The need to patrol the worlds oceans may be higher now than during the Cold War. Proliferation of nuclear and other weapons of mass destruction, the war on drugs and the enforcement of economic sanctions with embargoes will require an ability to locate and track vessels of interest over an extended period of time. A recent article by Rear Admiral Maness, Commander Patrol Wings Pacific written for MPA magazine, describes

..."surveillance as a fundamental requirement of maritime operations, and no platform in the Navy meets that requirement better than maritime patrol aircraft. The inherent range, endurance, and search rate of the P3 aircraft, further enhanced by ISAR, Global Positioning System navigation accuracy, and satellite data transmission, provide a powerful surveillance, Anti-Surface Warfare, targeting, and command - control, communications and intelligence(C3I) force multiplier. "¹⁸

With skill requirements similar to those necessary for the

¹⁸ Maness, Anthony, R. "The US Navy Maritime Patrol Force in the Pacific". Bridgetown, March 1992. Page 9.

ASUW mission, MPA has an will continue to be the "eyes and ears" of the fleet. Open ocean search and rescue (SAR) is the logical extension of surveillance and is a common mission for the community. The SAR mission has repeatedly been an instrument of international good will and humanitarian service. Because this platform can reach an assigned area quickly, search large portions of ocean and operate independently, the P3 can effectively project a forward presence or react to a crisis response requirement. Addition of "Cluster Ranger", the long range, electro-optical, digitally integrated video system, will provide real time monitoring to a remotely located CTF, thereby bringing another vital dimension to this important mission.

Anti-Submarine Warfare (ASW)

Is there still a submarine threat,¹⁹ and if so, what role should the MPA community play in the ASW mission?

A common view shared by many within and out of the Navy, is that the submarine threat disappeared with the Soviet

¹⁹The mere possession of hardware documented in this discussion does not constitute a "threat." Submarine crew training, material readiness, and hostile intent must also be present before a bonafide threat exists. Some countries possessing submarines are combat capable, some are not. We assume that purchase of hardware indicates an intent to become combat capable. Since political will and intent change frequently, threat, for the purpose of this research paper, is defined by the existence of hardware with the intent to become combat capable.

Union. While there is considerable evidence to support a shift in emphasis from blue water to shallow water ASW, we will provide evidence that conventional submarine proliferation is a major concern for power projection naval forces operating world wide.

The Third World / Shallow Water Submarine Threat

Our research on the emerging third world / shallow water submarine threat has shown widespread concern over submarine proliferation. The following quotations serve to illustrate our point. The first is from a high ranking Russian official:

...it would not be wise to withdraw from the market we have cornered. After all, arms trade is a highly profitable business...many state-run producers are craving orders, and believe they will be able to solve their problems by selling off their military products.²⁰

In December 1991, "Jane's Defence Weekly" made the following report concerning Iran's plans to buy submarines:

Iranian plans to buy three Soviet class diesel-electric submarines may be delayed by the upheavals in the Soviet Union and the consequences for its submarine building

²⁰Vladimir Shibayev, Russian Deputy Chairman of Government Committee for foreign relations, February 17, 1992.

programmes...

The Iranian programme deeply concerns U. S. military officials, despite any delays.

The official says that an Iranian submarine crew is currently undergoing training at a "Kilo" facility in Riga, Latvia, an indication of Iranian interest in going forward with the purchase.

According to Iranian press reports analyzed by US intelligence, the "Kilos" will be stationed at the Iranian naval base at Chah Bahar along the Gulf of Oman.

This would give Iran a submarine capability to monitor the Strait of Hormuz and all traffic moving into the Gulf.

Admiral Shamkhai, the Iranian naval chief, recently said his naval forces will extend their activities into international waters through submarine deployments. The USA expects to encounter increased "Kilo" exports as the Soviets look to generate essential hard currency, said the Pentagon official.²¹

In a recent testimony to the House Armed Services Committee, the Director of Naval Intelligence made this comment concerning the torpedo capability of third world submarines:

The third world torpedo threat will increase as advanced technologies are developed, applied, and exported by the major powers...

²¹Barbara Starr, Jane's Defence Weekly, December 23, 1991.

The widespread application of wake-homing torpedoes could create a significant threat to U. S. surface ships.²²

The Secretary of the Navy has likewise expressed his concern for the growing third world submarine threat:

...the proliferation of submarine technology in the third world adds a new challenge. We will have to counter quiet, modern non-nuclear submarines in shallow and littoral waters to support power projection operations. It will be one of our toughest problems in the future.²³

Perhaps the threat was best summarized by Representative Dave McCurdy:

The navy has recognized the threat posed by the proliferation of submarines in the third world... The loss of a single capital vessel would have serious consequences in any show-of-force operation by the U. S. Navy...the sinking of a U. S. capital ship would have precisely the same effect on the U. S. national will as the bombing of the marine billeting area in Lebanon did in 1983...²⁴

Our conversations with CINCLANTFLT staff confirmed their concern for the third world submarine threat.²⁵ Illustrations

²²Director of Naval Intelligence, statement to House Armed Services Committee, March 7, 1991.

²³H. L. Garrett, Secretary of the Navy, et. al., Department of the Navy 1991 Posture Statement, February 1991.

²⁴Representative Dave McCurdy (D-OK), "The Way Ahead," U. S. Naval Institute Proceedings, September 1991. Page 18-23.

²⁵Concern expressed by CTF 84 staff in conversation on May 14, 1992.

2 and 3 summarize the third world/shallow water ASW threat.²⁶

For those interested in a more detailed explanation of the third world submarine threat, please refer to Appendix I.

ILLUSTRATION 2

PROLIFERATION OF SUBMARINES IN THE THIRD WORLD

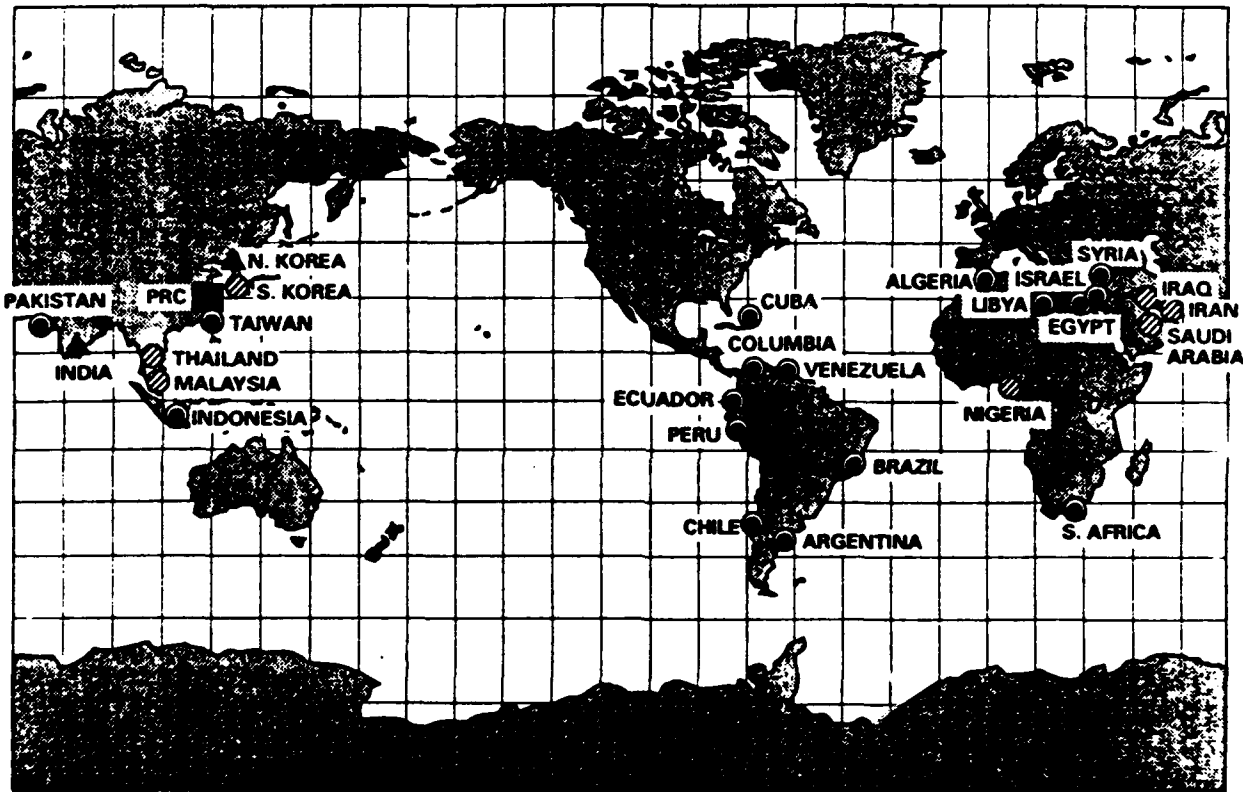

■ > 30 OPERATIONAL SUBMARINES

▲ > 15 OPERATIONAL SUBMARINES

● ≤ 10 OPERATIONAL SUBMARINES

⊘ NO OPERATIONAL SUBS BUT ORDERS HAVE BEEN MADE OR ARE BEING CONSIDERED

UNCLASSIFIED

SOURCE: JANE'S FIGHTING SHIPS

900175A.UK

²⁶Illustrations 2 and 3 are reproduced from viewgraphs taken from an OP-714 brief. For readers interested in a more detailed analysis of the third world submarine threat, Appendix I contains other unclassified viewgraphs from the same brief.

ILLUSTRATION 3

UNCLASSIFIED

PROLIFERATION OF MODERN SUBMARINES INTO 3RD WORLD ARSENALS

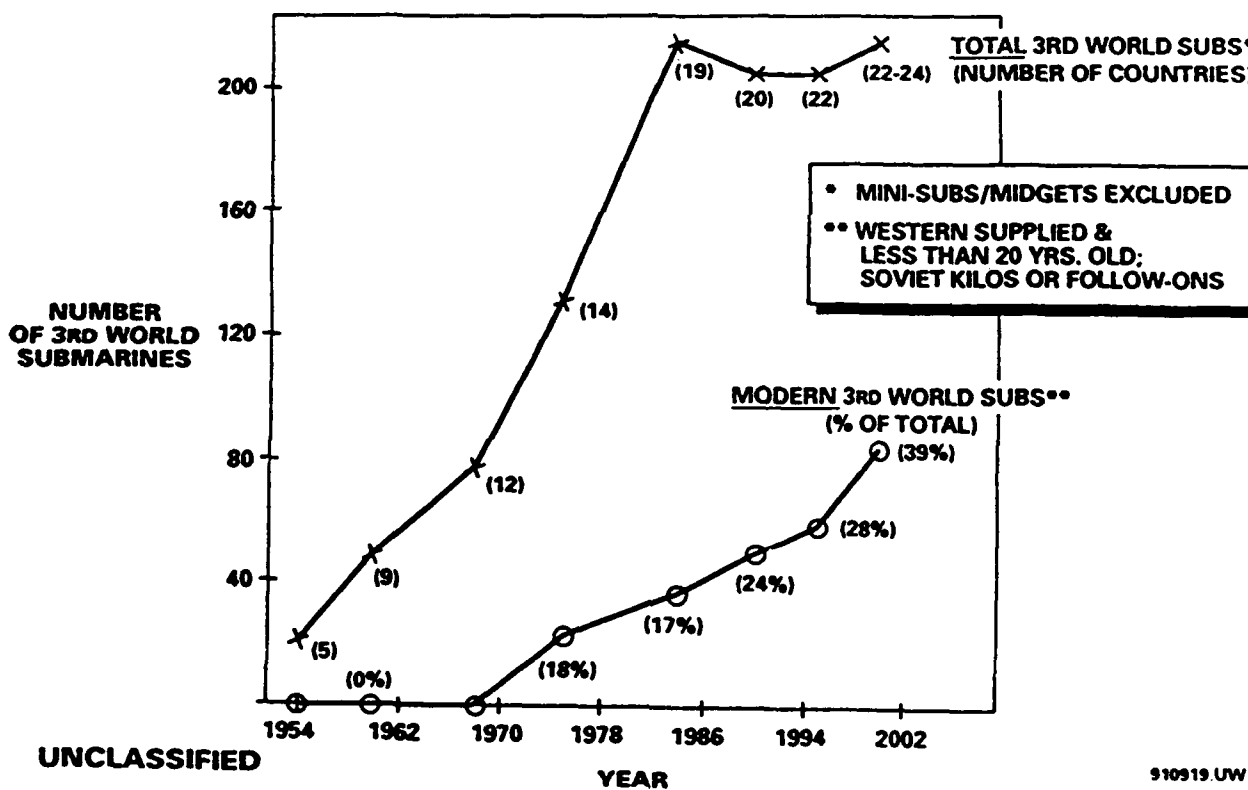

The CIS Submarine Threat

The most recent version of Jane's Fighting Ships shows the CIS still in possession of 328 submarines. Table IV lists the numbers of the various types of submarines.

TABLE IV
SUMMARY OF CIS SUBMARINES

	<u>SSBN</u>	<u>SSGN</u>	<u>SSN</u>	<u>SS</u>	<u>Aux</u>
Flt/Res	63	50	81	120	14
Building	4		12	5	0 ²⁷

Although the threat from the CIS appears relatively benign compared to the Soviet threat of the last 40 years, Table IV shows that the hardware capability still exists, though likely in a lower state of readiness.

Lifecycle studies of the remaining CIS submarine inventory, clearly indicate that a significant number of all categories of CIS submarines will remain operational through 2010 even in the absence of further construction programs.²⁸

²⁷Jane's Fighting Ships, Ninety-third edition, 1990-1991, (Jane's Information Group, 163 Brighton Road, Coulsdor, Surrey, CR 5 2NH, U.K.). Page 578-597.

²⁸ Data Source: brief from OP-714 (March 1992).

Illustration 4 is an estimate of the emergence of the next global threat based on a 20 year historic cycle.²⁹ Under certain political and economic conditions, a global threat could easily emerge from a nation with an existing blue water fleet.

ILLUSTRATION 4

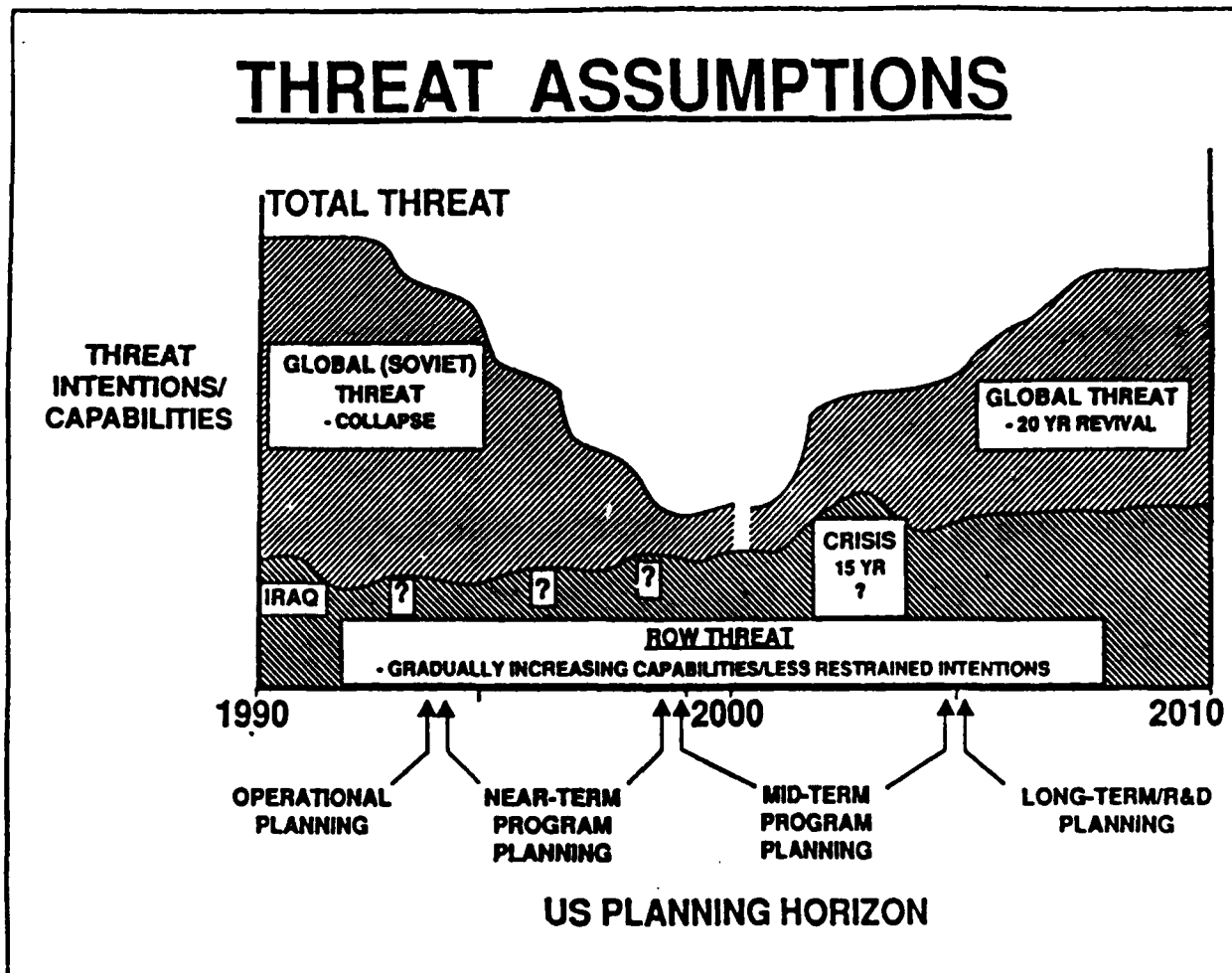

ONI CINCS BRIEF 10/91 - 36

²⁹ Data source: Director of Naval Intelligence brief to Unified CINCS October 1991 (slide 36).

Should an ASW capability be retained in the patrol community? Compared to other ASW air platforms (S3 and helicopters), the P3 has greater range and endurance, and has a speed advantage over all platforms except the S3. Compared to surface and submarine ASW platforms, the P3 has an obvious speed and range advantage. Since the P3 operates independent of the carrier, it is capable of reaching the operating area well in advance of the surface task force. This may be crucial to early ASW and surveillance sanitation efforts and protection of the task force especially when the P3 is the only available ASW platform. Such may be the case for an amphibious readiness group.

Besides being forward based, the P3 like all other airborne platforms, requires CAP when operating against an adversary with AAW capability.

Today's submarine threat is one of higher risks but lower stakes compared to the Cold War era, as the threat is primarily to naval forces rather than to the nation as a whole. Is a potentially hostile submarine operating within a battle group AOR an unacceptable risk?

We believe the Navy's ASW emphasis should shift from a blue water to shallow water focus and that maintaining the

mission in the MPA community is an essential element of the overall anti-submarine warfare effort.

Refueling Initiatives for the P3 (Give and Take)

The CVBG faces a critical shortage of organic refueling assets. With the KA-6B aircraft approaching the end of its

service life and no scheduled replacement, the S3B aircraft is now required to use almost half of its allotted flight time for refueling. This situation will only worsen as the KA-6B retires. Recently, OP-503C (the CNO P3C program manager) proposed a plan to help alleviate this problem. He conducted a feasibility study to equip the P3 with a give and take refueling capability that could add a tanking role to present and future P3s. The design calls for a give capacity of approximately 20,000 pounds of fuel through use of the center tank (tank five) and two buddy stores refueling packages.³⁰

Throughout the MPA community there is a widespread interest and a host of opinions on the topic of P3 tanking. At the recent VP Symposium (April, 1992), MPA involvement in this mission received the cautious support of a majority of senior community leaders including several flag officers in attendance.

The issue should be carefully explored due to the implications for both the MPA community and the CVBG. Several questions must be addressed.

(1) What are the implications of CVBG reliance on land based refueling assets?

Our discussions with senior TACAIR representatives³¹

³⁰ Source of data: OP-503C (March, 1992).

³¹ Data source: Proposals were discussed with senior NWC TACAIR personnel, most of whom were former A-6 and F/A-18 commanding officers and who flew numerous missions in the Gulf

indicate that they will use the P3 for tanking whenever it is available. The 20,000 lb capability is equal to approximately two S3Bs.

(2) Will the P3's primary missions of ASUW and ASW become subservient to tanking?

Although some multi-mission roles were discussed, in the opinion of our TACAIR representatives, the P3 community should be concerned about being used primarily as a refueler in exercises and normal CVBG support missions at the expense of ASUW and or ASW. In our opinion, this would result in a gross under utilization of a highly capable aircraft.

(3) How useful will the system be as an adjunct refueling asset for the carrier with only a 20,000 lb give capability? Should the P3's fueling system be modified to give fuel from the wing tanks also?

The issue is whether or we should limit our give capability to 20,000 lbs or modify the system to allow fueling from the wing tanks. Allowing fuel to be given from the wing tanks could present a fuel management problem to a relatively inexperienced plane commander leading to a fuel starvation incident. Our opinion is that this possibility could be countered with proper training and planning. Limiting the give capability to 20,000 lbs may artificially constrain the CVBG commander at a crucial time. As shown in Appendix II, a

War.

typical small strike package will require far more than a 20,000 lb refuel capability.

(4) What alternatives should be considered?

We believe there are three options worth exploring:

(a) Retrofit the plumbing for all or some P3C/P3B aircraft for the refuel mission and preposition the "buddy store"³² delivery systems to the forward deployed VP sites.

(b) Retrofit new production aircraft only (ie. Orion II) with the refueling modification and preposition the "buddy" stores delivery systems to the forward deployed VP sites.

(c) Retrofit and modify six to ten older P3Bs or P3Cs (after a SRP or SLEP as appropriate) into tanker only aircraft. These aircraft would be assigned to the forward deployed sites to be operated and maintained by the deployed squadron. This may be a cost effective and efficient use of older airframes and prevent underutilization of the P3's full mission capabilities.

Realistically, the P3 cannot replace the KA-6B, nor do we believe this desirable. At best, it can provide an adjunct tanker during a strike or provide a limited amount of fuel while performing other CVBG tasking.

The other half of the fueling equation concerns the

³² A "buddy store" is a self contained fueling pod that fits under an aircraft wing. It contains the hosing, pumps and equipment needed to transfer fuel from the refueling aircraft.

ability of the P3 to "take" fuel. This opens up a realm of options from longer on station times to an increased "give" capability for strike refueling. The P3 has been tested with a fueling probe and plans exist for a receiver type station similar to the Air Force³³ (see appendix II). Our primary concerns with this options are:

- (a) crew fatigue and reduced effectiveness from the additional on station time.
- (b) maintaining proficiency in the "receiving" mode of refueling.

Carrier Battle Group Support (CVBG) Mission of the P3

The P3 is unique in its numerous mission capabilities, long range and endurance. While other aircraft have similar capabilities, none of them can combine capabilities and performance of the P3 to coordinate, as well as perform the ASW and ASUW missions. This is particularly important when operating in support of a CVBG. The P3 can operate through numerous carrier launch and recovery cycles, effectively extending the CVBG's defense zone and strike range. Enhancements such as increased ISAR capabilities and SATCOMM could make the P3 an even more valuable asset to the CVBG.

³³ Data Source: OP-503C brief (March 1992).

Amphibious Readiness Group Support

As the number of CVBGs and SSNs decline, our ability to protect the Amphibious Readiness Group (ARG) in the traditional manner will diminish. In regional crisis scenarios or Near Expeditionary Operations (similar to the recent Somalia extraction), the ARGs may face third world submarines and or fast boats in littoral waters. MPA assets may be an alternative means of ASW and ASUW sanitation in the absence of a CVBG. The P3's range and endurance would enable it to protect far ahead of the ARG. Adaptation of CVBG support tactics would require little modification to be applicable to this new mission. In addition, the P3 could easily serve as an alternate means of SOF insertion in certain circumstances (ie. non-hostile AAW environment). A long range electro-optical camera system (discussed in a later chapter) could provide the ARG commander a real time video display of the operation - a level of support previously unattainable.

THE COUNTER NARCOTICS MISSION OF THE P3

Named as the lead agency for the Drug Interdiction mission, DOD has been actively involved in this mission since the establishment of the Vice President's South Florida Drug Interdiction Task Force in 1982. MPA (active and reserve) has been an active participant along with other communities since 1982, and during the past four years has flown over

71,500 flight hours in support of this mission.³⁴ Operations include coordination with Commanders Joint Task Force Four and Five, the US Coast Guard, the US Customs Service and the Drug Enforcement Agency throughout the southern US and Caribbean areas.

Primarily a specialized surface surveillance mission, MPA easily adapted to the counter narcotics mission. Mission performance does not require a full ASW crew. However, the unoccupied acoustic operators often serve as additional visual observers to reduce fatigue. Due to the small size of many of the suspect vessels, the crew must often rely on visual search techniques in addition to the P3's radar to spot the targets. A deployed active squadron or Reserve detachment tasked with CN may experience a decrease in readiness for other missions following a lengthy deployment.

Key operational sites for counter narcotics operations include NS Roosevelt Roads, Howard AFB Panama, NAS Key West and southern California.

A recent CINCLANTFLT initiative to specialize a number of P3s for this mission is under study at this time and has been given the name POSSE HUNTER (to be discussed in a later chapter).

³⁴ Source of data: OP-0955E (April, 1992).

Mining

Although mining has been a relatively low priority mission for the P3, it is still a valid mission for the MPA community. While the P3 is not platform of choice of mining operations planners, the impending retirement of the B-52s and A-6s may require a revisit of the relative importance of this mission.³⁵

Traditionally, the mining mission has been divided into offensive and defensive mining.³⁶ However, when addressing the mining capabilities of the P3, it should be viewed in terms of the threat environment, ie. high or low.

The P3's mining role has been limited due to its vulnerability, replacement cost and risk to a relatively large aircrew. Other platforms could either carry more mines and / or deliver them faster with more maneuverability. In a high threat mining operation against a heavily defended (AAW) target, the P3's survivability would be unlikely. Therefore, we believe that use of the P3 for mining should be limited to low (AAW) threat environment.

As an alternative, an SSN or surface ship could covertly deliver more mines than a P3. However, if timing is a

³⁵ Data Source: conversations with Mining Plans staff at COMINWARCOM (May 1992).

³⁶ We define offensive mining as the use of mines to prevent an enemy from leaving a port or to deny him access to a key body of water. Defensive mining establishes a minefield through which the enemy must penetrate to conduct his attack.

consideration and surface or submarine assets are unavailable, aerial mining may be the only solution. With B-52 and A6-B retirements, the P3 as a mining platform will become more important.³⁷ Using GPS, navigational accuracy will improve significantly and may enhance the mining capability of the aircraft.

Use of the P3 in an ANTI - SCUD Mission

During the Gulf War, defense against the relatively unsophisticated Scud missile was a major concern for US forces. This primitive missile had no little or tactical value but proved to be a highly effective terrorist tool that occupied a considerable amount of US resources in the location and destruction of the launchers. The proliferation of variants of this weapon will likely pose an increased threat to US forces in future operations.

Post Gulf War experimentation was conducted at Strike Warfare School in Fallon, Nevada, using the P3 to detect and direct a strike against SCUD launchers with tactics similar to those used in ASW. Initial results show this to be a promising concept needing further evaluation. The operating concepts call for the P3 to standoff beyond enemy SAM range

³⁷ Data Source: conversations with Mining Plans staff, Commander Mine Warfare Command (April 1992).

during the search and localization phase.³⁸ Following localization, the aircraft would then direct tactical assets to neutralize the target or to use a discriminatory standoff weapon if developed at a later date.

Airborne Early Warning (AEW)

Should the MPA community adopt the AEW mission?

Currently, the E2C is the CVBG's only AEW aircraft designed to provide the CVBG with long range electronic warnings of all airborne and surface threats. As an asset organic to the carrier, the CVBG commander would naturally be reluctant to lose this in favor of a Navy or Air Force land based asset. However, as the E2C approaches the end of its engineered service life (ESL), there appears to be no plans to fund a replacement aircraft. As the alternatives are considered, the use of a land based asset must not be ruled out. For example, the use of a P3B that has undergone a Sustained Readiness Program (SRP) to extend its life, with an electronics modification and a rotodome addition could serve as a viable platform. If this alternative is chosen then the question is who should perform the mission. Performance of the AEW mission requires extensive, specialized skills that require

³⁸Tactics used in ASW acoustic search and localization closely resemble tactics required for SCUD search and localization as both can effectively use negative information (ie. where the adversary isn't) as well as positive indications of the adversary's location.

lengthy training. Integrating this mission with other MPA missions would dilute or degrade the aircrews' abilities in other areas.

Unique Capabilities VP Can Contribute to Joint Operations

What is unique to MPA that is beneficial to joint operations? In simplest terms, versatility and adaptability. Although other platforms possess the capability to perform most of the missions above, only the MPA community has the versatility to perform any of the above missions, or a specified mix of the above missions on any given sortie. Furthermore, the aircraft's unrefueled range, endurance and speed, enable the community to support power projection forces globally on short notice.

When the first production P3 entered service in 1962, it is unlikely that anyone envisioned the platform's capacity for adapting. It has housed technological advances ranging from the search light to the Infra-red detection system, the original APS-80 radar to the ISAR, and celestial navigation to GPS. Only the C-130, another 1950's vintage aircraft used primarily for cargo, approaches the inherent adaptability of the P-3. While today we confront threats such as the third world submarine and SCUD missiles, it is likely that the same platform (or future variants such as the Orion II) and community will be equally as adaptable to unknown future

threats. This adaptability will be invaluable to joint operations both now and in the future.

CHAPTER V

Aircraft Aging Analysis

Recognizing the need for a follow on platform for the P3, the Navy selected Lockheed to produce the P7. In FY-91, the P7 was cut from the budget with no alternative for a follow on platform. In the meantime, the P3 has remained operational and continued to approach its engineered service life. This problem is receiving attention at the highest level within the DON. Recently, the Secretary of the Navy stated:

... "the Navy's P3C maritime patrol aircraft (MPA) provide long range endurance surface surveillance for the fleet and the ability to counter both nuclear and diesel electric submarines. Despite a significant reduction in the number of active and reserve P3 squadrons, the Navy anticipates that the retirement of large numbers of aging airframes will mean a shortfall of aircraft to support remaining squadrons by the end of the century. The Department of the Navy will undertake efforts this year to address this issue."³⁹

As the P3Bs and P3Cs begin to fall out of the inventory in 1994 and 1996 respectively, we believe that four alternatives should be considered:

- (1) Restart the competitive bid process for a follow on platform.

³⁹ Garrett, Department of the Navy 1992 Posture Statement, page 28.

(2) Purchase the Orion II - this is a modified P3C airframe with new engines, props and avionics. Include the UPDATE IV and any other desired sub-systems. If an Orion II is not feasible, purchase the P3C currently in production and include engine and avionics systems upgrades as the budget permits or retrofit at a later date in necessary when funds are available.

(3) Send the current P3Bs and P3Cs through a Sustained Readiness Program (SRP) to increase their useful service life by eight years.

(4) Send the current P3Cs through a SLEP to increase the useful service life by about 18 years. Modify with upgrades as funding permits.

Aging Analysis

Option (1) would provide the community with a new generation aircraft for the next 30 years. However, the current budget constraints make funding for a replacement aircraft unlikely.

Option (2) would not only keep the P3C line open, it might encourage other countries contemplating a purchase (Germans and the British) to actually place orders. This would of course lower the unit costs for the Navy. However, it is essential to keep the line open to avoid the prohibitive start up costs involved in reopening the line. The last P3Cs

are due off the line in 1995.

Option (3), the SRP, is a relatively inexpensive means to buy additional time on the current P3C inventory by extending the engineered service life (ESL). Designed for 20,000 flight hours at an average usage rate of 678 hours/year, the Navy artificially established the P3 ESL at 29.5 years.⁴⁰ When combined with a lower annual flying rate, the repair of certain structural members for corrosion can extend the airframe service life to the manufacturer's theoretical ESL of 38 years.⁴¹ Funding is programmed beginning in FY-94 through FY-99 for 51 aircraft and will delay the P3C fallout problem until 2004.⁴²

Option (4), the SLEP of the current P3Cs is the least cost effective method of extending the ESL. The estimated cost for a major SLEP is almost 80% of the price of a new P3C aircraft for mere a 50% gain in ESL with no provision for further extension. The average age of the aircraft would then be 47.5 years at retirement. Additionally, the cost of replacement parts would climb dramatically due to the costs of maintaining obsolescent production lines.

⁴⁰ESL would be lengthened by aircraft non aging time. This is the time the aircraft is out of reporting for certain maintenance actions.

⁴¹Source of data: OP-505I (March, 1992).

⁴²Source of data: OP-503C (March 1992).

CHAPTER VI

AIRCRAFT ENHANCEMENTS ANALYSIS

UPDATE IV - A Major P3C System Upgrade

The versatility of the P3 lies in the ability to incorporate a variety of major avionics and mission system changes with very few exterior changes. This precludes extensive and often expensive flight characteristics testing. Throughout the years there has been a logical progression of systems changes with the latest proposal designated UPDATE IV. Produced by Boeing, the tactical aircrew position layout resembles the P3A/B, taking advantage of enhance visual and verbal communications between tactical crewmembers.

Although the Update IV was designed to counter the quieter Soviet nuclear submarine threat its increased acoustic processing capabilities could provide a major advantage when operating against the third world diesel electric submarine threat.⁴³ The UPDATE IV also provides fusion integration of all sensors to simplify tactical decision-making, a

⁴³The UPDATE IV has 54 channel acoustic processing as compared to 32 channel acoustic processing of the P3C III.

significant advantage to the aircrew.

In our opinion the P3C III's passive acoustic technology would encounter difficulties with quiet diesel-electric submarines in shallow or bottom influenced water conditions. Improved active tracking technology, software and tactics, are required to correlate active and passive acoustic signals. While the UPDATE IV provides a significant signal processing advantage, it falls short of the active tracking technology necessary to successfully prosecute diesel-electric submarines in shallow water conditions.

Some of the major system highlights of the UPDATE IV package are listed in the Appendix III. ⁴⁴

Cluster Ranger

CLUSTER RANGER is a an electro optical video system that enables surveillance aircraft to covertly examine a vessel of interest or harbor while maintaining a safe standoff distance.

This is especially important for an aircraft that may operate independently or without CAP services. Additionally, CLUSTER RANGER provides real time visual feedback of long and short range surveillance to allow the CTF an unprecedented advantage in assessing a real or potential adversary. Combined with the platform's SATCOMM capability, the CTF could have the ability to immediately assess the vessel of interest and direct the

⁴⁴Data source: Boeing Corporation, Marketing Division.

aircrews efforts more efficiently. At this time, several systems are planned for procurement to be used primarily for counter narcotics, ASUW, ASW and ARG support missions. The system requires an aircraft wiring modification and is designed for a roll on, roll off capability (total system weight is approximately 400 pounds).

Long Range Video Camera System for the Reserve MPA Community

To enhance the counter narcotics and surface surveillance missions, the Reserve MPA community purchased nine portable, digital video recording systems with a satellite downlink capability (manufactured by the TELESIS corporation). It can provide instantaneous video stills and moving pictures of suspected vessels for the aircrew and the Task Force Commander who may be coordinating other interdiction assets. As a completely portable system, it does not require aircraft wiring modifications and is convenient for turnover between numerous Reserve aircrews in detachment operations. The portability feature minimizes the damage associated with moving a heavier system such as CLUSTER RANGER.⁴⁵

The system does not include a long range optical lens (for stand off) and compatibility with CLUSTER RANGER is unknown.

⁴⁵ Source of data: OP-0955E / OP-503C (Mar 1992).

Improved Processing and Display System (IPADS)

Designed to counter a quieter Soviet submarine threat, IPADS is an acoustic processing system upgrade and built for the P3B TACNAV MOD aircraft by the Magnavox Corporation. The advantages (over the current acoustic system in the P3B and some models of the P3C) is a two-fold increase in acoustic channel processing capability, the ability to receive 99 vice 32 sonobuoys channels, and improved operator cuing through automated decision aids.

Except for the additional channel processing capability, the system does not yield any increased detection capability. The automated decision aids include an improved panel to assist the operator, reduce fatigue and thereby increase potential detectability by several decibels. The system failed the initial testing and operational / technical (OPTECH) evaluation in May 1991 and rescheduled for a second test in July 1992. Pending successful test and evaluation, Congress has authorized the Navy to procure this system for the Naval Reserve P3B aircraft.

IPADS adds marginal gains in countering the emerging shallow water ASW threat through improved passive acoustic processing. It offers no major active acoustic processing advantage over the current P3C III aircraft.

Posse Hunter

POSSE HUNTER is a CINCLANTFLT initiative designed to outfit six P3Cs with special equipment to be used primarily in drug interdiction missions. Incorporating an enhanced electro optical, video system (CLUSTER RANGER), improved tactical communications equipment, and F-16 air to air intercept radar (similar to the one in the US Customs Service P3s), these aircraft would be used almost exclusively for this mission. Since the enhancements incorporated in these aircraft are essentially proven "off the shelf" capabilities, they may well improve the ability of the platform to accomplish the CN mission.

Weapons Capability

In the ASUW mission, the P3's only weapon is the Harpoon air to surface missile. Effective against most surface targets, the Harpoon's limiting factor is its inability to discriminate a specific target from other ships in close proximity. This factor alone prevents the P3 from being employed as a primary shooter in most ASUW encounters. This was the case during the Gulf War when the P3 was used for targeting and directing TACAIR assets in for the strike.

For the ASW mission, airborne ASW platforms including the P3 are faced with a deficiency in the ability to fire a weapon at a surfaced submarine (ie. a surfaced diesel-electric

submarine snorkeling for recharge). Current generation torpedoes were designed for a submerged submarine and would be basically ineffective against a surfaced submarine.

CHAPTER VII

TWO MEDIUM REGIONAL CRISES SCENARIO

We were not able to identify the unified CINCs' MPA mission and force level requirements for two medium regional crises scenario prior to the initiation of this project. (A description of current and potential future missions was given in Chapter IV). In this chapter, we will develop a methodology to aid in determining the MPA force level requirement through an analysis of two simultaneous regional crises.⁴⁶

(A) Scenario I: In 1998, North Korea invades South Korea.

(B) Scenario II: In 1998, Iraq and Iran join forces to invade Saudi Arabia and the UAE.

General Assumptions:

In addition to the assumptions given in the individual scenarios, the following assumptions apply to both:

(a) Both active and Reserve aircraft are homogenous in all

⁴⁶. 1991 US Naval War College War Game Scenarios.

respects.

(b) The CN mission could be suspended for the duration of the conflict, however, it will take an additional squadron every 6 months to maintain this mission if desired.

(c) Both crises are gradual escalations with heightening tensions. US MPA forces will provide 24 hr / day coverage and will initially fly three ASW / two ASUW flights / day in each scenario. Flight operations will increase to six ASW / four ASUW flights / day as the situation deteriorates.

(d) The conflicts are long, lasting 12 months or more between the initial buildup and eventual hostilities.

(e) The submarine force level estimates for each adversary are based on current data from OP-714 and may differ from the estimates provided by the War Game scenarios.

(f) Squadron rotations will remain at six months throughout the conflict.

(g) We used an eight hour on station period for ASW (tactical crew proficiency assumed to decline dramatically during long on station periods in an ASW prosecution due to fatigue) and a 12 hour on station period for ASUW (less fatiguing).

(h) The ASUW mission includes all surveillance, intelligence, fleet support and mining requirements.

(i) We assumed that both scenarios require coverage of two

separate areas simultaneously for both ASW and ASUW.

Therefore, at each site, ASW coverage requires six crews to cover six periods per day and ASUW coverage requires four crews to cover four periods per day.

(j) Active squadrons are manned at 10 crews per squadron. Reserve squadrons are manned at 13 crews per squadron.

(k) The recent pilot and flight engineer manning ratio changes were not considered.

(l) CAP services are available.

(m) Attrition was assumed to be 15%.

(n) The typical ASW and ASUW flights require a three hour preflight and a two hour postflight / debrief resulting in an average crew day of 16 - 18 hours. For safety and crew effectiveness, we assumed a 75 - 90 hour monthly rate per crew as a reasonable target for crew flight time over a six month rotation (total flight time per crew for six months would average 576 hours) ⁴⁷

Scenario I:

Background: The DPRK launched a massive attack across the DMZ with the objective of seizing Seoul before the US could reinforce its diminished presence in the ROK. Seoul is expected to be surrounded in four days. The ROK has asked

⁴⁷This monthly rate complies with guidelines established in the P3 NATOPS manual.

for full US military support under the provisions of the Mutual Defense Treaty of 1954.

(a) Pertinent aspects of US / ROK operational concept are:

(1) Commit available forces to assist ground forces in the defense of the ROK.

(2) Conduct ASW and ASUW operations in the Sea of Japan and the Yellow Sea.

(3) Conduct mining operations as directed by higher authority.

(4) Maintain SLOCs in the Sea of Japan and the Yellow Sea to the ROK.

(b) Assumptions: In addition to those listed earlier, the following apply specifically to scenario I:

(1) That the People's Republic of China remains neutral.⁴⁸

(2) That MPA could operate from a base in South Korea or South Western Japan (Honshu).

(3) That there exists no requirement to backfill MPA forces drawn from other

(4) The North Koreans possess 19 Romeo class and four

⁴⁸PRC submarine capability estimated to be 88 diesel electric submarines. J. R. Hill, "Third World Submarines and ASW Implications" (data from OP-714 brief of 9 Jan 1992). PRC possesses 3 SSBNs. J. R. Hill, Anti-Submarine Warfare (US Second Edition, 1991, U. S. Naval Institute Press, Annapolis, MD). Page 41 - 42.

Whiskey class submarines.⁴⁹

Appendix IV describes the methodology used to derive our conclusions. This scenario requires 140 aircrews.

Illustration 5 is a summary of scenario I requirements.

⁴⁹J. Benedict, "Third World Submarines and ASW Implications" (data source: OP-714 (Apr 1992)).

SCENARIO I

	CREWS REQD		CREW FLT HRS / MONTH		STa		STr	
Freq of Flts	6 / 4	3 / 2	6 / 4	3 / 2	6 / 4	3 / 2	6 / 4	3 / 2
Every other day	12 / 8	6 / 4	150/180	150/180	7	4	6	3
Every third day	18 / 12	9 / 6	100/120	100/120	11	6	8	4
Every fourth day	24 / 16	12 / 8	75/90	75/90	14	7	11	6

NOTES:

- (1) The figures 6/4 and 3/2 refer to the number of ASW/ASUW flights /day.
- (2) STa = required number of active squadrons manned @ 10 crews.
- (3) STr = required number of Reserve squadrons manned @ 13 crews.

Scenario II:

Background: "Saudi Arabia and other members of the Gulf Cooperation Council have been pumping oil to keep pace with rising world demand while keeping the price at the 1991 level, adjusted for inflation. Iran and Iraq are desperate for increased oil revenue to finish rebuilding from the Iran-Iraq and Gulf wars, modernize their armed forces and execute various domestic programs. It is because of these reasons that Saudi Arabia, et. al. wish to keep the price of oil low so there will be no repeat of Iranian or Iraqi bids for Gulf hegemony. Talks to date have not led to any accord on oil prices and so Iran and Iraq are now contemplating military action."⁵⁰ They have increased their military presence along the borders and have put their naval forces to sea.

(a) Pertinent Aspects of US / GCC operational concept are:

- (1) Commit available US forces to assist naval and ground forces in the defense of Saudi Arabia and the UAE.
- (2) Conduct ASW and ASUW operations in the Persian Gulf and Arabian Sea / Gulf of Oman.
- (3) Conduct mining operations as directed by higher authority.

⁵⁰Naval War College. "Global War Game Scenarios". Newport, RI, 1991. Page D-2-1.

(4) Maintain SLOCs in Persian Gulf and Arabian Sea / Gulf of Oman.

(5) Prevent restriction of navigation access through Straits of Hormuz.

(b) Assumptions: In addition to those listed earlier, the following apply specifically to this scenario:

(1) There is a backfill requirement of at least one squadron in the Mediterranean.

(2) MPA forces would operate from Masirah.

(3) Iran and Iraq are operating six Russian Kilo and W. German type 209 submarines (total) equipped with wake homing torpedoes and at least 12 mini- submarines.⁵¹ In addition, they are also operating gunboats with AAW capability and mine laying vessels.

Appendix IV describes the methodology used to derive our conclusions. **This scenario requires 170 aircrews.**

Illustration 6 is a summary of scenario II requirements.

Illustration 7 combines requirements of Scenarios I and II.

⁵¹J. Benedict, "Third World Submarines and ASW Implications" (Brief from OP-714), January 1992, predicts future Iraqi / Iranian force levels.

SCENARIO II

	CREWS REQD		CREW FLT HRS / MONTH		STa		STr	
	6 / 4	3 / 2	6 / 4	3 / 2	6 / 4	3 / 2	6 / 4	3 / 2
Freq of Flts	6 / 4	3 / 2	6 / 4	3 / 2	6 / 4	3 / 2	6 / 4	3 / 2
Every other day	12 / 8	6 / 4	150/180	150/180	10	7	8	5
Every third day	18 / 12	9 / 6	100/120	100/120	14	8	10	6
Every fourth day	24 / 16	12 / 8	75/90	75/90	17	10	13	8

NOTES:

- (1) The numbers 6/4 and 3/2 refer to the number of daily ASW/ASUW flights.
- (2) STa = required number of active squadrons manned @ 10 crews.
- (3) STr = required number of Reserve squadrons manned @ 13 crews.

SCENARIO I / II SUMMARY

	CREWS REQD		CREW FLT HRS / MONTH		STa		STr	
	6 / 4	3 / 2	6 / 4	3 / 2	6 / 4	3 / 2	6 / 4	3 / 2
Freq of Flts	6 / 4	3 / 2	6 / 4	3 / 2	6 / 4	3 / 2	6 / 4	3 / 2
Every other day	24 / 16	12 / 8	150/180	150/180	17	11	14	8
Every third day	36 / 24	18 / 12	100/120	100/120	25	14	18	10
Every fourth day	48 / 32	24 / 16	75/90	75/90	31	17	24	14

NOTES:

- (1) The numbers 6/4 and 3/2 refer to the number of daily ASW/ASUW flights.
- (2) STa = number of required active squadrons manned @ 10 crews .
- (3) STr = number of required Reserve squadrons manned @ 13 crews.

Summary of Conclusions:

With a total requirement of 310 aircrews for both scenarios, we examined the various active / Reserve force mix proposals to determine which would provide the required force level.

They are as follows:

(1) 18 active / 9 Reserve Squadrons - provides 297 aircrews.

(2) 13 active / 13 Reserve Squadrons - provides 299 aircrews.

(3) 13 active / 9 Reserve Squadrons - provides 247 aircrews.

(4) 18 active / 13 Reserve Squadrons - provides 349 aircrews.

Proposal (4) is the only proposal that provides a sufficient MPA force level to fight a two MRC scenario. Our case study did not consider MPA backfill requirements (outside of the Med) that may be needed throughout the world. The adoption of our proposal that provides fewer than 310 aircrews will leave the CINC with three options:

(1) Request allied MPA augmentation if the conflict becomes prolonged.

(2) Extend squadron rotation periods to greater than six months.

(3) Increase the aircrew monthly flight hours.

Enhancements Discussion

We assumed that all aircraft (active and Reserve) would be homogeneous. However, we also examined the missions for the scenarios and determined that certain aircraft enhancements are required for all aircraft in these scenarios. They are as follows:

- (1) ISAR - essential to effective ASUW / surveillance. Also a major advantage to ASW against diesel - electric submarines (when surfaced or snorkeling).
- (2) Improved active tracking capability for diesel - electric ASW.
- (3) Improved ESM if not operating all P3C UIII aircraft.
- (4) Long range electro-optical system (cluster Ranger or Telesis, subject to evaluation). Although purchased for the counter narcotics mission, it offers significant advantages to the ASUW mission.
- (5) Discriminatory Stand Off Weapons - long and short range.
- (6) P3 Survival package.
- (7) Update IV retrofit (includes ISAR and improved ESM) - could integrate new active tracking technology (if developed with Update IV manufacturer) with advanced passive acoustic and all other sensor data to speed detection of the target submarine.

CHAPTER VIII

FORCE MIX ANALYSIS

Cost Comparison Discussion

Although not the major focus of this paper, relative costs of active and Reserve MPA squadrons must be addressed. The Department of the Navy's 1992 posture statement⁵² made it clear that the Reserve component will assume a larger percentage of the "normal peace time mission" by performing more "direct or contributory support".

What is the "normal peace time mission" of the MPA community?

It encompasses many areas from the full spectrum of wartime missions including surveillance, ASW, counter narcotics, direct support of fleet exercises and search and rescue staged from any of the normal MPA sites.

Can cost savings be achieved by increasing the Reserve MPA portion of the normal peace time mission?⁵³

Two separate and independent cost studies comparing

⁵²Garrett, et. al., Department of the Navy 1992 Posture Statement. Page 33.

⁵³Discussion assumes no mission degradation due to proficiency, equipment differences, or availability.

annual active and Reserve MPA costs were conducted within the last seven years. The first by Ronald S. Feldman, for the Center For Naval Analyses (CNA),⁵⁴ was completed in May 1985. The second was conducted by Michael R. Wrinkle and Carl Eugene Carson, III,⁵⁵ at the Naval Postgraduate School (NPG), Monterey, CA, in June 1991, using a costing methodology developed by the RAND Corporation. The later study incorporated more recent cost data and provided more detailed methodology for closer review and is the basis for most of the following discussion.

Both studies were based on current peacetime activity levels of both active and reserve components. Subsequently, their final results are not applicable to a discussion that addresses a potential shift of peacetime mission. However, these studies do contain valuable insight and data from which we can draw some conclusions. Both studies, measuring current peacetime activity levels, arrived remarkably close to the same final figure. The CNA and NPG studies concluded that the annual cost of a RESFORON was 44% and 45.5% respectively of an active squadron. We point this out only to clarify the common

⁵⁴Ronald S. Feldman, "Estimating Annual O & S Costs of Active and Reserve Aviation Forces: A Methodology Illustrated Using VP Squadrons," (Center for Naval Analyses, 4401 Ford Avenue, P. O. Box 16268, Alexandria, VA, 22302-0268), May 1985.

⁵⁵Michael R. Wrinkle and Carl E. Carson, III, "Comparative Cost Analysis of P-3 Active and Reserve Aviation Forces: The Economics of Proposed Force Mix Alternatives," (Naval Postgraduate School, Monterey, Ca), June 1991.

misperception that a Resforon is always half as expensive as an active squadron. These figures have been used for several years when referring to active / Reserve MPA relative costs. Once again these figures are accurate if and only if there is no peacetime mission shift from active to Reserve component. This caveat is clearly addressed in the NPG study.

As noted above, data contained in the NPG study has significance to our discussion. Several conclusions can be drawn from Table V which is a summary of the Wrinkle / Carson study.⁵⁶

a. Since the Reserves employ "part time" personnel, use of the Reserves to perform the peace time mission clearly provides a manpower cost savings.

b. Concerning the sizeable cost differential between the active and Reserve POL, the hourly aircraft operating costs similar for both the active and Reserve components. The difference between the figures in section IV of table V is attributable to two reasons:

1. To date, Reservists do not fly as many peacetime missions as the active component and,
2. since the Reserve is composed primarily of NAVETS who are previously P-3 qualified, they have fewer required training flights.

⁵⁶Wrinkle and Carson, "VP Active/Reserve Cost Comparison Study." Page 56 (table reproduced).

c. The same reasoning in b. above applies to the cost differential in ordnance costs.

One correction to the study is offered. While the Reserve pilot and NFO training costs would be minimal, they do incur some costs in training some out-of-community pilots and NFOs.

ACTIVE / RESERVE COST COMPARISON SUMMARY

	USN	USNR	RATIO
I. PERSONNEL COSTS			
PAY AND ALLOWANCES:			
SELRES Officer	0	1,161,218	
Active Duty Officer	4,222,056	484,400	
SELRES Enlisted	0	1,028,660	
Active Duty Enlisted	7,742,147	3,140,640	
..... Total	<u>11,964,203</u>	<u>5,814,918</u>	48.6%
II. OTHER PERSONNEL AND BASE SUPPORT COSTS:			
Officer	607,257	347,853	
Enlisted	2,234,744	1,030,313	
..... Total	<u>2,842,001</u>	<u>1,378,166</u>	48.5%
III. REPLACEMENT ACQUISITION AND TRAINING COSTS:			
Pilot	4,568,924	0	
Naval Flight Officer	1,551,799	0	
Non Flight-Rated Officer	27,531	22,940	
Enlisted	1,172,353	142,061	
Special Active Duty Training	0	271,826	
..... Total	<u>7,320,607</u>	<u>436,827</u>	6.0%
IV. EQUIPMENT OPERATING COSTS:			
POL	3,458,432	1,307,736	
Maintenance supplies	1,040,000	832,840	
Replenishment spares	1,314,286	1,325,456	
Depot maintenance	2,266,278	2,147,916	
Modifications	1,073,493	1,047,006	
Ordnance	1,599,208	343,726	
..... Total equipment	<u>10,751,697</u>	<u>7,004,680</u>	65.1%
..... Total unit costs	32,578,508	14,634,591	44.5%

We can't establish the precise cost savings that result from a shift of peace time mission from the active to the Reserve, as it is wholly dependent on how much was shifted. We can conclude that there is a significant manpower savings by using the reserves vis a vis the active component in the peacetime role.

This discussion has focused primarily on the relative costs of the active and reserve component in the performance of the peace time mission. Since the normal condition is peace, there are significant cost savings in maintaining a Reserve squadron instead of an active squadron. However, when fully mobilized for a conflict, a Reserve squadron's cost will be slightly higher due to the more senior force structure.

Reserve Role in MPA

WHAT IS THE ROLE OF RESERVE MPA WITHIN THE CONTEXT OF THE NATIONAL MILITARY STRATEGY?

Contributory Support Versus Global Mobilization⁵⁷

⁵⁷Contributory support and direct support are the same. The definition of direct or contributory support used for this research paper is "the integration of Reserve elements into active components for the purpose of aiding or completing normal operations." Captain John M. Kirby, USNR, Reserve Component Force Planning: What the Future Holds. Page 589.

The following is the Commander Naval Air Reserve Force
Mission Statement:

To command the Naval Air Reserve Force so as to maintain assigned personnel and aircraft in a state of readiness and availability which will permit rapid employment in the event of full or partial mobilization.⁵⁸

Though we address only with the MPA community, the historic role of the Naval Reserve force in general has been directed toward global war with the Soviet Union. Throughout it's history, the Naval Reserve has made significant contributions to the peacetime missions of the Navy. Sometimes called direct or mutual support, reserve MPA has frequently provided contributory support in the past when the mission enhanced training and readiness or on a not-to-interfere basis with other mobilization for training requirements.

Table VI documents the contributory support of the reserve MPA community for the past three fiscal years.

⁵⁸Commander Naval Air Reserve Force, "Mission Statement," May 1992.

TABLE VI

LEVEL OF NAVAL AIR RESERVE MPA CONTRIBUTORY SUPPORT (CS)

<u>FISCAL YEAR</u>	<u>HOURS COUNTER NARCOTICS</u>	<u>TOTAL HOURS CS</u>
FY 89	782	3654
FY 90	1049	11,703
FY 91	2214	13,401 ⁵⁹

As stated in the preface, the Secretary of the Navy's Posture statement of March 1992 clearly sets the direction for future employment of reserve forces.

As the likelihood of full mobilization decreases, the Naval Reserve is being reoriented and equipped for crisis response. In addition, naval reservists will make greater contributions to peacetime operations and contingency support.⁶⁰

In reviewing the Secretary's statement, we believe that peace time operations may require a change in emphasis from traditional readiness gaining evolutions to more contributory support while at the same time balancing necessary training requirements.

⁵⁹Commander Naval Reserve Force 5312-1, "Selected Air Reserve Mutual/Fleet Support FY 89, 90, 91," 1-6, photocopied.

⁶⁰Garrett, et. al., Department of the Navy 1992 Posture Statement. Page 33.

Reserves and Forward Presence

Can Reserve MPA contribute to the forward presence role of the community? The answer is that it always has in the past and can continue to provide forward presence in the future. For many years now, Reserve MPA has deployed to the same forward world wide deployed sites as the active component. Each Resforon, at a minimum, augmented a forward deployed squadron with one half of it's personnel for two, two-week cycles, providing an average of six months augmentation at the deployed site.

During these "annual training" (AT) periods, they have performed the same missions as their active counterparts including participation in all major exercises. As the active component has downsized, the Reserve component has successfully assumed more of the forward presence role. The reserves are now the only MPA presence in some of the traditional forward deployed sites.⁶¹

Reserve MPA can continue to be a forward presence multiplier. The challenge is to maximize their value in this role.

⁶¹Although this is in a constant state of change, Reserves are currently the only MPA in Adak, Ak, Kadena, JA, and Bermuda. They are providing coverage through smaller detachments, spread out over a longer period of time.

Reserve MPA and Crisis Response

Can the reserves contribute to the crisis response role of the MPA community?

According to the Commander Naval Reserve Air Force, Rear Admiral R. K. Chambers:

Perhaps the crown jewel of interoperability occurred during Operation Desert Shield / Storm. Through a dedicated effort by COMPATWINGSPAC, two Reserve MPA aircrews saw action in the Gulf war...During combat operations, the flight crew from VP-91 was credited with targeting two Iraqi gun boats and then directing allied attack aircraft to the targets. Both Iraqi ships were destroyed.⁶²

Commander Patrol Wings Pacific said the following in regards Reserve MPA performance in the Gulf:

...I want to lay down an early marker that says our Reserves played a substantive role early and throughout this historic confrontation and conflict...you all performed superbly...we were right to press for approval for crews from the MAU (Master Augment Unit) and from VP-91 to deploy to the Indian Ocean...and to participate fully in Desert Storm...all did exactly as I knew they would-they worked hard, they were completely professional and they were easily integrated into our active force operations. We need to remember...the spirit of cooperation that permeated the whole experience.⁶³

The answer is "yes, if they are available." Reserve MPA will obviously be available immediately if the President exercises his authority under Section 673b of Title Ten, U. S.

⁶²Rear Admiral R. K. Chambers, USNR, "Wings at the Ready," Maritime Patrol Aviation, (March 1992). Page 11-16.

⁶³Rear Admiral A. R. Maness, USN, Commander Patrol Wings Pacific, "COMPATWINGSPAC message to Desert Storm participants, date time group 132355Z March 1991," March 13, 1991.

Code to order up to 200,000 Reservists. However, exercise of that authority sometimes includes political implications that may cause that option to be undesirable.

Obviously Reservists on active duty, including forward deployed squadrons, are available for crisis response. As discussed in the forward presence section above, this is for a significant portion of the year and will likely become more under the small detachment strategy. However, each Reservist's annual active duty obligation is limited to 15 to 17 days, an undesirable disruption during a crisis.

Desert Storm / Shield confirmed that a number of Reservists are available for voluntary recall at any given time.⁶⁴ Both Reserve MPA crews that participated in the Gulf War were volunteers as were many other Naval Reservists. There is a sizable resource of Reservists available for voluntary recall that could be counted as a crisis response resource with the development of the proper data base.

Our investigation indicates that at any given time Reserve MPA surveillance capable aircrews could be available for immediate voluntary recall to respond to a crisis.⁶⁵

⁶⁴CAPT J. M. Kirby, USNR, Ibid. Page 591, cites the following: Over 10,000 Reservists were voluntarily recalled to active duty prior to the Presidential Callup of the Selected Reserve.

⁶⁵We informally polled several squadrons and conferred with functional wing commanders / staff, and Op-095 staff, concerning the availability of volunteer MPA aircrews. The consensus was that the average squadron could muster at least one aircrew

In chapter XI, we will offer a detailed recommendation to enhance Reserve availability for crisis response.

capable of performing the surveillance mission on short notice for a total of thirteen crews Reserve MPA force wide.

CHAPTER IX

ACTIVE / RESERVE FORCE MIX

As the active VP squadrons have been reduced in numbers from 24 to 18 over the past two years, there have been various attempts to determine the optimum level of active and Reserve VP squadrons. We have listed the proposals of the major entities involved in the process below:

CINCs - while still under review, a recent joint CINC MPA coordinator conference on MPA force structure recommended a mix of 18 active / 9 Reserve VP squadrons as their requirement to fight a two MRC scenario.⁶⁶

JCS - in the absence of the CINCs' requirements, JCS proposed a 12 active / 6 - 12 Reserve squadron force for a two MRC scenario.⁶⁷

DON - the official DON position is in POM 93/94. The proposed 18 active / 9 Reserve force mix was based primarily on the historical (2:1) ratio of active to Reserve

⁶⁶ Data Source: Discussions with CTF-84 staff (MAY 1992).

⁶⁷ Data source: discussions with JCS (J-5) staff (April 1992).

squadrons.⁶⁸

Within DON, OP-06 proposed a 13 active / 13 reserve mix (1:1) based on the disestablishment of the MAUs and SAUs.⁶⁹ OP-05 proposed a 13 active / 9 reserve mix in order to save approximately \$50 million of a projected \$300 million shortfall.⁷⁰

Congress - will not allow any RESFORON cuts until the results of the active / reserve mix study are reported.⁷¹ It is our opinion that Congress' intent is to ensure the transfer of as much mission capability to the Reserve force as possible without adversely impacting readiness or creating the "hollow force" of the seventies.

NRA / ROA - oppose any cuts in the RESFORONS at this time.

The Ratio Issue

Underlying the above proposals is an attempt to determine

⁶⁸Data source: discussions with OP-0955E and OP-05 staff (April/May 1992).

⁶⁹ Data source: discussions with OP-06R (March 1992). Note: In the past, 24 Active squadrons were sufficient to sustain 13 reserve squadrons, two master augment units (MAUs) and numerous squadron augment units (SAUs). With the disestablishment of the MAUs and SAUs, we feel that the 2:1 ratio may be more than enough to maintain Resforon manning.

⁷⁰Data source: discussions with OP-05R (May 1992).

⁷¹Data source: discussions with OP-0955E (March/ April 1992).

the proper ratio of active to Reserve squadrons to meet the Navy's MPA mission requirements and provide a sufficient NAVET flow from the active to the Reserve to fill critical Reserve manning requirements. In some of the proposals, it appeared that the ratio issue was used to justify a desired force mix instead of mission requirements. **The fact is that sufficient empirical data is unavailable to determine a workable ratio (NAVET flow from the active to Reserve).** More importantly, a ratio should not determine the force level or mix. The level and mix should be requirement driven. We recognize that budget considerations will have a significant impact on the final force level and mix but we believe the risks of an insufficient force should be clearly illuminated. A detailed discussion of our research concerning Reserve manning and the flow of NAVETs from the active to the Reserve component follows:

Reserve Manning and the Active / Reserve Ratio Issue

The purpose of this discussion is to elaborate on the relationship of the flow of NAVETs from the active to the Naval Reserve MPA community. As discussed above, in Chapter VIII, the actual force mix should be driven by mission requirement as opposed to an acceptable ratio. The ratio becomes an issue when trying to predict a flow of NAVETs from the active MPA due to active personnel drawdowns. In light of

the various force mix proposals, we will present a model to predict when we believe this effect might occur.

Reserve Manning

Historically, the MPA Reserve force has been manned by personnel leaving the active force. With few exceptions, most of the pilot, NFO, and enlisted billets are filled by prior VP experienced NAVETs. This minimizes initial qualification training costs and allows the Reserve to concentrate on maintaining proficiency at a lower relative cost than the active component.⁷²

Demographics are a key factor in reserve MPA manning. RESFORONS co-located at VP bases (such as VP-91 at Moffett Field CA, and VP-62 at Jacksonville, FLA) tend to enjoy higher manning by prior VP-experienced NAVETs than more remote reserve bases.

Two questions are germane to this analysis of Reserve manning levels:

- (1) Can a correlation be established between the number of active VP squadrons and RESFORON manning levels?
- (2) To what extent have the recent cutbacks in active VP squadrons impacted Reserve VP manning?

Based on historical manning levels for VP RESFORONS, we

⁷²See Chapter VIII, Cost Comparison, for a detailed cost discussion.

discovered no significant difference in manning levels before and after the reduction of active squadrons. For the past four and one half years, the enlisted and officer manning levels averaged 89% and 94% respectively.⁷³ Data does not exist to determine the number of reserve affiliations that occurred due to active squadron decommissionings.⁷⁴

If not attributable to a NAVET flow from the active to the Reserve, then why did manning remain at a relatively constant level?

Concurrent with the decommissioning of the active squadrons, all SAUs and MAUs were disestablished. We believe that the migration of personnel from the SAUs and MAUs as a result of this was a primary factor in maintaining these RESFORON manning levels.⁷⁵

At his time, we cannot correlate the reserve manning level to the active force drawdown.

⁷³Data Source: /Commander Naval Air Reserve Force (Code 516). (May 1992).

⁷⁴Data Source: Commander Naval Reserve Force, (manpower analyst), May 1992. However, in all probability, this would be a relatively small number as many active duty personnel from decommissioned squadrons would be reassigned to fulfill their active duty obligations.

⁷⁵Reserve squadrons frequently are authorized to use commanders on overgrade waivers to man vacant billets (typically NFOs). Between 1990 and 1992, the number of commanders in RESFORONs on overgrade waivers decreased by 30%. Data source: CNARF code 516 (May 1992).

**Model For the Flow of NAVETs from the Active to Reserve
MPA Squadron.**

We assume that as the number of active squadrons decrease:

- (1) a surge of NAVETs will eventually flow from the active to the Reserve MPA (after their initial obligated service expires) and,
- (2) that at a certain point, the flow will diminish as the pool of available NAVETs decreases as a function of the drawdowns.

In order to predict when the surge of NAVETs departing active duty (as a result of decommissionings) will begin to affiliate with the Reserve, we have traced the career path of a typical of a NAVET Lieutenant.

A senior grade lieutenant (pilot or NFO) leaving the service eight years after commissioning⁷⁶ can remain in Reserve VP flying billet (under current rules) for approximately seven more years until promoted to commander.⁷⁷ Since the active squadron decommissionings began in 1991, we predict that the flow of NAVETs will begin in 1995, the year the lieutenant completes his obligation. Affiliating with a

⁷⁶We assume that most personnel (given the option) will fulfill their initial obligation prior to release from active duty.

⁷⁷ The exceptions are those who are selected for command and who may remain for an additional two to three years.

RESFORON in 1995, the typical officer NAVET can remain in the Reserve squadron for seven more years, until 2002 regardless of active squadron decommissionings.

Based on this model, we believe that Reserve MPA manning will remain at approximately the same level for the next 10 years.⁷⁸

The following table is a summary of the advantages and disadvantages of the most common MPA force structure options:

⁷⁸Based on historic reserve retention rates.

TABLE VII
ACTIVE / RESERVE FORCE MIX MATRIX

VARIABLES	18 A / 13 R 349 CREWS	18 A / 9 R 297 CREWS	13 A / 13 R 299 CREWS	13 A / 9 R 249 CREWS
FORWARD PRESENCE	5	4	4	2
CRISIS RESPONSE	5	4	3.5	1
TWO MAJOR REGIONAL CRISES	5	3	3	1
PEACE TIME OPS	5	4	4	1
NAVET FLOW	5	5	2	4
COST	1	2	4	5

SCALE: SCORES ARE RELATIVE TO EACH OTHER
1 - WORST 5 - BEST

NOTES:

- (1) Crisis Response assumes Voluntary Recall
- (2) Two MRC assumes Presidential Callup of Selected Reserves (PCSR)
- (3) Peace Time Ops = assumes Reserve emphasis or Contributory Support
- (4) NAVET Flow = the flow of active VP veterans to the Naval Reserve to man critical VP RESFORON billets (MAU and SAU billets no longer exist).

CHAPTER X

MISSION SPECIALTY SQUADRONS ANALYSIS

The existing MPA force structure evolved as a result of mission requirements over the last three decades. In this chapter we discuss the last element of the force structure with an analysis of the *mission specialty squadrons* concept.

The question we will address is:

Should squadrons (active and / or Reserve) specialize in a particular mission(s) or perform all platform missions?

This concept was proposed as a cost saving measure that enables retention of a reconstitutable MPA force.⁷⁹ Although there are several variations, essentially the concept suggests that some squadrons should perform all missions (including ASW) while some squadrons should perform only the ASUW, surveillance and counter narcotics missions (specifically not ASW).⁸⁰

⁷⁹D. Sweeney and H. Hilley, Maritime Patrol Air (MPA) in the national military strategy, (Naval War College, Newport RI, directed research), 1991.

⁸⁰ASW is the most difficult mission in terms of training costs and proficiency. ASW skills are by far the most perishable of MPA missions skills.

We believe the concept should be considered in the following context:

- (1) Does the concept allow for sufficient flexibility for crisis response (up to and including two MRCs)?
- (2) What are the risks of mission specialty in a crisis response scenario (up to and including two MRCs)?
- (3) Does the concept allow for sufficient flexibility for performance of the normal peacetime mission (for the reserve this is defined as the ability to provide contributory support)?
- (4) How does it affect CINC flexibility?
- (5) What are the peacetime risks?
- (6) How is OPS / PERSTEMPO affected?
- (7) What are the relative costs?⁸¹
- (8) How does it affect the talent flow (primarily the availability of personnel trained to the appropriate NECs) throughout the community?⁸²

⁸¹We have made the assumption that actual short term cost savings would be realized from the mission specialty squadrons. We offer a relative overview of cost savings as opposed to an in depth analysis.

⁸²For example, a naval flight officer who transfers from a mission specialty squadron to a full mission squadron would not possess the ASW skills to perform that mission thereby requiring further training. This problem is further complicated in the Reserve community as the decision of which squadron to affiliate with is based on demographics (ie. civilian job) as opposed to military orders. There could be no assurance of matching NECs / NOBCs to the appropriate squadron.

Why are full mission squadrons important to crisis response and CINC flexibility? With fewer squadrons deployed now than in the past, fewer crews are available to the Task Force Commander. It is essential that deployed crews, active and Reserve, are capable of responding to a crisis requiring any of the full spectrum of missions. Non-homogeneous capable squadrons could severely complicate operational-level crisis planning.

It should be apparent from the previous two MRCs discussion in Chapter VII that maintaining the present structure minimizes the risks while maximizing the CINC and crisis response flexibility. It also provides an acceptable OPS / PERSTEMPO as some surveillance squadrons (unqualified in ASW) would be unable to perform ASW tasking thereby increasing the workload for the full mission squadrons with the resulting unfavorable PERSTEMPO. This option does incur the highest short term costs.

In general the specialty squadron concept increases crisis response risks and minimizes overall flexibility, but incurs lesser short term costs. It would cause the OPS / PERSTEMPO problems noted above.

Reconstitution

The mission specialty concept provides for the

reconstitution of the ASW mission in the specialty squadrons but could not realistically reconstitute in sufficient time to respond to a crisis.⁸³

Table VIII is a summary of advantages and disadvantages full versus specialty mission squadrons with appropriate notes.

⁸³We estimate a minimum of two years to regenerate the acoustic skills and tactical crew stability necessary to be combat ready.

COMPARISON OF FULL VS SPECIALTY MISSION SQUADRONS

	WARTIME CR FLEX	CR RISK	PEACE TIME: CS FLEX	PERS/OPS TEMPO	COSTS	TALENT FLOW
CURRENT VP SQD	MAX	MIN	MAX	GOOD	CON	PRO
VP (S)	MIN	MAX	NEUTRAL	POOR	PRO	CON
RESERVE VP (S)	MIN	MAX	NEUTRAL	NOTE (5)	PRO	NEG NOTE (6)
CURRENT RESERVE VP	MAX	MIN	MAX	NOTE (5)	CON	N/A

NOTES:

- (1) VP(S) = Mission Specialty Squadron
- (2) Wartime CR = two MRCs vice global conflict.
- (3) CR Risk = accomplishing wartime mission with fewer ASW assets.
- (4) Costs = cost savings due to lower training and MPN / RPN costs.
- (5) Pers / Ops Tempo = applies to active VP squadrons. It is expressed as a ratio of at home squadrons to deployed squadrons and is currently 3:1.
- (6) Reserves could experience manning difficulties resulting in a decrease of desired operational assets available to the CINC.

CHAPTER XI

CONCLUSIONS AND RECOMMENDATIONS

The purpose of this chapter is to summarize our conclusions and recommendations. They are a synthesis of the analyses of missions, aircraft / enhancements, the Reserve role in MPA, the two MRC case study, and force structure.

Missions

The MPA community, operating the P-3 platform, can uniquely contribute to the national military strategy elements of *forward presence* and *crisis response*, and joint operations, by performing the missions discussed below. Although some capabilities may appear redundant to those of other platforms, the performance characteristics (range, speed, and endurance), and integrated sensor systems, enable the independent employment of these capabilities under circumstances that exclude other platforms.

We conclude the following with regards to MPA missions:

- (1) ASUW—that the OTH-T, ISAR, C3I, and Harpoon capabilities are valuable ASUW capabilities for independent or task group operations.

We recommend a major emphasis in training and readiness qualifications in this mission area.

(2) Surveillance and counter narcotics-that the need for open ocean and littoral water surveillance will increase with arms proliferation and an emphasis on embargoes as a means to enforce economic sanctions. Counter narcotics patrols will be a continuing effort to attack the supply side of the drug war. **We recommend an increased emphasis on the surveillance / counter narcotics missions training and capabilities.**

(3) ASW-that a significant third world submarine threat still exists. An unlocated, potentially hostile submarine operating within a battle group AOR is an unacceptable risk. Today's submarine threat is one of higher risks but lower stakes compared to the Cold War era, as the threat is primarily to Naval forces rather than to the nation as a whole. MPA is an essential element of the overall ASW effort. **We recommend the readiness / qualification emphasis shift from blue to shallow water ASW.**

(4) Refueling-that MPA can provide an adjunct refueling option for the CVBG.

We recommend that the MPA community assume the adjunct

tanking mission for CVBG by retrofitting six to ten heavy weight P3Bs or P3Cs (SLEP as necessary-aircraft to have no other significant major capabilities). Aircraft should be stationed at VP forward deployed bases and operated / maintained by the deployed VP squadron. Do not retrofit any other existing active or Reserve aircraft. **Defer decision on tanking capability for production aircraft (Orion II or follow on P3) pending evaluation of how effectively the capability is integrated by the CVBG.**

(5) CVBG / ARG support - that integration of the above missions into the CVBG and ARG expands the strike range and defensive zones of the group. In particular surface and sub-surface sanitation are critical prior to committing power projection forces in littoral waters.

We recommend an intensive coordinated operations improvement training program for MPA and immediate development of coordinated MPA / ARG tactics.

(6) Mining-although not the preferred mining platform, that retention of the P-3 mining mission is essential based on retirement of other airborne mining platforms (B-52 and A-6).

We recommend use of the P-3 for mining only in a non-AAW environment.

(7) Anti-SCUD-that the platform and community is easily and inexpensively adaptable to the mission based on early evaluations.

We recommend continued test and evaluation of anti-SCUD tactics.

(8) AEW - that it is not a mission readily adaptable to the patrol community. Training to the mission would degrade / dilute the community's ability to perform other missions.

We recommend rejection of the AEW mission.

Aircraft Aging and Enhancement

We conclude the following with regards to future upgrades for the P3:

(1) that beginning in 1996, the P-3 inventory will begin to decrease due to service life expirations and that a solution is needed to provide sufficient airframes to meet mission requirements established in the two MRC case study.

We recommend in order of priority the following solutions:

(a) restart the competitive bid process for another

follow on platform.

(b) purchase the Orion II-if funding not feasible, purchase the P3C currently in production-retrofit upgrades as the budget permits.

(c) send current P3Bs and P3Cs through a sustained readiness program (SRP) to increase their useful service life by eight years.

(d) send the current P3Cs through a SLEP to increase the useful service life by about 18 years. Modify with upgrades if funding permits.

(2) that based on the capabilities requirements of the two MRC scenario, certain enhancements are required to adequately perform the missions.

In order of priority, we recommend the following enhancements: (all active and Reserve aircraft should be homogeneous):

(a) ISAR - essential to effective ASUW. A major advantage against surfaced or snorkeling diesel - electric submarines.

(b) improved active detection and tracking capability-essential to effective ASW against third-world diesel submarines.

(c) improved ESM system for P3Cs and P3Bs - critical for ASUW operations.

(d) complete development of long range optical system - major advantage to CN, ASUW, CVBG and ARG missions. Active and Reserve equipment should be compatible (ie. either TELESIS or CLUSTER RANGER)

(e) develop (or modify an existing) a long range discriminatory, standoff weapon (minimum range of 70-100 nm) and a short range "point and shoot" weapon (minimum standoff of 10-15 nm).

(f) survivability package-for all P-3 aircraft.

(g) Update IV-(includes ISAR but we should not delay an immediate ISAR capability. Also includes an improved ESM system.)

(h) Posse Hunter-advantage for CN.

(i) IPADS-if funding is unavailable for Update IV or a follow on aircraft, retrofit P3Bs and P3C I through II.5s with IPADs, pending successful test and optech evaluation.

Table IX is a suggested schedule for desired enhancements discussed above:

TABLE IX

POTENTIAL SCHEDULE OF REQUIRED P3 ENHANCEMENTS

REQUIRED A/C ENHANCEMENTS	UNDER REVIEW (IN STUDY OR DEVELOPMENT)	NEAR TERM AVAILABILITY IF FUNDED (1-5 YRS)	LONG TERM AVAILABILITY IF FUNDED (5-10 YRS)
1. UPDATE IV	COMPLETE	X	
2. ISAR	COMPLETE	X	
3. CLUSTER RANGER	X	X	
4. POSSE HUNTER	X	X	
5. ESM	X	X	
6. WEAPONS (1)	X	X	
7. REFUEL CAP.(2)	X	X	X
8. ACTIVE TRACKING SYSTEM	X		X
9. IPADS	X	X	

NOTE:

- (1) Refers to both long and short range discriminatory standoff weapons.**
- (2) Refuel capability will depend upon what tanking configuration is chosen. The near term solution would be to use a P3B or older P3C and convert into a "tanker only" configuration. The long term solution would be to modify the ORION II if and when it is funded.**
- (3) Pending successful optech evaluation and a valid requirement.**

Reserve Role

(1) Based on the cost comparison analysis in Chapter VIII, there is a significant manpower savings by using the Reserve vis a vis the active component in the peacetime role. Furthermore, Reserve MPA has and can continue to provide contributory support and contribute to forward presence. We recommend maximum use of Reserve MPA in the peacetime operations through contributory support and, that contributory support take precedence if necessary over traditional readiness gaining evolutions.

Consideration should be given to revising the Reserve readiness equation to emphasize actual readiness prior to the annual training period instead of total year readiness.

(2) That numerous Reserve MPA volunteers are available to respond to crises and contingency operations.

We recommend that the Reserve MPA force streamline the procedures necessary for Reservists to volunteer for crisis response and contingency operations as follows: (Some of the following may have Reserve wide application.)

a. that each Reserve MPA squadron poll their personnel (aircrew and ground support) to determine who are available for immediate recall (48 hours) for a minimum time period of one month.

- b. that the existing RSTARS data base system be modified to code those Reservists available by NEC.
- c. that the data base be updated monthly by the squadrons and that their aircrew availability be reported in the remarks section of the monthly readiness report.
- d. That COMNAVAIRESFOR code 513 manage ADT (active duty for training) funds to support crisis response requirements.
- e. That functional wings identify a "first in the barrel" squadron monthly (or for some specified period) to provide a full mission capable aircraft and aircrew for launch within 48 hours. (This crew would not necessarily be an intact crew nucleus but rather a makeup crew capable of surveillance / ASUW for active backfill / augment). By accessing the data base, functional wings could fill any known personnel shortages from other squadrons with compatible aircraft.
- f. That following activation of the first aircraft / crew, another "first in the barrel" squadron / aircrew be identified.

We propose that these assets be used only for crisis response to backfill or augment the active component. They should not be used to mask funding shortfalls.

Force Structure

With regards to force structure, we conclude the following:

Force Level

(1) Based on the case study in Chapter VII, a minimum of 310 MPA aircrews are required to fight a two MRC war.

We recommend a minimum 310 MPA aircrews (active and Reserve combined) be maintained in the force structure.

Force Mix

(1) Based on the analysis summarized in the active / Reserve force mix matrix (Chapter VII), a mix of 18 active / 13 reserve squadrons will make the most cost effective contributions to the national military strategy.

We recommend a force mix of 18 active / 13 Reserve squadrons.

(2) The mix proposals that suggest a reduction in the number of Reserve squadrons based on an inadequate flow of NAVETS to sustain reserve manning are not valid.

Based on the discussion in chapter IX, active duty cuts will not affect reserve MPA manning for approximately 10 years. To reduce the number of Reserve squadrons based on this logic would not only degrade the MPA community's ability to respond to a crisis and provide contributory support, it would eliminate a number Reserve billets for

highly trained NAVETS to occupy.

In our opinion this is the most compelling argument for retaining the Reserve MPA structure. To do otherwise would result in the loss of a fully paid for, highly perishable skills resource, that could be otherwise maintained and utilized for a relatively low cost.

We recommend the following:

- (1) Do not reduce the number of Reserve MPA squadrons.
- (2) Establish a data base to track by NEC and NOBC those leaving active service and affiliating with the Naval Reserve by unit.
- (3) Use this data base to re-evaluate the ratio issue in five years and if appropriate, determine the implications of an inadequate ratio.

Mission Specialty Versus Full Mission Squadrons

(1) The mission specialty squadron concept does not provide the level of flexibility to meet the mission requirements for crisis response and adversely affects OPS / PERSTEMPO. Additionally, we don believe that the ASW mission could be reconstituted in time to respond to a crisis. We believe that these deficiencies heavily outweigh any short term cost benefits.

We recommend retention of the full mission squadron concept.

APPENDIX I

THIRD WORLD / SHALLOW WATER ASW THREAT⁸⁴

⁸⁴Data source for appendix A:J. Benedict, Third World Submarines and ASW Implications (brief), January 1992. Obtained from OP-714, ASW Plans.

EXAMPLES OF WESTERN DIESEL-ELECTRIC SUBMARINE EXPORTS TO THE 3RD WORLD

WESTERN EXPORTERS**

3rd WORLD IMPORTERS***

- W. GERMANY (TR 1700, TYPE 209)
 - ARGENTINA - (2) 209-1200, (2) TR 1700*, → (4) OTHER?
 - COLOMBIA - (2) 209-1200
 - ECUADOR - (2) 209-1300
 - INDIA - (2) → (4) 209-1500*, → (2) OTHER?
 - INDONESIA - (2) 209-1300*, → (2) OTHER?
 - PERU - (6) 209-1200
- UNITED KINGDOM (OBERON, VICKERS 540)
 - VENEZUELA - (2) 209-1300, → (2) OTHER?
 - BRAZIL - (1) → (4) 209-1400*, (3) OBERON, → (2) OTHER?
- FRANCE (AGOSTA, DAPHNE)
 - EGYPT - → (2) OBERON/PORPOISE OR OTHER?
 - CHILE - (2) 209-1300*, (2) OBERON, → (2) OTHER?
 - ISRAEL - (3) TYPE 540, → (2) DOLPHIN?
- SWEDEN (T96)
 - PAKISTAN - (2) AGOSTA, (4) DAPHNE, → (2) OTHER?
- NETHERLANDS (ZWAARDVIS)
 - S. AFRICA - (3) DAPHNE
 - TAIWAN - (2) HAI LUNG*, → (6) TYPE 209 OR OTHER?

TOTAL = 42 (CURRENT); 73 (NEAR-TERM; NEXT 10-15 YRS)

• MOST MODERN; OTHERS NEED ELECTRONICS UPDATE/MODERNIZATION
 ** EX U.S. DIESELS (25 YRS OLD) ARE NOT INCLUDED
 *** MALAYSIA, THAILAND, HAINAN, HAO S. ARABIA, NIGERIA AND OTHERS CONSIDERING SUB IMPORTS.
 JARIZ S. KOREA REPORTEDLY ORDERED IN TYPE 209-1400 SUBS (SOME BUILT INDIGENOUSLY)

SOURCE: 12/90 NAVY INTERNATIONAL, 90/91 JANE'S FIGHTING SHIPS, ETC.; PROJECTIONS REFLECT STATED GOALS/REQUIREMENTS, NOT NECESSARILY FISCAL AND POLITICAL CONSTRAINTS

EXAMPLES OF NON-WESTERN DIESEL-ELECTRIC SUBMARINE EXPORTS TO THE 3RD WORLD

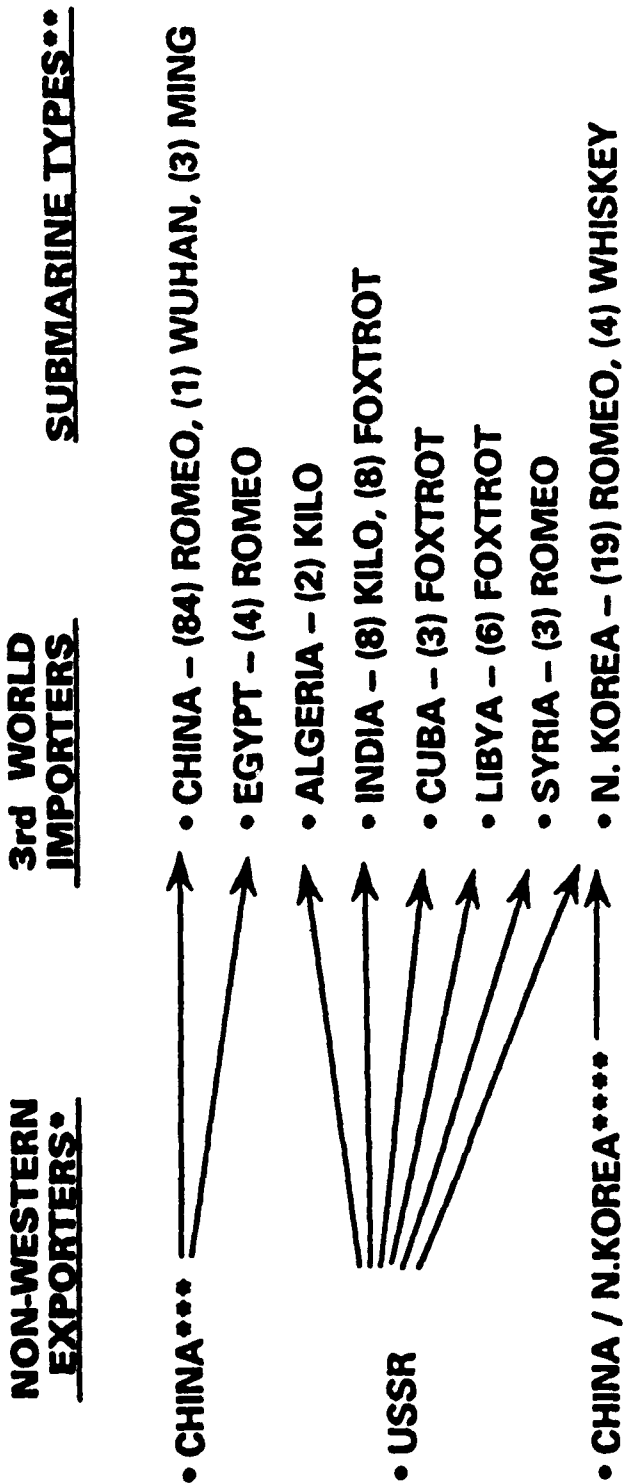

TOTAL = 145 (CURRENT); ? (FUTURE)

• FUTURE 3rd WORLD EXPORTERS COULD INCLUDE S. KOREA, TAIWAN & AFRICA, ISRAEL, ARGENTINA, BRAZIL, INDIA, N. KOREA, ETC.

** MOST OF THESE SUBS (ROMEO, WHISKEY, FOXTROT) NEED ELECTRONICS MODERNIZATION OR REPRESENT VERY OBSOLETE DESIGNS, E.G. ~ 1/2 OF CHINA ROMEOs CONSIDERED OPERATIONAL

*** BASED ON SOVIET DESIGNS

**** APPROXIMATELY TWO-THIRDS OF ROMEOs BUILT INDIGENOUSLY BY N. KOREA

UNCLASSIFIED

SOURCE: 12/90 NAVY INTERNATIONAL, 90/91 JANE'S FIGHTING SHIPS, ETC.

UNCLASSIFIED
**WESTERN SUPPLIED DIESEL SUBMARINE ORDERS BEING
 FILLED/NEGOTIATED/CONSIDERED FOR FUTURE (AS OF 5/91)**

3RD WORLD COUNTRY	ORDERS BEING FILLED	ORDERS BEING NEGOTIATED	ORDERS BEING CONSIDERED
<ul style="list-style-type: none"> • ARGENTINA • BRAZIL • CHILE 	4 TR 1700* (GERMAN) 3 TYPE 209s (GERMAN)		2 WESTERN EUROPEAN
<ul style="list-style-type: none"> • EGYPT • ISRAEL 		2 DOLPHIN (GERMAN)	2 OBERON/PORPOISE (U.K.) OR OTHER WESTERN EUROPEAN
<ul style="list-style-type: none"> • MALAYSIA • TAIWAN • S. KOREA 	6 TYPE 209s	2 T96 (SWEDISH)*** 1-2 DRAKEN (SWEDISH) 6 TYPE 209s	6 TYPE 209s OR OTHER EUROPEAN**** 0-6 TYPE 209s
<ul style="list-style-type: none"> • S. ARABIA • IRAN 		1 TRAINING SUBMARINE (W. EUROPEAN)	2-6 WESTERN EUROPEAN 6 TYPE 209s**
TOTAL	13	12-13	18-28
			43-54

• WORK AT A STANDSTILL DUE TO LACK OF ARGENTINE FUNDS
 •• REPORTEDLY MAY WANT TO RENEGOTIATE PREVIOUS ORDER THAT WAS CANCELLED WHEN SHAH WAS DETHRONED;
 ••• MAY HAVE TO GO ELSEWHERE DUE TO POLITICAL CONSTRAINTS ON GERMAN EXPORTS
 •••• LOOKS DOUBTFUL DUE TO APPARENT EXPENSE; MAY LOOK ELSEWHERE
 ••••• POLITICAL CONSTRAINTS ON DIRECT EXPORT BY GERMANS

UNCLASSIFIED

UNCLASSIFIED

STAGE SET FOR PROLIFERATION OF SSNS

- NUCLEAR NON-PROLIFERATION TREATY (NNPT) COMES UP FOR RENEWAL IN 1995
- 5 NATIONS PRODUCE NUCLEAR SUBS (U.S., USSR, U.K., PRC, FRANCE)
 - 3 OR 4 OF THEM ARE WILLING TO SELL, RENT OR LEASE SSNS
- VARIOUS OTHER NATIONS HAVE SHOWN INTEREST IN SSNS (BUT PROGRESS SLOW DUE TO FISCAL AND TECHNOLOGY CONSTRAINTS)
 - BRAZIL: PLANS FOR INDIGENOUSLY BUILT 2400T SUB WITH REACTOR (UNLIKELY BEFORE 2010)
 - CANADA: CONSIDERED ACQUIRING FRENCH RUBIS OR BRITISH TRAFALGAR SSN
 - INDIA: PREVIOUSLY LEASED SOVIET "C" SSGN; ONGOING INDIGENOUS SSN DEVELOPMENT PROGRAM SINCE 1974
 - SPAIN: IN 1985 APPROACHED FRENCH ON ACQUIRING RUBIS SSN
 - PAKISTAN: REPORTEDLY INTERESTED IN CHINESE HAN SSN; PREVIOUSLY SAID TO HAVE APPROACHED FRENCH ON RUBIS
 - ARGENTINA: INDIGENOUS PROGRAM ON HOLD SINCE 1988 DUE TO POLITICAL/FISCAL CONSTRAINTS

SOURCE: 10/31/88 AND 4/3/89 NAVY NEWS & UNDERSEA TECHNOLOGY

UNCLASSIFIED

912883.UW
Ref: MC99.4030-U

APPENDIX II

REFUELING DATA

This table shows the fuel requirement for a typical strike scenario package.

Note: All aircraft burn approximately the same amount of fuel per hour, require 2000 pounds from launch to overhead rendezvous and require 4000 pounds on top for recovery. The only variables are the length of the flight and a 4000 pounds fudge factor for any high speed egress or engaging / evasion.

a. Scenario - small strike package consisting of (4) F/A 18s, (1) EA-6B, and (1) A-6B flying a strike 450 nm from the carrier.

<u>Aircraft</u>	<u>Internal Fuel</u>	<u>Fuel Reqs</u>	<u>Delta</u>
(4) F/A 18	12k lbs	4 @ 24k	48k
(1) EA-6B	20k lbs	24k	4k
(1) A-6B	20K lbs	24k	<u>4k</u>
Total tanking requirements			56k

APPENDIX III

AIRCRAFT ENHANCEMENTS

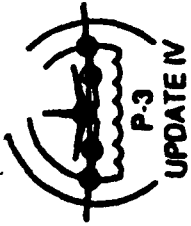

UNDERSTANDING THE PROBLEM EVOLUTION OF SUBMARINE QUIETING TECHNOLOGY

- Update III: 32 LOFAR sonobuoys -- UYS-1 processor
- Update IV: 12 HLA sonobuoys -- UYS-2, automated decision aids

Environment: P-3 alerted by cueing -- good acoustic conditions

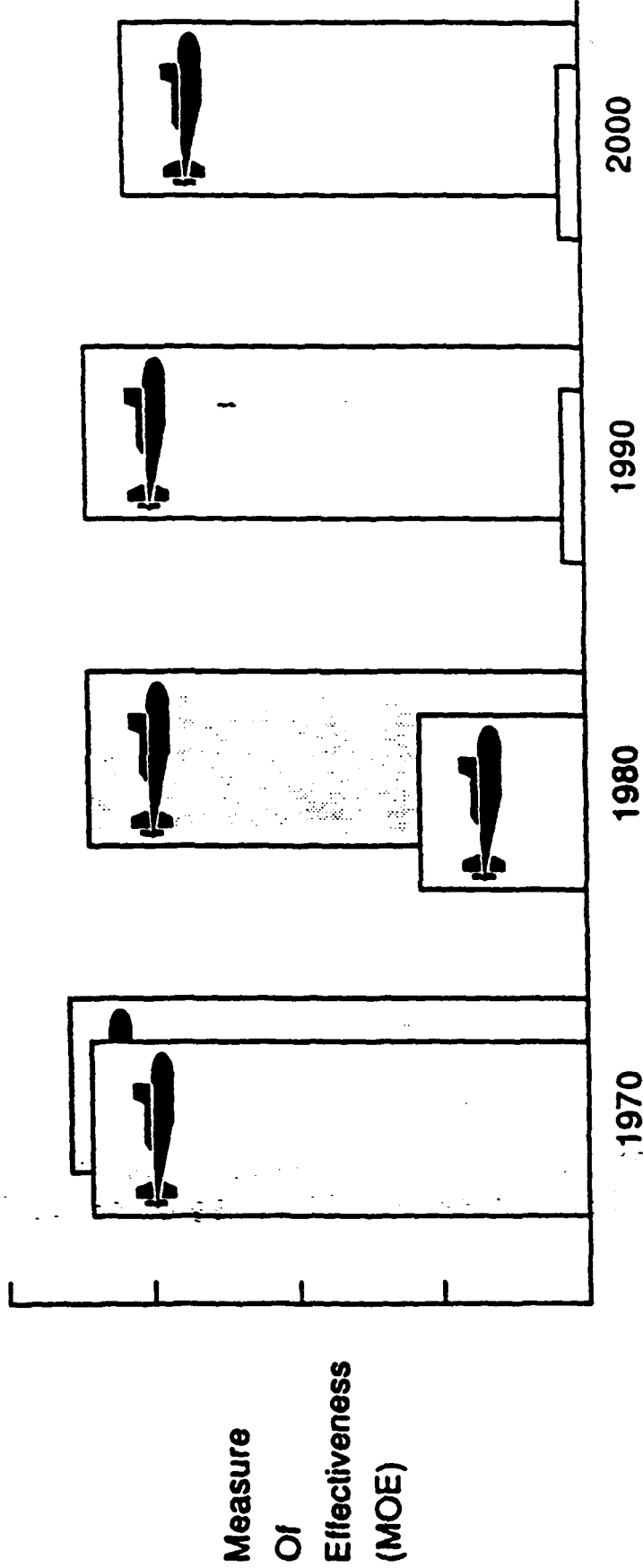



IMPROVED OPERATIONAL CAPABILITY

NOT AVAILABLE TO DTIC DOES NOT PERMIT FULLY LEGIBLE REPRODUCTION

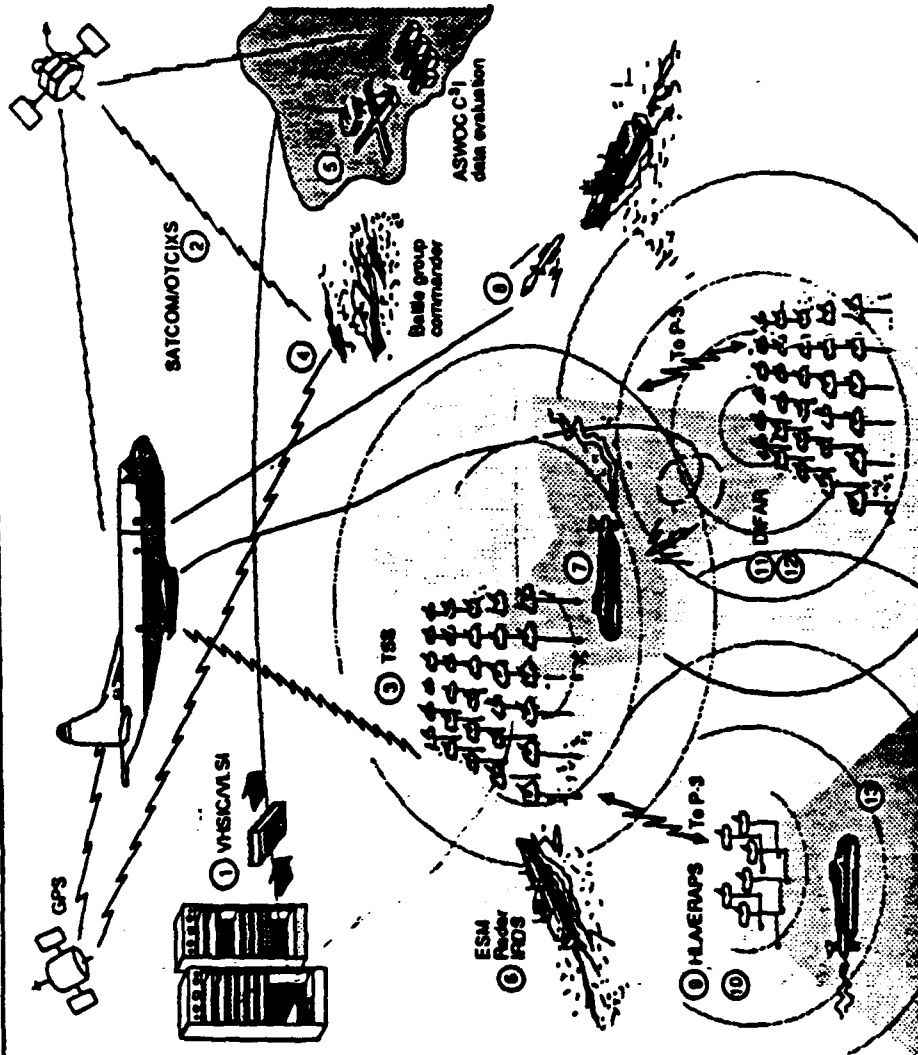

- Key Features**
- ① VNSICM/SI - Ease of maintenance plus future hardware growth
 - ② SATCOM/OTCIX real-time data link for coordinated operations
 - ③ Large area, Technical Surveillance Subsystem processing (TSS)
 - ④ Accurate grid-lock navigation
 - ⑤ Streamlined payload
 - ⑥ ESM, Radar, and FDS classification and tracking
 - ⑦ Automated localization and attack assist
 - ⑧ On-line Harpoon targeted launch
 - ⑨ HLAERAPS sensor data fusion (ASDF)
 - ⑩ Accurate sensor data fusion (ASDF)
 - ⑪ Enhanced on-board spatial sorting
 - ⑫ Contact management target classification (CMTC)
 - ⑬ Simultaneous prosecution of multiple submarine contacts

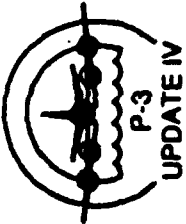

Update IV Counters the Submarine Threat

- **More power in acoustic processing**
 - UYS-2 enhanced modular signal processor
 - Advanced sonobuoys like ADAR and ERAPS
 - 54 DIFAR channels
- **Better utilization of available data**
 - 68020-based micro processor
 - Operator assists and decision aids
 - Multi-sensor correlation and data fusion
- **Enhanced communications and grid lock navigation with cooperative forces**
 - SATCOM via fleet satellite communications (FLEETSATCOM) network
 - GPS via NAVSTAR satellite system
- **Improved non-acoustic sensor capability**
 - New radar (APS-137)
 - New ESM (ALR-66(V)5)
- **Provisions for growth without redesign**
 - Expandable busses
 - 100% memory and throughput growth



ACOUSTIC SUBSYSTEM

Advanced sonobuoy receiver

- 99 RF channels, 60 acoustic channels
- Combined receiver and sonobuoy reference system function

UHF downlink command system (ASA-76)

54 DIFAR channel equivalent processor (UYS-2)

Full mission acoustic digital recording (rotary head technology)

Postprocessing in the acoustic interface unit (acoustic spatial data fusion, auto-detect, decision directed display, etc.)

Growth for advanced sonobuoys (ADAR, ERAPS, TSS, etc.)

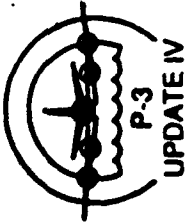

NON-ACOUSTIC SUBSYSTEM

APS-137 inverse synthetic aperture radar

- Long range classification imagery
- Small target detection
- On-line control (1553B)

ALR-66(V)5 advanced ESM

- Threat warning and accurate DF systems
- Complex emitter capable
- High density environment capable

AAS-36 infrared detection system

- Day / night passive classification imagery
- Computer tracking

ASQ-81 magnetic anomaly detector

- On-line signal for display
- Auto-detect software

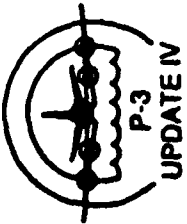

COMMUNICATIONS SUBSYSTEM

SATCOM capability

TEMPEST qualified intercommunications

On-line data link

23 OCT 87

A ASW(16)883.1



NAVIGATION SUBSYSTEM

High accuracy GPS

Independent navigation capability with LTN-72 INS

Automatic corrections of INS position to most accurate sensor (GPS, Omega, Radar)

Automatic flight path generation

- Operator entered fly-to-points
- Standard airways navigation

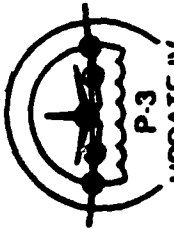

BETTER AIRCREW INTEGRATION WITH THE SYSTEM

UPDATE IV

Previous configuration

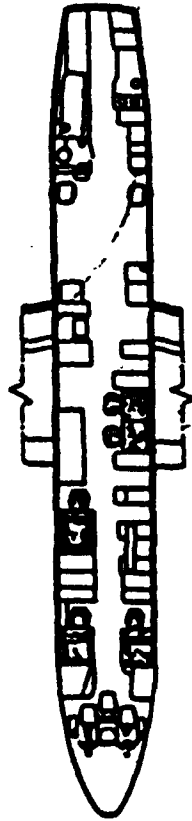

- Isolated operator stations
- Poor thermal distribution
- Noisy environment
- Poor interoperator communications
- Difficult cross-training

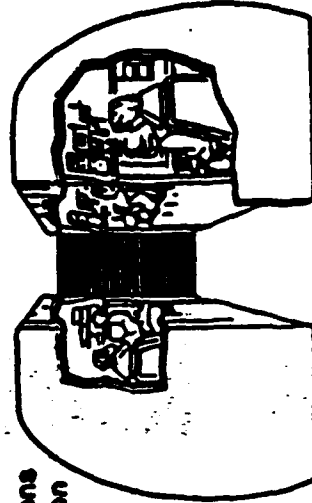

Update IV configuration

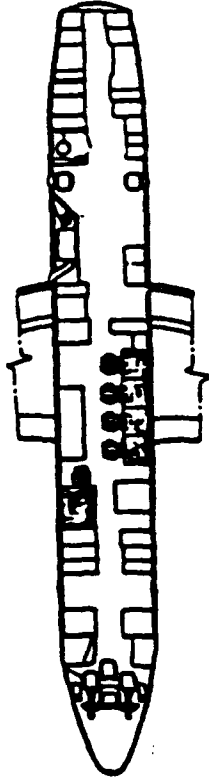

- Improved operator communications
- Increased system efficiency
- Easier cross-training
- Cost saver for retrofit and forward fit installation
- Improved thermal and noise environment

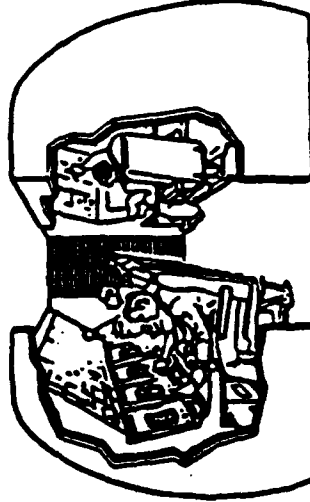

P-3 TANKER REFUELING F-18s WITH AIR REFUELING STORES

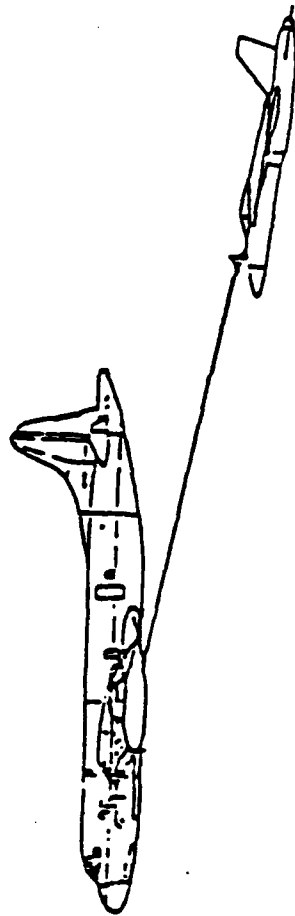
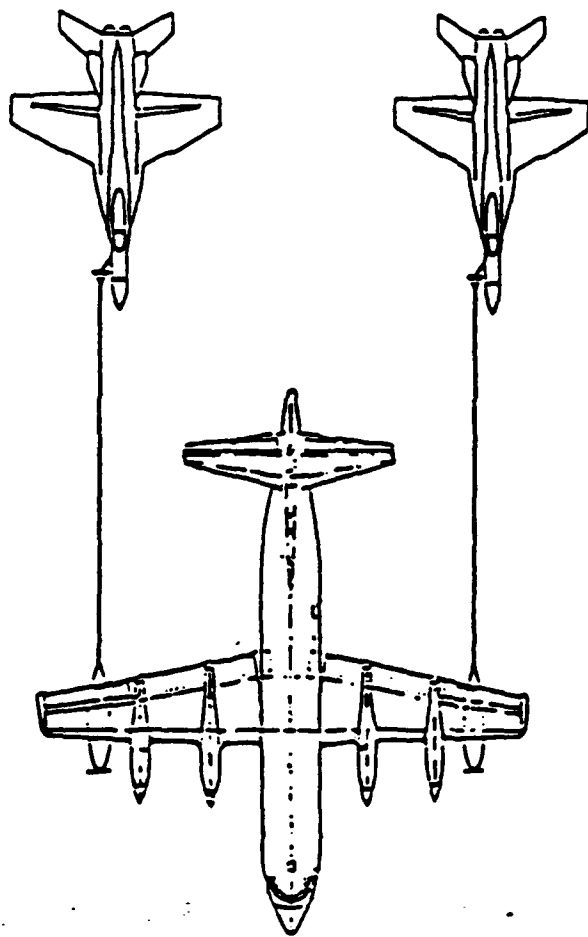

0 10 60
SCALE-FEET
APPROX

RECEIVER SEPARATION DATA

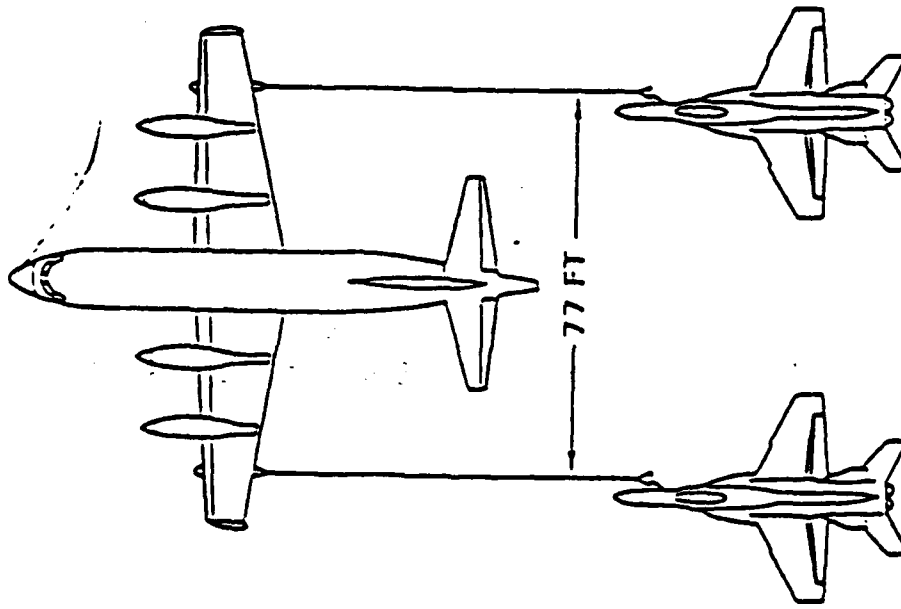

S-3A

68 ft., 8 in.

F-14A (UNSWEPT)

64 ft., 1 1/2 in.

A-6E EA-6B KA-6

53 ft., 0 in.

F/A-18 (WITH MISSILES)

40 ft., 4 3/4 in.

A-7E

38 ft., 9 in.

F-4J

38 ft., 7 1/2 in.

H-53 (ROTOR DIAMETER)

79 ft.

FLEET AIRCRAFT REFUELING DATA

Type Receiver	Maximum Altitude* (feet)	Refueling Speed Range (KIAS/M)	Optimum Engagement Speed and C/R	Typical Fuel Fuel Rate (PRM/No. Pumps)
A-4	35,000	200-300/.81	250/2-3	1600/2
A-6	30,000	200-300/.81	250/2-3	2800/2
A-7	30,000	200-300/.81	250/2-3	1800/2
AV-8A	35,000	200-300/.81	250/2-3	1100/1
F-4	30,000	200-300/.81	250/2-3	3300/2
F-14	35,000	200-300/.81	240/2-3	2800/2
F-18	35,000	200-300/.81	240/2-3	2300/2
S-3	25,000	200-275/.55	220/3-5	2300/2

*KC-10 maximum altitude fully loaded is 29,000 feet.

RECEIVER CAPABILITY OPTION

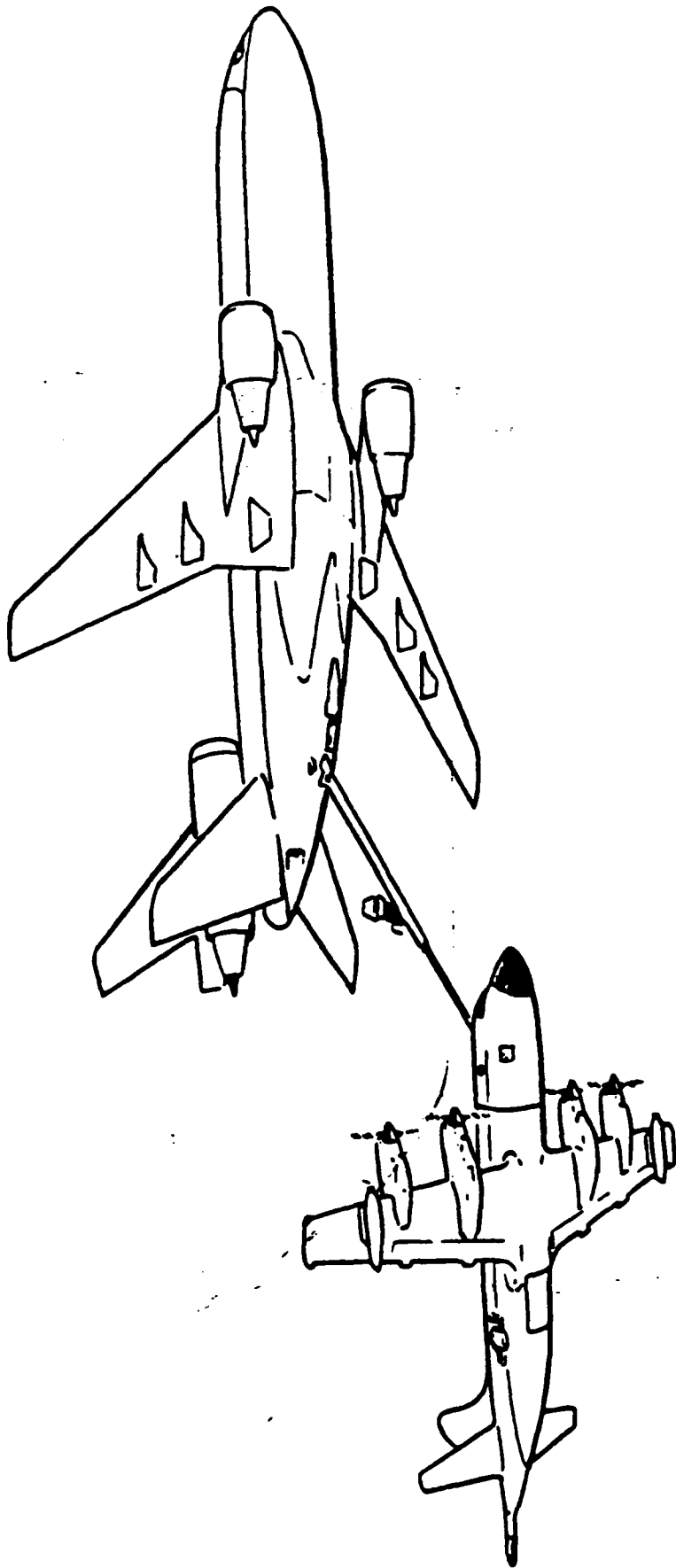

APPENDIX IV

CASE STUDY DATA

1. EXPLANATION OF SYMBOLS USED:

X1 = number of ASW aircrews required.

X2 = number of ASUW aircrews required.

X3 = number of backfill crews required for other operations.

XT1 = total aircrews needed to fly 6 ASW / 4 ASUW flights / day considering Rop.

XT2 = total aircrews needed to fly 3 ASW / 2 ASUW flights / day considering Rop.

Rop = op/pers tempo ratio (3:1) used by CNO in 1992.

STa = active squadrons required @ 10 aircrews (displayed for both XT1 and XT2 with consideration for Rop).

STr = reserve squadrons required @ 13 aircrews (displayed for both XT1 and XT2 with consideration for Rop).

2. FORMULA USED TO DETERMINE REQUIRED NUMBER OF AIRCREWS:

$XT = [(X1 + X2 + .15(X1+X2)) + X3] * Rop$

$Sta = XT / 10$

$STr = XT / 13$

SOURCES CONSULTED

Benedict, J., "Third World Submarines and ASW Implication,"
(source of data- OP-714, ASW Plans brief, 9 January 1992).

Data source OP-503C brief, March 1992.

Data source brief from OP-505I, March 1992.

Data source-Director of Naval Intelligence brief to Unified
CINCs October 1991 (slide 36)

Director of Naval Intelligence, statement to House Armed
Services Committee, March 7, 1991

Garrett, H. Lawrence, III, Secretary of the Navy, et. al.
Department of the Navy 1992 Posture Statement
February-March, 1992.

Hill, J. R. Anti-Submarine Warfare (U. S. Second Edition,
Annapolis, MD, U. S. Naval Institute Press, 1991).

Interview with CDR Barngrover, USN, CTF-84 staff, CINCLANTFLT,
Norfolk, VA, 14 May 1992.

Interview with CAPT Batwinis, USNR, COMNAVRESCUITCOM, New
Orleans LA, 18 March 1992.

Interview with CAPT Birr, USNR, COMRESPATWINGLANT, Norfolk,
VA., 6 April 1992.

Interview with CDR Brennock, USN, OP-714, Department of the
Navy, Pentagon Building, Washington, D.C. 24/25 March
1992.

Interview with CDR Bryant, USN, COMPATWINGSLANT Operations,
NAS Brunswick, Me., 10 April 1992.

Interview with CDR Bryant, USN, SECNAV OPA Special Assistant,
Department of the Navy, Pentagon Building, Washington, D.C.,
25/26 March 1992.

Interview with RADM Coleman, USN, COMPATWINGSLANT, NAS
Brunswick, Me., 10 April 1992.

Interview with COL C. J. Gilstad, USAFR, Air Force OLA,

Department of the Air Force, Pentagon Building, Washington,
D.C. 24 March 1992.

Interview with CDR Griffin, USN, JCS (J-5 staff), Pentagon
Building, Washington, D.C., 24 April 1992.

Interview with CAPT Goolsby, USN, CTF-84 staff, CINCLANTFLT,
Norfolk, VA, 14 May 1992.

Interview with CDR Halter, USNR, OP-06R, Department of the
Navy, Pentagon Building, Washington, D.C. 25 March 1992.

Interview with CAPT Harris, USNR, CNARF code 57, Commander,
Naval Air Reserve Force, New Orleans, LA, 17 March 1992.

Interview with CDR Hulley, USN, OP-0608A, Department of the
Navy, Pentagon Building, Washington, D.C. 25 March 1992.

Interview with CDR Johnson, USNR, OP-505I, Department of the
Navy, Pentagon Building, Washington, D.C., 25 March 1992.

Interview with CDR Jones, USNR, COMRESPATWINGLANT CSO,
Norfolk, VA., 6 April 1992.

Interview with CDR King, USNR, OP-06R, Department of the
Navy, Pentagon Building, Washington, D.C. 25 March 1992.

Interview with CDR Korthals, USNR, OP-095L1, Department of the
Navy, Pentagon Building, Washington, D.C., 25 March 1992.

Interview with CAPT Lekberg, USNR, OP-05R, Department of the
Navy, Pentagon Building, Washington, D.C. 24 March 1992.

Interview with CDR Levigne, USNR, CNARF (code 513), Commander,
Naval Air Reserve Force, New Orleans, LA, 16 March 1992.

Interview with CDR Miskill, USN, COMPATWINGSLANT Training, NAS
Brunswick, Me., 9 April 1992.

Interview with CDR Peterson, USNR, OP-0955E, Department of the
Navy, Pentagon Building, Washington, D.C. 23 March 1992.

Interview with RADM Ray, USN, SECNAV OPA, Department of the
Navy, Pentagon Building, Washington, D.C. 26 March 1992.

Interview with CDR Sinibaldi, USNR, CNARF (code 516),
Commander, Naval Air Reserve Force, New Orleans, LA, 16
March 1992.

Interview with CAPT (SEL) Zambornardi, USN, OP-503C,

Department of the Navy, Pentagon Building, Washington, D.C.,
25 March 1992.

Jane's Fighting Ships, Ninety-third edition, 1990-1991,
(Jane's Information Group, 163 Brighton Road, Coulsdor,
Surrey, CR 5 2NH, U.K.),.

Maness, Anthony, R. "The US Navy Maritime Patrol Force in the
Pacific". Bridgetown, March 1992. Page 9.

McCurdy, Dave, Representative, US Congress (D-OK), "The Way
Ahead," U. S. Naval Institute Proceedings, September
1991.

New York Times. 17, 23 February 1992.

Shibayev, Vladimir, Russian Deputy Chairman of Government
Committee for foreign relations, February 17, 1992.

Starr, Barbara, Jane's Defence Weekly, December 23, 1991.

Telephone conversation with COMMINEWARCOM Mining Plans staff,
May 1992.

Telephone conversation with COMNAVRESFOR (code 009E) retention
analyst, May 1992.

Telephone with LCDR Mills, USN, Pers 92, 4 May 1992.

Vincent, W. L., Rear Admiral, USN, "MPA-Responses to Changing
Threats," Maritime Patrol Aviation, March 1992.

Woodward, Sandy, Admiral, RN, One Hundred Days, Naval
Institute Press, Annapolis, 1992.