



US Army Corps
of Engineers
Construction Engineering
Research Laboratories

AD-A271 752



USACERL Technical Report FM-93/10
May 1993

2

Evaluation of Techniques To Eliminate Erosion From Under River Revetment Mattresses

by
Richard G. Lampo
James H. Long
Stanley L. Paul
Tom Boim

The Lower Mississippi Valley Division (LMVD) of the U.S. Army Corps of Engineers annually places several million square feet of articulated revetment mattresses to minimize erosion of the riverbed and banks adjacent to structures and levees. Mattress sections are replaced in those areas where surveys have indicated a deepening of the river bank or other possible mattress failure. Catastrophic levee failures have signaled the need to investigate the failure phenomenon and to recommend potential solutions that will minimize future catastrophic failures.

The objective of this research was to evaluate techniques to seal the gaps between the mattress blocks, thereby increasing protection against underlayment erosion. Based on preliminary investigations, researchers determined that the technique of attaching a geotextile to the bottom of the mattress appeared promising. The technique of sealing the gaps with flexible foams and epoxies was impractical.

Three of the 16 geotextiles tested exhibited the best combinations of behavior for use with revetment mattresses. Before a geotextile-concrete mattress could become standard practice, the mattress failure mechanism needs to be defined more accurately. The relationship between the composite mattress and river currents and soils should also be defined.

Approved for public release; distribution is unlimited.

SDTIC
ELECTE
NOV. 03. 1993
S B D

93-26579



00 11 048

The contents of this report are not to be used for advertising, publication, or promotional purposes. Citation of trade names does not constitute an official endorsement or approval of the use of such commercial products. The findings of this report are not to be construed as an official Department of the Army position, unless so designated by other authorized documents.

DESTROY THIS REPORT WHEN IT IS NO LONGER NEEDED

DO NOT RETURN IT TO THE ORIGINATOR

USER EVALUATION OF REPORT

REFERENCE: USACERL Technical Report FM-93/10, *Evaluation of Techniques To Eliminate Erosion From Under River Revetment Mattresses*

Please take a few minutes to answer the questions below, tear out this sheet, and return it to USACERL. As user of this report, your customer comments will provide USACERL with information essential for improving future reports.

1. Does this report satisfy a need? (Comment on purpose, related project, or other area of interest for which report will be used.)

2. How, specifically, is the report being used? (Information source, design data or procedure, management procedure, source of ideas, etc.)

3. Has the information in this report led to any quantitative savings as far as manhours/contract dollars saved, operating costs avoided, efficiencies achieved, etc.? If so, please elaborate.

4. What is your evaluation of this report in the following areas?

a. Presentation: _____

b. Completeness: _____

c. Easy to Understand: _____

d. Easy to Implement: _____

e. Adequate Reference Material: _____

f. Relates to Area of Interest: _____

g. Did the report meet your expectations? _____

h. Does the report raise unanswered questions? _____

i. General Comments. (Indicate what you think should be changed to make this report and future reports of this type more responsive to your needs, more usable, improve readability, etc.)

5. If you would like to be contacted by the personnel who prepared this report to raise specific questions or discuss the topic, please fill in the following information.

Name: _____

Telephone Number: _____

Organization Address: _____

6. Please mail the completed form to:

Department of the Army
CONSTRUCTION ENGINEERING RESEARCH LABORATORIES
ATTN: CECER-IMT
P.O. Box 9005
Champaign, IL 61826-9005

REPORT DOCUMENTATION PAGE

**Form Approved
OMB No. 0704-0188**

Public reporting burden for this collection of information is estimated to average 1 hour per response, including the time for reviewing instructions, searching existing data sources, gathering and maintaining the data needed, and completing and reviewing the collection of information. Send comments regarding this burden estimate or any other aspect of this collection of information, including suggestions for reducing this burden, to Washington Headquarters Services, Directorate for Information Operations and Reports, 1215 Jefferson Davis Highway, Suite 1204, Arlington, VA 22202-4302, and to the Office of Management and Budget, Paperwork Reduction Project (0704-0188), Washington, DC 20503.

1. AGENCY USE ONLY (Leave Blank)	2. REPORT DATE <p style="text-align: center;">May 1993</p>	3. REPORT TYPE AND DATES COVERED <p style="text-align: center;">Final</p>	
4. TITLE AND SUBTITLE <p style="text-align: center;">Evaluation of Techniques To Eliminate Erosion From Under River Revetment Mattresses</p>		5. FUNDING NUMBERS <p style="text-align: center;">IAO LMNED-86-68, dated August 1986</p>	
6. AUTHOR(S) <p style="text-align: center;">Richard G. Lampo, James H. Long, Stanley L. Paul, and Tom Boin</p>		8. PERFORMING ORGANIZATION REPORT NUMBER <p style="text-align: center;">TR FM-93/10</p>	
7. PERFORMING ORGANIZATION NAME(S) AND ADDRESS(ES) <p style="text-align: center;">U.S. Army Construction Engineering Research Laboratories (USACERL) PO Box 9005 Champaign, IL 61826-9005</p>		9. SPONSORING/MONITORING AGENCY NAME(S) AND ADDRESS(ES) <p style="text-align: center;">U.S. Army Engineering Division ATTN: CELMV PO Box 80 Vicksburg, MS 39181-0080</p>	
11. SUPPLEMENTARY NOTES <p style="text-align: center;">Copies are available from the National Technical Information Service, 5285 Port Royal Road, Springfield, VA 22161.</p>			
12a. DISTRIBUTION/AVAILABILITY STATEMENT <p style="text-align: center;">Approved for public release; distribution is unlimited.</p>		12b. DISTRIBUTION CODE	
13. ABSTRACT (Maximum 200 words) <p>The Lower Mississippi Valley Division (LMVD) of the U.S. Army Corps of Engineers annually places several million square feet of articulated revetment mattresses to minimize erosion of the riverbed and banks adjacent to structures and levees. Mattress sections are replaced in those areas where surveys have indicated a deepening of the river bank or other possible mattress failure. Catastrophic levee failures have signaled the need to investigate the failure phenomenon and to recommend potential solutions that will minimize future catastrophic failures.</p> <p>The objective of this research was to evaluate techniques to seal the gaps between the mattress blocks, thereby increasing protection against underlayment erosion. Based on preliminary investigations, researchers determined that the technique of attaching a geotextile to the bottom of the mattress appeared promising. The technique of sealing the gaps with flexible foams and epoxies was impractical.</p> <p>Three of the 16 geotextiles tested exhibited the best combinations of behavior for use with revetment mattresses. Before a geotextile-concrete mattress could become standard practice, the mattress failure mechanism needs to be defined more accurately. The relationship between the composite mattress and river currents and soils should also be defined.</p>			
14. SUBJECT TERMS revetment mattresses erosion rivers		15. NUMBER OF PAGES <p style="text-align: center;">74</p>	
17. SECURITY CLASSIFICATION OF REPORT <p style="text-align: center;">Unclassified</p>		16. PRICE CODE	
18. SECURITY CLASSIFICATION OF THIS PAGE <p style="text-align: center;">Unclassified</p>	19. SECURITY CLASSIFICATION OF ABSTRACT <p style="text-align: center;">Unclassified</p>	20. LIMITATION OF ABSTRACT <p style="text-align: center;">SAR</p>	

FOREWORD

This research was conducted by the U.S. Army Construction Engineering Research Laboratories (USACERL) for the Lower Mississippi Valley Division (LMVD) of the U.S. Army Corps of Engineers. Funding for this study was provided by the New Orleans District under an Intra-Army Order (IAO) for Reimbursable Services, number LMNED-86-68, dated August 1986. The LMVD technical monitor was Steve Ellis, CELMV.

The investigation was performed by the USACERL Engineering and Materials Division (FM), of the Infrastructure Laboratory (FL). Richard G. Lampo was the project principal investigator. Dr. Paul A. Howdyshell is Chief, CECER-FM. Dr. Michael J. O'Connor is Chief, CECER-FL. Contracted support was provided by Professors James H. Long and Stanley L. Paul from the Department of Civil Engineering at the University of Illinois. They were assisted by Tom Boin, a graduate student in Civil Engineering at the University of Illinois. The technical editor was Gloria J. Wienke, Information Management Office.

COL Daniel Waldo, Jr., is Commander and Director of USACERL, and Dr. L.R. Shaffer is Technical Director.

Accession For		<input checked="" type="checkbox"/>
NTIS	GRA&I	<input type="checkbox"/>
DTIC TAB		<input type="checkbox"/>
Unannounced		
Justification		
By		
Dist. Statement		
Availability Codes		
Avail and/or		
Special		
Dist		
A-1		

FORM 100 1-78 5

CONTENTS

SF 298	1
FOREWORD	2
LIST OF FIGURES AND TABLES	5
1 INTRODUCTION	9
Background	9
Objective	9
Approach	10
Scope	10
2 SURVEY OF MATTRESS OPERATION	13
Casting Mattress Sections	13
Transporting Mattress Squares	13
Mattress Placement	13
3 SURVEY OF SOLUTIONS	17
Constraints	17
Preliminary Investigations	17
Geotextiles	18
Previous Evaluation of Geotextiles With Revetment Mattresses	18
Reconsideration for Use of Geotextiles	19
4 GEOTEXTILES	21
Requirements for Survivability	21
Resistance to Tension	21
Resistance to Peeling	21
Resistance to Peeling With Respect to Resistance to Tearing	22
Resistance to Abrasion	23
Other Considerations	23
Denier and Surface Features	23
Geotextiles Tested	24
Geotextile Costs	27
5 LAUNCH LOADS AND DEFORMATIONS	28
Load While Passing Over Skids	28
Load While Approaching Mudline	31
Modes of Failure Due to Loads	33
6 LABORATORY TESTS	35
Wide-Strip Tensile Tests	35
Peel Tests (180 Degree Pull)	42
Additional Peel Tests (0 Degree Pull)	57
Bending Tests	59
Abrasion Tests	60

CONTENTS (Cont'd)

7	CONCLUSIONS AND RECOMMENDATIONS	69
	Conclusions	69
	Recommendations	69
	METRIC CONVERSION TABLE	70
	REFERENCES	71
	DISTRIBUTION	

FIGURES

Number		Page
1	Sinking Unit Placing a Revetment Mattress	11
2	Closeup of a Mattress in Place	11
3	Schematic of Cast Mattress Blocks	12
4	Illustration of Toe Scour Mode Theory	12
5	Internal Wire Insert	14
6	Bracket Wires Deformed by Lift Fixture	15
7	Tying Tool Used To Fasten Squares Together	15
8	Schematic of Constructed Mattress	16
9	Photomicrographs Showing (a) Woven and (b) Nonwoven Geotextile Fibers	20
10	Cross-Sectional View of the Launch Edge of the Sinking Plant	29
11	Welds on the Launch Edge of the Vicksburg Sinking Plant	30
12	Additional Normal Force Due to Launch Cable Pulling Down on Bracket Wire	32
13	Illustration of Cable Being Launched	32
14	Geometry of Block Joint "As-Cast" and at the Point of Maximum Upward Curvature	34
15	Joint in Equilibrium Configuration	34
16	Diagram of Loading Head for Wide-Strip Tensile Test	36
17	Photograph of Wide-Strip Tensile Test in Progress	37
18	Results of Wide-Strip Tensile Tests	40
19	Photographs of (a) Normal Fabric Fibers and (b) Hoechst Trevira Fibers	41
20	Schematic Setup of Specimens Used for Peel Tests	44
21	Closeup View of Plywood and Steel Form Work With Geotextiles in Place	44
22	View of Form for All Specimens	45
23	View of Forms With Concrete Placed	45

FIGURES (Cont'd)

Number		Page
24	Leveling of Concrete in Mold With Vibrator	46
25	Final Smoothing of Specimens With Trowel	46
26	Schematic of Saddle Used for Peel Test	47
27	Photograph of Saddle Used for Peel Test	47
28	Specimen for Peel Test Being Inserted Into Saddle	48
29	Specimen Oriented Vertically in Saddle	48
30	Specimen With Top Plate Clamped on Geotextile	49
31	Peel Test in Progress	49
32	Peel Test in Progress for Geotextile #4	50
33	Peel Test in Progress for Geotextile #2	50
34	Peel Strengths Measured for Different Construction Variables	53
35	Effect of the Direction of Load On Peel Strength	54
36	Photograph of Failed Peel Strength Specimen for Geotextile #13	55
37	Failure of Peel Test Specimen by Fabric Tearing Outside of Bond Area	56
38	Failure of Peel Test Specimen by Fabric Tearing at Tufts Embedded in Concrete	56
39	Geotextile #16 Peeled Easily Until Loops Were Encountered	58
40	Loops Embedded in Concrete Required Significant Loads To Pull Out	58
41	Nicolon Fabric in Bending Test	60
42	Schematic of Abrasion Device	61
43	Photograph of Abrasion Device	62
44	Welded Steel Plate Above the Two Concrete-Geotextile Specimens	63
45	Photograph of Welded Steel Plates Used in Abrasion Test	64

FIGURES (Cont'd)

Number		Page
46	View of Geotextile Specimen When Welds Were Oriented in the Direction of the Load	65
47	Photograph of Abrasion Test Specimens After Testing (a. #10; b. #6; c. #1; d. #2)	66

TABLES

1	List of Geotextiles and Critical Information	25
2	Results of Wide-Strip Tensile Tests	39
3	Concrete Mix for Tests	42
4	Results of Peel Tests	52
5	Results of Straight-Pull Peel Tests	59
6	Criteria Used To Determine the Damage Index	68
7	Results of Abrasion Tests	69

EVALUATION OF TECHNIQUES TO ELIMINATE EROSION FROM UNDER RIVER REVETMENT MATTRESSES

1 INTRODUCTION

Background

The Lower Mississippi Valley Division (LMVD) of the U.S. Army Corps of Engineers (USACE) annually places several million square feet of articulated revetment mattresses to protect the Mississippi River banks from erosion. Figure 1 shows a mattress being placed. Figure 2 shows a closeup of a mattress in place. The mattress is composed of concrete blocks (each measuring 17.75 x 46.25 x 3 in.* thick) that are connected together. A schematic of an individual block is shown in Figure 3. Overall, the completed in-place revetment mattress has a total open area of approximately 8 percent. The majority of this open area is concentrated in the cutout areas in the blocks, and to a lesser degree in the gaps between the blocks where they connect to longitudinal wires. (A more detailed description of mattress composition and corresponding dimensions is given in Chapter 2.)

If the revetment mattress does not stop bank erosion, the adjacent structure or levee could fail. Levee failure is a major concern, especially in areas where urban population centers and industrial complexes are close to the levee and the levee is at the river's edge. Mattress sections are replaced in those areas where surveys have indicated a deepening of the river bank or bed or other possible mattress failure.

The failure mechanism is not fully understood. One possibility is that certain river and subsurface flow conditions may suspend the fine, loose soil particles underlying the mattress and carry them away through the gaps in the mattress. Major levee failures below Baton Rouge, LA, signaled the need to investigate the failure phenomenon and to recommend potential solutions that will help avoid future catastrophic failures.

LMVD asked the U.S. Army Construction Engineering Research Laboratories (USACERL) to follow the assumption that soils are removed through the concentrated open areas in the mattress and evaluate techniques that could be used to seal the gaps between mattress components.

Objective

The objective of this research was to evaluate techniques to seal the gaps between the mattress blocks, thereby increasing protection against underlayment erosion.

*A metric conversion table is provided on page 70.

Approach

The original research plan contained five steps.

1. Observe and document information on the manufacturing of the mattress and how it is put in place,
2. Based on any operational constraints, evaluate techniques to seal the gaps between mattress blocks,
3. In coordination with LMVD, conduct laboratory and field tests to evaluate the various techniques,
4. Field test selected promising techniques during actual placement operations, and
5. Prepare final recommendations based on the field test results.

Scope

Due to LMVD budget constraints and a shift in Division priorities, this research was not completed as originally planned. The effort was halted before field testing during placement.

When this research commenced, erosion of the underlying soil through the mattress open area was considered to be a significant cause of revetment mattress failure. A recent advance in knowledge has been to link toe scour with the retrogressive mechanism of major bank failures, and to define and quantify the retrogression process.¹ The theory proposes that failure initiation begins as a scour hole near the toe of the bank slope at a point near the lower portion of the mattress or beyond the mattress. Once the hole becomes deep enough and the sides of the hole surpass a critical angle, the medium-dense to dense fine sands will flow from the oversteepened face. This oversteepened face then retrogresses up the slope on the runout angle α ($\pm 10^\circ$) (Figure 4). As this process is repeated, the mattress underlayment is virtually removed from behind the mattress. This toe scour mechanism is now considered to be the predominant mattress failure mechanism. This research focuses on techniques to reduce the erosion of soil through the mattress still considered to be a significant mattress failure mechanism.

¹ Victor H. Torrey, III, Joseph B. Dumbar, and Richard W. Peterson, *Retrogressive Failures in Sand Deposits of the Mississippi River, Report 1: Field Investigations, Laboratory Studies and Analysis of the Hypothesized Failure Mechanism*, Report No. GL-88-9 (U.S. Army Waterways Experiment Station, June 1988).

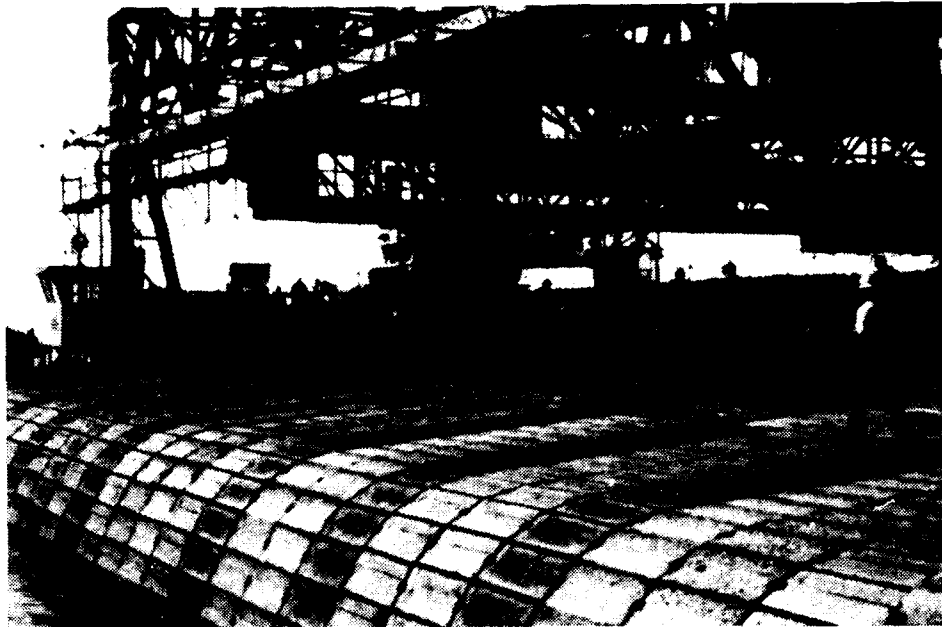

Figure 1. Sinking unit placing a revetment mattress.



Figure 2. Closeup of a mattress in place.

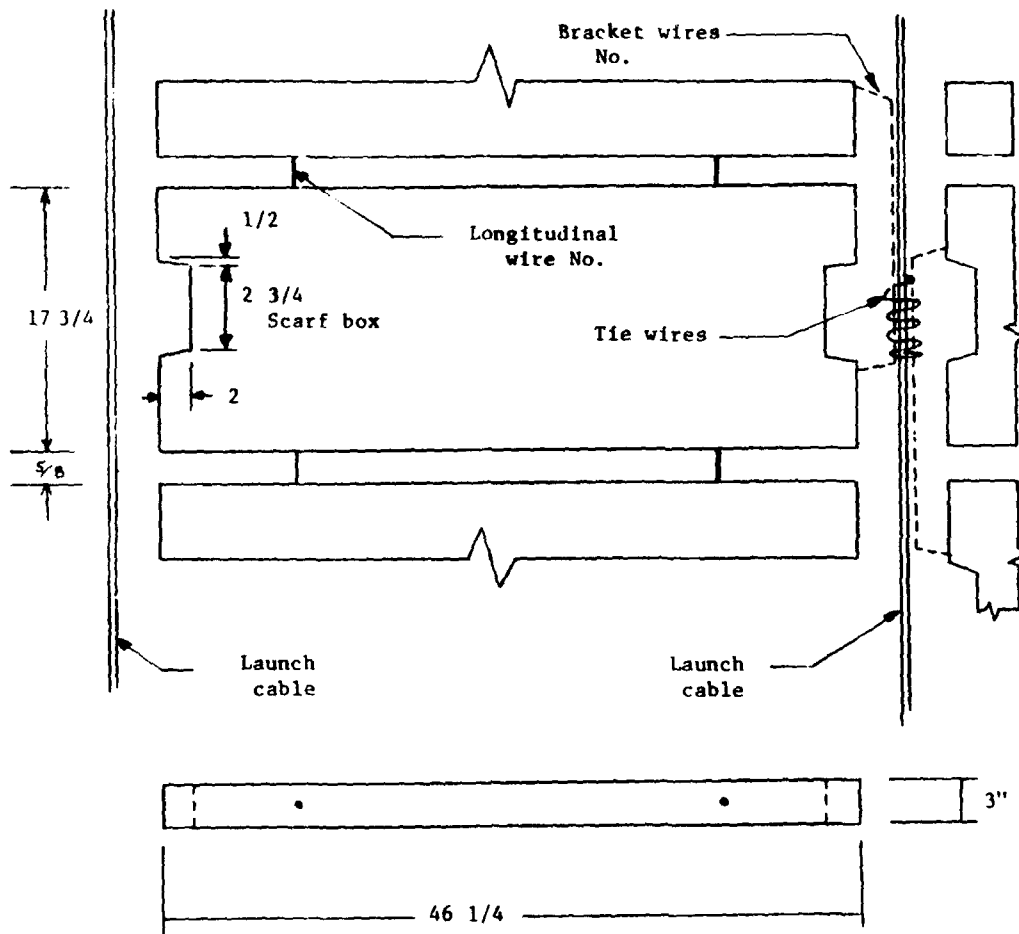

Figure 3. Schematic of cast mattress blocks.

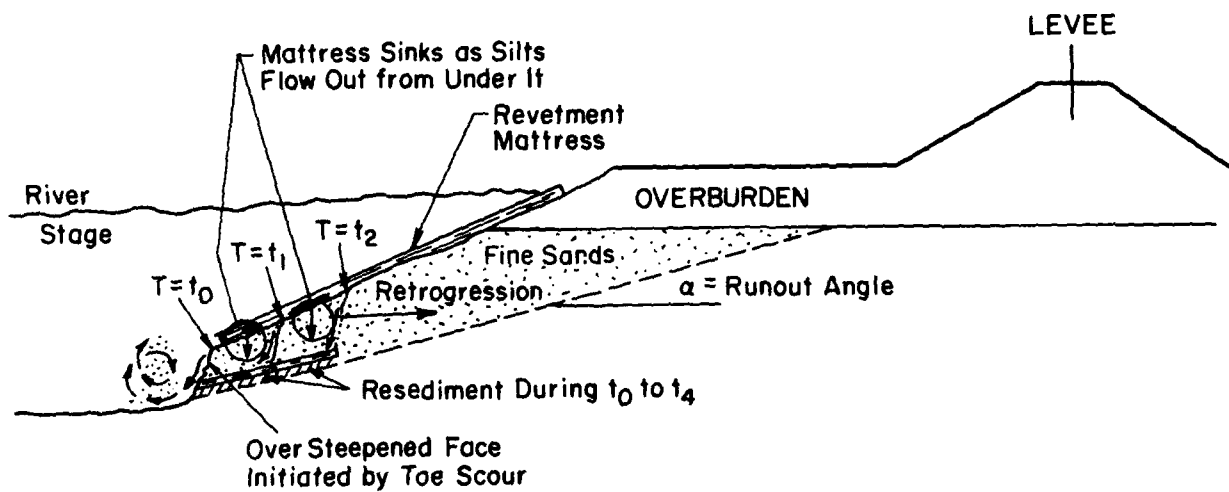

Figure 4. Illustration of toe scour mode theory.

2 SURVEY OF MATTRESS OPERATION

The revetment mattress operation includes: (1) casting the mattress sections (squares), (2) transporting the sections from the casting site to the sinking location, and (3) laying, or sinking, the constructed mattress. The first and third steps involve considerable manual labor. Any disruption of the sequence or timing can greatly increase total operational costs due to losses in labor productivity. To acquire a better understanding of the overall operation and identify areas where solutions could be attempted, the processes of casting, transporting, and sinking were observed.

Casting Mattress Sections

The revetment mattress is composed of several small concrete blocks connected together. These blocks are cast in a row with an internal wire insert as shown in Figures 3 and 5. The wire insert provides the longitudinal wires connecting the individual blocks in a row and the bracket wires used to connect the squares to each other. The cast unit is referred to as a square since it is approximately 100 square feet in area (roughly 4 ft wide x 25 ft long).

The casting procedure begins by placing the wire insert and metal form on top of kraft paper. The paper keeps the concrete from binding to adjacent layers. The wire insert is locked in place so it is centered in the thickness of the form. Concrete is then placed into the forms, leveled, and finished. After the concrete has set, the metal form is removed. As one layer of squares is curing, a second layer is cast on top. This sequence is repeated until 13 layers have been cast.

Transporting Mattress Squares

After the necessary curing time has passed, the cast mattress squares are ready to be transported to the site. The stack of 13 squares is picked up by a crane equipped with a special fixture and is placed on a flatbed trailer. The crane's special fixture contains teeth that hook the exposed bracket wires. The lower wires frequently are deformed by this action as shown in Figure 6. After being moved to the river, the squares are unloaded from the trailer onto a barge and transferred to the sinking location.

Mattress Placement

The Corps has two mattress sinking units. It is on these units, or physical plants, where the squares are connected to form the mattress and placed on the riverbank or riverbed. One unit operates out of the Memphis District; the other out of the Vicksburg District. Although these units have some different features, their overall operations are the same.

The mattress squares are picked up from the supply barge and placed in a single layer on the deck of the sinking unit. The squares are connected together with a corrosion resistant tie wire wrapped around adjacent bracket wires (Figure 3). The tie is placed using the tying tool shown in Figure 7. The tying operation also incorporates a heavy steel cable used in launching the mattress. This launch cable is run longitudinally on the sides of the mattress squares. The cable is dispensed from below the deck of the sinking plant. A schematic of the constructed mattress is shown in Figure 8.

The concentrated open areas are easily seen in Figure 8. The gaps between the individual blocks of a given square are typically 5/8-in. wide. The gap between each longitudinal row of squares is typically 1 in. The largest open areas are where the scarf box cutouts line up for the tying tool. This opening is approximately 3 x 8 in. for an assembled mattress.

Mattress placement starts by tying several rows of squares and positioning them as close to the water's edge as possible by using a mechanical "finger" that extends from the front of the sinking unit. The ends of the launching cables are secured to the riverbank and the finger is retracted. After another section of mattress is tied together, the mattress moves down a slight incline on rollers to the launch edge of the sinking unit. The mattress is pulled over the launch edge as the sinking unit moves away from the shoreline and by the weight of that portion of the mattress already in the water. Sections of mattress are tied and launched every 3 to 5 minutes. When enough mattress length has been placed, the launch cables are cut, thereby releasing that section of the mattress. The sinking unit is then repositioned upstream to start another pass. The next pass will typically overlap the previous mattress as required depending on field conditions. This process continues until the complete area of riverbank or riverbed to be revetted is finished.

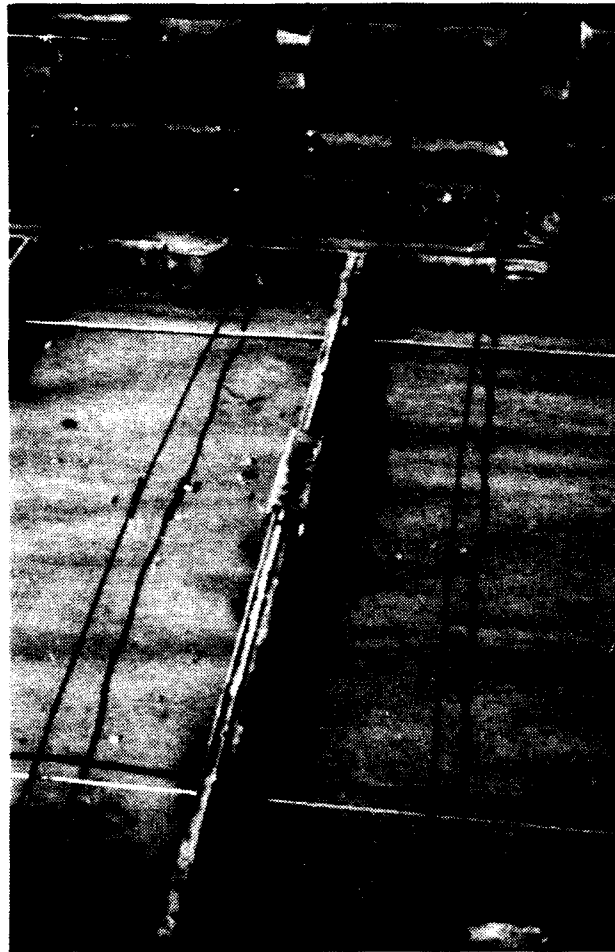

Figure 5. Internal wire insert.



Figure 6. Bracket wires deformed by lift fixture.



Figure 7. Tying tool used to fasten squares together.

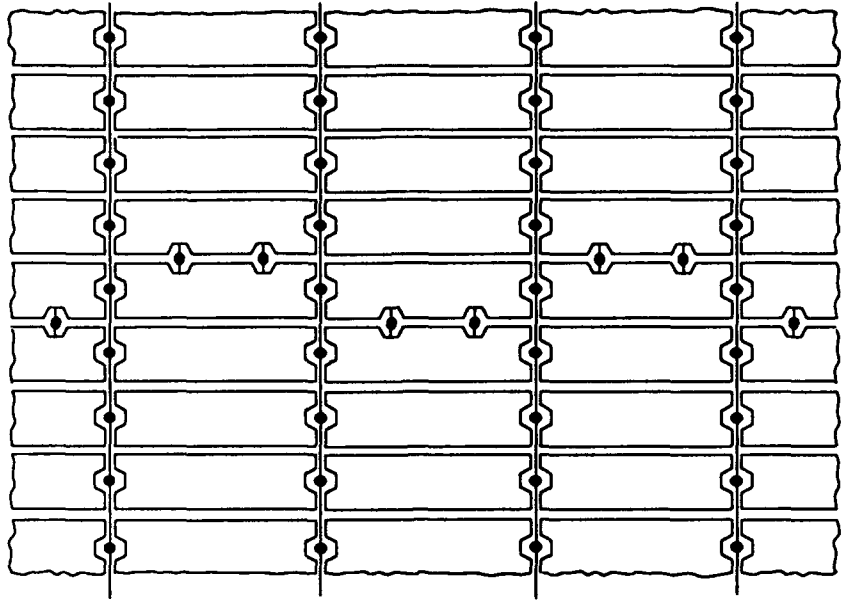

Figure 8. Schematic of constructed mattress.

3 SURVEY OF SOLUTIONS

Constraints

LMVD personnel indicated that any technique used to eliminate erosion of the soil under revetment mattresses must conform to the following operational and physical plant constraints:

1. The technique must not cause the launch sequence to exceed 10 minutes.
2. The technique must be functional in all types of weather, especially if it is raining or if the mattress components are wet.
3. The technique must not pollute the river with undesirable leachates.
4. Total operational costs (both labor and materials) to place a section of "erosion resistant" mattress must be less than the cost to place a double thickness (offset to stagger the openings) of the current mattress design. At the start of this project, sinking costs were about \$80 per square and material costs were about \$50 per square. The \$130 total per installed square was, of course, a maximum limit. LMVD personnel set a more idealistic target of \$60 per square for addition costs.
5. Major changes to the existing sinking plants are not acceptable.
6. Any changes to the mattress sections must not make placement/sinking more difficult or dangerous. This item is especially important in river "hot spots" where turbulent currents exert high stresses on the suspended mattress during sinking.

Preliminary Investigations

Since the majority of the open area is represented by the gaps between each longitudinal row of mattress squares, the initial study efforts addressed the possibility of filling these gaps by injecting or applying a material. The substance would be applied after the squares were tied together, but before the sections were launched. After a thorough review of the sinking operations and various materials to fill the gaps, this technique was regarded as impractical for one or more of the following reasons.

1. The filler material may have less than 5 minutes to acquire sufficient cohesive and adhesive strengths before being lowered into the water. Although certain flexible foams or epoxies might work under very controlled conditions, these materials do not lend themselves well to the type of environment present on the sinking plant, especially without major physical plant changes. Rapid curing and attainment of physical properties would be absolutely necessary for the material to have any chance of surviving the stresses of the launching process. The currents pushing against the filler material would tear loose any material that did not have sufficient adhesion to the mattress materials (i.e., the concrete, launching cables, or bracket wires) or poor material cohesive strengths.
2. Possible wet conditions of the mattress component surfaces further reduce the chance for proper bonding or curing.

3. Placing the mattress in locations where the current is strong is sometimes difficult, even when some of the water can flow through the existing open area in the mattress. Occasionally the pressures are great enough to break launch cables. Completely closing the mattress open area poses a safety hazard, especially for personnel on the launching deck. A mattress with almost no open area would exacerbate the situation.

4. Even if some filler material could survive launch and sinking, the amount needed to fill the gaps in the current mattress design would make this technique uneconomical. On a volume basis, concrete is much cheaper than the candidate filler materials.

5. Some filler material, especially when subjected to constant immersion, is not durable. The chemical composition of some materials and additives increases the possibility of leaching.

6. The technique of fastening strips of preformed solid or porous sheets into or over the openings was also considered. This approach would most likely require additional personnel to attend the operation and properly attach the material to the bracket wires and/or launch cables. Also, the scarf box cutouts present a nonuniform gap that would require an oversized piece of material for complete coverage. The cutouts along the 4-ft ends of the squares where they are attached together in the longitudinal rows would also need to be covered. Attaching an oversized sheet of material on top of the squares would reduce the effectiveness and/or survivability of the material since the river currents would tend to lift it, fold it, or tear it apart.

Geotextiles

Since the technique of attaching filler strips to the top of the mattress is impractical, the technique of attaching it to the bottom was evaluated. In this technique, the in-place mattress blocks, cables, and exposed bracket wires would secure the material. Geotextiles are ideal candidates since such materials are readily available and would not present a completely impermeable layer. Because geotextiles are porous, water would drain from the soil side and reduce the potential for swelling due to water pressure buildup under the mattress. Also, depending on the percent of open area of the geotextile that would allow water to flow through the material, launching difficulties could be lessened in "hot" currents.

Previous Evaluation of Geotextiles With Revetment Mattresses

In 1977, USACE with cooperation from the Mississippi River Commission and LMVD attempted to assess the advantages and determine potential problems associated with the combined use of a geotextile and an articulated concrete block mattress.² Full-scale field tests were conducted in Tennessee and Kentucky in which concrete blocks were cast directly on a geotextile.

The behavior of the concrete-geotextile composite was observed during a full-scale launch procedure. The composite appeared to perform adequately after specific measures to improve the bonding characteristics between the concrete and the geotextile were adopted. Specific measures were necessary because the geotextile alone exhibited inadequate bond strength with the concrete. The bond strength was

² B.J. Littlejohn, *Use of Plastic Filter Cloth in Revetment Construction: Potamology Research Project II*, Report No. 21.5 (Potamology Investigations, August 1977).

improved by sewing two 1/8-in. hollow polyethylene cords along the length of the geotextile and near the edge of the forms for the concrete blocks. The concrete flowed around the cords during the casting process and anchored the geotextile to the concrete. Only a few minor separations occurred between the concrete blocks and the geotextile during the launch process. The full-scale tests demonstrated that the fabric could survive the launch procedure. However, no studies were conducted on the concrete-geotextile after the launch to determine if the fabric was intact and in place. A minor disadvantage with the procedure was that cords had to be sewn into the geotextile, presenting an extra step in the construction. Proper placement of the cords was an additional consideration during casting.

The fabric was a geotextile with the trade name Poly-Filter X, supplied by Carthage Mills Incorporated. Poly-Filter X is a monofilament, woven geotextile with an Equivalent Opening Size (EOS) of 70 and a Percent Open Area (POA) of 5. The fibers composing the geotextile are made of polypropylene.

Other tests in 1984 and 1985 with geotextiles was conducted wherein the fabric was incorporated during the tying operation. Sheets of fabric were laid over the deck rollers and launch cables. The squares were then placed on top of the fabric and fastened together as usual. The fabric was sandwiched between the launch cables and the concrete blocks.

The fabric had to be cut to insert the tying tool over the bracket wires and the launch cables. Having to manually spread out the fabric and make the cuts in the fabric, decreased production substantially. Even with practice, it took more than 30 minutes for a launch sequence. The survivability of the fabric during launch and sinking was unknown.

Reconsideration for Use of Geotextiles

Since the basic concept of attaching a geotextile to the underside of the mattress appeared to be promising, researchers looked into automating the process. The step requiring the most time was the manual operation of spreading out the fabric before mattress construction. Therefore, if the fabric could be dispensed as a continuous sheet, considerable time could be saved. Rolls of fabric could be mounted on the back end of the sinking unit; the fabric could then be used only if needed. Unfortunately, the sinking units do not have enough clearance to safely mount fabric rolls on the back. Dispensing the fabric from the front of the sinking unit and attaching it under the mattress just before launching was also considered. This technique is also not possible without major changes to the physical plants. Because of the restriction on major changes to the sinking units, the technique of attaching the fabric to the squares as they are being cast was reconsidered.

Many new geotextiles have been introduced to the market since the previous tests were conducted. Woven and nonwoven geotextiles have been manufactured to satisfy the requirements of different uses (e.g., civil engineering). Additionally, the products are more economical today and the geotextile industry is more competitive than 15 years ago when it was a "special service" industry. With the variety of economic materials available today, the feasibility of the concrete-geotextile solution was reinvestigated.

Both woven and nonwoven geotextiles have been used successfully worldwide in civil engineering works to protect against loss of soil while allowing water to pass freely through the fabric.³ Therefore, the current study includes the investigation of both woven and nonwoven geotextiles. Figure 9 contains photomicrographs showing the basic fiber differences between these two types of geotextiles.

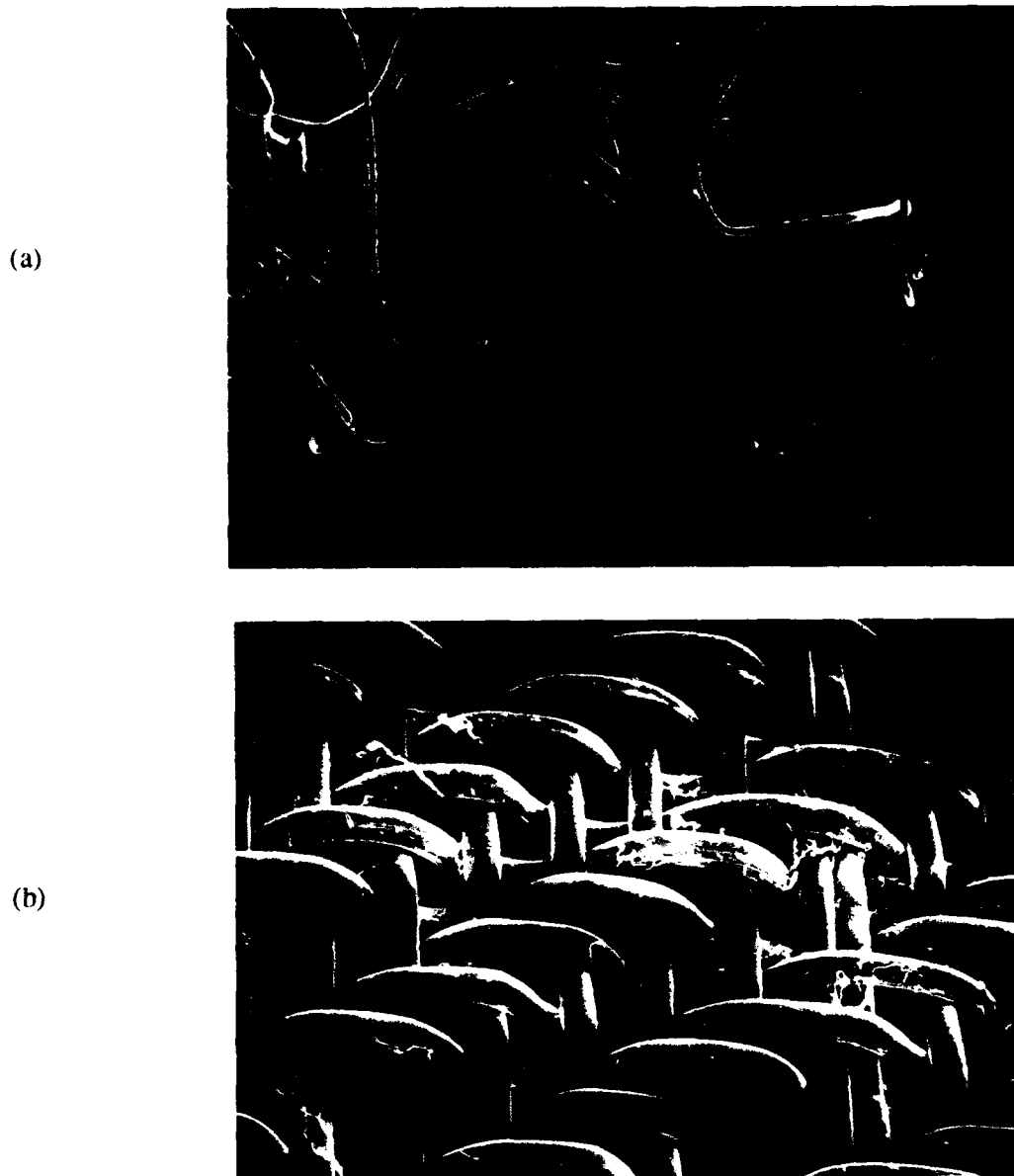

Figure 9. Photomicrographs showing (a) woven and (b) nonwoven geotextile fibers.

³ R.M. Koerner, *Designing with Geosynthetics* (Prentice-Hall, 1986); R.V. VanZanten, *Geotextiles and Geomembranes in Civil Engineering* (Halsted Press, 1986); B.R. Christopher and R.D. Holtz, *Geotechnical Engineering Manual* (U.S. Department of Transportation, Federal Highway Administration, February 1984).

4 GEOTEXTILES

Requirements for Survivability

To be successful, a geotextile must be able to protect soil from erosion after being subjected to the stresses, strains, and abrasion that occur during the casting, handling, and launching procedures. The geotextile must demonstrate durability, resistance to abrasion and tearing, good bond strength to concrete, and sufficient strength. Integrity of the geotextile between gaps of the mattress must be ensured. The ability to resist the effects of these hazards depends on fabric characteristics such as type of weave, size and chemical composition of individual fibers, and thickness.

Resistance to Tension

The geotextile may tear if tensile strains exceed the rupture strain. Tensile strains occur during the launch operation as the mattress approaches the mudline and is subjected to an upward curve. If the geotextile is bonded firmly to the concrete (no slippage occurs at the interface between the geotextile and the concrete), tensile strains can approach 160 percent for the portion of the geotextile located between gaps. If the geotextile and concrete form a bond that can be broken at the interface by tensile loads, a portion of the geotextile will separate from the concrete during high stresses. This lengthens the portion of geotextile over which tensile deformations are applied and therefore reduces the tensile strains imposed on the geotextile. Thus the geotextile can minimize the effects of tension by

1. Being able to withstand tensile strains around 160 percent without tearing, or
2. Reducing the magnitude of tensile strains by slipping along the concrete-geotextile interface and increasing the length of geotextile over which the tensile deformations are applied.

All geotextiles considered for this project will rupture or tear if the tensile strain is large enough. However, depending on the characteristics of the fabric, there is a wide range of strains at which tearing occurs. The characteristics of the geotextile during extension are important because they may govern the suitability of the material. Generally, woven geotextiles rupture at much lower strain levels (usually less than 30 percent) than do nonwoven geotextiles (typically greater than 80 percent). Therefore, based solely on the requirement that the geotextile be capable of resisting large strains without tearing, nonwoven geotextiles are better suited to survive the launching procedure.

Woven geotextiles can also survive large deformations by bonding to the blocks at some distance from the edge, so a greater length of geotextile is available for straining. The total tensile strain in the geotextile thus may be reduced to a value less than 30 percent; tearing is prevented.

Resistance to Peeling

The geotextile must also exhibit sufficient bond to resist peeling away from the concrete mattress. Separation at the interface between the concrete blocks and the geotextile can occur if a weak bond exists under one or more of the following conditions:

1. During handling, transportation, and launching of the mattress (random pulling of the geotextile),

2. As the geotextile skids over the rollers (the geotextile may get caught in some projection and peel away from the mattress).

3. If a loose end of the geotextile folds under the moving mattress (it may snag and be peeled away),

4. As the mattress enters the water (the current may peel the fabric away from the concrete block), and

5. As the mattress is placed at the mudline (the curvature of the mattress may stretch the geotextile, break the bond, and allow the fabric to peel away).

Geotextiles respond differently when the fabric is pulled parallel with its plane; this behavior will be discussed later.

The peel strength of a geotextile is a measure of the strength of the interface between the geotextile and concrete. There is little information about the peel strength between concrete and geotextiles. However, there are specific requirements for the two materials if the peel strength is to be adequate. These requirements are as follows:

1. The geotextile should have a geometry that allows concrete to flow around and embed the individual fibers,

2. The fibers of the geotextile embedded in the concrete should be strong enough to provide adequate resistance to tensile failure during peeling, and

3. The concrete should flow readily before being cast and have good tensile strength.

The first two requirements can be realized by using a geotextile with relatively large fiber diameters (denier), strong tensile strength (e.g., polyester), large openings (large EOS), and a loose arrangement of fibers. Such a geotextile would have large voids to allow concrete to flow into the pores.

If the geotextile exhibits weak peel strength, the bond strength could be enhanced significantly by incorporating projections that attach the geotextile to the concrete and provide good anchorage. The concrete should be as strong as possible and flow readily around the fibers to embed them.

Resistance to Peeling With Respect to Resistance to Tearing

The ideal geotextile should be able to stretch significantly and form a bond with the concrete that is stronger than the geotextile's tensile strength. This would ensure that the material remain in place even if handling or installation procedures were conducive to separating the geotextile from the concrete blocks. If such a geotextile began to rip or tear from the concrete block, it would tear only up to the interface of the concrete block or point of anchorage and stop rather than propagate a bond failure. The significance of this would be that a small piece of geotextile may tear off, but most of the geotextile would not separate from the concrete blocks.

Geotextiles with these characteristics generally have projections extending above the surface that serve as anchors and prevent it from peeling away from the concrete.

Resistance to Abrasion

The geotextile is subjected to abrasion as the mattress slides over the metal surface of the launching fingers. This action has the potential to damage the geotextile by tearing, shearing, gouging, and cutting.

The skids of the launching barge may be covered with several longitudinal welds to reduce wear on the skids. Undoubtedly, these welds will be uneven and cause the material to tear, peel, or abrade as it slides over the welds. Geotextiles composed of a dense arrangement of strong fibers, such as polyester, provide better resistance to the effects of abrasion than fiber composed of polypropylene. Additionally, higher fiber density would favor higher-weight fabrics.

Other Considerations

Other aspects such as cost, resistance to environmental exposure, and stiffness of the geotextile are also important. The geotextile should be inexpensive since several million square feet of mattress are placed every year. This requirement favors the use of materials that are already manufactured and produced in large quantities rather than those specially designed for bonding with concrete.

Portions of the geotextile will be exposed to the sunlight and open environment from the time the blocks are cast until the time they are tied together and launched. These portions include the edges protruding from the blocks and the strips between the blocks on the top layers of the stacks of cast mattress squares. The time of this exposure may be as much as 1 year. Therefore, the geotextile should be able to resist effects of weathering and exposure to sunlight (ultraviolet [UV] radiation). Both polypropylene and polyester offer adequate resistance to UV radiation when carbon black is added to the fiber material.

During the process of casting concrete directly on the geotextile, the high alkalinity of the concrete can degrade some polymers in the geotextile. Polyesters may degrade (lose some of their strength) due to prolonged alkaline exposure. Polypropylene, however, resists degradation in alkaline environments more successfully.

The bending stiffness of the geotextile is also important. The geotextile should be stiff enough to allow loose ends to span the 2- to 4-in. gap and protect soil from eroding between the blocks. It should also be stiff enough to preclude fluttering due to water flowing between the gaps.

Denier and Surface Features

Nonwoven geotextiles are composed of fibers oriented randomly throughout the geotextile. It is important for developing a good bond with the concrete that the individual fibers be as strong and durable as possible and that large open spaces exist between the fibers to allow the concrete to flow around them anchoring them to the concrete. Therefore, a nonwoven geotextile should have a large denier, a large void ratio, and most importantly, a large void size. For example, in a comparison between the bond strength of two equal-weight geotextiles with the same thickness and chemical composition but with different

deniers, tests would show that the geotextile with the large denier size would exhibit stronger bond with the concrete because the individual fibers are stronger, and because there is more space for the concrete to flow around the fibers and provide good anchorage. Generally, woven geotextiles will exhibit inferior bond strengths unless special measures are incorporated to modify the surface of the geotextile. Geometric features can be added to geotextiles to improve their bond characteristics.

Several off-the-shelf products show promise and may perform adequately during installation, launching, and post launching. Since relatively little information is available regarding bond strength and abrasion resistance of geotextiles and the geotextile-concrete interface, a series of tests were performed and are discussed in Chapter 6.

Geotextiles Tested

Sixteen different geotextiles from seven different manufacturers were tested. The bond characteristics of both surfaces were tested for most of the geotextiles. More than 150 tests were performed to assess the effect of the construction procedure and characteristics of the geotextile on developing strength and bond with the mattress.

Nonwoven Geotextiles

Five manufactures provided 11 different nonwoven geotextiles. Nonwoven geotextiles possess many of the properties needed to provide protection against erosion while also providing a surface for bonding with concrete. Nonwoven geotextiles have been used world-wide for drainage and separation as referenced in Chapter 3. Table 1 lists the geotextiles studied in this investigation and the properties that help identify the material.

Several of the geotextiles (4 through 11) are off-the-shelf products while others (1 through 3) were developed specially for this project. Although geotextiles #1 through #11 are nonwoven, there are differences in the way they were manufactured, materials that compose the fibers, and geometry of the fibers.

The first three nonwoven geotextiles listed in Table 1 were manufactured by Foss and do not represent products currently on the market. However, small quantities were made available for testing. These geotextiles are considered "unique" because they have large voids, large denier, and the ability to survive large strains without tearing.

Geotextiles #1 through #3 were constructed of large denier fibers (20) and had a very fuzzy texture because of the large thickness/weight ratio. Geotextile #1 is composed of polyester fibers. Numbers 2 and 3 were composed of polypropylene. Geotextile #2 had the largest void size of the fabrics tested, and geotextile #3 was identical to fabric #2 except it was impregnated with latex during the manufacturing process. The latex coated the fibers and made the fabric stiffer while still allowing it to be permeable. This stiffness would help the fabric remain in place and protect the soil between gaps in the mattress as water from the river currents flowed above. The more flexible geotextiles would tend to flutter due to river currents, or the edge flaps would bend back due to pressure from the current during launching.

Table 1
List of Geotextiles and Critical Information

No.	Manu- facturer	Product	Weight (oz/sq yd)	Thickness (mils)	Weave	Heat Treat	Filament Length	Color	Fiber	Denier Size	EOS	POA	Comments
1	Foss	G6001A	12	356	nonwoven	no	stapled	white	polyester	20	na	na	
2	Foss	G6001B	12	413	nonwoven	no	stapled	black	polypropylene	20	na	na	
3	Foss	G6001C	12	386	nonwoven	no	stapled	black	polypropylene	20	na	na	Impregnated with latex
4	Foss	Geomat 400	12	146	nonwoven	no	stapled	gray	polyester	12	100	na	
5	Foss	Geomat 100	6	121	nonwoven	no	staples	gray	polyester	12	60	na	
6	Phillips	Supac 12NP	11	145	nonwoven	yes	stapled	gray	polypropylene	10	100-120	na	Calendered on one side
7	Phillips	Supac 8NP	7.2	100	nonwoven	yes	stapled	gray	polypropylene	10	70-100	na	Calendered on one side
8	Reemay	Typar 3601	6	24	nonwoven	yes	continuous	gray	polypropylene	10	170-200	na	Calendered on one side
9	Reemay	Typar 3401	4	15	nonwoven	yes	continuous	gray	polypropylene	na	70-100	na	
10	Hoechst	Trevira 1125	7.1	100	nonwoven	no	continuous	gray	polyester	4.8	70	na	
11	Amoco	4557	12	na	nonwoven	yes	stapled	black	polypropylene	4*	70	na	
12	Nicolon	40/30A	5.6	30	woven	na	monofilament	black	polypropylene	565	40	20	
13	Nicolon	40/30A	5.6	30	woven	na	monofilament	black	polypropylene	565	40	20	Tuft added for bond
14	Nicolon	40/30A	5.6	30	woven	na	monofilament	black	polypropylene	565	40	20	2 Tufts for bond
15	Nicolon	40/30A	5.6	30	woven	na	monofilament	black	polypropylene	565	40	20	2 Tufts (sparse)
16	Robusta	Robusta	16	na	woven	na	**	black	polypropylene	na	na	na	Patented loops for bond

* - estimated from microscopic measurements of fibers
** - fibrillated and twisted yarns

The remaining nonwoven geotextiles (#4 through #11) are off-the-shelf products. The two Foss products (#5 and #4) are stapled, nonwoven geotextiles with polyester fibers, and reported weights of 6 and 12 oz/sq yd, respectively. They have a relatively loose weave. Additionally, the stapled fibers allow large fabric strains before rupture.

The geotextiles provided by Phillips (Supac, #6 and #7) are nonwoven with stapled fibers. One side of the fabric was heated during the manufacturing process to create a relatively smooth surface. The other side of the fabric is rough and fuzzy. Concrete bonds better with the rough textured face than the heated side because there is more void space between fibers.

The two products from Reemay (#8 and #9, Typar 3601 and Typar 3401) are lightweight nonwoven geotextiles that are heated and pressed during the manufacturing process. This results in a thin fabric with very small void spaces.

Hoechst provided geotextile #10 (Trevira 1125), a needle-punched, nonwoven geotextile with continuous polyester fibers. The individual fibers are much straighter than fibers in geotextiles #1 to #7 and appear to be oriented primarily in the longitudinal direction. Several individual fibers can be seen above the surface of the geotextile providing it with a rough, fuzzy surface.

The Amoco 4557 (#11) is a needle-punched, polypropylene nonwoven fabric with one side heat treated; thus, one side of the fabric is smooth and the other side is rough.

Although many more nonwoven geotextiles are manufactured, those tested during this research represent a cross-section of products commonly available. Most of the nonwoven geotextiles currently on the market are believed to perform within the range observed within this study.

Most of the geotextiles selected for testing were relatively thick. A thick geotextile is preferred because it is better able to resist the abrasion during the launch procedure and it would have enough tensile strength to force failure through bond rather than tensile failure of the fabric.

Woven Geotextiles

Woven geotextiles (#12 through #16) can also provide protection for the soil between the gaps in the concrete mattress. Four of the geotextiles tested (#12 through #15) were manufactured by Nicolon and one (#16) was manufactured under the name of Robusta. The Nicolon geotextiles are the same except for the characteristics of the polymer tufts sewn into the fabric for improving bond. Geotextiles #12 and #16 are "off-the-shelf" products; the others were manufactured specially by Nicolon for this research project. Woven geotextiles typically bond poorly with concrete because their tight weave prevents the fibers from anchoring in the concrete. Additionally, woven geotextiles rupture at strains of less than 30 percent (approximately) and therefore are poorly suited to survive strains imposed as the mattress is placed. Methods to improve the bond strength between the woven geotextile and the concrete incorporate structural projections that are tied to the fabric and allow embedment into concrete.

Geotextile #12 has monofilament fibers with large opening sizes and a large percent open area. Since the woven material bonds poorly with concrete, special modifications were incorporated. The other Nicolon samples contained tufts of fibrillated polypropylene yarn protruding from the geotextile. For fabric #13, the yarns were sewn from the back of the geotextile so they could not be pulled out from the top side without breaking the individual fibers of either the geotextile or tufts. The tufts resembled the

same material from which artificial grass is made. Tufts of polypropylene yarns were produced by sewing individual rows (6 across) to form a 1-in. wide tuft. The concrete would flow around the tufts and provide good anchorage. Geotextile #14 was identical to #13 except anchorage was provided by two tufts running parallel to each other and separated by approximately 6 in. Many of the individual yarns were removed from the tufts in geotextile #15. The sparse tufts allowed better penetration and embedment in the concrete.

The manufacturing procedure used to insert tufts in the Nicolon geotextile damaged some of the fibers that compose the material. Therefore, every tuft sewn in the fabric formed a line of weakness. Tests were conducted in both the warp and weft directions to determine the effect of the lines of weakness on the strength of the fabric and on the bond strength.

The Robusta product (#16) is manufactured in the Netherlands specifically for bonding with concrete. The patented fabric consists of a tightly woven geotextile with individual yarns composed of fibrillated polypropylene. Very strong loops of polypropylene fibers are woven in the structure of the fabric without affecting the fabric strength significantly. The loops embed in the concrete and provide anchorage while the integral weave of the loop and geotextile resist any tendency to be separated from the geotextile. The fabric is relatively strong and bonds extremely well with concrete cast directly on it. The geotextile has been used successfully by the Dutch for many years.

Other woven materials with projections designed to anchor the geotextile to the concrete could have been custom manufactured and tested; however, the main purpose of these tests was to determine what modifications to woven fabrics would be necessary to ensure the fabric's survival during the launch procedure, if the modifications would help, and what possible consequences may result from modifying the geotextile.

Geotextile Costs

Material costs for the geotextiles vary with quantity ordered, current prices of polymer materials, and other factors. Therefore it is difficult to determine the cost of each product. The costs of geotextiles #1 through #15 were less than \$1.50/sq yd at the time of the tests. This cost is similar to other geotextiles of similar weights. Thus, it may be concluded that the majority of woven and nonwoven geotextiles are inexpensive. At approximately \$1.50 per square yard for the geotextile, the additional material costs would be approximately \$16.70 per mattress square. Even with some additional labor costs at the casting site and the sinking plant, the total additional cost should be well below the desired \$60 maximum per square.

The most expensive geotextile was #16 at approximately \$3.60/sq yd. Additional material costs using this fabric would be approximately \$40 per mattress square. With additional labor costs at the sinking and casting sites, total additional costs could come close to the \$60 per square maximum. However, this geotextile exhibited the most favorable properties during most of the laboratory tests conducted on the fabric and concrete-geotextile composites.

5 LAUNCH LOADS AND DEFORMATIONS

Any geotextile used with a revetment mattress must be able to survive the abrasion and strain associated with launching. The geometry of the edge of the barge (launch edge) is shown in Figure 10. A geotextile attached to the bottom of the mattress is subjected to friction and abrasion as the concrete-geotextile composite passes over the edge of the barge. Abrasion can damage the fabric or cause it to peel away from the concrete. The geotextile must also resist the abrasion at the edge of the barge. It must also be able to resist tensile strains as the composite approaches the river bed. The mattress assumes an upward curvature as it approaches the mudline, which can induce significant tensile strain in the fabric attached to the bottom surface. Therefore, the geotextile must be able to resist the tensile strain without debonding or rupturing.

Load While Passing Over Skids

Any geotextile used with a revetment mattress is subjected to abrasion as it is pulled over the edge of the barge. The geometric shape and the surface texture of the launching skid significantly influence the normal and tangential force at the contact between the mattress and the edge of the barge.

Barges used for launching have been in service for many years and the surface of the launching skid is smooth. However, the edge of one of the launching plants (the Vicksburg plant) is maintained by welding beads of hardened steel along the surface of the launch skid that contacts the mattress during launching (Figure 11). The welds are formed with rods containing a very hard steel and are oriented both perpendicular and parallel to the direction the mattress moves. The weld surface is rough and the weld thickness varies. The influence of the welds on forces imposed on the geotextile will be greatest immediately following maintenance of the edge because the surfaces of the welds are roughest at this time. This condition was assumed and simulated for evaluating the geotextiles.

It was necessary to consider the force applied to the concrete blocks and the geometry of the edge over which the blocks move to estimate loads between the geotextile and edge of the barge. A radius of 19.75 in. (Figure 10) was used to represent the geometry of the launch skid and each block was taken to be 18 in. wide.

The division of force between the launch cables and the longitudinal wires was evaluated using results reported by Kearney and Prendergast.⁴ Although their study considered concrete blocks with widths different from those considered in this study, the conclusions regarding the relative magnitudes of load shared between the launch cables and wires should still be a valid approximation. The maximum total downward force considered on the mattress at the edge of the launch barge in Technical Report M-94 was the weight of 100 ft of mattress hanging in the water, which was also adopted for the current study.

The weight of an individual block was calculated to be roughly 214 lb based on dimensions shown in Figure 3. Since the blocks are submerged, the buoyant weight of 124 lb/block was used to determine the total weight of the mattress hanging in the water 100 ft. This length consists of 4 squares at 16 blocks per square, or a total force of 8.0 kips at the water surface. Though the blocks have slightly different

⁴ F. Kearney and J. Prendergast, *Study of Articulated Concrete Revetment Mattress: Test and Analysis—Results of FY 1974 Program*, Technical Report M-94/ADA 021774 (U.S. Army Construction Engineering Research Laboratory [USACERL], January 1976).

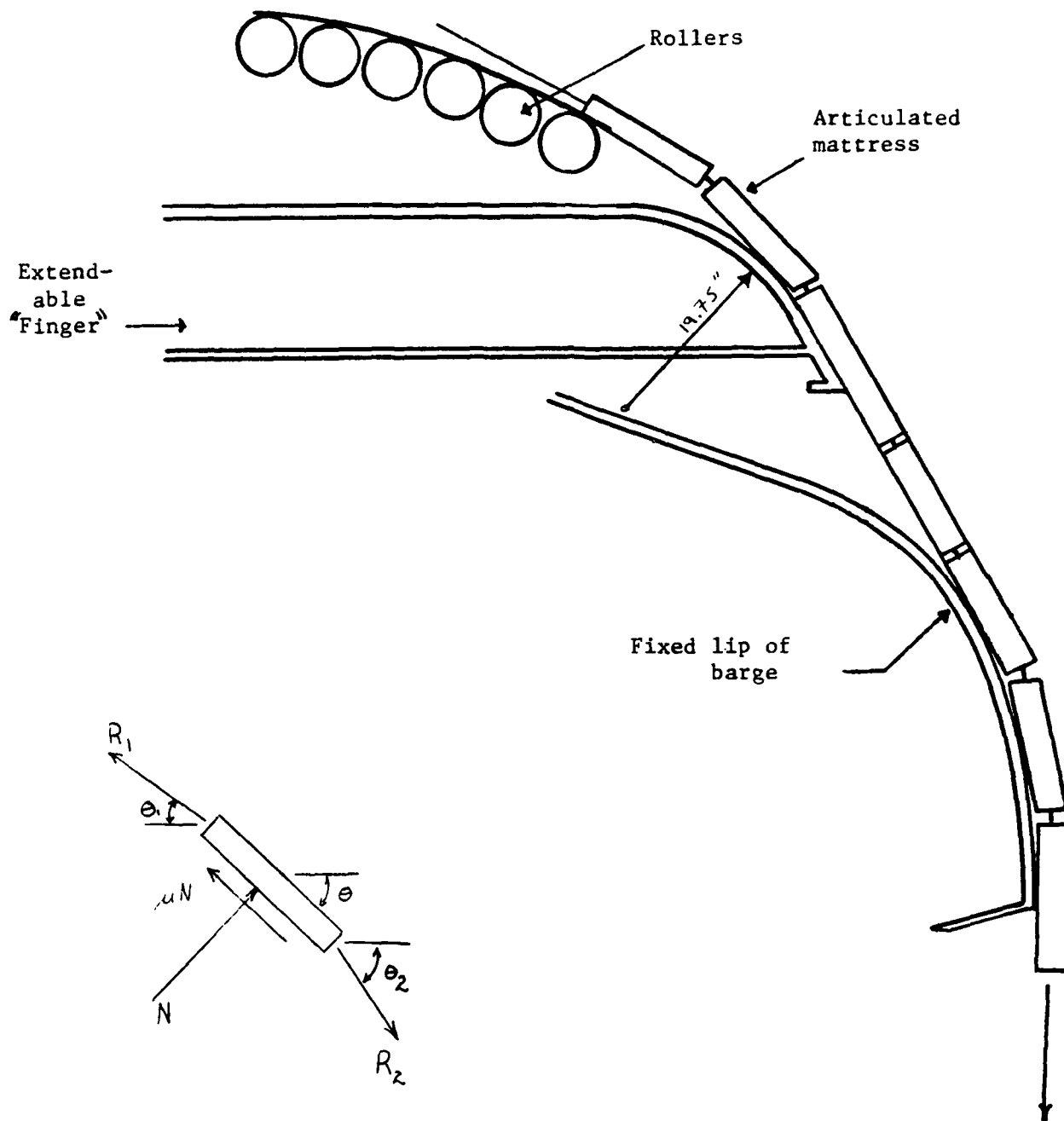

Figure 10. Cross-sectional view of the launch edge of the sinking plant.

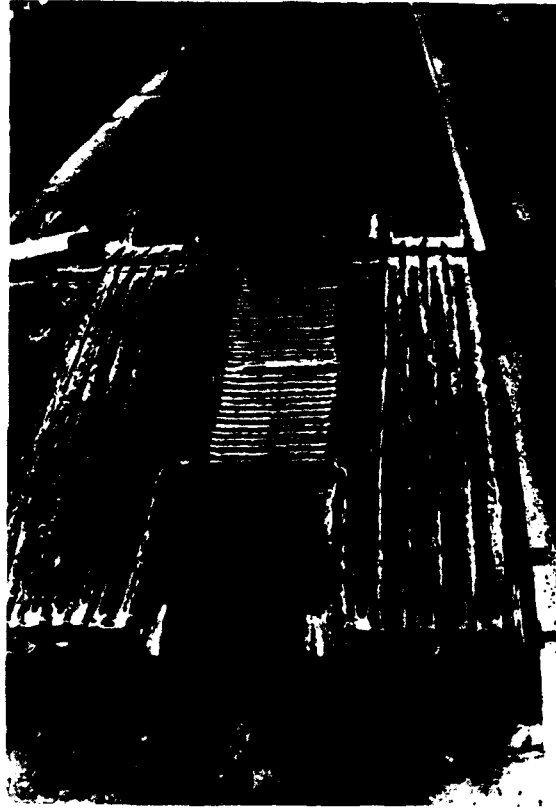

Figure 11. Welds on the launch edge of the Vicksburg sinking plant.

dimensions in the investigation discussed in TR M-94, the total submerged weight of 100 ft of mattress agrees well with the computed value in that report. The weight of four additional blocks between the water surface and the curved edge of the barge was added to this weight providing a total force of 8.9 kips.

The mattress weight is supported by both the longitudinal wires connecting the blocks and the launch cables between the squares to which the blocks are attached by bracket wires. The launch cable is fairly stiff; the bracket wires connecting the cables to the concrete blocks are flexible. The distribution of total load between the launch cable and longitudinal wires depends on the stiffness of the bracket wires. For the bracket wire dimensions used, however, the launch cables support most of the load.

A computer model⁵ was used to determine that approximately 30 percent of the total force is carried by the longitudinal wires between blocks, resulting in a force of 2.7 kips. The normal and shear forces acting on a block as it progresses over the curved edge of the barge are shown in Figure 10. The forces vary as the block progresses because the direction of the force in the longitudinal wires on each side must agree with the location of the adjacent blocks and the direction of these forces affect the normal force on the skid.

Various positions of the block on the surface of the launch skid were considered and the normal force, N , and shear force, μN , at the contact point were calculated for each position using equations of equilibrium. Normal forces were calculated to range from 1.7 to 2.3 kips as the block moved over the launch skid. (The maximum normal force of 2.3 kips was used in the abrasion tests discussed in Chapter 6.)

Another factor also contributes to normal forces. The launch cable is pulled down against the skid plates at the edge of the barge as the mattress passes over the launch skid (Figure 12). The launch cable pulls the bracket wire down, which results in a downward force on the concrete blocks and increases the force between the block and launch surface. This effect is small compared to the normal load already calculated; thus, the maximum value of the normal force previously calculated was used to estimate the normal force applied in the abrasion tests.

Load While Approaching Mudline

The launch begins with the barge near the shore and the launch finger extended while the launch cables are tied to the bank. The finger is then retracted and the barge backs away from the shore. As the blocks are assembled, the barge moves back from the bank, allowing the mattress to hang in the water. An illustration of the mattress suspended in the water during a launch is shown in Figure 13.

At the lowest point in the water, the mattress curves upward causing gaps along the top surface to close and gaps along the bottom surface to widen. The mattress is fed out as it is assembled, and the barge movement is adjusted so the mattress extends straight down from the edge of the barge until it rests on the bottom. A small tension is maintained on the assembly of squares, but the curvature is sharpest at the change in angle from the vertical to the mudline slope as shown in Figure 13. The increase in the gap width between blocks along the bottom where the geotextile is attached causes the geotextile to stretch. Tensile strain imposed on the geotextile can be calculated assuming the two blocks rotate about

⁵F. Kearney and J. Prendergast.

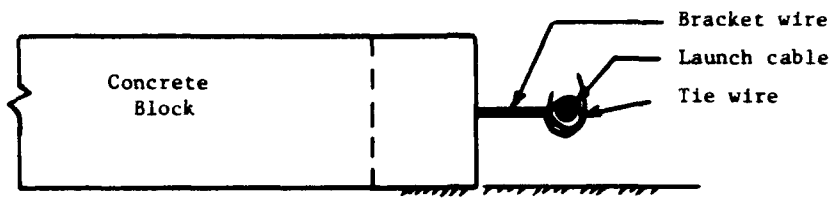

Configuration of launch cable and bracket wire on rollers when they are tied together

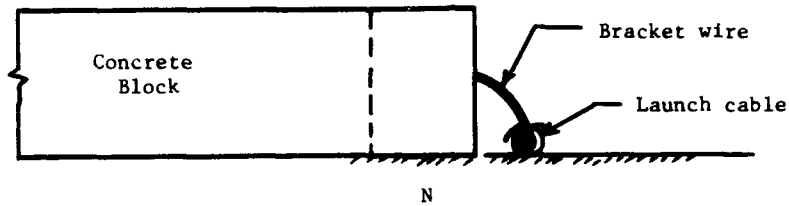

Configuration of launch cable and bracket wire as blocks are launched over movable finger

Figure 12. Additional normal force due to launch cable pulling down on bracket wire.

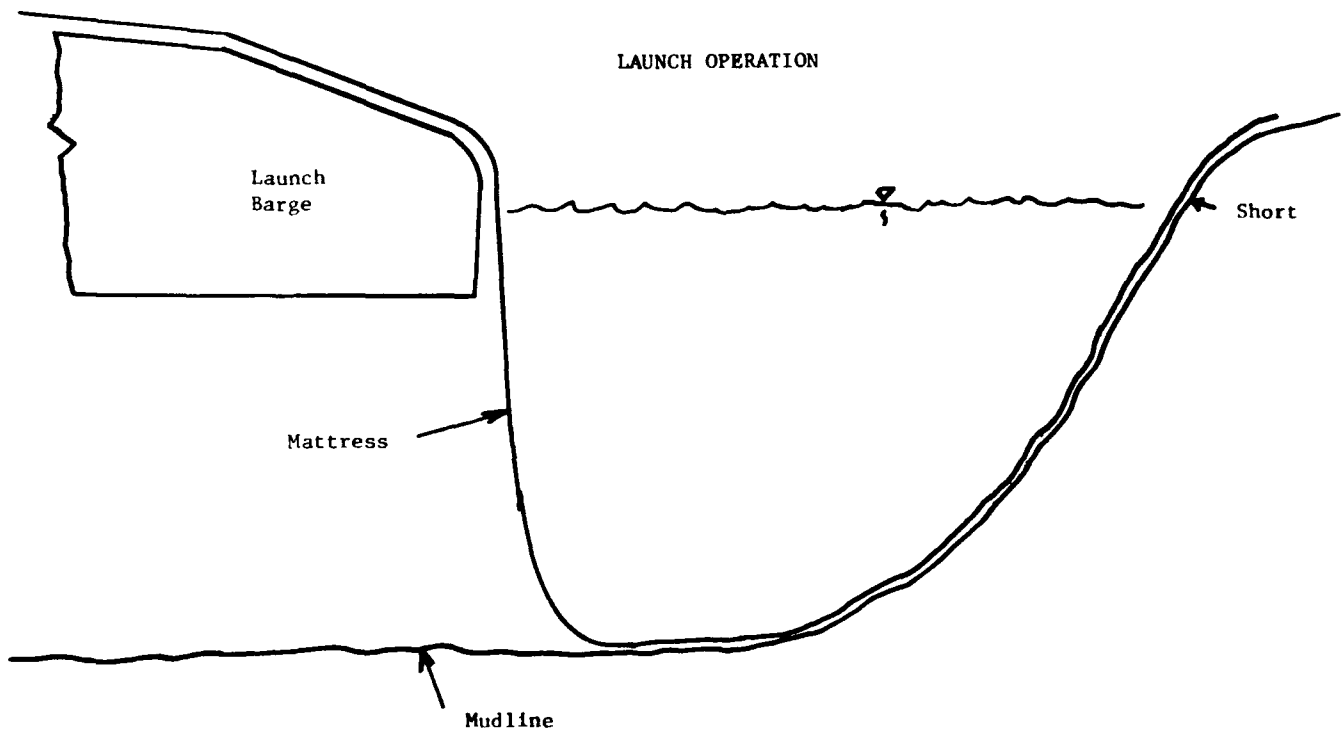

Figure 13. Illustration of cable being launched.

the wire reinforcement. It is believed that the curvature at the bottom will reach its maximum value, which occurs when the gap at the top surface closes completely. The geometry of the joint in the as-cast and closed-at-top-surface condition are shown in Figure 14. It is assumed that the fabric provides so little structural resistance that the closed-at-top-surface condition can be attained. If conditions exist where the bond between the geotextile and mattress is very strong and the geotextile exhibits high strength and modulus, the geotextile may contribute structurally to the resistance and the closed-at-top-surface condition may not be reached. However, the closed-at-top-surface condition provides an upper value of tensile strains the fabric must survive.

The tensile strains imposed on the geotextile along the bottom surface of the mattress can be estimated from the geometry change of the joint shown in Figure 15. When the blocks are cast there is a 0.625-in. gap at the bottom surface. In the deformed position, the gap extends to 1.625 inches. A geotextile bonded to the mattress on both sides of the gap would experience a tensile strain of 160 percent. In reality, there would be some bond failure between the fabric and concrete near the edge of the block that would allow the extension to be distributed over a greater length of fabric, thus reducing the strain. For example, if debonding occurred for 1.0 inch along each side of the gap, the elongation would still be 1.0 inch, but it would be distributed over 2.625 in. (instead of 0.625 in.) so the strain would be only 38 percent. A fabric suited to survive the deformations between the gaps must be able to withstand large strains or to experience limited, but not excessive, debonding.

Modes of Failure Due to Loads

Failure of the geotextile between gaps can occur in two ways. The fabric may tear if its tensile strength is less than the strength of its bond with the concrete. If a tear occurs in the geotextile at the joint between the concrete blocks, the fabric cannot prevent soil erosion. A second type of failure may occur if loads imposed on the fabric exceed the bond strength between the fabric and concrete but are smaller than the tensile strength of the geotextile. In this case, the fabric could remain intact but may peel away from the mattress allowing the river current to carry it away from the mattress. However, the fabric can both debond and perform properly if the amount of debonding is limited.

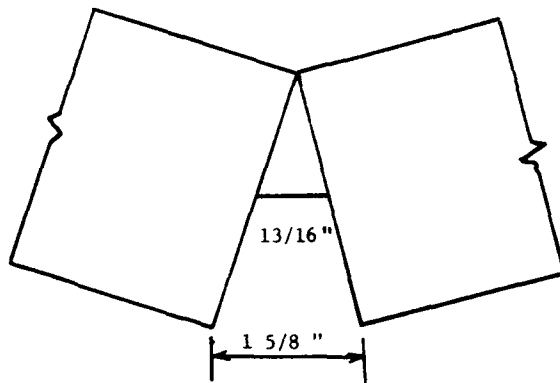
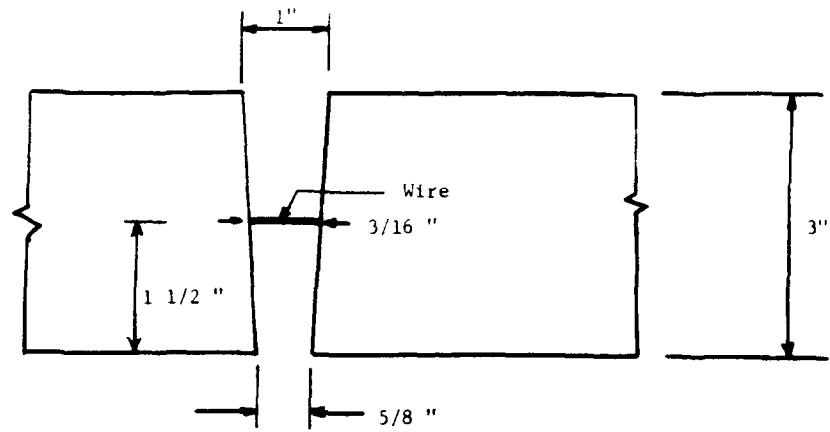

Figure 14. Geometry of block joint "as-cast" and at the point of maximum upward curvature.

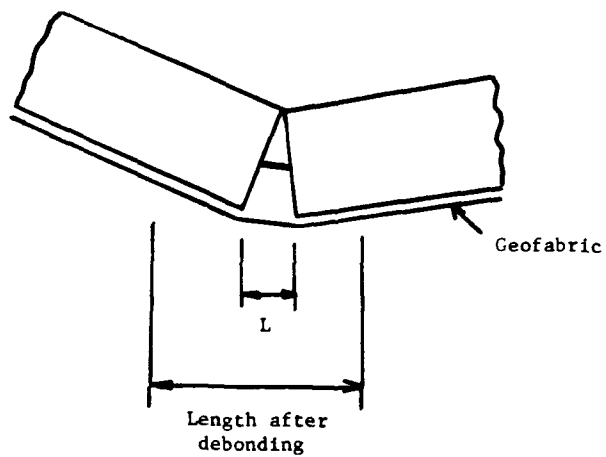

Figure 15. Joint in equilibrium configuration.

6 LABORATORY TESTS

Under contract from USACERL, the Department of Civil Engineering at the University of Illinois researched the feasibility of incorporating geotextiles with the concrete mattress to reduce the risk of levee erosion. The study was limited to determining whether adequate bond strength could be developed between the geotextile and the concrete mattress to withstand loads during transportation and launching. Tests were developed to simulate deformation conditions similar to those anticipated during launching. Three basic tests were used to define the suitability of the geotextiles: wide-strip tensile tests, peel tests, and abrasion tests. Bending tests were also performed on selected geotextiles. The tests were conducted on several geotextile and concrete-geotextile composites.

The wide-strip tensile test was performed to determine the strength and stress-strain characteristics of the geotextile. The peel test was used to determine the bond strength between the geotextile and the concrete. The abrasion test was performed to simulate loads and boundary conditions associated with the geotextile being dragged over the edge of the barge during launching.

Tension-shear and tension-bending tests were conducted on geotextiles that performed well on the first three tests. These additional tests evaluated the behavior of the geotextile when bonded to concrete and subjected to tension. All five tests are described below.

Wide-Strip Tensile Tests

Specimen Preparation

Geometric and procedural details of the wide-strip tensile tests performed for this study follow closely the recommendations made by ASTM D4595-86.⁶ The geotextile was cut into an 8-in. square. A 2-in. strip along the top and bottom of the sample was coated with a liquid polyester resin and allowed to harden for at least 24 hours. Four holes were punched through the polyester-reinforced fabric along a line 1 in. from the edge of the specimen. The specimen was then inserted into loading heads that clamped metal plates across the polyester-reinforced edges, thus preventing slippage between the clamps and the geotextile. The geometry of the loading head is illustrated in Figure 16. The two ends of the geotextile were clamped by steel plates and pulled apart at a rate of 0.5 in./min while the load-deformation characteristics at the head of the clamp were recorded. The deformation rate was selected based on a speed that allowed the geotextile to fail in a reasonable amount of time, but slow enough to allow detailed observations to be recorded during the test.

Wide-strip tensile tests were conducted for all the geotextiles. A photograph of the wide-strip tensile test is shown in Figure 17. Effects of several variables were investigated, such as the effect of the rate of extension on the stress-strain behavior, the effect of moisture on the stress-strain characteristics and the effect of orientation of the geotextile with respect to the orientation of the axial load. Measurements of load and deformation were recorded for each test and visual details of failure were observed and documented.

⁶ ASTM D4595-86, "Test Method for Tensile Properties of Geotextiles by the Wide-Width Strip Method," *Annual Book of ASTM Standards*, Vol 04.08 (American Society for Testing and Materials).

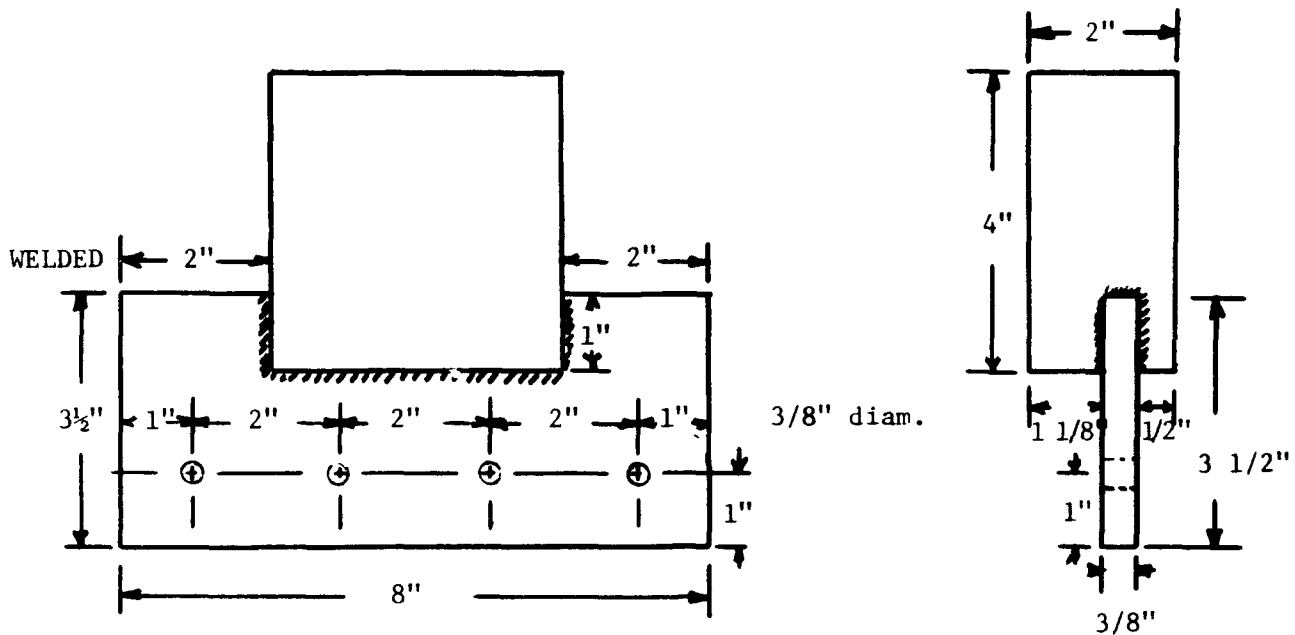

MACHINE ATTACHMENT

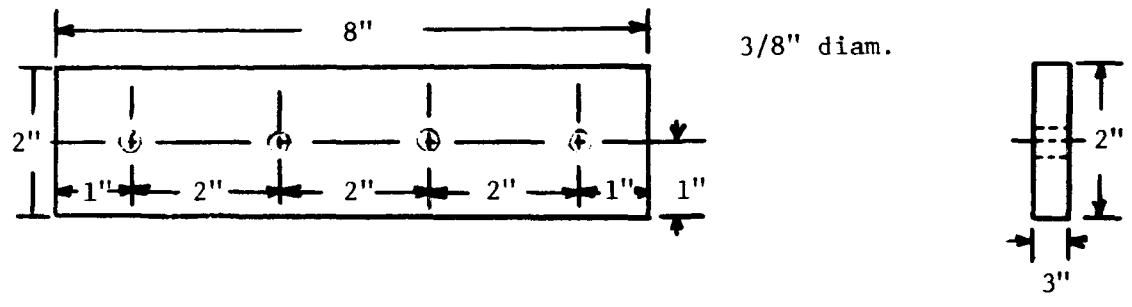

RIBBED PLATE

Figure 16. Diagram of loading head for wide-strip tensile test.

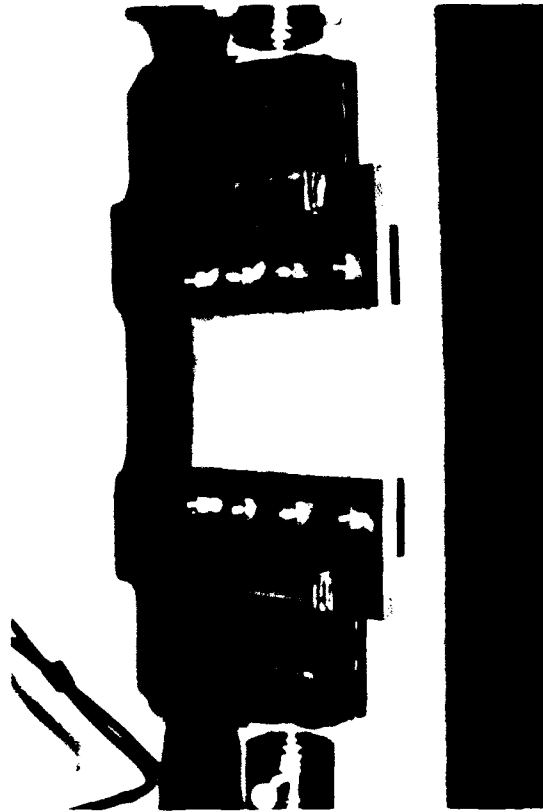

Figure 17. Photograph of wide-strip tensile test in progress.

Visual Appearance of Failed Specimens

Three types of failure patterns were observed during the wide-strip tension tests conducted on the nonwoven fabrics: rupture of the geotextile by tearing (1) across the middle, (2) diagonally, or (3) horizontally near the clamping plates. Most of the failures exhibited classic failure patterns by beginning to tear at one side and progressing across the specimen. Rupture of individual fibers produced noticeable popping sounds during the tests.

The modes of failure during a wide-strip tensile test can be influenced by the boundary conditions applied by the clamps used to pull the fabric. To ensure proper boundary conditions were being applied by the grips, each specimen was inspected during and after testing. Elongation of the specimen within the clamps was monitored by drawing a line along the geotextile-clamp interface. This line was observed during the tests to remain stationary; thus, the fabric was not stretching within the clamps. After the wide-strip tensile test was complete, the specimen was removed from the testing device, and the holes previously punched in the geotextile were inspected. If the geotextile slipped in the clamps during the test, the bolts passing through the four holes would bear against the fabric and elongate the holes. Because no hole elongation was evident for any geotextile except #8, it was determined that the method adopted for clamping the geotextile wide-strip specimens was adequate and imposed boundary conditions consistent with those specified by ASTM D4595-86.

Some specimens tore diagonally or along the geotextile-clamp interface. Geotextiles #1 through #3 generally experienced failure accompanied by the geotextile rupturing near or adjacent to the clamps.

Failures that occurred near and parallel to the clamp were associated with fabrics that experienced very large strains before rupture. Specimens #4 through #11 exhibited failures that passed through the middle of the sample.

Observations made during wide-strip tensile tests on woven materials indicated rupture through the middle of the specimen and no hole elongation. Vertical fibers on the edges of the sample elongated and frayed. The edge fibers also broke just before reaching the peak load. Failure propagated from the edge and proceeded across the middle of the sample.

Woven materials modified to improve bond characteristic of the geotextile exhibited less strength than the original specimens. Modification caused damage to some of the fibers in the woven fabric. Failure of the modified geotextiles occurred along the lines of weakness created by the added loops or tufts. Reduced strengths, and a tendency to rupture along predefined lines of weakness were observed for geotextiles #13 through #16.

The appearance of geotextile #16 after rupture was slightly different from the appearance of #12. As axial tension was applied, the horizontal fibers of #16 (normal to the pull direction) separated from one another while the vertical fibers elongated and frayed. The difference in appearance at failure can be attributed to fibrillated yarns used in #16, while monofilaments were used for geotextile #12.

Results

Results from more than 100 tensile tests on the geotextiles are summarized and shown in Table 2. The maximum strengths and strains reported for the geotextiles loaded in the warp direction represent the average of three wide-strip tensile tests. One test was conducted to determine the strength with the load in the cross-machine direction. The results of the wide-strip tensile tests are shown in Figure 18.

The nonwoven geotextiles ruptured at strain levels between approximately 50 and 140 percent. Geotextiles #2, #3, and #6 experienced strains above 90 percent before rupturing. This is probably due to their loose weave, polypropylene composition, and use of stapled fibers. Geotextile #2 experienced the most strain of any fabric by rupturing at an extension of 140 percent. This fabric has a very loose weave and a stapled fiber composition. The minimum strain at rupture for a non-woven geotextile loaded in the machine direction was experienced by geotextile #10 at 55 percent. This was because the fibers were tighter, more highly oriented, and made of polyester. All these factors contribute to a more brittle behavior. The straightness of the fibers in geotextile #10 is illustrated in Figure 19 by comparing the fiber orientation of #10 with that of another nonwoven geotextile.

The woven geotextiles generally failed at strains less than 30 percent. Several variations of the woven types are listed in Table 1 because the stress-strain behavior of a woven fabric can be anisotropic due to the geometry of the weave and the density of the fibers in each direction. Additionally, the orientation of the yarns or loops used to improve the bond affects the stress-strain characteristics. Geotextile #12 ruptured at a load of 210 lb/in. at a strain of 32 percent.

Geotextile #15 exhibited lower strengths than the parent fabric, #12. The manufacturing process required to insert the tufts damaged some fibers of the geotextile. These specimens were tested in directions parallel and perpendicular to the orientation of the tufts and the reductions in strength are shown in Figure 18. The strength of geotextile #13 with tufts oriented parallel to the direction of load is approximately 15 percent less than the tufted fabric. This reduction is slight because the lines of weakness run parallel to the direction of load and the undamaged fibers run continuously along the length of the wide-strip

Table 2

Results of Wide-Strip Tensile Tests

No.	Mfg/Product	Load in Machine Direction		Load in Cross-Machine Direction	
		Maximum Tensile Strength (lb/in.)	Strain at Max. Strength (percent)	Maximum Tensile Strength (lb/in.)	Strain at Max. Strength (percent)
1	Foss G6001A	87	66	128	56
2	Foss G6001B	53	141	100	81
3	Foss G6001C	50	91	103	39
4	Foss Geomat 400	42	85	80	50
5	Foss Geomat 100	24	61	32	52
6	Phillips Supac 12NP	102	91	160	98
7	Phillips Supac 8NP	82	81	116	81
8	Reemay Typar-3601	66	73	74	79
9	Reemay Typar-3401	*	*	*	*
10	Hoechst Trevira 1125	99	55	81	51
11	Amoco 4557	*	*	*	*
12	Nicolon 40/30A	210	32	178	43
13	Nicolon-with 1 tuft	180	24	35	8
14	Nicolon-with 2 tufts	**	**	35**	8**
15	Nicolon-with 2 tufts (sparse)	**	**	35**	8**
16	Robusta	540	14	358	16

* - Test not performed.

** - Test not performed, but results would be similar to Nicolon with 1 tuft.

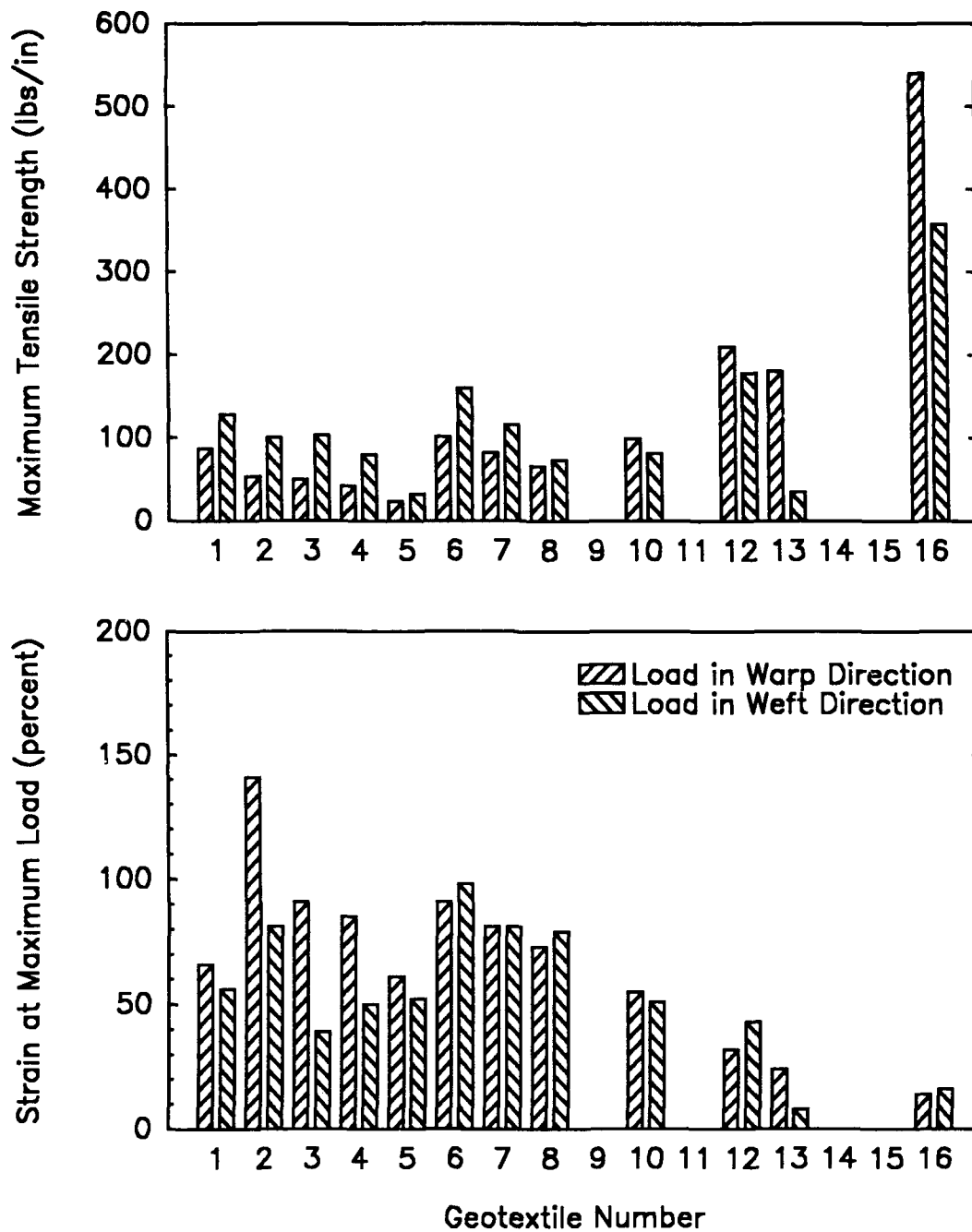

Figure 18. Results of wide-strip tensile tests.

(a)



(b)

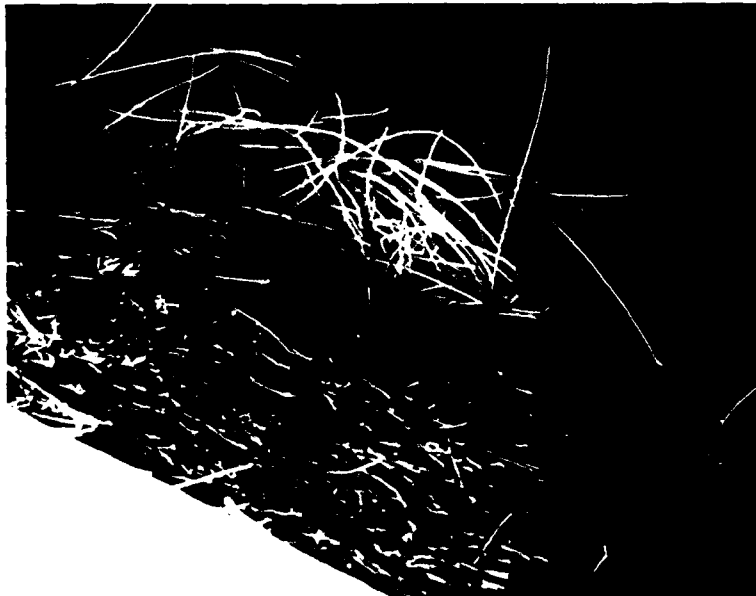

Figure 19. Photographs of (a) normal fabric fibers and (b) Hoechst Trevira fibers.

specimen. However, a reduction of approximately 80 percent resulted when the load was oriented perpendicular to the line of tufts. The severe reduction in this direction occurred because the line of damage significantly reduced the number of undamaged fibers running continuously along the length. The presence of two rows of tufts (geotextile #14) decreased the strength slightly more than experienced with only one row because twice as many fibers were damaged. However, for loads oriented along the weft, the strength was very similar to that of geotextile #13 because the fabric continued to fail along the same line of weakness.

Geotextile #16 also had a certain degree of anisotropy due to the loops modifying the structure of the slit film woven geotextile and due to the different density of yarns in each direction. The negative effect of the loops was minimized by adopting a manufacturing process that induced minimal damage to the fibers of the geotextile.

Peel Tests (180 Degree Pull)

Specimen Preparation

Specimens for the peel test were composed of concrete blocks 8 by 8 by 3 in. cast on geotextile specimens. Sixteen blocks were cast from each batch of concrete, and sixteen specimens from the same geotextile were used for each cast. Twelve specimens of fabric measuring 9 by 32 in. were cut with the longer dimension parallel to the warp and 4 specimens of the same size were cut with the longer dimension in the weft direction. Some geotextiles had a different surface texture on each side, so additional tests were conducted to determine the peel strengths resulting from casting concrete on the rough side and smooth side of the geotextile.

Concrete used in the experiments was similar to concrete used for mattress blocks. Proportions of the concrete mix were scaled from weights used in the field to produce a volume of 1 cu yd. Components and proportions of the concrete mix used to make laboratory specimens are shown in Table 3.

Table 3
Concrete Mix for Tests

Component	Amount
Coarse Aggregate	152 lb
Fine Aggregate	97 lb
Cement	22 lb
Fly Ash	5.5 lb
Calcium Chloride	0.3 lb
Water	16 lb
Water Reducer	43 mL
Air Entrainer	13 mL

Well-graded river gravel with maximum particle size less than 1 in. was used as the coarse aggregate and mixed thoroughly with the other dry ingredients. Liquid agents and calcium chloride were allowed to dissolve in the water before it was added to the dry components. Additional water was added when necessary to achieve a 3-in. slump; the amount of extra water varied from 1 to 3 lb.

The fresh mix of concrete was cast on top of the geotextile in four separate units with each unit containing four blocks. Steel angles and plates were bolted on 2 by 4 ft sheets of plywood. The geotextile specimens were placed on the plywood and aligned so that 12 in. of fabric would extend beyond the edge of the finished concrete block. The geotextile was held in place by the steel angles that formed the 8-in. square concrete blocks (Figures 20, 21, and 22). Each of the four forms was used to investigate the effect of different variables. Four blocks in Form 1 were cast as control specimens. The concrete was placed with a scoop, worked into the corners and edges of the form and leveled (Figure 23). A mechanical vibrator was then run across the top to smooth the rough surface (Figure 24). The geotextiles were wetted before the concrete was placed to form the four blocks cast in Form 2. Water was poured on the form and allowed to soak in; the excess water was removed. Form 3 used specimens identical to Form 1, except the geotextile was cut in the weft direction. Specimens for Form 4 were cast by inserting the vibrator into the concrete in the form many times to assure good flow of the concrete around the fibers of the geotextile. All specimens were troweled smooth (Figure 25). Six 2-in. cubes were cast from the remaining concrete. The cube molds were also vibrated across the top. Specimens and cubes were then covered with damp burlap and plastic and allowed to set for about 24 hours in the laboratory, after which they were removed from the forms, set aside, and covered for another 48 hours. Specimens were then stacked to await testing.

Test Apparatus

Peel tests were conducted in a Tinius Olsen Testing Machine which provided control of the rate of displacement and a pen-plot of the load-deflection relationship for each test. Specimens were held in a special saddle (Figures 26 and 27) fastened to the bottom platen of the machine. The saddle held the concrete block in a vertical position to expose the geotextile surface (Figure 28). The long portion of the geotextile was oriented vertically, folded, and clamped into a grip attached to the machine's top platen (Figures 29 and 30). This allowed a length of about 9 in. of geotextile to stretch between the grip and interface where the geotextile was embedded in the concrete surface.

Test Procedure

Peel tests were run conducted 7 and 21 days after casting. A photograph of the peel test in progress is shown in Figure 31. The geotextile was peeled at an initial rate of 0.5 in./min until a relatively uniform peeling load was attained. In most cases this was achieved when the geotextile peeled a distance of 1 to 2 in. The rate of deformation was then changed during the test to 2 in./min, 10 in./min, and 20 in./min until a uniform peeling load was reached at each load. Typically, the average peel strength at faster rates was slightly higher than that of the initial rate, but so was the variation in load. The variation increased significantly at the higher rates of 10 and 20 in./min, and rarely was there enough geotextile left to produce an extended plot of the load. Observations of the geotextile and concrete interface, the visual appearance of the geotextile, and the final surface of the concrete after testing were recorded.

General Observations

Control specimens of the nonwoven geotextiles typically had a number of fine fibers embedded in the concrete and small bits of concrete embedded in the geotextile (Figures 32 and 33). During the test,

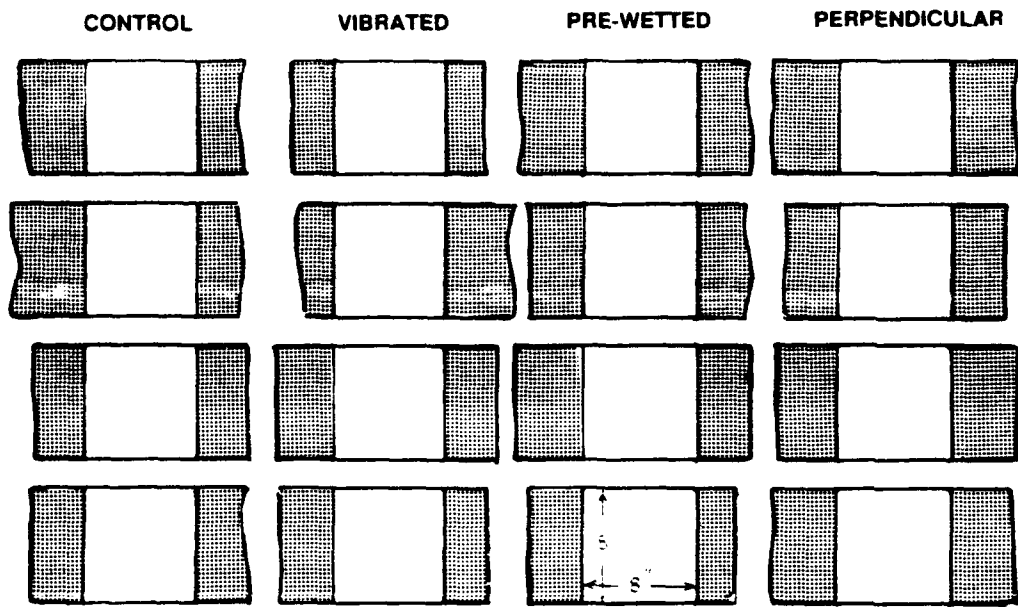

SPECIMEN GEOMETRY



Figure 20. Schematic setup of specimens used for peel tests.

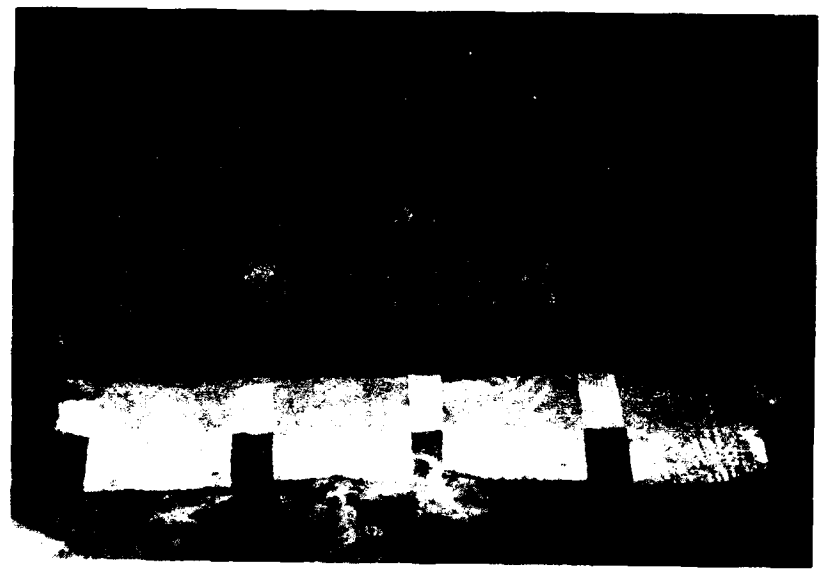

Figure 21. Closeup view of plywood and steel form work with geotextiles in place.

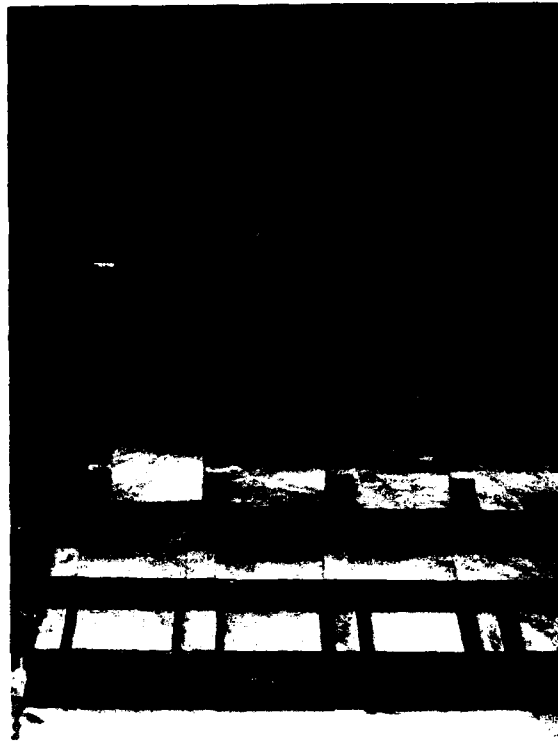

Figure 22. View of form for all specimens.

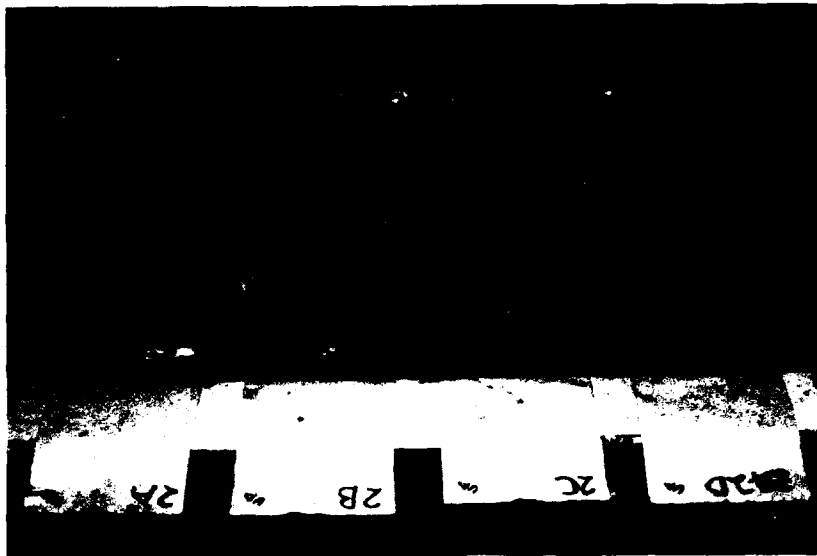

Figure 23. View of forms with concrete placed.



Figure 24. Leveling of concrete in mold with vibrator.



Figure 25. Final smoothing of specimens with trowel.

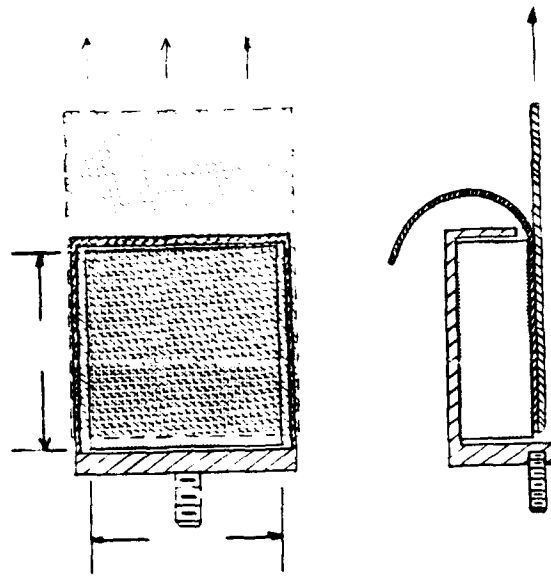

PEEL TEST DETAILS

Figure 26. Schematic of saddle used for peel test.



Figure 27. Photograph of saddle used for peel test.



Figure 28. Specimen for peel test being inserted into saddle.



Figure 29. Specimen oriented vertically in saddle.

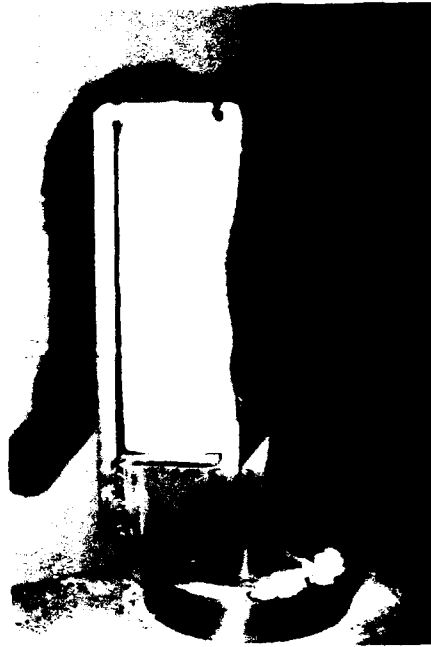

Figure 30. Specimen with top plate clamped on geotextile.

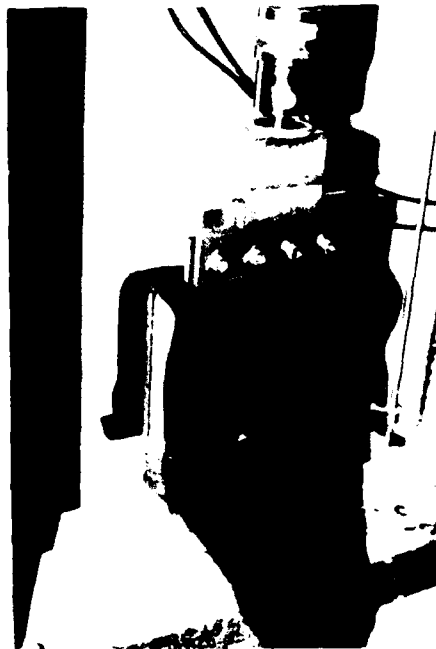

Figure 31. Peel test in progress.

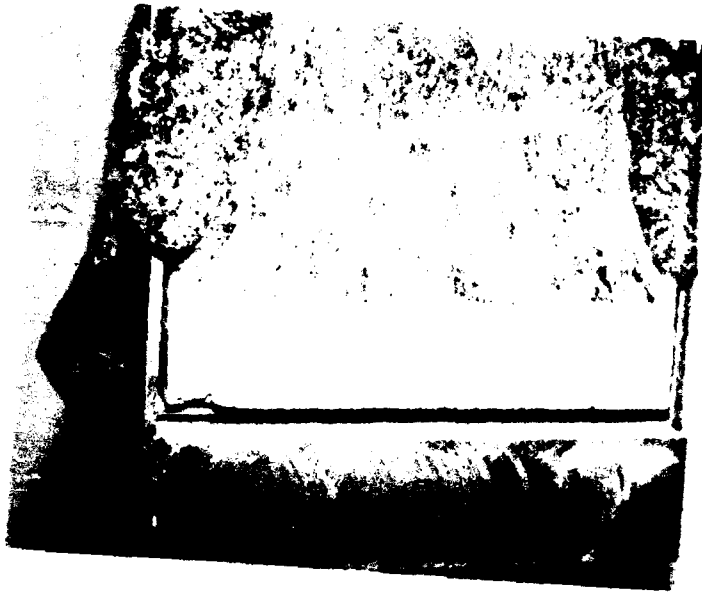

Figure 32. Peel test in progress for geotextile #4.



Figure 33. Peel test in progress for geotextile #2.

snapping of individual fibers produced faint but noticeable crackling noise and small amounts of concrete powder fell from the geotextile-concrete interface as the geotextile was peeled back.

Prewetting of the geotextile decreased the peak peeling load. During the test, the crackling of breaking fibers was not heard and very little concrete dust was falling from the block. Wetting allowed cement paste to penetrate completely through the geotextile, producing a thin layer of cement on the bottom surface. This observation gave the illusion that prewetting allowed the concrete to flow through the geotextile and potentially form a better bond. However, examination of peeled specimens showed very few geotextile fibers embedded in the concrete block, while the exposed surface of the concrete-geotextile interface was relatively smooth.

The blocks in which the warp of the geotextile was perpendicular to the direction of peel exhibited peel strengths similar to control values. Therefore, orientation of the fabric or the load direction appears to be a minor variable affecting the peel strength of the concrete-geotextile interface.

The effect of increased vibration of the concrete mix during casting seemed to influence peel strengths the greatest by increasing the peel strength consistently. Exposed surfaces where the concrete-geotextile interface had been peeled away had many fibers embedded in it and the geotextile had more concrete particles embedded in it. It was observed that the concrete did flow around more fibers than in the control, although it was also observed that the cement did not soak through the fabric during the casting procedure.

Results

The average peak load achieved at a deformation rate of 0.5 in./min is tabulated and summarized in Table 4. Results of the peel tests indicated the bond strength after 7 or 21 days were essentially identical. Further tests on the fabric also indicated that the peel strengths were not affected significantly by the slump of the concrete. Tests with 3-in. and 6-in. slumps showed little difference in bond strength.

Results of peel tests in which the effect of construction procedure on the peel strength are shown in Figure 34. The relative peel strengths of the fabrics can be seen as well as the relative effect of each construction procedure. Geotextiles that were prewetted developed the least bond strength of the four construction procedures. During the process of pouring concrete on the prewetted geotextile, the cement adjacent to the prewetted geotextile settled out of the concrete mix and left a veneer of weaker concrete at this interface. Therefore, anchorage into the concrete became weaker and the bond strength was reduced.

Specimens vibrated during construction had the greatest bond strengths. The vibration anchored the fibers of the geotextile, and increased the bond strength an average of 20 percent.

The bond strength generally increased slightly in the weft direction. The increase was small for the nonwoven geotextiles, but very significant for the woven geotextiles. The significant effect of orientation of load on the bond strength occurred for those specimens that had special anchorage projections. For loads applied parallel to the anchorage row, smaller bond strengths resulted because only a small portion of the tufts or loops were used. For loads oriented perpendicularly to the rows of anchorage, the anchorage of the tufts were affected simultaneously and resulted in much greater bond strengths. In fact, the fabric material in geotextiles #13 through #15 failed when loaded in the perpendicular direction because the load exceeded the tensile strength of the fabric rather than the bond strength. An illustration comparing the relative strengths of bond in the warp direction (control) and weft direction (perpendicular) can be seen in Figure 35.

Table 4

Results of Peel Tests

No.	Mfg./Product	Peel Strengths - Rough Side Up				Peel Strengths - Smooth Side Up			
		Control (lb./in.)	Pre-wetted (lb./in.)	Perpendicular (lb./in.)	Vibrated (lb./in.)	Control (lb./in.)	Pre-wetted (lb./in.)	Perpendicular (lb./in.)	Vibrated (lb./in.)
1	Foss G6001A	9.2	3.2	8.2	10.6	4.9	3.9	5.1	6.6
2	Foss G6001B	24.8	8.8	29.1	22.3	14.6	10	17.4	19.7
3	Foss G6001C	14.1	*	*	*	17.3	*	*	*
4	Foss Geomat 400	14	*	*	*	13.3	*	*	*
5	Foss Geomat 100	8.9	*	*	*	10.3	*	*	*
6	Phillips Supac 12NP	6.9	3.4	6.3	5.3	1.4	0.6	1.8	2.2
7	Phillips Supac 8NP	8.4	1.4	9.6	12.2	1.6	0.9	3.6	2.5
8	Reemay Typar-3601	0.2	*	*	*	*	*	*	*
9	Reemay Typar-3401	0.2	*	*	*	*	*	*	*
10	Hoechst Trevira 1120	1.1	2.3	1.5	4.3	3.1	1.4	3.2	3.1
11	Amoco 4557	5.9	*	*	*	*	*	*	*
12	Nicolon 40/30A	0.3	*	0.4	3.8	*	*	*	*
13	Nicolon-with 1 tuft	9.5	*	37.3	15.6	*	*	*	*
14	Nicolon-with 2 tufts	12.9	*	30.4	21.3	*	*	*	*
15	Nicolon-with 2 tufts (sparse)	8.6	*	29.8	*	*	*	*	*
16	Robusta	59.4	*	91.9	*	*	*	*	*

*Test not performed.

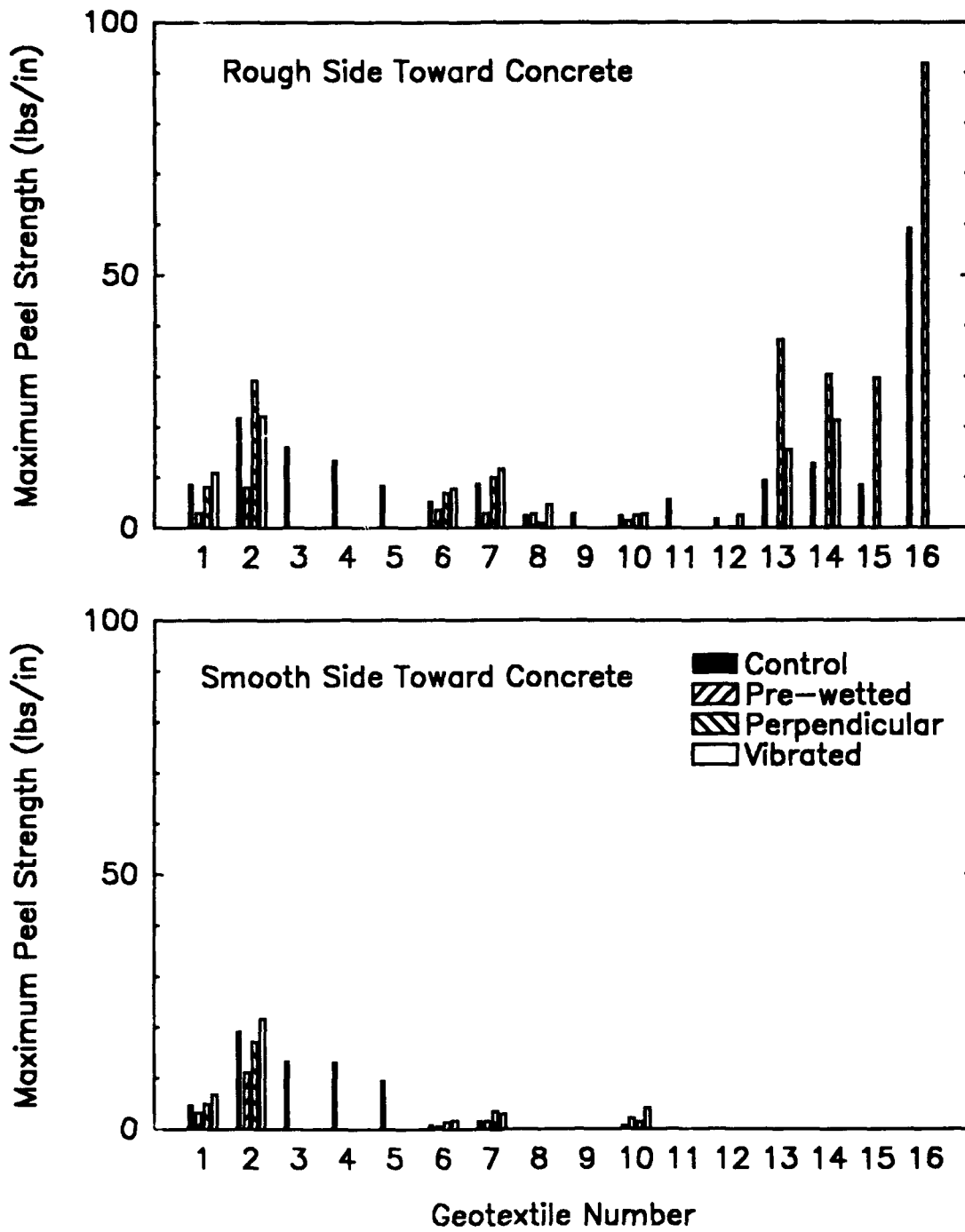

Figure 34. Peel strengths measured for different construction variables.

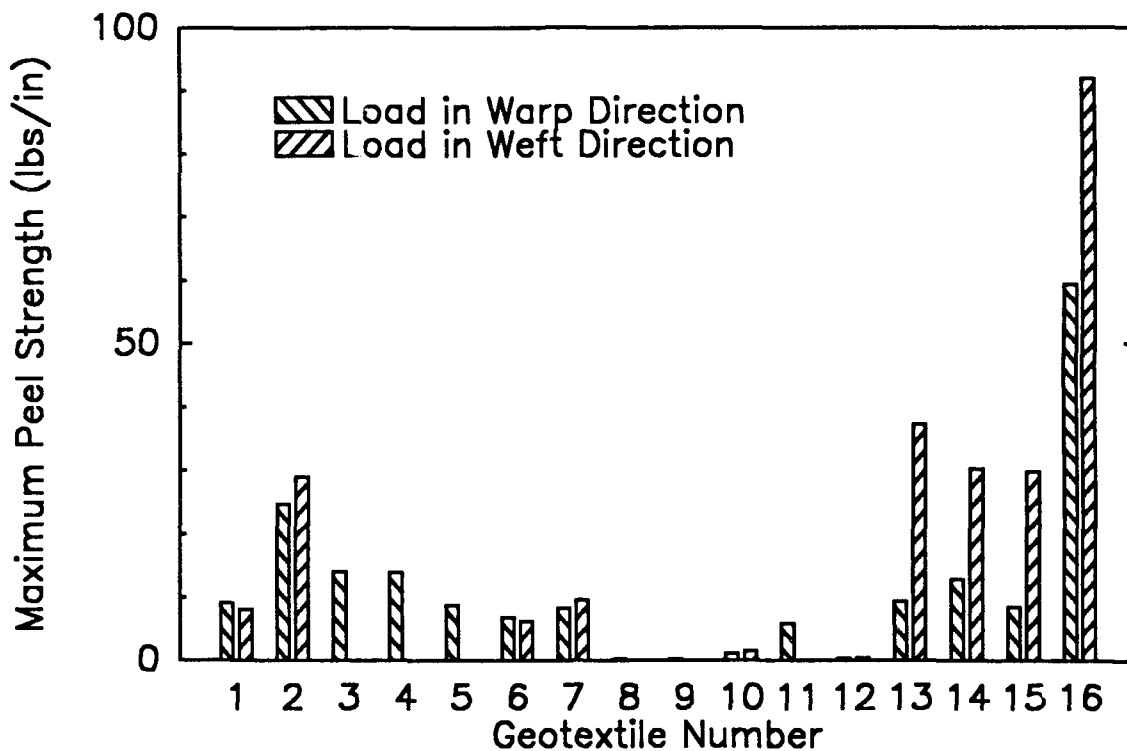

Figure 35. Effect of the direction of load on peel strength.

The peel strengths observed for the nonwoven materials are explained in terms of open void spaces in the fabric. The effect of size of the voids on peel strength (rough side toward concrete) is shown in Figure 34. The average distance between fibers was calculated from the weight and thickness of the fabric, and the denier of the fibers. In general, fabrics with larger voids and denier, such as geotextiles #1 through #3, tended to have a higher bond strength while fabrics with smaller voids exhibited lower bond strengths. Those fabrics with different textures on the two surfaces, such as #6 and #7, have different peel strengths for each side. The rough side of the fabric tended to exhibit a higher peel strength than the smooth side because the rough side had larger openings that allowed concrete to enter the fabric and surround the fibers.

The poorest bond strength was exhibited by fabrics #8 and #10. Poor bond strength for fabric #8 occurs because it has very small voids, thus the concrete cannot flow around the fibers to embed them. However, geotextile #10 has a void size significantly larger than #8. The weak bond exhibited in #10 is due to its internal structure. Geotextile #10 is composed of several sheets of thinner fabric which can be peeled easily. Therefore, the concrete may bond to a sheet, but the sheet peels away from the fabric with relatively little force.

Woven and Modified Geotextiles

The peel strength for the woven materials (without projections for improvement of bond) was insignificant. The geotextile could be separated from the concrete block with a force less than 2 lb/in. Therefore, woven fabrics without modifications to improve bond do not provide adequate bond strength required to survive the handling and installation procedures involved with launching.

Geotextiles modified for improvement of bond performed very well in developing bond between the geotextile and the concrete blocks. The Nicolon with tufts provided a significant improvement in the bond strength. Failure of the tufted geotextile occurred when embedded portions of the tufts pulled from the back of the geotextile (Figure 36). The 1-in. thick row of tufts were too dense to allow concrete to flow around the tufts and embed properly; therefore, some of the intermediate rows of tufts were removed leaving only the outside rows.

Blocks were cast and tested with the modified tufts, but essentially the same peel strength was reported. The governing factor for the peel strengths were the orientation of the load and the strength of the woven geotextile. With the load oriented in the same direction as the tufts, the bond between the tufts and the concrete failed (Figure 36). The bond between one end of each individual tuft and the concrete failed, allowing the fabric to pull away from the tuft; the fabric itself did not fail. However, if the tufts were oriented perpendicular to the direction of load, rupture occurred within the fabric because of planes of weakness within the geotextile; bond failure did not occur (Figures 37 and 38). The planes of weakness were caused by the manufacturing process used to insert the tufts into the fabric. Higher strengths and better bond strengths would have been obtained if fewer tufts were installed. Fewer tufts would allow concrete to flow around the tufts and provide better anchorage, and also cause less structural damage to the woven geotextile.



Figure 36. Photograph of failed peel strength specimen for geotextile #13.

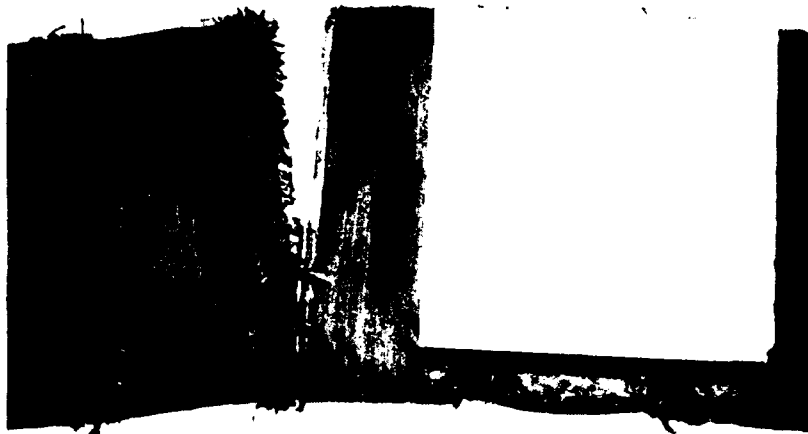

Figure 37. Failure of peel test specimen by fabric tearing outside of bond area.



Figure 38. Failure of peel test specimen by fabric tearing at tufts embedded in concrete.

The Robusta fabric performed well. The loops embedded in the concrete and developed adequate anchorage to provide a significant resistance to peel (Figure 39). Additionally, the geotextile woven fabric remained intact and provided an adequate structural function by transferring load to the embedded loops. Failure occurred during peel tests when the loops unraveled behind the slit film geotextile into which the loops were tied (Figure 40). However, it often took over 120 lb/in. force to induce peel. This load is several times greater than that of the other fabrics tested.

Additional Peel Tests (0 Degree Pull)

Specimen Preparation

A second type of peel test was used to determine bond strength. This test was conducted to simulate the loads imposed on a fabric when the mattress reaches the mudline and experiences an upward curvature. Specimens, the test apparatus, and the test procedure were identical to the original peel test (described previously) except that the specimen was pulled directly from the top of the concrete block. Thus the angle of pull was 0 degrees instead of 180 degrees. Geotextiles #2, #15, and #16 were tested in the perpendicular and parallel directions. The ends of the fabric were coated with fiberglass resin. The fabric was gripped by the top jaws of the loading head, allowing about 1 in. gauge length between the bottom edge of the jaw and the edge of the block. All tests were run at a rate of 0.5 in./minute. The behavior of the fabric was observed and the length of fabric over which debonding occurred was measured. Observations recorded during the straight-pull peel tests are summarized in Table 5 and discussed below for geotextiles #2, #15, and #16.

Geotextile #2 (perpendicular and parallel)

As the specimen was loaded, the fabric began to stretch from the grips to the top of the block. Deformations due to stretching were seen to extend down the surface of the block about 3/4 in. This same region was debonded from the block. Failure occurred when the fabric between the grip and the block ruptured. The behavior was identical for both orientations of the specimen.

Geotextile #15 (perpendicular)

The specimen was cast with two rows of tufts, perpendicular to the direction of pull, separated by about 4 in. Each row consisted of two lines of tufts about 1 in. apart. The fabric originally had six lines of tufts in each row, but the middle four were removed to improve the flow of wet concrete around the remaining tufts. The fabric immediately debonded from the entire surface after only a small tensile load was applied. The first line of tufts closest to the top of the block began to stretch, closely followed by the other line 1 in. lower on the block. The fabric failed by tearing between the two lines of tufts. At the point of maximum load, the bottom row of tufts were also stretching (indicating that they too were resisting load).

Geotextile #15 (parallel)

This specimen was cast so that two rows of tufts were parallel to the direction of pull. As the specimen was loaded, the fabric debonded from the surface upon reaching a peak load and all tufts began to stretch.



Figure 39. Geotextile #16 peeled easily until loops were encountered.

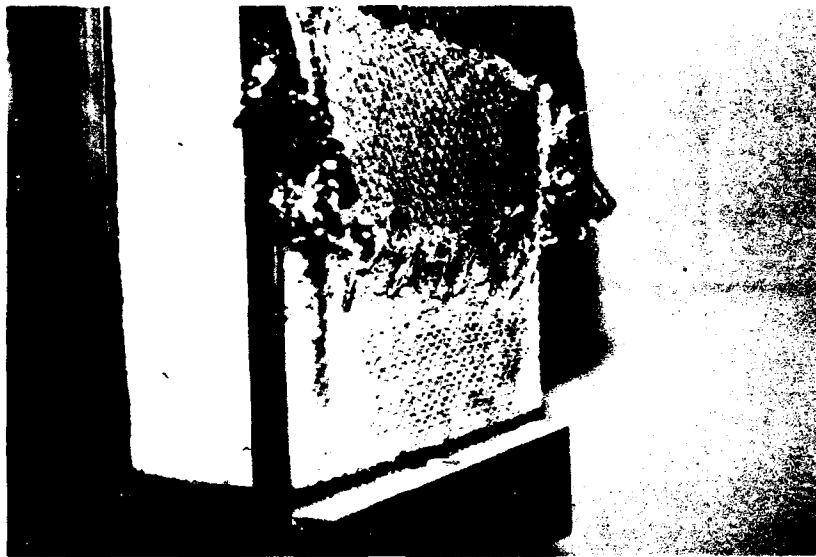

Figure 40. Loops embedded in concrete required significant loads to pull out.

Table 5
Results of Straight-Pull Peel Tests

Geotextile Number	Direction	Peak Load (lb/in.)	Dev. Length (in.)
#2	Perpendicular	44	1/2
	Parallel	66	3/4
#15	Perpendicular	56	6
	Parallel	67	8
#16	Perpendicular	136	6
	Parallel	75	8

Geotextile #16 (perpendicular)

Two rows of loops about 3 in. apart were cast perpendicular to the direction of pull. The fabric debonded at low tensile loads and the loops began to stretch. Both rows of loops contributed to resisting the load, and failure occurred upon reaching a peak load.

Geotextile #16 (parallel)

A specimen was cast with two rows of loops parallel to the direction of pull. The fabric debonded at low tensile loads and both rows of loops down the entire surface of the block began to stretch. Failure occurred by a combination of loops pulling out of the concrete and away from the fabric.

Bending Tests

Additional tests were performed on geotextiles #2, #15, and #16 to assess how well each would perform during the launch procedure when the curvature of the mattress causes tensile strains to be imposed upon the fabric. Two 8-in. square blocks of concrete were cast adjacent to each other and on top of a continuous piece of the geotextile. The blocks were separated by approximately 0.625 in. to simulate the separation between blocks in the mattress. A loading yoke was devised to apply deformations and rotations to the concrete blocks until a strain of 160 percent was achieved along the face in which the geotextile was attached (Figures 14 and 41). Behavior of the geotextile was observed and recorded during the test.

Results of the bending tests showed that geotextiles #2 and #16 performed adequately by being able to withstand the 160 percent strain without rupturing. Geotextile #2, a nonwoven material, maintained a tight bond over the whole length of the concrete-geotextile interface. Geotextile #16, a woven material with loops added to improve the bond, debonded in locations where there were no loops. However, the loops remained anchored and the geotextile-concrete bond remained intact.

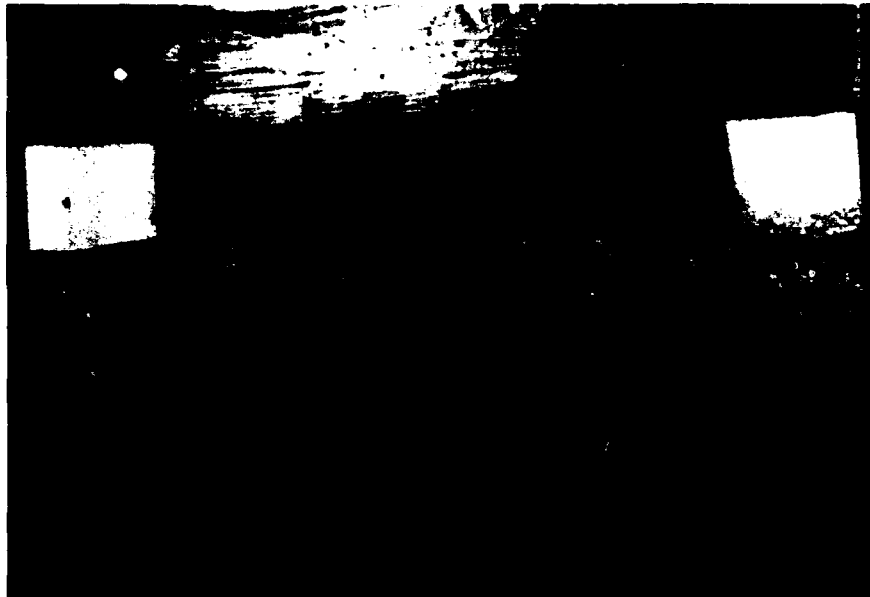

Figure 41. Nicolon fabric in bending test.

Geotextile #15 failed to perform adequately during the test. The geotextile separated from the concrete, but the tufts remained embedded and intact. As bending of the blocks continued, the strains imposed on the fabric caused it to rupture and tear. Failure was due to the tufts being spaced too close together. Had the tufts been spaced farther apart, strains could have been reduced (because of a greater length over which to spread the deformations) and the fabric could have survived.

Abrasion Tests

The abrasion tests were conducted to evaluate the relative resistance to damage during loads and deformations similar to that experienced during launching. The intention was not to replicate the exact loading, as this would require a very complex test device and test procedure that would make it difficult to run enough tests to compare and evaluate a variety of geotextiles.

The edge of the barge over which the mats are launched is reinforced with welds both parallel and perpendicular to direction of movement (Figure 11). Over time, the welds are abraded by the concrete blocks during launching. The surface of the welds become smoother and would be less damaging to the geotextile. The most severe condition occurs when the welds have recently been formed and are still rough.

Specimen Preparation

The device shown in Figure 42 was designed to subject 8-in. square specimens to normal and shear loads anticipated during the launch procedure. A photograph of the device is shown in Figure 43. The

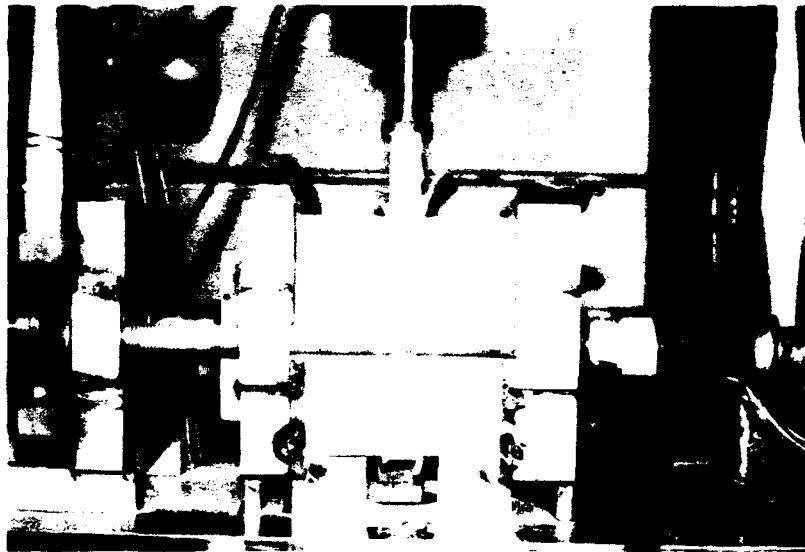

Figure 43. Photograph of abrasion device.

concrete blocks were oriented vertically with the geotextile contacting the steel plate and placed between the concrete blocks. The concrete blocks were compressed using the hydraulic ram with a force that simulated a range of values comparable to that experienced by the geotextile during launching. The steel plate projects vertically above the top of the concrete specimens by 4.0 in. (Figure 44).

The loading device was placed on the flat bed of a hydraulic testing machine with automatic controls in a position so that the loading head could force the steel plate downward. With a predetermined lateral force on the geotextile-steel plate interface, the steel plate was forced downward at a controlled rate of 0.2 in./min. The load-deformation history was recorded on an X-Y plotter and it was found that the load varied as the slip occurred. Therefore, when the load became constant, the vertical load and the load cells that provided the lateral load were read simultaneously and the values were used to calculate the effective friction coefficient. In some cases, more than one set of readings was taken at a given lateral force, and the values were averaged. Readings were taken at lateral loads of 3200, 6400, and 12,400 lb. These loads correspond to pressures of 50, 100, and 200 psi. Pressures of 50 and 100 psi are believed to occur at the interface between the geotextile and the edge of the barge during the launch procedure. The 200 psi load corresponds to a pressure larger than anticipated in a launch procedure.

Normal load between the steel plate and geotextile was provided by the hydraulic ram shown in Figure 42. Hydraulic pressure for this ram was initially provided by a hand pump; but it was found that as the steel plate was forced between the geotextile surfaces and the welds penetrated the geotextile the normal force decreased. It was necessary to adjust the lateral pressure continuously during loading. This manual adjustment could not be carried out smoothly during loading, so the hand pump was replaced with an air to oil intensifier. This device is a positive displacement pump in which the piston is driven by air pressure. The air side of the piston is larger than the oil side so that oil pressures can be obtained that



Figure 44. Welded steel plate above the two concrete-geotextile specimens.

are greater than the air pressure. The oil pressure is then adjusted with a regulator on the air sides because it is much easier to regulate air than oil. This device allowed the regulation of the normal pressure within much closer tolerances.

The steel plates used in these tests were 1.0 in. thick and were covered with welds to simulate the edge of the barge over which the mats are launched. Two separate plates were prepared with rows of welds 1.0 inch apart and running parallel to the direction of movement in one plate and perpendicular to the direction of movement in the other plate (Figure 45). The welds were approximately 1/8 in. high; extreme variations above the average height were ground off.

Observations During Tests

The test device provided an average of two friction coefficients in each test since there are two steel plate-geotextile interfaces resisting the load. At low normal loads, there was very little damage to the geotextiles. However, at greater loads, the projections of the welds penetrated into the geotextile and sometimes through the geotextile into the concrete. It is reasonable therefore, that the friction coefficient was observed to increase with greater normal load because the weld penetrated to the concrete. The visible damage to the geotextile by abrasive action and the loosening from the concrete are measures of the resistance and bonding of the geotextile to the concrete.



Figure 45. Photograph of welded steel plates used in abrasion test.

Tests with the welds parallel to the direction of movement showed that the effective friction coefficient was less for this test than for tests with the welds perpendicular. Damage to the geotextile was much less; a groove was worn in the geotextile along the welds that did not extend through the geotextile even at the largest normal pressure and there was no tendency to tear the geotextile off the concrete (Figure 46). Therefore, most of the tests were performed with the welds perpendicular to the direction of movement.

Results

Several of the geotextiles were tested in the abrasion device. The friction coefficients varied between 0.14 and 0.27. However, of greater importance was the ability of the fabric to survive the abrasive forces exerted during the test. Damage to the geotextile and concrete-geotextile interface was observed and recorded after each test. Photographs of the abraded surfaces of the geotextile-concrete interface are shown in Figure 47.

Close inspection allowed quantitative evaluation of the integrity of the geotextile. The percentage of total area of geotextile abraded through to the concrete was used as a quantitative measure of damage, and the concrete-geotextile interface damage was based on the percentage of the total area of the geotextile that separated from the concrete. A damage index of 1 to 5 was assigned to each geotextile on the basis of these observations with a value of 1 assigned to the most abrasion resistant behavior and 5 representing very unfavorable behavior. Guidelines for assigning a quantitative measure of the abrasion resistance to qualitative measurements are provided in Table 6.

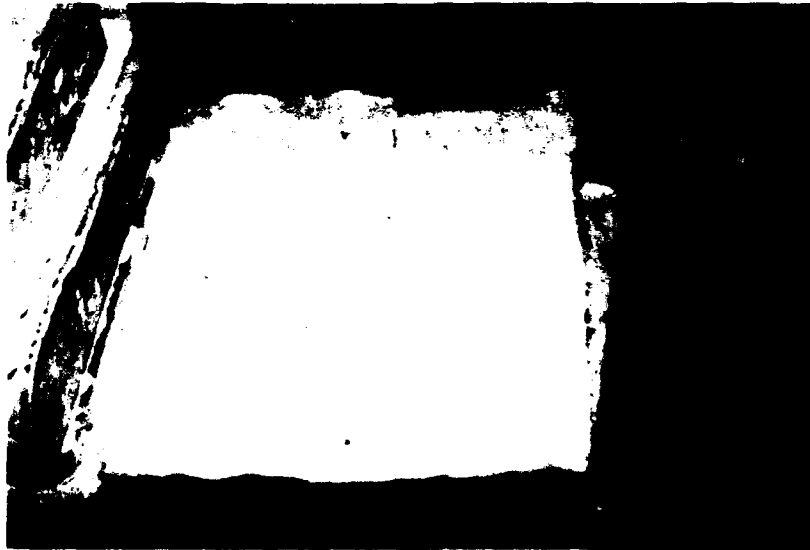

Figure 46. View of geotextile specimen when welds were oriented in the direction of the load.

It is emphasized that the normal loads applied during the abrasion test are greater than those anticipated during a launch procedure. Damage to the geotextile will probably be less than observed during testing because of the different magnitude of normal force. In fact, the geotextiles that behaved poorly during this test may actually perform satisfactorily in a full scale launch. Therefore, the damage index should be treated as a relative scale in which the behavior of several geotextiles can be compared and ranked. All the geotextile-concrete blocks experienced some damage as a result of the loads imposed during the abrasion test.

Nonwoven Geotextiles

All the nonwoven geotextiles exhibited some abrasion along with some separation between the geotextile and the concrete block. Geotextile #1 experienced a great degree of loss of geotextile due to abrasion; however, the remaining portions of the geotextile continued to exhibit good bond characteristics. The fabric abraded at locations where the welds on the steel plate contacted the surface of the geotextile. The movement of the welds tended to drag portions of the fabric until debonding or tearing occurred.

Some of the specimens were able to resist abrasion quite well. Geotextiles #2 and #3 performed very well with almost no abrasion and no apparent debonding (except where the abrasion occurred). Others, such as geotextiles #6 and #7, survived the test with moderate damage. Geotextile #10 survived the abrasion test with minor damage, however debonding occurred over a large percentage of the block. (Other geotextiles were not tested because they performed poorly on the peel test; no further tests were conducted on the fabrics.) Quantitative results for the geotextiles subjected to abrasion tests are shown in Table 7.

(a)

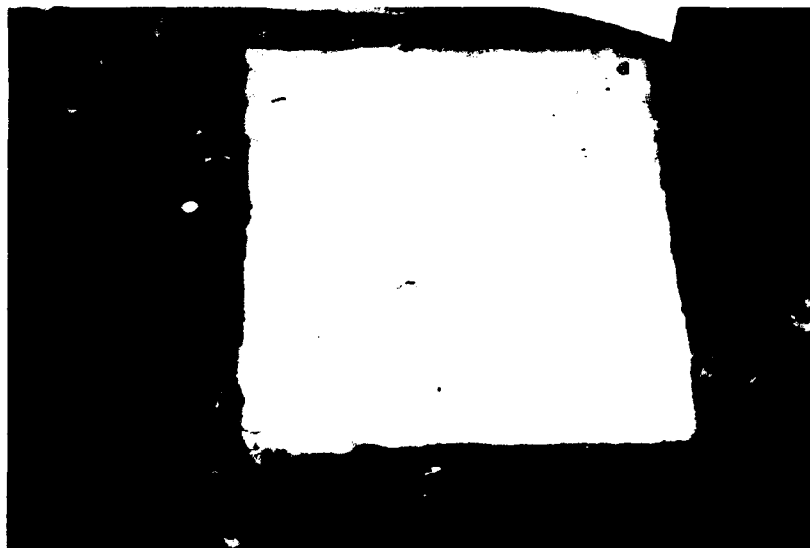

(b)

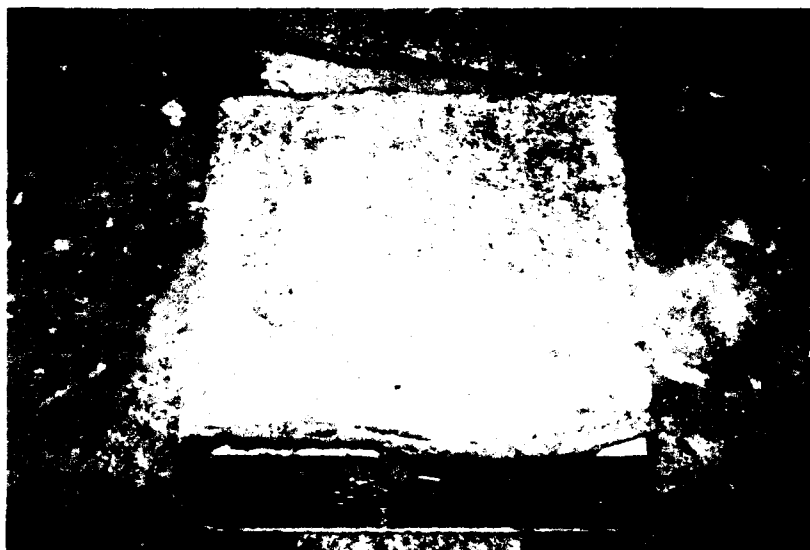
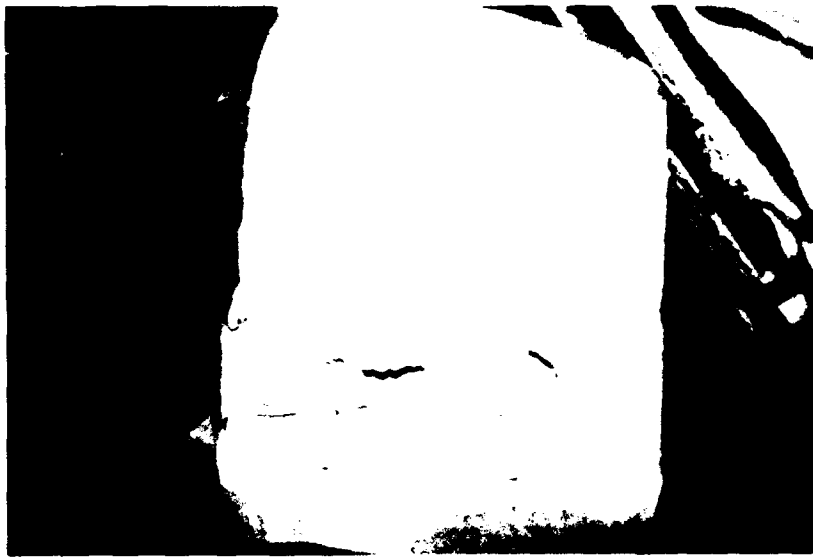

Figure 47. Photographs of abrasion test specimens after testing (a, #10; b, #6; c,#1; d,#2).

(c)



(d)



Figure 47. (Cont'd)

Table 6
Criteria Used To Determine the Damage Index

Percent of Abraded Area	Damage Index
less than 2	1
between 2 and 20	2
between 10 and 25	3
between 25 and 50	4
greater than 50	5

Table 7
Results of Abrasion Tests

No.	Percent Area Abraded	Percent Area Broken	Damage Index
1	15	5	3
2	8	5	2
3	4	0	2
4	*	*	
5	*	*	
6**	3	30	3
6***	2	0	2
7**	7	25	3
7***	3	0	2
8	*	*	
9	*	*	
10	15	80	4
11	*	*	
12	40	90	5
13	25	0	2
14	25	0	2
15	25	0	2
16	*	*	

* - Test not performed.

** - Rough side toward concrete during cast.

*** - Smooth side toward concrete during cast.

Woven Geotextiles

The woven geotextiles performed well in the abrasion test, except for #12 which performed poorly because of its low bond strength. This fabric maintained its integrity, but debonded from the concrete block. The geotextiles with loops or tufts performed quite well. Although there was some damage in the fabric, the geotextiles remained intact; they debonded throughout the contact area except where the loops or tufts were embedded. Here, the bond remained strong and capable of resisting environmental loads that would tend to separate the fabric from the concrete. A list of the results of the abrasion tests performed on woven geotextiles is given in Table 7.

7 CONCLUSIONS AND RECOMMENDATIONS

Conclusions

Assuming that a significant mode of revetment mattress failure is erosion of underlying soil through the mattress open area, techniques to seal these gaps were evaluated. Based on preliminary investigations, researchers determined that the technique of attaching a geotextile to the bottom of the mattress appeared promising. The technique of sealing the gaps with flexible foams and epoxies was impractical.

The technique of attaching a geotextile to the bottom of the revetment mattress was further evaluated in light of the operational and physical plant constraints defined by LMVD. To better understand the nature of these constraints, complete operational details including mattress casting and sinking operations were observed. Based on these observations 16 geotextiles and various geotextile-concrete composites were tested.

Laboratory tests were used to apply loads and deformations that simulated environmental conditions that could be imposed during launching. Of the 16 woven and nonwoven geotextiles tested, numbers #16, #2, and #15 exhibited the best combinations of behavior. Geotextile #15 could have performed better if the sewn-in tufts used to improve the bond were sparser and the rows were spaced farther apart. Better bond characteristics are realized if the geotextile incorporates tufts, loops, etc. However, the locations of tufts and their influence on the strength of the geotextile must be a design consideration.

Several tests were conducted to impose load on the geotextile and geotextile/concrete interface. General conclusions can be drawn with respect to the type of geotextile most likely to provide favorable behavior. Nonwoven should have a large denier and a loose weave to provide large void spaces. Woven geotextiles and nonwoven geotextiles without large denier and large voids must have separate yarns included in the fabric that can embed in the concrete and provide adequate anchorage between the concrete and fabric.

When launched, the geotextile would protrude beyond the edge of the concrete on each of the longitudinal sides approximately 2 to 2 1/2 in. As demonstrated by the previous efforts of Littlejohn, this overlap is not a major hindrance to the tying operation.

At \$16.70 per square (plus some additional labor costs) all of the geotextiles tested except #16 are well within the desired maximum additional cost of \$60 per mattress square. The cost for geotextile #16 is \$40 per square. when the additional labor costs are included, the total cost of #16 could be very near the maximum.

Recommendations

Before a geotextile-concrete mattress combination could become a standard practice it is important to define more accurately the mattress failure mechanisms. If the principal cause of failure is not erosion of subsoils through the mattress voids, procedures to reduce the mattress open area or fill the gaps between the squares may not be worthwhile.

The behavior and effectiveness of the fabric when in place and subjected to the river currents should also be identified. Although the fabric from one square would overlap the fabric from the adjacent

square, the fabric could still be lifted by river currents. The launching cable and bracket wires would pose some obstruction to fabric movement. However, the river currents may still be great enough to flutter the fabric and erode the soil through the lifted fabric.

The fabric-soil compatibility should be evaluated. Ideally the fabric must remain permeable to water flow but prevent significant soil loss. Final fabric selection would need to be based not only on the geotextile strength and geotextile-concrete binding properties but on the geotextile filtering properties to handle the range of soil type that would be encountered.

The relationship between the geotextile-mattress combination and river currents during the sinking operation needs to be defined. One possibility is that the overlapping fabric covering the gaps would make sinking more difficult due to reduced current flow through the mattress. On the other hand, the current may lift and flow around the fabric overlaps causing minimal effect on the sinking operation.

Knowledge of the mode of mattress failure is paramount to the success of this technique. Reduced scale and full scale flume testing should be performed to better determine the principal failure mechanisms. If soil erosion through the mattress is at least a contributing factor, fabric-mattress combinations should also be evaluated in the flume tests. Bench testing should be performed to determine if those fabrics that will survive the launching procedures will also perform well as a separating and freely draining fabric. Flume tests could also determine the effectiveness of the overlapping fabric and whether fastening the overlaps together is necessary to keep the soil in place.

One of the drawbacks to casting the fabric into the mattress is the "all-or-none" aspect, i.e., that it would not be feasible logistically to use a fabric/mattress combination only at specific locations with the greatest need. This would mean paying for fabric at many locations where the articulated concrete mattress alone would be adequate. However, if major changes to the existing physical plants are ever contemplated, consideration should be given to accommodate the "as needed" attachment of geotextiles to the mattress on the assembly plant decks.

A method to determine the location and depth of the mattress is important in determining if the mattress has moved. Current inspection procedures do not distinguish between soil which may be on top of the mattress and the mattress itself. The mattress could be completely washed away and not even detected. Techniques need to be developed to monitor mattress movements. Miniaturized electronics, remote sensing techniques and field data collection devices make the development of such an inspection/research technique more feasible than a few years ago. Sensors or miniature conduits for the sensors to be positioned into could be attached to the mattress during assembly. A remote control robotic inspection apparatus could also be developed to provide closeup pictures of the mattress in place. The combination of the two techniques would provide valuable insights to actual mattress behavior, especially during floods and in known trouble spots.

METRIC CONVERSION TABLE

1 ft	=	0.305 m
1 in.	=	25.4 mm
1 kip	=	4448 N
1 lb	=	0.453 kg
1 psi	=	6.89 kPa
1 sq ft	=	0.093 m ³

REFERENCES

- ASTM D 4595-86, "Test Method for Effects of Temperature on Stability of Geotextiles by the Width-Strip Method," *Annual Book of ASTM Standards*, Vol 04.08 (American Society for Testing and Materials).
- Christopher, B.R., and R.D. Holtz, *Geotechnical Engineering Manual* (U.S. Department of Transportation, Federal Highway Administration, February 1984).
- Littlejohn, B.J., *Use of Plastic Filter Cloth in Revetment Construction: Potamology Research Project II*, Report No. 21.5 (Potamology Investigations, August 1977).
- Kearney, F., and J. Prendergast, *Study of Articulated Concrete Revetment Mattress: Test and Analysis—Results of FY 1974 Program*, Technical Report M-94/ADA021774 (U.S. Army Construction Engineering Research Laboratory, January 1976).
- Koerner, R.M., *Designing With Geosynthetics* (Prentice-Hall, 1986).
- Torrey III, Victor H., Joseph B. Dumbar, and Richard W. Peterson, *Retrospective Failures in Sand Deposits of the Mississippi River, Report I.: Field Investigations, Laboratory Studies and Analysis of the Hypothesized Failure Mechanism*, Report No. GL-88-9 (U.S. Army Waterways Experiment Station, June 1988).
- VanZanten, R.V., *Geotextiles and Geomembranes in Civil Engineering* (Halsted Press, 1986).

USACERL DISTRIBUTION

Chief of Engineers

ATTN: CEHEC-IM-LH (2)
ATTN: CEHEC-IM-LP (2)
ATTN: CECG
ATTN: CERD-M
ATTN: CECC-P
ATTN: CERD-L
ATTN: CECW-P
ATTN: CECW-RR
ATTN: CECW-O
ATTN: CECW
ATTN: CERM
ATTN: CERD-C
ATTN: CERD-ZA
ATTN: DAEN-ZCM
ATTN: DAEN-ZCE
ATTN: DAEN-ZCI

CEHSC

ATTN: CEHSC-F 22060
ATTN: CEHSC-TT 22060
ATTN: CEHSC-ZC 22060
ATTN: DET III 79906

US Army Engr District

ATTN: Library (38)

US Army Engr Division

ATTN: Library (12)

CEWES 39180

ATTN: Library

CECRL 03755

ATTN: Library

Engr Societies Library

ATTN: Acquisitions 10017

Naval Facilities Engr Command

ATTN: Facilities Engr Cmd (8)

ATTN: Division Offices (11)

ATTN: Public Works Center (8)

ATTN: Nav Constr Btln Ctr 93043

ATTN: Nav Cvl Engr Lab 93043 (3)

Tyndall AFB 32403

ATTN: AFESC Program Ofc

ATTN: Engrg & Srvc Lab

US Gov't Printing Office 20401

ATTN: Rec Sec/Deposit Sec (2)

Nat'l Institute of Standards & Tech

ATTN: Library 20899

Defense Tech Info Center 22304

ATTN: DTIC-FAB (2)

113

05/93