

AD-A274 574

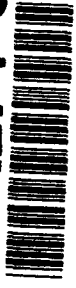

UNITED STATES ARMY
COMMUNICATIONS-ELECTRONICS COMMAND



FORT MONMOUTH, NEW JERSEY

S DTIC
ELECTE
JAN 06 1994
A

93-31364



This document has been approved for public release and sale; its distribution is unlimited.

ADVANCE PLANNING BRIEFING FOR INDUSTRY

"SOFTWARE ACQUISITION STREAMLINING"

SHERATON EATONTOWN HOTEL & CONFERENCE CENTER
OCTOBER 20, 1993

93 12 27 069

1

2
168/ps

**UNITED STATES ARMY
COMMUNICATIONS-ELECTRONICS COMMAND**



FORT MONMOUTH, NEW JERSEY

ADVANCE PLANNING BRIEFING FOR INDUSTRY

"SOFTWARE ACQUISITION STREAMLINING"

**SHERATON EATONTOWN HOTEL & CONFERENCE CENTER
OCTOBER 20, 1993**



DEPARTMENT OF THE ARMY
HEADQUARTERS, US ARMY COMMUNICATIONS-ELECTRONICS COMMAND
AND FORT MONMOUTH
FORT MONMOUTH, NEW JERSEY 07703-5000



REPLY TO
ATTENTION OF

Office of the Commanding General

Ladies and Gentlemen:

On behalf of the Communications-Electronics Command (CECOM) and the C3I community, I am pleased to present to you the proceedings of the Software Acquisition Streamlining Advance Planning Briefing for Industry (APBI). The purpose of this briefing is to provide industry with a thorough understanding of the Software Acquisition Streamlining Process, focusing on the Streamlined Acquisition Approach, Software Standards and Reuse.

Government and Industry must continue working together to meet the Army's needs with lower operational and support costs. I want to share with you the software engineering initiatives at this Command and welcome your feedback to help bring the traditional software acquisition problems under control.

I welcome your participation in our APBI program.

Sincerely,

Otto J. Guenther
Major General, U.S. Army
Commanding

NOTICE

This publication contains the briefings presented during this Advance Planning Briefing for Industry (APBI). Following the APBI a Proceedings Book containing these briefings, any revised charts, and any information disclosed by the government during the conduct of the one-on-one sessions will be published. Copies of the Proceedings Book may be obtained, for a minimum fee, by contacting the Defense Technical Information Center (DTIC). The telephone number is (703) 274-6867.

We hope that the above publications prove beneficial to your long-range planning efforts. If you have any additional questions and/or suggestions please contact the Program Analysis and Evaluation Directorate, AMSEL-PE-OD, ATTN: Mari Aufseeser, (908) 532-5054.

DISCLAIMER

The use of trade names in this report does not constitute official endorsement of any products. This report may not be cited for purpose of advertisement.

The information provided is accurate as of the time of publication, and may be subject to change.

**THE OVERALL CLASSIFICATION
OF THIS PUBLICATION IS
UNCLASSIFIED**

ADVANCE PLANNING BRIEFING FOR INDUSTRY

**OCTOBER 20, 1993
SHERATON EATONTOWN HOTEL AND CONFERENCE CENTER
EATONTOWN, NEW JERSEY**

**MEETING CHAIRMAN
MR. JOHN H. SINTIC
DIRECTOR, SOFTWARE ENGINEERING, CECOM**

AGENDA

WEDNESDAY, OCTOBER 20, 1993

- 0700 REGISTRATION**
- 0815 ADMINISTRATIVE REMARKS**
- 0825 WELCOMING REMARKS**
COL Domenic F. Basile
Deputy Commander for Business,
CECOM
- 0845 APBI OVERVIEW**
Dennis J. Turner
Software Engineering Directorate, CECOM
- 0900 SESSION I: SOFTWARE STANDARDS AND TECHNIQUES**

SESSION OVERVIEW AND INTRODUCTION
MODERATOR
Mr. John T. LeBaron
Software Engineering Directorate, CECOM
- 0910 SOFTWARE DEVELOPMENT DOCUMENTATION (SDD) AND ITS IMPACT
ON FUTURE ACQUISITIONS**
Mr. Jeffrey Heman
Software Engineering Directorate, CECOM
- 0930 SOFTWARE MODELING AND SIMULATION**
MAJ Gordon W. Robson
Software Engineering Directorate, CECOM
- 0950 SOFTWARE ARCHITECTURES AND REUSE AND ITS IMPACT
ON SOFTWARE DEVELOPMENT**
Mr. Gerald R. Brown
Software Engineering Directorate, CECOM
- 1015 QUESTIONS AND ANSWERS**
- 1030 BREAK**

- 1050 **SESSION II: STREAMLINING THE ACQUISITION APPROACH**
- SESSION OVERVIEW AND INTRODUCTION**
 MODERATOR
 Mr. George E. Sumrall
 Software Engineering Directorate, CECOM
- 1100 **STREAMLINED ACQUISITION GUIDANCE**
 -DOCUMENTATION-STREAMLINING AND REVIEW PRACTICES
 -REDUCTION OF DATA ITEM DESCRIPTIONS
 -RISK ABATEMENT PLAN
 Mr. Andrew C. Mills
 Software Engineering Directorate, CECOM
- 1125 **SOFTWARE CAPABILITY EVALUATIONS AND THEIR IMPACT ON**
 THE SOURCE SELECTION PROCESS
 Mr. Jeffrey Harman
 Software Engineering Directorate, CECOM
- 1150 **STREAMLINED INTEGRATED SOFTWARE METRICS APPROACH**
 Mr. Stewart Fenick
 Software Engineering Directorate, CECOM
- 1220 **CECOM SOFTWARE OMBUDSMAN**
 Dr. Martin I. Wolfe
 Software Engineering Directorate, CECOM
- 1230 **QUESTIONS AND ANSWERS**
- 1245 **CLOSING REMARKS**
 Mr. John H. Sintic
 Director, Software Engineering, CECOM

CONTENTS

	Page
SESSION OVERVIEW	1
SESSION I: SOFTWARE STANDARDS AND TECHNIQUES	19
Session Overview and Introduction	20
Software Development Documentation (SDD) and its Impact on Future Acquisitions	27
Software Modeling and Simulation	41
Software Architectures and Reuse and its Impact on Software Development	57
SESSION II: STREAMLINING THE ACQUISITION APPROACH	75
Session Overview and Introduction	76
Streamlined Acquisition Guidance	83
Software Capability Evaluations and their Impact on the Source Selection Process	95
Streamlined Integrated Software Metrics Approach	135
CECOM Software Ombudsman	159
USING REMARKS	165
SYMPOSIUM PARTICIPANTS	169

DTIC QUALITY INSPECTED 8

Accession For	
NTIS	CRAC
DTIC	
Unannounced	
Justification	
By <i>per call</i>	
Date	
Availability	
Dist	Availability
<i>A-1</i>	

APBI OVERVIEW



Dennis J. Turner

UNCLASSIFIED

SOFTWARE PROCESS CONCERNS

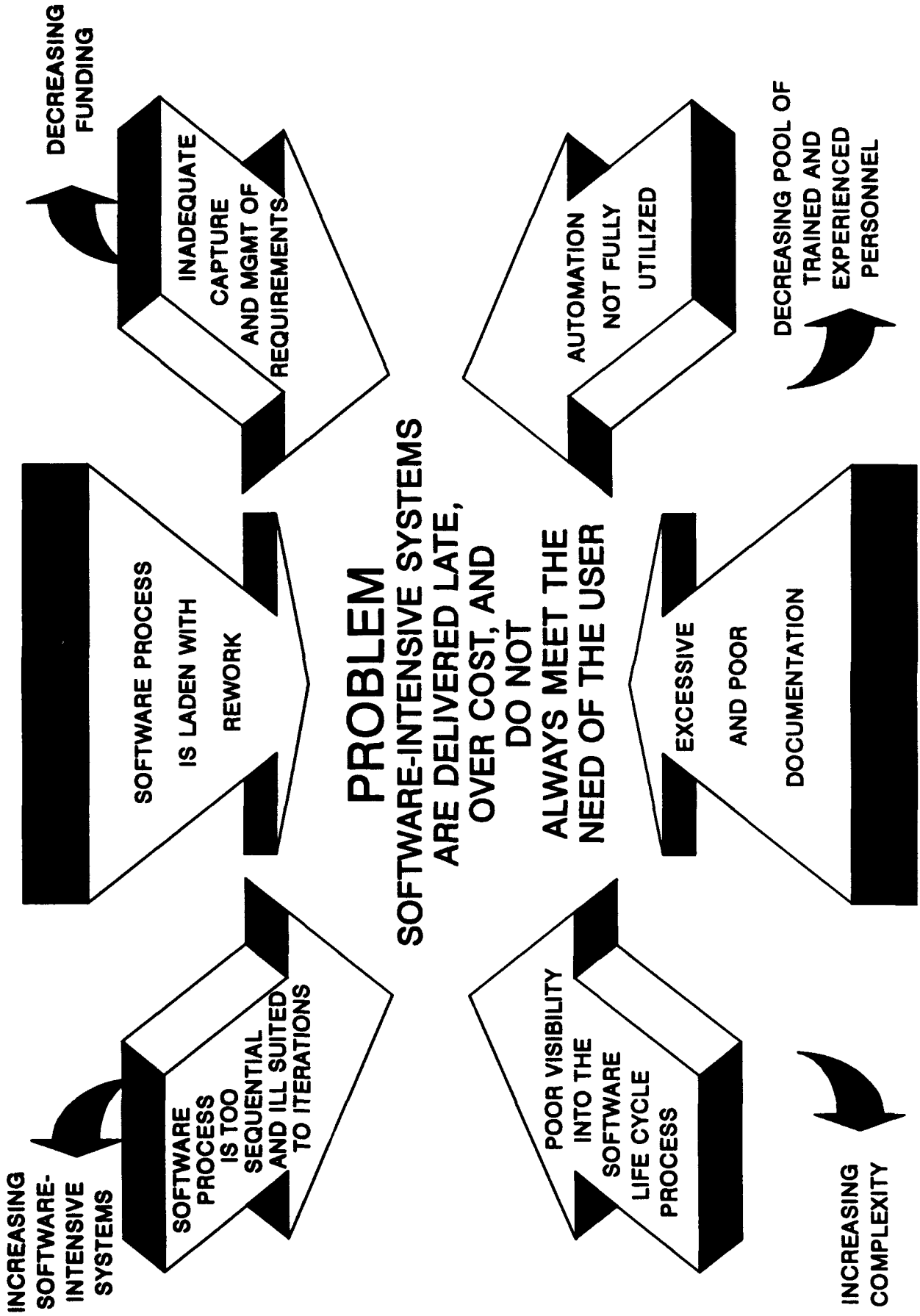

DOD SOFTWARE DEMAND (CONSERVATIVE) SAVINGS MODEL

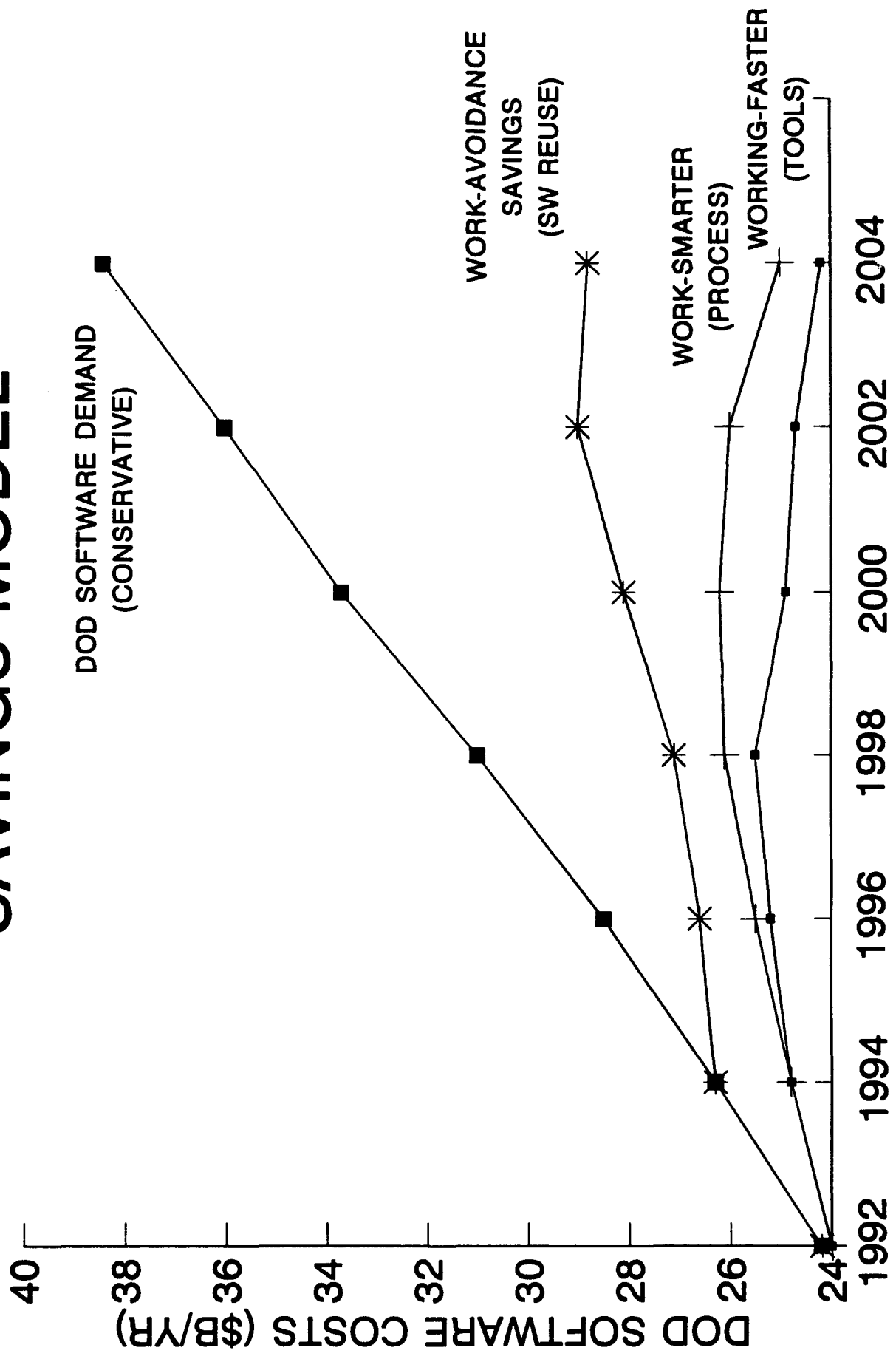

OUR SOFTWARE CHALLENGES FALL INTO MANY CATEGORIES

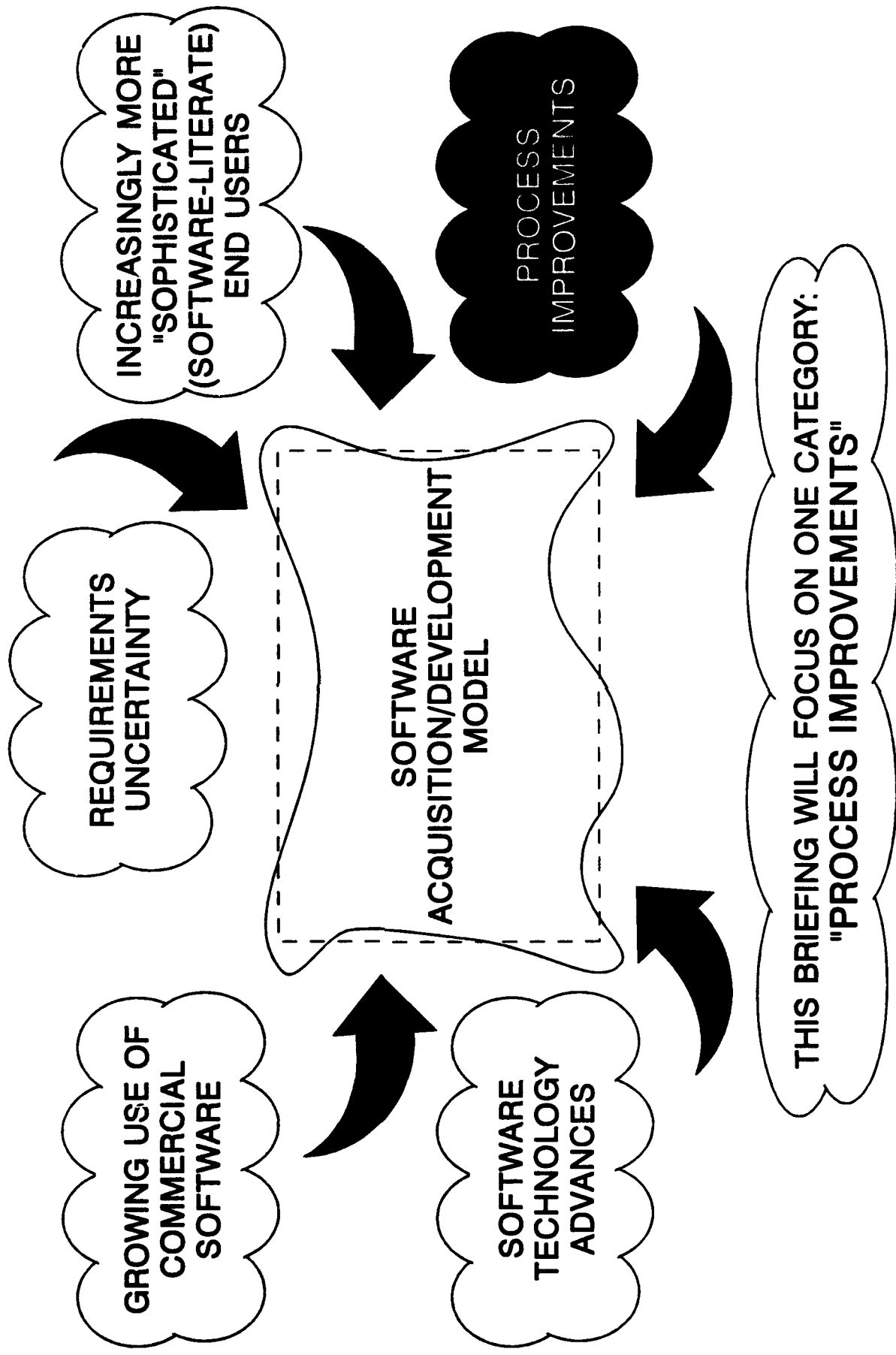

KEY PROCESS IMPROVEMENT THRUSTS

- EMPHASIZING "RISK" IDENTIFICATION AND ABATEMENT
- EMPHASIZING SOFTWARE "ARCHITECTURE"
- EMPHASIZING SOFTWARE PROCESS MATURITY
- STREAMLINING SOFTWARE DOCUMENTATION
- REWARDS FOR SUCCESSFUL PERFORMANCE

UNDERLYING THEMES:

- ABANDON OLD PRACTICES THAT DON'T MAKE SENSE
- ADOPT NEW PRACTICES THAT DO MAKE SENSE
- FOCUS ON "RISK"

EMPHASIZING RISK IDENTIFICATION AND ABATEMENT

- **MOTIVATION:**
 - EXPERIENCE HAS SHOWN THAT MOST OF OUR "HORROR STORIES" COULD HAVE BEEN AVOIDED HAD MORE EFFECTIVE RISK MANAGEMENT BEEN EMPLOYED
 - CONSERVATION OF (SCARCE) RESOURCES SUGGESTS AN EMPHASIS OF "RISK AREAS" NOT "SAFE ZONES"
- **SOLUTION:**
 - IN SOURCE SELECTION:
 - ASK OFFERS TO IDENTIFY RISKS (PRODUCT AND PROCESS) AND THEIR PLANS TO MANAGE THEM
 - EVALUATE PROPOSALS BASED ON THE THOROUGHNESS AND INTEGRITY OF THE INFORMATION PROVIDED
 - TAKE INTO ACCOUNT IN THE SOURCE SELECTION DECISION
 - INCLUDE RISK ABATEMENT PLAN IN THE RESULTANT CONTRACT
 - IN CONTRACT MANAGEMENT:
 - PROVIDE FINANCIAL REWARD FOR SUCCESSFUL RISK ABATEMENT

**WE WILL INCREASE OUR EMPHASIS ON RISK MANAGEMENT
AND REWARD SUCCESSFUL RISK MITIGATION**

EMPHASIZING SOFTWARE ARCHITECTURE

PROBLEM:

- TOO MANY ACQUISITIONS DON'T EMPHASIZE
 - REUSE
 - CAPITALIZING ON EXISTING (GOVERNMENT AND COTS) SOFTWARE ("IMPORTING" SOFTWARE)
 - DEVELOPING NEW SOFTWARE WITH THE NEEDS OF FUTURE SYSTEMS IN MIND ("EXPORTING" SOFTWARE)
 - THE NEED FOR EVOLUTION (OVER A LONG PERIOD OF TIME)

ARCHITECTURE IS THE KEY IN BOTH AREAS

EMPHASIZING SOFTWARE ARCHITECTURE (Continued)

SOLUTION:

- CONDUCT A DOMAIN ANALYSIS IN EACH OF OUR PRINCIPAL BUSINESS AREAS AND DEFINE ARCHITECTURES THAT MEET THEIR NEEDS (PRESENT AND FUTURE)
- EMPHASIZE SOFTWARE ARCHITECTURE IN SOURCE SELECTION AND CONSIDER THE EXTENT TO WHICH PROPOSED APPROACHES ACCOMMODATE OUR CONCERNS FOR REUSE AND EVOLUTION
- EMPHASIZE ARCHITECTURAL IMPACTS/ISSUES AS REQUIREMENTS CHANGE (DURING INITIAL ACQUISITION, DURING PDSS)

**AS IN ANY TECHNICAL ENDEAVOR, IF
THE ARCHITECTURE ISN'T RIGHT,
SIGNIFICANT PROBLEMS WILL EMERGE**

EMPHASIZING SOFTWARE PROCESS MATURITY (SEI FRAMEWORK)

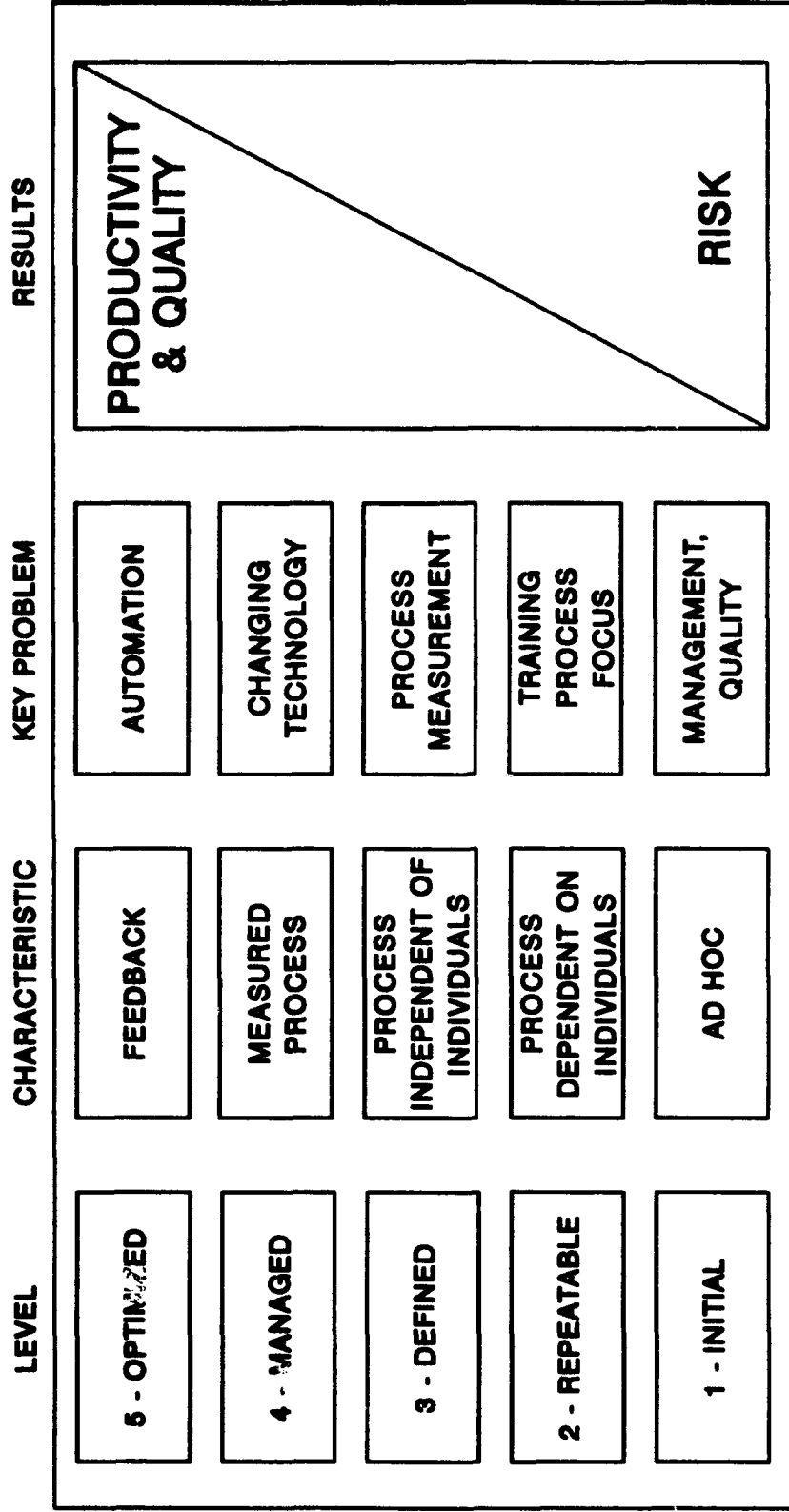

THE
DEFENSE INDUSTRY
IS HERE

EMPHASIZING SOFTWARE PROCESS MATURITY

- **IN SOURCE SELECTION:**
 - **EVALUATE PROCESS MATURITY OF OFFERORS**
 - **TIE PROCESS RISK EVALUATION TO SOURCE SELECTION DECISION**
- **DURING CONTRACT EXECUTION:**
 - **MONITOR IMPLEMENTATION OF RISK ABATEMENT PLANS**
 - **REWARD SUCCESSFUL RISK MITIGATION**

INDUSTRY MUST UNDERSTAND THAT PROCESS MATURITY AND PROCESS IMPROVEMENT ARE IMPORTANT TO US!

EMPHASIZING SOFTWARE PROCESS MATURITY

(Continued)

- **WITHIN GOVERNMENT ORGANIZATIONS:**
 - **ESTABLISH MATURITY BASELINE (THROUGH SELF-ASSESSMENT)**
 - **INITIATE AGGRESSIVE IMPROVEMENT PLAN**

**GOVERNMENT ORGANIZATIONS NEED
TO IMPROVE THEIR PROCESSES TOO**

STREAMLINING SOFTWARE DOCUMENTATION

- OBJECTIVE:
 - ELIMINATE UNNECESSARY COST, TIME
 - IMPROVE QUALITY, SUBSTANCE

- APPROACH:
 - APPLY CORPORATE EXPERIENCE AND COMMON SENSE TESTS TO DOCUMENTATION REQUIREMENTS DECISIONS
 - ENCOURAGE INDUSTRY TO PROPOSE THEIR INTERNAL DOCUMENTATION METHODS WHENEVER POSSIBLE
 - EMPLOY MACHINE-READABLE DOCUMENTATION
 - REVIEW IN "REAL TIME" (NOT AFTER THE FACT)
 - EMPLOY SKILLED REVIEW TEAMS:
 - ON-LINE
 - IN-PLANT

**SIGNIFICANT OPPORTUNITIES
FOR COST REDUCTION**

REWARDING SUCCESSFUL PERFORMANCE CONTRACT TYPES

- MANY CONTRACT TYPES ARE AVAILABLE AND HAVE BEEN USED FOR SOFTWARE
- EXPERIENCE HAS LED US TO CONCLUDE THAT "AWARD FEE" VEHICLES ARE THE MOST EFFECTIVE

AWARD FEE CONTRACTS PROVIDE
THE REWARD FOUNDATION THAT
ENABLES US TO ENSURE THAT ARMY
INTERESTS ARE BEING SATISFIED

HYBRID CONTRACTS

- IN SITUATIONS WHERE WE NEED A CONTRACT FOR SOFTWARE DEVELOPMENT AND OTHER PRODUCTS/SERVICES, A "HYBRID" CONTRACT TYPE MAY HAVE CONSIDERABLE MERIT:

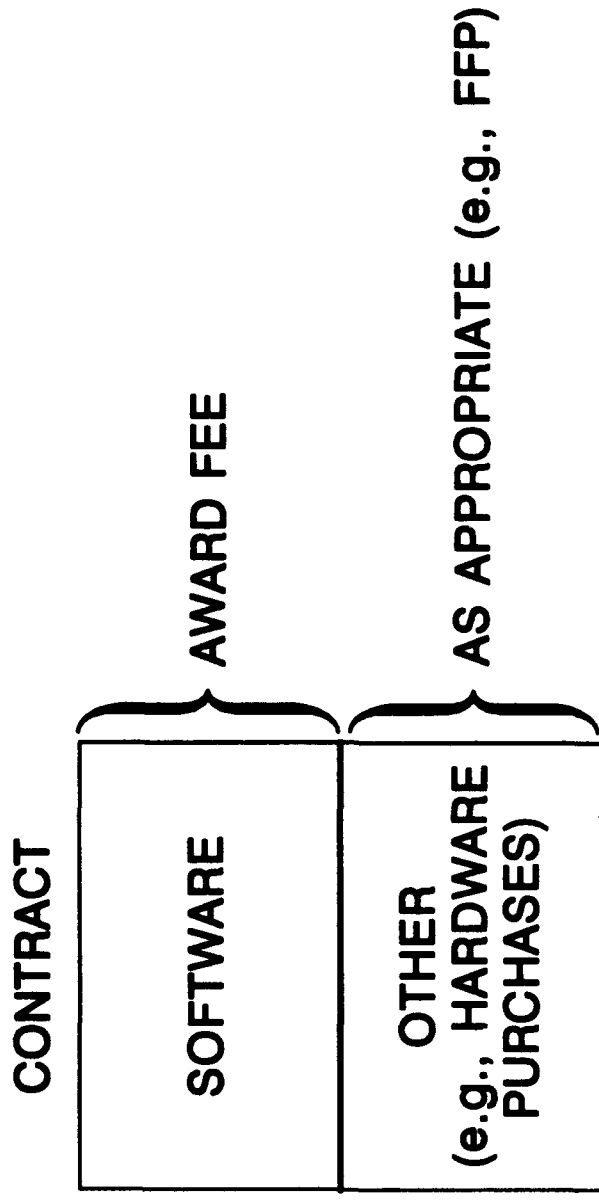

**EXPECT TO SEE HYBRID CONTRACTS
(WHEN SITUATIONS WARRANT THEM)**

SUMMARY

WE NEED TO EMPHASIZE:

- RISK IDENTIFICATION/ABATEMENT
- SOFTWARE ARCHITECTURE
- PROCESS MATURITY
- DOCUMENTATION STREAMLINING
- REWARDS FOR SUCCESSFUL PERFORMANCE

IMPLICATIONS:

- MORE UP-FRONT ENGAGEMENT
- DISCIPLINED, FLEXIBLE INTERACTIONS THROUGHOUT SOURCE-SELECTION, CONTRACT EXECUTION

RECALLING THE BIGGER PICTURE

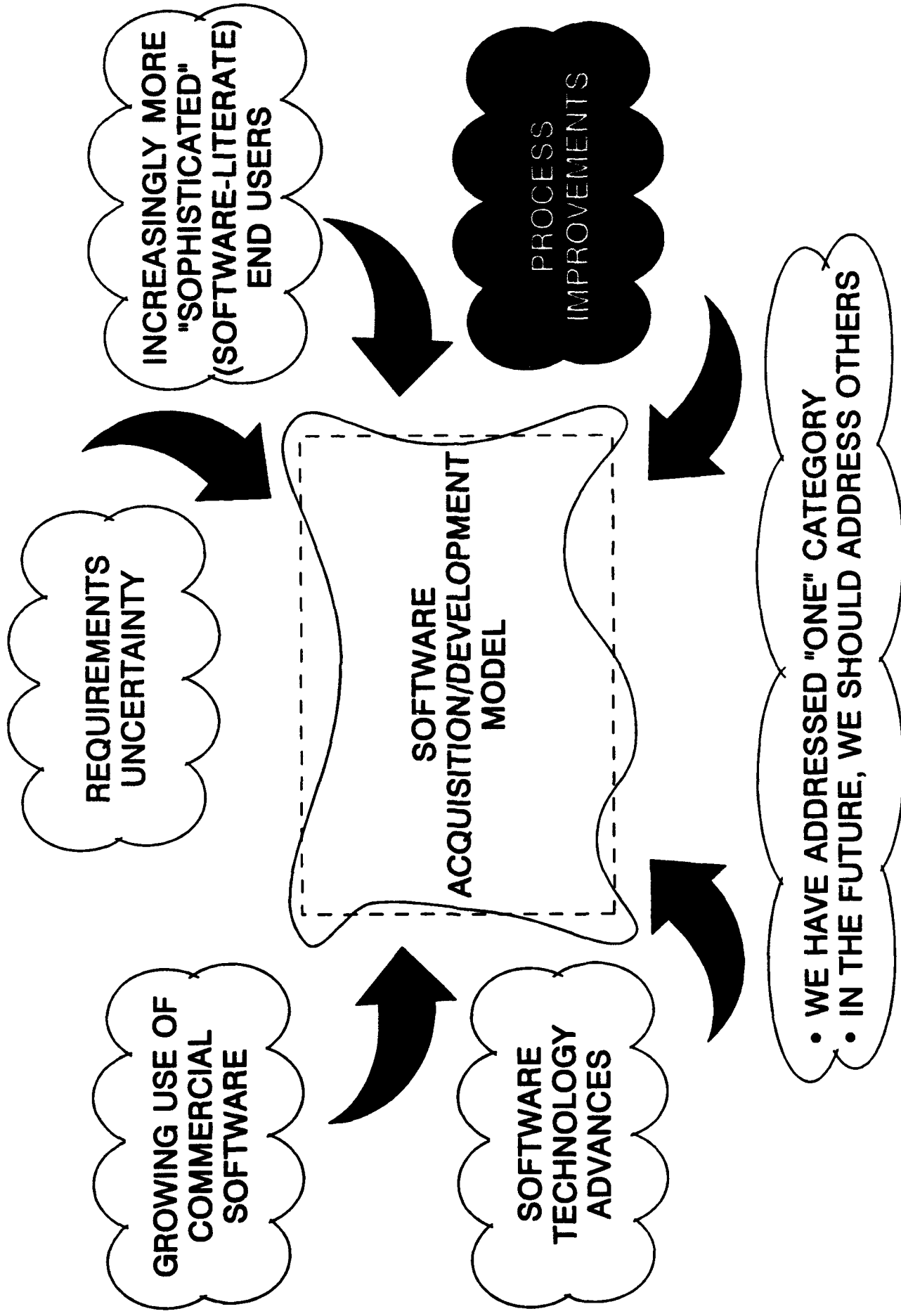

NOTES

SESSION 1

SOFTWARE STANDARDS AND TECHNIQUES



UNCLASSIFIED

SESSION 1

OVERVIEW AND INTRODUCTION

**MODERATOR
JOHN T. LEBARON**

UNCLASSIFIED

SOFTWARE ACQUISITION CONCERNS

INCREASING NUMBER OF SOFTWARE-INTENSIVE SYSTEMS

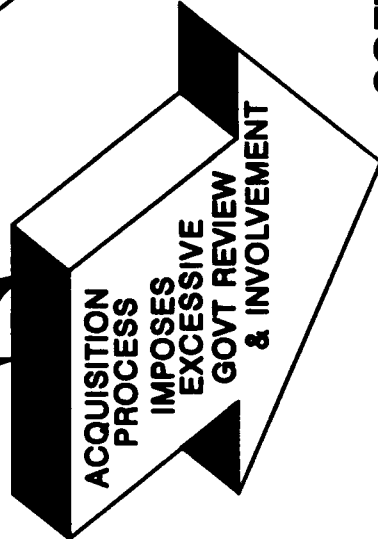
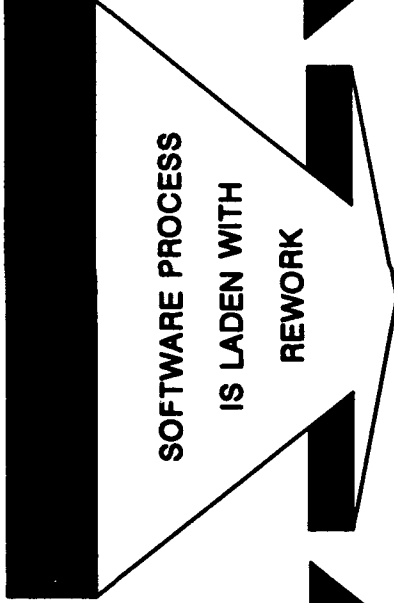
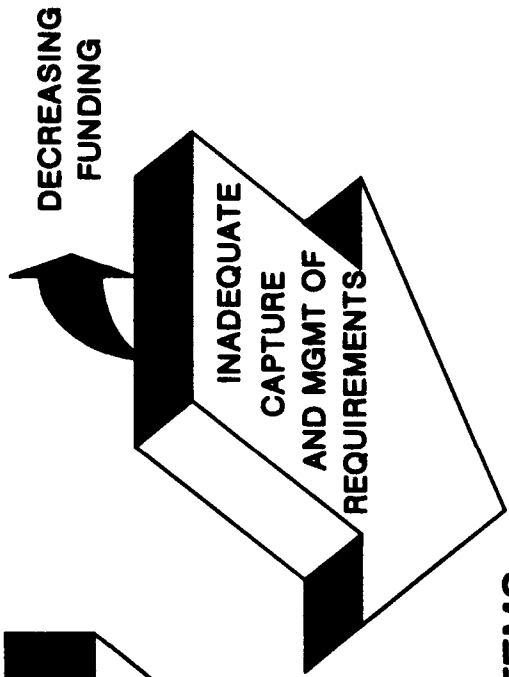

PROBLEM

SOFTWARE-INTENSIVE SYSTEMS ARE DELIVERED LATE, OVER COST, DO NOT ALWAYS MEET THE NEEDS OF THE USER, AND ARE DIFFICULT & COSTLY TO MAINTAIN

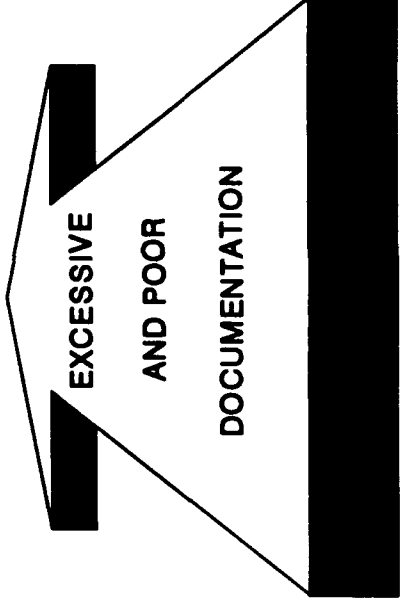
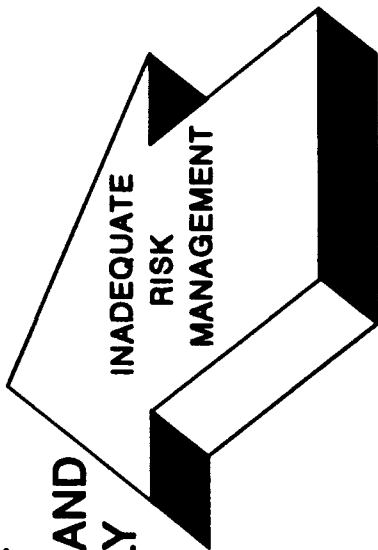
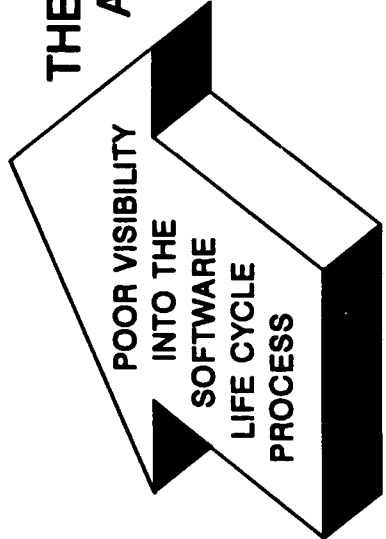

INCREASING COMPLEXITY

SOFTWARE STANDARDS AND TECHNIQUES

SOFTWARE DEVELOPMENT &
DOCUMENTATION STANDARDS

MIL-STD-2167A
DOES NOT

ISSUES

MIL-STD-SDD
DOES

ALLOW FOR THE USE OF CASE TECHNOLOGY

RESTRICTION OF DOCUMENTATION

PROVIDE INSIGHT INTO SOFTWARE DEVELOPMENT EFFORTS

PROVIDE FOR NON-SEQUENTIAL OR ITERATIVE SOFTWARE
DEVELOPMENT PROCESSES

SOFTWARE STANDARDS AND TECHNIQUES

SIMULATION
& MODELING

SOFTWARE
ARCHITECTURE
& REUSE

DISTRIBUTED
INTERACTIVE
SIMULATIONS

STARS
DEMONSTRATION
PROGRAM

ISSUES

SOFTWARE PROCESS IS LADEN WITH REWORK
INABILITY TO CAPTURE AND MANAGE REQUIREMENTS

**TO FURTHER INQUIRE
CONTACT:**

JOHN T. LEBARON

**HQ U.S. ARMY CECOM
ATTN: AMSEL-RD-SE-R-ESD-SES
FORT MONMOUTH, NJ 07703-5000
(908) 532-1803**

UNCLASSIFIED

NOTES

**SOFTWARE DEVELOPMENT
DOCUMENTATION (SDD) AND ITS
IMPACT ON FUTURE ACQUISITIONS**

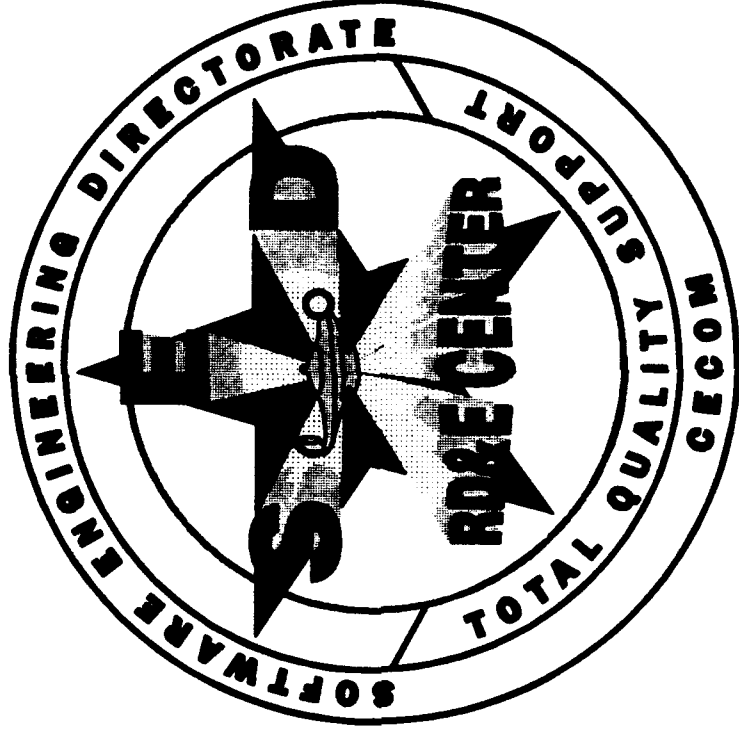

Jeffrey Herman

UNCLASSIFIED

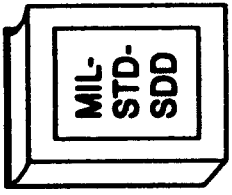

MIL-STD-SDD

- **BACKGROUND/RATIONALE FOR CURRENT INITIATIVE**
- **SDD EMPHASIS**
- **IMPACT ON SED AND ARMY ACQUISITION PRACTICES**

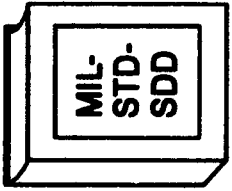

BACKGROUND

THE PROLIFERATION OF SOFTWARE STANDARDS RESULTED IN A RIGID SOFTWARE DEVELOPMENT PROCESS

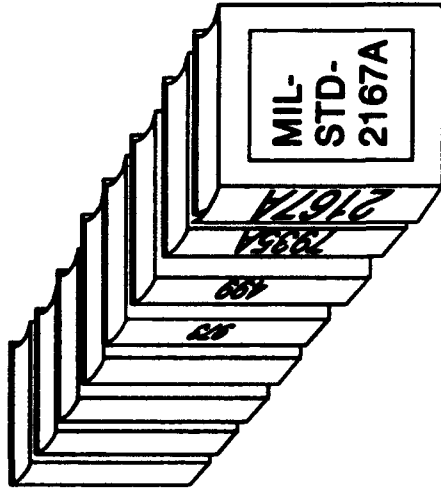

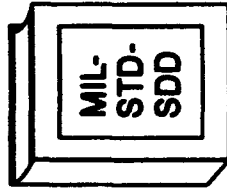

BACKGROUND

RATIONALE FOR NEW STANDARD

- HARMONIZATION OF DOD-STD-2167A AND DOD-STD-7935A ACHIEVED THROUGH:
 - DIRECT USER FEEDBACK
 - INDUSTRY ASSOCIATIONS
 - GOVERNMENT/INDUSTRY WORKSHOPS
 - DoD PROCESS ACTION TEAMS
 - ADDITIONAL ANALYSIS

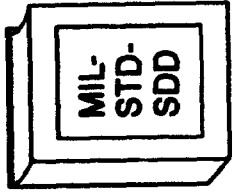

SDD EMPHASIS

- DOCUMENTATION
- SOFTWARE PROCESS/ALTERNATE LIFE CYCLES
- SOFTWARE COMPONENT STRUCTURE
- SUPPORTABILITY
- REUSE
- METRICS

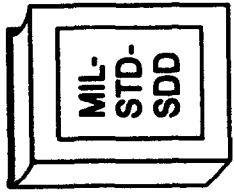

SDD EMPHASIS

DOCUMENTATION

- **EMPHASIS SHIFTED FROM CREATION OF DOCUMENTS TO IMPROVING PERFORMANCE**
- **ALLOWS USE OF AS-BUILT INFORMATION**
- **PROVIDES GUIDANCE TO REDUCE DOCUMENTATION DELIVERABLES**

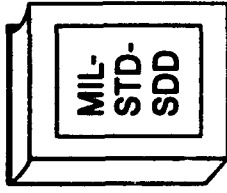

SDD EMPHASIS

SW PROCESS/ALTERNATIVE LIFE CYCLES

- **FLEXIBLE TO PERMIT ALTERNATIVE SOFTWARE PROCESSES**
- **CONTRACTOR DEFINES THE PROCESS WITHIN SDD FRAMEWORK**
- **GUIDANCE PROVIDED FOR INCREMENTAL AND EVOLUTIONARY DEVELOPMENT**

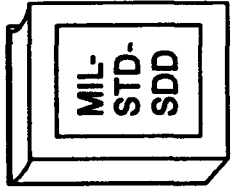

SDD EMPHASIS

SOFTWARE COMPONENT STRUCTURE

- **HIERARCHICAL STRUCTURE ELIMINATED**
- **PROVIDES FLEXIBILITY TO ACCOMMODATE OTHER STRUCTURES**
- **TESTING APPROACH ASSOCIATED WITH CHOSEN SOFTWARE STRUCTURE**

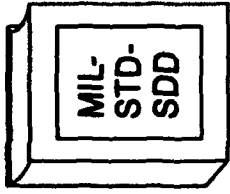

SDD EMPHASIS

SUPPORTABILITY

- **CAPTURE OF ADDITIONAL INFORMATION SUCH AS RATIONALES**
- **USE OF REVIEWABLE AND DELIVERABLE WORK PRODUCTS**
- **REQUEST IDENTIFICATION OF RISK ASSOCIATED WITH SUPPORTABILITY**

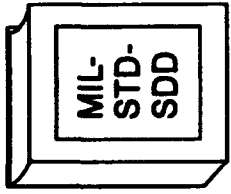

SDD EMPHASIS

REUSE

- EMPHASIS ON INCORPORATING REUSABLE SOFTWARE
- DETAILED CRITERIA PROVIDED FOR EVALUATION OF REUSABLE SOFTWARE
- GUIDANCE PROVIDED FOR TAILORING SDD PRODUCTS WHEN INCLUDING REUSABLE SOFTWARE

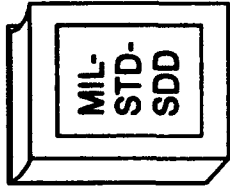

SDD EMPHASIS

METRICS

- SUPPORTS USE OF SOFTWARE MANAGEMENT INDICATORS
- PROVIDES CANDIDATE LIST BUT DOES NOT MANDATE ITS USE

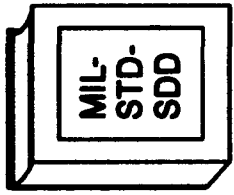

SUMMARY

- SDD IS COMING (EARLY 1994)
- MORE RELIANCE ON USE OF CONTRACTOR PROCESSES AND TOOLS
- REDUCED DOCUMENTATION
- DEPENDENCE ON RISK ABATEMENT

**TO FURTHER INQUIRE
CONTACT:
JEFFREY HERMAN**

**HQ U.S. ARMY CECOM
ATTN: AMSEL-RD-SE-R-ESD
FORT MONMOUTH, NJ 07703-5000
(908) 532-8071**

UNCLASSIFIED

NOTES

SOFTWARE MODELING AND SIMULATION

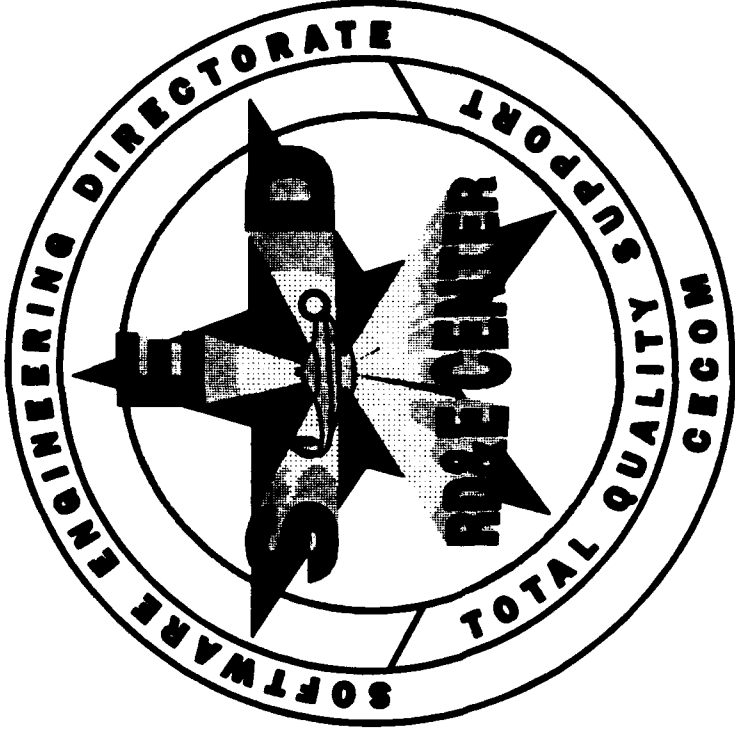

MAJ Gordon W. Robson

UNCLASSIFIED

PURPOSE

- **PROVIDE INFORMATION ON OUR SOFTWARE NEEDS FOR MODELING AND SIMULATIONS TO INCLUDE FUTURE BUSINESS PRACTICES**

SOFTWARE BUSINESS PRACTICE CHANGES

- SIMULATIONS AND MODELS HAVE BECOME THE ACQUISITION PREFERENCE FOR THE FUTURE
- A SIMULATION AND MODELING PLAN WILL BE REQUIRED FOR ALL NEW TACTICAL SYSTEMS AND ADVANCED TECHNOLOGY DEMONSTRATIONS (TIED TO DODD 5000 SERIES)
- SOFTWARE TECHNOLOGIES ARE NEEDED FOR BOTH SIMULATION AND TACTICAL SYSTEMS
- DISTRIBUTED INTERACTIVE SIMULATION (DIS) ESTABLISHES STANDARDS AND PROTOCOLS FOR FUTURE DoD NEEDS

INDUSTRY MUST:

- **BUILD/RETAIN SIMULATION & MODELING EXPERTISE**
- **ADDRESS SIMULATION & MODELING IN PROPOSALS**

DISTRIBUTED INTERACTIVE SIMULATIONS (DIS) THE FUTURE

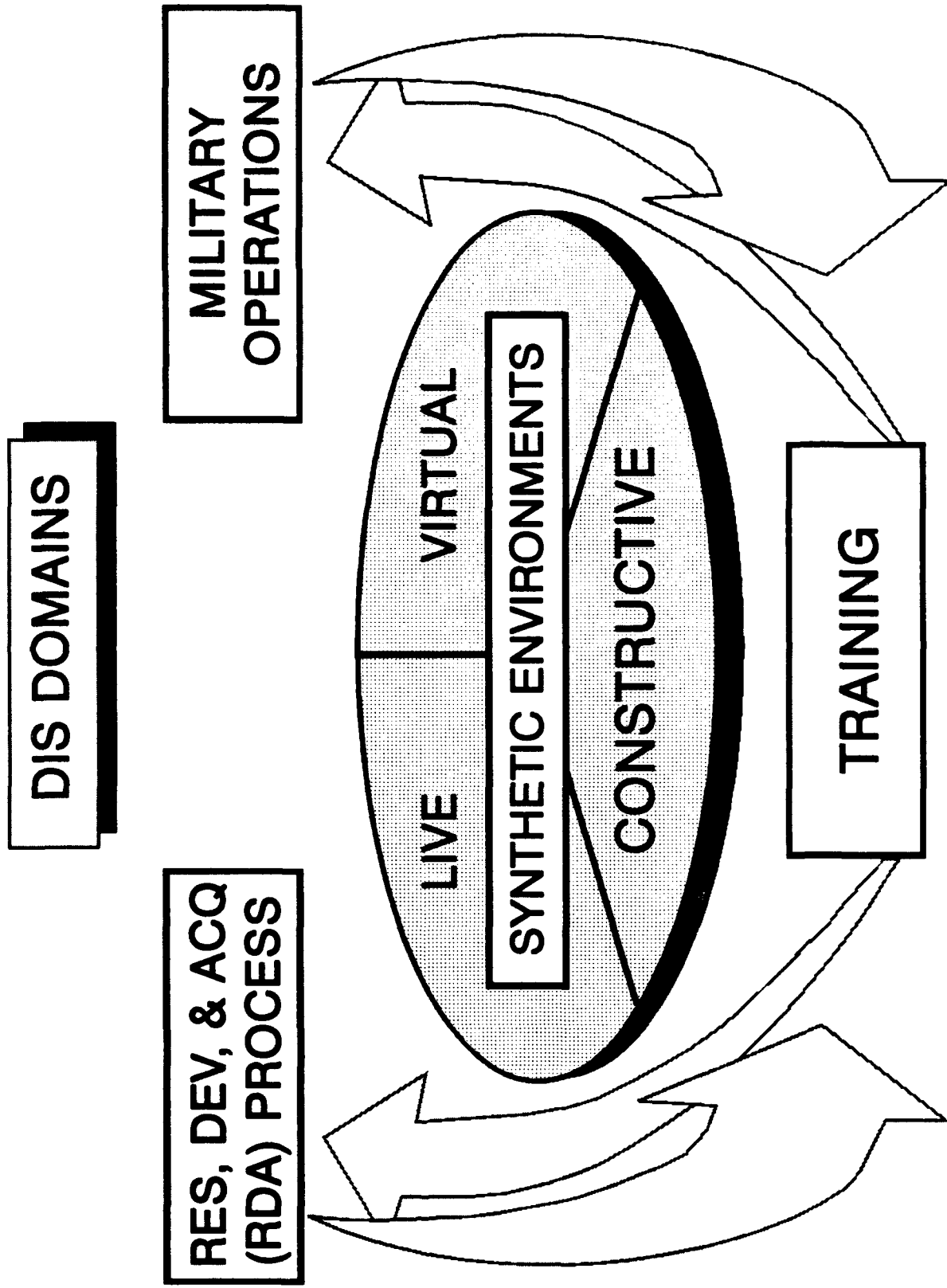

CECOM RDEC SED SUPPORT TO STRICOM

LIFE CYCLE SOFTWARE ENGINEERING

- **TECHNICAL SUPPORT FOR:**
 - **REQUIREMENTS SPECIFICATIONS**
 - **REQUEST FOR PROPOSAL**
 - **SOURCE SELECTION**
- **INDEPENDENT VALIDATION AND VERIFICATION**
- **PROGRAM SUPPORT TO PMs:**
 - **COMPUTER RESOURCES LIFE CYCLE MANAGEMENT PLAN (CRLCMP)**
 - **TEST AND EVALUATION MASTER PLAN (TEMP)**
 - **INTEGRATED LOGISTICS SUPPORT PLAN (ILSP)**
 - **PROGRAM REVIEWS**
- **POST DEPLOYMENT SOFTWARE SUPPORT**

STRICOM

SYSTEMS

UNDER

DEVELOPMENT

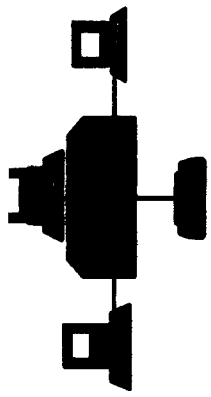

CONTINUOUS

WARSIM 2000

SUPPORTS COMMAND AND STAFF TRAINING

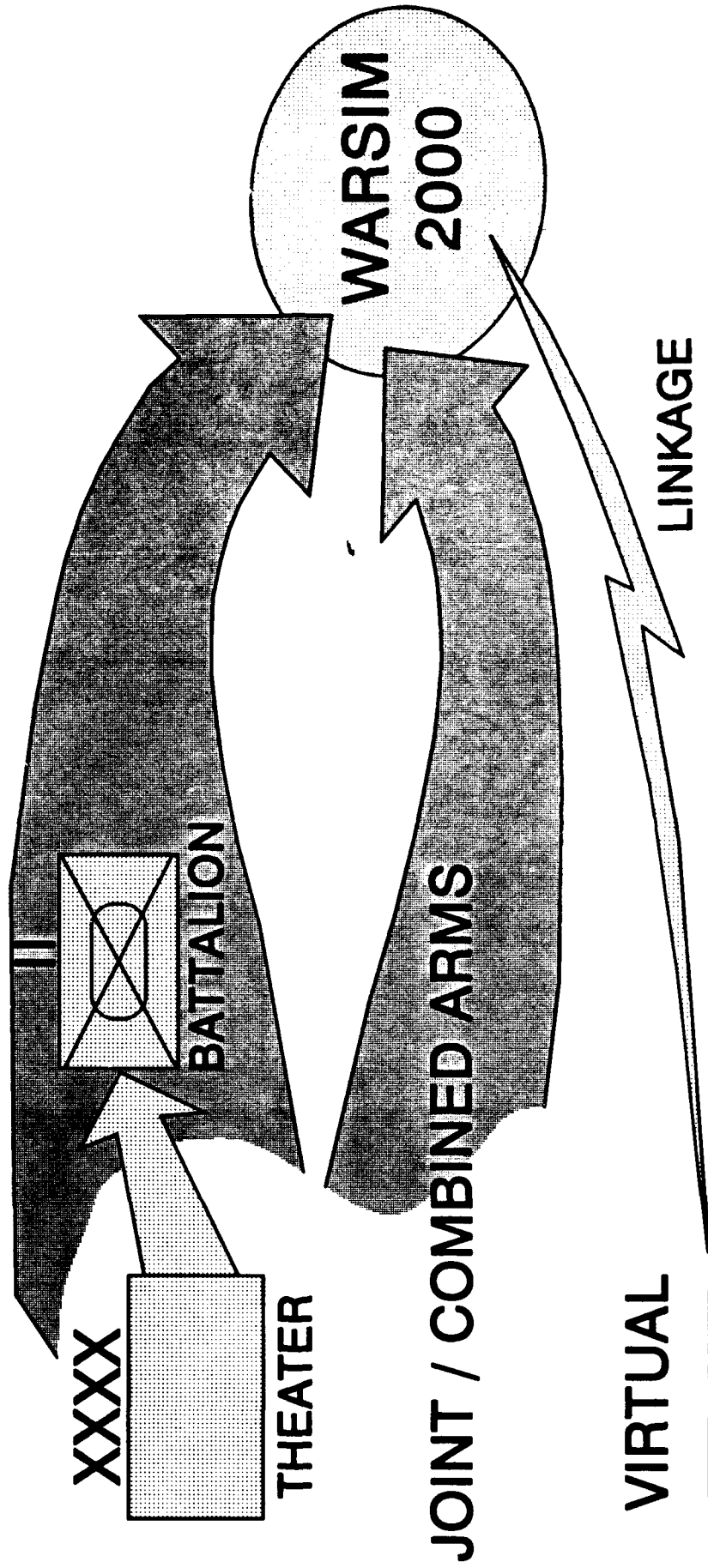

XXXX

THEATER

BATTALION

WARSIM
2000

JOINT / COMBINED ARMS

VIRTUAL

LIVE

LINKAGE



VIRTUAL CLOSE COMBAT TACTICAL TRAINER (CCTT)

SUPPORTS INDIVIDUAL CREW AND SMALL UNIT
TRAINING

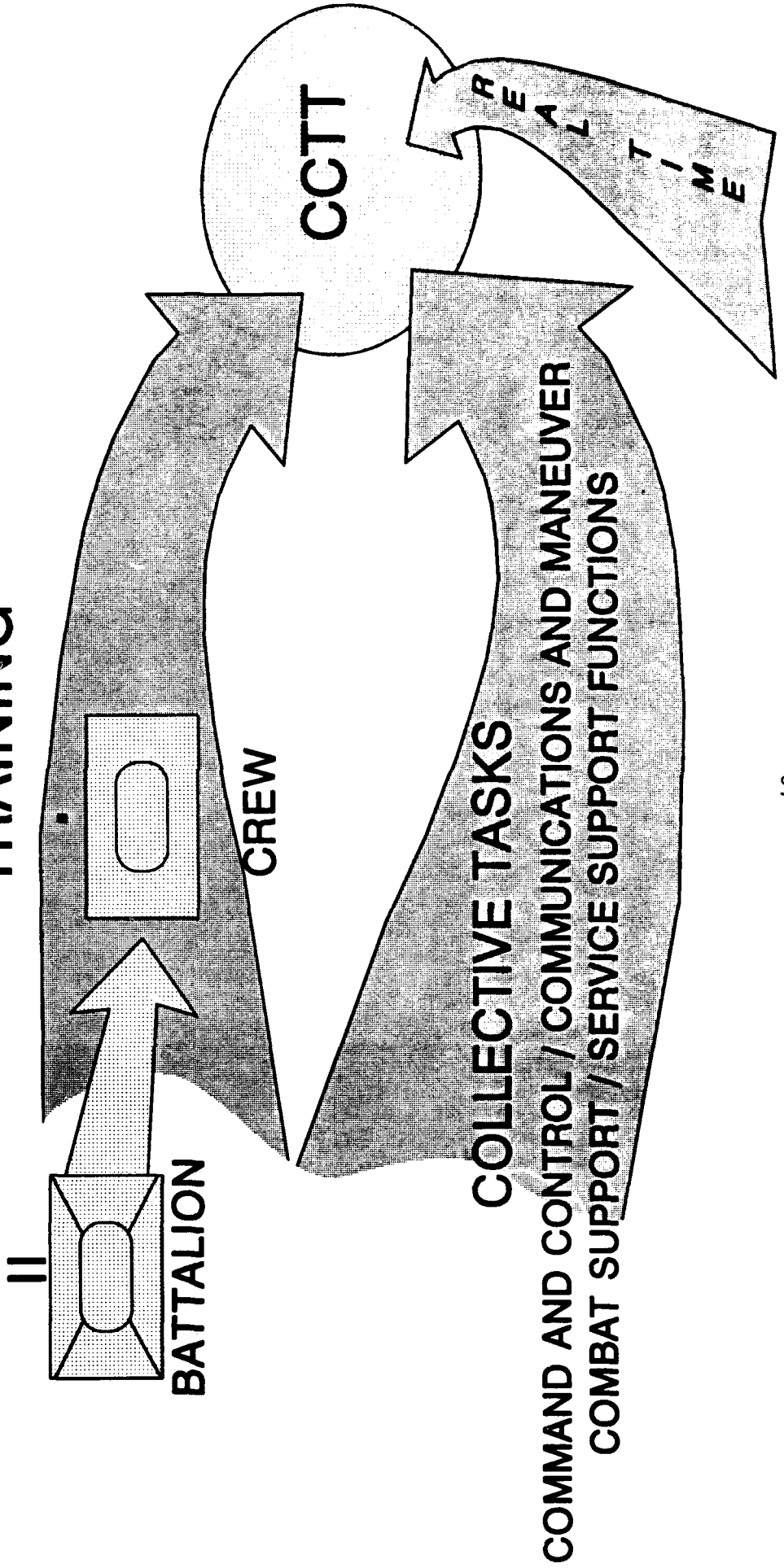

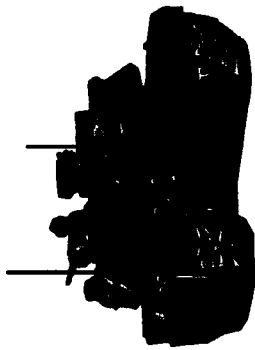

**LIVE
COMBAT TRAINING CENTER
INSTRUMENTATION SYSTEMS**

**SUPPORTS SMALL UNIT THROUGH BRIGADE
LEVEL TRAINING**

**FORCE ON
FORCE**

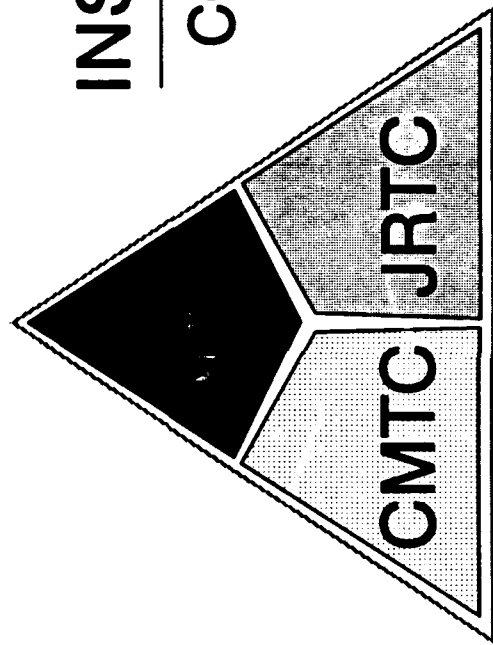
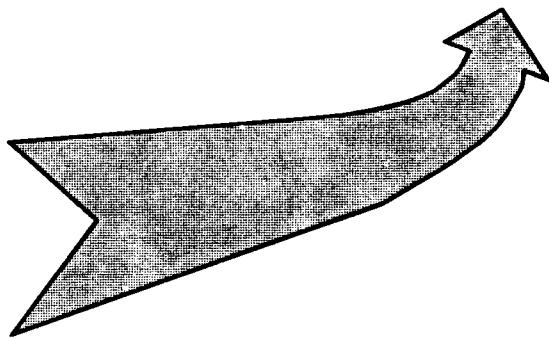

**INSTRUMENTATION
COLLECTS DATA OF
ACTUAL PLAY**

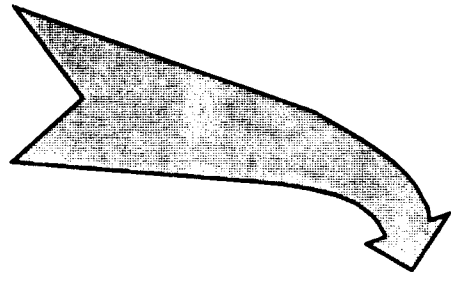

**AFTER ACTION REVIEW
TAKE HOME PACKAGE**

SOFTWARE TECHNOLOGIES

LIVE

INTEGRATED
SELECTIVE
SENSING
SELF-CONFIGURING
ROLE PLAYING

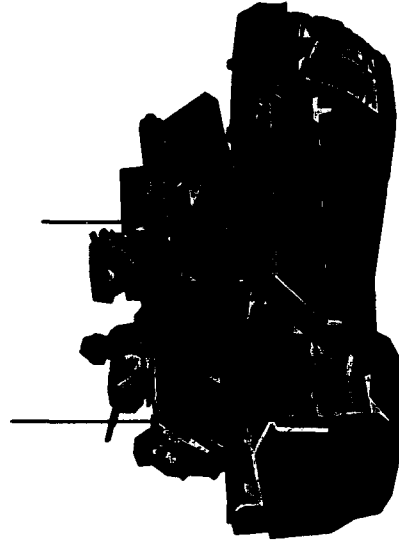

VIRTUAL

STANDARD INTERFACES
DYNAMIC TERRAIN
SEMI-AUTOMATED FORCES
SIMULATION CORRELATION

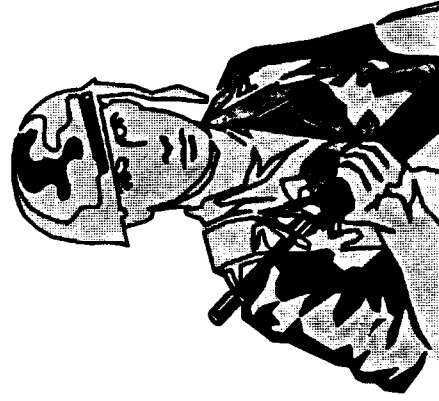

CONSTRUCTIVE

SEMI-AUTOMATED
FORCES
INTERACTIVE TERRAIN
EFFECTIVE AFTER
ACTION REVIEW
LINKAGE-INTERFACE

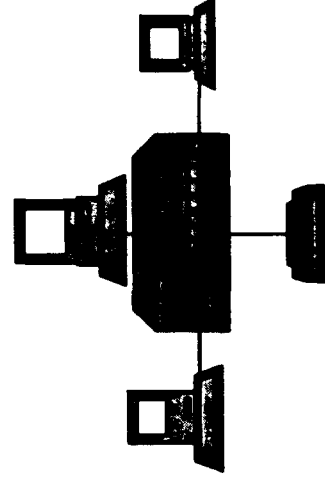

SOFTWARE TECHNOLOGIES

COMMON NEEDS

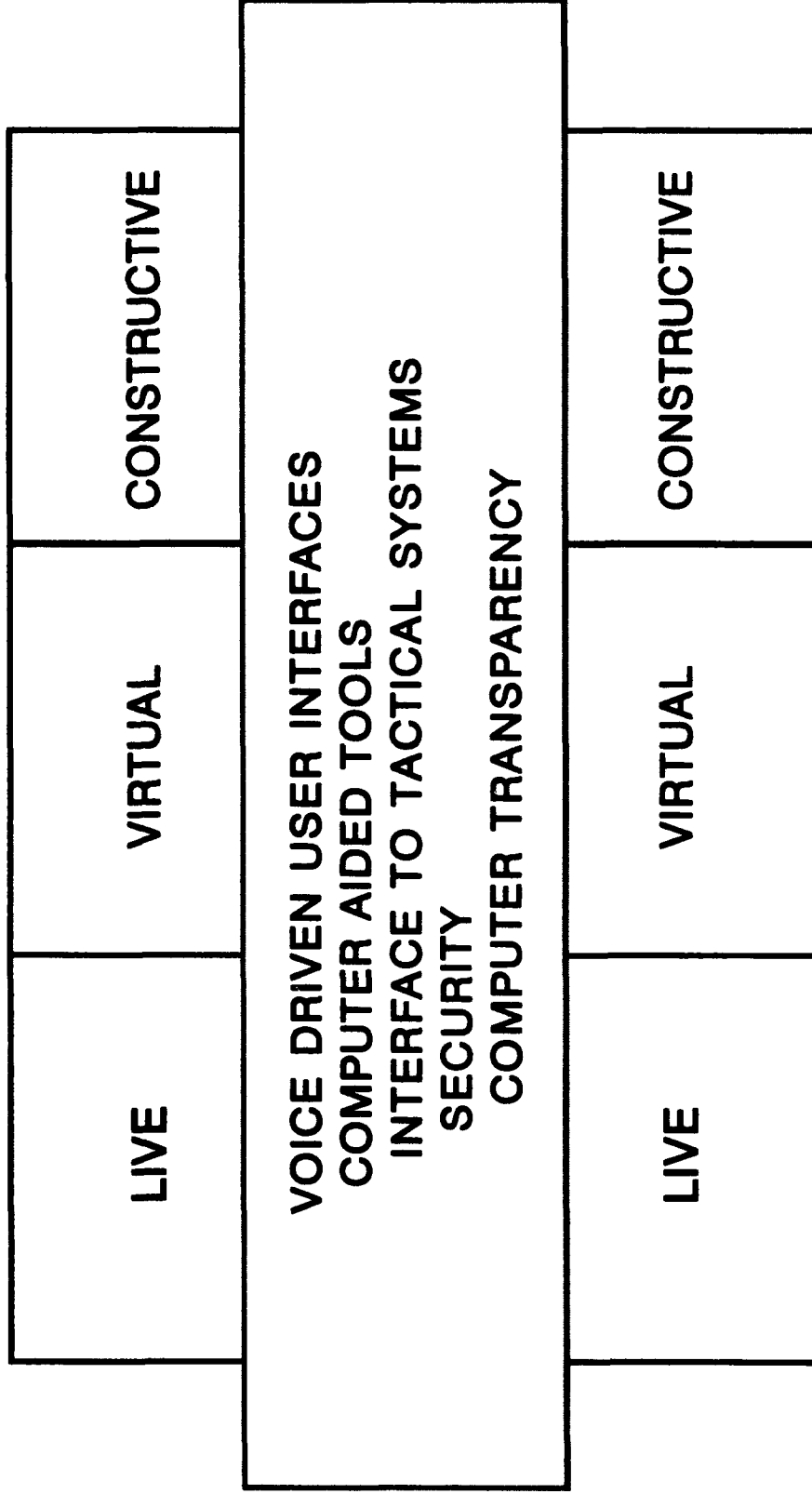

SUMMARY

- SIMULATIONS AND MODELS HAVE BECOME THE ACQUISITION PREFERENCE FOR THE FUTURE
- A SIMULATION AND MODELING PLAN WILL BE REQUIRED FOR ALL NEW TACTICAL SYSTEMS AND ADVANCED TECHNOLOGY DEMONSTRATIONS (TIED TO DODD 5000 SERIES)
- SOFTWARE TECHNOLOGIES ARE NEEDED FOR BOTH SIMULATION AND TACTICAL SYSTEMS
- DISTRIBUTED INTERACTIVE SIMULATION (DIS) ESTABLISHES STANDARDS AND PROTOCOLS FOR FUTURE DoD NEEDS

INDUSTRY MUST:

- **BUILD/RETAIN SIMULATION & MODELING EXPERTISE**
- **ADDRESS SIMULATION & MODELING IN PROPOSALS**

DISTRIBUTED INTERACTIVE SIMULATION

POINTS OF CONTACT

**STRICOM:
(LEAD AGENCY)**

LTC JAN DRABCZUK
ACTING PM DIS
(407) 381-8765
CDR, STRICOM
ATTN: AMSTI-DIS
12350 RESEARCH PARKWAY
ORLANDO, FL 32826-3276

CECOM:

JOHN SILIATO
CHIEF, MODELING AND SIMULATION BRANCH
(908) 544-4708
CDR, CECOM
ATTN: AMSEL-RD-ST-CE-M
FORT MONMOUTH, NJ 07703-5203

**TO FURTHER INQUIRE
CONTACT:**

MAJ GORDON ROBSON

HQ U.S. ARMY CECOM

ATTN: AMSEL-RD-SE-SY-CC-TM

**FORT LEAVENWORTH, KS 66027-5600
(913) 684-7635**

UNCLASSIFIED

NOTES

SOFTWARE ARCHITECTURES AND REUSE AND ITS IMPACT ON SOFTWARE DEVELOPMENT



Gerald Brown

UNCLASSIFIED

SOFTWARE REUSE PROGRAM

**TRANSFER OF ARPA'S CONCEPTS OF
MEGAPROGRAMMING IN CONJUNCTION
WITH THE SOFTWARE TECHNOLOGY FOR
ADAPTABLE RELIABLE SYSTEMS (STARS)
CONCEPTUAL FRAMEWORK FOR REUSE
PROCESS (CFRP)**

**THE CECOM RDEC SOFTWARE ENGINEERING
DIRECTORATE (SED) SOFTWARE REUSE
PROGRAM DEFINES A CONTEXT FOR
INCORPORATING REUSE INTO THE SOFTWARE
DEVELOPMENT AND MAINTENANCE PROCESSES**

SOFTWARE REUSE OBJECTIVES

- **TO IDENTIFY AND ADAPT REUSE TECHNOLOGY TO ENHANCE PRODUCTIVITY FOR MISSION CRITICAL DEFENSE SYSTEMS (MCDSSs)**
- **TO TRANSITION REUSE TECHNOLOGY TO PRACTICE**
- **TO IDENTIFY THE RISKS ASSOCIATED WITH ADOPTING REUSE TECHNOLOGY**

STRATEGIC REUSE

- CECOM TRANSITION TO STRATEGIC/SYSTEMATIC REUSE IS BASED ON:
 - DoD SOFTWARE REUSE VISION AND STRATEGY
 - ARMY STRATEGIC REUSE PLAN

CECOM SED APPROACH TO STRATEGIC REUSE

- **FOCUS ON REUSE WITHIN DOMAINS**
- **USE A PHASED APPROACH**
- **THE ARMY STARS DEMO PROJECT WILL PROVIDE
THE ENABLING ELEMENTS OF SYSTEMATIC REUSE**
- **ENCOURAGE INVESTMENT (BOTH GOVERNMENT
AND INDUSTRY) TO CREATE PROVEN COMPONENTS
CONSISTENT WITH THE DoD APPROACH**

DOMAIN SPECIFIC APPROACH TO REUSE

INFORMATION SYSTEMS COMMAND AND CONTROL WEAPON SYSTEMS

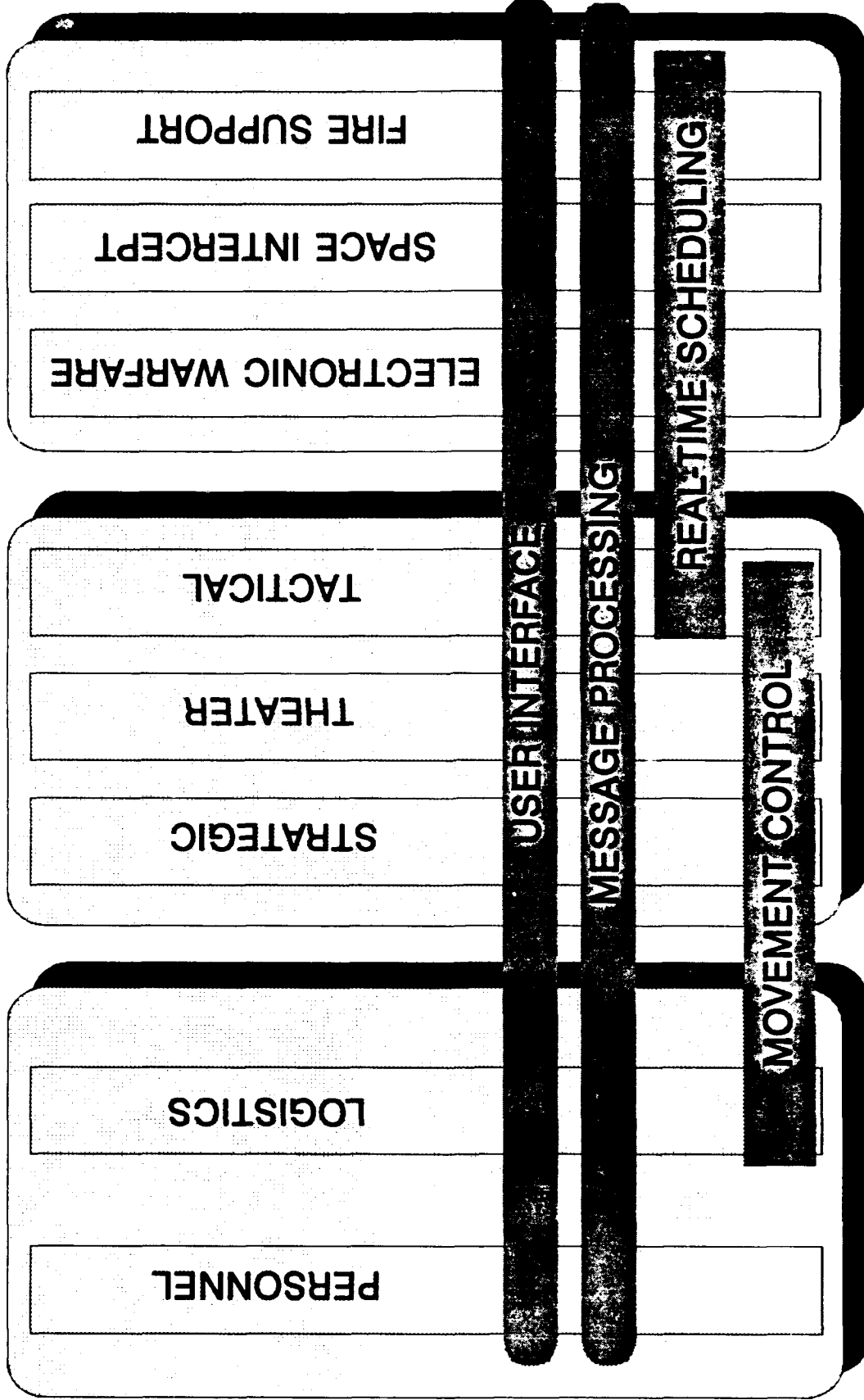

DEFINITION: A DOMAIN IS THE FUNCTIONAL AREA COVERED BY A FAMILY OF SYSTEMS OR ACROSS SYSTEMS WHERE SIMILAR SOFTWARE REQUIREMENTS EXIST

ARMY STARS DEMONSTRATION PROJECT: INTRODUCTION

- JOINTLY SPONSORED BY CECOM RDEC SED AND STARS
 - MEMO OF AGREEMENT SIGNED BY LTG KIND, DISC4, DR. DENMAN, ARPA DIRECTOR, AND MG GUENTHER, CG CECOM
 - SED IS TEAMED WITH UNISYS GOVERNMENT SYSTEMS GROUP AS STARS PRIME SUPPORTING THE ARMY DEMO PROJECT
- DEMONSTRATE BENEFITS OF THE STARS TECHNOLOGY THROUGH THE REENGINEERING OF THE ARMY'S IMPROVED GUARDRIAL V (IGRV)

STARS ROLES AND RELATIONSHIPS

SERVICE COUNTERPARTS

STARS PRIMES

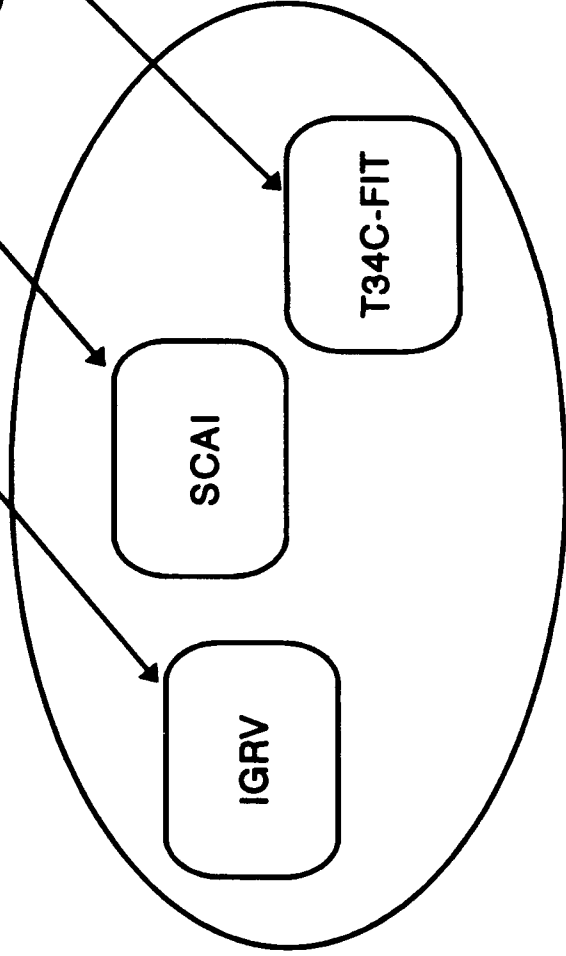
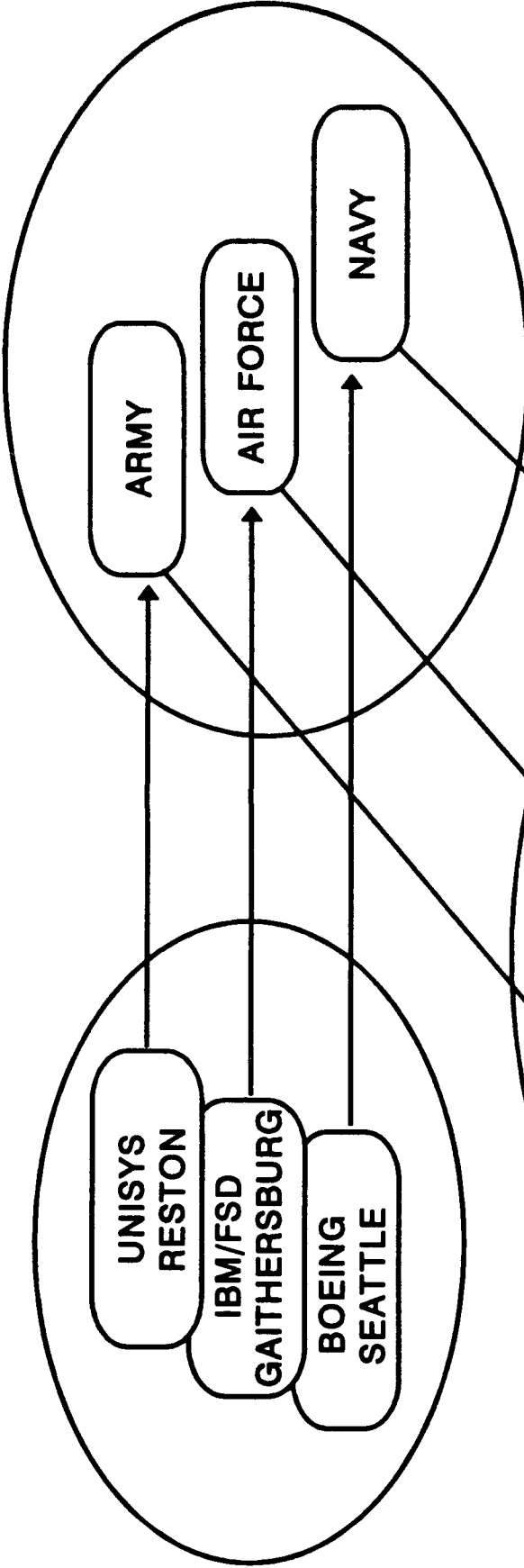

IGRV - IMPROVED
GUARDRAIL V

SCAI - SPACE C2
ARCHITECTURAL
INFRASTRUCTURE

T34C-FIT - AIRCRAFT
TRAINING SIMULATOR,
FLIGHT INSTRUMENT
TRAINER

APPLICATIONS

ARMY STARS DEMO - APPROACH

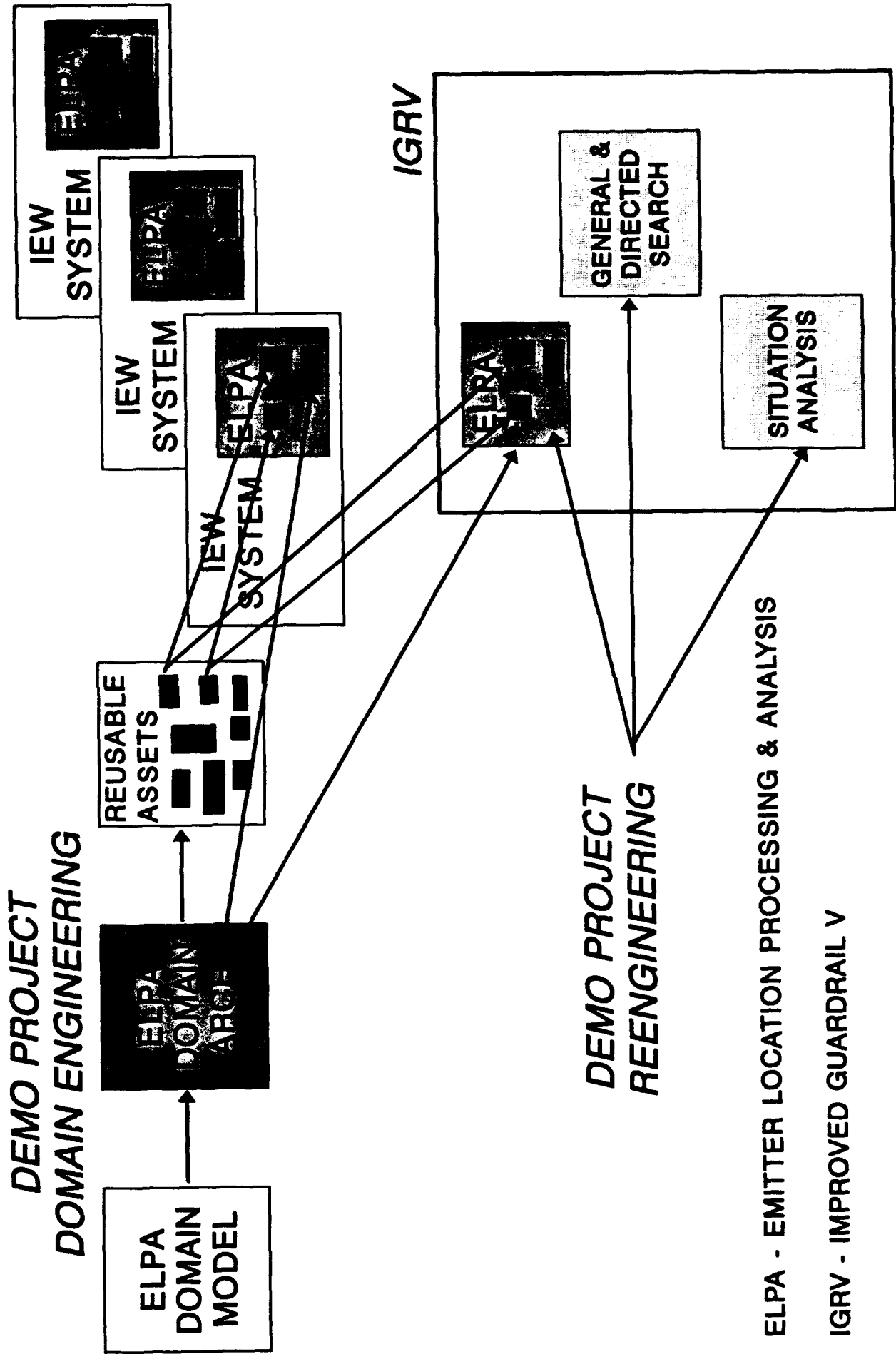

STARS REUSE TECHNOLOGIES LEVERAGED BY ARMY DEMO

- **CONCEPTUAL FRAMEWORK FOR REUSE PROCESS**
 - REUSE MANAGEMENT - PLAN, ENACT, LEARN
 - REUSE ENGINEERING - CREATE, MANAGE,
UTILIZE

STARS REUSE TECHNOLOGIES LEVERAGED BY ARMY DEMO

(Continued)

- **ORGANIZATIONAL DOMAIN MODELING (ODM)**
 - **ADVOCATES SEPARATION OF DESCRIPTIVE AND PRESCRIPTIVE ANALYSIS**
 - **PROVIDES A SET OF WORK PRODUCTS FOR DOMAIN ANALYSIS**
 - **INDEPENDENT OF SOFTWARE DEVELOPMENT METHOD**

STARS REUSE TECHNOLOGIES LEVERAGED BY ARMY DEMO (Continued)

- REUSE LIBRARY FRAMEWORK (RLF)
 - KNOWLEDGE-BASED TOOL USED FOR A DOMAIN SPECIFIC LIBRARY AND DOMAIN MODELING
 - INCLUDES A GRAPHICAL BROWSER TO ALLOW THE USER TO INTERACT WITH THE LIBRARIES AND DOMAIN MODELS

SYSTEMATIC APPROACH TO IEW REUSE

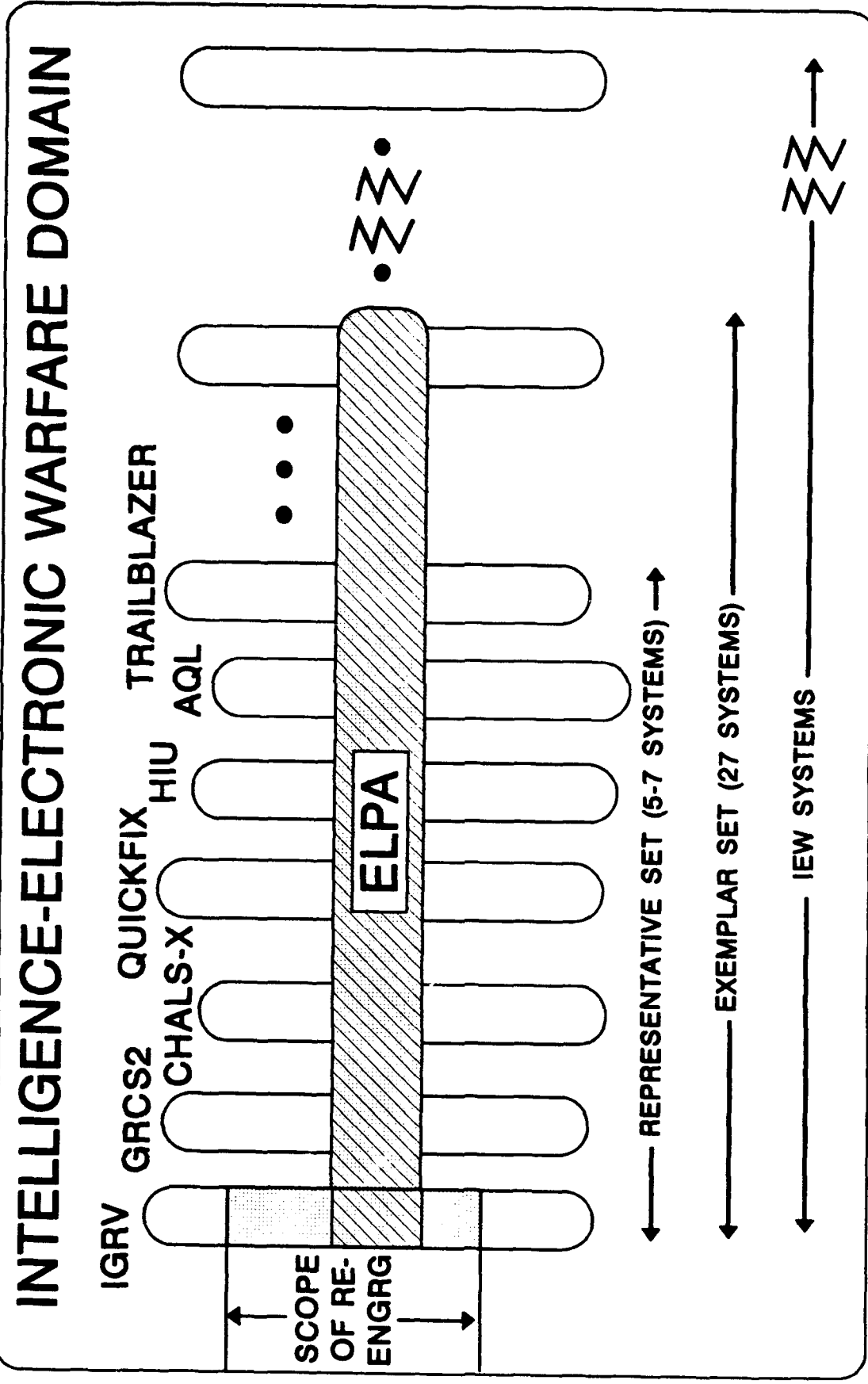

- APPLICATION ENGINEERING
- DOMAIN ENGINEERING

STRATEGIC REUSE IMPACT ON INDUSTRY

- **STRATEGIC REUSE STABILIZES DOMAINS;
CREATES OPPORTUNITIES FOR INVESTMENT**
- **DOMAIN MODELS AND ARCHITECTURES:
PROVIDE THE FOUNDATION FOR BETTER
REQUIREMENTS DEFINITION; REDUCE COST
OVERRUNS**
- **THE ARMY STARS DEMO PROJECT IS A TEST
CASE; RISK REDUCTION STEP TAKEN BY DoD -
WILL BENEFIT THE BUSINESS COMMUNITY**

SOFTWARE REUSE PAY-OFF

- **INCREASE THE EFFICIENCY OF THE SOFTWARE DEVELOPMENT AND MAINTENANCE PROCESSES**
- **IMPROVES REQUIREMENTS DEFINITION AND RAPID PROTOTYPING**
- **THE ARMY STARS DEMO PROJECT PROVIDES AN IMPORTANT FIRST STEP**
- **THE CECOM RDEC SED APPROACH INCLUDING RISK ANALYSIS AND PLANS FOR TRANSITIONING TO OTHER IEW SYSTEMS AND OTHER SUBDOMAINS OF C3I**

SUMMARY

- **CECOM COMMITTED TO DOMAIN-SPECIFIC, ARCHITECTURE-BASED REUSE**
- **REVIEW YOUR BUSINESS STRATEGIES TO IDENTIFY AND SCOPE DOMAINS OF INTEREST**
- **INCORPORATE DOMAIN-SPECIFIC REUSE APPROACH INTO PROPOSALS**

**TO FURTHER INQUIRE
CONTACT:
GERALD BROWN**

**HQ U.S. ARMY CECOM
ATTN: AMSEL-RD-SE-R-ESD-SPT
FORT MONMOUTH, NJ 07703-5000
(908) 532-2566**

UNCLASSIFIED

NOTES

SESSION 2

STREAMLINING THE ACQUISITION APPROACH



UNCLASSIFIED

SESSION 2

OVERVIEW AND INTRODUCTION

MODERATOR

George E. Sumrall

UNCLASSIFIED

SOFTWARE ACQUISITION CONCERNS

INCREASING
NUMBER OF
SOFTWARE-
INTENSIVE
SYSTEMS

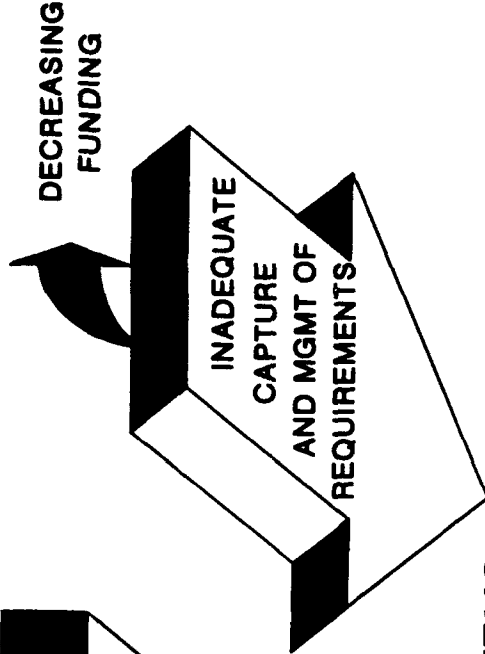
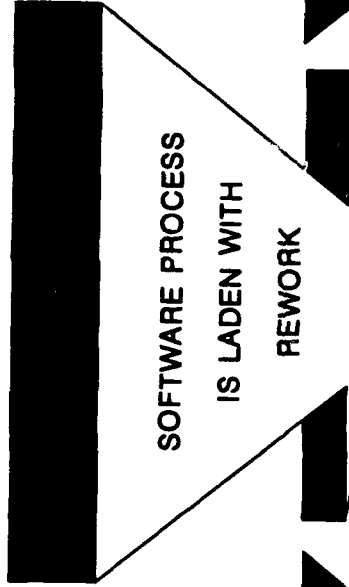
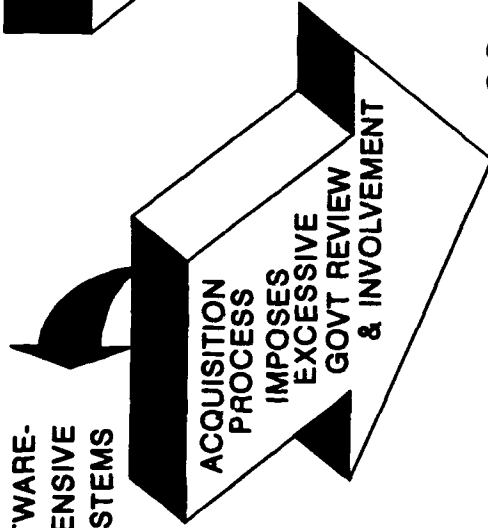

PROBLEM

SOFTWARE-INTENSIVE SYSTEMS
ARE DELIVERED LATE, OVER COST,
DO NOT ALWAYS MEET
THE NEEDS OF THE USER, AND
ARE DIFFICULT & COSTLY
TO MAINTAIN

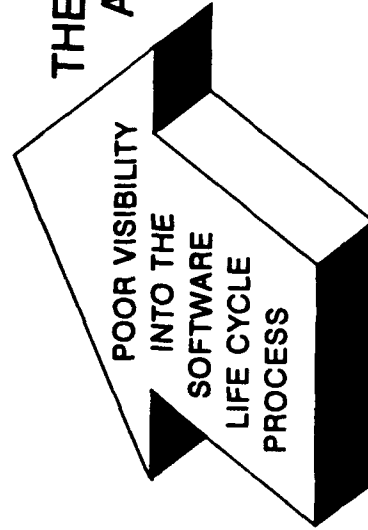

INCREASING
COMPLEXITY

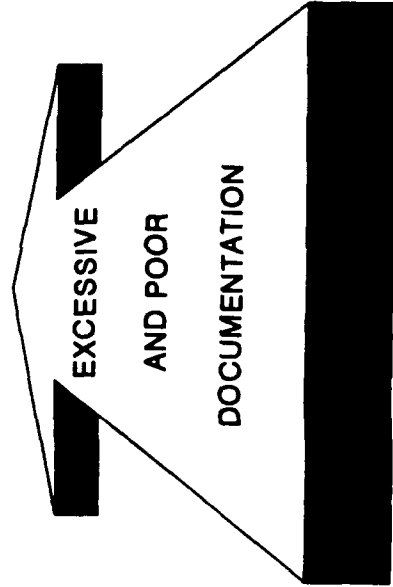
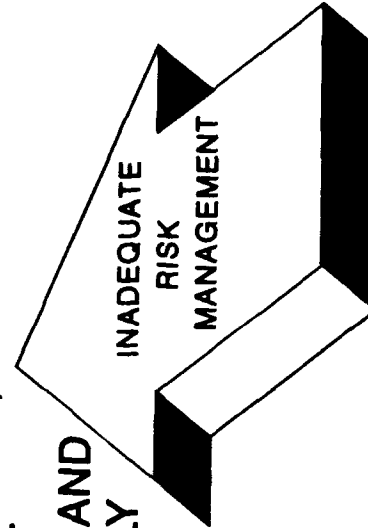

DECREASING POOL OF
TRAINED AND
EXPERIENCED
PERSONNEL

ACQUISITION STREAMLINING

MEANS:

- REMOVING OLD BARRIERS
- ADDING FOCUS ON PROCESS AND RISK

PHILOSOPHY:

- GOVERNMENT WILL SPECIFY "WHAT"
- CONTRACTOR RESPONSIBLE FOR:
 - DETERMINING "HOW-TO"
 - IDENTIFYING AND MANAGING RISK
- ELIMINATING UNNECESSARY DATA ITEMS

ACQUISITION STREAMLINING (Continued)

IMPLICATIONS:

- MORE UP-FRONT ENGAGEMENT
- DISCIPLINED, FLEXIBLE, DYNAMIC INTERACTION
 - BEFORE CONTRACT AWARD
 - DURING CONTRACT EXECUTION
- WANT TO AVOID SURPRISES IN PURSUIT OF OUR PRODUCT

STREAMLINING THE ACQUISITION APPROACH

PRESENTATIONS

STREAMLINED ACQUISITION GUIDANCE - ANDY MILLS

SOFTWARE CAPABILITY EVALUATION
AND ITS IMPACT ON THE SOURCE
SELECTION PROCESS - JEFF HERMAN

STREAMLINED INTEGRATED SOFTWARE - STEWART FENICK
METRICS APPROACH

CECOM SOFTWARE OMBUDSMAN - DR. MARTIN WOLFE

**TO FURTHER INQUIRE
CONTACT:**

GEORGE E. SUMRALL

**HQ U.S. ARMY CECOM
ATTN: AMSEL-RD-SE-R-ESD-SPT
FORT MONMOUTH, NJ 07703-5000
(908) 532-2342**

UNCLASSIFIED

NOTES

STREAMLINED ACQUISITION GUIDANCE



Andrew C. Mills

UNCLASSIFIED

SOFTWARE ACQUISITION STREAMLINING

- **AN IMPROVED WAY TO:**
 - **PREPARE SOLICITATIONS**
 - **SELECT QUALIFIED OFFERORS**
 - **CONDUCT, MONITOR, AND MANAGE SOFTWARE ACQUISITION**
- **BASED ON:**
 - **NOT SPECIFYING "HOW TO DEVELOP" SOFTWARE, BUT "WHAT TO DEVELOP"**
 - **CHOOSING A "MANAGEABLE" RISK PATH**

STREAMLINED ACQUISITION TARGETS FOR IMPROVEMENT

- **DOCUMENTATION AND REVIEW PRACTICES**
 - **REDUCTION OF DATA ITEMS**
 - **SHIFT TO INDUSTRY PRACTICES**
 - **PRODUCTIVITY INCREASE**
- WHILE REDUCING RISK IN ACQUISITION**

IMPROVEMENT APPROACH

- **FOCUS ON RISK -- SOURCE SELECTION AND AFTER AWARD**
- **MINIMIZE CONTRACTUAL REQUIREMENTS "WHAT" NOT "HOW"**
- **SUBSTITUTE CONTRACTOR WORK PRODUCTS FOR DOCUMENTATION**
- **REPLACE DOCUMENT REVIEW WITH VISIBILITY INTO EMERGING SOFTWARE**
- **APPROVE BASELINES WHEN THEY ARE STABLE**

STATUS

- OPPORTUNISTIC INCORPORATION OF STREAMLINING METHODOLOGY
- NOW SEEING POSITIVE RESULTS FROM EARLY IMPLEMENTATION
- DEFINED PROCEDURE USED FOR STREAMLINING
- REFINING METHODOLOGY FOR SOLICITATIONS/SOURCE SELECTION

IMPACTS ON INDUSTRY

- INDUSTRY PROPOSALS MUST BE
 - MANAGEABLE
 - COMPATIBLE WITH STREAMLINING
 - ORIENTED TO RISK REDUCTION
- OFFEROR TO PROVIDE
 - SOFTWARE RISK INFORMATION
 - PLAN FOR RISK ABATEMENT
- RISK MEASURES TO ENSURE
 - SOFTWARE QUALITY
 - TIMELY PRODUCT DELIVERY
 - EARLY RISK IDENTIFICATION

IMPACTS ON INDUSTRY

(Continued)

- **DEVELOPER RETAINS DESIGN RESPONSIBILITY DURING DEVELOPMENT**
- **DEVELOPER EXPECTED TO PROVIDE AUTOMATED TOOL ACCESS**
- **GOVERNMENT ACCESS INFORMATION WITH MINIMAL ASSISTANCE**
- **LESS WAITING FOR GOVERNMENT REVIEW CYCLE AND COMMENTS**

PAYOFFS

- **REDUCED COST, IMPROVED SCHEDULE**
- **LESS EXTRANEIOUS DOCUMENTATION**
- **EASIER GOVERNMENT/CONTRACTOR INTERACTION, MORE VISIBILITY**
- **TECHNOLOGY USE ENABLED**
- **MORE FRIENDLY TO INDUSTRY**
- **BETTER HANDLING OF RISK**

SUMMARY

- FOCUS ON RISK -- SOURCE SELECTION AND AFTER AWARD
- MINIMIZE CONTRACTUAL REQUIREMENTS "WHAT" NOT "HOW"
- SUBSTITUTE CONTRACTOR WORK PRODUCTS FOR DOCUMENTATION
- REPLACE DOCUMENT REVIEW WITH VISIBILITY INTO EMERGING SOFTWARE
- APPROVE BASELINES WHEN THEY ARE STABLE

**TO FURTHER INQUIRE
CONTACT:
ANDREW MILLS**

**HQ U.S. ARMY CECOM
ATTN: AMSEL-RD-SE-R-ESD-SPT
FORT MONMOUTH, NJ 07703-5000
(908) 532-2081**

UNCLASSIFIED

NOTES

SOFTWARE CAPABILITY EVALUATIONS AND THEIR IMPACT ON THE SOURCE SELECTION PROCESS



Jeffrey Herman

UNCLASSIFIED

OBJECTIVES

- EXPLAIN EVOLUTION OF SCE
- DEFINE SOFTWARE CAPABILITY EVALUATIONS (SCE)
- DESCRIBE GOALS OF THE SCE
- SOURCE SELECTION EFFECTS AND RESULTS
- EXPLAIN DIFFERENCE BETWEEN SCE AND SPA
- CECOM SED INVOLVEMENT
- BENEFITS OF SCE

THE MATURITY MODEL FRAMEWORK

**A RELATIVE SCALE AND MATRIX USED TO
ASSIST AN ORGANIZATION IN DETERMINING
WHERE ITS SOFTWARE PRACTICE IS TODAY
AND WHERE IT CAN BE TOMORROW**

MATURITY MODEL FRAMEWORK

LEVEL	CHARACTERISTIC	KEY PROCESS AREAS	RESULTS
OPTIMIZING	IMPROVEMENT FED BACK INTO PROCESS	DEFECT PREVENTION TECHNOLOGY CHANGE MANAGEMENT PROCESS CHANGE MANAGEMENT	PRODUCTIVITY & QUALITY
MANAGED	(QUANTITATIVE) MEASURED PROCESS	DEFECT PREVENTION TECHNOLOGY CHANGE MANAGEMENT PROCESS CHANGE MANAGEMENT	
DEFINED	(QUALITATIVE) PROCESS DEFINED AND INSTITUTIONALIZED	ORGANIZATION PROCESS FOCUS ORGANIZATION PROCESS DEFINITION TRAINING PROGRAM INTEGRATED SOFTWARE MANAGEMENT SOFTWARE PRODUCT ENGINEERING INTER GROUP COORDINATION	
REPEATABLE	(INTUITIVE) PROCESS DEPENDENT ON INDIVIDUALS	REQUIREMENTS MANAGEMENT SOFTWARE PROJECT PLANNING SOFTWARE PROJECT TRACKING SOFTWARE SUBCONTRACT MANAGEMENT SOFTWARE QUALITY ASSURANCE SOFTWARE CONFIGURATION CONTROL	
INITIAL	(INFORMAL)		RISK

SCE METHOD EVOLUTION 1987- PRESENT

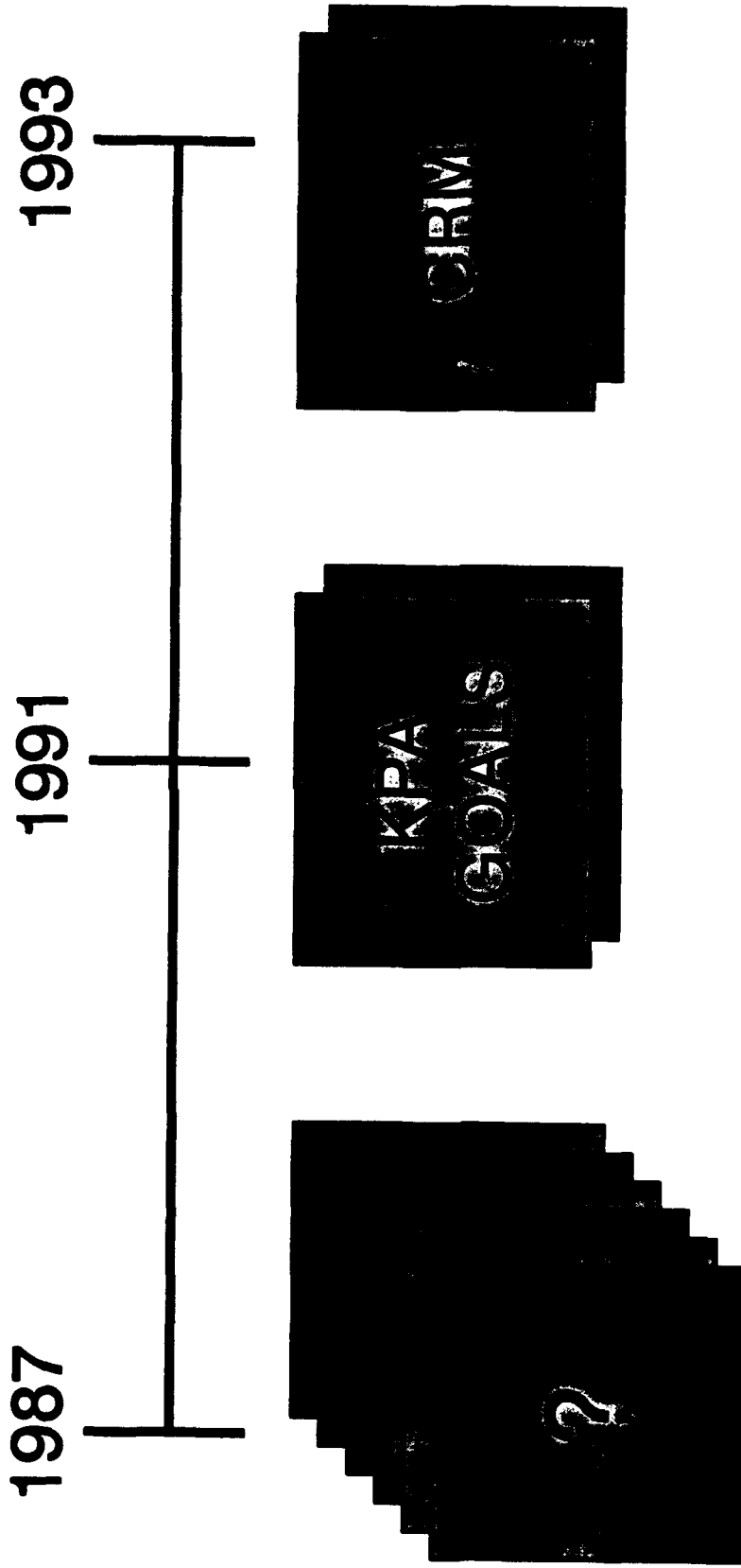

SOFTWARE CAPABILITY EVALUATION DEFINITION

**A METHOD TO EVALUATE THE SOFTWARE PROCESS
CAPABILITY OF ORGANIZATIONS TO GAIN INSIGHT INTO
THEIR SOFTWARE DEVELOPMENT CAPABILITY**

- A STRUCTURED APPROACH TO COLLECT DATA
RELEVANT TO AN ORGANIZATION'S SOFTWARE
PROCESSES**
- DATA EVALUATED AGAINST A DEFINED STANDARD
WHICH HAS STRUCTURAL FEATURES TO FACILITATE
COMMUNICATIONS AMONG USERS**
- PERFORMED BY A TRAINED TEAM KNOWLEDGEABLE
IN SOFTWARE ENGINEERING PROCESSES**

SOFTWARE ENGINEERING PROCESS IMPROVEMENT

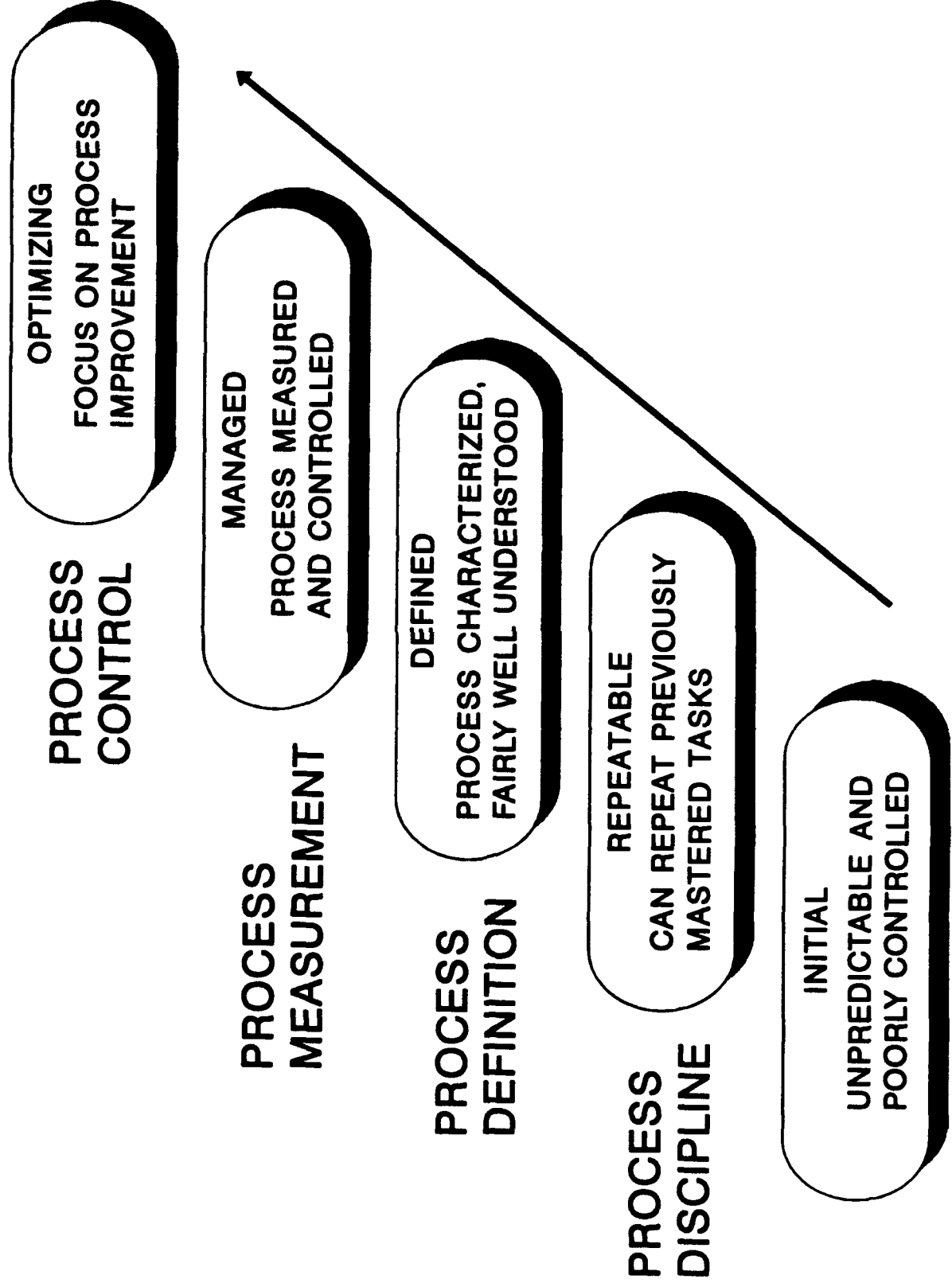

MATURITY MODEL FRAMEWORK-INITIAL LEVEL

LEVEL	CHARACTERISTIC	KEY PROCESS AREAS	RESULT
5 OPTIMIZING	IMPROVEMENT FED BACK INTO PROCESS	DEFECT PREVENTION TECHNOLOGY CHANGE MANAGEMENT PROCESS CHANGE MANAGEMENT	PRODUCTIVITY & QUALITY
4 MANAGED	(QUANTITATIVE) MEASURED PROCESS	DEFECT PREVENTION TECHNOLOGY CHANGE MANAGEMENT PROCESS CHANGE MANAGEMENT	
3 DEFINED	(QUALITATIVE) PROCESS DEFINED AND INSTITUTIONALIZED	ORGANIZATION PROCESS FOCUS ORGANIZATION PROCESS DEFINITION TRAINING PROGRAM INTEGRATED SOFTWARE MANAGEMENT SOFTWARE PRODUCT ENGINEERING INTER GROUP COORDINATION	
2 REPEATABLE	(INTUITIVE) PROCESS DEPENDENT ON INDIVIDUALS	REQUIREMENTS MANAGEMENT SOFTWARE PROJECT PLANNING SOFTWARE PROJECT TRACKING SOFTWARE SUBCONTRACT MANAGEMENT SOFTWARE QUALITY ASSURANCE SOFTWARE CONFIGURATION CONTROL	
1 INITIAL	(INFORMAL)		

INITIAL LEVEL ORGANIZATION CASE STUDY

LEVEL 1 - INITIAL

JOE IS AN EXPERIENCED AUTO MECHANIC

JOE OPENS AN AUTO SHOP

JOE HIRES SOME EXPERT MECHANICS

EACH MECHANIC DOES A TUNE-UP, BRAKE JOB, AND WHEEL ALIGNMENT IN HIS/HER OWN WAY

THE JOB IS ONLY AS GOOD AS THE MECHANIC

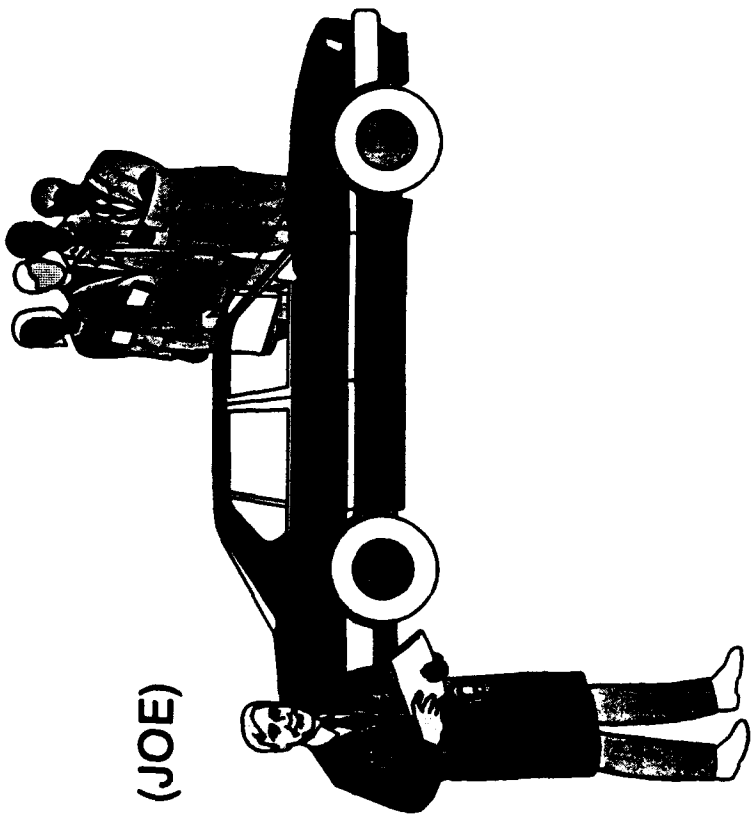
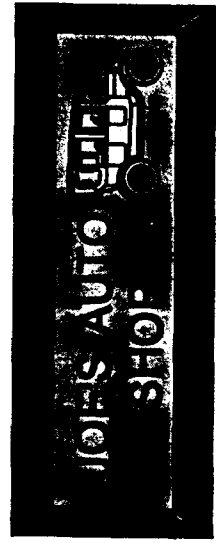

INITIAL MATURITY LEVEL

**81% OF ORGANIZATIONS THAT HAVE BEEN
ASSESSED ARE AT LEVEL 1 (INITIAL)**

MATURITY MODEL FRAMEWORK-REPEATABLE LEVEL

LEVEL	CHARACTERISTIC	KEY PROCESS AREAS	RESULTS
5 OPTIMIZING	IMPROVEMENT FED BACK INTO PROCESS	DEFECT PREVENTION TECHNOLOGY CHANGE MANAGEMENT PROCESS CHANGE MANAGEMENT	PRODUCTIVITY & QUALITY
4 MANAGED	(QUANTITATIVE) MEASURED PROCESS	DEFECT PREVENTION TECHNOLOGY CHANGE MANAGEMENT PROCESS CHANGE MANAGEMENT	
3 DEFINED	(QUALITATIVE) PROCESS DEFINED AND INSTITUTIONALIZED	ORGANIZATION PROCESS FOCUS ORGANIZATION PROCESS DEFINITION TRAINING PROGRAM INTEGRATED SOFTWARE MANAGEMENT SOFTWARE PRODUCT ENGINEERING INTER GROUP COORDINATION	
2 REPEATABLE	(INTUITIVE) PROCESS DEPENDENT ON INDIVIDUALS	REQUIREMENTS MANAGEMENT SOFTWARE PROJECT PLANNING SOFTWARE PROJECT TRACKING SOFTWARE SUBCONTRACT MANAGEMENT SOFTWARE QUALITY ASSURANCE SOFTWARE CONFIGURATION CONTROL	
1 INITIAL	(INFORMAL)		

REPEATABLE LEVEL ORGANIZATION CASE STUDY

LEVEL 2 - REPEATABLE

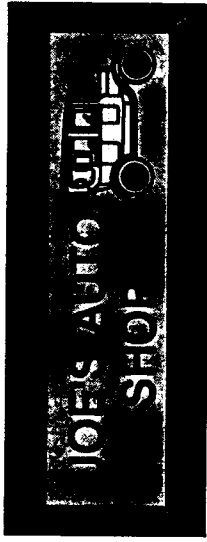

JOE TALKS TO HIS MECHANICS ABOUT SOME COMMON PRACTICES

JOE CAN NOW ESTIMATE HOW LONG A JOB WILL TAKE

JOE CAN NOW TAKE APPOINTMENTS AND SCHEDULE TASKS FOR MECHANICS

JOE CHECKS QUALITY OF WORK

PROBLEMS ARISE WHEN SOMETHING NEW IS INTRODUCED TO THE PROCESS

(JOE)

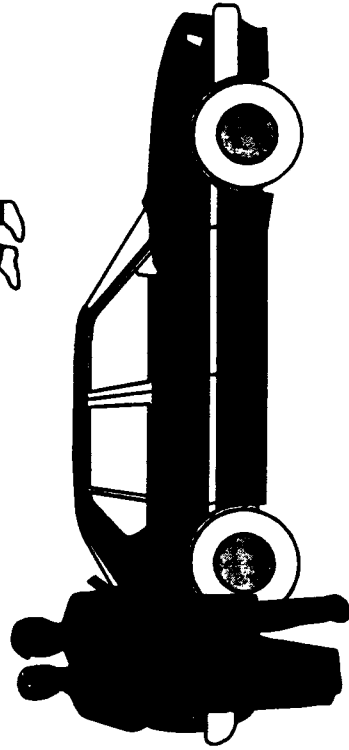
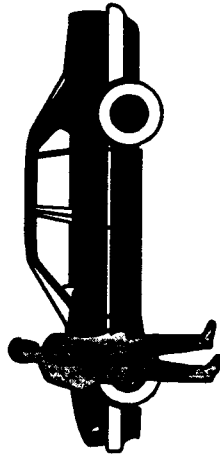

REPEATABLE MATURITY LEVEL

**12% OF ORGANIZATIONS THAT HAVE BEEN
ASSESSED ARE AT LEVEL 2 (REPEATABLE)**

MATURITY MODEL FRAMEWORK-DEFINED LEVEL

LEVEL	CHARACTERISTIC	KEY PROCESS AREAS	RESULTS
5 OPTIMIZING	IMPROVEMENT FED BACK INTO PROCESS	DEFECT PREVENTION TECHNOLOGY CHANGE MANAGEMENT PROCESS CHANGE MANAGEMENT	PRODUCTIVITY & QUALITY
4 MANAGED	(QUANTITATIVE) MEASURED PROCESS	DEFECT PREVENTION TECHNOLOGY CHANGE MANAGEMENT PROCESS CHANGE MANAGEMENT	
3 DEFINED	(QUALITATIVE) PROCESS DEFINED AND INSTITUTIONALIZED	ORGANIZATION PROCESS FOCUS ORGANIZATION PROCESS DEFINITION TRAINING PROGRAM INTEGRATED SOFTWARE MANAGEMENT SOFTWARE PRODUCT ENGINEERING INTER GROUP COORDINATION	RISK
2 REPEATABLE	(INTUITIVE) PROCESS DEPENDENT ON INDIVIDUALS	REQUIREMENTS MANAGEMENT SOFTWARE PROJECT PLANNING SOFTWARE PROJECT TRACKING SOFTWARE SUBCONTRACT MANAGEMENT SOFTWARE QUALITY ASSURANCE SOFTWARE CONFIGURATION CONTROL	
1 INITIAL	(INFORMAL)		

DEFINED LEVEL ORGANIZATION CASE STUDY

LEVEL 3 - DEFINED

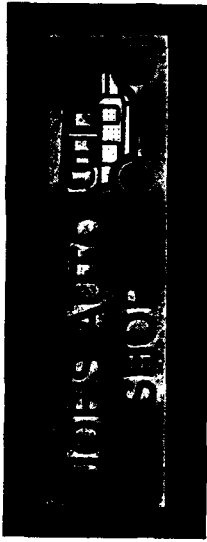

JOE WRITES THE PROCESS DOWN
SO THERE IS NO CONFUSION

MECHANICS COME AND GO, BUT JOE
CAN TRAIN THE NEW STAFF

THE AUTO JOBS ARE TAILORED
WHEN NECESSARY FOR NEW
SITUATIONS

JOE AND THE MECHANICS MEET
REGULARLY TO DISCUSS PROCESS
IMPROVEMENTS

JOE WISHES HE KNEW HOW TO
IMPROVE PRODUCTIVITY

(JOE)

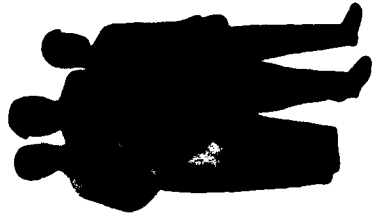
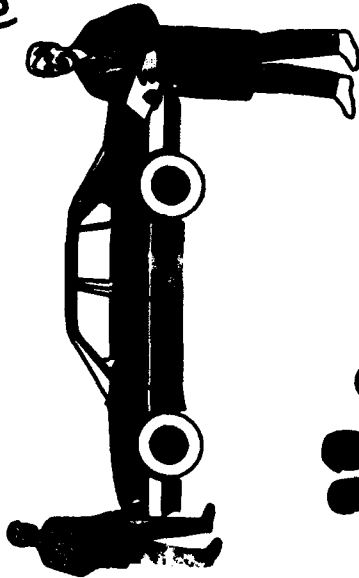

DEFINED MATURITY LEVEL

**7% OF ORGANIZATIONS THAT HAVE BEEN
ASSESSED ARE AT LEVEL 3 (DEFINED)**

MANAGED LEVEL ORGANIZATION CASE STUDY

LEVEL 4 - MANAGED

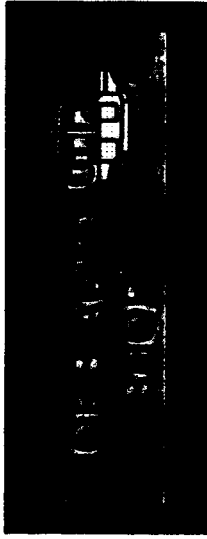

JOE PUTS MEASURES IN PLACE TO TRACK PRODUCTIVITY AND QUALITY

JOE BEGINS TO IDENTIFY WHERE THE BOTTLENECKS IN THE AUTO REPAIR TASKS ARE

JOE IDENTIFIES THE NEED FOR AUTOMATIC TEST EQUIPMENT TO INCREASE PRODUCTIVITY AND REDUCE HUMAN ERROR

JOE WISHES HE COULD SOLVE PROBLEMS BEFORE THEY GET TOO BIG

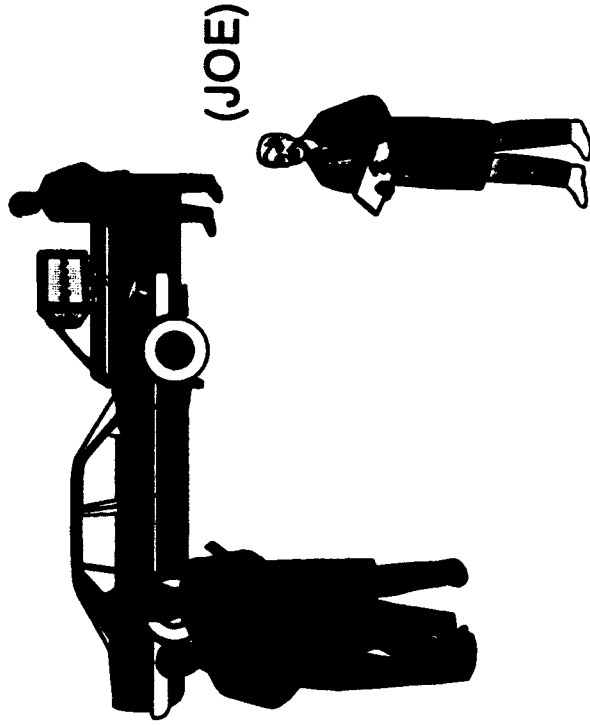

MANAGED MATURITY LEVEL

**0% OF ORGANIZATIONS THAT HAVE BEEN
ASSESSED ARE AT LEVEL 4 (MANAGED)**

OPTIMIZING LEVEL ORGANIZATION CASE STUDY

LEVEL 5 - OPTIMIZING

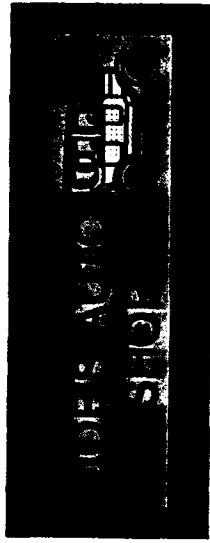

JOE NOW COLLECTS DETAILED METRICS ON THE PROCESS

JOE CAN ANTICIPATE A PROBLEM BEFORE IT BECOMES A BIG PROBLEM

JOE AND HIS MECHANICS ARE IN A CONSTANT CYCLE OF PROCESS IMPROVEMENTS

THE AUTO REPAIR PROCESS IN JOE'S SHOP IS GETTING BETTER ALL THE TIME

JOE'S AUTO SHOP CAN HEAD OFF PROBLEMS EARLY AND INFUSE NEW TECHNOLOGY; THE PROCESS IS EVOLVING

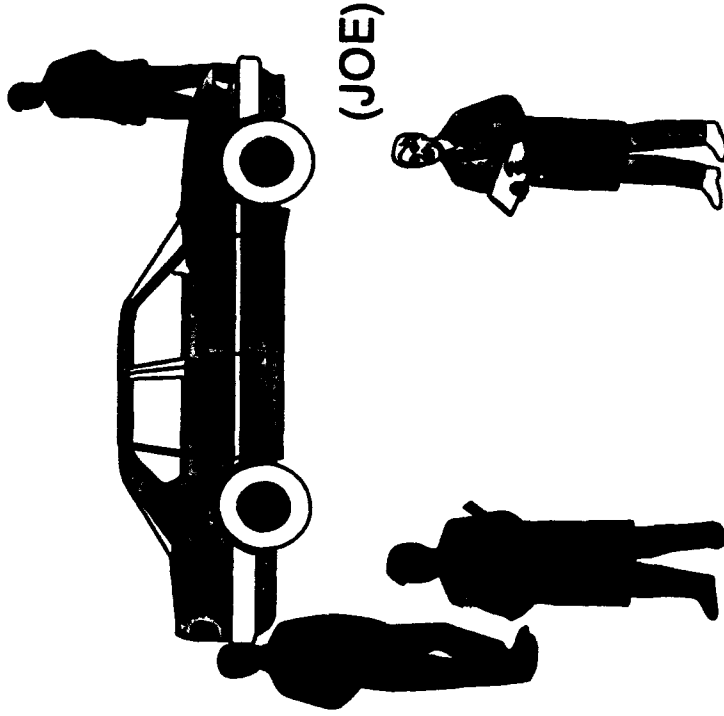

SELECTION OF TARGET PROCESS CAPABILITY

- **THE TARGET PROCESS CAPABILITY (TPC) IS THE STANDARD BY WHICH ALL OFFERORS ARE TO BE EVALUATED**
- **A SUBSET OF THE KEY PROCESS AREAS (KPAs) IDENTIFIED IN THE CAPABILITY MATURITY MODEL (CMM) WILL BE SELECTED BASED ON THEIR CRITICALITY TO THIS ACQUISITION**
- **THE TPC IS THE COMBINATION OF THE CRITICAL KPAs AND THE OTHER KPAs BELOW THE CRITICAL KPAs ON THE CMM**

CRITICAL SUBPROCESS AREAS

WHAT

- THE SUBPROCESS AREAS WHICH ARE MOST PERTINENT TO PROJECT RISK

WHY

- TO FOCUS THE INVESTIGATION

HOW

- SELECTED THROUGH ANALYSIS OF THE
 - ORGANIZATIONS' PROPOSED PROJECT PROFILE REPRESENTING THE EXPERIENCE THAT IS NEEDED
 - ORGANIZATIONS' PROJECT PROFILES REPRESENTING THEIR EXPERIENCE
 - TARGET PROCESS CAPABILITY REPRESENTING THE CUSTOMER'S VIEW OF WHAT IS DESIRED

SCE TEAM COMPOSITION

- **CORE DRAWN FROM WITHIN THE EVALUATING ORGANIZATION**
- **4-6 TOTAL (SOFTWARE/ACQUISITION PEOPLE)**
- **2-3 SENIOR PEOPLE (7 YEARS EXPERIENCE)**
- **2 PEOPLE WITH PRIOR SCE EXPERIENCE**
- **ONE INEXPERIENCED MEMBER AT MOST**

TEAM PROFILE

- WORKING UNDERSTANDING OF THE CAPABILITY MATURITY MODEL
- EXPERIENCE REQUIRED
 - SOFTWARE DEVELOPMENT
 - SOFTWARE MANAGEMENT
 - ACQUISITION
- SKILLS REQUIRED
 - INTERPERSONAL RELATIONSHIP
 - PLANNING AND ORGANIZING
- ATTRIBUTES
 - PATIENCE
 - PERSEVERANCE

PROFESSIONAL JUDGEMENT

- THE EVALUATION TEAM NEEDS TO KNOW HOW TO EVALUATE THE ORGANIZATION IN RELATION TO THE MATURITY MODEL
- DIFFERENT ORGANIZATIONS HAVE DIFFERENT PROFILES
 - SMALL, MEDIUM, AND LARGE PROJECTS
 - MATRIX OR LINE ORGANIZATIONAL STRUCTURE
 - DIFFERENT DEVELOPMENT METHODOLOGIES
 - DIFFERENT CONTRACT ARRANGEMENTS
 - DIFFERENT APPLICATION DOMAINS
- THE TEAM NEEDS SUFFICIENT SOFTWARE ENGINEERING AND MANAGEMENT EXPERIENCE TO EXERCISE JUDGEMENT

GOALS OF THE SCE

- TO MAKE HIGHER QUALITY SOURCE SELECTION DECISION BY VERIFYING THAT THE KEY PROCESS AREAS THAT ARE REQUIRED TO SUCCESSFULLY DEVELOP THE SYSTEM ARE ADEQUATELY ADDRESSED BY THE CONTRACTOR
- IDENTIFY AREAS OF RISK IN THE CONTRACTOR'S SOFTWARE DEVELOPMENT PROCESS FOR RISK MITIGATION DURING CONTRACT MONITORING
- USE AS THE METRIC FOR PROCESS IMPROVEMENT AWARD INCENTIVES
- SEND A MESSAGE TO CONTRACTORS THAT A MATURE AND IMPROVING SOFTWARE DEVELOPMENT PROCESS IS IMPORTANT TO DoD

SOURCE SELECTION ACTIVITIES AFFECTED BY THE SCE

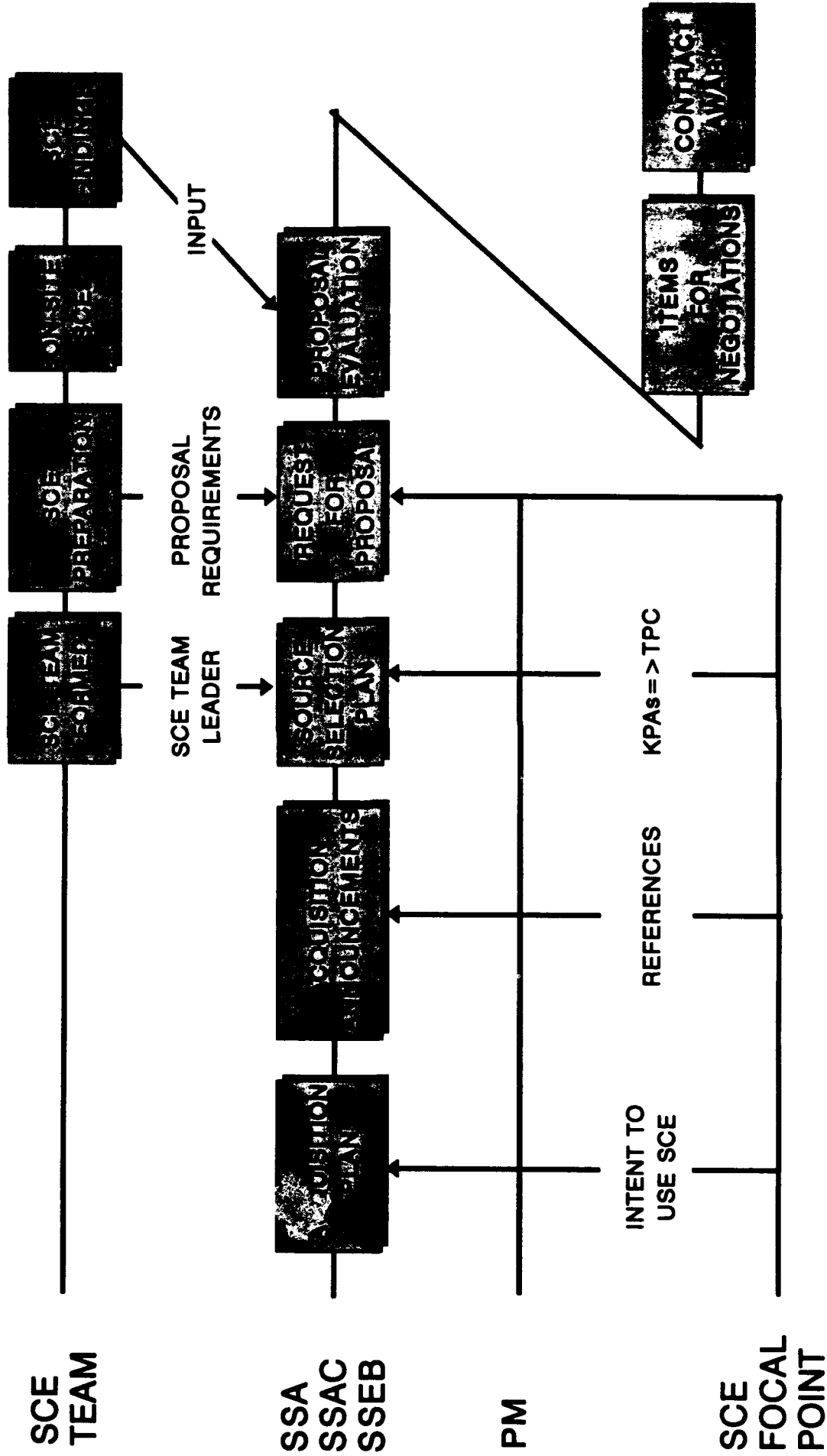

FINDINGS

- **PROJECT MANAGEMENT**
- **SOFTWARE QUALITY ASSURANCE**
- **COST/SIZE ESTIMATION**
- **SUBCONTRACTOR MANAGEMENT**

SOURCE SELECTION RISKS

- **TO DATE, NO CONTRACT AWARD HAS BEEN HELD UP BECAUSE OF QUESTIONS RAISED ABOUT THE SCE FINDINGS**
- **TO DATE, NO SOURCE SELECTION HAS BEEN DELAYED BECAUSE OF THE SCE PROCESS**

SAMPLE SCE RESULTS

- PROJECT MANAGEMENT**
 - **COMMITMENT PROCESS AT SENIOR AND FIRST-LINE MANAGEMENT LEVELS REQUIRES STRENGTHENING**
- **STRENGTHS**
 - **PROJECT RESPONSIBILITIES ARE DEFINED AND DOCUMENTED**
 - **MECHANISM IN PLACE TO ASSURE THAT SOFTWARE SUBCONTRACTORS FOLLOW A DISCIPLINED SOFTWARE DEVELOPMENT PROCESS**
- **WEAKNESSES**
 - **COMMITMENT PROCEDURES AT SENIOR AND FIRST-LINE MANAGEMENT LEVELS COULD NOT BE VALIDATED BY THE TEAM**
 - **MANAGEMENT ATTENTION TO TESTING AND PROGRESS OF TESTING APPEARED TO BE LACKING IN ALL PROJECTS INVESTIGATED**
- **IMPROVEMENT ACTIVITIES**
 - **TASK GROUP IS IN PLACE TO ADDRESS SENIOR MANAGEMENT ISSUE**

DOCUMENTATION TO LOOK FOR

- SIGNATURE BLOCK
- DOCUMENT DATE
- VERSION NUMBER
- ENFORCEMENT DATE
 - IF DOCUMENTS, WHICH WERE REQUESTED IN WRITING, ARE NOT PRESENT AT THE TIME OF THE DOCUMENT REVIEW, THEY WILL BE CONSIDERED NONEXISTENT. ANY INFORMATION REFERENCING SUCH DOCUMENTS WILL BE CONSIDERED FALSE INFORMATION.

A COMPARISON

EVALUATIONS

- FOR GOVERNMENT'S USE IN SOURCE SELECTION OR CONTRACT MONITORING
- RESULTS KNOWN TO THE GOVERNMENT
- SUBSTANTIATE CURRENT PRACTICE
- ASSESS CONTRACTOR COMMITMENT TO IMPROVE
- ANALYZE CONTRACT PERFORMANCE POTENTIAL

IDENTIFY RISKS AND MOTIVATE CHANGES IN CONTRACTOR'S SOFTWARE MANAGEMENT AND ENGINEERING PRACTICES.

ASSESSMENTS

- FOR THE USE OF THE ORGANIZATION
- RESULTS ARE CONFIDENTIAL
- ASSESS CURRENT PRACTICE
- ACT AS CATALYSTS FOR IMPROVEMENT
- PROVIDE INPUT FOR IMPROVEMENT ACTION PLAN

CHARACTERIZE THE CONTRACTOR'S CURRENT SOFTWARE ENGINEERING PROCESS. IDENTIFY THE MOST CRITICAL PROCESS ISSUES. FACILITATE THE INITIATION OF PROCESS IMPROVEMENT ACTIONS.

AN ANALOGY

- **AN ASSESSMENT IS LIKE ASKING YOUR BROTHER-IN-LAW TO HELP YOU PREPARE YOUR INCOME TAXES**
- **AN EVALUATION IS LIKE HAVING THE IRS DO AN AUDIT OF YOUR TAXES**

CECOM SED INVOLVEMENT

TRAINING

- **TRAINED 104 SED PERSONNEL TO DATE**
- **1-DAY EXECUTIVE OVERVIEW DESIGNED FOR MANAGERS;
22 PEOPLE ATTENDED**

SEI INTERFACE

- **HAS REPRESENTATION ON THE SCE ADVISORY BOARD**
- **PARTICIPATES IN WORKSHOPS AND SEMINARS HELD BY SEI**
- **DEVELOPED 2 DRAFT REGULATIONS**
- **IMPLEMENTATION GUIDE**
- **JUST IN TIME TRAINING**

IMPACT ON INDUSTRY

- SCE MENTION AMONG GENERAL NOTICES TO OFFERORS
- RFP SECTION M NOTICE ABOUT SCE ROLE IN EVALUATION FACTORS FOR AWARD
- RFP SECTION L CONTAINS PROPOSAL PREPARATION INSTRUCTIONS ABOUT ANSWERING SCE QUESTIONNAIRE, SUBMITTING PROJECT PROFILES, AND GENERATING THE SCE APPENDIX
- PREPARATION TIME ALLOCATION FOR SCE
- TRAINING OF PERSONNEL IN THE CMM AND SCE METHODOLOGY

BENEFITS OF THE SCE

- **SCE INTRODUCES REALISM INTO THE PROPOSAL REVIEW PROCESS**
- **SCE INFORMATION IS TIMELY, REAL, AND BASED ON CURRENT PROJECTS/PRACTICES**
- **SCE HELPS TO CLARIFY THE OFFEROR'S SOFTWARE DEVELOPMENT PLAN (SDP)**
- **BETTER IDENTIFY AND EVALUATE THE RISKS POSED BY EACH CONTRACTOR TEAM**
- **SCE INTRODUCES OBJECTIVITY INTO THE PROPOSAL REVIEW (TRAINED TEAM COMPARING EACH OFFEROR TO A STANDARD, i.e., CMM)**
- **MANAGE RISK AFTER CONTRACT AWARD**

SUMMARY

- SCES HAVE BECOME A COMMON PRACTICE IN SOURCE SELECTION
- HELPS CONTRACTOR FOCUS INTERNAL PROCESS IMPROVEMENT

MATURE AND IMPROVING SOFTWARE DEVELOPMENT PROCESS IS:

- IMPORTANT TO DoD
- INTEGRAL TO COMPETITIVE EDGE

NOTES

STREAMLINED INTEGRATED SOFTWARE METRICS APPROACH



Stewart Fenick

UNCLASSIFIED

SOFTWARE MEASUREMENT

**A CRITICAL TOOL FOR
GOVERNMENT AND INDUSTRY
TO ENSURE THE DISCIPLINED
CREATION AND EXECUTION OF
SOFTWARE CONTRACTS
EFFORTS**

PROBLEMS WITH CURRENT METRICS APPROACHES

- **METRICS SET PROLIFERATION**
- **SHORT-TERM PROBLEM SOLUTIONS NOT
BEING EXTENDED TO LONG-TERM PROBLEM
ELIMINATION**

CECOM'S METRICS APPROACH

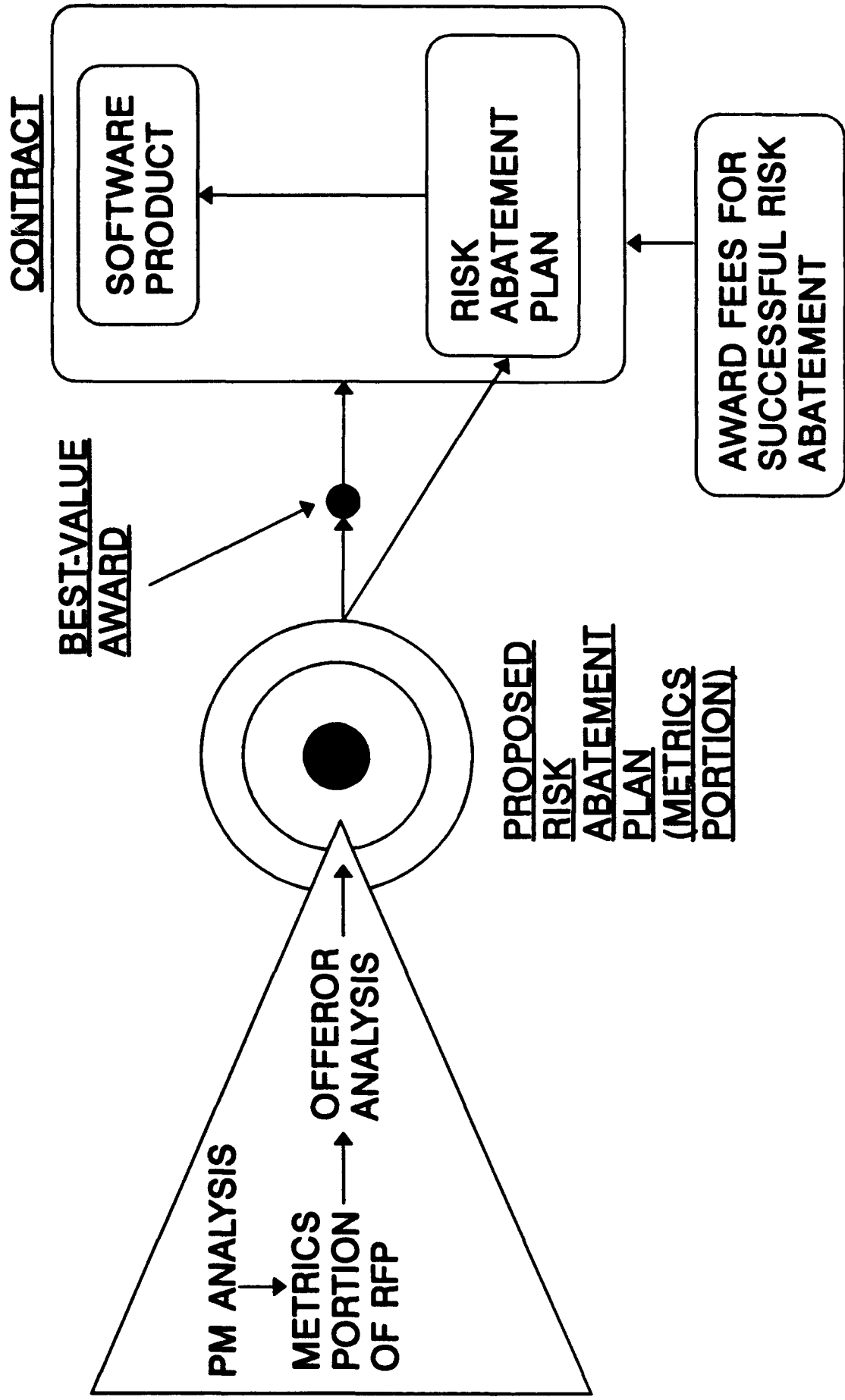

PROGRAM MANAGER ANALYSIS

- **PRODUCT REQUIREMENTS**
- **ARMY METRICS POLICIES - e.g., STEP**
- **CECOM INTEGRATED METRICS FRAMEWORK GUIDELINES**
 - **EXECUTIVE MANAGEMENT METRICS**
 - **STATE-OF-THE-PRACTICE METRICS SETS**
 - **FRAMEWORK COMPONENTS**
 - **PROGRAM ISSUES**

EXECUTIVE MANAGEMENT METRICS



PROVIDING THE BIG PICTURE TO THOSE
WHO CAN DO THE MOST ABOUT IT

"STEPPING BACK FROM DETAILS; LOOKING AT
TRENDS; AND BRINGING TIMELY INFORMATION TO THE
LEVEL OF THOSE WITH THE BEST OVERALL VIEW AND
BEST ABILITIES FOR MAKING PROGRAM DECISIONS . . .

. . . AND, THE MOST AT STAKE"

METRICS PROCESS FRAMEWORK COMPONENTS

- **UP-FRONT SYSTEM REQUIREMENTS ANALYSIS**
- **ISSUE IDENTIFICATION**
- **DATA VALIDITY/DATA SOURCE VALIDITY**
- **TAILORING**
- **CORRELATION ANALYSIS PROCESS**

METRICS PROCESS FRAMEWORK COMPONENTS (Continued)

- **EFFICIENT MANAGEMENT STRUCTURE/
COMMUNICATIONS**
- **DYNAMIC LIFE-CYCLE APPLICATION**
- **AUTOMATION/TIMELY REPORTING**
- **METRICS EXPERTISE**
- **PROCESS IMPROVEMENT/CAPABILITY
MATURITY**

METRICS ANALYSIS

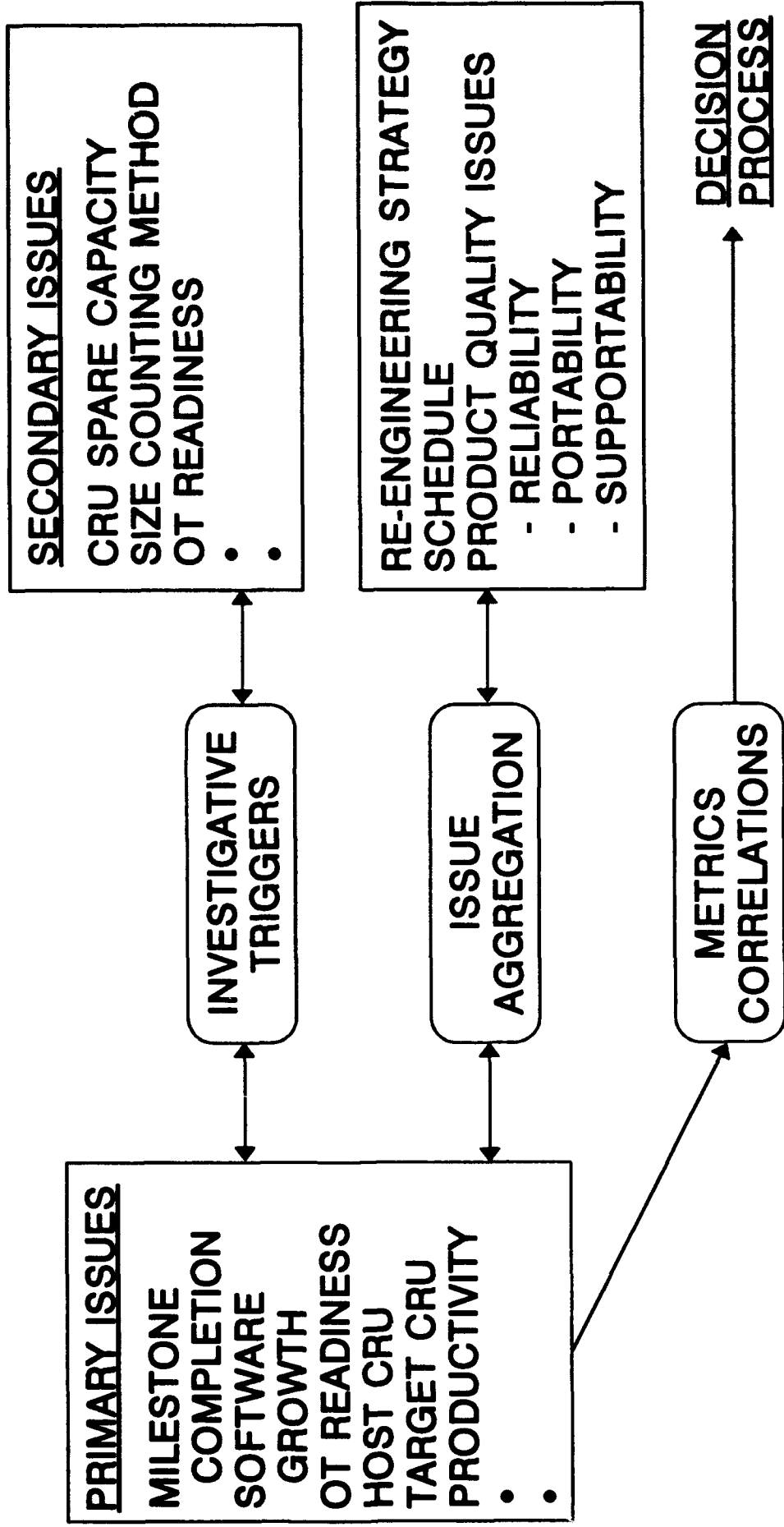

DECISION PROCESS

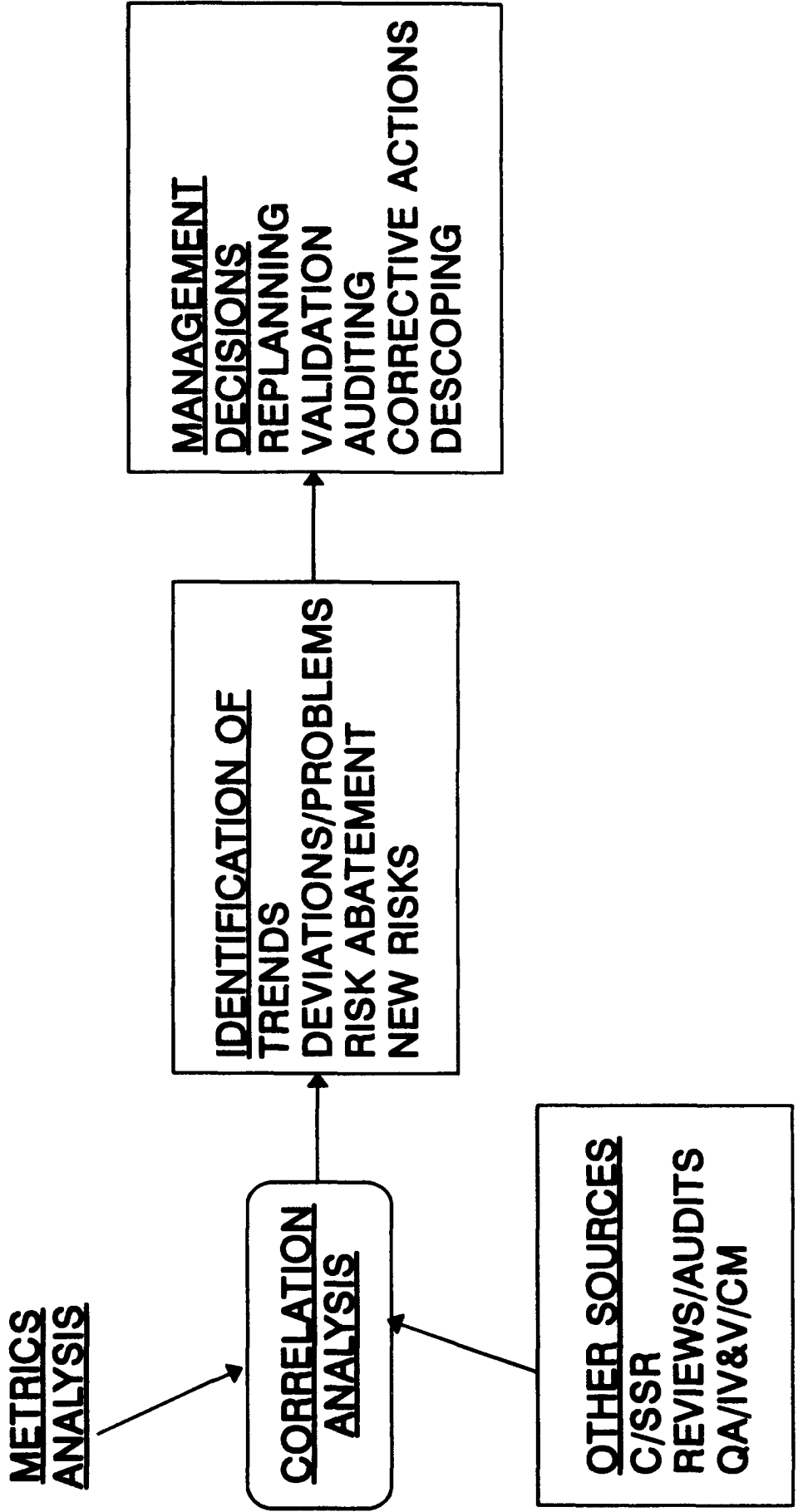

ISSUES LIST

PRIMARY ISSUES

PLANS & BUDGET
COST
PERSONNEL
SUBCONTRACTOR MANAGEMENT
INCREMENTAL RELEASE CONTENT
SYSTEM ARCHITECTURE
MILESTONE COMPLETION
SOFTWARE GROWTH
OT READINESS
HOST CRU
TARGET CRU
STABILITY - REQUIREMENTS & DESIGN
DESIGN STRUCTURE
DEVELOPMENT PROGRESS
REUSE
PRODUCTIVITY
ERROR PROFILES
Ada USAGE

SECONDARY ISSUES

CSU LEVEL METRICS
TEST ADEQUACY
SIZE COUNTING METHOD
EFFORT PER PHASE
COMPLEXITY/MODULARITY
MODULE CRITICALITY
PCR PRIORITY
PERSONNEL TURNOVER
OVERTIME
CONTRACTOR CAPABILITY
MANAGEMENT STRUCTURE
CRU SPARE CAPACITY
STAFF EXPERIENCE/TRAINING
ADHERENCE TO STANDARDS
DESIGN METHODOLOGY
REUSE LIBRARY
DOCUMENTATION

CECOM'S METRICS APPROACH

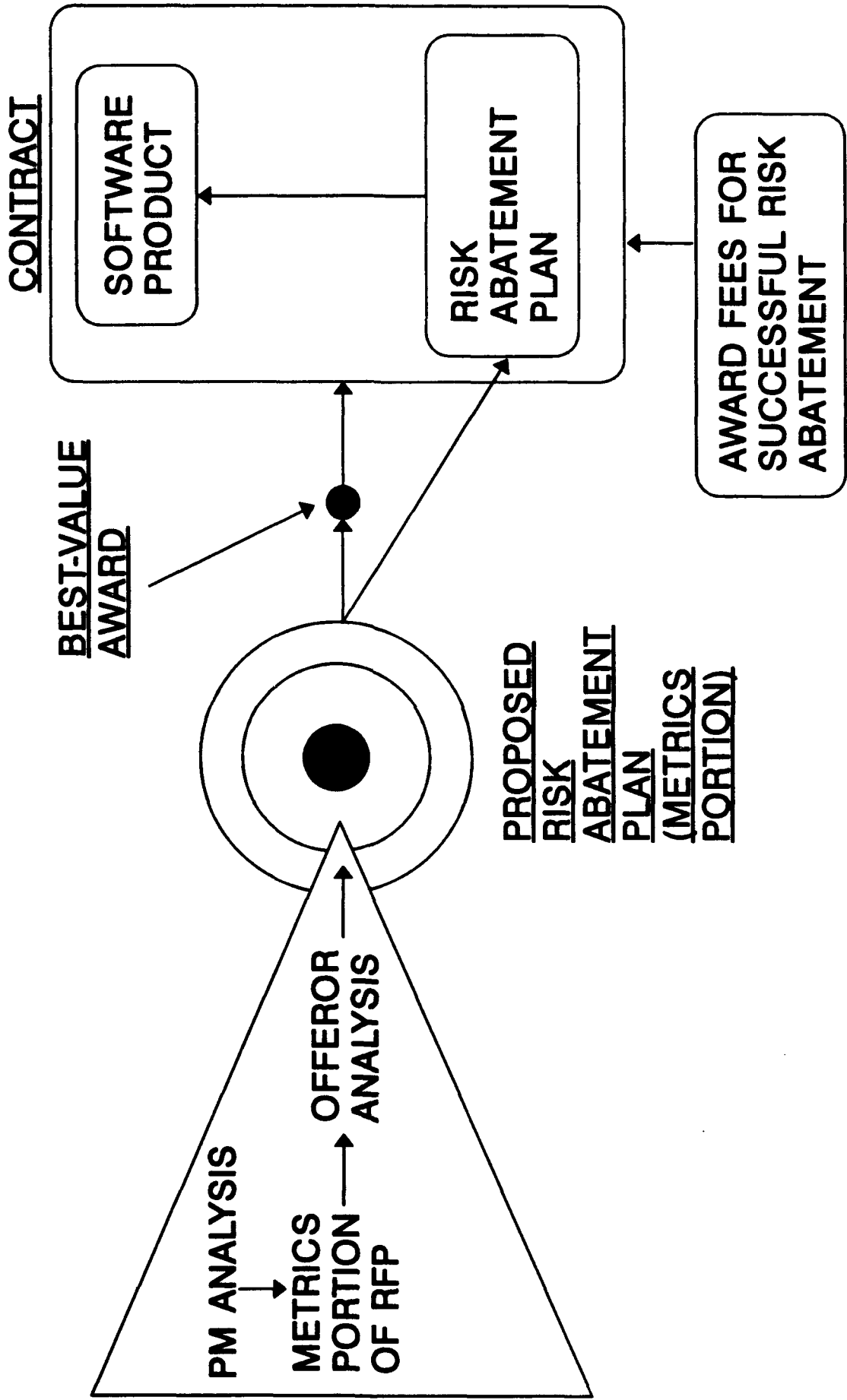

RFP REQUIREMENTS

- **OFFERORS EVALUATE GOVERNMENT IDENTIFIED PROGRAM MANAGEMENT ISSUES AND METRICS PROGRAM REQUIREMENTS**
- **OFFERORS IDENTIFY THEIR OWN PROGRAM MANAGEMENT ISSUES**
- **OFFERORS PROPOSE RISK MANAGEMENT-BASED METRICS PROGRAM INCORPORATING OFFERORS METRICS METHODOLOGY AND RFP REQUIREMENTS**

CECOM'S METRICS APPROACH

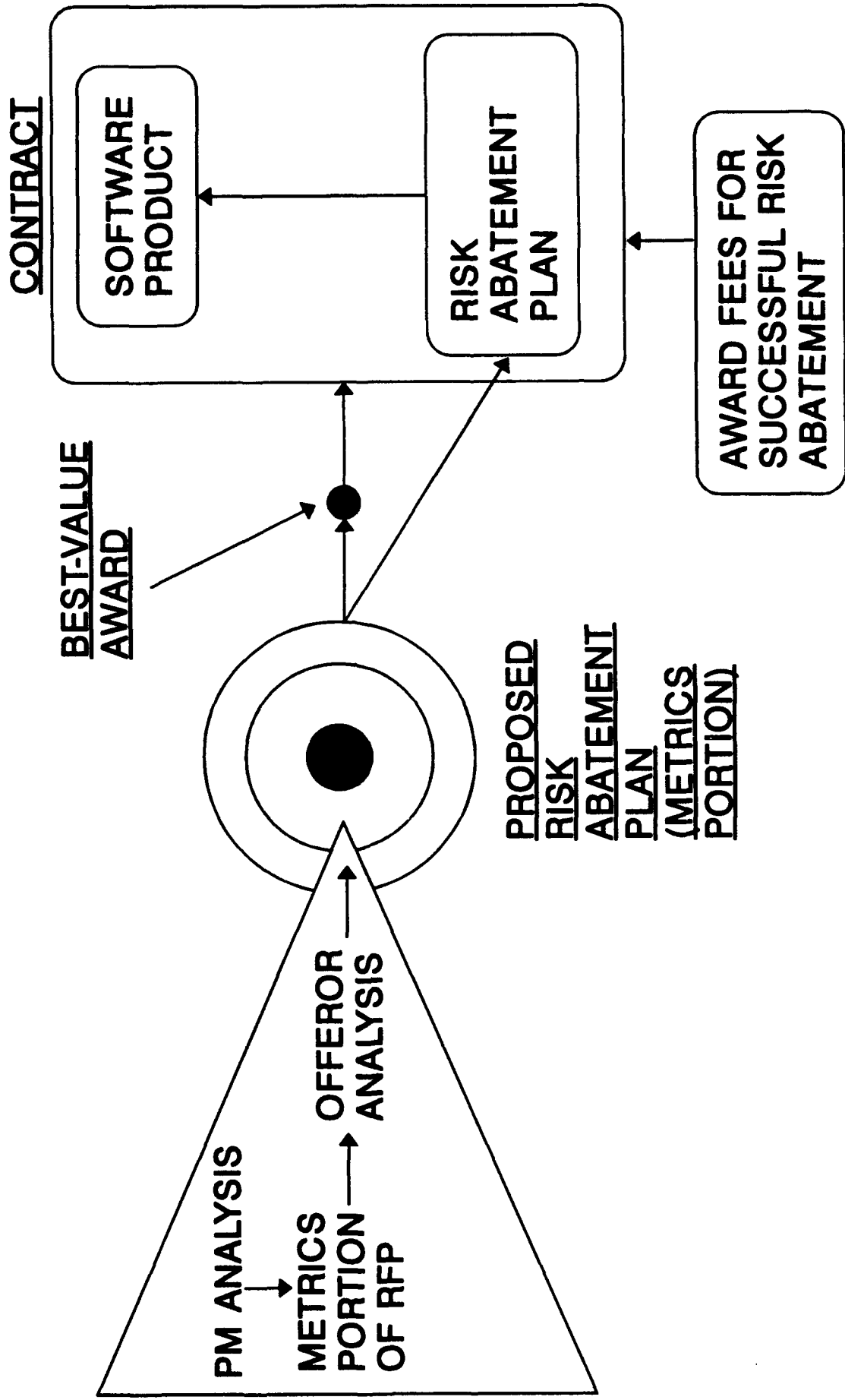

OFFEROR ANALYSIS SHOULD CONSIDER

- **METRICS PORTION OF RFP**
- **OFFEROR'S PRODUCT PROPOSAL**
- **STATE-OF-THE-PRACTICE METRICS SETS**
- **INTERNAL COMPANY PRACTICES**

WHAT DOES CECOM'S METRICS INITIATIVE MEAN TO INDUSTRY

- **PROPOSED METRICS PROGRAM WILL BE USED AS PART OF THE PROPOSED RISK ABATEMENT PLAN**
- **NEED TO LEVERAGE COMPANY METRICS PRACTICES**
- **CMM-RELATED MEASUREMENT PROCESS IMPROVEMENT SHOULD BE A COMPANY OBJECTIVE**
- **NEED TO DEVELOP METRICS EXPERTISE**

WHAT DOES CECOM'S METRICS INITIATIVE MEAN TO INDUSTRY

- STREAMLINED MEASUREMENT PRACTICES
 - REDUCE COLLECTION/INJECTION DELAY TIME
 - AUTOMATION/TIMELY REPORTING
 - IMPROVED MANAGEMENT PRACTICES/ COMMUNICATIONS
 - ELECTRONIC DOCUMENTATION/AUDITING
 - UP-FRONT ANALYSIS/UNDERSTANDING OF SYSTEM REQUIREMENTS
 - CAPTURING/DISSEMINATING LESSONS LEARNED
 - TAILORING
 - NEED TO DEVELOP STRATEGIES FOR DEALING WITH ISSUE CHANGES OVER THE LIFE-CYCLE
 - ROBUST DATA SETS; SMART SWAPPING

METRICS PROGRAM BENEFITS

- **COMMUNICATION**
 - **COMMON PERSPECTIVE, UNDERSTANDING, OBJECTIVES**
- **VALIDATION**
 - **OF DATA AND OF INTERPRETATION OF RESULTS**
- **INCREASED PROGRAM CONTROL**
 - **NO ROSY PICTURES, NO SURPRISES**
 - **TRACK RESOURCES, PROGRESS, QUALITY**
 - **EARLY INSIGHT/USEFUL DECISIONS**

METRICS PROGRAM BENEFITS

- **LESSONS LEARNED WILL LEAD TO:**
 - **PROJECT/PRODUCT IMPROVEMENT**
 - **PROCESS IMPROVEMENT - ACQUISITION, SOFTWARE, METRICS, MANAGEMENT**
 - **SMARTER PLANNING AND ESTIMATING**
 - **IMPROVED REQUIREMENTS DEFINITION/ CONTRACT LANGUAGE**

- **ORGANIZATIONS WILL IMPROVE/MOVE UP CMM**
 - **INCREASED CAPABILITIES LESSEN BURDEN OF TECHNICAL RISK**

SUMMARY

- **OFFEROR'S METRICS PROGRAM MUST BE INCLUDED IN THE RISK MANAGEMENT PLAN AND WILL ULTIMATELY BE INCORPORATED INTO THE CONTRACT**
- **OFFERORS SHOULD LEVERAGE EXISTING METRICS SETS AND EXISTING INTERNAL PRACTICES**
- **OFFERORS SHOULD ENDEAVOR TO ENHANCE THEIR CAPABILITY FOR PROVIDING AN INTEGRATED METRICS STRATEGY TO MEET GOVERNMENT NEEDS**

**THE CECOM PHILOSOPHY HAS BEEN CAPTURED AS
GUIDANCE FOR OUR PEOS AND PMS IN THE -
"STREAMLINED INTEGRATED SOFTWARE METRICS
APPROACH (SISMA) GUIDEBOOK - APPLICATION OF
STEP METRICS"**

IT IS AVAILABLE TO INDUSTRY

TO BE PLACED ON THE DISTRIBUTION LIST, CONTACT:

**STEWART FENICK
(908) 532-2117/2342**

**TO FURTHER INQUIRE
CONTACT:
STEWART FENICK**

**HQ U.S. ARMY CECOM
ATTN: AMSEL-RD-SE-R-ESD-SPT
FORT MONMOUTH, NJ 07703-5000
(908) 532-2117**

UNCLASSIFIED

NOTES

CECOM SOFTWARE OMBUDSMAN



Dr. Martin I. Wolfe

UNCLASSIFIED

FUNCTIONS

- **ACT AS FACILITATOR BETWEEN GOVERNMENT/INDUSTRY IN RESOLVING SOFTWARE ENGINEERING ISSUES**
- **PROMOTE AND HIGHLIGHT CECOM INITIATIVES FOR IMPROVING THE SOFTWARE DEVELOPMENT PROCESS**
- **IDENTIFY MECHANISMS TO ALLOW AND ENCOURAGE FEEDBACK FROM INDUSTRY**
- **OPEN UP CHANNELS OF COMMUNICATION WITH INDUSTRY ON ISSUE(S) ASSOCIATED WITH THE SOFTWARE LIFE CYCLE**

TYPICAL AREAS OF CONCERN

- DOCUMENTATION
- REVIEW PROCESS TOO COSTLY
- WAIVERS
- DYNAMIC CHANGES TO REQUIREMENTS
- SOFTWARE MANAGEMENT ISSUES AND CONCERNS

**TO FURTHER INQUIRE
CONTACT:**

DR. MARTIN I. WOLFE

OR

MS. BARBARA FROMHOLD



**HQ U.S. ARMY CECOM
SOFTWARE OMBUDSMAN
SOFTWARE ENGINEERING DIRECTORATE
ATTN: AMSEL-RD-SE-R-ESD
FORT MONMOUTH, NJ 07703-5000
(908) 532-2423/1351**

UNCLASSIFIED

NOTES

**APBI
CLOSING REMARKS**



John H. Sintic

UNCLASSIFIED

A NEW WAY OF DOING BUSINESS

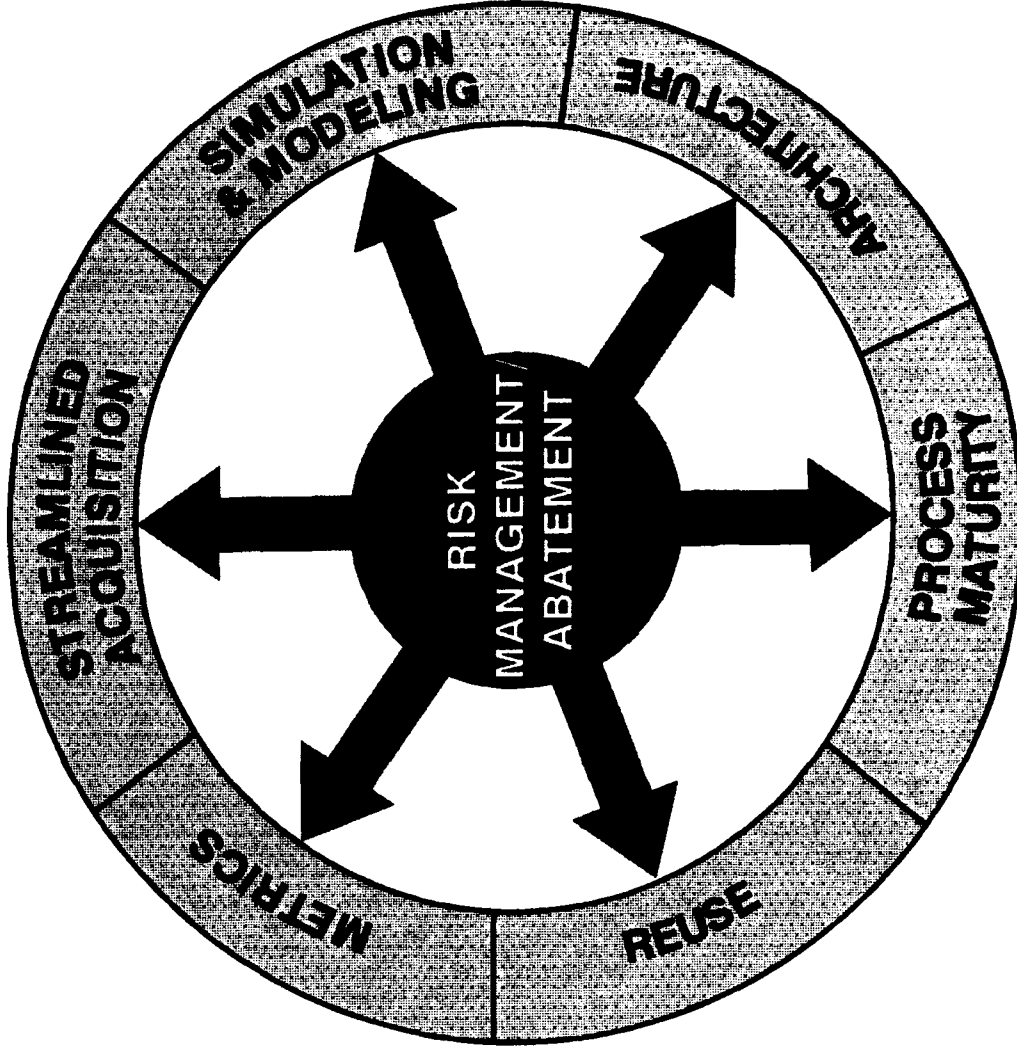

INDUSTRY AND GOVERNMENT MUST EFFECT "CHANGE" TO MEET THE SOFTWARE CHALLENGES OF THE FUTURE

NOTES

**SYMPOSIUM
PARTICIPANTS**

COL DOMENIC F. BASILE
Deputy Commander for Business
HQ, US Army Communications-Electronics Command
AMSEL-DCB
Fort Monmouth, New Jersey 07703
(908) 532-3559

MAJ GORDON W. ROBSON
HQ, US Army Communications-Electronics Command
Software Engineering Directorate
AMSEL-SY-CC-TM
Fort Monmouth, New Jersey 07703
(913) 684-7635

MR. JOHN H. SINTIC
HQ, US Army Communications-Electronics Command
Director, Software Engineering
AMSEL-RD-SE-D
Fort Monmouth, New Jersey 07703
(908) 532-8280

MR. DENNIS J. TURNER
HQ, US Army Communications-Electronics Command
Software Engineering Directorate
AMSEL-RD-SE-D
Fort Monmouth, New Jersey 07703
(908) 532-8205

DR. MARTIN I. WOLFE
HQ, US Army Communications Electronics Command
Software Engineering Directorate
AMSEL-RD-SE-R-ESD
Fort Monmouth, New Jersey 07703
(908) 532-2423

MR. GERALD R. BROWN
HQ, US Army Communications-Electronics Command
Software Engineering Directorate
AMSEL-RD-SE-R-ESD-SPT
Fort Monmouth, New Jersey 07703
(908) 532-2117

MR. JOHN T. LeBARON
HQ, US Army Communications-Electronics Command
Software Engineering Directorate
AMSEL-RD-SE-R-ESD-SES
Fort Monmouth, New Jersey 07703
(908) 532-1803

MR. GEORGE E. SUMRALL
HQ, US Army Communications-Electronics Command
Software Engineering Directorate
AMSEL-RD-SE-R-ESD-SPT
Fort Monmouth, New Jersey 07703
(908) 532-2342

MR. STEWART FENICK
HQ, US Army Communications-Electronics Command
Software Engineering Directorate
AMSEL RD-SE-R-ESD-SPT
Fort Monmouth, New Jersey 07703
(908) 532-2117

MR. JEFFREY HERMAN
HQ, US Army Communications-Electronics Command
Software Engineering Directorate
AMSEL-RD-SE-R-ESD-SES
Fort Monmouth, New Jersey 07703
(908) 532-8071

MR ANDREW C. MILLS
HQ, US Army Communications-Electronics Command
Software Engineering Directorate
AMSEL-RD-SE-R-ESD-SPT
Fort Monmouth, New Jersey 07703
(908) 532-2081