

N71-1851988 Oct

AD-A279 239

e-3

20135



TR 70062

APRIL

1970



Crown Copyright  
1970

ROYAL AIRCRAFT ESTABLISHMENT

TECHNICAL REPORT 70062

DTIC  
ELECTE  
MAY 12 1994  
S F D

(1)

**THE DESIGN AND DEVELOPMENT  
OF AN AIRCRAFT MOUNTING  
PRINTED-CIRCUIT SPIRAL  
AERIAL COVERING THE  
RANGE 200-800 MHz**

by

D. P. L. May

G. F. Milne, B.Sc.

F. G. Baker

This document has been approved  
for public release and sale; its  
distribution is unlimited.

LIBRARY COPY

OCT 15 1971

LANGLEY RESEARCH CENTER  
LIBRARY, NASA  
HAMPTON, VIRGINIA

UNLIMITED

94-14023

MINISTRY OF TECHNOLOGY  
FARNBOROUGH HANTS

04 E 00 113

ROYAL AIRCRAFT ESTABLISHMENT

Technical Report 70062

April 1970

THE DESIGN AND DEVELOPMENT OF AN AIRCRAFT MOUNTING  
PRINTED-CIRCUIT SPIRAL AERIAL COVERING THE RANGE 200-800 MHz

by

D. P. L. May

G. F. Milne, B.Sc.

F. O. Baker

SUMMARY

The design and development of a right hand circularly polarized unidirectional aerial, covering 200-800 MHz in two octave-wide ranges is described. Measured characteristics are given. The beam-width and circularity are remarkably constant throughout the band; half power beam width being about 82 degrees. Ellipticity is as low as 0.5 dB with a maximum of 3.0 dB at 800 MHz. The feed impedance is 50 ohms unbalanced and the gain is about 7 dB relative to a circular isotropic source. The complete aerial can be housed in a space of about 75 cm in circumference x 40 cm deep and is particularly suitable for aircraft installations where projections beyond the hull are undesirable.

Departmental Reference: Rad 1026

Accession For	
NTIS CRA&I	<input checked="" type="checkbox"/>
DTIC TAB	<input type="checkbox"/>
Unannounced	<input type="checkbox"/>
Justification	
By	
Distribution /	
Availability Codes	
Dist	Avail and/or Special
A-1	

CONTENTS

	<u>Page</u>
1 INTRODUCTION	3
2 CHOICE OF SPIRAL TYPE	4
3 THEORY OF OPERATION	4
3.1 Radiation	4
3.2 Diameter of spiral	5
3.3 Suppression of rear-radiation	5
4 DESIGN OF THE AERIAL SYSTEM	5
4.1 General	5
4.2 Impedance modification	5
4.3 Number of turns	6
5 RECOMMENDED METHODS FOR CONSTRUCTION OF THE PRINTED- CIRCUIT SPIRAL AERIAL	6
6 FEED SYSTEM	7
7 AERIAL RANGE MEASUREMENTS	8
7.1 R.A.E. Radio Department Aerial Range at Lasham	8
7.2 Spiral aerial measurements	8
7.3 Limits of useful bandwidth	9
7.4 Power test	10
8 CONCLUSIONS	10
Table 1 Summary of measurements on the archimedian spiral antenna	12
Table 2 'Off-axis' ellipticity of archimedian spiral aerial	13
References	14
Illustrations	Figs. 1-20
Detachable abstract cards	

## 1 INTRODUCTION

A project concerning UHF experimental communications between aircraft and ground stations via spacecraft links led to the requirement for an aircraft aerial having the following characteristics:-

- (a) Unidirectional radiation pattern.
- (b) Near-perfect circular polarization.  
(Right hand circular, i.e. clockwise viewed through aerial, looking at co-station.)
- (c) Bandwidth, minimum 12% and preferably 34%.
- (d) Maximum gain consistent with (b) and (c).
- (e) Feed system 50 ohms unbalanced.
- (f) Transmitted power handling capacity of at least 200 watts.
- (g) Minimum disturbance to aircraft hull. (Preferably easily removable.)

It was also of importance that the polarization circularity, Voltage Standing Wave Ratio (VSWR) and polar pattern should remain constant over the spectrum.

Research into the literature led to the decision to investigate the 'Spiral Aerial'. Several forms of dual arm flat spiral aerials have been the subject of a number of theoretical articles, e.g. Refs. 1, 2, 3 and 4. These aerials can conveniently be constructed by printed-circuit techniques, thus reducing the space requirement. During development of the aerial it was found that a full octave of bandwidth could be obtained, when a rear-radiation-suppression cavity was used, whilst meeting the other requirements of the immediate project. Interest stimulated by this discovery led to the development of the aerial system to be described. Basically this covers 200 to over 400 MHz when using a cavity depth of about 33 cm. This range can be changed to cover 400 to over 800 MHz by the simple expedient of reducing the cavity depth to about 16 cm.

It is considered that the R.A.E. development of this type of aerial together with the printed-circuit feed transformers<sup>5</sup> marks a significant advance in the 'state of the art'. Also during the development, the input impedance was designed to be 100 ohms, this being a much more convenient figure than the theoretical 150 to 180 ohm types described in the literature. The beam-width of the developed aerial is about 100 degrees between the 6 dB points. The polarization is circular within 2.0 dB over most of the operational bandwidth 200-800 MHz.

## 2 CHOICE OF SPIRAL TYPE

The literature on 'flat' spirals falls into two main categories 'Equiangular' and 'Archimedian'. The former type is said to have less symmetry<sup>1</sup> and it was not investigated further. Archimedian spirals can be constructed in square or circular form<sup>1,3</sup>. The circular form promised easier fabrication and suggested better possibilities for obtaining the required circular polarisation characteristics.

It was decided, therefore, to investigate the circular Archimedian type, an illustration of which is given in Fig. 1. This shows the printed circuit aerial only. The complete aerial system includes a transformer (Figs. 2 and 3) and a rear-radiation-suppression cavity. Fig. 4 illustrates a printed circuit aerial with a transformer in position. The completed design was mounted in the aircraft parachute exit door and is shown in Fig. 5.

## 3 THEORY OF OPERATION

### 3.1 Radiation

In common with many other types of aerial, the mechanism of radiation is not precisely understood. The following is an extract from Wolfe and Bawer<sup>3</sup>.

"The point of view is taken that the dual arm spiral antenna behaves as though it were a two wire transmission line which is gradually transformed into a radiating structure. Allowable radiation bands exist for all circles whose circumference is an integral number of wavelengths etc. Consider an isolated, tightly wound, dual arm spiral in which the two arms are excited by currents of equal amplitude and  $180^{\circ}$  out of phase. In the vicinity of and for some distance removed from the origin, the currents in adjacent conductors are out of phase so that little or no radiation occurs. As one proceeds further away from the origin along the curves, the phase relationship between the currents in adjacent conductors becomes random so that the net radiated energy in this region is small. This situation persists until a diameter corresponding to a circle of circumference equal to one wavelength is approached. In the neighbourhood of this diameter the currents in adjacent arms are in phase and the condition for efficient radiation exists."

It is evident that, provided such an aerial has sufficient turns, it will have broad band characteristics. It will also be shown that, provided certain conditions are met, the radiated polarization will be circular. The reader's attention is drawn to the references for further information.

### 3.2 Diameter of spiral

Bawer and Wolfe have shown<sup>3</sup> that the diameter of the aerial should not drop much below half a wavelength if maximum gain is to be realized. Since the lowest frequency of interest in our application was about 228 MHz and minimum size was important, the diameter of the final model as described was fixed at  $\lambda/2$  at this frequency.

### 3.3 Suppression of rear-radiation

The spiral aerial element has bidirectional radiating properties. The rear-radiation was suppressed by means of a circular closed-back cavity. This cavity was made to be slightly greater in diameter than the spiral itself so as to clear the outer edge of the spiral. Bawer and Wolfe stated that if the spiral diameter is not less than one half wavelength, the 'on-axis' ellipticity should not be worse than about 2 dB<sup>3</sup>. This conclusion was borne out in practice, moreover, the 'off-axis' circularity was very good, as will be shown later. In addition, it has been demonstrated during this development, that for cavity diameters of one half wavelength or more the maximum gain is obtained. The gain remains very constant over the bandwidth of the aerial when the cavity depth is fixed at one quarter wavelength at the low frequency end of the band. By this means the gain of the cavity-backed system is of the order of 7.5 dB relative to a circular isotropic radiator. This development has also shown that the use of a rear-radiation suppressing cavity limits the bandwidth to about one octave. Further comments and measured polar diagrams appear later in this paper.

## 4 DESIGN OF THE AERIAL SYSTEM

### 4.1 General

The frequency range of project interest was 228 to 310 MHz, so that primary consideration was given to the design of an aerial for this spectrum. At the lower frequency, this gave a spiral diameter of 66.6 cm. A cavity diameter of 68.82 cm was then chosen to provide adequate edge clearance. The cavity depth was fixed initially at  $\lambda/4$  at 228 MHz. This aerial, Fig. 5, covered 200 to 450 MHz. By reducing the cavity depth in two further steps, the upper limit can be extended to over 900 MHz. (See Sections 7 and 8.)

### 4.2 Impedance modification

Bawer and Wolfe suggest<sup>1,3</sup>, that element width and spacing are fairly non-critical and that to provide the maximum number of turns is of major

importance (for polarization circularity, maximum bandwidth and gain). However, in all the cases described in the literature, the conductor width to spacing ratio was unity - resulting in an input impedance of 180 ohms or so. Since this impedance is inconveniently high for most applications, the conductor width to spacing ratio of the practical aerial was adjusted to 2.6:1. Subsequent tests of the complete assembly showed that the impedance thus provided is almost exactly 100 ohms and, for all practical purposes, is purely resistive over the bandwidth. The actual dimensions chosen for conductor width and spacing between turns were 6.5 mm and 2.5 mm respectively which was expected to provide a reasonable area of conductor and sufficient spacing to ensure fair power handling.

#### 4.3 Number of turns

The ratio of width to spacing determined the number of turns (which could be accommodated in the diameter) at 17.5 per arm. This number and spacing was considered (correctly) to be enough to meet the conditions previously described.

### 5 RECOMMENDED METHODS FOR CONSTRUCTION OF THE PRINTED CIRCUIT SPIRAL AERIAL

The drawing for a spiral is geometrical, and the method used depends on the required accuracy. For the purpose of the two-arm spiral aerial described in this paper, the accuracy in track width and spacing between the two arms were considered of greater importance than true spirality. The drawing was therefore built up by a series of intersecting quadrants (for basic construction see Fig. 6).

Using Cut-n-Strip material, the quadrants were cut with the aid of a beam-compass. For each successive quadrant a quarter of the space between each convolution was added to the radii.

The space per convolution was 18 mm, therefore the radii centres were accurately plotted 4.5 mm apart, to form the corners of a square, and the sides of the square extended to form the intersection lines as indicated in Fig. 6.

Along one intersection line, e.g. line 'A', the widths of track and spaces were precisely plotted. Then, from centre 1, the compass was adjusted for radius 'a' and an arc struck through quadrant A-B. Without adjustment to the compass, a like arc was struck through quadrant C-D. This was repeated for

the required number of tracks and spaces through these two quadrants. Provided the points on intersection line 'A' are accurately plotted it should be a simple matter to complete quadrants B-C and D-A from centres 2 and 4 respectively.

If a manually operated co-ordinatorgraph is available for the plotting and cutting of the quadrants this would be of immense value. Greater accuracy would be obtained, considerable time saved, and much of the long and acute concentration and eye strain of the draughtsman removed.

Should a more accurate spiral shape be required then a computer tape driven co-ordinatorgraph should be used. However, the method used for these models proved to be entirely satisfactory from the electrical viewpoint.

The spiral conductor is formed in the required sense, i.e. right hand circular or left hand circular. In the case described, the former condition was used. 'Right Hand Circular' being herein defined as a clockwise direction taken by the spiral element when it is seen 'looking through' the aerial in the direction of the co-station (spacecraft).

## 6 FEED SYSTEM

A printed circuit unbalanced 50 ohms to balanced 100 ohms transformer is used for feeding the aerial. This design springs from the same literature, and has been developed simultaneously with the aerial development at R.A.E.<sup>5</sup>.

A typical transformer, is shown in Figs. 2 and 3. Briefly, this consists of a sheet of dielectric material, copper clad on both sides. The copper is etched away from one side to form a 50 ohm strip-line primary over an earth plate. The secondary is formed by removing part of this earth plate so as to produce a single turn loop, with its centre earthed and the load (aerial) connected in series at the point remote from earth. Some of these transformers will cover a frequency range of as much as 10:1 for a voltage standing wave ratio not exceeding 2:1. An example of this is shown in Fig. 7.

When used with this aerial system a 50 ohm to 100 ohm step-up transformer is mounted directly on to the spiral aerial and uses a symmetrical (CENTRE) feed position for the primary connection. The assembly is illustrated in Figs. 4 and 5. Full dimensional information for reproducing the actual transformers used during the aerial development is given in Figs. 2, 3 and 7, 8. It will be seen from Fig. 7, that this transformer should be suitable for use

over the whole range 200-800 MHz. (Since the original project frequency range of the aerial finished at just over 300 MHz, the transformer of Fig. 2 was used initially during the development and was replaced by that of Fig. 7 later.)

## 7 AERIAL RANGE MEASUREMENTS

### 7.1 R.A.E. Radio Department Aerial Range at Lasham

Fig. 9 shows the layout of the range. The technique used is to transmit from the aerial under test, in this case the spiral aerial, and receive on a 9 ft diameter parabolic dish with a half wave dipole, the distance between the spiral aerial and the half wave dipole being 88 metres. The receiving aerial is mounted on the roof of a cabin containing the receiver and radiation pattern recorder (Fig. 10); rotation of the pole turntable is controlled from the receiver cabin, the plotting table being connected to the pole turntable by a synchro system. The half wave dipole in the dish can also be rotated, thus varying the receiver aerial polarization, and synchro linked to the plotting table. The radiation pattern recorder used is the 'Allscott Radiation Pattern Recorder Type 245' in which the co-ordinate system can be either Polar or Cartesian, the former giving a dynamic range of 30 dB, and the latter a dynamic range of 50 dB. Rotation of the pole turntable gives the spiral aerial radiation pattern, whilst rotation of the receiving half wave dipole gives the polarization pattern.

### 7.2 Spiral aerial measurements

The lowest frequency measured was determined by the spiral dimensions whilst the top frequency was determined by the minimum usable cavity depth which in turn was determined by the balun dimensions.

The lower frequency limit was not expected to be much below the design figure of 228 MHz (using a  $\lambda/4$  depth cavity at this frequency). Figs. 12a, 12b and 12c confirm this premise, the polar radiation pattern improving rapidly from 150 MHz to 200 MHz and being near perfect at 228 MHz. (See Section 3.3.)

From 228 MHz to about 450 MHz the pattern was very consistent but deteriorated at 500 MHz (Fig. 14a). Since the feed transformer was introducing a slight mismatch at this frequency (Fig. 2) this transformer was replaced by that shown in Fig. 7. Whilst this change effected some improvement, as can be

seen by comparing Figs. 14a and 14b, it was apparent that the cavity depth, which had become  $\lambda/2$  at 456 MHz, was responsible for the deterioration. Changing the cavity depth to 16 cm ( $\lambda/4$  at 468 MHz) resulted in a very good polar radiation pattern at 500 MHz (Figs. 14c and 14d). The patterns remained good up to about 750 MHz with the 16 cm cavity in use, and were acceptable at 800 MHz but became badly distorted at 900 MHz (Figs. 15d and 16a). This was a little below the frequency at which the cavity became  $\lambda/2$  deep (936 MHz).

A further reduction in cavity depth to 9.2 cm (the minimum which would accommodate the smallest transformer available) improved the pattern considerably at 900 MHz (Figs. 16b and 16c), but severe distortion again became apparent as the frequency was raised to 1000 MHz (Fig. 17a). Since the  $\lambda/4$  and  $\lambda/2$  frequencies corresponding to 9.2 cm are 820 MHz and 1640 MHz respectively, this improvement related to that obtained at 500 MHz by reducing the cavity below  $\lambda/2$  in depth. However the octave bandwidth cavity function should not have introduced the distortion below some 1600 MHz. It is probable that the restriction, to 900 MHz or so, was due to the increasing effect with frequency of the non-parallel surfaces of the cavity back (flat) and the curved aerial element, i.e. the cavity was not a right cylinder (Fig. 5).

The radiation patterns and some polarization pattern measurements are shown in Figs. 12-20. Also included is a radiation pattern of a half wave dipole at 500 MHz (Fig. 31). This was done for the purpose of gain measurement by substitution. Provided that both the spiral aerial and the half wave dipole are well matched to the feeder impedance, that equal power is fed to both aeri-als, and that the same receiving aerial is used to plot radiation patterns of both, then a comparison of these patterns (Figs. 14c and 31) will give the gain of the spiral aerial relative to a half wave dipole. The spherical polar co-ordinate system used is defined in Fig. 11 and a summary of the results obtained is shown in Table 1.

Polarization circularity patterns of the spiral aerial, at 500 MHz, were plotted for various 'off-axis' angles (Figs. 19a-20d). Table 2 shows the values of ellipticity obtained for various 'off-axis' angles.

### 7.3 Limits of useful bandwidth

The limits to extension of bandwidth were shown to be as follows:-

(a) High frequency

When the depth of the cavity equals  $\lambda/2$  the beam pattern starts to divide and deteriorates rapidly as frequency increases.

(b) Low frequency

When the diameter of the spiral element and cavity becomes less than  $\lambda/2$ , the polarization circularity deteriorates. For example in the test case (design frequency,  $f_d$ , 228 MHz) the ellipticity at 228 MHz was 0 dB.

A reduction of 11.4% in frequency produced polar ellipticity of 2 dB and a further frequency reduction to 15% below  $f_d$  - caused 8 dB of ellipticity.

7.4 Power test

The complete aerial, together with a type 'B' transformer<sup>5</sup> (Fig. 2), was tested under power transfer conditions. This was done at 225 MHz and 300 MHz with a mean power input of 150 W. The duration of each run was 20 minutes, and no damage to the aerial or transformer could be found at the end of the tests.

8 CONCLUSIONS

This development has increased the available information upon spiral aeriels as follows:-

(a) The impedance has been changed from about 180 ohms to 100 ohms, thus easing feeding problems.

(b) The effect of cavity depth has been investigated and shown to cause polar diagram distortion when this depth is one half wavelength or more.

(c) Previous literature gives information upon polarization circularity 'on-axis' only. Results are given in this paper for angles between  $0^\circ$  and  $80^\circ$ .

(d) The effect of reducing the frequency below that at which the diameter of the spiral is one half wavelength has been investigated. This shows that the aerial can be used below this frequency with some deterioration in polarization circularity.

The aerial system described is particularly suitable for aircraft mounting where projections outside the hull are undesirable.

The frequency range 200-800 MHz can be covered in two equal steps, 200-400 and 400-800 MHz, simply by changing to the cavity depth appropriate

to one of these two octave-wide bands. If it is an advantage to be able to change range quickly, this could be achieved by making the cavity back-plate adjustable to one of the two positions as required. A mechanical system to allow this adjustment to be done in-situ should not be difficult to design.

Suitable wide-band unbalanced to balanced feed transformers have been designed and tested. These cover a greater bandwidth than required for the one octave cavity restriction. In fact, a single transformer will cover the whole range 200-800 MHz. The design of these transformers is given fully in Ref. 5. This paper provides a design for covering the range particular to the project aerial. The polarization circularity of the aerial system, both 'on' and 'off' axis is very good. The half-power beam width is about  $82^\circ$ .

Table 1

SUMMARY OF MEASUREMENTS ON THE ARCHIMEDIAN SPIRAL ANTENNA

Balun	Type 'B' (X4)										Type 'D' (X14)									
	150	200	228	255	300	400	500	500	500	500	600	700	800	900	900	900	1000	1100		
3 dB Beam-width	$E_\psi$ $E_\theta$	$E_\psi$ $E_\theta$	$E_\psi$ $E_\theta$	$E_\psi$ $E_\theta$	$E_\psi$ $E_\theta$	$E_\psi$ $E_\theta$	$E_\psi$ $E_\theta$	$E_\psi$ $E_\theta$	$E_\psi$ $E_\theta$	$E_\psi$ $E_\theta$	$E_\psi$ $E_\theta$	$E_\psi$ $E_\theta$	$E_\psi$ $E_\theta$	$E_\psi$ $E_\theta$	$E_\psi$ $E_\theta$	$E_\psi$ $E_\theta$	$E_\psi$ $E_\theta$	$E_\psi$ $E_\theta$	$E_\psi$ $E_\theta$	
	80° 85°	90° 90°	86° 80°	86° 73°	66° 68°	80° 88°	80° 88°	120° -	78° 60°	60° 38°	96° 107°	77° -	-	-	60° 88°	78° -	-	-	-	
'0'-axis' Ellipticity (dB)	9.0	2.0	2.0	1.5	1.0	2.5	7.5	5.0	<0.5	2.0	1.0	3.0	1.5	4.0	12.0					
Cavity	Diameter = 69 cm, depth = 33 cm										Diameter = 69 cm, depth = 16 cm									
											Diameter = 69 cm, depth = 9.2 cm									

Cavity depth = 9.2 cm is minimum possible due to balun dimensions.

Table 2'OFF-AXIS' ELLIPTICITY OF ARCHIMEDIAN SPIRAL AERIAL

$\theta$	$0^\circ$	$10^\circ$	$20^\circ$	$30^\circ$	$40^\circ$	$50^\circ$	$60^\circ$	$70^\circ$	$80^\circ$	$90^\circ$
Ellipticity (dB)	<0.5	1.0	2.0	3.0	5.0	6.0	8.0	11.0	15.0	20.0

Frequency - 500 MHz

REFERENCES

- | <u>No.</u> | <u>Author</u>           | <u>Title, etc.</u>   |
|------------|-------------------------|--|
| 1          | J. J. Wolfe<br>R. Bawer | Designing printed-circuit spiral antennas<br><i>Electronics</i> , 99-103, April 1961   |
| 2          | V. H. Rumsey            | Frequency independent antennas. University of Illinois. (Informal presentation given at the URSI International Symposium on Electromagnetic Theory. University of Toronto, June 1959.) |
| 3          | J. J. Wolfe<br>R. Bawer | The spiral antenna. <i>IRE International Convention Record, Part 1</i> , p 84-95 (1960)  |
| 4          | John D. Dyson           | The equiangular spiral antenna. <i>IRE Trans: on Antennas and Propagation</i> , April 1959   |
| 5          | D. P. L. May            | Engineered designs for very wide band radio frequency transformers (BALUNS) using printed-circuit strip-line techniques<br>R.A.E. Technical Report 70063 (1970)                        |

Fig.1

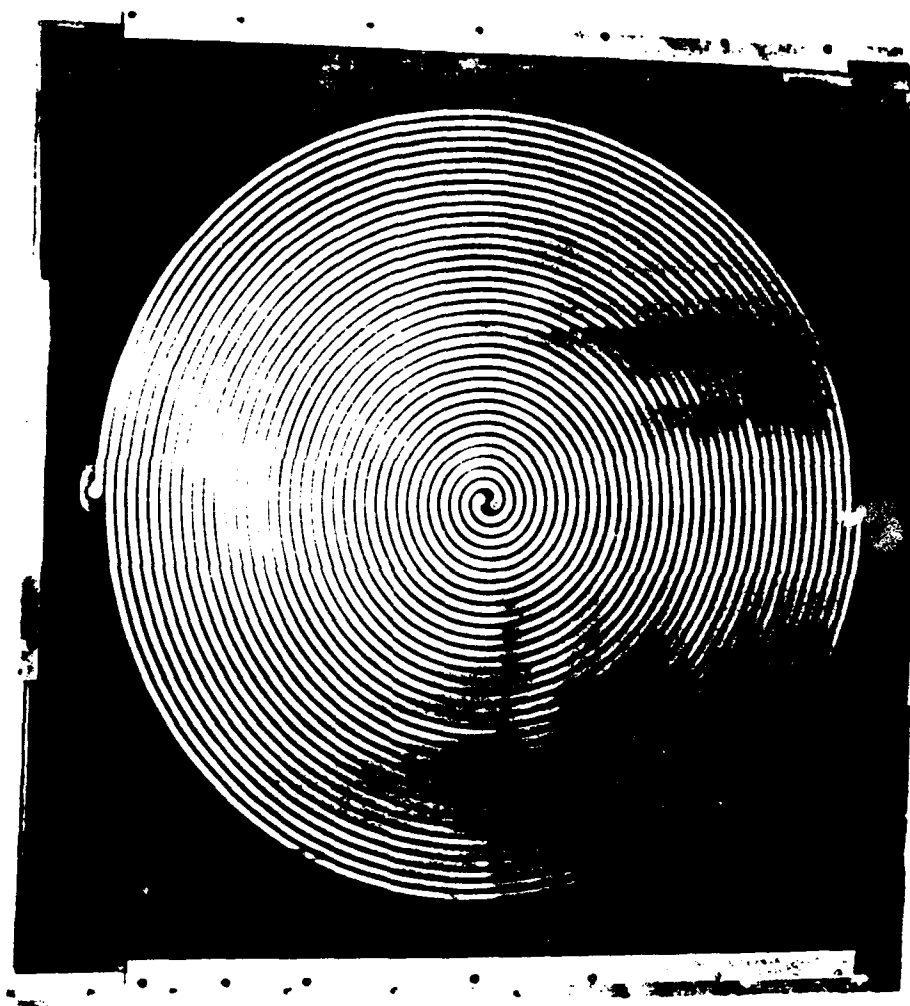
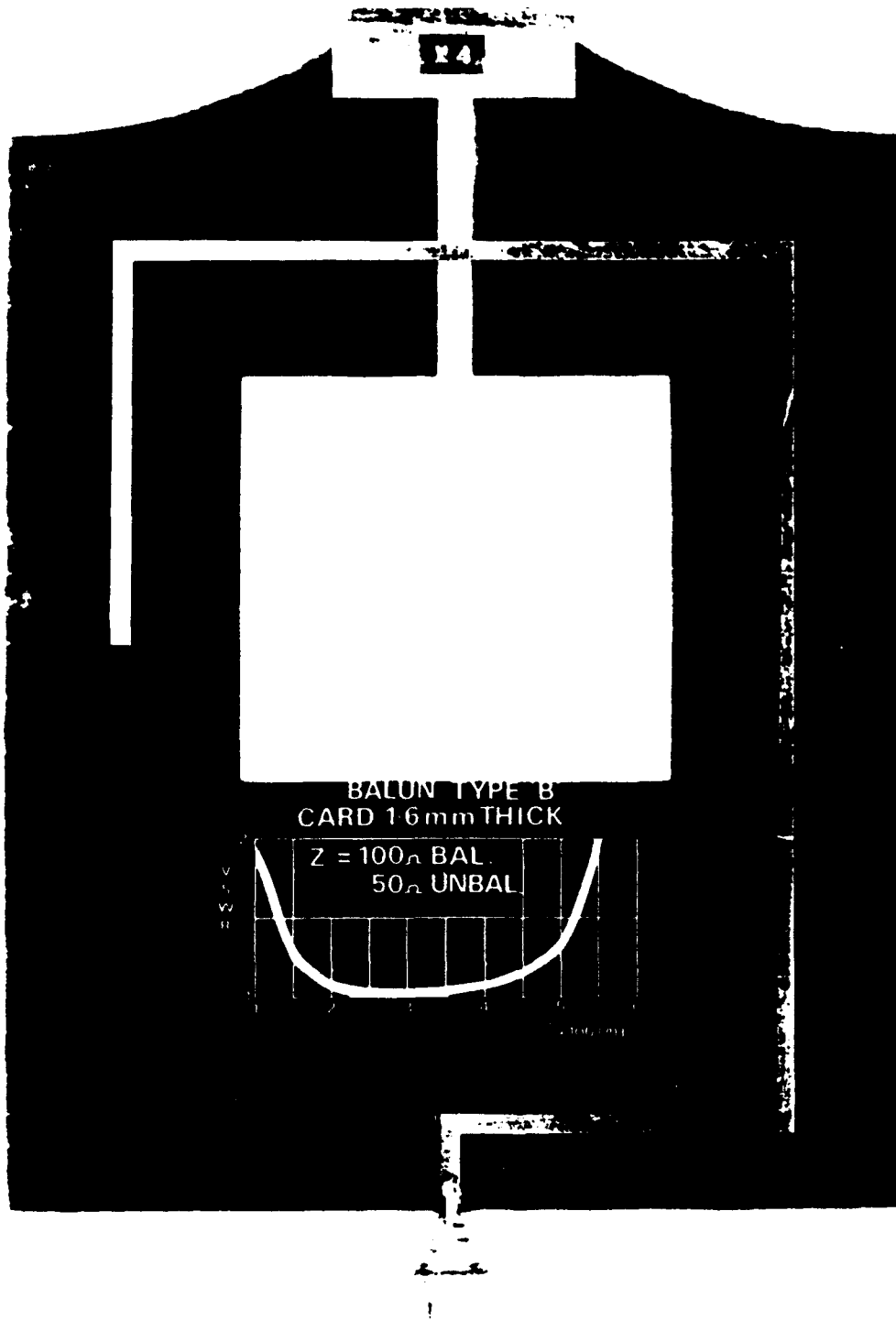

Fig.1 Circular Archimedian spiral printed circuit aerial

NEG NO C6790 1 R70062

Fig.2



Balun type "B"

Fig.2 R.F.transformer as used for 200-450 MHz(1/16" SRBP)

.08 .14 .3 .42 1.2 1.6 1.8

Fig. 3a  
dE .piF

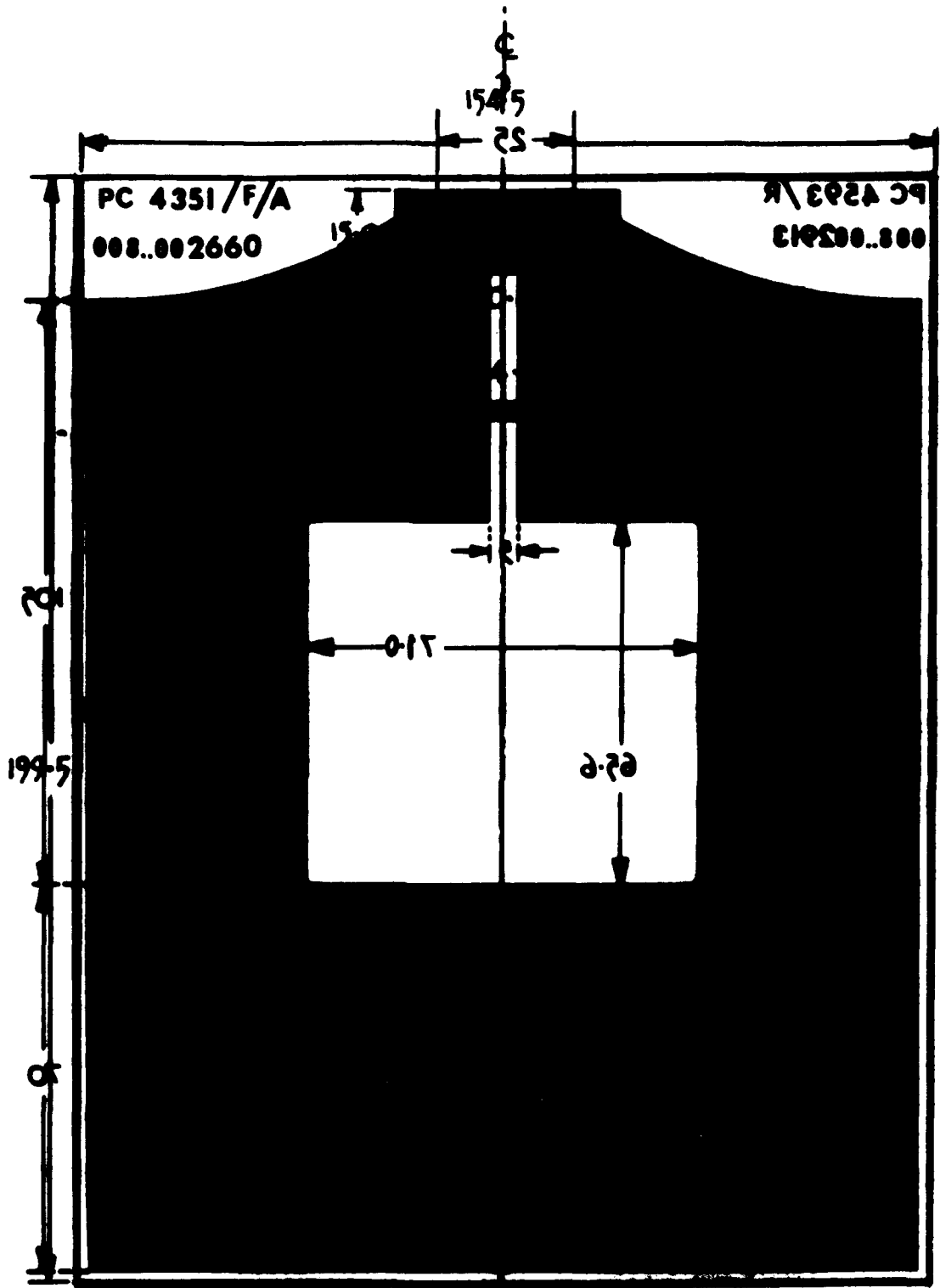

ALL DIMENSIONS IN mm

ALL DIMENSIONS IN mm

FIG. 3a R.F. TRANSFORMER 100-550 MHz DIMENSIONS

FIG. 3b R.F. TRANSFORMER 100-550 MHz DIMENSIONS  
PC 4351/F/A

PC 4351/R

Best Available Copy

TR 70062  
JW 10005

008 902299  
008 805200



**Fig.4**

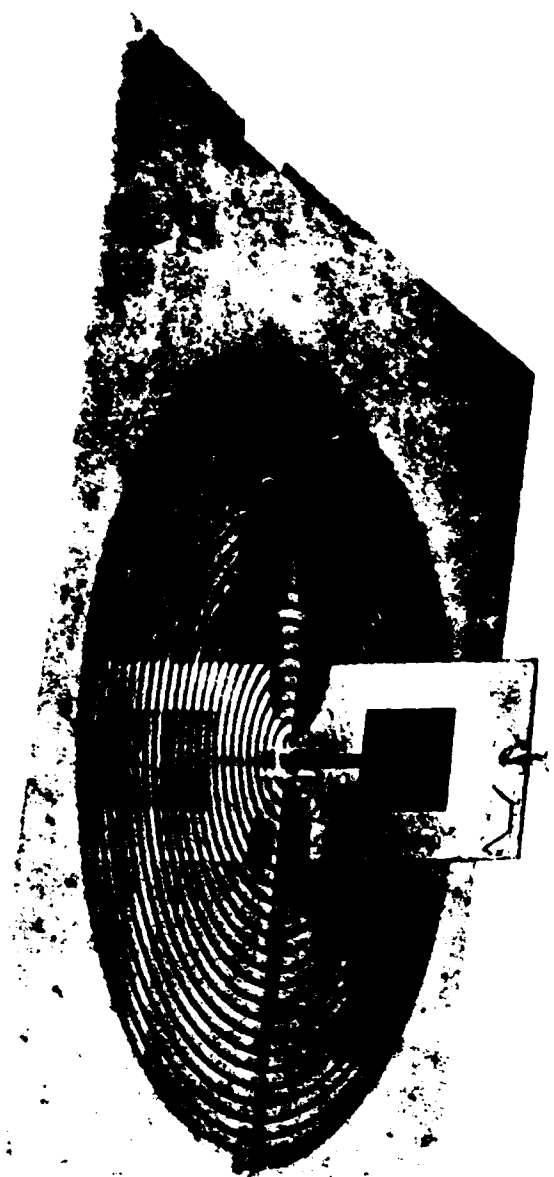

**Fig.4 Aerial and transformer. Showing transformer mounting position**

NOC6792 TR70062

Fig.5

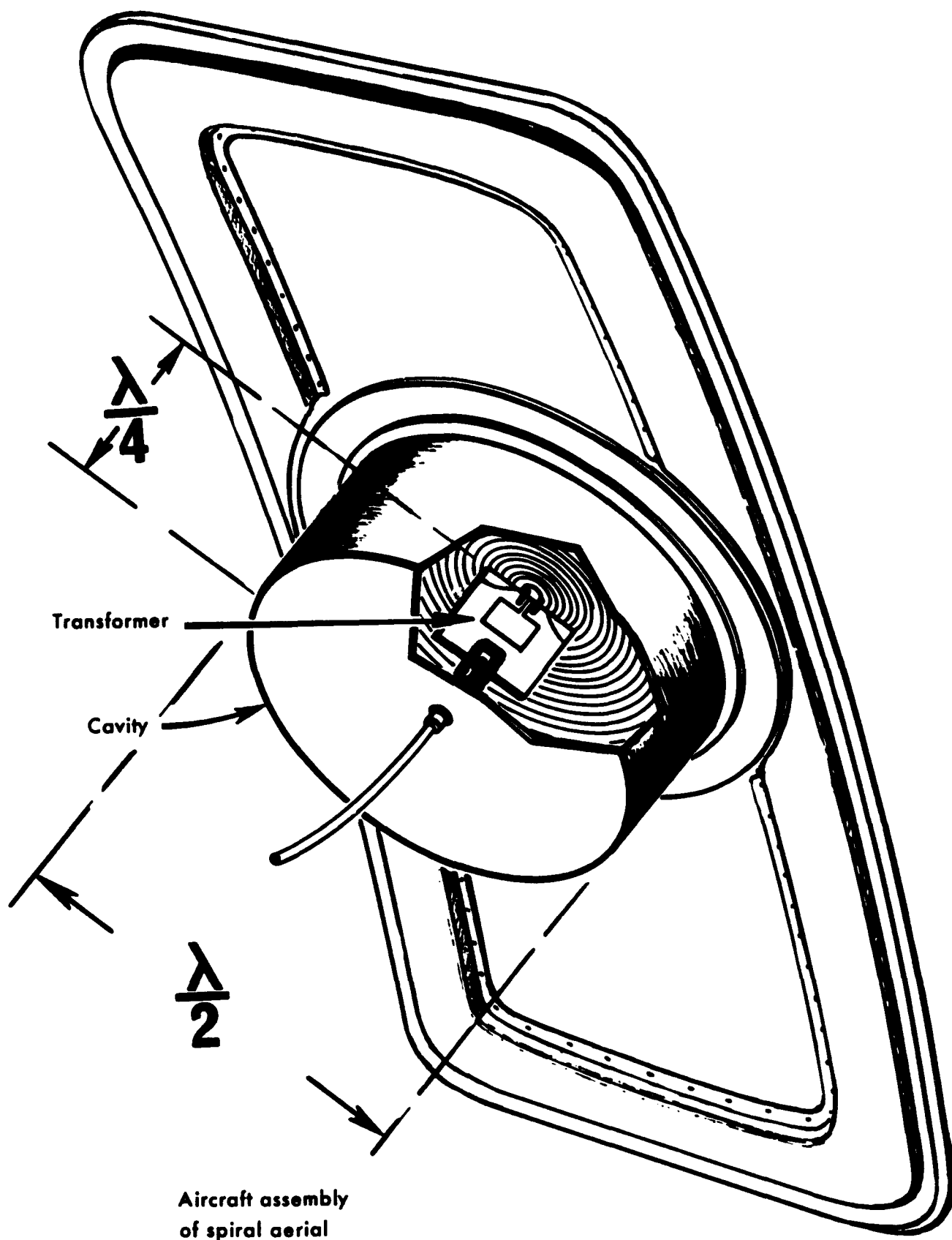

Fig.5. Complete aerial system mounted in aircraft parachute exit door

Fig.6 a & b

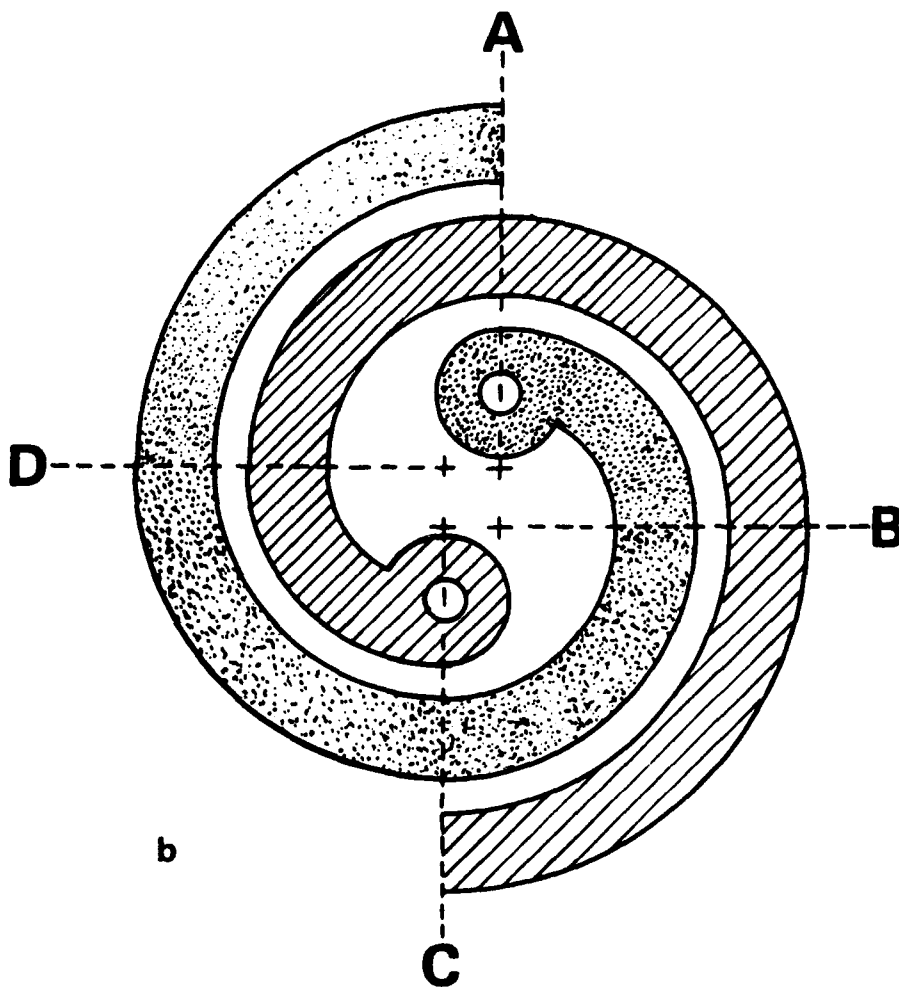
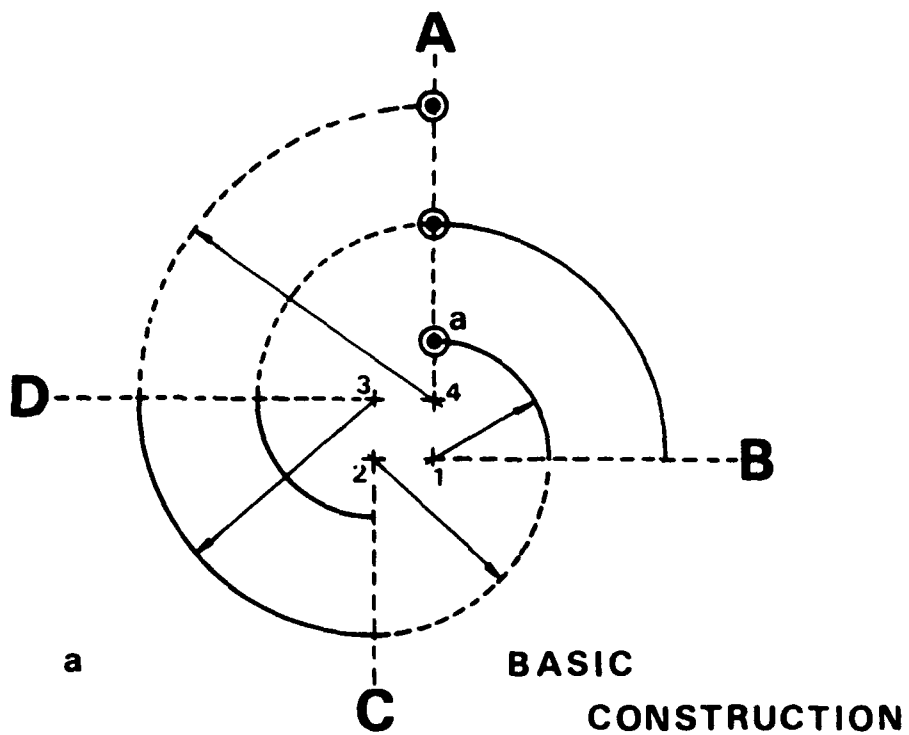
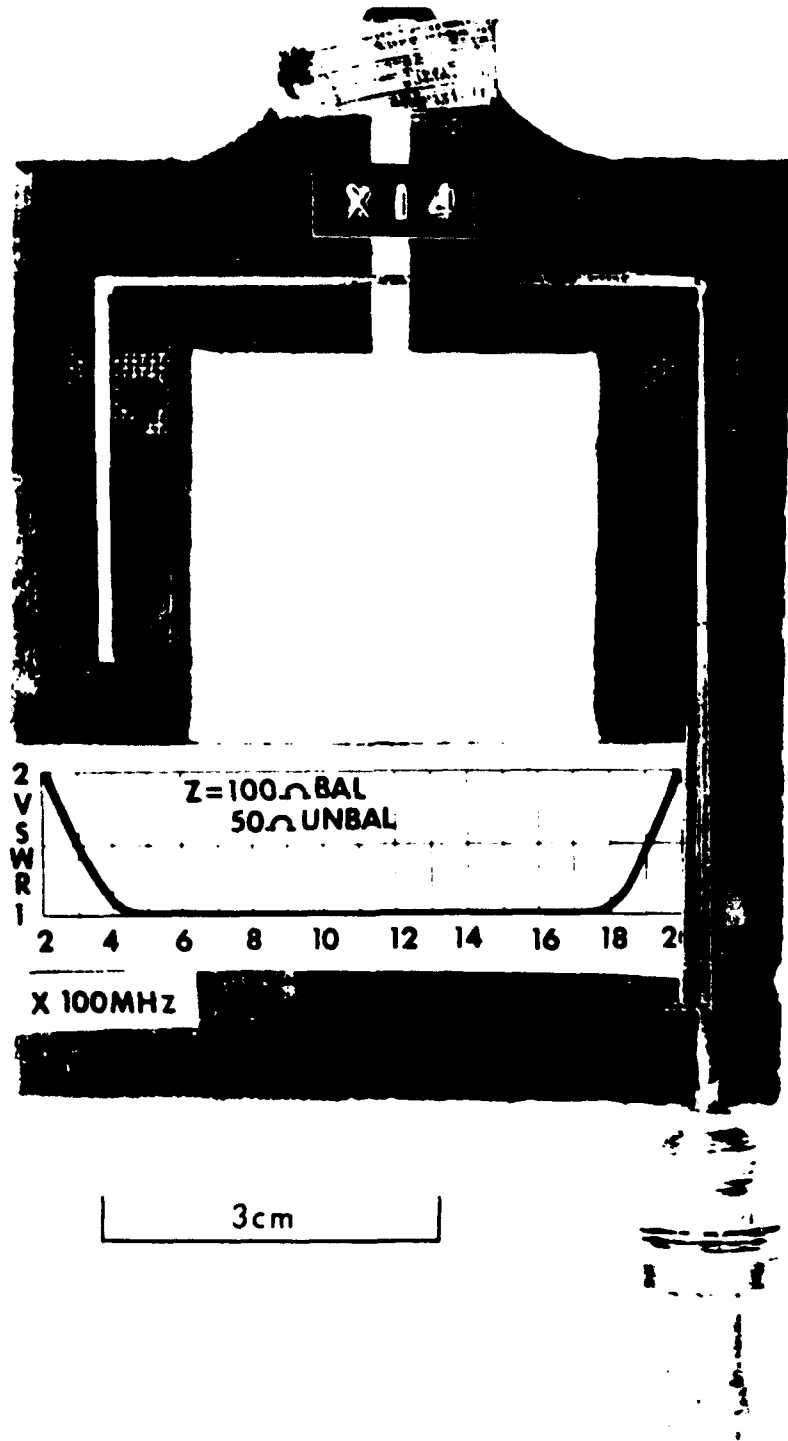

FIG. 6 a & b  
CONSTRUCTION OF THE ARCHIMEDIAN SPIRAL AERIAL.

TR 70062

008 902230

Fig.7



Balun type "D"

Fig.7 R.F.transformer as used for 500-1100 MHz (1/32" fibreglass)

TR 70062  
LV J0005

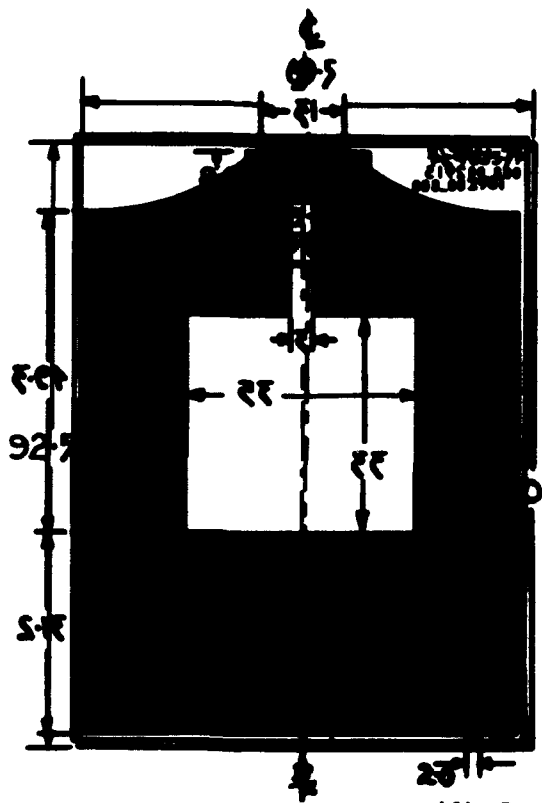

ALL DIMENSIONS IN mm

FIG. 8 b R.F. TRANSFORMER 200 - 2000 MHz DIMENSIONS  
 FIG. 8 a R.F. TRANSFORMER 500 - 5000 MHz DIMENSIONS  
 PC4635/F  
 PC4522/R  
 F/5294CP

008 902301  
000 805305

Best Available Copy

Fig. 8b

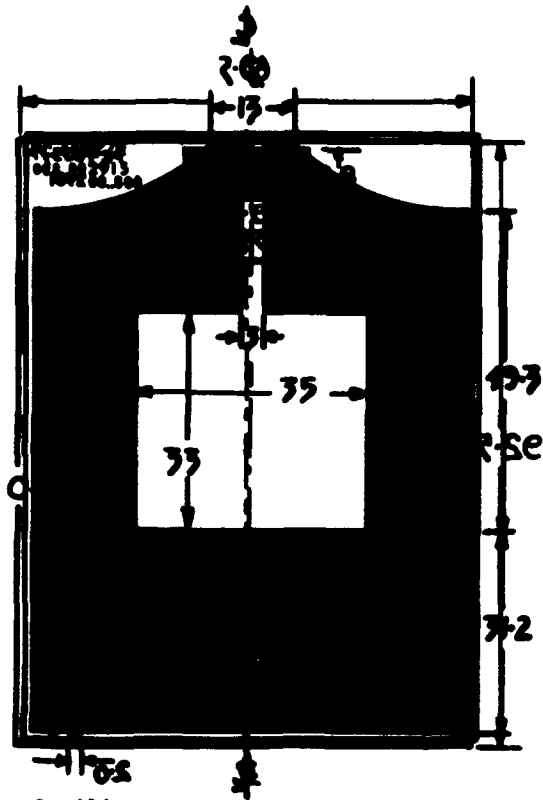

ALL DIMENSIONS IN mm

FIG. 8 b R.F. TRANSFORMER 200 - 2000 MHz DIMENSIONS

PC 4595/R

PC 4632/F

Best Available Copy

Best Available Copy

TR 70062

1W 10095

008 902302

008 005201

08 14 3 42 1.2 1.9 1.81

NEGNO C6795 TR.70062

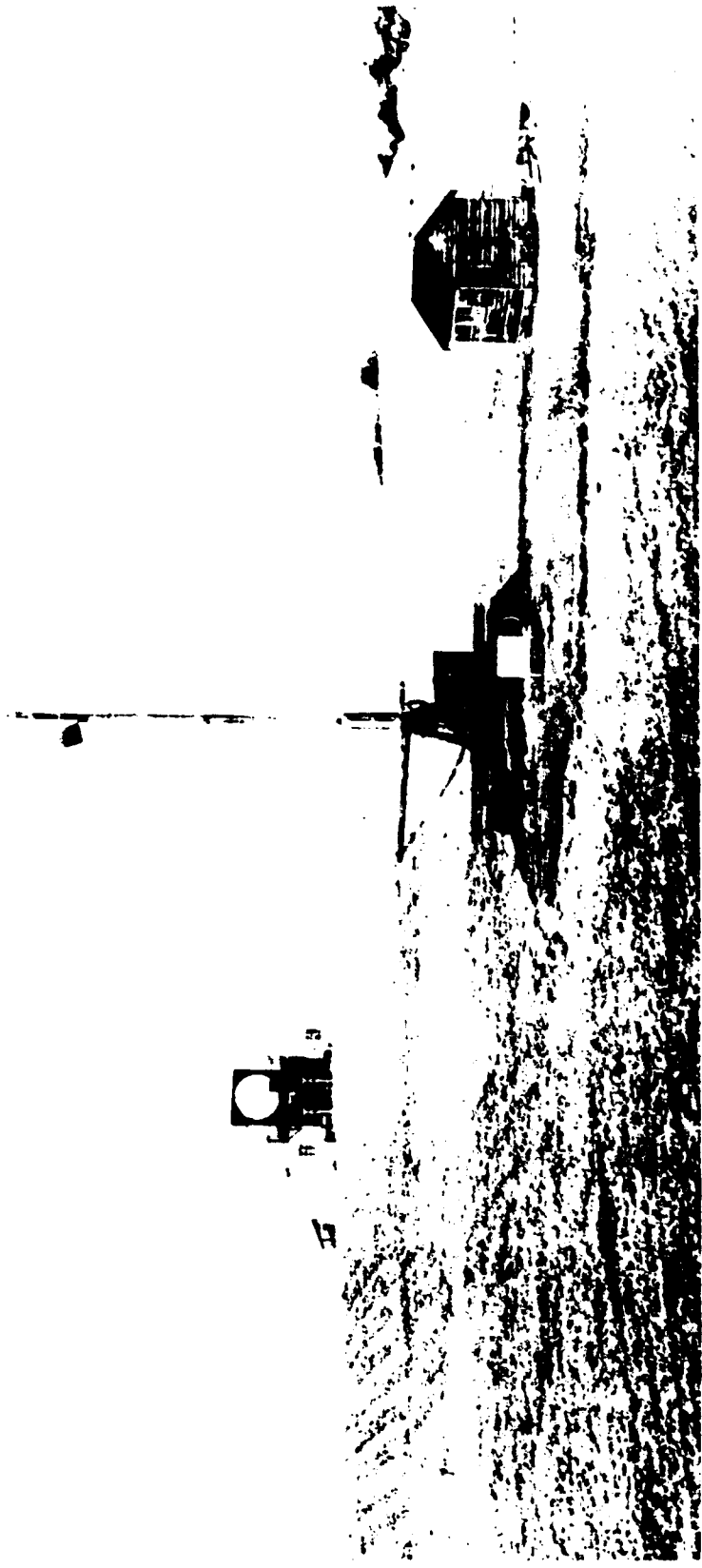

Fig.9 General view of aerial measuring range

Fig.9

Fig.10

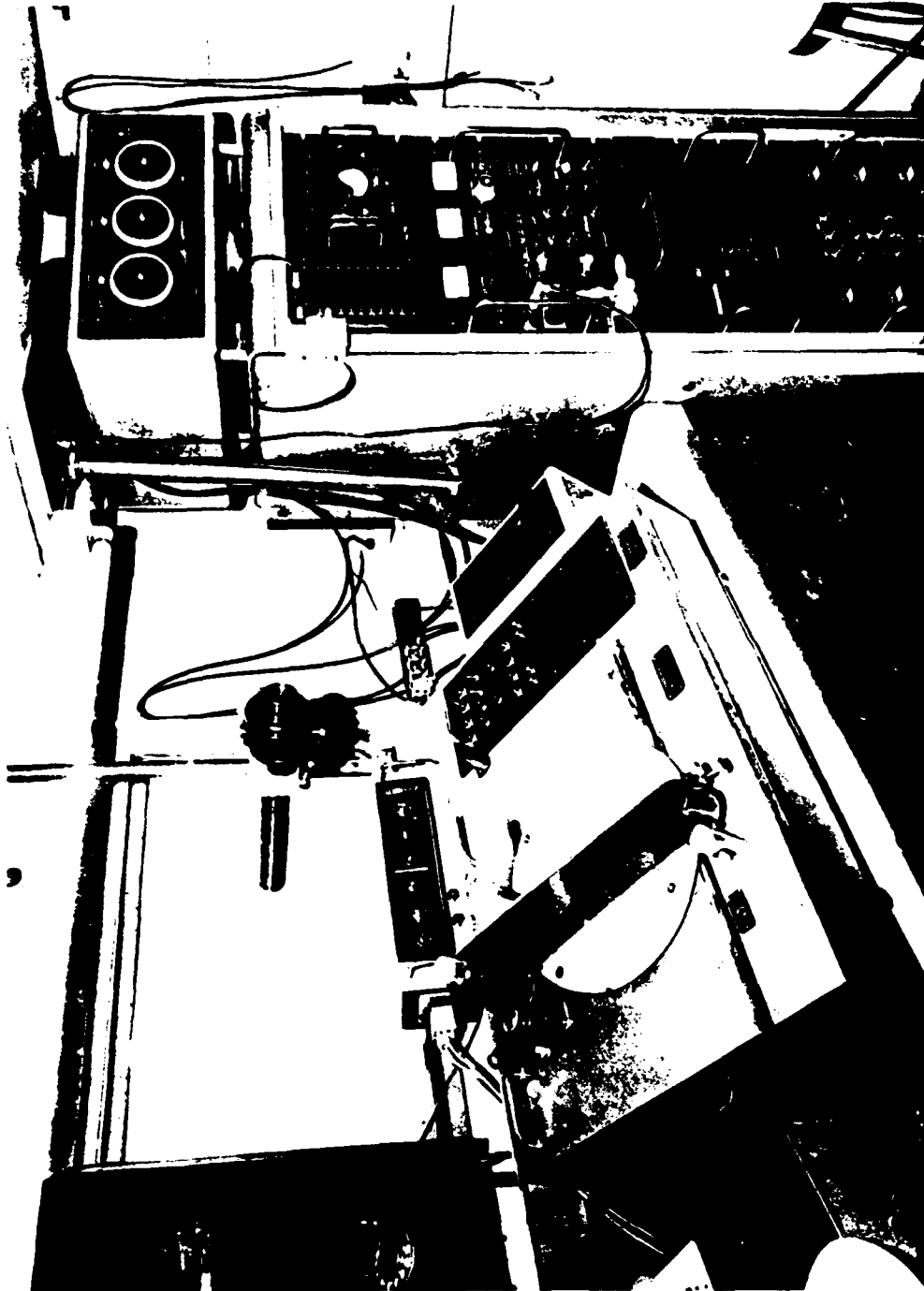
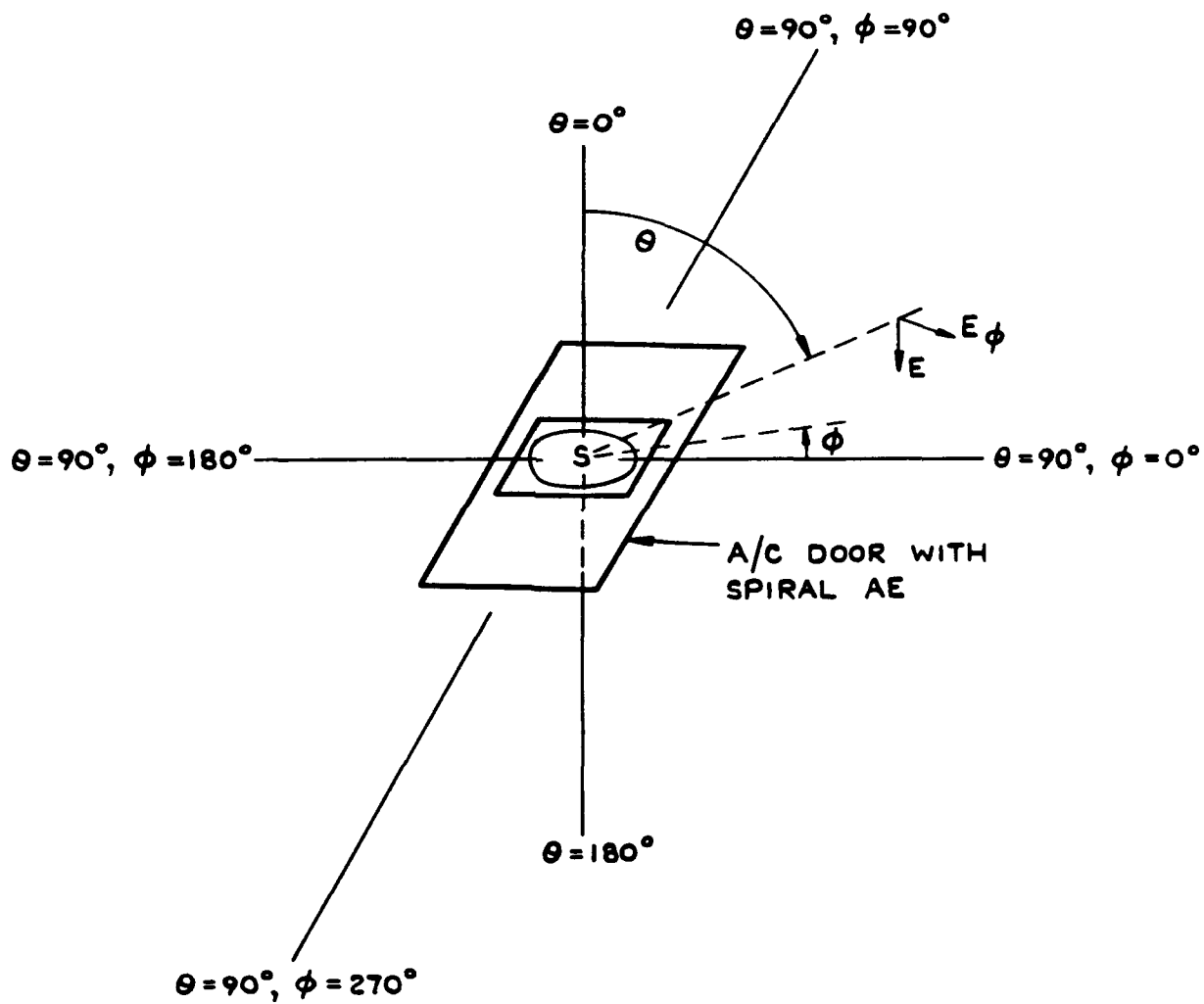

Fig.10 Aerial view of receiver cabin showing recording equipment

TR 70C62



008 902231

FIG.II SPHERICAL POLAR CO-ORDINATE SYSTEM

Fig. 12a&b

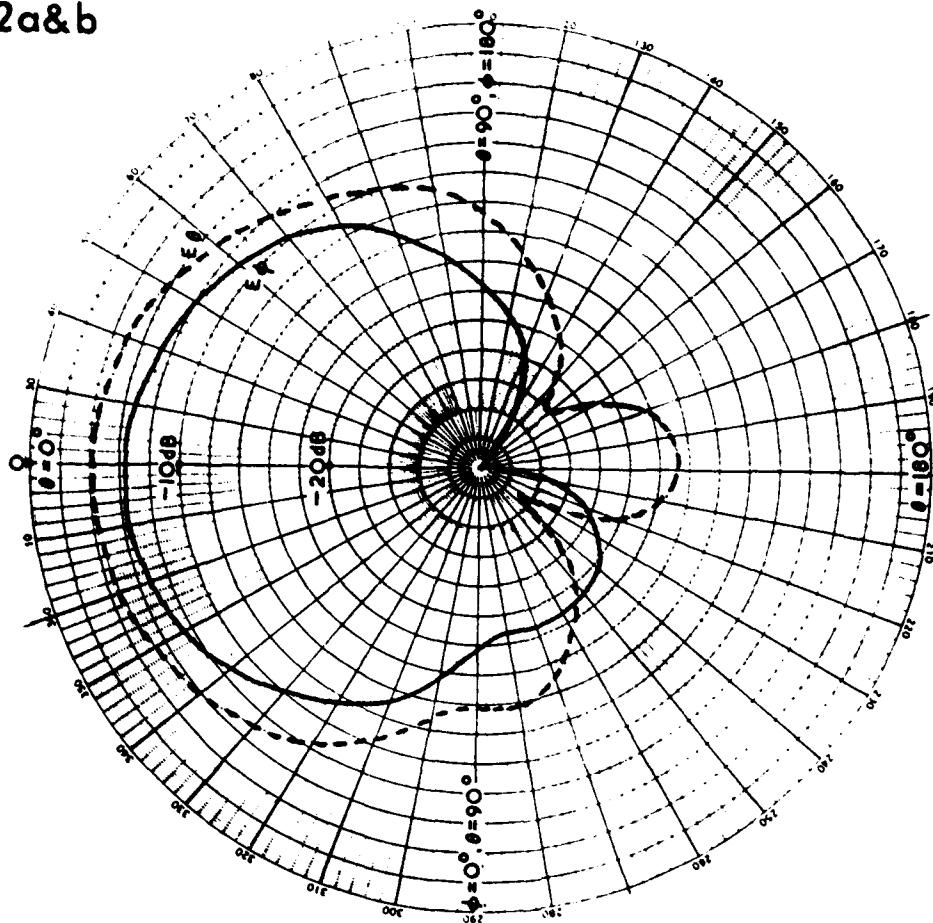

Fig.12b. Spiral aerial radiation pattern-  
200MHz., balun type "B", cavity  
diam.69cm,cavity depth 33cm

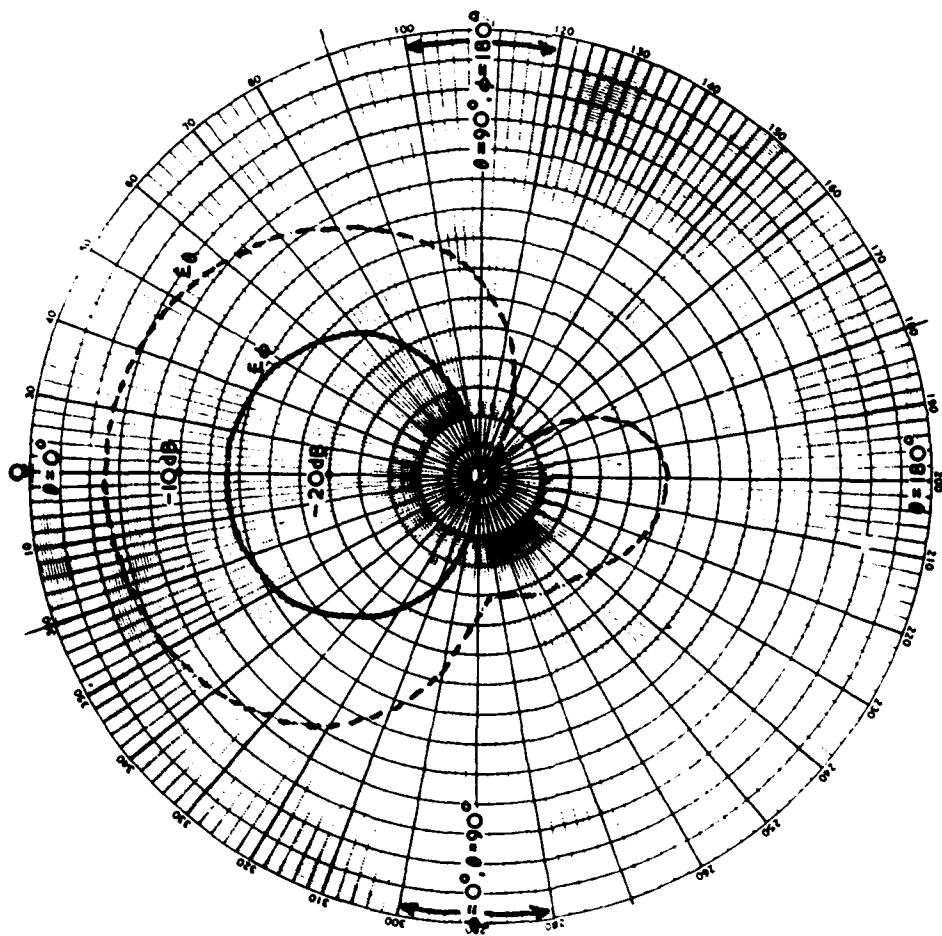

Fig.12a. Spiral aerial radiation pattern-  
150MHz., balun type "B", cavity  
diam.69cm,cavity depth 33cm

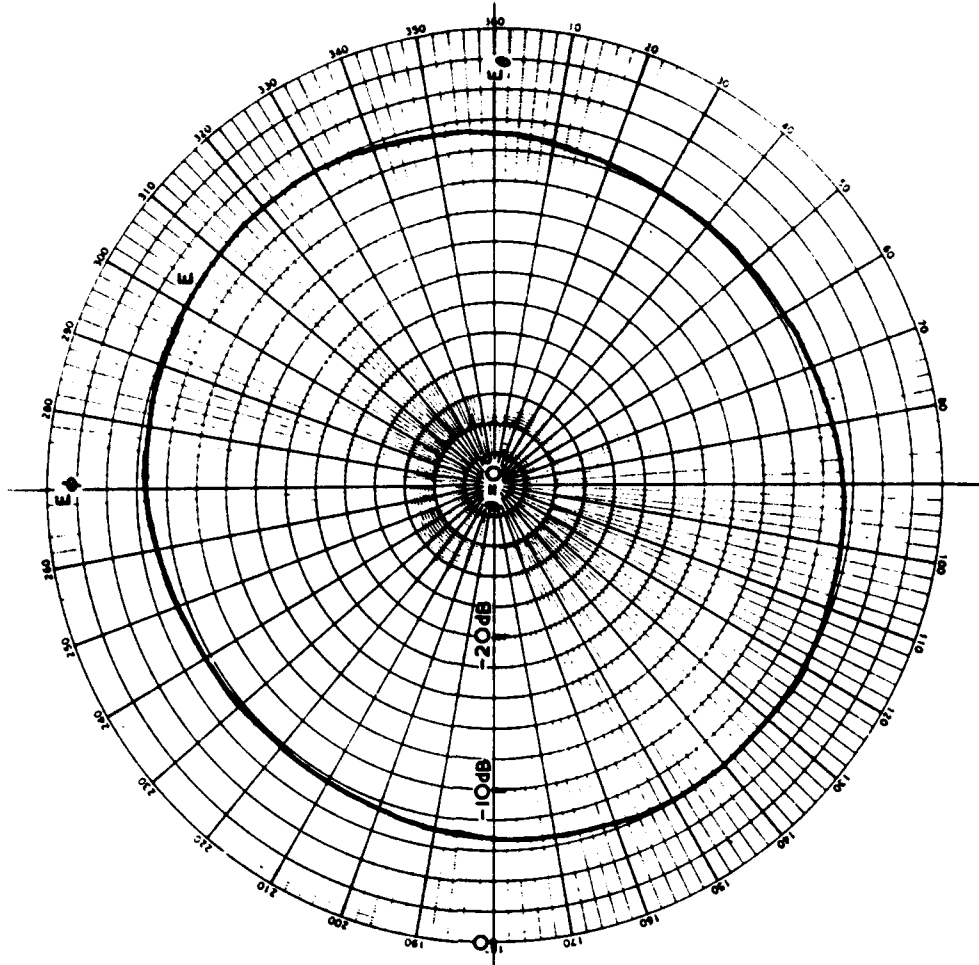

Fig. 12c&d

Fig.12d Spiral aerial polarisation pattern -  
228MHz.,balun type "B",cavity  
diam.69cm,cavity depth 33cm

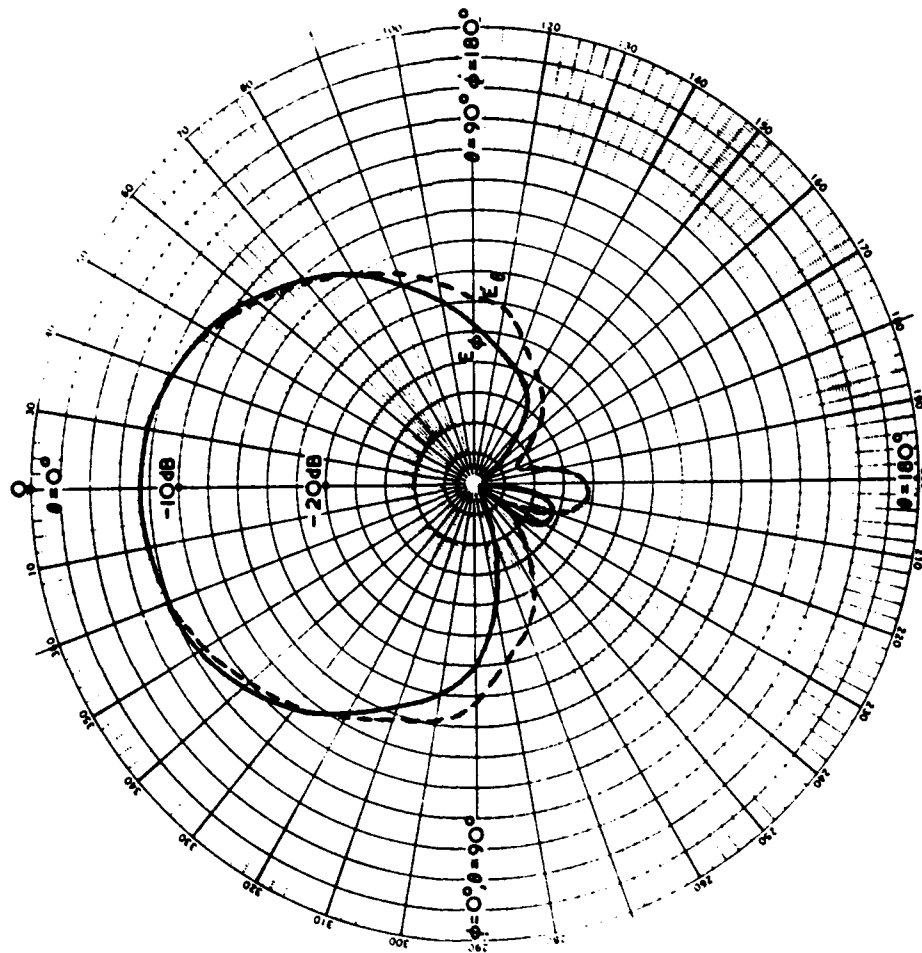

Fig.12c Spiral aerial radiation pattern -  
228MHz.,balun type "B",cavity  
diam.69cm.,cavity depth 33cm

Fig. 13a&b

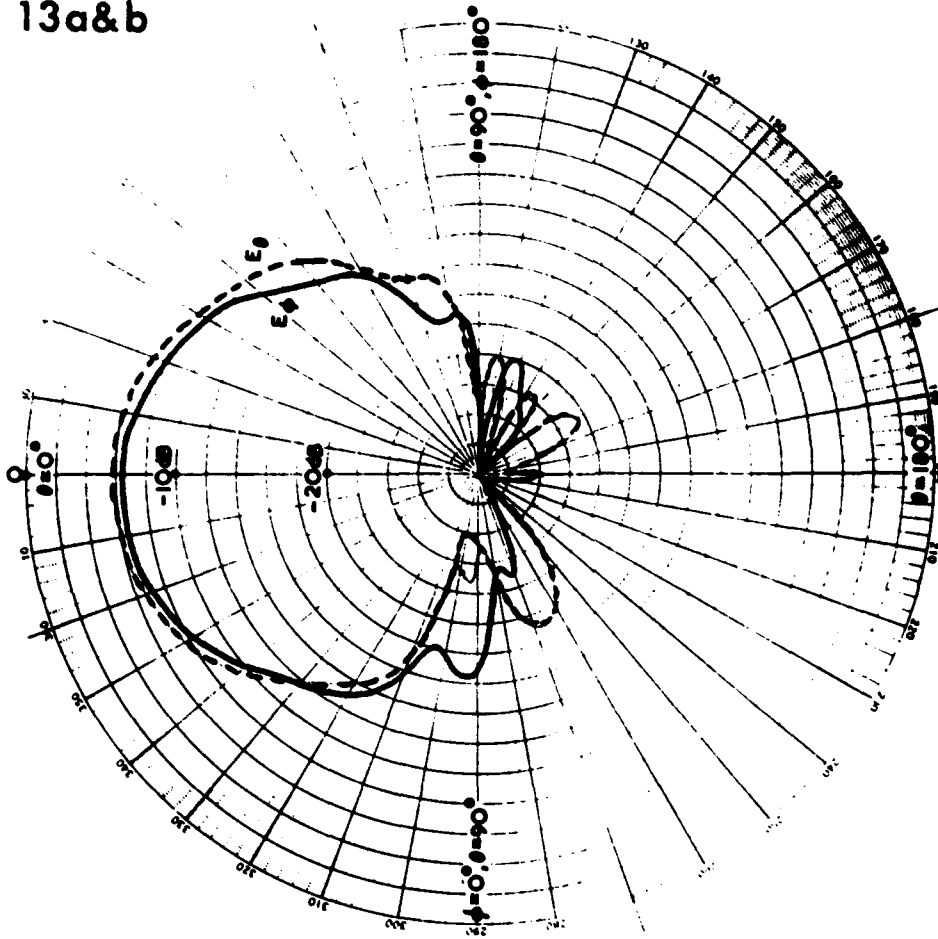

Fig.13b Spiral aerial radiation pattern-  
300MHz., balun type "B", cavity  
diam. 69cm, cavity depth 33cm

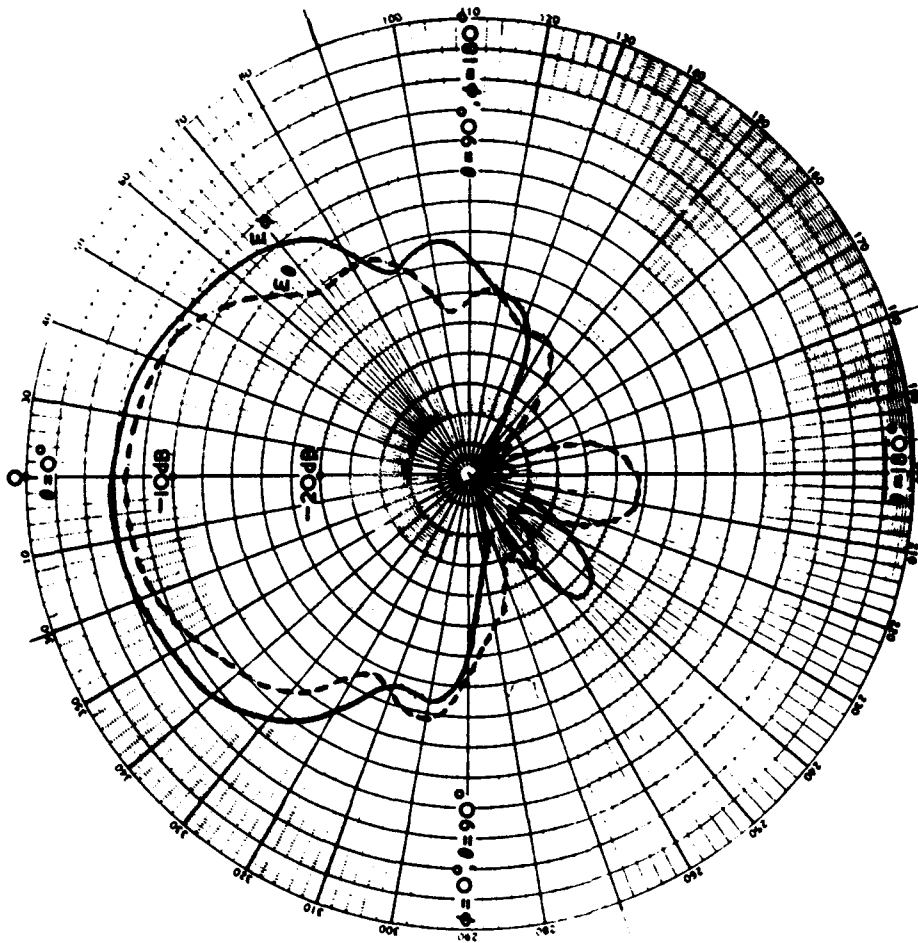

Fig.13a Spiral aerial radiation pattern-  
255MHz., balun type "B", cavity  
diam. 69cm, cavity depth 33cm

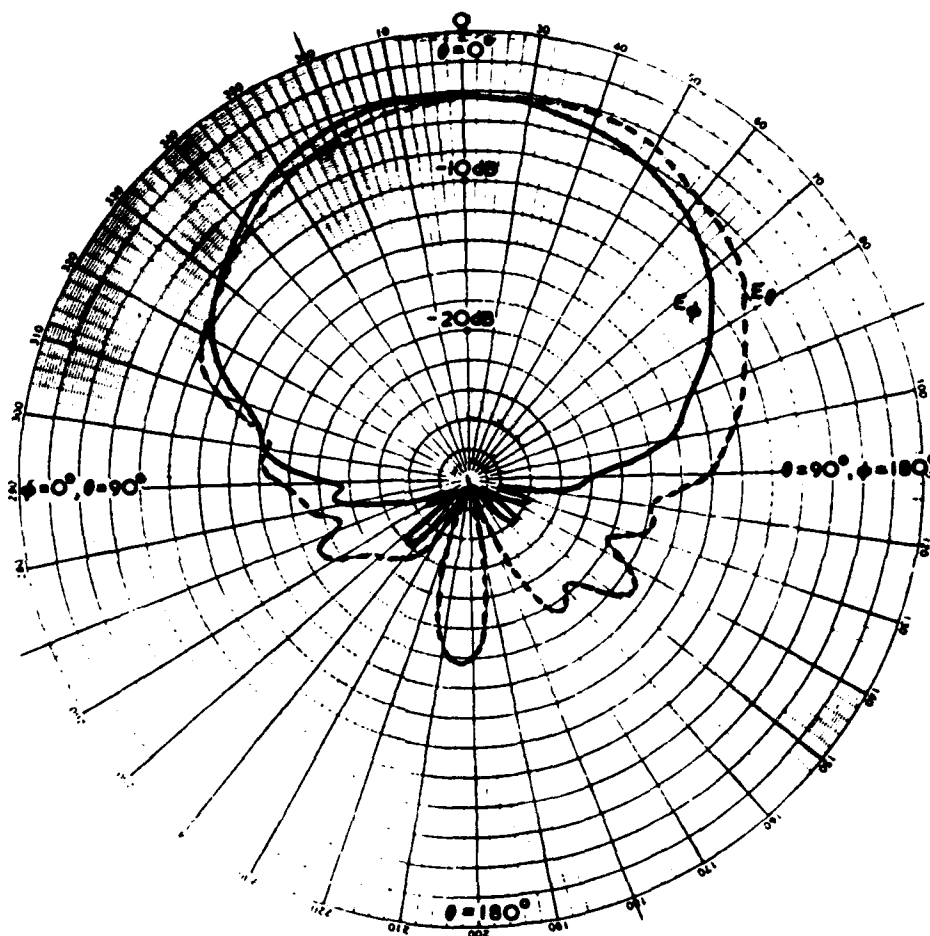

Fig.13c Spiral aerial radiation pattern-400MHz., balun type "B", cavity diam.69cm, cavity depth 33cm.

Fig.14a&b

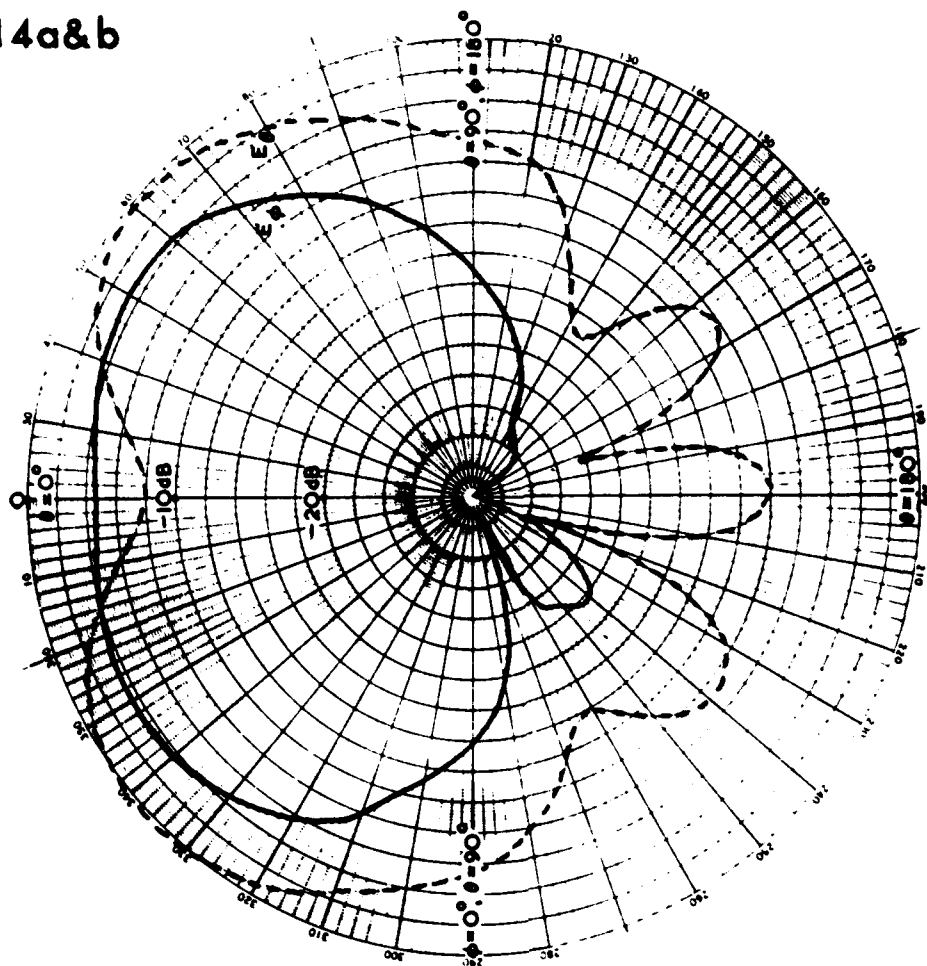

Fig.14b. Spiral aerial radiation pattern-  
500MHz., balun type "D", cavity  
diam.69cm.,cavity depth 33cm

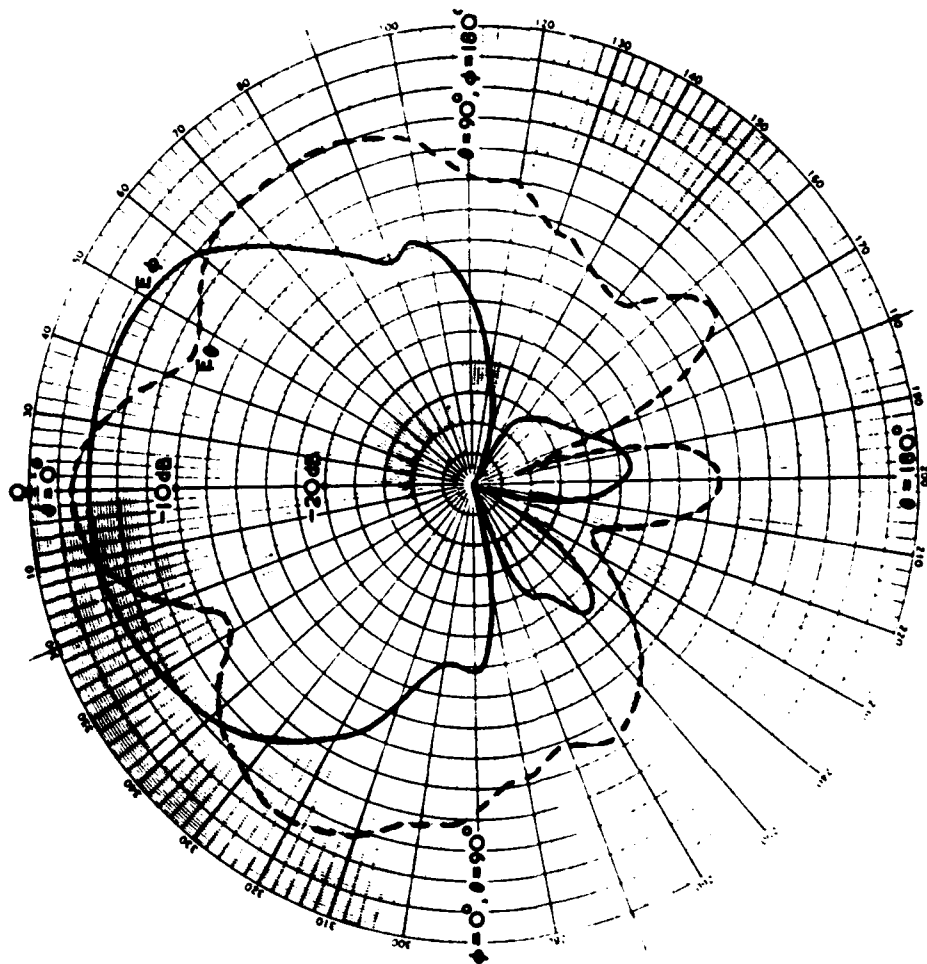

Fig.14a Spiral aerial radiation pattern-  
500MHz., balun type "B", cavity  
diam.69cm.,cavity depth 33cm

Fig.14c

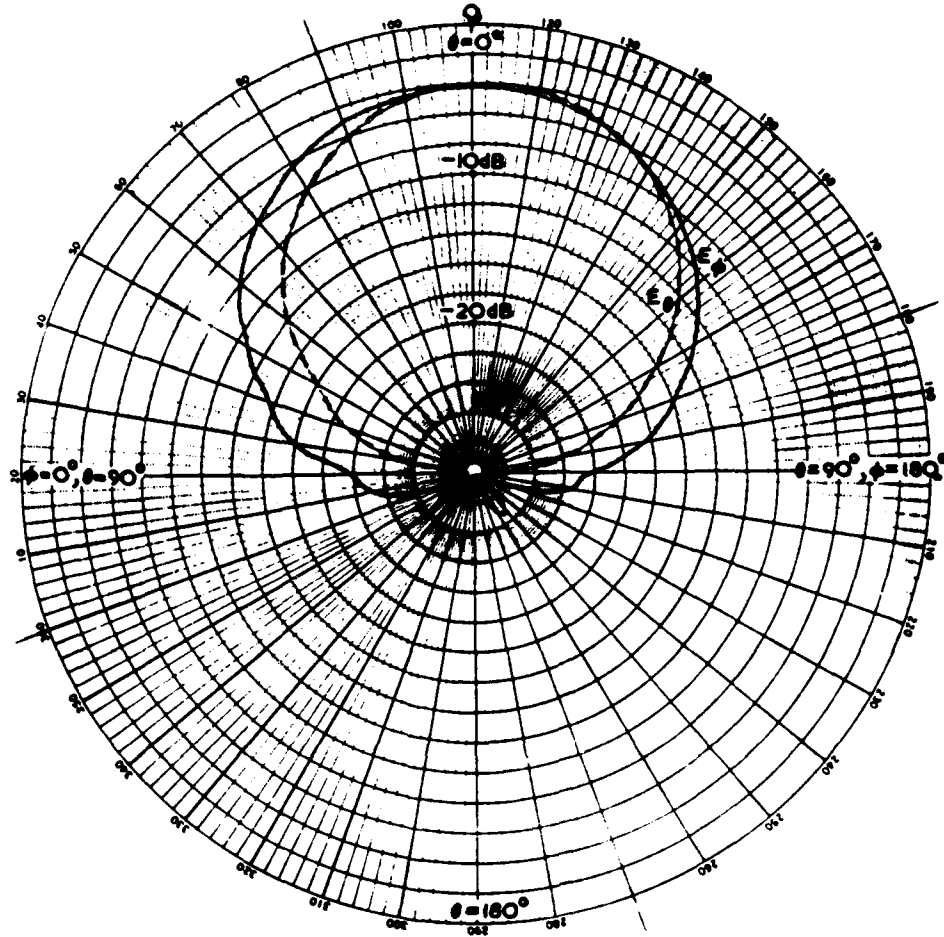

Fig.14c Spiral aerial radiation pattern-500MHz.,balun type "D",cavity diam.69cm.,cavity depth 16cm.

Fig.15a&b

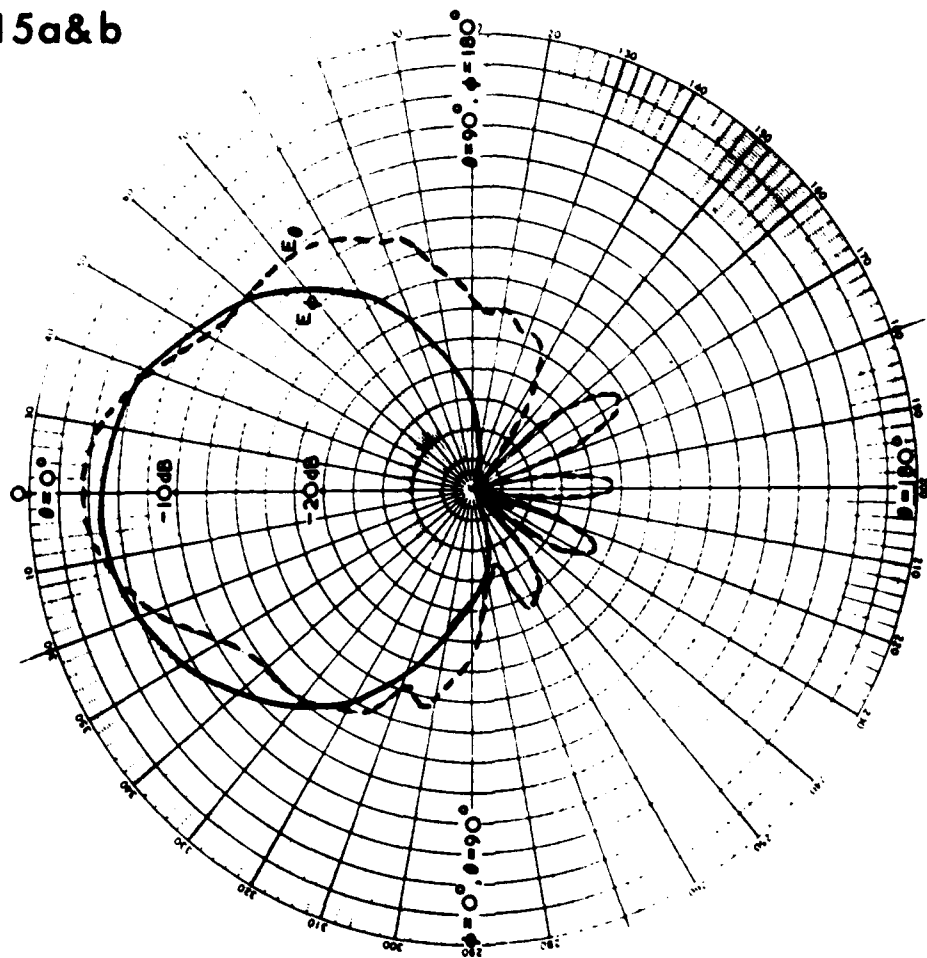

Fig.15b Spiral aerial radiation pattern-  
600MHz.,balun type "D",cavity  
diam.69cm.,cavity depth 16cm.

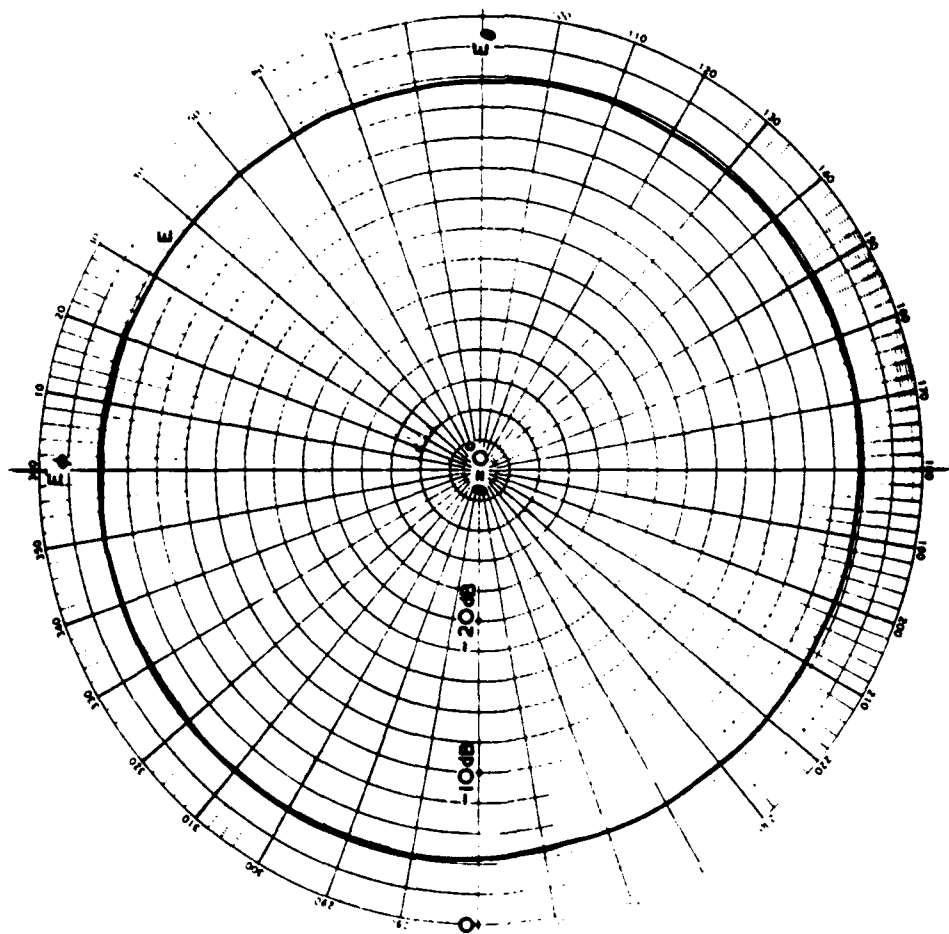

Fig.15a. Spiral aerial polarisation pattern-  
500MHz.,balun type "D",cavity  
diam.69cm.,cavity depth 16cm.

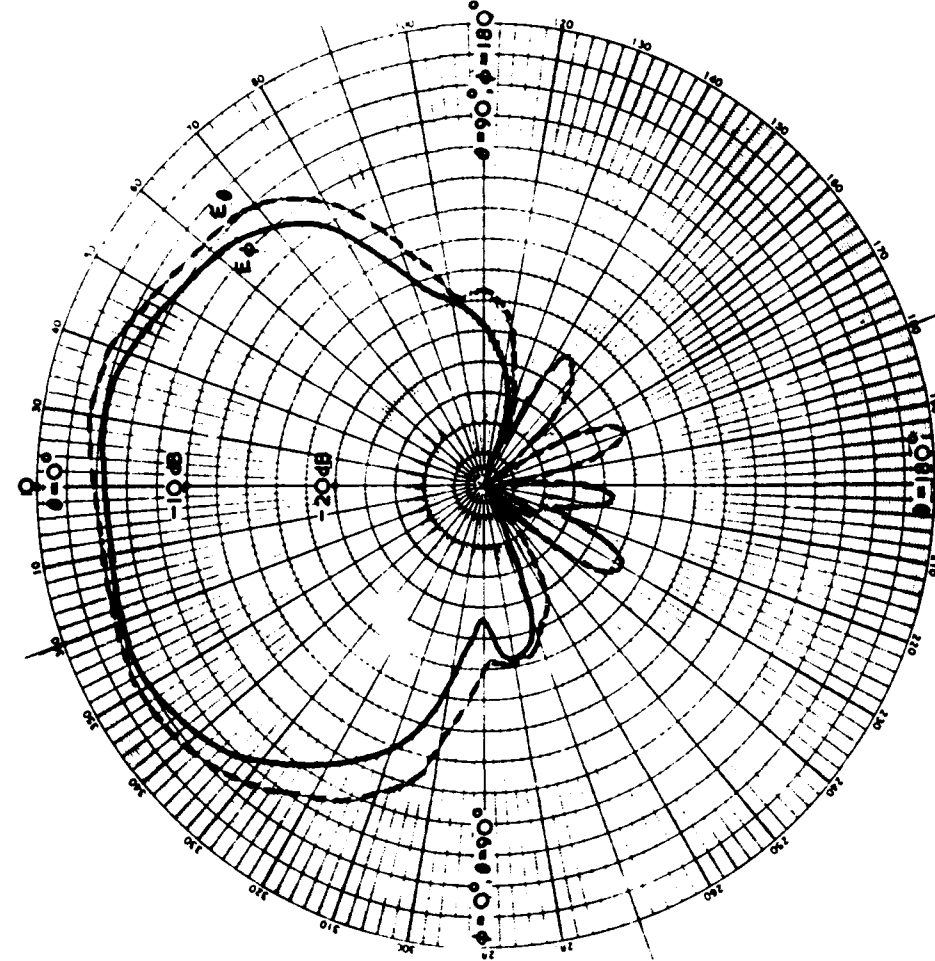

Fig.15c. Spiral aerial radiation pattern-  
700MHz.,balun type "D",cavity  
diam.69cm.,cavity depth 16cm

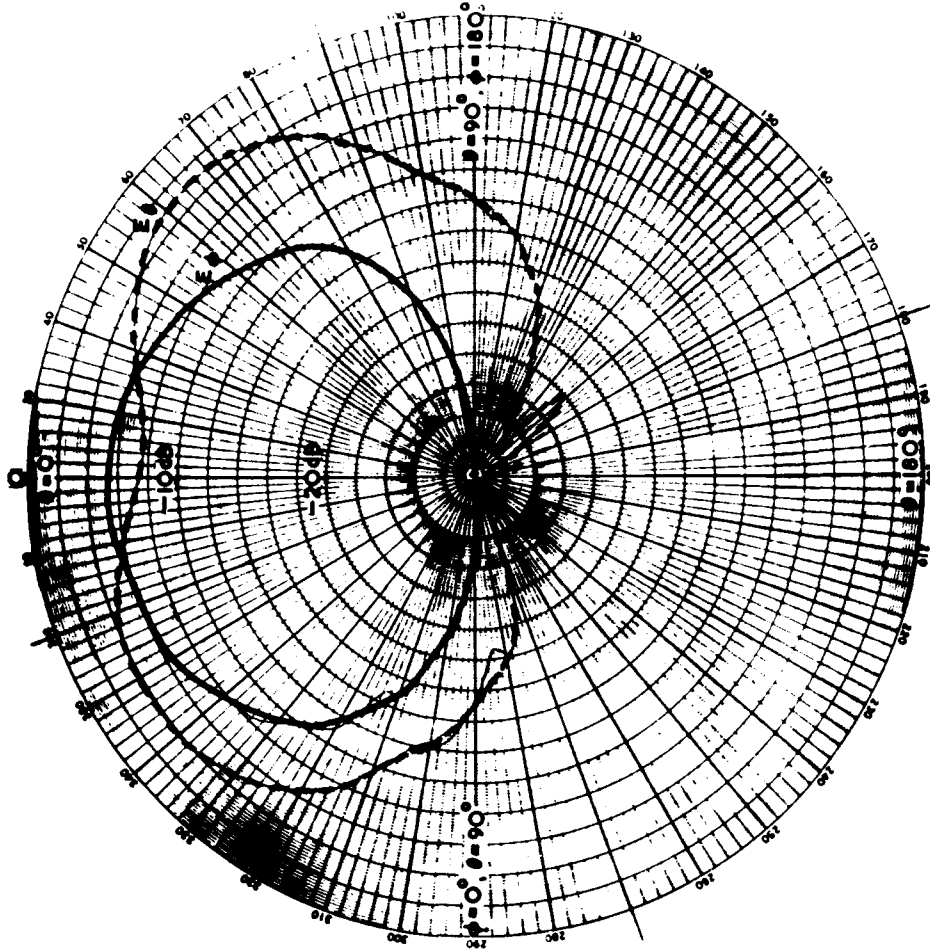

Fig.15d. Spiral aerial radiation pattern-  
800MHz.,balun type "D", cavity  
diam.69cm.,cavity depth 16cm

Fig.16a&b

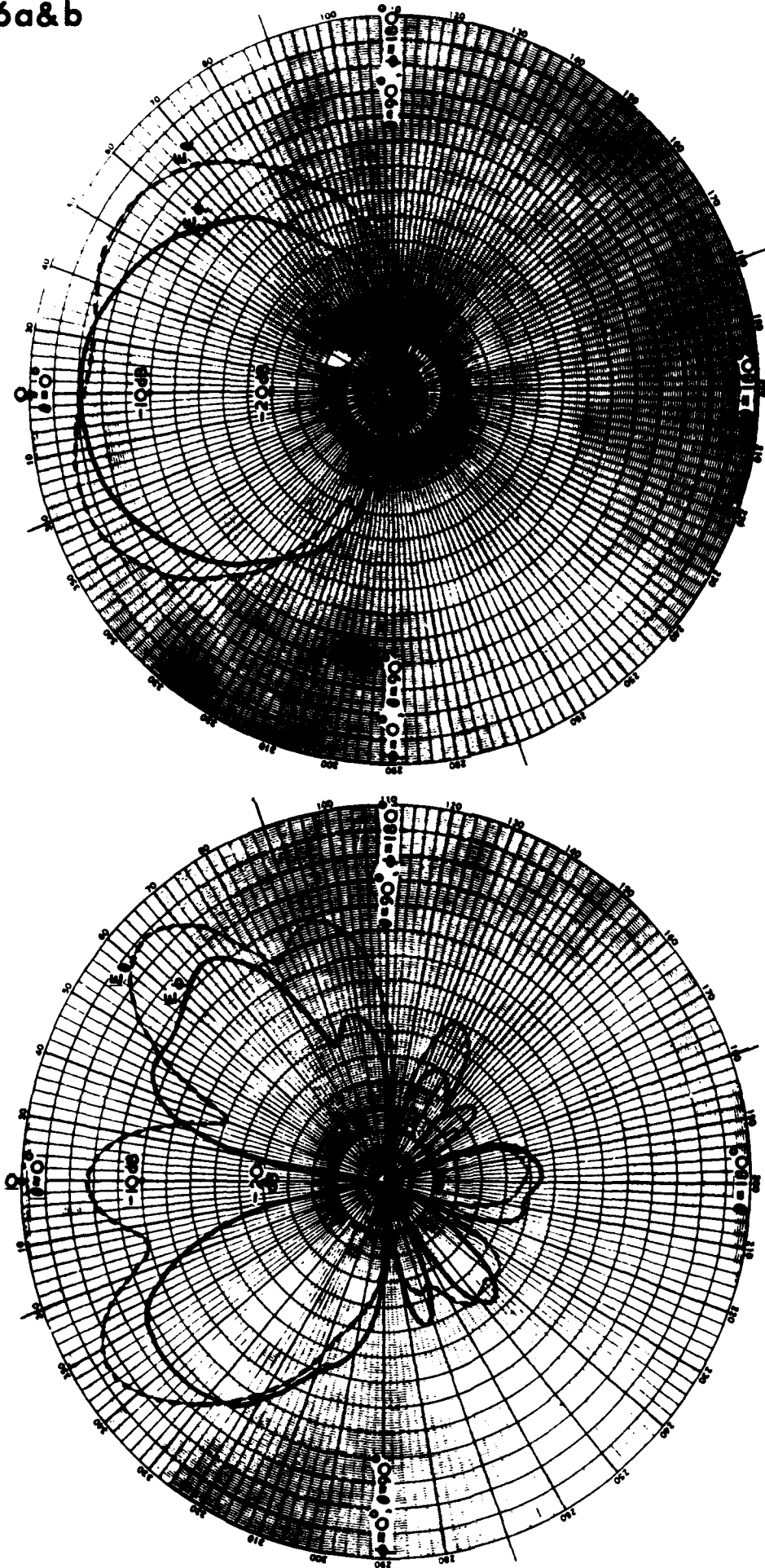

Fig.16a Spiral aerial radiation pattern-  
900MHz.,balun type "D",cavity  
diam.69.,cavity depth 16cm

Fig.16b Spiral aerial radiation pattern-  
900MHz.,balun type "D",cavity  
diam.69cm.,cavity depth 9.2cm.

Fig.16c

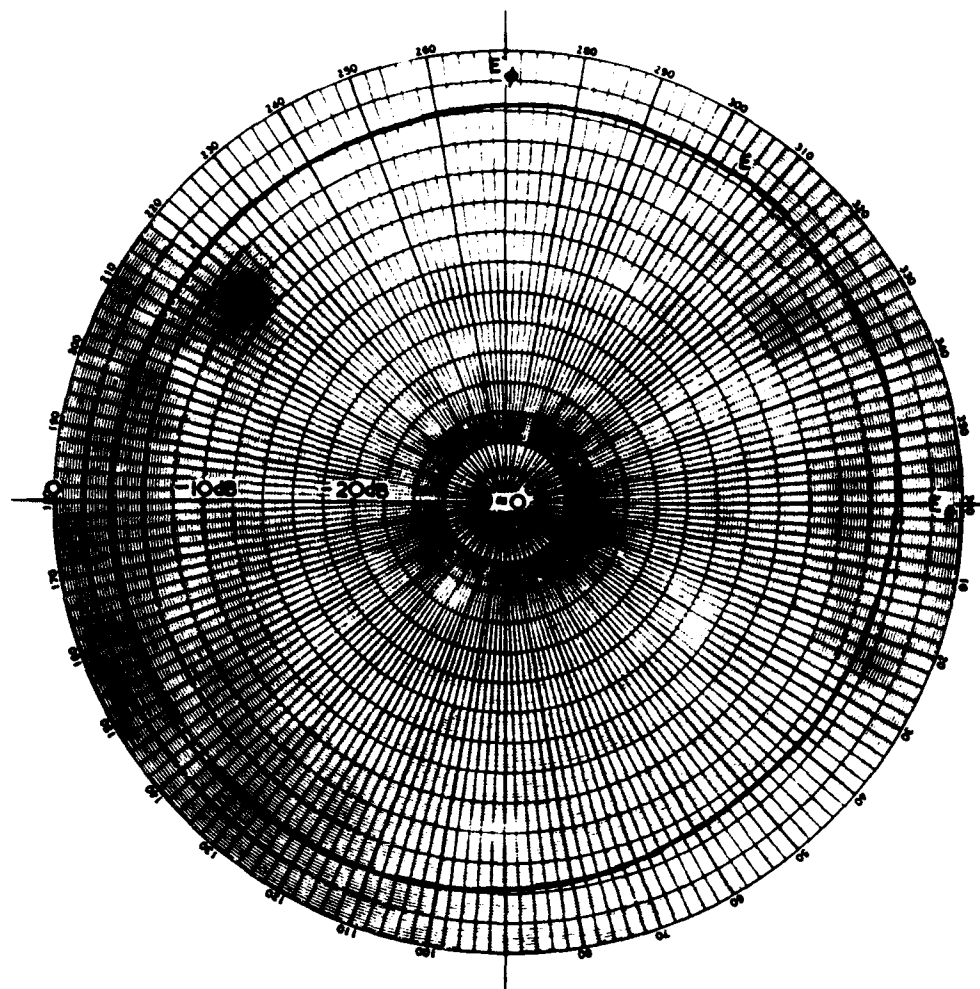

Fig.16c Spiral aerial polarisation pattern-900MHz.,balun type'D',cavity diam.69cm.,cavity depth 9.2cm.

Fig.17a&b

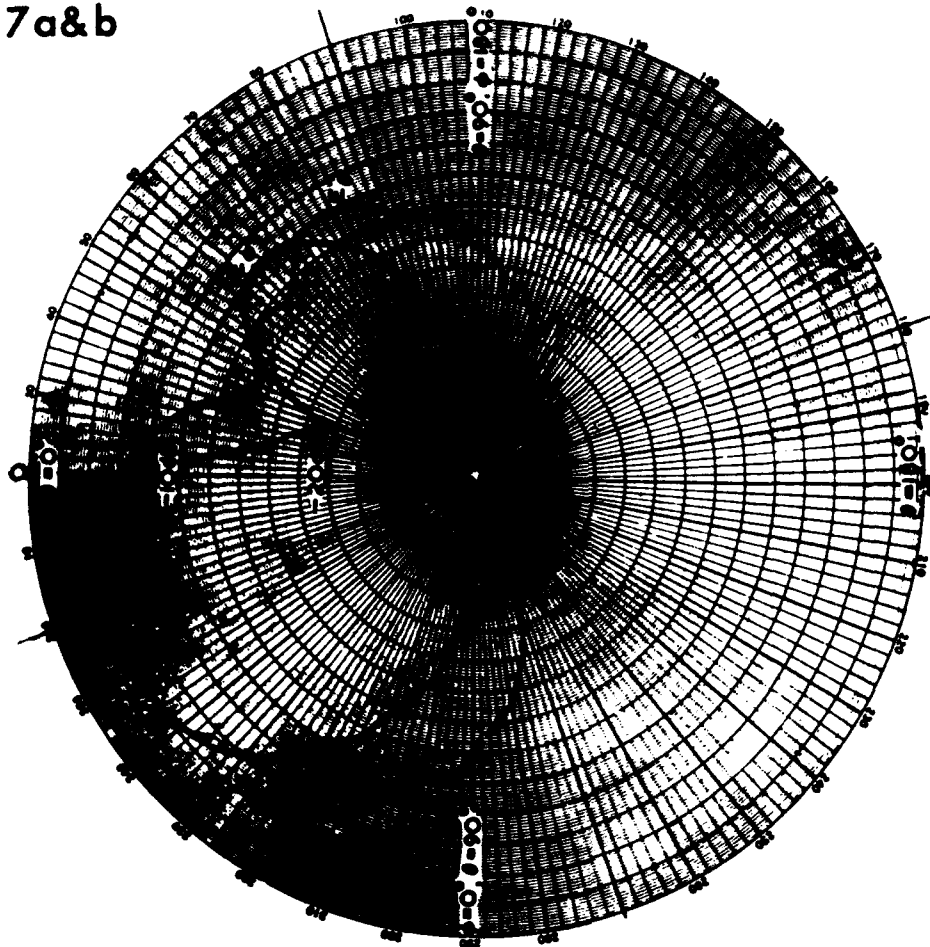

Fig.17b Spiral aerial radiation pattern-  
1100MHz.,balun type "D", cavity  
diam.69cm.,cavity depth 9.2cm.

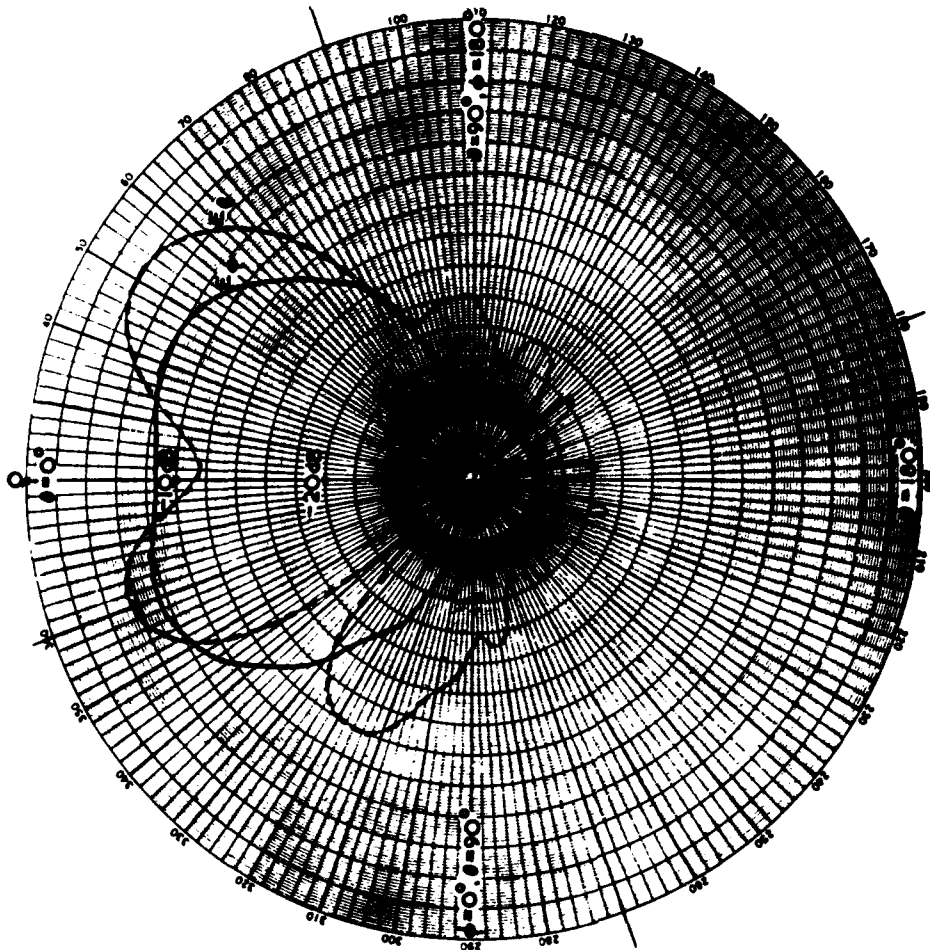

Fig.17a Spiral aerial radiation pattern-  
1000MHz.,balun type "D", cavity  
diam.69cm.,cavity depth 9.2cm.

Fig.18

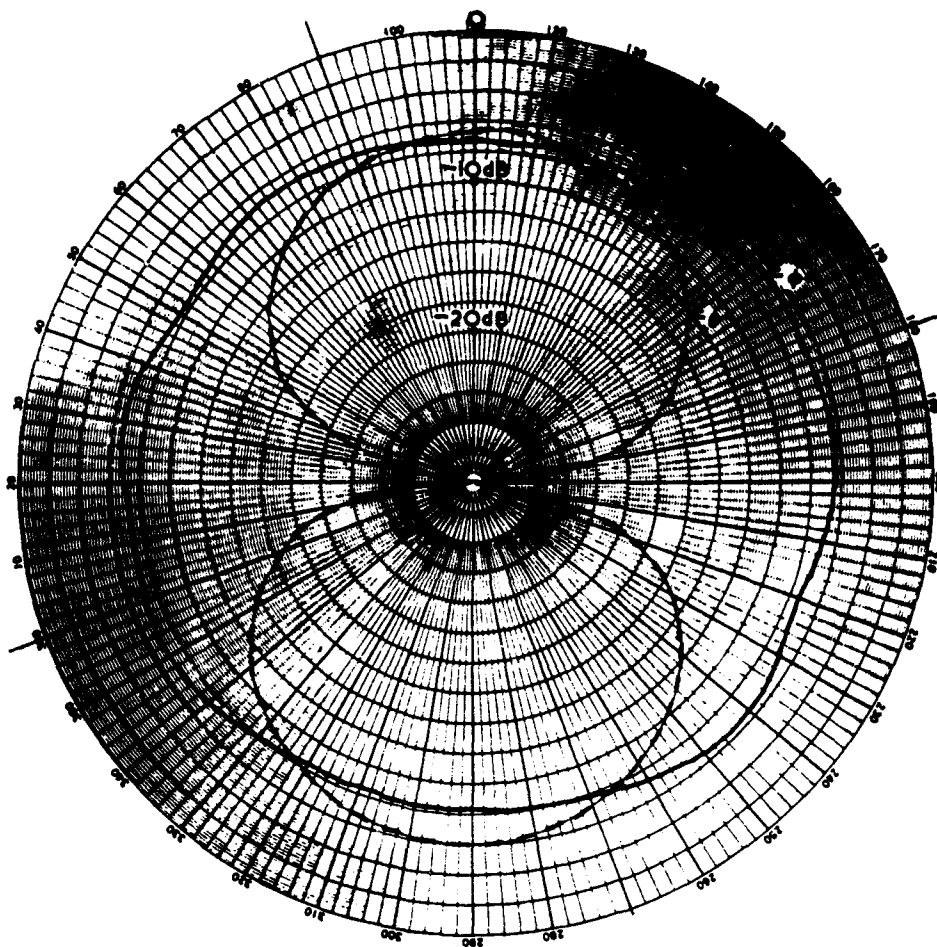

Fig.18. Half-wave dipole radiation pattern—500MHz.

Fig.19a&b

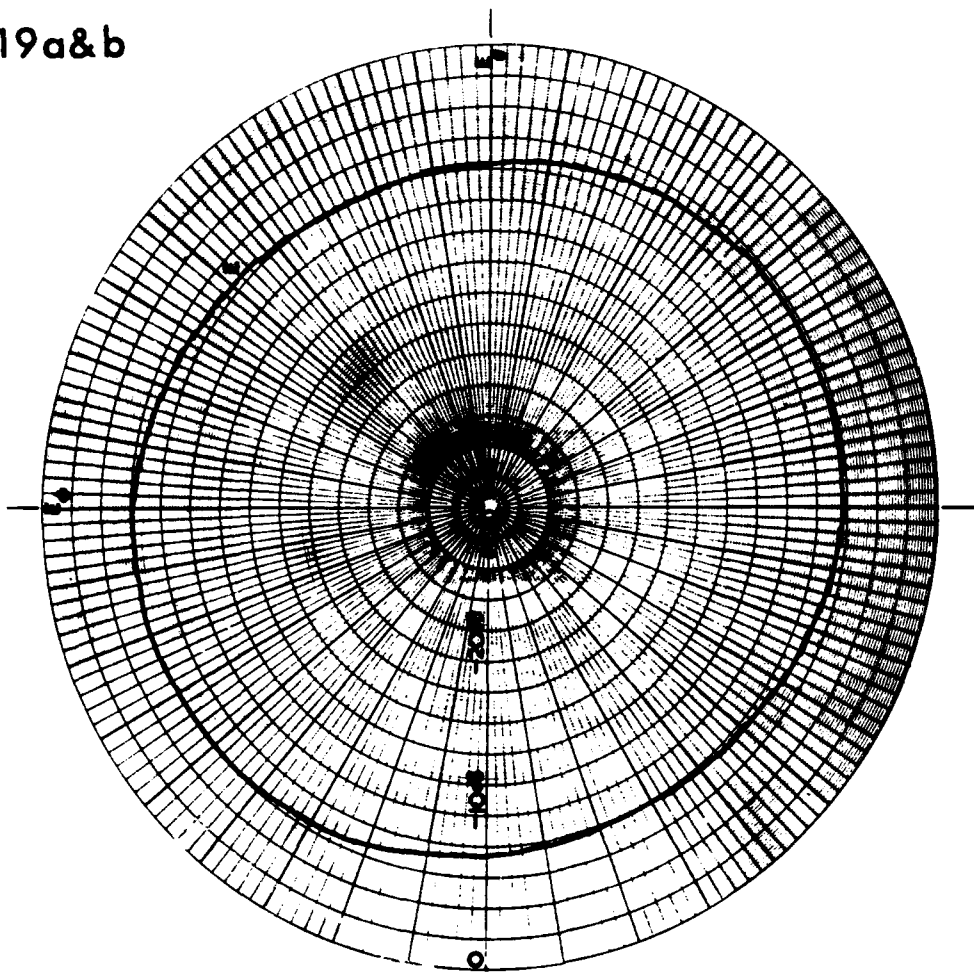

Fig.19b Spiral aerial polarisation pattern at  $\theta=20^\circ$ —500MHz., balun type "D", cavity diam 6.9cm., cavity depth 16cm.

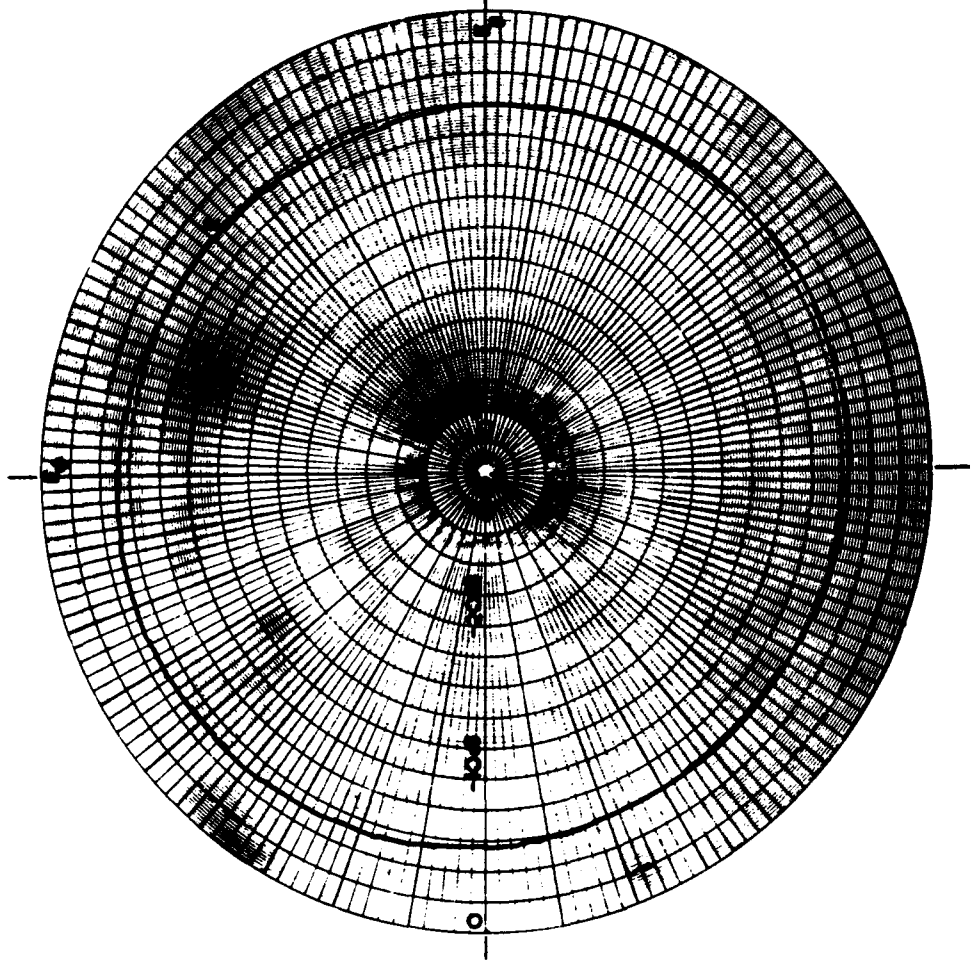

Fig.19a Spiral aerial polarisation pattern at  $\theta=10^\circ$ —500MHz., balun type "D", cavity diam.69cm., cavity depth 16cm .

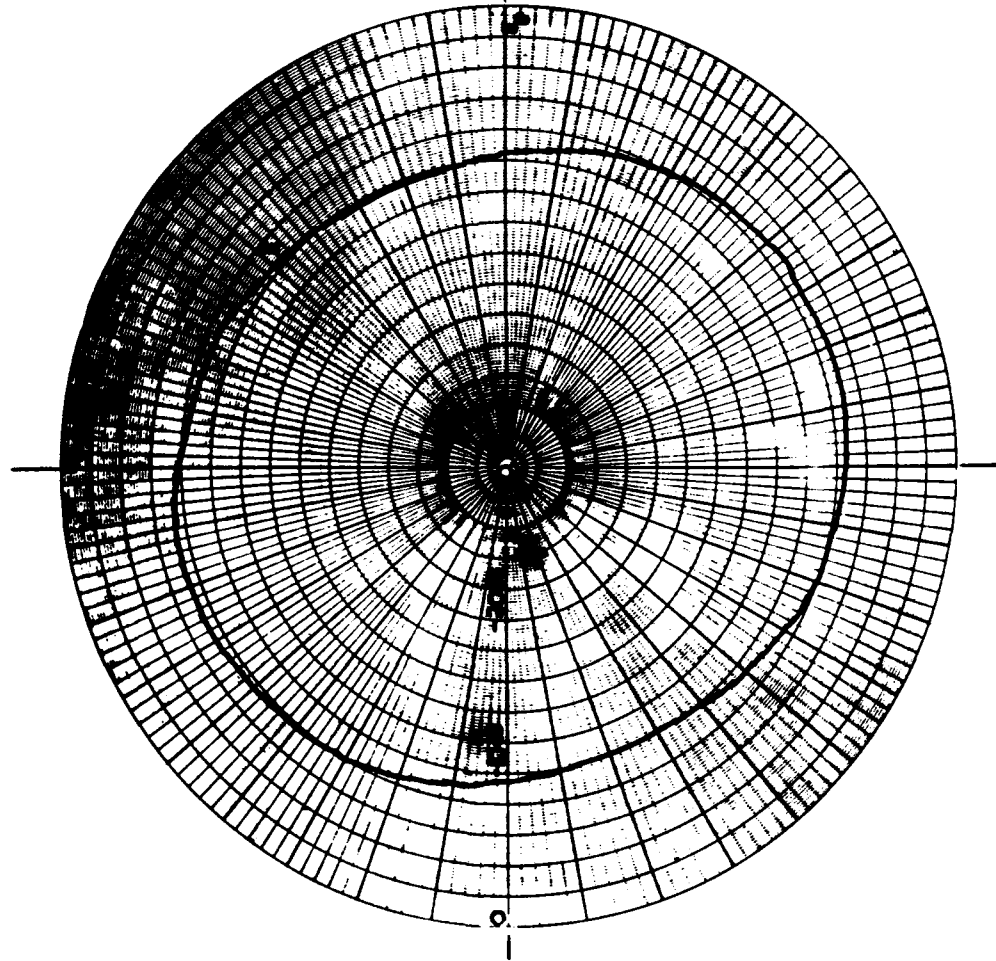

Fig.19c Spiral aerial polarisation pattern at  $\theta=30^\circ$ —500MHz.,balun type "D",cavity diam.69cm.,cavity depth 16cm.

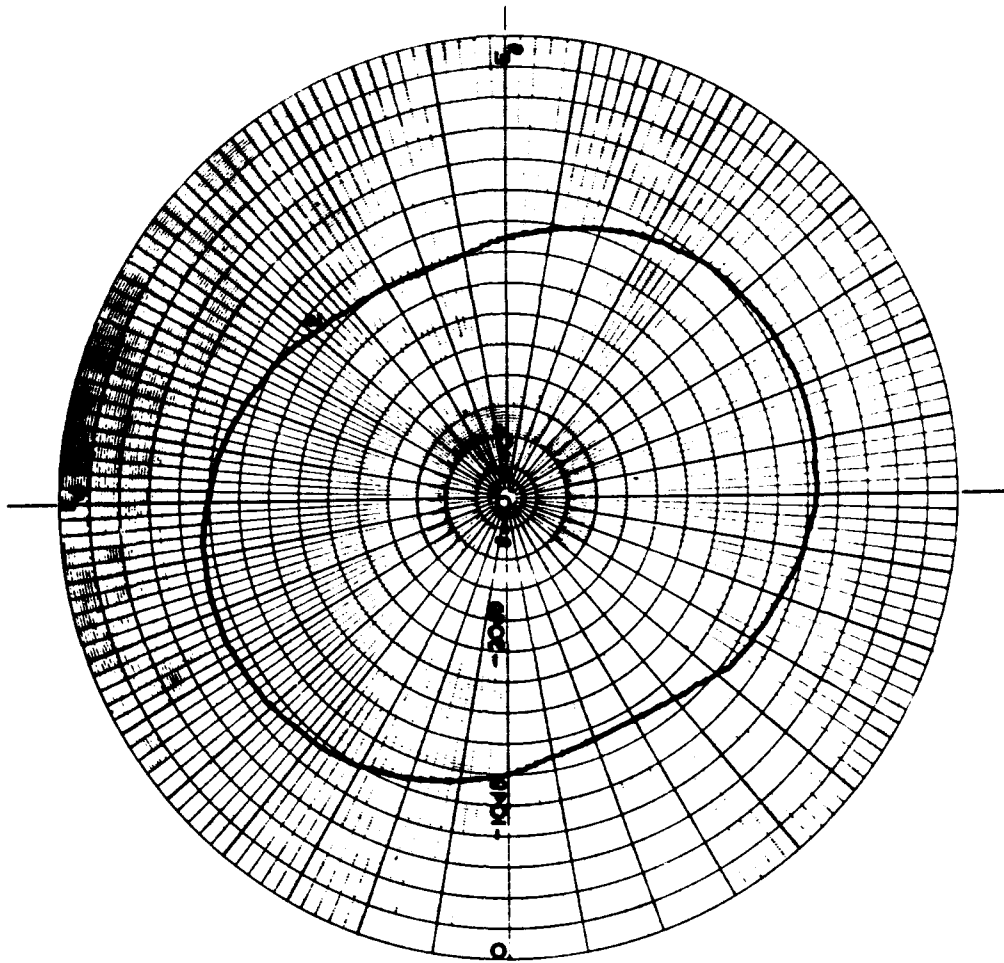

Fig.19d. Spiral aerial polarisation pattern at  $\theta=40^\circ$ —500MHz.,balun type "D",cavity diam.69cm.,cavity depth 16cm.

Fig.20a&b

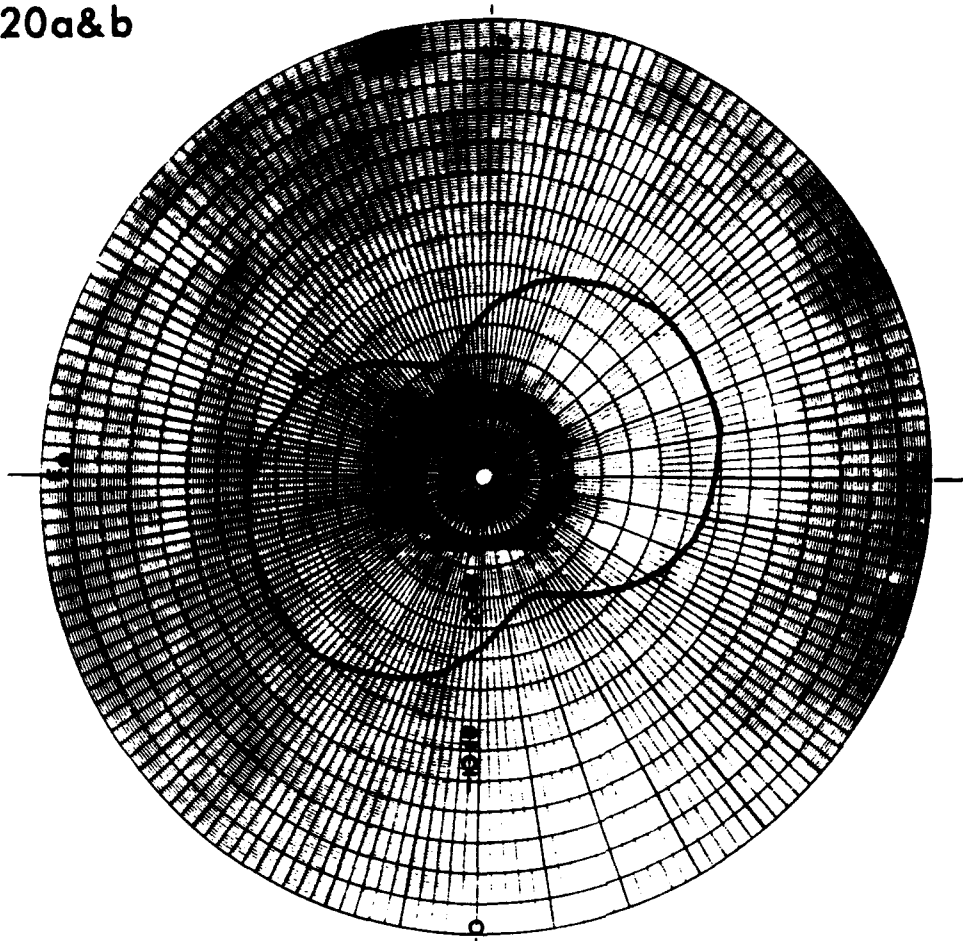

Fig.20b Spiral aerial polarisation pattern at  
 $\theta=60^\circ$ —500MHz.,balun type "D", cavity  
diam.69cm.,cavity depth 16cm.

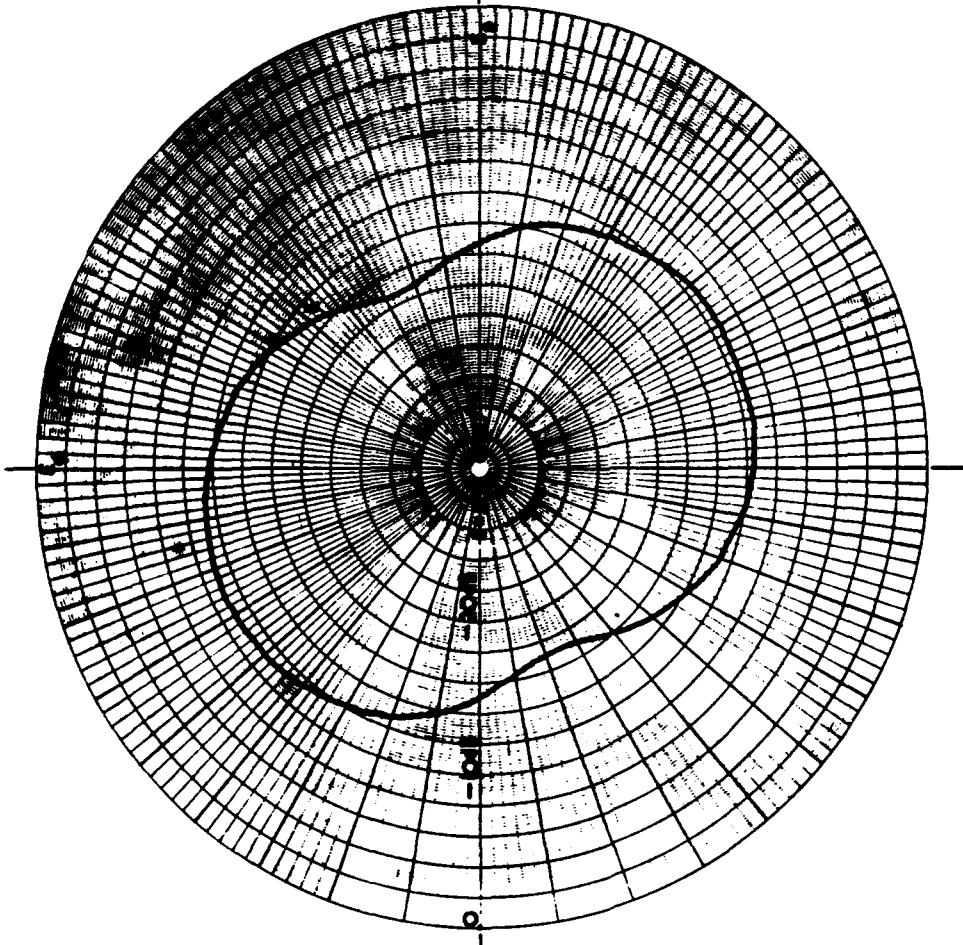

Fig.20a Spiral aerial polarisation pattern at  
 $\theta=50^\circ$ —500MHz.,balun type "D", cavity  
diam.69cm.,cavity depth 16cm.

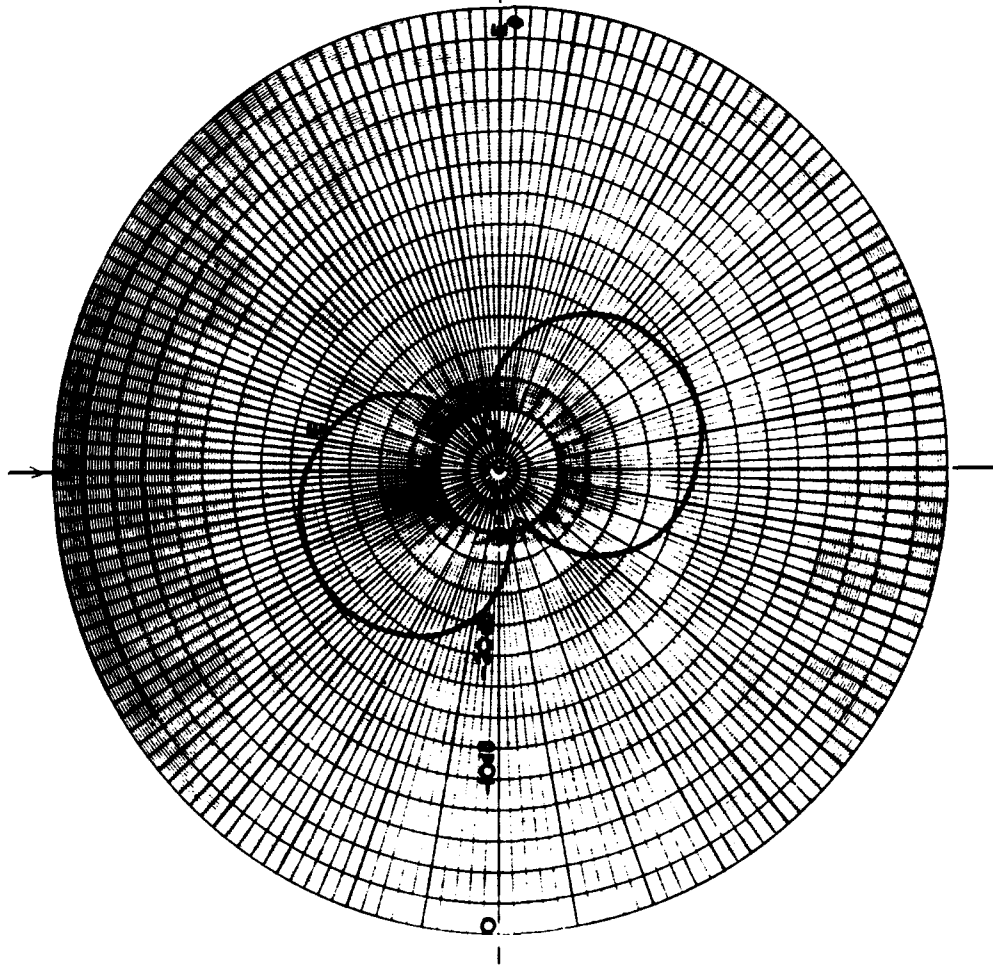

Fig.20c Spiral aerial polarisation pattern at  
 $\theta=70^\circ$ —500MHz.,balun type "D",cavity  
diam.69cm.,cavity depth 16cm

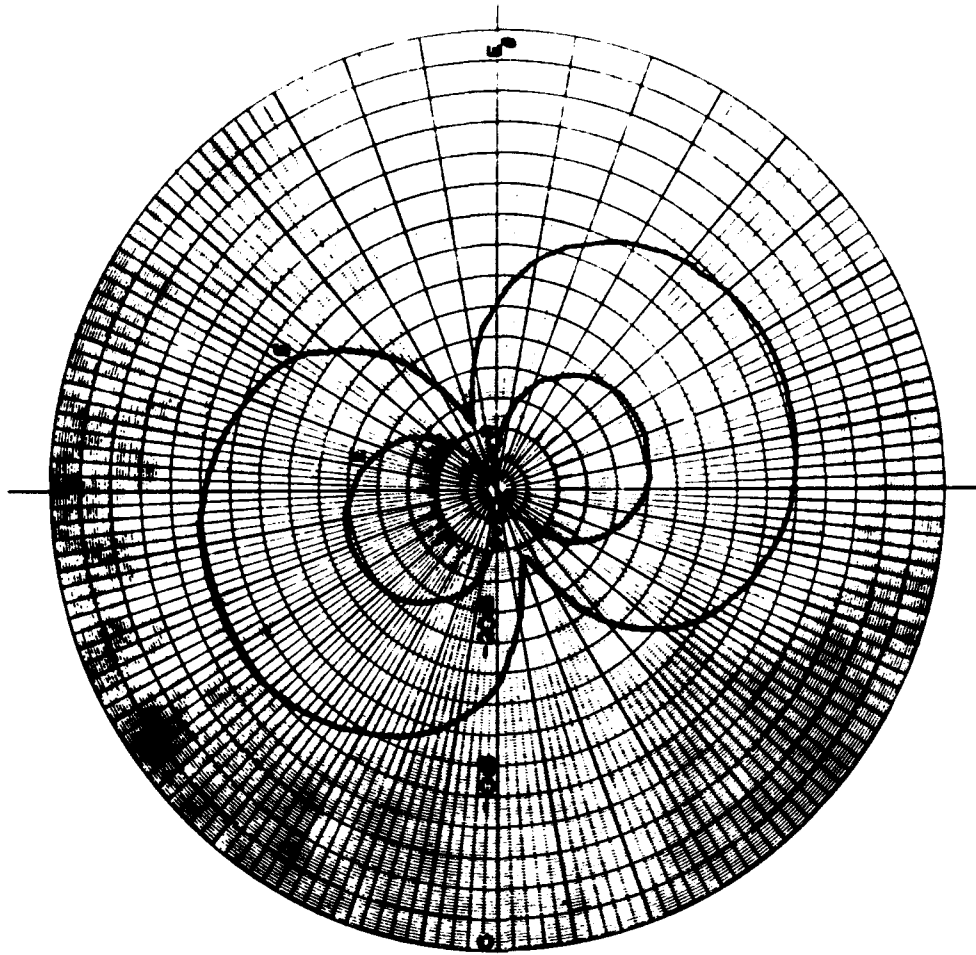

Fig.20d Spiral aerial polarisation pattern at  
 $\theta=80^\circ$ —500MHz.,balun type "D",cavity  
diam. 69cm.,cavity depth 16cm

**DETACHABLE ABSTRACT CARD**

May, D. P. L.  
Milne, G. F.  
Baker, F. O.

621.396.676 :  
621.3.049.75 :  
621.3.029.63

May, D. P. L.  
Milne, G. F.  
Baker, F. O.

621.396.676 :  
621.3.049.75 :  
621.3.029.63

THE DESIGN AND DEVELOPMENT OF AN AIRCRAFT MOUNTING PRINTED-CIRCUIT  
SPIRAL AERIAL COVERING THE RANGE 200-800 MHz

Royal Aircraft Establishment Technical Report 70062

The design and development of a right hand circularly polarized unidirectional aerial, covering 200-800 MHz in two octave-wide ranges is described. Measured characteristics are given. The beam-width and circularity are remarkably constant throughout the band; half power beam-width being about 82 degrees. Ellipticity is as low as 0.5 dB with a maximum of 3.0 dB at 800 MHz. The feed impedance is 50 ohms unbalanced and the gain is about 7 dB relative to a circular isotropic source. The complete aerial can be housed in a space of about 75 cm in circumference 40 cm deep and is particularly suitable for aircraft installations where projections beyond the hull are undesirable.

THE DESIGN AND DEVELOPMENT OF AN AIRCRAFT MOUNTING PRINTED-CIRCUIT  
SPIRAL AERIAL COVERING THE RANGE 200-800 MHz

Royal Aircraft Establishment Technical Report 70062

The design and development of a right hand circularly polarised unidirectional aerial, covering 200-800 MHz in two octave-wide ranges is described. Measured characteristics are given. The beam-width and circularity are remarkably constant throughout the band; half power beam-width being about 82 degrees. Ellipticity is as low as 0.5 dB with a maximum of 3.0 dB at 800 MHz. The feed impedance is 50 ohms unbalanced and the gain is about 7 dB relative to a circular isotropic source. The complete aerial can be housed in a space of about 75 cm in circumference 40 cm deep and is particularly suitable for aircraft installations where projections beyond the hull are undesirable.