

REPORT DOCUMENTATION PAGE

Form Approved
OMB No. 0704-0188

Public reporting burden for this collection of information is estimated to average 1 hour per response, including the time for reviewing instructions, searching existing data sources, gathering and maintaining the data needed, and completing and reviewing the collection of information. Send comments regarding this burden estimate or any other aspect of this collection of information, including suggestions for reducing this burden, to Washington Headquarters Services, Directorate for Information Operations and Reports, 1215 Jefferson Davis Highway, Suite 1204, Arlington, VA 22202-4302, and to the Office of Management and Budget, Paperwork Reduction Project (0704-0188), Washington, DC 20503.

1. AGENCY USE ONLY (Leave blank)		2. REPORT DATE December 1994		3. REPORT TYPE AND DATES COVERED Final	
4. TITLE AND SUBTITLE VLF CUTLER HOLLOW CORE CABLE REPAIR/REPLACEMENT				5. FUNDING NUMBERS PE: OMN WU: DN587543	
6. AUTHOR(S) P. M. Hansen				8. PERFORMING ORGANIZATION REPORT NUMBER TR 1681	
7. PERFORMING ORGANIZATION NAME(S) AND ADDRESS(ES) Naval Command, Control and Ocean Surveillance Center (NCCOSC) RDT&E Division San Diego, CA 92152-5001				10. SPONSORING/MONITORING AGENCY REPORT NUMBER	
9. SPONSORING/MONITORING AGENCY NAME(S) AND ADDRESS(ES) Space and Naval Warfare Systems Command Washington, DC 20363-5100				11. SUPPLEMENTARY NOTES	
12a. DISTRIBUTION/AVAILABILITY STATEMENT Approved for public release; distribution is unlimited.				12b. DISTRIBUTION CODE	
13. ABSTRACT (Maximum 200 words) The objective of this project was to find a solution to the hollow core cable breakage problem in the VLF Cutler topload. A field survey was conducted. Some candidate solutions were developed and costed out. Drawings and specifications were prepared for two of these options.					
14. SUBJECT TERMS hollow core cable corona considerations topload panels field surveys				15. NUMBER OF PAGES 75	
				16. PRICE CODE	
17. SECURITY CLASSIFICATION OF REPORT UNCLASSIFIED		18. SECURITY CLASSIFICATION OF THIS PAGE UNCLASSIFIED		19. SECURITY CLASSIFICATION OF ABSTRACT UNCLASSIFIED	
				20. LIMITATION OF ABSTRACT SAME AS REPORT	

Technical Report 1681
September 1994

VLF Cutler Hollow Core Cable Repair/Replacement

P. Hansen

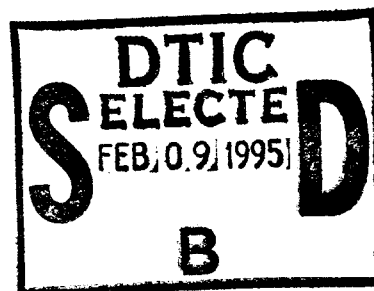

19950206 186



Technical Report 1681
September 1994

VLF Cutler Hollow Core Cable Repair/Replacement

P. Hansen

1994-09-14

NAVAL COMMAND, CONTROL AND
OCEAN SURVEILLANCE CENTER
RDT&E DIVISION
San Diego, California 92152-5001

K. E. EVANS, CAPT, USN
Commanding Officer

R. T. SHEARER
Executive Director

ADMINISTRATIVE INFORMATION

This project was carried out by personnel in the Systems Development Branch (Code 832) of the Naval Command, Control and Ocean Surveillance Center, RDT&E Division, at the request of the Commander, Naval Computer and Telecommunications Command (CNCTC). Drawings were prepared by the Atlantic Naval Facilities Engineering Command (LANTNAVFACENGCOM). Sponsorship was provided by the Space and Naval Warfare Systems Command.

Released by
P. A. Singer, Head
Systems Development Branch

Under authority of
D. M. Bauman, Head
Submarine Communications
Division

Approval For
DTIC GRA&I
Unannounced
Justification

By
Distribution
Availability Codes
Avail and/or
Special

Dist
A-1

PK

EXECUTIVE SUMMARY

OBJECTIVES

The objective of this project was to find a solution to the hollow core cable breakage problem in the VLF Cutler topload. A field survey was conducted. Some candidate solutions were developed and costed out. Drawings and specifications were prepared for two of these options.

RESULTS

The findings of the field survey were the following: (1) The 225-ft sections of hollow core have never been observed to break; only the 775-ft sections have broken. (2) Severe icing conditions often exist at Cutler during winter, and deicing is necessary for the topload conductors. The support catenary does not deice, and short sections of conductor cable could be attached to it that would not deice. (3) No spare Calsun bronze® or hollow core cable was on site. The spare cable on site is not suitable as a topload conductor because it does not have enough resistance to deice properly. (4) The panel hoist winches are already at maximum load, and increasing the total weight in the topload panels is not practical.

Maintaining the existing operational capability to operate at full power down to 14 kHz is desirable in order to provide contingency long-range coverage when using the planned split-array mode. One operational area that could be reached in this way is the Arabian Sea. Surface electric field calculations indicate that a 1.5-inch-diameter cable is necessary to eliminate corona formation at the lower frequencies. This eliminates the option of repairing the hollow core cable by replacing the end fittings and making up the lost length by extension of the 1-inch-diameter Calsun bronze.

CONCLUSIONS

Four options are presented that retain full existing operational capability, and replace or repair only the 775-ft hollow core sections. Option 2 is the recommended long-term solution with option 4 recommended for short-term, or emergency repairs if necessary. Options 1 and 3 are included as contingencies.

(1) Replace the 775-ft sections of hollow core with a specially made 1.47-inch-diameter cable having a stainless steel core and copper alloy exterior. This will add 7750 lbs to the outer portion of the topload and requires a commensurate reduction in insulator weight. The amount of weight reduction required cannot be achieved by removing insulators from the existing strings of Lapp insulators without reducing the withstand voltage below acceptable limits. Thus, this option requires replacing the Lapp insulators with new Racal-Decca safety core insulators. The cost of this option is \$2.2M for the new cables installed, with another \$0.75M for the new insulators.

(2) Cut and replace the end fittings on the hollow core, retaining a 250-ft section while replacing the remaining 550 ft with a specially made 1.3-inch-diameter cable having a stainless steel core and copper alloy exterior. The cost of the cable alone for this option is estimated to

be \$1.43M (\$0.75M less than option 1). This option adds less weight to the topload so compensating weight reduction can be accomplished by removal of a few Lapp insulators; thus, saving the cost of new insulators (an additional \$0.75M). The only drawback is the lack of experience in the manufacture of composite cables and some uncertainty as to the breaking strength of this cable. This is not a serious drawback as the breaking strength will likely be acceptable for the Cutler application.

(3) Cut and replace the end fittings on the hollow core sections, while retaining as much cable as possible. The total length cut out by this and the previous repair would be approximately 16 ft, which would be made up with 1.5-inch copperweld cable (nondeicing) located at the support catenary end. This solution is less expensive (estimated at \$500k) and extends the hollow core life about 10 years, at which time the same repair could be repeated by using a longer (25-ft) section of copperweld.

(4) Repair the existing hollow core by cutting and replacing the end fittings only on severely damaged sections. Replace the missing 16 ft of hollow core with 1.01-inch copperweld having a 1-inch copper jumper in parallel (nondeicing) as a 2-wire cage with cable separation of 4 inches, center to center. VLF Jim Creek has copperweld cable available and can produce the sections. The major cost is installation, which could be done by Cutler personnel.

Drawings have been prepared by LANTNAVFACENGCOM for options 3 and 4, which are included as appendix E. Originally, option 3 was to be the interim or emergency fix. However, option 4, which was developed after preparation of the option 3 drawings, is the simplest and least expensive and, therefore, became the recommended option for interim or emergency repairs.

RECOMMENDATIONS

(1) The above options range from a permanent, but expensive, 100% replacement program to an inexpensive interim repair for individual cables as needed. Since the extent of the problem cannot be known until the internal condition of the cables is determined, it is recommended that the Navy x-ray all 192 hollow core connections before deciding which option to pursue.

(2) Jim Creek personnel should prepare some 1.01-inch-diameter copperweld sections according to the drawings provided and ship them to Cutler to have available as an interim or emergency fix (option 4) should the x-ray program indicate that any hollow core cables have six or more broken wires. Also, procure the special clamps required to maintain the 4-inch center-to-center spacing between the copperweld cable and the 1-inch copper jumper.

(3) A firm price should be obtained from vendors for the recommended 1.3-inch-diameter cables, and plans and costs developed for the installation of option 2 as the permanent fix.

(4) No spare cable exists on site for either the 1-inch-diameter Calsun bronze or the 1.5-inch hollow core conductor cables used in the Cutler antenna topload. No vendor can supply either of these cables off-the-shelf. We did, however, find an off-the-shelf alumoweld cable, 1.01 inches in diameter, that could be used as a direct replacement for the Calsun bronze. If the alumoweld cable is installed as a partial replacement, and is in contact with copper alloy cables, suitable bimetallic fittings will be needed to reduce electrolytic corrosion.

CONTENTS

BACKGROUND	1
APPROACH	2
ANTENNA DESCRIPTION	2
DEICING	5
HOLLOW CORE BREAKAGE HISTORY	6
THE SPECIFIC PROBLEM	8
APPROACH	8
FINDINGS	8
CABLE DAMAGE	8
SPARE CABLE ON SITE	9
DEICING RECORDS	9
CORONA CONSIDERATIONS	10
MEASURED CORONA EXTINCTION GRADIENTS	13
SPECIAL CABLES	14
OFF-THE-SHELF CABLES	14
REPAIR/REPLACEMENT OPTIONS	16
OPTION 1	16
OPTION 2	17
OPTION 3	18
OPTION 4	18
CONCLUSIONS AND RECOMMENDATIONS	20
REFERENCES	21
APPENDICES	
A. A COMPUTER ANALYSIS OF THE USNRS CUTLER VLF ANTENNA	A-1
B. BASIS FOR CUTLER CONDUCTOR SELECTION	B-1
C. SHERBURNE METAL PRODUCTS, INC. QUOTE	C-1
D. CUTLER TOPLOAD, MULTIWIRED CAGE GRADIENTS	D-1
E. MODIFICATIONS TO VLF ANTENNA TOP PANELS	E-1

FIGURES

1. VLF Cutler 3
2. Cutler topload panel 4
3. Cutler VLF tophat (14.0 kHz) 11
4. Cutler VLF tophat (17.8 kHz) 11
5. Cutler VLF tophat (24.0 kHz) 12
6. Cutler topload, maximum gradients single array, 1.5-inch and 1-inch cables 12
7. Corona extinction gradient versus diameter (uncorrected for air dens) 13
8. Cutler VLF tophat 17
9. Cutler topload estimated cage gradient 1.01-inch-diameter wires near the catenary ... 19

TABLES

1. Alloy and strand makeup for Cutler panels 14
2. Cutler hollow core replacement options 15

BACKGROUND

The U.S. Navy operates several very low frequency (VLF) and low frequency (LF) transmitting sites around the world as a part of the submarine broadcast system (SBS). The Navy has used LF radio broadcasts for ship-to-shore communications since the turn of the century. The Navy's VLF/LF shore transmitting sites have been constructed, modified, and upgraded at various times over the course of this history. The antennas at each site are unique in that they are of different types, constructed at different times, operate at different frequencies, have different radiated power capabilities, have different bandwidths, etc.

The Cutler VLF transmitter, located in Washington County, ME, became operational on 4 January 1961. The Cutler antenna consists of two arrays, each having six diamond-shaped topload panels made up of cables hoisted by halyards that are attached to 13 towers. Each panel has eight active cables, called conductors, that carry the radio frequency (RF) current. One support catenary cable crosses the eight conductors in the center of the diamond. The RF conductors in these topload panels are specially designed with low enough resistance to have acceptable losses for VLF radiation, but enough resistance to enable deicing with 60-Hz current during winter months. Most of the cables consist of a 1-inch-diameter strand of a special alloy called Calsun bronze. However, in order to provide corona-free operation at the high-radiated power levels, some sections of the conductors are 1.5 inches in diameter. The 1.5-inch diameter conductors were specially made with hollow center conductors covered by Everdure® alloy exterior wires in order to meet the size, strength, resistance, and weight requirements for use in the antenna. These cables, known as hollow core cables, make up part of the outer two cables on each panel. The hollow core sections on the cables inside of the catenary are 225 ft long, while those on the outside of the catenary are 775 ft long.

During 1972, a fractured cable wire was found on the exterior of one hollow core cable near one of the terminals. More detailed inspections of the cables were done in 1972, '73, '74, and '75. Damage to the hollow core cables was found in 22 locations on the 775-ft cables. The entire antenna system consists of 192 hollow core cable terminals. Half of these are on the ends of the long hollow core cables and half on the ends of the short hollow core cables.

A major effort was carried out over several months by the Naval Civil Engineering Laboratory (NCEL) to determine the cause of the fractured cables and recommend a fix. This effort included radiographic (x-ray) inspection of the cables, and installation of an accelerometer on a cable at Cutler. The radiographic inspection revealed internal damage in the form of broken wires that could not be observed externally. NCEL recommended immediate repair or replacement for cables with six or more broken wires. In order to determine internal damage, an x-ray program was undertaken each summer for several years. Conversations with the NCEL personnel involved indicated that the damage was caused by large wind-driven vibrations that occur under rare special circumstances. All of the failures occurred within a few inches of the terminal fittings on the longer hollow core cables. No breaks have occurred in the 1-inch cables that attach to the hollow core.

Because no direct replacement for the hollow core cable was available during the NCEL effort, the recommendation was to repair the hollow core by cutting off the damaged portions

and installing new swage-type end fittings. These fittings are large crimp-on connectors or terminals. The length of cable removed by the cutting was to be replaced by inserting a piece of hollow copper pipe at each end. The 1-inch-diameter copper-cable electrical jumper across the mechanical junction was to be clamped to the hollow core cable in the usual way. In addition, the jumper would be clamped to the terminal fitting with a special clamp to add support to the hollow core cable in the area near the terminal end. This repair was subsequently implemented. Replacement of all 96 terminals on the 775-ft pieces of hollow core were completed from 1978 to 1989.

Recently (summer 1992), a few years after completion of these repairs, exterior cable damage was visually observed at two locations near the new terminals on two of the 775-ft hollow core cables. This was the same type of symptom that eventually led to the 100% repair project. Because of this, the Commander, Naval Computer and Telecommunications Command (CNCTC) decided to replace all the hollow core cable, if possible, and tasked NRaD to specify a suitable replacement cable. Specifically, it was to be determined if the hollow core could be partially or completely replaced by the spare 1-inch-diameter Calsun bronze cable thought to be available on site. We were also asked to investigate the possibility of using off-the-shelf non-deicing cables.

To date, the visual inspections of the cable that have been accomplished show minor exterior damage in only two locations. This, by itself, does not dictate the necessity for a replacement project. However, due to the hollow core construction, internal breaks can exist with no external evidence. The overall cable condition, including internal wires, can not be determined visually. An x-ray program is needed to determine the present extent of damage. This information can be used to estimate the breakage rate and remaining cable life.

APPROACH

Field surveys were performed at the Cutler transmitter to examine the damaged cables, spare cable, deicing process, and to interview the personnel involved. Reference documents were obtained that described the previous NCEL effort. Surface electric fields on the topload wires as a function of position and frequency were determined by computer calculation. Corona voltage limitations on wires of similar diameter were measured at the Forestport High Voltage Test Facility. Various manufacturers were contacted, but no off-the-shelf cable having suitable diameter, strength, weight, and resistance was found. Kershner, Wright and Hagaman P. C. (KW&H) was contracted to locate a replacement cable and, subsequently, designed several special cables of various diameters that could be used in place of the hollow core. However, these cables are all heavier than the existing cable and very expensive. One manufacturer was found that could produce these cables (Sherburne Metal Products, Inc.) and a quote was obtained.

ANTENNA DESCRIPTION

The U.S. Navy VLF transmitting station at Cutler, ME is the "flagship" of the Navy's fixed very low frequency (FVLF) transmitting sites and has been operational since 4 January 1961. The station is located in Washington County, ME on a peninsula near the small town of Cutler.

This site normally operates with a radiated power level of 1-million watts termed “full power,” and at times as high as 1.8-million watts radiated, termed “maximum power.” In order to radiate power levels of this magnitude in the VLF band, an enormous antenna system is required. The Cutler VLF antenna consists of two separate arrays (north and south), each consisting of 13 towers. Every array has a center or zero tower called NO (for the north array) and SO (for the south array), which are 997.5 ft tall. Each array has six middle towers 875.0 ft tall, which are located with equal spacing on a circle of radius 1825 ft centered on the zero tower. Each array also has six outer towers 799.0 ft tall, also equally spaced on a circle of radius 3070 ft centered on the zero tower. A plan view of this antenna is given in figure 1. Every array is over 1 mile across and, together, they cover almost the entire peninsula. This antenna system is one of the largest in the world.

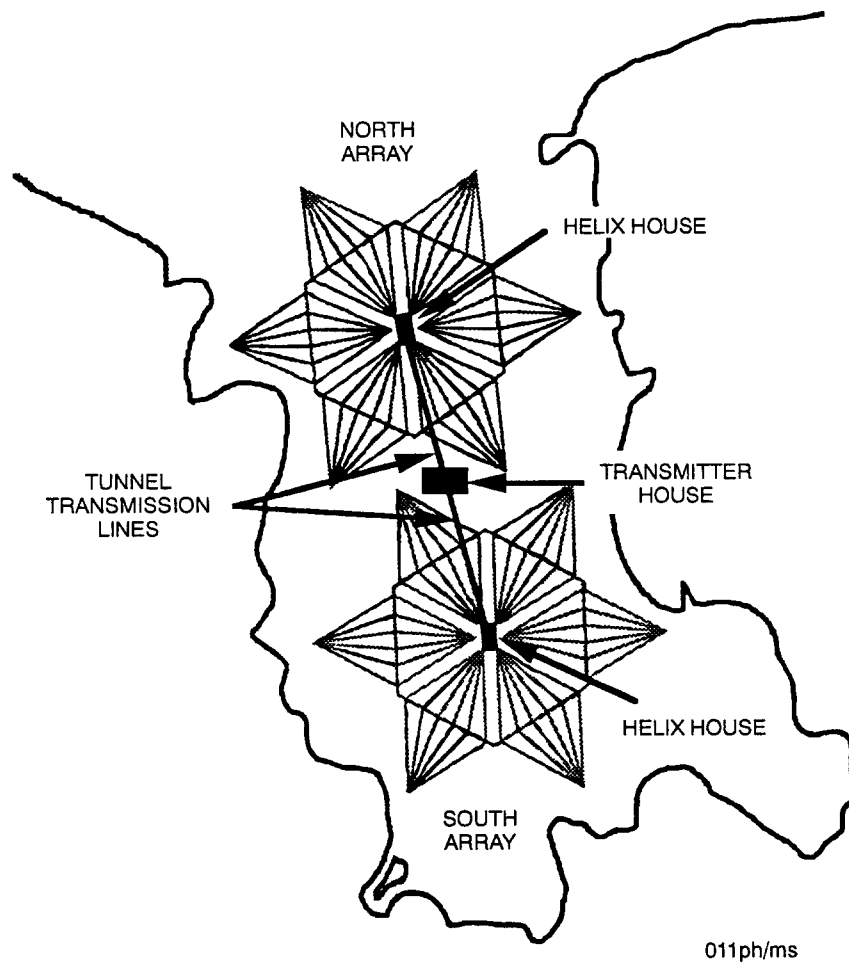

Figure 1. VLF Cutler.

Each array consists of six diamond-shaped panels made up of cables supported from the towers by insulated halyards leading to permanent winches located at the bottom of each tower. A top view of one panel is given in figure 2. Each panel has eight active cables called conductors that carry the RF current. One support catenary cable crosses the eight conductors in the center of the diamond. The RF cables in these topload panels are specially designed to have low enough

resistance to have acceptable loss for VLF radiation, but enough resistance to enable deicing by running 60-Hz current through them when needed during the winter.

Most of the conductor cables consist of 1-inch-diameter wire made from a special alloy called Calsun bronze. However, in order to provide corona-free operation at the high-power levels, some sections of the cables are 1.5 inches in diameter. These cables, specially made with hollow center conductors covered by exterior wires, were made of Everdure alloy in order to meet the size, strength, resistance, and weight requirements. The cables, known as hollow core cables, make up part of the outer two cables on each panel. The hollow core sections on the cables inside of the catenary are 225 ft long, while those on the outside of the catenary are 775 ft long.

The halyards are insulated from the panels by a string of 16 Lapp compression cone fail-safe insulators with large grading rings on each end (figure 2). Each individual fail-safe insulator weighs 750 lbs and the complete insulator string, plus hardware, weighs more than 6 tons. One insulator string is on each panel corner, and the total weight of insulators on each panel exceeds 24 tons.

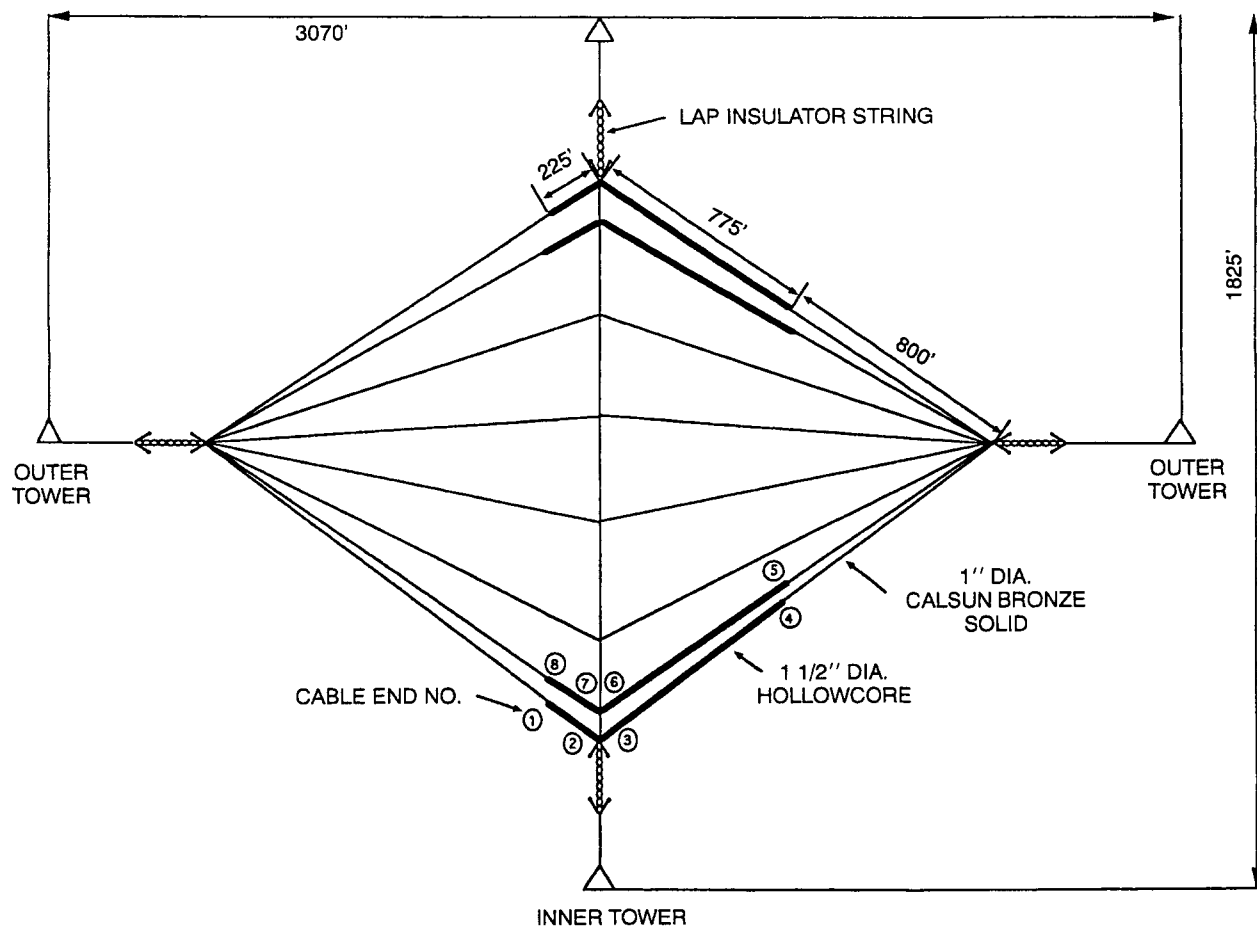

Figure 2. Cutler topload panel.

DEICING

The weather conditions along the coast of Maine are such that severe icing occurs during the winter months. The original requirement for the VLF Cutler transmitter called for continuous operation in all weather conditions. In order to survive severe icing, the antenna halyards are lead through a counterweight system so that as the ice buildup increases the panel weight, the counterweights let the halyards out, lowering the panel. The counterweight system is designed to allow the panels to lower all the way to the ground, if necessary. During installation, this actually happened. As the ice melts, the counterweights hoist the panels back to their original position; thus, the arrays will survive no matter how large the amount of ice buildup.

However, as the ice builds up and the panel lowers, the antenna capacitance increases and the antenna must be retuned. The tuning range is limited and the limit eventually reached whereby the antenna can no longer be tuned and transmission ceases. The solution to this problem is to deice the antenna system by heating the wires with 60-Hz current. Constructing a deicing system that would allow simultaneous transmission and deicing would have been prohibitively expensive. Instead, two arrays have been built that allow transmission on one array while the other is deicing. This approach allows ice to build up on the transmitting array while the other array is deicing. When the one array is sufficiently deiced, the roles are reversed. This continues as long as necessary. Obviously, for this approach to allow continuous transmission, the deicing system must completely remove ice from one array in, at most, the amount of time it takes to reach the tuning limit on the other array. The design value for heating chosen to accomplish this was 1.64 Watts per square inch of surface area, which corresponds to approximately 500 kW per panel or 3 MW for the entire array. The Cutler deicing system has the capability of operating at up to four times this much heating. Note that deicing power significantly exceeds transmit power.

The topload panels are fed by a four-wire cage made up of 1-inch copper cables. For transmitting, eight topload panel cables are all fed in parallel, one pair fed by each of the cage wires. For deicing, the topload cable pairs are fed in series with 60-Hz current. To provide the correct amount of heating with reasonable 60-Hz current, the topload cables need to have an appropriate resistance. For a given current, the heating in watts per square inch should be essentially the same for all cables. The deicing system is configured such that each 1-inch-diameter copper cable in the feed cage carries the full deicing current. This current is divided between two of the 1-inch-diameter topload conductors. Since heating is proportional to current squared, these topload cables must have about four times the resistance of the feed cage cables to provide the same heating. This was accomplished by making the 1-inch topload cables out of Calsun bronze, which has a conductivity equal to 19% of copper.

The heating in the 1.5-inch-diameter portion of the cables must be 50% greater than in the 1-inch diameter cable because the surface area is proportional to the diameter. Consequentially, the larger diameter sections must have more resistance, which is contrary to the normal variation of resistance with diameter. This was accomplished by making a composite cable known as hollow core by using hollow copper tubes in the inner portion and wires of a copper alloy called Everdure, which has a conductivity equal to 7.75% of copper, for the outer portion. Mechanical connections of the topload conductor cables are made using swage-type end fittings combined

with clevis shackles. Electrical connection is insured by crossing the mechanical connections with a 1-inch-diameter copper jumper cable clamped to the cables on both sides.

HOLLOW CORE BREAKAGE HISTORY

VLF Cutler became operational in 1961. The panels are lowered for inspection each summer during a maintenance period. During 1972, a fractured cable strand was found in the 1.5-inch hollow core cable near the tip of one of the cable terminals. More detailed inspections of this area were done in 1972, '73, '74, and '75. Similar damage to the hollow core cables was found in 22 locations. There are 192 hollow core cable terminals in the entire antenna system. Half of these are on the longer 775-ft sections and half are on the shorter 225-ft sections. The damage was only observed on the longer cable sections. A major effort was carried out by NCEL to determine the cause and to recommend a fix for this problem. This effort included radiographic (x-ray) inspection of the cables, and installation of an accelerometer on a cable for observation of the vibrations that remained in place for several months (Lew & Takahashi, 1976; Gaberson & Takahashi, 1975).

The results of the NCEL analysis indicated that the failures were caused by wind-driven vibrations of the cable and jumper, which flexed the hollow core cable at the location where it entered the end fitting. Conversations with Mr. Tingley Lew and Dr. Howard Gaberson of NCEL indicated that the vibration problem was caused by large aeolian vibrations (vortex shedding and galloping). Dr. Gaberson indicated that these large amplitude vibrations are rare and occur only when the wind conditions are just right. All of the failures observed to date have occurred in the 750-ft hollow core cables because they are longer and subject to more wind vibration. The report also indicated that a large share of the failures were in panels approximately orthogonal to the prevailing north wind direction. All of the failures occurred about 2.5 inches from the end of the swage terminals. These swage terminals are large crimp type connectors that cover approximately 2 ft of the cable at the end. The swage fitting provides a stiff connection to the cable; thus, any cable motion flexes the cable most at the point where it exits the swage. The major share of the breaks were in the outer layer of hollow tubes, located just under the outer layer of solid strands. No breaks were observed in the 1-inch Calsun bronze hollow core or in the shorter 225-ft sections of hollow core.

Dampers were not recommended as part of the solution for two reasons. First, it was felt that the clamp on the vibration dampers available at that time could lead to localized stress in the vicinity of the clamp and result in more failures. Secondly, the analytic results prepared by NCEL indicated that the many modes with differing frequency could cause the damage. Which modes were causing the damage could not be determined. Therefore, their frequencies could not be specified. Since the available dampers absorb energy in a limited frequency range, it was not possible to select the appropriate dampers.

It was recommended that the hollow core cable ends be radiographed yearly, and that any cable with six or more broken wires, which corresponds to a 10% reduction in breaking strength, should be repaired immediately. The recommended repair procedure is described in detail in Lew & Takahashi (1976).

As there was no replacement hollow core cable available at that time, the recommended repair was to cut off the damaged cable portions, replace the end fittings, and add a solid copper

bar insert to make up for the length of cable cut off. A 1-inch copper cable electrical jumper was to be clamped to the hollow core cable in the usual way. In addition, the jumper would be clamped to the terminal fitting (swage) with a special clamp in an attempt to reinforce the hollow core cable near the terminal. It was recommended that all of the 192 hollow core cable ends be repaired in this manner.

Lew and Takahashi (1976) give a detailed procedure for cutting and replacing the swage terminals on the hollow core cable. They recommend cutting the hollow core cable at a distance of 21 inches from the tip of the old swage terminal. Cuts to remove damaged portions of the cable could be made up to 33 inches from the tip. New terminations were put on the cable ends and a copper rod insert with stainless steel buffers for wear resistance was used to make up for the length cut off. In addition, two shackles were added to allow rotation in two directions. The insert and shackles are 4.5 ft long and add approximately 1-ft total length when the cut location is 21 inches. If the cable were cut at the 33-inch position, the extra length added by the insert would only be about 2 inches. The extra length is added so that the cable will not be under any increased tension. Mr. Lew said that vibration rates and, hence, strand breakage rates increase rapidly with tension. This suggests the possibility of extending the life of the hollow core by reducing the tension in the hollow core conductors. This was discussed with the NAVFAC structural engineers, (Prince and Deneky)¹, and was rejected because it would redistribute the tensions throughout the topload. This would change the configuration of the topload and require a new structural analysis to be sure no failure would occur under heavy wind loading. Also, reducing tension can actually increase large scale oscillations (galloping), which is the primary candidate for the failure mechanism.

The repaired portion of each terminal includes about 9.5 ft of material (copper bar, shackles, jumper cable, and clamps) that does not have the appropriate resistivity to enable deicing by electrical heating. Both Mr. Lew and Dr. Gaberson indicated that this would not cause a structural problem (which appears to be so) as this fix has been in place for several years now. In a phone conversation, T. K. Lew (6 April 1993) recommended that, in the future, all extension pieces required for repairs of both ends of the cable should be located at the end of the cable nearest to the tower (catenary). This would reduce problems that might result from increased loading if the extension pieces did not deice well. He also indicated, due to the uncertainty of the amount of cable cut off, making the extension longer, so as to lengthen the spans by 1 or 2 ft would reduce tension.

Conversations with Mr. Lew indicated that approximately four terminations were replaced during the 1978–1979 time period using the recommended method. He observed the first two repairs and stated that great care was taken to select swage materials compatible with the cable. The swage termination and the cable should have, as near as possible, the same modulus of elasticity. It is not known if this was done for all repairs.

Mr. George Thomas of NAVCOMMU Cutler indicated during a phone conversations with Mr. Jim Schukantz (NRaD) that with the technique developed by NCEL between 1985–1989, they completed replacement of all 96 end fittings on the 775-ft hollow core cable sections. Thus,

¹Prince, R., and B. Deneky, Chief Engineer for towers and structural engineer at LANTNAVFACENCOM, personal communications.

all the 775-ft hollow core sections have new end fittings that were installed over a period of 11 years (1978–1989). The shorter 225-ft sections of hollow core have not been repaired and still have the original end fittings.

THE SPECIFIC PROBLEM

During the summer maintenance period of 1992, breaks in the external portion of the hollow core wires were observed near two of the hollow core terminations. As a result, CNCTC decided to find a suitable cable to replace the 1.5-inch hollow core and tasked NRaD to find such a cable. The original requirement was to find a suitable 1-inch cable to replace the 1.5-inch hollow core cable. More specifically, could the hollow core cables be replaced with the spare 1-inch-diameter Calsun bronze cable thought to be on site and/or easily obtainable. A part of the investigation was to include the investigation of the possibility of using a cable that would not deice.

APPROACH

Field surveys were performed at Cutler to examine the damaged cables, the spare cable, de-icing records, and to interview the personnel involved. Reference documents were obtained that documented the previous NCEL effort. Surface electric fields on the topload wires as a function of position and frequency were determined by computer calculation. Corona voltage limitations on wires of similar diameter were measured at the Forestport High Voltage Test Facility. Various manufacturers were contacted, but no off-the-shelf cable having suitable diameter, strength, and weight was found. KW&H were contracted to locate a suitable cable and subsequently designed several special cables of various diameters that could be used in place of the hollow core. These cables are all heavier than the existing hollow core cable and quite expensive. KW&H found one manufacturer (Sherburne Metal Products, Inc.) who would quote on these cables.

FINDINGS

CABLE DAMAGE

The field surveys concluded that no damage to hollow core has ever been observed on the shorter (225 ft) sections.

At present, external evidence of damage exists at the two locations shown below. The connection number refers to the numbered locations in figure 2.

Panel Number	Nearest Tower	Connection Number	Replacement Date
N-5	N6	3	1986
N-3	N2	5	1984

The external damage is similar to that previously observed (broken outer strands). At present, one outer strand is broken in one location, and two outer strands are broken at the other location. The breaks are within 2 inches of the jumper clamp near the swage end fitting.

NCEL recommended that clamps containing the copper jumper wire be replaced on the hollow core cable and a nearby clamp on the termination fitting in an attempt to reinforce the hollow core cable at the point where it enters the swage termination. However, all this did was to move the location of the problem. Note that the time from replacement to initial evidence of external failure was 6 to 8 years. The time until repair becomes absolutely necessary is not known because the internal condition of the cable is not known. To date, only visual inspections of the cable have been accomplished, and only minor exterior damage in two locations is visible. This, by itself, does not dictate the necessity for a replacement project. However, due to the hollow core construction, the cable can have internal breaks with no external evidence. The overall cable condition, including internal wires, cannot be determined visually. An x-ray program is needed to determine the extent of present damage, which can be used to estimate the breakage rate and remaining cable life.

SPARE CABLE ON SITE

The station list of spares includes 2000 ft of spare 1-inch-diameter Calsun bronze cable. No such cable is on site now. No spare 1.5-inch hollow core cable is listed in the spares list nor on site now. One cable reel containing a cable similar to the Calsun bronze was found in the riggers storage yard. This reel contains about 2530 ft of cable from which an 18-inch section was cut and taken to Forestport for further analysis. This cable is made up of 37 #7 wires and the outer layer of wires appear to be made up of Calsun bronze, while the core wires appear to be copper. Resistance measurements confirmed that the outer layer of wires has the conductivity of Calsun bronze (19~ Cu), and the inner wires have the conductivity of pure copper. This cable would not be suitable as replacement for the topload conductors as its net resistance is too low for deicing, and the strength of this cable would be less than the Calsun bronze cable.

The conclusion is that there is no spare cable for either the 1-inch-diameter Calsun bronze or the 1.5-inch-diameter hollow core topload conductors at Cutler.

DEICING RECORDS

The deicing records, beginning in 1986, were obtained from the power plant. Analysis of these records shows that deicing is used at various times in the months between August and April. The power applied was between 3 MW and 6 MW, but was typically at or near 6 MW. There were 93 incidents, which include some amount of time deicing one of the two arrays over the seven winters from 1986 through 1994, or about 13 incidents per winter. Each incident goes from a few minutes up to a little more than 1 hour of deicing.

Typically, several incidents occurred in a sequence as the deicing power was switched between the two arrays several times. For example, during the winter of 1986–1987 six major periods of deicing were listed, which consisted of respectively 7, 2, 3, 5, 10, and 3 incidents. During recent winters, four major periods of deicing have taken place. For example, during the winter of 1991–1992, four major periods consisting of 4, 2, 2, and 2 incidents, and during the winter of 1992–1993, four major periods consisting of 2, 1, 4, and 6 incidents occurred. During the last winter (1993–1994), there were 3 major deicing periods consisting of 4, 1, and 4 incidents.

Sometimes, these major periods of deicing are spread over more than 1 day. For example, on 24 February 1994, deicing started at 11:46 AM and continued intermittently until 11:05 AM the next day.

Conversations with the station personnel indicated that thick ice (approximately 2 radial inches) was observed on the guy wires during the winter of 1992–1993.

The deicing circuit is such that the cross support catenary does not carry current and does not deice. This is a very heavy cable and, presumably, the design considered ice loading on this cable. Thus, short sections of repair or replacement cable that will not deice could be located at the catenary with no effect on structural integrity.² The information cited throughout this section was obtained from documentation of the previous NCEL effort.

The conclusion is that icing is a major consideration at Cutler and using cables that will deice over most of their length is necessary; but, short sections that did not deice are acceptable as long as they were located at the support catenary.

CORONA CONSIDERATIONS

The diameter of the cables in the topload was chosen to keep the surface electric fields below the level that causes corona. The antenna modelling computer program NEC-IV was used to calculate the charge density on the topload wires as a function of position and frequency (Deneris & Logan, included as appendix A). Surface electric field (gradient) was calculated from the charge density for the assumption of smooth wires using maximum power radiated from a single array (worst case) (Deneris et al, 1994). Figure 3 shows the calculated gradient along the outside two cables in the outer half panel operating at 14 kHz. The curves labeled 1.5 inches are for the existing configuration with 775 ft of hollow core cable and the remainder 1-inch cable. The curves labeled 1 inch are for a hypothetical configuration with all 1-inch-diameter cable. For the existing configuration, the gradient is locally maximum at two locations; one on the 1.5-inch-diameter wire that occurs at the catenary, and the second on the 1-inch-diameter wire at the connection between the 1-inch- and 1.5-inch-diameter cables. Figures 4 and 5 give similar curves for the gradient, which is much lower, when operating at 17.8 kHz and 24.0 kHz.

Originally, the designers estimated that the maximum gradient would be on the outer conductors near the catenary and designed the system to have a gradient of less than 0.8 kV/mm at that location. A plot of the gradient at this location versus frequency taken from the original model study (Alberts et al., 1957) is given in figure 6. Included on this figure is the gradient at the same location calculated by NEC-IV, which gives excellent agreement. From this plot, it is seen that the gradient at 14.0 kHz on the 1.5-inch-diameter cable is slightly above the corona requirement of 0.8 kV/mm. The curve in figure 6 labeled NEC4 1 inch shows the maximum gradient on the 1-inch-diameter wire where it attaches to the 1.5-inch cable. At 14.0 kHz, this gradient is slightly above 1 kV/mm. Figure 6 also includes the maximum power antenna base current for single array operation versus frequency from Picard & Burns (1961), which was used to calculate the gradients.

² Prince, R., and B. Deneky, Chief Engineer for towers and Structural Engineer at LANTNAVFACENGCOM, personal communications.

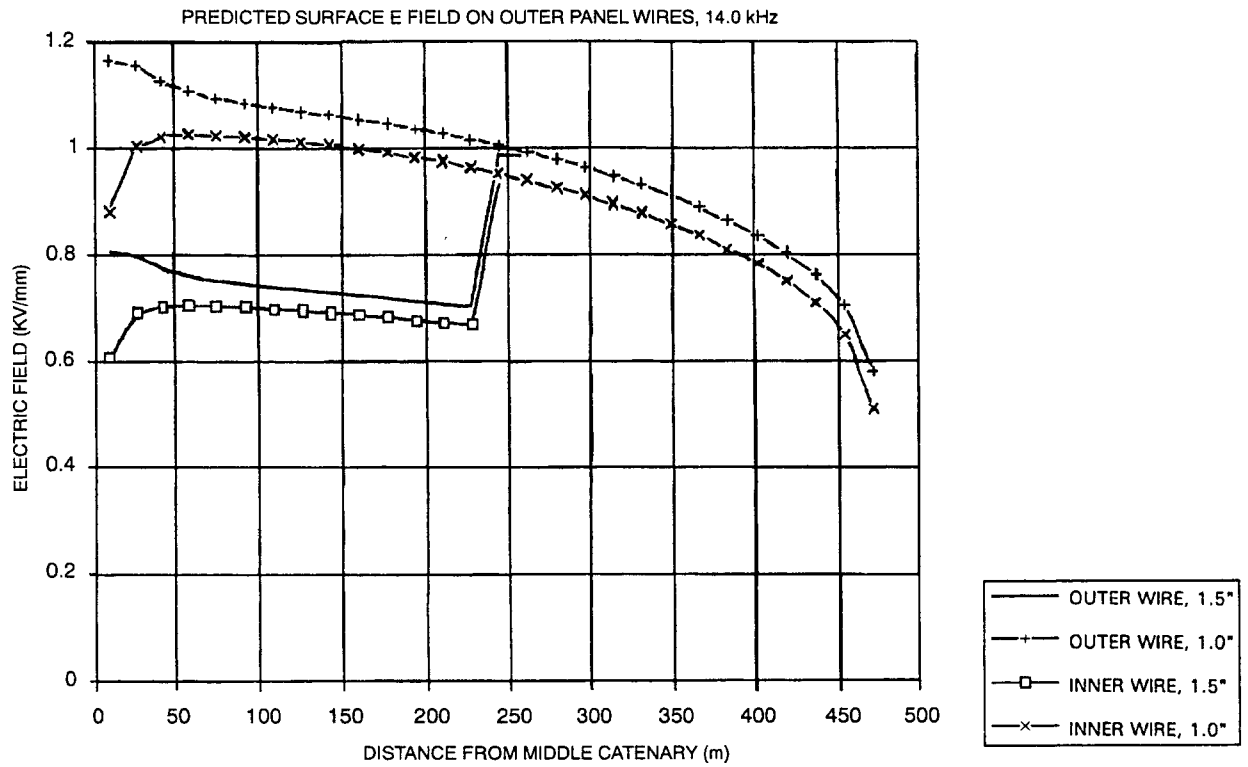

Figure 3. Cutler VLF tophat (14.0 kHz).

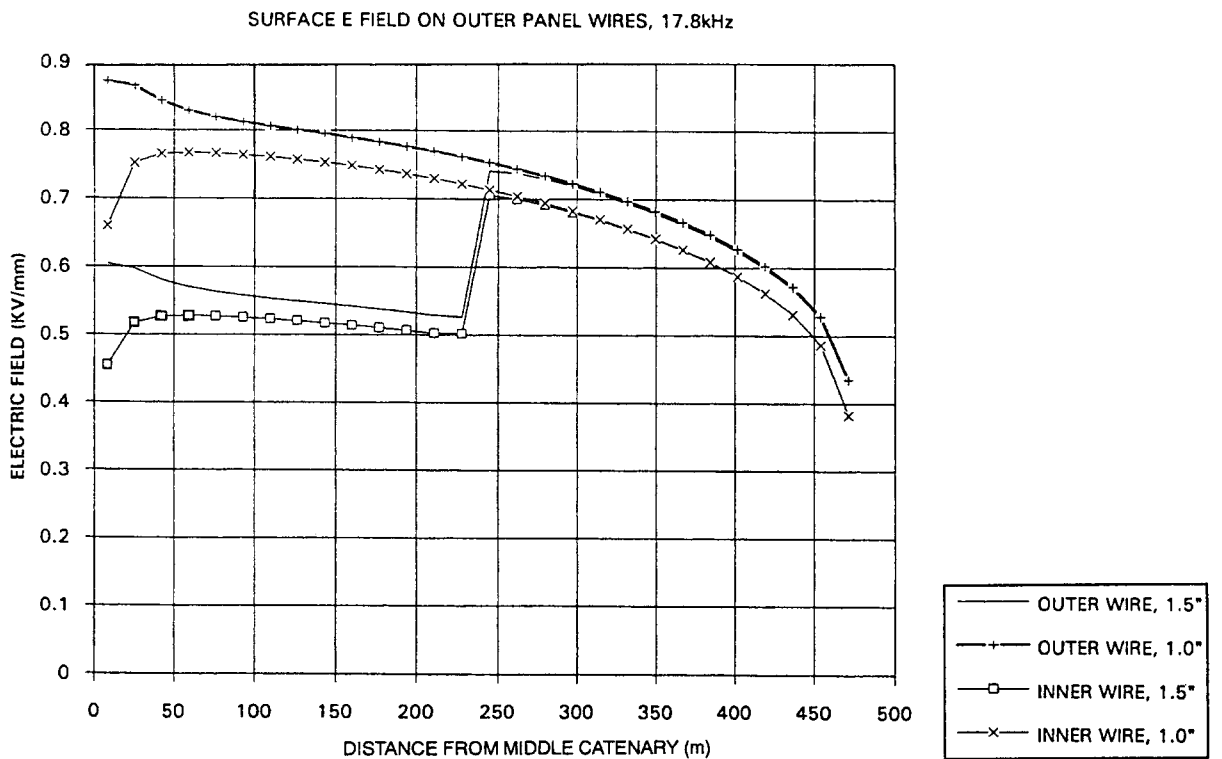

Figure 4. Cutler VLF tophat (17.8 kHz).

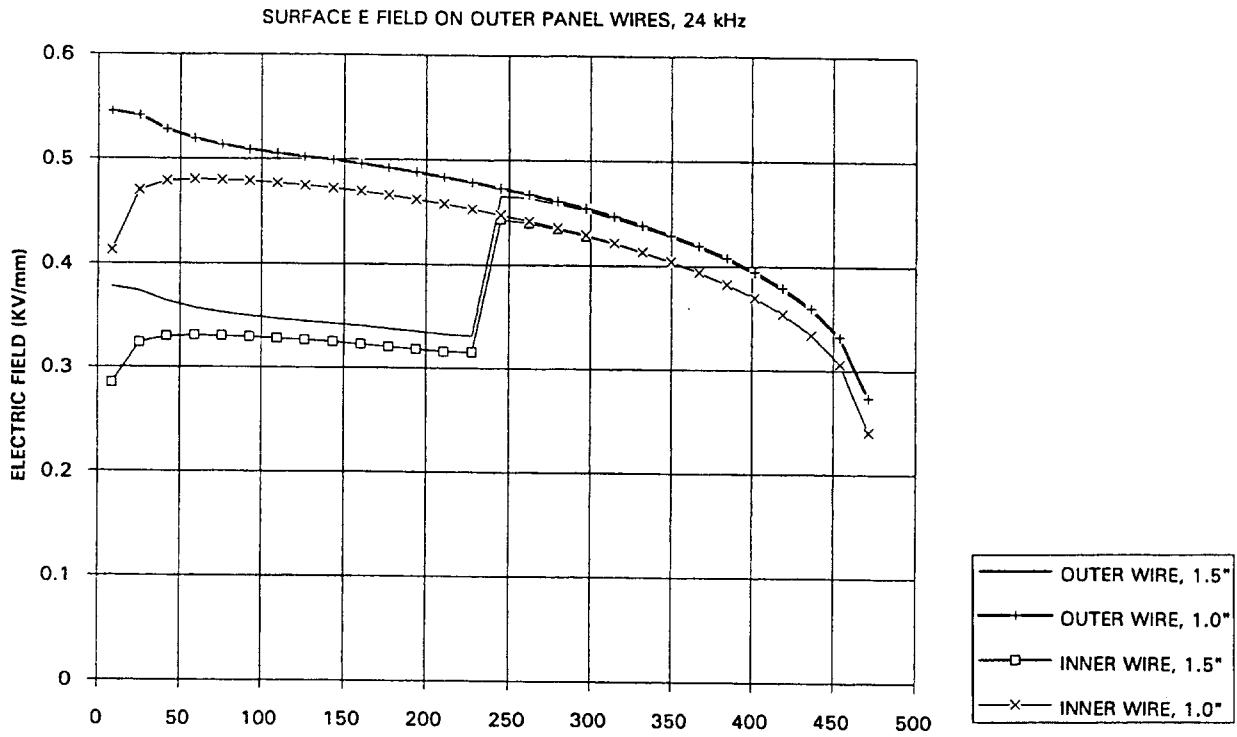

Figure 5. Cutler VLF tophat (24.0 kHz).

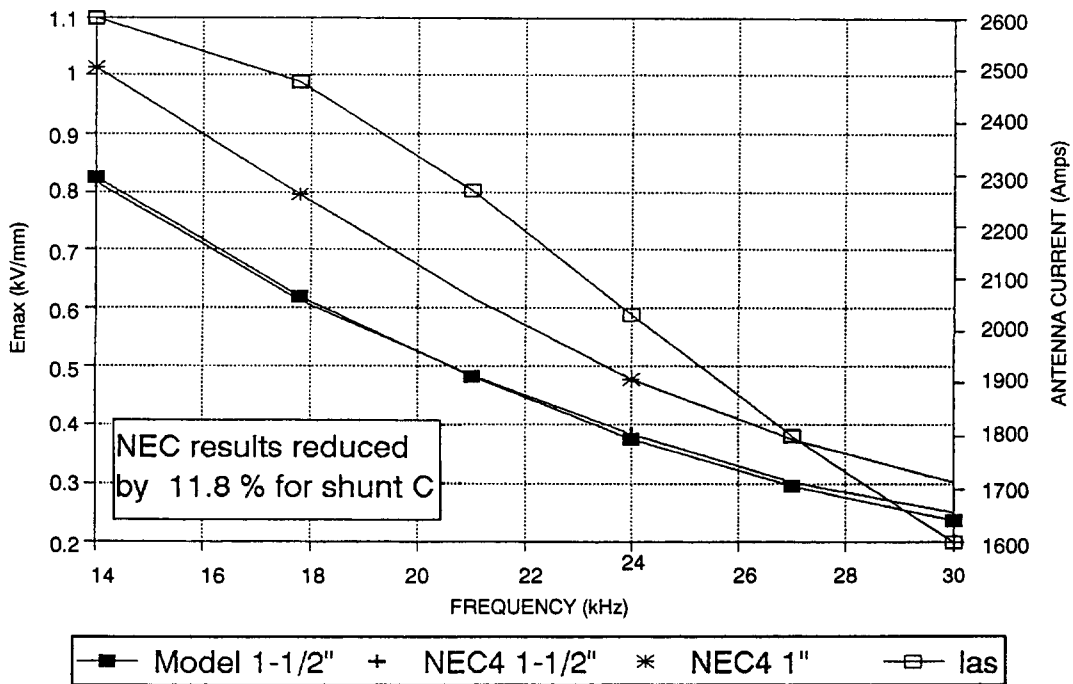

Figure 6. Cutler tophat, maximum gradients single array, 1.5-inch and 1-inch cables.

MEASURED CORONA EXTINCTION GRADIENTS

The gradient for corona extinction was measured on two frequencies at the Forestport High Voltage Test Facility for several wires having diameters in the vicinity of 1 inch. The results are shown in figure 7. Note that the gradient was calculated as if the wire were smooth.

By extrapolating the curve of figure 7 to a 1.5-inch- (38.1-mm) diameter wire, a design gradient of 0.8 kV/mm for wet conditions is adequate. Note that the frequency factor would make the extinction gradient a few percent higher than the results of figure 4 at 14.0 kHz (Watt & Hansen, 1992).

For the 1-inch- (25.4-mm) diameter wire, a reasonable wet design gradient from figure 7 would be 0.95 kV/mm at 28 kHz and a few percent more at 14.0 kHz.

Using the above design limits and examining figure 3, it is clear that the Cutler design is marginal at 14.0 kHz from the point of view of corona formation. In fact, the 1.5-inch-diameter cable would need to be extended and the 1-inch-diameter cable shortened to reduce the maximum gradient on the 1-inch cable below the design limit of 0.95 kV/mm.

For operation on 17.8 kHz, the curve labeled "outer wire I" in figure 4 gives the gradient that would exist if the 1.5-inch wire were replaced with a 1-inch-diameter wire. This curve indicates that this replacement would result in marginal operation at 17.8 kHz because the maximum gradient is slightly in excess of 0.95 kV/mm.

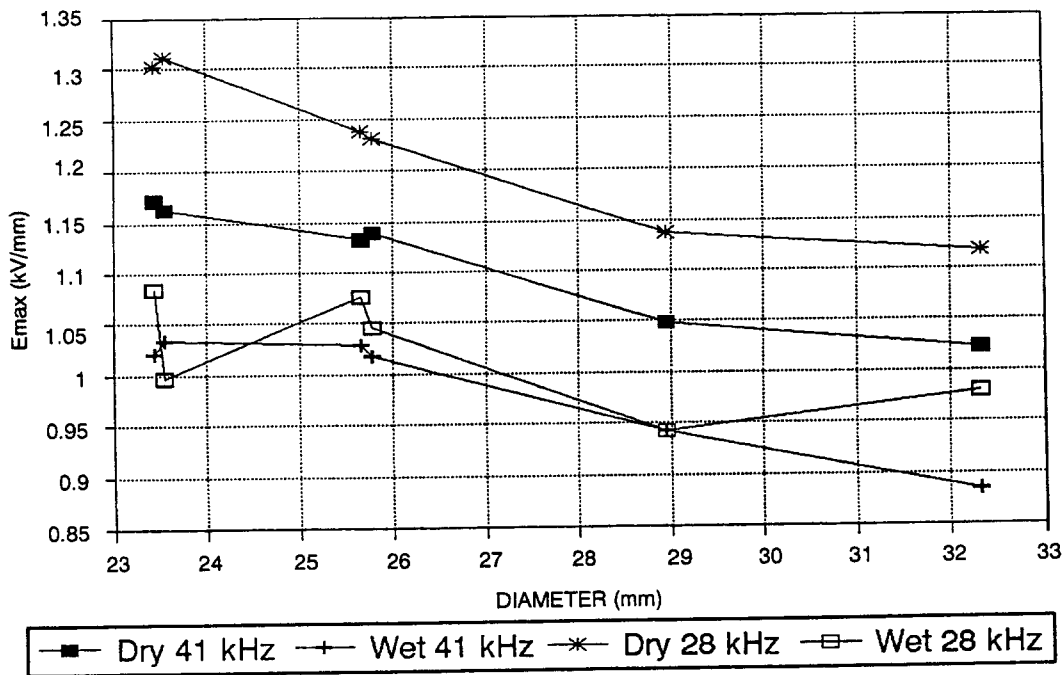

Figure 7. Corona extinction gradient versus diameter (uncorrected for air dens).

SPECIAL CABLES

KW&H designed several special cables of various diameters that could be used in place of the hollow core. Table 1, taken from their report (included as appendix B), shows the options they considered. Table 2 gives weights, breaking strength, and resistance for the KW&H recommendations, as well as the various other cables that have been considered.

Table 1. Alloy and strand makeup for Cutler panels.

WIRE ALLOY	STRAND DIAMETER	NO. OF WIRES	WIRE AWG	WIRE DIAMETER	STRAND MAKE-UP	RES. 1000 ft	RES. TARGET	RES. DEV.
C65100	1.46	61	#6	0.162	24/37*	0.10539	0.1054	-0.2%
EVR651	1.46	61	#6	0.162	56/5	0.10517	0.1054	-0.6%
Cu. 8.5	1.46	61	#6	0.162	38/23	0.1048	0.1054	-5.7%
EVR651	1.46	61	#6	0.162	61/0	0.09966	0.1054	0.25%
Cu. 8.5	1.3	61	#7	0.144	61/0	0.09646	0.0939	-10/0
Cu. 65100	1.3	61	#7	0.144	41/20	0.0928	0.0939	

NOTE: RES. TARGET is desired resistance.
RES/1000 ft is resistance obtained from strand makeup listed.
* Core conductors are stainless steel alloy #302

OFF-THE-SHELF CABLES

Several manufacturers were contacted, but no off-the-shelf cable with suitable diameter, strength, weight, and resistance was found that could replace the hollow core directly. Most of the off-the-shelf cables considered are aluminum or alumoweld. Table 2 lists a 1.01-inch-diameter alumoweld cable that has the appropriate parameters to replace the 1-inch Calsun bronze, including a resistance only 7% less than that of the existing cable. However, if this cable were to be used as a partial replacement, a method for corrosion control would be needed in locations where the aluminum interfaces with copper alloy. The corrosion problem has been solved at Jim Creek by using special bimetallic interfaces at these connections.

Table 2. Cutler hollow core replacement options.

Alloy	Strand Makeup Cable#out/#core		DC Res 1000 ft	Res Target	Res Dev %	Wt/ft	Added Wt/ft	Total Length Installed	Insulators			
	Dia	AWG #							Added Weight lbs	To Be Removed	Break Strength kips	
Existing	1.0	37, #7	0.0722	0.0722	0.00	2.230					73.5	
Calson Bronze Hollow core	1.5	39/37	0.1399	0.1084	29.11	2.672					62.0	
Copper Alloy	1.46	61, #6	0.1052	0.1055	-0.28	4.250	1.578	26400	1756	2.3	85.8	
Everdure 1010	1.3	61, #7	0.0965	0.0939	2.71	3.470	0.798	37200	7775	10.4	62.8	
Cu 8.5	1.41	24/37, #6	0.1054	0.1019	3.47	5.180	2.508	26400	1505	2.0	115.3	
1 Cu 13, SS 304	1.3	19/42, #7	0.0928	0.0939	-1.19	3.356	0.684	792				
2 Cu 651, SS 304	1.46	61, #6										
3 Cuweld	1.27		0.0294	0.0917	-67.98	3.466	0.794				73.5	
4 Cuweld	1.01		0.0467	0.0730	-36.01	2.180	-0.492					
Aluminum Alloy												
ASCR Falcon TW	1.4		0.0111	0.1013	-89.04	2.038	-0.634	792	-42		66.1	
Alweld	1.27		0.0425	0.0917	-53.71	2.802	0.13					
Alweld	1.01		0.0675	0.0730	-7.43	1.762	-0.91				100.7	
Quick Inexpensive Solutions												
1 - 16 ft - 6 inch length of CuWeld 1.458-inch-diameter												
2 - 16 ft - 6 inch length of CuWeld 1.01-inch-diameter plus 1 or 2 cage wires												
3 - 16 ft - 6 inch length of ASCR 1.402-inch-diameter												
Long Term Solutions												
1 - Replace all hollow core with 1.46-inch-diameter CU+SS adds 2.508 #/ft or 7775 #/panel												
2 - Leave in 250 ft of existing hollow core + 750 ft of 1.3-inch-diameter insert adds 0.684 #/ft or 1505 #/panel.												

REPAIR/REPLACEMENT OPTIONS

The available options have been analyzed and compared for practicality and cost. The four options presented all assume retention of full existing operational capability, and replacement or repair of the 775-ft hollow core sections only. Option 2 is the recommended long-term solution with option 4 recommended for short-term or emergency repairs, if necessary. Table 2 contains further information about the various cables considered and the options listed below are indicated in the table by number.

OPTION 1

Replace the 775-ft section of hollow-core cable with the cable labeled EVR 651 in table 1 (the KW&H recommended solution). The EVR 651 cable has a 1.47-inch diameter and consists of 37 #6, #302 stainless steel alloy wires in the core with 27 #6, #651 low silicon bronze alloy wires on the outside. Sherburne Metal Products, Inc. of Sherburne, NY has provided a bid to supply 48,000 ft of this cable at \$1.5M (appendix C). Before installation, the cable would need to be prestressed, cut, and end fittings put on, estimated to cost another \$200k.

This cable adds 2.05 lbs/ft, or 7524 lbs per panel, over the weight of the existing hollow core cable. This added weight requires the removal of about 10 insulators per panel to equalize the weight. The details of the removal of these insulators needs to be worked out. At least two insulators per string of 16 could be removed without degrading the withstand voltage. However, since three or more insulators would need to be removed from some strings, the withstand voltage could be reduced enough to impact performance. This is considered a major drawback to this approach.

Installation, including removal of the appropriate insulators, is estimated to cost \$500k and would take place over two summers. Most of the work could be done with only one array down, except for the panels in the bow tie area between the two arrays, which would require 1 week each of down time. The replacement project would take place over two summers, one for each array.

To avoid any performance reduction that would result from the removal of so many insulators, it is strongly recommended that new insulators be used to reduce the weight for this option. The existing Lapp compression cone insulators can be replaced with special high-strength Racal-Decca safety core insulators. The details of the new insulators, such as the number, size, and grading hardware need to be worked out. Without further analysis, it is estimated that one Racal-Decca insulator per corner will be needed if the large existing corona rings are retained. A detailed design effort may indicate that only one insulator is needed. The new insulators will cost about \$15k each, including hardware and shipping. Thus, estimated total cost for new insulators at all 48 panel corners is \$750k. The cost of insulator installation is estimated to be the same as the cost of removing the Lapp insulators, which is included in the above cost of cable installation. Thus, the total cost of this option will be \$2.2M for the new cable and up to \$0.75M more for new insulators.

OPTION 2

KW&H recommended two 1.3-inch-diameter cables, which are shown in tables 1 and 2. One cable is made up entirely of a copper alloy with 8.5% conductivity of copper. The other is a special cable using a higher conductivity copper alloy Cu 851 for the exterior and a stainless steel core. A 1.3-inch-diameter cable could be used without reducing operational capability by retaining a length of the 1.5-inch-diameter hollow core cable in the region where the gradient is highest. The approach is to retain 250 ft of the hollow core in the outer half panel at the catenary end. The remaining 550-ft section would be replaced with the new 1.3-inch-diameter cable. A plot of the estimated gradient at 14.0 kHz is included in figure 8, which shows that the maximum gradients for this option are within the design limits for corona formation.

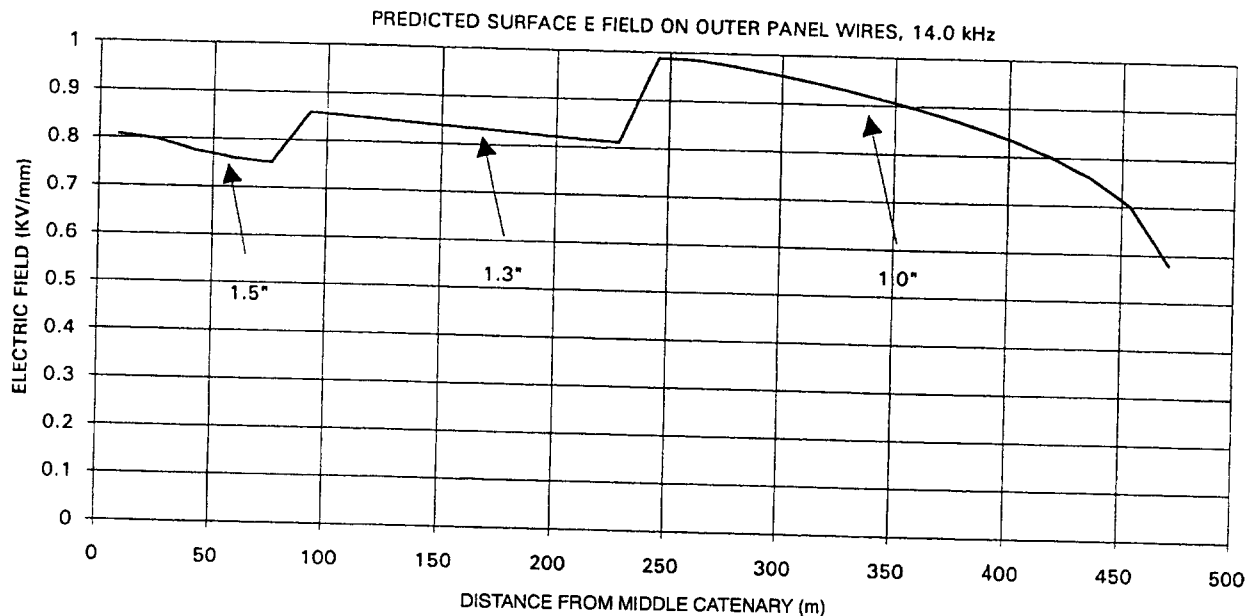

Figure 8. Cutler VLF tophat.

This short length of hollow core presumably would not have the breakage problem. Even if it did, enough spare hollow core remains to replace it two more times. The remaining 550 ft would be made up of the new special stainless-steel core 1.3-inch-diameter cable. This cable adds 0.684 lbs/ft, or about 1505 lbs per panel, and requires removal of only two insulators per panel. This option will be less expensive than option 1 because the cable diameter and length required are smaller; thus, less material is required.

Originally, the all Cu 8.5 alloy cable recommended by KW&H was thought to be less expensive as it is made entirely of the same alloy. Unfortunately, a supplier for the Cu 8.5 alloy cable has not yet been found. Sherburne has stated that they will make a slightly modified version of the other 1.3-inch-diameter cable suggested by KW&H (table 1), which consists of a core of 19 #6, #302 wires, with an exterior made up of 41 #6, copper alloy CDA 651 wires, which Sherburne produces regularly. This composite cable is acceptable and is included in table 2. It would add slightly less weight than that added by the alternative of 100% copper alloy and requires removal of only three insulators per panel.

To make this cable, Sherburne will use two subcontractors: one to supply the stainless steel and another to strand the cable. The quote given in appendix C for 30,000 ft is \$727,310. Sherburne has not had any experience with composite cables and the above quote includes the cost of a 500-ft trial sample for testing to be sure that the cable actually meets the requirements. They are somewhat concerned about the final breaking strength, which is hard to predict for composite cables. However, it is almost certain that the final breaking strength for this type of cable will be acceptable. The estimated cost for stretching, cutting, and installation of end fittings for this cable is again \$200k. Installation cost is the same as option 1, or \$500k, for a total of \$1.43M. New insulators are not necessary, but can be added to this solution for \$0.5M. Option 2 is the least costly long-term solution and should last indefinitely. It is the recommended long-term fix, given that one is needed, and dependent on the outcome of the x-ray program.

OPTION 3

A third option, suggested by Bernie Deneky of LANTNAVFACENGCOM, would repair the hollow core by cutting off the ends and replacing the new end fittings while retaining as much hollow core as possible. The length cut out by this and the previous repair is approximately 16 ft, which would be replaced with a section of 1.5-inch copperweld cable (nondeicing) located at the support catenary end. This solution is relatively inexpensive (less than \$750k without new insulators) and extends the life of the hollow core about 10 years, at which time the same repair could be repeated by using a longer (20-ft) section of copperweld for another 10 years or so. One drawback of this solution is that the 1.5-inch copperweld is a special order.

OPTION 4

This option is similar to option 3, but uses 1.01-inch copperweld cable for the added 16-ft piece. The Navy already has this cable on site at VLF Jim Creek, and it could be made available for the cost of the end fittings and shipping.

In order to control the gradient, this cable would have to be paralleled with a 1-inch copper jumper held in place by Burndy clamps. In effect, this forms a 2-wire cage. Appendix D gives the details of the calculation of the maximum gradient that would occur on a small section of the 2-wire and 3-wire cage in the Cutler topline by using the methods of Hansen (1992). The gradient versus wire spacing at 14 kHz for 2- and 3-wire cages made from 1.01-inch wire and located near the catenary are given in figure 9. Note that the 2-wire cage gradient is slightly over 0.9 kV/mm, which would be acceptable for a 1-inch-diameter wire from figure 5. However, the equivalent diameter to use for the corona onset of a cage is not known exactly. At 60 Hz, some data indicate the cage equivalent diameter for capacitance (see appendix D for definition) is a good approximation to the equivalent diameter for corona onset (see figure 6 of Miller, 1956). If this is so, then the design gradient for the cage should be 0.8 kV/mm. In order to get gradients below this value, the 2-wire cage would need to have the wires spaced apart with a center-to-center wire separation of 4 inches. From figure 9, it is shown that a 3-wire cage would be acceptable with wire separation of only 1 inch. These are the recommended wire separations for these two cages. It would be useful to investigate this phenomena to determine a better value for the equivalent radius for corona onset. The 4-inch wire separation for the 2-wire cage means that the special clamps will be required, giving the wires the required 4-inch center-to-center separation. For the 3-wire cage, the standard clamps give adequate spacing.

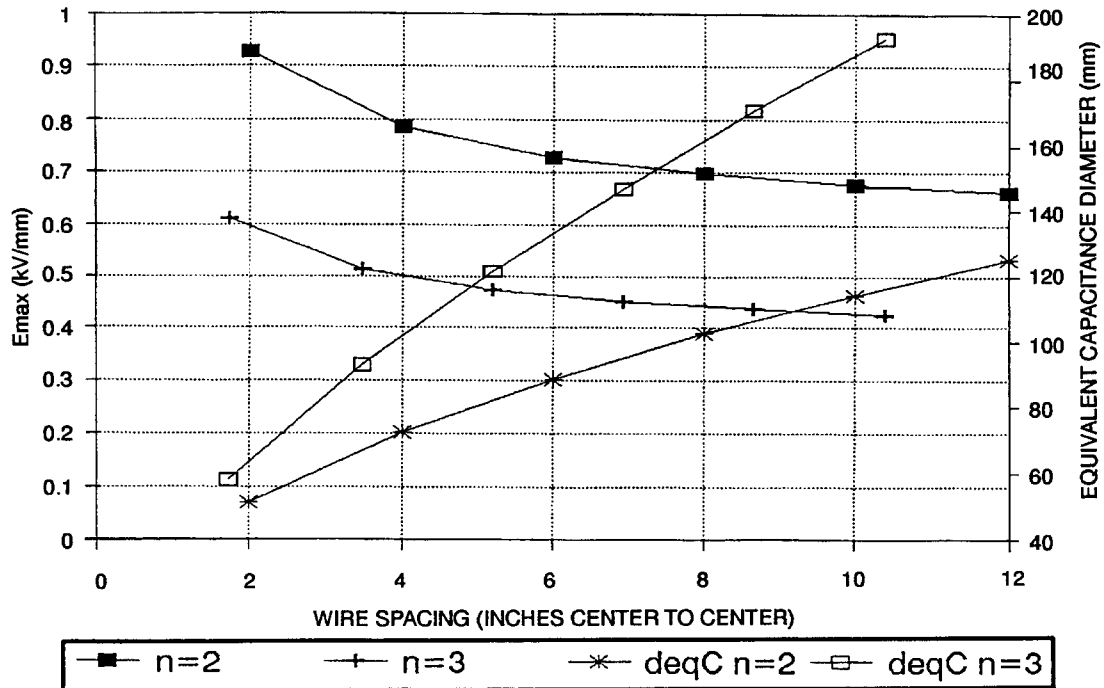

Figure 9. Cutler topload estimated cage gradient 1.01-inch-diameter wires near the catenary.

This cage section will not deice, but since it is short and located at the support catenary, this is acceptable. The major cost of this option involves installation, which could be done by Cutler personnel. This fix would extend the life of the hollow core for about 10 years and could be repeated once more for another 10 years. It is the least expensive and could easily be available to start installation by next summer. The 2-wire version of this option is the recommended short-term fix for any cables that the x-ray program indicates will need immediate repair.

Drawings have been prepared by LANTNAVFACENCOM for options 3 and 4, which are included as appendix E. Originally, option 3 was to be the interim or emergency fix. However, option 4, which was developed after preparation of the option 3 drawings, is the simplest and least expensive and, therefore, became the recommended option for interim or emergency repairs.

CONCLUSIONS AND RECOMMENDATIONS

(1) The repair/replacement options range from a permanent, but expensive, 100% replacement program to an inexpensive interim repair for individual cables, as needed. Since the extent of the problem cannot be known until the internal condition of the cables is determined, it is recommended that the Navy x-ray all 192 hollow-core connections before deciding which option to pursue.

(2) Jim Creek personnel should prepare some 1.01-inch-diameter copperweld sections according to the drawings provided. These sections should be shipped to Cutler to have available as an interim or emergency fix (option 4) should the x-ray program indicate that there are any hollow core cables with six or more broken wires. Also, the special clamps required to maintain the 4-inch center-to-center spacing between the copperweld cable and the 1-inch copper jumper should be procured.

(3) Pursue option 2 as the permanent fix by developing plans and costs for the installation of the 1.3-inch cable. This will include having NAVFAC engineers work with the manufacturer to be sure the cable will be structurally acceptable.

(4) No spare cable exists on site for either the 1-inch-diameter Calsun bronze or the 1.5-inch hollow core conductor cables used in the Cutler antenna topload. No vendor is available that can supply either of these cables off-the-shelf. We did, however, find an off-the-shelf, 1.01-inch-diameter alumoweld cable that could be used as a direct replacement for the Calsun bronze. If the alumoweld cable is installed as a partial replacement and is in contact with copper alloy cables, suitable bimetallic fittings would be needed to reduce electrolytic corrosion.

REFERENCES

- Alberts, W. S., R. E. Ankers, L. L. Lynwood, L. C. Hice, and C. C. Phillips, "U.S. Naval Radio Station Cutler Maine Recommended Radiation System Design," DECO Report No. 13-s-4, 28 June 1957.
- Deneris, C. A., J. H. Schukantz, P. M. Hansen, J. C. Logan, "NEC4 Analysis of a Navy VLF Antenna," 10th Annual Review of Progress in Applied Computational Electromagnetics, Monterey, CA, March 1994.
- Gaberson, H. A., and S. K. Takahashi, "Investigation of Hollow Core Cable Breakage at VLF Cutler, Maine," FY 75 Report 51-047, NCEL internal report, June 1975.
- Hansen, P. M., "Optimum Design of Multiwire Cages for High Voltage Applications," Naval Ocean Systems Center, NOSC TR 1495, August 1992.
- Lew, T. K. and S. K. Takahashi, "Antenna at NAVCOMMU Cutler," NCEL Technical Memorandum M-51-76-17, December 1976.
- Miller, C. J., Jr., "Mathematical Prediction of Radio and Corona Characteristics of Smooth, Bundled Conductors," AIEE Transactions, pp. 1029-1037, October 1956.
- Pickard and Burns, Inc. (P&B), "Final Report On Proof of Performance Tests Cutler VLF Antenna U.S. Naval Radio Station (T) Washington County, Maine," P&B Publication No. 715, 25 August 1961.
- Watt, A. D., and P. M. Hansen, "VLF/LF Corona Investigation," NRaD TD 2266, May 1992.

**APPENDIX A
SECTION I**

A COMPUTER ANALYSIS OF THE USNRS CUTLER VLF ANTENNA

by

**C. A. Deneris and J. C. Logan
NRaD, Code 824
11 January 1993**

OBJECTIVE

Our objective in this analysis is to predict the changes in current and charge distribution on the VLF antenna at Cutler, Maine, after the proposed hollow core wire replacement. We present results at 17.8 kHz and 24.0 kHz for two antenna configurations. All data is normalized to a 1.0 ampere feedpoint current.

ANTENNA GEOMETRY

The actual antenna at Cutler consists of two toploaded monopoles. Each monopole has six diamond shaped panels made up of wires. These panels are arrayed as a six pointed star. Due to the enormous size of each antenna, we considered only one monopole in this analysis.

Each array is suspended from 13 conducting, grounded towers. A center tower supports one point of all six diamonds. There are two concentric rings of six towers, symmetric about the central tower. The outer ring supports the outside corner of each diamond. The inner ring supports the remaining points of each panel. All the panels are insulated from the supporting towers.

Each panel has eight wires that run from the center tower to the outer tower. The inner four wires are 1 inch in diameter. The outer four wires have a stepped diameter of 1.5 inches near the inner tower ring. These wires are scheduled for replacement by 1-inch-diameter wires.

COMPUTER MODELS

We performed the antenna analysis using the single precision version of the method-of-moments computer program NEC-4. We used two configurations for the calculations. The first model (configuration 1) used 1.0 and 1.5 inch diameter wires, while the second (configuration 2) used only 1.0 inch wires. Figure 1 is a view of the whole antenna. Figures 2 and 3 show the top view of a single panel for configuration 1 and 2 respectively.

Since the actual antenna is rather complex, we made several approximations to construct the models. For instance, we modeled the panel elements as straight rather than catenary wires. None of the guy wires are modeled, and we assume a perfect ground. Since none of the towers are electrically connected to the panels, they are freestanding in the model. In the feed region, we used only one download for each panel. Also, since the center tower is not fed, the feed structure is somewhat asymmetric. This causes a slight drift in current and charge values from panel to panel. Finally, since the dual outer wires on each side of the panels are so close, we were forced to alter the geometry somewhat to allow NEC-4 to recognize them as separate wires. The critical area on these wires is at the insulators, near the inner tower ring. Therefore, we modeled them as a single wire near the vertex of each panel. At a distance of 17.15 m. (one segment length) from the vertex, they split into two wires. The angle between the two wires is correct to achieve the specified separation at the inner tower ring.

We used a large number of segments to give the best resolution possible for the current and charge distributions. Samples of both quantities are provided at approximately 17 m. intervals.

However, this required 2997 unknowns and took several hours to run. We thought it impractical to increase the resolution beyond this point. Table 1 summarizes some of the specific dimensions used for each configuration. The wire numbers correspond to those in Figures 2 and 3. The 1.5-inch wires in configuration 1 that we have plotted data for are 9, 24, 27, and 28. The 1.0-inch wires are 18, 19, 31, and 32. The wire numbers for configuration 2 are 9, 18, 19, and 24.

Table 1. Dimensions of the NECA Cutler antenna model.

Antenna Element	Configuration 1: Length (m)	1", 1.5" Wires Radius (m)	Configuration 2: Length (m)	1" Wires Only Radius (m)
Center Tower	298.6	1.829	298.6	1.829
Inner Towers	266.7	1.829	266.7	1.829
Outer Towers	243.5	1.829	243.5	1.829
Downleads	167.7	1.829	167.7	1.829
Inner Panel Wires				
Inner 1.0" (19)	370.7	0.013	439.3	0.013
Inner 1.5" (28)	68.58	0.019	---	---
Outer 1.0" (18)	412.1	0.013	480.2	0.013
Outer 1.5" (27)	68.09	0.019	---	---
Outer Panel Wires				
Inner 1.0" (24,32)	235.9	0.013 (#32)	472.1	0.013 (#24)
Inner 1.5" (24)	236.2	0.019 (#24)	---	---
Outer 1.0" (9,31)	243.9	0.013 (#31)	480.1	0.013 (#9')
Outer 1.5" (9)	236.2	0.019 (#9)	---	---

RESULTS

For this analysis, we calculated effective height (h_e), input impedance, and current and charge distributions for both configurations. Table 2 presents the effective height and impedance results for both 17.8 and 24.0 kHz.

Table 2. Cutler VLF antenna analysis results.

Configuration	17.8kHz		24.0 kHz	
	h_e (m)	Impedance (Ω)	h_e (m)	Impedance (Ω)
1) 1", 1.5" Wires	185	0.192-j73.1	186	0.356-j40.6
2) 1" Wires Only	185	0.192-j73.0	186	0.356-j40.5

The attached graphs contain plots of the current and charge distributions for the outer two wires on a representative panel. The graphs are grouped by frequency and compare the results with and

without the 1.5-inch wires. Our primary interest is in the outside pair of wires since they are the ones in danger of going into corona. "Inner Panel" refers to the side of the panel from the middle catenary to the center tower. "Outer Panel" is the side from the middle catenary to the outer tower. The electrical quantities are plotted as a function of distance from the middle catenary. Note that the data on the inner panel wires do not extend all the way to the vertex. Since we were forced to approximate the outer two wires as a single wire near the inner vertices, we give results only as far as the junction of these wires in the model. Also note that the change in radius shows clearly as a discontinuity in the charge plots.

COMMENTS

As we mentioned previously, the current and charge values drift slightly on corresponding wires from panel to panel. This results from using the single precision version of NEC-4, and the asymmetry in the feed structure of the model. The large size of the model dictated that we use single precision. The feed structure is asymmetric since it is an approximation of the actual antenna feed. At any rate, the drift was not too severe (<15%), and we considered it to be acceptable given the approximations made. The charge values presented represent the worst case (i.e., largest) values for each wire.

Data for 17.8 kHz

Current Magnitude on Outside Wire, Inner Panel
Charge Magnitude on Outside Wire, Inner Panel
Current Magnitude on Inner Wire, Inner Panel
Charge Magnitude on Inner Wire, Inner Panel
Current Magnitude on Outside Wire, Outer Panel
Charge Magnitude on Outside Wire, Outer Panel
Current Magnitude on Inner Wire, Outer Panel
Charge Magnitude on Inner Wire, Outer Panel

Data for 24.0 kHz

Current Magnitude on Outside Wire, Inner Panel
Charge Magnitude on Outside Wire, Inner Panel
Current Magnitude on Inner Wire, Inner Panel
Charge Magnitude on Inner Wire, Inner Panel
Current Magnitude on Outside Wire, Outer Panel
Charge Magnitude on Outside Wire, Outer Panel
Current Magnitude on Inner Wire, Outer Panel
Charge Magnitude on Inner Wire, Outer Panel

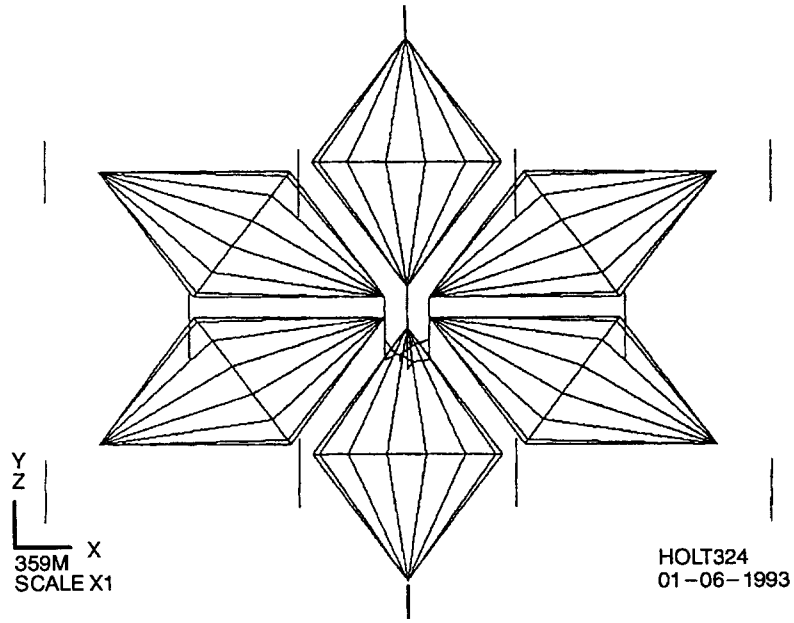

Figure 1. Antenna model from above.

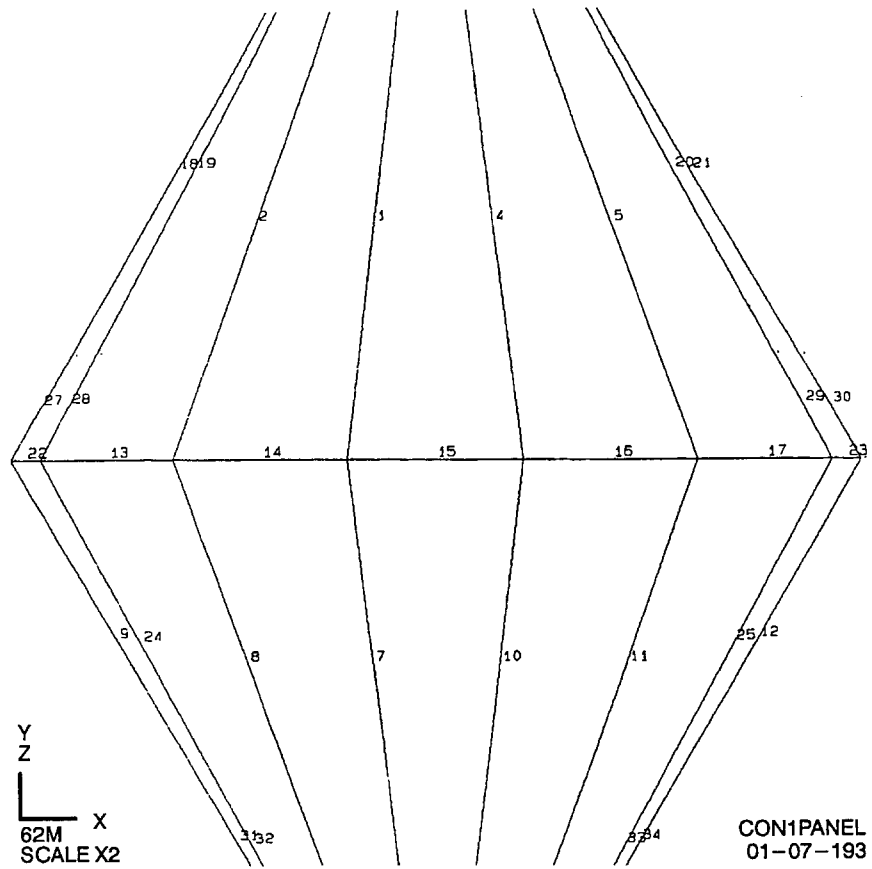

Figure 2. Plan view of a single panel.

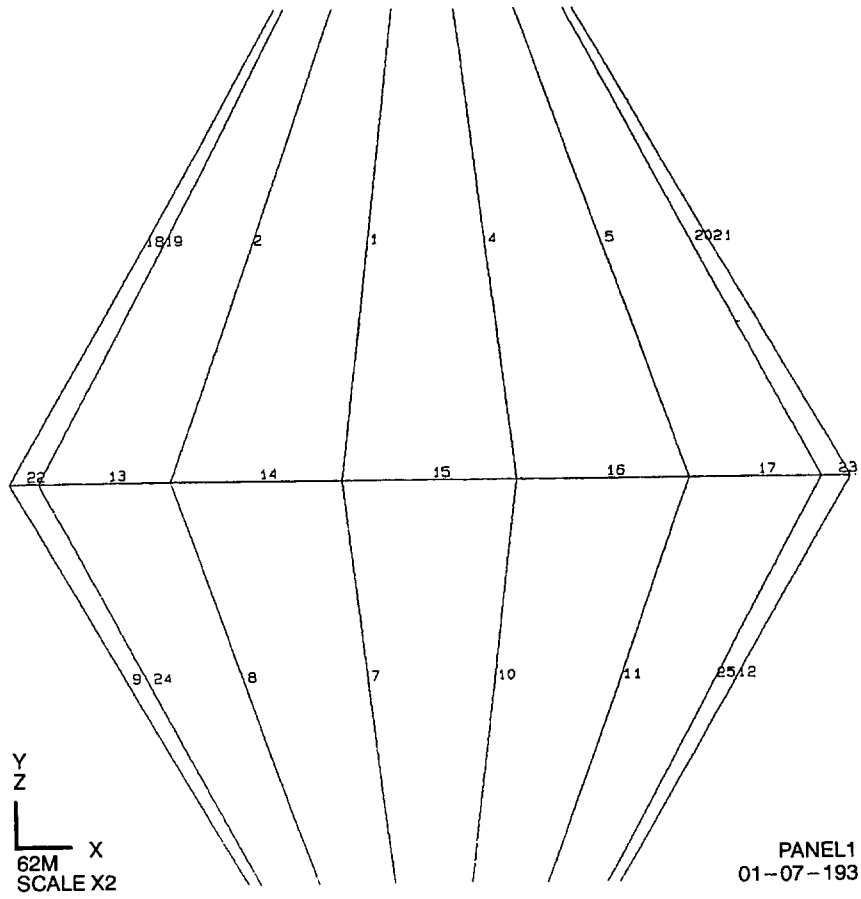
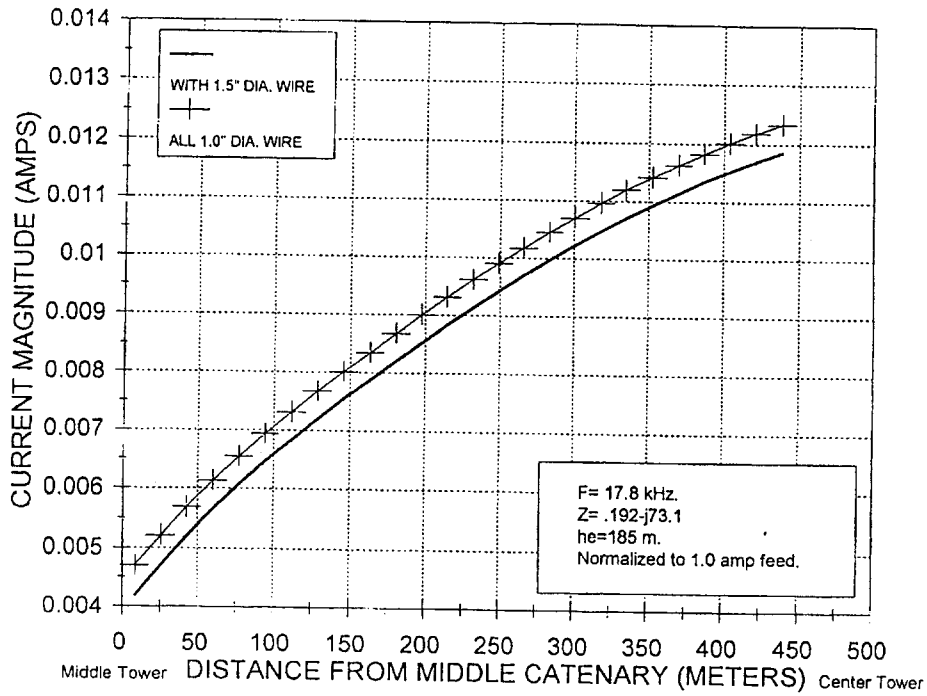

Figure 3. CFG2 panel.

17.8 kHz DATA

CUTLER VLF TOPHAT CURRENT ON OUTSIDE WIRE, INNER PANEL



CUTLER VLF TOPHAT CHARGE ON OUTSIDE WIRE, INNER PANEL

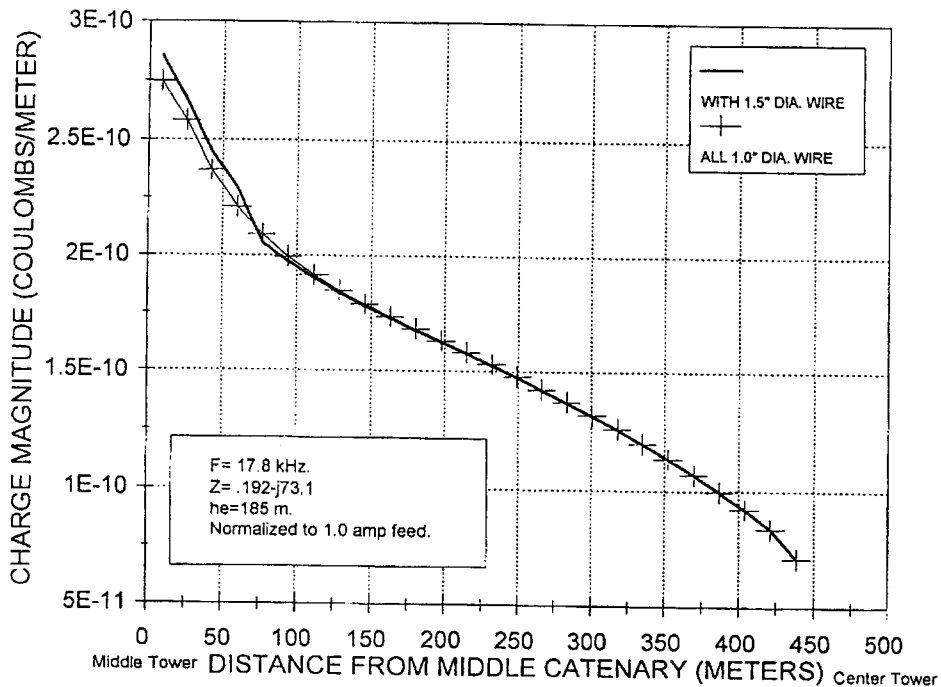

CUTLER VLF TOPHAT CURRENT ON INNER WIRE, INNER PANEL

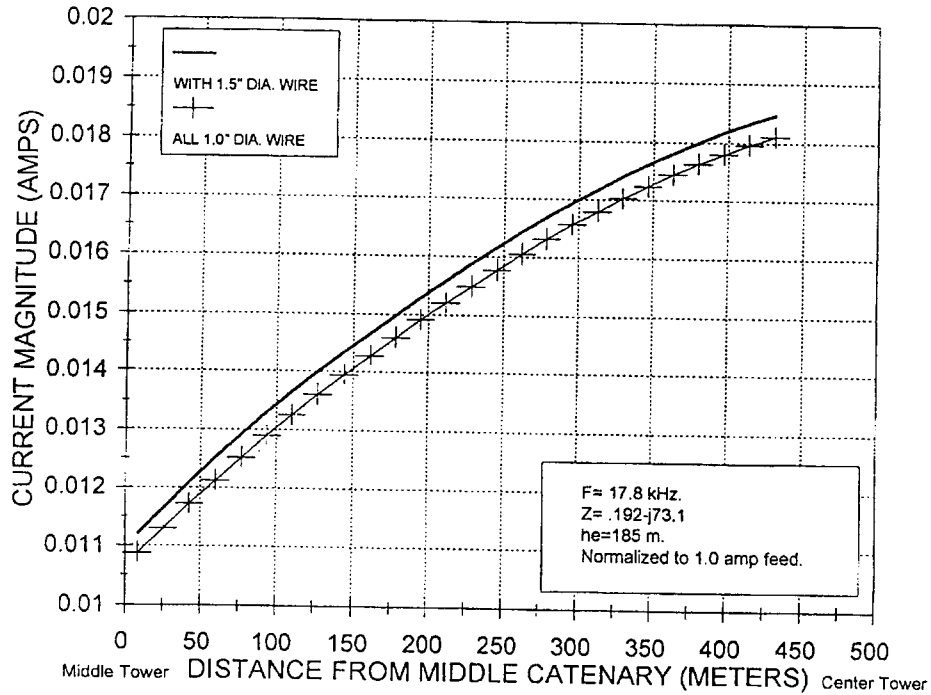

CUTLER VLF TOPHAT CHARGE ON INNER WIRE, INNER PANEL

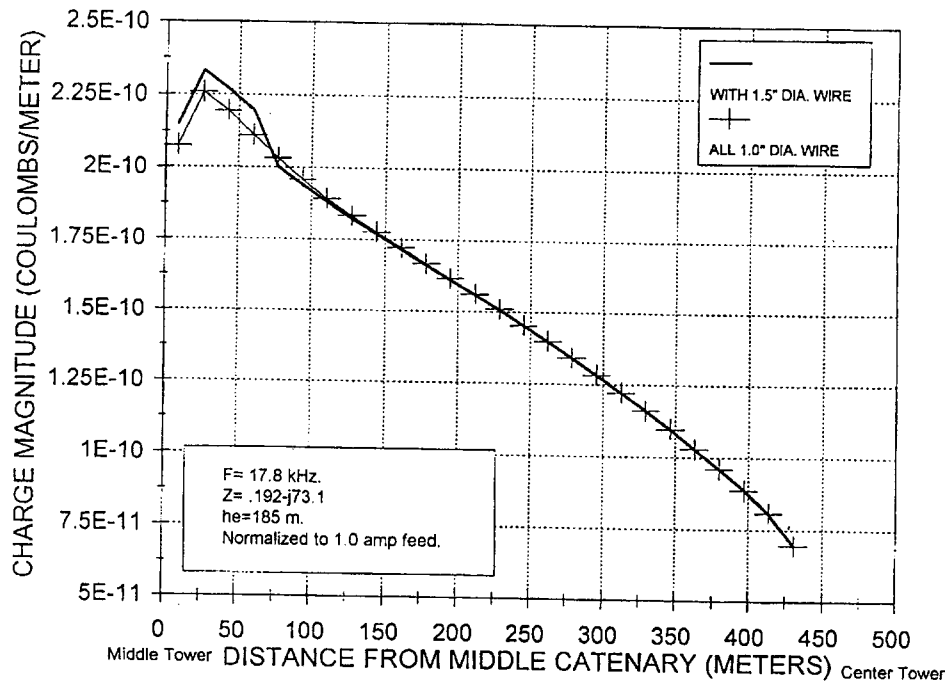

CUTLER VLF TOPHAT CURRENT ON OUTSIDE WIRE, OUTER PANEL

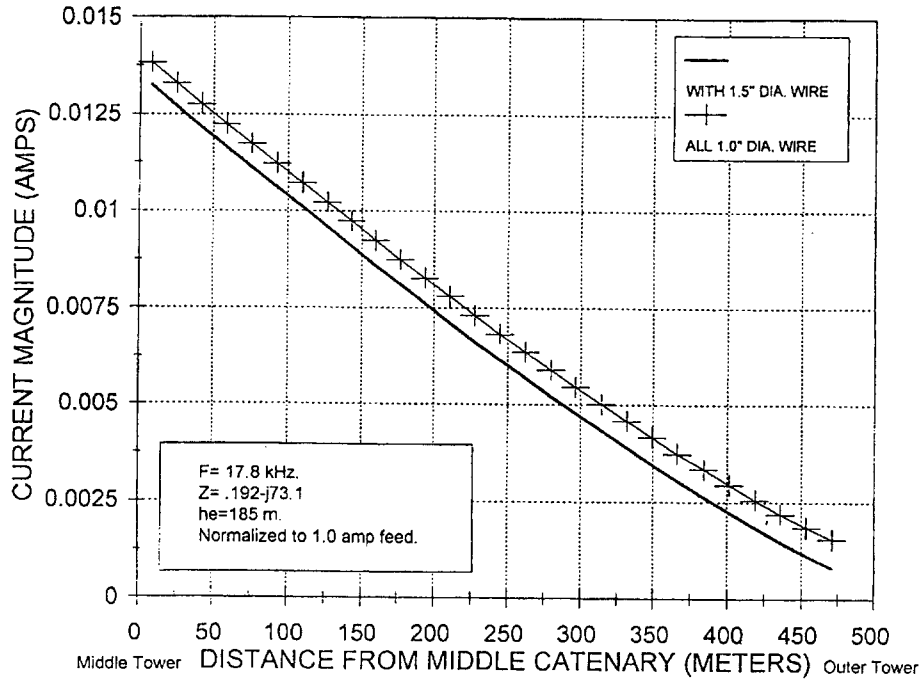

CUTLER VLF TOPHAT CHARGE ON OUTSIDE WIRE, OUTER PANEL

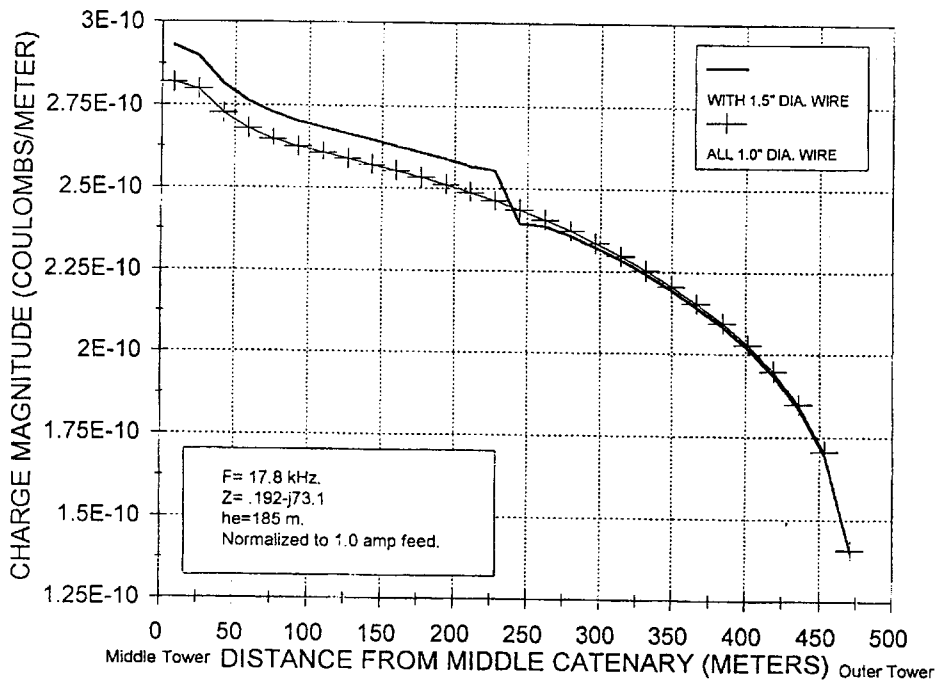

CUTLER VLF TOPHAT CURRENT ON INNER WIRE, OUTER PANEL

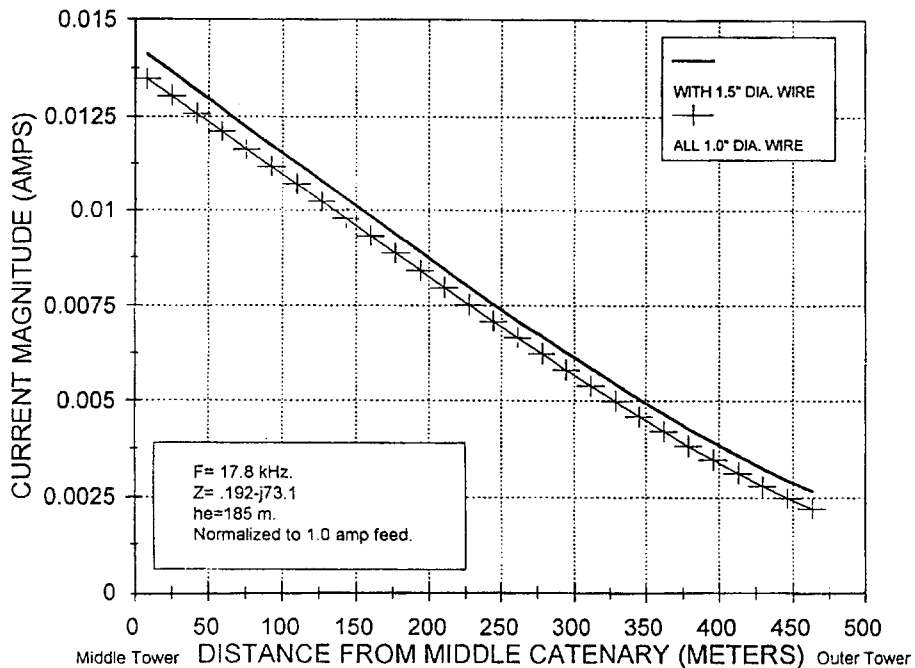

CUTLER VLF TOPHAT CHARGE ON INNER WIRE, OUTER PANEL

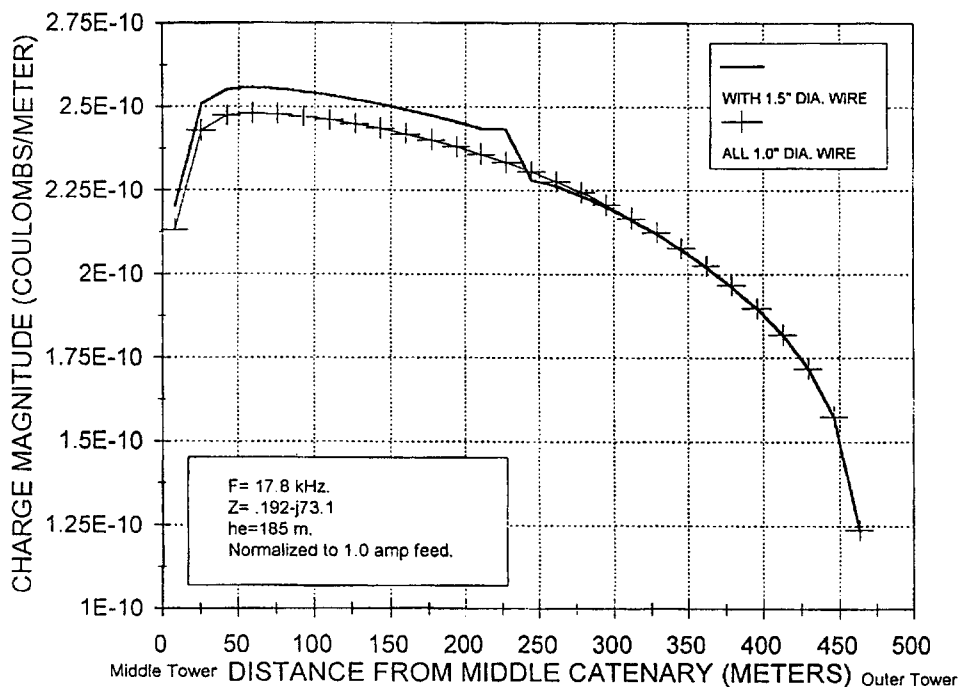

24.0 kHz DATA

CUTLER VLF TOPHAT CURRENT ON OUTSIDE WIRE, INNER PANEL

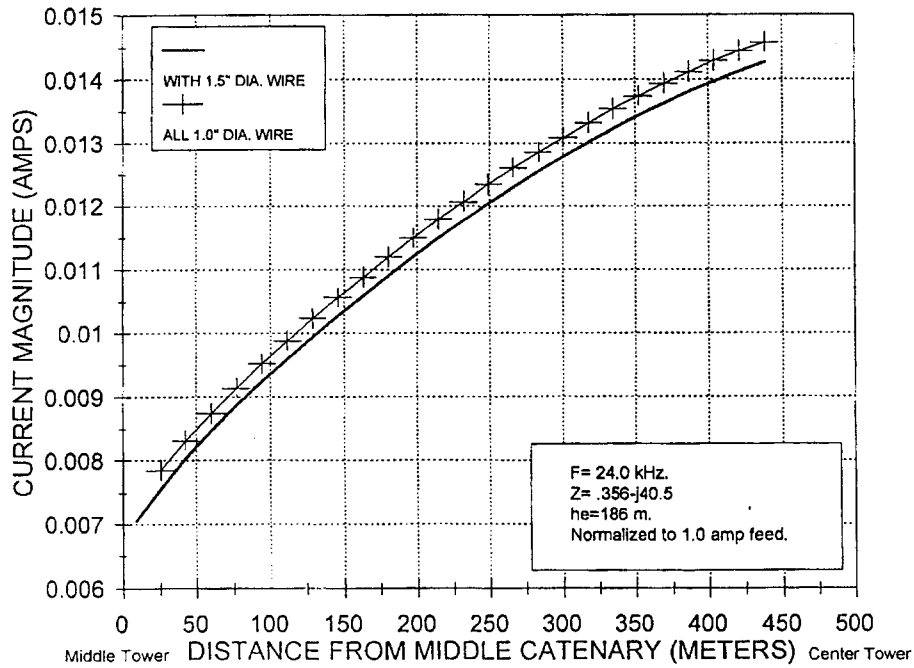

CUTLER VLF TOPHAT CHARGE ON OUTSIDE WIRE, INNER PANEL

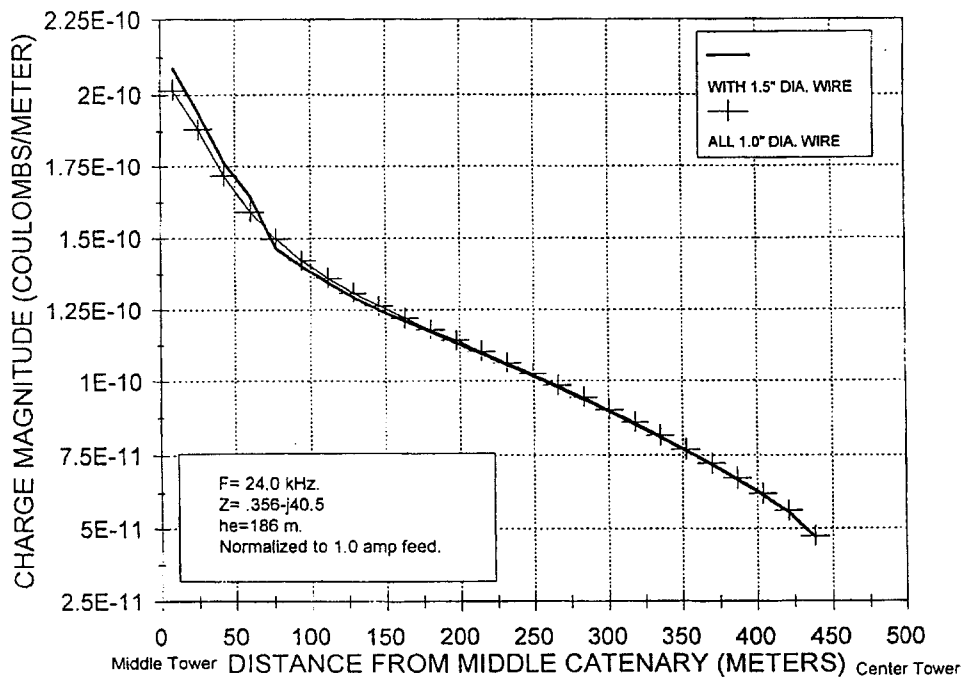

CUTLER VLF TOPHAT CURRENT ON INNER WIRE, INNER PANEL

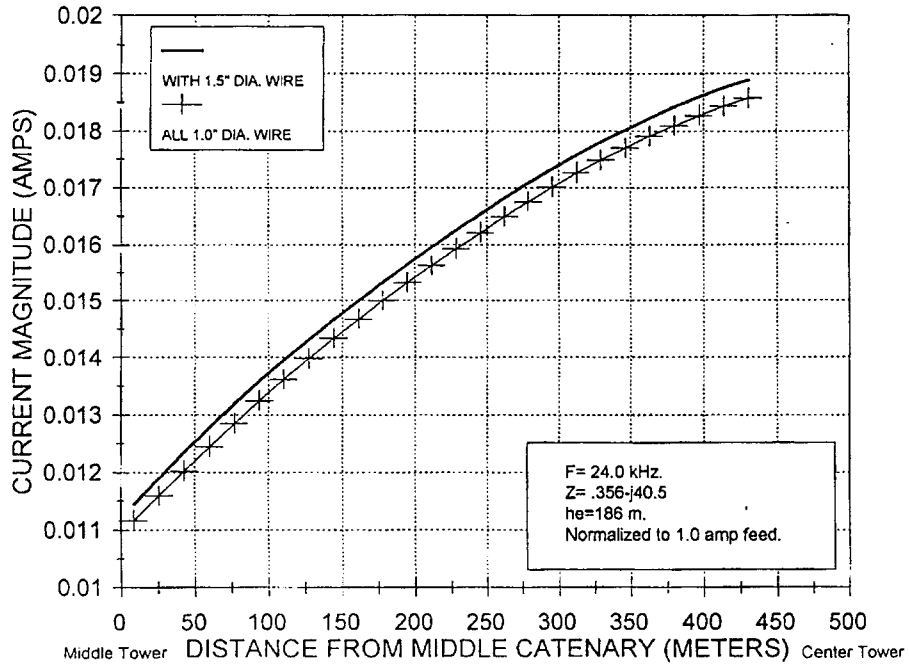

CUTLER VLF TOPHAT CHARGE ON INNER WIRE, INNER PANEL

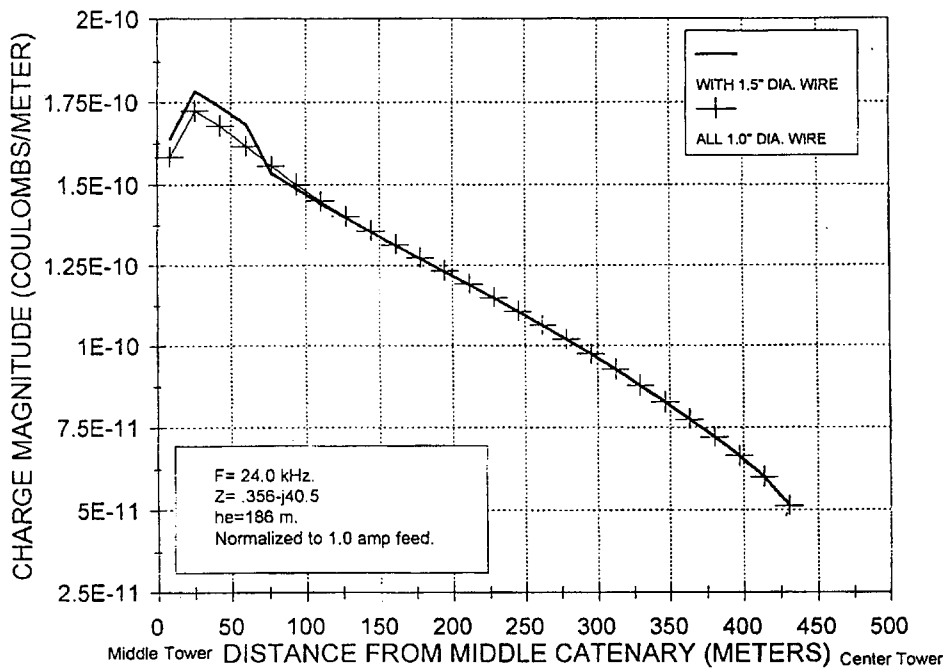

CUTLER VLF TOPHAT CURRENT ON OUTSIDE WIRE, OUTER PANEL

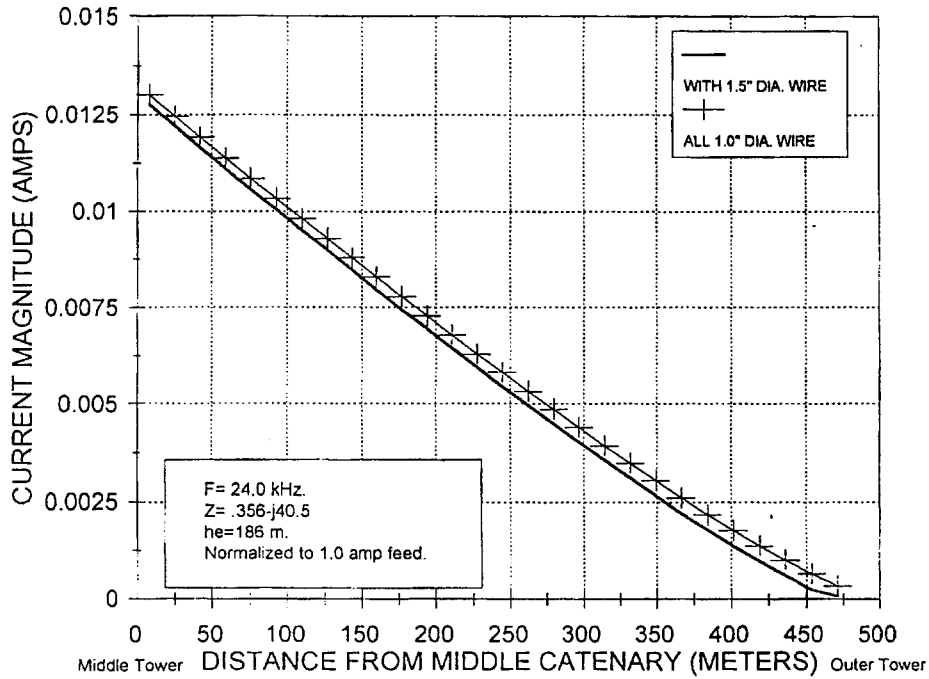

CUTLER VLF TOPHAT CHARGE ON OUTSIDE WIRE, OUTER PANEL

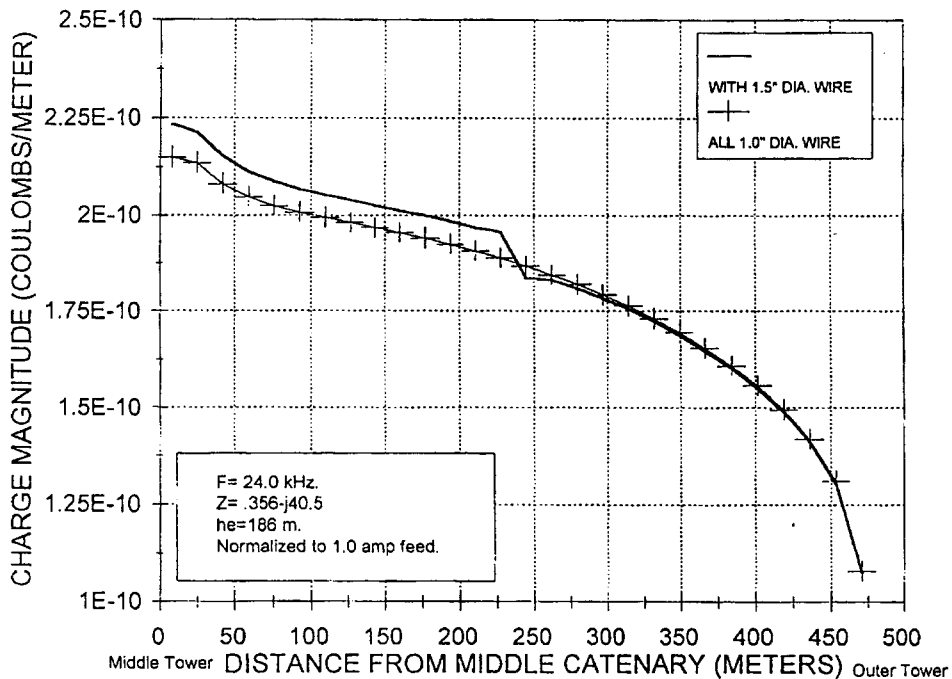

CUTLER VLF TOPHAT CURRENT ON INNER WIRE, OUTER PANEL

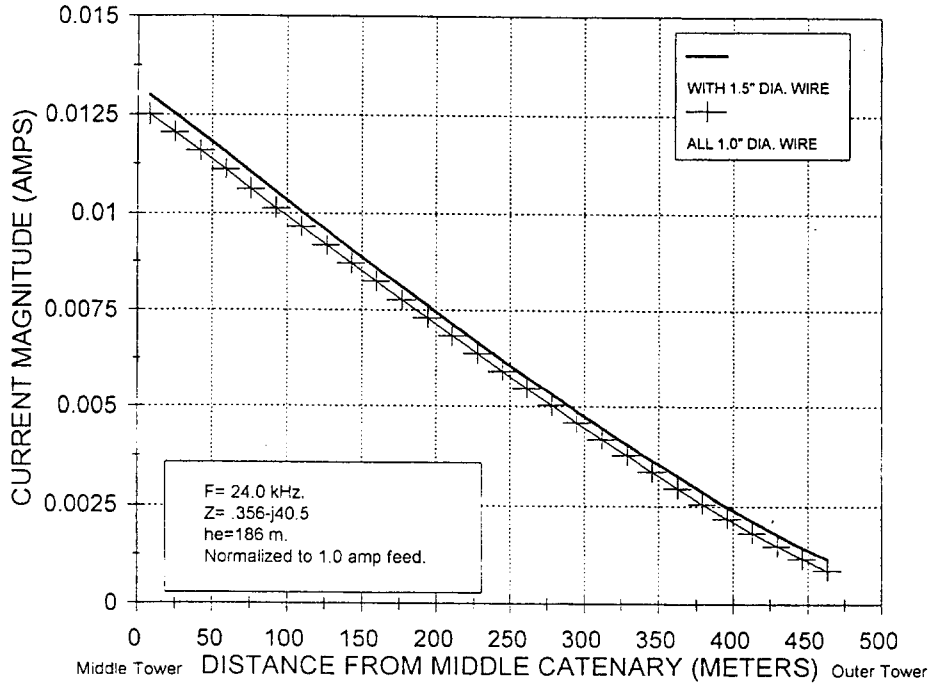

CUTLER VLF TOPHAT CHARGE ON INNER WIRE, OUTER PANEL

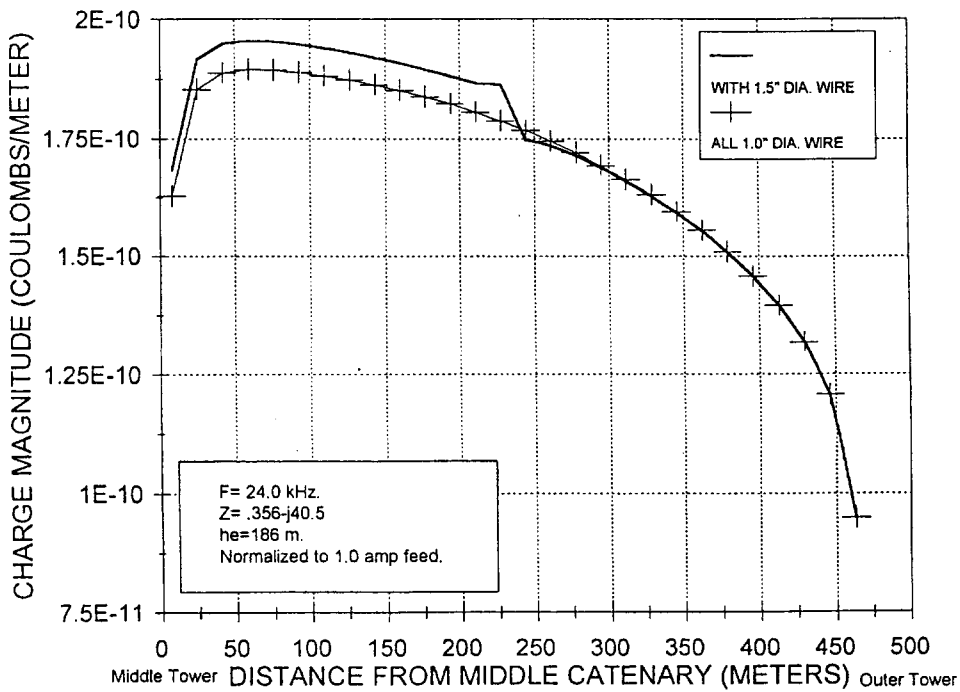

**APPENDIX A
SECTION II**

**A COMPUTER ANALYSIS OF THE USNRS CUTLER VLF ANTENNA
ADDENDUM: 25 FOOT SEPARATION CONFIGURATION**

by

**C. A. Deneris and J. C. Logan
NRaD, Code 824
12 February 1993**

OBJECTIVE

Our objective in this analysis is to compute the change in charge distribution on the VLF antenna at Cutler, Maine, when the separation distance between the outer two panel wires changes from 54 to 25 feet. We wish to determine if the charge decreases for this configuration. As before, we present results at 17.8 kHz and 24.0 kHz. All data are normalized to a 1.0 ampere feed current.

COMPUTER MODEL

Presently, the dual outer wires on the Cutler antenna are 16.5 meters (54 ft) apart at the middle catenary insulator assembly. We modeled this configuration (configuration 2) in our previous analysis. We now investigate the change in charge distribution when the separation decreases to 7.62 meters (25 ft).

As with configuration 2, the small distance between the two extremely long wires forces us to model them as a single wire near the vertex of each panel. However, we have to increase the length of the single wire from approximately 33 meters (108 ft) to 273 meters (895 ft). This is a significant change, but it is necessary to allow NEC-4 to recognize the wires as separate. The segmentation is similar to configuration 2. Charge samples occur at approximately 17 meters (56 ft) intervals. This results in 2829 unknowns. Table 3 summarizes some of the dimensions for this model. The wire numbers correspond to those in figure 4.

Table 3. Dimensions of the NEC-4 Cutler antenna configuration 3 model.

Configuration 3: 25' Separation				
	Inner Panel		Outer Panel	
	Outer Wire (18)	Inner Wire (19)	Outer Wire (9)	Inner Wire (24)
Length (m)	207.4	203.4	480.1	476.3
Radius (m)	0.013	0.013	0.013	0.013

RESULTS

We calculated input impedance and current and charge distributions for the antenna. Table 4 contains the impedance results for both frequencies. The values are very close to those for the previous configurations.

Since we are primarily interested in charge distributions, the attached graphs do not contain any current distribution information. However, these data are available if necessary. The graphs compare the configuration 3 results with those for configuration 2. As before, the charge is plotted as a function of distance from the middle catenary. "Inner Panel" refers to the side of the panel from the middle catenary to the center tower. The "Outer Panel" is the other side.

Table 4. Cutler VLF antenna configuration 3 impedance calculation results.

Configuration 3: 25' Separation	
Frequency (kHz)	Input Impedance (Ω)
17.8	.191-j74.2
24	.355-j41.3

The first two graphs show data for the inner panel wires from the middle catenary until the wires join (200 m). There is an artificial discontinuity at this point resulting from the single wire approximation. Although not appearing in the first two graphs, the discontinuity is shown in the final graph. This graph shows the results for the entire length of the inner panel wires. It clearly shows the jump in both configurations at their respective junctions. Note that the charge for both configurations approaches the same value after the wires have joined. However, since the junctions do not occur at the same place, the charge appears to be much higher in the configuration 3 case.

COMMENTS

Our results indicate a slight decrease ($\cong 3\%$) in the charge magnitude for both inner panel wires when the separation distance is shortened. There is also a slight drop on the outer panel/outer wire distribution. Based on these results, it appears that moving the inner wire closer to the outer wire had the desired effect. However, we have some reservations about the data, and would like to caution against drawing any strong conclusions from the results.

There are two issues that concern us. First, we are unsure how much moving the junction point on the outer wires affected the resulting charge at the end of the wires. It may be incorrect to compare these new results with configuration 2, without first moving the junction point and running that case again. Time and money constraints prevent us from testing this at present. Second, there is a small segment issue along the middle catenary. For this configuration, the distance between the ends of the inner and outer wires is only 7.62 meters ($\cong 10^{-4}\lambda$). While that is not necessarily a problem, we note it as a possible error source.

Charge Magnitude on Inner Panel Wires, 17.8 kHz
 Charge Magnitude on Inner Panel Wires, 24.0 kHz
 Charge Magnitude on Outer Panel Wires, 17.8 kHz
 Charge Magnitude on Outer Panel Wires, 24.0 kHz
 Charge on Inner Panel Wires—Entire Length, 17.8 kHz

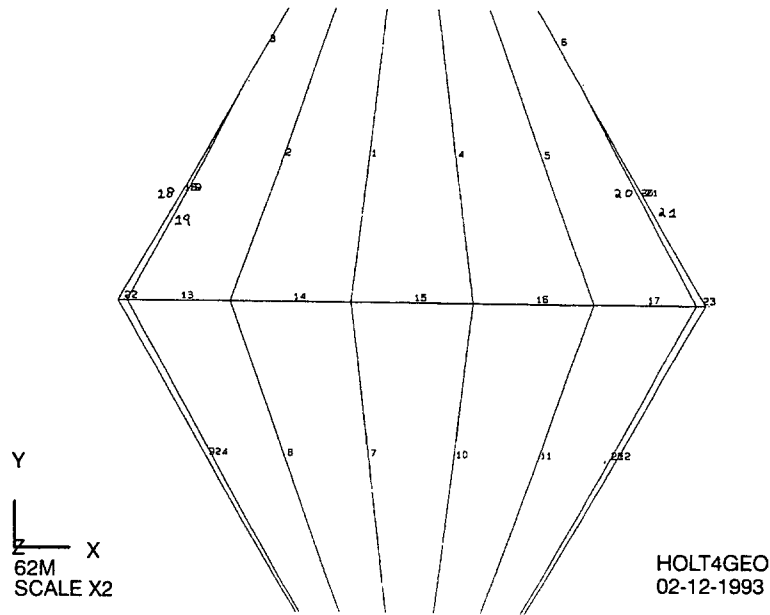
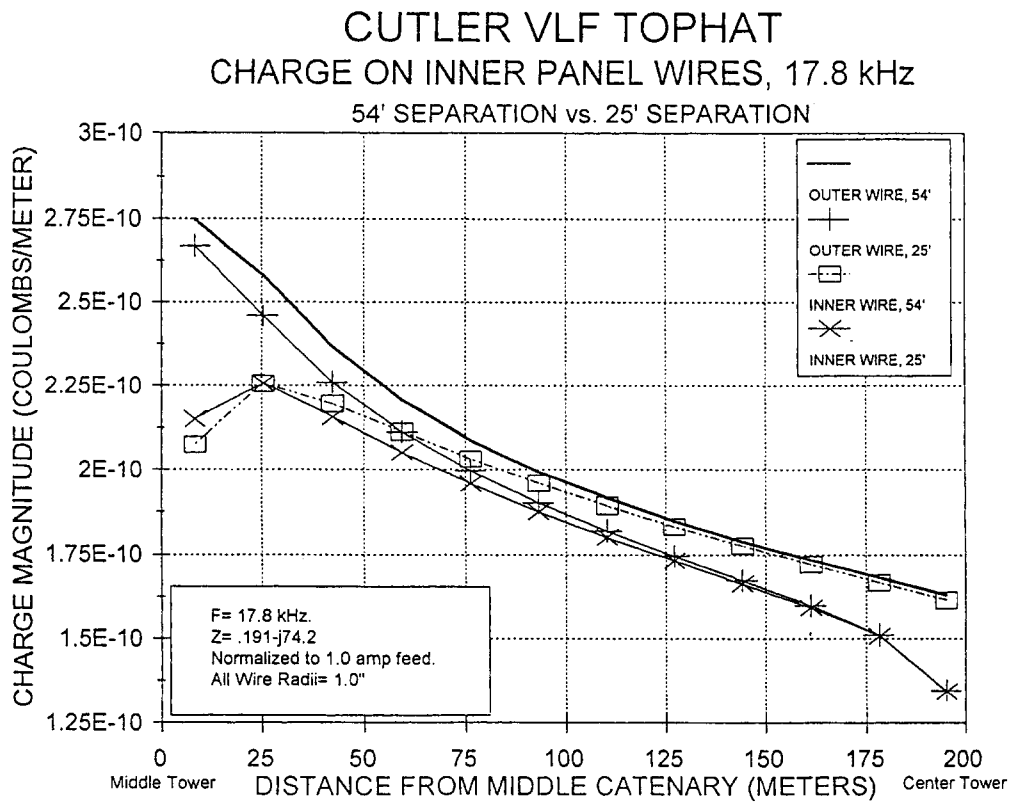

Figure 4. Plan view of a single panel, configuration 3.



CUTLER VLF TOPHAT

CHARGE ON INNER PANEL WIRES, 24.0 kHz

54' SEPARATION vs. 25' SEPARATION

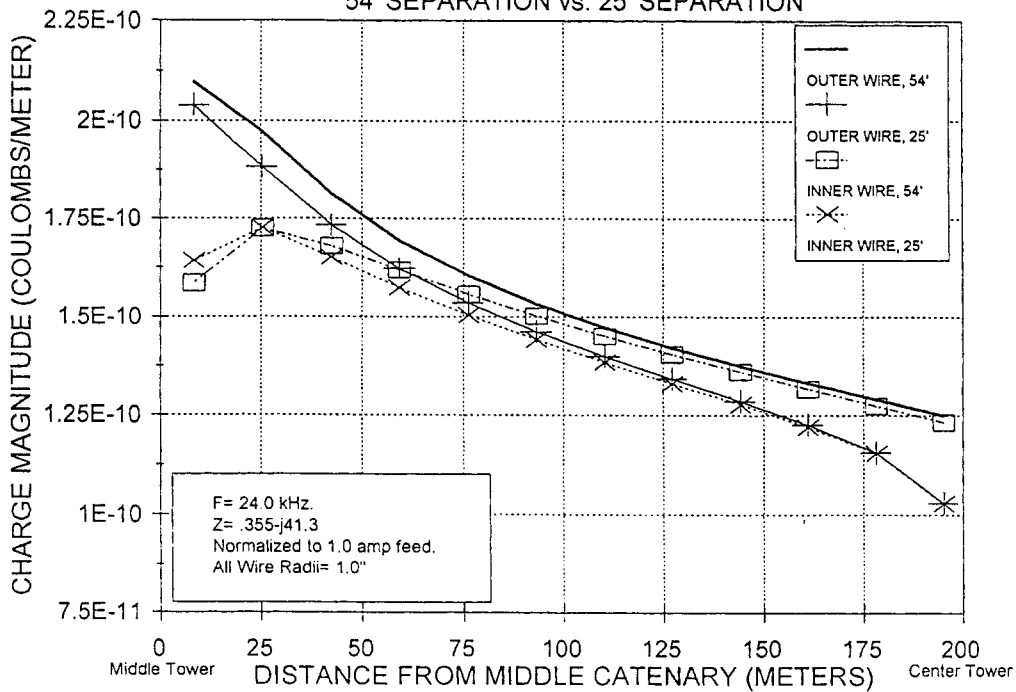

CUTLER VLF TOPHAT

CHARGE ON OUTER PANEL WIRES, 17.8 kHz

54' SEPARATION vs. 25' SEPARATION

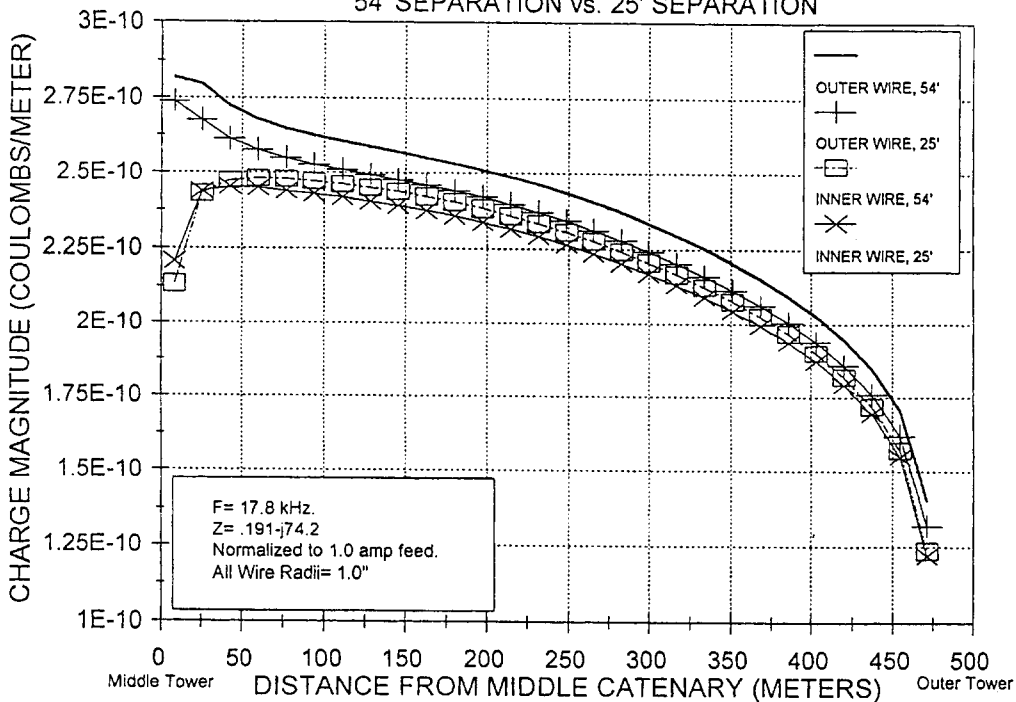

CUTLER VLF TOPHAT CHARGE ON OUTER PANEL WIRES, 24.0 kHz

54' SEPARATION vs. 25' SEPARATION

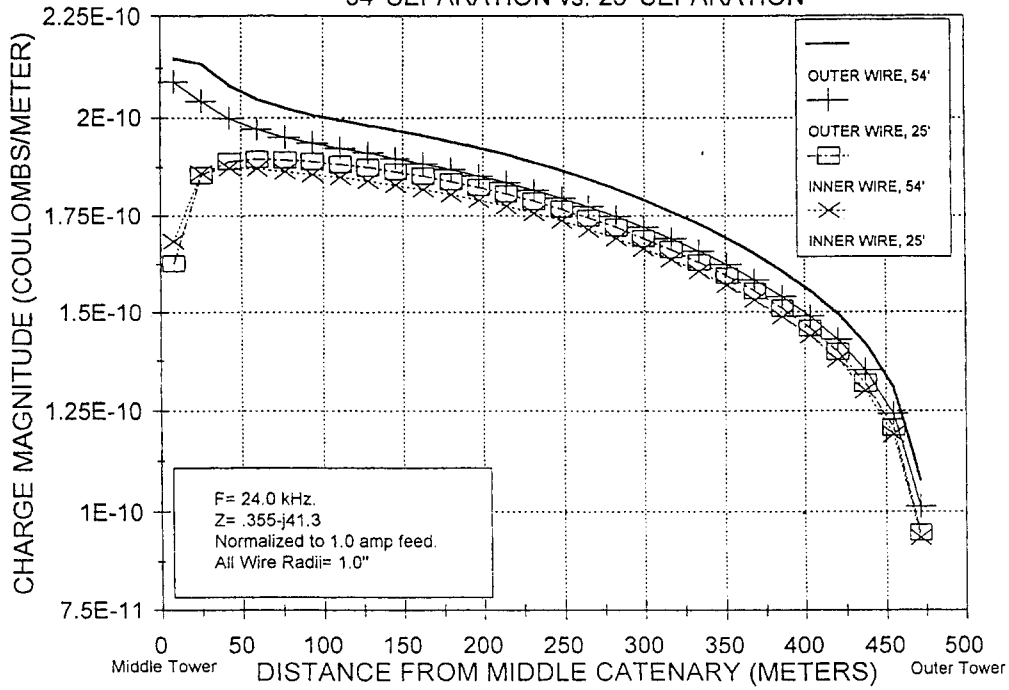

CUTLER VLF TOPHAT CHARGE ON INNER PANEL WIRES, 17.8 kHz

54' SEPARATION vs. 25' SEPARATION

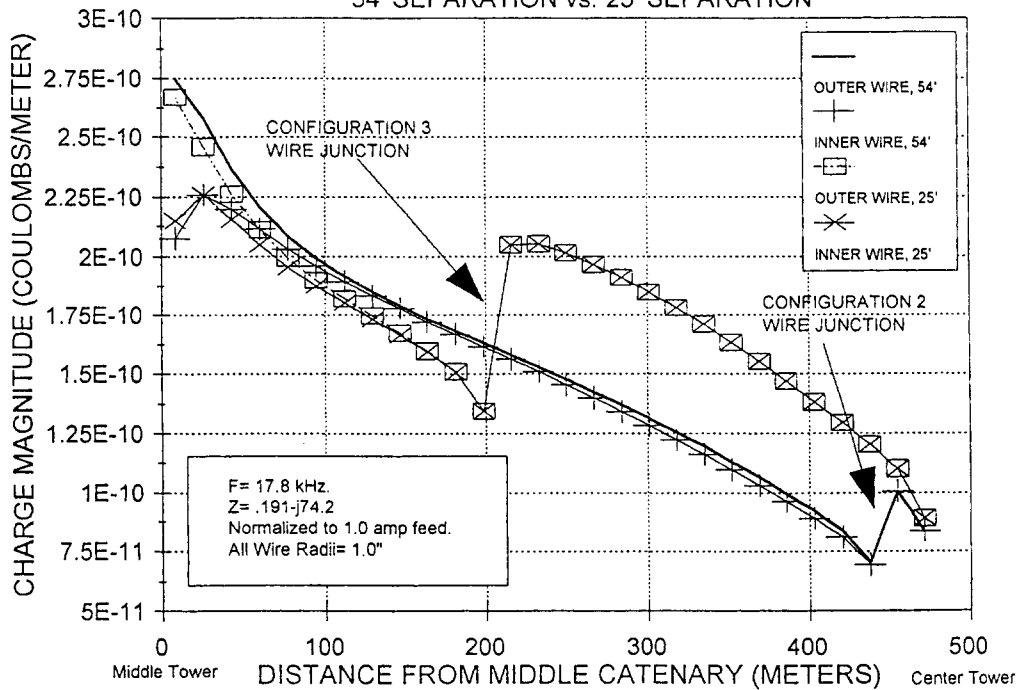

APPENDIX B
BASIS FOR CUTLER CONDUCTOR SELECTION

Prepared by

Kershner, Wright & Hagaman, P.C.
February 12, 1993

1.0 General

The Navy's VLF antenna at Cutler, Maine, consists of two large arrays each array consisting of six elevated, diamond-shaped panels made up mainly of one inch diameter Calsun bronze conductors. Larger diameter (1 1/2 inch) Everdur conductors are used over a portion of each outer panel to provide additional voltage-gradient control within the area of the grounded support towers.

Icing of the antenna panels during the winter is prevented by driving 60 Hz current through the antenna panel conductors. The resistance of the existing conductor alloys was chosen to provide adequate power dissipation from the 60 Hz de-icing current but negligible loss from the VLF antenna current.

The antenna has been operational since Jan. 4, 1961, and for several years radiographic inspection of the Everdur conductors taken during scheduled inspection and maintenance periods has revealed failures of the hollow wires within the interior of the 1 1/2 inch conductors. The failures occur near the conductor termination sockets. The repair necessitates cutting back the Everdur strand that contains the broken wires, installing a longer compression sleeve (to keep the conductor length constant and re-socketing the conductor. Further shortening of the Everdur in this manner is no longer considered to be feasible since the added length of the sleeves cannot accommodate the necessary flexibility at the socket termination.

The objective of this study is to survey currently available conductor materials and recommend a replacement for the existing hollow-core Everdur conductor.

2.0 Conductor Selection

The conductivity of the Calsun bronze alloy is given by Anaconda, the original supplier, as 1.1 E7 mhos/meter.¹ The conductor supplied by them consists of 37 AWG #7 wires and is computed to have a DC resistance of .07224 ohms/1000 ft. An equivalent replacement conductor for the existing Everdur would have a nominal diameter of approximately one and one-half inches and a resistance that would result in the same power dissipation per unit area as that of the existing one-inch Calsun bronze.

It appears that the diameter of the replacement conductor may be reduced. Analysis of a NEC computer study conducted at NRaD, Code 824, which was received during the course of this

¹ Anaconda American Brass Company, Publication B-36, 1962.

study², suggests that the diameter of the replacement conductor can be reduced without exceeding the allowable voltage gradient at 17.8 kHz.

The conductors of the antenna panels are isolated by means of small low-voltage insulators so as to form a series circuit to the 60 Hz de-icing current. The design provides for an average power dissipation of 1.63 watts per square inch of conductor surface.³

The resistance of the existing one-inch Calsun bronze strand is .07224 ohms/1000 ft. The resistance of the replacement cable must be increased by the diameter increase ratio in order to keep the unit de-icing dissipation equal to that of the other panel conductors. For example, if the replacement conductor has a nominal diameter of 1.46 inches (91 #6 wires), the replacement strand should have a resistance of .07224 times 1.46 or .1054 ohms/1000 ft.

3.0 Recommendations

Table I lists the alloy and strand construction of a number of conductors that are electrically suitable for replacement of the existing Everdur conductors. All, except two, require "core wires" of relatively high resistance, non-magnetic stainless steel in order to reach the required conductor resistance for a given conductor diameter. The principal drawback to this approach is the increased cost of fabrication and procurement.

Two conductors listed in Table I that do not require core wires are the 1.46 inch diameter conductor comprised entirely of 61 #6 Everdur wires and the 1.3 inch diameter conductor of 61 #7 Cu. 8.5 wires. Either of these are considered to be satisfactory replacements for the Everdur and are recommended provided they meet the structural requirements. A de-icing current of 920 amperes provides a power dissipation of 1.63 watts/in.² for the existing Calsun bronze conductors and comparable dissipation for the two conductors recommended. The de-icing current is adjustable by the operator to meet the requirements of the weather conditions.

Everdur and Calsun bronze are trademarks of copper alloys held by Anaconda Co. Everdur has a conductivity 6.5% that of copper, and Calsun bronze, 19% that of copper. Copper alloy Cu. 8.5 and Cu. 13 have conductivities of 8.5% and 13% respectively.

² A Computer Analysis of the USNRS Cutler VLF Antenna, C.A. Deneris and J.C. Logan, NRaD, Code 824, January 11, 1993.

³ Recommended Radiation System Design, U.S. Navy VLF Radio Station Cutler Maine, Developmental Engineering Corp., Leesburg, VA, June 28, 1957.

TABLE I
ALLOY AND STRAND MAKEUP FOR CUTLER PANELS

WIRE ALLOY	STRAND DIAMETER	NO. OF WIRES	WIRE AWG	WIRE DIAMETER	STRAND MAKEUP	RES. 1000 FT.	RES. TARGET	RES. DEV.
C65100	1.46	61	#6	.162	24/37*	.10539	.1054	
EVR651	1.46	61	#6	.162	56/5	.10517	.1054	-.2%
Cu. 8.5	1.46	61	#6	.162	38/23	.1048	.1054	-.6%
EVR651	1.46	61	#6	.162	61/0	.09966	.1054	-5.7%
Cu. 8.5	1.3	61	#7	.144	61/0	.09646	.0939	0.25%
Cu. 65100	1.3	61	#7	.144	41/20	.0928	.0939	-1.0%

NOTE:

RES.TARGET is desired resistance

RES./1000 FT. is resistance obtained from strand makeup listed

- Core conductors are stainless steel Alloy #302

APPENDIX C
SHERBURNE METAL PRODUCTS, INC.
QUOTE

Sherburne Metal Products, INC.

Gregory Panagiotakis
Vice President of Marketing
and Technology

40 S. Main Street
P.O. Box 740
Sherburne, NY 13460
Telephone 607/874-4441
Fax 607/874-8878

TO: BOYNTON HAGAMAN

FROM: GREGORY PANAGIOTAKIS

SHERBURNE METALS IS PLEASED TO PRESENT A PROPOSED QUOTE FOR
YOUR CONSIDERATION REGARDING THE SPECIAL CABLE FOR THE ANTENNA.

PRODUCT: 1,600 KCMIL 61/ .162" (37-Wire Core # 302 stainless Steel alloy + 24
Wires # 651 Low Silicon Bronze Alloy) —48,000 Feet.

PRICE: TOTAL CAPITAL EXPENDITURES _____ \$ 85,000 DOLLARS
(ITEMS INCLUDED ARE: PREFORMER,
WIRE STRAIGHTENER, POWER CUTTER AND WELDER.)

MANUFACTURING COSTS:

ROME CABLE _____ \$ 26,768 / 1,000 FT
(MATERIAL COSTS INCLUDING STEEL, ARE INCLUDED)
SHERBURNE METALS _____ \$ 2,708 / 1,000 FT
(COPPER COSTS ARE INCLUDED)

LENGTH OF CABLE IS 48,000 FT.

THEREFORE THE TOTAL COST IS: \$ 85,000
+ 48,000 FT @ 29,478 / 1,000 FT \$ 1,414,848

TOTAL _____ \$ 1,509,848 FOR 48,000 FT.

\$ 31.45

FOB: STATE OF MAINE.

DELIVERY: 180 DAYS AFTER ORDER.

REGARDS

Gregory Panagiotakis
GREGORY PANAGIOTAKIS

RECEIVED
FEB 22 1994

2/22/97

Sherburne Metal Products, INC.

Gregory Panagiotakis
Vice President of Marketing
and Technology

40 S. Main Street
P.O. Box 740
Sherburne, NY 13460
Telephone 807/674-4441
Fax 607/674-6578

TO: PEDER HANSEN
NRAD CODE 832
SAN DIEGO, CA. 92152
TEL (619) 553-4187
FAX (619) 553-4204

SUBJECT: YOUR FAXES OF JULY 30, 1994, & SEPT. 1994.

SHERBURNE METALS IS PLEASED TO PRESENT A PROPOSED QUOTE FOR
YOUR CONSIDERATION REGARDING THE SPECIAL CABLE FOR THE ANTENNA.

PRODUCT: CABLE COMPOSED OF 61 STRANDS OF # 7 GAUGE (.1443 IN.).
MADE OF A CORE OF 19 STRANDS, MADE OF # 302 Stainless Steel alloy,
PLUS 42 STRANDS OF CDA 651 Low Silicon Bronze Alloy.

THE CABLE WILL BE 1.3 IN. DIAMETER +/- 5%
BREAKING STRENGTH TO BE AROUND 67,000 LBS. *SS Core 59,000 Lbs*
DC RESISTANCE TO BE (.0939 +/- .0015) OHMS / 1,000 FT
WEIGHT TO BE APPROXIMATE 3.7 LBS PER FOOT. *3.75*

PRICE : \$727,310 OVER ALL LENGTH 30,000 FT.

COMMENT: SINCE SOME OF THE PARAMETERS OF THE CABLE STATED WERE
DEVELOPED BY OTHERS THAN SHERBURNE WE WISH TO STATE THAT WE
NEED TO DEVELOP AND PRODUCE A 550 FOOT SAMPLE CABLE FOR
EVALUATION ; THE COST OF THIS IS INCLUDED IN THE PRICE. IF WE ARE NOT
SUCCESSFUL WITH THE SAMPLE WE WILL NOT BE ABLE TO DO THE ORDER.

LENGTHS: 2 SEGMENTS OF 560 FEET ON A REEL..

FOB: STATE OF MAINE.

DELIVERY: IF ORDERED BEFORE OCT. 31 1994 , WE WILL HAVE NO
PROBLEM MAKING THE APRIL 30, 1995 DELIVERY DATE.

APPENDIX D
CUTLER TOPLOAD, MULTIWIRED CAGE GRADIENTS

The objective of this work is to estimate the gradient on a small section of multiwire cage placed in the outer two topline conductors of the VLF Cutler antenna near the support catenary. It has been shown that the capacitance of a wire at a certain height above ground in the presence of other wires can be expressed in the same form as that for a single wire above ground, but at a different height, when the other wires are far away with respect to the wire radius (Hansen, see references in main body of report).

$$C_1 = \frac{2\pi\epsilon_0}{\ln\left(\frac{2h'}{a}\right)}, \quad (1)$$

where C_1 is the capacitance per unit length, a is the radius of the wire and h' is the scale height, which is greater than the actual height to account for the effect of the other wires. If there are no other wires nearby, then scale height is equal to actual height.

The charge density q_1 is equal to the voltage times C_1 . Keeping the voltage constant but changing the diameter, examination of equation (1) leads to the similarity relationship relating charge density to wire diameter given in equation (2).

$$\frac{q_1}{q_2} = \frac{\ln(2h'/a_2)}{\ln(2h'/a_1)}. \quad (2)$$

The scale height could be determined by inverting equation (1) directly if charge density, voltage, and wire radius are known. Charge density can be calculated using NEC-IV, but the voltage cannot be calculated. However, given charge density for two different size wires and assuming constant (but unknown) voltage, then scale height can be solved by inverting the similarity relationship which gives the following:

$$2h' = \left\{ \frac{a_1}{a_2} \right\}^{1/\left(\frac{q_1}{q_2} - 1\right)},$$

where q_1 and q_2 are the charge densities for the two conditions and a_1 and a_2 are the respective radii.

Calculations of the Cutler topline gradients have been done using NEC-IV for two different size wires (1 inch and 1.5 inch). For the 14.0 kHz case, these gradients (surface E fields), near the catenary, have the values 1.176 kV/mm for the 1-inch wire and 0.818 kV/m for the 1.5-inch wire (see figure 3 of text). Charge density on a wire is proportional to electric field times radius. Thus, the charge density ratio q_1/q_2 is equal to $(E_1 * a_1)/(E_2 * a_2)$. Substitution of this ratio into equation (2) gives a scale height of 4373 inches or 364 ft.

The total capacitance per unit length C_1 of a cage of wires in the same location is determined by formula similar to that for the capacitance of a single wire,

$$C_1 = \frac{2\pi\epsilon_0}{\ln(2h'/a_{eqC})} ,$$

where a_{eqC} is the cage equivalent radius for capacitance.

The relative charge density on the cage for the same voltage that was present for the other two cases (1-inch and 1.5-inch wires) can be determined from the similarity relationship

$$q_c = q_1 \frac{\ln(2h'/a_{eqC})}{\ln(2h'/a_1)} = q_2 \frac{\ln(2h'/a_{aac})}{\ln(2h'/a_1)} .$$

Given the total charge density, the maximum gradient on a cage is given by the following formula.

$$E_m = \frac{q_1}{n} \left\{ \frac{1}{a} + \frac{n-1}{b+a/2} \right\} ,$$

where n is the number of wires in the cage and b is the radius of the cage (i.e., a circle through the centers of the cage wires).

Gradients on some proposed cages for use in the Cutler toplod have been calculated using the above approach and are given in figure 6 of the main report.

APPENDIX E
MODIFICATIONS TO VLF ANTENNA TOP PANELS

MODIFICATIONS TO VLF ANTENNA TOP PANELS

CUTLER, MAINE

NAVAL COMMUNICATION UNIT

SHEET NO.	SHEET TITLE	NAVFAC DWG. NO.	EFD DWG. NO.
T-1	TITLE SHEET	4300161	400161
G-1	GENERAL REQUIREMENTS & MATERIAL SPECIFICATIONS	4300162	400162
S-1	ANTENNA SITE PLAN	4300163	400163
S-2	ANTENNA ARRAY PERSPECTIVE	4300164	400164
S-3	PANEL PLAN	4300165	400165
S-4	CALSIUM BRONZE - HOLLOWCORE CONNECTION	4300166	400166
S-5	MIDDLE CATERWAY CONNECTION	4300167	400167
S-6	HOLLOWCORE TERMINAL END FITTING DETAIL	4300168	400168
S-7	ARTICULATOR PLATE DETAILS	4300169	400169
S-8	MISCELLANEOUS DETAILS	4300170	400170

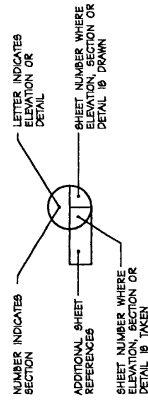

COPIES OF THESE DRAWINGS MAY BE OBTAINED FROM:

ATLANTIC DIVISION
NAVAL FACILITIES ENGINEERING COMMAND
ENGINEERING AND DESIGN DIVISION
1510 GILBERT STREET
NORFOLK, VIRGINIA 23511-2699

PHONE: (804) 444-9918

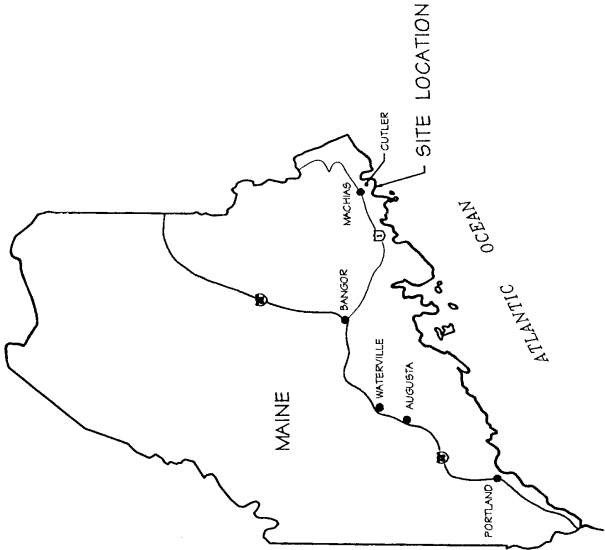

LOCATION MAP

NAVY COMMUNICATION UNIT MODIFICATIONS TO VLF ANTENNA TOP PANELS CUTLER, MAINE		TITLE SHEET 4300161
ATLANTIC DIVISION NAVAL FACILITIES ENGINEERING COMMAND ENGINEERING AND DESIGN DIVISION 1510 GILBERT STREET NORFOLK, VIRGINIA 23511-2699		SHEET NO. T-1 OF 1
LANTIV LANTIV CORPORATION 1000 WEST 10TH AVENUE DENVER, COLORADO 80202		DATE: 10/1/81 DRAWN BY: [Signature] CHECKED BY: [Signature]
REVISIONS NO. DESCRIPTION DATE		PROJECT NO. 4300161

		PROJECT: ANTENNA SITE PLAN CLIENT: NAVY COMMUNICATIONS UNIT LOCATION: CUTLER, MAINE DATE: 1964	DRAWING NO.: 4300113 SHEET NO.: 1 OF 1
REVISIONS NO. DATE DESCRIPTION 1 11/64		PROJECT ENGINEER: [Signature] CHECKED: [Signature] DRAWN: [Signature]	SCALE: 1" = 1000' GRAPHIC SCALE: 0' 1000' 2000' 3000' 4000' 5000'

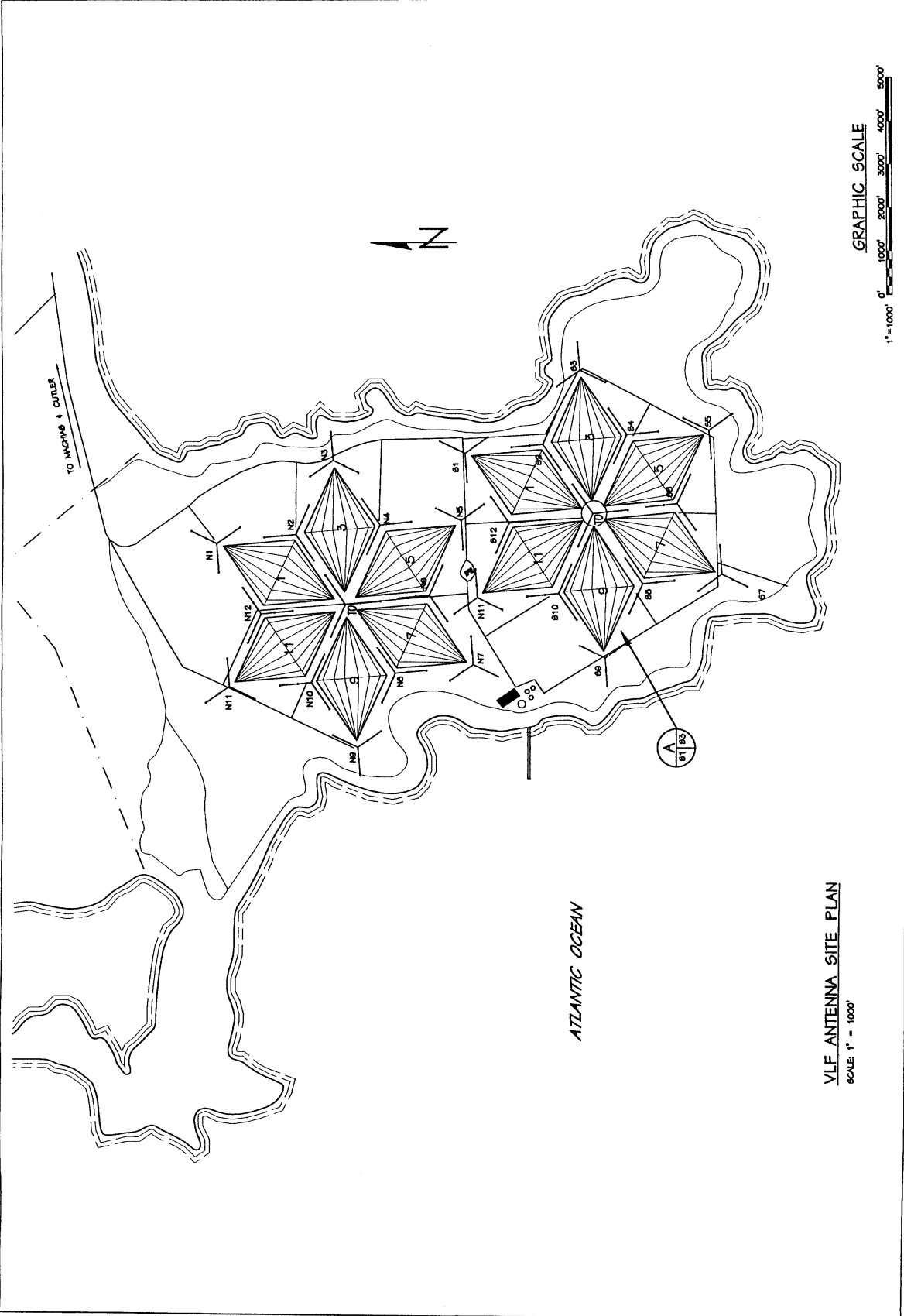

		LANTIV LANTIV CORPORATION 1000 WEST 10TH AVENUE DENVER, COLORADO 80202	
PROJECT: NAVY COMMUNICATION UNIT MODIFICATIONS TO VLF ANTENNA CLIENT: NAVY DRAWING: 6-3		SHEET NO. 1 OF 1 DATE: 10/1/83 DRAWN BY: J. J. [unclear] CHECKED BY: [unclear] APPROVED BY: [unclear]	
REVISIONS NO. DESCRIPTION 1. [unclear]		PANEL PLAN MODIFICATIONS TO VLF ANTENNA	

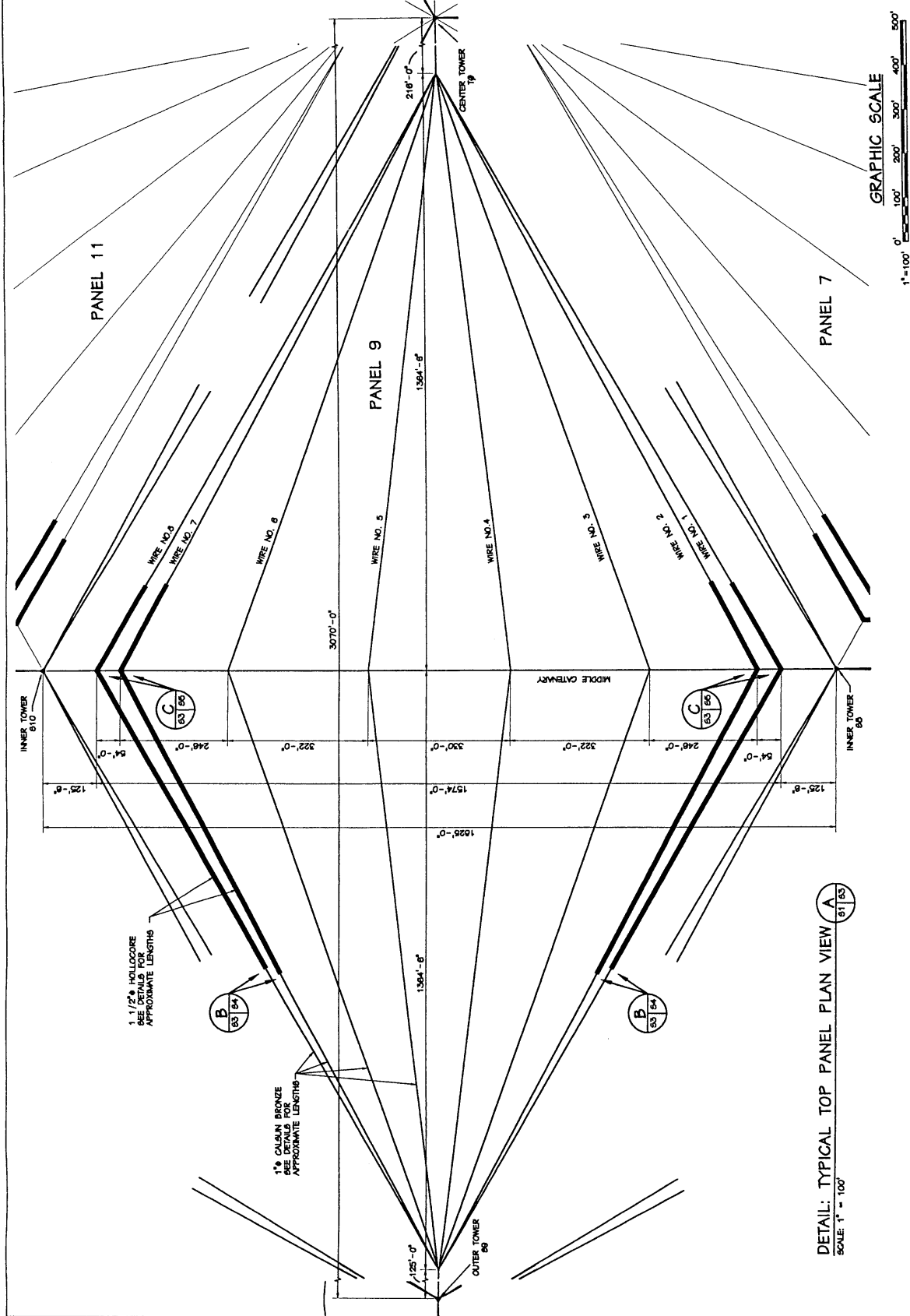

DETAIL: TYPICAL TOP PANEL PLAN VIEW
 SCALE: 1" = 100'

1 1/2" HOLLOWCORE
 SEE DETAILS FOR
 APPROXIMATE LENGTHS

1" GALVAN BRONZE
 SEE DETAILS FOR
 APPROXIMATE LENGTHS

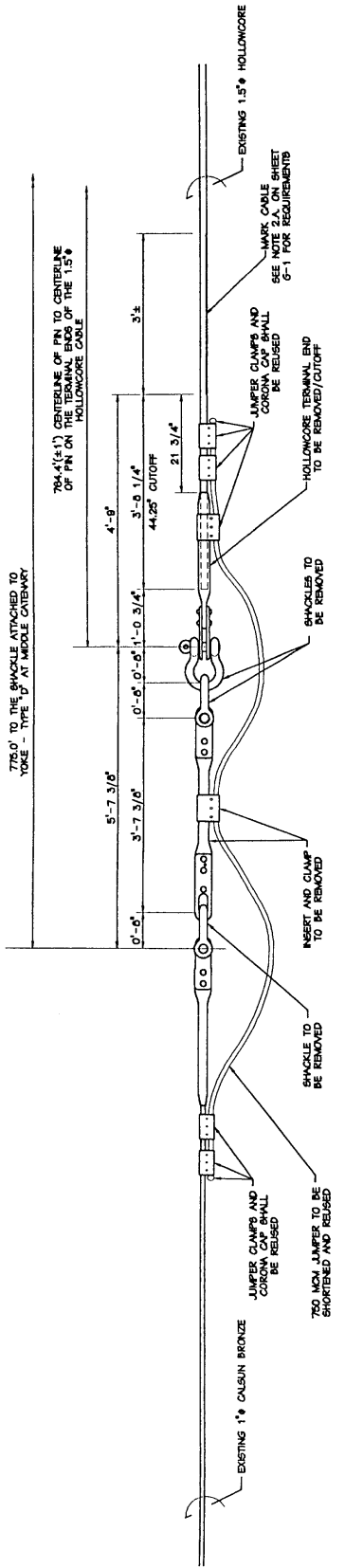

EXISTING CONDITION

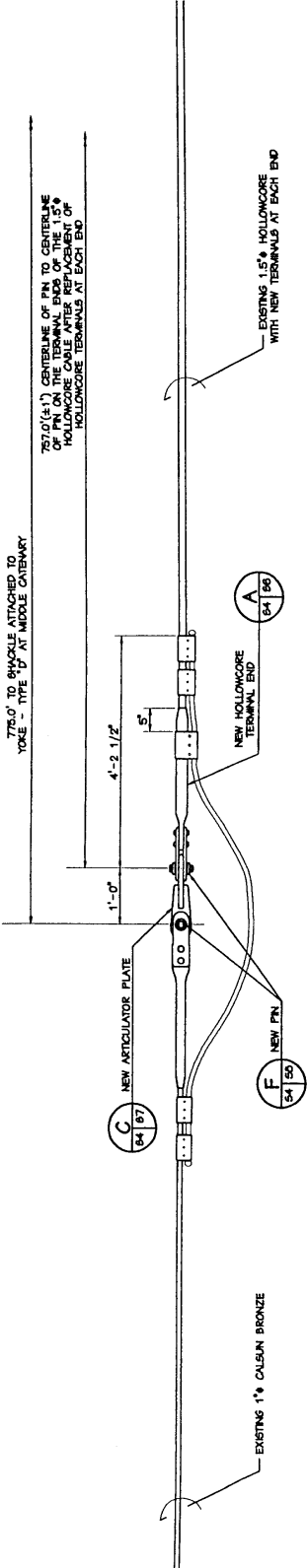

NEW CONDITION

DETAIL: CALSUN BRONZE - HOLLOWCORE CONNECTION
 SCALE: 1" = 1'-0"



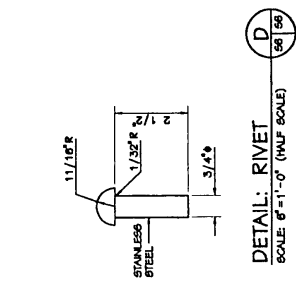
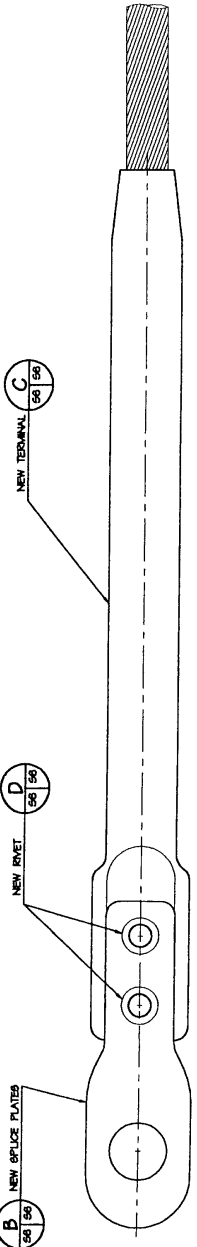
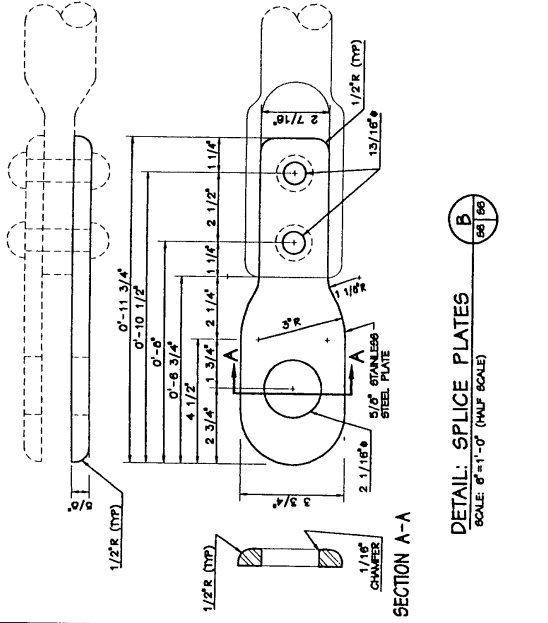
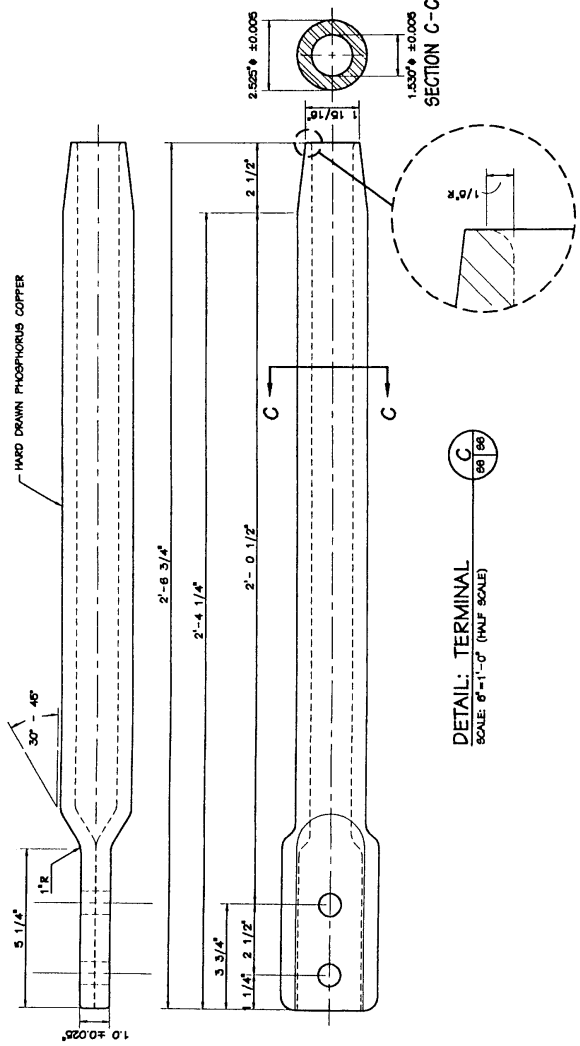

DETAIL: HOLLOWCORE TERMINAL END
 SCALE: 6"=1'-0" (HALF SCALE)

DETAIL: RIVET
 SCALE: 6"=1'-0" (HALF SCALE)

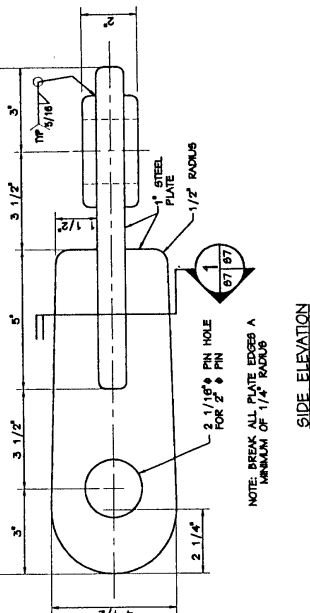
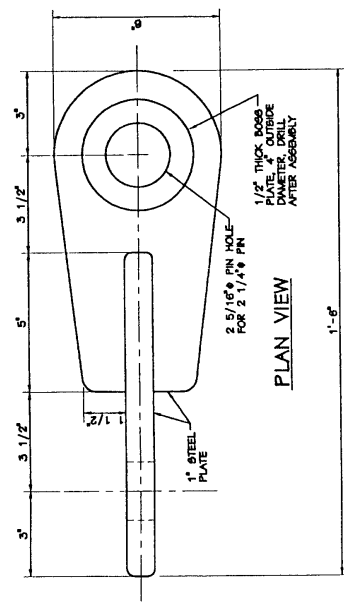

GRAPHIC SCALE

0" 1" 2" 3" 4" 5" 6"

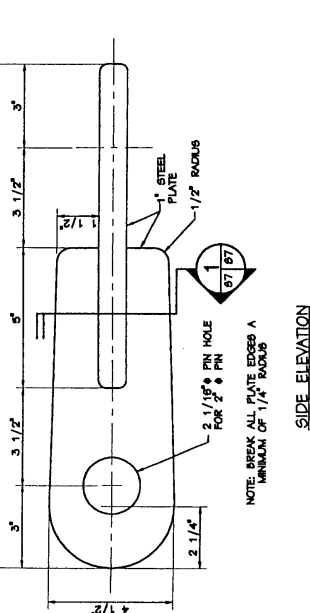
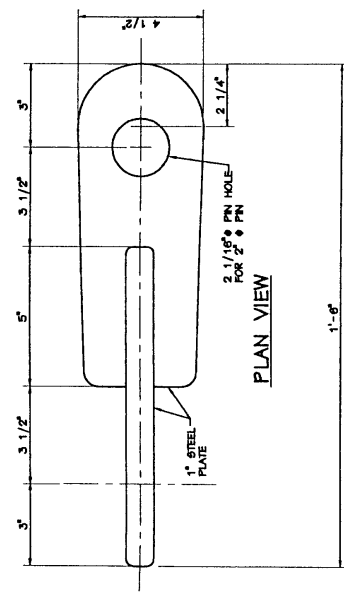
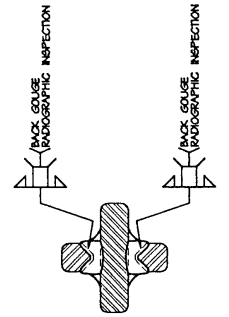

DETAIL C

SCALE: 6" = 1'-0" (HALF SCALE) 64 | 67

21a. NAME OF RESPONSIBLE INDIVIDUAL

P M. Hansen

21b. TELEPHONE (include Area Code)

(619) 553-4187

21c. OFFICE SYMBOL

Code 832

INITIAL DISTRIBUTION

Code 0012	Patent Counsel	(1)
Code 0271	Archive/Stock	(6)
Code 0274	Library	(2)
Code 542	J. A. Ferguson	(1)
Code 824	J. W. Rockway	(1)
Code 824	J. H. Schukantz	(1)
Code 824	J. C. Logan	(1)
Code 832	P. M. Hansen	(5)
Code 832	K. J. Cain	(1)
Code 832	P. A. Singer	(1)
Code 832	P. L. Pelland	(1)
Code 832	D. Lawrence	(1)
Code 893	A. R. Dean	(1)

Defense Technical Information Center Alexandria, VA 22304-6145	(4)	U.S. Naval Security Group Activity CNCTC Representative FPO AE 09419-1002
NCCOSC Washington Liaison Office Washington, DC 20363-5100		Naval Research Laboratory Washington, DC 20375-5000
Center for Naval Analyses Alexandria, VA 22302-0268		COMSUBLANT Norfolk, VA 23511-2492
Navy Acquisition, Research and Development Information Center (NARDIC) Arlington, VA 22244-5114		NCTAMS LANT Norfolk, VA 23511-2199
GIDEP Operations Center Corona, CA 91718-8000		U.S. STRATCOM Offutt AFB, ND 68113-6600
Chief of Naval Operations Washington, DC 20350-2000		U.S. Coast Guard OMEGA Navigation System Center Alexandria, VA 22310-3998
Space and Naval Warfare Systems Command Arlington, VA 22245-5200	(2)	Continental Electronics Manufacturing Dallas, TX 75227
Naval Computer and Telecommunications Command Washington, DC 20394-5460		Electrospace Systems, Inc. Arlington, VA 22202
Naval Electronics Engineering Center Portsmouth, VA 23705		Kershner, Wright & Hagaman Alexandria, VA 22312
Naval Facilities Engineering Service Center Port Hueneme, CA 93043	(2)	Pacific Sierra Research San Diego, CA 92123
Naval Facilities Engineering Service Center Washington, DC 20374-5018		Pacific Sierra Research Arlington, VA 22209
Naval Facilities Engineering Command Norfolk, VA 23511-6287		Consultants: A. N. Smith A. D. Watt W. Gustafson A. Prestholt
Naval Facilities Engineering Command San Bruno, CA 94066		(2)