

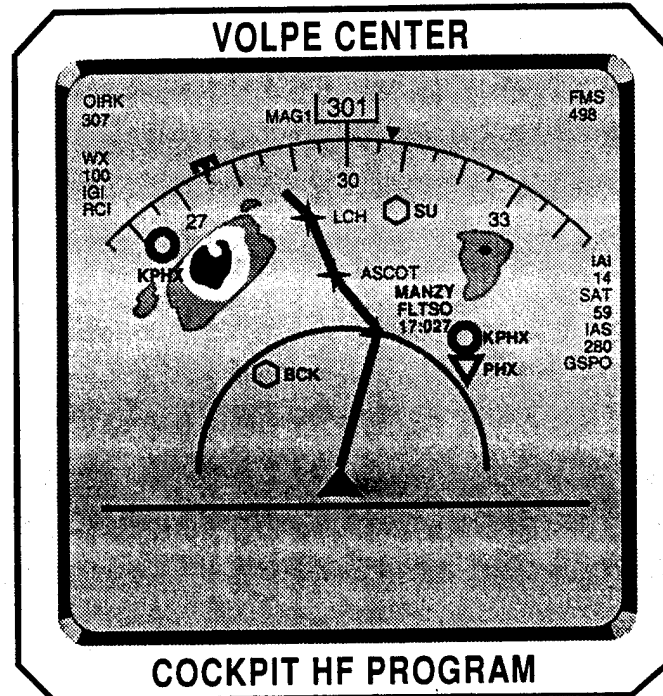

Resource Document for the Design of Electronic Instrument Approach Procedure Displays

DOT/FAA/RD-95/2
DOT-VNTSC-FAA-95-9

Office of Aviation Research
Washington, DC 20591

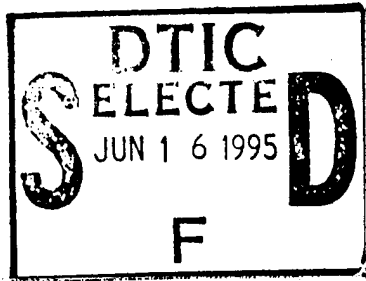

COCKPIT HF PROGRAM

~~Original contains color~~
plates: All DTIC reproductions will be in black and white.

U.S. Department of Transportation
Research and Special Programs Administration
John A. Volpe National Transportation Systems Center
Cambridge, MA 02142

Final Report
March 1995

This document is available to the public through the National Technical Information Service, Springfield, Virginia 22161

This document has been approved for public release and sale; its distribution is unlimited.



U.S. Department of Transportation
Federal Aviation Administration

19950614 002

NOTICE

This document is disseminated under the sponsorship of the Department of Transportation in the interest of information exchange. The United States Government assumes no liability for its contents or use thereof.

NOTICE

The United States Government does not endorse products or manufacturers. Trade or manufacturers' names appear herein solely because they are considered essential to the objective of this report.

REPORT DOCUMENTATION PAGE

Form Approved
OMB No. 0704-0188

Public reporting burden for this collection of information is estimated to average 1 hour per response, including the time for reviewing instructions, searching existing data sources, gathering and maintaining the data needed, and completing and reviewing the collection of information. Send comments regarding this burden estimate or any other aspect of this collection of information, including suggestions for reducing this burden, to Washington Headquarters Services, Directorate for Information Operations and Reports, 1215 Jefferson Davis Highway, Suite 1204, Arlington, VA 22202-4302, and to the Office of Management and Budget, Paperwork Reduction Project (0704-0188), Washington, DC 20503.

1. AGENCY USE ONLY (Leave blank)		2. REPORT DATE March 1995		3. REPORT TYPE AND DATES COVERED Final Report July 1993 - December 1994	
4. TITLE AND SUBTITLE Resource Document for the Design of Electronic Instrument Approach Procedure Displays				5. FUNDING NUMBERS FA5E2/A5007	
6. AUTHOR(S) Melanie C. Wright, Todd Barlow					
7. PERFORMING ORGANIZATION NAME(S) AND ADDRESS(ES) Monterey Technologies, Inc.* 1143G Executive Circle Cary, NC 27511				8. PERFORMING ORGANIZATION REPORT NUMBER DOT-VNTSC-FAA-95-9	
9. SPONSORING/MONITORING AGENCY NAME(S) AND ADDRESS(ES) U.S. Department of Transportation Federal Aviation Administration Research and Development Service Washington, DC 20591				10. SPONSORING/MONITORING AGENCY REPORT NUMBER DOT/FAA/RD-95/2	
11. SUPPLEMENTARY NOTES *under contract to: U.S. Department of Transportation Research and Special Programs Administration John A. Volpe National Transportation Systems Center Cambridge, MA 02142					
12a. DISTRIBUTION/AVAILABILITY STATEMENT This document is available to the public through the National Technical Information Service, Springfield, VA 22161				12b. DISTRIBUTION CODE	
13. ABSTRACT (Maximum 200 words) Instrument approach procedure (IAP) charts play a large role in contributing to the success or failure of approaches and landings. Paper IAP charts have been criticized for excessive clutter, for text sizes that are too small to read, and for inadequate terrain representation. The electronic presentation of approach information may counteract these criticisms by providing automatic or pilot controlled filtering of the information displayed. However, without careful attention to human factors issues early in the design and development of electronic IAPs (EIAPs), new problems may result. The goal of this project was to develop preliminary guidelines for designers and certifiers of EIAPs to assure that EIAPs help rather than hinder pilots during approach and landing. To identify potential human factors problems in the design of EIAPs, current paper IAP charts and the instrument approach task were studied. Pilots were interviewed and literature describing the information requirements of the task and the cognitive implications of the task were reviewed. A cognitive task analysis was performed. Specific features and functions were identified that may be beneficial to an EIAP. Literature was reviewed in the areas of cognitive psychology, human-computer interaction, and aviation to identify design concepts and principles for the design of these features and functions. Guidelines were developed from the design concepts and principles and, finally, prototypes of EIAPs were designed in accordance with the new guidelines. DTIC QUALITY INSPECTED 3					
14. SUBJECT TERMS instrument approach procedures, electronic displays, human factors, cognitive design guidelines, human-computer interaction, terrain displays, cockpit displays, display clutter, display dynamics, aviation human factors.				15. NUMBER OF PAGES 242	
				16. PRICE CODE	
17. SECURITY CLASSIFICATION OF REPORT Unclassified		18. SECURITY CLASSIFICATION OF THIS PAGE Unclassified		19. SECURITY CLASSIFICATION OF ABSTRACT Unclassified	
20. LIMITATION OF ABSTRACT					

PREFACE

This report is the culmination of the second phase of a contract to identify guidelines for the design of electronic instrument approach procedure displays (EIAPs). It combines the knowledge gained in phase I of the project on the operational aspects of the instrument approach procedure task and key cognitive issues in the design of EIAPs with information available in human-computer interaction literature. This document identifies general human-computer interaction principles for the design of EIAPs and guidelines for implementation of specific features and functions on an EIAP.

This report is submitted by Monterey Technologies, Inc. under a contract with Battelle (Subcontract No. 38125(4529)-2183). Dr. Michael McCauley served as the Program Manager for Monterey Technologies, Inc. Additional operational and human factors guidance for this project was provided by Mr. Stephen Werts and Mr. Donald Vreuls. The contributions of Dr. McCauley, Mr. Werts, and Mr. Vreuls are greatly appreciated by the author.

This project is part of a continuing effort at the John A. Volpe National Transportation Systems Center to develop human factors design guidelines for electronic depiction of instrument approach procedures. Dr. M. Stephen Huntley directed this research for the Volpe Center. Mr. Donald Eldredge of Battelle acted as Program Manager for Battelle. Dr. Daniel Hannon of Battelle also provided invaluable insight into the development of this report. The author appreciates the support of Dr. Huntley of the Volpe Center and of Mr. Eldredge and Dr. Hannon of Battelle.

This work was funded by the FAA's Human Factors Program under the Office of Chief Scientific and Technical Advisor for Human Factors.

Accession For	
NTIS CRA&I	<input checked="" type="checkbox"/>
DTIC TAB	<input type="checkbox"/>
Unannounced	<input type="checkbox"/>
Justification	
By	
Distribution /	
Availability Codes	
Dist	Avail and/or Special
A-1	

METRIC/ENGLISH CONVERSION FACTORS

ENGLISH TO METRIC

LENGTH (APPROXIMATE)

1 inch (in) = 2.5 centimeters (cm)
 1 foot (ft) = 30 centimeters (cm)
 1 yard (yd) = 0.9 meter (m)
 1 mile (mi) = 1.6 kilometers (km)

METRIC TO ENGLISH

LENGTH (APPROXIMATE)

1 millimeter (mm) = 0.04 inch (in)
 1 centimeter (cm) = 0.4 inch (in)
 1 meter (m) = 3.3 feet (ft)
 1 meter (m) = 1.1 yards (yd)
 1 kilometer (k) = 0.6 mile (mi)

AREA (APPROXIMATE)

1 square inch (sq in, in²) = 6.5 square centimeters (cm²)
 1 square foot (sq ft, ft²) = 0.09 square meter (m²)
 1 square yard (sq yd, yd²) = 0.8 square meter (m²)
 1 square mile (sq mi, mi²) = 2.6 square kilometers (km²)
 1 acre = 0.4 hectare (he) = 4,000 square meters (m²)

AREA (APPROXIMATE)

1 square centimeter (cm²) = 0.16 square inch (sq in, in²)
 1 square meter (m²) = 1.2 square yards (sq yd, yd²)
 1 square kilometer (km²) = 0.4 square mile (sq mi, mi²)
 10,000 square meters (m²) = 1 hectare (he) = 2.5 acres

MASS - WEIGHT (APPROXIMATE)

1 ounce (oz) = 28 grams (gm)
 1 pound (lb) = 0.45 kilogram (kg)
 1 short ton = 2,000 pounds (lb) = 0.9 tonne (t)

MASS - WEIGHT (APPROXIMATE)

1 gram (gm) = 0.036 ounce (oz)
 1 kilogram (kg) = 2.2 pounds (lb)
 1 tonne (t) = 1,000 kilograms (kg) = 1.1 short tons

VOLUME (APPROXIMATE)

1 teaspoon (tsp) = 5 milliliters (ml)
 1 tablespoon (tbsp) = 15 milliliters (ml)
 1 fluid ounce (fl oz) = 30 milliliters (ml)
 1 cup (c) = 0.24 liter (l)
 1 pint (pt) = 0.47 liter (l)
 1 quart (qt) = 0.96 liter (l)
 1 gallon (gal) = 3.8 liters (l)
 1 cubic foot (cu ft, ft³) = 0.03 cubic meter (m³)
 1 cubic yard (cu yd, yd³) = 0.76 cubic meter (m³)

VOLUME (APPROXIMATE)

1 milliliter (ml) = 0.03 fluid ounce (fl oz)
 1 liter (l) = 2.1 pints (pt)
 1 liter (l) = 1.06 quarts (qt)
 1 liter (l) = 0.26 gallon (gal)
 1 cubic meter (m³) = 36 cubic feet (cu ft, ft³)
 1 cubic meter (m³) = 1.3 cubic yards (cu yd, yd³)

TEMPERATURE (EXACT)

$$[(x-32)(5/9)]^{\circ}\text{F} = y^{\circ}\text{C}$$

TEMPERATURE (EXACT)

$$[(9/5)y + 32]^{\circ}\text{C} = x^{\circ}\text{F}$$

QUICK INCH - CENTIMETER LENGTH CONVERSION

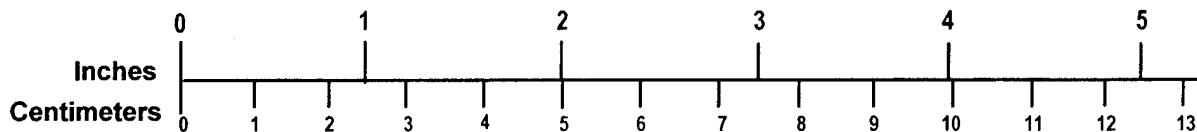

QUICK FAHRENHEIT - CELSIUS TEMPERATURE CONVERSION

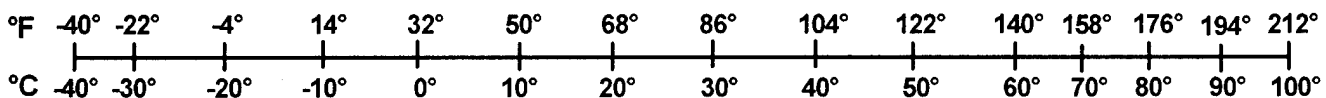

For more exact and or other conversion factors, see NBS Miscellaneous Publication 286, Units of Weights and Measures.
 Price \$2.50 SD Catalog No. C13 10286

Updated 1/23/95

TABLE OF CONTENTS

<u>Section</u>	<u>Page</u>
1. INTRODUCTION	1
2. THE INSTRUMENT APPROACH TASK	5
2.1 Description of the Instrument Approach Task	5
2.2 Information Requirements of the Instrument Approach Task	8
2.3 Cognitive Implications of the Instrument Approach Task	12
3. GENERAL HUMAN-COMPUTER INTERACTION PRINCIPLES	15
3.1 Know the User and the Task	16
3.2 Consistency	21
3.3 Directness (No Interpretation)	23
3.4 Visibility	26
3.5 Limit the Number of Modes	29
3.6 Pilot Control	32
3.7 Simplicity	35
3.8 Forgiveness	38
3.9 Feedback	41
3.10 Locate and Group Information in a Meaningful Manner (e.g., by Function, Importance, Sequence, and Frequency)	44
4. FEATURES AND FUNCTIONS	47
How is Information Displayed or Coded?	
4.1 Alphanumerics/Text	49
4.2 Symbols/Icons	53
4.3 Color	58
4.4 Size, Highlighting	63
4.5 Labels, Legends	66
4.6 Aircraft Location, Planned Route, Current Path Depiction	70
4.7 Terrain Displays, Ground and Obstacle Clearance Information	73
4.8 Auditory Displays (Audible Codes, Voice Output)	78
How is Information Grouped and Arranged?	
4.9 Windows/Pages	83
4.10 Menus	88

TABLE OF CONTENTS (cont.)

<u>Section</u>	<u>Page</u>
4.11 Frame of Reference	97
4.12 Invariant Display Areas	101
4.13 Strategies of Grouping Information	104
4.14 Methods for Grouping Information	110
4.15 Map Scale	116
4.16 Design for Appropriate Task/Phase of Flight (e.g., Design for Planning, Design for Final Approach)	119
4.17 Minimizing Errors, Minimizing Effects of Interruptions, Error Recovery	123
4.18 Integration With Other Cockpit Systems	127
How Does the Display Change (by Pilot or Automatically)?	
4.19 Input Devices	130
4.20 Pilot Control of Displays and Custom Displays	136
4.21 Zooming	141
4.22 Scrolling and Panning	146
4.23 Display Dynamics	150
4.24 Declutter - Layering Information, Minimizing Information	153
4.25 Automation	157
4.26 Memory Aids, Sequence Reminders, Highlighting	163
4.27 Airport/NAVAID Search	168
5. PROTOTYPE ELECTRONIC INSTRUMENT APPROACH PROCEDURE DISPLAYS	171
5.1 Current Paper IAP Charts	172
5.2 Prototype 1 - Touch to Zoom, Configuration Specific EIAP	177
5.3 Prototype 2 - Discrete Pilot Choices for Declutter	183
5.4 Prototype 3 - Visible, Conventional Controls During Approach	189
6. CHECKLIST	195
7. REFERENCES	209
8. INDEX	217

LIST OF FIGURES

<u>Figure</u>		<u>Page</u>
1-1	Current Paper IAP Chart	2
2-1	Phases of the Approach	6
4-1	Linear Sequential Menus	89
4-2	Simultaneous Menus	90
4-3	Hierarchical Menus	90
4-4	Connected Graph Menus	92
4-5	Event Trapping Menus	92
5-1	NOAA Paper IAP Chart	176
5-2	Prototype EIAP 1	181
5-3	Prototype EIAP 1 in Color	182
5-4	Prototype EIAP 2	188
5-5	Prototype EIAP 3	193

LIST OF TABLES

<u>Table</u>		<u>Page</u>
2-1	Information Requirements for the IAP Task	11
4-1	CIE UCS Units for Eight Colors	60
4-2	Identifiable Auditory Dimensions	81
4-3	Considerations for Identifying the Best Strategy of Grouping Information	106
4-4	Considerations for Determining the Best Method of Grouping Related Information	113
4-5	Information Prioritization Based on Phase of Flight	119

ACRONYMS/ABBREVIATIONS

AMA	area minimum altitude
ARP	Aerospace Recommended Practice
AS	Aerospace Standard
ATC	air traffic control
ATIS	automatic terminal information service
CIE	Commission Internationale de l'Eclairage
DH	decision height
DME	distance measuring equipment
EFIS	electronic flight instrument system
EIAP	electronic instrument approach procedure
EHSI	electronic horizontal situation indicators
FAA	Federal Aviation Administration
FMS	flight management systems
GPWS	ground proximity warning systems
GS	glide slope
HCI	human-computer interaction
IAP	instrument approach procedure
IFR	Instrument Flight Rules
ILS	instrument landing system
IM	intermediate marker
MAP	missed approach point
MDA	minimum descent altitude
MEA	minimum enroute altitude
MM	middle marker
MSA	minimum safe altitude
NAVAID	navigation aid
ND	navigation displays
NDB	non-directional beacon
NM	nautical miles
NOAA	National Oceanic and Atmospheric Administration
NOS	National Ocean Service
SAE	Society of Automotive Engineers
STAR	standard terminal arrival route
TACAN	tactical air navigation
UCS	Uniform Chromaticity System
VOR	very high frequency omnidirectional range
VORTAC	colocated VOR and TACAN NAVAIDs

EXECUTIVE SUMMARY

Approach and landing are considered to be the most difficult phases of flight. Twenty-five to fifty percent of aircraft accidents occur during the approach and landing phases of flight (Baker, Lamb, Guohua, and Dodd, 1993; Blanchard, 1991). Both pilots (Friend, 1988) and researchers (Taylor and Hopkins, 1975; Mykityshyn and Hansman, 1992) have addressed the role that instrument approach procedure (IAP) charts play in contributing to the success or failure of an approach or landing. Current paper IAP charts are quite complex, containing a large amount of information in a very small area. Paper IAP charts have been criticized for excessive clutter, for text that is too small to read, and for inadequate terrain representation (Friend, 1988; Mykityshyn and Hansman, 1992). Work is underway at the Volpe Center to improve the presentation of information on paper IAP charts (Multer, Warner, Disario, and Huntley, 1991; Osborne, 1992; Huntley and Osborne, 1994).

Glass cockpit technology allows the display of approach information on an electronic display. Electronic display of IAPs presents practical advantages such as ease of information update and compact storage. On the human factors side, electronic instrument approach procedure displays (EIAPs) provide format flexibility, potential for pilot control and customizing, potential for reduced clutter, and integration with other glass cockpit systems. However, without careful attention to human factors issues early in the design and development of EIAPs, new problems may result. For example, an EIAP may require a pilot to make display selections during the instrument approach, adding to the workload of the task. The goal of this project was to identify potential problems in the use of EIAPs and present guidelines for designers and certifiers of EIAPs to assure that EIAPs help rather than hinder pilots during approach and landing.

Current paper IAP charts and the instrument approach task were analyzed to identify potential human factors problems in the design of EIAPs. Pilots were interviewed and literature describing the information requirements of the task and the cognitive implications of the task were reviewed. A cognitive task analysis was performed (see Clay, 1993 for details of this initial work). Once the information requirements and task analysis was complete, specific features and functions were identified that may be beneficial to an EIAP. Literature was reviewed in the areas of cognitive psychology, human-computer interaction, and aviation to identify design concepts and principles for the design of these features and functions. Guidelines were developed from the design concepts and principles and, finally, prototypes of EIAPs were designed in accordance with the new guidelines.

Results of the analysis of the instrument approach task suggested that the task is quite different from the tasks that are normally considered in documents that provide human-computer interaction guidelines. The pilot is subject to high temporal demand, performing a number of other tasks concurrently, and constantly subject to interruption. Pilots must be able to access information from the display quickly and accurately. An EIAP system can not require a high degree of pilot interaction. Special attention must be paid to information display characteristics such as text and symbol size and spacing, information grouping, map

scale, and display dynamics such as moving aircraft or zoom features. The literature review lead to the identification of a large number of human factors design guidelines related to these specific features. This document presents these guidelines.

Two types of guidelines are presented. First, ten general principles that apply throughout the design of the system are presented. Examples of these principles are maintaining consistency throughout the system, displaying information so that the interpretation of the information comes naturally to the user, and ensuring adequate feedback throughout the system.

Second, twenty-seven specific features or functions for an EIAP are presented with guidelines for each. Three main areas include how information is displayed or coded, how information is grouped and arranged, and how information changes. Display and coding features include the presentation of alphanumeric and symbols with specific recommendations for sizes and other presentation issues. Guidelines are provided on the use of color, including issues such as the number of colors and recommended hues. Guidelines also are presented on other coding issues that are more specific to EIAPs such as the depiction of aircraft location and terrain displays. The section on grouping and arranging information covers features such as windows, menus, reference frame, map scale, designing for the appropriate phase of flight, designing to minimize errors, and integration with other cockpit systems. The section on display change presents guidelines on display dynamics that are controlled either automatically or by the pilot. Some examples include input devices, zooming, scrolling, declutter, customization, and pilot control.

Empirical evidence was available for guidelines on some of the features presented. For example, some of the coding guidelines had empirical bases. Most of the guidelines, however, are based on experience or expert knowledge rather than empirical evidence. Comments and examples are provided in the document following each guideline to help users apply the guideline, identify the exceptions, and determine the criticality of the guideline. A summary of the guidelines is provided in checklist form at the end of the document.

Three prototype EIAPs were developed, following the guidelines of the document. The three prototypes are presented with descriptions of functions and discussion of how some of the principles and guidelines were used in creating the designs. Examples of features discussed in the prototypes include: 1) touch-screen zooming, 2) an inset overview window, 3) alternate buttons that allow a quick switch to an alternate runway or airport, 4) a profile view that displays only precision or non-precision information depending on pilot selections, 5) pilot control of North-up or Track-up reference frame, and 6) a declutter option that allows pilots to remove certain types of information. Three prototypes are used to exemplify the features because any one prototype that contained all of the features would be too complex for pilots to use during an instrument approach. Designers will have to choose which features are most beneficial and what combination provides the best display while maintaining simple interaction for the pilot.

A number of questions remain to be answered in the development of EIAPs. First, will pilot performance improve when pilots use an EIAP rather than paper IAP charts? Work has already been completed in this area (Hofer, Palen, Higman, Infield, and Possolo, 1992; Mykityshyn and Hansman, 1991) and indicates that there is no loss and possibly a limited gain in performance through the use of electronic charts over paper charts. However, most of the work completed so far has used prototypes that allowed the pilot to interact with the display very little if at all. How much or how little can a pilot interact with an EIAP and at what times? How much attentional resource does the pilot have available to operate an EIAP? Given that the pilot will only be able to control a few functions on an EIAP, which combination is most beneficial? Further study of systems with different combinations of features and functions is warranted. Prototypes should be developed and tested in simulation. The Volpe Center is currently developing a prototype for these purposes. Prototypes of instrument approach information integrated with other electronic flight instrumentation have been evaluated with mixed results (Hofer, Palen, Higman, Infield, and Possolo, 1992; Mykityshyn and Hansman, 1992; and Kuchar and Hansman, 1992). More research on how information from the many different sources in the cockpit is used and how different information sources may interact would be helpful in identifying the ideal method of presenting instrument approach information. Increasing use of GPS as a navigation aid in the cockpit suggests that the interaction between GPS information displays and instrument approach information also should be studied in considering the presentation of instrument approach information. It is clear that there are many advantages to displaying instrument approach information in an electronic format. The guidelines and examples presented in this document suggest a number of ways electronic displays can be used to benefit pilot performance; however, the actual implementation of different combinations of these features remains to be tested and evaluated.

1. INTRODUCTION

The approach and landing phases of flight are considered to be the most difficult and suffer an unusually high percentage of aircraft accidents compared to other phases of flight (Baker, Lamb, Guohua, and Dodd, 1993; Blanchard, 1991). Both pilots (Friend, 1988) and researchers (Taylor and Hopkins, 1975; Mykityshyn and Hansman, 1992) have addressed the role instrument approach procedure (IAP) charts play in contributing to the success or failure of an approach or landing. Current paper IAP charts (see Figure 1-1) have been criticized for excessive clutter, for text that is too small to read, and for inadequate terrain representation (Friend, 1988; Mykityshyn and Hansman, 1992). Work is underway to improve the presentation of information on paper IAP charts (Multer, Warner, Disario, and Huntley, 1991; Osborne, 1992; Huntley and Osborne, 1994).

The advancement of technology in the cockpit encourages the display of approach information on an electronic display. Electronic display of IAPs presents practical advantages such as ease of information update and compact storage. On the human factors side, electronic instrument approach procedure displays (EIAPs) provide format flexibility, potential for pilot control and customizing, potential for reduced clutter, and integration with other glass cockpit systems. However, the high workload and increased potential for accidents during an instrument approach suggests that the presentation of approach information is highly critical. For this reason, extreme caution is warranted in the design of EIAPs.

This document attempts to identify potential problems due to the more interactive and dynamic nature of an EIAP and to provide guidelines to ensure that pilots are able to access needed information quickly and easily. It is intended to be a resource for the development of handbooks, guidelines, and/or checklists for certifiers and designers of EIAPs. The information was obtained from a review of literature on aviation displays, cognitive psychology, and human-computer interaction. Several guidelines documents have been consulted to identify the guidelines that are most relevant to the development of EIAPs. This report is organized into five major sections:

- In Chapter 2, the procedures involved in the instrument approach task, the information requirements of this task, and cognitive implications for pilots performing an instrument approach procedure are reviewed.
- General principles for the design of EIAPs are presented in Chapter 3 with a description of the principle, guidelines related to the principle, example applications of guidelines on an EIAP, and associated references.
- Chapter 4 presents specific features and functions relevant to the design of EIAPs with a description, guidelines, examples, and references.
- In Chapter 5, three prototype EIAPs are described to provide readers with examples of EIAP designs that exemplify many of the guidelines presented in the document.

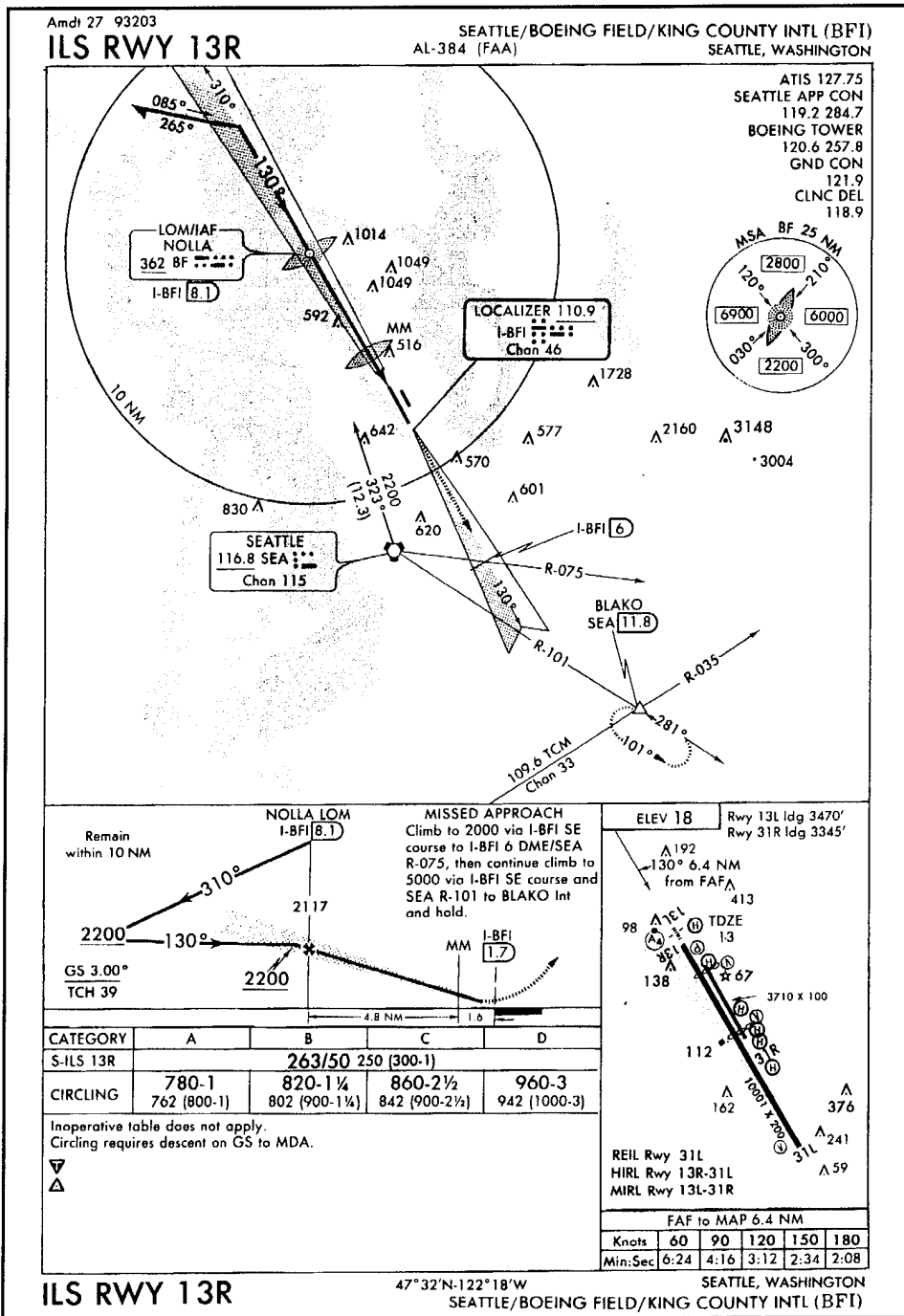

Figure 1-1. - Current Paper IAP Chart
 (See Section 5.1 for a complete description of current paper charts)

In Chapter 6, an initial checklist for certifiers and designers of EIAPs is provided. The checklist summarizes guidelines presented in Chapters 3 and 4.

Many of the guidelines presented in this report are based on experience or expert knowledge rather than empirical evidence. None of the guidelines are intended as requirements or standards. There will always be situations that create exceptions to the guidelines as presented. For this reason, readers should pay careful attention to the comments and examples following the guidelines for more information including possible interactions between guidelines and possible exceptions to the guidelines.

The goal in the creation of this document was to concentrate on the features and functions that may be used in an EIAP. Because the information was tailored to the specific application, this document does not cover a broad range of human-computer interaction guidelines. Readers are referred to more general user interface design guidelines such as Smith and Mosier (1986) for guidelines covering all aspects of electronic displays. In addition, this document was created to consider all possibilities for electronic display of IAPs. Real world constraints or standards that may be posed, such as limits on the pilot's control of the display after final approach or requirements to display certain information at all times, may limit the use of certain features and functions that are discussed.

2. THE INSTRUMENT APPROACH TASK

Prior to evaluating or designing an electronic instrument approach procedure chart, it is imperative that the certifier or designer be very familiar with the instrument approach task. A brief review of the task, the information requirements of the task, and the cognitive implications of the task is presented here. This is a summary of information provided previously (see Clay, 1993, for a more complete discussion).

2.1 DESCRIPTION OF THE INSTRUMENT APPROACH TASK

An instrument approach procedure is required any time a pilot must make a landing in conditions which prohibit visual navigation to the airport. Instrument approach procedures may be used as a navigation aid even when visual navigation is possible.

The instrument approach task actually begins when the pilot is constructing his or her flight plan. At that time the pilot reviews weather conditions, the applicable instrument approach procedures, and terrain around the departure site, landing site, and alternate. The pilot also plans the flight route, climb, descent, and fuel consumption.

A great deal of prior knowledge is required to plan and fly an instrument flight. The pilot must be familiar with navigation and with Instrument Flight Rules (IFR). This includes the knowledge of air traffic control (ATC) and familiarity with various navigation aids (NAVAIDs) to be used along the route and during the approach to landing. The pilot must know how each system works, how to control the avionics associated with the system, and how to interpret the cockpit displays pertaining to these systems.

The principle component of the instrument approach task begins when the pilot nears the destination and is ready to prepare for descent (see Figure 2-1). Each pilot may prepare for the approach by performing actions in a slightly different order, and will perform these actions as opportunity permits. The actions that a pilot performs during this pre-approach phase include:

- Tune a radio to the automatic terminal information service (ATIS) (if it is available) frequency to receive up-to-date airport information - weather (winds and visibility), the active runway, the approaches in progress, the ATIS information designator code, and any other pertinent information.
- Select an appropriate standard terminal arrival route (STAR) and IAP.
- Use information provided by ATIS and the IAP to compute the landing speed, approach times, and approach and missed approach power settings.
- Review the IAP to become familiar with the approach in progress. This includes planning the approach and becoming familiar with the airport and surrounding area.

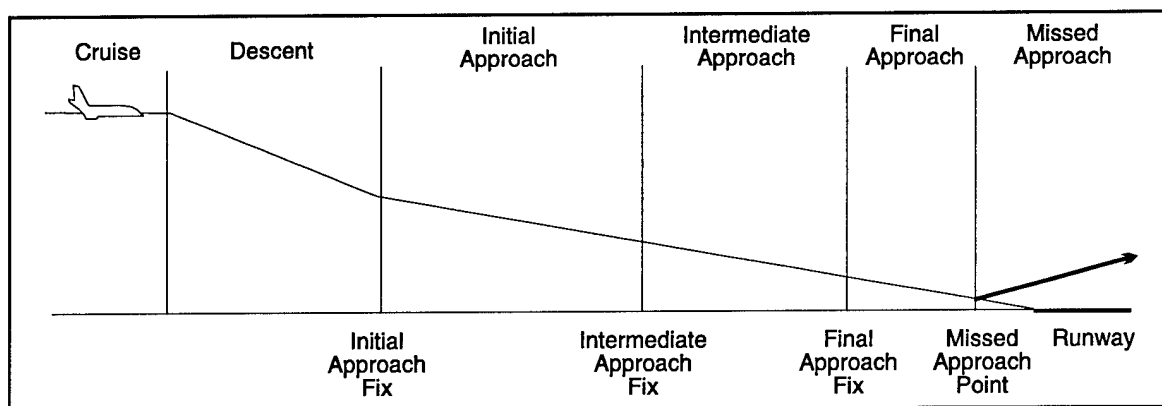

Figure 2-1. Phases of the Approach

- If applicable, brief the crew on the approach procedure.
- Execute the descent checklist.
- Use information from the appropriate IAP chart to pre-tune communication and navigation radios.
- Review the fuel status.
- Listen to the radio to learn traffic flow, weather and probable speed restrictions.
- If it is a commercial flight, comply with company radio arrival procedures.
- Communicate with ATC - state intentions, state information designator of last edition of ATIS, and listen to, repeat, and state intentions to comply (or not and why) with instructions. Communications with ATC may indicate that the approach has changed and require that many of the above actions be repeated.

While the above actions are being performed, the pilot also flies the aircraft -- controlling attitude, altitude (descending), heading, and speed toward the final destination. Eventually, control of the aircraft will be handed from center to approach control. At this time, the pilot will be navigating the aircraft toward the initial approach fix by means of NAVAIDs through published approach procedures and onboard avionics or by radar vectors provided by ATC.

Anytime after the handoff from center to approach control, the aircraft may be (a) cleared for the approach or (b) cleared to a fix (clearance limit) short of the airport of intended landing, told to hold, and told when to expect further clearance. In general, if the aircraft is not cleared for the approach, some of the following tasks will be performed, as appropriate, to the

clearance limit fix; if the aircraft is cleared for the approach, all of the following tasks will be completed:

- Navigate to initial approach fix identified on IAP chart (or fly specified vectors).
- Intercept and fly inbound course (or curved path) identified on IAP chart.
- Intercept and fly descent profile specified on IAP chart (non-precision approach) or glide slope (precision approach).
- Configure aircraft for landing - adjust landing gear, flaps, spoilers, lights, airspeed.
- Execute landing checklist.
- Reconfirm minimum descent altitude (MDA) (non-precision approach) or decision height (DH) (precision approach) specified on IAP chart.
- Review missed approach procedures, especially the initial pull-up and course instructions.
- Reconfirm winds and aircraft performance limits.
- Contact tower ATC and receive landing clearance.
- Acquire visual contact with the runway environment at or before DH or MDA, then continue to land or perform a missed approach.
- If landing - flare aircraft, reduce power, reverse thrust, deploy spoilers, brake as required, turn off the active runway, and taxi to gate or parking.
- If visual contact is not acquired (except in the case of a Category III landing), execute missed approach - add climb power, pull-up, turn to missed approach heading. When clear of runway, retract landing gear, apply flap schedule, follow missed approach course and altitude instructions.
- Navigate to missed approach fix. Enter holding pattern or proceed as directed to another approach attempt, holding, or execute flight plan to alternate.

The description of the instrument approach task provided above is very general. It is impossible to provide a specific description of an approach task without identifying the many factors that affect the task. Some of the factors that affect the instrument approach task are:

- Approach type (e.g., instrument landing system (ILS) vs. non-directional beacon (NDB) approach, precision vs. non-precision)

- Approach complexity
- Number of pilots
- Weather
- Time of day
- ATC instructions and air traffic
- Avionics available in aircraft
- Company operations policies
- Maintenance status
- Aircraft performance characteristics (speed, weight, etc.)
- Geography, topography, man-made obstacles

2.2 INFORMATION REQUIREMENTS OF THE INSTRUMENT APPROACH TASK

It is important for certifiers and designers of EIAP charts to be aware of the information required for presentation on an EIAP. Determination of the importance and frequency of use of the information displayed on charts will help in the evaluation of EIAPs. Several researchers have studied the information requirements of the IAP task (Blanchard, 1991; Hofer, Palen, Dresel, and Jones, 1991; Hofer, Palen, Higman, Infield, and Possolo, 1992; International Air Transport Association, 1975; Mykityshyn, Bussolari, and Hansman, 1990; Mykityshyn and Hansman, 1992; Ricks, 1993).

A review of the literature on IAP information requirements indicated that the information required is highly dependent on the situation (Hofer, Palen, Dresel, and Jones, 1991) and that pilots have a great deal of trouble identifying information items for removal from the charts (Blanchard, 1991). Ricks (1993) has shown that pilots acquire information from approach charts 42% more often in a non-precision approach than in a precision approach. He has also shown that 18% more information was acquired in vectored scenarios than non-vectored scenarios.

Because each of the researchers utilized different methods and different scenarios in determining information requirements, the results were varied. However, Clay (1993) stated the following three conclusions based on the results available:

1. Pilots would prefer to continue to have all of the information currently displayed on IAP charts (with the possible exception of obstacles). Although they may not use all of the information for every approach, there are situations in which they would like to have the information.
2. Pilots' information needs change throughout the approach task.
3. There is evidence from different experiments to indicate that there may be some core group of information items which can be identified as most important in the instrument approach task (Hofer, 1993).

Clay (1993) also concluded that the information on IAP charts is used in two distinctly different ways:

1. The IAP chart is used as a reference that provides specific pieces of information which are read off the chart and used immediately. For example, a pilot will read a communication frequency off the chart and then immediately tune the radio to that frequency. The same is true of NAVAID frequencies. Pilots also may use MDAs in the same way - read the altitude and then set a bug (marker) on the altimeter for that altitude.
2. The IAP chart also is used for planning purposes. During the descent or pre-approach phase, the pilot will review the chart and plan the approach. The pilot will look at all of the NAVAIDs available for the approach to decide which NAVAID frequency to tune into which receiver so that in the end the primary (or possibly some other) NAVAID is tuned into the number 1 receiver. The pilot may decide to tune an alternate NAVAID as a double-check for the primary. The pilot also will look at terrain information (if the area is unfamiliar) to construct a mental picture of the terrain surrounding the airport, especially in the missed approach area. The pilot will look at the airport layout and runway light configurations to form a mental picture of what to look for as the approach is made.

The second manner of using IAP charts sheds some light on the conclusion that pilots do not want to give up any of the current information provided on IAP charts. Although they may not use all of the data specifically to perform some action, they do use it to help plan ahead and to develop some expectations for the approach. The value of this information is not easily measured; however, cognitive psychologists know that having the correct expectations leads to better performance of perceptual tasks (Eysenck, 1984).

Pilot information requirements change throughout the approach. During the descent or pre-approach phase pilots require most of the information on the approach chart. Information that is used for planning purposes (most of the information on the chart) and initial communication and NAVAID frequencies are needed during the descent or pre-approach phase. Later in the approach (most likely during the initial approach phase) the pilot may refer to the approach chart to access communication frequencies and NAVAID frequencies in order to change settings or to double-check them. During the final approach phase and at the very start of a missed approach, the pilot is usually too busy to refer to the approach chart at all and the information requirements are not as great.

Clay (1993) also attempted to identify the core group of information based on studies by Hofer, Palen, Higman, Infield, and Possolo (1992); Mykityshyn and Hansman (1992); Huntley (1993); Blanchard (1991); and through her own interviews of pilots. Table 2-1 presents a prioritized list of core information items. These items come from the following sources:

1. The top 36 (category A) of Hofer, Palen, Higman, Infield, and Possolo's (1992) list of "primary items" (with some editing and grouping of specific items)
2. The top ten of Mykityshyn and Hansman's (1992) three phases of flight "most critical items" (again, with some editing and grouping, there were a number of overlaps for each phase)
3. The items determined to be important enough to present in Huntley's (1993) "briefing strip" for improved paper IAP charts
4. The top ten "most important items" selected by 20 percent or more of the pilots in a study by Blanchard (1991)
5. The items regarded as "most important" by general aviation pilots interviewed by Clay (1993)

The second column in Table 2-1 displays the number of sources (of the five mentioned) that identified the item. This provides an indication of the order of importance of the items.

**Table 2-1.
Information Requirements for the IAP Task**

INFORMATION ITEM	Number of References Identifying This Item
Primary NAVAID Information (especially frequency)	5
Approach or Inbound Course	5
Minimum Descent Altitude (DH for precision approach)	5
Minimums (altitude and visibility for the given aircraft category)	5
Communication Frequencies (ATIS, approach, tower, and ground - with ground the least important)	5
Secondary NAVAID Information (frequency most important)	5
Missed Approach Point	4
Missed Approach Instructions (especially the first two actions)	4
Stepdown altitudes (or glide slope intercept altitude)	4
Distances/DME or Time to Missed Approach Point	3
Final Approach Fix	3
Initial Approach Fix	3
Final Approach Course, Radials	3
Airport Diagram (especially runway specifics, runway light configuration)	3
Approach (type of approach to what runway)	2
Airport and City	2
Touchdown Zone (or airport) Elevation	2
Notes	1
Minimum Sector Altitudes	1

2.3 COGNITIVE IMPLICATIONS OF THE INSTRUMENT APPROACH TASK

The review of the instrument approach task and related information requirements provides some insight into major cognitive implications of the approach task. The following list identifies aspects of the task that certifiers and designers of EIAPs should be aware of when evaluating or designing an EIAP. For further discussion of theoretical and experimental research related to the cognitive concepts introduced here, refer to Clay (1993). Many of these issues will resurface later in this document as they are related to specific guidelines for various features and functions:

- The pilot is subject to high temporal demand. Pilot workload increases, problem solving abilities decrease, and decision making performance decreases as time pressure increases.
- The pilot must have a great deal of background knowledge. This includes knowledge of navigation systems and IFR rules (including a number of specific conditional rules for the instrument approach).
- The pilot must remember to perform different sequences of actions at different phases of the approach. The pilot may or may not have memory aids for each of these actions. If a pilot forgets to perform any one of a number of actions during the approach, the pilot will have to make up for the error later. This will cause workload to increase at a time when workload is already high, greatly increasing the difficulty of the task.
- The pilot must be able to quickly and accurately extract needed information from various sources (ATIS, ATC, IAP chart, co-pilot, or aircraft displays) and remember the information long enough to apply it (turn to the appropriate IAP chart, enter in a frequency, set a timer, etc.).
- The pilot must be able to review and integrate the information on the approach chart to help in planning the approach and setting up expectations for the approach.
- The pilot is constantly subject to interruptions such as ATC communication which may affect memory of actions to complete and of information to apply.
- The pilot is constantly subject to ATC requiring changes to the planned approach. Changes in the approach require pilots to discard old plans and create new plans, often with less time than was available initially. Changes in plan introduce a new set of potential errors due to confusion with the original plan.
- The actions that a pilot must perform will be highly dependent on a number of situational factors, therefore, the pilot must be able to tailor his or her actions to each approach.

- The pilot's need for information is highest during the pre-approach phase when there is more time and the pilot has more resources available for planning. Workload is highest from the initial approach phase through landing. During the final approach, the pilot must focus on flying the aircraft and the ability to contribute cognitive resources to other tasks is limited.
- The pilot must continually monitor the flight of the aircraft during the approach. Control of the aircraft is always the pilot's primary task. As changes are required, (such as altitude changes and directional changes required during the approach) the pilot is required to contribute more resources to flying the aircraft and has less time and cognitive capacity available for secondary tasks such as accessing information on an approach chart.
- The pilot must remain aware of the aircraft position/location throughout the approach.
- The pilot may be required to perform mental arithmetic to determine proper headings, accounting for wind.
- The pilot must use spatial abilities to mentally rotate information on the IAP chart to match it to the aircraft's current orientation.
- The pilot utilizes a number of rules of thumb to aid in performance of various tasks. This indicates that the mental arithmetic required is too difficult for pilots to perform or remember without such aids. Memorization of rules of thumb also adds to the information a pilot must be able to access from memory during the approach. In addition, the rules may be less accurate than the actual calculations required, so pilots may have to correct for inaccurate calculations at various times during the approach.
- The instrument approach task often is a stressful situation for the pilot. Stress can cause decreases in cognitive ability and can lead to cognitive capture or tunneling. Stress may cause the pilot to focus on one part of the task to the exclusion of other important parts of the task.

3. GENERAL HUMAN-COMPUTER INTERACTION PRINCIPLES

Ten general principles for the design and certification of EIAPs are presented in this section. The principles are:

- 3.1 Know the User and the Task
- 3.2 Consistency
- 3.3 Directness (No Interpretation)
- 3.4 Visibility
- 3.5 Limit the Number of Modes
- 3.6 Pilot Control
- 3.7 Simplicity
- 3.8 Forgiveness
- 3.9 Feedback
- 3.10 Locate and Group Information in a Meaningful Manner (e.g., by Function, Importance, Sequence, and Frequency)

These basic principles are applicable throughout all aspects of any electronic display. Designers should be very familiar with the intent of each of these principles and should strive to design EIAPs that are consistent with the principles. In many cases the application of one principle may conflict with the application of another principle. When this occurs, designers and certifiers should carefully weigh the costs and benefits of each principle to determine the appropriate combination or design for the specific situation. Solutions to some of these trade-offs may be found in Chapter 4 on specific features and functions for an EIAP.

Each principle is presented in the same format. First, a description of the principle is presented. Relevant applications of the principle to EIAPs may be presented in this description. The second section for each principle is a list of design/certification guidelines. The guidelines attempt to point out areas where the principle should be applied. However, the nature of general principles does not lead to specific, concrete guidelines. In addition, many of the guidelines presented are based on experience or expert knowledge rather than empirical evidence. None of the guidelines are intended as requirements or standards. There will always be situations that create exceptions to the guidelines as presented. The format implemented by Smith and Mosier (1986) in which relevant examples and comments follow the guidelines is implemented here as clarification of some guidelines.

Note: Where a reference follows a guideline, the guideline is based specifically on information in the reference. In some cases the guideline is worded in the same manner as a guideline in the original document. In most cases the wording has been modified to be more specific to EIAPs. The original authors may not agree with the application of the guideline or the wording as presented here.

A list of references related to the principle is then presented. Finally, a graphic example is presented. The example displays a DO and a DON'T based on the application of one of the guidelines.

3.1 KNOW THE USER AND THE TASK

Knowledge of the task and of the users' conceptual models of that task are extremely important in interface design. IBM Corporation's interface design guidelines (1991) emphasize that there may be very important differences between a user's conceptual model of a task and the designer's conceptual model of the task. Apple's interface design guidelines (1993) suggest studying a typical "day in the life" of users to watch them on the job, analyzing the steps necessary for accomplishing the task. Current literature in cognitive psychology dealing with individual's representation of knowledge (mental models) confirms the importance of designing a system that corresponds to the user's conceptual model (Canon-Bowers, Tannenbaum, Salas, and Converse, 1991; Norman, 1988).

For the current project, in-depth knowledge of the pilot and the instrument approach task are required. See Chapter 2 or other references (Blanchard, 1991; Clay, 1993; DeRee, 1990; Friend, 1988; Hofer, Palen, Dresel, and Jones, 1991; Hofer, Palen, Higman, Infield, and Possolo, 1992; International Air Transport Association, 1975; Mykityshyn and Hansman, 1992; NASA-Langley Research Center, 1993; Taylor, 1985) for a description of both the instrument approach task and information requirements of the task. Many of the principles presented here are based on the summary of the task presented in Chapter 2.

This principle applies to many of the features and functions presented in Chapter 4 of this report. More specific guidelines are presented in the applicable sections.

3.1.2 Guidelines

3.1.2.1 EIAPs should be designed to be consistent with pilots' conceptual model of the instrument approach task (IBM Corporation, 1991).

Example: Pilots view the approach task as any other instrument flight task, albeit with a tighter measure of precision. Lateral and vertical course representations on paper charts are consistent with the pilot's model until breakout. At breakout, the task becomes more visual and the pilot switches to a forward looking visual model of the world. An EIAP that presented a breakout view showing runway and landing light configurations or a photograph of the expected breakout view prior to breakout would help the pilot to quickly attain a visual reference, and would be consistent with the pilot's conceptual model of the task.

Comment: Pilots' conceptual models of the IAP task are influenced by current paper approach plates. Consistency with paper approach plates may also be

beneficial, although there are a number of functions an EIAP may provide that may be superior to paper charts. While EIAPs may not be totally consistent with paper charts, designers should ensure that presentation of critical information does not conflict with current paper representations.

Comment: Designers should consider performing a task analysis to completely understand the task and pilots' model of the task.

- 3.1.2.2 The operational sequence of the EIAP system should be compatible with actual instrument approaches.

Example: If an EIAP incorporates a line of buttons accessing different views or pages, the buttons should be ordered from top to bottom or left to right to provide information in the order in which it is required.

Example: An EIAP may be structured to follow the order currently used in crew briefings.

- 3.1.2.3 Where possible, the amount of background knowledge that is required for the task should be reduced. Requirements for memorization of instrument approach rules, actions, symbols, and procedures should be minimized if possible.

Example: Providing a pictorial presentation of the runway lighting system eliminates the requirement for pilots to memorize lighting systems and the associated acronyms.

Example: The use of standard symbols that are consistent with other charts and other electronic displays will reduce memorization requirements.

Example: Displaying only the appropriate MDA or DH in a location and size that is quickly readable will eliminate the need for pilots to memorize the MDA or DH. Presentation of current and next expected communication frequency and presentation of gate assignment in the airport/taxi view may also reduce memorization requirements.

Example: A graphical presentation of the missed approach will eliminate requirements for pilots to memorize text instructions. A pictorial memory of the graphics may also be easier to maintain than memory of text (Klatzky, 1975).

- 3.1.2.4 The EIAP should be designed for both planning and discrete information retrieval.

Example: NAVAIDs and associated frequencies are used in both approach planning and discrete information retrieval tasks. Planning is best facilitated by locating the information geographically. Discrete information retrieval may be

facilitated by locating the information consistently. The presentation of NAVAID frequencies at both the geographical location and in a consistent location (e.g., at the top of the approach plate) will facilitate both planning and discrete information retrieval.

- 3.1.2.5 Controls should allow pilots to access information quickly with minimum thought and action.

Example: Require only one press of a button with an obvious label to retrieve information, rather than requiring two actions to select a choice grouped under a menu that may not have a direct label.

- 3.1.2.6 Memory aids should be provided.

Example: Allow highlighting of key information, or allow recognition (e.g., choose from a list) rather than recall of information.

- 3.1.2.7 If possible, situational factors should be accounted for automatically.

Example: Some situational factors may be accounted for automatically (such as a glide slope out of service) with an appropriate alerting system and an update to appropriate information such as minimums. Many other factors (such as a middle marker or lighting system out of service) may have to be entered manually.

Comment: See Section 4.29 on automating functions for cautions about implementing automatic changes in information -- in this example, some alert or a change to a status line would be necessary to alert the pilot that the minimums have changed.

Example: The EIAP may calculate and display the runway length requirement based on knowledge of the aircraft weight.

- 3.1.2.8 Designers should consider providing functions on EIAPs that reduce the need for common rules of thumb.

Example: The display of aircraft location in the profile view would reduce the need for pilots to use a "three degrees of glide slope equals 300 feet per NM" rule of thumb.

Example: The display of lead points for transitions such as a turn from an arc to a radial will also eliminate the need for certain rules of thumb.

Example: The EIAP may display the required descent rate and may display and account for cross winds automatically.

3.1.3 References

Apple Computer Inc., 1993; Blanchard, 1991; Clay, 1993; DeRee, 1990; Friend, 1988; Hofer, Palen, Dresel, and Jones, 1991; Hofer, Palen, Higman, Infield, and Possolo, 1992; IBM Corporation, 1991; International Air Transport Association, 1975; Mykityshyn, Bussolari, and Hansman, 1990; Mykityshyn and Hansman, 1992; NASA-Langley Research Center, 1993; Taylor, 1985.

3.1.4 Graphic Example

DON'T expect pilots to have time to spend using electronic maps similar to those available for desktop computers. This example presents complex search functions, menu-based choices, a windowing system, and a complex tool bar that are inappropriate for in-flight use. The interface provides the pilot with so many choices that it is more difficult to remember what choices perform what functions. In addition, windowing systems allow users to mask key information so that they may lose needed information.

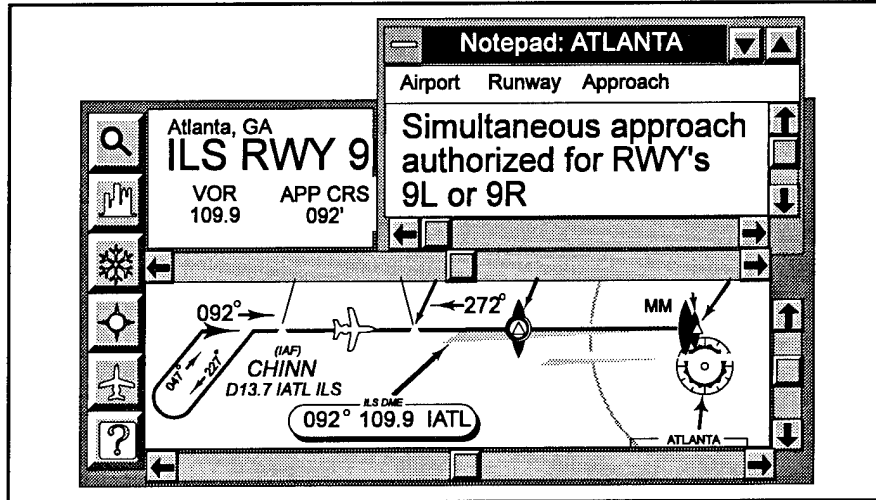

DO provide a basic display with a small number of easy to use features that provide the most utility. This example employs a simple one button push to access alternate approaches or airports. Information is displayed in invariant areas and there are no obstructing windows. More complex functions such as "seek" can be used pre-approach.

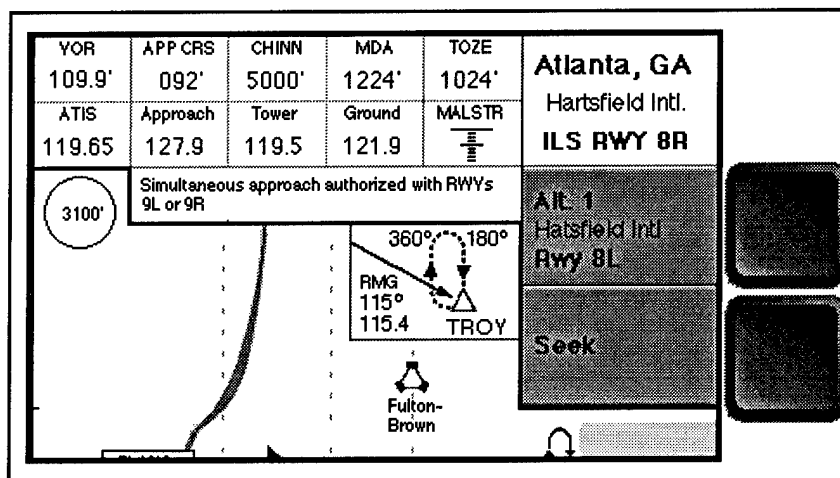

3.2 CONSISTENCY

The need for consistency in any human-computer interface is a basic principle that is repeated again and again. Not only do symbols, terminology, and location of information need to be consistent, but the control of the system must be consistent throughout. The interface should act or react to pilot selections in a consistent manner. Accurate expectations lead to faster visual search speeds and more accurate comprehension. This impact of expectancy on speed of visual search and comprehension is very important in tasks where reaction time is limited.

3.2.1 Guidelines

3.2.1.1 Consistent symbols should be used throughout the EIAP (DOD, 1993).

Comment: A standard set of symbols should be created for use across all EIAPs. Appendix B of Aerospace Recommended Practice (ARP) 4102/7 (SAE, 1988) on electronic displays provides a list of standard symbology recommended for use on electronic horizontal situation indicators (EHSIs) and navigation displays (NDs) that may be appropriate for use on electronic instrument approach procedure charts. The Society for Automotive Engineers (SAE) subcommittee on aeronautical charting (SAE G10) is currently developing standard symbols for use on electronic charts.

3.2.1.2 Where possible, symbols that are consistent with those used on paper charts should be used.

Comment: Symbols with high detail currently used on paper charts may not transfer well to electronic medium, especially if the symbols are small.

3.2.1.3 Except for map symbols and text that indicate geographical locations, information should be located consistently on the electronic display for each chart and for each page within a chart.

Comment: See Section 4.11 on invariant display areas for more information.

3.2.1.4 Ensure that the interface reacts consistently to pilot selections (IBM Corporation, 1991).

Example: If a touch of the screen zooms in on the area selected in a plan view, a touch of the screen should also zoom in on the area selected in an airport view. At the very least, the same control action should not perform some other critical function such as switching to Track-up in a different view.

Example: If a press of a right arrow moves a cursor from one input field to the next input field in one area or situation, the same action should not move a cursor from a group containing several fields to another group in a different area or situation.

Comment: This guideline is related to the principle "Limit the Number of Modes." Refer to Section 3.5 for exceptions to this guideline.

- 3.2.1.5 Consistent terminology and phraseology within and between EIAP charts should be maintained (Wiener and Nagel, 1988; Brown, 1988).

Comment: Existing standards for the use of abbreviations and acronyms should be followed (a list is provided in Aerospace Standard (AS) 425B -- Nomenclature and Abbreviations, Flight Deck Area -- available through the Society of Automotive Engineers (SAE)). New standards specific to EIAPs may be developed.

- 3.2.1.6 Information from different sources (ATIS, ATC, IAP charts, instrument displays) should be consistent in terms of terminology and symbology.

3.2.2 References

Andre and Wickens, 1992; Apple Computer, Inc., 1992; Brown, 1988; Department of Defense, 1993; IBM Corporation, 1991; Mangold, Eldredge, and Lauber, 1992; Microsoft Corporation, 1992; NASA Space Station Freedom Program Office, 1992; Neisser, 1976; Shneiderman, 1987; SAE, 1988; Stokes, Wickens, and Kite, 1990; Wiener and Nagel, 1988.

3.2.3 Graphic Example

DON'T use two sets of symbols that represent the same objects or concepts. This figure shows some of the differences between Jeppesen-Sanderson charts and NOAA/NOS charts. The top row shows the VORTAC symbol; the second row shows the symbols for man-made and natural obstacles.

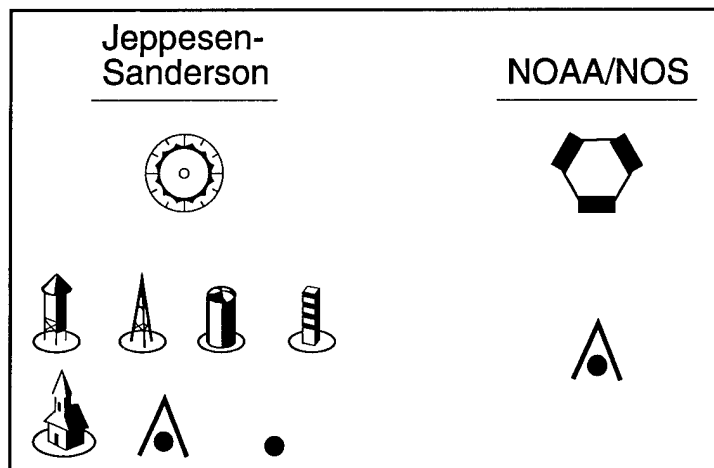

DO use a consistent set of symbols in all electronic enroute and approach chart displays.

3.3 DIRECTNESS (NO INTERPRETATION)

Directness refers to displaying information, or providing tools or controls in such a way that the interpretation of the information or the control comes naturally to the user. Neither recoding, nor instructions, nor interpretation is required. Information is integrated into a format so that perception of the information is direct. The principle of "Directness" is behind a number of different guidelines and principles in information display. Williges, Williges, and Elkerton (1987) list compatibility as one of their seven general principles for software interfaces. They define compatibility as minimizing the amount of information recoding that is necessary for the user. IBM Corporation's interface guidelines (1991) allude to the principle of directness when they recommend that the user interface be made transparent. The user is not aware of the tools provided by the interface (e.g., how to get to certain information), instead he or she is focused on the information of interest. Other HCI literature (Helander, 1988; Apple, 1993) touts the benefits of direct manipulation -- manipulation of objects and controls in a manner that appears natural (often through the use of metaphors). Many people refer to the directness provided by an interface when they suggest that an interface is intuitive.

3.3.1 Guidelines

- 3.3.1.1 Minimize the amount of information recoding that will be necessary (Williges, Williges, and Elkerton, 1987). Information should be displayed in its most integrated form so that it can be directly perceived.

Example: Display the aircraft location directly on the EIAP chart (O'Hare and Roscoe, 1990). Pilots will see where they are on the display directly and will not have to integrate information from cockpit displays and the approach plate to estimate their position.

Example: Display the aircraft heading, predicted horizontal path, and predicted vertical path directly on the EIAP chart.

Example: Display a pictorial representation of runway light configurations, rather than an acronym or abbreviation that represents the configurations.

Example: There are several pieces of information an EIAP may present that would eliminate the need for pilots to perform mental arithmetic during the approach. For example, an EIAP may show rates of descent to approximate glide slope, rates of descent to cross a fix at a required altitude, rates of climb to clear obstacles on missed approach, predicted altitude at a fix crossing, time to arrive (or a countdown) at a fix, or predicted speed when passing through 10,000' on descent.

Example: If possible, display actual time or distance to missed approach point rather than a table of times that require interpolation.

- 3.3.1.2 The interface should behave in a manner that appears natural to the pilot in the flight environment.

Comment: Interfaces should be tested using representative tasks to verify that the actions required to control the system and the results of those actions are as expected by the user. Task errors or long times to complete tasks indicate that there is a problem with the interface.

Comment: There may be a trade-off between directness and display size, visual search time, or clutter. If a designer displays all choices directly on the screen with explanatory labels, the required actions and results will be obvious, but pilots will require a longer time to search and find the appropriate choice or the labels will take up valuable display space. Designers must find a balance between natural controls and the display of key information within the constraints of the display space.

- 3.3.1.3 EIAPs should adhere to the user's organization of data, as well as vocabulary and language (Williges, Williges, and Elkerton, 1987).

Example: The presentation of missed approach instructions (textual or graphical) on the plan or profile view in the area of the graphical depiction of the missed approach point, altitude, and/or holding pattern is an example of presentation of information that adheres to the pilot's organization of data.

3.3.2 References

Apple, 1993; Helander, 1988; IBM Corporation, 1991; O'Hare and Roscoe, 1990; Shneiderman, 1987; Williges, Williges, and Elkerton, 1987.

3.3.3 Graphic Example

DON'T present several different pieces of information that the pilot must integrate through mental arithmetic before it is useful. For example, current paper charts provide a table of aircraft speeds and missed approach times that require the pilot to interpolate and then set a separate timer to count down. In this example, the pilot is travelling at 98 knots and must interpolate between 5:16 and 3:57 to determine the time from the final approach fix to the missed approach point. A better solution is to display this information in a more integrated format as shown in the example below. EIAPs provide the capability to improve on existing paper chart formats as shown in this example.

MIRL Rwy 7-25 and 1-19					
FAF to MAP 7.9 NM					
Knots	60	90	120	150	180
Min:Sec	7:54	5:16	3:57	3:10	2:38
RICHLAND, WASHINGTON					

DO present information that is directly usable by the pilot. An EIAP should be programmed to calculate the aircraft's speed and location so that a direct countdown of time or distance to missed approach can be displayed automatically. In this example, the time to the missed approach point while the pilot is flying at 98 knots is displayed directly. The time counts down automatically so that it always displays the appropriate time based on the aircraft position.

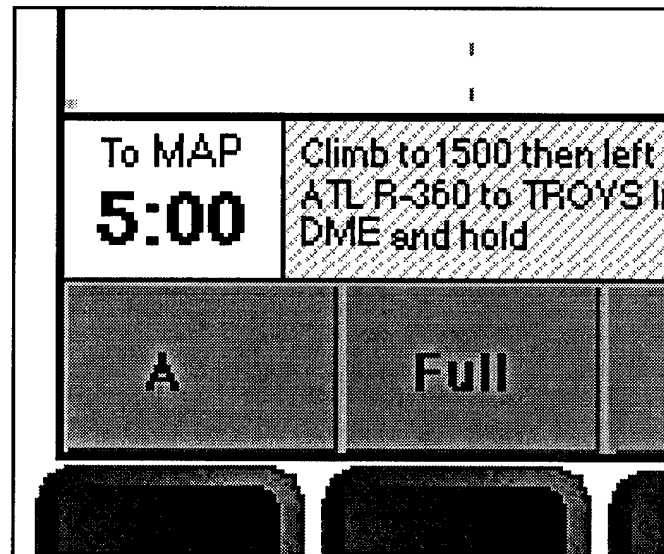

3.4 VISIBILITY

Norman (1988) states that visibility is one of the most important principles of interface design. Interface designers should strive to make all features, functions, actions, and controls visible to the user. In cases where everything cannot be made directly visible (due to space constraints that may lead to clutter), interface designers should provide a visible clue to lead the user to the feature. Examples of clues include the presentation of meaningful labels or icons on controls to indicate what other information is available or the use of ellipses (...) to indicate that more information is available. Not only should designers make it visibly obvious how to perform a function, but they should also make the results of the action visible. By providing users with an interface in which all features and functions are visible, the designer also makes the constraints of the system obvious. The user does not waste time searching for a function he or she thinks should be available when, in actuality, it is not. By following the principle of visibility, designers also make their interface more direct. The principles on the use of modes (Section 3.5) and feedback (Section 3.9) are also related to the principle of visibility.

3.4.1 Guidelines

- 3.4.1.1 Strive to make all features, functions, actions, options, and controls visible to the user (Brown, 1988).

Example: Provide a button labeled Next Page on a key pad to indicate a page turn option rather than require pilots to select two keys such as Function and Enter (the choice is not visible -- it must be remembered from a user manual) to turn a page.

Comment: Functions like the "touch to zoom" option described in Prototype 1 (see Chapter 5) are not explicitly visible to the user. It is used in the prototype because it incorporates a simple, somewhat natural (the user touches the area of interest), and frequently used control. However, the number of functions like this one should be limited and should only be used in cases where the control is simple, frequently used (e.g., as on desktops -- double-click of a mouse button to open), and consistent (the same control should not perform a different function under different conditions).

- 3.4.1.2 A list for choices (recognition) should be used rather than requiring the user to remember (recall) and type in a choice (IBM Corporation, 1991).

Example: When a pilot is choosing the specific approach to an airport, a list of approach choices should be presented. The pilot should not be required to remember the available choices or a specific syntax for entering the approach name.

3.4.1.3 Sequences should be visibly indicated, if necessary (Brown, 1988).

Example: If a setup page requires the user to first choose the state, then the city, then the airport for the approach, the entry fields or choice listings should be presented from top to bottom or left to right in the appropriate order.

3.4.1.4 Results of actions should be shown as visible effects (Brown, 1988).

Comment: If an action does not result in a visible change of the EIAP, some other visible indication such as a message, a change of a status line, or a change in the control (a button may appear pressed in) should occur.

3.4.1.5 System settings should be displayed (Brown, 1988).

Example: If the EIAP allows entry of, or determines automatically, aircraft category and configuration information, this information should be displayed on the EIAP.

3.4.2 References

Brown, 1988; IBM Corporation, 1991; Norman, 1988.

3.4.3 Graphic Example

DON'T provide controls in which it is not visibly obvious what function they perform. In this example, the labels for the buttons are on the display and there is only a slight visible clue (the shade of gray) to the association.

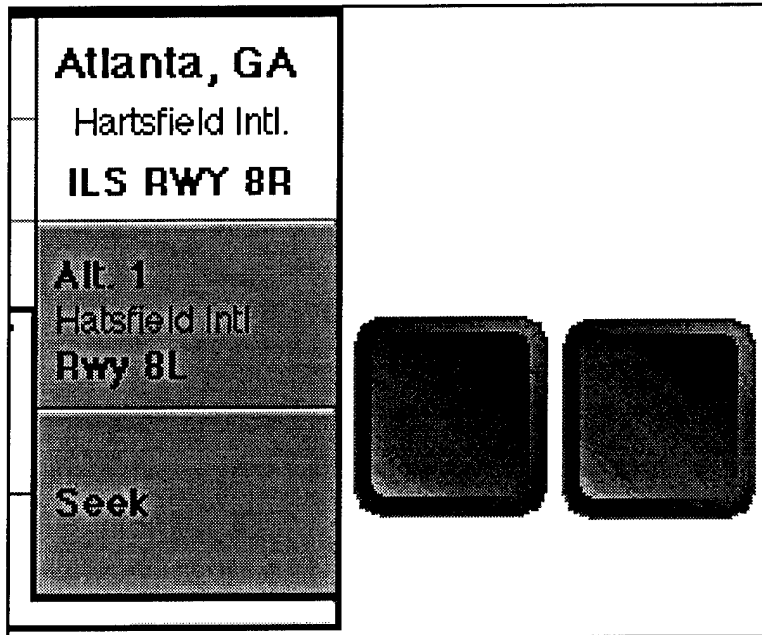

DO make the function of controls visible. In this example, the close proximity of the gray labels to the gray buttons makes the association clear.

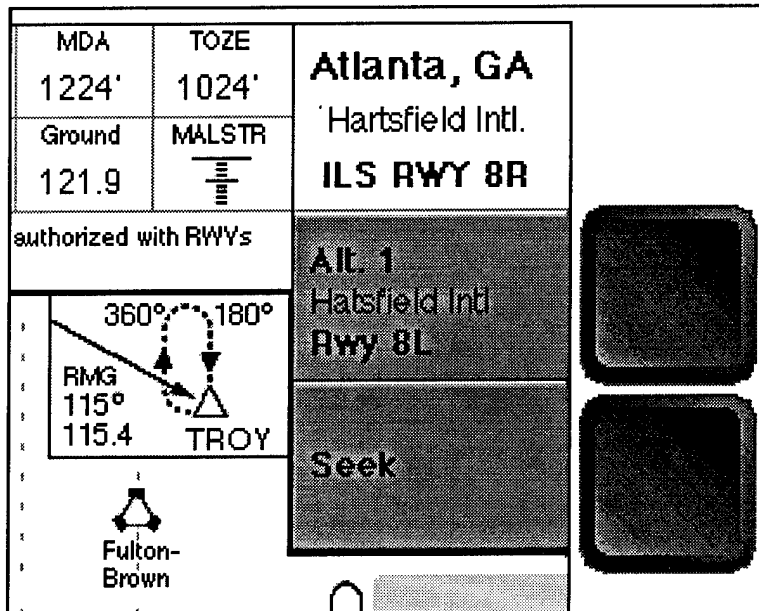

3.5 LIMIT THE NUMBER OF MODES

The term "modes" refers to separate states or situations in which the same actions or controls may cause different responses. For example, a graphical drawing tool may have a text mode and a drawing mode. The same actions by the user in the two different modes may cause different responses by the system. The use of modes in human-computer interfaces often causes problems for users. This is because users often forget what mode they are in. Adams, Adams, Huntley, and Eldredge (1993) identified mode errors as common in the use of GPS receivers. Modes directly conflict with the principle of consistency. This problem can be especially troublesome in situations where actions must be made quickly or actions cannot be undone.

A system that is feature rich, incorporates a high degree of functionality, and uses multiple modes may be difficult to use and requires skilled users. A system that incorporates only essential features and requires only one (or a few) mode(s) is easy to use and can be used by casual or occasional users. Designers must consider these trade-offs carefully in the design of an EIAP. In addition, designers should remember that certain features of the instrument approach task (high workload, high risk, time critical) weight decisions in the direction of a system limited to essential features with few modes. For these reasons, designers should limit the use of modes. There are, however, situations in which modes can not be completely avoided. For example, in an EIAP there may be very compelling reasons to provide a Planning mode and a Navigation mode or a North-up display mode and a Track-up display mode. In these situations the following guidelines help ease the difficulties in the use of modes (IBM Corporation 1991; Apple, 1992).

3.5.1 Guidelines

3.5.1.1 The two (or more) modes should be visually distinctive (Apple, 1992).

Example: A Track-up mode may incorporate a fairly distinctive compass grid whereas the North-up mode has no grid but incorporates a North-up symbol, making it easy to distinguish the two modes.

3.5.1.2 A mode indicator should be available to make it easy for users to identify the current mode.

Example: A number of software applications use different icons as cursors to indicate mode. Mode may also be indicated in a status bar at the bottom of the display.

3.5.1.3 A fast and easy method of switching between modes should be implemented (IBM Corporation, 1991).

3.5.1.4 Features and functions between modes should be as consistent as possible.

Example: While a North-up and Track-up display mode may look different, the "zoom" function should behave the same way in both modes.

Comment: Care should be taken when features or functions behave differently in different modes. A pilot may perform an action that is correct in one mode but incorrect in a different mode. Visible cues should be used as necessary to prevent this type of error. If an error does occur, it must be easily reversible.

3.5.1.5 For short term modes, a "spring-loaded" function should be used so that the user will not accidentally remain in a mode he or she does not want (Apple, 1992).

Example: The user may be required to push in and turn a cursor movement knob when making large movements across the screen while simply turning the knob (without pushing in) will make small cursor movements.

Comment: Designers may also consider the use of a time-based mode that will release after a certain amount of time. Care should be taken in the use of a time-based mode to be certain that needed information isn't removed before the action is complete.

3.5.1.6 Modes may be used when they emulate familiar activities (e.g., are direct) (Apple, 1992).

Example: A separate setup mode (in which the pilot chooses an appropriate approach chart) may resemble the pilot's physical activities in locating an appropriate paper chart, while an Approach Chart mode resembles the actual use of a paper chart.

3.5.2 References

Adams, Adams, Eldredge, and Huntley, 1993; Apple, 1992; IBM Corporation, 1991.

3.5.3 Graphic Examples

DON'T make infrequently used modes as accessible as frequently used modes. This figure shows a menu hierarchy in which the plan view mode (which pilots will use most often) is at the same level as those used to select the state, city, airport, and approach. The pilot must cycle through six different choices in choosing a mode.

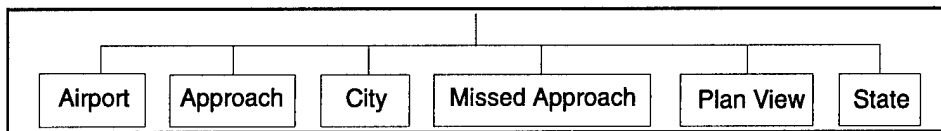

DO choose modes by frequency of use and suitability to tasks. In this figure, the menu hierarchy contains three modes, (a) set-up, in which the pilot chooses the state, city, airport, and approach, (b) plan view or approach, and (c) missed approach. In comparison to the hierarchy in the figure above, this structure allows the pilot to cycle quickly through the three modes.

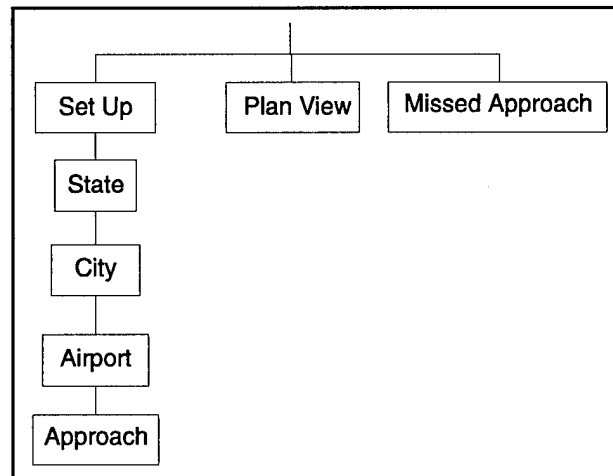

3.6 PILOT CONTROL

Another often repeated principle in HCI literature is "allow the user to control the interface" (Apple, 1993; IBM Corporation, 1991). This principle is also repeated in various forms in aviation literature. For example, Endsley and Bolstad (1993) recommend that the pilot be incorporated into the control of information filtering. Huey and Wickens (1993) suggest that different features of electronic map displays should be available based on pilot demand. There are certainly practical reasons for allowing pilots to control the information presented on an EIAP since it would take an enormous research effort to predict exactly what information a pilot needed at any given time. In addition, pilot control of information will accommodate individual differences among pilots.

Many of the features that provide pilots with control of the electronic map are described in the Features and Functions section. Pilots may find it useful to control frame of reference, display scale, terrain display, and aircraft configuration settings. There is, of course, a trade-off involved in providing pilots with control of the EIAP. Every feature that adds to the capability to control or customize an interface may also add to the complexity of the interface. In addition, increased pilot control may also increase pilot workload. Pilot control features should be chosen and implemented carefully. See Section 3.2 on customizing for related information.

3.6.1 Guidelines

- 3.6.1.1 Users should be able to take initiative and control their interaction with the computer; designers should try to anticipate user requirements and provide appropriate control options and computer responses in all cases (Smith and Mosier, 1986).

Comment: Many of the features and functions in Chapter 4 discuss various control options that would be useful for EIAPs.

- 3.6.1.2 Pilots should be able to control the sequence of a computer transaction through explicit control. User action should be interrupted only in emergency situations (Smith and Mosier, 1986).

Example: Changing views or pages automatically based on phase of flight may be problematic for pilots. The change may interrupt some action the pilot was performing. Caution should be used in implementing any system that incorporates automatic sequencing.

- 3.6.1.3 Users should be allowed to control the amount, format, and complexity of displayed data as necessary to meet task requirements (Smith and Mosier, 1986).

Comment: A default format determined by the designer (based on careful study of the instrument approach task) or determined by the pilot pre-approach should be provided for the approach view of the EIAP.

- 3.6.1.4 When information requirements cannot be predicted through knowledge of the task, pilots should be able to choose information that is needed during the task.

Comment: In the case of EIAPs, choice of information display must be immediately visible, fast to operate, immediately responsive, and limited in number.

3.6.2 References

Apple, 1993; Endsley and Bolstad, 1993; Huey and Wickens, 1993; IBM Corporation, 1991; Smith and Mosier, 1986.

3.6.3 Graphic Example

In this example, the display of obstacles is filtered based on obstacle height.

DON'T change the altitude filter automatically based on aircraft altitude without providing a clear visual or auditory message of the change.

Altitude Filter = 5000'

Altitude Filter = 1000'

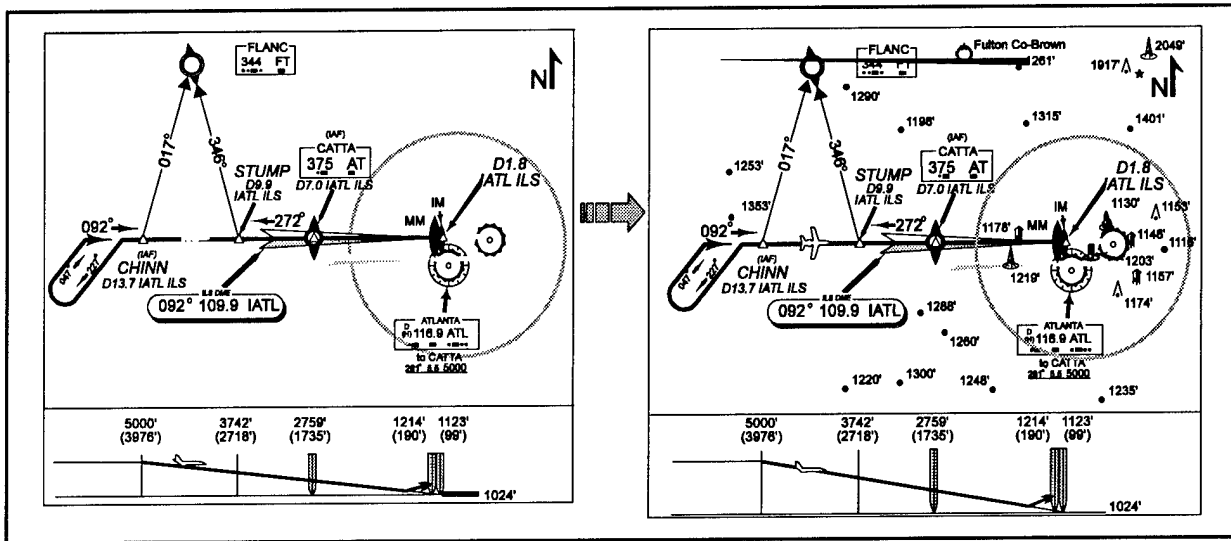

DO allow pilots to control features such as terrain declutter and zoom and **DO** display the results of pilot actions.

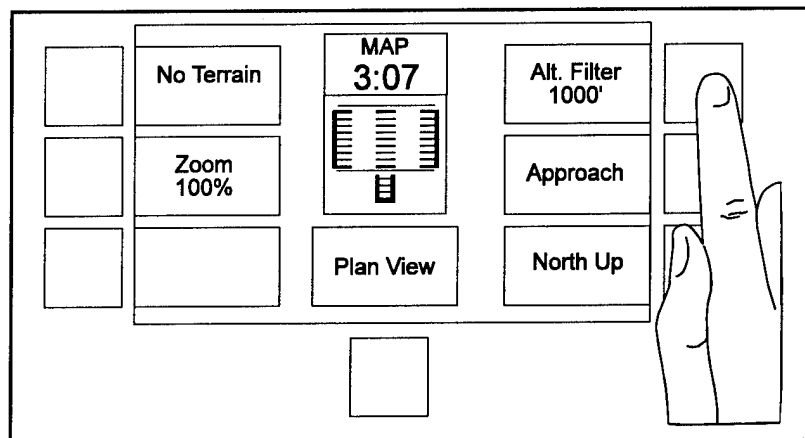

3.7 SIMPLICITY

Webster's Dictionary (Cayne, 1992) defines simple as "consisting of only one kind, part, etc; consisting of few parts; easy to deal with, understand." Simplicity is the opposite of complexity. Aretz (1988) emphasizes the importance of reducing the complexity of electronic map displays. Following the above principles on consistency, visibility, directness, and limiting the use of modes will help to reduce the complexity in EIAPs. In addition, the number of available features and functions (and the amount of information presented) must be minimized. Unfortunately, this means that maintaining simplicity is often a direct trade-off with providing functionality and, possibly, pilot control.

Brown (1988) makes a recommendation to "avoid excess functionality." The challenge for designers is to identify key functions and eschew excess functions. Designers are much better equipped to meet this challenge if they have followed the principle of knowing both the user and the task.

There are also methods of maintaining simplicity without completely eliminating functionality. Brown's (1988) recommendation for progressive disclosure and graceful evolution suggests that designers can provide an initially simple interface that allows users to discover more functionality as they become more experienced. This type of interface requires careful attention to the principle of visibility since more advanced functions may not be directly visible. The designer must carefully provide the visual cues for more advanced functions. In the case of EIAP design, it is not likely that pilots will have time available to do much exploring or discovering while using the EIAP. However, Martel and Ward (1993) suggest a type of short-term "progressive disclosure" method that may be useful for an EIAP. They recommend that the initial map display be simple and provide limited information. This will allow pilots to orient themselves. Then, detail can be added after the pilots have an initial concept of the basic approach path. This is preferred to the method of providing a highly detailed (and complex) view and then requiring the pilots to declutter information.

While pilots may indicate that they want all of the features implemented on an EIAP, designers must remember that if a feature is implemented in a fashion that is not immediately usable, it has not really added any functionality, and has likely increased the overall complexity.

3.7.1 Guidelines

3.7.1.1 The number of features/functions provided in an EIAP should be limited (Brown, 1988).

Comment: The limit on the number of functions provided will be dependent on which functions are chosen and how they are implemented.

Comment: One way of determining the key features would be to ask pilots to prioritize desired features and then implement as many of the high priority features that can be implemented in an easy to use fashion within design constraints.

Comment: Three different prototypes were required to present examples of the various functions discussed in this document (see Chapter 6); any one prototype with all of these features would be too complex.

3.7.1.2 All functions should be rapidly accessible (DOD, 1993) and simple to execute.

Comment: A test of an EIAP using realistic tasks that require access of each of the functions available will identify (through errors or excess time required) functions that require excessive time to access or are difficult to execute.

3.7.1.3 Only needed information should be displayed on the EIAP (Brown, 1988).

Comment: Refer to Section 2.2 on information requirements of the task and the following references for a discussion of information needed on EIAPs: Blanchard, 1991; Clay, 1993; DeRee, 1990; Friend, 1988; Hofer, Palen, Dresel, and Jones, 1991; Hofer, Palen, Higman, Infield, and Possolo, 1992; International Air Transport Association, 1975; Mykityshyn and Hansman, 1992; NASA-Langley Research Center, 1993; Taylor, 1985.

3.7.1.4 Additional tasks or steps should not be added to the task. Use of an EIAP should not require more time, effort, or interpretation than the use of paper IAP charts.

Example: Once a pilot is on final approach, he or she should not have to touch the EIAP to receive needed information.

3.7.2 References

Aretz, 1988; Blanchard, 1991; Brown, 1988; Clay, 1993; DeRee, 1990; DOD, 1993; Friend, 1988; Hofer, Palen, Dresel, and Jones, 1991; Hofer, Palen, Higman, Infield, and Possolo, 1992; International Air Transport Association, 1975; Mykityshyn and Hansman, 1992; NASA-Langley Research Center, 1993; Taylor, 1985; Webster, 1992.

3.7.3 Graphic Example

DON'T overload an EIAP with excess functionality. In this example, the Zoom feature allows a pilot to choose from five different types of zoom. Five different types of zoom may be appropriate for a graphics drawing package, but it is excessive for an EIAP and adds unwarranted complexity.

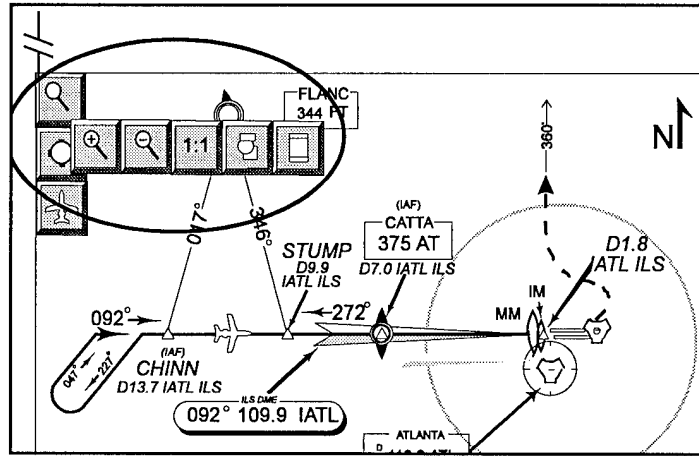

DO choose a few key functions and implement them in a simple, straightforward manner. In this example, only Zoom In and Zoom Out options are available with the Zoom function. If many symbols are used throughout the system, textual labels will reduce memory requirements.

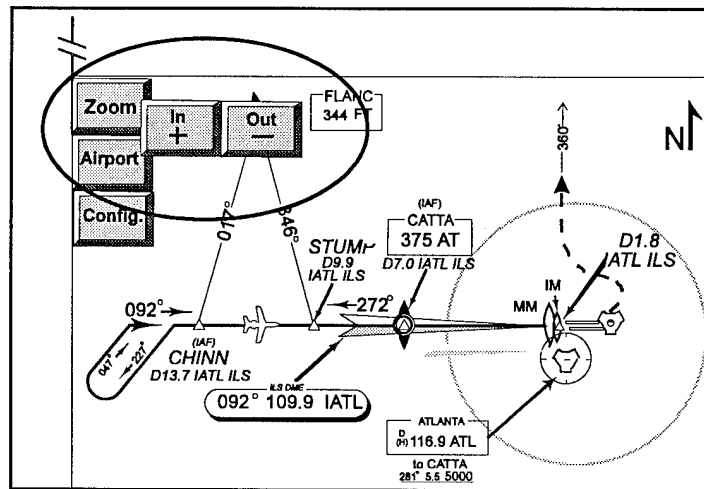

3.8 FORGIVENESS

Users of an interface should be provided with an easy method of undoing actions that were made in error. In the case of an EIAP, pilots should be able to quickly return to a view or state that was previously displayed. The use of default configurations and allowing pilots to access any page or view from all other pages or views are examples of methods that can be used to provide forgiveness. During an instrument approach, time is so important that a pilot must have the ability to cancel actions that require a long system response time (for example, the pilot may have requested (in error) an alternate procedure that requires a long response time due to database access). Block (1993) explains that there are a number of control actions that a pilot can make that are not easily forgiven. He suggests that pilots plant "mental cactuses" around those controls to remind them to exercise care. A pilot should not have to plant any mental cactuses on his or her EIAP.

3.8.1 Guidelines

- 3.8.1.1 If pilots have the capability to customize views through features such as zooming or declutter, a fast and easy way should be provided for the pilot to return the EIAP to a default configuration.

Example: Provide a default button that, with one action, returns the EIAP to a default view -- the default may be supplied by the designer or customized by the pilot. See Section 4.2 on customization for more information.

- 3.8.1.2 Designers should provide controls that can be easily returned to previous or default states.

Example: Rotary knobs with detents that allow the user to feel discrete changes in the control can be more easily returned to a default state than continuous rotary control knobs. Markers on the knobs and on the panel or display that indicate the normal or default position will help users to return controls to those positions.

Example: Selector switches or buttons with two or three discrete states will also be more forgiving than continuous controls.

- 3.8.1.3 Designers should consider providing an UNDO control that will allow the user to reverse any action (Smith and Mosier, 1986).

- 3.8.1.4 Users should always be warned before they initiate a task that will cause irretrievable data loss (Apple, 1992).

Comment: For an EIAP, there should be no way a pilot could perform a task that would cause loss of navigational data; however, there may be some tasks where a pilot could lose display settings information.

- 3.8.1.5 If an action cannot be made reversible, the EIAP should inform the user and allow an alternate action (IBM Corporation, 1991).

Example: If the EIAP allows the user to change the system defaults, and there is no way to return to the original defaults provided by the manufacturer, a warning and a means of canceling the action should be provided.

- 3.8.1.6 Word the prompt for a confirmation to warn users explicitly and provide a CONFIRM control that is unique from an ENTER control (Smith and Mosier, 1986).

Example: The warning "Change of system defaults will permanently **erase** manufacturer-supplied defaults, CONFIRM change of system defaults?" is better than "CONFIRM change of system defaults?".

Example: Care should be taken to make sure that the response to a confirmation is consistent. If, for one warning a pilot must respond Yes or No to the question "Do you want to continue with this action?" and for a different warning a pilot must respond Yes or No to the question "Do you want to cancel this action?", the responses are different for the same choice and errors are likely to occur.

Comment: Tasks which require a confirmation such as in this example should probably only be performed pre-approach.

- 3.8.1.7 If a pilot requests an action that requires a long system response time, provide a means for canceling the request.

Comment: A more preferable EIAP design is one in which no actions require a long system response time.

3.8.2 References

Apple, 1992; Hix and Hartson, 1993; IBM Corporation, 1991; Smith and Mosier, 1986.

3.8.3 Graphic Example

DON'T implement functions that require a long system response time without providing the user with some means to cancel the function.

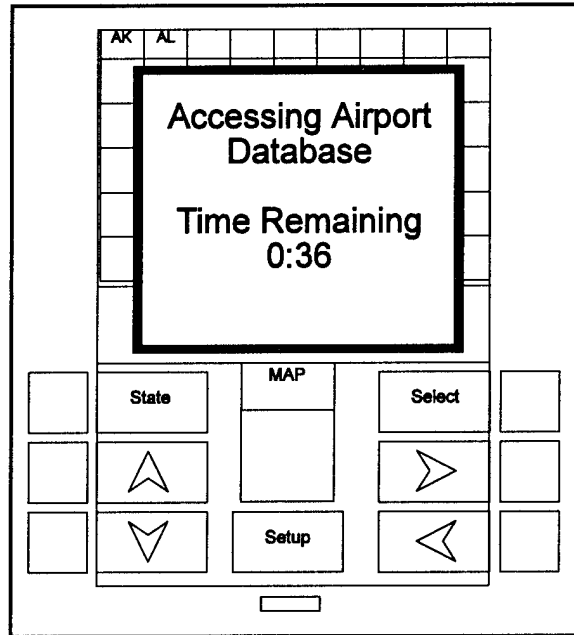

DO provide a method for pilots to quickly cancel an action that requires a long system response time.

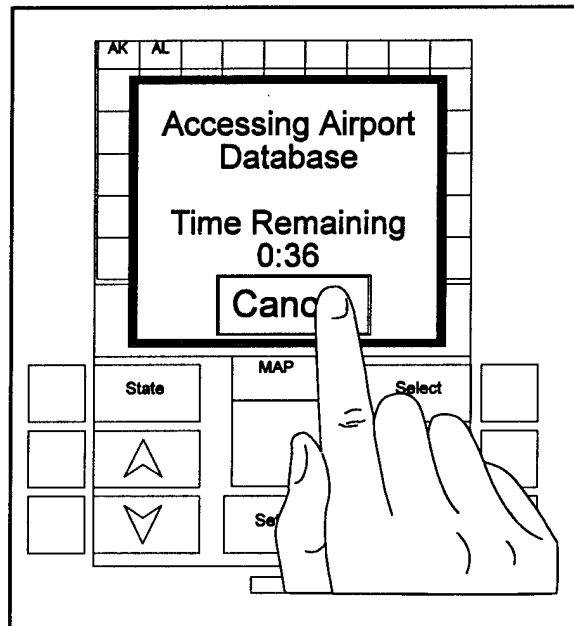

3.9 FEEDBACK

Users should always be provided with immediate and meaningful feedback for system events. The feedback should be direct and visible (may also be auditory or tactile, but the meaning should be obvious). This applies to actions that a pilot takes (e.g., if a pilot presses a touch-screen "button", the consequences of the button press should be immediately visible and the button should take on the appearance of being pressed in) and events that occur outside of the pilot's control of the EIAP (e.g., display of the pilot's aircraft). The feedback should keep the pilot aware of the situation and provide the pilot with any information needed to change the situation.

3.9.1 Guidelines

3.9.1.1 The EIAP should provide displayed feedback for all user actions during data entry; keyed entries should be displayed stroke by stroke (Smith and Mosier, 1986).

3.9.1.2 Ensure that the computer acknowledges every control entry immediately; for every action by the user there should be an immediate visible or audible reaction from the computer (Smith and Mosier, 1986).

Comment: In some cases, the appropriate reaction is the response expected (e.g., when the pilot presses a panning control, information on the display moves so that a different section of the map is in view). Because the instrument approach task is time critical, the speed of response should be very fast (less than one second).

Comment: If no visible response is associated with a choice, some other visible response should be provided to indicate that the action was processed, such as a message, a change in a status line, or a change in a label.

3.9.1.3 If a computer response is slow (more than one second), provide a message or indicator that the action is being processed and an indication when the action is completed.

Comment: The type of message or indicator is dependent on the speed of the response. If the response time is greater than 1 second but less than 3 or 4 seconds, a simple change in cursor style or a short message in a status line should be appropriate. For longer response times, a message providing some quantitative indication of time passing is preferable. An option to cancel the action may also be provided.

3.9.1.4 Provide feedback if a pilot selects an inappropriate control (Smith and Mosier, 1986).

Example: If a pilot tries to display the missed approach view when the view is already displayed, provide feedback such as a beep or a message stating "currently selected."

Example: If a pilot chooses to hide or move critical information items that can not be altered, such as the decision height, provide feedback that the action is not allowed.

- 3.9.1.5 Provide feedback by displaying appropriate identifications, settings, and mode indications (Smith and Mosier, 1986).

Example: Display the name of the airport and city, the aircraft configuration settings, the current mode, the page name, type, or number, and other identification, settings, or mode information in a consistent location.

- 3.9.1.6 When an item is selected for an operation, highlight the selected item(s) (Smith and Mosier, 1986).

Comment: If an item can not be selected, indicate its unavailability.

3.9.2 References

Apple, 1992; IBM Corporation, 1991; Smith and Mosier, 1986.

3.9.3 Graphic Example

DON'T expect users to know what information is presented to them without providing labels or titles. In this example, the user has selected the state Georgia, and the appropriate cities for Georgia are displayed. There is, however, no visible feedback to indicate that the cities displayed are Georgia cities.

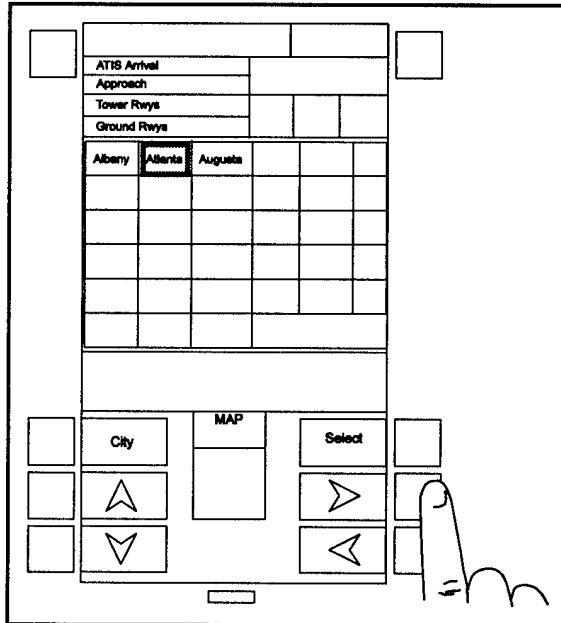

DO provide feedback in terms of labels and titles to help maintain pilot awareness of the information displayed. In this example, the user has selected Georgia and the state is displayed in the heading above the city selections. As each city is highlighted/selected a label of the city and state is displayed in the top left corner.

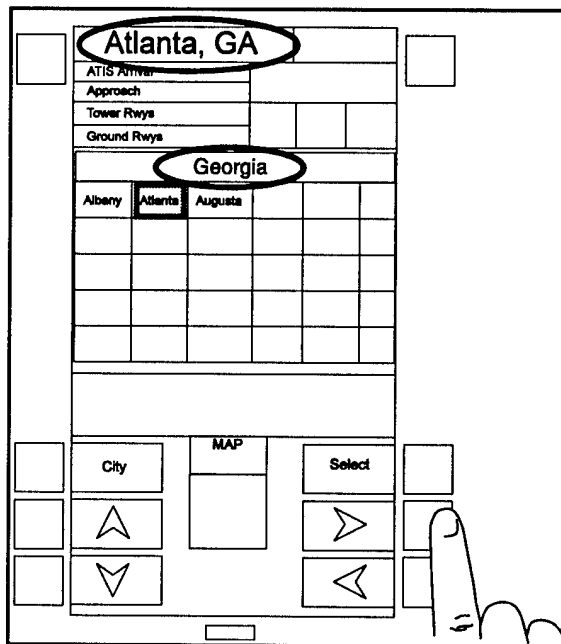

3.10 LOCATE AND GROUP INFORMATION IN A MEANINGFUL MANNER (E.G., BY FUNCTION, IMPORTANCE, SEQUENCE, AND FREQUENCY)

The final general principle to be applied to the design of electronic displays ensures that information is located and grouped throughout the EIAP in a meaningful manner. Grouping of information in a meaningful manner helps the user to develop a conceptual framework for working with the system. A good conceptual framework allows users to organize the system into a few small groups rather than a large number of disconnected items. These smaller groups may be referred to as chunks. Chunking is a technique used to make memorization of several items easier (telephone numbers chunked into a three-digit number and a four-digit number are easier to remember than seven distinct numbers). Meaningful grouping of information on an EIAP makes it easier to remember what actions to perform and where to look to locate needed information. There are several different meaningful groupings that can be applied to an EIAP. The best strategies for grouping information include grouping by frequency of use, function, importance, and sequence. Often, designers will have to consider trade-offs of different grouping strategies since more than one may apply.

3.10.1 Guidelines

3.10.1.1 Information on an EIAP should be located and grouped in a meaningful manner.

Example: Communication frequencies may be grouped with other important information such as approach course and minimum descent altitude at the top of the display. Within that location, communication frequencies should be grouped based on sequence of use.

See Features and Functions Sections 4.12 and 4.13 for more specific guidelines and references related to the grouping of information.

3.10.2 Graphic Example

DON'T locate information in an order that is out of sequence with the task. In the following example the communication frequencies are ordered ATIS, Approach, Ground, then Tower (or ATIS, Ground, Approach, Tower -- neither is correct).

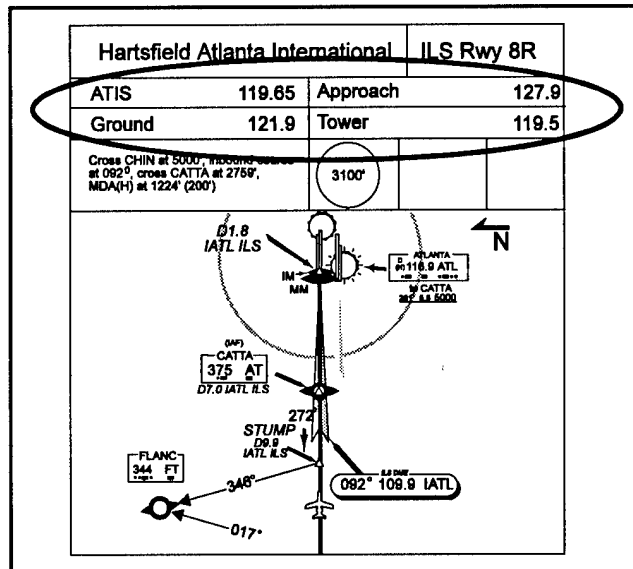

DO locate information in an order that is in sequence with the task. In this example the communication frequencies are ordered correctly as ATIS, Approach, Tower, then Ground.

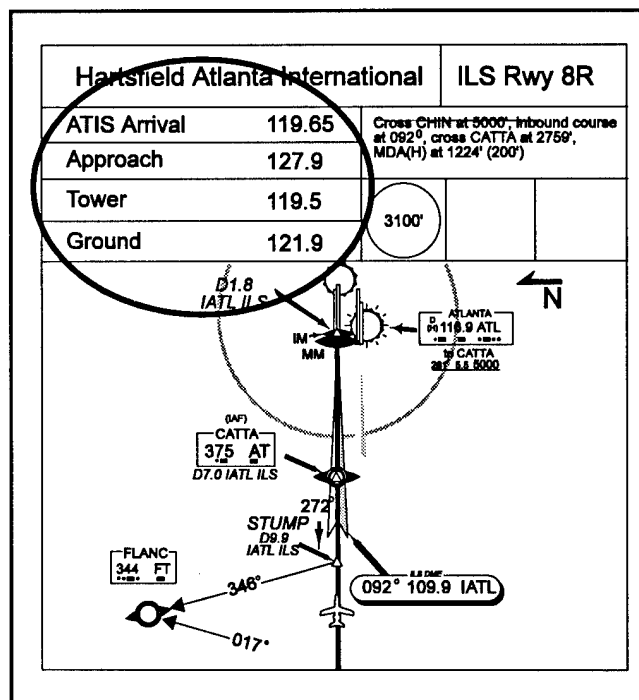

4. FEATURES AND FUNCTIONS

This section of the document describes twenty-seven features or functions that may be presented on an electronic display of instrument approach charts. The features and functions are more unique to map and situation displays than the general principles. They are intended to cover areas that may not currently have a large number of human factors guidelines available. Not all of the features described here will be used on any one EIAP. In fact, real-world constraints may determine that certain features are not feasible at all. If a certain feature or function of interest is not included, readers are encouraged to check the index since there is a wide range of terminology in the design of electronic displays and guidelines for design may overlap. For coverage of general issues related to the design of electronic displays, readers are referred to user interface design guidelines such as Smith and Mosier (1986).

Section 2.2 presented the information requirements of the instrument approach task. It is generally accepted that all of the information currently displayed on paper charts should also be provided on electronic charts. However, the means of displaying the information may change. For example, while paper charts display a table of time to missed approach point, electronic charts may have the capability to display a countdown of time or distance to missed approach point which provides the same type of information in a more direct and usable format. The core set of information presented in Table 2-1 (page 11) also should be given special consideration in determining what information should be displayed. While previous sections discussed what information should be displayed, the following features and functions discuss how the information should be displayed, how the information should be arranged, and how the information or display may change. The features and functions are organized as follows:

How is Information Displayed or Coded?

- 4.1 Alphanumerics/Text
- 4.2 Symbols/Icons
- 4.3 Color
- 4.4 Size, Highlighting
- 4.5 Labels, Legends
- 4.6 Aircraft Location, Planned Route, Current Path Depiction
- 4.7 Terrain Displays, Ground and Obstacle Clearance Information
- 4.8 Auditory Displays (Audible Codes, Voice Output)

How is Information Grouped and Arranged?

- 4.9 Windows/Pages
- 4.10 Menus
- 4.11 Frame of Reference
- 4.12 Invariant Display Areas

- 4.13 Strategies of Grouping Information
- 4.14 Methods for Grouping Information
- 4.15 Map Scale
- 4.16 Design for Appropriate Task/Phase of Flight (e.g., Design for Planning, Design for Final Approach)
- 4.17 Minimizing Errors, Minimizing Effects of Interruptions, Error Recovery
- 4.18 Integration With Other Cockpit Systems

How Does the Display Change (by Pilot or Automatically)?

- 4.19 Input Devices
- 4.20 Pilot Control of Displays and Custom Displays
- 4.21 Zooming
- 4.22 Scrolling and Panning
- 4.23 Display Dynamics
- 4.24 Declutter - Layering Information, Minimizing Information
- 4.25 Automation
- 4.26 Memory Aids, Sequence Reminders, Highlighting
- 4.27 Airport, NAVAID Search

As in the section on general principles, each feature is first defined or described. The second section for each feature or function is a list of design/certification guidelines. The guidelines are more specific than those presented in the general principles since they are applicable to one specific feature or function, thus they may be easier to apply. As was discussed previously for the general principles, many guidelines are not based on experimental evidence and certain exceptions will apply. The comments and examples will help readers to identify trade-offs in applying the guidelines. Many of the guidelines will not be applicable if the feature or function is not available on the EIAP in question. The checklist following this section will help determine the application of guidelines if there is any question. A list of references related to the principle is also presented. Finally, a graphic example displaying a DO and a DON'T based on the application of one of the guidelines is presented.

4.1 ALPHANUMERICS/TEXT

Text and alphanumerics are currently used throughout paper IAP charts. City names, airport names, NAVAID names, notes, missed approach instructions, altitudes, and times are all coded with alphanumerics. One problem with text is that it often takes more space than symbols. Another problem is that some information (e.g., spatial information such as direction) is more suited to a graphical display. However, text is often the best means of representing information because the meaning of words and numbers is quickly (automatically) inferred by most of the population. It can be more precise and less easily confused than graphic or symbolic representations. Good representation of alphanumeric information is important for the readability of electronic instrument approach procedures.

4.1.1 Guidelines

- 4.1.1.1 EIAPs should display alphanumerics in a sans serif font that avoids the use of characters that are similar to one another (Degani, 1992).

Example: A sans serif font such as this one: [AaBbCcDdEeFf], with distinctive P's and R's; G's, O's, and C's; and E's, B's, and D's is usually more legible than a font with serifs such as this one: [AaBbCcDdEeFf].

- 4.1.1.2 Conventional capital and lower-case presentation of text should be used, especially for long chunks of text (Degani, 1992; Hartley, 1981; Phillips, 1979; Tinker, 1963).

Comment: Although lower case words have more distinguishable word forms than upper case words, other design standards or guidelines may suggest presentation of text in all capitals.

Comment: Upper case presentation may be preferable for display of a single character (e.g., D 5.8 to represent DME distances). Upper case is also commonly accepted to indicate that the information presented is an acronym (MM) rather than a stand-alone word (Middle Marker).

Comment: Case should be consistent across text unless a different case (such as all capitals) is used for highlighting key information (e.g., "then climbing LEFT turn to 2000' (Jeppesen, 1989)").

Comment: Conventional punctuation should also be used (Smith and Mosier, 1986).

Comment: If upper case is required, consider enlarging the first letter of the word to enhance the legibility of the word (e.g., CLIMB TO 2000') (Degani, 1992).

- 4.1.1.3 Alphanumerics should be presented in a size that is readable from the proper location in the cockpit environment.

Comment: Aerospace Recommended Practice (ARP) 4102/7 (SAE, 1988) lists minimum sizes for symbols and text on electronic displays. Primary data should be at least 6 milliradians in size. Secondary data and descriptive legends should be at least 4 milliradians in size.

- 4.1.1.4 Adequate spacing and height to width ratios should be used for alphanumerics.

Comment: Recommendations for text printed on paper include: (1) height to width ratio should be approximately 5 : 3, (2) the vertical spacing should be not less than 25 - 33% of the overall font size, and (3) the horizontal spacing should be approximately 25% of the overall size and not less than one stroke width (Degani, 1992; Woodson, 1981).

Comment: The FAA (1992) recommends a stroke width to height ratio of 1:6 for 8 point type and 1:5.5 for 12 point type.

Comment: Since these recommendations are dependent on display medium, designers should test alphanumerics for readability on the display medium used under the appropriate environmental conditions (lighting and vibration).

- 4.1.1.5 Only one or two different typefaces should be used for emphasis (Degani, 1992).

Comment: Section 4.4 discusses highlighting methods such as bolding and blinking that may apply to alphanumerics.

- 4.1.1.6 The use of abbreviations and acronyms should be avoided (Brown, 1988) except where they are common and familiar.

- 4.1.1.7 Avoid the use of hyphenations (Smith and Mosier, 1986).

- 4.1.1.8 Sentences should be short, concise, distinct, affirmative, and in the active voice (Smith and Mosier, 1986).

Comment: Both speed and accuracy of comprehension are improved with the use of concise, distinct, affirmative, and active sentences.

Example: The active sentence "Contact UNICOM for advisory." is preferable to "UNICOM should be contacted for advisory."

Example: The distinct wording "will not" is preferable to "won't" (Smith and Mosier, 1986).

Example: The affirmative instruction "Clear the screen before entering data" is preferable to the negative instruction "Do not enter data before clearing the screen" (Smith and Mosier, 1986).

Comment: The wording of a sentence should be concise but understandable. Omitting words such as "the," "a," "of," "by," etc. may save space, but care should be taken to ensure that comprehension is not reduced (Smith and Mosier, 1986).

4.1.1.9 If several related items must be displayed, a logically ordered, single column list is preferred (Smith and Mosier, 1986).

Comment: Text in a list should be left justified (Smith and Mosier, 1986).

Comment: Numbers in a list should be justified by decimal point (Smith and Mosier, 1986).

4.1.2 References

Degani, A., 1992; FAA, 1992; Hartley, 1981; Phillips, 1979; SAE, 1988; Smith and Mosier, 1986; Tinker, 1963.

4.1.3 Graphic Example

DON'T use fonts with serifs. DON'T string together related textual information in paragraph form.

ATIS	119.65
Approach	127.9
Tower	119.5
Ground	121.9

ATIS 119.65 Approach 127.9 Tower 119.5 Ground 121.9
--

DO use capital and lower case letters, sans serif fonts, and present information in list form with appropriate spacing.

ATIS	119.65
Approach	127.9
Tower	119.5
Ground	121.9

4.2 SYMBOLS/ICONS

The importance of the proper use of symbols and icons was made apparent in a review of cognitive issues in the design of EIAPs (Clay, 1993). The advantages of saving space and providing direct visual interpretations are apparent. The addition of a visual representation of runway light configurations and iconic missed approach instructions by Huntley and his colleagues (Huntley, 1993) demonstrated these advantages. Pilots often try to create a mental picture of the scene they are looking for when they emerge from the clouds. A symbolic representation of runway lights as opposed to cryptic acronyms helps to facilitate this. Iconic missed approach instructions also provide pilots with a visual representation of the actions to take in a missed approach situation (Osborne and Huntley, 1992). Because people have relatively good memory for pictures (see Klatzky, 1975, for a review), pilots are able to remember the highly important first two instructions without having to look down at the approach chart. However, evidence also exists to indicate that overuse or poor representation of icons can easily lead to confusion (Kansas, 1993). In cases where the symbol or icon can not be designed to provide immediate recognition of the item with a simple (little detail) pictorial, the use of labels or the ability to access legends may be needed. In cases where the item to be represented is not graphic in nature, a textual representation alone may be preferred.

Several guidelines for the use of icons are available from various sources in HCI literature (Apple, 1993; Brown, 1988; DOD, 1993). The Department of Defense presents an entire chapter on the use and design of icons. In general it is suggested that icons look like the object they represent and that the detail of the icon be minimized so that only the most important identifying features are shown. What appears representative and easy to recognize by a designer is often not recognizable by the user. All symbols should be tested for recognition with a representative population. Another guideline can be added to those provided in HCI literature for icons on an EIAP - icons should look like those that are used on paper charts. Although the level of detail may not be as great on EIAPs, those features that distinguish different symbols on paper charts should be used to distinguish symbols on EIAP charts. This will ease transfer of learning for pilots who have been using paper charts.

EIAPs may provide the capability to reduce the number of different symbols used. Currently, paper IAP charts use different symbols for the same concept (e.g., final approach fix and flight path in the profile view) depending on whether the approach to be flown is precision, or non-precision, so that both the precision and non-precision information can be displayed on the same chart. An EIAP may provide the pilot the capability to specify which type of approach will be flown, eliminating the need for different symbols. An EIAP also provides the capability to use color or other highlighting methods to distinguish information rather than using an extremely large set of symbols.

4.2.1 Guidelines

- 4.2.1.1 Standards should be established for symbols and used consistently (DOD, 1993; Smith and Mosier, 1986). Symbols should be identical both within and across EIAP charts.

Comment: The Society for Automotive Engineers (SAE) subcommittee on aeronautical charting (SAE G10) is currently developing standard symbols for use on electronic navigation displays.

Comment: Take advantage of population stereotypes by using symbols that look like those presented on paper IAP charts, and those that have identical meaning in other cockpit displays (DOD, 1993). In the case where Jeppesen and National Oceanic and Atmospheric Administration (NOAA) charts use different symbols, consider using the symbol with less detail.

Comment: Appendix B of Aerospace Recommended Practice (ARP) 4102/7 (SAE, 1988) on electronic displays provides a list of standard symbology recommended for use on electronic horizontal situation indicators (EHSI) and navigation displays (ND) that may be appropriate for use on electronic instrument approach procedure charts.

Comment: Symbols with high detail currently used on paper charts will not transfer well to electronic medium because of the reduced resolution of electronic displays relative to printed matter.

- 4.2.1.2 Symbols should be presented in a size that makes them discernable from the proper location in the cockpit environment.

Comment: Aerospace Recommended Practice (ARP) 4102/7 (SAE, 1988) lists minimum sizes for symbols and text on electronic displays. Primary data should be at least 6 milliradians in size. Secondary data and descriptive legends should be at least 4 milliradians in size.

- 4.2.1.3 Symbols or icons should be designed to look like the object they represent and tested with a representative group of users (Apple, 1993; Brown, 1988; Smith and Mosier, 1986).

- 4.2.1.4 All icons or symbols should be distinguishable from other icons or symbols (DOD, 1993).

- 4.2.1.5 The detail provided in an icon should be minimized so that only important identifying features are shown (Apple, 1991; DOD, 1993). Simple, concrete symbols are preferred over abstract, complex symbols (DOD, 1993).

4.2.1.6 Ensure that users can attribute only one meaning to each icon or symbol (DOD, 1993).

4.2.1.7 If no visual representation of the information to be represented is available, a simple geometric symbol with a label or legend should be used; or a textual representation should be considered.

Example: Some geographic locations on IAPs have no physical representation (e.g., intersections, glide slope intercepts) but require a symbol denoting the location of the point. Simple geometric symbols may be used to represent these points in space.

4.2.1.8 The number of symbols or icons that are displayed on an EIAP should be minimized.

Comment: Minimizing the number of symbols utilized in any system will reduce memory requirements for a user. Currently, between 50 and 100 symbols are used on paper charts, many are obvious and require no interpretation. Others are not. It may not be possible to reduce the number of symbols on EIAPs very much from those used on paper charts. EIAP designers should have very convincing reasons to add new symbols to a display. More research is needed to identify the minimum set of symbols for an electronic display of IAPs (see 4.2.1.1).

4.2.1.9 The rationale for providing different symbols should be evaluated to determine whether some symbols may be eliminated in an EIAP.

Example: Current paper charts may use separate symbols for information that is conceptually the same except one symbol is for a precision approach and a different symbol is for a non-precision approach (e.g., approach path on Jeppesen charts). This is so that both precision and non-precision information may be presented in the same approach chart profile view. However, an EIAP has the capability to easily display either a precision or a non-precision profile (there is no need to display both at the same time) based on pilot selection, so the two symbols may be the same. For this implementation, the EIAP must also have the capability for the pilot to quickly switch between precision and non-precision in the event that a NAVAID signal is lost during the approach. This may eliminate the need for extra symbols and may reduce memory requirements, clutter, and complexity.

4.2.1.10 If texture is used to code a symbol, simple hatching is preferable to elaborate patterns (Smith and Mosier, 1986)

4.2.1.11 Essential labels should be displayed with the symbol (DOD, 1993).

Comment: See Section 4.5 on labels and legends.

4.2.1.12 Provide a means for the user to identify unknown symbols (DOD, 1993).

Example: A legend page or context-sensitive help (help for a selected symbol) should be available with textual descriptions for each symbol.

4.2.1.13 Do not allow symbols to overlap. Provide a "bring to front" feature if they do (DOD, 1993).

Comment: Standard rules should be developed for determining the priority of symbol display if symbols occupy the same space on the display.

4.2.2 References

Clay, 1993; DOD, 1993; Huntley, 1993; Kansas, 1993; Osborne and Huntley, 1992; SAE, 1988; Smith and Mosier, 1986.

4.2.3 Graphic Example

DON'T use symbols that contain a great deal of detail (high spatial frequency).

DO keep symbols simple and concrete so they are easily recognizable and distinguishable from each other.

The following example shows how symbols with less detail compare to symbols with greater detail as the size of the symbol changes:

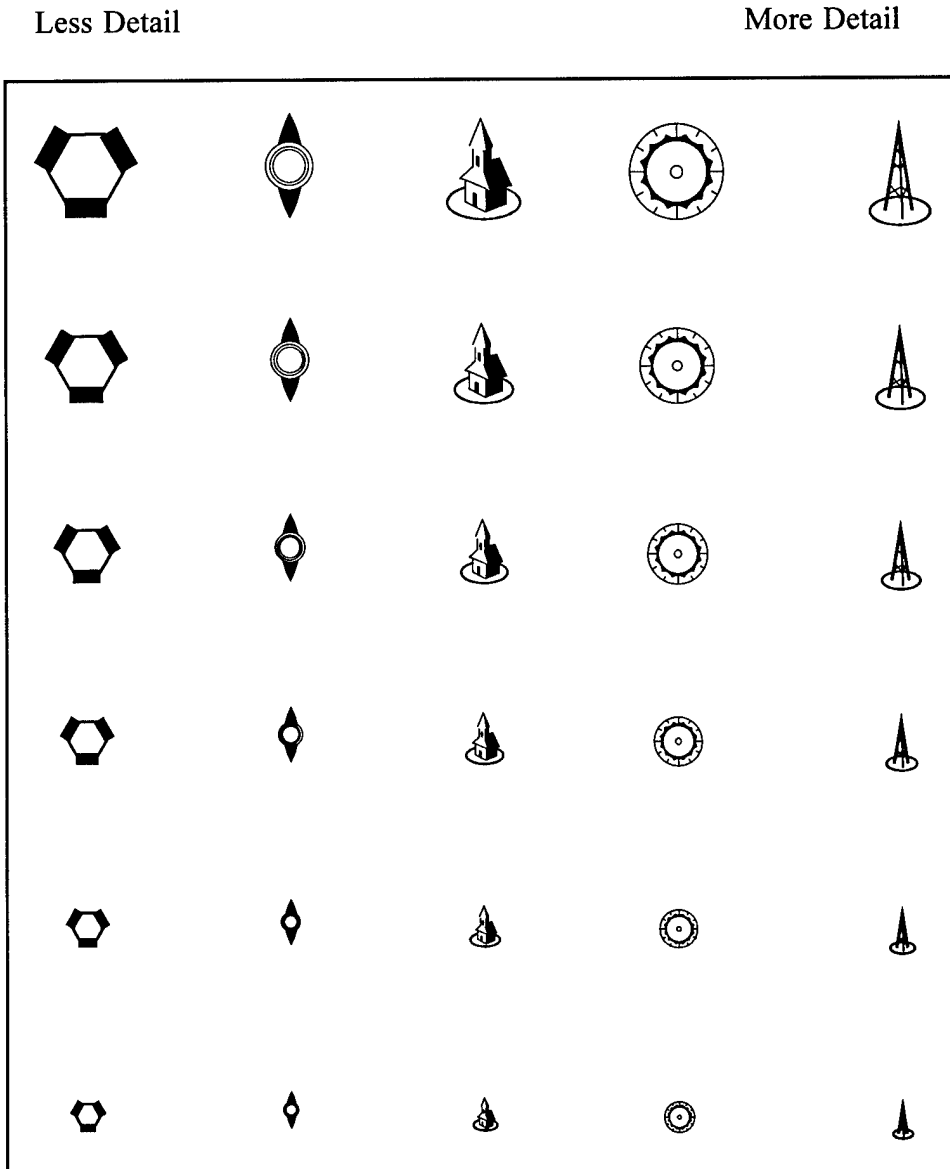

4.3 COLOR

Williams (1966) compared search time for targets based on different coding schemes. He found that color coded targets were located more quickly (7.6 seconds) than size coded objects (16.4 seconds) and shape coded objects (20.7 seconds). He also found that redundant coding of color and size (6.1 seconds) and color and shape (7.1 seconds) improved visual search performance over use of a single code. Color enhances simple visual search greatly. Since EIAPs may provide color capability at a fraction of the cost of color on paper, color should be considered for use on EIAPs.

There are many guidelines available on the use of color in human-computer interfaces (see Hennessy, Hutchins, and Cicinelli, 1990 and Hopkin, 1992). The usefulness of color on complex, high information density displays makes it potentially beneficial for use on EIAPs. The proper use of color has the ability to declutter and speed visual search (Hopkin, 1992). Pilots in a study by Mykityshyn and Hansman (1992) found that color on an EIAP had a decluttering effect.

The use of color also has potential disadvantages. Hopkin warns that color coding has the problem of visual dominance over other codings. Color codings are treated as operationally significant. People will recognize the color code of an information item before the shape or size of the item. It is important to use color coding redundantly with other methods of coding and consistently. Improper use of color may lead individuals to ignore critical information. For these reasons, careful consideration of the guidelines below and extensive testing should be performed before color is implemented on EIAPs.

The use of color should coincide with population stereotypes so it matches the existing expectations of pilots. There are two different sets of expectations that should be considered when determining the color coding to be used on an electronic display of cartographic information in the cockpit -- aircraft cockpit stereotypes and cartographic stereotypes (see Clay, 1993 for a table comparing the two conventions). In an aircraft cockpit, red generally indicates an urgent warning or a threat, while the cartographic convention for red is important items, roads, cities, or hot. AC 25-11 (FAA, 1987) and ARP 4102 (SAE, 1988) suggest a mapping of colors to meanings that incorporates a combination of cartographic and cockpit stereotypes (see Section 4.3.1.3).

4.3.1 Guidelines

- 4.3.1.1 If used, color should be used consistently throughout the EIAP and throughout the entire cockpit.
- 4.3.1.2 The number of color codes used should be minimized. For casual users or when color is used for absolute discrimination, the number of colors should be limited to four maximally discriminable colors. For experienced, long-term users or when

color is used for comparison, up to seven colors may be used (Hennessy, Hutchins, and Cicinelli, 1990).

Comment: The actual number of colors that may be used is debatable. The AC25-11 (FAA, 1987), ARP4102 (SAE, 1988), and E-2C enhanced main display unit (Hennessy, Hutchins, and Cicinelli, 1990) color sets (see Sections 4.3.1.3 and 4.3.1.4) incorporate eight different colors (including white).

4.3.1.3 Color codes that are consistent with existing standards of either cockpit electronic displays or topographical conventions should be used.

Comment: AC 25-11 (FAA, 1987) and ARP4102 (SAE, 1988) suggest the following standard meanings for colors on electronic displays in cockpits:

Warnings	Red
Flight envelope and system limits	Red
Cautions, abnormal sources	Amber/Yellow
Earth	Tan/Brown
Scales and associated figures	White
Engaged modes	Green
Sky	Cyan/Blue
ILS deviation pointer	Magenta
Flight director bar	Magenta/Green

	<u>Code 1</u>	or	<u>Code 2</u>
Fixed reference symbols	White		Yellow
Current data, values	White		Green
Armed modes	White		Cyan
Selected data, values	Green		Cyan
Selected heading	Magenta		Cyan
Active route/flight plan	Magenta		White

4.3.1.4 A standard set of colors for color coding should be developed for use on EIAPs. The actual colors should be specified in precise CIE (Commission Internationale de l'Eclairage) 1976 Uniform Chromaticity System (UCS) units (SAE ARP 1874, 1988). See Silverstein and Merrifield (1985), or Hennessy, Hutchins, and Cicinelli (1990) for a discussion on the use and measurement of color in electronic displays.

Comment: Hennessy, Hutchins, and Cicinelli (1990) recommend the CIE 1976 UCS units listed in Table 4-1 for the eight colors mentioned in AC 25-11 (FAA, 1987) and ARP4102 (SAE, 1988). These sets of colors were created in an evaluation of the E-2C enhanced main display unit. The first set is the set of maximally discriminable colors **for the eight colors given**. The second set is a set of subdued colors for the eight colors given. Neither of these sets constitute

standards for cockpit displays. They are merely recommendations for coordinates to be used to represent colors in the cockpit.

Table 4-1.
CIE UCS Units for Eight Colors
 (Hennessy, Hutchins, and Cicinelli, 1990)

Color	Maximally discriminable colors		Subdued colors	
	u'	v'	u'	v'
Red	0.4161	0.5285	0.3819	0.5112
Green	0.1206	0.5613	0.1462	0.5546
Blue	0.1724	0.1681	0.1594	0.2679
Orange (Amber)	0.3347	0.5119	0.2794	0.4998
Yellow	0.2023	0.5204	0.2023	0.5204
Light Blue (Cyan)	0.1590	0.3052	0.1600	0.3800
Pink (Magenta)	0.2595	0.3079	0.2500	0.3700
White	0.1978	0.4684	0.1978	0.4684

4.3.1.5 Users' perceptions of color should be evaluated as displayed on the actual background colors and in the actual environment (cockpit lighting) to ensure that color perception is as expected.

4.3.1.6 Where users must make relative judgements for different colored areas of a display (as in displaying changes in terrain elevation), consider using tonal coding (different shades of one hue) rather than spectral coding (different hues) (Smith and Mosier, 1986).

Comment: Perceptually different shades of colors may be difficult to implement on an electronic display in a cockpit. Even if shades are discriminable under certain conditions, shades may wash out in extremely bright cockpit conditions. Designers should ensure that redundant coding such as lines outlining the different shades and elevation numbers are used in addition to shading.

4.3.1.7 As the number of colors increases, increase the size of the color coded objects (Hennessy, et al, 1990).

Comment: Color may not be an appropriate coding mechanism for small objects. SAE ARP 4032 (1988) states that blue/green differences are hard to distinguish with symbol sizes smaller than about 8.5 milliradians and red/green differences are difficult to distinguish with symbol sizes smaller than about 4.5 milliradians.

4.3.1.8 Use color codes that are redundant with other codes (such as shape or text) (Hopkin, 1992).

Comment: Because of the range of ambient light from very dark to very bright in cockpit environments, color may wash out and therefore it is necessary that color be redundant with other coding schemes.

4.3.2 References

Beringer, Allen, Kozak, and Young, 1993; Clay, 1993; DOD, 1993; Hennessy, Hutchins, and Cicinelli, 1990; Hopkin, 1992; Mykityshyn and Hansman, 1992; SAE ARP 1874, 1988; SAE ARP 4032, 1988; Silverstein and Merrifield, 1985; Smith and Mosier, 1986.

4.3.3 Graphic Example

DON'T use more than the maximum recommended number of colors. Too many colors will make it difficult for users to remember the meaning of the colors and will reduce the effectiveness of color advantages such as reduced search time (see figure on page 62).

DO use colors as recommended in standards and use shades of the same color to indicate relative information (see figure on page 182).

DON'T use color excessively.

NOT FOR NAVIGATION

YOR 110.9	APPCRS 164°	CHINN 5100'	MDA 4200'	TOZE 3900'	Ashville, NC Regional ILS RWY 16
ATIS 120.2	Approach 125.8	Tower 121.1	Ground 121.9	MALSTR 	

78
56

78
56

Circleing not authorized west of Rwy 16-34
ILS unusable from 1/2 NM inbound

AIT. 1
Ashville Reg.
Rwy 16

Seek

209° 029°

SNOWERD
109.8 SOT

KEANS 375 IM

SUGARLF
112.2 SUG

ASHA
SGLF
112.2

SPBG
113.7

5100

KEANS
4600'

4200

2165'

5.1

.4

To Map
22:43

Climb to 5000 and hold BRA DRB

5000

→
BRA
DRB

A Full GS In ILS Full
R/YR 2600'

4.4 SIZE, HIGHLIGHTING

Size coding may be used to emphasize information of greater importance by displaying it in a larger size. Increased size may be used to accentuate information that is in the current "layer." As a code, the use of three different sizes is ideal, while five size steps is considered the maximum (Potash, 1977). Size also may be used to emphasize the importance of certain textual information items (see Section 4.4.1.4).

Electronic displays provide designers with the opportunity to utilize other methods of coding such as brightness (highlighting or bolding), reverse video, and blinking. These methods of coding should be used sparingly since they may slow down a pilot's ability to retrieve unhighlighted material. Novel, unexpected stimuli are best used for warnings or cautions since they both draw attention to themselves and are well remembered (Eysenck, 1984).

See Sections 4.1.1.3 and 4.2.1.2 for minimum recommended sizes for text and symbols.

4.4.1 Guidelines

- 4.4.1.1 No more than three different sizes of symbols should be used if size is used as a coding mechanism (Potash, 1977).
- 4.4.1.2 For size coding, a larger symbol should be at least 1.5 times the height of the next smaller symbol (Smith and Mosier, 1986).
- 4.4.1.3 Increased size makes an object more salient; therefore, objects which are most important and necessary for the current phase of a task should have greater size.

Comment: Size differences provide good emphasis cues to support display decluttering.

- 4.4.1.4 Important textual information should be presented in a larger font size than other textual information.

Example: Information such as communication and NAVAID frequencies that must be extracted exactly from the EIAP chart may be displayed in a larger font than the labels associated with them. Jeppesen Sanderson (1992) uses formats that take advantage of the salience provided with increased size. In the first example below, the NAVAID frequencies are presented in a larger, bolder font. In the second example below, key altitudes and directions stand out among the capital and lower case text.

COLUMBUS Approach **126.55**
ATLANTA Center **120.45**

MISSED APPROACH: Climb to 1500' then climbing RIGHT turn to 2000'
direct EUF VOR and hold.

- 4.4.1.5 Other methods of highlighting such as brightness (bolding), reverse video, and blinking should be used sparingly (possibly only for warnings and cautions).

Comment: It may be possible to provide pilots with the ability to highlight a group of information that is currently in use by changing the brightness (or by dimming current information that is not in use) as a decluttering mechanism. This may provide a layering of information. Pilots should be provided control over these methods of grouping information and should be able to quickly return to the original or default state.

Comment: If brightness coding is used, only two states should be available -- bright and dim. It is also preferable to use only two states of blink rates -- blinking or not blinking (Smith and Mosier, 1986).

- 4.4.1.6 If brightness, blinking, or reverse video are used to highlight warnings or cautions, the pilot should be provided with the ability to turn them off.

Comment: Any method of highlighting that is used for warnings or cautions (e.g., brightness, reverse video, blinking) should be used consistently for cautions and warnings only (Smith and Mosier, 1986).

4.4.2 References

Eysenck, 1985; Potash, 1977; Smith and Mosier, 1986; Williams, 1966.

4.4.3 Graphic Example

DON'T overuse coding such as highlighting, reverse video, and blinking. Users will be unable to remember the meaning of various codes or the coding will lose its emphasis capability if it is overused. In this example, the briefing text is in reverse video, the ATIS and tower frequencies are bolded, and the word "Approach" is written in outline form.

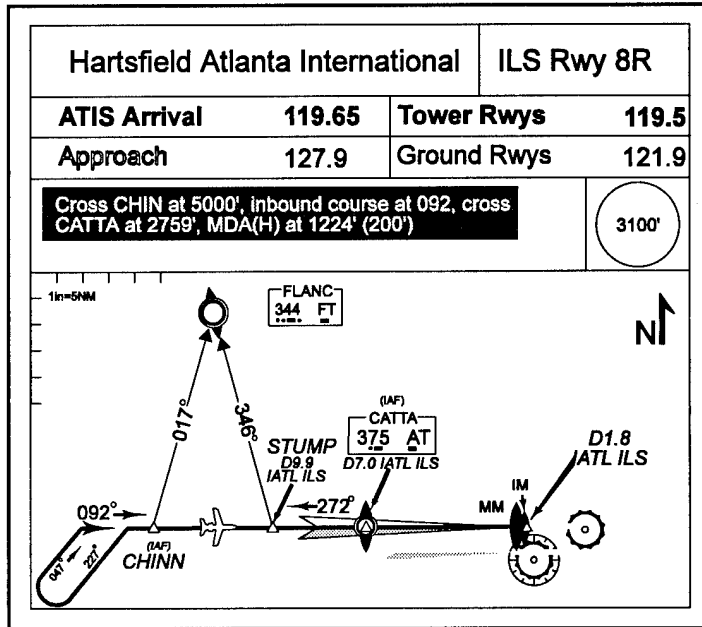

DO use emphasis coding judiciously for important information items. In this example, frequencies are presented in a bolder type than labels to help pilots quickly locate and read the frequencies. Key NAVAID's and altitudes stand out in the briefing text due to the size difference between the all capitals and the lower case letters.

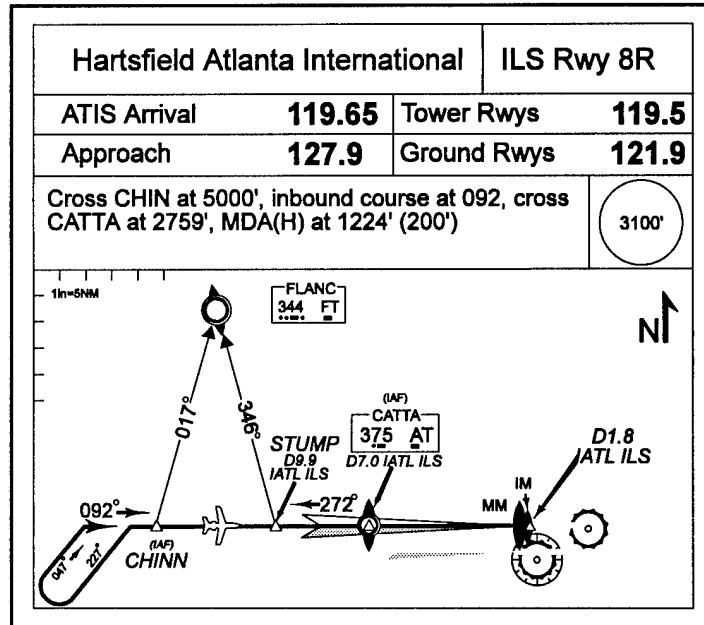

4.5 LABELS, LEGENDS

A great deal of instrument approach information is provided on legend pages of current paper IAP charts. EIAPs afford the opportunity to provide faster access to this type of information. Currently, pilots study symbols and their meanings in ground school and may occasionally look up information on a legend enroute, prior to the approach. The main question that will determine how legends are implemented on EIAPs is whether or not legend information would be beneficial during an approach. If this capability is beneficial, designers may choose to incorporate a touch-screen or some other quick request of legend information. If not, the information may be provided on a separate page that may require more steps to access or is available during setup or planning of the approach.

The capability to access information about a symbol quickly also may reduce the need to provide labels on some symbols that are currently labeled on paper charts. For example, an EIAP designer may choose to display marker beacon symbols without the MM and IM labels. However, designers should be aware of the disadvantages of requiring pilots to request labels. Acronyms and abbreviations are often more meaningful to pilots and allow faster and more accurate identification than a symbol with label request available. Requiring pilots to request information adds to the number of actions a pilot must perform. The decluttering benefit of removing the label must outweigh the additional requirement to request information.

4.5.1 Guidelines

4.5.1.1 Consistent, concise, and distinct labels that adequately describe the associated object or field should be used (Smith and Mosier, 1986).

Example: An MSA circle that specifies minimum safe altitude around a NAVAID may be labeled "MSA CFY NDB." Spelling out "minimum safe altitude" is not necessary due to the familiarity of the acronym. If this format is used, it should be used consistently for all MSA circles on all the approaches.

4.5.1.2 If data entry fields are used, the labels for the fields should be distinctive in appearance from the data in the fields (Smith and Mosier, 1986).

4.5.1.3 Labels should be positioned consistently and should be positioned adjacent to the associated object or field (Smith and Mosier, 1986).

Example: Choose a label position (e.g., above, to the right, above and to the right) and use it consistently for all symbols and obstacles.

Comment: An exception is when the use of the consistent label position will obstruct some other object. Under these conditions, position the label adjacent to

the object and verify that there is no confusion that the label may be associated with another object.

Comment: It will be difficult for designers to maintain consistent positioning of labels on dynamic displays such as track-up displays. If consistent positioning can not be maintained, designers should verify through testing that users associate moving labels with the appropriate objects and that the labels and objects do not obstruct one another in a way that limits the access of needed information.

4.5.1.4 Horizontal presentation of labels should be maintained when the display is rotated.

Comment: Labels that are associated with a line and are embedded in the line may require rotation with the line. Overlap problems are likely to occur otherwise. Designers should verify, however, that the text remains as close as possible to the normal, right side up, reading from left to right orientation (e.g., a rule may be required to switch the orientation of the text when the line rotates 180 degrees, so that the text does not appear upside down).

4.5.1.5 Consider automatic addition of detail with zoom.

Example: A designer may provide only the NAVAID designator and frequency in zoomed out conditions. As the display is zoomed in, add other information such as the full NAVAID name, the NAVAID type, whether or not voice is transmitted, and the morse code.

4.5.1.6 For legend information, use of an invariant "information area" in a consistent location on the display should be considered.

Comment: The bottom or top of the screen is commonly accepted as an information or status area.

Comment: The use of a consistent information area rather than presenting the information directly next to symbols reduces the likelihood that the information will overlay other important information in the view.

Comment: The use of a consistent information area provides pilots with a consistent location to look for information. This will offset some of the effects of interruptions if a pilot selects a NAVAID, then has to look away, then looks back to the display. This would be especially beneficial in a track-up moving map display because pilots will have less trouble relocating information in a consistent location than they would relocating a label that has moved.

Comment: This implementation can also have negative effects if a pilot is looking at a point he or she is choosing (for example with a touch-screen) and expects the

information to appear there. Pilots may have to learn to look elsewhere for the information. Another option (if avoiding obstruction/reducing clutter is not the goal) would be to display the information in both places.

4.5.2 References

Smith and Mosier, 1986.

4.5.3 Graphic Example

DON'T position labels inconsistently in relation to the symbol they are associated with unless space problems require unusual placement. In this example there is no set label position strategy. Labels are positioned above, below, to the right and to the left of the symbols. If symbol and labels will overlap, as in the presentation of the Cook NDB in this example, adjust the label positioning.

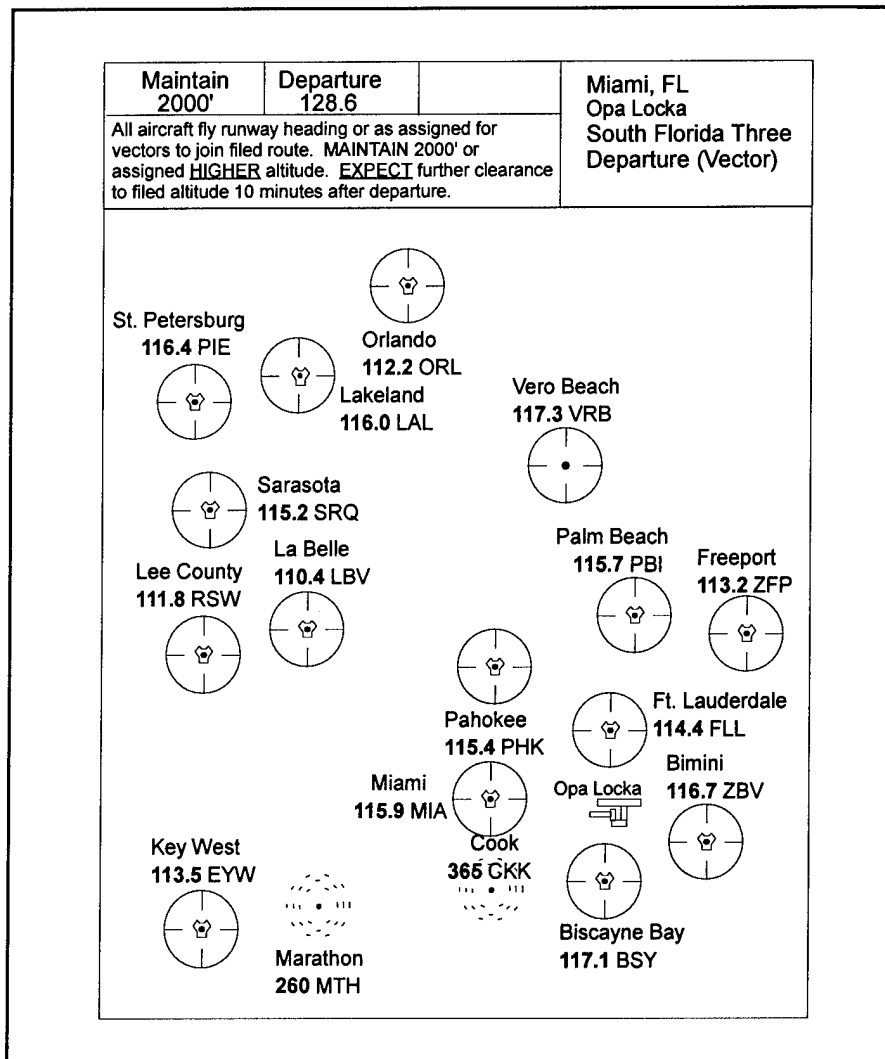

DO position labels in a consistent position relative to the symbol or control they are associated with and verify that the label will not be confused with another symbol or control. In this example, a line from the symbol encloses the labels making the relationship obvious. Additional lines added to a display may increase display clutter and should be used only where needed. In this example, two sides of a box around the label provide enough of a visual attachment to link the label to the symbol while minimizing added clutter and allowing for labels of varying length.

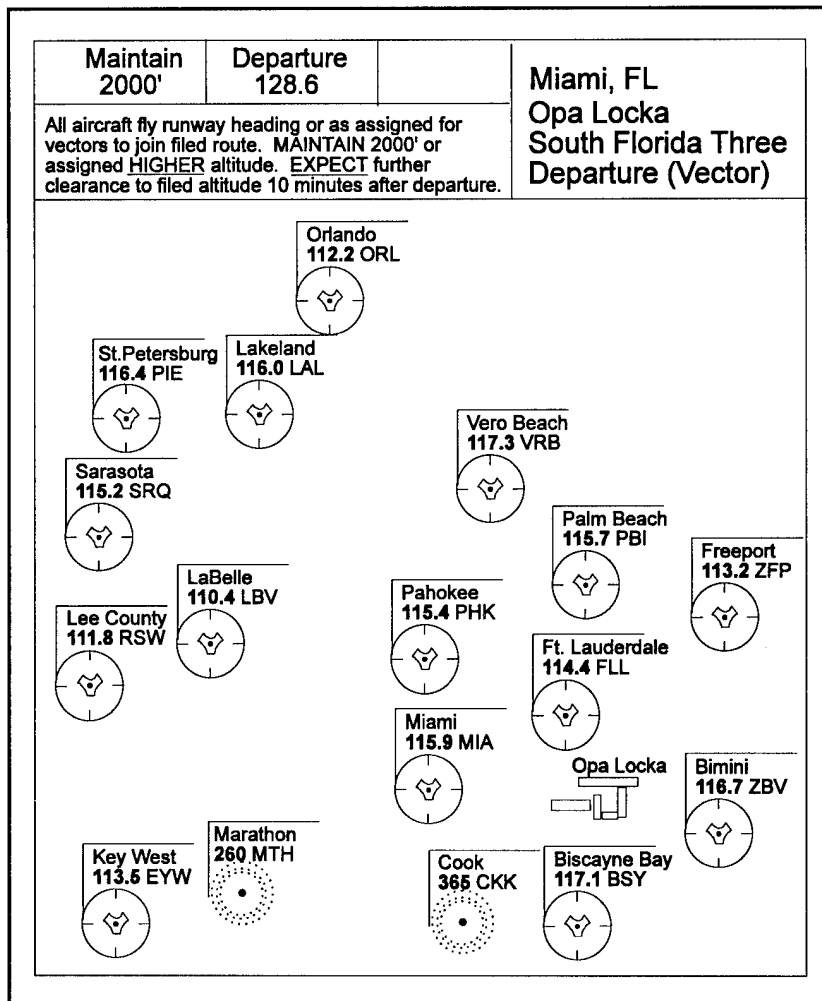

4.6 AIRCRAFT LOCATION, PLANNED ROUTE, AND CURRENT PATH DEPICTION

Another feature that would be useful in an EIAP is the display of the aircraft location, current (historical and/or predicted future) path, and planned route. The advantages of displaying the aircraft position on an EIAP are undoubtedly great. The pilot will be able to see aircraft position directly and will not have to integrate information from a number of cockpit displays to estimate aircraft position. Display of current aircraft position may also speed visual search of information close to the aircraft position. Pilots will remain aware of the aircraft position and will be able to quickly spot it on the display. They can then search from that spot to neighboring information of interest. Display of current aircraft position has also been shown to facilitate pilots in avoiding obstructions that are displayed in the path of the aircraft (Kuchar and Hansman, 1992). Display of aircraft location in a profile view provides a direct representation of vertical position in relation to various stepdown altitudes in the approach. This should aid pilots' awareness of vertical position in the approach. Huey and Wickens (1993) add that both a current path and planned route should be displayed on electronic maps. To some extent, paper IAPs currently display planned routes. EIAPs may provide the capability to display a specific route chosen by the pilot or based on ATC clearance. Current path may be represented by a velocity vector or some predictor display of future position based on current heading and velocity.

NASA-Langley (1993) found that for a terminal area electronic map, pilots prefer to see an ownship vector and they prefer that this vector indicate speed (and, in some situations, stopping distance). They recommended that an electronic map also display the cleared taxi route as a solid color-coded line. Section 4.3 also discusses the possible benefits provided by an EIAP that calculates and displays dynamic information such as crossing times and altitudes for fixes.

One concern in the display of predicted and planned routes is that pilots may use the display for course guidance. Currently, IAPs are used for planning and navigation. If EIAPs provide course guidance capability, more research is needed to identify potential problem areas. For example, how can maps be designed to provide pilots with the best information to navigate the approach, but not so much that the displays are used for course guidance? Or, if the display is used for course guidance, what other information may be needed?

4.6.1 Guidelines

4.6.1.1 Aircraft location should be displayed on an EIAP.

Example: Consider display of ownship in both a plan and profile view -- especially if different lateral scales are used for the two views.

Comment: Appendix B of Aerospace Recommended Practice (ARP) 4102/7 (SAE, 1988) contains recommended symbology for ownship for both plan and profile views.

- 4.6.1.2 The addition of a velocity or predicted route vector to the current location aircraft symbol should be considered.

Comment: If a predicted route vector is used, adopt a consistent computer model for calculating the predicted route (Smith and Mosier, 1986).

Comment: The model should use present velocity and both vertical and horizontal acceleration to predict the path for the next one, two, or three minutes. A segment of a circle should result for any case with acceleration. This will allow the pilot to intercept the required path with greater precision than is currently possible with mental arithmetic and estimations.

- 4.6.1.3 Display of planned route on an EIAP chart (perhaps color coded) should be considered.

Comment: Current approach charts display a type of planned route for all aircraft once they are on the approach; however, electronic charts provide the capability to display customized planned routes including a specific arrival route into the approach.

- 4.6.1.4 Make differences between actual aircraft location, predicted path, and planned or ideal path easily distinguishable on an EIAP (Smith and Mosier, 1986).

Comment: A dashed line representing predicted path is commonly used in cockpit displays.

4.6.2 References

Huey and Wickens, 1993; Kuchar and Hansman, 1992; NASA-Langley, 1993.

4.6.3 Graphic Example

DON'T display predicted path and planned path using the same color or line code. In this example, predicted path and planned path are both coded with a dashed line in the plan and profile views.

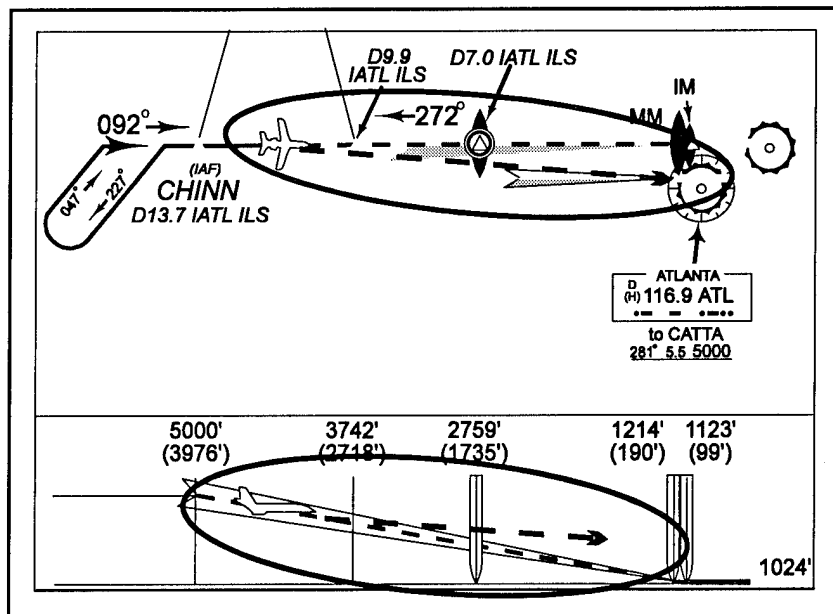

DO ensure that predicted path and planned route are easily distinguishable. In this example, planned path is displayed with a solid line while predicted path is displayed with a dashed line.

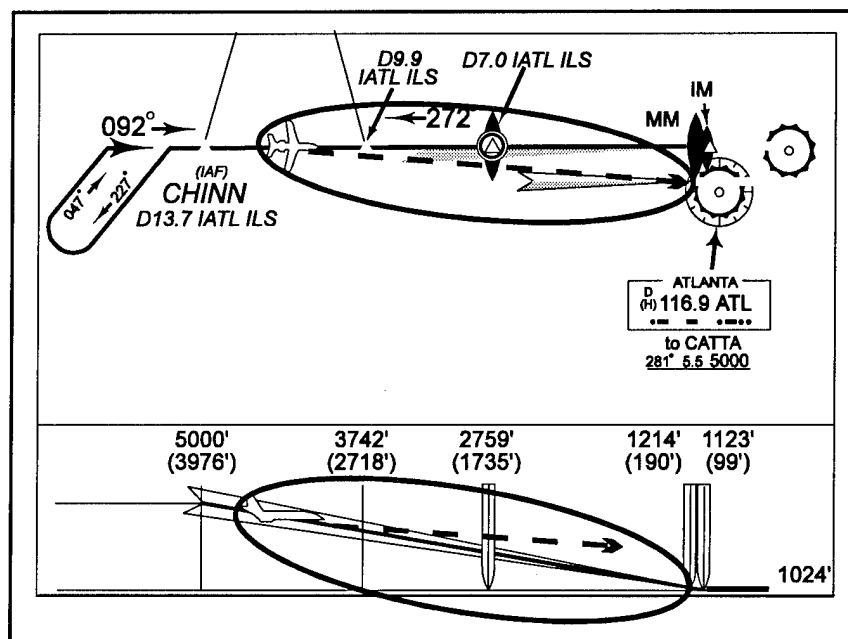

4.7 TERRAIN DISPLAYS, GROUND AND OBSTACLE CLEARANCE INFORMATION

The issue of terrain display has been heavily debated for IAPs. Several possible methods exist for presentation of terrain on EIAPs. They include display of minimum safe altitudes, shaded contours, contour lines, color contours, ATC clearances, profile of terrain, spot depiction of obstacle clearance, and others. Cognitive psychology literature on decision making and reasoning (Ashcraft, 1988; Wickens, 1984) suggests that pilots are not likely to pay attention to more than two different terrain depiction methods. Kuchar and Hansman (1992) found that most airline pilots tested paid attention to both MSAs and spot elevations but that during the approach they relied almost completely on ATC vectors for terrain clearance. Kuchar and Hansman also make the distinction between providing information for "Terrain Situational Awareness," to provide pilots with a mental picture of the surrounding terrain to avoid potential hazards, and providing "Terrain Alerting" information, to elicit an evasive response from the pilot. Currently, IAP charts are used for providing terrain situational awareness while ground proximity warning systems (GPWS) provide pilots with terrain alerting (when available). EIAPs provide the potential to integrate these two types of information presentation in one system. Kuchar and Hansman presented a prototype graphical GPWS system that alerted pilots of hazards through yellow and red terrain contours. Pilots found this type of system desirable.

In an evaluation of prototype EIAPs, Kuchar and Hansman (1992) found a slight advantage of a contour display over a spot elevation display when pilots assumed responsibility for terrain clearance (this occurred only after the pilots recognized that the ATC had previously provided an erroneous vector). Pilots also preferred the contour display to the spot elevation display, stating that the contour display provided greater terrain situation awareness. Kuchar and Hansman (1992) also found that depiction of the aircraft on the display also improved terrain awareness over awareness provided by current paper charts. Pilots are more likely to recognize hazards with a spot elevation format if the aircraft symbol appears as though it will intersect the spot elevation symbol. Pilots preferred spot elevations to be rounded up to the nearest 100', rather than to the nearest one foot as they are currently presented on paper charts.

One recommendation to designers for the display of terrain is to choose one or two comprehensive methods of depicting terrain and eliminate the other methods. Another possibility is to provide several methods of displaying terrain, ground, and obstacle clearance information and allow pilots to choose which method they prefer displayed or allow pilots to declutter terrain or obstacle information to which they do not attend.

4.7.1 Guidelines

- 4.7.1.1 The aircraft position should be displayed directly on views of the EIAP depicting terrain (Kuchar and Hansman, 1992).

Comment: Display of aircraft position on the EIAP allows pilots to directly compare the position of the aircraft with the location of surrounding terrain.

- 4.7.1.2 EIAPS should provide precise (to approximately 100 feet) terrain elevation representation (either via contour lines or spot elevations) in the area surrounding the airport.

Comment: Less precise terrain information such as MSA circles or minimum enroute altitudes (MEAs) incorporating safety buffers may be suitable enroute and prior to final approach.

Comment: If both precise elevation representation (such as spot elevations) and minimum altitudes incorporating safety buffers (such as MSAs) are used on an EIAP, care should be taken to make sure that there is no chance of confusion between the different numbers (Kuchar and Hansman, 1992).

- 4.7.1.3 The number of different methods of displaying terrain and obstacles should be limited. If several display options are provided, pilots should be given the capability to customize the display and remove some of the terrain representations.

- 4.7.1.4 Smooth contour lines may be preferable to spot elevation for terrain awareness (Kuchar and Hansman, 1992).

Comment: ICAO (1983, 1984) standards call for spacing of 500, 1000, or 2000 feet between contour lines. Designers should consider spacing based on rate of change of terrain -- steep terrain may require 1000' or 2000' spacing while gradual terrain may require 500' or 1000' spacing. Designers may also consider changing the spacing based on zoom level -- zoomed out views may use greater spacing than zoomed in views. Contour spacing should be evaluated for potential clutter and ease of reading labels.

Comment: The ICAO (1983, 1984) standard lowest altitude of terrain to be displayed by a contour line is at the next even 1000' at least 500' above airport altitude.

- 4.7.1.5 Consider using color coding with gradually changing shades of one hue for increasing or decreasing terrain.

Example: Shades of dark green (or dark brown), gradually becoming lighter as terrain elevation increases, may be appropriate to represent terrain. The smaller areas of high terrain will stand out against a dark background. The large areas of low terrain will blend in with the a background reducing potentially distracting effects.

- 4.7.1.6 Terrain elevation labels should be large enough and sufficiently separated for ease of reading.

Comment: Area minimum altitudes (AMA) recommended by ICAO (1983, 1984) standards are often depicted with a shorthand in which thousands of feet are shown in bold face, with hundreds of feet in a smaller type face (e.g., **43** for 4300 feet).

Comment: Spot elevations may be rounded up to the nearest 100' rather than given to the nearest foot (e.g., 1300' vs. 1268'). This presentation is easier to read and provides pilots with the information needed for sufficient clearance of the object (Kuchar and Hansman, 1992).

- 4.7.1.7 If spot elevations are used for terrain presentations, consider shading (or coloring) the area around the obstacle to indicate the size of the area where hazards exist. Pilots will be able compare the location of the aircraft symbol with the (more direct) presentation of the hazard.

- 4.7.1.8 If smooth contour lines are not presented on the EIAP, MSA information should be made available for terrain awareness.

Comment: Consider displaying the location of the aircraft relative to MSA sectors.

Example: Consider placing an aircraft symbol at the appropriate location within the MSA circle or overlay the MSA circle on a plan view that displays the aircraft location.

- 4.7.1.9 Consider highlighting or displaying the appropriate MSA or MEA based on current aircraft position.

Example: The MSA circle could be replaced with a dynamic digital presentation of the MEA or MSA based on current aircraft position.

Comment: If the MSA circle is replaced with a single minimum altitude based on current aircraft location, some other means of providing terrain situation awareness (contour lines or MSA sectors) also should be provided.

Example: The portion of the MSA circle where the aircraft is currently located (or the actual minimum altitude within the circle) could be highlighted (e.g.,

underlined). This would allow the pilot to quickly locate the applicable MSA without eliminating MSA information for neighboring sectors that help to provide terrain situation information.

4.7.1.10 The integration of a GPWS with the EIAP should be considered.

Example: Kuchar and Hansman (1992) implemented graphical GPWS in which contour lines changed colors to yellow for caution and red for emergency when the distance between the aircraft and the terrain decreased to a certain level and when the rate at which the aircraft approached the terrain increased to a certain level. Pilots found this type of system to be desirable.

4.7.2 References

Ashcraft, 1988; DOD, 1993; Lewis and Falleson, 1989; Kuchar and Hansman, 1992; Wickens, 1984.

4.7.3 Graphic Example

DON'T incorporate too many of the above mentioned methods of displaying terrain without providing a pilot with an obvious method to choose which terrain display methods are used at a given time. In this example, the combination of contour shading with MSA altitudes displayed directly on the plan view makes it unclear whether the numbers indicate actual terrain elevations or MSAs with a safety clearance built in.

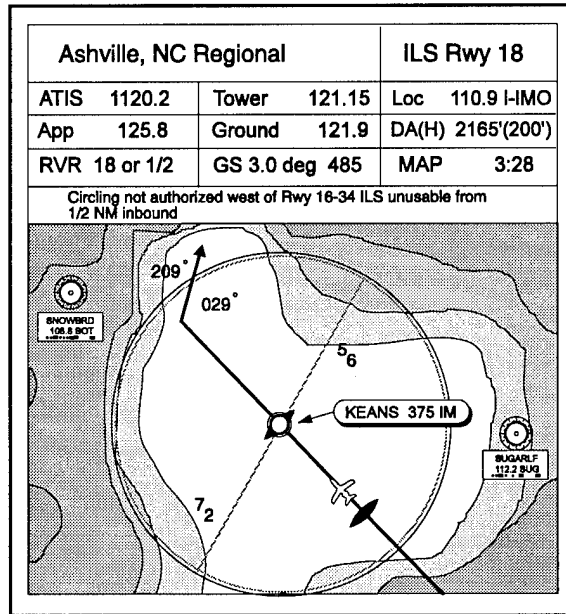

DO limit the number of terrain depiction methods or provide pilots with the means of customizing terrain depiction. Also, take advantage of the EIAPs capability to highlight the relevant MSA for the pilot. In this example, contours provide terrain awareness and only the relevant MSA based on aircraft location is displayed digitally.

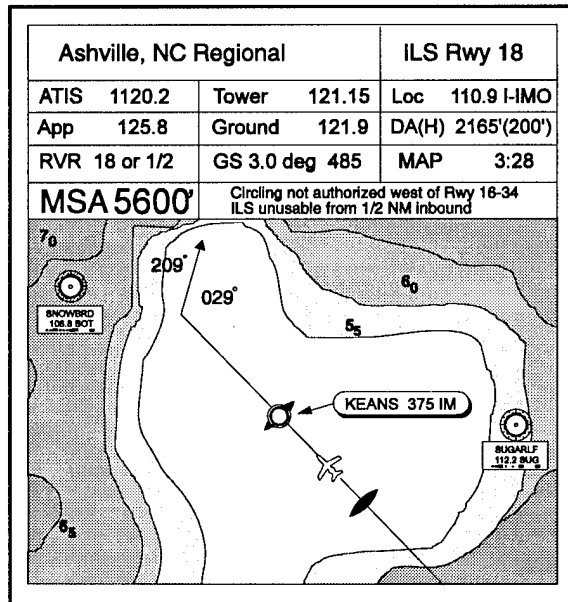

4.8 AUDITORY DISPLAYS (AUDIBLE CODES, VOICE OUTPUT)

Although pilot acceptance of auditory displays is not universal, these displays offer the following advantages over visual displays:

- They can alert the pilot to a critical situation more quickly than visual displays.
- Pilots can be alerted regardless of their gaze or head position.
- The pilot does not have to visually attend to the display and can continue current visual tasks.
- They can be used in conditions where vision is degraded (e.g., glare on the display screen).
- They do not take up display space.
- The direction of an auditory display can also cue the pilot about the source of the information (Stokes & Wickens, 1988; Stokes, Wickens, & Kite, 1990).

Auditory displays can help relieve excessive visual requirements of a task. For an EIAP, space is limited and visual clutter may reduce the effectiveness of certain aspects of the display (such as warnings or changes to the display). In situations such as these, an auditory display can alert users to important aspects of a visual display. Attention requirements of the task also dictate whether an auditory display should be used. Auditory displays are more intrusive than visual displays. This attribute can be advantageous in certain situations. For example, auditory displays may be used on an EIAP for alerts or warnings. Another possible use of auditory display on EIAPs is auditory feedback during a data entry task. When the pilot enters data, a tone could signal whether the data were valid and accepted by the system.

Both speech and nonspeech signals can be used in auditory displays. The choice of speech or nonspeech displays depends on the complexity of the information, the length of the message, the criticality of the message, the pilot's workload during message presentation, ambient noise, and existing auditory displays. Tones are most suited to automatic communication of limited information and stop and start timing. Complex sounds are suitable to sounds with general meaning such as irregularly occurring signals (e.g., alarms). Speech displays are most effective for rapid communications of complex multidimensional information. Information concerning displacement, direction, and rate may be presented in a form compatible with the desired response with a speech display.

Speech displays use either digitized recordings or machine synthesized speech. Current synthesized speech systems produce speech output that sounds like it was produced by a machine. In situations in which there are many voices such as the cockpit, non-human speech output may be beneficial. However, synthetic speech is more susceptible to interference from other noise than nonspeech displays. A speech warning message is appropriate for tasks that have infrequent warnings. However, tasks with many warnings should not use speech warnings. An aspect of the speech modality that causes people to attend to the message is the serial presentation of information. If the pilot diverts his or her attention from the speech

for a moment, an important portion of the message may be lost. Pilots may attend more to speech than to visual displays. The temporal nature of speech displays is a drawback unless users can replay the message. Speech displays require greater presentation time than comparable visual displays and pilots may not comprehend the speech message until the message is almost complete.

There are many factors that must be considered when designing speech displays for the cockpit (see Simpson, McCauley, Roland, Ruth, & Williges (1985) for a review of speech displays). EIAP systems that use speech displays should be integrated into the existing speech displays in the flight management system.

4.8.1 Guidelines

4.8.1.1 Auditory displays are appropriate under the following circumstances:

- The message is simple and short,
- The message will not be referred to later,
- The message requires an immediate or time-based response,
- There is no room for another visual display or the number of visual displays overloads the pilot's attention and processing resources,
- Redundant display of information is desirable,
- The population stereotype for the mode of presentation is an audio display (McCormick & Sanders, 1982; MIL-STD-1472D).

4.8.1.2 Tones, complex sounds, and speech should be used for displaying different types of information.

Comment: For an EIAP, tones are most suitable for automatic communication of limited information and stop and start timing. Tones may be suitable for data entry feedback or indication of status change. Complex sounds are suitable for sounds with general meaning. Complex sounds may be appropriate for irregularly occurring alerts or alarms. Speech may be used for communication of quantitative or qualitative information. Information concerning displacement, direction, and rate (if provided by an auditory display) should be presented with a speech display.

Comment: Due to the high noise environment and the requirement to consider other auditory displays in the cockpit, designers should carefully consider the effects and interactions of the various types of auditory displays before implementing them.

4.8.1.3 Verbal messages are superior to nonverbal auditory signals for complex messages.

Comment: In high workload situations, speech displays are preferable to nonspeech displays. Pilots may forget the meaning of nonspeech signal coding, whereas language is overlearned and less susceptible to decrements to performance.

4.8.1.4 Displays using the extremes of auditory dimensions should be avoided.

Comment: Very high or low frequency displays may not be detected. High amplitude signals can startle, disrupt concentration and distract others in the cockpit. Auditory displays should use frequencies between 200 and 5000 Hz, preferably between 500 and 3000 Hz.

4.8.1.5 Auditory displays should use distinctive coding (e.g., sirens, bells, chimes, buzzers, and tones of different frequencies) for each signal.

Comment: EIAP auditory displays should be distinctive from auditory displays in other cockpit systems (e.g., altitude alerts, traffic avoidance).

Comment: Auditory displays are impractical in conditions with high ambient noise or existing auditory displays. In these situations, auditory displays must be discernable from background noise. Signal amplitude should be at least 15dB (Boff & Lincoln) to 20dB (MIL-STD-1472D) above the amplitude of the masked threshold. The amplitude of noncritical auditory signals should be adjustable. Auditory alerting signals should be intermittent and changing over time. Avoid steady state signals.

4.8.1.6 Auditory signals are characterized by frequency (pitch), amplitude (loudness), temporal position, spatial location, and multidimensional attributes (e.g., timbre). Displays with multidimensional coding should use more levels of fewer dimensions rather than fewer levels of more dimensions.

Example: To produce 6 different audio signals, use 3 levels of amplitude and 3 levels of frequency instead of 2 levels of amplitude, 2 levels of frequency, and 2 levels of duration.

Comment: Table 4-2 shows the number of identifiable dimensions for characteristics of audio signals.

**Table 4-2.
Identifiable Auditory Dimensions**

Signal Characteristic	Number of Identifiable Auditory Dimensions
Amplitude	4-5
Frequency	4-7
Duration	2-3
Intensity and Frequency	9

4.8.1.7 Pilots should have a simple means of stopping an auditory display.

Comment: Pilots should be able to turn off noncritical auditory displays at any time. They should not be allowed to disable critical audio displays.

4.8.1.8 Complex information should be presented with a two-stage signal. The first stage is an attention demanding signal. The second stage is the information signal.

Comment: MIL-STD-1472D suggests using the first 0.5 second of the audio signal as the attention demanding signal. Both the attention demanding signal and the information signal should be unique for each audio display.

4.8.1.9 The same signal should designate the same information at all times (McCormick & Sanders, 1982).

4.8.1.10 Visual and auditory displays should be combined to transmit important information.

Comment: Voice messages should be direct transmission of visual messages. Onset of an audio alert should correspond with onset of a visual alert.

4.8.1.11 Auditory displays should not be used to convey spatial information.

Example: An auditory display should not be used to indicate the distance from the aircraft position to a beacon (e.g., through the use of some auditory dimension such as loudness).

Comment: An exception to this guideline is the use of auditory displays to indicate general directional information (e.g., above, below, to the left, to the right). For example, an auditory warning of traffic may originate from the direction in which the traffic threat exists.

4.8.2 References

Boff and Lincoln, 1988; McCormick and Sanders, 1982; MIL-STD-1472D, 1989; Simpson, McCauley, Roland, Ruth, and Williges, 1985; Stokes and Wickens, 1988; Stokes, Wickens, and Kite, 1990.

4.9 WINDOWS/PAGES

Windows are used on various desktop systems to allow users to maintain several different views of a specific application. For an EIAP, several windows or pages of information may be provided for one instrument approach procedure. This feature allows designers to compensate for the decrease in resolution that comes with using electronic displays over paper displays. It also provides designers with the potential to provide a less cluttered display than current paper charts provide.

A number of guidelines are available in both the IBM (1991) and Apple (1993) interface guidelines about the use of windows in interfaces. Many of the guidelines deal with issues specifically related to the control of windows (e.g., minimizing, scrolling, placement of buttons). Fast access of various windows or pages in an EIAP is so important that many of the features provided by the IBM CUA and Apple Macintosh interfaces are not applicable. It is probably not feasible to provide pilots with the capability to maintain several different windows open at a given time. Pilots should, however, be able to see what views are available at all times and navigate to any of those views from any other view. Pilots should not have to worry with sizing or minimizing windows. The controls should be kept simple so there is no way a pilot could get "lost" in the windows. The change of views should also be controlled specifically by the pilot. An appropriate flow of screens may be made visible by placement of screen changing controls but pilots should not be forced to follow this flow.

One window feature that may be useful for EIAP is the use of small, temporary, overlay windows. The use of small windows for presentation of information such as missed approach instructions, briefing information, or details about a specific NAVAID provides pilots the opportunity to retrieve this information and display it over some part of the larger view. Thus, the information is normally not seen, reducing clutter, but when it is needed, the majority of the main screen remains in view. Careful attention should be paid to ensure that the actions required to retrieve and remove a temporary window are easy and obvious, and that the location of the smaller window does not obstruct key information.

4.9.1 Guidelines

- 4.9.1.1 If an EIAP contains too much data for display on a single frame, the data may be partitioned into separate displayable windows or pages (Smith and Mosier, 1986).

Example: Separate windows or pages may be used for the plan view and for the airport view.

Comment: Windows implementations on many desktop computers offer capabilities to change the size of windows and position windows over one another (cascaded). A quick select of the window in the background brings it to the foreground for use. Another alternative is the display of windows adjacent to one

another without overlap (tiled). These features may provide the capability to view information needed from two windows at the same time (or close to the same time with quick selections to switch back and forth between windows). However, this function should be evaluated carefully in the IAP environment because it also increases the possibility that a pilot may not be able to find the page or view he or she needs.

Comment: EIAPs may benefit more from the use of separate pages or display areas than from windows as they are currently used in desktop systems. Pilots may quickly switch between pages or may choose needed information to be displayed in two or more display areas on the screen.

- 4.9.1.2 Functionally related items should be displayed on the same page (Smith and Mosier, 1986).

Comment: See Section 4.12 for more discussion on grouping information and how to determine what information should be grouped together on the same page or in the same view.

- 4.9.1.3 Windows should look and act consistently (DOD, 1993).

Example: If a certain control choice causes one window to open or close, it should cause the same response for all windows.

Example: The same features (borders, title bars, line weights, button sizes, etc.) should be used for all windows unless highlighting of a certain feature in a certain window is desired.

- 4.9.1.4 A limit on the maximum number of windows that can be effectively opened for each system should be determined (DOD, 1993).

Comment: The total number of acceptable windows will be dependent on the design of the EIAP. In general, it is expected that more than three or four windows may cause an EIAP to be overly complex. However, designers and evaluators should consider the ease with which one can switch to a needed window, the visibility of the alternative window choices, and the phase of the approach in which the window changes are expected to be made before determining the acceptability of the number of windows. For example, pilots may be able to page through several windows pre-flight or enroute; however, once on final approach, pilots should have all the information normally needed available without requiring any changes. Important information that may be needed quickly (such as missed approach information) should be immediately accessible if it is not already visible.

- 4.9.1.5 If separate windows or pages are used, a meaningful title or label should be displayed for each window or page (Smith and Mosier, 1986).
- 4.9.1.6 Temporary window overlays may be used to display information such as missed approach procedures, briefing instructions, legend information, etc. over the main window as needed. However, caution should be used as specified in Sections 4.9.1.7 - 4.9.1.10.
- 4.9.1.7 Ensure that temporary windows do not completely cover the main window (DOD, 1993).
- 4.9.1.8 Limit the number and size of temporary window overlays that are available.

Comment: Small temporary window overlays may be a good way to display added information without removing the main display; however, as the number of different windows that a pilot has to choose from increases, the likelihood that a pilot will forget how to retrieve the information needed, will accidentally overlay important information, or will temporarily "lose" needed information will increase.

Comment: The actual number of temporary window overlays that may be used will be dependent on the implementation. Considering the amount of information that will have to be displayed on an EIAP, it is likely that three or four temporary window overlays will probably be a reasonable limit. However, if clear distinct labels are provided so that the pilot does not have to remember what information is available, visual search of the choices is fast, and safeguards are provided against overlaying critical information, more windows may be made available.

Comment: If several temporary window overlays are made available, designers and certifiers should ensure that the means of retrieving and removing the windows is obvious, easy, and fast. The labels used on controls accessing the windows and the grouping of choices for accessing the windows should be clear and meaningful.

- 4.9.1.9 Designers should avoid covering the center of the map area, main area, or critical areas of the display with a temporary window overlay (Bowser, 1991).

Example: Care should be taken that the position of the window overlay does not interfere with task critical information (such as the MDA) wherever the task critical information may be located on the display.

Example: Windows should not overlay an area where a caution or warning would appear. If this is necessary, the caution or warning should be given a priority to appear on top until the pilot chooses to remove it.

- 4.9.1.10 When a window temporarily obscures other displayed data, be sure the information will reappear when the temporary window is removed (DOD, 1993).
- 4.9.1.11 All windows or views that are available for a given EIAP should be visibly evident to the pilot at all times (or the pilot should be able to access a list of available views in one step). It should be visibly obvious that more data is available and what type of data is available on other pages.
- 4.9.1.12 The pilot should be able to switch from any view to any other view with a minimum number of steps (preferably one).
- 4.9.1.13 Pilots should have control over which window is displayed at any given time.

Comment: A possible exception is the display of emergency warnings.

4.9.2 References

Apple, 1993; Bowser, 1991; Department of Defense, 1993; Hix and Hartson, 1993; IBM, 1991.

4.9.3 Graphic Example

DON'T provide pilots with a multiple windowing platform that can easily lead to a cluttered display and problems locating needed information. The temporary overlay of notes is larger than needed and obstructs key information.

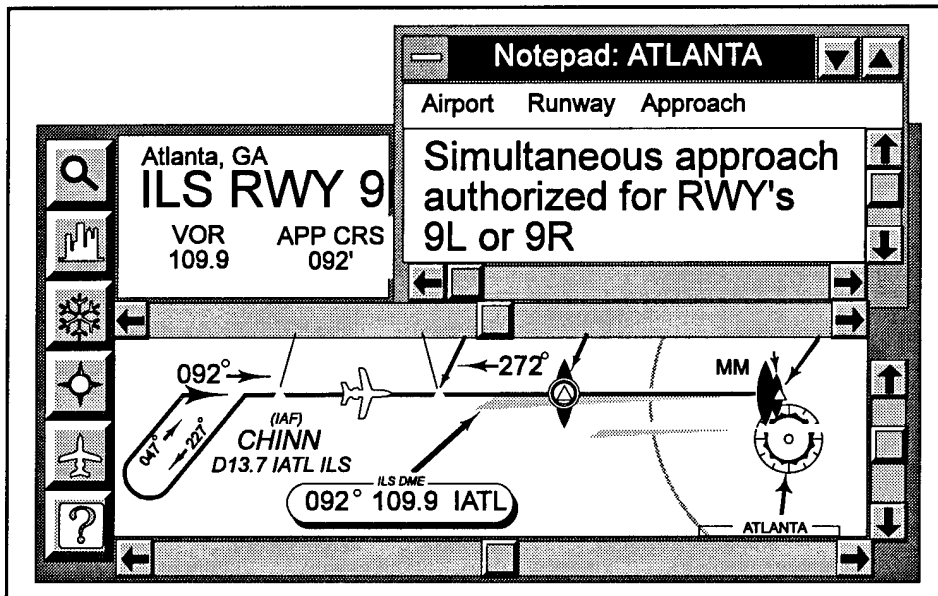

DO provide pilots with a system that provides a visual reference to all the views that are available and allows them to quickly change to a view that contains needed information. In this example, three different views (Plan, Breakout, and Airport) are available for the top section and three different views (Profile, Brief, and Missed Approach) are available for the bottom section. Pilots may choose any combination of top and bottom views, but only one may be seen in each section at a given time. It is immediately clear which views are available, and it is impossible for a pilot to overlay or lose important information.

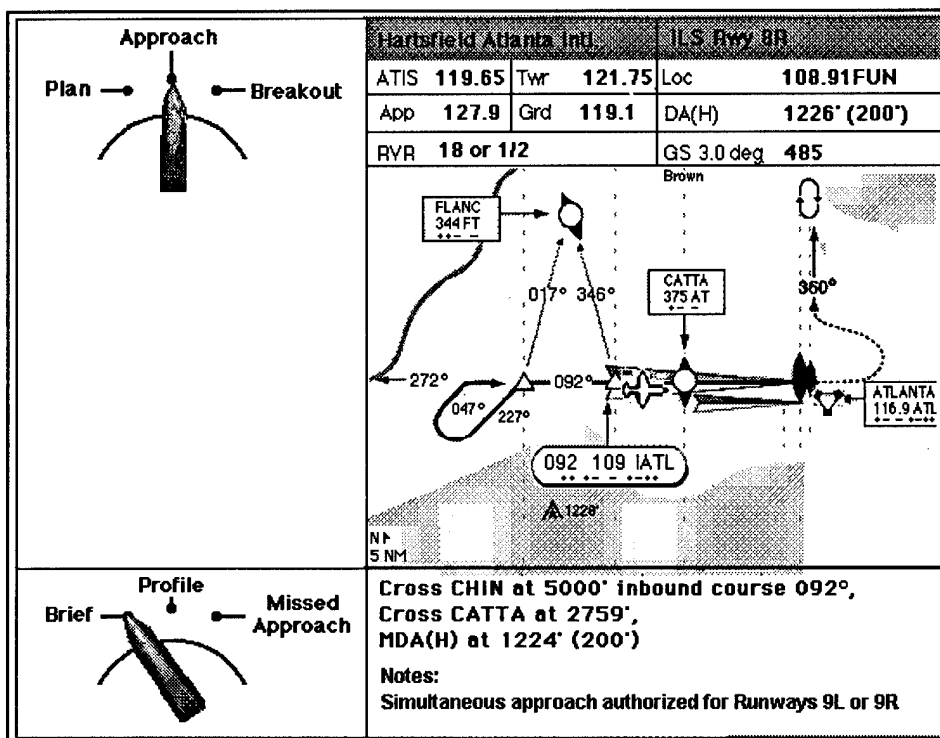

4.10 MENUS

There are five menu structures that could be implemented in an EIAP (Norman, 1991). Each menu structure is suitable for different purposes and they can be combined within a user interface. EIAP designers should consider the strengths of each menu structure when designing the pilot-machine interface.

Single menus offer the pilot one selection from a set of mutually exclusive options. A single menu presents all the relevant information so that the pilot does not have to consider other alternatives when choosing the menu option. For example, a system prompt, like a warning that the MAP is 30 seconds away or the ATC has changed the runway, that requires the pilot's response, is a single menu. The EIAP could display a menu that requires the pilot to affirm reception of this message before clearing the menu. This type of menu has limited utility since few decisions that a pilot makes can be encapsulated into a single menu.

Sequential linear menus are a series of single menus that the pilot must traverse to accomplish a task. The type and number of menus is predefined, which means that the pilot always encounters the same menus in the same order while interacting with the system. Decision logic can be built into the menu system to determine the content of the menus based on pilot responses to preceding menus. For example, the first menu might ask the pilot to choose the type of approach; the following menu would present options for the chosen approach. Successful interface design depends on congruence between the pilot's perception of the task sequence and the sequence presented by the menu system. If the menu sequence does not match the pilot's perception, the pilot may want to complete the task in a different order. Poor alignment between menu sequence and perception can also lead to errors. Correcting errors in sequential menus can also be a problem as movement forward and backward along a linear path can be confusing. Figure 4-1 shows an example of sequential linear menus. In this example, the pilot must select the runway, then the type of approach, then the approach category. The order of the menus remains unchanged regardless of which option is selected on each menu, although the options may change as a result of earlier selections.

Simultaneous menus present all the menu options at once. Display size and resolution limit the amount of information presented in a simultaneous menu. Completing a simultaneous menu is similar to filling out a form. The pilot can enter data and select menu options in several places on the menu and in any order. Figure 4-2 shows a simultaneous menu that is equivalent to the sequential linear menus in Figure 4-1. The pilot can select one option for Runway, Type of Approach, and Approach Category. The order in which they are selected is unimportant.

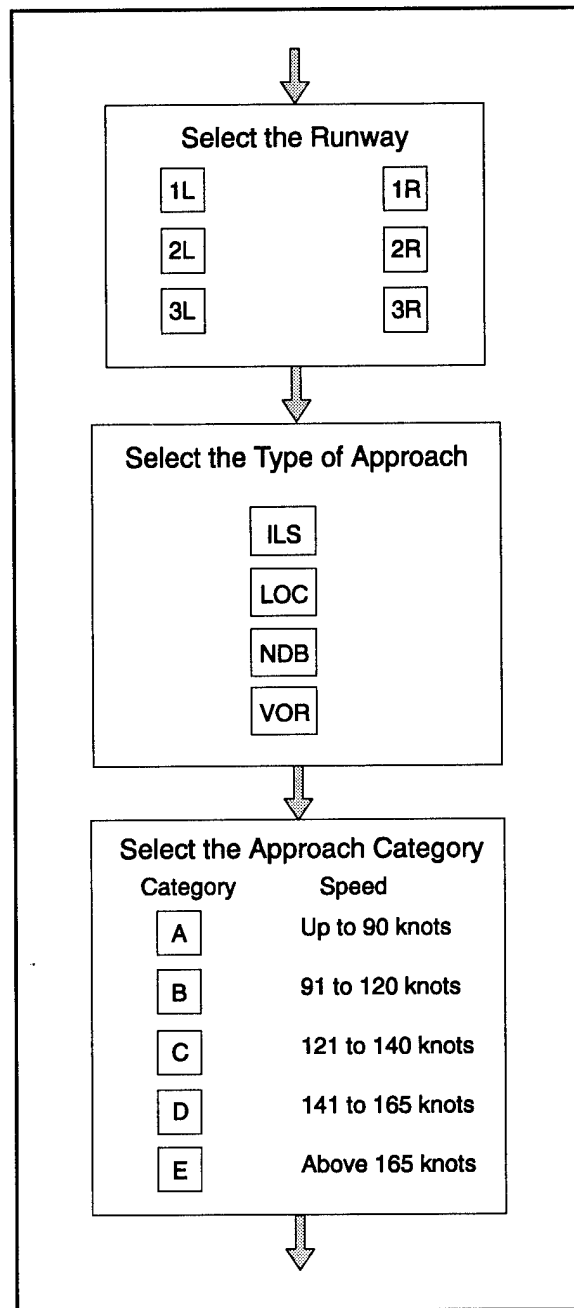

Figure 4-1. Linear Sequential Menus

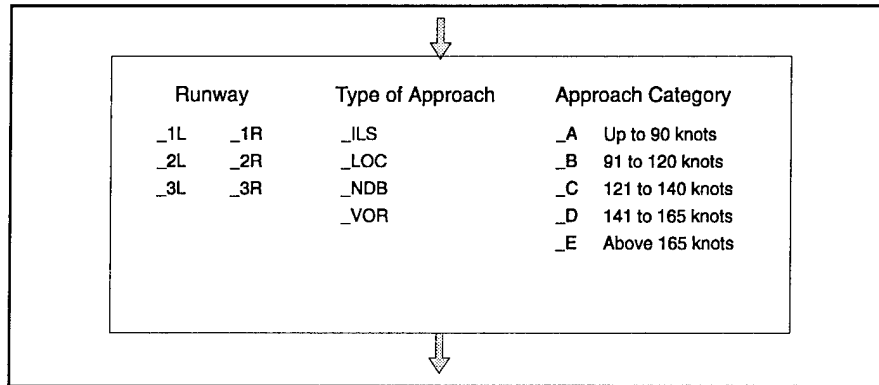

Figure 4-2. Simultaneous Menu

Hierarchical menus are sequential linear menus in which progressing through the menu reveals increasingly refined choices. As the user progresses through the menus, the options become more specific instances of the first menu selection. For example, in Figure 4-3, the pilot is using the menus to select the destination airport, the first menu asks the pilot to choose the state (e.g., Georgia), then the city in Georgia, and then the airport in the city. As with sequential menus, the user's understanding of the task may not match the task as it is defined by the hierarchy. To avoid uncertainty and allow the user to recover from errors, hierarchical menus should permit the user to move back to the previous menu or return to the highest level menu. Hierarchical menus can vary in depth and breadth. Depth is the number of levels between the highest level menu (i.e., main menu) and the terminal menu. In the example in Figure 4-3, the hierarchy is 3 levels (state, city, airport) deep. Breadth is the number of menus at each level. The hierarchy in Figure 4-3 is 50 levels wide at the highest level. Most hierarchical menus are not symmetric, which means that the menu depth is not equal across the breadth of the hierarchy. Methods to determine the optimal breadth and depth of a hierarchical structure are beyond the scope of this document. Refer to Norman (1991) for a complete discussion of hierarchical menu design.

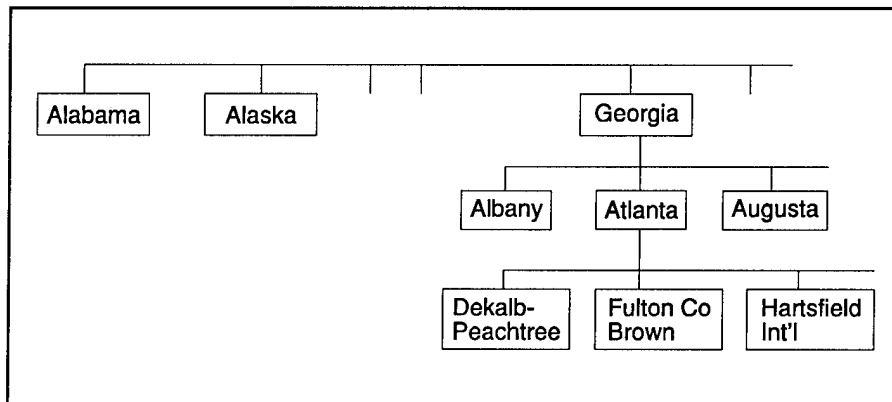

Figure 4-3. Hierarchical Menus

Connected graph menus are menu structures in which all the menus are directly or indirectly linked. Pilots may move from menu to menu without the linear restriction imposed by linear sequential or hierarchical menus. There may be several paths between two menus. For example, the pilot may want to choose the type of approach and the destination airport. In a connected graph menu structure, the pilot could start by choosing either the approach or the destination. The example in Figure 4-4 shows a connected graph menu structure in which there are seven menus. All of the menus can be reached from at least two other menus. As shown by the arrows at both ends of the connections, there is not a linear sequence imposed on the interface. This type of structure gives the pilot a perception of control over the system. The difficulty with connected graph menus is the need to limit the number of options available from each menu. The connections between menus should represent logical connections present in the tasks being performed. Not all menus can be accessible at any time (i.e., not all menus are directly connected to every other menu).

Event trapping menus are a set of sequential menus imposed on a hierarchical or connected graph structure. Selection of a menu item (a) changes a system parameter without leaving the original display (e.g., changes the zoom level), (b) temporarily displays a new set of menus to perform a specific function (e.g., selection of information to display on the plan view), or (c) permanently changes to another display (e.g., changes the mode from Set-Up to Approach). If there are no invariant menu options and each mode has a different set of menus, users can become disoriented. However, if there are a set of menu options that are invariant across all display modes, event trapping menus provide a sense of stability. Figure 4-5 shows an event trapping menu for Prototype 2 (described in Section 3.3) using the connected graph structure in Figure 4-4. There are seven modes which can be displayed. While the left three button functions change with each mode, the right three and the center buttons retain the same functions. The zoom, orientation (North-up/Track-up), and undo functions are available in all modes except Set-up.

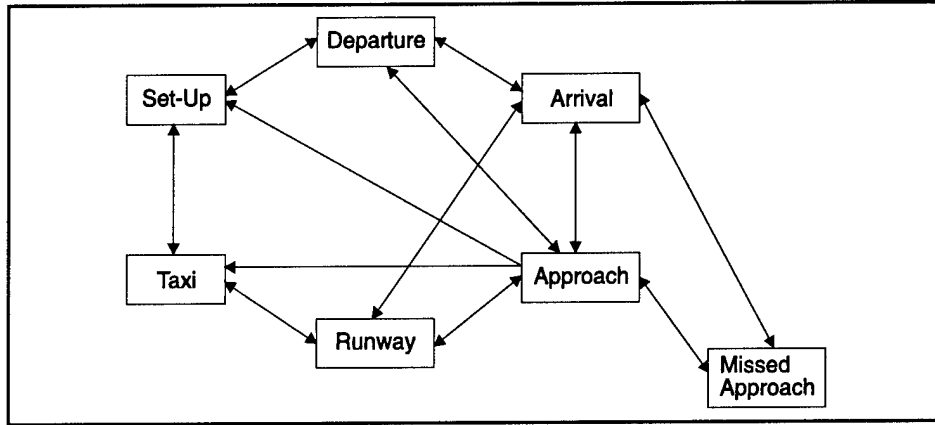

Figure 4-4. Connected Graph Menus

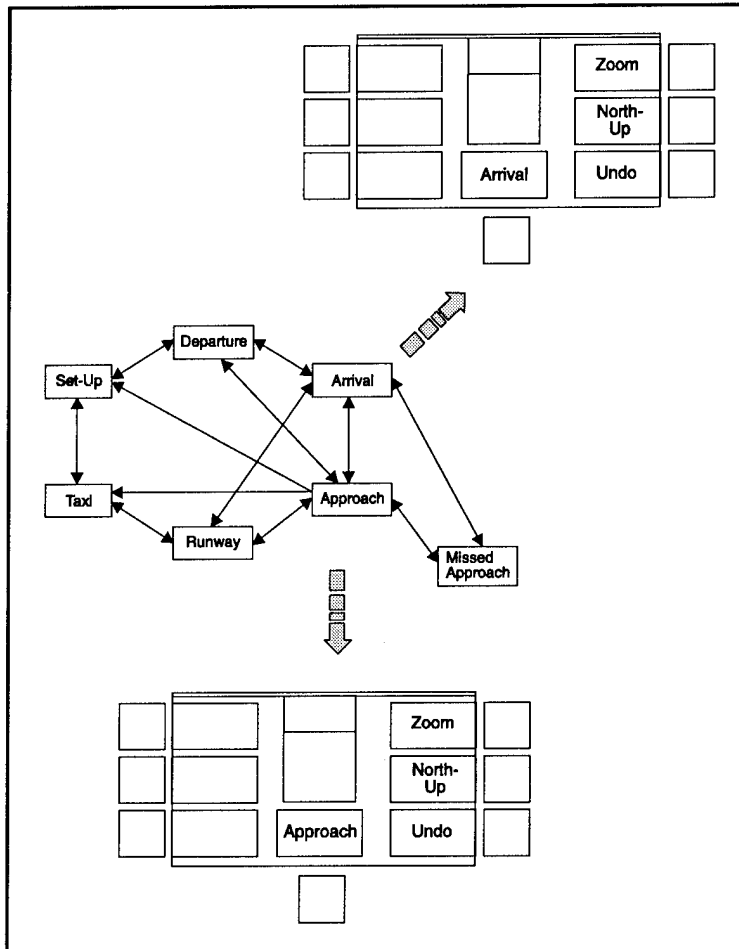

Figure 4-5. Event Trapping Menus

4.10.1 Guidelines

4.10.1.1 Menu selection should be used for tasks that involve a limited set of alternatives (Smith & Mosier, 1986).

4.10.1.2 The number of options per menu and the number of menus should optimize decision and selection time.

Comment: The menu structure should be designed to minimize menu traversal and response time: (a) minimize the total number of menus, (b) make computer response time relatively fast (less than 1 second). If response time is slow, experienced users will want to bypass a series of menus and enter commands directly.

4.10.1.3 The amount of information in a menu should be appropriate for the reading time available to the pilot.

4.10.1.4 Each menu should indicate what led to the current menu, the reason for the current selection, and the nature of the selection. In hierarchic menus, display the pilot's current position in the hierarchy.

4.10.1.5 Menu options should be meaningful and unambiguous.

Example: See the second Graphic Example (4.10.3) describing unambiguous presentation of menu labels.

Comment: The menu should signify whether menu options will move between menu nodes, display new information, enter data, or execute procedures (Norman, 1991).

4.10.1.6 Menu options can be single words, brief phrases, or longer descriptions. The terminology should be familiar and consistent.

Comment: Menu items that are phrases should be verb phrases with parallel construction (e.g., Display the plan view, Select the approach). Keywords in the menu options should stand out. If the menu options are used in conjunction with a command language, the options should be consistent with the commands.

4.10.1.7 Graphic images to represent menu options should be distinctive and recognizable (see Section 4.3 Symbols and Icons).

Comment: Avoid nonstandard marks in the menu. Don't put icons or symbols in the menu structure unless they replace text and the meaning is clear. Icons or symbols add visual clutter and do not add information that is not contained in the text.

4.10.1.8 The screen layout should focus attention on the appropriate menu.

Comment: Locate menus consistently and show their special function. This is relevant when the menu items share display space with other types of information.

4.10.1.9 The number of steps required to make a selection should be minimized (e.g., place the cursor at the first menu option).

Comment: The method of selecting a menu option should be consistent across menus. Selection should be verified prior to implementation. A starting point should be provided to which the pilot can return from any place in the menu structure. Return to the next highest level or return to the highest level or origin should require only one action.

4.10.1.10 The menu option layout should facilitate visual scanning by the pilot.

Comment: Options should be ordered to reveal structure and relationships among them (e.g., order the menu options based on frequency of use or task order). Alphabetic grouping should only be used when the menu options are unrelated to the task being performed and there is no means of determining which menu options are most likely to be selected. Avoid random or arbitrary ordering of options. Menu options should be displayed in a single column.

Comment: Data entry and menu options should be located at a position expected by the pilot. Menu options should be distinguishable from other types of display items (e.g., data). The format of information should be consistent from menu to menu. Use a consistent font within and across menus (Hollands & Merikle, 1987).

Comment: An exception is the use of several parallel columns when space is limited. However, speed of visual scanning is especially important during the approach so menu options should be limited to those that can be displayed in one column for items used during the approach.

Comment: Another exception is the display of high level menus adjacent to the lower level menu for that option.

4.10.1.11 Pilots should have the option of bypassing menus and entering commands directly. Command entry should permit the stacking of menu selections to bypass the display of menus.

Comment: Menu selection by keyed codes should use the initial or some unique letter for the command. Menu option names should not be artificially constructed so that the first letters are unique for each command. It is more important that the names used are the most descriptive and meaningful labels for the action. The

second letter may be used as a keyed code when commands have the same first letter.

Comment: An exception is the assignment of numbers to options when the numbers represent an ordered task sequence. If the menu options are numbered, do not arbitrarily assign numbers to each menu option. Numbering should begin with 1, not 0. Number and letter coding should not be combined.

4.10.1.12 Hierarchical menus should branch and funnel.

Comment: The menu structure should be broad and shallow rather than narrow and deep. Command menus should have a minimum of 8 options. Wide breadth of early choices will minimize early response errors. More menu levels available should be indicated via graphic symbols such as an ellipsis, or arrow. Critical items should be at higher levels of a hierarchical menu structure (MacGregor, Lee, & Newman, 1986; Norman, 1991).

4.10.2 References

Apple Computer, Inc., 1992; DoD, 1993; Hollands & Merikle, 1987; MacGregor, Lee, & Newman, 1986; Norman, 1991; Smith & Mosier, 1986.

4.10.3 Graphic Example

DON'T show too many options in a simultaneous menu. In this example, the cities and states are displayed on the same menu.

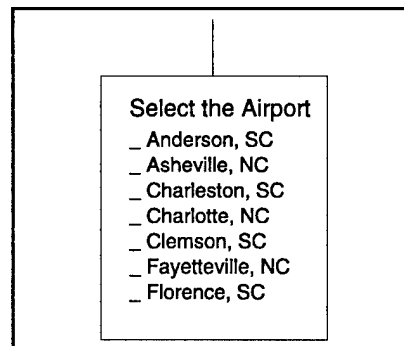

DO create separate menus when the number of options exceeds that which can be displayed in one menu. In this example, the menus have been broken down into a states menu and a cities menu.

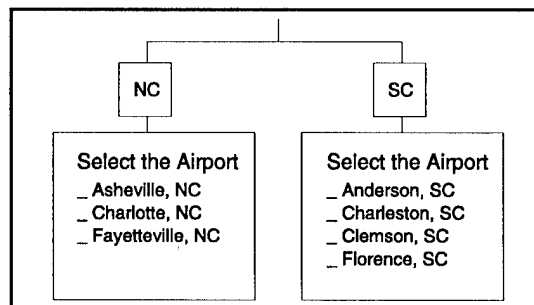

Menu labels sometimes indicate both system function and the status of that function. A declutter function might toggle between the options "Obstacles On" and "Obstacles Off".

DON'T present the options so that the choices or settings are ambiguous. These examples show two inferior menu designs. In the first, the only option is "Obstacles On." The top box shows the menu when the function is active. The check mark indicates that obstacles will be shown. The bottom box shows the menu when the function is inactive. However, the pilot may still believe that the function is active because of the term "Obstacles On."

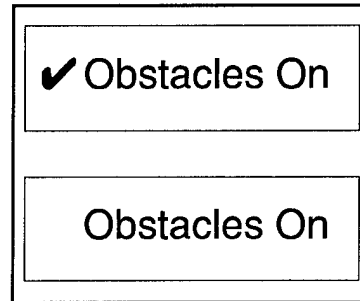

In the second example, the function toggles between either "Obstacles On" or "Obstacles Off." The top box shows the menu when the function is active and the bottom box shows the menu when the function is inactive. Pilots could become confused about the method of switching between the two options.

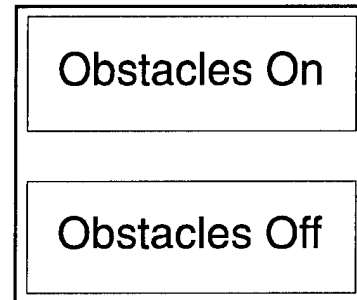

DO present the options so that the choices and settings are unambiguous. The following example shows an unambiguous method of presenting the two options. Both "Obstacles On" and "Obstacles Off" are shown together. The check mark indicates the status of the declutter function. Color coding is also a good method of indicating which function is selected -- for example, the selected function may appear green while the non-selected function would appear gray.

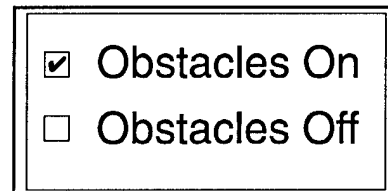

4.11 FRAME OF REFERENCE

Conclusions of a literature review of various experiments on map reference frames (Clay, 1993) indicate that for planning purposes a static, North-up frame of reference may be better than a rotating and translating, Track-up frame of reference, but for navigation a Track-up frame of reference may be better than North-up. Hofer, Kimball, Pepitone, Higman, Infield, and Possolo (1993) found that first officers and captains answered ego-centered probe questions more quickly with a Track-up electronic map and they answered world-reference probe questions more quickly with a North-up electronic map. They also found that captains preferred a North-up electronic map first and an approach plate integrated with the primary navigation display second while first officers liked the North-up electronic map and the Track-up electronic map equally well. Mykityshyn and Hansman (1992) found that, for an EIAP (a combination of planning and navigating), pilots preferred a static, North-up map with a moving aircraft symbol to a Track-up map. Research by Baty, Wempe, and Huff (1975) suggests that a North-up map that translates with aircraft location but does not rotate may be advantageous for planning purposes. Aretz (1991) proposed a technique of displaying a North-up reference frame with a dynamic wedge that indicates the area in the pilots ego-centered view for both planning and navigating. A frame of reference in line with the airport runway may also be considered for some (or all) views of an EIAP. Electronic displays also provide the capability to allow pilots to toggle between two or more reference frames.

4.11.1 Guidelines

- 4.11.1.1 A consistent reference frame should be maintained to decrease the likelihood of errors (Stokes, Wickens, and Kite, 1990) or extreme caution should be taken to ensure that pilots will not become confused in implementing an option for pilots to choose North-up and Track-up (see Section 4.11.1.2).

Comment: North-up reference frames are more suitable for planning purposes.

Comment: A North-up translating map maintains a North-up reference frame but moves with aircraft position. A North-up moving map (Baty, Wempe, and Huff, 1975) may combine some of the planning advantages of the North-up map with some of the navigational references of the Track-up map.

Comment: A static, North-up map with a wedge indicating the pilots ego-centered view (Aretz, 1991) may also combine some of the planning advantages of the North-up map with the navigational advantages of a Track-up map.

Comment: A consistent reference frame will ensure that pilots always interpret the information the same way; however, it requires the designer to choose one reference frame that may not be ideal in all situations for all pilots. Providing pilots with the choice of reference frame will allow the pilot to choose the best

reference frame for the type of task he or she is performing. Designers may choose not to allow pilot choice but to present some information North-up (e.g. a planning page) and other information Track-up (e.g., a breakout view). If the change in reference frame is not by pilot choice, designers must ensure that the change in reference frame is visually obvious.

- 4.11.1.2 If a choice of reference frame is provided (or different reference frames are provided on different views), provide distinctive visual cues (a frame, background, label or symbol) that distinguish the two reference frames (DOD, 1993).

4.11.2 References

Aretz (1991); Baty, Wempe, and Huff, 1975; Clay, 1993; Cooper and Podgorny, 1976; DOD, 1993; Hofer, Kimball, Pepitone, Higman, Infield, and Possolo, 1993; Martel and Ward, 1993; Stokes, Wickens, and Kite (1990).

4.11.3 Graphic Example

DON'T automatically change reference frames within a given view. In this example, the view is automatically changed from North-up to Track-up when the pilot zooms in to a certain level. Because the pilot did not perform an action to make the change, he or she may not be aware of the change and may be confused or disoriented by the display.

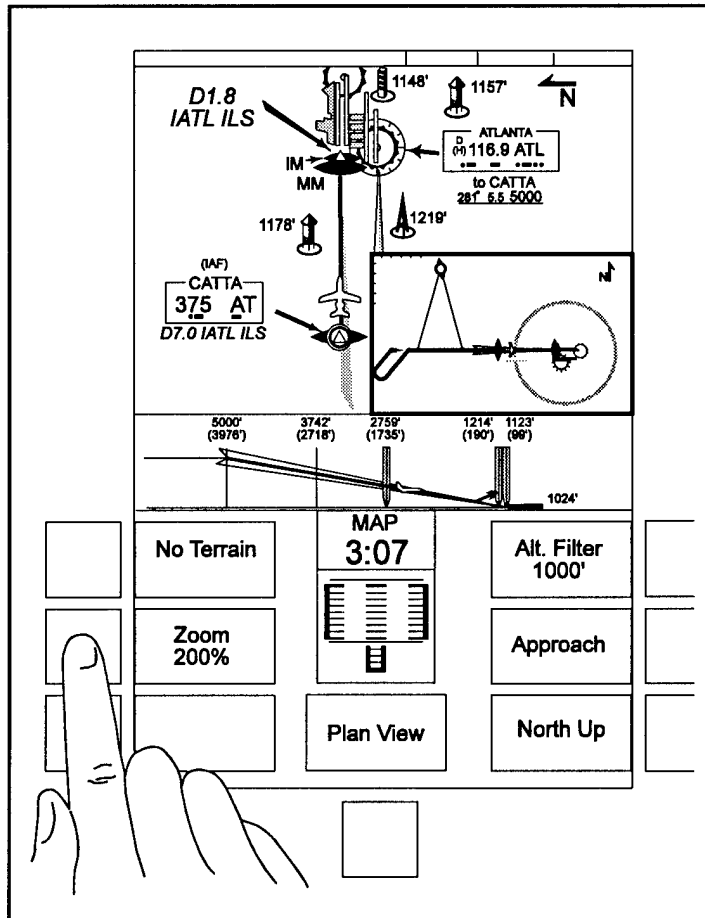

DO provide pilots with the capability to change from North-up to Track-up if they desire.

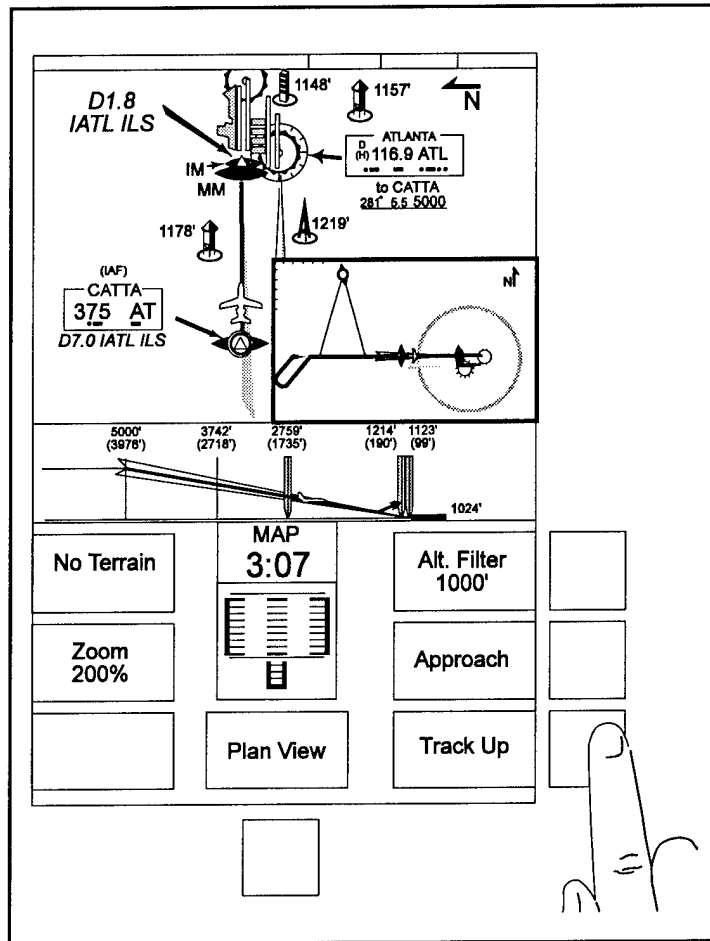

4.12 INVARIANT DISPLAY AREAS

Key information (see Section 2.2) should be located in an invariant area on the screen. This is especially true if some of the display is dynamic so that geographically-based symbols or labels are constantly changing locations. For example, the primary NAVAID frequency is considered a critical piece of information. If this information is constantly changing locations based on the geographical position of the primary NAVAID symbol on a dynamic screen, it may be difficult for the pilot to quickly relocate the information if needed. It may be necessary to place this information both geographically and in an invariant area such as the top or bottom of the display. Other critical EIAP information items are not geographically located (such as communication frequencies) and are needed throughout the approach. This type of information should be presented in an invariant display area that does not change from one view to another or when the pilot chooses a change in zoom or scale. Many systems also incorporate an invariant status area at the bottom or top of the display. Designers may be able to capitalize on population stereotypes by presenting status information at the bottom or top of the EIAP display.

4.12.1 Guidelines

- 4.12.1.1 Page or window titles should be consistently placed at the top of the display (Smith and Mosier, 1986).
- 4.12.1.2 Status information or messages should be placed in an invariant area, preferably at the bottom or top of the display (IBM, 1991).
- 4.12.1.3 Task critical information or information that may be needed continuously throughout the task should be located in an invariant display area (Brown, 1988). Examples of task critical information for the instrument approach task include primary NAVAID identifiers and frequencies, approach course, decision altitude, minimum visibility, approach type and runway, communication frequencies, final approach fix altitude, and touchdown zone elevation.

4.12.2 References:

Brown, 1988; IBM, 1991; Smith and Mosier, 1986.

4.12.3 Graphic Example

DON'T locate key information such as communication frequencies in different positions on two different pages of a display.

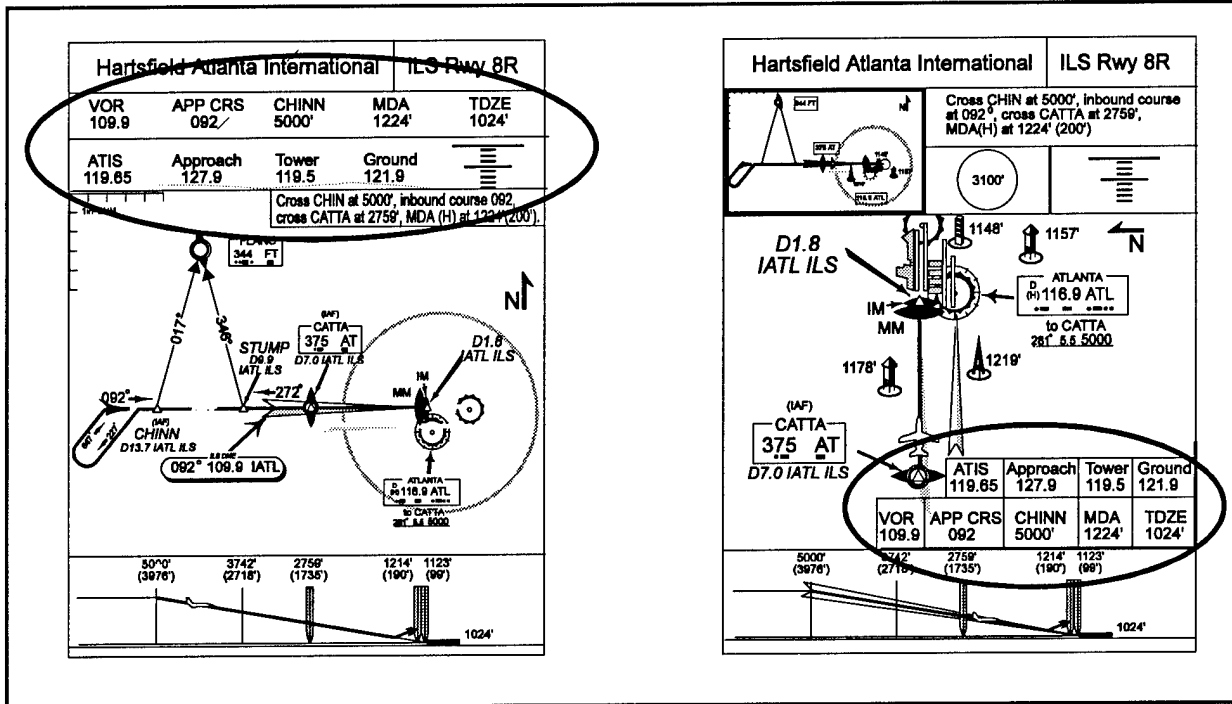

DO maintain a consistent location of all key information. In this example key information is always present in the same location on all pages used during an approach.

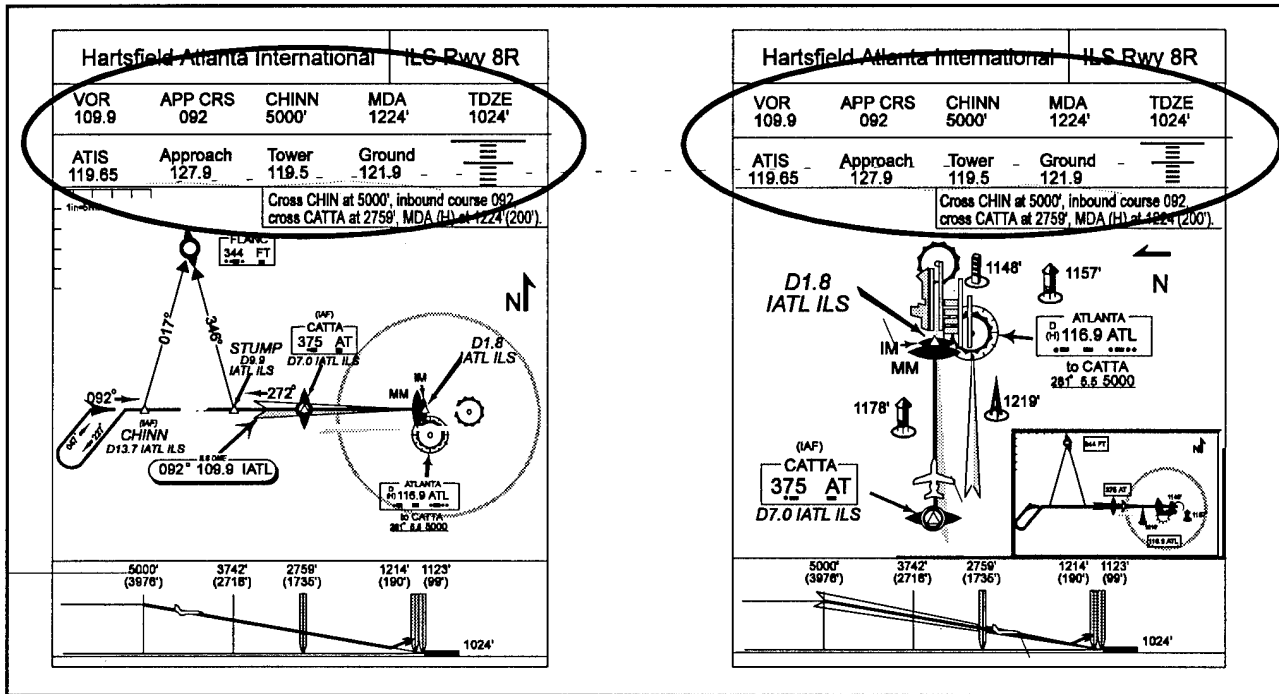

4.13 STRATEGIES OF GROUPING INFORMATION

A key issue in the design of EIAPs is the strategy used for grouping information. Information should be grouped by importance, frequency, function, sequence, or some other logical grouping such as alphabetic or chronological grouping. In the case of EIAPs, different functional and sequential strategies include grouping based on:

- 1) the orientation of information (e.g., horizontal vs. vertical),
- 2) whether the information is spatial (better presented graphically) or verbal (better presented textually) in nature,
- 3) the type of task to be performed (planning vs. actual navigation),
- 4) whether the information is static or dynamic in nature,
- 5) the functional differences between information (e.g., communication or NAVAID frequencies, terrain or obstructions, altitude or visibility minimums, etc.),
- 6) the phase of flight in which the information will be used, or
- 7) some combination of the above.

There are different groupings available for the most important information or the most frequently used information. Current guidelines on grouping information do not provide enough information for making strategy decisions for such a complex system. However, a combination of task knowledge (see Chapter 2 and Section 3.1) and logical grouping based on importance, frequency, function, or sequence will help designers develop efficient strategies. A table is provided following Guideline 4.13.1.10 suggesting different grouping strategies for an EIAP. Designers should be aware that this table is based on a subjective evaluation of the task and does not represent any empirical data.

4.13.1 Guidelines

- 4.13.1.1 Information should be grouped according to sequence of use (Smith and Mosier, 1986).

Example: If an EIAP contains several windows or pages, group information on the pages by sequence of use so that information that is needed at the same time will be available in the same view.

Comment: An instrument approach task is sequential in nature. While any information may be needed at any given time, designers can predict some order (such as phase of flight) in which the information will be used.

- 4.13.1.2 If an EIAP contains several windows or pages, information that must be integrated or compared for a given task should be grouped in the same view (Smith and Mosier, 1986).

Example: While pilots are viewing the stepdown altitudes in a profile view to plan their descent, they also may wish to view the MDA for their aircraft category and configuration. Designers should group this information on the same page, possibly in the same area. If the EIAP is capable of displaying the specific MDA for the aircraft, the EIAP may display this information directly in the profile view (possibly highlighted to indicate the significance of the MDA over other stepdown altitudes displayed in the profile view).

4.13.1.3 Information should be grouped according to function (Smith and Mosier, 1986).

Example: Communication frequencies support a different function than minimums. Pilots will expect communication frequencies to be grouped together and minimums to be grouped together.

4.13.1.4 Information should be grouped by importance or criticality.

Comment: Particularly important information should be grouped in a prominent location such as the top of the display (Smith and Mosier, 1986). It should also be presented in a consistent location.

Comment: Important or critical information on an EIAP includes primary NAVAID frequency, approach course, minimums, communication frequencies, missed approach point, missed approach instructions (especially the first two actions of the missed approach).

4.13.1.5 Information should be grouped by frequency of use.

Comment: Frequently used items (e.g., communication frequencies, NAVAID frequencies and identifiers, final approach course, decision altitude, etc.) also benefit from placement at the top of the display and placement in a consistent location (Smith and Mosier, 1986).

4.13.1.6 Information should be grouped based on spatial properties (e.g., information that is lateral in nature should be grouped together and information that is vertical in nature should be grouped together).

Example: The grouping of information in the plan and profile view on paper charts is an example of grouping information based on spatial properties.

4.13.1.7 Information may be grouped based on the type of task the pilot is performing.

Example: Information used for planning or briefing the approach may be placed on a separate page or window overlay from information used for navigating the approach.

4.13.1.8 Information should be arranged in a manner that is consistent with pilots' previous experiences.

Example: Arrangement of information in a manner similar to current paper IAP charts is consistent with pilots' previous experiences.

4.13.1.9 If information to be presented is not related in any of the ways mentioned above, it should be grouped alphabetically or in ascending or descending order as is appropriate.

Example: Lists of states, cities, airports should be presented in alphabetic order, although they may be grouped by region first.

4.13.1.10 Designers and certifiers should use task knowledge (see Chapter 2 and references below) to determine which grouping strategy (e.g., importance, function, sequence, or frequency) takes precedence when information is related in more than one way.

Comment: Sequential grouping should probably take precedence for high level grouping (such as grouping on separate pages) while function or criticality may take precedence for grouping within one page or view.

Comment: It is difficult to specify a given grouping strategy for all situations. Table 4-3 presents considerations for identifying the best grouping strategies under different circumstances. The designer should be aware, however, that this suggestion is not based on experimental evidence and will not be appropriate for every design.

Table 4-3.
Considerations for Identifying the Best Strategy of Grouping Information

Strategy	Considerations
Sequence	Grouping by sequence is important for high level grouping (e.g., grouping on separate pages). Information that must be used concurrently should be grouped on the same page or even in the same view area. Grouping by sequence should also be considered first when ordering items in a list (e.g., communication frequencies in the order used).
Importance/Criticality	Grouping by importance or criticality should be considered when identifying items to be displayed in the most prominent or easily located areas (such as the top and bottom of pages or view areas). Items of extreme importance should be placed in a consistent location in all views or pages.

**Table 4-3. (cont.)
Considerations for Identifying the Best Strategy of Grouping Information**

Strategy	Considerations
Function	Grouping by function should be considered when determining the major delineations of a page (such as separate view areas). In addition, pilot choices (such as declutter features or frame of reference choices) should be grouped within menus by function.
Frequency of Use	Frequency of use may be considered when determining information to be grouped on separate pages. For example, some items may be used so infrequently that they could be removed from the main display and grouped together on a separate page that may be requested. Frequently used items should also be located in areas that are quickly located through visual search (such as the top, bottom, or sides of the display, or in a special boxed-in or shaded area of the display).
Other methods (alphabetically, numerically)	Other methods of grouping should be considered when no other relationships between the information exist. For example, choices in a menu list should be grouped according to frequency of use and function. However, if none is used more frequently than another and there are no functional commonalities between items, the items may be listed alphabetically.

4.13.2 References

Blanchard, 1991; Clay, 1993; DeRee, 1990; Friend, 1988; Hofer, Palen, Dresel, and Jones, 1991; Hofer, Palen, Higman, Infield, and Possolo, 1992; International Air Transport Association, 1975; Mykityshyn and Hansman, 1992; NASA-Langley Research Center, 1993; Smith and Mosier, 1986; Taylor, 1985.

4.13.3 Graphic Example

DON'T group information that may need to be integrated or compared on separate pages, requiring the pilot to remember or record the information. In this example, when the missed approach view is chosen, only the missed approach information on the plan view (symbolic representation of missed approach heading and holding pattern) is added. The missed approach instructions are not available.

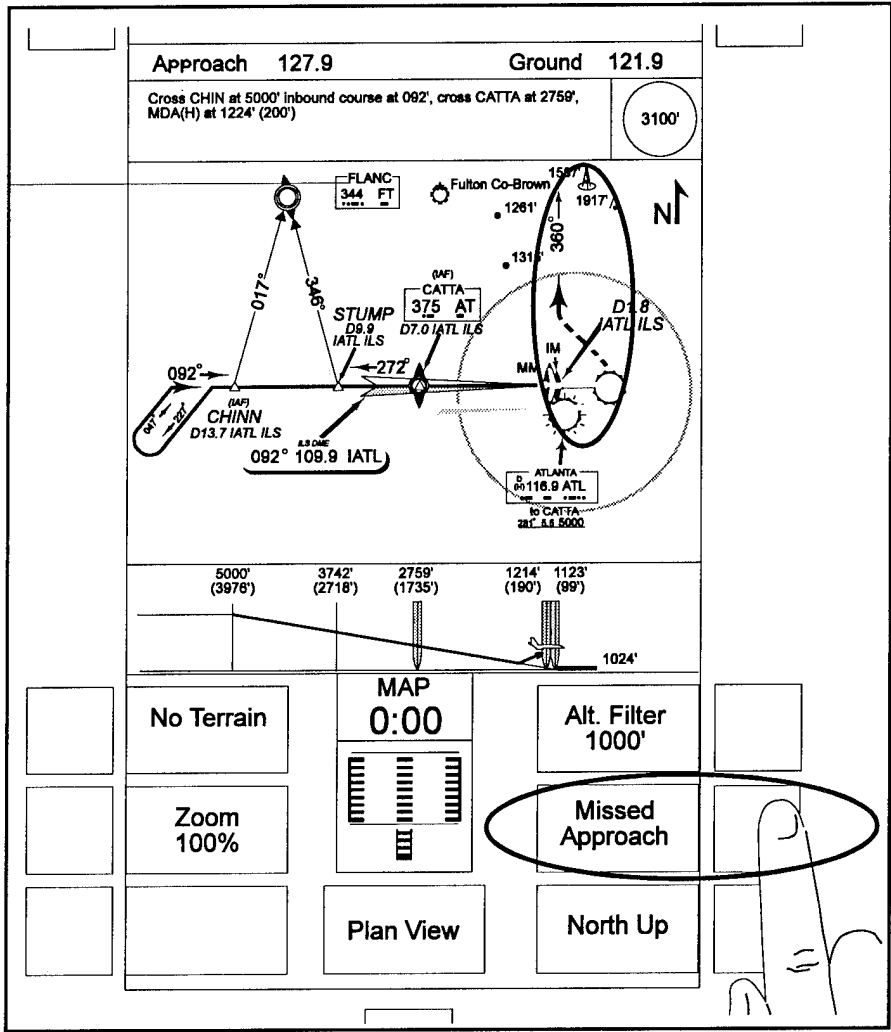

DO include all data relevant to a particular task in one display page or frame. In this example, when the missed approach view is chosen, missed approach symbology is added to the plan view, and the missed approach instructions are presented at the top of the page.

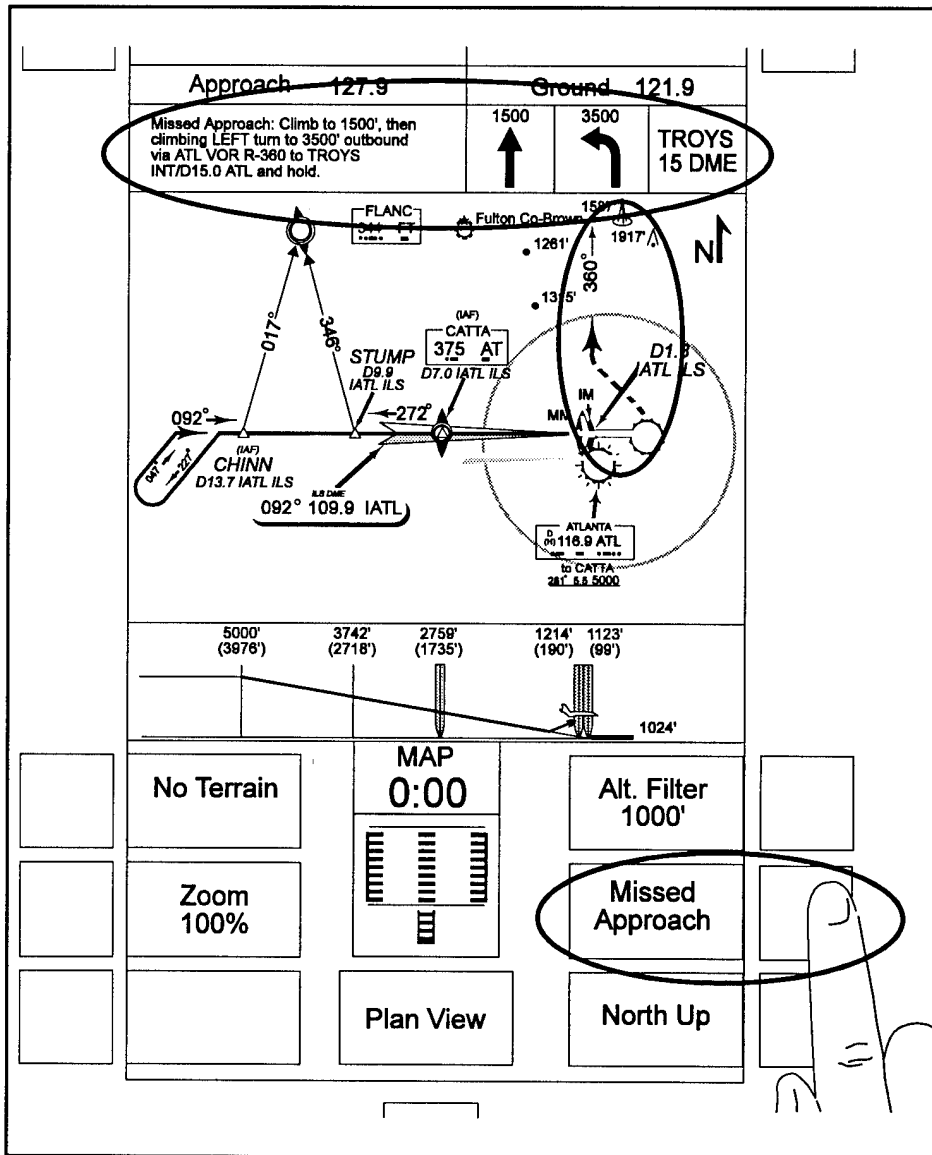

4.14 METHODS FOR GROUPING INFORMATION

There are a number of different ways information may be arranged so that it is perceived as a group. Gestalt Laws of perceptual organization suggest that information will be perceived as a group through proximity, similarity, continuity, and closure (Eysenck, 1984; Koffka, 1935).

The law of proximity states that elements that are close to other elements appear as a group. Thus, information may be organized to provide a meaningful structure that aids visual search by simply placing related information close together, boxes or lines that can add to the clutter on a display may not be needed. Care should be taken, however, in locating information elements close together. In some situations, placing other text or symbols close to a word may prolong the time that it takes to recognize the word, especially if the information is located near the beginning of the word (Noyes, 1980). Adequate spacing between grouped objects should be provided to ensure identification of the items as separate objects.

The law of similarity suggests that elements that resemble each other appear as a group. For example, a group of symbols colored red but not located near one another may stand out to an observer as a group. This is the basis for many coding schemes (coding is discussed in more detail in Sections 4.2-4.4). Color, brightness or contrast, size, and shape are all dimensions on which an information element can be made similar. Similarity is successful as a grouping mechanism when several similar elements are present, few different codes are present, and non-group members are sufficiently dissimilar from group members. Current IAP charts utilize so many different symbols that there is very little grouping based on similarity. Each item of information on the display appears to be different from every other one with only relations by proximity and closure (see below) apparent. Color coding may allow the presentation of information spatially while still providing some level of grouping information based on similarity of color. This makes the relationship between information much more apparent.

The law of continuity states that elements tend to be grouped in a way that minimizes abrupt changes in visual direction. Information in a column appears in a group because there is no change in visual direction as the eye moves down the column. Lines or boxes around the column may not be needed since the information itself forms a visual line. The law of closure states that elements arranged within a closed region are seen as a group. A closed region need not always be continuous lines. Shading may provide a grouping effect without adding to display clutter. The principles of continuity and closure are utilized in the display of information in tables. Grids in tables help people to match the information in a cell with the appropriate row or column label. Using finer (lighter) lines for grids than for information in the table may speed up the search of needed information since it allows matching to the appropriate rows and columns while adding very little display clutter.

4.14.1 Guidelines

- 4.14.1.1 Information should be grouped by locating the information close together in space.

Example: Locate the identifier and frequency for a NAVAID close to the symbol representing the NAVAID.

Comment: An example of the difficulty of using proximity as a grouping mechanism is represented in the current presentation of frequencies and identifiers. The frequency and identifier of a NAVAID run together with no distinctive separation (e.g., 111.8 HVR), making it more difficult to distinguish them. Displaying the identifiers in smaller or lighter text than the frequencies may help in distinguishing the two separate information items and may help the user to see each separate item as a whole (which speeds processing of the information), while still allowing them to be grouped together through proximity (e.g., **111.8** HVR) .

- 4.14.1.2 Information should be grouped by using similar features (codes) for related information.

Example: The use of symbols to signify NAVAIDs of the same type is a form of coding that groups information.

Example: Color coding may be used to make several items appear as a group.

Example: Similarity can also help distinguish groups of information that the designer would like to appear distinct but must be located close together:
THIS IS A GROUP *and this is a group*

- 4.14.1.3 The number of codes that are used for grouping should be minimized.

Comment: The more different codes that are used to represent related groups of information, the less effective the codes will be (pilots may not remember the meaning of the codes, or it may take longer for users to categorize information properly).

- 4.14.1.4 Continuity should be used to group information.

Example: Where textual information must be grouped, it should be displayed in tabular form to take advantage of natural continuity.

Example: The continuous path of the aircraft through the profile view provides continuity that helps to group the information related to vertical path of the aircraft.

- 4.14.1.5 Closure (through the use of lines, boxes, or shading) should be used to signify and group information when proximity and similarity are not effective.

Comment: Thin lines may be preferable to thick lines because they are less likely to interfere with or overpower primary information.

- 4.14.1.6 The amount of extra information added to a display to group information through continuity or closure should be minimized.

Comment: An experiment by Multer, Warner, Disario, and Huntley (1991) compared different formats used by various agencies for presenting communication frequencies. They found that a format in which the label and frequency were boxed and spaced horizontally across the IAP resulted in faster reaction time and greater pilot preference than other formats including a columnar format (see graphic example in Section 4.14.4). It should not be assumed that the presence of the boxes or lines alone caused this result. The authors note that the boxed format also used a greater separation between items and the boxes provided a grouping of the label with the frequency that was not apparent in other groupings. Similar groupings using space alone may provide the same or better results.

- 4.14.1.7 Designers should consider the characteristics of the information to be grouped in order to determine the best method to use for grouping related information.

Comment: As is true for identifying *what* information should be grouped together (see Section 4.13 on grouping strategies), it is not possible to specify a specific set of rules or a specific precedence for determining *how* to group information together. Table 4-4 suggests some considerations for determining the best method of grouping information under certain circumstances.

Table 4-4.
Considerations for Determining the Best Method of Grouping Related Information

Grouping Method	Considerations
Proximity	Grouping by proximity allows grouping of information without added clutter of symbols, lines, shading, etc., and should be considered first when identifying grouping methods. Displays such as EIAPs often have so much information that proximity alone is not a sufficient means of grouping information (e.g., there may not be enough "white space" between non-grouped items to delineate the groups) and proximity must be combined with other methods. Labels should always be grouped with the items they represent through proximity. Information that must be used concurrently should also be grouped through proximity.
Similarity (Coding)	Similarity or coding may be used to identify similar items which are not used concurrently. Similarity (e.g., of symbol size, text size or face, etc.) may also help to reinforce grouping by proximity in a crowded display.
Continuity	Taking advantage of natural continuity (such as lines created by columns of text) is preferable to adding lines or shading to create continuity for grouping.
Closure (Lines, Boxes, Shading)	When groups created by proximity, similarity, or natural continuity are not immediately obvious and there is a possibility of confusion, grouping through the addition of lines, boxes, or shading should be considered. Closure may help to create functionally related groups that speed visual search.

4.14.2 References

Eysenck, 1984; Koffka, 1935; Multer, Warner, Disario, and Huntley (1991); Noyes, 1980; Tufte, 1990.

4.14.3 Graphic Example

DON'T present textual information in a format such that the information is strung together and there is no grouping of related information. These examples resulted in slower reaction times and low pilot ratings in an experiment by Multer, Warner, Disario, and Huntley (1991). In the first example, the frequencies are grouped with the labels through proximity but the spacing between the labels and the frequencies probably slowed search time. In the second example, misaligned rows may have been the slowing factor. Also, the spacing between rows and between columns is roughly equal so that the grouping relationships are not clear. In the third example, the alignment is proper but the greater spacing between the columns than between the rows causes users to group the column of labels together and the column of frequencies together, rather than grouping the labels with the frequencies by row.

Amdt 8	
NBD RWY 4	
ISLIP APP CON	120.5 367.2
ISLIP TOWER	119.3 233.2
GND CON	121.7
CLNC DEL	121.85
ATIS	128.45

Amdt 8	
NBD RWY 4	
ISLIP APP CON	120.5 367.2
ISLIP TOWER	119.3 233.2
GND CON	121.7
CLNC DEL	121.85
ATIS	128.45
RADIO	122.6
CTAF	119.3

Amdt 8	
NBD RWY 4	
ISLIP APP CON	120.5 367.2
ISLIP TOWER	119.3 233.2
GND CON	121.7
CLNC DEL	121.85
ATIS	128.45
RADIO	122.6
CTAF	119.3

DO group related information together through proximity or closure. The first example resulted in the fastest reaction time and highest pilot preference in Multer, Warner, Disario, and Huntley (1991). The boxes make the grouping of the label with the frequency quite obvious. The second example exemplifies guidelines on the presentation of related alphanumeric information (Section 4.1). This method is the same as the rightmost method above except more space has been added between the rows to indicate that the rows should be grouped (label with frequency) rather than the columns.

Amdt 8						
NBD RWY 4						
ISLIP APP CON 120.5 367.2	ISLIP TOWER 119.3 233.2	GND CON 121.7	CLNC DEL 121.85	ATIS 128.45	RADIO 122.6	CTAF 119.3

Amdt 8	
NBD RWY 4	
ISLIP APP CON	120.5 367.2
ISLIP TOWER	119.3 233.2
GND CON	121.7
CLNC DEL	121.85
ATIS	128.45
RADIO	122.6

4.15 MAP SCALE

Horizontal (plan) views and vertical (profile) views require different map scales for their use. Within the profile view, the scale is different for the horizontal axis (lateral information) than for the vertical axis (altitude information). In addition, the lateral scale for the profile view often varies in order to display greater detail information closer to the runway. There is no indication that a variable scale in the profile view has ever caused problems for pilots using paper charts. A higher tracking accuracy is required for the vertical task than the lateral task, even on final approach (Fadden, Braune, and Wiederman, 1992). Thus, it may be necessary to provide a smaller scale ratio for vertical information than for lateral information. The unequal scales cause the angle representations to be exaggerated vertically. One question related to this issue is, "will this affect use of the EIAP?". An initial answer is probably not. Preliminary studies of a flight path predictor by Fadden, Braune, and Wiederman (1992) found that scale differences between horizontal and lateral information of as much as 20:1 do not have negative influence on typical airline flying tasks.

The presentation of instrument approach charts on electronic displays provides designers with the ability to quickly change map scale. This change can occur based on user action (for example, if a pilot zooms in on a section of the chart or explicitly specifies the scale) or designers may create electronic charts that change scale automatically based on aircraft position. The use of variable map scales will be directly related to issues dealing with the grouping of information on display pages (for example, a plan view may automatically provide the pilot with a different scale than an approach view), the use of dynamic displays, and the zooming feature (an equal change in scale in all directions is equivalent to zooming - see Section 4.20). A variable map scale may be less important if the pilot has a dynamic translating display than if the display is static.

4.15.1 Guidelines

- 4.15.1.1 An indicator that identifies the current map scale or states that the information is "Not to Scale" should be provided on a map display.
- 4.15.1.2 When changing scales, an indicator that continually shows the appropriate scale or an indicator of the expansion factor should be displayed (DOD, 1993; Smith and Mosier, 1986).
- 4.15.1.3 Tick marks on scale axes should be numbered or labeled corresponding to major scale divisions and should include a label containing descriptions and units of measurement on each axis (DOD, 1993).

Comment: Standard intervals of 1, 2, 5, or 10 (or multiples of 10) should be used (Smith and Mosier, 1986).

- 4.15.1.4 An inset or window should be provided to show the maximum available map coverage (DOD, 1993).
- 4.15.1.5 If scales are expanded to emphasize a limited range of data, breaks in the axes should be displayed to indicate discontinuities (DOD, 1993).
- 4.15.1.6 A linear scale should be employed rather than a logarithmic or other non-linear scale (Smith and Mosier, 1986).
- 4.15.1.7 If pilots have the capability to change scale (e.g., by zooming) in the EIAP and a profile and plan view are presented in the same view, consider using the same scale for lateral information in the profile view as is used for lateral information in the plan view.

Comment: If a change of scale is not provided, it may be necessary to provide different lateral scales for the two views in order to display the relevant information within the space provided. In fact, it may be necessary to present the information in the profile view at a variable scale in order to display details as necessary. If the lateral profile scale is variable, there should be some indication (such as a display of distance between points in the approach profile) of the scale of information displayed.

- 4.15.1.8 If a scale grid is provided, pilots should be allowed to turn the grid on and off (DOD, 1993).
- 4.15.1.9 If a scale grid is provided, it should be presented in a format that does not overwhelm or obscure the information on the display (e.g., use thin, dashed, or lightly colored lines) (Smith and Mosier, 1986).

4.15.2 References

DOD, 1993; Fadden, Braune, and Wiederman, 1992; Smith and Mosier, 1986.

4.15.3 Graphic Example

DON'T use the same scale for the vertical direction in the profile view as the lateral direction in either view. This example shows the profile view with a vertical:horizontal scale ratio of 1:1.

DON'T display information on a scale that is not clearly labeled.

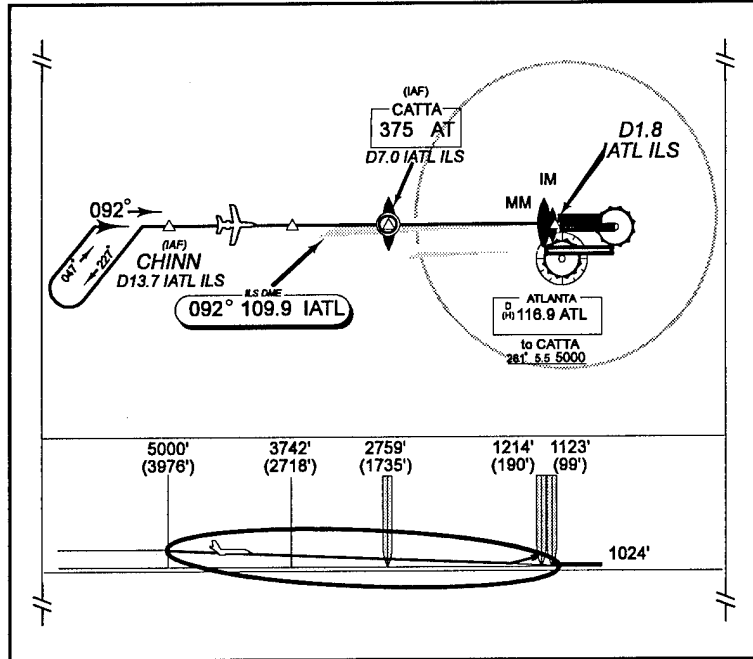

DO consider using an exaggerated scale for the vertical direction. This example shows a vertical:horizontal scale ratio of 3:1.

DO provide indications of the scales used in both the profile and plan views.

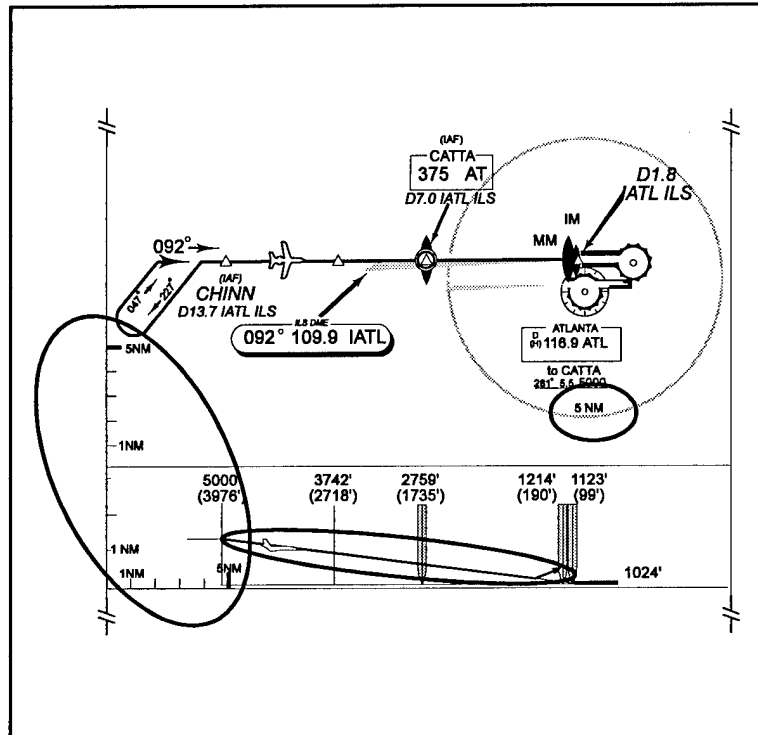

4.16 DESIGN FOR APPROPRIATE TASK/PHASE OF FLIGHT (E.G., DESIGN FOR PLANNING, DESIGN FOR FINAL APPROACH)

Due to the nature of the instrument approach task, some functions may be appropriate for certain phases of flight or certain aspects of the task, but will not be appropriate for others. For example, pilots will need an EIAP that supports both planning and discrete information retrieval (see Section 4.1). In addition, pilots will be more able to interact with an EIAP pre-flight or enroute than they will after the final approach fix. Mykityshyn, Bussolari, and Hansman (1990) classified information on the IAP as critical, supplemental, or extraneous based on phase of flight. The following table (Table 4-5), based on their study of an ILS approach and a VOR-DME approach, presents the information considered critical for each of the approach phases.

Table 4-5.
Information Prioritization Based on Phase of Flight
 (based on data from Mykityshyn, Bussolari, and Hansman, 1990)

Approach Phase	Critical Information Elements	Comment
Pre-approach	MSA, ATIS, header, footer, minimum altitude/visibility, runways, airport obstructions, airport elevations	Everything on current paper charts is critical or supplemental in this planning phase, nothing is extraneous.
Terminal area entry to initial approach fix	MSA, minimum altitude at first fix/ NAVAID, frequency/information at first fix /NAVAID, localizer frequency/ information, approach control frequency, minimum airport elevation	Extraneous information at this point includes airport information, some NAVAID information, some communication aids.
Initial approach fix to final approach fix	Approach course, minimum altitude at glide slope intercept, glide slope at outer marker, outer marker frequency/ information, first NAVAID information, localizer information, minimum airport elevation	Airport information, some NAVAID information, and some communication aids remain extraneous at this point.
Final approach fix to missed approach point (MAP), or to landing rollout	Approach course, MAP course, MAP altitude, MSA, NAVAID information, middle marker, inner marker, localizer, tower control, minimum altitude, touchdown zones, lighting	Almost everything that is not critical (except fixes, glide slope, holding information, and approach control) is considered extraneous in this leg.
MAP to holding or circling maneuver	Approach to MAP, hold at MAP, MAP altitude, MSA, localizer, approach control, minimum altitude	Almost everything not listed as critical (except tower control, MM, IM, NAVAID information) is considered extraneous at this point.
Touchdown to landing rollout	Runway diagram, touchdown zone	Almost everything not listed as critical (except GS, tower and ground frequencies, runways, and parking areas) is extraneous.

**Table 4-5. (cont.)
Information Prioritization Based on Phase of Flight**

Approach Phase	Critical Information Elements	Comment
Turn-off from active duty runway; taxi to parking	Ground control, clearance, ATIS, taxiways, parking areas	Almost everything not listed as critical (except tower, runways) is extraneous.

Designers must consider the type of task the pilot will be performing while using the EIAP. The differences in information needs and pilot workload during different phases of flight must be addressed. See also Chapter 2 and Section 3.1 for more information describing the types of tasks that may be performed on an EIAP and how they differ by phase of flight.

4.16.1 Guidelines

4.16.1.1 An EIAP should provide a mode or view that assists the pilot in planning the approach.

Example: A plan summary feature may be incorporated in which pilots choose specific items of information to be listed in a plan summary. Pilots would choose only information relevant to their flight and a sequentially ordered list could be created for quick reference.

Example: A planning mode may incorporate more features such as the capability to zoom out and view a larger area around the approach area, or the capability to declutter or add features than may be allowed in a final approach mode.

4.16.1.2 Different views or modes based on phase of flight should contain features and functions appropriate to the phase of flight.

Example: A final approach view should allow minimal if any control by the pilot. The pilot should be able to customize the view to show all needed information prior to the final approach fix. Features such as automatic altitude alerting (for stepdown altitudes, decision altitude, missed approach altitude) and automatic panning to show missed approach information should be considered over features that require the pilot to make control actions.

4.16.1.3 Different features and functions should use implementations that are appropriate to the type of task the pilot will be performing.

Example: A wide view could be presented to facilitate planning during the initial approach phase. The view could narrow to a more detailed view during the final approach phase, reducing clutter and allowing pilots to quickly access needed information while navigating. The view may then scroll to a missed approach view if needed. There should be some means of manually selecting these

functions to allow for reviewing during cruise or descent and to allow for individual preference during the approach.

4.16.2 References

Mykityshyn, Bussolari, and Hansman, 1990.

4.16.3 Graphic Example

DON'T add to a pilots workload by requiring pilots to request critical pieces of information during high workload phases of flight such as the final approach phase.

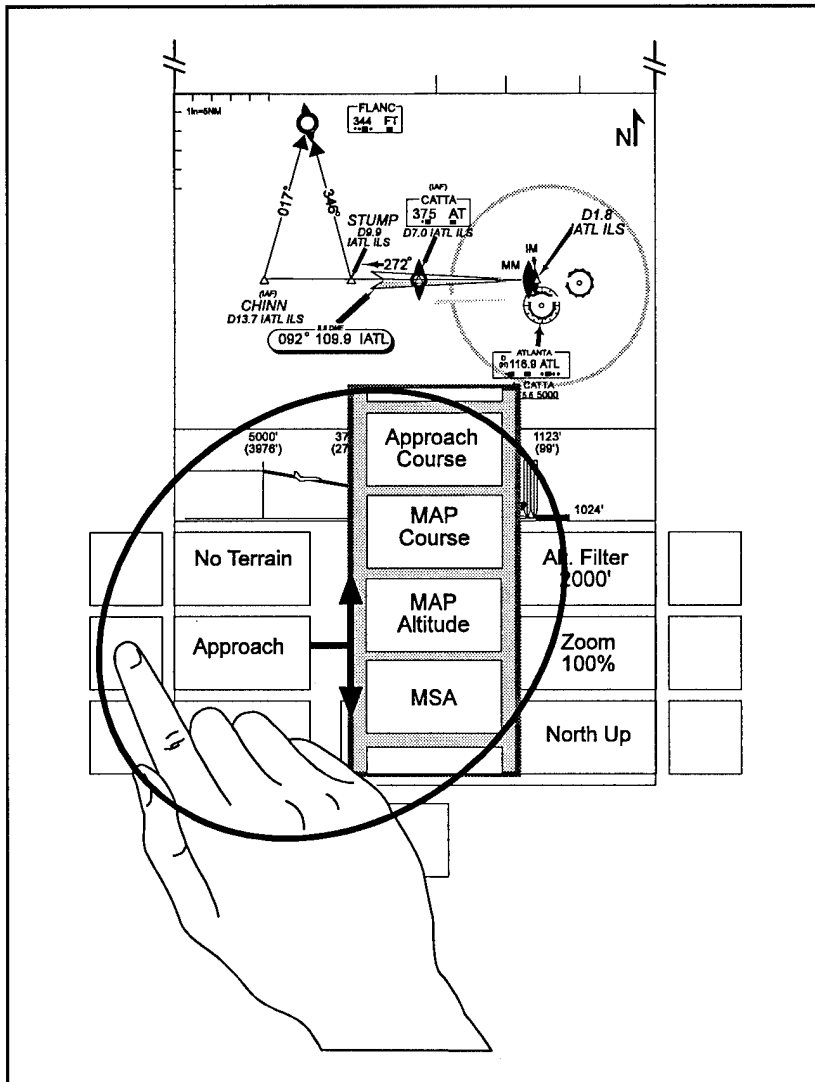

DO incorporate features that allow pilots to use the EIAP appropriately based on phase of flight or task type. In this example, the view is automatically panned to in order to center in on the missed approach information. The graphical missed approach icons are automatically added to the area in the profile where the pilot is likely to be looking on final approach.

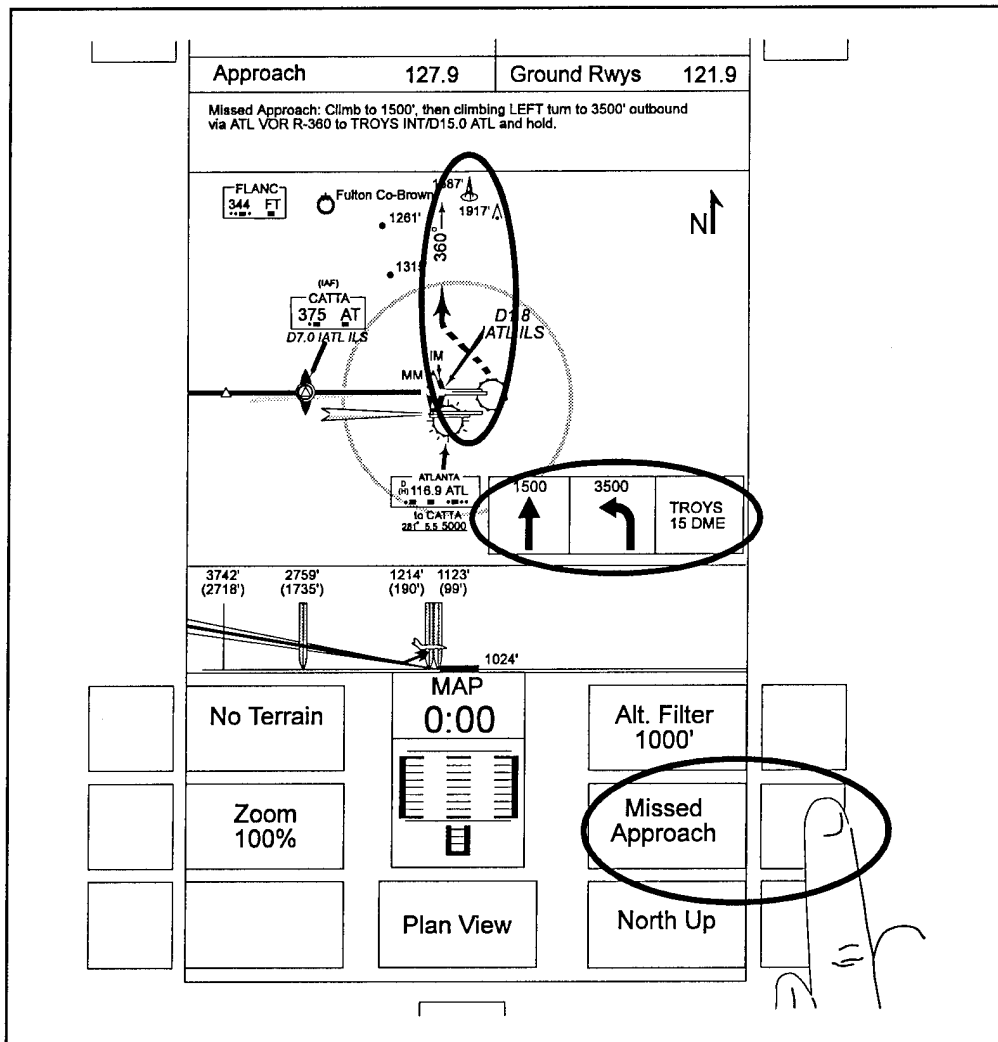

4.17 MINIMIZING ERRORS, MINIMIZING EFFECTS OF INTERRUPTIONS, ERROR RECOVERY

Certain types of errors are common in humans when they are performing tasks at a skill-based (highly practiced or automatic) level. Reason (1990) presents a categorization of these errors that may help designers to create EIAPs that will minimize errors. Reason's error classification includes the following error types:

- **Double-Capture Slips:** missing an unusual step in a well-learned sequence (e.g., missing a confirmation check at an outer marker when there is no aural alert, such as when an approach is over water and the outer marker is determined by DME);
- **Omissions Following Interruptions:** missing a step in a sequence due to an interruption (e.g., missing a confirmation check due to an ATC interruption);
- **Reduced Intentionality:** capture of attention by a different source, and forgetting the original task (e.g., receiving a radio call while in the middle of a checklist, then forgetting the position in the checklist);
- **Perceptual Confusions:** using a similar object or an object in the expected location instead of the appropriate object (e.g., changing the frequency on an active communications radio rather than the inactive one adjacent to it, while transmitting acknowledgement on that same radio);
- **Interference Errors:** confusion of two similar tasks (e.g., confusion between a heading knob and course knob on an HSI);
- **Omissions:** due to mis-timed checks (e.g., forgetting to set the switch to a new communication frequency that has been entered and calling the previous controller instead of the one expected);
- **Repetitions:** thinking you have not completed a task that you have completed, and repeating it (e.g., forgetting whether you have completed a programming sequence for a flight management system (FMS) and having to repeat it);
- **Reversals:** starting an action, then reversing it before it is complete (e.g., after a communications frequency change has been acknowledged, flipping the switch to the radio with the new frequency, then absent mindedly flipping back to the old one).

Reason (1990) also discusses errors that occur in tasks that are not well learned or skill-based. Tasks that require the use of rules or knowledge to perform them are also subject to errors. Errors may occur when a rule is misapplied to a certain situation or when the rule the person is using is incorrect. People tend to be rigid with rules. If a rule was successful in the past, people may continue to use it, even if it is no longer optimal (Reason, 1984). In addition, "Failures of prospective memory -- forgetting to remember to carry out intended actions at the appointed time and place -- are among the most common forms of human fallibility (Reason & Mycielska, 1982)."

One problem with the IAP task that may increase the likelihood of errors is the number of interruptions that may occur during the task. Interruptions may do the following: (1) divert

attention away from the task; (2) cause a pilot to forget information being held in memory for a short time; (3) increase the time it takes to visually locate information on a display; (4) cause errors in performance of skill-based tasks; (5) increase time required for planning and reasoning tasks; (6) cause mis-applications of rules; and (7) cause pilots to forget to perform future actions. EIAPs should be designed to minimize these effects of interruptions as much as possible. Designers should use caution in implementing any functions in an EIAP that may add interruptions to the approach task.

4.17.1 Guidelines

- 4.17.1.1 Designers should consider providing means of keeping the pilot aware of where he or she is in a sequence of activities.

Example: The display of aircraft location will help the pilot remain aware of where he or she is within the instrument approach procedure. An aircraft displayed in the profile view directly indicates which stepdown altitude is the current minimum.

Comment: See Section 4.26 on memory aids, sequence reminders, and highlighting.

- 4.17.1.2 Designers should consider highlighting or providing the pilot with a method to highlight important information, unusual activities, or crucial steps for a given approach.

Example: The EIAP may incorporate a function that allows pilots to choose key symbols, words, or numbers (via touchscreen or some type of cursor control) to display the item at a greater brightness than other items on the screen. This type of highlighting is similar to the use of "bugs" to mark altitude limits on altimeters, etc.

Example: The EIAP may automatically highlight items that are considered by the designer to be key information for the given approach.

Comment: Automatically highlighting information reduces workload for the pilot; however, automatic highlighting will not be able to account for situational factors as well as allow the pilot to choose items to highlight.

- 4.17.1.3 If consistency of location of an information item is used to promote skill-based processing - it must **always** be followed.

Comment: Certain key information (e.g., minimum descent altitude) may be displayed in a consistent location to help pilots develop an automatic skill for locating the information. However, if occasionally (i.e., for certain approaches or

on certain pages or views) the information is presented in a different location and/or a different but similar (e.g., touchdown zone elevation) item appears in the same location, pilots are likely to confuse the two items and an error could result - even if appropriate labels are used.

- 4.17.1.4 If EIAP presents information in a format that does not require mental manipulation, the possibility of rule-based errors is reduced.

Example: Pilots have commented that they sometimes have trouble reconciling the aircraft's location in space with the information presented in an MSA circle. If the applicable MSA based on current aircraft location is displayed directly (e.g., a digital display of only the applicable altitude), the applicable MSA is highlighted within an MSA circle, or the location of the aircraft within the MSA circle is indicated, the pilot does not need to integrate the two pieces of information (aircraft location and MSA circle information) and errors are less likely to occur.

- 4.17.1.5 EIAPs should use constraints, both natural and artificial, to guide the user to the next appropriate action or decision (Norman, 1988).

Example: Functions that are inappropriate to use on the EIAP at a given time should be disabled so the user can not choose them. There should be a visible indication when a function is disabled.

Example: If a pilot has the capability to choose what information is displayed where on an EIAP, one constraint may be that the heading area can not be changed so that key information is always present in a consistent location.

- 4.17.1.6 Designers should assume that errors may occur and plan for error recovery. It should be easy to reverse operations and hard to implement non-reversible ones (Norman, 1988).

Comment: See Sections 3.8 and 3.9 on Forgiveness and Feedback.

4.17.2 References

Norman, 1988; Reason, 1984; Reason, 1990; Reason & Mycielska, 1982.

4.17.3 Graphic Example

DON'T set up a pilot for errors by presenting similar looking but conceptually different information in the same location on two different views of the EIAP. In this figure, the plan view on the left shows a magnified view with an unmagnified view in the bottom right corner. The plan view on the right shows the magnified view with the missed approach information in the bottom right corner. Although the missed approach view is labeled, under high workload conditions, a pilot may initially mistake one view for the other.

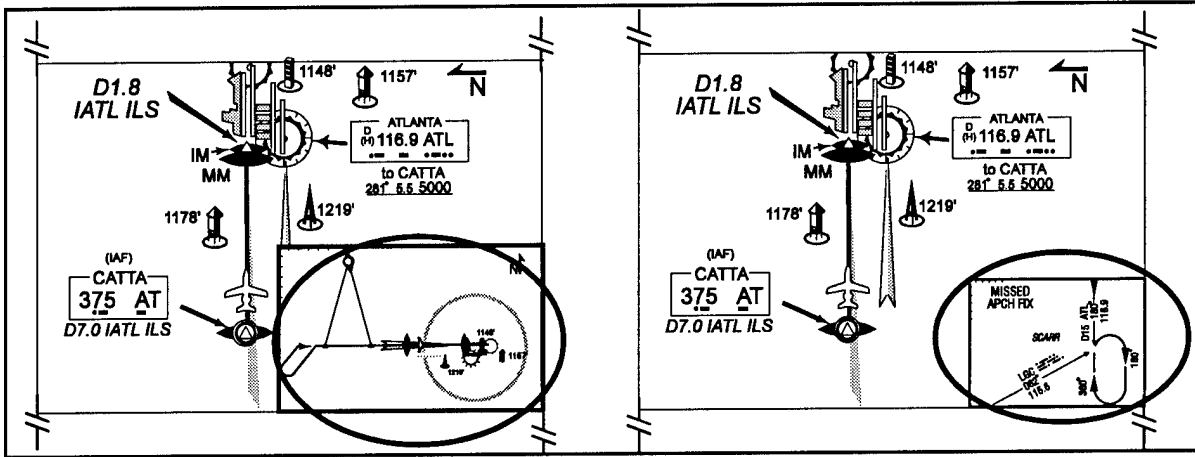

DO ensure the distinctiveness of information items that may be confused by locating them in different places and/or by using distinctive presentations. In this figure, the unmagnified plan view is drawn in the lower right corner and the missed approach view is drawn in the upper left corner. This positioning will reduce the probability that the pilot will confuse one view for the other.

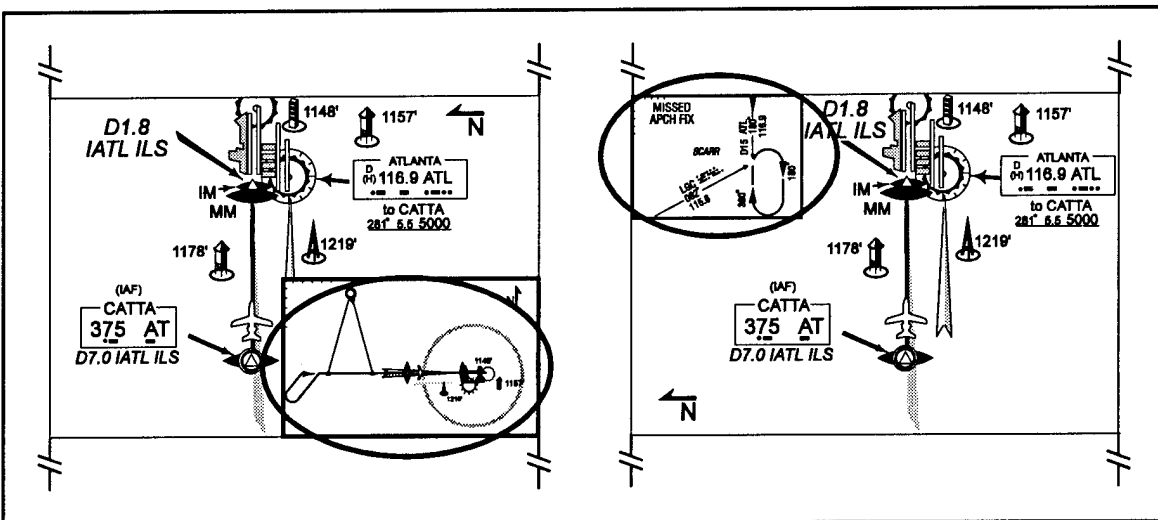

4.18 INTEGRATION WITH OTHER COCKPIT SYSTEMS

Design and certification of an EIAP system can not be completed without consideration of how the system will be integrated with other cockpit systems. Researchers have suggested that, rather than implementing an independent EIAP system, instrument approach information may be incorporated into other electronic systems such as the electronic flight instrument system (EFIS) navigation display (Hofer, Palen, Higman, Infield, and Possolo, 1992). An integrated system would reduce space requirements, group related information, reduce redundant sources of information, and reduce the number of displays that require attention. However, Mykityshyn and Hansman (1992) tested an integrated system and discovered that pilots preferred an IAP separate from the primary navigation display for planning purposes. This result suggests that a North-up EIAP may be the appropriate complement to a Track-up EFIS navigation display.

There are a number of other integration issues to be considered. For example, flight management systems (FMS's) require the flight crew to enter flight plan data. An EIAP should be able to take advantage of this information in determining the appropriate information to display. Pilots should not be required to enter the same data into two independent systems. If an EIAP is integrated with an FMS, it may be possible to utilize some of the same controls (such as an FMS keypad) rather than introducing a new set of independent controls. Also, EIAPs may include a small subset of the functions provided by FMS's for use on general aviation aircraft that do not have FMS. The interaction between the EIAP and other systems such as ground proximity warning systems (GPWS) and altitude alerting systems should also be considered. Kuchar and Hansman (1992) developed a prototype EIAP that incorporated a graphical ground proximity warning system that received a favorable review from pilots (see Section 4.7). EIAPs may also be integrated with altitude alerting systems to automatically update the next appropriate altitude for an alert.

If early EIAP systems are only minimally integrated with FMS, EFIS, GPWS, or altitude alerting systems, designers and certifiers must remain aware of the relationship between the EIAP and these systems. Information presented on separate systems should be consistent and compatible. Careful consideration should be given to the presentation of redundant information. In some cases the display of redundant information may be necessary -- for example, if the system is designed for use in cockpits with different avionics suites, if the redundancy is presented as a backup, or if information is presented in different ways based on the way in which the information is used. Where possible, the removal of redundant information will minimize clutter in the cockpit. In addition, the location of an EIAP in comparison to other cockpit avionics must also be considered. Related information and information that requires integration between the EIAP and other instrumentation should be located in close proximity (Vincow and Wickens, 1993; Ritchie, 1988).

4.18.1 Guidelines

- 4.18.1.1 EIAPs should be consistent with other cockpit systems in the presentation of information.

Example: EIAP symbols, terminology, units (e.g., NM), coding, and scales should be consistent with other cockpit displays.

- 4.18.1.2 EIAPs should be designed to avoid redundancy with other cockpit information systems.

- 4.18.1.3 EIAPs should be located in close proximity to related displays.

Comment: Paper charts are currently displayed centrally (normally clipped to the center of the control yoke). An EIAP will probably need to be mounted on or near the main instrument panel. Unfortunately, there is little space available for additional displays in most aircraft.

Comment: Further research is necessary to determine the implications for design of an EIAP incorporated into or shown with an FMS or ELS and displayed on one of the CRTs associated with the FMS.

4.18.2 References

Hofer, Palen, Higman, Infield, and Possolo, 1992; Kuchar and Hansman, 1992; Mykityshyn and Hansman, 1992; Ritchie, 1988; Vincow and Wickens, 1993.

4.18.3 Graphic Example

DON'T implement an EIAP that is inconsistent with other cockpit displays. In this example the symbols on the EIAP are inconsistent with symbols on an electronic horizontal situation indicator (EHSI).

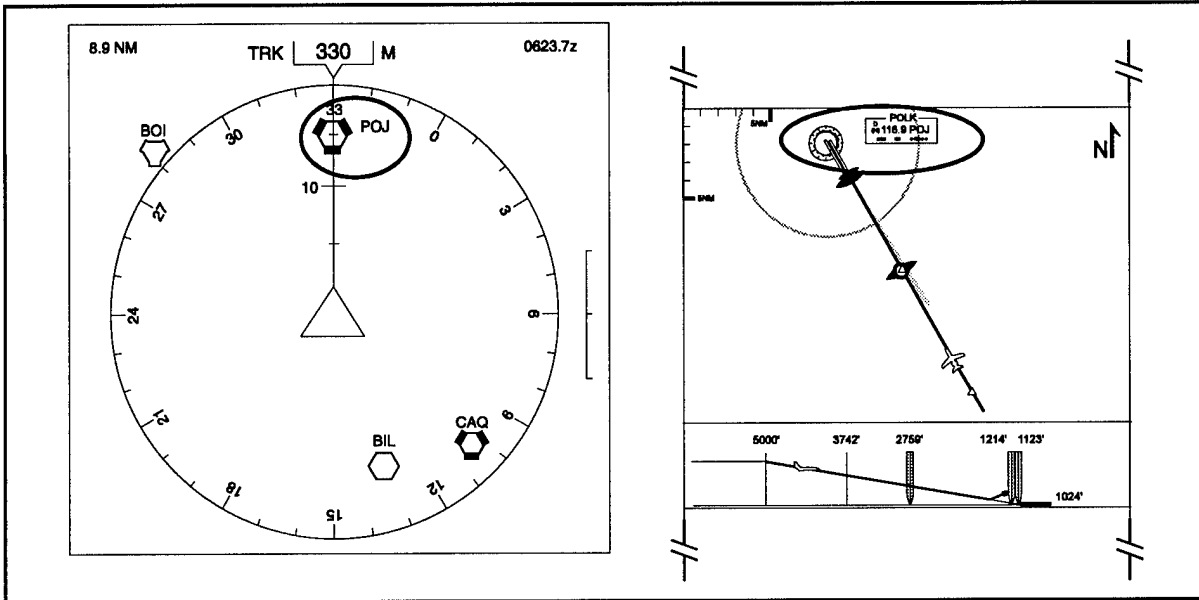

DO use the same symbols, terminology, units, and display arrangement conventions on the EIAP as are used on other cockpit displays.

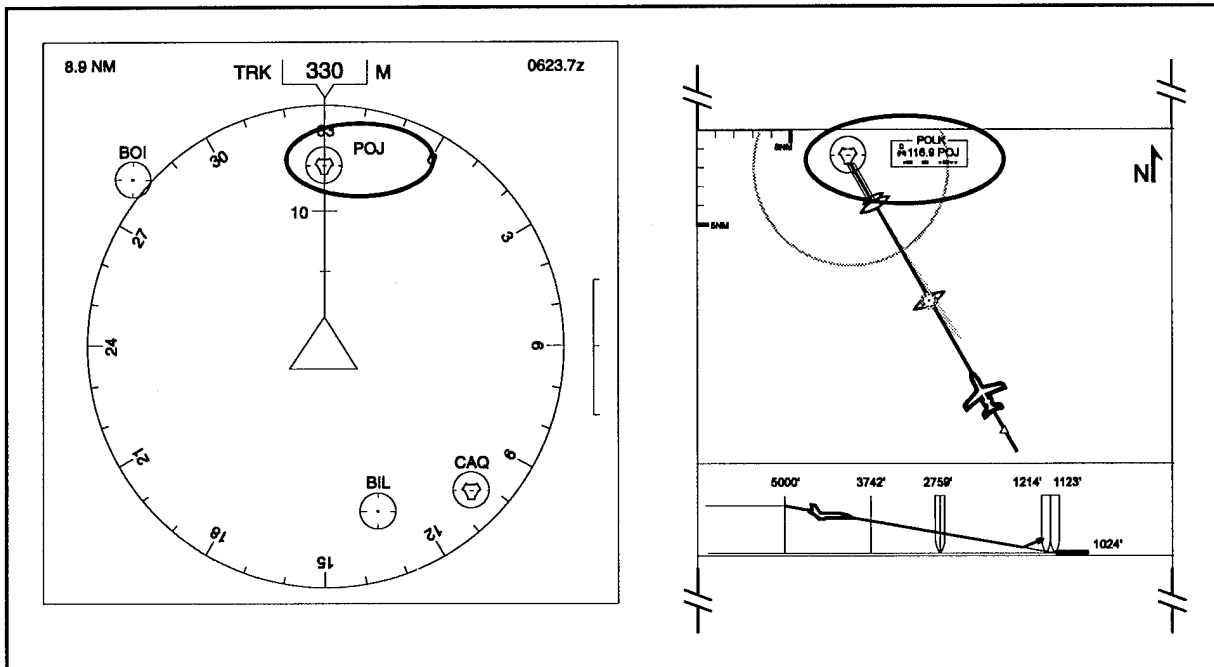

4.19 INPUT DEVICES

Any EIAP that allows pilot control of the display will require some type of input or control device. The control must be acceptable within the cockpit environment accounting for motion, vibration, and other biodynamic effects such as turbulence. Alternatives include keypads, pointing devices such as trackballs or joysticks, touch-screen controls, knobs, dials, rotary selector switches, and voice controls. Pointing devices such as a trackball or joystick may be difficult to implement for an EIAP since they require space to work and a free hand. Finger-tip controlled joysticks may be implemented on an EIAP but will require that the control be mounted in a location where the pilot has a hand rest or grip to steady his or her hand. Touch screens combine the display and control on one surface. Touch screens provide one possible method of control for EIAPs but disadvantages include immediate acceptance of input on touch (although a requirement to confirm a selection with an enter key is one method for reducing this problem) and a large touch area required due to vibration and motion in the aircraft environment. Touch screens also require that the display be located within the reach of the individual controlling the EIAP. Keypads may be suitable for the aircraft environment but they do not provide the same type of direct manipulation capabilities that are provided with pointing devices or touch screens. A discussion and comparison of all of the various input devices for electronic systems is beyond the scope of this document. The reader is referred to MIL-STD-1472D (1989), Kantowitz and Sorkin (1983), Helander (1988), Brown (1988), VanCott and Kinkade (1972), and McCormick and Sanders (1992) for more information on the design of controls.

The term "soft controls" is often used to describe controls provided by the software of a system, displayed on the screen. Examples include menus, soft buttons, sliders, check boxes, and direct manipulation (e.g., drag and drop). They may be manipulated through the use of a pointing device to make selections. Other controls such as arrow keys on a keypad or push buttons located next to the display may also be used to manipulate soft controls. In general, the number of soft controls used on an EIAP should be limited. Menus and check boxes may be used in a pre-flight situation where the pilot is setting up the EIAP for the flight and possibly providing customizing information. Controls for EIAPs during flight will necessarily be limited to those that can be selected quickly, those for which the outcome of the selection is clear, and controls for which the result of the selection is immediately visible. Menus were discussed in detail in Section 4.10. A number of references such as Apple (1992), IBM (1991), and Smith and Mosier (1986) discuss the use of soft controls in greater detail.

Programmable push buttons or bezel buttons are probably the most appropriate method of control for the cockpit environment. Bezel buttons on a multi-function display combine hard push buttons to the side of the display with "soft" labels on the display that change based on pilot selections. Programmable push buttons are hard buttons with small displays on the buttons that enable the labels on the buttons to change. The number of features and functions that a pilot can control easily may be reduced through the use of bezel buttons over those that

are available through touch screen or cursor control since the display area associated with the control will be limited to the edges of the display.

4.19.1 Guidelines

4.19.1.1 Touch screen controls should be implemented with arm or hand supports (Brown, 1988).

4.19.1.2 Touch screen controls should be used only for course positioning information (Brown, 1988). Finer positioning requires a cursor control device such as a finger tip joystick.

Comment: A touch pad cursor control such as the small capacitance sensing graphics tablet used on Apple portable computers may be a good cursor control choice for the cockpit environment. It has no moving parts, is impervious to dirt, and the fingertip can be steadied by pressing harder against the pad with no effect on movement of the cursor.

4.19.1.3 The area that may be touched or selected with a cursor control device (Brown, 1988; Smith and Mosier, 1986) should be large and should be visible (clearly designated as a selectable field).

Comment: Target size is a function of the cursor size and the control sensitivity. The area should be larger than the cursor/fingertip and large enough so the user can position the cursor within it.

Comment: MIL-STD-1472D (1989) specifies the size of the selectable area required for touch screen displays (3/4"x 3/4" minimum). Designers should also ensure that the size of the selectable area (either by cursor control or touch screen) is usable while experiencing cockpit vibration.

Example: If a menu item is selectable with a cursor or with a touch-screen, the active area for selection should include the entire label for the menu rather than requiring users to use fine control to select a single letter, or a small symbol on the item.

Example: Selectable areas on a display should be distinguished from non-selectable areas through the use of shading, color coding, or some other means.

4.19.1.4 Input controls should incorporate feedback that indicates whether the entry has been accepted or not.

Comment: Controls such as buttons and selector switches provide natural tactile feedback due to the mechanical nature of the control. Touch screen controls or soft

controls may require added auditory feedback (such as a beep when touched) or visual feedback (such as a change in color or a check box that changes to checked). If the pilot wishes to operate a control without watching the display (e.g., when the pilot is approaching the missed approach point and must be constantly looking out the windshield) tactile or auditory feedback is required.

Comment: An indicator light may provide good visual feedback in the cockpit where the environment is noisy and other aural signals are already in use. Lights may draw more attention than a simple change on an already cluttered display. A light may be mounted adjacent to the display or may be incorporated into a button. While the button may have good tactile feedback, added visual feedback may be necessary for the pilot to quickly recognize the current state of the button.

4.19.1.5 Designers should take steps to minimize accidental activation of controls.

Example: Some touch-screen controls are especially susceptible to accidental activation. The designer may choose to require the user to select "Enter" or some fixed key following each selection to prevent accidental activation (Brown, 1988).

Example: Pointing devices (cursor control devices) such as trackballs or joysticks may minimize accidental activation by requiring two actions, such as a click to highlight and a second click to choose, rather than one (Smith and Mosier, 1986).

Comment: Controls that extend beyond the control panel surface such as joysticks are also susceptible to accidental activation. These types of controls should be positioned so that crew members are not likely to accidentally bump into or knock the controls.

4.19.1.6 Dedicated keys that perform one specific function should be used for critical or frequent inputs (Brown, 1988).

Comment: A dedicated key will provide the consistency necessary for a user to quickly perform a critical function.

Example: Frequently used keys may include an enter key or arrow keys. A critical function key may be a "Missed Approach" key.

4.19.1.7 Keys should be placed on a keyboard or on the control panel in a manner that is compatible with the display and compatible with accepted norms.

Example: The left arrow key should be placed to the left of a group of directional keys and the right arrow key should be placed to the right of the group. This is an example of spatial compatibility.

Comment: Frequently used keys should be placed at the ends or corners of groups of keys to aid in quick location of the keys and to minimize accidental activation of nearby keys (Brown, 1988).

- 4.19.1.8 EIAP systems should be flexible in their use of input devices and system control (Smith and Mosier, 1986).

Example: Designers should consider providing more than one method of controlling the display. Both a pointing device and keypad control may be provided for input to the EIAP. By providing more than one method of control, designers allow for individual differences and for differences due to the type of task being performed.

- 4.19.1.9 Control of the EIAP should require a minimum number of user actions (Smith and Mosier, 1986).

- 4.19.1.10 Actions required to control the EIAP should be consistent. (Smith and Mosier, 1986).

Example: If an EIAP implemented a function in which a single key is dedicated to each type of object (e.g., NAVAIDs, obstacles, etc.), the functions associated with a key (e.g., press key = more information, shift+key = hide object, etc.) should be consistent for all types of objects.

Example: If an EIAP incorporates different modes or views, functions that are common to the different modes (e.g., zooming, panning) should require the same actions to control.

- 4.19.1.11 EIAPs should respond quickly (less than 1 second) to user actions (Smith and Mosier, 1986).

Comment: Any delay in system response should be signified by the system (see Section 4.9 on feedback).

- 4.19.1.12 EIAPs that require or allow input of alphanumeric commands should implement a standard area for input of information (Smith and Mosier, 1986).

Example: A dedicated command line that is in a consistent location across all views should be used if an EIAP allows entry of commands.

Comment: The entry of alphanumeric information in different locations on the screen is acceptable for form filling functions such as entering pre-flight information. In this case, data entry areas should be visibly different (through the

use of shading or some other means) from areas that display static information such as labels.

4.19.2 References

Apple, 1992; Ballas, J., Heitmeyer, C. and Perez, M., 1992; Brown, 1988; Helander, 1988; IBM, 1991; Kantowitz and Sorkin, 1983; McCormick and Sanders, 1992; MIL-STD-1472D, 1989; Smith and Mosier, 1986; VanCott and Kinkade, 1972.

4.19.3 Graphic Example

DON'T position controls in a manner that is incompatible with standard practices.

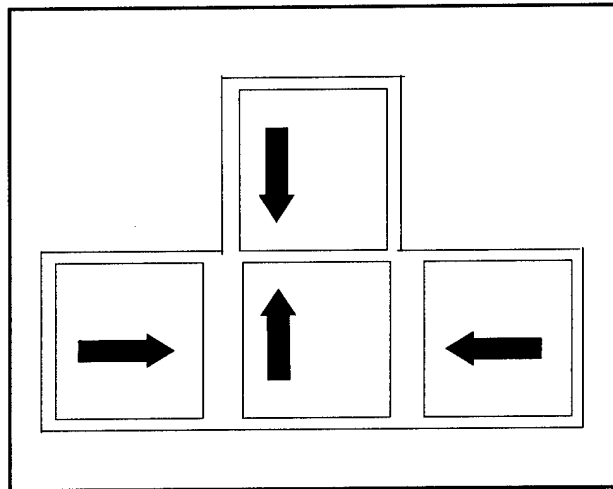

DO position controls in a manner that is compatible with standard practices and so that their use is natural.

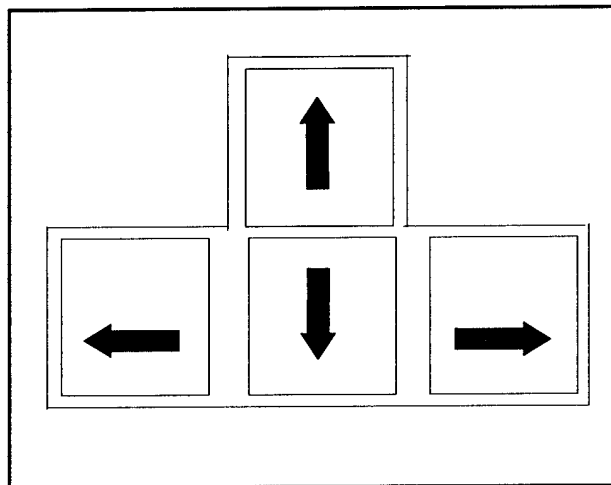

DON'T require fine control of a touch screen or cursor control device for selection of EIAP choices.

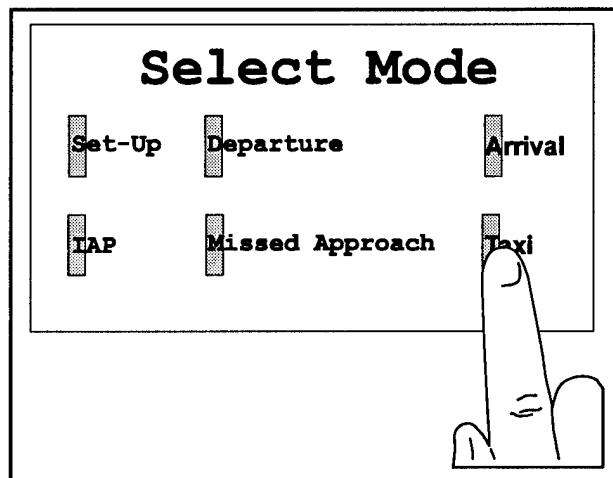

DO provide a large area in which a user may select EIAP choices.

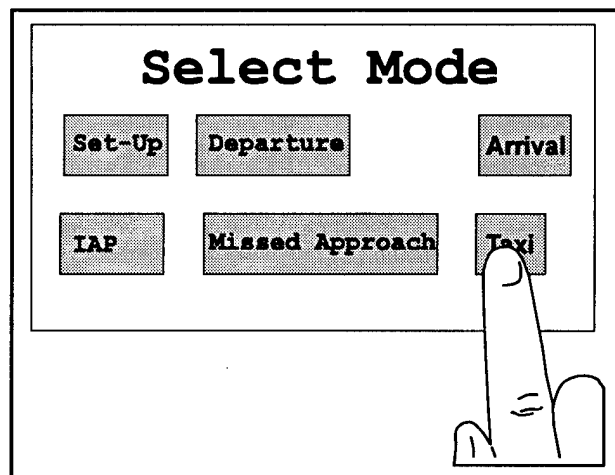

4.20 PILOT CONTROL OF DISPLAYS AND CUSTOM DISPLAYS

One of the major advantages of electronic IAPs over paper IAPs is the capability of EIAPs to allow interactive and customized presentation of information. There is a range of display specification that may be available from designs specific to the needs of certain aircraft or situations (e.g., airline versus general aviation) to pilot control of information display in flight. With simple software changes, designers may create different EIAPs (that access a common database) based on the unique information needs of different pilots in assorted aircraft. Or, pilots may be given the capability to customize their display when they initially receive the systems (or pre-flight when there may be several users of the same system). This enables the pilot to reduce clutter by removing extraneous information from the display.

Pilots may also be able to control certain aspects of the display based on their preferences and based on current information needs during flight. Several features have been identified by researchers for implementation on EIAPs or navigation displays. Martel and Ward (1993) have suggested orientation changes (North up or Track up), zooming, and adding and removing layers of information. Pilots in a study by Mykityshyn and Hansman (1991) stated that they liked the capability to declutter an EIAP. Pilots in a study at NASA-Langley (1993) liked the capability to choose map orientation and map scale (or choose that the map scale be variable), and to view an airport insert. The capability to insert personal comments on the EIAP may also be beneficial to pilots. Specific pilot control features are discussed in more detail in the following sections.

Stokes and Wickens (1988) caution designers about providing pilots with the capability to control a display -- "The decision to allow a pilot to choose what and how much information should be displayed on a particular panel may well decrease visual workload, but it may impose unwanted workload costs on two other pilot resources: those related to memory and to responses." According to Stokes and Wickens, the pilot must remember what other information is available (what is not currently displayed) and how to obtain it. The pilot must also perform some action to select needed information. In addition, Moray (1984) cautions that pilots may be more likely to forget to sample information if it is not continuously visible.

Pilot control features on an EIAP can be designed to account for some of the concerns of researchers such as Stokes and Wickens (1988) and Moray (1984). By providing a visible indication of what information is not currently displayed (through the use of meaningful labels or lists), pilots will be able to quickly recognize what other information is available rather than rely on memory. Highly visible and natural controls to make required actions easy will also combat the potential workload increase. In addition, designers may choose to restrict pilot control of highly critical information such as communication frequencies or terrain so that it remains continuously visible. Designers may also restrict pilot control of certain features to pre-flight or initial display customization.

4.20.1 Guidelines

- 4.20.1.1 An EIAP should be customizable to specific aircraft and pilots to display only the necessary information for that pilot and to reduce visual clutter.

Comment: Custom displays may account for pilot differences, aircraft differences, and situational differences, reducing the amount of information that must be displayed on the approach plate.

Comment: The decrease in display resolution on an electronic chart from that available on a paper chart requires that the amount of information displayed on a single page be reduced.

Comment: As much customization as possible should take place automatically or during pre-flight to reduce pilot control workload requirements to control the display during flight.

- 4.20.1.2 If pilots are allowed to control the displays during flight, visual references should be provided to indicate information that is not displayed but may be requested.

Example: A button that is used to hide and remove obstacles should have a label that changes based on the current state of the system (e.g., "Obstacles Shown," "Obstacles Hidden") rather than a static label that does not indicate the state of the system (e.g., "Obstacles"). An "Obstacles Hidden" label is a visual indication that obstacle information may be displayed.

Comment: Designers should consider fixing critical information so that it can not be hidden or moved. Certain information such as communication frequencies may be present on several different views of an EIAP.

- 4.20.1.3 EIAP systems should provide a feature that allows fast and easy return to a default configuration.

Example: A default key may be provided to allow pilots to quickly return to the system default for display of approach information.

Comment: A feature that allows pilots to define their own default configuration also should be considered.

- 4.20.1.4 The amount of information and the manner in which information may be controlled or customized should be limited.

Comment: Providing pilots with the ability to completely change the display will increase the complexity of the system and may make it more difficult for users to take advantage of more basic functions of the system.

Comment: Designers must consider the effects of different users on a single system in determining pilot control features. If pilots are allowed to change the location of key pieces of information, other pilots using the system may have trouble locating needed information. If pilots are given the capability to define their own default configuration, it may be necessary to allow separate defaults for several users of the same system.

- 4.20.1.5 Designers should consider implementing a feature that allows pilots to enter personal comments on the approach plate.

Comment: Pilots may receive notices about changes to particular approaches prior to receiving a scheduled database update or notices about temporary changes to approach procedures. The capability to insert custom comments will allow pilots to include this information directly on the electronic approach plate.

4.20.2 References

Martel and Ward, 1993; Moray, 1984; Mykityshyn and Hansman, 1991; NASA-Langley, 1993; Stokes and Wickens, 1988.

4.20.3 Graphic Example

DON'T provide pilot control features that require the pilot to rely on recall of other information that may be important to display.

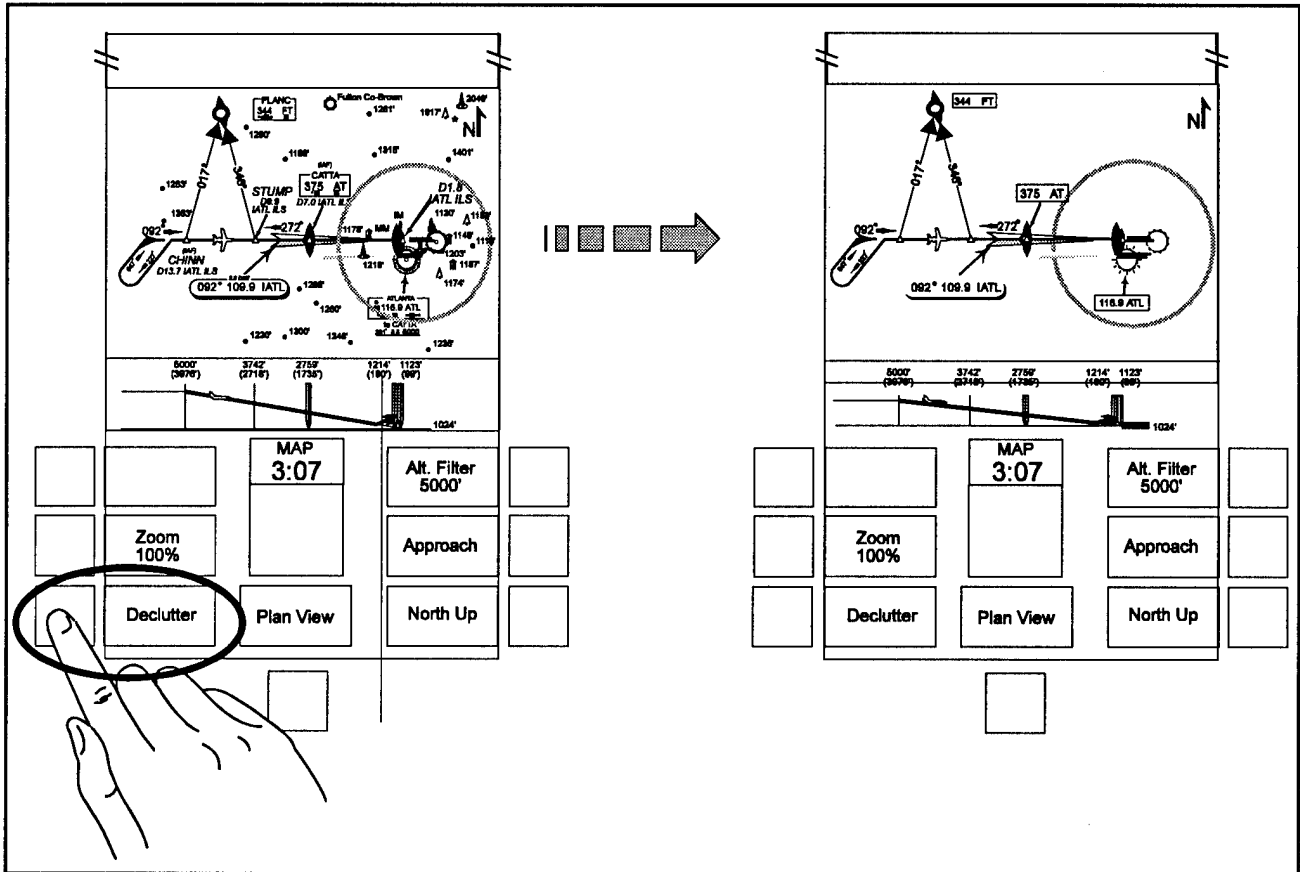

DO provide a visual reference that indicates what information is currently displayed and what information is available upon request.

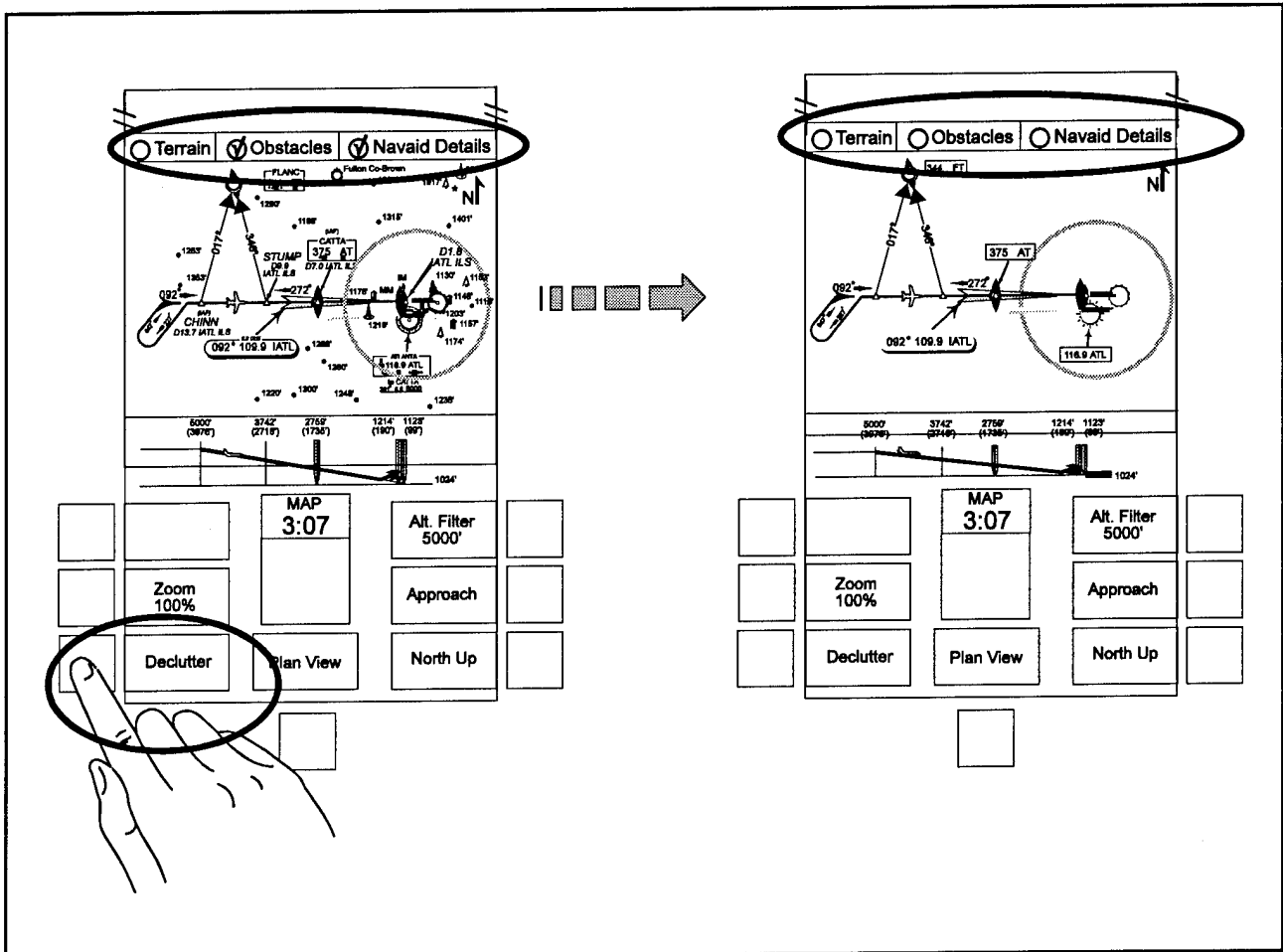

4.21 ZOOMING

Zooming refers to the function that allows users to specify a smaller or larger area to view. "Zooming in" refers to decreasing the area of view and, potentially, increasing either the size or the detail of information displayed. "Zooming out" refers to increasing the area of view and decreasing either the size or the detail of individual items displayed. One difficulty in implementing zooming features is how to provide both zoom and point functions. This capability is currently employed in a number of different ways in desktop graphics packages. Some implementations allow users to select zoom (in) mode and then specify (by pointing and clicking) the area of the display they wish to zoom in on. Each click zooms the display a pre-determined discrete amount. By specifying "zoom out" the user may step out each level of zoom. Other applications allow users to box in an area, thus specifying both the location and the level of zoom. This implementation provides a single discrete definition of the area to display and may encompass a wider range of zoom choices than functions that provide a few discrete levels of zoom. The advantages of a zoom function on an EIAP include 1) the capability to zoom out and view a larger area of information for planning purposes, 2) the capability to zoom in to see more detailed information about an area of interest, and 3) the capability to zoom in and increase the size of information displayed in a certain area for easier reading.

4.21.1 Guidelines

- 4.21.1.1 Designers should consider providing a means for zooming (in and out) in an electronic instrument approach procedure (DOD, 1993).
- 4.21.1.2 Zooming should not cause problems in reading symbols, labels, or other map features (DOD, 1993).

Example: In order to maintain sizes at a readable level when the display is zoomed out, a zoom feature may not change the size of information such as text and symbols in proportion to the level of zoom. However, this may lead to overlap problems as the display is zoomed out. Designers that implement this type of zoom should ensure that some method (such as removal of detail or abbreviation of information) is used so that overlap does not occur.

Example: If information such as text and symbols do change in proportion to the level of zoom, overlap is less of a problem. However, as the display is zoomed out, text and symbols will become unreadable. Designers of this type of system may consider implementing features such as the removal of text that is too small to read and allowing users to select objects for a small window overlay of information in a readable size.

Comment: Symbols that represent actual geographical areas (such as water, contours, etc.) should change size as appropriate with the level of zoom.

- 4.21.1.3 The level of detail (number of symbols and features depicted) displayed should be modified to match the degree of zooming used (i.e., more detail for close views and less for large area perspectives) (DOD, 1993).

Comment: Designers should consider the task the pilot is performing and the information needed for that task when removing detail as a pilot zooms out or adding detail as a pilot zooms in. For example, if a pilot zooms out, he or she may be planning the arrival (or perhaps looking for alternate arrivals or airports) so it may be best for the EIAP to remove obstacles but maintain contour lines, or to remove procedure turn and missed approach details but maintain NAVAID symbols and associated information.

Comment: The filtering of information to maintain an appropriate level of detail requires complicated computer logic that may not be easily implemented on an EIAP.

- 4.21.1.4 Continuous zooming is preferable to discrete (DOD, 1993).

Comment: In the cockpit, however, controls that have discrete changes (e.g., a rotary knob with detents) may be easier to operate than continuous controls.

- 4.21.1.5 When zooming in, symbols should be collapsed into fewer summary symbols to declutter (DOD, 1993).

Example: Contour lines may change from 500' separations to 1000' separations. Close obstacles may be combined into one group of obstacles displaying the highest obstacle elevation.

- 4.21.1.6 A method for quickly returning to the normal display size should be provided when zooming (DOD, 1993).

Example: A default button or "push to reset" control could be provided to quickly return the display to the default zoom level.

Comment: Default zoom levels may be different based on the phase of the approach or the current view selected.

- 4.21.1.7 When changing scales through zooming, an indicator should continually display the current scale (DOD, 1993).

4.21.1.8 An inset or window should be available to show the maximum available map coverage (DOD, 1993).

4.21.1.9 Ensure that zooming affects displayed data in the same way (Smith and Mosier, 1986).

Comment: Scalar information such as distance from the airport and distance between symbols should be affected equally with a zoom. Some information such as text and symbol size may not be required to change at the same scale as other information (although changes within an appropriate range may be helpful).

4.21.2 References

Bowser, 1991; Department of Defense, 1993; Lewis and Fallesen, 1989; Smith and Mosier, 1986.

4.21.3 Graphic Examples

DON'T allow pilots to zoom in on a section of a display without providing a reference to where the display is in the overall scene.

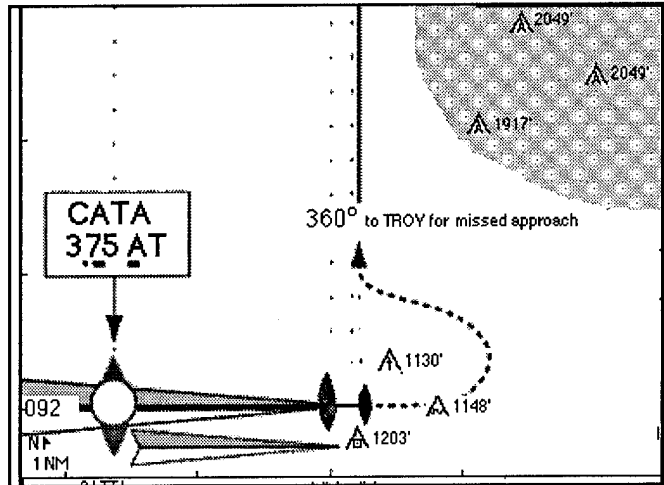

DO provide an inset that delineates what area is displayed.

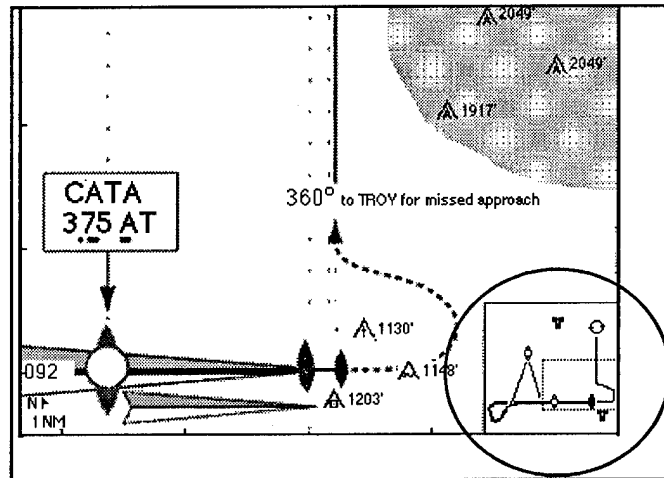

DON'T maintain the same level of detail from a zoomed in view when the display is zoomed out.

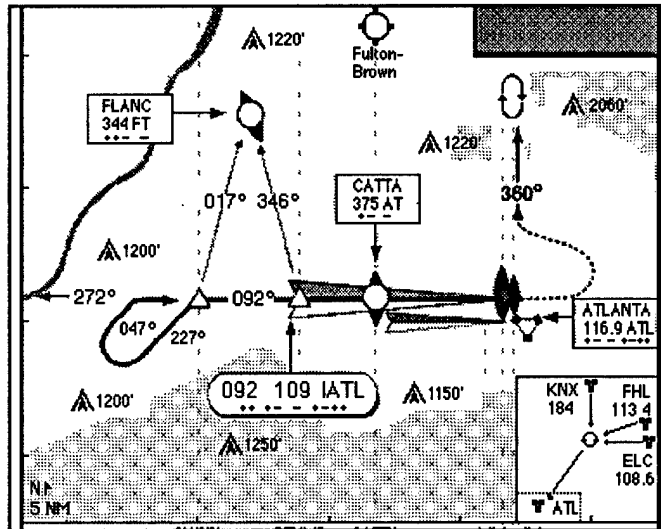

DO declutter a zoomed out view by removing less important information or combining symbols into summary symbols. In this example, fewer obstacles are displayed (only those over 1250 feet) and only the NAVAID identifier and frequency are displayed (morse code and name have been removed).

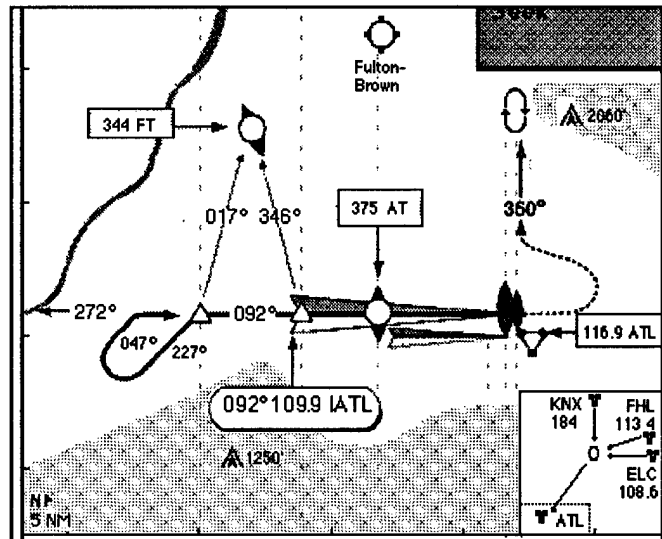

4.22 SCROLLING AND PANNING

Smith and Mosier (1986) distinguish two different functions that allow a user to view information that extends beyond the limits of the display frame. According to Smith and Mosier, a panning function uses a model in which a display frame moves over a fixed array of data and a scrolling function uses a model in which data moves behind a fixed display frame. "Moving a camera across a fixed scene illustrates panning. Moving a specimen beneath the fixed eyepiece of a microscope illustrates scrolling" (Smith and Mosier, 1986). According to this interpretation the command "Up 10" in a scrolling system would indicate that the data behind the frame would move up 10, displaying ten lines of new data at the bottom of the screen with ten lines disappearing from the top. "Up 10" in a panning system would suggest that the frame would move up displaying new data at the top with data disappearing at the bottom. Smith and Mosier also indicate that panning may be more natural than scrolling for inexperienced users.

A problem with this distinction is that the "scroll bar" control is a common control in a number of systems. While the model for scrolling is of data moving behind a display, the common implementation of a scroll bar control is that if you press the up arrow, new information is presented at the top of the screen (Apple, 1992), as if you were moving the frame up, as in a panning operation. In either case, the preferred method of presenting information that extends beyond the display area is for the control to act as or with the frame. Up would indicate that the frame moves up (and/or the data moves down), whether up is presented as a command, an arrow, or as the user pressing the cursor at the top of the screen. A left arrow indicates that the frame moves to the left (and/or data moves to the right behind the screen).

4.22.1 Guidelines

4.22.1.1 If information extends beyond the display frame, consider implementing panning to allow users to view information beyond the frame of the page.

Comment: Continuous panning may be preferable to discrete panning (DOD, 1993), although discrete control movements may be easier in a cockpit environment.

4.22.1.2 If panning is used, be sure the control acts as the frame (Apple, 1992).

Example: Pressing up on the control causes the frame to move up and the data to move down so that new information appears at the top of the display. See the graphic example in Section 4.22.3.

4.22.1.3 During panning, an indicator of position in the overall display should be provided (DOD, 1993).

Example: An inset map may be used with a symbol or code (i.e., shading) to indicate which part of the larger picture is currently displayed.

- 4.22.1.4 If panning is provided, a means of rapidly returning to the starting point should be provided (DOD, 1993).

Example: A default (or return) button may be used. A control with a center detent may also be used.

Comment: In the case of an EIAP, the "starting point" will likely be a section of the map around the airport.

4.22.2 References

Apple, 1992; Smith and Mosier, 1986.

4.22.3 Graphic Example

DON'T synchronize the action of the panning/scrolling control with the data in the display rather than with the frame.

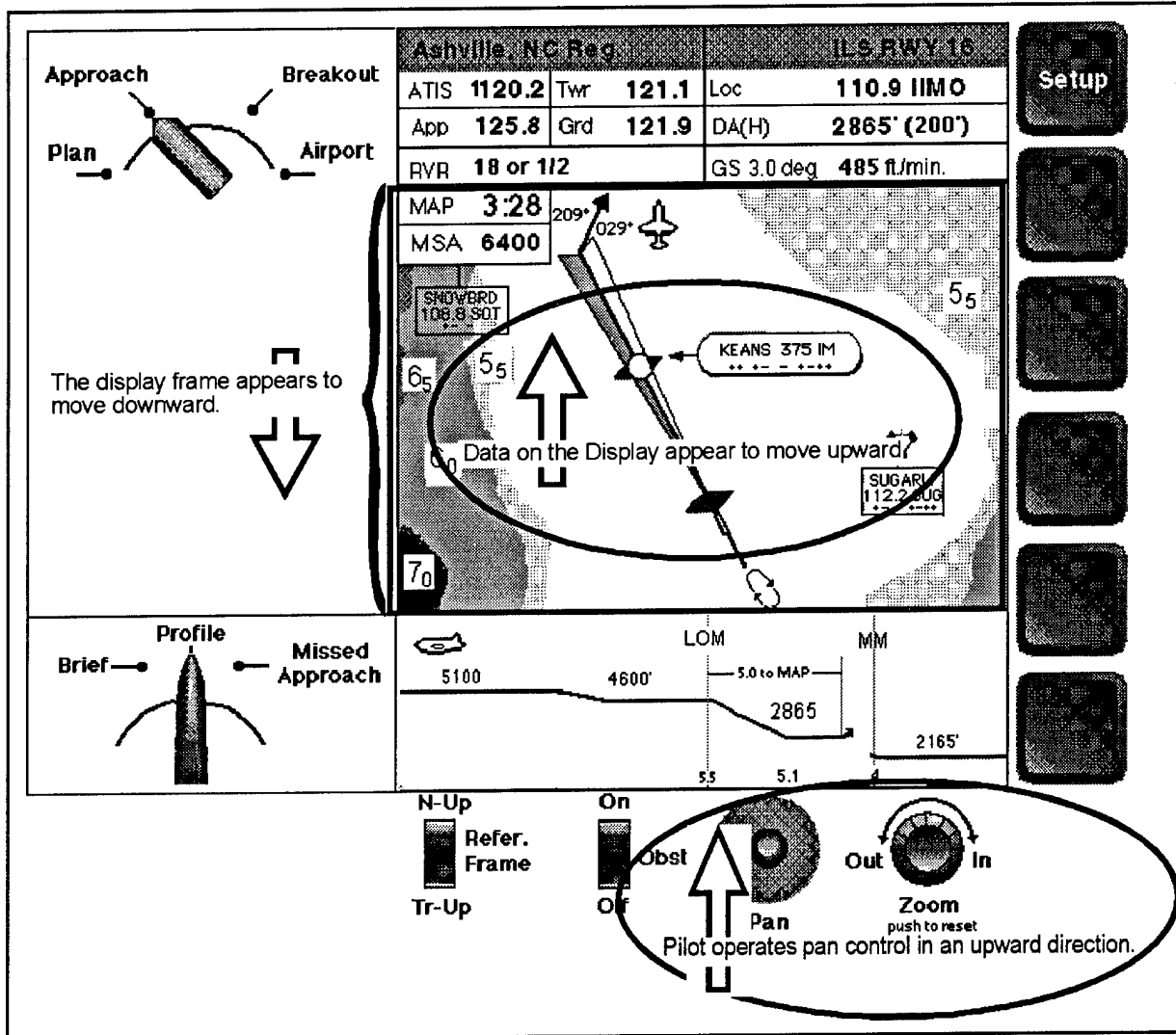

DO follow the metaphor of panning a frame as if it were a camera moving around the data. In this example, as the panning control is pushed upward, the data in the display moves down, as if the frame were moving up, so that new information appears at the top of the screen.

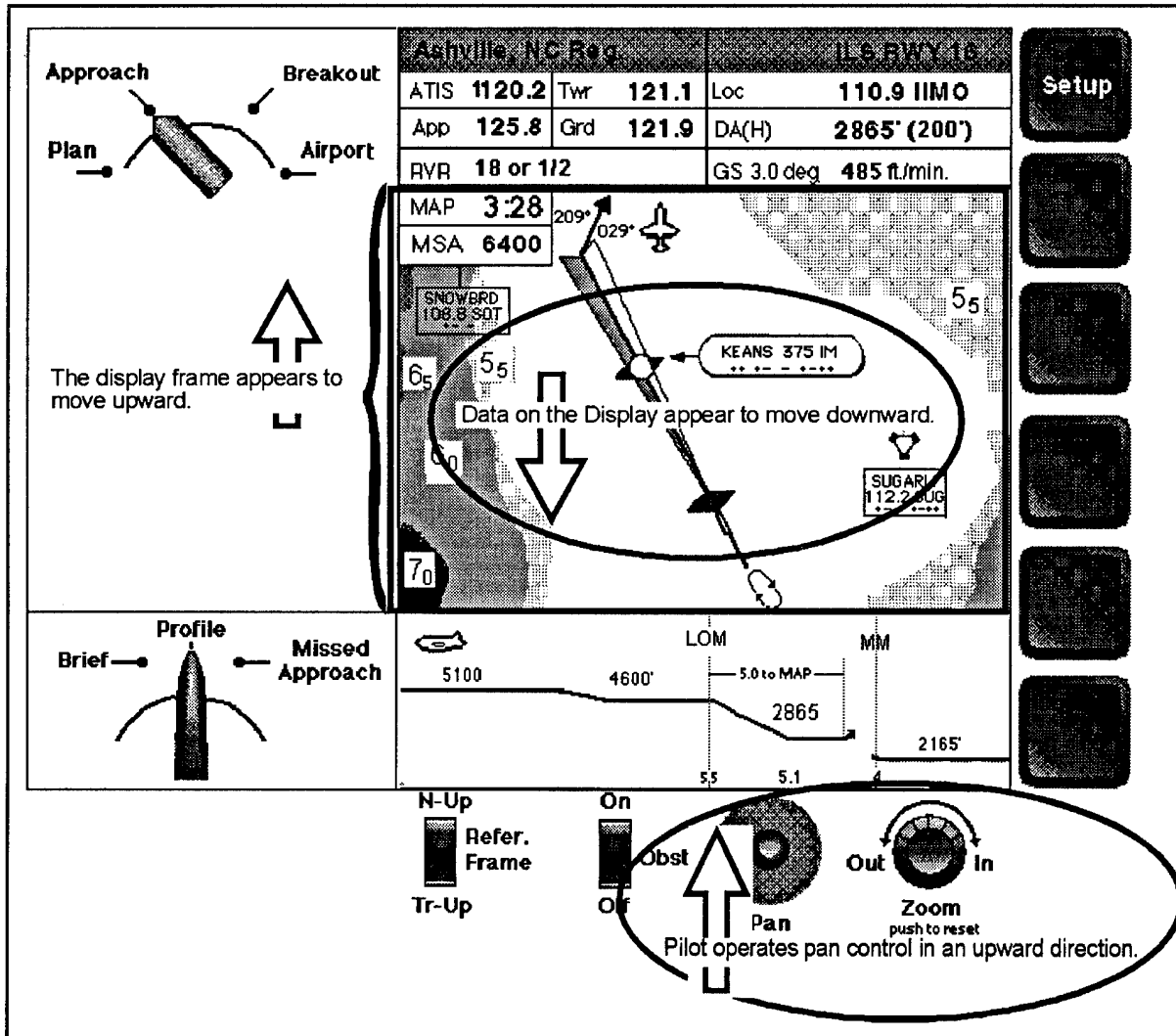

4.23 DISPLAY DYNAMICS

Electronic displays provide the capability to display dynamic geographical or aircraft position information. The display of aircraft position or the use of a translating and rotating reference frame are dynamic features discussed in other sections. There are a number of dynamic display issues that must be addressed before guidelines can be presented on the use of this feature. The rotation of text or symbols into a non-upright position or the rotation or translation of dynamic information that obstructs other information are examples of potential problems. Unfortunately, literature is scarce on issues related to dynamic displays and many of the issues are not apparent until prototypes that actually provide moving maps are developed and tested. Designers should test dynamic displays in realistic environments with potential users to identify any problems. Smith and Mosier (1986) and the Department of Defense (1993) have identified a few potential problems and associated guidelines for the use of dynamic displays.

4.23.1 Guidelines

4.23.1.1 Automatic display update should be implemented (Smith and Mosier, 1986).

Comment: A pilot should not have to perform an action to update the display.

4.23.1.2 The user should have the capability to freeze automatically updated information (Smith and Mosier, 1986).

Comment: For the situation where the amount of information that is moving is very minor (such as a single moving aircraft on a stable geographical display), a freeze may not be necessary. However, if geographical and textual information are dynamic, display freeze may be needed for reading information and/or for allowing pilots to orient themselves.

4.23.1.3 When a dynamic display is in a frozen state, a label or indicator that the display is frozen should be provided, changes that have occurred should be signaled, and the display should be resumed at current real time (Smith and Mosier, 1986).

4.23.1.4 When data are changing and displays are automatically updated, some stable display elements should be provided (Smith and Mosier, 1986).

Example: Coordinates, geographic boundaries, grids may act as stable references.

4.23.1.5 When moving data may overlay other data elements, display logic should determine which objects have priority and which may be obscured. All data should resume display when no longer obscured (Smith and Mosier, 1986).

Example: On an EIAP with a moving aircraft symbol, the aircraft symbol should have priority over other objects. Objects with continuous lines such as approach course symbols, circling symbols, or grids may be given lower priority than discrete symbols and text since they may still be seen with other objects obstructing them.

4.23.1.6 A consistent horizontal orientation of text should be maintained wherever possible in a dynamic display.

Comment: Computing power and potential overlap problems may require that texts rotate in relation to their associated symbols. For example, text that is embedded in a line, such as a course line, will have to rotate with the line to remain embedded in it. However, if text is rotated with symbols in this manner, a rule must be implemented to ensure that text remains in an upright position (e.g., text that rotates beyond 90 degrees above or below the horizontal will have to be "flipped" so that it does not appear upside-down).

4.23.2 References

DOD, 1993; Smith and Mosier, 1986.

4.23.3 Graphic Example

DON'T allow text to rotate so that it becomes difficult to read. In this example the 60 degree indication rotates to an upside down position (easily confusable with 90 degrees) when rotated 90 degrees.

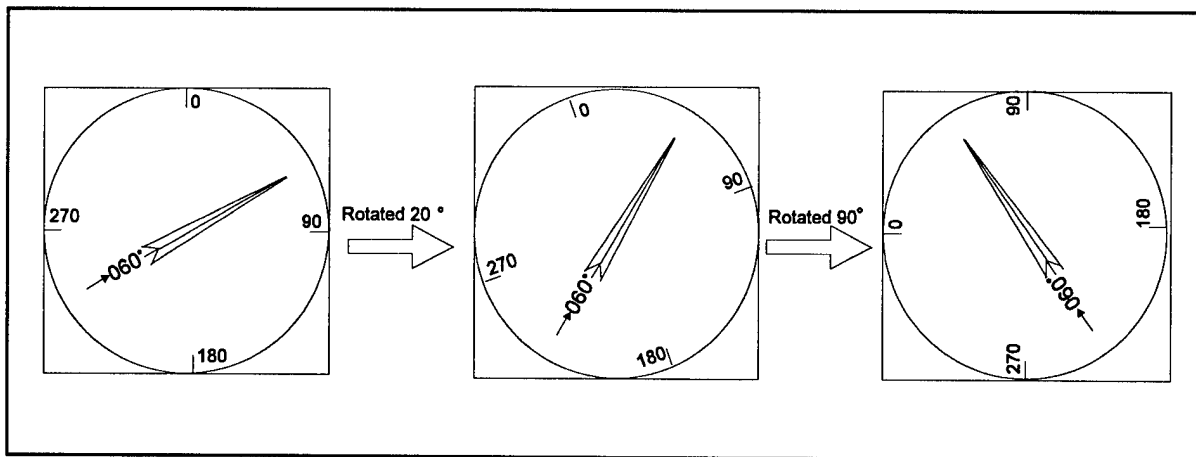

DO maintain a consistent horizontal orientation of textual information. In this example all numbers remain horizontal allowing fast and easy reading. The circle around the 60 degree indicator indicates the amount of display space that will have to remain clear so that there is no overlap as other symbols are rotated and the text remains horizontal.

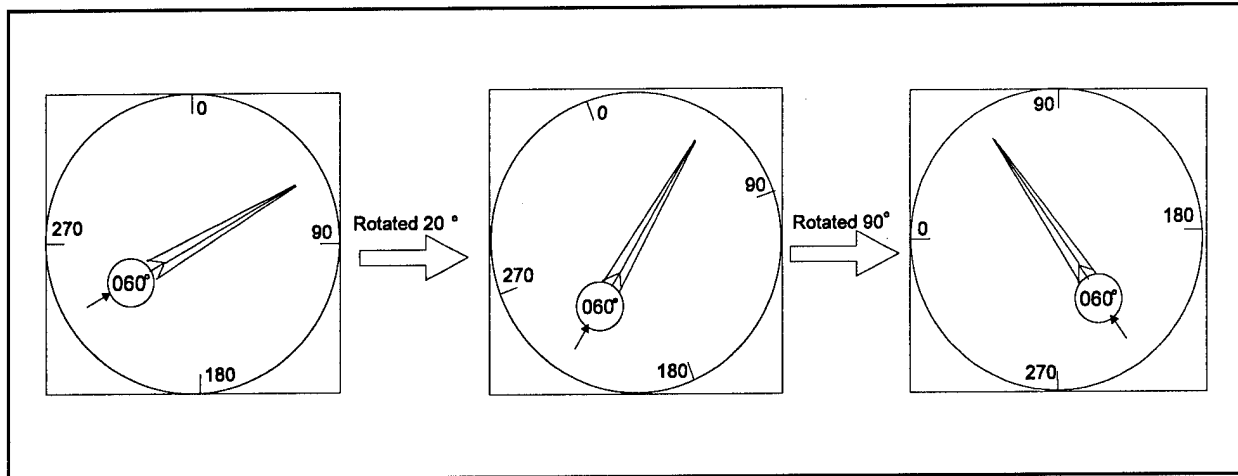

If space constraints or other constraints require that text rotate with the display, designers should verify that rotated text remains up right. In this example, the 60 degree indicator is in line with the approach course and rotates with the course; however, after it rotates beyond 90 degrees it is flipped over so that it remains in an upright position.

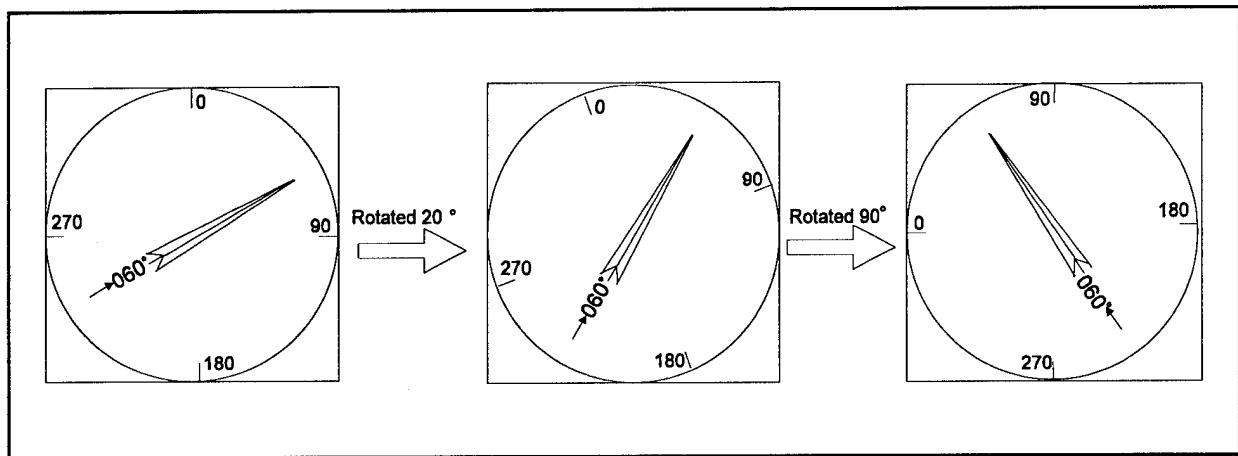

4.24 DECLUTTER - LAYERING INFORMATION, MINIMIZING INFORMATION

There are a number of different ways of implementing a declutter feature on an EIAP. One method is to group information into layers. The EIAP may then be decluttered or detail added through the removal and addition of these layers. The information on the layers may be grouped in any of the means discussed in the section on grouping strategies. For example, obstacles, secondary NAVAID symbols, and textual information may each be grouped on a separate layer. There are a number of ways of implementing the addition and removal of these layers. The layers may be added and removed automatically, for example, as the aircraft proceeds through the approach or as the pilot zooms the display in or out. Pilots may be given control to add and remove layers through "show obstacles" types of controls. Pilots also may be given control through a customizing screen or window that allows them to choose which specific layers they would like to see. Pilots also may be given the capability to design their own overlays. For example, they may be allowed to select which layers they would like for a default or basic display and then select another layer for an "add detail" command that may be selected in flight. Mykityshyn and Hansman (1992) explored a decluttering feature in which pilots could declutter obstacles. Pilots liked the feature and believed that it would not increase workload since they would not use it if they did not have time. As was mentioned in the section on general principles, Martel and Ward (1993) recommend displaying a decluttered display first, allowing the pilot to gain a general impression of the layout of the approach. Then the pilot may add detail to the display as needed. They also recommend that detail be added and removed gradually - major changes may cause confusion.

Another possible declutter implementation is to minimize the size of the information or simplify the information rather than remove it. Schultz, Nichols, and Curran (1985) found that partial removal of features by minimizing symbols and removing labels was as effective a decluttering technique as total removal. By removing only parts of items or minimizing the items, clutter is reduced; however, pilots still have a visual clue that more information is available if needed. This is the principle behind minimizing windows to icons on desktop systems. After a window is minimized, the icon serves as a reminder of the presence of the window. This technique is currently used on paper charts through the use of smaller localizer course marker symbols for alternate approaches to parallel runways on NOS charts.

Pilots may be given the capability to specifically select items to be removed or minimized then they could request more detailed information on specific objects (such as textual information on a NAVAID) as needed.

4.24.1 Guidelines

4.24.1.1 Designers should consider providing pilots with the capability to specify a default configuration and the means to return to the default configuration quickly.

Example: A pilot may be able to specify what specific information to display as a default (i.e., NAVAID information - yes, contour lines - yes, obstacles - no, etc.), then a button or control should allow the pilot to quickly return to these options if he or she has changed the display configuration from the default.

- 4.24.1.2 If the default configuration is not determined by the pilot, an uncluttered display should be presented initially and the pilot should be allowed to add detail (Martel and Ward, 1993).

Comment: This guideline appears to contrast with the way pilots use information in the instrument approach task. Pilots use almost all of the information on paper charts in early planning phases. Later in the approach they access less information. However, if a pilot is presented with the uncluttered display and then has the capability to add information in layers during the planning phase, it may help planning since all the information is available and is accessed in a few manageable chunks, rather than all at once.

- 4.24.1.3 Enough different layers of information should be provided so that the pilot may add or remove detail gradually (Martel and Ward, 1993).

Comment: Designers should be careful not to provide too many different layers because users will be unable to remember more than a few choices. Different numbers of layers (probably not more than four) may be appropriate depending on the implementation (fewer declutter layers may be needed if features such as zooming declutter automatically).

- 4.24.1.4 If information is removed or minimized, a visual cue should be provided that more information is available and an indication of how to retrieve it.

Example: A list or labels signifying what information is currently displayed or what information remains to be added should be considered.

4.24.2 References

Martel and Ward, 1993; Mykityshyn and Hansman, 1992.

4.24.3 Graphic Example

DON'T implement a declutter feature that removes several different types of information and does not display clearly what objects have been removed and may be requested. In this example, a single press of the Declutter button removes terrain lines, obstacles, and NAVAID details at once.

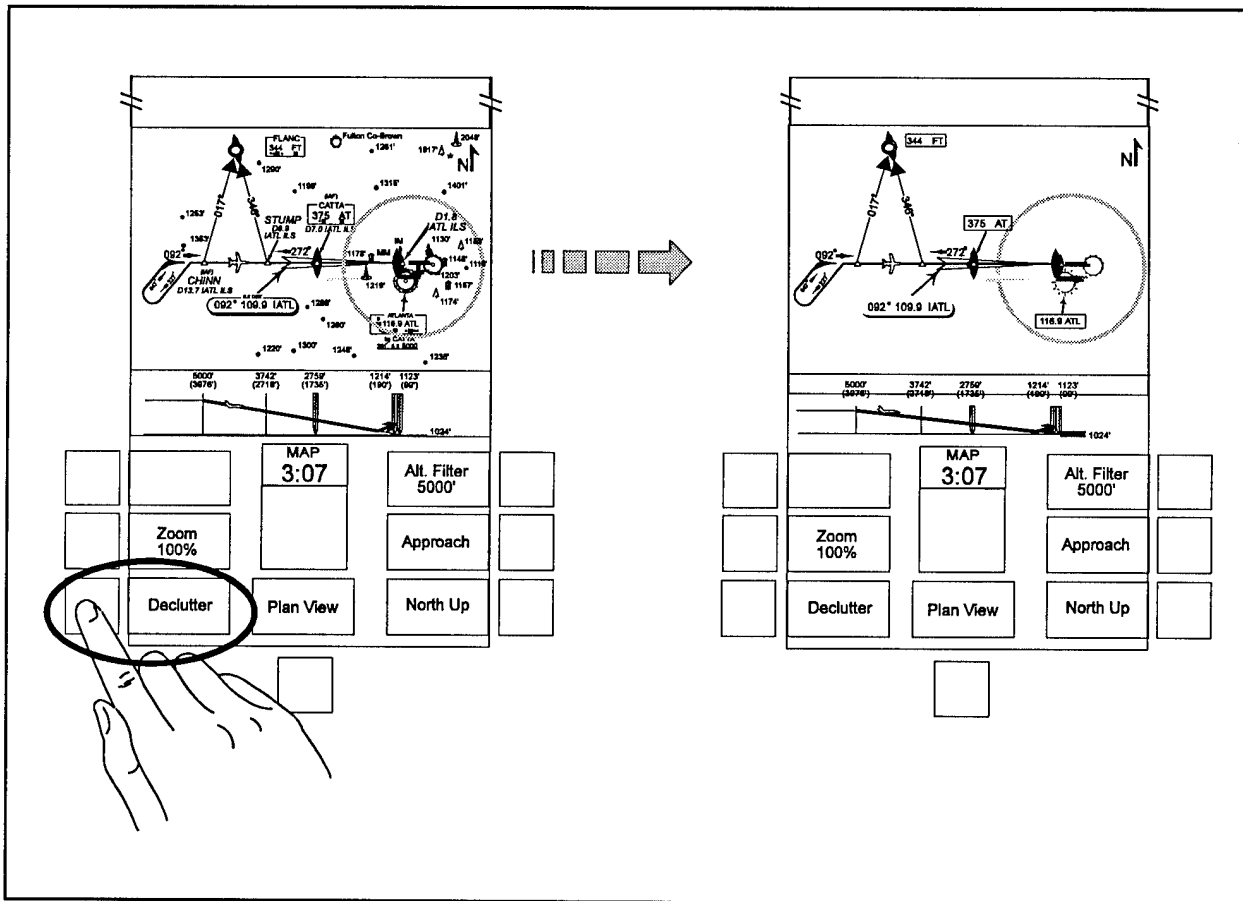

DO allow pilots to declutter layers of information gradually, with a visual indication of what information has been removed. In this example, each touch of the Declutter button removes a layer of information. With the first touch terrain lines are removed. This example shows the second touch to remove obstacles. A third touch would be required to remove NAVAID details. In addition, there is a status display that always indicates what information has been removed.

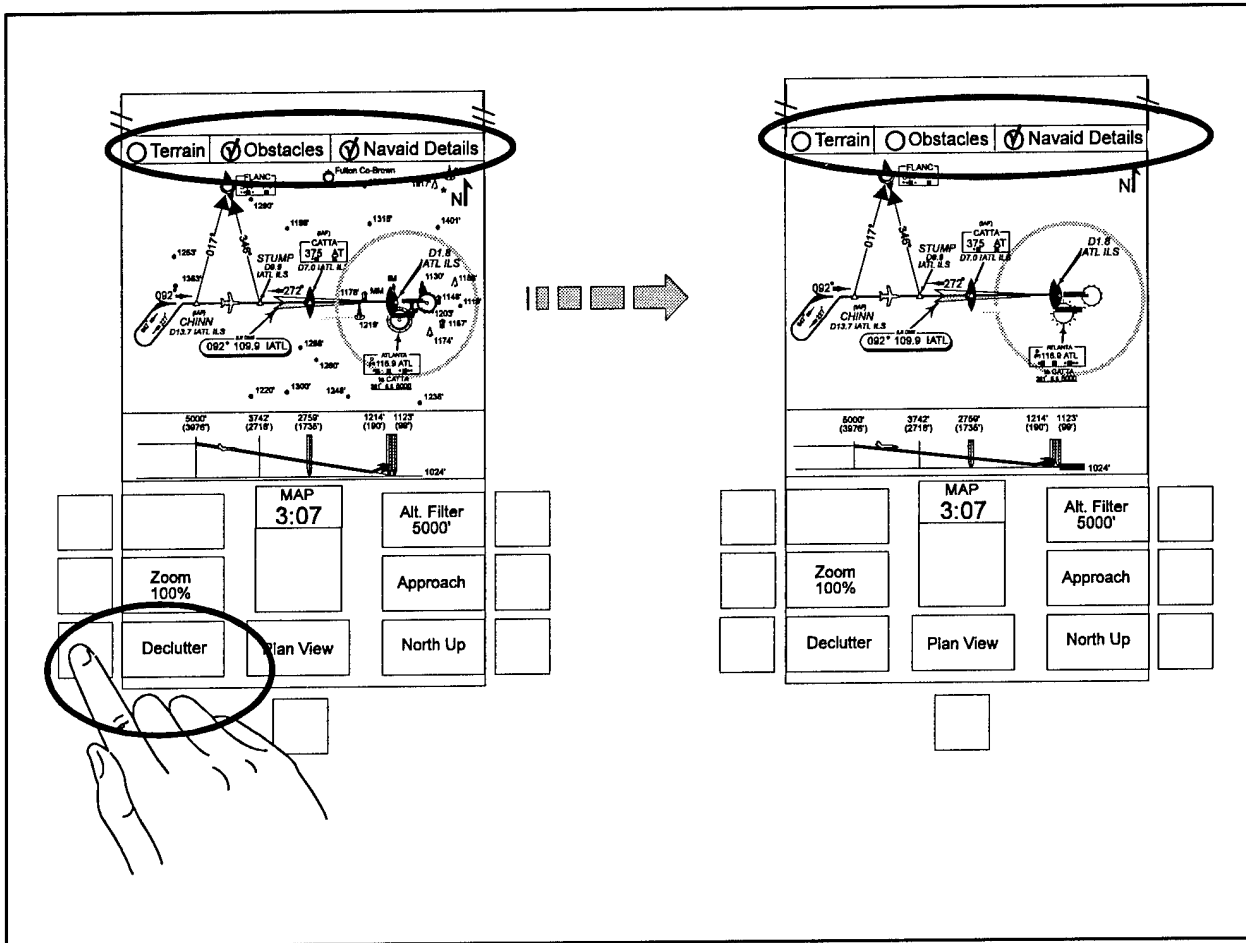

4.25 AUTOMATION

Automation refers to the offloading of tasks from the pilot to the EIAP system. Instrument approaches require pilots to perform several tasks simultaneously. Pilots must execute their primary task of keeping the aircraft on the approach path as defined by the EIAP. They must also execute secondary tasks such as communicating with ATC, setting altitude bugs, and changing NAVAID frequencies. In most cases, systems are automated to increase performance and safety by improving control accuracy and reliability (Rouse & Morris, 1986). Automating secondary tasks (i.e., EIAP tasks) would allow the pilot to concentrate on the primary task of flying the aircraft.

Automation of EIAP functions could occur at two levels -- high level and low level automation. High level automation would take the form of a task aid with decision making capabilities. A task aid could perform primary EIAP tasks such as selecting approaches and displaying the associated approach chart. Automation at this level could reduce the pilot's discretion in how to perform their job. Rouse and Morris (1986) identified the following five functions of automation for task aids: 1) the generation of alternatives, 2) the evaluation of alternatives, 3) the selection among alternatives, 4) the implementation of alternatives, and 5) the observation of results. Ideally, task aids should address limits to human capabilities and the impact of adverse environmental effects. Task aids should be designed to support, not replace, human perception and decision making.

Quite often, system designers justify automation with reductions in pilot mental and physical workload. Unfortunately, task aids usually increase pilot workload. One reason is that designers increase system functionality while automating the system. The other reason is that automated systems require the pilot to control the task aid. Automation also requires monitoring and intervention that did not exist previously. For example, the pilot must monitor the automated system and understand what the system is doing at any point in time. Should the system fail, the pilot must be able to take control of the aircraft. This type of monitoring and control requires the pilot to understand both the automation system and the aircraft. Automation may trade off one type of cognitive complexity (plan ahead and remember data) for another (plan ahead and remember how to access the data). According to Wiener (1988), the full nature of this trade-off is not yet known. As with any system, the task-aid user interface must be easy to use and understand. An EIAP task aid adds programming, engaging, and disengaging tasks. The pilot must develop a strategy for choosing when to automate a function based on an assessment of task demands and objectives, and the time and effort needed to program, engage, and disengage the task aid. An automated EIAP would have to be integrated into the flight management system. High level automation of EIAPs is not recommended without further research.

Low level automation, on the other hand, facilitates use of the EIAP but does not contribute to the pilot's decisions. For example, automatic scrolling of map views, automatic centering of magnified views, and automatic verification of VOR frequencies would all increase the

pilot-EIAP system performance without impacting the pilot's discretion on how to perform the job. Low level automation can include functions that contribute to the EIAP's usability. This type of automation reduces the number of pilot actions required to effectively use the EIAP. Examples of automated interface aids include:

Data entry - the EIAP automatically enters the frequencies after the pilot selects the airport and approach.

Data validation - the pilot enters the airport and frequencies and the EIAP notifies the pilot if any of the data was incorrectly entered.

View updates - the plan view automatically pans as the aircraft location changes.

Automatic declutter - the amount of detail automatically changes depending on the magnification level.

Phase of flight changes - the EIAP automatically changes from planning to approach to breakout to taxi (or missed approach) based on the current phase of the approach.

While this level of automation aids pilot task performance, it does not focus on a particular task. Rather, the aiding exists throughout the system and is an integral part of the pilot-EIAP interface.

4.25.1 Guidelines

4.25.1.1 Automation should only be used for functions that do not require the pilot to exercise significant levels of skill, judgement, and/or creativity.

Comment: Pilots should be involved in the selection of features that will be automated. Only the system functions that personnel are willing to lose control over should be automated. (Mackie & Wylie, 1988; Rouse & Morris, 1986).

Comment: An automated function should be easier to operate than the manual function it replaces.

4.25.1.2 Automated functions should not require constant checking by the pilot.

4.25.1.3 Automated task aids should provide data on which to base judgements rather than commands that pilots must execute.

Example: A task aid should provide several feasible alternatives from which the pilot can choose.

Example: A task aid should automatically notify the user of meaningful patterns or events. A task aid should predict future data based on historical data and alert the pilot when it predicts a future problem.

Comment: Provide pilot control of data that is used to make the decisions. Pilots should be able to see the data that went into the decision made by a task aid. A task aid should assign probabilities for each option (rank order). Pilots should be able to provide their own options.

Comment: Pilots want to understand the decision rules in any decision-aiding task even when the source of the rules is acknowledged experts in the field. Task aids should not simply show the final decision without showing the course of decision making or viable alternatives.

- 4.25.1.4 Appropriate computer logic based on models of physical probability and models of instrument approach procedures should be used to validate data entries.

Example: An automated system could automatically check to ensure that a communication or NAVAID frequency that a pilot entered matched one of the communication or NAVAID frequencies for the current approach.

- 4.25.1.5 Automatic computation of data that is already available to the computer should be provided.

Example: The system could display lead points for transitions such as a turn from an arc to a radial or could display the required descent rate and account for cross winds automatically.

- 4.25.1.6 Automatic cross-file updating should be provided so the pilot does not have to enter the same data twice.

Comment: An EIAP should automatically enter redundant data when one piece of data defines the other. The system could require the pilot to check the automatic data entry when data accuracy is vital or provides security.

- 4.25.1.7 Designers should consider automatic declutter of information such as removal of detail as the display is zoomed out, declutter of non-precision or precision information based on the pilot's choice of approach, or removal of information as the aircraft moves beyond the location of the information.

Comment: Designers should use caution in implementing automatic declutter based on phase of flight or aircraft location since the function may remove information that the pilot is using or may startle the pilot.

Example: The EIAP system may pan to allow pilots to view missed approach information (and remove initial approach information) on both the plan and profile view after the plane passes a point such as the final approach fix.

- 4.25.1.8 The map scale should be automatically adjusted when changing the magnification.
- 4.25.1.9 Stable display elements should be provided when the system automatically updates geographic or location data.
- 4.25.1.10 Ensure that automation does not disrupt the performance of a task and does not startle the user.

Example: An EIAP that automatically changes views based on phase of flight should be implemented carefully to ensure that the information does not automatically disappear as the pilot is using it.

- 4.25.1.11 Ensure that the pilot is notified of automatic changes to the display.

Example: If the display automatically changes scale from 10 NM to 5 NM after the pilot crosses the final approach fix, a clear visual indication of the change should appear. Designers should also consider implementing an auditory alert of automatic changes (especially those that may require immediate attention) to the display.

4.25.2 References

DoD, 1993; Kirlik, 1991; Rouse and Morris, 1986; Sheridan, 1992; Smith and Mosier, 1986; Wiener, 1988; Wylie and Mackie, 1988.

4.25.3 Graphic Examples

DON'T automatically change several dimensions of the plan view at once. In this figure, the plan view has rotated from North-Up to Track-Up as the plane approaches the middle marker. The display has also increased in magnification and eliminated some display elements.

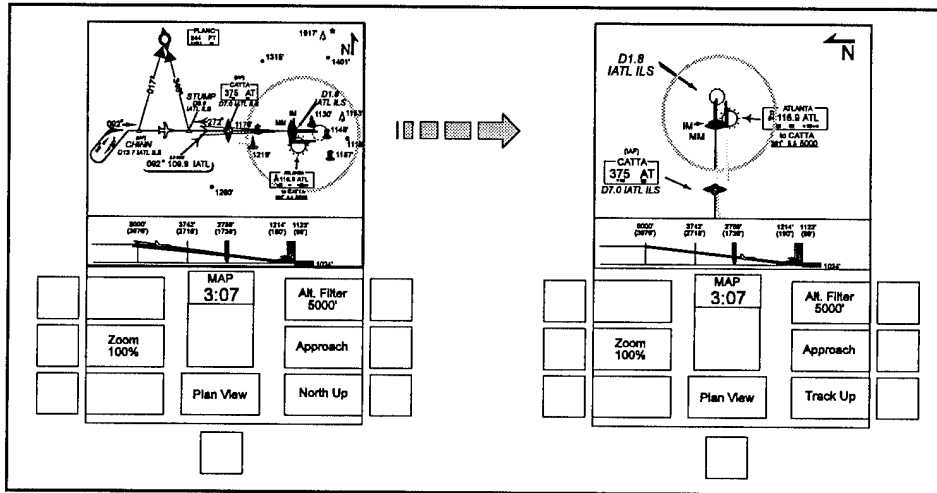

DO allow the pilot to control any changes to the display. In this figure, the pilot manually changes the plan view from North-Up to Track-Up as the plane approaches the middle marker. The level of detail and magnification level remains the same. The pilot should be able to specify which functions occur automatically and which require manual activation.

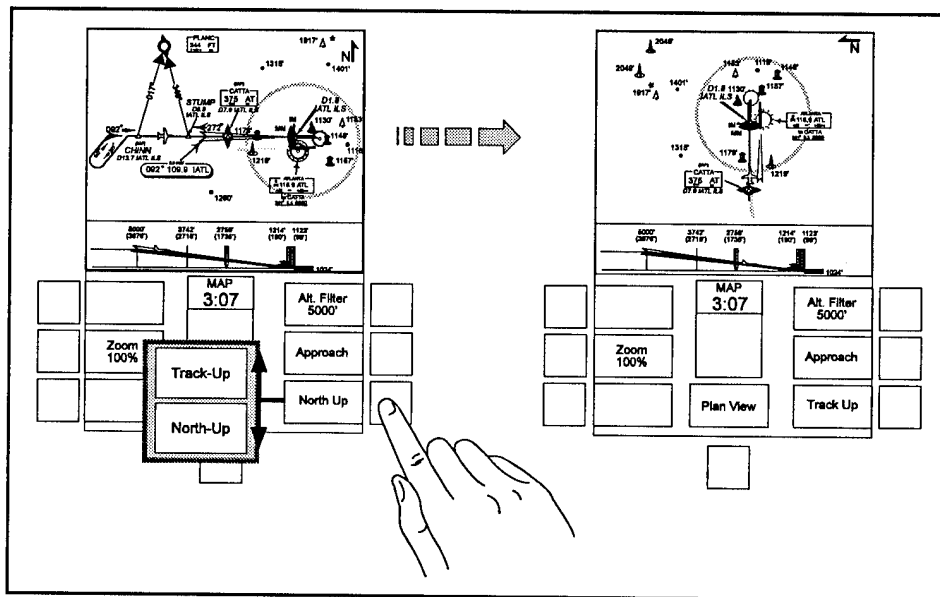

DON'T maintain a large amount of detail in small views of large areas. In this example the inset maintains more detail than is necessary for the purpose of seeing where the aircraft is located in a larger view.

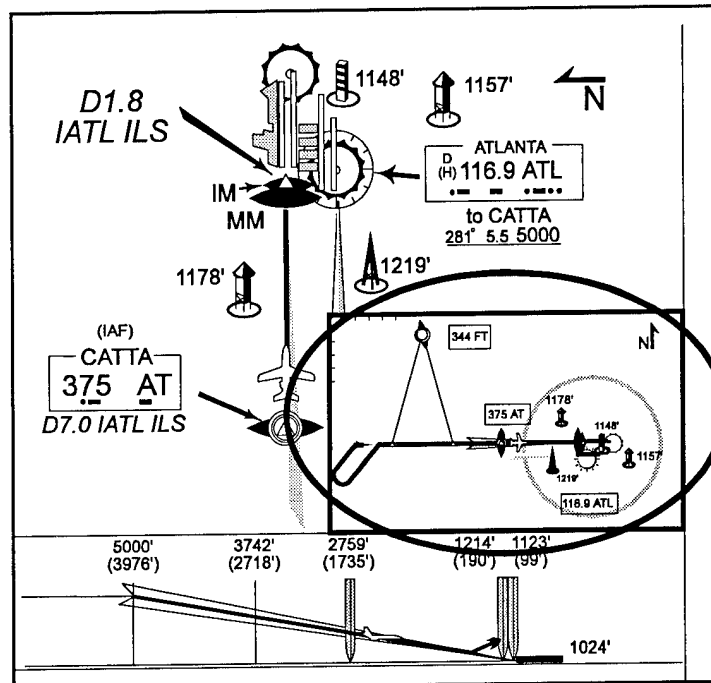

DO automatically remove detail in small views of large areas. In this example, enough detail is provided for the pilot to determine the location of the aircraft on a broader scale.

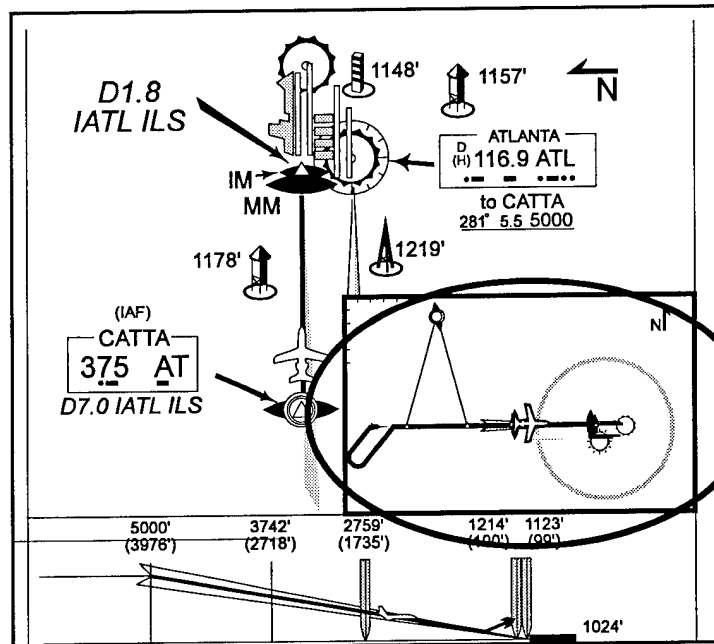

4.26 MEMORY AIDS, SEQUENCE REMINDERS, HIGHLIGHTING

The instrument approach task is highly procedural. Pilots must remember general procedures that apply to all approach tasks, specific procedures that apply to different types of approaches, procedures specific to the aircraft being flown, and procedures described on the approach plate. If a pilot forgets to perform any one of a number of procedural actions during the approach, problems will arise later in the approach. Common consequences of missed steps include landing without landing clearance (Chappell, 1994) and landing with landing gear up (Block, 1994). Often, workload is so high during the final phases of the approach that pilots forget to lower the landing gear or to tune into the tower ATC and receive landing clearance. Interruptions (see Section 4.17) and pilot fatigue also affect a pilot's ability to remember to perform required actions. According to Sears (1986), pilots' deviations from basic operational procedures caused the highest percentage of accidents between 1959 and 1983. For these reasons, pilots use a number of different techniques (e.g., checklists, "bugs" on instruments) to help them remember critical steps or critical information in flight. EIAPs provide the capability to incorporate memory aids or sequence reminders directly into the source of approach procedure information.

Many of the guidelines discussed throughout this document will help to reduce forgetting during the approach task. The display of aircraft location and information arranged in the appropriate sequence will help remind pilots of where they are within the approach and of what step should be taken next. Visibility of display options will provide reminders that information is available and should be accessed at the appropriate time. The grouping of related information will allow pilots to organize the approach procedure into a few chunks of information rather than into a larger number of individual information items that are harder to remember. Other techniques that are currently used as memory aids in the cockpit may be incorporated into the EIAP. Alarms or cautions may be implemented to alert the pilot if he or she has missed a step. The capability to insert bugs or to highlight certain key information would also be beneficial as a memory aid on an EIAP.

4.26.1 Guidelines

- 4.26.1.1 Designers should consider the use of alarms, cautions, or highlights as memory aids or sequence reminders on EIAPs.

Example: An EIAP may be integrated with the altitude alerting system for the approach area. Pilots could enter (or the appropriate altitude could be determined automatically) stepdown altitudes, the decision altitude, and the missed approach altitudes for alerts.

Example: If the aircraft crosses a specific location on the approach and the appropriate communication channel for air traffic control has not been accessed, a

caution could appear on the EIAP or the appropriate communication frequency could change appearance to attract attention.

Comment: If auditory alarms are implemented, caution is needed to ensure that the alarms are given the proper priority within the cockpit. If other more critical alarms are activated, the EIAP alarms should be postponed until the critical situations have been resolved.

- 4.26.1.2 Designers should consider providing pilots with the capability to highlight specific information on the display to act as memory aids or reminders.

Example: An EIAP may allow a pilot to highlight the information associated with a NAVAID as he or she prepares to enter the frequency into the navigation system. If the pilot is interrupted before completing this sub-task, the highlighted information serves as a reminder and aids the pilot in quickly re-locating information.

- 4.26.1.3 If an EIAP system provides alarms as reminders, alerts and alarms should be used judiciously and users should be able to specify the conditions under which alarms will activate (Smith and Mosier, 1986) (also see Section 4.8 on auditory displays).

Example: System settings should allow pilots to specify which alarms will be activated under which conditions. This will allow pilots to customize the alerts based on the aircraft and the specific situation and may minimize the possibility of false alarms.

Comment: Certain alarms may be considered critical (e.g., if the EIAP is integrated with a terrain alerting system). In those cases, the alarms may be implemented under fixed conditions.

- 4.26.1.4 Alarms should be distinctive and consistent (Smith and Mosier, 1986).

Comment: The distinctiveness and consistency of alarms must be considered within the entire cockpit and not just within the EIAP.

Example: If color codes are used as cautions, yellow should always be used for cautions, red should always be used for warnings. If blinking is used as a caution or alert, blinking should always be used rather than using blinking in one situation and reverse video in another. If a code such as yellow, red, or blinking is used to indicate a caution or warning, it should only be used for a caution or warning and not in any other situation. Also see Section 4.3 on color.

Example: If auditory alarms are used, the alarms should be distinctive from any other auditory alarms in the cockpit so that it is clear that the alarm is associated

with the EIAP. The alarm should be distinct from other auditory codes (such as a beep to indicate acceptance of input) on the EIAP. Any auditory code used for caution or warning should be used consistently as a caution or warning only.

- 4.26.1.5 The EIAP should allow fast and simple alarm acknowledgment (Smith and Mosier, 1986).

Example: An EIAP that provides an auditory alarm (such as an altitude alert or terrain avoidance alert) should provide a simple control for turning off the alarm.

Comment: If an auditory alarm is accompanied by a visual message or code (such as a change of color), the EIAP should allow the user to turn off the auditory alarm without removal of the visual indication of the problem.

Comment: If blinking is used as a cautionary code, allow users to turn off the blinking, especially if the blinking item is textual and must be read.

- 4.26.1.6 Codes such as blinking, bolding, warnings, reverse video, and color should be used sparingly (see Section 4.4).
- 4.26.1.7 Group related information together and present information in the appropriate sequence to help reduce forgetting due to interference (see Sections 4.13 and 4.14).

4.26.2 References

Block, 1994; Chappell, 1994; Sears, 1986; Smith and Mosier, 1986.

4.26.3 Graphic Example

DON'T use colors such as yellow and red as terrain contour colors if yellow and red are used to caution aircraft close to terrain. In the first example on the following page (page 167), the yellow and red coding in the lower left corner is a caution that the plane is close to terrain. The yellow and red coding in the upper right corner indicates an increase in terrain elevation. The pilot may not realize that he or she is flying close to terrain because he or she may mistake the yellow and red coding in the lower left corner as a terrain contour rather than a cautionary signal.

DO reserve codes that are used to caution pilots for those purposes only. In the second example on the following page (page 167), shades of green are used to indicated changes in elevation of the terrain. Red and yellow are reserved for use as cautions and warnings. Pilots will be alerted to the potentially dangerous situation more quickly if the yellow and red coding is reserved for cautions only.

DON'T use the same codes to represent caution and normal states.

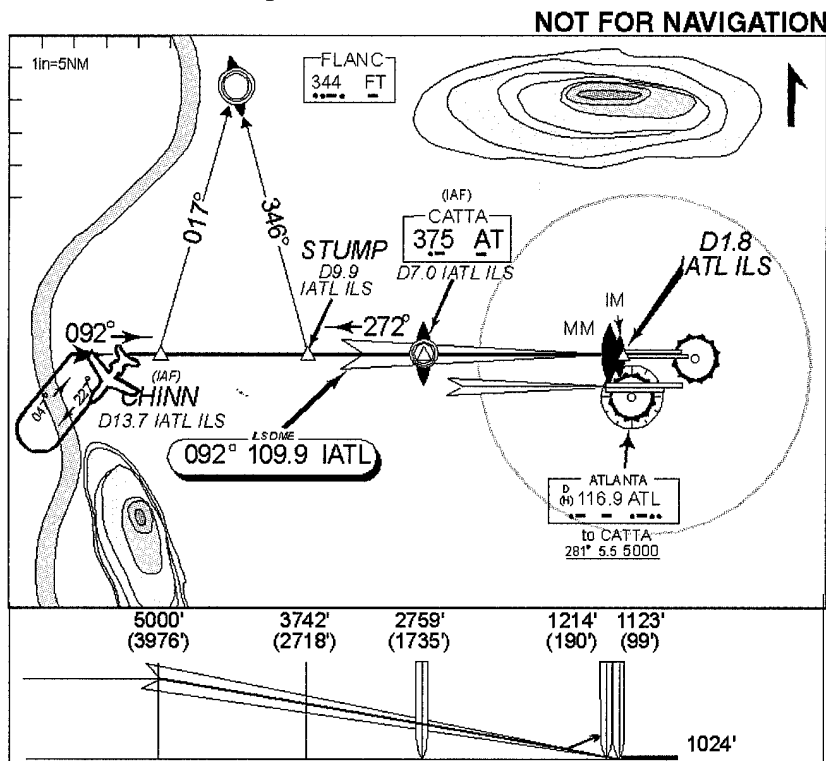

DO reserve cautionary codes for cautions only.

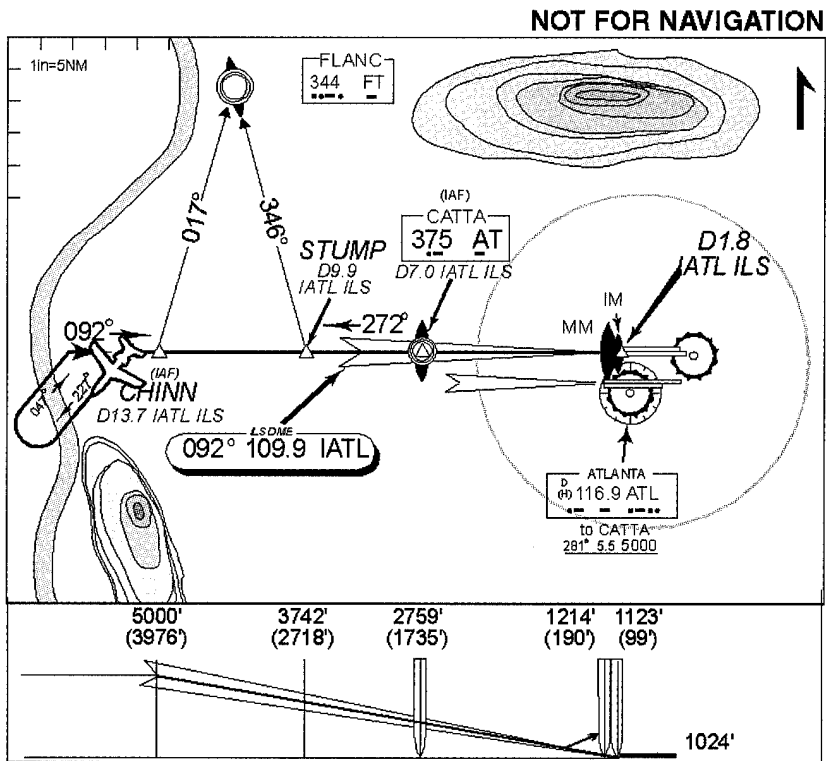

4.27 AIRPORT/NAVAID SEARCH

Recent research on the design of EIAPs (Hofer, Palen, Dresel, and Jones, 1991; Hofer, Palen, Higman, Infield, and Possolo, 1992; Kuchar and Hansman, 1992; Mykityshyn and Hansman, 1991; NASA-Langley, 1993) has focused on presentation of information on the approach chart with the appropriate approach chart already present on the screen. Little research is available on how the pilot accesses the correct approach chart and on the availability of alternate approach charts. With paper approach charts, pilots have cognitively easy (although physically cumbersome) access to the needed approach chart, to alternate approaches to the same airport, and to approaches for nearby airports. An EIAP system should make access of appropriate approach information easier and faster than locating the proper paper chart.

One issue in the design of approach chart search for EIAPs is the organization of the search. Paper charts are organized alphabetically by states and within each state alphabetically by airports (NOS) or by city (Jeppesen). Pilots first search for the correct state, then for the correct city or airport, then for the appropriate approach (which they may not know until they receive ATIS information). Organization by airport name may be preferable if pilots do not know the name of the city where the airport is located. Organization by city name may allow pilots to locate alternate airports (if there are others available in the same city) more quickly. EIAPs provide the capability to search on any piece of information the pilot knows about the location. For example, a pilot may choose a state, then the EIAP would display a list of cities in the state, then the pilot may choose the city and a list of airports would be displayed. Or, if the pilot knows the airport name, he or she may enter the name and directly access the appropriate chart. EIAPs may even allow pilots to search for a specific NAVAID.

EIAPs provide the capability to display search information graphically. A touch-screen (or cursor controlled) EIAP may start with a map of the world or country and allow the pilot to zoom in on (in steps) the approach chart by touching the geographical area of interest at each zoom level. The EIAP may also incorporate a hierarchical tree view of states, cities, airports, and approaches to help pilots quickly find the approach chart of interest. The EIAP could display the appropriate ATIS frequency for each airport at the airport level before the pilot selects the specific approach. Consequently, the pilot would not have to choose an approach in order to get the ATIS frequency and then have to change after listening to ATIS information.

Two features that should be considered for approach chart search for EIAPs are automatic search and a quick switch to alternate approaches. Automatic selection of cities, airports, or approaches based on information entered in an FMS (requires integration with the FMS) or based on aircraft location may be incorporated into an EIAP. The capability to override the automatic selection would be required in such a system. EIAPs should provide a fast means to call up alternate approach charts. Different approaches to the same airport and approaches to alternate airports determined during flight planning should be pre-set so that during the approach the pilot need only make a quick selection (such as a button press) to switch to an alternate approach.

4.27.1 Guidelines

4.27.1.1 Approach chart search functions should be flexible in methods used.

Example: An approach chart search function may supply a list of all possible cities in a given region so that a pilot can recognize rather than recall the city he or she is looking for. On the other hand, the pilot should also be able to type in the city name or the first few letters of the city name (and the search function would move to highlight the correct location in the list) in order to move more quickly through the list.

Example: An approach chart search function may allow pilots to search on any of a number of information items such as state, city, airport, approach type, or NAVAID.

4.27.1.2 The EIAP system should automatically remove from a list those search choices that are not valid based on previous pilot selections.

Example: Once a given state is chosen, the city list should only display cities within that state.

4.27.1.3 The EIAP should reduce memory requirements by providing lists of choices for a pilot to recognize and choose rather than requiring the pilot to recall specific names.

4.27.1.4 Designers should consider presenting a default approach chart initially based on logic such as most frequently landed airport, the previous airport the pilot took off from, or a default airport identified by the pilot.

4.27.1.5 The database of approach charts should be organized in a manner that is natural and consistent with the pilot's model of the data (Smith and Mosier, 1986).

Example: A top-down geographical organization of search data is more natural and consistent with pilots' models than organization of approaches alphabetically by airport names for all airports in the U.S.

4.27.2 References

Hofer, Palen, Dresel, and Jones, 1991; Hofer, Palen, Higman, Infield, and Possolo, 1992; Kuchar and Hansman, 1992; Mykityshyn and Hansman, 1991; NASA-Langley, 1993; Smith and Mosier, 1986.

4.27.3 Graphic Example

DON'T organize search data in a manner that is inconsistent with pilots' model of the information.

Airports with ILS Approaches	
Asheville, NC	Greensboro, NC
Burlington, NC	Greenville, SC
Chapel Hill, NC	Hilton Head, SC
Charlotte, NC	Kinston, NC
Clemson, SC	➤ Raleigh-Durham, NC
Columbia, SC	
Fayetteville, NC	
Florence, SC	

DO organize search data in a hierarchical fashion that is natural and consistent with pilots' model of the information.

Airports with ILS Approaches	
<u>North Carolina</u>	<u>South Carolina</u>
Asheville	Clemson
Burlington	Columbia
Chapel Hill	Florence
Charlotte	Greenville
Fayetteville	Hilton Head
Greensboro	
Kinston	
➤ Raleigh-Durham	

5. PROTOTYPE ELECTRONIC INSTRUMENT APPROACH PROCEDURE DISPLAYS

This section presents a brief evaluation of current paper IAP charts, pointing out key information presentation features. Then, three electronic IAP prototypes are presented and described to provide examples of potential differences between paper and electronic IAP charts. The three prototypes also exemplify many of the features and guidelines discussed earlier in the document.

This section also demonstrates some of the advantages and disadvantages of electronic IAPs. Mykityshyn and Hansman (1992) mentioned a number of advantages of electronic charts over paper charts including ease of information update, format flexibility, and the ability to merge with other glass cockpit functions such as ground proximity warning systems. Additionally, electronic IAP charts provide the capability to tailor the display based on automatically determined or entered information such as aircraft location, aircraft configuration, aircraft speed, and pilot preference. With this information available to a computer, only necessary information will be displayed and much of the information that clutters paper charts to account for varying factors may be eliminated. Another advantage of electronic charts is the capability for dynamic and interactive presentation of information. Aircraft location may be displayed dynamically, or a Track up reference frame may be used. The pilot may request information when it is needed so that infrequently used information does not clutter the display.

A disadvantage of electronic charts over paper charts is poor display resolution, requiring larger type and symbols on electronic charts. EIAPs may require pilots to view more than one page to see the same amount of information available on one paper page. The capability to modify electronic displays to display only needed information may diminish this problem. However, if pilots are required to take control actions to control the display during the approach, workload may be increased. Proper design of an EIAP will capitalize on the advantages without allowing the disadvantages to create potential safety or workload problems. The guidelines in this document will help designers and certifiers to ensure that pilots will be able to access needed information quickly and easily.

The three prototypes have been designed to cover a number of the features and functions discussed in this document. Because one of the general principles in the design of EIAPs is simplicity, more than one prototype is needed to display all of the features. Any one EIAP that contained all the features presented would be a poor example because of the complexity involved in incorporating so many features. In addition, considering different examples allows application of guidelines on systems incorporating different hardware capabilities. While this document does not discuss hardware beyond guidelines for input devices, assumptions are made of certain hardware capabilities for the three prototypes. The assumptions may not correspond to the hardware used in the development of actual EIAPs, however, the principles exemplified should apply to systems with other hardware configurations.

Finally, it is important to state that no one EIAP design is perfect. Many trade-offs must be considered including trade-offs between capability and simplicity, between capability and cost, between efficient use of display space and clear and visible controls, etc. Each design presents different advantages and disadvantages. Certifiers, designers, and researchers should not view the examples presented here as anything more than presentation aids for demonstration of EIAP display guidelines. The designs illustrate many of the concepts discussed, but are in no way complete. None of the prototypes have been tested by users as any new design should be. Keeping in mind the principles and guidelines presented in Chapters 3 and 4, readers are encouraged to consider other (perhaps better) implementations and combinations of features and functions on an EIAP.

5.1 CURRENT PAPER IAP CHARTS

This section describes current paper IAP charts developed by the National Ocean Service (NOS) and Jeppesen. Both manufacturers are taking steps to update the chart formats described below. Refer to Osborne, Huntley, Turner, and Donovan's (in press) report of a flight-tested prototype instrument approach procedure chart design for up to date improvements in paper charts. The current practice in the design of IAP charts is a 5" × 8" format produced by either the National Ocean Service (NOS) or Jeppesen. NOS charts are available in booklets based on regions. Jeppesen charts come in separate pages to be placed in a notebook - this provides Jeppesen users with the capability to update their charts more frequently and at less cost, than if they had to replace whole regions of charts. NOS charts are less expensive than Jeppesen charts; however, Jeppesen charts are used by more than 90% of U.S. commercial airlines (Mykityshyn and Hansman, 1992). Both chart makers divide their charts into the following content areas.

5.1.1 Headings

Margin identifications or headings include information such as the name and location of the airport and the procedure number of the chart. Communication frequencies for the airport and minimum safe altitudes (in the Jeppesen charts) are also presented at the top of the chart. Jeppesen charts enclose the communication frequencies with a border in a consistent upper left location and present the frequencies in larger bolder type than the labels immediately to the right of the labels. NOS charts do not enclose the communication frequencies and present them either at the top left or at the top right. Frequencies are normally located below the labels, but not consistently. Labels and frequencies are the same size and boldness type.

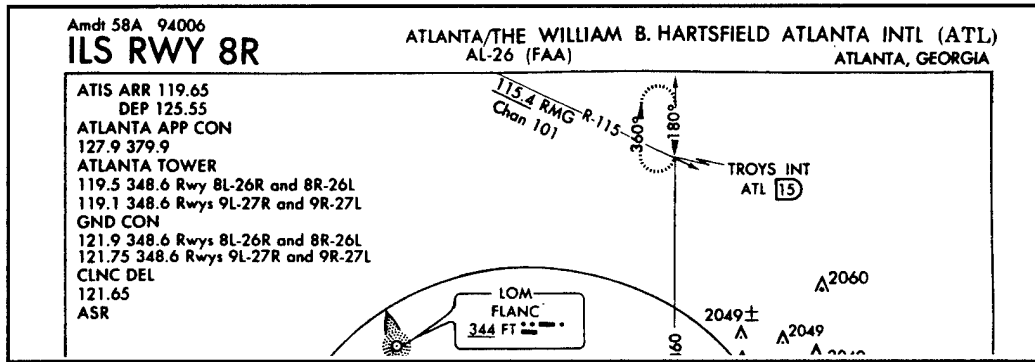

5.1.2 Plan View

The plan view covers the airport and surrounding area, and provides information about the approach procedure. Information in this section of the chart includes the initial approach segment, procedure turn, final approach segment and instructions, enroute facilities, feeder facilities, terminal routes, holding patterns, waypoints with data, radio aids to navigation, obstacles, spot elevations, and many other important pieces of information required for an instrument approach. Much of this information is displayed in symbolic form with a legend provided on a different page. Unfortunately, NOS and Jeppesen differ in their use of symbology.

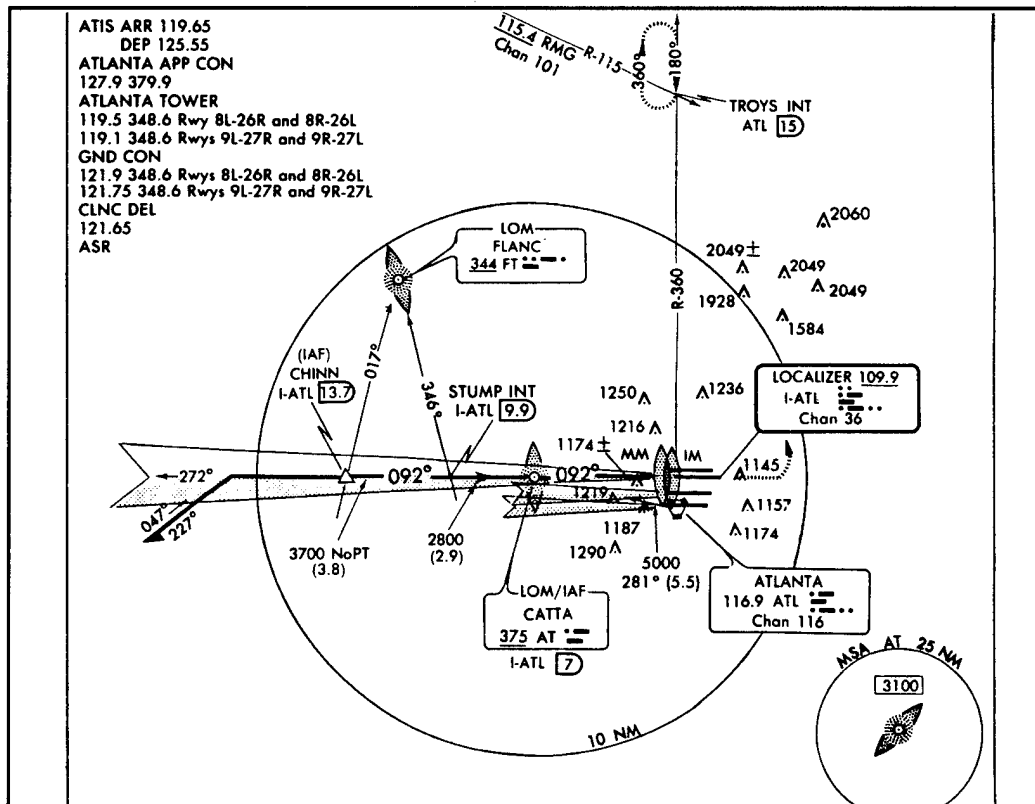

5.1.3 Profile View

The profile view is a side view of the approach, providing a graphical depiction of altitude information. The profile view depicts the minimum altitude for procedure turn, minimum distance for procedure turn, altitudes over prescribed fixes, and distance between fixes. The profile view on an ILS approach may contain separate profiles for both a precision and non-precision approach. Near the profile view, (within it to the top left or right for NOS charts) and immediately below it for Jeppesen charts, are the missed approach instructions. Missed approach instructions are written out in text (smaller type is used on the NOS chart than on the Jeppesen chart).

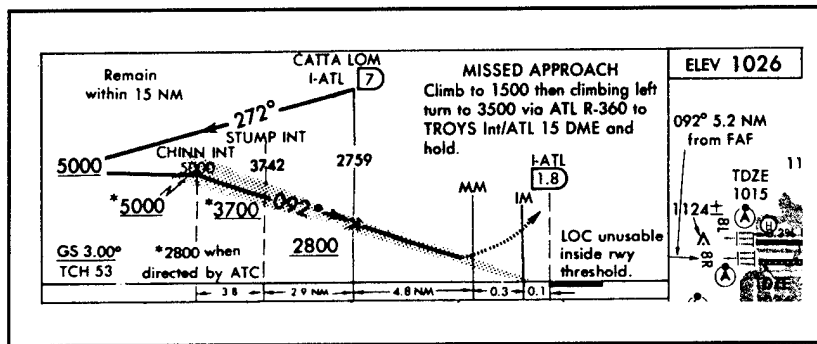

5.1.4 Aerodrome Sketch

NOS charts provide an Aerodrome sketch directly on the IAP chart. It includes information such as airport elevation, usable runway length, approach lights, runway gradient, time and speed table from final approach fix to missed approach point, and more. Jeppesen places the aerodrome sketch on the back of the first instrument approach procedure for a given airport. This format allows the information to be presented at a much larger scale and to provide more information. However, display of information on a separate page creates added tasks for the pilot including finding the page, finding a place to display it, and flipping back and forth between the aerodrome sketch and the IAP. Clearly there are advantages and disadvantages of both methods.

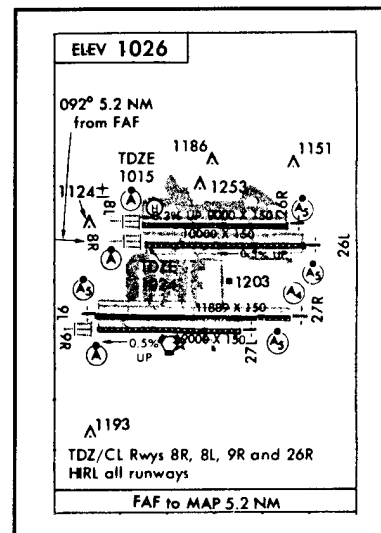

5.1.5 Minimums

The final major section on current IAP charts is the minimums section. Both chart makers place this information at the bottom of the chart. This section contains important information about minimums for the approach such as decision height or minimum descent altitude and visibility. Tables provide pilots the means to locate the appropriate minimum based on their aircraft category and type of approach. Jeppesen charts also provide minimums on the IAP chart for special "instrument out" conditions while NOS charts provide tables of adjustment calculations to determine these minimums on a separate page. The same advantages and disadvantages that apply to the aerodrome sketch apply here. However, because Jeppesen charts do place the aerodrome sketch elsewhere, they are able to display more minimum information than NOS in approximately the same size type.

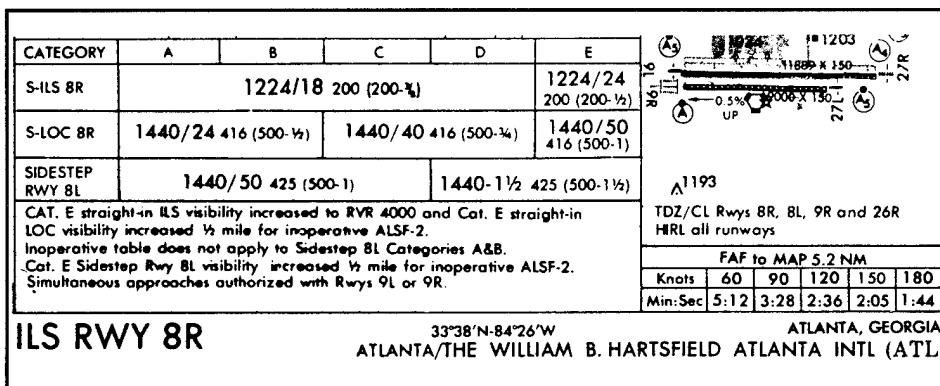

5.1.6 Notes, Time to Missed Approach, Glide Slope

Other information that may be provided at the bottom of the chart includes notes, time to missed approach and glide slope information. Jeppesen provides notes directly on the plan view of the chart while NOS reserves a box at the bottom of the chart for notes. NOS also uses some coded symbols for common notes. Time to missed approach and glide slope are normally presented in a tabular form for the pilot to determine based on estimated ground speed.

Figure 5-1 displays an entire NOAA paper IAP chart with the areas discussed noted.

Amdt 58A 94006
ILS RWY 8R

ATLANTA/THE WILLIAM B. HARTSFIELD ATLANTA INTL (ATL)
 AL-26 (FAA)
 ATLANTA, GEORGIA

ATIS ARR 119.65
 DEP 125.55
 ATLANTA APP CON
 127.9 379.9
 ATLANTA TOWER
 119.5 348.6 Rwy 8L-26R and 8R-26L
 119.1 348.6 Rwys 9L-27R and 9R-27L
 GND CON
 121.9 348.6 Rwys 8L-26R and 8R-26L
 121.75 348.6 Rwys 9L-27R and 9R-27L
 CLNC DEL
 121.65
 ASR

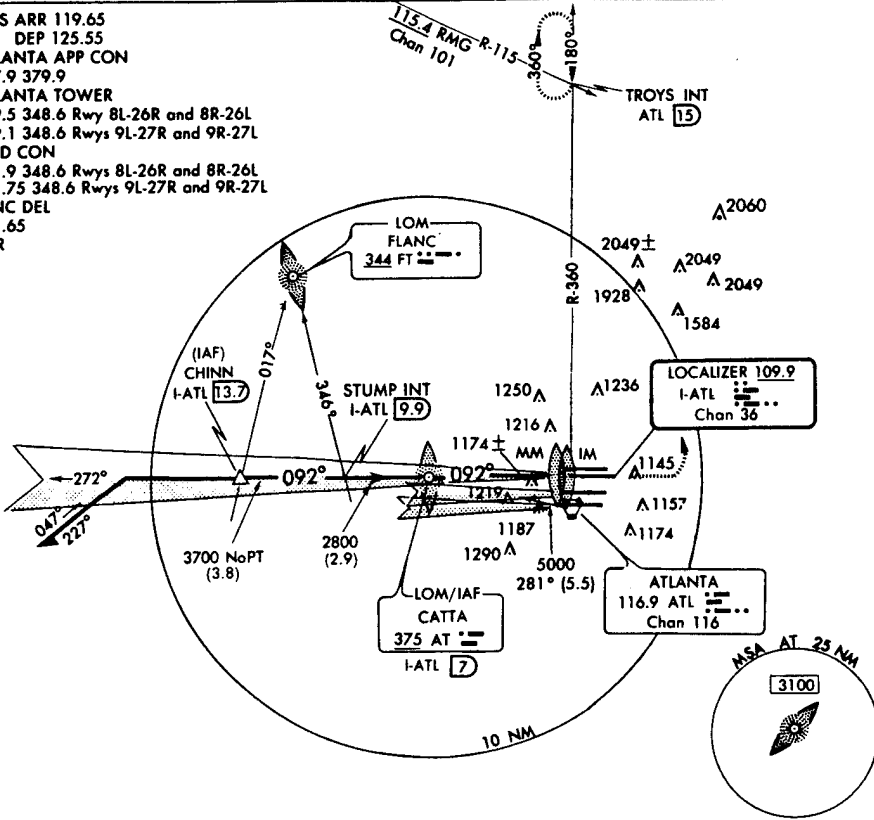

1. Headings

2. Plan View

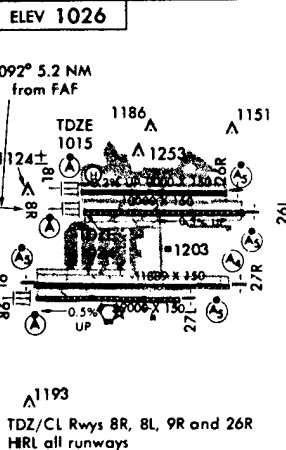
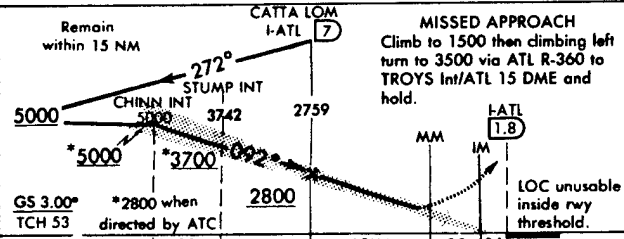

3. Profile View

4. Aerodrome Sketch

CATEGORY	A	B	C	D	E
S-ILS 8R	1224/18 200 (200-¾)				1224/24 200 (200-½)
S-LOC 8R	1440/24 416 (500-½)		1440/40 416 (500-¾)		1440/50 416 (500-1)
SIDESTEP RWY 8L	1440/50 425 (500-1)			1440-1½ 425 (500-1½)	

CAT. E straight-in ILS visibility increased to RVR 4000 and Cat. E straight-in LOC visibility increased ½ mile for inoperative ALSF-2.
 Inoperative table does not apply to Sidestep 8L Categories A&B.
 Cat. E Sidestep Rwy 8L visibility increased ½ mile for inoperative ALSF-2.
 Simultaneous approaches authorized with Rwys 9L or 9R.

FAF to MAP 5.2 NM					
Knots	60	90	120	150	180
Min:Sec	5:12	3:28	2:36	2:05	1:44

5. Minimums

ILS RWY 8R

33°38'N-84°26'W
 ATLANTA/THE WILLIAM B. HARTSFIELD ATLANTA INTL (ATL)
 ATLANTA, GEORGIA

Figure 5-1. NOAA Paper IAP Chart

5.2 PROTOTYPE 1 - TOUCH TO ZOOM, CONFIGURATION SPECIFIC EIAP



The first prototype is a fairly simple design incorporating some of the features and functions to be discussed. The design emulates a nine inch by five inch touch screen display.

Prototype 1 contains the following key features.

5.2.1 Heading

Information that has been identified as highly important by pilots is presented in an invariant display area across the top row -- VOR Frequency, Approach Course, Initial Approach Fix Altitude, Minimum Descent Altitude, Touchdown Zone Elevation, and Approach, Airport and City Name.

In the second row, communication frequencies and an iconic representation of the runway light configuration are presented in an invariant display area. An MSA circle and any notes are also provided in the heading information.

VOR 109.9'	APP CRS 092'	CHINN 5000'	MDA 1224'	TDZE 1024'	Atlanta, GA Hartsfield Intl. ILS RWY 8R
ATIS 119.65	Approach 127.9	Tower 119.5	Ground 121.9	MALSTR 	
	Simultaneous approach authorized with RWYs 9L or 9R				Air 1 Hartsfield Intl
					

5.2.2 Alternate Buttons

Buttons (that also could be implemented as touch-screen buttons) allow the pilot to quickly select pre-determined alternates. Pressing the Seek button takes the pilot to another screen in which he or she may select other approaches or airports and identify the alternate to be displayed for quick selection.

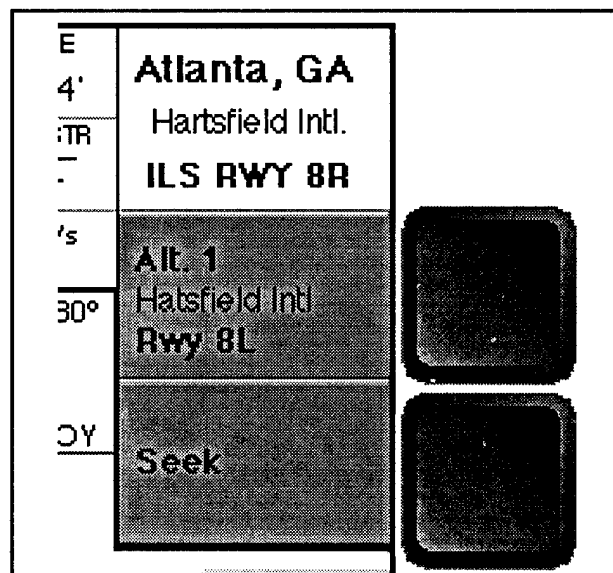

5.2.3 Plan View with Touch to Zoom

The plan view is similar to the plan view presented in paper charts. Some of the symbols have been redesigned to reduce the detail and make them more recognizable on electronic displays. In areas with a large number of obstacles, only the highest obstacle is displayed. The plan view also contains a "touch to zoom" feature. The display zooms in a pre-determined amount around the area touched. The plan view displays an inset to indicate where the view is in the "big picture". Pilots can zoom out by touching the big picture inset. Pilots may choose to zoom in to get a larger representation for ease of reading or to access more detailed information. As pilots continue to zoom in they will see an airport view complete with information currently available on airport diagrams. They may want to zoom out to get a better overview of the area. When pilots zoom out beyond the instrument approach area, they will access standard terminal arrival routes (STARs). In the following example, a touch of the screen at the 360 degree radial to the missed approach zooms in on the area, displaying a larger view with more detail in that area. To zoom back out to the previous zoom level, users simply touch the inset to the lower right.

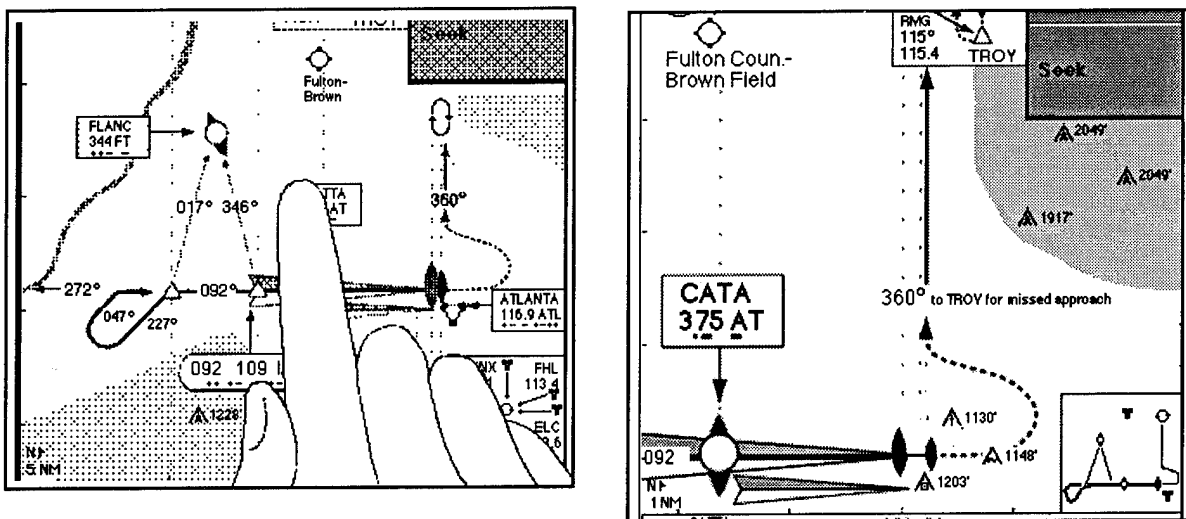

5.2.4 Profile View Specific to Approach Type

The lateral scale of the profile view is equal to that in the plan view so that it changes with zoom level. The profile view is specific to the type of approach the pilot is flying. Unlike paper charts, only precision or non-precision information is presented, not both, reducing clutter. Pilots may quickly switch from a precision to non-precision profile by changing the configuration setting (see Section 5.2.6). The first of the two following examples shows the profile view for a precision approach. The second example shows the profile view after a pilot has selected a non-precision approach and has zoomed in on the final approach area.

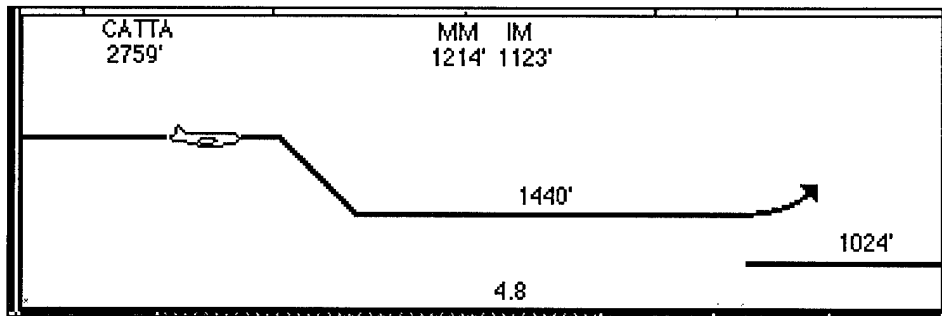
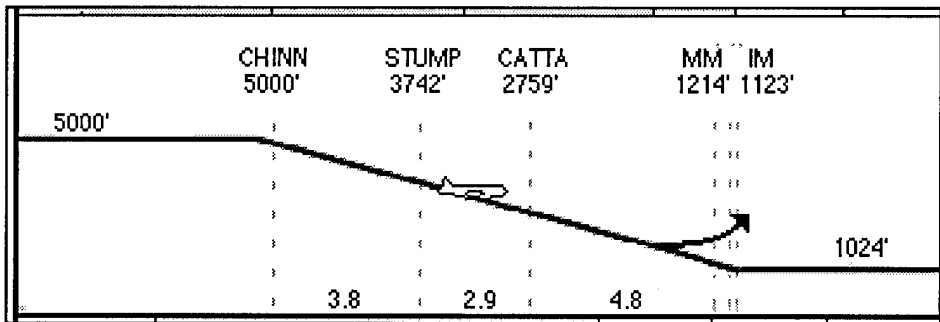

5.2.5 Missed Approach Information

Missed approach instructions include a textual and iconic representation. Longer missed approach instructions would be represented by displaying only icons with a touch-screen capability to switch to the textual display. A countdown of time to missed approach is included. The time or distance to missed approach is more direct and preferred to the time tables provided on paper IAPs.

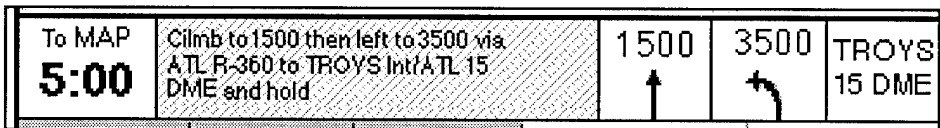

5.2.6 Category and Configuration Control, Display - Minimums

Both category and configuration information can be quickly changed by the three buttons on the lower left of the prototype. The pilot simply cycles through the appropriate choices (dependent on the current approach) with a touch of the button. This implementation is appropriate as long as the number of choices are limited and the system responds rapidly to selections. Information in the EIAP will change as appropriate (e.g., minimums -- also the MDA in the heading area, precision vs. non-precision profile). The current selected configuration is also indicated by the labels displayed next to the buttons. The minimums table has been shortened (see Figure 5-2) to display only the appropriate minimums (runway visual range and minimum altitude) for the configuration being flown.

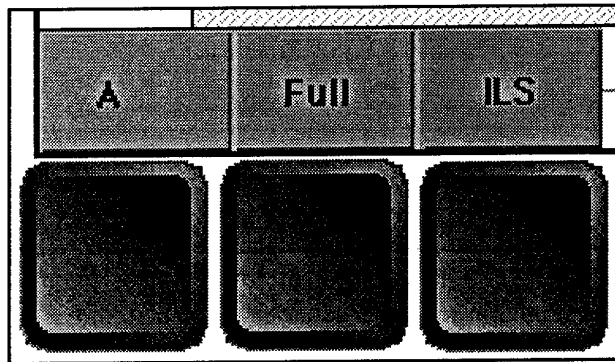
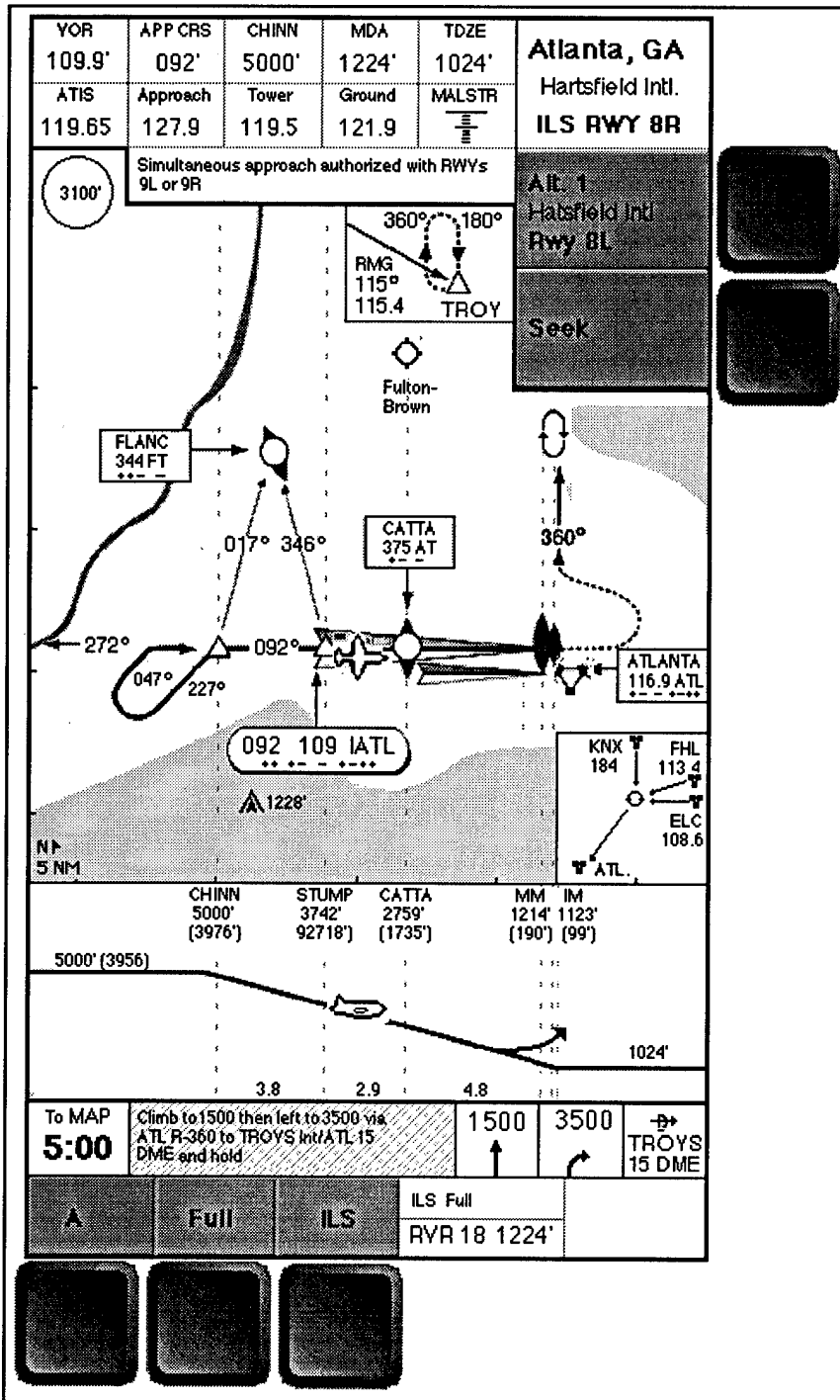

Figure 5-2 presents Prototype 1 with the areas discussed above noted. Terrain elevation is depicted in Prototype 1 using color contour lines at 1000 foot intervals. Each contour elevation is noted on the display using the AMA abbreviation for elevations. Figure 5-3 on page 171 is a color representation of Prototype 1 at an airport with higher terrain features.



1. Important information in top row.

2. Communication frequencies, runway light configuration, time to missed approach, notes.

3. Alternate display buttons

4. Plan view - Page 178 displays the EIAP after the pilot has touched the screen to zoom in

5. Profile view

6. Missed approach instructions

7. Category and configuration selection, minimums - see page 180 for changes based on pilot selections.

Figure 5-2. Prototype EIAP 1

NOT FOR NAVIGATION

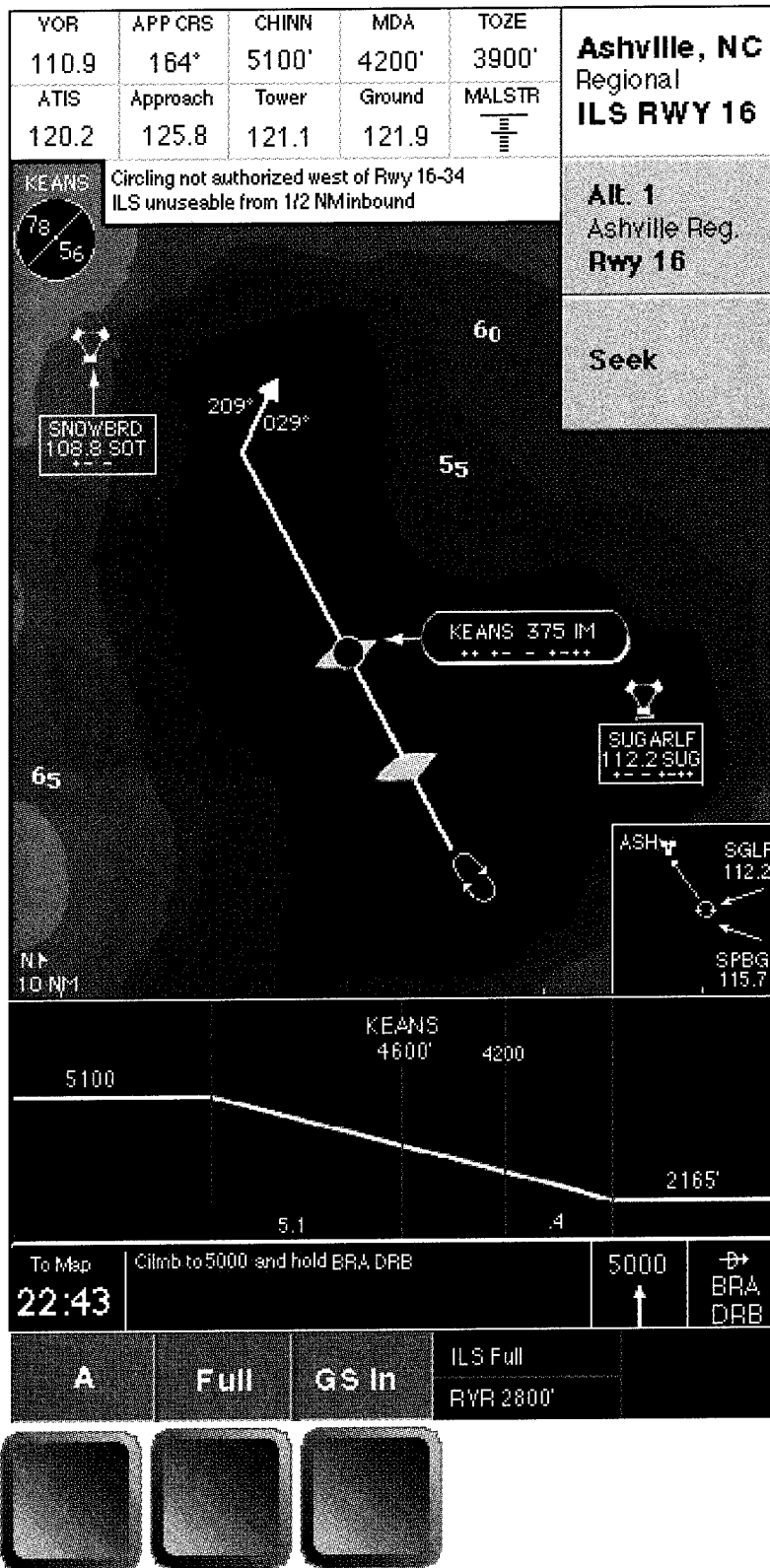

Figure 5-3. Prototype EIAP 1 in Color

5.3 PROTOTYPE 2 - DISCRETE PILOT CHOICES FOR DECLUTTER

The second prototype incorporates three distinct modes and a number of different declutter choices for the pilot. The three modes are:

- the IAP or approach mode,
- the setup mode,
- the legend mode.

Only the IAP mode is described in detail in this section. The setup mode provides the capability for the pilot to choose the approach airport, specify the aircraft configuration and category, and choose the default configuration for the display. The legend mode provides a legend of symbols and their meanings.

All of the buttons for the EIAP work in the same manner so the pilot does not have to remember how to operate different controls. Each button cycles through no more than four choices for each control. One problem with this type of control is that all of the choices for each control are not visible at all times. For this reason, it is imperative that the number of choices for each control be limited and that the system response time to choices be rapid so the pilot can quickly cycle through choices until he or she finds the appropriate choice. Another alternative is to display the options within the display labels (e.g., Terrain - ON OFF), and highlight the current selection, then pilots will see the choices available.

Prototype 2 allows the user to control the information display more than Prototype 1 allows; however, this control is not without cost. If the landing category or configuration is changed in flight, the pilot would have to first switch to a setup mode before being able to input the changes to update the display, this is not true in Prototype 1. These trade-offs should be carefully considered in the design of EIAPs.

Prototype 2 contains the following key features.

5.3.1 Headings

Key information such as the airport name, approach and runway name, and communication frequencies are displayed at the top of the chart. The Airport and Runway buttons also allow the pilot to quickly cycle through neighboring airports and the approaches/runways available at those airports. The three airports nearest the original airport selected are available by pressing the Airport button. With each press of the button, the possible approaches for the current airport are available by pressing the Runway button (the initial approach displayed is the most frequently used approach for the given airport). Pilots may also switch to the setup mode to choose other airports.

Hartsfield Atlanta Intl.		ILS Runway 8R	
Atis Arrival	119.65	Tower Rwys	119.5
Approach	127.9	Ground Rwys	121.9

5.3.2 Brief and MSA

A textual brief of the approach is displayed at the top of the chart. The briefing description highlights the key information including the primary NAVAID names, NAVAID crossing altitudes, approach course, and the minimum descent altitude. The MSA circle also is presented in the heading area. The aircraft location and direction is displayed directly within the MSA circle so the pilot does not have to compare the location of the aircraft with the location of the MSA circle to determine the minimum safe altitude.

Cross CHIN at 5000' inbound course at 092°, cross CATTÀ at 2759', MDA(H) at 1224' (200')	
---	---

This area also is used to display the missed approach text when the pilot chooses to display missed approach information.

5.3.3 Plan View

The plan view is similar to that presented in the paper charts and in Prototype 1. The terrain is represented by contour lines that can be turned on and off and by obstacles that may be filtered based on elevation. The obstacle elevation choices will vary based on the terrain surrounding the airport. For example, around Atlanta the choices would be 1000' (display all obstacles -- touchdown zone elevation is 1024'), 1500' (display all obstacles at an elevation higher than 1500'), 2000', and 2500'. At an airport with higher terrain such as Asheville, NC, the choices may be 2000' (touchdown zone elevation is 2165'), 3000', 4000', and 5000'. Of course, usability testing would have to be performed to determine the appropriate computer logic for determining the best obstacle filter choices.

The orientation of the approach mode in Prototype 2 may be changed from North-up to Track-up with the touch of a button (see Section 4.11 for a discussion of frame of reference). The plan view may also be zoomed to 75%, 100%, 125%, or 150%. The zoom is centered on a location where the aircraft remains in the lower one-third of the view in the Track-up mode. In the North-up mode, the zoom is centered on a location where the airport remains in the same approximate location on the screen (determined by best layout of information to view the key features of the approach procedure). This choice is based on the assumption

that most pilots will use the North-up mode for planning and the Track-up mode for navigation. However, this issue requires further research before definitive choices can be made.

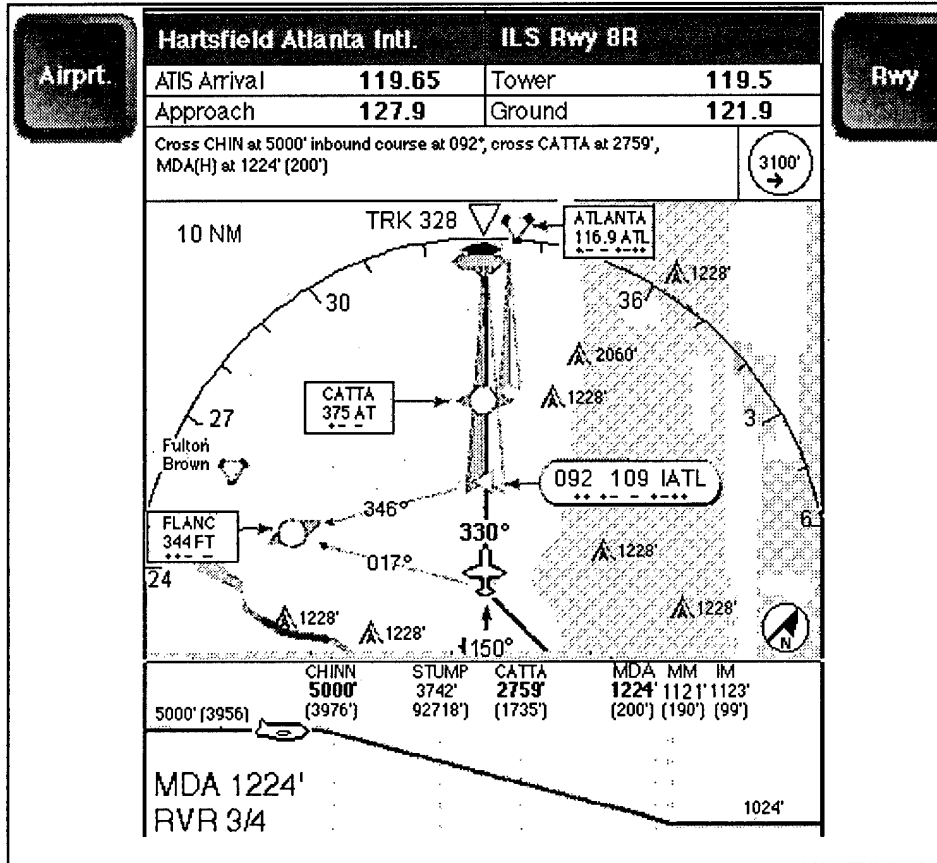

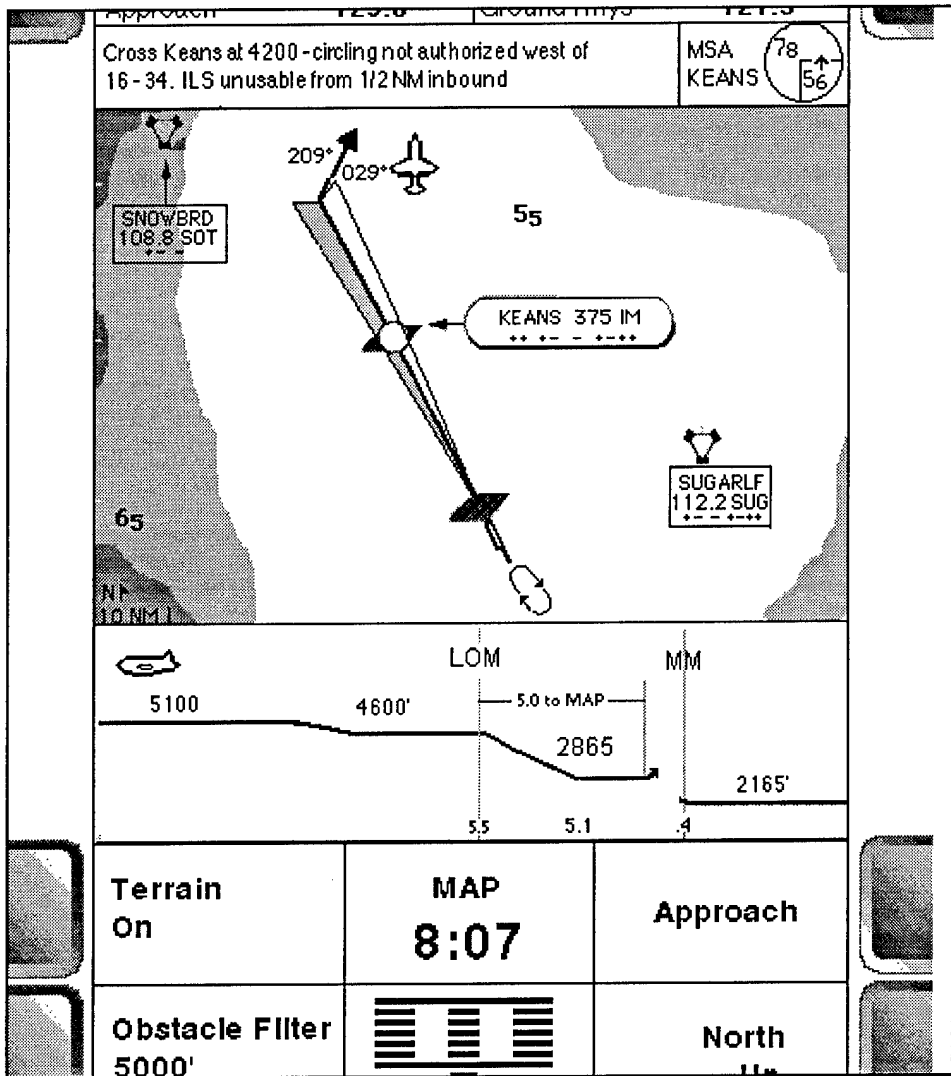

5.3.4 Profile View

The profile view for Prototype 2 also displays either the precision or non-precision approach profile as determined by selections in the setup mode. The minimum descent altitude is displayed in the profile view along with the other appropriate minimum altitudes. Both the minimum descent altitude and minimum visibility are displayed in the lower left hand corner of the profile view.

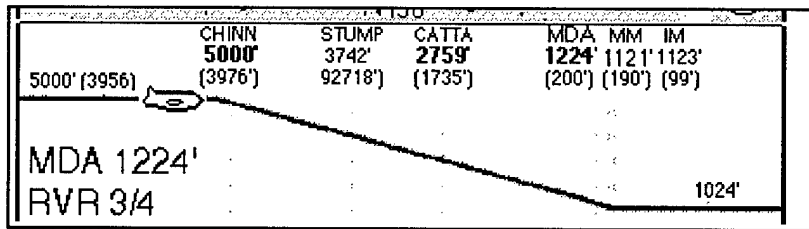

5.3.5 Controls, Time or Distance to MAP, Approach Light Configuration

The approach light configuration and time or distance to MAP (as chosen by the pilot in the setup mode) are displayed in the lower center section of the EIAP. The lower third of Prototype 2 also contains most of the controls for the EIAP. The pilot can control the following:

- (a) the presence or absence of terrain contours,
- (b) the degree of detail in the presentation of obstacles,
- (c) the presence or absence of NAVAID information,
- (d) whether the EIAP displays Approach information only or Approach and Missed Approach information,
- (e) whether the EIAP uses a Track-up or North-up frame of reference,
- (f) the level of zoom for the display, and
- (g) the mode of the display.

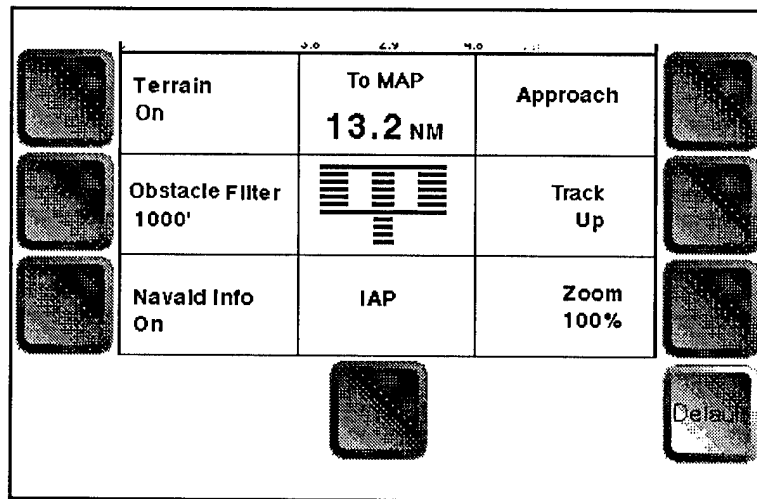

The pilot selects the default choices for these controls in the setup mode. The final control is a Default button that, when selected, returns all of the other choices to the default mode. Prototype 2 is shown in Figure 5-4.

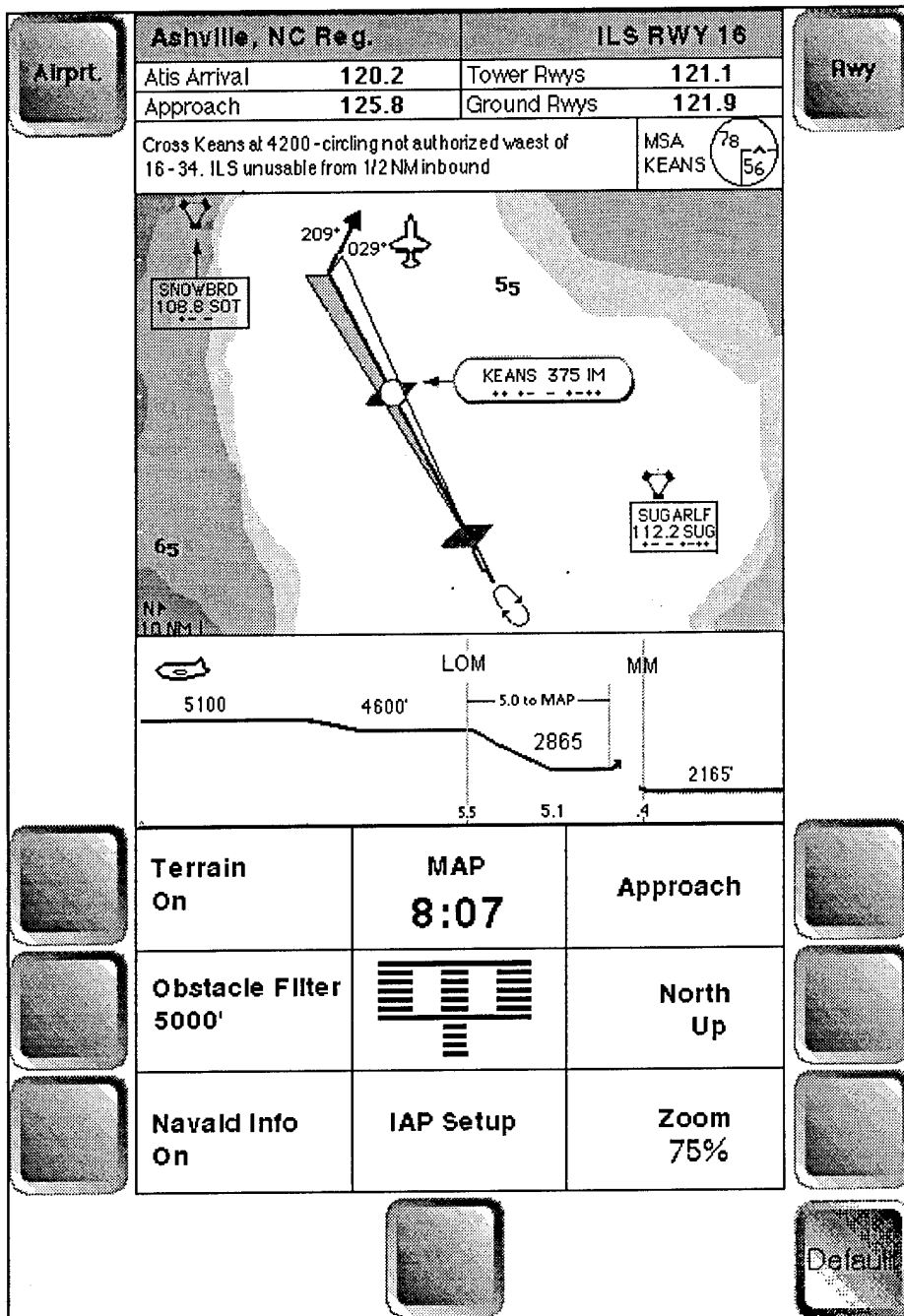

1. Airport name, approach name, communication frequencies, airport and approach control buttons

2. Briefing text and MSA

3. Plan view

4. Profile view

5. Minimum visibility, time or distance to MAP, runway lights, and EIAP controls

6. EIAP page or mode control

Figure 5-4. Prototype EIAP 2

5.4 PROTOTYPE 3 - VISIBLE, CONVENTIONAL CONTROLS DURING APPROACH

Prototype 3 incorporates some of the same functions as the previous prototypes. In Prototype 3, nearly all of the EIAP control functions that should be used during the approach phase are easily accessible with conventional cockpit controls. After the pilot has chosen an approach chart and identified the approach category and configuration, he or she will use conventional selector switches, rotary controls, and toggle switches to control the display as needed. Multi-function push buttons to the right of the EIAP are only used during setup prior to the approach phase.

Prototype 3 incorporates two main areas that can display any of three different views as chosen by the pilot. Any combination of views may be easily selected by the pilot for the two main display areas.

Prototype 3 contains the following key features.

5.4.1 Heading

Key information such as the airport name, approach and runway name, communication frequencies, primary NAVAID frequency, decision altitude, minimum visibility, glide slope, minimum safe altitude and distance to MAP are displayed at the top of the chart. Although it is not displayed here, EIAPs afford the possibility of displaying only the current and next communication frequency rather than all communication frequencies.

Ashville, NC Reg.		ILS RWY 16	
ATIS 120.2	Tower 121.15	Loc 110.9 I-IMO	
Approach 125.8	Ground 121.9	DA(H) 2165' (200')	
RVR 18 or 1/2		GS 3.0 deg	485
MAP 3:28			
MSA 6400			

5.4.2 Main Display Area

The pilot can select one of three views to display in the largest display area of the EIAP -- a plan view (similar to a STAR), an approach view (similar to current paper chart plan views), a breakout view, and an airport view. The view choices are immediately visible and the control is obvious to the pilot. The breakout view provides the pilot with a visual picture of what he or she will see as he or she breaks out of the clouds. The pilot has the capability to display the information in the main view as North-up or dynamic Track-up. The pilot may show or hide obstacles in the main view. The pilot has controls to pan around the main view to see areas surrounding the displayed information. The zoom control also provides the pilot with the capability to zoom in or out on the view.

Because the views (plan, approach, breakout, airport) are actually on different scales (basically different levels of zoom), the zoom in this implementation has a smaller range than the zoom in Prototype 1. Also, the level of detail changes occur with changes in views so there is no need to implement complex programming to allow changes in detail with this zoom implementation.

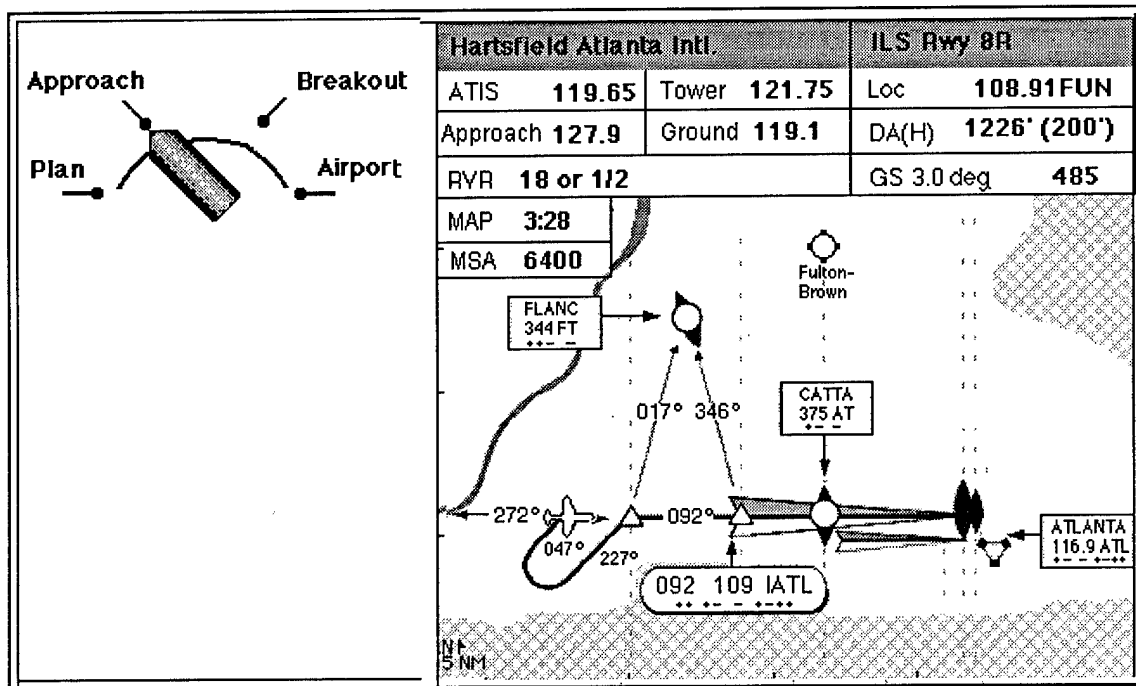

5.4.4 In-Flight Controls

Toggle switches allow the pilot to choose between a North-up and a Track-up reference frame and between displaying or hiding obstacles. A finger-tip joystick allows the pilot to pan around the view in the larger section of the display. It is expected that the cursor control for Prototype 3 would be mounted so that a hand rest will allow the pilot to operate the finger-tip joystick. Detents in the control make it easy for the pilot to quickly return to a centered view. Panning will most likely be used by pilots early in the approach during planning. Panning may not be appropriate on final approach due to the required heads-down time. A rotary control zoom function also provides a quick reset to the default zoom level.

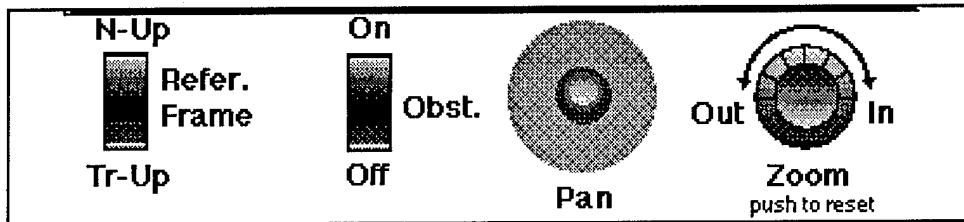

5.4.5 Multi-Function Push Buttons

Multi-function push buttons are used only in the setup stage of the approach. A touch of the Setup button places the EIAP in a setup mode and labels are displayed for the push buttons. Pilots use the buttons pre-flight and are not expected to use them during the approach. The setup mode allows the pilot to choose the appropriate approach chart and set the approach category and configuration. A number of other pre-approach functions may also be incorporated using the multi-function push buttons.

Prototype 3 is displayed in Figure 5-5.

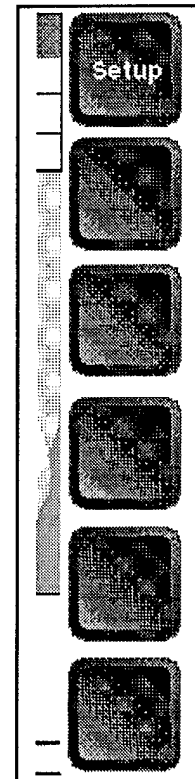

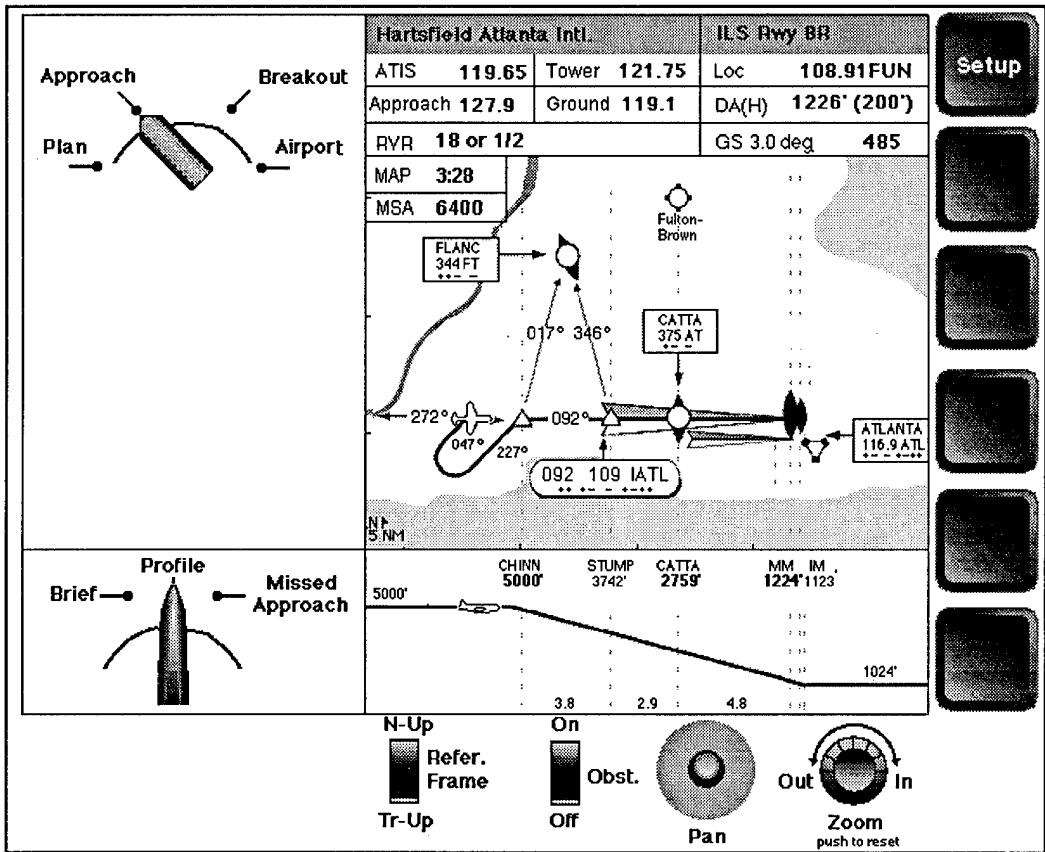

Key information in Invariant Heading Area

Multi-function push buttons for use in setup mode

Rotary selector switches to choose views for two view areas. Lines indicate the area the selector switches control.

North-up/Track-up and Obstacles On/Off toggle switches

Pan and Zoom controls

Figure 5-5. Prototype EIAP 3

6. CHECKLIST

This chapter combines the guidelines from Chapter 3 on General Principles and from Chapter 4 on Features and Functions into a checklist for use by certifiers and designers of EIAPs. The checklist does not list all of the guidelines as presented in the document. Rather, the checklist summarizes the key guidelines, following the same organization as a document. The relevant section of the document is listed in parenthesis following the related section in the checklist. This checklist is not intended to be a requirement or a standard for the design or certification of guidelines. Rather, it serves as a reminder of some of the basic principles and potential problem areas discussed in the document, and may be helpful for certifiers and designers as a quick reference. Readers are encouraged to read the document prior to using the checklist and to refer to the document in cases where more information is needed in a specific area. Many of the guidelines, and thus, checklist items, are subjective in nature and require interpretation based on operational experience. The checklist should be used **in addition to** flight testing of EIAPs. If certifiers use the checklist prior to flight testing an EIAP system, the checklist may act as a reminder and help create a mindset for the identification of potential problems in flight.

GENERAL GUIDELINES

- 1. EIAP Fidelity with IAP Task (3.1)** - The EIAP design should correspond to the user's conceptual model of the IAP task. The EIAP design should facilitate the IAP task.

Guidelines	Acceptable		Comments
1.1 Does the EIAP provide all information necessary for the IAP task?	Yes	No	
1.2 Does the EIAP display only relevant information (e.g., based on aircraft category and type of approach)?	Yes	No	
1.3 Is the flow of the EIAP system comparable to the flow of the IAP task?	Yes	No	
1.4 Do controls in the EIAP system allow pilots to access information quickly with minimum thought and action?	Yes	No	
1.5 Does the EIAP facilitate both IAP planning and discrete information retrieval?	Yes	No	

- 2. Consistency (3.2)** - The EIAP design should act and react to pilot selections in a consistent manner. Symbols, terminology, and location of information need to be consistent.

Guidelines	Acceptable		Comments
2.1 Are symbols used consistently throughout the EIAP?	Yes	No	
2.2 Except for information that indicates geographical location, is information located in a constant position within the EIAP? (e.g., task critical information should always be located in the same place)	Yes	No	
2.3 Does the interface react consistently to pilot selections?	Yes	No	
2.4 Does the interface use consistent terminology within and between EIAP charts?	Yes	No	

3. **Directness/Compatibility (3.3)** - In general, use of the EIAP system should be intuitive to pilots. It should display information and provide tools or controls in such a way that the use of the EIAP system is natural to the pilot. The amount of information recoding should be kept to a minimum.

Guidelines	Acceptable		Comments
3.1 Does the EIAP interface behave in a way that is natural and intuitive to pilots?	Yes	No	
3.2 Does the information in the EIAP adhere to the pilot's vocabulary and organization of data?	Yes	No	
3.3 Is the information displayed so that it requires a minimum of recoding or interpretation? (e.g., uses pictures of runway configurations rather than acronyms)	Yes	No	

4. **Visibility (3.4)** - To the extent possible, all EIAP features, functions, actions, and controls should be visible to the pilot. In any case where the feature cannot be made directly visible, the interface should provide a visible cue that can lead the pilot to the feature. In addition to making actions visible, the EIAP should make the results of actions visible.

Guidelines	Acceptable		Comments
4.1 Are all features, functions, actions, and controls visible to the pilot?	Yes	No	
4.2 Whenever multiple choices exist (e.g., approaches to an airport) does the EIAP list the of choices?	Yes	No	
4.3 If sequences are required for performing actions, are they visibly indicated?	Yes	No	
4.4 Are results of pilot selections visibly indicated?	Yes	No	
4.5 Are system settings displayed? (e.g., is aircraft category displayed)	Yes	No	

5. **Limit the Use of Modes (3.5)** - Modes are separate states or situations in which the same actions may cause different responses by the system. This often leads to errors. The number of modes should be limited and when separate modes are implemented, caution is necessary.

Guidelines	Acceptable		Comments
5.1 Is the number of modes limited (one is best, if there are more, are they easily remembered)?	Yes	No	
5.2 Are all modes visually distinctive?	Yes	No	
5.3 Does a mode indicator display the current mode?	Yes	No	
5.4 Is switching between modes fast and easy?	Yes	No	
5.5 Where possible, are features and functions within different modes consistent? If not, are the differences in the functions easily discernable?	Yes	No	

6. **Pilot Control (3.6)** - Pilots should have control over the display of information on the EIAP. Pilot control features should be implemented in a manner that does not overly complicate the system.

Guidelines	Acceptable		Comments
6.1 Does the pilot have control over major functions of the system such as information filtering or declutter, the change of sequential views during the approach, the frame of reference?	Yes	No	
6.2 Can the pilot access any information item that may be needed at any given time?	Yes	No	

7. **Simplicity (3.7)** - The time critical nature of the instrument approach task requires that EIAPs be as simple as possible. Consistency, visibility, directness, and limited functionality help to maintain a simple system.

Guidelines	Acceptable		Comments
7.1 Are the number of features and functions in the system limited so that they do not create an overly complex interface?	Yes	No	
7.2 Are all functions rapidly accessible and simple to execute?	Yes	No	
7.3 Is the information displayed on the EIAP restricted to necessary information only?	Yes	No	
7.4 Does use of the EIAP require the same or less time, effort, or interpretation as the use of paper IAP charts?	Yes	No	

8. **Forgiveness (3.8)** - An EIAP system should be forgiving in its interactions with the user. Users should be able to easily undo actions made in error and the system should warn users when they are about to perform an action that is not easily reversed.

Guidelines	Acceptable		Comments
8.1 Does the EIAP provide a fast and easy way to return to default view conditions?	Yes	No	
8.2 Does the EIAP provide a method to reverse user actions (such as an "undo" control)?	Yes	No	
8.3 Are users always warned before they complete a task that causes irretrievable data loss or before they perform an action that is not reversible?	Yes	No	
8.4 If an action requires a long system response time (more than 3-4 seconds), does the user have a means of canceling the action?	Yes	No	

9. **Feedback (3.9)** - Users should always be provided with immediate and meaningful feedback for user or system initiated events. Sometimes feedback is inherent in the response to the actions, if it is not, the system should provide feedback such as a message.

Guidelines	Acceptable		Comments
9.1 Does the EIAP provide feedback for user actions during data entry? Are keystrokes displayed stroke by stroke?	Yes	No	
9.2 Does the EIAP system respond to every control action with an immediate visible or auditory reaction?	Yes	No	
9.3 Does the system provide a message or indicator when system response is slow (more than 1 second) and the user is required to wait?	Yes	No	
9.4 Does the system provide feedback to indicate what items are available for selection (or what items are not available for selection) and what items are currently selected?	Yes	No	

10. **Locate and Group in a Meaningful Manner (e.g., by function, importance, sequence, and frequency) (3.10)** - All information should be arranged and grouped on the EIAP in a meaningful manner. Grouping by function, importance, sequence, and frequency ensures a meaningful layout and, therefore, faster visual search.

Guidelines	Acceptable		Comments
10.1 Is the information arranged and grouped on the EIAP in a meaningful manner? See also Features and Functions checklist.	Yes	No	

FEATURES AND FUNCTIONS (Version 1)

1. How is Information Displayed or Coded?

Guidelines	Acceptable		Comments
<p>1.1 Are alphanumerics presented appropriately? (4.1)</p> <ul style="list-style-type: none"> · sans serif font with distinctive letters used · adequate size, spacing, and height to width ratio for alphanumerics · minimum (preferably 2 or less) number of typefaces used · acronyms and abbreviations avoided except where familiar · all sentences easily understandable · related items presented in logically ordered lists 	Yes	No	
<p>1.2 If symbols or icons are used, are they used appropriately? (4.2)</p> <ul style="list-style-type: none"> · symbols or icons look like the objects they are intended to represent · symbols are large enough · essential labels are provided with each symbol · all symbols or icons are distinct · the level of detail in symbols or icons has been minimized so that only important identifying features are shown · each symbol or icon has only one meaning · the number of symbols or icons has been kept to a minimum 	Yes	No	

<p>1.3 If color is used as a coding mechanism, is it used appropriately? (4.3)</p> <ul style="list-style-type: none"> · color codes are used consistently with existing standards of either cockpit electronic displays or topographical conventions · less than eight color codes are used · color codes are used redundantly with other codes (e.g., shape, size, labels) · a method is provided for the pilot to identify unknown color codes or meaning is obvious · colors are perceived correctly in cockpit 	Yes	No	
<p>1.4 If size or highlighting are used as coding mechanisms, are they used appropriately? (4.4)</p> <ul style="list-style-type: none"> · the most important symbols are largest · uses three or fewer sizes · at least 1.5 difference between sizes · warnings or cautions are coded consistently · highlighting can be turned off 	Yes	No	
<p>1.5 Are labels and legends used properly? (4.5)</p> <ul style="list-style-type: none"> · consistent, concise, distinct, meaningful labels used · static labels distinct from data entry fields · labels positioned adjacent to associated objects · labels positioned consistently in relation to associated objects · labels maintain horizontal presentation 	Yes	No	
<p>1.6 If displayed, are aircraft location, planned route, and current path displayed appropriately? (4.6)</p> <ul style="list-style-type: none"> · aircraft location, planned route, or current path displayed accurately · aircraft location, predicted path, and/or planned path distinguishable 	Yes	No	

<p>1.7 Is terrain information displayed properly? (4.7)</p> <ul style="list-style-type: none"> · precise terrain elevation representation (to approximately 100') displayed in the area surrounding the airport · at least one method of terrain display that promotes terrain situational awareness (e.g., contour lines or MSA circle) · the number of terrain depiction methods limited so that the user is not confused by too many different methods of terrain depiction · terrain elevation labels large enough and sufficiently separated · the meaning of terrain elevation labels (actual elevation or safe elevation with a buffer) obvious 	Yes	No	
<p>1.8 Is auditory information presented properly? (4.8)</p> <ul style="list-style-type: none"> · extremely high and low frequency sounds avoided (best frequencies -- 500 to 3000 hz) · distinctive codes for each signal · consistent codes for same meaning · compatible with other cockpit systems · simple method to turn off 	Yes	No	

2. How is Information Grouped and Arranged?

Guidelines	Acceptable		Comments
<p>2.1 If windows are used to display separate views, are they used appropriately? (4.9)</p> <ul style="list-style-type: none"> · functionally related items are displayed on the same page · windows behave consistently · each window has a meaningful label · temporary windows do not obscure important information · simple way to open/close windows or switch between windows 	Yes	No	
<p>2.2 Are menus implemented appropriately? (4.10)</p> <ul style="list-style-type: none"> · number of menus and number of options limited to those that can be searched and decided on in time allowed · menu options meaningful and unambiguous · familiar and consistent terminology · consistent menu location · menu choices ordered appropriately · fast paths provided if needed · menu structure broad and shallow, not narrow and deep 	Yes	No	
<p>2.2 Is the frame of reference provided by the EIAP appropriate to the task? (4.11)</p> <ul style="list-style-type: none"> · uses a consistent frame of reference, or · allows the pilot to choose the frame of reference and provides a visibly obvious cue that it has changed and a visible indicator of current reference frame · Track-up reference frames show indication of compass direction 	Yes	No	
<p>2.3 Is key information (e.g., labels, task critical information, status) located in an invariant area on the screen? (4.12)</p>	Yes	No	

<p>2.4 Is the information in the EIAP logically grouped? (4.13)</p> <ul style="list-style-type: none"> · information is grouped by sequence - information needed at the same time, available in the same view · information is grouped by function · information is grouped by importance or criticality · information is grouped by frequency of use · information is grouped based on the task the pilot is performing (e.g., planning vs. navigation) 	Yes	No	
<p>2.5 Is related information grouped through the use of white space or through the judicious use of techniques such as lines, boxes, and shading? (4.14)</p>	Yes	No	
<p>2.6 Is the map scale indicated properly on the EIAP? (4.15)</p> <ul style="list-style-type: none"> · scale of both plan and profile view indicated · linear scale, familiar units, and standard tick mark intervals used · grids unobtrusive and removable 	Yes	No	
<p>2.7 Is the information presented in a manner appropriate to the task and phase of flight? (4.16)</p> <ul style="list-style-type: none"> · correct information displayed or easily available for each phase · mode or view that assists in planning available 	Yes	No	

<p>2.8 Does the EIAP provide safeguards against errors? (4.17)</p> <ul style="list-style-type: none"> · critical information always displayed in a consistent location and format · constraints prevent errors (non-selectable items appear different, warnings for data loss) · appropriate sequence of actions indicated · items that may be confused are displayed in a distinct location or format 	Yes	No	
<p>2.9 Is the EIAP consistent with other cockpit symbols, terminology, units, scales, and layout? Is it located in a position that is compatible with other cockpit systems? (4.18)</p>	Yes	No	

3. How Does the Display Change?

Guidelines	Acceptable		Comments
<p>3.1 Are proper input devices used for the EIAP? (4.19)</p> <ul style="list-style-type: none"> · cursor control devices and touch-screens have appropriate hand support for use · area to be touched or selected is sufficiently large for cockpit environment · input controls incorporate feedback to indicate acceptance of data entry · accidental activation of controls minimized · controls compatible with normal movement and with accepted standards · fast (less than 1 second) response to control input 	Yes	No	

<p>3.2 Are customizing features implemented properly? (4.20)</p> <ul style="list-style-type: none"> · customizing provided as needed for pilot, aircraft, and situational differences · visual display of current state of system · if extensive customizing is allowed -- a fast and easy return to default condition is provided · customizing does not overly complicate the system · alternate users considered if necessary 	Yes	No	
<p>3.2 Is zooming implemented properly? (4.21)</p> <ul style="list-style-type: none"> · does not cause obstruction of information · does not make information unreadable · is within an acceptable range · provides a method to quickly return to a normal setting · provides an indication of zoom level or position (e.g., an inset of overview) 	Yes	No	
<p>3.3 Is panning implemented properly? (4.22)</p> <ul style="list-style-type: none"> · panning control moves in same direction as frame -- data moves in opposite direction to control · indicator of overall position provided (e.g., inset view) · rapid means to return to normal setting provided 	Yes	No	
<p>3.4 Are potential problems of display dynamics accounted for? (4.23)</p> <ul style="list-style-type: none"> · display updated automatically · if dynamics influence readability - display can be frozen · frozen state indicated · stable display elements provided · critical information never obscured · text in readable position consistently 	Yes	No	

<p>3.5 Are decluttering features implemented properly? (4.24)</p> <ul style="list-style-type: none"> · a visible indication of absent or minimized information · an obvious means of retrieving hidden information · if decluttering is extensive, a quick return to a normal or default state 	Yes	No	
<p>3.6 Are automatic functions used appropriately? (4.25)</p> <ul style="list-style-type: none"> · used only for functions that do not require extensive pilot skill · does not require constant checking · used for computations of available data · redundant data entered automatically 	Yes	No	
<p>3.7 Are memory aids, sequence reminders, alerts, and alarms used properly? (4.26)</p> <ul style="list-style-type: none"> · alerts and alarms used judiciously and are pilot controllable · alerts and alarms distinctive, consistent, and compatible with other cockpit systems · fast and simple alarm acknowledgment · blinking, bolding, warnings, reverse video, color used sparingly 	Yes	No	
<p>3.8 Are airport and NAVAID search functions implemented properly? (4.27)</p> <ul style="list-style-type: none"> · flexible methods for search · display only valid choices · facilitate recognition rather than require recall · natural organization of data consistent with pilot's conceptual model 	Yes	No	

7. REFERENCES

- Adams, R., Adams, C., Eldredge, D., and Huntley, M. (1993). Determination of Loran-C/GPS Human Factors Issues. (VNTSC Report No. DOT-VNTSC-93-3). Cambridge, MA: U.S. Department of Transportation, John A. Volpe National Transportation Systems Center.
- Andre, A. and Wickens, C. (1992). Compatibility and Consistency in Display-Control Systems: Implications for Aircraft Decision Aid Design. Human Factors 34: 639-653.
- Apple Computer, Inc. (1992). Macintosh Human Interface Guidelines. Reading, Massachusetts: Addison Wesley Publishing Company.
- Aretz, A. (1988). A Model of Electronic Map Interpretation. Proceedings of the Human Factors Society 32nd Annual Meeting, (Anaheim, CA): 130-134.
- Aretz, A. (1991). The Design of Electronic Map Displays. Human Factors 33: 85-101.
- Ashcraft, M. (1988). Human Memory and Cognition. Harper Collins.
- Baker, S., Lamb, L., Guohua, L., and Dodd, R. (1993). Human Factors in Crashes of Commuter Airplanes. Aviation, Space, and Environmental Medicine 64(1): 63-68.
- Ballas, J., Heitmeyer, C. and Perez, M. (1992). Evaluating Two Aspects of Direct Manipulation in Advanced Cockpits. CHI '92 - Association for Computing Machinery (ACM) Conference on Human Factors in Computing Systems Conference Proceedings.
- Baty, D., Wempe, T., and Huff, E. (1974). A Study on Aircraft Map Display Location and Orientation. IEEE Transactions on Systems, Man, and Cybernetics 4: 560-568.
- Beringer, D., Allen, R., Kozak, K., and Young, G. (1993). Responses of Pilots and Nonpilots to Color-coded Altitude Information in a Cockpit Display of Traffic Information. Proceedings of the Human Factors and Ergonomics Society 37th Annual Meeting, (Seattle, WA): 84-87.
- Blanchard, J. (1991). Instrument Approach Procedures Chart. A Study of the User Population's Preferences Including Terrain Depiction. (CAAR Report No. CAAR-15410-91-2). Daytona Beach, FL: Embry-Riddle University, Center for Aviation/Aerospace Research.
- Block, T. (1993, October). The Hand is Quicker than the Brain. Plane and Pilot: 14-15.

- Bowser, S. (1991). Review of Army Tactical Command and Control System Soldier-Machine Interface Issues. (Pacific Northwest Laboratory Report No. PNL TO 91-04). Fort Lewis, Washington: U.S. Army Tactical Command and Control System Experimentation Site.
- Brown, C.M. (1988). Human-Computer Interface Design Guidelines. Norwood, New Jersey: Ablex Publishing Corporation.
- Cayne, B. (Ed.) (1992). New Webster's Dictionary and Thesaurus of the English Language. Danbury, CT: Lexicon Publications, Inc.
- Clay, M. (1993). Key Cognitive Issues in the Design of Electronic Displays of Instrument Approach Procedure Charts. (VNTSC Report No. DOT-VNTSC-FAA-93-18). Washington, D.C.: Federal Aviation Administration, U.S. Department of Transportation.
- Cooper, L. and Podgorny, P. (1976). Mental Transformations and Visual Comparison Processes: Effects of Complexity and Similarity. Journal of Experimental Psychology: Human Perception and Performance 2: 503-514.
- Degani, A. (1992). On the Typography of Flight-Deck Documentation. (NASA Contractor Report No. 177605, Contract NCCS-327). Moffett Field, California: Ames Research Center, National Aeronautics and Space Administration.
- Department of Defense (1993). Department of Defense Technical Architecture Framework for Information Management Volume 8. Human Computer Interface Style Guide. Version 3.0. Defense Information Systems Agency.
- De Ree, H. (1990, April). Colour Coding of En Route Flying Charts. Displays, 73-78.
- Endsley, M. R., and Bolstad, C. A. (1993). Human Capabilities and Limitations in Situation Awareness. In AGARD Conference Proceedings 520. Combat Automation for Airborne Weapon Systems: Man/Machine Interface Trends and Technologies, 19-1 - 19-10.
- Eysenck, M. (1984). A Handbook of Cognitive Psychology. London: Lawrence Erlbaum Association.
- Fadden, D., Braune, R., and Wiederman, J. (1992). Spatial Displays as a Means to Increase Pilot Situational Awareness. Atlanta, GA: Human Factors Society Annual Meeting Poster Presentation.

- Federal Aviation Administration, Department of Transportation (1987). Advisory Circular - Transport Category Airplane Electronic Display Systems (AC No. 25-11). Washington D.C.: Department of Transportation, Federal Aviation Administration.
- Federal Aviation Administration, Department of Transportation (1992). Human Factors Design Principles for Instrument Approach Procedure Charts: Volume 1 - Readability. Washington D.C.: Department of Transportation, Federal Aviation Administration.
- Friend, V. (1988, June). Caution: High Terrain All Quadrants. Airline Pilot 57(6): 21-25.
- Helander, M. (Ed.) (1988). Handbook of Human-Computer Interaction. New York, NY: Elsevier Science Publishing Company, Inc.
- Hennessy, R., Hutchins, C., and Cicinelli, J. (1990). Color Requirements for the E-2C Enhanced Main Display Unit. (Monterey Technologies, Inc. Report No. MTI 9002, Contract No. N00019-89-C-0174). Washington, DC: Department of the Navy.
- Hix, D. and Hartson, H. (1993). Developing User Interfaces - Ensuring Usability Through Product and Process. New York: John Wiley and Sons, Inc.
- Hofer, E.F., Palen, L.A., Dresel, K.M., and Jones, W.P. (1991). Flight Deck Information Management Phase I. (Boeing Commercial Airplane Group Document D6-56305, Contract No. DTFA01-90-C00055). Washington DC: Federal Aviation Administration.
- Hofer, E.F., Palen, L.A., Higman, K.N., Infield, S.E., and Possolo, A. (1992). Flight Deck Information Management Phase II. (Boeing Commercial Airplane Group Document D6-56305-1, Contract No. DTFA01-90-C00055). Washington DC: Federal Aviation Administration.
- Hollands, J.G. and Merikle, P.M. (1987). Menu Organization and User Expertise in Information Search Tasks. Human Factors 29: 577-586.
- Hopkin, V. D. (1992). Issues in Color Application. In H. Widdel and D. L. Post (Eds.) Color in Electronic Displays. New York, NY: Plenum Press: 191-206
- Huey, B. and Wickens, C. (Eds.) (1993). Workload Transition - Implications for Individual and Team Performance. National Research Council. Washington, DC: National Academy Press.
- Huntley, M. S. (1993). Verbal presentation: NASA Langley (unpublished).

- IBM Corporation (1991). Common User Access Guide to User Interface Design. Cary, NC: Author.
- International Air Transport Association (1975, November). Safety in Flight Operations. Twentieth Annual Conference. Approach Plates (Conf. 20/WP-35 Agenda Item 3.4, Presented by United Airlines). Istanbul, Turkey.
- Jeppesen-Sanderson (1992). Instrument Approach Charts. Englewood, Co.: Jeppesen Sanderson.
- Kansas, D. (1993). The Icon Crisis: Tiny Pictures Cause Confusion. TheWall Street Journal, 17 November: B1, B8.
- Kantowitz, B. and Sorkin, R. (1983). Human Factors Understanding People-System Relationships. New York, NY: John Wiley & Sons.
- Kirlik, A. (1991). Modeling Strategic Behavior in Human-Automation Interaction: Why an "Aid" Can (and Should) Go Unused. Human Factors 35: 221-242.
- Klatzky, R.L. (1975). Human Memory: Structure and Processes. San Francisco, CA: W.H. Freeman and Co.
- Koffka, K. (1935). Principles of Gestalt Psychology. New York, NY: Harcourt, Brace & World.
- Kuchar, J. K., and Hansman, R. J. (1992). Advanced Terrain Displays for Transport Category Aircraft (Tech. Report DOT-VNTSC-FAA-92). Federal Aviation Administration, U. S. Department of Transportation.
- Lewis, H. and Fallesen, J. (1989). Human Factors Guidelines for Communication and Control Systems: Battlefield and Decision Graphics Guidelines. Research Project 89-01. U.S. Army Research Institute for the Behavioral and Social Sciences, Alexandria, VA.
- MacGregor, E.L., Lee, E., and Newman, L. (1986). Optimizing the Structure of Database Menu Indexes: A Decision Model of Menu Search. Human Factors 28: 387-399.
- Mackie, R.R. & Wylie, C.D. (1988). Factors Influencing Acceptance of Computer-Based Innovations. In Handbook of Human-Computer Interaction. Holland: Elsevier: 1081-1106.
- Mangold, S. J., Eldredge, D., and Lauber, E. (1992). A Human Factors Handbook for Instrument Approach Procedure Chart Design. (Tech. Report DOT-VNTSC-FAA-92). Columbus, OH.

- Martel, A. and Ward, G. (1993, April). Ergonomic Development of Digital Map Displays. British Aerospace Public Ltd. Co. Military Aircraft Div. In AGARD, Combat Automation for Airborne Weapon Systems: Man/Machine Interface Trends and Technologies. (Kingston-upon-Thames, England) (SEE N93-28850 11-54): 8.
- Microsoft Corporation (1992). The Windows Interface. An Application Design Guide. Redmond, Washington: Microsoft Press.
- Moray, N. (1984). Attention to Dynamic Visual Displays in Man-Machine Systems. In R. Parasuraman & R. Davies (Eds.), Varieties of Attention. New York: Academic Press: 485-512.
- Multer, J., Warner, M., Disario, R. and Huntley, M. (1991). Design Considerations for IAP Charts: Approach Course Track and Communication Frequencies. (VNTSC Report No. DOT-VNTSC-FAA-91-11). Cambridge, MA: U.S. Department of Transportation, John A. Volpe National Transportation Systems Center.
- Mykityshyn, M., Bussolari, S., and Hansman, R. (1990). Approach Chart Information Analysis. (MIT Aeronautical Systems Laboratory Report No. ASL-90-1, Contract No. DTRS-57-88-C-00078, Task 2). Cambridge, MA: U.S. Department of Transportation, John A. Volpe National Transportation Systems Center.
- Mykityshyn, M. G., and Hansman, R. J. (1991). Development and Evaluation of Prototype Designs for Electronic Display of Instrument Approach Information. (Tech Report DTRS-57-88-C-00078). Cambridge, MA: MIT.
- NASA-Langley Research Center (1993). Verbal presentation to VNTSC, Battelle, and Monterey Technologies, Inc., March 9, 1993. Norfolk, VA: NASA-Langley Research Center.
- NASA Space Station Freedom Program Office (1992). Space Station Freedom Program (SSFP) Flight Human-Computer Interface Standards. (SSP 30570). Reston, Virginia: Space Station Freedom Program Office.
- Neisser, U. (1976). Cognition and Reality: Principles and Implications of Cognitive Psychology. San Francisco, CA: W. H. Freeman and Company.
- Norman, D. A. (1988). The Psychology of Everyday Things. New York, NY: Basic Books, Inc.
- Norman, K.L. (1991). The Psychology of Menu Selection. Designing Cognitive Control at the Human/Computer Interface. Ablex: Norwood, NJ.

- Noyes, L. (1980). The Positioning of Type on Maps: The Effect of Surrounding Material on Word Recognition Time. Human Factors 22: 353-360.
- O'Hare, D., and Roscoe, S. (1990). Flightdeck Performance: the Human Factor. Ames, IA: Iowa State University Press.
- Osborne, D. and Huntley, M. (1992). Design of IAP Charts: Comprehension Speed of Missed Approach Instructions Coded in Text or Icons. (VNTSC Report No. DOT-VNTSC-FAA-92-3). Cambridge, MA: U.S. Department of Transportation, John A. Volpe National Transportation Systems Center.
- Osborne, D.W., Huntley, Jr., M.S., Turner, J.W., and Donovan, C.M. (in press). The Effect of Instrument Approach Procedure Chart Design on Pilot Search Speed and Response Accuracy: Flight Test Results. Cambridge, MA: U.S. Department of Transportation, John A. Volpe National Transportation Systems Center.
- Potash, L. (1977). Design of Maps and Map-Related Research. Human Factors 19(2): 139-150.
- Reason, J. (1984). Lapses of Attention. In Parasuraman, R. and Davies, R. (Eds.) Varieties of Attention. New York: Academic Press, Inc.
- Reason, J. (1990). Human Error. New York, NY: Cambridge University Press.
- Reason, J. and Mycielska, K. (1982). Absent-minded? The Psychology of Mental Lapses and Everyday Errors. Englewood Cliffs, NJ: Prentice-Hall.
- Ricks, W. and Rogers, W. (1993). Management of Approach Plate Information Study (MAPLIST). Verbal presentation to VNTSC, Battelle, and Monterey Technologies, Inc., March 9, 1993. Norfolk, VA: NASA-Langley Research Center.
- Ritchie, M. (1988). General Aviation. In Wiener, E. & Nagel, D. (Eds.) Human Factors in Aviation, San Diego: Academic Press Inc.: 561-590.
- Rouse, W.B. & Morris, N.M. (1986). Understanding and Enhancing User Acceptance of Computer Technology. IEEE Transactions on Systems, Man, and Cybernetics 16: 965-973.
- SAE ARP 1874 (1988). Design Objectives for CRT Displays for Part 25 (Transport) Aircraft. Aerospace Recommended Practice. Warrendale, PA: Society of Automotive Engineers.

- SAE ARP 4032 (1988). Human Engineering Considerations in the Application of Color to Electronic Aircraft Displays. Aerospace Recommended Practice. Warrendale, PA: Society of Automotive Engineers.
- SAE ARP 4102/7 (1988). Electronic Displays. Aerospace Recommended Practice. Warrendale, PA: Society of Automotive Engineers.
- Sears, R. (1986). A New Look at Accident Contributions and the Implications of Operational and Training Procedures. In Nagel, D. (1988), Human Error in Aviation Operations. In Wiener, E. and Nagel, D. (Eds.) (1988), Human Factors in Aviation, San Diego, CA: Academic Press, Inc.: 263-303.
- Sheridan, T. (1992). Telerobotics, Automation, and Human Supervisory Control. Cambridge: MIT Press.
- Shneiderman, B. (1987). Designing the User Interface. Strategies for Effective Human-Computer Interaction. Reading, MA: Addison-Wesley Publishing Company.
- Silverstein, L., and Merrifield, R. (1985). The Development and Evaluation of Color Systems for Airborne Applications: Phase 1: Fundamental Visual, Perceptual, and Display System Considerations.
- Simpson, C., McCauley, M., Roland, E., Ruth, J., and Williges, B. (1985). System Design for Speech Recognition and Generation. Human Factors 27: 115-142.
- Smith, S. and Mosier, J. (1986). Guidelines for Designing User Interface Software. (USAF Electronic Systems Division Report No. ESD-TR-86-278, Mitre Corporation Report No. 10090). Hanscom Air Force Base, Massachusetts: USAF, AFSC, Electronic Systems Division (NTIS Document No. AD A177 198).
- Stokes, A. and Wickens, C. (1988). Aviation Displays. In Wiener, E. & Nagel, D. (Eds.), Human Factors in Aviation. San Diego: Academic Press, Inc.: 387-431.
- Stokes, A., Wickens, C., and Kite, (1990). Display Technology: Human Factors Concepts. Warrendale, PA: Society of Automotive Engineers.
- Taylor, R. and Hopkin, V. (1975). Ergonomic Principles and Map Design. Applied Ergonomics 6.4: 196-204.
- Taylor, R. (1985, October). Colour Design in Aviation Cartography. Displays: 187-201.
- Tufte, E. (1990). Envisioning Information. Cheshire, CT: Graphics Press.

- Vincow, M. and Wickens, C. (1993). Spatial Layout of Displayed Information: Three Steps Toward Developing Quantitative Models. Proceedings of the HFES 37th Annual Meeting.
- Wickens, C. (1984). Engineering Psychology and Human Performance. Columbus, OH: Charles E. Merrill Publishing Co.
- Wickens, C. and Flach, J. (1988). Information Processing. In Wiener, E. and Nagel, D. (Eds.) (1988), Human Factors in Aviation. San Diego: Academic Press, Inc.: 111-155.
- Wiener, E. (1988). Cockpit Automation. In Wiener, E. and Nagel (Eds.), Human Factors in Aviation. San Diego, CA: Academic Press, Inc.: 433-461.
- Wiener, E. and Nagel, D. (Eds.) (1988). Human Factors in Aviation. San Diego: Academic Press, Inc.
- Williams, L., (1966). The Effect of Target Specification on Objects Fixed During Visual Search. Perception and Psychophysics. Reprinted in Boff, K., Kaufman, L., and Thomas, J. (Eds.). Handbook of Perception and Human Performance. Vol. II, Cognitive Processes and Performance. New York: John Wiley and Sons: 28-77.
- Williges, R., Williges, B. and Elkerton, J. (1987). Software Interface Design. In Salvendy (1987). Handbook of Human Factors. New York: John Wiley and Sons: 1416-1449.

8. INDEX

AUTHOR INDEX

A

Adams, C..	29, 30
Adams, R.	29, 30
Allen, R.	61
Andre, A.	22
Apple Computer, Inc	16, 19, 22-24, 29, 30, 32, 33, 38, 39, 42, 53, 54, 83, 86, 95, 130, 131, 134, 146, 147
Aretz, A.	35, 36, 97, 98
Ashcraft	73, 76

B

Baker, S.	1
Ballas, J.	134
Baty, D.	97, 98
Beringer, D.	61
Blanchard, J.	1, 8-10, 16, 19, 36, 107
Block, T.	38, 163, 164
Bolstad, C.	32, 33
Bowser, S.	85, 86, 143
Braune, R.	116, 117
Brown, C.M.	22, 26, 27, 35, 36, 50, 53, 54, 59, 75, 101, 130-134
Bussolari, S.	8, 19, 119, 121

C

Cayne, B.	35, 36
Cicinelli, J.	59
Clay, M.C.	1, 5, 8-10, 12, 16, 19, 36, 53, 56, 58, 61, 97, 98, 107
Cooper, L.	98

D

Degani, A.	49-51
Department of Defense	21, 22, 36, 53-56, 61, 76, 84-86, 95, 98, 116, 117, 141-143, 146, 147, 150, 151, 160
DeRee	16, 19, 36
Disario, R.	1, 112-115

Dodd, R. 1
 Dresel, K.M. 8, 16, 19, 36, 107, 168, 169

E

Eldredge, D. 22, 29, 30
 Elkerton, J. 23, 24
 Endsley, M.R. 32, 33
 Eysenck, M. 9, 63, 64, 110, 113

F

Fadden, D. 116, 117
 Fallesen, J. 143
 Federal Aviation Administration 50, 51, 58, 59
 Friend, V. 1, 16, 19, 36, 107

G

Guohua, L. 1

H

Hansman, R.J. 1, 8-10, 16, 19, 36, 58, 61, 70, 71, 73-76, 97,
 107, 119, 121, 153, 154, 168, 169, 171, 172
 Hartson, H. 39, 85
 Heitmeyer, C. 134
 Helander, M. 23, 24, 130, 13
 Hennessy, R. 58-6
 Higman, K.N. 8-10, 16, 19, 36, 97, 98, 107, 127, 128, 168, 169
 Hix, D. 39, 86
 Hofer, E.F. 8-10, 16, 19, 36, 107, 127, 128, 168, 169
 Hollands, J.G. 94, 95
 Hopkin, V.D. 1, 58, 61
 Huey, B. 32, 33, 70, 71
 Huff, E. 97, 98
 Huntley, M.S. 1, 9, 10, 29, 30, 53, 56, 112-115, 172
 Hutchins, C.. . . . 58-61

I

IBM Corporation 16, 19, 21-24, 26, 27, 29, 30, 32, 33, 39, 42, 83, 86, 101, 130, 134
 Infield, S.E. 8-10, 16, 19, 36, 107, 127, 128, 168, 169

International Air Transport Association 8, 16, 19, 36, 107

J

Jeppesen-Sanderson 22
Jones, W. 8, 16, 19, 36, 107, 168, 169

K

Kansas, D. 53, 56
Kantowitz, B. 130, 134
Kirlik, A. 160
Kite, K. 22, 78, 82, 97, 98
Klatzky, R.L. 53
Koffka, K. 110, 113
Kozak, K. 61

L

Lamb, L. 1
Lauber, E. 22
Lee, E. 95
Lewis, H. 76, 143

M

MacGregor, E.L. 95
Mackie, R.R. 158, 160
Mangold, S.J. 22
Martel, A. 35, 98, 136, 138, 153, 154
McCauley, M.E. 79, 82
Merikle, P.M. 94, 95
Merrifield, R.M. 59, 61
Microsoft Corporation 22
Moray, N. 136, 138
Morris, N.M.. 157, 158, 160
Mosier, J.N. 3, 15, 32, 33, 36, 37, 39, 40, 47, 49-51, 54-56, 60, 61,
63, 64, 66, 68, 71, 83-85, 93, 95, 101, 104, 105, 107,
130-134, 143, 146, 147, 150, 151, 160, 164, 165, 169
Multer, J. 1, 112-115
Mycielska, K. 123, 125

Mykityshyn, M.G. 1, 8-10, 16, 19, 36, 58, 61, 97, 107, 119, 121, 127, 128, 136,
138, 153, 154, 168, 169, 171, 172

N

Nagel, D. 22
NASA-Langley Research Center 16, 19, 36, 107
NASA Space Station Freedom Program Office 22
Neisser, U. 22
Newman, L. 95
Norman, D.A. 16, 26, 27, 125
Norman, K.L. 88, 90, 93, 95
Noyes, L. 110, 113

O

O'Hare, D. 23, 24
Osborne, D.W. 1, 53, 56, 172

P

Palen, L.A. 8-10, 16, 19, 36, 107, 127, 128, 168, 169
Perez, M. 134
Podgorny, P. 98
Possolo, A. 8-10, 16, 19, 36, 107, 127, 128, 168, 169
Potash, L. 63, 64

R

Reason, J. 1, 3, 93, 123, 125, 157, 183
Ricks, W. 8
Ritchie, M. 127, 128
Roland, E.F. 79, 82
Roscoe, S. 23, 24
Rouse, W.B. 157, 158, 160
Ruth, J.C. 79, 82

S

SAE ARP 4032 61
SAE ARP 4102/7 21, 22, 50, 51, 54, 56, 58, 59, 71
SAE ARP 1874 61
Sears, R. 163, 164

Sheridan, T.B.	160
Shneiderman, B.	22, 24
Silverstein, L.D.	59, 61
Simpson, C.A.7	9, 82
Smith, S.L.	3, 15, 32, 33, 36, 37, 39, 40, 47, 49-51, 54-56, 60, 61, 63, 64,66, 68, 71, 83-85, 93, 95, 101, 104, 105, 107, 130-134, 143, 146, 147, 150, 151, 160, 164, 165, 169
Sorkin, R.	130, 134
Stokes, A.	22, 78, 82, 97, 98, 136, 138

T

Taylor, R.	1, 16, 19, 36, 107
Tufte, E.	113

V

Vincow, M.	127, 128
--------------------	----------

W

Ward, G.	35, 98, 136, 138, 153, 154
Warner, M.	1, 112-115
Wempe, T.	97, 98
Wickens, C.	22, 32, 33, 70, 71, 73, 76, 78, 82, 97, 98, 127, 128, 136, 138
Wiederman, J.	116, 117
Wiener, E.	22, 157, 160
Williams, L.	58, 64
Williges, B.H.	23, 24, 79, 82
Wylie, C.D.	158, 160

Y

Young, G.	61
-------------------	----

SUBJECT INDEX

A

- Aerodrome sketch 174-176
- Aircraft
 category 11, 27, 105, 175, 196, 197
 environment 184
 location . 18, 23, 47, 70, 74, 75, 81, 97, 124, 125, 158, 159, 163, 168, 171, 184, 202
 path see Path
 position 13, 70, 74, 75, 97, 116, 150
 route see Route
 speed 171
 symbol 71, 73, 75, 97, 151
- Airports 20, 106, 142, 168, 169, 166, 177
- Alarm 78, 79, 163-165, see also Alert, Auditory alarm, Warning
- Alert . . . 18, 78-81, 123, 127, 158, 160, 163-165, see also Alarm, Auditory alarm, Warning
- Alphanumeric 47-50, 115, 133, 201, see also Text
- Alternate 166, 177
- Approach lights 166, 174, 176
- Approach path 35, 55, 157, see also Path
- Altitude
 AMA 75
 final approach fix altitude 101
 MDA 7, 9, 17, 85, 105, 180
 MEA 74, 75
 MSA 66, 73-77, 119, 125, 177, 184, 188, 203
 decision altitude see Decision altitude
- Air traffic control (ATC) 5-8, 12, 22, 70, 73, 88, 123, 157, 163
- Auditory
 alarm/warning 164, 165, see also Alarm, Alert, Warning
 display 47, 78-82, 164
 feedback 78, 132, see also Feedback

Automation/automatic 48, 150, 157-162

B

Blinking 50, 63-65, 164, 165, see also Highlight

Box 69, 96, 110-115, 141, 175

Breakout 16, 87, 98, 158, 190

Brief (of approach) 5, 6, 87, 93, 184

Brightness 63-65, 110, 124, see also Highlight

Button see Controls

C

Cautions see Alarms, Alerts, Warnings

City/cities 11, 27, 31, 43, 49, 58, 90, 95, 106, 168, 169

Clearance 6, 7, 47, 70, 73, 75, 77, 120, 163

Clutter 1, 24, 26, 55, 68, 69, 74, 78, 83, 93, 110,
113, 120, 127, 136, 137, 153, 171, 178, see also Declutter

Cockpit 1, 5, 23, 48, 50, 54, 58-61, 70, 71, 78-80,
127-132, 142, 146, 163, 164, 171, 189, 202, 203

Codes/coding 5, 49-82, 94, 95, 110-111, 145, 147, 164-166, 202, 203

Cognitive (aspects of task, workload) 5, 9, 11-13, 16, 53, 73, 157

Color 47, 53, 58-61, 70-74, 76, 96, 110, 111, 131, 132, 164-166, 180, 182, 202

Comments (on an EIAP) 138

Communication aids 119

Compatibility 23, 132, 197

Directness 15, 23, 24, 35, 197, 199
Display(s) size 24, 88, 142
Dynamic display 67, 116, 150, 151, see also Moving map

E

Error(s) 12, 24, 29, 30, 36, 38, 39, 48, 88, 90, 95, 97, 123-126, 198, 199

F

Feedback 15, 26, 41-43, 78, 79, 125, 131-133, 200
 auditory 78, 132
 tactile 131, 132
 visual 41-43, 132

Font 49, 50, 52, 63, 94, 201
 size 50, 63

Forgiveness 15, 38, 125, 199

Frame of reference 32, 47, 97-100, 107, 150, 171, 184, 187, 192, 198, 204

Frequency/frequencies 5, 8, 9, 11, 12, 15, 17, 18, 31, 44, 45, 57,
 63, 65, 67, 80, 81, 94, 101, 102, 104-107,
 111, 112, 114, 115, 119, 123, 136, 137, 145,
 157-159, 164, 168, 172, 177, 181, 183, 188, 189, 200, 203

G

Group(ing) 7, 8, 9, 13, 20, 42, 45, 51, 60, 61, 79, 80, 98, 98,
 101, 103-106, 118, 124, 132, 142, 152, 154, 188
 strategy 104-109
 method 110-115

H

Heading (aircraft) 6, 7, 23, 59, 70, 108, 123

Headings (approach chart) 13, 125, 172, 176, 177, 180, 183, 184, 189, 193

Highlight 18, 42, 47-50, 53, 63-65, 75, 77, 84, 124, 132, 163, 164, 169, 183, 202

I

IAP (paper) chart 1, 2, 5-13, 16, 22, 36, 49, 53, 54, 66, 73, 84, 106, 110,
112, 119, 123, 127, 171, 172, 174-176, 183, 196, 199

Icon 26, 29, 47, 53-55, 93, 122, 153, 179, 191, 201, see also Symbol

Information requirements 1, 5, 7-12, 16, 33, 36, 47

Input 22, 48, 130, 131, 133, 165, 171, 183

Inset view 117, 143, 144, 147, 162, 178

Instrument approach task 4-12

Integrate/integration 12, 23, 25, 48, 70, 73, 76, 79, 97, 104,
108, 125, 127-129, 157, 163, 164, 168

Interference 78, 123, 165

Interruptions 12, 48, 67, 123, 124, 163

Invariant display areas 20, 21, 47, 67, 91, 101, 177, 193, 204

J

Jeppesen-Sanderson 22, 172

K

Knowledge 3, 5, 12, 15-18, 33, 104, 106, 123

L

Label(s) 18, 24, 26, 28, 37, 41, 43, 53, 55, 63, 66-69, 74, 75,
85, 93, 94, 96, 98, 101, 110, 112-116, 125, 130, 131, 134
136, 137, 141, 153, 154, 150, 172, 180, 183, 192, 201-204

Layering, information layers 48, 64, 136, 153, 154, 156

Legend 47, 50, 53-55, 56, 66, 67, 85, 173, 183, 202

M

Memory 12, 13, 17, 18, 37, 48, 53, 55, 123, 124, 136, 163, 164, 169
aid(s) 12, 18, 48, 124, 163, 164

Menu(s) 18, 20, 31, 47, 88-96, 107, 130, 131, 204
options 88-96, 204

Message/prompt 27, 34, 39, 41, 42, 78, 79, 88, 165, 200

Minimums 11, 18, 104, 105, 175, 176, 180, 181

Missed approach 5, 7, 9, 11, 17, 23-25, 31, 42, 47, 49, 53, 64,
83-85, 87, 105, 108, 109, 119, 120, 122, 126, 132,
142, 158, 159, 163, 174, 175, 178, 179, 181, 184, 187, 191

Mode(s) 15, 22, 26, 29-31, 35, 42, 59, 79, 91, 120, 133,
141, 183-185, 187, 188, 192, 193, 198

Moving map 67, 97, see also Dynamic display

N

NAVAID 5, 6, 9, 11, 17, 18, 48, 49, 55, 63, 65-67, 83, 101, 104, 105, 111,
119, 133, 142, 145, 153-157, 159, 164, 168, 169, 184, 187, 189

NOAA/NOS 22, 54, 153, 168, 172-176

North-up see Frame of reference

Notes 11, 49, 86, 175, 177, 181

O

Obstacle(s) 8, 22, 23, 34, 47, 66, 73-75, 96, 133, 137, 142,
145, 153-156, 173, 178, 184, 187, 190, 192, 193

Organization of data 24, 104-115, 168-170, 197

P

- Pages see Windows
- Panning 41, 48, 120, 133, 146-149, 159, 190, 192, 193
- Perceptual confusions 123
- Phraseology 22
- Pilot
- control 1, 5, 32, 35, 148, 130, 136-139, 159, 198
 - decisions 157
 - task 4-12, 158
- Plan view 21, 31, 75, 77, 83, 91, 93, 108, 109, 116, 117,
126, 158, 161, 173, 175, 176, 178, 181, 184, 188, 190
- Planning 5, 9, 119-122
- Population stereotypes 54, 58, 79, 101
- Predicted path 23, 70-72, 202
- Profile view 18, 24, 53, 55, 70, 105, 112, 116-118,
124, 159, 174, 176, 178, 181, 187, 188, 191
- Prompt see Message

R

- Reference frame see Frame of reference
- Reverse video 63-65, 164, 165, see also Highlight
- Route(s) 5, 47, 59, 70-72, 202

S

- Scale(s) 32, 48, 59, 70, 101, 116-118, 128,
136, 142, 143, 160, 162, 174, 178, 190
- Scroll(ing) 48, 83, 120, 146-149, 157

Search time	24, 58, 61, 114
Shading	60, 75, 77, 110, 112, 113, 131, 134, 147
Simplicity	15, 35-37, 171, 172, 199
Spacing	50, 52, 74, 110, 114, 201
Speech	
displays	47, 78-82
warnings	78
synthetic	78
Spot elevation	73, 74
Status	6, 8, 18, 27, 29, 41, 67, 79, 101, 156, 204
Symbol(s)	17, 21, 22, 29, 37, 47, 49, 50, 53-57, 59, 61, 63, 66-69, 71, 73, 75, 197, 98, 101, 110, 111, 113, 131, 124, 128, 129, 141-143, 145, 147, 150-152, 171, 175, 178, 196, 201, 202
size	113, 143
System response	38-40, 133, 183, 199, 200

T

Task sequence	5-7, 88, 95
Task analysis	17
Task aid(s)	157-159
Terminology	21, 22, 47, 93, 128, 129, 196, 204
Terrain	
display	32, 73-77, 127, 203
contour	73-77, 166
Text	1, 17, 21, 29, 47, 49-52, 54, 61, 63, 65, 67, 93, 110, 111, 113, 141, 143, 150-152, 174, 184, 188
height to width ratio	50, 201
lower case	49, 50, 52
size	113
upper case	49, 52

Track-up see Frame of reference

U

Undo 38, 91, 199

V

Visibility 5, 11, 15, 26, 35, 84, 101, 104, 119, 163, 175, 187-189, 197, 199

Voice output see Speech displays

W

Warning(s) 39, 58, 59, 63, 64, 73, 78, 81, 85, 86, 88,
127, 164-166, 171, 202, see also Alarms, Alerts

Weather 5, 6, 8

Window(s) 20, 47, 83-86, 101, 104, 105, 117, 141, 143, 153, 204
inset 117, 143, 144, 147, 162, 178

Workload 1, 12, 13, 29, 32, 78, 79, 120, 121,
124, 126, 136, 137, 153, 157, 163, 171
physical 157

Z

Zoom(ing) 21, 26, 30, 34, 37, 38, 48, 67, 74, 91, 101, 116-117, 120, 133,
136, 141-144, 154, 168, 177, 178, 181, 184, 187, 190, 192, 193