



**U. S. Army Rotary-Wing  
Emergency Egress Study**

By

**Timothy R. Swingle**

**Research Support Division**

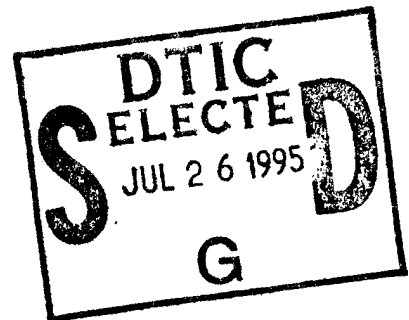

**May 1995**

**DTIC QUALITY INSPECTED 5**

Approved for public release; distribution unlimited.

19950725 007

**U.S. Army Aeromedical Research Laboratory  
Fort Rucker, Alabama 36362-0577**

## Notice

### Qualified requesters

Qualified requesters may obtain copies from the Defense Technical Information Center (DTIC), Cameron Station, Alexandria, Virginia 22314. Orders will be expedited if placed through the librarian or other person designated to request documents from DTIC.

### Change of address

Organizations receiving reports from the U.S. Army Aeromedical Research Laboratory on automatic mailing lists should confirm correct address when cor-responding about laboratory reports.

### Disposition

Destroy this document when it is no longer needed. Do not return it to the originator.

### Disclaimer

The views, opinions, and/or findings contained in this report are those of the author(s) and should not be construed as an official Department of the Army position, policy, or decision, unless so designated by other official documentation. Citation of trade names in this report does not constitute an official Department of the Army endorsement or approval of the use of such commercial items.

Reviewed:

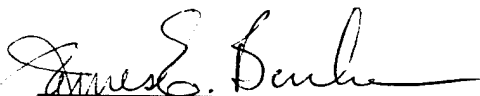

JAMES E. BURKE

MAJ, MS

Director, Research Support Division

Released for publication:

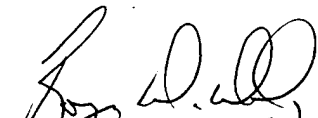

ROGER W. WILEY, O. D., Ph.D.

Chairman, Scientific  
Review Committee

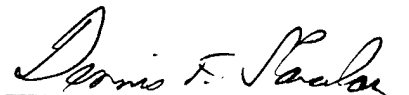

DENNIS F. SHANAHAN

Colonel, MC, MFS  
Commanding

REPORT DOCUMENTATION PAGE

1a. REPORT SECURITY CLASSIFICATION Unclassified		1b. RESTRICTIVE MARKINGS	
2a. SECURITY CLASSIFICATION AUTHORITY		3. DISTRIBUTION / AVAILABILITY OF REPORT	
2b. DECLASSIFICATION / DOWNGRADING SCHEDULE			
4. PERFORMING ORGANIZATION REPORT NUMBER(S) USAARL Report No. 95-23		5. MONITORING ORGANIZATION REPORT NUMBER(S)	
6a. NAME OF PERFORMING ORGANIZATION U.S. Army Aeromedical Research Laboratory	6b. OFFICE SYMBOL (If applicable) MCMR-UAR-FS	7a. NAME OF MONITORING ORGANIZATION U.S. Army Medical Research and Materiel Command	
6c. ADDRESS (City, State, and ZIP Code) P.O. Box 620577 Fort Rucker, AL 36362-0577		7b. ADDRESS (City, State, and ZIP Code) Fort Detrick Frederick, MD 21702-5012	
8a. NAME OF FUNDING / SPONSORING ORGANIZATION	8b. OFFICE SYMBOL (If applicable)	9. PROCUREMENT INSTRUMENT IDENTIFICATION NUMBER	
8c. ADDRESS (City, State, and ZIP Code)		10. SOURCE OF FUNDING NUMBERS	
		PROGRAM ELEMENT NO.	PROJECT NO.
		TASK NO.	WORK UNIT ACCESSION NO.
11. TITLE (Include Security Classification)  (U) U.S. Army Rotary-wing Emergency Egress Study			
12. PERSONAL AUTHOR(S) Timothy R. Swingle			
13a. TYPE OF REPORT Final	13b. TIME COVERED FROM _____ TO _____	14. DATE OF REPORT (Year, Month, Day) 1995 May	15. PAGE COUNT 33
16. SUPPLEMENTARY NOTATION			
17. COSATI CODES		18. SUBJECT TERMS (Continue on reverse if necessary and identify by block number)	
FIELD	GROUP	SUB-GROUP	
15	01		
08	09		
19. ABSTRACT (Continue on reverse if necessary and identify by block number)  This study was conducted in support of a NATO AGARD (Advisory Group for Aerospace Research and Development) effort to survey emergency egress mechanisms for all helicopters. This particular study deals with U.S. Army helicopters. The study consists of photographs and diagrams of each exit system, and a brief synopsis of the emergency egress procedure including: location and description of the operating mechanism, location of and ease of viewing the operating instructions, force required to operate, direction of opening, size of aperture and restrictions to evacuation, overall ease of operation and access for crews, and extent of instructions in the operators manual.			
20. DISTRIBUTION / AVAILABILITY OF ABSTRACT <input checked="" type="checkbox"/> UNCLASSIFIED/UNLIMITED <input type="checkbox"/> SAME AS RPT. <input type="checkbox"/> DTIC USERS		21. ABSTRACT SECURITY CLASSIFICATION Unclassified	
22a. NAME OF RESPONSIBLE INDIVIDUAL Chief, Science Support Center		22b. TELEPHONE (Include Area Code) (334) 255-6907	22c. OFFICE SYMBOL

Acknowledgments

I would like to thank CPT David Parker, commander, A Company, 1/223th Aviation Battalion, ATB, for allowing me to utilize his aircraft. Also, I wish to thank the mechanics of DynCorp at Fort Rucker for assisting me in the study. For a variety of assistance, I am grateful to these coworkers at USAARL: Linda Messer for her background research; Larry Thomas for his photography; James Burkett for manufacturing of the test equipment; Udo Volker Nowak for his editing; and John Sowell for his publishing support.

Accession For	
NTIS CRA&I	<input checked="" type="checkbox"/>
DTIC TAB	<input type="checkbox"/>
Unannounced	<input type="checkbox"/>
Justification _____	
By _____	
Distribution /	
Availability Codes	
Dist	Avail and/or Special
A-1	

Table of contents

List of figures . . . . .	1	11. UH-60 cabin emergency egress handles . . . . .	7
Background . . . . .	3	12. UH-60 cabin emergency exits . . . . .	22
Method . . . . .	3	13. AH-1 copilot/gunner cockpit area . . . . .	8
Results and discussion . . . . .	4	14. AH-1 copilot/gunner emergency egress handle . . . . .	8
Conclusions . . . . .	16	15. AH-1 pilot cockpit area . . . . .	9
References . . . . .	17	16. AH-1 pilot emergency egress handle . . . . .	9
Appendix A. Figures supplement . . .	18	17. AH-1 cockpit emergency exits . . . . .	23

List of figures

1. UH-1 cockpit area . . . . .	4	18. AH-64 copilot/gunner cockpit area . . . . .	10
2. UH-1 cockpit emergency egress handles . . . . .	4	19. AH-64 copilot/gunner emergency egress handle . . . . .	10
3. UH-1 cockpit diagram . . . . .	19	20. AH-64 pilot cockpit area . . . . .	10
4. UH-1 cabin area . . . . .	20	21. AH-64 pilot emergency egress handle . . . . .	11
5. UH-1 cabin emergency egress handles . . . . .	5	22. AH-64 ground crew emergency egress handle . . . . .	11
6. UH-1 cabin emergency exits . . . . .	5	23. AH-64 cockpit emergency exits . . . . .	24
7. UH-60 cockpit area . . . . .	6	24. OH-58 cockpit area . . . . .	12
8. UH-60 cockpit emergency egress handles . . . . .	6		
9. UH-60 cockpit diagram . . . . .	21		
10. UH-60 cabin area . . . . .	7		

Table of contents (Continued)

25. OH-58 cockpit emergency egress handles . . . . .	12	34. CH-47 cockpit and cabin emergency exits . . . . .	26
26. OH-58 cabin area . . . . .	13	35. CH-47 cabin area and ramp emergency exits . . . . .	27
27. OH-58 cabin emergency egress handles . . . . .	13	36. UH-1 Huey schematic showing dimensions of egress areas . . .	28
28. OH-58 emergency exits . . . . .	25	37. UH-60 Black Hawk schematic showing dimensions of egress areas . . . . .	29
29. CH-47 cockpit area . . . . .	14	38. AH-1 Cobra schematic showing dimensions of egress areas . . .	30
30. CH-47 cockpit emergency egress handles . . . . .	14	39. AH-64 Apache schematic showing dimensions of egress areas . . .	31
31. CH-47 cabin area emergency egress door strap . . . . .	15	40. OH-58 Kiowa schematic showing dimensions of egress areas . . .	32
32. CH-47 cabin area emergency egress window straps . . . . .	15	41. CH-47 Chinook schematic showing dimensions of egress areas . . .	33
33. CH-47 cabin area emergency egress ramp . . . . .	15		

## Background

This study was a partial effort to survey the emergency egress mechanisms for all helicopters in support of a North American Treaty Organization (NATO) Advisory Group for Aerospace Research and Development (AGARD). This part of the study deals only with U.S. Army helicopters.

A literature search revealed the only U.S. study of this kind had been a survey of egress from U.S. Navy fixed-wing jet aircraft over water. A study was done by BioTechnology, Inc., to see how best to present the emergency egress information in the manual of the Naval Air Training and Operating Procedures Standardization Program (NATOPS). The study concluded that the best way to facilitate learning was for the manual to strongly emphasize pictorial descriptions. Also, the study's authors found that presentations with pictorial support had a higher rate of learning and retention (Post and Kershner, 1979).

The Naval Aerospace Medical Institute then was tasked to prepare mechanicals (layouts) on emergency egress to be included in all aircraft NATOPS manuals. This tasking also included standardization of the mechanicals. The process for manual standardization was developed by Lee, 1990. This paper follows Lee's suggested presentation method.

## Method

The intent of the study was to evaluate various factors affecting the egress from U.S. Army helicopters. Factors include: location and description of the operating mechanism, location of and ease of viewing the operating instructions, force required to operate, direction of opening, size of aperture and restrictions to evacuation, overall ease of operation and access for crews, extent of instructions in the operator's manual, and finally photos of each apparatus.

Operator's manuals for each aircraft were reviewed and pertinent information was extracted to include system descriptions, operating procedures, and equipment diagrams. In all the operator's manuals, chapter 2 describes systems and chapter 9 covers emergency procedures.

The study was conducted at Cairns Army Airfield, Fort Rucker, Alabama. Aircraft used were from "A" Company, 1/223 Aviation Battalion. The results were obtained by attaching a Chatillon DPP-25 force gauge to the emergency egress handles on the aircraft and operating the mechanism according to the operator's manual. All handles that required safeties were safely tied with 0.020" safety wire. The cockpit exit restrictions common to most U.S. helicopters are the collective (left side only), the cyclic, and armor plating.

The aircraft studied were the UH-1 Huey, the UH-60 Black Hawk, the AH-1 Cobra, the AH-64 Apache, the OH-58 Kiowa, and the CH-47 Chinook. The study was divided into two areas of concentration for each aircraft: the cockpit egress and the cabin area egress.

**Note: All nonphoto figures are found in the Appendix.**

## Results and Discussion



UH-1 Huey

Cockpit --- Emergency exit release handles are located on the front of the cockpit doors, directly above the upper hinge. The T-shaped handles are yellow and black striped. Operating instructions are readable easily and located on the front door frame above the T-handle, as



Figure 1. UH-1 cockpit area.

shown in Figures 1 and 2. Pulling the T-handle upwards pulls a cable which releases pins through the door hinges. Once the pins come out, the hinge separates, and the cockpit door is free to fall away. Force required to break the safety and disengage the pins is 25-30 lbs. The door then will fall off by itself or with slight pressure upon it. The opening then is the size of the door frame minus the restric-

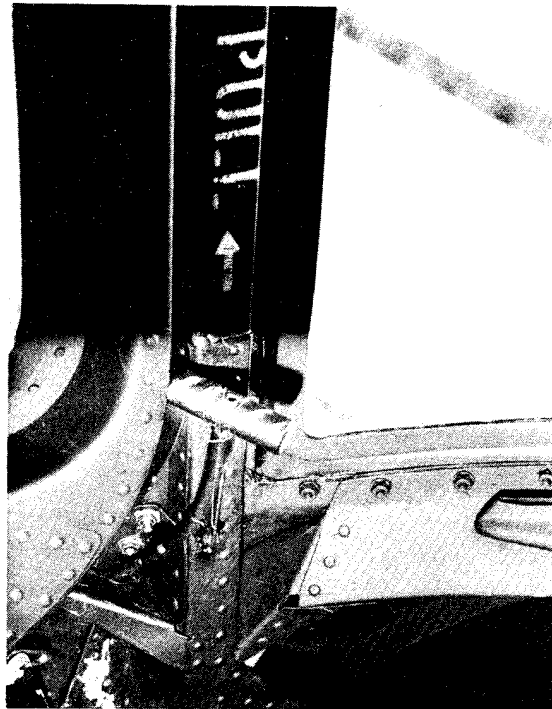

Figure 2. UH-1 cockpit emergency egress handles.

tions of the cyclic, armor plate and the collective. The operator's manual displays the emergency exit release handles, but does not have them labeled as seen in the Appendix, Figure 3. Emergency procedures in chapter 9 of the operator's manual are simple and adequate. The cockpit

doors jettison easily and quickly. The armor protection panel on the seat is difficult to slide rearward and takes both hands to operate. With the panel forward, it is difficult to egress and this is the procedure's weak link.

Cabin --- The cabin door window emergency release handles are located at the bottom center of each window. The handles are yellow and black striped. Operating instructions clearly are visible as can be seen in Figures 4 and 5. Lifting up on the handle with 20-25 lbs. of force

retracts stops along the bottom of the window. The bottom of the window then can be pulled inward with minimal force. The top of the window falls free of the frame and the entire window drops into the cabin. It is important to note the window can not be pushed outward, it must be pulled inside, and is so noted in the instructions. Then occupants are unrestrained from exiting the aircraft. The operator's manual displays a labeled picture of the exits and handles as seen in the Appendix, Figure 6. Emergency procedures in chapter 9 are simple and adequate.

Figure 5. UH-1 cabin emergency egress handles.

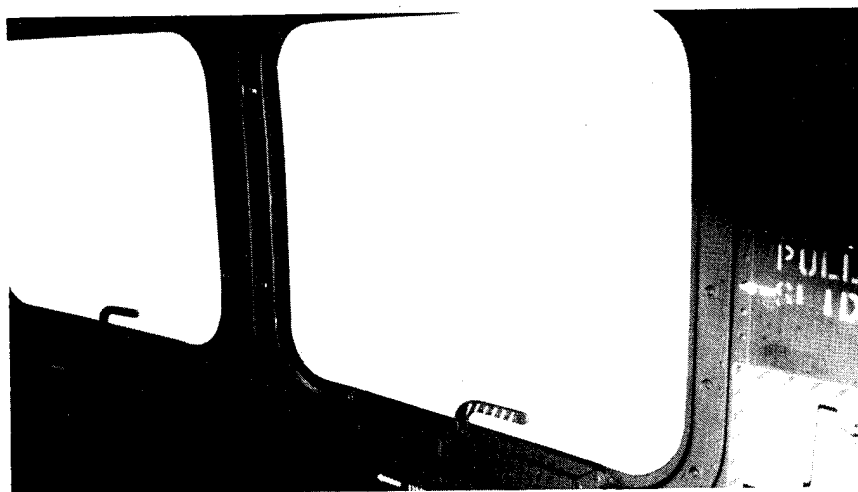

Figure 6. UH-1 cabin emergency exits.



### UH-60 Black Hawk

Cockpit --- Emergency release handles are located on the inside frame of each cockpit door. They allow the cockpit doors to be jettisoned in case of an emergency. The handles are yellow and are

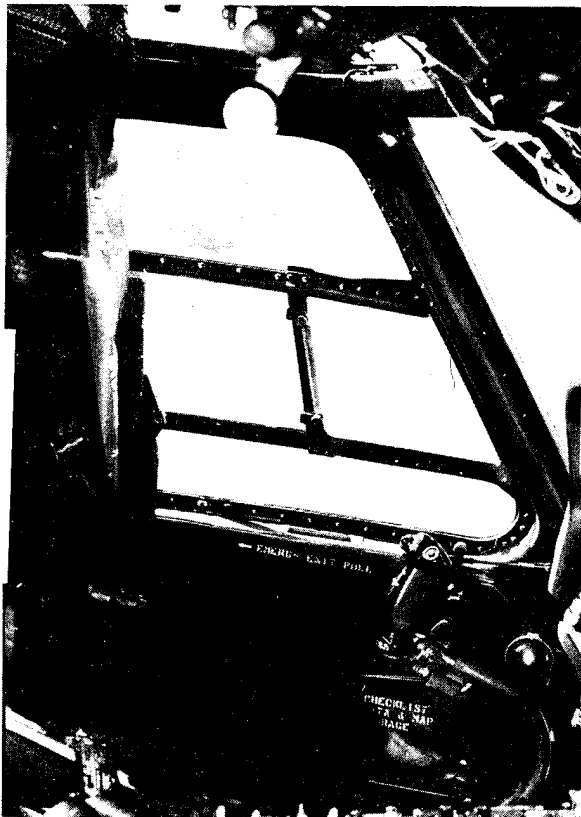

Figure 7. UH-60 cockpit area.

surrounded with ample instructions as shown in Figures 7 through 9. Pulling the emergency handle with 40-45 lbs. of force turns a cam inside the door allowing the door to be separated from the hinge at the mounting points. The operator's manual emergency procedure states the door then may be jettisoned by kicking the lower forward corner. This procedure works; however, on the doors tested, it required *substantial* force to dislodge the door from the hinge. Once the connection is broken, the door falls away from the aircraft. As with the UH-1, the egress is hampered substantially if the protective armor plating has been moved forward. However, unlike the UH-1, the plating on the UH-60 can be moved rearward with only

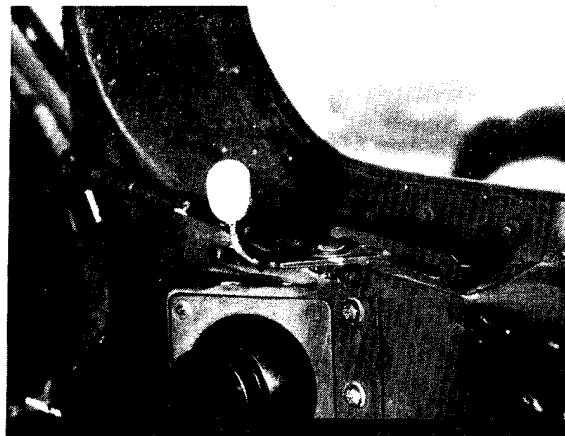

Figure 8. UH-60 cockpit emergency egress handles.

one hand. The weak link of this procedure is the process of kicking the door away from the hinge.

Cabin --- The egress from the cabin area of a UH-60 is unique and poses no

physical difficulties, but it could be confusing under certain circumstances. First under normal egress procedures, passengers seated in the aft area are unable to reach the handle of the cabin door when the system of seating four across the center is used. The doors must be opened by someone sitting in the forward area or from the outside. Second, there is only one cabin door window jettison handle on each cabin door, and they are in different locations on each side. The handles are located under the front window on the left cabin door and under the rear handle on the right side door as shown in Figures 10 and 11. In the Appendix, the cabin's emergency exits can be seen in Figure 12. The locations make it very difficult for passengers in the front area to operate the right side emergency exit, and for passengers in the rear area to jettison the cabin windows on the left side. The direction of handle pull on each side also is different. On the left side the handle is pulled aft and the handle on the right is pulled forward as explained under emergency exits in the operator's manual. On the positive

side of the egress procedure, it takes only approximately 10 lbs. of force to operate the handles and then the windows easily are pushed outward. Pulling the handle releases both the front and the rear cabin door windows on that side.

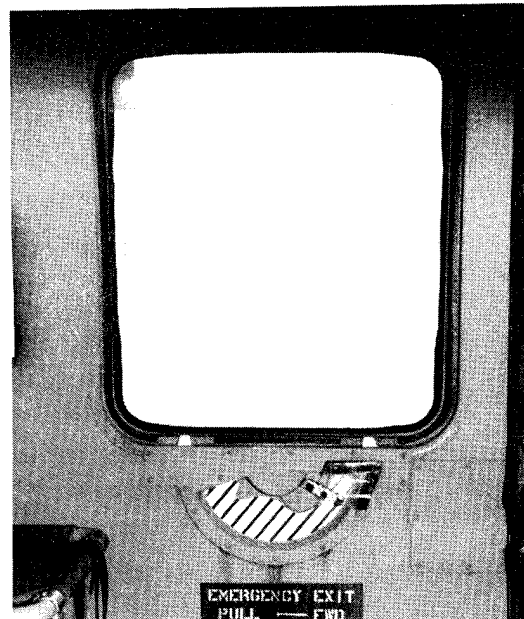

Figure 10. UH-60 cabin area.

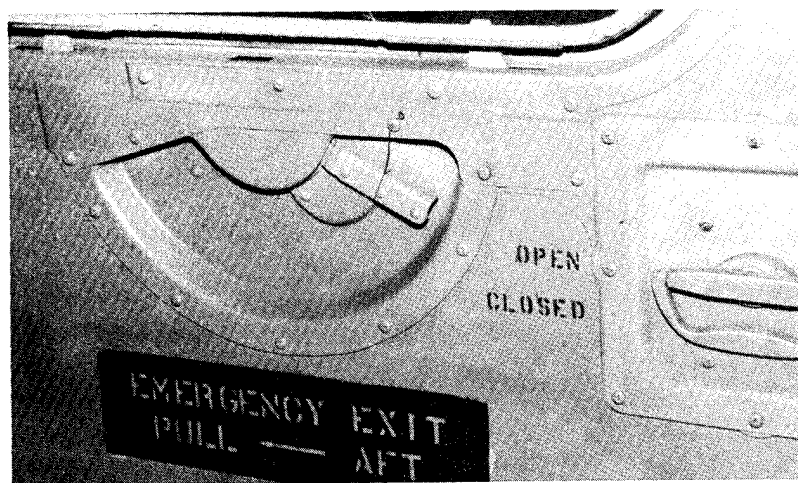
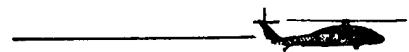

Figure 11. UH-60 cabin emergency egress handles.





### AH-1 Cobra

Cockpit only --- The Cobra contains a canopy jettison system that can be operated from either the pilot's rear seat or the copilot/gunner's, (CPG) front seat. The arming/firing mechanisms are located near the instrument panel and have operating instructions on them as shown in Figures 13 through 17. These firing mechanisms are operated by turning the handle 90 degrees counterclockwise with a torque of 6-12 inch-pounds. This maneuver arms



Figure 14. AH-1 copilot/gunner emergency egress handle.

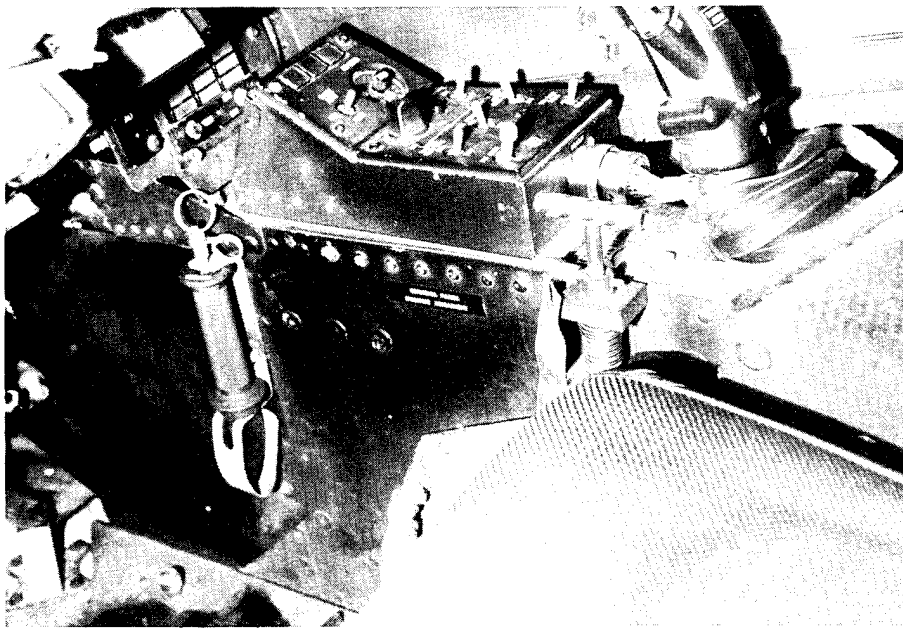

Figure 13. AH-1 copilot/gunner cockpit area.

the assembly. The operator then pulls the handle with 20-35 lbs. of tension, firing the primer and causing the cutting assembly to be detonated. The process is completed by the detonation cord, that burns around the periphery of all the side panels, sever-

ing them from the fuselage. This system is explained in chapter 2, section II of the operator's manual, but there are no emergency procedure steps outlined in chapter 9. Once the canopy is jettisoned, there is a clear access area for the pilots to egress.

Figure 15. AH-1 pilot cockpit area.

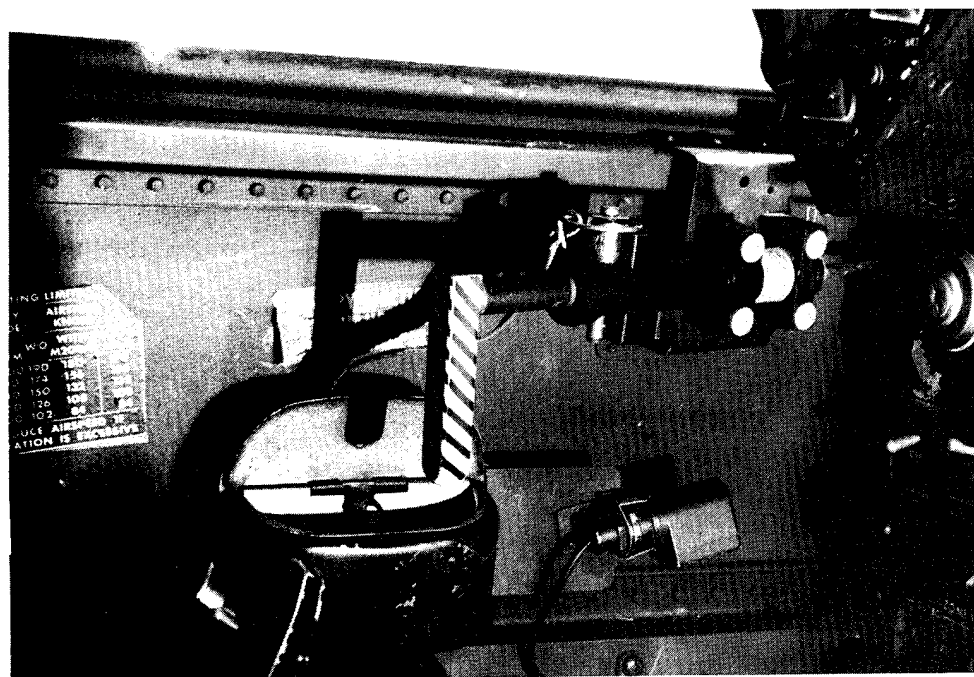
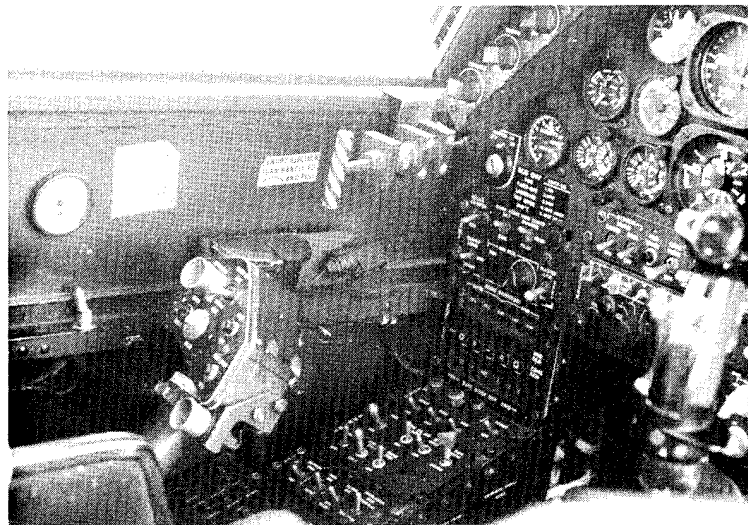

Figure 16. AH-1 pilot emergency egress handle.





**AH-64 Apache**

Cockpit only --- The Apache also has a canopy jettison system that expels the four acrylic panels on the sides of the pilot and CPG stations. The Apache however, has three canopy jettison handles. One is on the upper left corner of the pilot's instrument panel. A second is at the upper left corner of the CPG panel. And the third is the external ground crew handle located on the front of the aircraft, under a quick-release panel directly forward of the CPG's windshield as shown in Figures 18 through 23. Like the Cobra, the Apache system is based on an arming/firing handle, a primer/initiator, and a

detonation cord around the periphery of the side panels. The operating instructions again are directly on the jettison handles. The system is armed by rotating the canopy jettison handle 90 degrees left or right, which then uncovers the word ARMED on both sides of the handle. The system then is activated by pushing the jettison handle in, detonating the primer/initiator within the handle. The system is explained very well in chapter 2 of the operator's manual. The emergency egress procedures are in chapter 9.

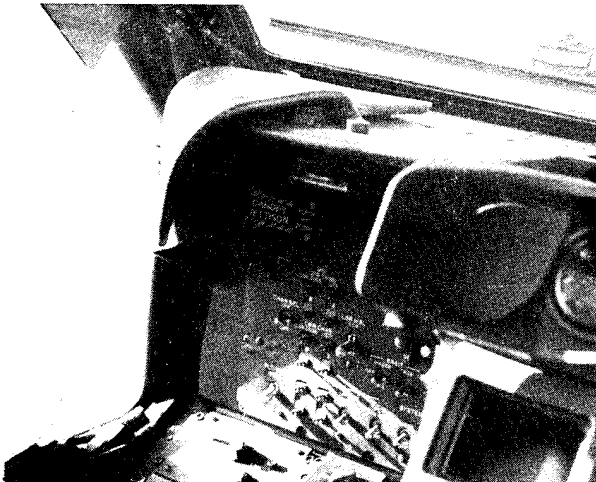

**Figure 18. AH-64 copilot/gunner cockpit area.**



**Figure 19. AH-64 copilot/gunner emergency egress handle.**

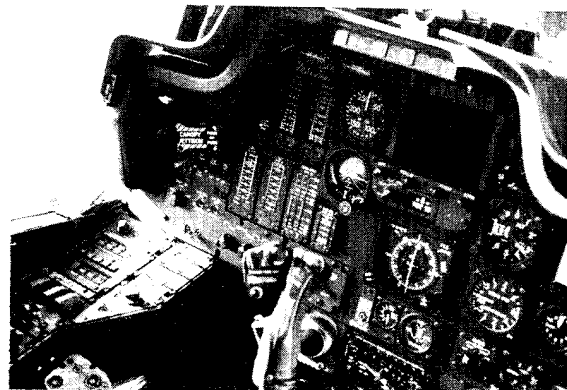

**Figure 20. AH-64 pilot cockpit area.**

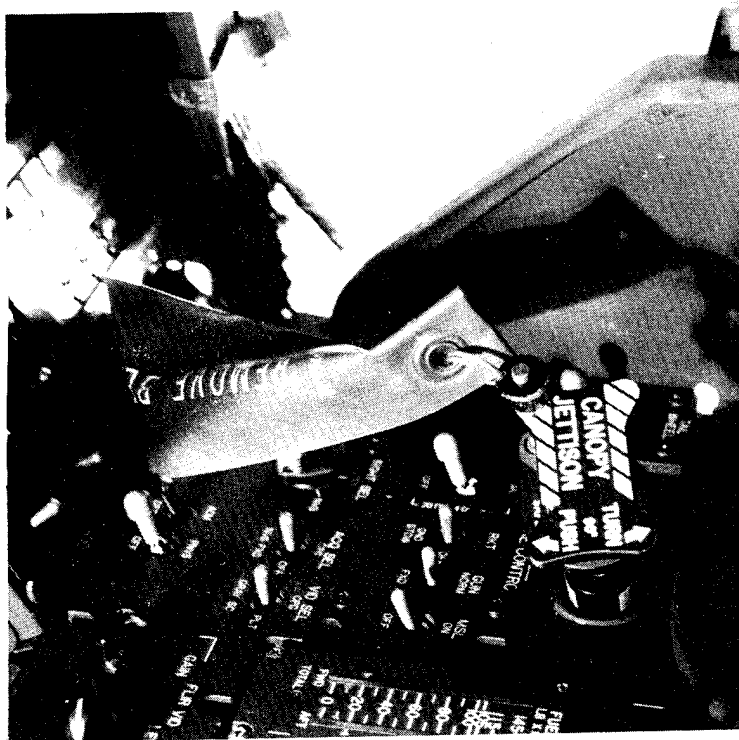

Figure 21. AH-64 pilot emergency egress handle.

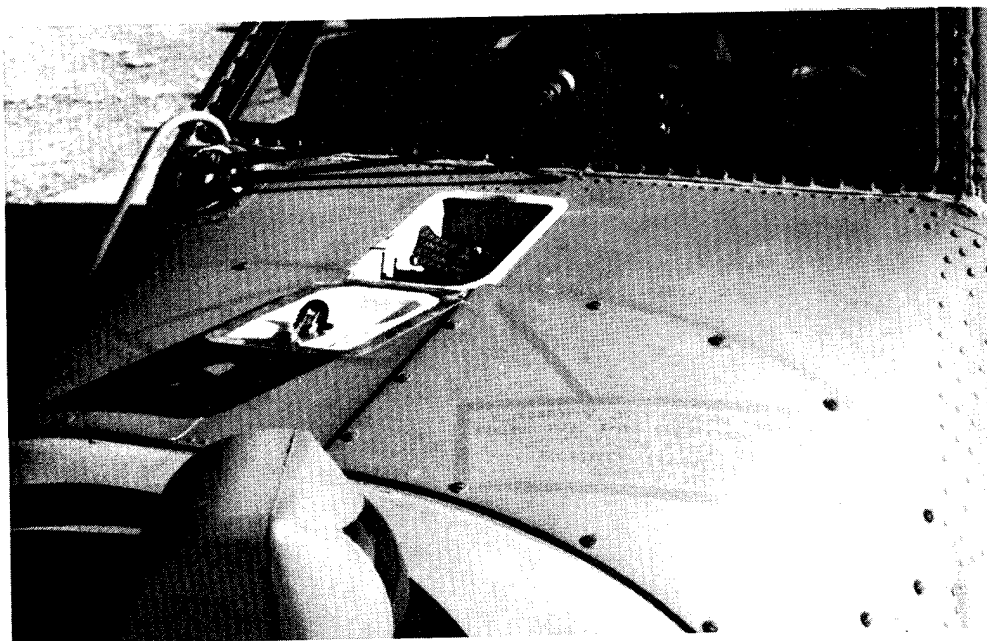

Figure 22. AH-64 ground crew emergency egress handle.





### OH-58 Kiowa

Cockpit --- The cockpit door emergency jettison handles are located on the inside of the door frames just above the upper hinges. The yellow handles are di-

rectly above the emergency exit labels on the door frame as shown in Figures 24 through 26. Pulling aft on the handle with a force of 15-25 lbs. pulls pins on both hinges, allows the hinges to separate, and internal springs then push the door out and away from the aircraft. The handle was difficult to pull aft if there was pressure on the handle towards the center of the cockpit while pulling. We found the end of a mounting bolt restricted the rotation of this lever. This easily was compensated for by applying slight outward pressure on the handle while pulling aft. The armor plating opens easily and quickly

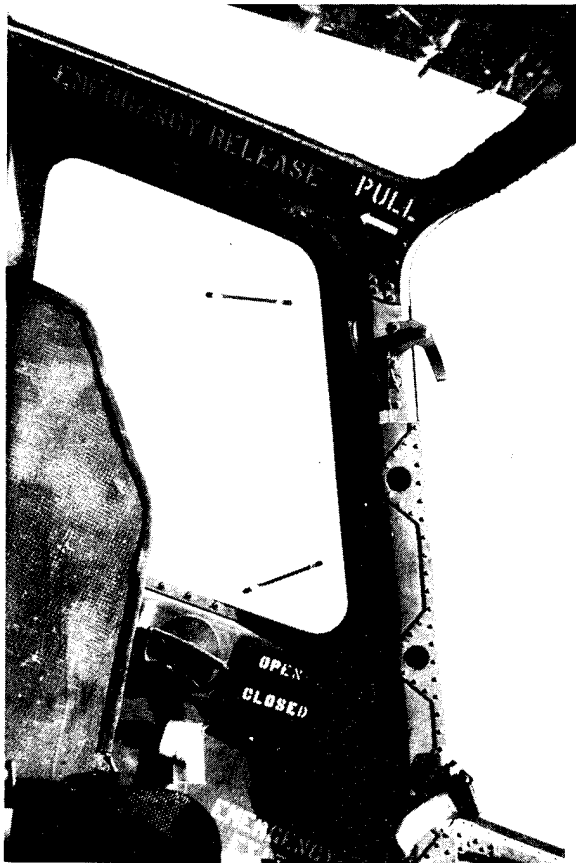

Figure 24. OH-58 cockpit area.

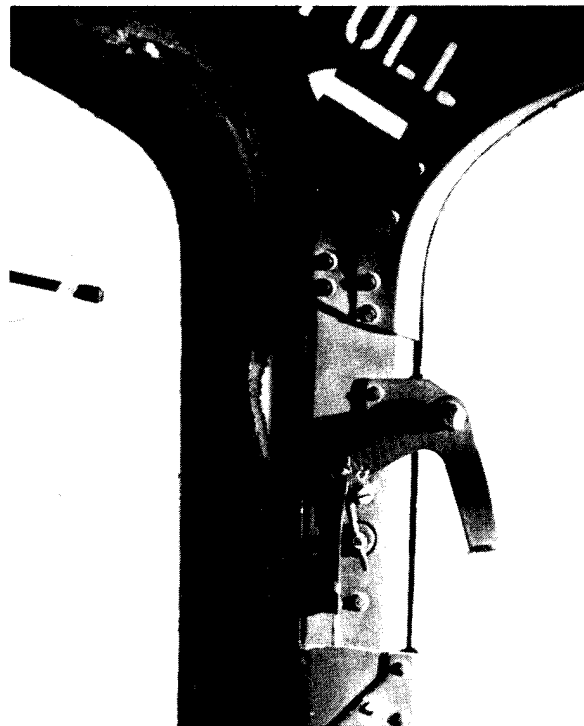

Figure 25. OH-58 cockpit emergency egress handles.

with the outside hand and is not an obstacle while exiting the aircraft. However, if for some reason, i.e., hard landing, the armor should become stuck, the egress area would be reduced substantially. The operator's manual has good figures of the



Figure 26. OH-58 cabin area.

emergency jettison handles and has concise and simple operating instructions in chapter 9. Also, it is important to note in this aircraft the cockpit emergency handles are in a good location to be utilized as hand rests. The operator's manual has a warning in chapter 2 that this may result in inadvertent jettisoning of cockpit doors.

Cabin --- The cabin emergency jettison handles are located on the aircraft frame between the cockpit and cabin doors. The handles are yellow and black striped with instructions on the frame immediately below them as shown in Figures 26 through 28. They operate in a similar fashion and equally as effectively as the cockpit jettison system. The difference is that the cabin handle must be pushed forward and the force required is 25-30 lbs. The door then is easily popped off with the assistance of springs, opening a large egress area. It should be pointed out that if the passenger in the rear is restricted by their inertial reel seat restraint, they may have difficulty reaching the emergency handle because of the distance.

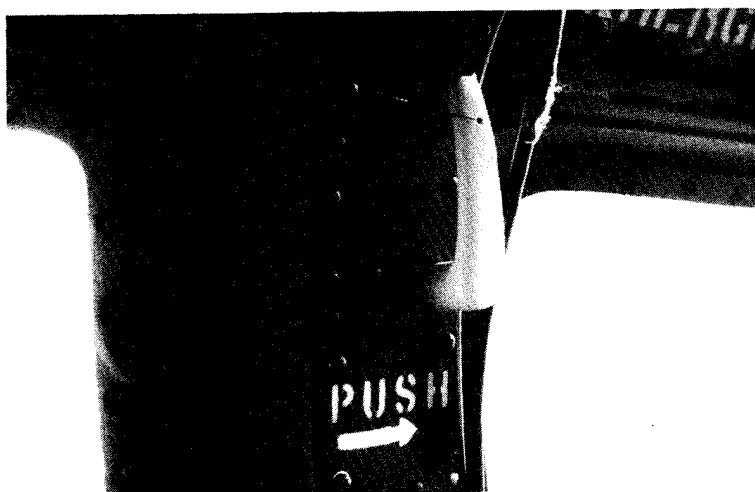
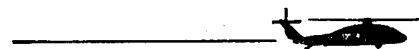

Figure 27. OH-58 cabin emergency egress handles.





### CH-47 Chinook

Cockpit --- Inside handles for the cockpit door emergency exit are located directly above the cockpit doors. The handles are yellow and black striped with operating instructions on them as shown in Figures 29 and 30. The handles either can be pushed up or pulled down to disengage the entire door from the frame. The door then falls out, top first. There are no warnings in the operator's manual about using this handle as a hand rest, but care

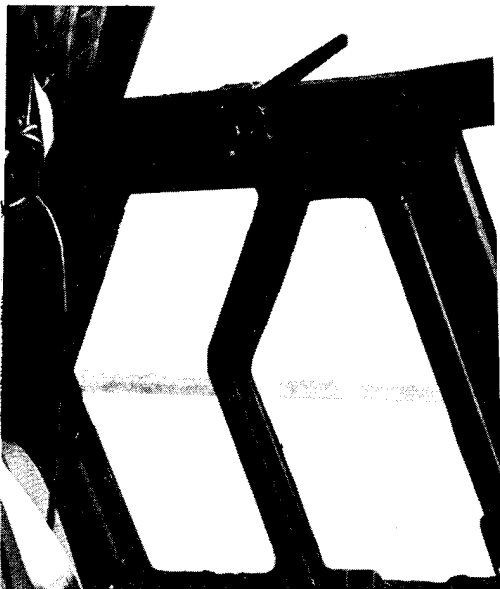

Figure 29. CH-47 cockpit area.

must be taken to prevent accidental jettisoning. The system also may be activated by outside emergency handles located directly below and aft of the cockpit doors. To operate, the handle first must be extended from the aircraft, then turned

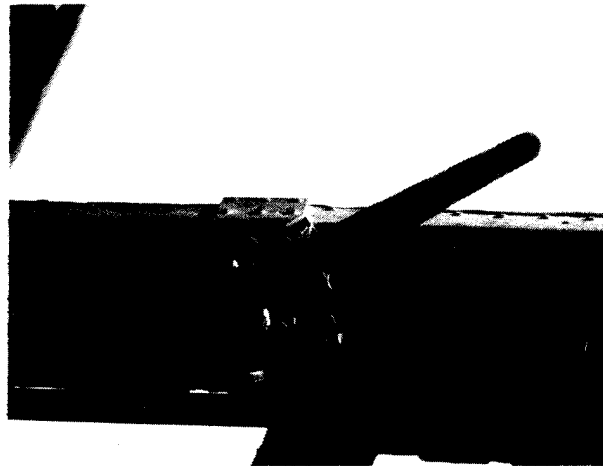
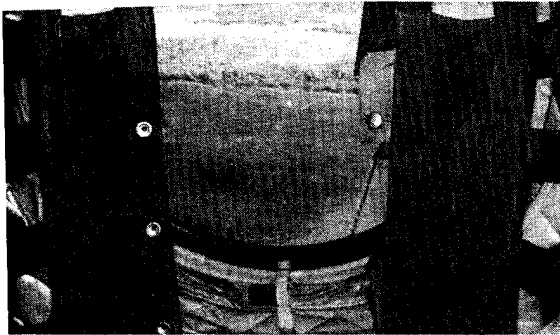

Figure 30. CH-47 cockpit emergency egress handles.

while pushing in the trigger button. The instructions for this procedure are painted on the side of the aircraft. When this technique is used, the bottom of the door comes out first. The person operating the exterior handle should be aware of, and avoid the falling door. The force required to turn either handle is between 35 and 40 lbs. With the door off, there is ample room to exit the aircraft. The operator's manual contains ample pictures of the emergency escapes in chapter 9 as shown in Figure 31.

Cabin --- Emergency egress from the cargo area of a Chinook is accomplished by jettisoning the windows, the

emergency exit on the ramp shell, the shell itself, or exiting through the cargo hook viewing hatch. The windows are jettisoned by pulling a yellow strap hanging from each window as shown in Figure 32. The strap is connected to a seal that runs completely around the window. Pulling the strap away breaks the entire seal and the window then can be pushed out. In addition to the window, a square panel around the window comes out with the front exits on either side, and the exit located on the ramp shell. Adequate instructions for operating these emergency exits are located near the exits and in chapter 9 of the operator's manual as shown in Figures 34 and 35.



**Figure 32.** CH-47 cabin area emergency egress window straps.



**Figure 31.** CH-47 cabin area emergency egress door strap.

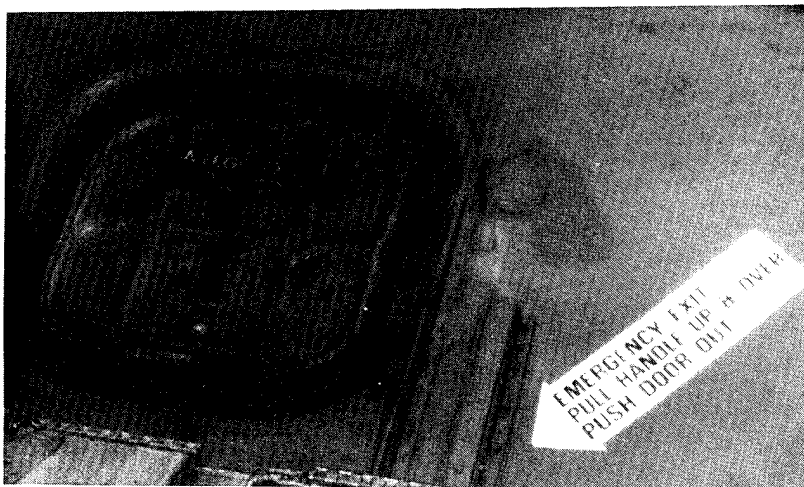

**Figure 33.** CH-47 cabin area emergency egress ramp.

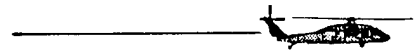

## Conclusions

There is no specific standardized method to describe emergency egress procedures in U.S. Army helicopters. The procedures are covered in chapters 2 and 9 of each operator's manual, but not necessarily in the same sections in every manual. Each aircraft has a slightly different mechanism or technique for initiating the egress process. These different procedures are displayed in or on the aircraft in strategic locations to facilitate proper usage. It is critical that pilots and passengers familiarize themselves with each aircraft. A crew and passenger briefing is required. Each helicopter's operator's manual has a preflight check list, including the emergency egress procedures.

The standard aircraft exit restrictions from the cockpit are: the collective (left side only), the cyclic, and protective armor plating if installed. Under normal egress procedures, the collective and cyclic are not very restrictive, the UH-60 collective is even collapsible. However, any time the protective armor plating is used and is difficult to retract, there is the potential for a substantial reduction in the size of the egress opening. The UH-1 Huey is an example.

During any emergency, helmet visors should be down; this is important especially during an emergency egress.

Pilots and crew members should feel safe and confident they will be able to egress from an aircraft in case of a mishap. However, they need to remember that knowledge of the proper egress procedures for the specific aircraft being flown is essential for an expeditious egress. Also, it should be noted that an egress or survival knife always can be used to exit an aircraft as a last resort.

### References

- Operator's Manual, Army Model UH-1H/V Helicopters, TM 55-1520-210-10, 15 Feb 88.
- Operator's Manual, Army Model UH-60A/L Helicopters, TM 1-1520-237-10, 31 Aug 94.
- Operator's manual, Army model AH-1S helicopters, TM 55-1520-236-10, 11 Jan 80.
- Operator's manual, Army model AH-64A helicopters, TM 55-1520-238-10, 28 Jun 84.
- Operator's manual, Army model OH-58A/C helicopters, TM 55-1520-228-10, 17 Jan 89.
- Operator's manual, Army model CH-47 helicopters, TM 55-1520-240-10, 30 Apr 92.
- Post, T. J., and Kershner, R. L. 1979. An evaluation of a new format for presenting ejection information in a NATOPS manual (Contract No. N00014-77-C-0312). Falls Church, VA: Biotechnology, Inc.
- Lee, C. J. 1990. Standardization of NATOPS emergency egress procedures. Proceedings of the 28th Annual Symposium SAFE Association, Newhall, CA. pp 196.

Appendix A.  
Diagrams.

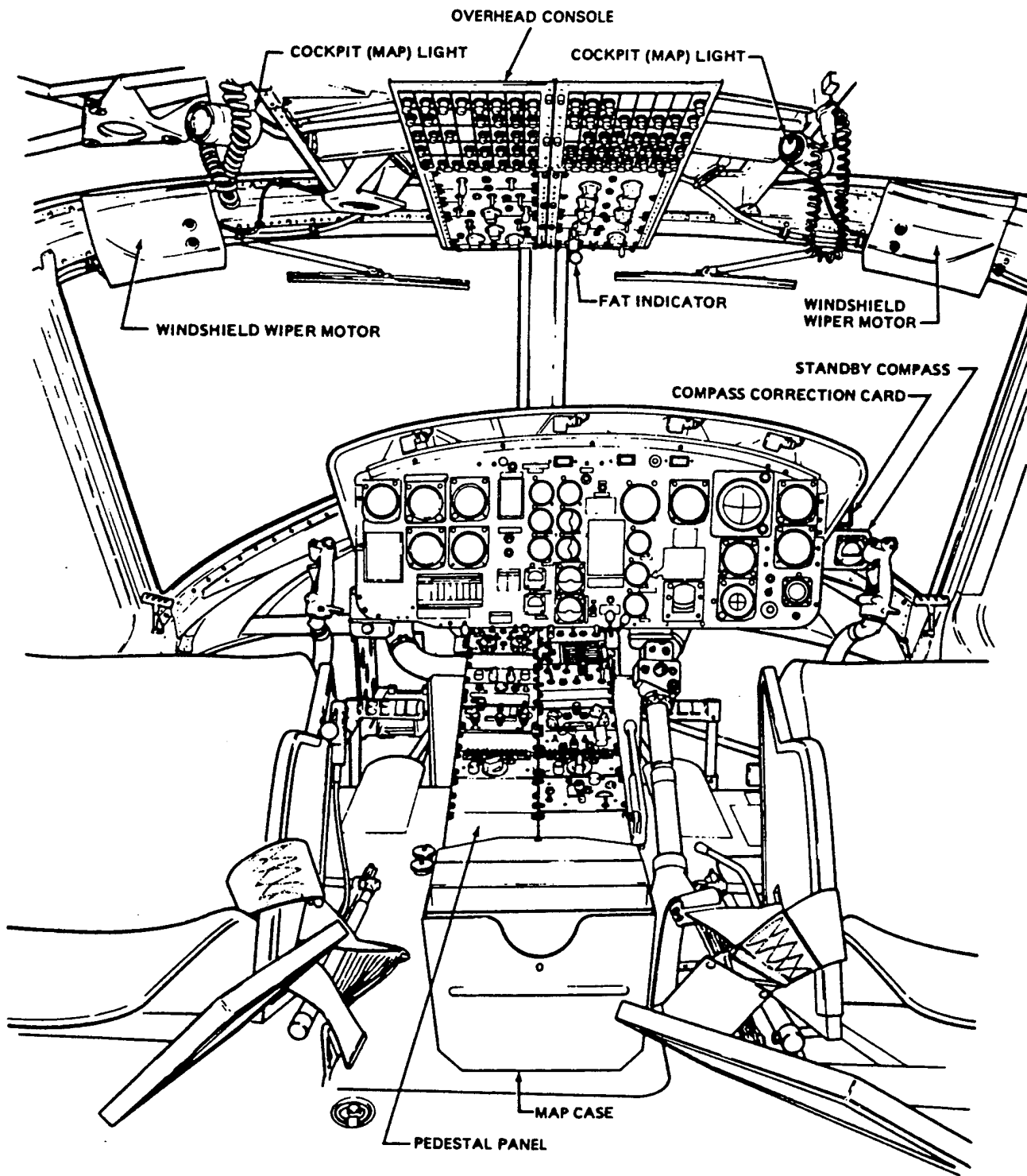
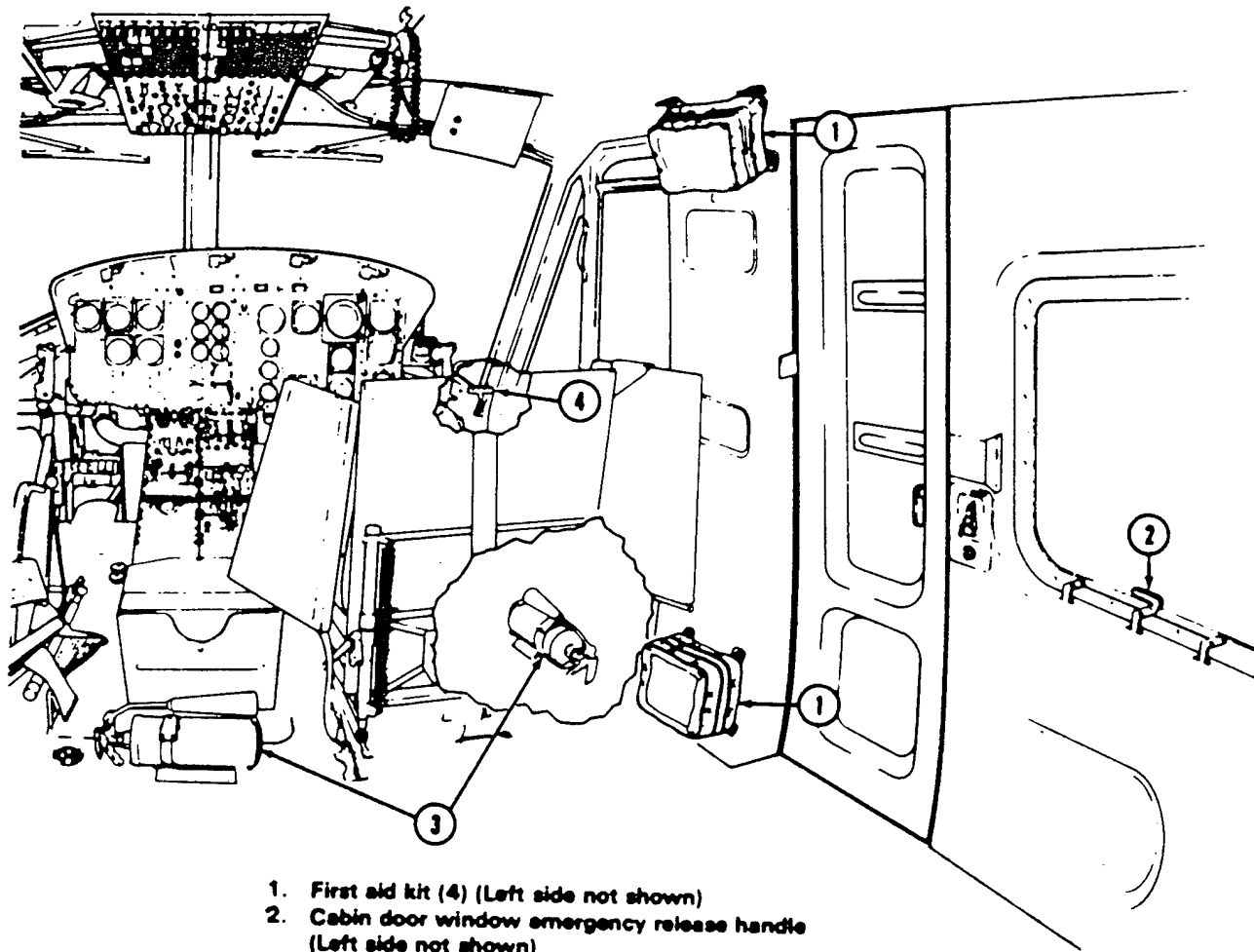
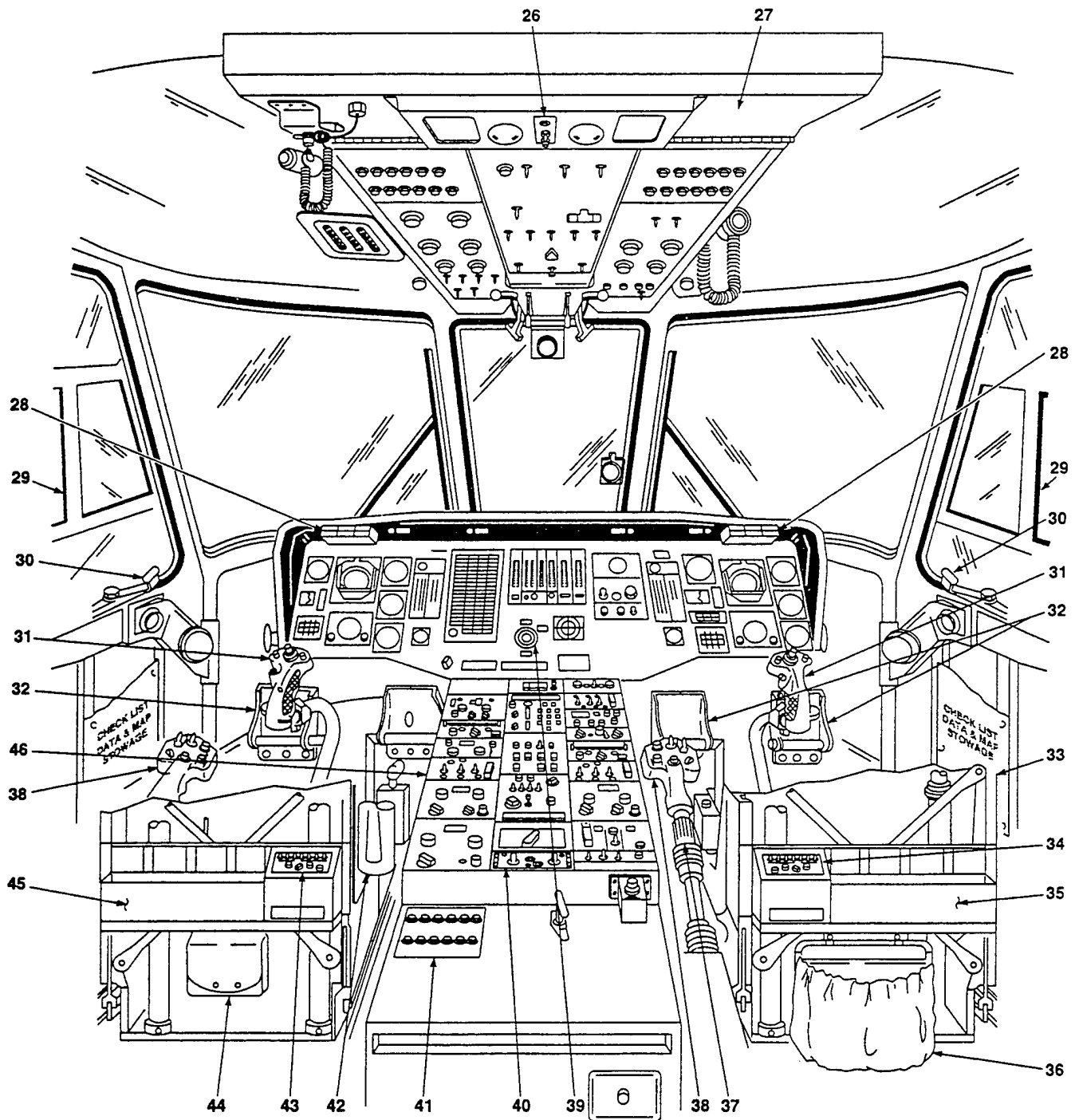

Figure 3. UH-1 cockpit diagram.



1. First aid kit (4) (Left side not shown)
2. Cabin door window emergency release handle (Left side not shown)
3. Fire extinguisher (1)
4. Crew door jettison handle (Left side not shown)

Figure 4. UH-1 cabin area.



- |                                    |   |   |
|------------------------------------|---|---|
| 26. COCKPIT FLOODLIGHT CONTROL     | 34. CREW CHIEF / GUNNER ICS CONTROL PANEL               | 41. BATTERY / BATTERY UTILITY BUS CIRCUIT BREAKER PANEL |
| 27. UPPER CONSOLE                  | 35. CREW CHIEF AMMUNITION / GRENADE STOWAGE COMPARTMENT | 42. FIRE EXTINGUISHER                                   |
| 28. MASTER WARNING PANEL           | 36. STOWAGE BAG   | 43. GUNNER'S ICS CONTROL PANEL                          |
| 29. SLIDING WINDOW                 | 37. COLLECTIVE STICK FRICTION CONTROL                   | 44. FIRST AID KIT                                       |
| 30. COCKPIT DOOR EMERGENCY RELEASE | 38. COLLECTIVE STICK GRIP                               | 45. GUNNER'S AMMUNITION / GRENADE                       |
| 31. CYCLIC STICK                   | 39. ENGINE IGNITION KEYLOCK                             | 46. COPILOT'S SIDE LOWER CONSOLE                        |
| 32. DIRECTIONAL CONTROL PEDALS     | 40. LOWER CONSOLE                                       |   |
| 33. PILOT'S SEAT                   |   |   |

Figure 9. UH-60 cockpit diagram.

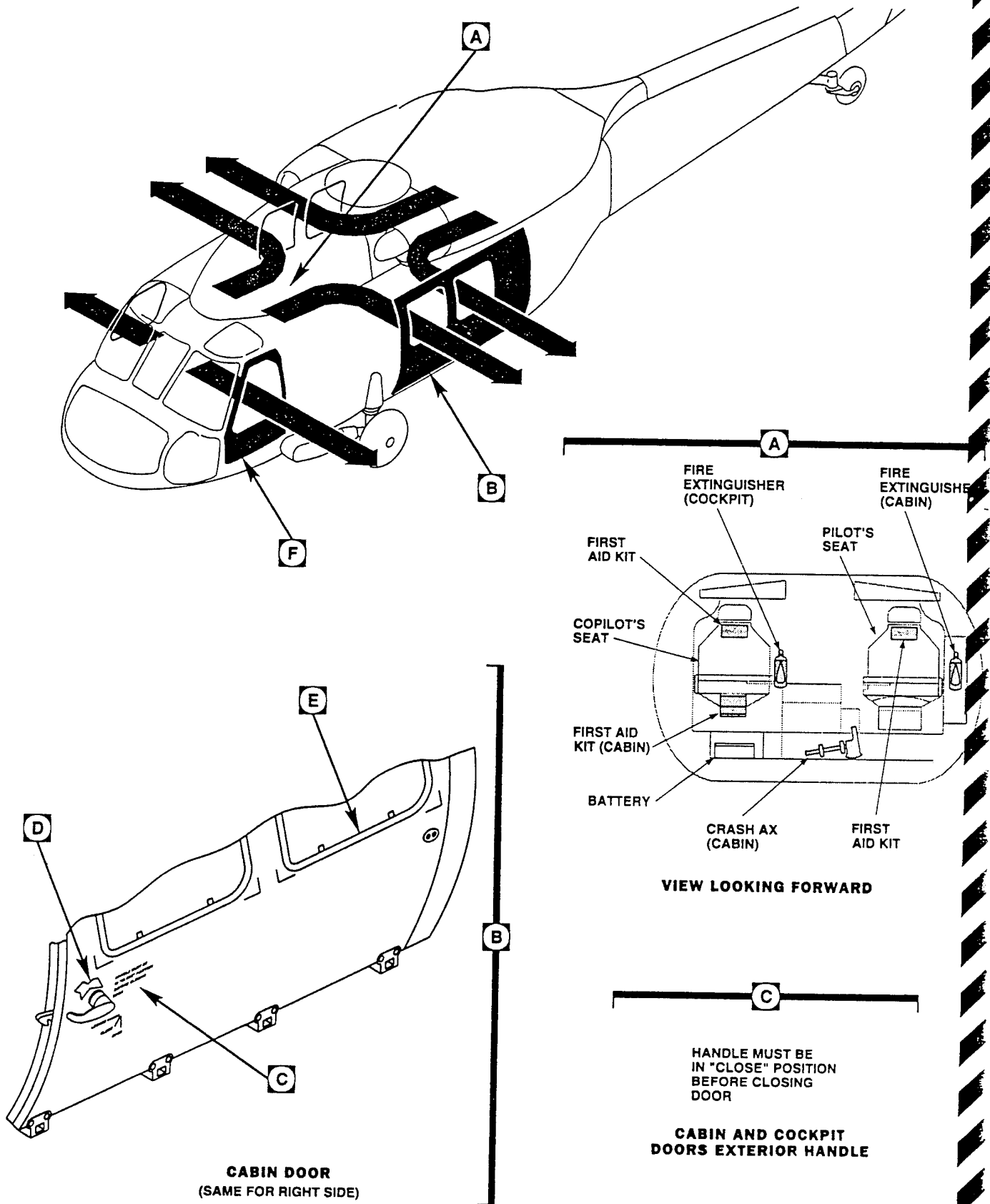

Figure 12. UH-60 cabin emergency exits.

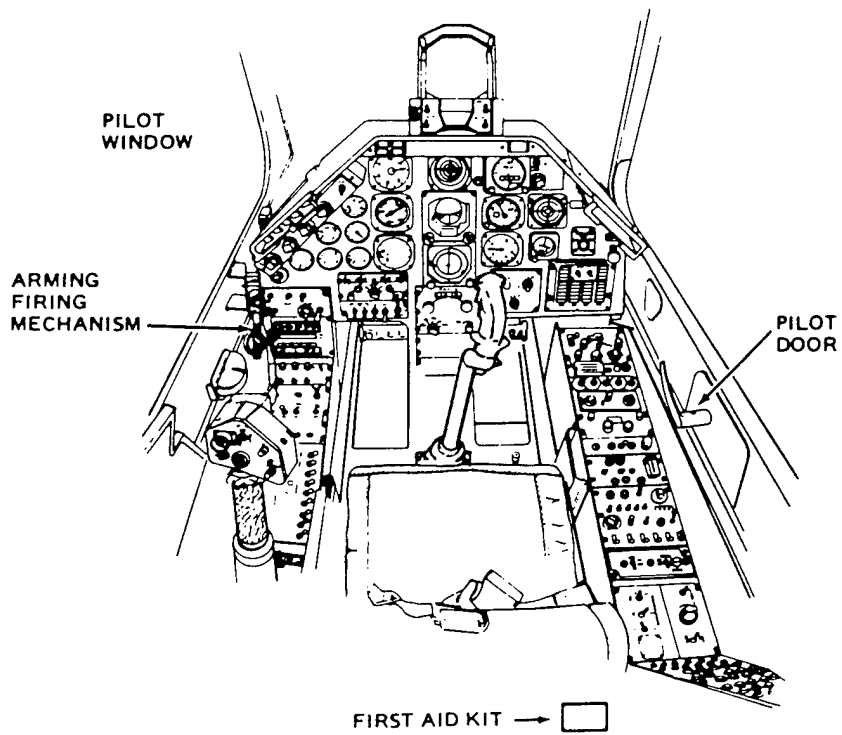
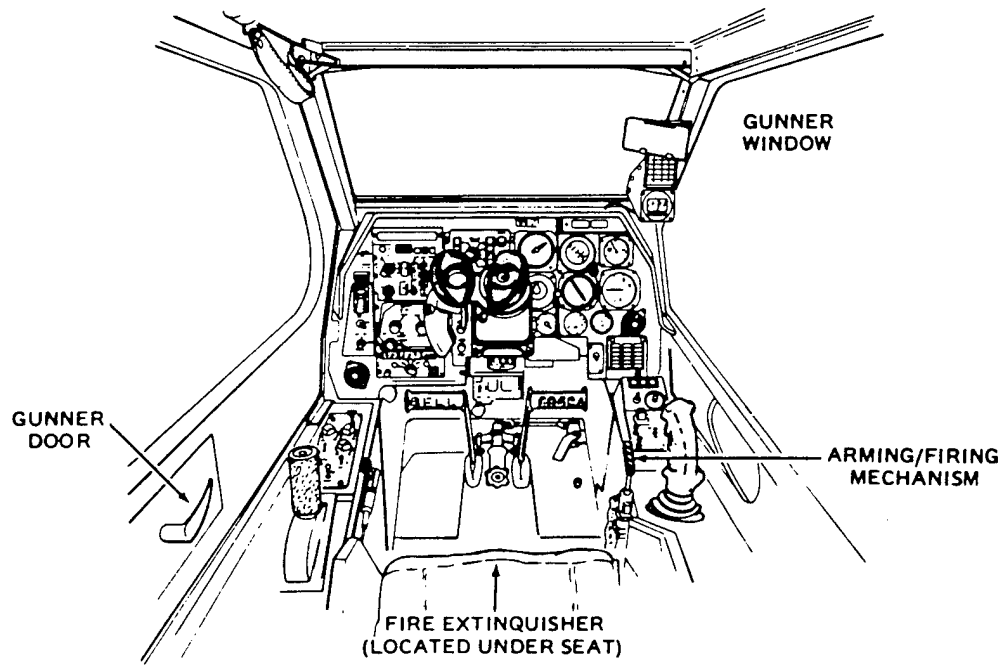

Figure 17. AH-1 cockpit emergency exits.

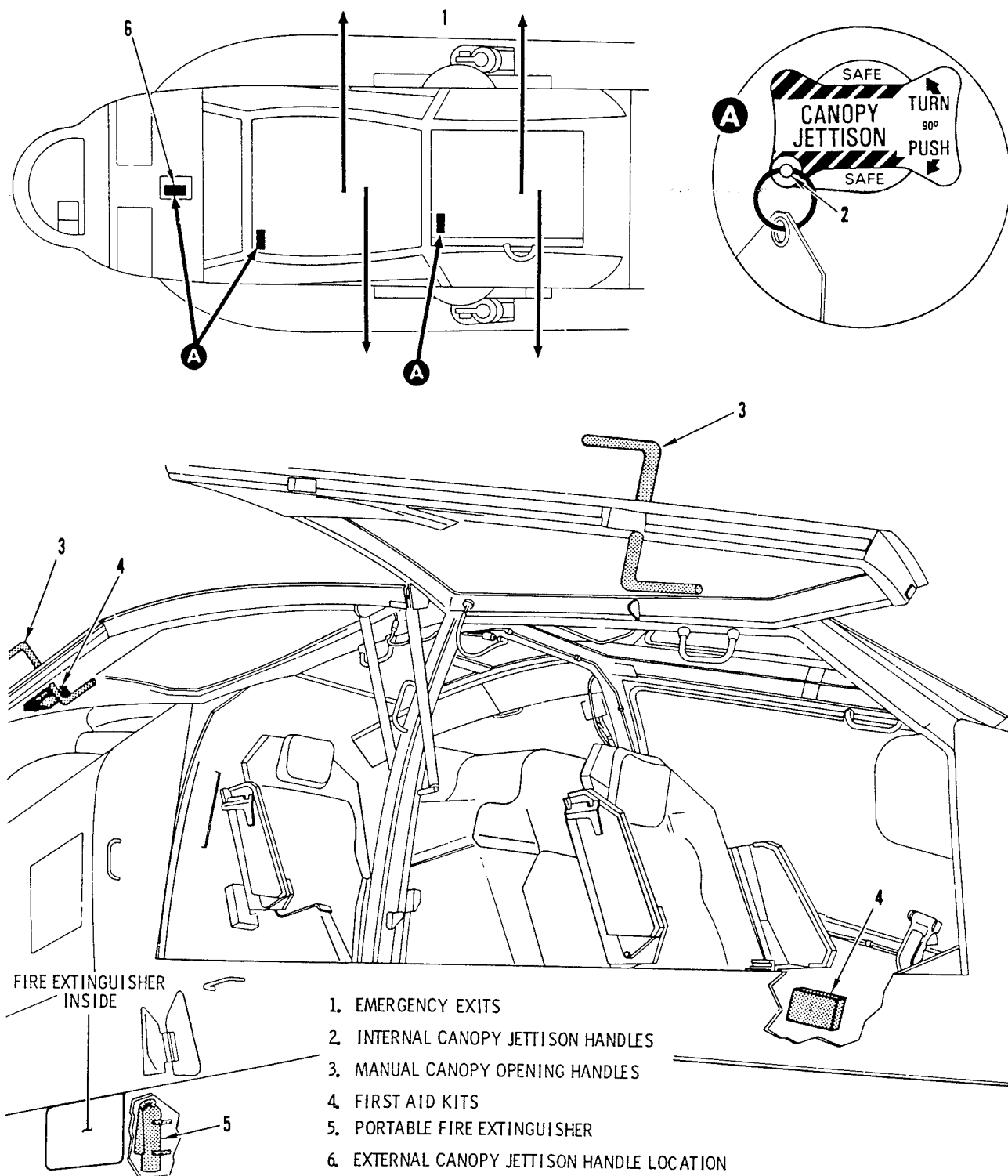

Figure 23. AH-64 ground crew emergency egress handles.

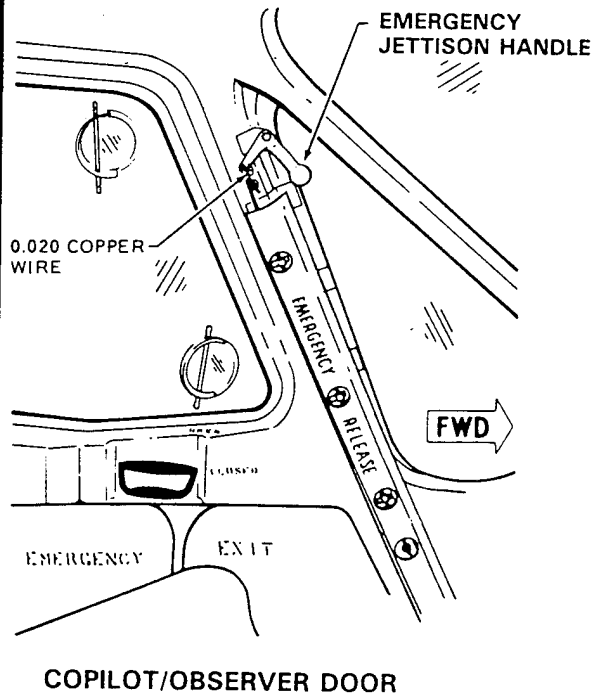
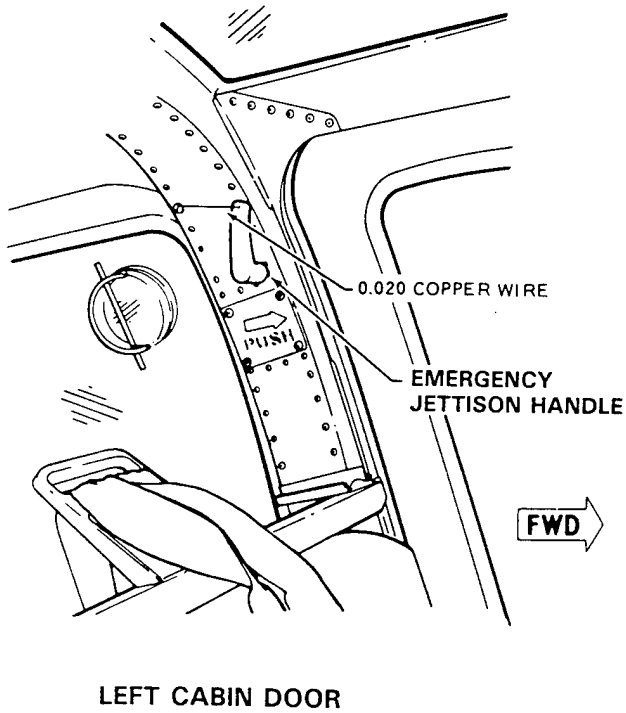
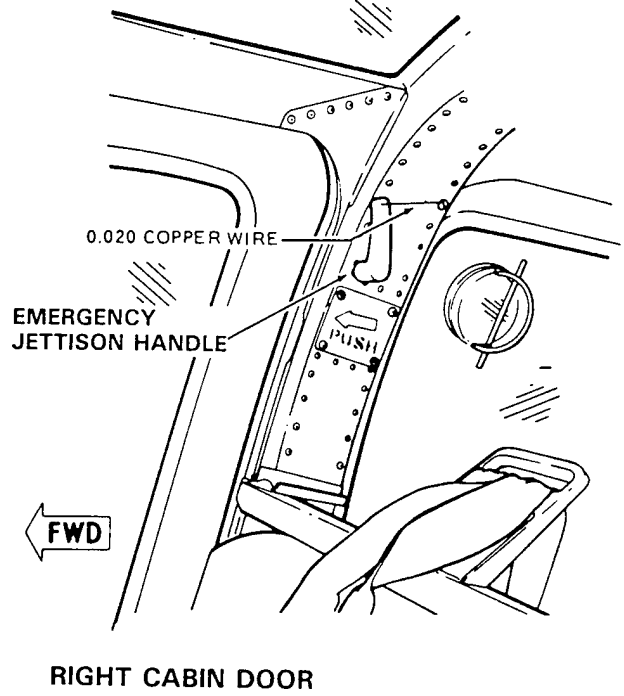
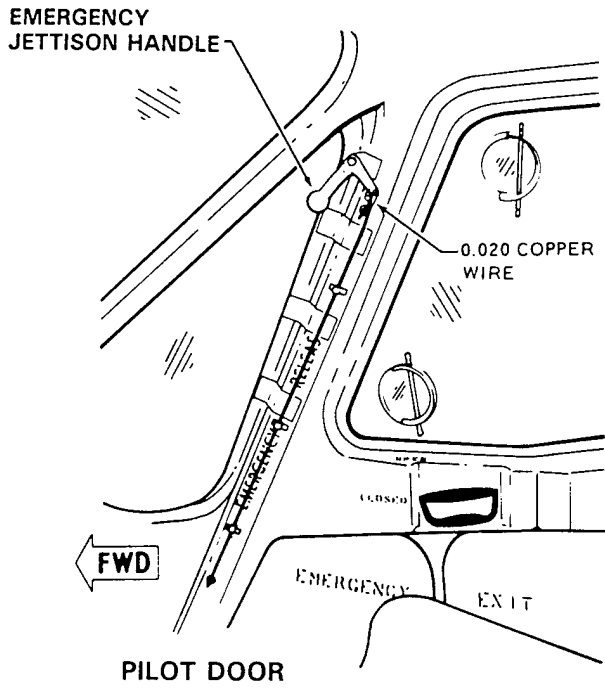
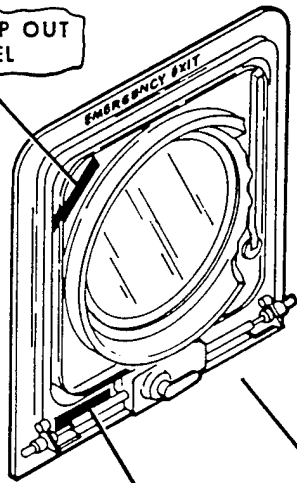

Figure 28. OH-58 cabin emergency egress handles.

PULL STRAP OUT  
PUSH PANEL



TURN HANDLE UP  
LIFT DOOR

EMERGENCY EXIT  
PULL STRAP OUT  
PUSH WINDOW OUT

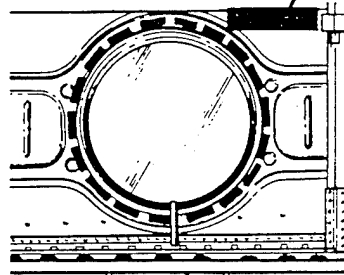

ALTERNATE ESCAPE EXIT  
PULL STRAP OUT  
PUSH WINDOW OUT  
( TYPICAL 9 CABIN WINDOWS )

EMERG EXIT  
TURN HANDLE ←

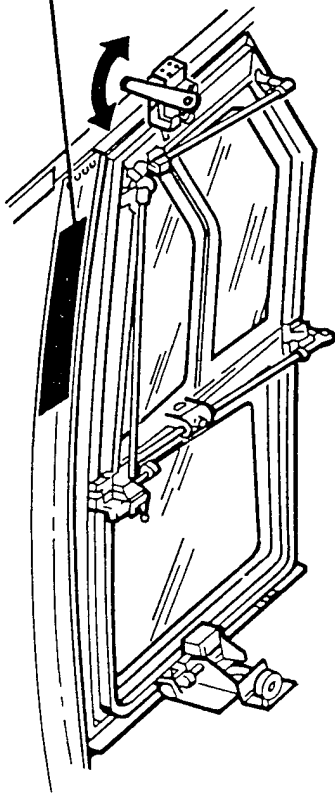

DOOR JETTISON  
PUSH TRIGGER  
TURN HANDLE DOWN

EMERGENCY EXIT  
PULL STRAP OUT  
PUSH PANEL

Figure 34. CH-47 cockpit and cabin emergency exits.

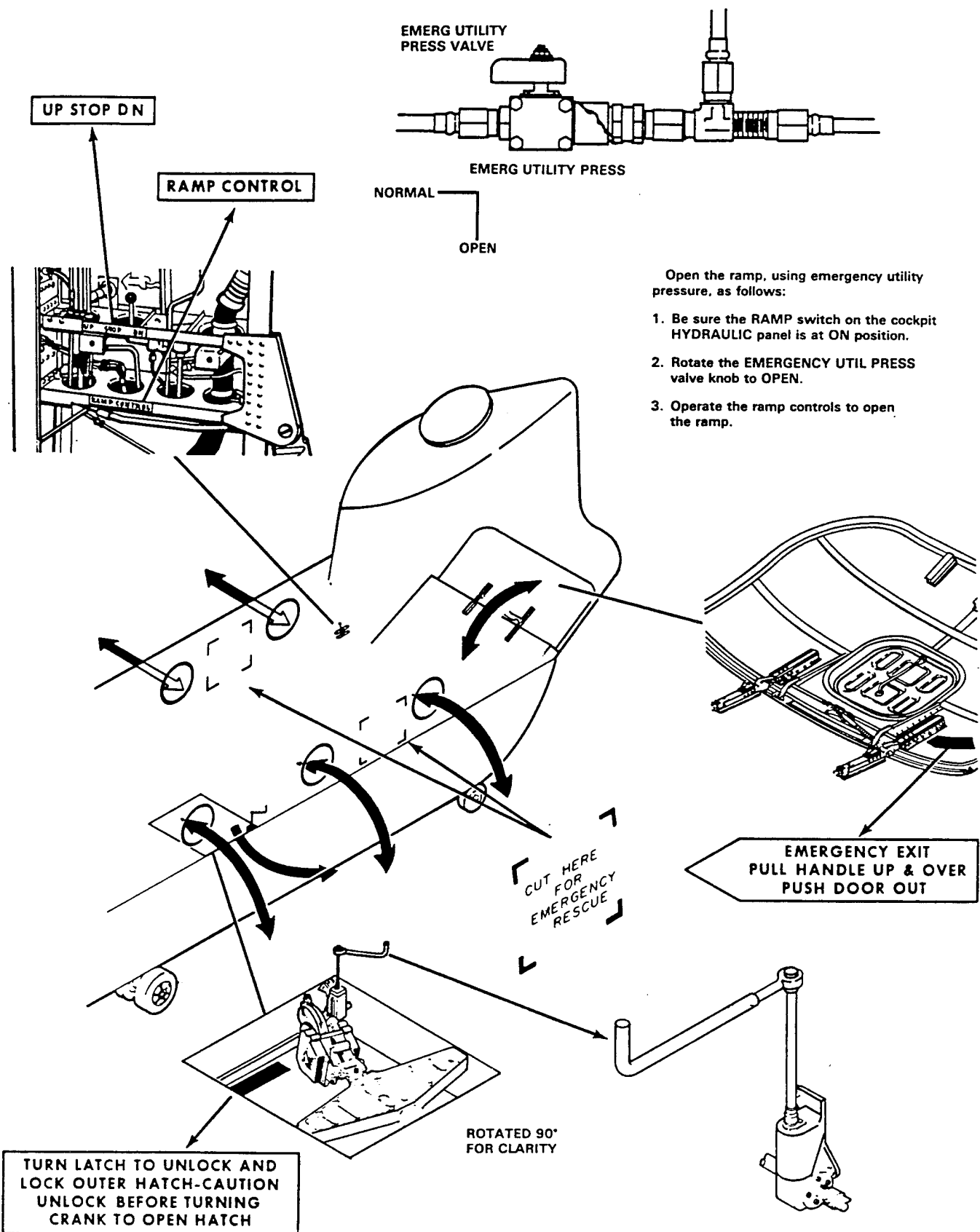

Figure 35. CH-47 cabin area and ramp emergency exits.

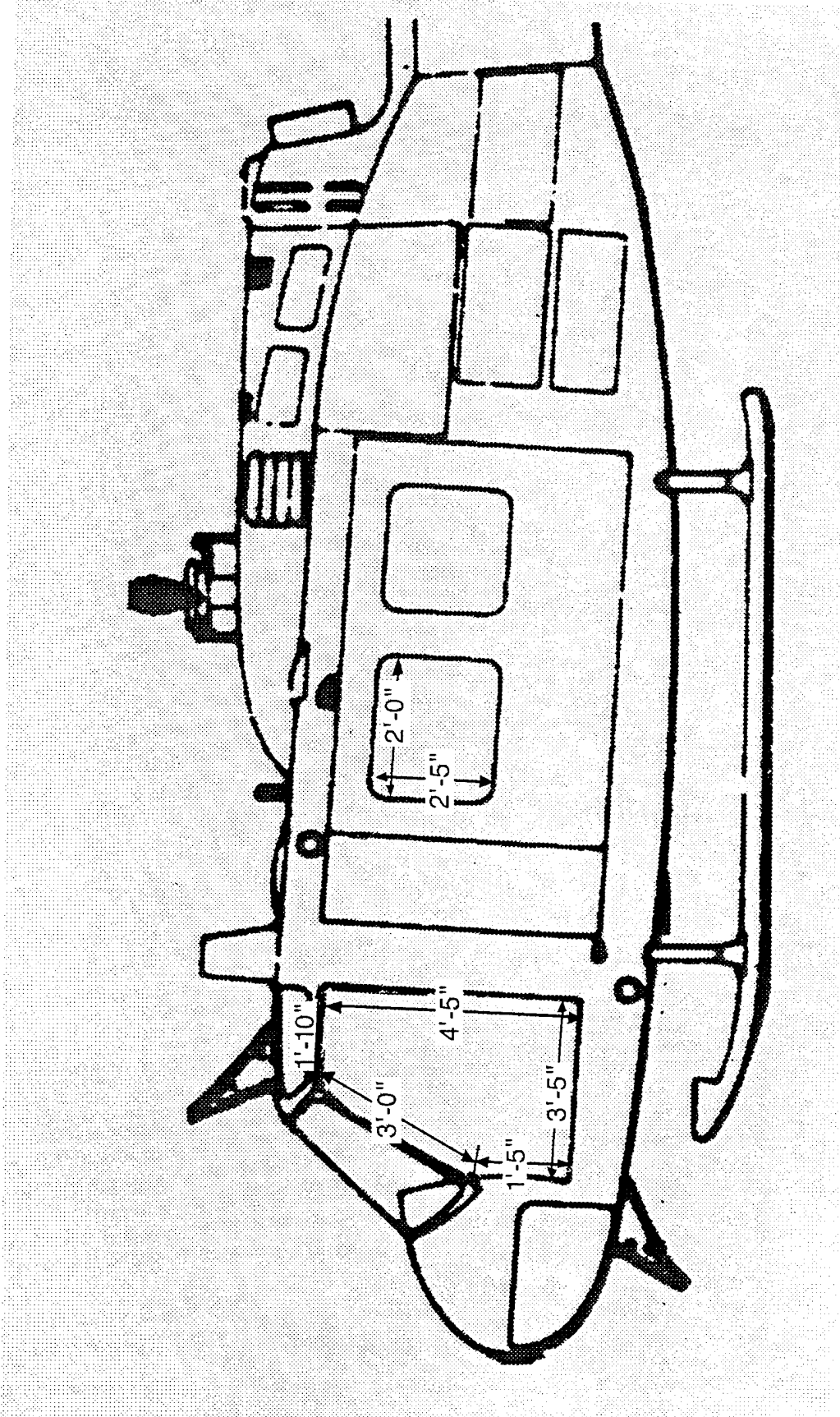

Figure 36. UH-1 Huey schematic showing dimensions of egress areas.

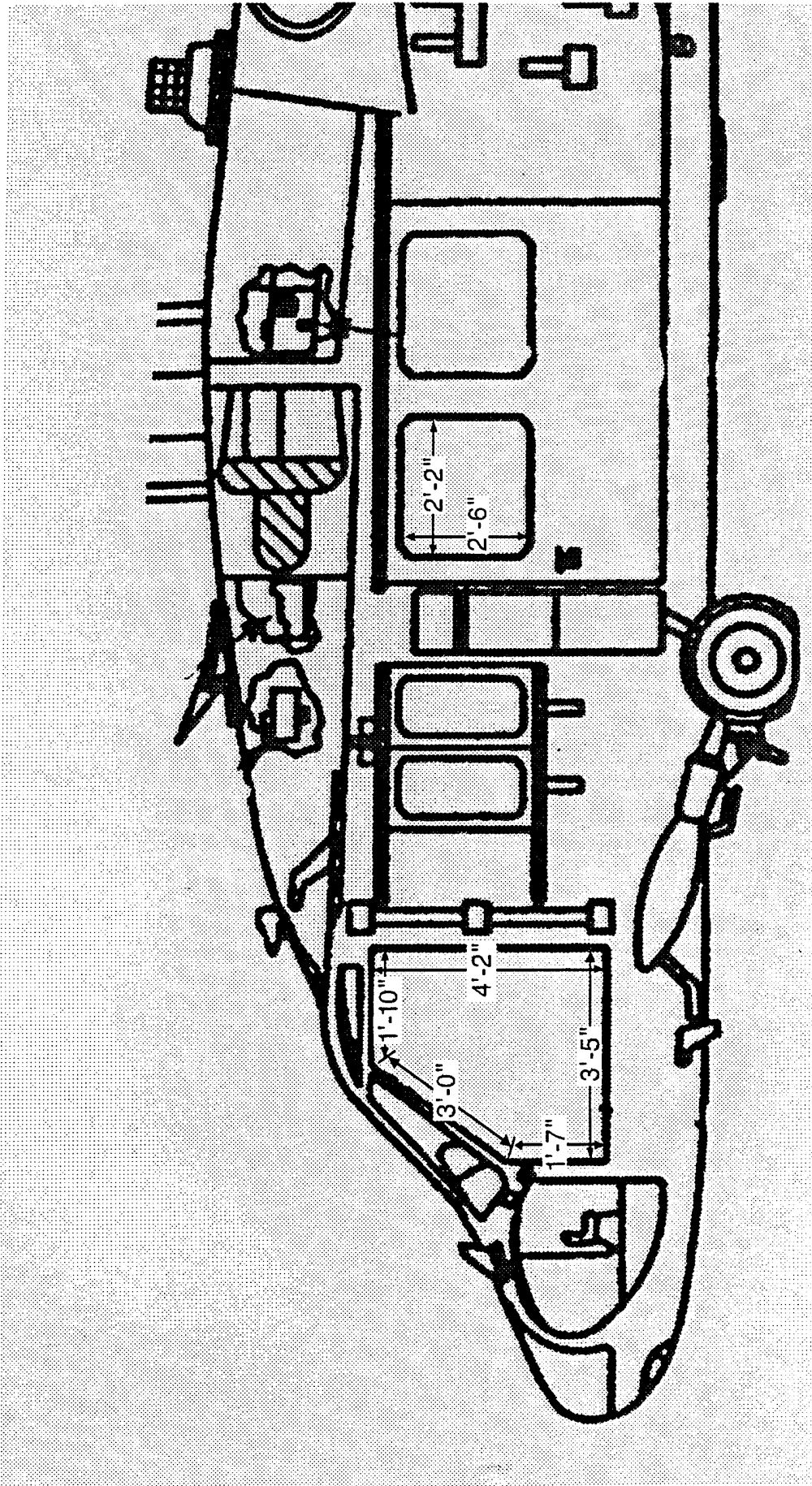

Figure 37. UH-60 Black Hawk schematic showing dimensions of egress areas.

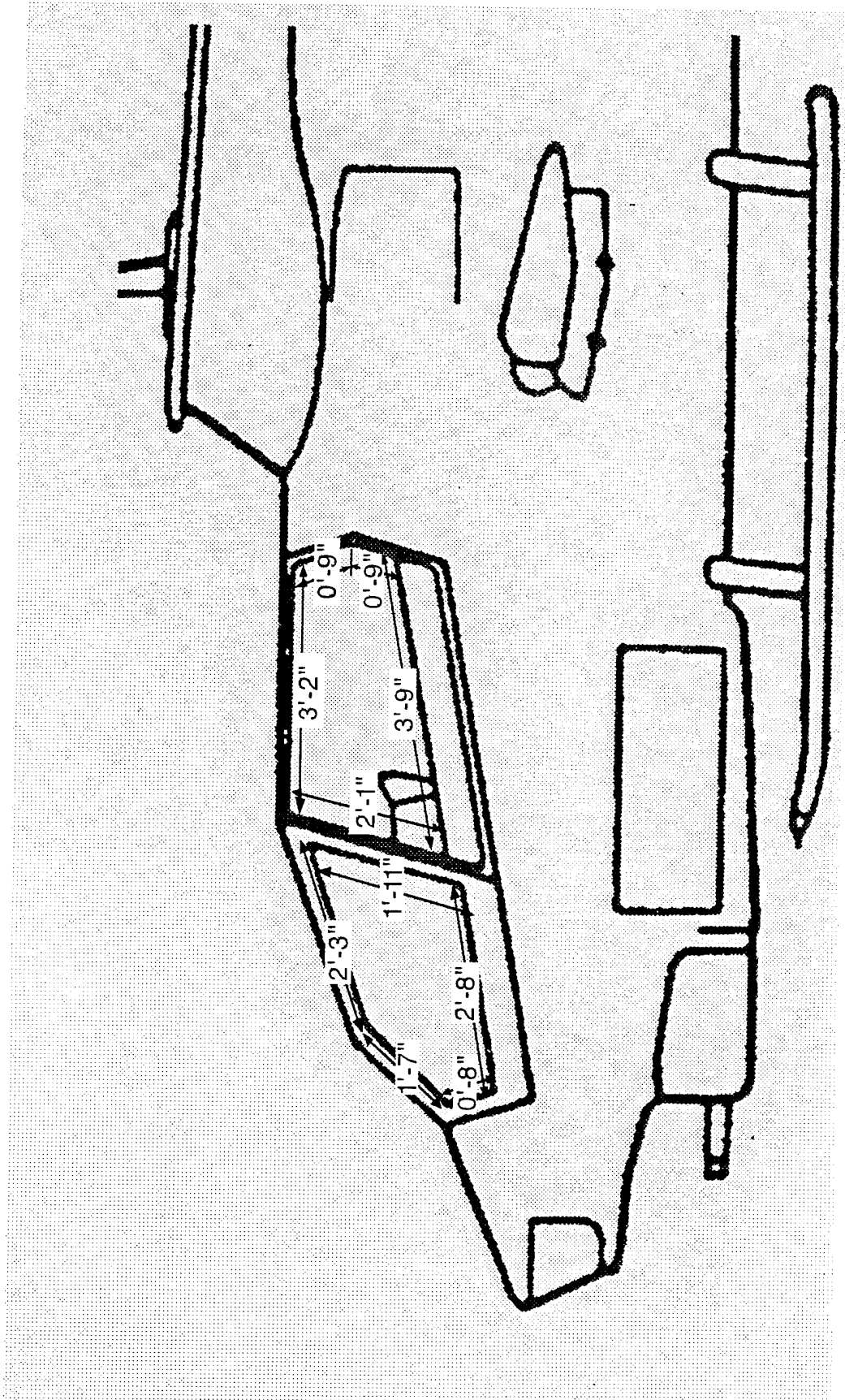

Figure 38. AH-1 Cobra schematic showing dimensions of egress areas.

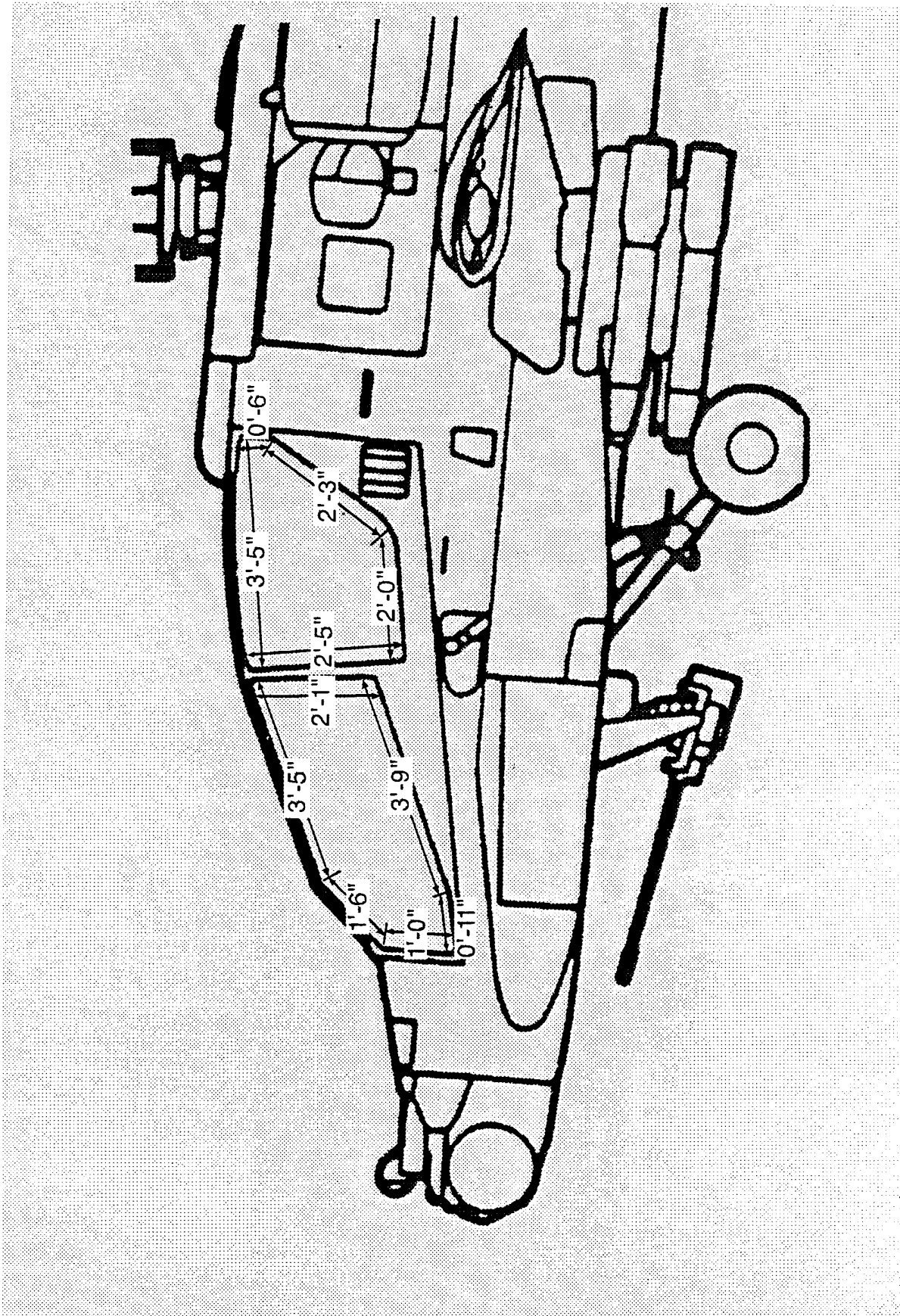

Figure 39. AH-64 Apache schematic showing dimensions of egress areas.

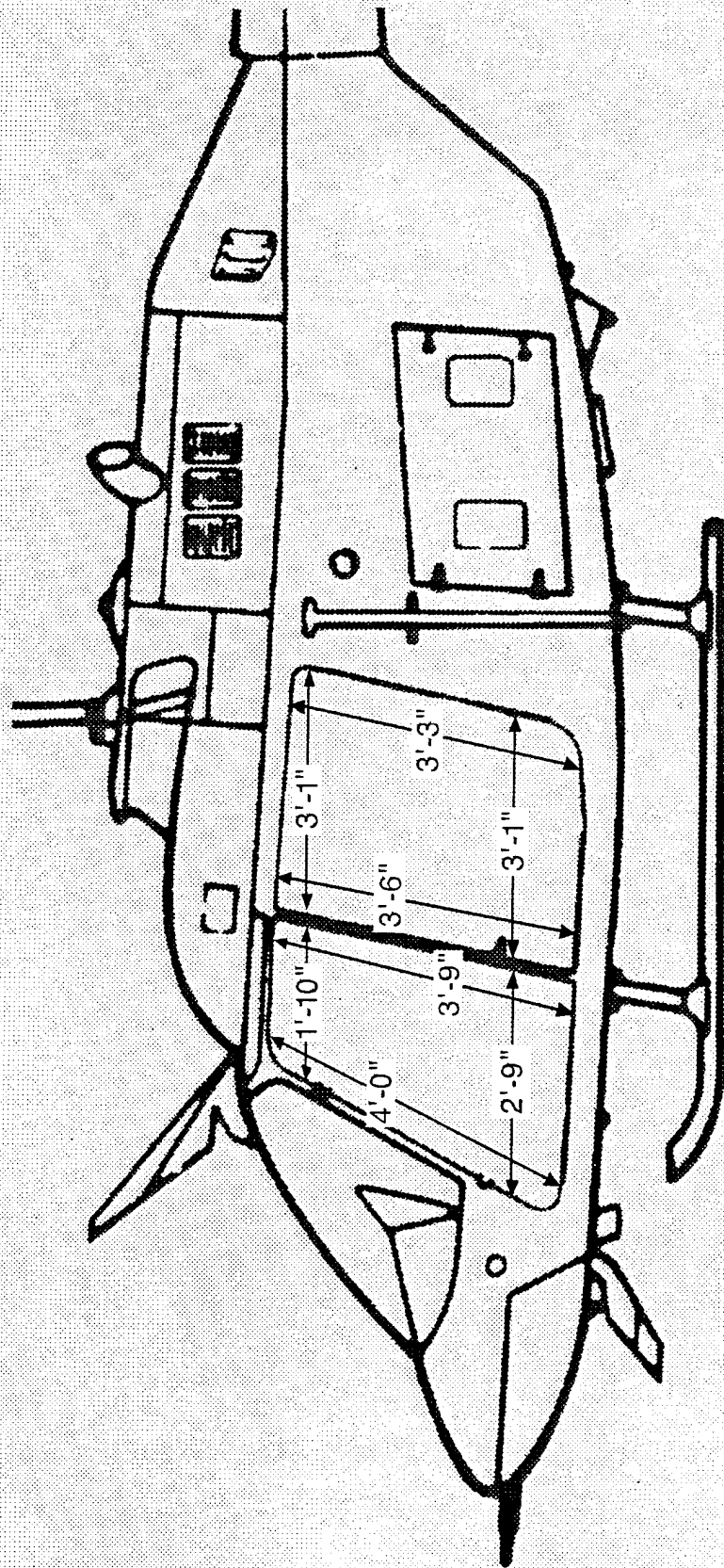

Figure 40. OH-58 Kiowa schematic showing dimensions of egress areas.

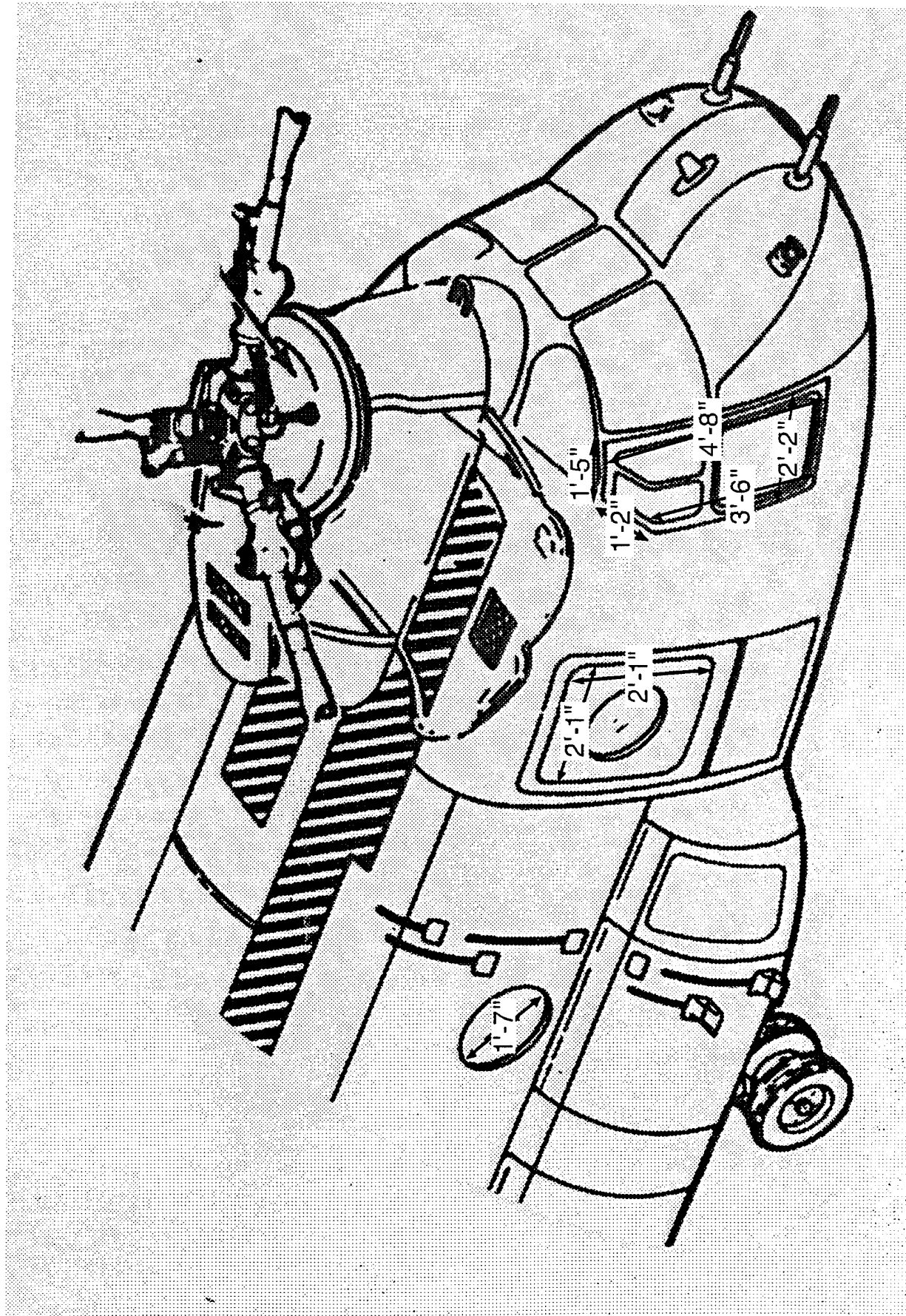

Figure 41. CH-47 Chinook schematic showing dimensions of egress areas.

Initial distribution

Commander, U.S. Army Natick Research,  
Development and Engineering Center  
ATTN: SATNC-MIL (Documents  
Librarian)  
Natick, MA 01760-5040

Chairman  
National Transportation Safety Board  
800 Independence Avenue, S.W.  
Washington, DC 20594

Commander  
10th Medical Laboratory  
ATTN: Audiologist  
APO New York 09180

Naval Air Development Center  
Technical Information Division  
Technical Support Detachment  
Warminster, PA 18974

Commanding Officer, Naval Medical  
Research and Development Command  
National Naval Medical Center  
Bethesda, MD 20814-5044

Deputy Director, Defense Research  
and Engineering  
ATTN: Military Assistant  
for Medical and Life Sciences  
Washington, DC 20301-3080

Commander, U.S. Army Research  
Institute of Environmental Medicine  
Natick, MA 01760

Library  
Naval Submarine Medical Research Lab  
Box 900, Naval Sub Base  
Groton, CT 06349-5900

Executive Director, U.S. Army Human  
Research and Engineering Directorate  
ATTN: Technical Library  
Aberdeen Proving Ground, MD 21005

Commander  
Man-Machine Integration System  
Code 602  
Naval Air Development Center  
Warminster, PA 18974

Commander  
Naval Air Development Center  
ATTN: Code 602-B  
Warminster, PA 18974

Commanding Officer  
Armstrong Laboratory  
Wright-Patterson  
Air Force Base, OH 45433-6573

Director  
Army Audiology and Speech Center  
Walter Reed Army Medical Center  
Washington, DC 20307-5001

Commander/Director  
U.S. Army Combat Surveillance  
and Target Acquisition Lab  
ATTN: SFAE-IEW-JS  
Fort Monmouth, NJ 07703-5305

Director  
Federal Aviation Administration  
FAA Technical Center  
Atlantic City, NJ 08405

Director  
Walter Reed Army Institute of Research  
Washington, DC 20307-5100

Commander, U.S. Army Test  
and Evaluation Command  
Directorate for Test and Evaluation  
ATTN: AMSTE-TA-M (Human Factors  
Group)  
Aberdeen Proving Ground,  
MD 21005-5055

Naval Air Systems Command  
Technical Air Library 950D  
Room 278, Jefferson Plaza II  
Department of the Navy  
Washington, DC 20361

Director  
U.S. Army Ballistic  
Research Laboratory  
ATTN: DRXBR-OD-ST Tech Reports  
Aberdeen Proving Ground, MD 21005

Commander  
U.S. Army Medical Research  
Institute of Chemical Defense  
ATTN: SGRD-UV-AO  
Aberdeen Proving Ground,  
MD 21010-5425

Commander  
USAMRMC  
ATTN: SGRD-RMS  
Fort Detrick, Frederick, MD 21702-5012

HQ DA (DASG-PSP-O)  
5109 Leesburg Pike  
Falls Church, VA 22041-3258

Harry Diamond Laboratories  
ATTN: Technical Information Branch  
2800 Powder Mill Road  
Adelphi, MD 20783-1197

U.S. Army Materiel Systems  
Analysis Agency  
ATTN: AMXSY-PA (Reports Processing)  
Aberdeen Proving Ground  
MD 21005-5071

U.S. Army Ordnance Center  
and School Library  
Simpson Hall, Building 3071  
Aberdeen Proving Ground, MD 21005

U.S. Army Environmental  
Hygiene Agency  
ATTN: HSHB-MO-A  
Aberdeen Proving Ground, MD 21010

Technical Library Chemical Research  
and Development Center  
Aberdeen Proving Ground, MD  
21010-5423

Commander  
U.S. Army Medical Research  
Institute of Infectious Disease  
ATTN: SGRD-UIZ-C  
Fort Detrick, Frederick, MD 21702

Director, Biological  
Sciences Division  
Office of Naval Research  
600 North Quincy Street  
Arlington, VA 22217

Commandant  
U.S. Army Aviation  
Logistics School ATTN: ATSQ-TDN  
Fort Eustis, VA 23604

Headquarters (ATMD)  
U.S. Army Training  
and Doctrine Command  
ATTN: ATBO-M  
Fort Monroe, VA 23651

IAF Liaison Officer for Safety  
USAF Safety Agency/SEFF  
9750 Avenue G, SE  
Kirtland Air Force Base  
NM 87117-5671

Naval Aerospace Medical  
Institute Library  
Building 1953, Code 03L  
Pensacola, FL 32508-5600

Command Surgeon  
HQ USCENTCOM (CCSG)  
U.S. Central Command  
MacDill Air Force Base, FL 33608

Director  
Directorate of Combat Developments  
ATTN: ATZQ-CD  
Building 515  
Fort Rucker, AL 36362

U.S. Air Force Institute  
of Technology (AFIT/LDEE)  
Building 640, Area B  
Wright-Patterson  
Air Force Base, OH 45433

Henry L. Taylor  
Director, Institute of Aviation  
University of Illinois-Willard Airport  
Savoy, IL 61874

Chief, National Guard Bureau  
ATTN: NGB-ARS  
Arlington Hall Station  
111 South George Mason Drive  
Arlington, VA 22204-1382

AAMRL/HEX  
Wright-Patterson  
Air Force Base, OH 45433

Commander  
U.S. Army Aviation and Troop Command  
ATTN: AMSAT-R-ES  
4300 Goodfellow Bouvelard  
St. Louis, MO 63120-1798

U.S. Army Aviation and Troop Command  
Library and Information Center Branch  
ATTN: AMSAV-DIL  
4300 Goodfellow Boulevard  
St. Louis, MO 63120

Federal Aviation Administration  
Civil Aeromedical Institute  
Library AAM-400A  
P.O. Box 25082  
Oklahoma City, OK 73125

Commander  
U.S. Army Medical Department  
and School  
ATTN: Library  
Fort Sam Houston, TX 78234

Commander  
U.S. Army Institute of Surgical Research  
ATTN: SGRD-USM  
Fort Sam Houston, TX 78234-6200

Air University Library  
(AUL/LSE)  
Maxwell Air Force Base, AL 36112

Product Manager  
Aviation Life Support Equipment  
ATTN: SFAE-AV-LSE  
4300 Goodfellow Boulevard  
St. Louis, MO 63120-1798

Commander and Director  
USAE Waterways Experiment Station  
ATTN: CEWES-IM-MI-R,  
CD Department  
3909 Halls Ferry Road  
Vicksburg, MS 39180-6199

Commanding Officer  
Naval Biodynamics Laboratory  
P.O. Box 24907  
New Orleans, LA 70189-0407

Assistant Commandant  
U.S. Army Field Artillery School  
ATTN: Morris Swott Technical Library  
Fort Sill, OK 73503-0312

Mr. Peter Seib  
Human Engineering Crew Station  
Box 266  
Westland Helicopters Limited  
Yeovil, Somerset BA20 2YB UK

U.S. Army Dugway Proving Ground  
Technical Library, Building 5330  
Dugway, UT 84022

U.S. Army Yuma Proving Ground  
Technical Library  
Yuma, AZ 85364

AFFTC Technical Library  
6510 TW/TSTL  
Edwards Air Force Base,  
CA 93523-5000

Commander  
Code 3431  
Naval Weapons Center  
China Lake, CA 93555

Aeromechanics Laboratory  
U.S. Army Research and Technical Labs  
Ames Research Center, M/S 215-1  
Moffett Field, CA 94035

Sixth U.S. Army  
ATTN: SMA  
Presidio of San Francisco, CA 94129

Commander  
U.S. Army Aeromedical Center  
Fort Rucker, AL 36362

Strughold Aeromedical Library  
Document Service Section  
2511 Kennedy Circle  
Brooks Air Force Base, TX 78235-5122

Dr. Diane Damos  
Department of Human Factors  
ISSM, USC  
Los Angeles, CA 90089-0021

U.S. Army White Sands  
Missile Range  
ATTN: STEWS-IM-ST  
White Sands Missile Range, NM 88002

Director, Airworthiness Qualification Test  
Directorate (ATTC)  
ATTN: STEAT-AQ-O-TR (Tech Lib)  
75 North Flightline Road  
Edwards Air Force Base, CA 93523-6100

Ms. Sandra G. Hart  
Ames Research Center  
MS 262-3  
Moffett Field, CA 94035

Commander  
USAMRMC  
ATTN: SGRD-UMZ  
Fort Detrick, Frederick, MD 21702-5009

Commander  
U.S. Army Health Services Command  
ATTN: HSOP-SO  
Fort Sam Houston, TX 78234-6000

U. S. Army Research Institute  
Aviation R&D Activity  
ATTN: PERI-IR  
Fort Rucker, AL 36362

Commander  
U.S. Army Safety Center  
Fort Rucker, AL 36362

U.S. Army Aircraft Development  
Test Activity  
ATTN: STEBG-MP-P  
Cairns Army Air Field  
Fort Rucker, AL 36362

Commander  
USAMRMC  
ATTN: SGRD-PLC (COL R. Gifford)  
Fort Detrick, Frederick, MD 21702

TRADOC Aviation LO  
Unit 21551, Box A-209-A  
APO AE 09777

Netherlands Army Liaison Office  
Building 602  
Fort Rucker, AL 36362

British Army Liaison Office  
Building 602  
Fort Rucker, AL 36362

Italian Army Liaison Office  
Building 602  
Fort Rucker, AL 36362

Directorate of Training Development  
Building 502  
Fort Rucker, AL 36362

Chief  
USAHEL/USAAVNC Field Office  
P. O. Box 716  
Fort Rucker, AL 36362-5349

Commander, U.S. Army Aviation Center  
and Fort Rucker  
ATTN: ATZQ-CG  
Fort Rucker, AL 36362

Dr. Sehchang Hah  
Dept. of Behavior Sciences and  
Leadership, Building 601, Room 281  
U. S. Military Academy  
West Point, NY 10996-1784

Canadian Army Liaison Office  
Building 602  
Fort Rucker, AL 36362

German Army Liaison Office  
Building 602  
Fort Rucker, AL 36362

French Army Liaison Office  
USAAVNC (Building 602)  
Fort Rucker, AL 36362-5021

Australian Army Liaison Office  
Building 602  
Fort Rucker, AL 36362

Dr. Garrison Rapmund  
6 Burning Tree Court  
Bethesda, MD 20817

Commandant, Royal Air Force  
Institute of Aviation Medicine  
Farnborough, Hampshire GU14 6SZ UK

Defense Technical Information  
Cameron Station, Building 5  
Alexandra, VA 22304-6145

Commander, U.S. Army Foreign Science  
and Technology Center  
AIFRTA (Davis)  
220 7th Street, NE  
Charlottesville, VA 22901-5396

Commander  
Applied Technology Laboratory  
USARTL-ATCOM  
ATTN: Library, Building 401  
Fort Eustis, VA 23604

Commander, U.S. Air Force  
Development Test Center  
101 West D Avenue, Suite 117  
Eglin Air Force Base, FL 32542-5495

Aviation Medicine Clinic  
TMC #22, SAAF  
Fort Bragg, NC 28305

Dr. H. Dix Christensen  
Bio-Medical Science Building, Room 753  
Post Office Box 26901  
Oklahoma City, OK 73190

Commander, U.S. Army Missile  
Command  
Redstone Scientific Information Center  
ATTN: AMSMI-RD-CS-R  
/ILL Documents  
Redstone Arsenal, AL 35898

Aerospace Medicine Team  
HQ ACC/SGST3  
162 Dodd Boulevard, Suite 100  
Langley Air Force Base,  
VA 23665-1995

U.S. Army Research and Technology  
Laboratories (AVSCOM)  
Propulsion Laboratory MS 302-2  
NASA Lewis Research Center  
Cleveland, OH 44135

Commander  
USAMRMC  
ATTN: SGRD-ZC (COL John F. Glenn)  
Fort Detrick, Frederick, MD 21702-5012

Dr. Eugene S. Channing  
166 Baughman's Lane  
Frederick, MD 21702-4083

U.S. Army Medical Department  
and School  
USAMRDALC Liaison  
ATTN: HSMC-FR  
Fort Sam Houston, TX 78234

NVESD  
AMSEL-RD-NV-ASID-PST  
(Attn: Trang Bui)  
10221 Burbeck Road  
Fort Belvoir, VA 22060-5806

CA Av Med  
HQ DAAC  
Middle Wallop  
Stockbridge, Hants S020 8DY UK

Dr. Christine Schlichting  
Behavioral Sciences Department  
Box 900, NAVUBASE NLON  
Groton, CT 06349-5900

Commander  
Aviation Applied Technology Directorate  
ATTN: AMSAT-R-TV  
Fort Eustis, VA 23604-5577

COL Yehezkel G. Caine, MD  
Surgeon General, Israel Air Force  
Aeromedical Center Library  
P. O. Box 02166 I.D.F.  
Israel

HQ ACC/DOHP  
205 Dodd Boulevard, Suite 101  
Langley Air Force Base,  
VA 23665-2789

41st Rescue Squadron  
41st RQS/SG  
940 Range Road  
Patrick Air Force Base,  
FL 32925-5001

48th Rescue Squadron  
48th RQS/SG  
801 Dezonias Road  
Holloman Air Force Base,  
NM 88330-7715

HQ, AFOMA  
ATTN: SGPA (Aerospace Medicine)  
Bolling Air Force Base,  
Washington, DC 20332-6128

ARNG Readiness Center  
ATTN: NGB-AVN-OP  
Arlington Hall Station  
111 South George Mason Drive  
Arlington, VA 22204-1382

35th Fighter Wing  
35th FW/SG  
PSC 1013  
APO AE 09725-2055

66th Rescue Squadron  
66th RQS/SG  
4345 Tyndall Avenue  
Nellis Air Force Base, NV 89191-6076

71st Rescue Squadron  
71st RQS/SG  
1139 Redstone Road  
Patrick Air Force Base,  
FL 32925-5000

Director  
Aviation Research, Development  
and Engineering Center  
ATTN: AMSAT-R-Z  
4300 Goodfellow Boulevard  
St. Louis, MO 63120-1798

Commander  
USAMRMC  
ATTN: SGRD-ZB (COL C. Fred Tyner)  
Fort Detrick, Frederick, MD 21702-5012

Commandant  
U.S. Army Command and General Staff  
College  
ATTN: ATZL-SWS-L  
Fort Leavenworth, KS 66027-6900

Director  
Army Personnel Research Establishment  
Farnborough, Hants GU14 6SZ UK

Dr. A. Kornfield  
895 Head Street  
San Francisco, CA 94132-2813

Mr. George T. Singley, III  
Deputy Assistant Secretary of the Army  
for Research and Technology  
and Chief Scientist  
ATTN: Room 3E374  
103 Army Pentagon  
Washington, DC 20310-0103

The Honorable Gilbert F. Decker  
Assistant Secretary of the Army  
for Research, Development,  
and Acquisition  
ATTN: Room 2E672  
103 Army Pentagon  
Washington, DC 20310-0103

Dr. Craig Dorman  
Office of the Deputy Director,  
Defense Research and Engineering  
ATTN: Room 3D129LM  
103 Army Pentagon  
Washington, DC 20310-0103

HQ, AFOMA  
ATTN; SGPA (Aerospace Medicine)  
Bolling Air Force Base,  
Washington, DC 20332-6188

Cdr, PERSCOM  
ATTN: TAPC-PLA  
200 Stovall Street, Rm 3N25  
Alexandria, VA 22332-0413