

NUWC-NPT Technical Report 10,458  
21 July 1995

# A Hierarchical Fuzzy Controller for Intercept Guidance With a Forbidden Zone

A. F. Bessacini  
R. F. Pinkos  
Combat Systems Department

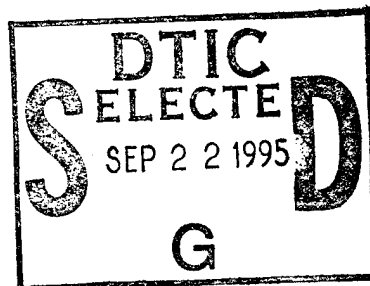

19950919 368

**Naval Undersea Warfare Center Division  
Newport, Rhode Island**

Approved for public release; distribution is unlimited.

DTIC QUALITY INSPECTED 5

## **PREFACE**

This report was prepared under the NUWC Bid and Proposal (B&P) Program. The B&P Program provides funding for preliminary, conceptual, and technical work necessary for the generation of complete and comprehensive proposals for direct-funded work.

The technical reviewer for this report was W. G. Ravo (Code 2214).

**Reviewed and Approved: 21 July 1995**

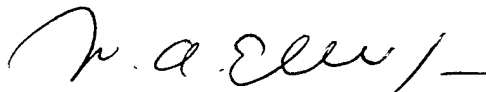
A handwritten signature in black ink, appearing to read 'P. A. La Brecque', with a horizontal line extending from the end of the signature.

**P. A. La Brecque**  
**Head, Combat Systems Department**

# REPORT DOCUMENTATION PAGE

*Form Approved*  
**OMB No. 0704-0188**

Public reporting for this collection of information is estimated to average 1 hour per response, including the time for reviewing instructions, searching existing data sources, gathering and maintaining the data needed, and completing and reviewing the collection of information. Send comments regarding this burden estimate or any other aspect of this collection of information, including suggestions for reducing this burden, to Washington Headquarters Services, Directorate for Information Operations and Reports, 1215 Jefferson Davis Highway, Suite 1204, Arlington, VA 22202-4302, and to the Office of Management and Budget, Paperwork Reduction Project (0704-0188), Washington, DC 20503.

<b>1. AGENCY USE ONLY (Leave blank)</b>	<b>2. REPORT DATE</b> 21 July 1995	<b>3. REPORT TYPE AND DATES COVERED</b> Final	
<b>4. TITLE AND SUBTITLE</b>  A Hierarchical Fuzzy Controller for Intercept Guidance With a Forbidden Zone		<b>5. FUNDING NUMBERS</b>	
<b>6. AUTHOR(S)</b>  A. F. Bessacini R. F. Pinkos			
<b>7. PERFORMING ORGANIZATION NAME(S) AND ADDRESS(ES)</b>  Naval Undersea Warfare Center Division 1176 Howell Street Newport, RI 02841-1708		<b>8. PERFORMING ORGANIZATION REPORT NUMBER</b>  TR 10,458	
<b>9. SPONSORING/MONITORING AGENCY NAME(S) AND ADDRESS(ES)</b>		<b>10. SPONSORING/MONITORING AGENCY REPORT NUMBER</b>	
<b>11. SUPPLEMENTARY NOTES</b>			
<b>12a. DISTRIBUTION/AVAILABILITY STATEMENT</b>  Approved for public release; distributed is unlimited.		<b>12b. DISTRIBUTION CODE</b>	
<b>13. ABSTRACT (Maximum 200 words)</b>  The problem of automatic, external control of an underwater vehicle such that it obeys an intercept guidance law while remaining outside a region defined relative to a time-varying measurement is considered in this report. The approach herein uses fuzzy set theory to develop a hierarchical controller that deals with multiple competing goals and determines the necessary commands to be sent over a two-way communication link between the launching platform and the vehicle being guided. Control of the vehicle entails use of a time-varying data input stream from the launching platform sensor. The controller is implemented in a simulation to demonstrate and analyze performance.			
<b>14. SUBJECT TERMS</b> Combat Control Systems			<b>15. NUMBER OF PAGES</b> 33
Remote Control Target Tracking	Vehicle Intercept Guidance Fuzzy Logic and Control	Hierarchical Controller Competing Goals	<b>16. PRICE CODE</b>
<b>17. SECURITY CLASSIFICATION OF REPORT</b> Unclassified	<b>18. SECURITY CLASSIFICATION OF THIS PAGE</b> Unclassified	<b>19. SECURITY CLASSIFICATION OF ABSTRACT</b> Unclassified	<b>20. LIMITATION OF ABSTRACT</b> SAR

## TABLE OF CONTENTS

Section	Page
LIST OF ILLUSTRATIONS .....	ii
LIST OF TABLES .....	ii
1 INTRODUCTION.....	1
1.1 Purpose .....	1
1.2 Background.....	1
2 SYSTEM DESCRIPTION .....	5
2.1 Intercept Hierarchical Fuzzy Control Subsystem .....	6
2.1.1 Forbidden Zone Unit.....	6
2.1.2 Primary Goal Error Unit .....	7
2.1.3 Secondary Goal Error Unit .....	7
2.1.4 Multi-Goal Fuzzification Unit .....	7
2.1.5 Multi-Goal Rule-Based Unit .....	13
2.1.6 Defuzzification Unit.....	17
2.1.7 Command Conditioner Unit .....	17
2.2 SYSTEM OPERATION.....	19
3 SIMULATION RESULTS .....	21
3.1 Non-Evasive Contact.....	21
3.2 Evasive Contact.....	24
3.3 Hierarchical vs Non-Hierarchical Control.....	26
4 CONCLUSIONS.....	29
5 REFERENCES.....	31

Accession For	
NTIS CRA&I	<input checked="" type="checkbox"/>
DTIC TAB	<input type="checkbox"/>
Unannounced	<input type="checkbox"/>
Justification .....	
By .....	
Distribution /	
Availability Codes	
Dist	Avail and/or Special
A-1	

## LIST OF ILLUSTRATIONS

Figure	Page
1a Intercept Control Loop .....	2
1b Problem Geometry .....	2
2 Geometry for Guidance Point control With Forbidden Zone .....	4
3 Overall System Structure for Hierarchical Intercept Control .....	5
4 Hierarchical Intercept Fuzzy Control System .....	6
5 Graphical Representation of Membership Functions for Fuzzy Inputs for Primary Goal .....	9
6 Graphical Representation of Membership Functions for Fuzzy Inputs for Secondary Goal and Output Control Set .....	11
7 Multi-Goal Rule-Based Unit .....	13
8 Matrices for Primary Goal in Rule-Based Unit .....	14
9 Matrix for Secondary Goal in Rule-Based Unit .....	14
10 Example of Determination of Composite Implication Function .....	16
11 Representation of the Hierarchical Intercept Command Conditioning Unit .....	18
12a Trajectory Plot for Non-Maneuvering Contact With Hierarchical Control .....	22
12b $e_s$ Response Curve for Trajectory Shown in Figure 12a .....	23
12c $\Delta e_{gp}$ Response Curve for Trajectory Shown in Figure 12a .....	23
13a Trajectory Plot for Hierarchical Control for the Maneuvering Target Case .....	24
13b $e_s$ Response Curve for Trajectory Shown in Figure 13a .....	25
13c $\Delta e_{gp}$ Response Curve for Trajectory Shown in Figure 13b .....	25
14a Trajectory Plot for a Simple Intercept Control Against a Maneuver Target .....	26
14b $e_s$ Response Curve for Trajectory in Figure 14a .....	27
14c $\Delta e_{gp}$ Response Curve for Trajectory in Figure 14a .....	27

## LIST OF TABLES

Table	Page
1 $C$ and $\delta$ Constants for Primary Goal Membership Functions .....	12
2 $C$ and $\delta$ Constants for Secondary Goal and Output Membership Functions .....	12
3 Run Parameters .....	21

# A HIERARCHICAL FUZZY CONTROLLER FOR INTERCEPT GUIDANCE WITH A FORBIDDEN REGION

## 1. INTRODUCTION

### 1.1 PURPOSE

This report deals with the problem of automatic, external control of an underwater vehicle such that it obeys an intercept guidance law while remaining outside a region defined relative to a time-varying measurement. The approach herein uses fuzzy set theory to develop a hierarchical controller that deals with multiple competing goals and determines the necessary commands to be sent over a two-way communication link between the launching platform and the vehicle being guided. Control of the vehicle entails use of a time-varying data input stream from the launching platform sensor. The controller is implemented in a simulation to demonstrate and analyze performance.

### 1.2 BACKGROUND

In present submarine combat control systems (SCCS), various guidance strategies can be employed for postlaunch control of a vehicle (torpedo). Previous work<sup>1,2</sup> has addressed the use of fuzzy controllers for bearing rider strategies. Intercept guidance is another well known strategy used in SCCS to guide a vehicle to a contact and is employed when a complete contact state vector exists (range, course, bearing, and speed). The goal of this technique is to maintain the vehicle at the appropriate angle so as to result in an intercept of the contact by the vehicle or vehicle guidance point as some future time. This is an important guidance mode since the trajectory results in the vehicle reaching the contact in minimum time using minimum fuel.

Other work has treated the development of fuzzy controllers for the intercept guidance mode for the single goal situations where it is desired that the pursuing vehicle intercepts the target and also when it is desired that the guidance point intercepts the target. This report addresses development of a fuzzy controller for the intercept guidance strategy when the situation is such that multiple goals exist (i.e., it is desired that the guidance point follow an intercept trajectory without violating the constraint of remaining outside a specified region). Operator loading in complex multi-sensor/multi-vehicle operational scenarios now makes it mandatory to develop and employ robust, automatic guidance schemes in order that the system operator is free to focus attention on tasks of a more supervisory decision-making nature.

An overall block diagram of the system being addressed is depicted in figure 1. The problem can be described as one in which a vehicle is launched from a moving platform. Sensors aboard the platform obtain noisy, time-varying measurements of the bearing and range to the contact. A two-way communication link is available between the vehicle and launcher; this serves as the information channel that allows the launching platform to send the postlaunch commands to the vehicle and the vehicle to send back the feedback data necessary to determine

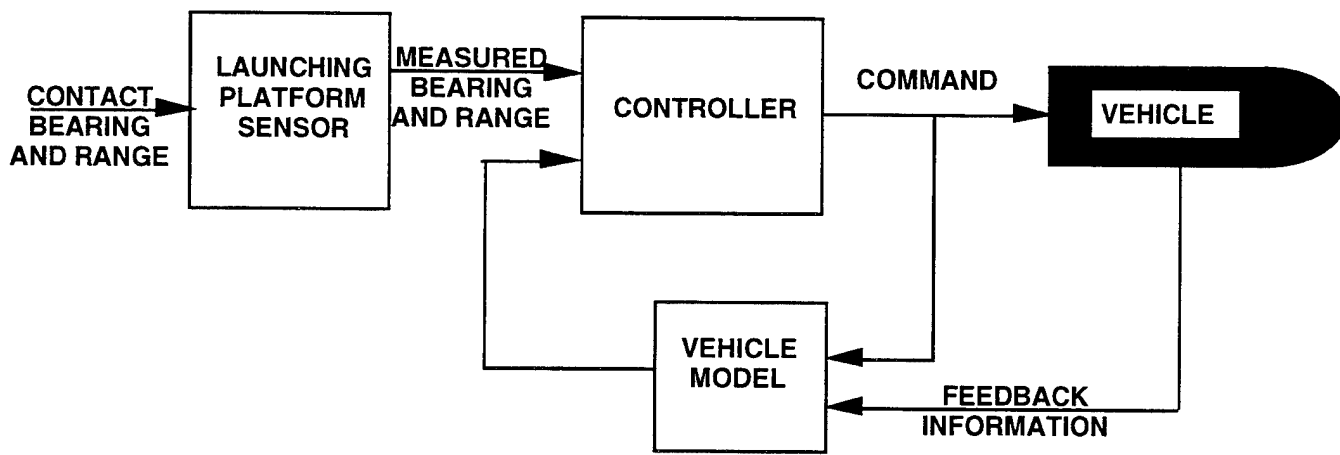

Figure 1a. Intercept Control Loop

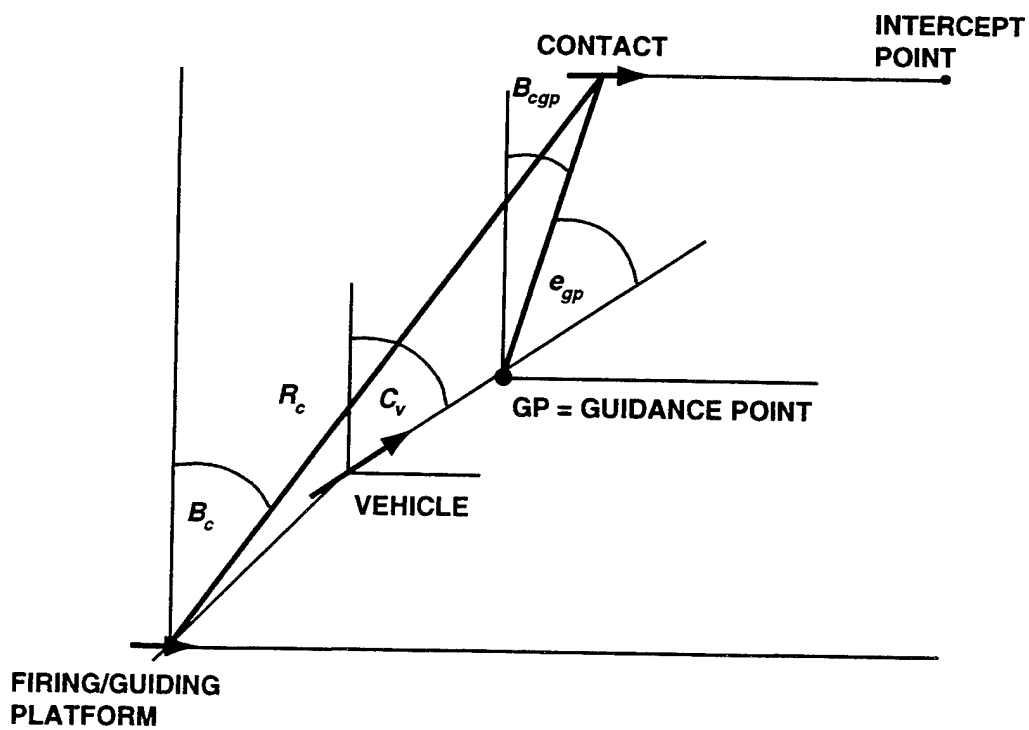

Figure 1b. Problem Geometry

its state. The present control mechanism uses measured contact information ( $B_c$ , contact bearing,  $R_c$ , contact range.), estimated contact information ( $C_c$ , contact course and  $S_c$ , contact speed) and vehicle guidance point positional information to determine the commands that maintain the vehicle's course such that intercept occurs. These commands are continuously provided to the actual vehicle via the wire communication link. These commands are also provided to update the vehicle model, a mathematical replica of the actual vehicle that resides in the SCCS. The vehicle model provides position and status information to the control mechanism continuously for postlaunch guidance operation.

Previous work<sup>3,4</sup> had resulted in the development of a simple, robust fuzzy logic controller, which addressed the following limitations:

- Current systems required the determination of the entire contact state vector to compute the intercept course; the single goal fuzzy intercept technique used only measured information.
- Present system approach had no mechanism for including heuristic information or trial and error experimental data into the controller design.
- Present systems do not automatically generate and issue vehicle trajectory commands.

However, one of the remaining disadvantages/limitations deals with the problem of the vehicle attaining a position where it interferes with the reception of the very signal required to provide the necessary guidance.

The hierarchical fuzzy controller for intercept guidance in this report accommodates the situation where multiple, conflicting goals exist. The multi-goal problem (figure 2) addressed has:

- A primary goal that requires the vehicle not enter a specified zone around the bearing line, and
- A secondary goal that requires that the vehicle guidance point remain on an intercept course on its trajectory to the contact.

No restrictions are placed on either launcher or contact motion. An example of a situation that requires this type of control is when a vehicle is acoustically searching for a contact and it is desired to guide a point on a minimum fuel/time trajectory, while maintaining separation from the line along which the contact-related signal is being measured to prevent contaminating the signal.

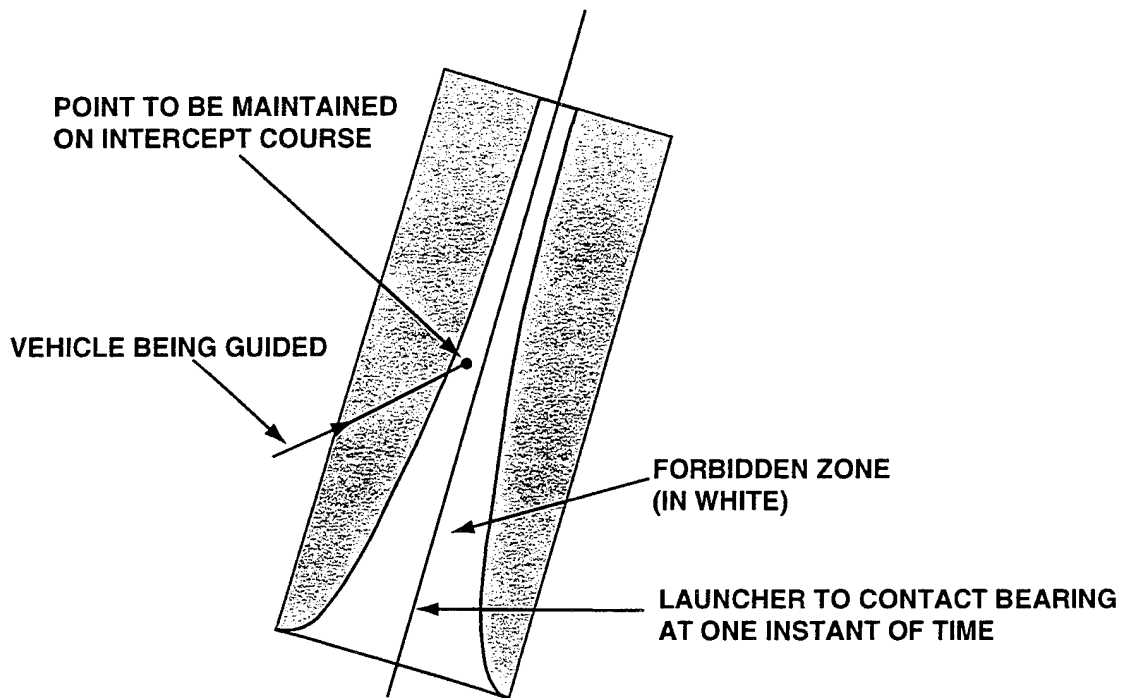

*Figure 2. Geometry for Guidance Point Control With Forbidden Zone*

## 2. SYSTEM DESCRIPTION

The overall system for constrained intercept control is shown in figures 3 and 4. The sensor subsystem provides the launcher platform position data from its navigational sensors and contact bearing ( $B_c$ ) and contact range ( $R_C$ ), noisy data streams obtained from its contact sensors. The vehicle model subsystem provides the vehicle state. The intercept hierarchical fuzzy subsystem processes the sensor and vehicle model data to produce a constrained vehicle intercept trajectory based on competing primary and secondary goals. The following units are included in the hierarchical fuzzy controller. The forbidden zone unit contains the mathematical function that defines the zone from which the vehicle operation is prohibited. The primary and secondary goal error units use both the measured and computed parameters to determine the appropriate error signals. The primary goal unit uses an error that corresponds to whether or not the vehicle is inside the forbidden zone ( $e_s$ ) and a measure of the rate of change of this error ( $\Delta e_s$ ). The secondary goal error unit uses an error ( $e_{gp}$ ) defined as the difference between the contact bearing from the vehicle guidance point ( $B_{cgp}$ ) and the vehicle course ( $C_v$ ), and the rate of change of the absolute value of this error ( $\Delta e_{gp}$ ). The multi-goal fuzzification unit uses these crisp variables ( $e_s$ ,  $\Delta e_s$ ,  $e_{gp}$ ,  $\Delta e_{gp}$ ) along with predefined membership functions to determine primary or secondary fuzzy linguistic variables based on the competing primary or secondary goals. The rule-based unit contains the rule sets for both the primary and secondary goals; these rules use the goal-related linguistic inputs to determine linguistic or fuzzy output commands. The defuzzification unit provides the mechanisms for converting fuzzy control outputs to the crisp control  $u$  necessary to achieve the appropriate goal. The command conditioner unit applies a constraint to  $u$  to ensure that a command is never given that would result in a velocity component in the direction of the launching platform during the early phases of postlaunch control. It also conditions the command as a function of the guidance distance and the range of the vehicle's guidance point from the contact. The resultant command is sent to the weapon via the wire and also the vehicle model where, together with the vehicle feedback data, it is used to update the vehicle kinematic parameters.

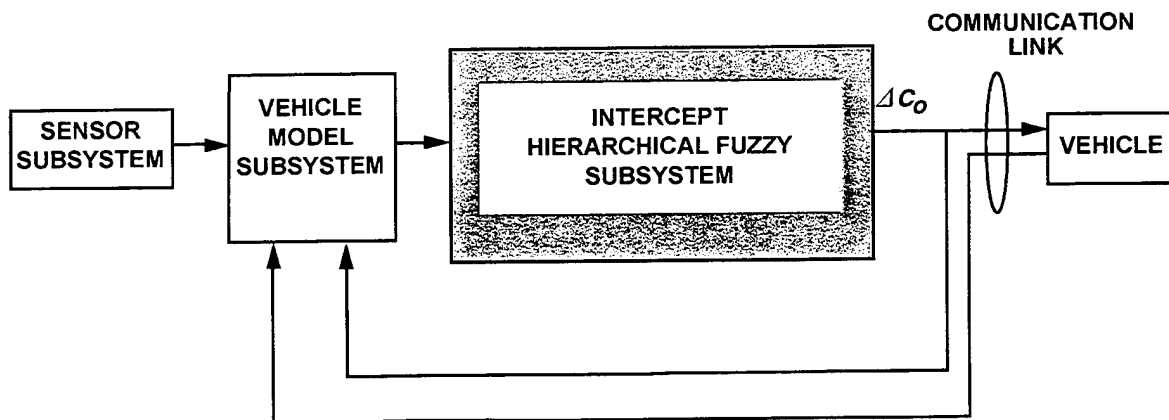

*Figure 3. Overall System Structure for Hierarchical Intercept Control*

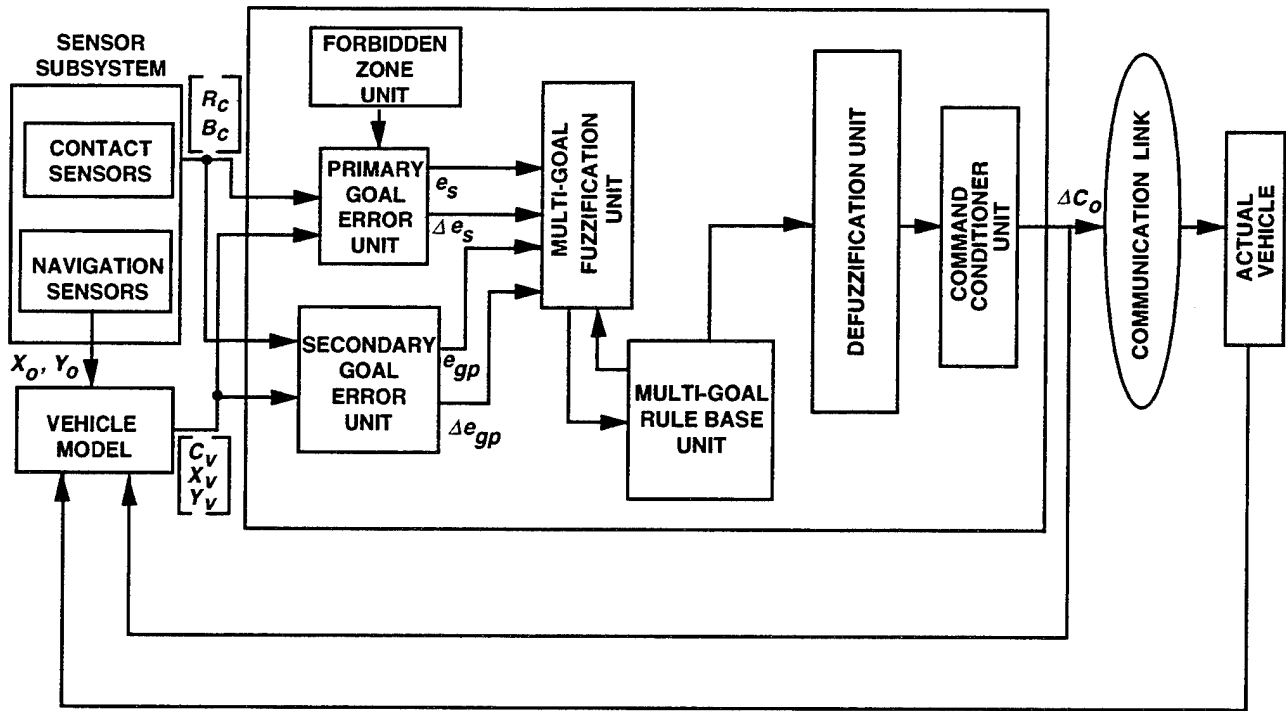

Figure 4. Hierarchical Intercept Fuzzy Control System

## 2.1 INTERCEPT HIERARCHICAL FUZZY CONTROL SUBSYSTEM

The functional elements comprising the hierarchical fuzzy control system are the forbidden zone unit, primary goal error unit, secondary goal error unit, multi-goal fuzzification unit, multi-goal rule-base unit, defuzzification unit, and the command conditioner unit. A description of each of these units follows.

### 2.1.1 Forbidden Zone Unit

In the intercept problem, it is undesirable to guide a vehicle so as to interfere with the contact information being sensed. In this embodiment, this common problem is addressed through the definition of what is referred to as a forbidden zone. Since the desirable/undesirable position of the vehicle changes as a function of both vehicle range and contact motion, the zone defined herein is an angular separation, which is a function of vehicle range and is applied

relative to the contact bearing. This can be written as

$$\theta_s = \theta_m e^{-r/c} ,$$

where  $\theta_m$  = maximum angular separation,  $r$  = range from launcher to vehicle, and  $c$  = constant.

Although this is the forbidden zone model used in the simulation runs made herein, other models could also be used.

### 2.1.2 Primary Goal Error Unit

The primary goal established is the requirement that the vehicle not enter the predefined region. The variables associated with this goal are defined as

$$x1 = e_s = |B_v - B_c| - \theta_s ,$$

$$x2 = \Delta e_s = |e_s|_k - |e_s|_{k-1} ,$$

where  $x1$  represents the angular measure of the amount that the vehicle is inside or outside the forbidden zone and  $x2$  is a measure of the rate of change of  $x1$ . Note, the following fuzzy control was derived for  $-90 \leq B_v \leq 90$  and  $-90 \leq B_c \leq 90$ .

### 2.1.3 Secondary Goal Error Unit

The secondary goal consists of the requirement to maintain the guidance point on an intercept course to the contact. Characterization of this goal is accomplished using the variables

$$x3 = e_{gp} = B_{cgp} - C_v ,$$

$$x4 = \Delta e_{gp} = |B_{cgp} - C_v|_k - |B_{cgp_{k-1}} - C_{v_k}| ,$$

where  $x3$  is the error associated with maintaining the guidance point on the intercept course and,  $x4$  is a measure of the rate of change of the contact bearing from the vehicle guidance point minus the vehicle course.

### 2.1.4 Multi-Goal Fuzzification Unit

The fuzzification unit takes crisp inputs and encodes them into fuzzy sets. Encoding,<sup>5,6</sup> of the system inputs requires mapping crisp numerical measurements into primary or secondary fuzzy set representations or linguistic variables based on competing primary and secondary goals. The universes of discourse for primary goal variables  $x1$  and  $x2$  comprise three linguistic variables, defined by the inventors to be the following term sets:

$$T(x1) = \{T^1_{x1}, T^2_{x1}, T^3_{x1}\} = (N, Z, P),$$

$$T(x2) = \{T^1_{x2}, T^2_{x2}, T^3_{x2}\} = (N, Z, P),$$

where N = negative, Z = zero, and P = positive.

The universes of discourse for secondary goal variables x3 and x4 comprise the three and seven linguistic variables, respectively, defined by the inventors .to be the following term sets:

$$T(x3) = \{T^1_{x3}, T^2_{x3}, T^3_{x3}\} = (N, ZE, P),$$

$$T(x4) = \{T^1_{x4}, T^2_{x4}, T^3_{x4}, T^4_{x4}, T^5_{x4}, T^6_{x4}, T^7_{x4}\} = (NL, NM, NS, ZE, PS, PM, PL),$$

where *NL* = Negative Large, *NM* = Negative Medium, *NS* = Negative Small, *N* = Negative, *ZE* = Zero, *P* = Positive, *PS* = Positive Small, *PM* = Positive Medium, and *PL* = Positive Large.

For the primary goal, the set of membership functions  $\mu(x1)$  corresponding to x1 and the set of membership functions  $\mu(x2)$  corresponding to x2 are:

$$\mu(x1) = \{\mu^1_{x1}, \mu^2_{x1}, \mu^3_{x1}\}$$

$$\mu(x2) = \{\mu^1_{x2}, \mu^2_{x2}, \mu^3_{x2}\},$$

and are graphically depicted in figure 5 (a) and (b), respectively, and are given by the following equations:

for  $j = 1$  and  $i = 2$ ,

for  $j = 2$  and  $i = 2$ ,

$$\mu^i_{xj} = 1 - (|xj - C^i_{xj}|) / \delta^i_{xj}$$

$$\text{for } C^i_{xj} - \delta^i_{xj} \leq xj \leq C^i_{xj} + \delta^i_{xj}$$

$$\mu^i_{xj} = 0$$

$$\text{for } C^i_{xj} - \delta^i_{xj} > xj > C^i_{xj} + \delta^i_{xj}$$

for  $j = 1$  and  $i = 1$

for  $j = 2$  and  $i = 1, 3$

$$\mu^i_{xj} = 1 - (|xj - C^i_{xj}|) / \delta^i_{xj}$$

$$\text{for } a^i C^i_{xj} \geq a^i xj \geq a^i (C^i_{xj} - a^i \delta^i_{xj}),$$

$$\mu^i_{xj} = 1$$

$$\text{for } a^i C^i_{xj} < a^i xj,$$

$$\mu^i_{xj} = 0$$

$$\text{for } a^i (C^i_{xj} - a^i \delta^i_{xj}) > a^i xj.$$

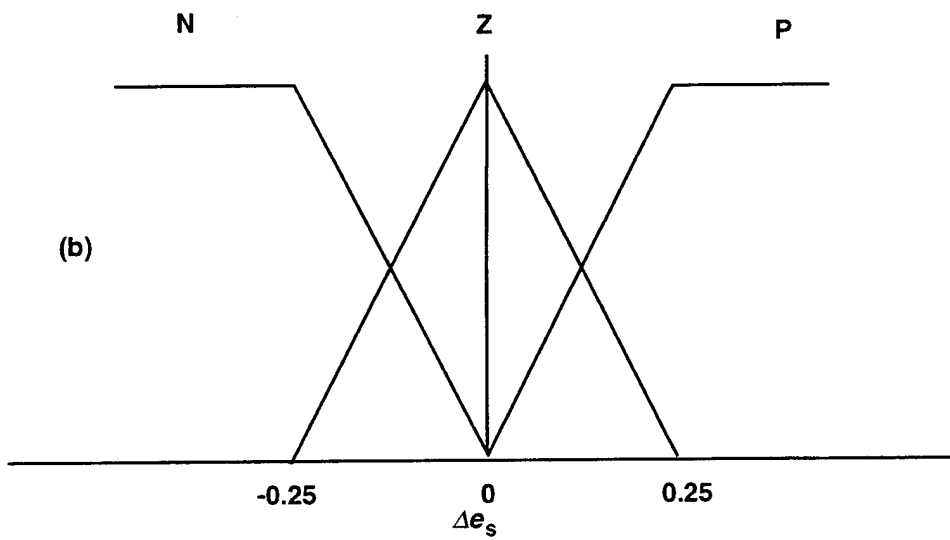
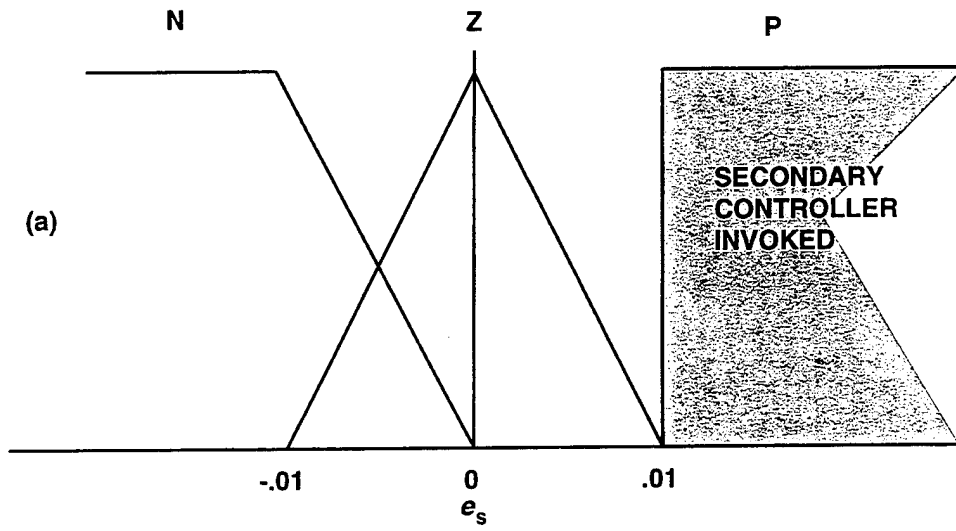

*Figure 5. Graphical Representation of Membership Functions for Fuzzy Inputs for Primary Goal*

where  $a^i = 1$ , except for  $i = 1$  where  $a^1 = -1$ .

for  $j = 1$  and  $i = 3$

$$\mu_{xj}^i = 1 \quad \text{for } C_{xj}^i \leq xj$$

$$\mu_{xj}^i = 0 \quad \text{for } C_{xj}^i > xj$$

The set of membership functions  $\mu(x3)$  corresponding to  $x3$  and the set of membership functions  $\mu(x4)$  corresponding to  $x4$  are:

$$\mu(x3) = \{\mu_{x3}^1, \mu_{x3}^2, \mu_{x3}^3\}$$

$$\mu(x4) = \{\mu_{x4}^1, \mu_{x4}^2, \mu_{x4}^3, \mu_{x4}^4, \mu_{x4}^5, \mu_{x4}^6, \mu_{x4}^7\},$$

and are depicted in figures 6a and 6b, respectively, and given by the following equations:

for  $j = 3$  and  $i = 2$

for  $j = 4$  and  $i = 2,3,4,5,6$

$$\mu_{xj}^i = 1 - (|xj - C_{xj}^i|) / \delta_{xj}^i \quad \text{for } C_{xj}^i - \delta_{xj}^i \leq xj \leq C_{xj}^i + \delta_{xj}^i,$$

$$\mu_{xj}^i = 0 \quad \text{for } C_{xj}^i - \delta_{xj}^i > xj > C_{xj}^i + \delta_{xj}^i$$

for  $j = 3$  and  $i = 1,3$

for  $j = 4$  and  $i = 1,7$

$$\mu_{xj}^i = 1 - (|xj - C_{xj}^i|) / \delta_{xj}^i \quad \text{for } a^i C_{xj}^i \geq a^i xj \geq a^i (C_{xj}^i - a^i \delta_{xj}^i)$$

$$\mu_{xj}^i = 1 \quad \text{for } a^i C_{xj}^i < a^i xj$$

$$\mu_{xj}^i = 0 \quad \text{for } a^i (C_{xj}^i - a^i \delta_{xj}^i) > a^i xj$$

where  $a^i = 1$ , except for  $i = 1$  where  $a^1 = -1$ .

The system output variable or control variable is the vehicle course command ( $\Delta C$ ) and the universe of discourse for  $\Delta C$  comprise seven linguistic variables defined by the following term set:

$$T(\Delta C) = \{T_{\Delta C}^1, T_{\Delta C}^2, T_{\Delta C}^3, T_{\Delta C}^4, T_{\Delta C}^5, T_{\Delta C}^6, T_{\Delta C}^7\} = (NL, NM, NS, ZE, PS, PM, PL).$$

The set of membership functions  $\mu(\Delta C)$  corresponding to output  $\Delta C$ ,

$$\mu(\Delta C) = \{\mu_{\Delta C}^1, \mu_{\Delta C}^2, \mu_{\Delta C}^3, \mu_{\Delta C}^4, \mu_{\Delta C}^5, \mu_{\Delta C}^6, \mu_{\Delta C}^7\},$$

is depicted in figure 6(c) and given by the following equations:

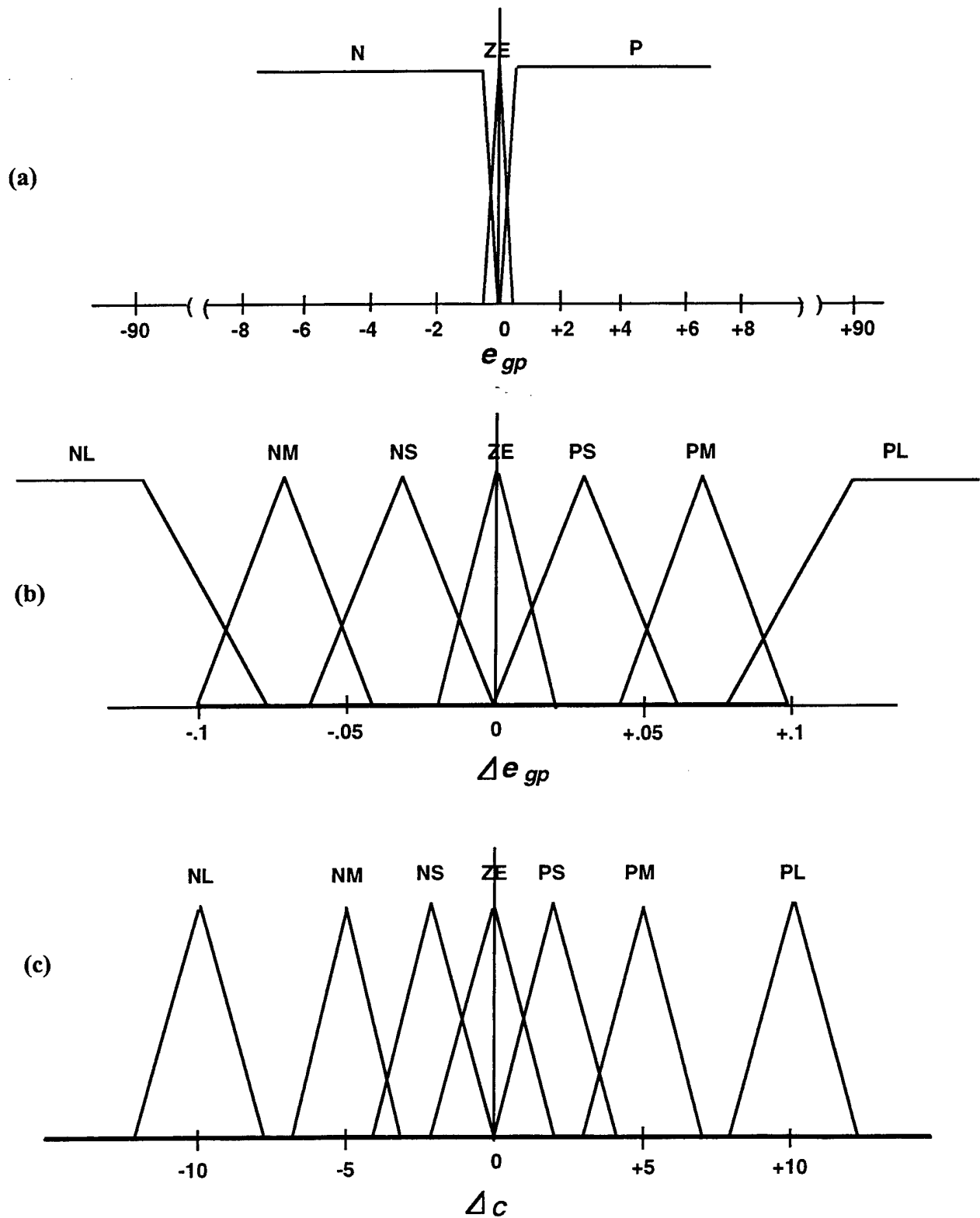

*Figure 6. Graphical Representation of Membership Functions for Fuzzy Inputs for Secondary Goal and Output Control Set*

for  $i = 1, 2, 3, 4, 5, 6, 7$

$$\mu_{\Delta C}^i = 1 - (|\Delta C - C_{\Delta C}^i|) / \delta_{\Delta C}^i \quad \text{for } C_{\Delta C}^i - \delta_{\Delta C}^i \leq \Delta C \leq C_{\Delta C}^i + \delta_{\Delta C}^i,$$

$$\mu_{\Delta C}^i = 0 \quad \text{for } C_{\Delta C}^i - \delta_{\Delta C}^i > \Delta C > C_{\Delta C}^i + \delta_{\Delta C}^i.$$

The values of the membership equation constants  $C$  and  $\delta$  are given in tables 1 and 2.

**Table 1.  $C$  and  $\delta$  Constants for Primary Goal Membership Functions**

$i$	$\mu(x_1)$		$\mu(x_2)$	
	$C_{x_1}^i$	$\delta_{x_1}^i$	$C_{x_2}^i$	$\delta_{x_2}^i$
1	-0.01	.01	-0.25	0.25
2	0	.01	0	0.25
3	+0.01	--	0.25	0.25

**Table 2.  $C$  and  $\delta$  Constants for Secondary Goal and Output Membership Functions**

$i$	$\mu(x_3)$		$\mu(x_4)$		$\mu(\Delta C)$	
	$C_{x_3}^i$	$\delta_{x_3}^i$	$C_{x_4}^i$	$\delta_{x_4}^i$	$C_{\Delta C}^i$	$\delta_{\Delta C}^i$
1	-0.5	0.5	-0.12	0.04	-10.0	2.0
2	0.0	0.5	-0.07	0.03	-5.0	2.0
3	0.5	0.5	-0.03	0.03	-2.0	2.0
4	--	--	0.0	0.01	0.0	2.0
5	--	--	0.03	0.03	2.0	2.0
6	--	--	0.07	0.03	5.0	2.0
7	--	--	0.12	0.04	10.0	2.0

### 2.1.5 Multi-Goal Rule-Based Unit

Figure 7 is a depiction of the fuzzy rule-based unit that comprises the heuristic relationships (i.e., IF THEN rules) between the fuzzy inputs and outputs and fuzzy implication operations.

The rule section is comprised of two sections: one corresponding to the primary goal and the second corresponding to the secondary goal. The matrices of figure 8 define the heuristic relationships necessary to accomplish the primary goal. Each entry in these matrices corresponds

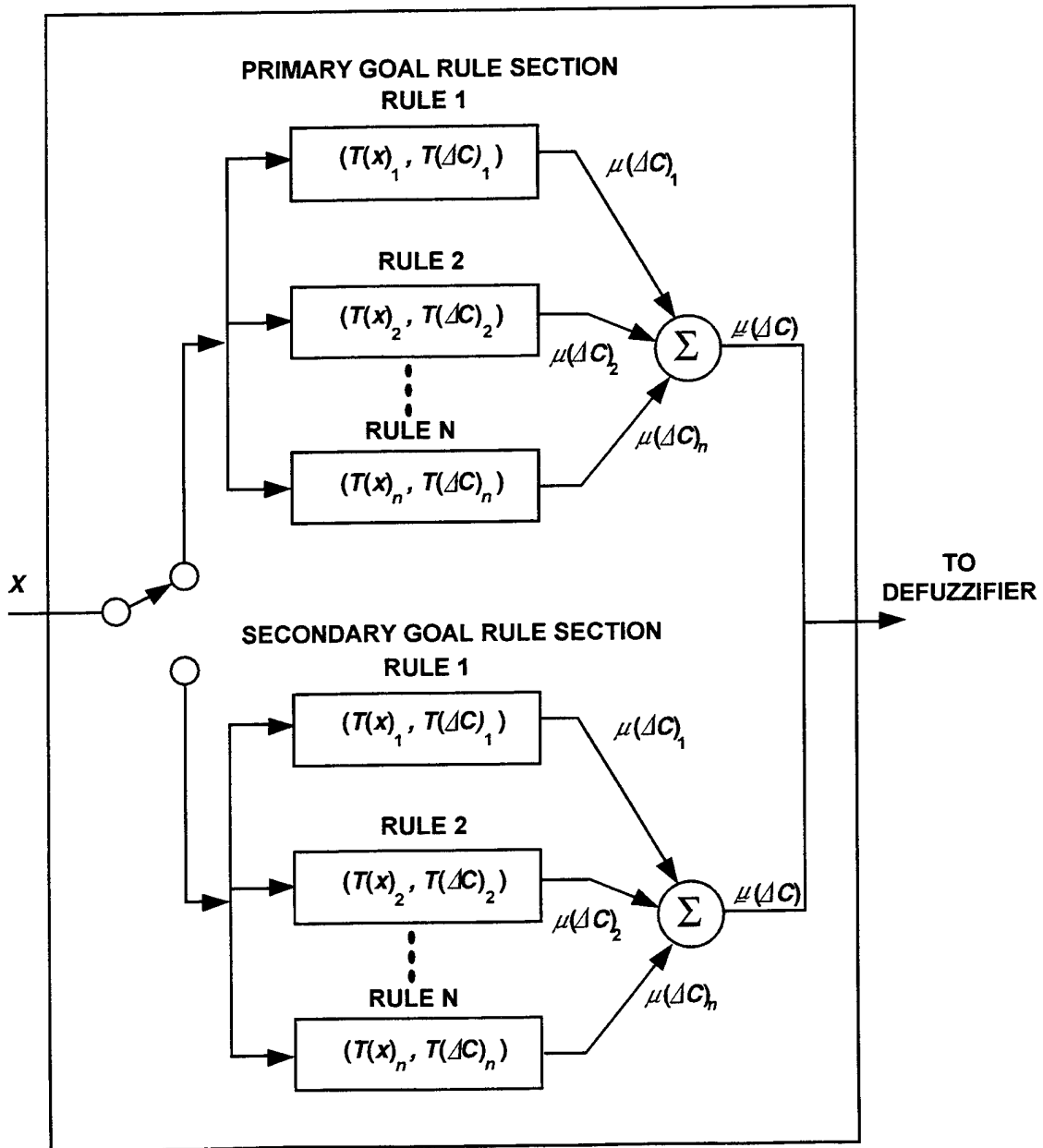

Figure 7. Multi-Goal Rule-Based Unit

		$e_s$		
		N	Z	P
N		PS	PS	-
$\Delta e_s$ Z		PM	ZE	-
P		PL	ZE	-

$B_v - B_c > 0$

		$e_s$		
		N	Z	P
N		NS	NS	-
$\Delta e_s$ Z		NM	ZE	-
P		NL	ZE	-

$B_v - B_c > 0$

**Figure 8. Matrices for Primary Goal in Rule-Based Unit**

to a 'rule' and defines the input output relationships between the fuzzy variables; for example, the rule defined by the entry in the first row and first column of the first matrix is:

**IF  $e_s$  is N AND  $\Delta e_s$  is N AND  $(B_v - B_c)$  is positive THEN  $\Delta C$  is PS.**

The matrix of figure 9 define those rules necessary to accomplish the second objective and are of a similar form. The rule defined by the entry in the first row and first column is:

**IF  $e_s$  is P AND  $e_{gp}$  is N AND  $\Delta e_{gp}$  is NL THEN  $\Delta C$  is PL.**

		$\Delta e_{gp}$						
		NL	NM	NS	ZE	PS	PM	PL
N		PL	PM	PS	ZE	NS	NM	NL
$e_{gp}$ ZE		PL	PM	PS	ZE	NS	NM	NL
P		NL	NM	NS	ZE	PS	PM	PL

**Figure 9. Matrix for Secondary Goal in Rule-Based Unit**

It is in this unit where the hierarchical structure of the controller is established. Here, it is observed that the rules pertaining to the primary or secondary goal are conditioned via the decision as to whether or not the vehicle resides outside the forbidden zone, i.e.,  $e_s > 0.01$ . Based on this condition, the appropriate set of variables are processed in the multi-goal fuzzification unit and the appropriate set of rules is employed in the rule-based unit. The generation of the matrices did not require a mathematical description of system dynamics but rather intuitive knowledge of system behavior.

For each fuzzy rule that is fired, there is a fuzzy implication and an associated fuzzy implication function. The determination of the fuzzy implication functions is explained through the use of an example. Assume the four rules in the second primary goal matrix are fired:

1. **IF**  $x_1$  is  $T^2_{x_1}$  **AND**  $x_2$  is  $T^2_{x_2}$  **THEN**  $\Delta C$  is  $T^4_{\Delta C}$ ,
2. **IF**  $x_1$  is  $T^2_{x_1}$  **AND**  $x_2$  is  $T^1_{x_2}$  **THEN**  $\Delta C$  is  $T^3_{\Delta C}$ ,
3. **IF**  $x_1$  is  $T^1_{x_1}$  **AND**  $x_2$  is  $T^2_{x_2}$  **THEN**  $\Delta C$  is  $T^2_{\Delta C}$ ,
4. **IF**  $x_1$  is  $T^1_{x_1}$  **AND**  $x_2$  is  $T^1_{x_2}$  **THEN**  $\Delta C$  is  $T^3_{\Delta C}$ .

The numerical strength of the output of rules 1, 2, 3, and 4 can be expressed, respectively, as:

$$\begin{aligned}\zeta_{(1)} &= y^2_{x_1} \wedge y^2_{x_2} = \min(y^2_{x_1}, y^2_{x_2}), \\ \zeta_{(2)} &= y^2_{x_1} \wedge y^1_{x_2} = \min(y^2_{x_1}, y^1_{x_2}), \\ \zeta_{(3)} &= y^1_{x_1} \wedge y^2_{x_2} = \min(y^1_{x_1}, y^2_{x_2}), \\ \zeta_{(4)} &= y^1_{x_1} \wedge y^1_{x_2} = \min(y^1_{x_1}, y^1_{x_2}).\end{aligned}$$

where

$y^i_{x_j}$  is  $\mu^i_{x_j}$  evaluated at a specific value of  $x_j(t)$  at time  $t$ ,  
and

$\wedge$  denotes fuzzy 'and'.

The inferred output control function from the first rule is  $\zeta_{(1)}\mu^4_{\Delta C}$ . Similarly, the inferred functions from the second through fourth rules are  $\zeta_{(2)}\mu^3_{\Delta C}$ ,  $\zeta_{(3)}\mu^2_{\Delta C}$ , and  $\zeta_{(4)}\mu^3_{\Delta C}$ ,  
where

$\zeta_{(1)}\mu^4_{\Delta C} = \mu(\Delta C)_{(1)}$  = the output control function for rule 1 defined by  $\mu^4_{\Delta C}$  multiplied by the value  $\zeta_{(1)}$ .

$\zeta_{(2)}\mu^3_{\Delta C} = \mu(\Delta C)_{(2)}$  = the output control function for rule 2 defined by  $\mu^3_{\Delta C}$  multiplied by the value  $\zeta_{(2)}$ .

$\zeta_{(3)}\mu^2_{\Delta C} = \mu(\Delta C)_{(3)}$  = the output control function for rule 3 defined by  $\mu^2_{\Delta C}$  multiplied by the value  $\zeta_{(3)}$ .

$\zeta_{(4)}\mu^3_{\Delta C} = \mu(\Delta C)_{(4)}$  = the output control function for rule 4 defined by  $\mu^3_{\Delta C}$  multiplied by the value  $\zeta_{(4)}$ .

The output composite implication function ( $\underline{\mu}(\Delta C)$ ) of the rule-based unit for this example is expressed as:

$$\underline{\mu}(\Delta C) = \mu(\Delta C)_{(1)} + \mu(\Delta C)_{(2)} + \mu(\Delta C)_{(3)} + \mu(\Delta C)_{(4)}.$$

The determination of the composite implication function is shown graphically in figure 10 for the above example.

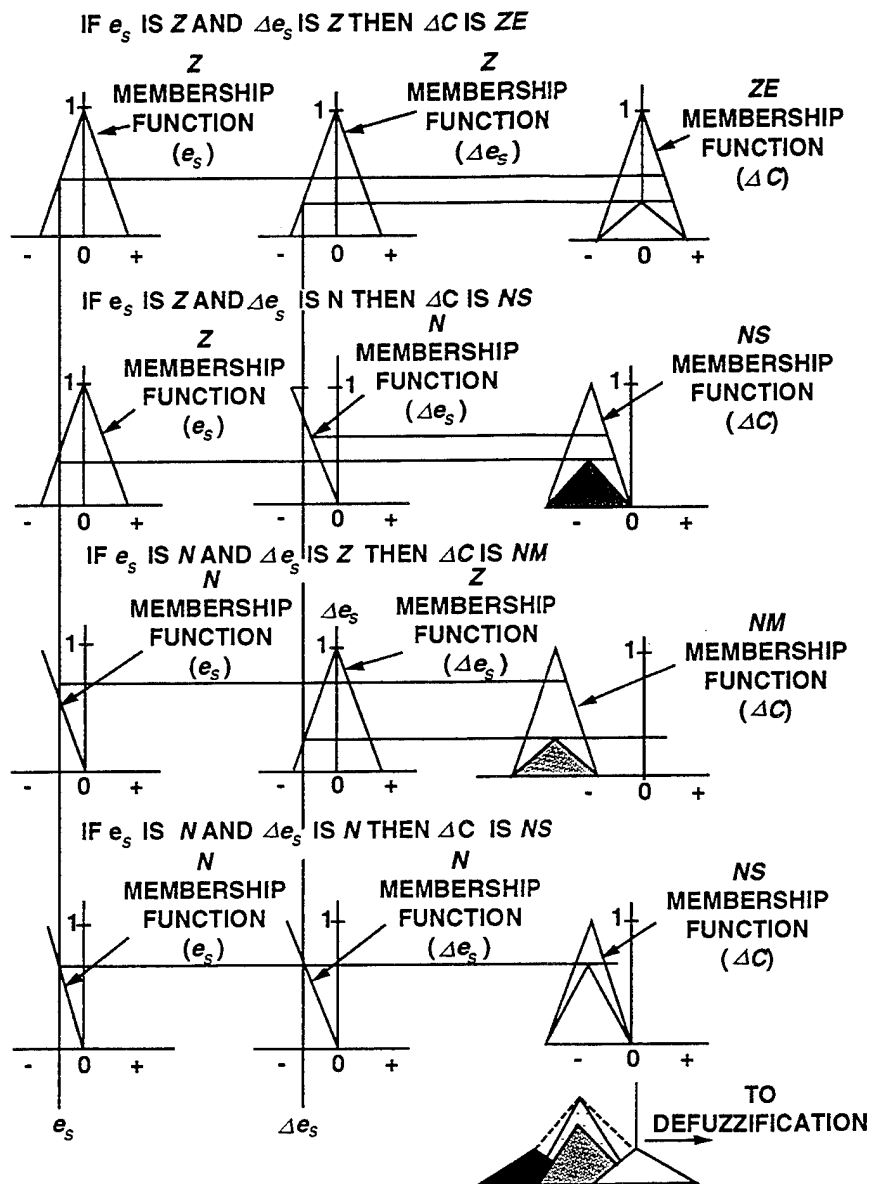

Figure 10. Example of Determination of Composite Implication Function

### 2.1.6 Defuzzification Unit

The defuzzification unit takes the fuzzy outputs from the multi-goal rule-based unit and decodes them into a crisp output that is acceptable for use in vehicle control. This unit employs a strategy that maps fuzzy control actions defined over an output universe of discourse (see figure 6c) into a space of crisp control actions (i.e., course commands). The method of defuzzification used in this application is the centroid method.<sup>7</sup> The centroid of the composite function is used as the crisp control value and is computed as follows:

$$\Delta C = \frac{\sum_k \{(\zeta_k) C_{\Delta C(k)} I_{\Delta C(k)}\}}{\sum_k \zeta_k I_{\Delta C(k)}}$$

where

$\sum_k$  indicates summation over all the rules fired.

$I_{\Delta C(k)}$  and  $C_{\Delta C(k)}$  are defined as the respective area and centroid of the  $k$ th rule consequent set membership function.

### 2.1.7 Command Conditioner Unit

Command conditioning for intercept control deals with two types of modifications that are made to the commands generated by the defuzzification process. Figure 11 is a graphical representation of this portion of the unit.

The first type of conditioning is related to insuring the safety of the launching platform and is applied during both primary and secondary control when the range from the guidance point to the contact ( $R_{GD}$ ) exceeds a value that is a function of the guidance distance ( $GD$ ); i.e.,  $R_{GD} > 1.5 GD$ . The control commands coming from the defuzzification unit are interrogated to determine if these commands exceed limits that are governed by the tactical situation. The value of the vehicle course command limits,  $L_1$  and  $L_2$ , are defined, to assure there is no vehicle velocity component toward the firing vessel, as follows:

$$L_1 = Bv + 90^\circ - (C_v)_{k-1}$$

$$L_2 = Bv - 90^\circ - (C_v)_{k-1}$$

where

$(C_v)_{k-1}$  is the vehicle course from the last update cycle.

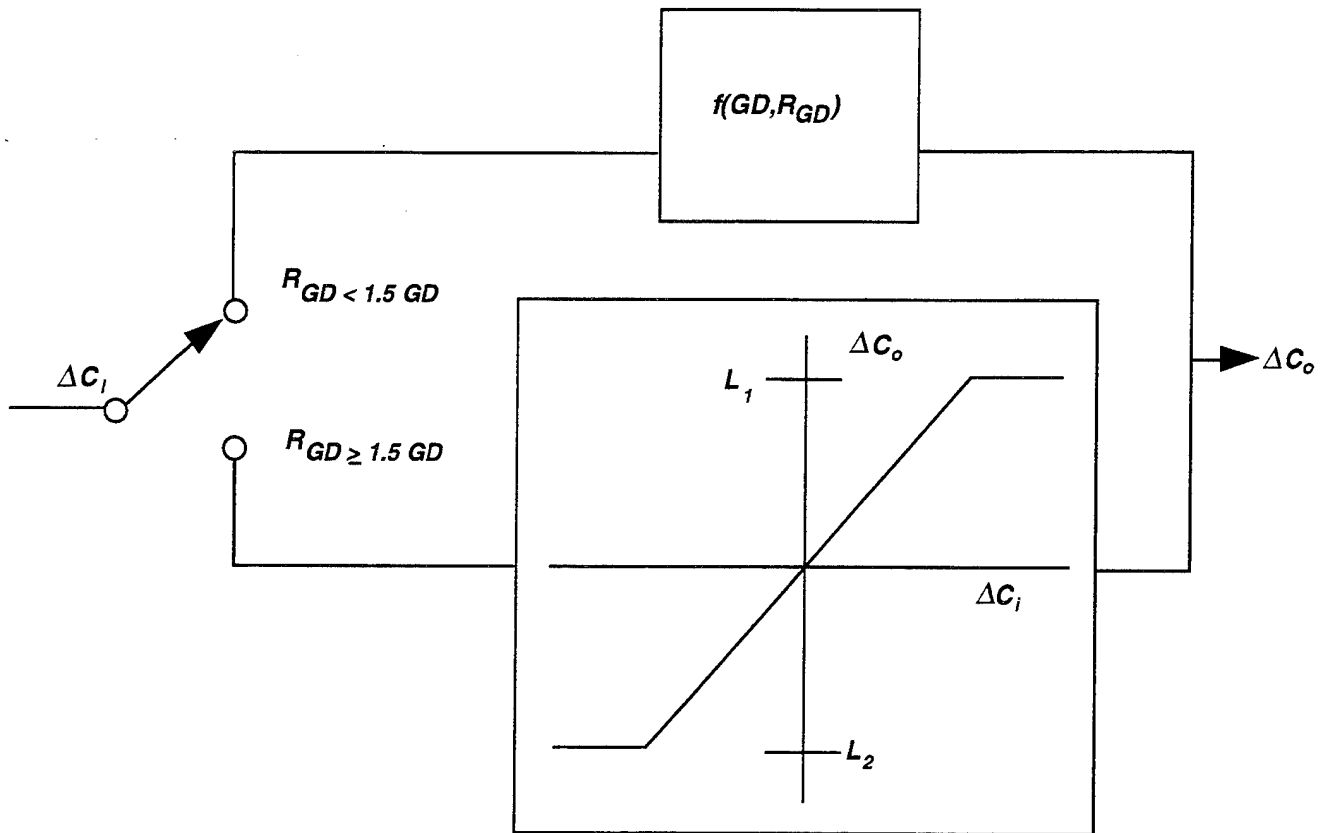

Figure 11. Representation of the Hierarchical Intercept Command Conditioning Unit

These limits ensure that the trajectory of the vehicle that would result from the addition of the fuzzy control system commands does not have a velocity component in the direction of the firing vessel. When the computed command exceeds the limit, only the portion of the command that will result in the vehicle being on a trajectory that is perpendicular to the vehicle bearing line is sent to the weapon. Note that because the course command limits in the constraint unit are dependent on the tactical situation, these limits are determined every update cycle.

Another form of command conditioning is performed when  $R_{GD} < 1.5GD$ . The modifications that are made to the command during this phase of operation are a function of both the vehicle guidance distance and the range from the vehicle to the contact. This empirically obtained gain is expressed as:

$$K = f(GD, R_{GD}) = 0.133(R_{GD} / GD)(R_{GD} / GD + 1).$$

## 2.2 SYSTEM OPERATION

In the operation of the hierarchical fuzzy control intercept system, the contact bearing, the forbidden zone angular separation, and the vehicle bearing are combined to form a separation error ( $e_s$ ), which corresponds to whether or not the vehicle is inside the forbidden zone. The absolute value of this error from the previous update cycle is subtracted from the current angle's absolute value to form the change in the separation error between the vehicle and the forbidden zone ( $\Delta e_s$ ). The bearing of the contact measured from the vehicle guidance point is combined with the vehicle course to form the guidance point error ( $e_{gp}$ ). The absolute value of the angle between the vehicle course and the contact bearing measured from the vehicle guidance point from the previous update cycle is subtracted from the current angle's absolute value to form the change in angle between the vehicle course and the contact bearing from the vehicle guidance point ( $\Delta e_{gp}$ ). Based on primary or secondary goal selection, either the forbidden zone error and the change in this error are converted from crisp numerical values to fuzzy inputs (primary linguistic variables) by the fuzzification unit; or the vehicle guidance point error and the rate of change of this angle are converted from crisp numerical values to fuzzy inputs (secondary linguistic variables) by the fuzzification unit. Based on these inputs and the sign of the difference between the vehicle bearing and contact bearing, the multi-goal fuzzy rule-based unit invokes all the appropriate rules to determine the resultant fuzzy output actions necessary to achieve the appropriate goal. These actions are combined and sent to the defuzzification unit. The composite fuzzy output is converted to a crisp numerical course command. The command conditioning unit further interrogates this command to determine what portion of the command, if any, should be issued to the vehicle based on tactical considerations. The conditioned course command output is automatically sent to the actual vehicle over the wire communication link and is also provided to update the vehicle model in the SCCS. The process described herein is not a one time postlaunch activity, but it goes on continually throughout the postlaunch encounter.

### 3. SIMULATION RESULTS

A computer simulation was developed that includes the contact vehicle model, launching platform model, forbidden zone model, and a model of the vehicle being guided. The hierarchical fuzzy system for vehicle intercept control and zone avoidance was implemented and test runs were made to demonstrate and analyze performance. Data were obtained to reflect the ability of the controller to maintain the vehicle outside the forbidden zone while attempting to place the vehicle on a course that allows the guidance point to intercept the contact. A number of simulation runs were made to examine performance, and response curves were obtained for the various problem geometries. Table 3 contains the values for the selected runs included in this report. In all cases, the initial range to the contact was 6000 yards, the initial bearing to the contact was 0°, and the guidance distance was 1000 yards. The forbidden zone selected was described by the equation

$$\theta_s = \theta_m e^{-r/c},$$

where

$$\begin{aligned} \theta_m &= 20^\circ, \\ c &= 2000 \text{ YD.} \end{aligned}$$

*Table 3. Run Parameters*

Run No.	Vehicle		Contact					Launcher	
	SV (yd/sec)	CVI (deg)	ST (yd/sec)	CT (deg)	STE (yd/sec)	CTE (deg)	t <sub>m</sub> (sec)	SO (yd/sec)	CO (deg)
1	20	15	10	90	--	--	--	10	90
2	20	15	10	135	15	315	150	0	--
3*	20	15	10	135	15	315	150	0	--

\* Without Hierarchical Controller

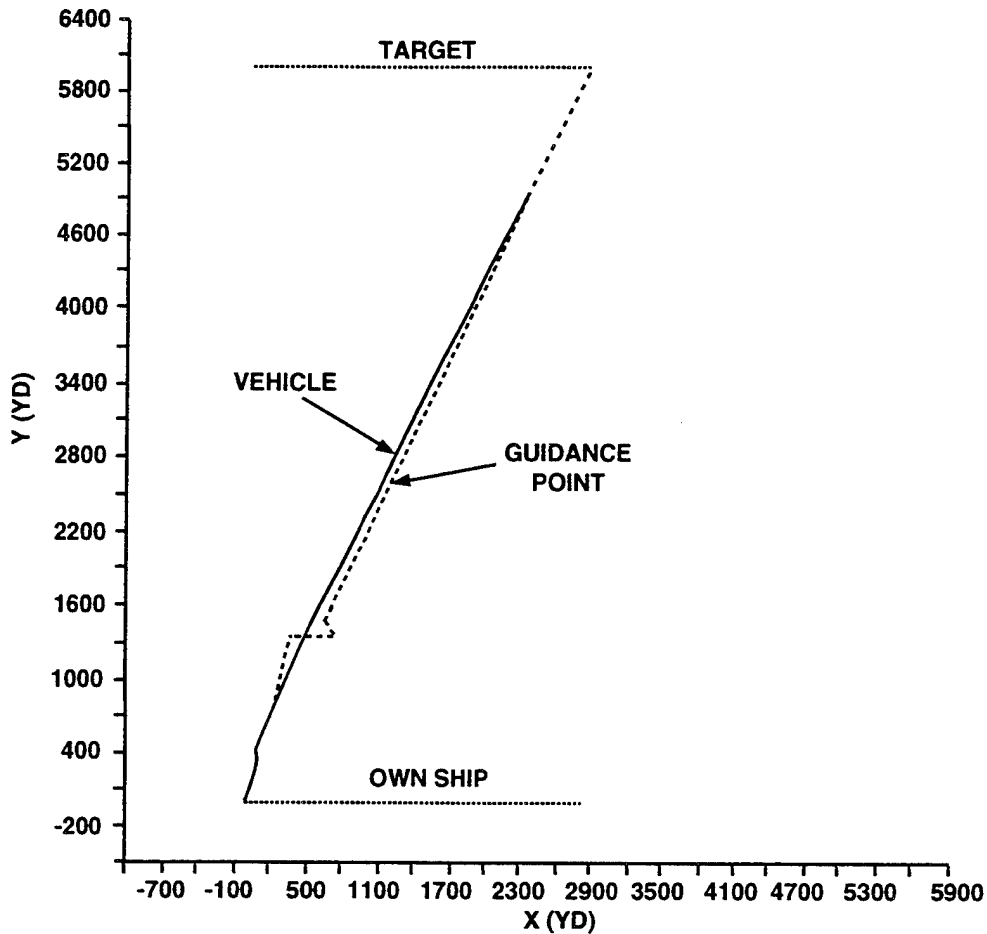

Figure 12a. Trajectory Plot for Non-Maneuvering Contact With Hierarchical Control

### 3.1 NON-EVASIVE CONTACT

Run #1 is for the situation in which the launcher and the contact are both traveling on the same fixed course of  $90^\circ$  and same constant velocity throughout the run (see figure 12a). The vehicle is launched on an initial course of  $15^\circ$ . When control is initiated at 20 seconds, the vehicle is within the forbidden region as shown by the large negative boundary separation error in figure 12b. The hierarchical controller selects primary control; and because the vehicle lags the bearing line, negative course commands are issued to steer the vehicle to exit this zone. As the vehicle is steered away from the bearing line to exit the forbidden zone, the angular rate of the intercept angle becomes more negative (see figure 12c) until the vehicle crosses the forbidden zone boundary at 26 seconds. At this point the secondary controller is activated and the guidance point intercept angular rate is reduced to approximately zero at 32 seconds, placing the vehicle guidance point on an intercept trajectory with the contact. This intercept course results in the vehicle re-penetrating the forbidden zone 1 second later and primary control is again selected. This oscillation between primary and secondary control continues for another 43 seconds. At 76 seconds, the motion of the contact bearing line, the size of the guidance distance, the orientation of the vehicle, and the decreasing boundary separation angle with increasing vehicle range result in a geometry that allows the vehicle to maintain a course for guidance point intercept of the contact without re-penetrating the forbidden zone for the remainder of the run.

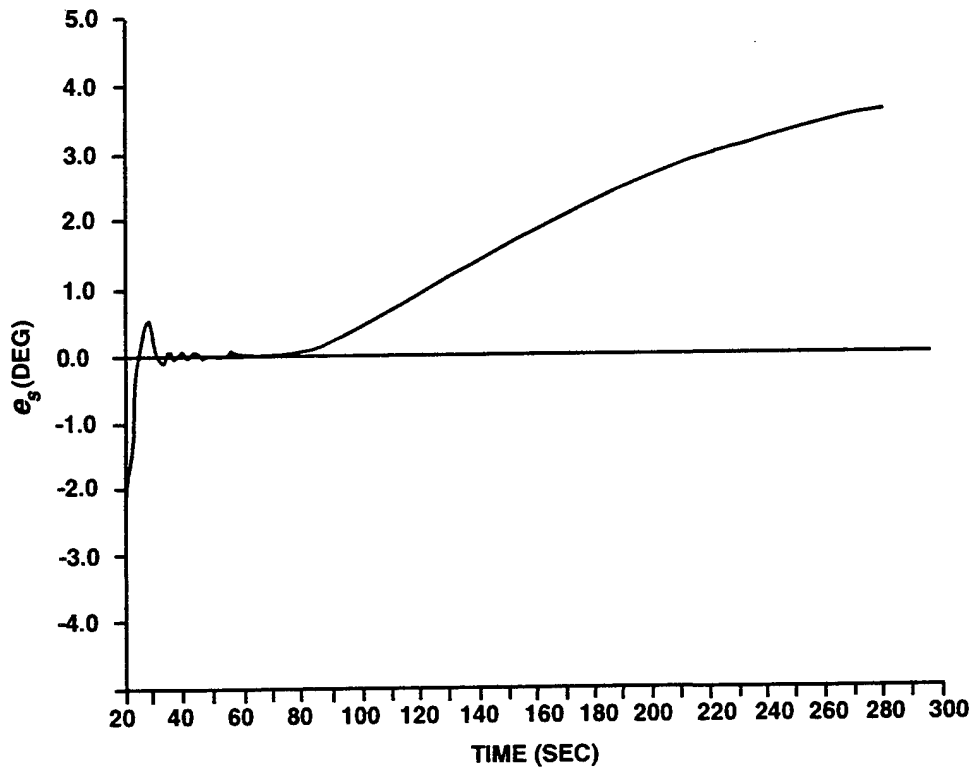

Figure 12b.  $e_s$  Response Curve for Trajectory Shown in Figure 12a

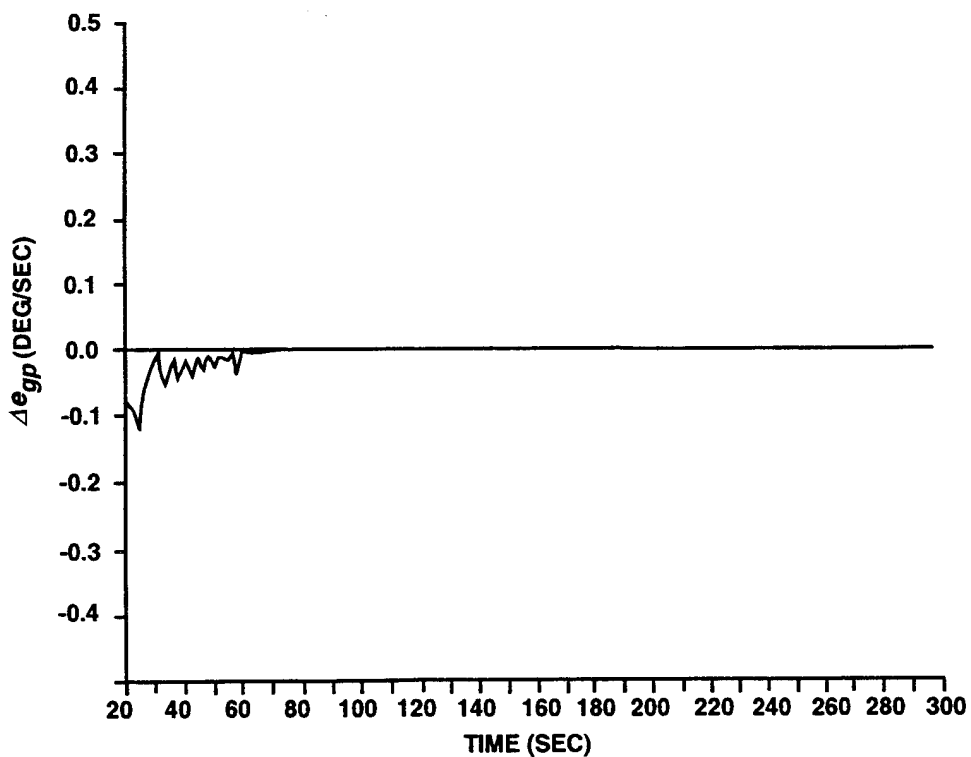

Figure 12c.  $\Delta e_{gp}$  Response Curve for Trajectory Shown in Figure 12a



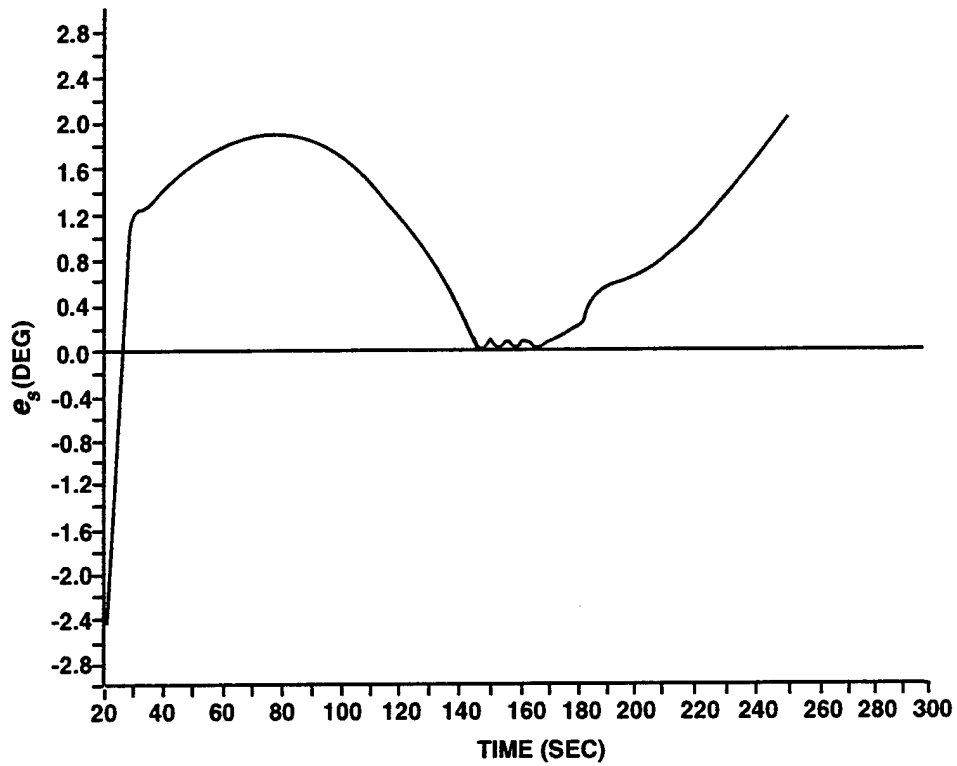

Figure 13b.  $e_s$  Response Curve for Trajectory Shown in Figure 13a

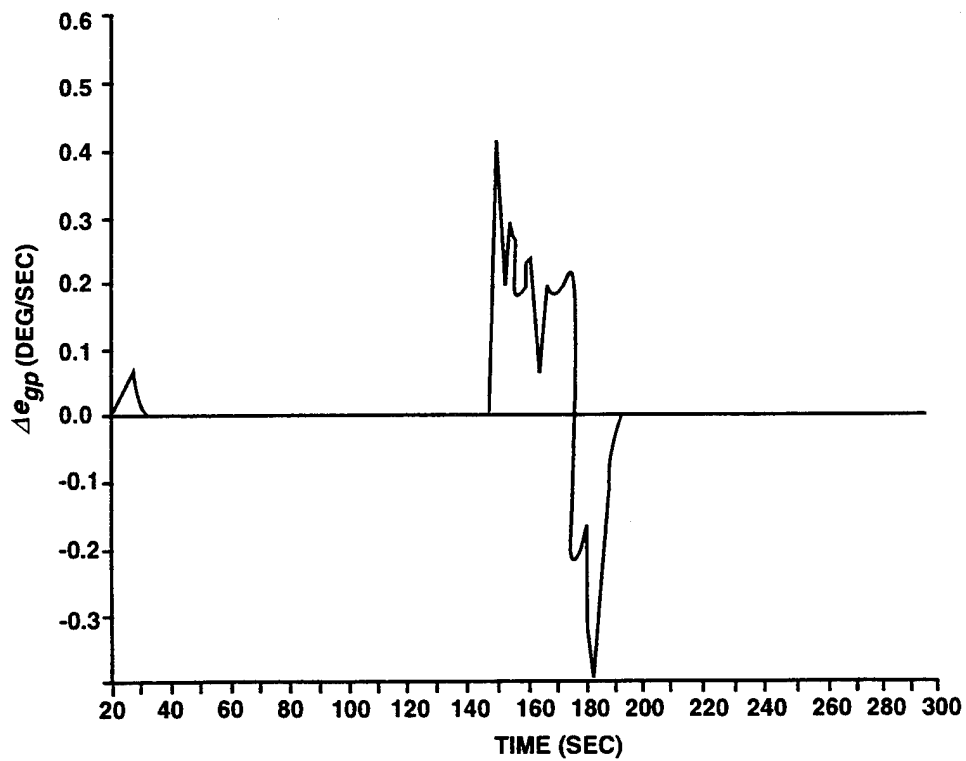

Figure 13c.  $\Delta e_{gp}$  Response Curve for Trajectory Shown in Figure 13a

### 3.3 HIERARCHICAL VS NON-HIERARCHICAL CONTROL

The behavior exhibited in figures 14a through 14c for the single goal controller is similar to the behavior exhibited by the hierarchical controller in figures 13a through 13c for the first 150 seconds. While single goal control allows the vehicle to operate in the forbidden zone (i.e., negative boundary separation errors in figure 14b), for the most part, the geometry is such that the vehicle is on a guidance point intercept trajectory and not within the forbidden zone. When the contact maneuvers at 150 seconds, the controller continuously attempts to keep the vehicle guidance point on an intercept path with the contact throughout the maneuver (non-zero intercept angular rate error from 150 to 192 seconds in figure 14c results in a series of control commands updating the vehicle's intercept trajectory). Since the single goal controller does not prevent the vehicle from entering the forbidden zone, the control responses are well behaved as exhibited by the smooth vehicle guidance point trajectory in figure 14a during the contact maneuver. In contrast, the hierarchical controller is required to maintain the vehicle outside the forbidden zone resulting in a more *jittery* vehicle intercept guidance track as previously discussed. Although the single goal controller exhibits excellent performance, vehicle operation in the forbidden zone could degrade the contact signal measurements at the launcher. This presence could prevent the launcher from detecting the contact maneuver and result in no vehicle trajectory updates until about 50 seconds after the contact has maneuvered.

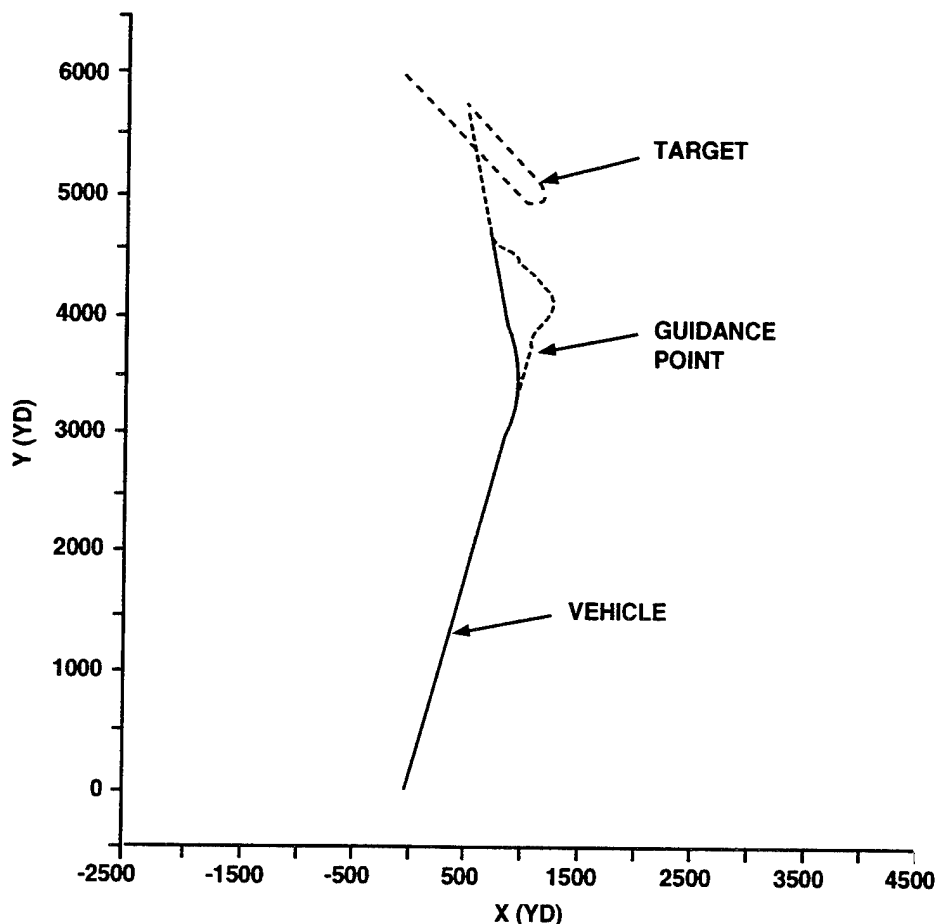

Figure 14a. Trajectory Plot for a Simple Intercept Control Against a Maneuvering Target

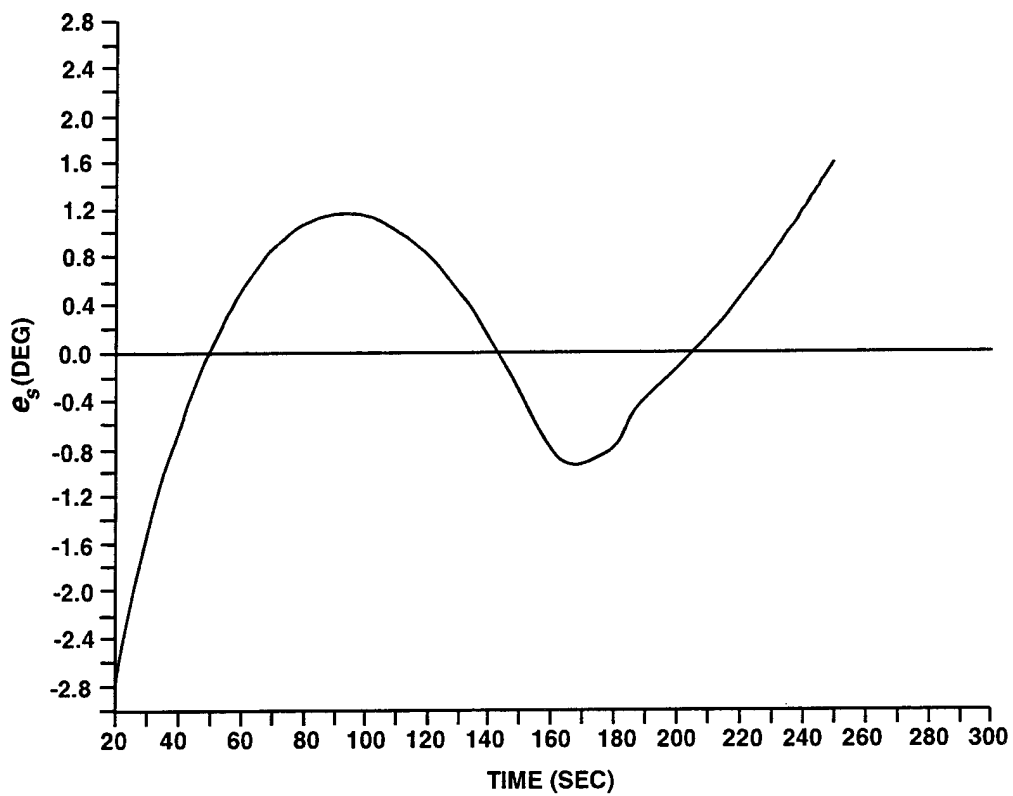

Figure 14b.  $e_s$  Response Curve for Trajectory in Figure 14a.

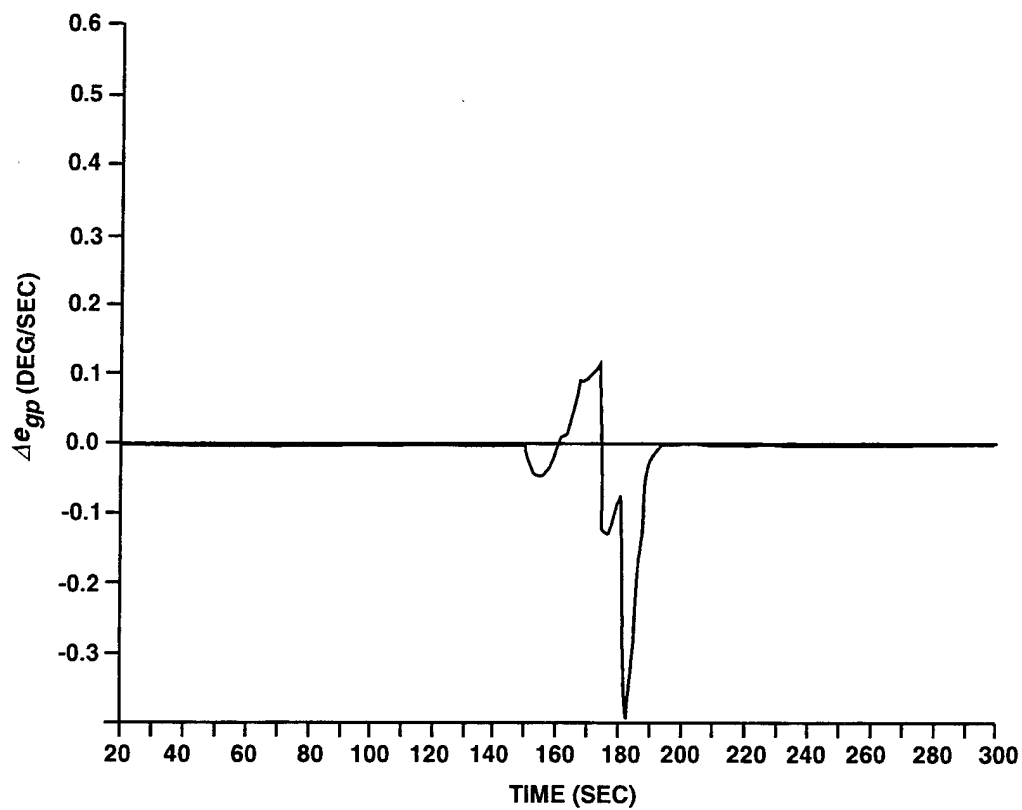

Figure 14c.  $\Delta e_{gp}$  Response Curve for Trajectory in Figure 14a

## 4. CONCLUSIONS

A fuzzy control system for intercept guidance of a vehicle launched from a moving platform against non-evasive and evasive contacts was formulated. A hierarchical structure was used to allow the system to mediate between two competing goals. Robust performance was demonstrated via the use of a computer simulation.

The intercept control strategy required the determination of vehicle commands that placed/maintained the vehicle on a trajectory such that the guidance point would intercept the contact at some future time. In addition, the control had to be executed in a manner that kept the vehicle outside a pre-defined zone (forbidden region).

The fuzzy controller achieved good system performance using three sets of rules. Different sets of rules were required to achieve primary and secondary goals while accounting for what side of the bearing line the vehicle was operating. The sets of rules used indications of the size of angular errors associated with the contact, the forbidden zone and the vehicle, in conjunction with estimates of the vehicle's closure/opening rates on the forbidden zone and used values related to the contact bearing relative to the vehicle laminar point and the rate of change of this relative bearing. Further, the change in the position of the guidance point, due to a given course command, is a function of tactical parameters. This was compensated for through the introduction of a gain that conditioned the outputs from the fuzzy controller. A command limitation that also depended on tactical situation parameters was also imposed to prevent the vehicle from having a velocity component in the direction of the launcher. The rules were formulated using only intuitive knowledge and experience regarding characteristic intercept operation. Formulation of the controller did not require any further mathematical description of system dynamics.

For various types of contact motion, the guidance point was continuously placed on an intercept trajectory with the contact, under the constraint that required the vehicle to remain outside a pre-defined zone. Good behavior was demonstrated for stationary, linear, and nonlinear contact motion (sample linear and non-linear runs were included). Geometries in which the vehicle course for guidance point intercept of the contact do not produce high closure rates on the forbidden zone boundary resulted in the best error responses and minimize the switching between primary and secondary control.

The hierarchical fuzzy intercept guidance scheme devised has the following advantages and new features:

Advantages -

- The fuzzy controller design emulates operations that reflect heuristic considerations through the use of a rule-based expert system in which is embedded a knowledge base that reflects the thinking processes a human might go through in manipulating the system.

- The fuzzy controller requires only the measured parameters of range and bearing as opposed to the complete contact state vector.
- The fuzzy controller design *automatically* generates and issues vehicle control commands such that the vehicle follows an intercept trajectory while remaining outside a pre specified zone.
- The fuzzy control scheme is a simple design that provides robust behavior. As new situations arise the controller design has the inherent capability to be tuned using experimental data from the new situations.

New Features -

- Controller design is such that it mediates between two competing goals in an intercept guidance scenario through the use of a hierarchical structure.
- The controller design limits or conditions the controller commands based on the latest tactical situation information.

## 5. REFERENCES

1. A. F. Bessacini and R. F. Pinkos, "A Constrained Fuzzy Controller for Beam Rider Guidance," NUWC-NPT Technical Report 10,200, Naval Undersea Warfare Center Division, Newport, RI, 28 May 1993.
2. A. F. Bessacini and R. F. Pinkos, "A Hierarchical Constrained Fuzzy Controller for Beam Rider Guidance With A Forbidden Zone," NUWC-NPT Technical Report 10,392, Naval Undersea Warfare Center Division, Newport, RI, 7 March 1995.
3. A. F. Bessacini and R. F. Pinkos, "Intercept Vehicle Guidance via a Fuzzy Controller," NUWC-NPT Technical Report 10,454, Naval Undersea Warfare Center Division, Newport, RI, 28 April 1995.
4. A. F. Bessacini and R. F. Pinkos, "Acoustic Vehicle Intercept Guidance via a Conditioned Fuzzy Controller," NUWC-NPT Technical Report 10,456, Naval Undersea Warfare Center Division, Newport, RI, 28 April 1995.
5. E. Cox, "Fuzzy Fundamentals," *IEEE Spectrum*, October 1992, pp. 58-61.
6. C. C. Lee, "Fuzzy Logic in Control Systems: Fuzzy Logic Controller Part I and Part II," *IEEE Transactions on Systems, Man, and Cybernetics*, vol. 20, no. 2, 1990, pp. 404-435.
7. B. Kosko, *Neural Networks and Fuzzy Systems*, Prentice Hall, Englewood Cliffs, NJ, 1992.

## INITIAL DISTRIBUTION LIST

Addressee	No. of Copies
Commander, Submarine Force Atlantic	1
Commander, Submarine Force Pacific	1
Commander, Submarine Development Squadron 12	1
Advanced Research Projects Agency	1
Submarine Base, Pearl Harbor	1
Naval Postgraduate School	1
Naval War College	1
Naval Sea Systems Command (ASTO-E, PMS-393, PMO-425, PMO-4253 -- W. Curles)	4
Naval Air Warfare Center, Weapons Division, China Lake (C2158 -- P. Kersten)	2
Defense Technical Information Center	12
Center for Naval Analyses	1