

STUDY REPORT
CAA-SR-91-10

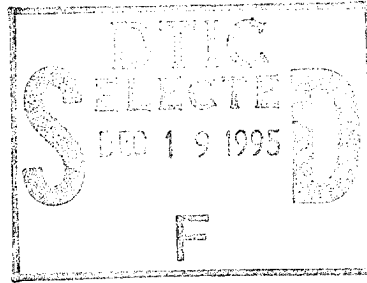

**ATTRITION CALIBRATION (ATCAL)
EVALUATION PHASE I - DIRECT FIRE
(ATVAL PHASE I)**

JULY 1991



19951211 019

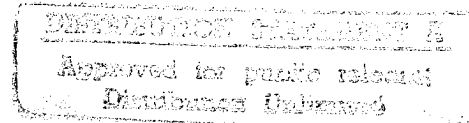

PREPARED BY
FORCES DIRECTORATE

US ARMY CONCEPTS ANALYSIS AGENCY
8120 WOODMONT AVENUE
BETHESDA, MARYLAND 20814-2797



DISCLAIMER

The findings of this report are not to be construed as an official Department of the Army position, policy, or decision unless so designated by other official documentation.

Comments or suggestions should be addressed to:

Director
US Army Concepts Analysis Agency
ATTN: CSCA-FO
8120 Woodmont Avenue
Bethesda, MD 20814-2797

SECURITY CLASSIFICATION OF THIS PAGE

REPORT DOCUMENTATION PAGE				Form Approved OMB No 0704-0188	
1a. Report Security Classification UNCLASSIFIED		1b. Restrictive Markings			
2a. Security Classification Authority		3. Distribution/Availability of Report			
2b. Declassification/Downgrading Schedule					
4. Performing Organization Report Number(s) CAA-SR-91-10		5. Monitoring Organization Report Number(s)			
6a. Name of Performing Organization US Army Concepts Analysis Agency		6b. Office Symbol (if applicable) CSCA-FOT	7a. Name of Monitoring Organization		
6c. Address (City, State, and ZIP Code) 8120 Woodmont Avenue Bethesda, MD 20814-2797		7b. Address (City, State, and ZIP Code)			
8a. Name of Funding/Sponsoring Organization		8b. Office Symbol (if applicable)	9. Procurement Instrument Identification Number		
8c. Address (City, State, and ZIP Code)		10. Source of Funding Numbers			
		PROGRAM ELEMENT NO.	PROJECT NO.	TASK NO.	WORK UNIT ACCESSION NO.
11. Title (Include Security Classification) Attrition Calibration (ATCAL) Evaluation Phase I - Direct Fire (ATVAL Phase I)					
12. Personal Author(s) Hugh W. Jones					
13a. Type of Report Final		13b. Time Covered From Mar 90 To Jun 91	14. Date of Report (Year, Month, Day) 1991 June		15. Page Count 127
16. Supplementary Notation					
17. COSATI Codes			18. Subject Terms (Continue on reverse if necessary and identify by block number)		
FIELD	GROUP	SUB-GROUP	ATCAL, shooter importance, target availability, response, bias, probability of kill (PK), extrapolation, calibration		
19. Abstract (Continue on reverse if necessary and identify by block number)					
This study explores and documents some practical applications of the ATCAL algorithm. Specifically, ATCAL's ability to extrapolate from a base calibration to varying force compositions, force sizes, force frontages, and force ratios is examined.					
20. Distribution/Availability of Abstract <input checked="" type="checkbox"/> UNCLASSIFIED/UNLIMITED <input type="checkbox"/> SAME AS RPT <input type="checkbox"/> DTIC USERS			21. Abstract Security Classification UNCLASSIFIED		
22a. Name of Responsible Individual Hugh W. Jones		22b. Telephone (Include Area Code) 301-295-5251		22c. Office Symbol CSCA-FOT	

DD Form 1473, JUN 86

Previous editions are obsolete.

SECURITY CLASSIFICATION OF THIS PAGE

OF	<input type="checkbox"/>
3d	<input checked="" type="checkbox"/>
1	<input type="checkbox"/>
ty Codes	
and/or special	
Dist	A-1

per
12-19-95
ce

STUDY REPORT
CAA-SR-91-10

**ATTRITION CALIBRATION (ATCAL) EVALUATION PHASE I - DIRECT FIRE
(ATVAL PHASE I)**

July 1991

Prepared by

**FORCES DIRECTORATE
Mr. Hugh W. Jones, Study Director**

**US Army Concepts Analysis Agency
8120 Woodmont Avenue
Bethesda, Maryland 20814-2797**

This document was prepared as part of an internal CAA project.



**ATTRITION CALIBRATION (ATCAL)
EVALUATION PHASE I - DIRECT FIRE
(ATVAL PHASE 1)**

**STUDY
SUMMARY
CAA-SR-91-10**

THE REASON FOR PERFORMING THE STUDY was to learn more about the Attrition Calibration (ATCAL) algorithm. Specifically, the question to be answered was how well does the ATCAL extrapolate from calibrated parameters to compute attrition and rounds fired in theater models. The ATCAL algorithm is the linkage between high-resolution tactical analysis and theater modeling.

THE STUDY SPONSOR was the Director, US Army Concepts Analysis Agency (CAA).

THE STUDY OBJECTIVES were to:

- (1) Determine the limitations of ATCAL (i.e., extrapolation).
- (2) Analyze appropriateness of current ATCAL inputs (i.e., division versus brigade).

THE SCOPE OF THE STUDY included three theaters of data: Korea 1991 (Regional Assessment Combat Capability Korea (RACCK)), Europe OMNIBUS 1991 division samples, Europe OMNIBUS 1991 brigade samples, and Southwest Asia 1991 (Iraq).

THE MAIN ASSUMPTIONS of this work are that:

- (1) It is highly desirable for theater battle assessment to come directly from a high-resolution tactical simulation. Of course, this is not practical, and therefore ATCAL must be employed.
- (2) ATCAL emulates what a high resolution tactical simulation would do if embedded within a theater model.
- (3) ATCAL outputs and tactical simulation outputs are the primary measures of effects.

THE BASIC APPROACHES used in this study were to:

- (1) Employ a three-phased experiment which evaluates ATCAL.
- (2) Phase I: use an established OMNIBUS 1991 Europe set of combat samples as a base case. Determine for what parameters ATCAL is expected to extrapolate.
- (3) Phase II: develop brigade samples from the OMNIBUS case and run both Standalone ATCAL and CEM for division and brigade samples. Record problems in building the samples and differences in input and output.
- (4) Phase III (extrapolation check): run stylized (multitank type) division samples through Phase II ATCAL. However, construct inputs for Phase II to request single tank type data. Check results of this test with experimentally-derived division and brigade samples from the Combat Sample Generator (COSAGE).

THE PRINCIPAL FINDINGS of the work reported herein are as follows:

(1) ATCAL does reproduce itself when asked to compute shots and kills from the same densities of equipment as from the calibrated sample.

(2) If ATCAL is to extrapolate properly, it needs to address a number of issues simultaneously. These issues can be broken down into four basic components: (1) force ratio, (2) force composition, (3) force size, and (4) force frontage.

(a) Force Ratio. CEM Version VI force ratios are computed for attacker and defender at the subsector level. ATCAL produces shots and kills from these subsector battles which, in turn, can be used to compute force exchange ratios (FERs). When these CEM force ratios are plotted as a function of FER, one notes that the points are normally distributed about the calibrated ATCAL sample. ATCAL is limited in ability to extrapolate tactical simulation results at different force ratios other than the calibrated ratio. Additional calibration samples are necessary if the theater force ratio frequency of occurrence shows many engagements well outside of the calibrated ratio.

(b) Force Composition. When going from forces with three tank types to different forces with one tank type, ATCAL extrapolated well. ATCAL also extrapolated well for similar changes in armored personnel carrier (APC) types. (All comments apply to both Blue and Red).

(c) Force Size. ATCAL extrapolates well to like sizes of initially calibrated numbers of vehicles. However, ATCAL shots and kills fall short of expected results when extrapolating for smaller numbers of vehicles.

(d) Force Frontage. The current method of modifying target availabilities to represent changes in frontage is lacking in rigor. For example, weapon systems with small ranges of engagement are able to engage up to 22 times the number of targets that were in the calibrated sample.

(3) ATCAL indirect fire was found not to shoot beyond calibrated round per tube per day limits - even when no artillery caps were employed in ATCAL Phase 1. When more artillery assets were introduced, the rounds per tube per day decreased significantly. Artillerists argue, and models such as COSAGE and the Target Acquisition and Force Simulation Model (TAFSM) predict, that with more artillery, rounds per tube per day should increase, or at worst, remain the same.

(4) The ATCAL methodology is being addressed to develop alternatives for the indirect fire and force frontage issues.

(5) More samples need to be developed for ATCAL to do a better job at extrapolating for force ratio. Smaller samples also need to be developed to address the shortcoming of ATCAL with regard to force size extrapolations.

THE STUDY EFFORT was directed by Mr. Hugh W. Jones, Forces Directorate.

COMMENTS AND QUESTIONS may be sent to the Director, US Army Concepts Analysis Agency, ATTN: CSCA-FOT, 8120 Woodmont Avenue, Bethesda, Maryland 20814-2797.

Tear-out copies of this synopsis are at back cover.

CONTENTS

CHAPTER		Page
1	EXECUTIVE SUMMARY	1-1
	Concept	1-1
	Study Methodology	1-1
	Underlying Assumptions	1-1
	Significant Results	1-2
	ATVAL Study Report Synopsis	1-2
2	INTRODUCTION	2-1
	Background	2-1
	Purpose	2-2
	Objectives	2-2
	Measures of Effectiveness (MOE)	2-3
	Scenario	2-4
3	SETTING UP THE EXPERIMENT	3-1
	Models and Processors	3-1
	The ATCAL Logic	3-2
	Methododology	3-6
	Indirect Fire	3-6
	Assumptions	3-6
4	EXECUTING THE EXPERIMENT	4-1
	Establishing Extrapolation Requirements	4-1
	CEM Subsector Engagements	4-2
	Developing Brigade Samples	4-6
	Developing Homogeneous Samples	4-6
	Division versus Brigade Front in ATCAL	4-8
5	EVALUATING THE EXPERIMENT	5-1
	ATCAL Extrapolation for Force Ratio	5-1
	ATCAL Extrapolation for Force Size	5-11
	ATCAL Extrapolation for Force Frontage	5-14
	ATCAL Extrapolation for Force Composition	5-18
6	OBSERVATIONS	6-1

APPENDIX

		Page
A	Study Contributors	A-1
B	Study Directive	B-1
C	Bibliography	C-1
D	Example of CEM Detail Battle Analysis from the "Detail Report"	D-1
E	Box and Whisker Plots	E-1
F	Distribution	F-1

GLOSSARY

Glossary-1

STUDY SUMMARY (*tear-out copies*)

FIGURES

FIGURE		Page
2-1	Components of the ATCAL Process	2-2
3-1	Flow Within the ATCAL Methodology	3-2
3-2	ATCAL Model Flow Diagram	3-3
3-3	Sequence of the ATCAL Process	3-4
4-1	Red Attacks Blue Defense Intense (posture 2)	4-2
4-2	Red Attacks Blue Defense Intense (Posture 2)	4-3
4-3	Force Frontage, CEM Subsectors vs COSAGE Frontage	4-4
4-4	CEM Subsector: Numbers of Equipment per Battle	4-5
4-5	Defense Intense Force Composition; CEM Weapon Composition vs COSAGE Weapon Composition	4-6
4-6	Test Procedure for Evaluating Force Composition Extrapolation	4-7
4-7	Test Procedure for Evaluating Force Size Extrapolation	4-8
4-8	Example of Tactical Frontage Situation	4-9
4-9	Example of Theater Frontage Situation	4-10
4-10	ATCAL Average Engagement Range (km) Relationship to Modify COSAGE Target Availabilities	4-11
5-1	Force Ratio vs FER for Blue Defense Intense	5-2
5-2	Force Ratio vs FER for Red Attack, Blue Hasty Defense	5-2
5-3	Force Ratio vs FER for Blue Delay, Red Hasty Defense	5-3
5-4	Blue Direct Fire Ammunition Expenditures	5-4
5-5	Red Direct Fire Ammunition Expenditures	5-5
5-6	Whiskers of the Box and Whisker Plot	5-6
5-7	Box of the Box and Whisker Plot	5-6
5-8	COSAGE Shots by MIA1, 1.5:1 Force Ratio	5-7
5-9	COSAGE Kills by MIA1, 1.5:1 Force Ratio	5-7
5-10	System Exchange Ratio for MIA1, 1.5:1 Force Ratio	5-8
5-11	Loss Exchange Ratio, 1.5:1 Force Ratio	5-8
5-12	Fractional Exchange Ratio, 1.5:1 Force Ratio	5-8
5-13	COSAGE Shots by MIA1, 7.0:1 Force Ratio	5-9
5-14	COSAGE KILLS by MIA1, 7.0:1 Force Ratio	5-9

FIGURE		Page
5-15	System Exchange Ratio for M1A1, 7.0:1 Force Ratio	5-10
5-16	Loss Exchange Ratio, 7.0:1 Force Ratio	5-10
5-17	Fractional Exchange Ratio, 7.0:1 Force Ratio	5-10
5-18	COSAGE Shots by M1 Brigade Level	5-12
5-19	COSAGE Kills by M1 Brigade Level	5-12
5-20	System Exchange Ratio for M1 Tank Brigade Level	5-12
5-21	Loss Exchange Ratio for M1 Brigade	5-13
5-22	Fractional Exchange Ratio for M1 Brigade	5-13
5-23	Theater Model, Battles by Force Ratio and Km Frontage (all postures)	5-15
5-24	Theater Model Battles by Force Ratio and Km Frontage (defense intense)	5-16
5-25	Theater Model, Equipment/Km Frontage (all postures)	5-17
5-26	Theater Model, Equipment/Km Frontage (defense intense)	5-17
5-27	COSAGE vs ATCAL, Shots by Bradley Fighting Vehicles	5-18
5-28	COSAGE vs ATCAL Kills by Bradley Fighting Vehicles	5-19
5-29	COSAGE vs ATCAL, SER for Bradley Division	5-19
5-30	COSAGE vs ATCAL, LER for Bradley Division	5-20
5-31	COSAGE vs ATCAL, FER for Bradley Division	5-20
5-32	COSAGE vs ATCAL Shots by M1A1	5-21
5-33	COSAGE vs ATCAL Kills by M1A1	5-21
5-34	COSAGE vs SER for M1A1	5-21
5-35	COSAGE vs ATCAL, LER for M1A1 Division	5-22
5-36	COSAGE vs ATCAL, FER for M1A1 Division	5-22
5-37	COSAGE vs ATCAL, Shots by T80	5-22
5-38	COSAGE vs ATCAL, Kills by T80	5-23
5-39	COSAGE vs ATCAL, SER for T80	5-23
5-40	COSAGE vs ATCAL, FER for T80 Division	5-23
5-41	COSAGE vs ATCAL, FER for T80 Division	5-24
5-42	COSAGE vs ATCAL, Shots by T72 (M1 replacement also)	5-24
5-43	COSAGE vs ATCAL, Kills by T72 (M1 replacement also)	5-25
5-44	COSAGE vs ATCAL, SER for T72 (M1 replacement also)	5-25
5-45	COSAGE vs ATCAL, LER for T72 Division (M1 replacement also)	5-25
5-46	COSAGE vs ATCAL, FER for T72 Division (M1 replacemnt also)	5-26
E-1	Loss Exchange Ratio, 1.5:1 Force Ratio	E-2
E-2	Fractional Exchange Ratio, 1.5:1 Force Ratio	E-2
E-3	System Exchange Ratio for M1A1, 1.5:1 Force Ratio	E-3
E-4	COSAGE Shots by M1A1, 1.5:1 Force Ratio	E-3
E-5	COSAGE Kills by M1A1, 1.5:1 Force Ratio	E-4
E-6	System Exchange Ratio for T80, 1.5:1 Force Ratio	E-4
E-7	COSAGE Shots by T80, 1.5:1 Force Ratio	E-5
E-8	COSAGE Kills by T80, 1.5:1 Force Ratio	E-5
E-9	Loss Exchange Ratio, 7.0:1 Force Ratio	E-6
E-10	Fractional Exchange Ratio, 7.0:1 Force Ratio	E-6
E-11	System Exchange Ratio for M1A1, 7.0:1 Force Ratio	E-7
E-12	COSAGE Shots by M1A1, 7.0:1 Force Ratio	E-7
E-13	COSAGE KIlls by M1A1, 7.0:1 Force Ratio	E-8
E-14	System Exchange Ratio for T80, 7.0:1 Force Ratio	E-8
E-15	COSAGE Shots by T80, 7.0:1 Force Ratio	E-9

FIGURE		Page
E-16	COSAGE Kills by T80, 7.0:1 Force Ratio	E-9
E-17	Fractional Exchange Ratio for Bradley Division	E-10
E-18	System Exchange Ratio for Bradley Division	E-10
E-19	Loss Exchange Ratio for Bradley Division	E-11
E-20	COSAGE Shots by Bradley, Bradley Division	E-11
E-21	COSAGE Kills by Bradley, Bradley Division	E-12
E-22	COSAGE Shots by M1, Brigade Level	E-12
E-23	COSAGE Kills by M1, Brigade Level	E-13
E-24	COSAGE Shots by M1, Division Level	E-13
E-25	COSAGE Kills by M1, Division Level	E-14
E-26	Loss Exchange Ratio, M1/T72	E-14
E-27	Fractional Exchange Ratio, M1/T72	E-15
E-28	System Exchange Ratio for M1, M1/T72	E-15
E-29	COSAGE Shots by M1, M1/T72	E-16
E-30	COSAGE Kills by M1, M1/T72	E-16
E-31	System Exchange Ratio for T72, M1/T72	E-17
E-32	COSAGE Shots by T72, M1/T72	E-17
E-33	COSAGE Kills by T72, M1/T72	E-18
E-34	Fractional Exchange Ratio, T72 Army	E-18
E-35	System Exchange Ratio for T72, T72 Army	E-19
E-36	Loss Exchange Ratio for T72, T72 Army	E-19
E-37	COSAGE Shots by T72, T72 Army	E-20
E-38	COSAGE Kills by T72, T72 Army	E-20
E-39	System Exchange Ratio for M1, Division Level	E-21
E-40	Loss Exchange Ratio, Division Level	E-21
E-41	Fractional Exchange Ratio, Division Level	E-22
E-42	Fractional Exchange Ratio, FST/T80	E-22
E-43	Loss Exchange Ratio, FST/T80	E-23
E-44	System Exchange Ratio for T80, FST/T80	E-23
E-45	COSAGE Shots by T80, FST/T80	E-24
E-46	COSAGE Kills by T80, FST/T80	E-24
E-47	System Exchange Ratio for FST, FST/T80	E-25
E-48	COSAGE Shots by FST, FST/T80	E-25
E-49	COSAGE Kills by FST, FST/T80	E-26
E-50	COSAGE Shots by M1A1, M1A1/M1	E-26
E-51	COSAGE Kills by M1A1, M1A1/M1	E-27
E-52	System Exchange Ratio for M1A1, M1A1/M1	E-27
E-53	COSAGE Shots by M1, M1A1/M1	E-28
E-54	COSAGE Kills by M1, M1A1/M1	E-28
E-55	System Exchange Ratio for M1, M1A1/M1	E-29
E-56	Loss Exchange Ratio, M1A1/M1	E-29
E-57	Fractional Exchange Ratio, M1A1/M1	E-30
E-58	System Exchange Ratio for M1 Tank, Brigade Level	E-30
E-59	Loss Exchange Ratio for M1 Brigade	E-31
E-60	Fractional Exchange Ratio for M1 Brigade	E-31

TABLES

TABLE		Page
3-1	Model (M) and P) Definitions	3-1
3-2	ATCAL Processing Order	3-5
3-3	ATCAL Processing Order	3-5
4-1	Tank-on-tank Engagements: A Probability Table	4-1
4-2	COSAGE Frontages by Posture; Based on a US or Non-US Division	4-4
4-3	COSAGE Frontages by Posture; Based on a US or Non-US Brigade	4-6
5-1	Percent Differences of Direct Fire Ammo Expenditures	5-11

CHAPTER 1

EXECUTIVE SUMMARY

1-1. **CONCEPT.** The mission of the US Army's Concepts Analysis Agency (CAA) is to support theater-level analysis. To this end, the Attrition Model using Calibrated Parameters (ATCAL) is an objective treatment of attrition, quite new in concept and application. ATCAL successfully replaces firepower score attrition methodologies at CAA which were difficult to defend.

a. The key element within ATCAL is the concept of theater attrition being directly tied to calibration parameters. This calibration procedure relies upon a tactical simulation to generate attrition parameters. These parameters include such data as probability of kill (PK), shots, kills, average engagement ranges, target availabilities, shooter importances, and others.

b. Although this paper uses the Combat Sample Generator (COSAGE) as the tactical simulation and the Concepts Evaluation Model (CEM) as the theater model, in theory, any tactical or theater-level model can be used with ATCAL.

1-2. **STUDY METHODOLOGY.** The study effort is an experiment to determine the limitations of ATCAL. "How well does ATCAL extrapolate?" is a first order limitation that this paper addresses in great detail.

a. The extrapolation process refers to the way in which ATCAL imputes theater attrition from the tactical killer/victim scoreboards. Of course, there are only a selected few calibration samples from which ATCAL has to work. Therefore, part of the question on extrapolation centers around how the tactical combat samples are built to fit into the ATCAL process. For example, it is known that the assessment levels between the tactical and theater games are different. Unit sizes, force composition, forward edge of the battle area (FEBA) width, and force ratios are the major differences involved.

b. This study uses comparative analysis as the method to test ATCAL extrapolation. Both COSAGE and ATCAL are tested in side-by-side comparisons. Observations are then made on how well the two methodologies compare to each other. The experimental design takes into account the fact that COSAGE is a stochastic simulation, whereas ATCAL works within a deterministic environment.

1-3. **UNDERLYING ASSUMPTIONS.** This study presupposes that the most desirable process with which to evaluate theater-level attrition is one in which a tactical simulation could be used as an integral part of the overall theater model. Of course, due to many computational constraints, this is currently not the case. However, it is assumed that ATCAL gives the same result that COSAGE would, if embedded within the theater environment. This study also refers to many examples of comparative testing between ATCAL and COSAGE. It is assumed that the COSAGE comparative values would not be biased by different analysts doing the same task.

1-4. **SIGNIFICANT RESULTS.** Overall, ATCAL performs well across a wide range of situations. Most of the testing showed that, if anything, ATCAL suffers from not having a sufficient range of combat samples from which to draw calibration parameters. Work is currently underway to downsize the calibration base from that of a division to a brigade. These results will then be tested within a theater environment.

a. However, certain aspects of the ATCAL indirect fire methodology were found not to track with practical experience. A new study, ATVAL II, is convening to address the ATCAL indirect fire topic in greater detail. This work will produce a study report similar to this document except that the main effort will center around ATCAL artillery concepts rather than on direct fire logic.

b. The ATCAL methodology dealing with frontage transformations on target availability needs to be re-addressed. The ATCAL equations which produce the modified target availabilities are too subjective and not well defined.

1-5. **ATVAL STUDY REPORT SYNOPSIS.** This study report is divided into six chapters. The second chapter defines the problem of evaluating ATCAL and examines the history behind previous methods of computing theater attrition.

a. Chapter 3 defines the tools used in the ATCAL evaluation (ATVAL). Some of the basic logic and process behind the ATCAL equations are also examined. Definitions can be found in the Glossary.

b. The fourth chapter sizes the problem that ATCAL has to solve. To begin with, it illustrates the way in which the theater model utilizes data from ATCAL. Differences between the calibrated data from COSAGE and theater data are illustrated. Problems and possible solutions are discussed.

c. Chapter 5 analyzes the experiment. Graphs and charts are presented which compare observed results from ATCAL to expected results from COSAGE. These observations are restated and summarized in Chapter 6. Recommendations are also presented.

CHAPTER 2

INTRODUCTION

2-1. **BACKGROUND.** During the early 1980s, a method of computing equipment and personnel losses was formulated by Dr. Alan Johnsrud. This new algorithm was named ATCAL; an Attrition Model Using Calibrated Parameters. ATCAL was destined to become the heart of attrition calculations in theater models such as CEM VI, Force Evaluation Model (FORCEM), TAC THUNDER, and RAND's CADEM. Basically, ATCAL replaced the way in which theater-level attrition was handled at the time. Before 1983, losses of equipment and personnel were computed via firepower scores. It was decided to abandon this method in favor of one which was based on operational probabilities of kill.

ATCAL begins with results from a tactical simulation which can give individual weapon/target shot and kill matrices. During the past decade, the COSAGE Model has been used to produce the calibration parameters necessary for the execution of ATCAL. These calibration parameters are as follows:

- Shots: Ammunition expenditures from weapons. This is main gun (or secondary gun) expenditures at target types (i.e., M1A1 main armament versus T72).
- Kills: Kills of vehicle types by weapon. Same as above, only for kills.
- PK: Operational probability of kill. Accounting for the synergisms of battle and their effect on static probability of kill. For example, modifying an initial static PK by moving firer, moving target, and other battle considerations.

Average engagement range of shooter: The average engagement range over all target types that a shooter will engage. This is used to scale the availability of targets down to theater subsector frontages. (See Chapter 5, Research Topics.)

Frontage: Posture frontage from the tactical simulation. Frontages in COSAGE vary from 15 kilometers (km) to 60 km, whereas subsector frontages in CEM average 2 km to 5 km. Tactical frontages are measured across a Blue division in the attack or defense.

Simulation length: This parameter is the length of time on which the high-resolution sample was based. It is important to know this in order to obtain the same relationship between time periods within the theater and tactical models.

b. The tactical simulation yields other ancillary information which ATCAL uses for further computation. For example, COSAGE uses a fire prioritization schema based on PKs. This fire allocation is only a by-product of the tactical effort yet is very important for round-to-target allocation of expenditures by ATCAL. Other computed parameters in ATCAL which are derived from the high resolution simulation are rate of fire and shooter importances.

Both of these parameters are discussed in Dr. Johnsrud's ATCAL paper, noted in the bibliography of this document.

2-2. **PURPOSE.** The purpose of the experiment is to learn more about the ATCAL methodology and the ATCAL process. Unfortunately, the ATCAL process involves more than simply understanding the equations within the ATCAL methodology. This is because the ATCAL process involves a number of complex steps in order to calibrate, link, roll up, and extrapolate from calibrated data in a theater environment (see Figure 2-1). In other words, understanding the steps within the process is just as important as understanding the ATCAL methodology itself.

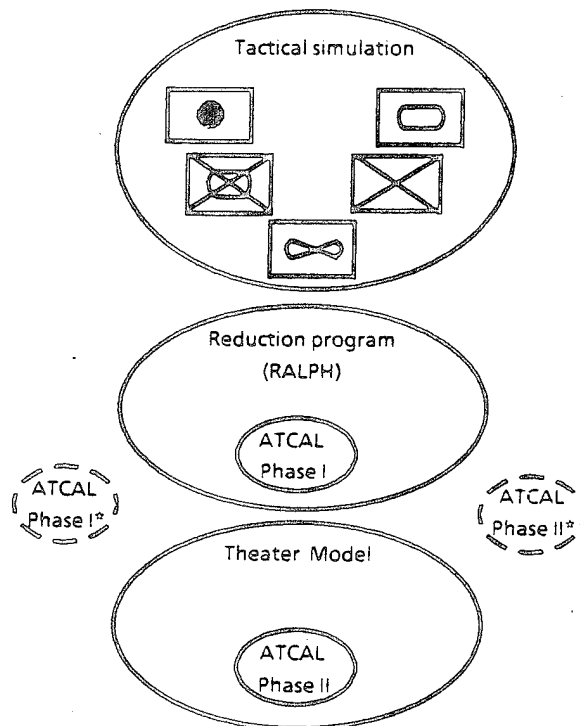

*Note: although for production purposes ATCAL Phases I and II are embedded within other processes, they also exist in standalone modes for offline analysis.

Figure 2-1. Components of the ATCAL Process

2-3. **OBJECTIVES.** There are two objectives of the study which relate to the application of ATCAL and one which relates to an ongoing research project.

a. **Objective 1.** Determine the limitations of ATCAL with regard to extrapolation. If ATCAL is to extrapolate properly, it needs to address a number of issues simultaneously. These issues can be broken down into four basic components: (1) force ratio, (2) force composition, (3) force size, and (4) force frontage.

(1) **Force Ratio.** CEM VI force ratios are computed for attacker and defender at the subsector level. ATCAL produces shots and kills from these subsector battles which in turn can be used to compute force exchange ratios

(FER). When CEM force ratios are plotted as a function of FER, one hopes that the points are normally distributed about the calibrated ATCAL sample.

(2) **Force Composition.** Experiment to determine if changing types of vehicles from the base calibration sample causes problems in the extrapolation.

(3) **Force Size.** Check to see if changing the numbers of vehicles from the base calibration sample causes problems in the extrapolation.

(4) **Force Frontage.** Experiment to determine if ATCAL extrapolation is adversely affected by the current method of changing frontage.

b. **Objective 2.** This second objective is to analyze the appropriateness of current ATCAL inputs within the theater context. This objective examines the overall requirement of ATCAL from the CEM perspective (not just extrapolation). This objective calls for analyzing CEM battles at the subsector level and for postulating what is and is not possible to change in order to achieve a better cohesion within the ATCAL process. Tactical simulation and CEM runs were made under a variety of situations to help meet this objective.

c. **Objective 3.** Still under research and development at the writing of this document are two facets involving attrition computations. The first is a project called Quick Sample which is hoped to be a surrogate for the tactical combat samples. Although this is not directly related to ATCAL, it is hoped that a quicker method of producing the voluminous calibration data which ATCAL requires can be achieved. The second element of this objective is to attempt to implement the Howard equations which are, in effect, theorized corrections to some of the ATCAL equations (see Glossary).

2-4. **MEASURES OF EFFECTIVENESS (MOE).** Table 2-1 lists all of the MOE used within this study.

Table 2-1. Measures of Effectiveness

- | |
|--|
| <ol style="list-style-type: none"> 1. Average shots fired in a 24-hour timeframe. 2. Average kills achieved in a 24-hour timeframe. 3. Surviving densities of weapon systems 4. Tactical simulation low and high values over 'N' replications 5. Operational probability of kills |
|--|

2-5. **SCENARIO.** This study employed three theaters for examination: Europe, Southwest Asia, and Northeast Asia. The data came from the studies entitled OMNIBUS 1991 Europe, RACCK 91 Korea, and COSWA 1991 (Southwest Asia). The purpose for using such an extensive data base was to rigorously test ATCAL's extrapolation capabilities across a wide variety of situations. Additionally, different scenarios were employed to obtain weapon/target interactions for different mixes of units which are indigenous to specific theaters (i.e., Korea is an infantry-heavy theater, whereas Europe is not).

CHAPTER 3

SETTING UP THE EXPERIMENT

3-1. **MODELS AND PROCESSORS.** As previously discussed (see Figure 2-1), the ATCAL process involves a number of models in its schema. These models and processors each have a unique role to play in the development and execution of ATCAL calibration parameters and in the running of ATCAL itself. Most models are known by their acronyms and the models in the ATCAL process are no exception. One confusing aspect of ATCAL is that it is in two parts. ATCAL Phase I and ATCAL Phase II do different things in the process. It is sufficient for the reader to observe at this point that both phases of ATCAL also go under the pseudonyms of RALPH (Phase I) and Standalone ATCAL (Phase II). The definitions listed in Table 3-1 will be of help.

Table 3-1. Model (M) and Processor (P) Definitions

Acronym	Name and purpose
COSAGE (M)	Combat Sample Generator. Two-sided, symmetrical, mid-resolution, stochastic combat simulation. Models ground-to-ground, ground-to-air, and air-to-ground combat. This tool develops firer/target interactions and final killer/victim scoreboards upon which the ATCAL calibration parameters are based.
RALPH (P)	Reduction ATCAL Link, Phase I. This processor has two basic functions. First, it rolls up equipment from COSAGE so that the expected equipment to be played in CEM is not only in the same numerical sequence, but also fits stringent CEM number of equipment limitations. The second function of the RALPH processor is to calibrate the data from COSAGE according to the equations listed in CAA Technical Paper CAA-TP-83-3, ATCAL: An Attrition Model Using Calibrated Parameters.
ATCAL PHASE I (P)	Same definition for RALPH except that this processor does not need the voluminous data from COSAGE to develop the calibration parameters. Instead, this computer program assumes that RALPH has been run and uses outputs from the RALPH processor to recompute calibration parameters. This processor is used offline when problems are found in the initial calibration and time does not permit rerunning the COSAGE process.
ATCAL PHASE II (STANDALONE) (P)	This is the iterative process which employs a convergence scheme to compute attrition and shots fired for both direct and indirect fire weapon systems offline. See CAA-TP-83-3, ATCAL: An Attrition Model Using Calibrated Parameters, for further information.
COMBINE BOARDS PROCESS (P)	The Tactical Branch of the Forces Directorate produces different postures of varying force ratios. They are Blue Attack, Blue Delay, Blue Defense Intense, Static, Red Attack, Blue Attack Hasty, and Red Attack Hasty. They also produce high tech and low tech killer/victim scoreboards for both US and non-US forces. The Combine Boards Processor collects all postures of data for both US and non-US forces and creates a single mapping for input into the theater model, CEM.
CEM (M)	Concepts Evaluation Model. CEM is a two-sided, fully automated, deterministic computer simulation capable of aggregating conventional land and air warfare results over an extended campaign. Attrition and ammo consumption are computed via ATCAL, embedded within the CEM code. This is the same program as discussed under the ATCAL Phase II program above, but physically located within CEM.

3-2. THE ATCAL LOGIC. During this study, the ATCAL methodology was studied as well as the ATCAL process. The methodology employed by ATCAL is iterative in nature, using convergence on tactical simulation kills as a stopping criteria. Figure 3-1 illustrates the flow of the ATCAL methodology.

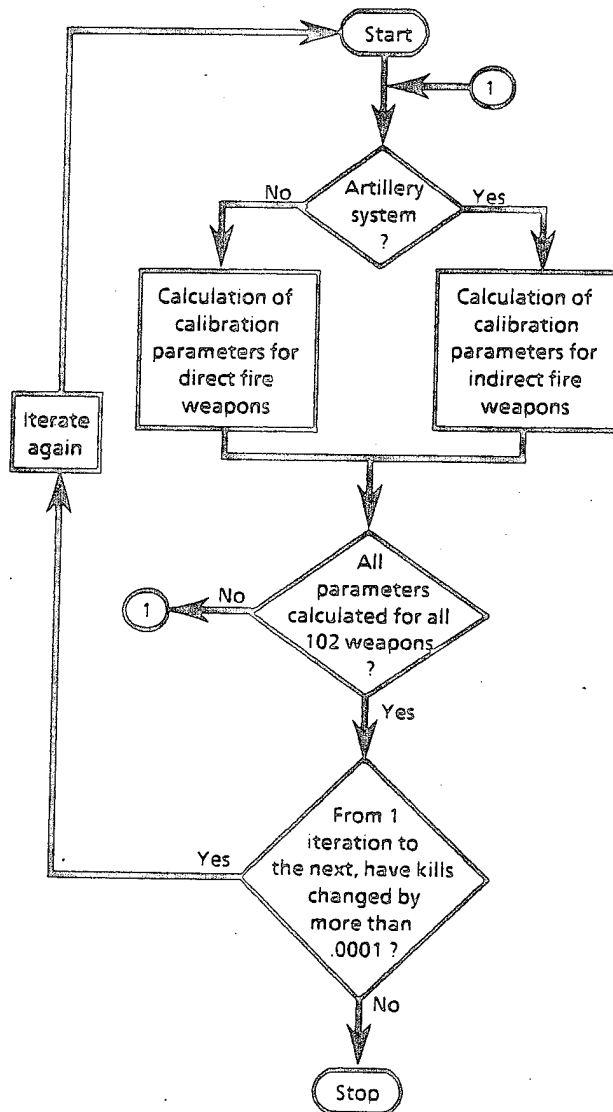

Figure 3-1. Flow Within the ATCAL Methodology

a. Direct and indirect fire systems employ different modules within the code, but in general subscribe to the general outline as illustrated above. ATCAL, as found within the overall attrition calibration process, is now examined. Figure 3-2 illustrates how each model/processor relates to the ATCAL process as a whole.

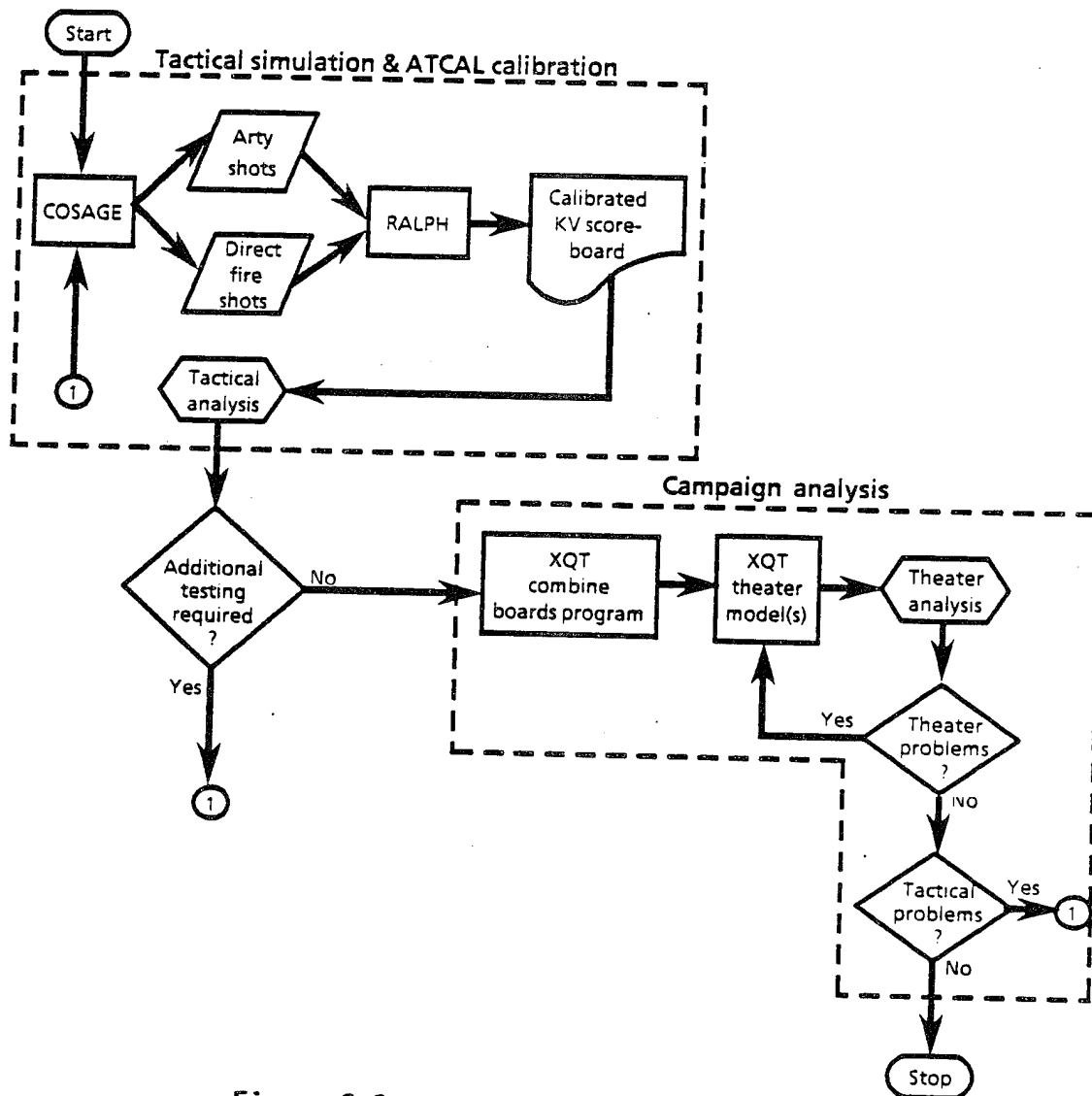

Figure 3-2. ATCAL Process Flow Diagram

b. Seen a different way, Figure 3-3 gives the sequencing of the ATCAL process in capsulated form.

Start 					Finish
1st Process	2d Process	3d Process	4th Process	5th Process	
TACTICAL SIMULATION	REDUCTION PROGRAM	ATCAL PHASE II	COMBINE BOARDS	THEATER MODEL	
Gives firer/target interactions. Calculates operational PKs	Referred to as Phase 1 ATCAL. Computes calibration parameters	Same ATCAL as in theater models. Also used offline for quality check	Combines all six tactical simulation postures for correct mapping into theater input	Gives theater losses, logistic consumption	

Figure 3-3. Sequence of the ATCAL Process

c. It is a common problem for computer-driven methodologies to sometimes develop a bias for input data in consistently the same sequential order. This bias can sometimes lead to constant, but erroneous, results. Table 3-2 shows the input order for ATCAL as it has been used for the past decade. The order was changed to that as seen in Table 3-3. Notice that elements which were last in Table 3-2 are now first in Table 3-3. ATCAL was then run for both perturbations of the ATCAL methodology. No differences were found in any of the output results.

Table 3-2. ATCAL Processing Order

<u>Category</u>	<u>Sequence #</u>	<u>Category</u>	<u>Sequence #</u>
● TANKS	(1 - 12)	● TANKS	(52 - 63)
● APC	(13 - 24)	● APC	(64 - 75)
● HEL	(25 - 29)	● HEL	(76 - 80)
● AT/M	(30 - 41)	● AT/M	(81 - 92)
● PERSONNEL	(42)	● PERSONNEL	(93)
● ARTY	(43 - 50)	● ARTY	(94 - 101)
● CAS	(51)	● CAS	(102)

Table 3-3. ATCAL Processing Order

<u>Category</u>	<u>Sequence #</u>	<u>Category</u>	<u>Sequence #</u>
● CAS	(102)	● CAS	(12 - 1)
● ARTY	(101 - 94)	● ARTY	(24 - 13)
● PERSONNEL	(93)	● PERSONNEL	(29 - 25)
● AT/M	(92 - 81)	● AT/M	(41 - 30)
● HEL	(80 - 76)	● HEL	(42)
● APC	(75 - 64)	● APC	(50 - 43)
● TANKS	(63 - 52)	● TANKS	(51)

(Note that Table 3-3 differs from Table 3-2 in the sequencing of inputs; i.e., tanks = 1 versus CAS = 1.)

3-3. **METHODOLOGY.** The method of evaluating ATCAL can be divided into four phases. They are as follows:

a. Phase I. Use an established OMNIBUS 1991 Europe set of combat samples as a base case. Examine theater outputs to learn what measures of effects might be appropriate. As an aside, more timely analysis can be accomplished with ATCAL converted to personal computer (PC) application. Of course, this also enhances transportability of the methodology to users outside of the CAA sphere of influence.

b. Phase II. This phase determines the limits of the experiment. Finalize the CEM theater outputs to be used as MOE. Examine the CEM distributions of battles versus posture, battles versus frontage and types of equipment firer/target engagements for which ATCAL is expected to extrapolate.

c. Phase III. This portion of the study builds new tactical tools with which to evaluate ATCAL's extrapolation performance for different force sizes and force ratios than have previously been gamed (i.e., division versus brigade). Other tactical tools involve building homogeneous or generic division/brigade samples (i.e., one generic type of tank/APC.) Brigade samples are developed from the Europe, OMNIBUS standard. Run both Standalone ATCAL and CEM for division and brigade samples. Record problems in building the samples and differences in brigade and division tactical simulation input and output. Problem lists will play a role in the overall feasibility of whether or not to adopt brigade-sized samples. Build statistical analysis from both brigade- and division-level analysis.

d. Phase IV. Phase IV represents the extrapolation check across all four extrapolation boundaries mentioned in Chapter 2. Execute Standalone ATCAL by running stylized (multitank type) division samples through Phase II ATCAL. However, construct inputs for Phase Two ATCAL to request single tank type data. Check results of experimentally-derived division and brigade samples with single tank types built from Phase III. Compare results and document.

3-4. **INDIRECT FIRE.** ATCAL indirect fire was found not to shoot beyond calibrated round per tube per day limits--even when no artillery caps were employed in ATCAL Phase I. When more artillery assets were introduced, the rounds per tube per day decreased dramatically. Some artillery experts (and models such as COSAGE and TAFSM) predict that with more artillery (and more sensors), rounds per tube per day should increase, or at worst, remain the same. This topic was deemed to be important enough to spin off another study; ATVAL Phase II - Indirect Fire. This study will address all of the ramifications of ATCAL on indirect fire systems and is intended to begin this fiscal year.

3-5. ASSUMPTIONS. The main assumptions upon which this paper is based are that:

- a. It is highly desirable for theater battle assessment to come directly from a high-resolution tactical simulation. It is the tactical simulation that builds the calibration parameters in the first place. Unfortunately, today, no computer in the world is large enough to execute both the tactical and strategic simulations simultaneously. Therefore, ATCAL was built to be a surrogate for running the tactical simulation within the theater model. As such, COSAGE is assumed to be base truth in all comparisons with ATCAL.
- b. ATCAL emulates what a high resolution tactical simulation would do if embedded within a theater model. This assumption is the underpinning of the way in which this experiment checked ATCAL Phase II results. (See paragraph 3-3, Methodology, Phases III and IV.)
- c. ATCAL outputs and tactical simulation outputs are the primary measures of effects.

CHAPTER 4

EXECUTING THE EXPERIMENT

4-1. ESTABLISHING EXTRAPOLATION REQUIREMENTS. Various methods were used in order to establish CEM expectations of ATCAL in the area of extrapolation. The following is a synopsis of the data and methods employed.

a. The four paradigms for extrapolation as outlined in paragraph 2-3, Chapter 2, came about as a result of using ATCAL, and not as a result of an elaborate test. Over the past decade, ATCAL has changed very little, and its use has formed the underpinning for hundreds of Army studies. This broad-scale application has shed light on the points which ATCAL should consider, or said another way, how ATCAL should work. Although these four paradigms for extrapolation came about in a rather *ad hoc* fashion, the proving or disproving of them as ATCAL tenets is now the center of the experiment. In order to size the problem, the study centers on outputs from the theater model--CEM battles.

b. CEM battles are the final proving ground in which ATCAL performs its function. As earlier discussed, the calibration parameters obtained from the tactical simulation form the basis for calculation of rate-of-fire, attrition, and ammunition expenditures at theater level. However, the end product of ATCAL lies in a number of CEM output reports. One such report is the CEM Detail Report. Although quite voluminous, this nut-and-bolt level output reveals much about each individual battle that occurs in CEM and provides a window for ATCAL researchers to examine the results of extrapolation. Appendix D gives an example of the data contained in such a report. This is the only division-level report which provides individual killer/victim results for all postures (including static).

c. This data was the primary source for CEM extrapolation requirements: the simultaneous solution for each of the four extrapolation paradigms listed in Chapter 2. Multiple computer programs had to be written to summarize tank-on-tank and number of battle by posture queries. One such example of program output obtained from the theater model is listed in Table 4-1.

Table 4-1. Tank-on-tank Engagements: A Probability Table

Number of Blue tank types	No of Red tank types				Row totals
	0	1	2	3	
0	0.0	2.3	1.7	2.2	6.2%
1	0.0	1.4	3.9	9.8	15.1%
2	0.0	22.1	10.9	14.6	47.6%
3	0.0	17.8	2.3	11.0	31.1%
Column totals	0%	43.6%	18.8%	37.6%	

d. As an interpretive aid, this table illustrates that 22.1 percent of all CEM battles occurred with two Blue tank types engaging one Red tank type. (This example originates from OMNIBUS 91 Europe, where 4,859 total battles are assessed.)

e. The purpose of this analysis is to calculate in real terms what the requirements of ATCAL are; Table 4-1 addresses what ATCAL should expect to handle in terms of force composition. It is evident that 43.6 percent of the time, Blue tanks will only face one type of Red tank. On the other hand, 37.6 percent of the time, Blue tanks are expected to encounter no fewer than three Red tank types per battle. Establishing extrapolation requirements for force ratios is done in a similar fashion.

4-2. CEM SUBSECTOR ENGAGEMENTS. In addition to the extrapolation requirements noted for the above, force frontage also needs to be addressed. Again the CEM Detail Report was utilized along with the CEM Movement Report. These reports generate data similar to that found in Figures 4-1 and 4-2.

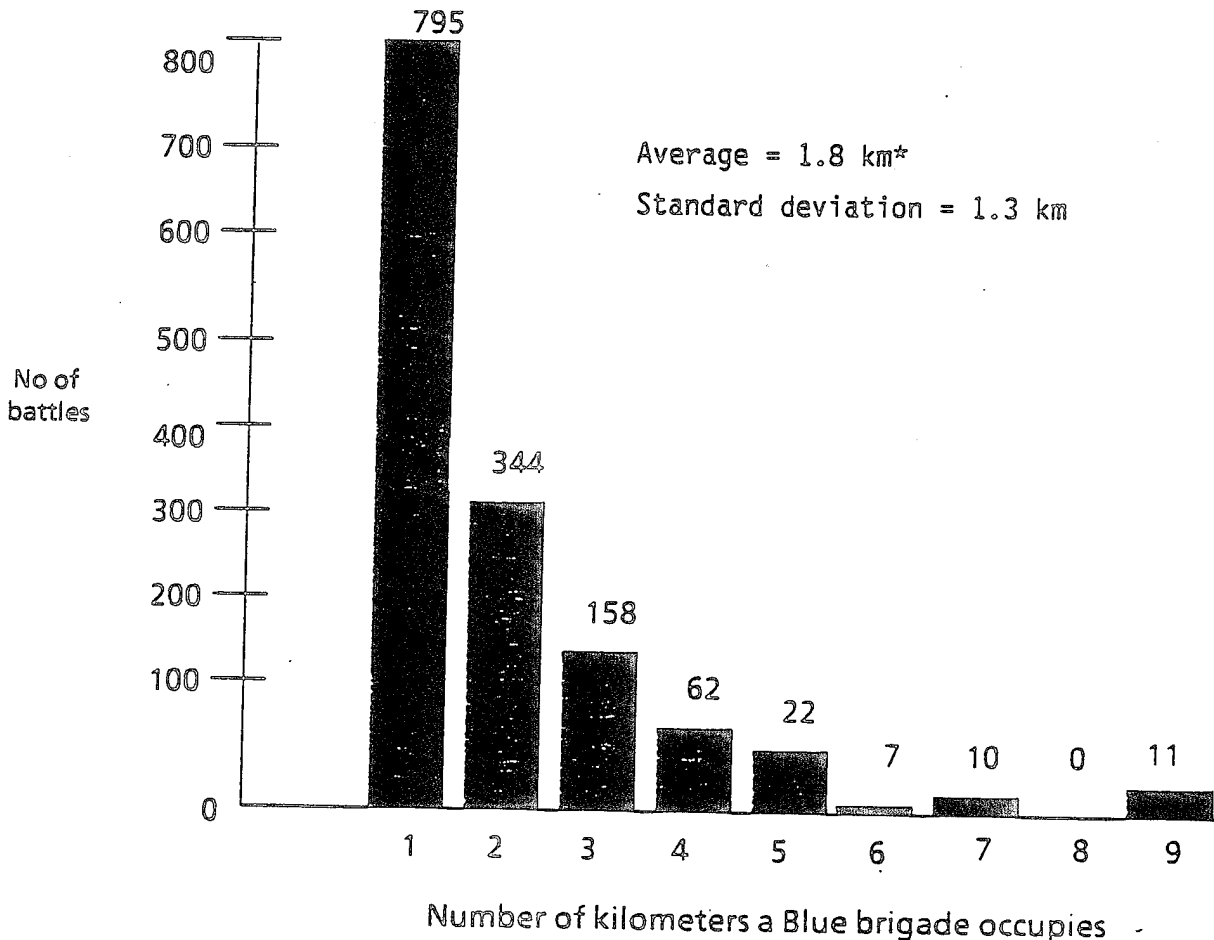

*NOTE: due to space limitations, only part of the complete distribution is pictured here.

Figure 4-1. Red Attacks Blue Defense Intense (posture 2)

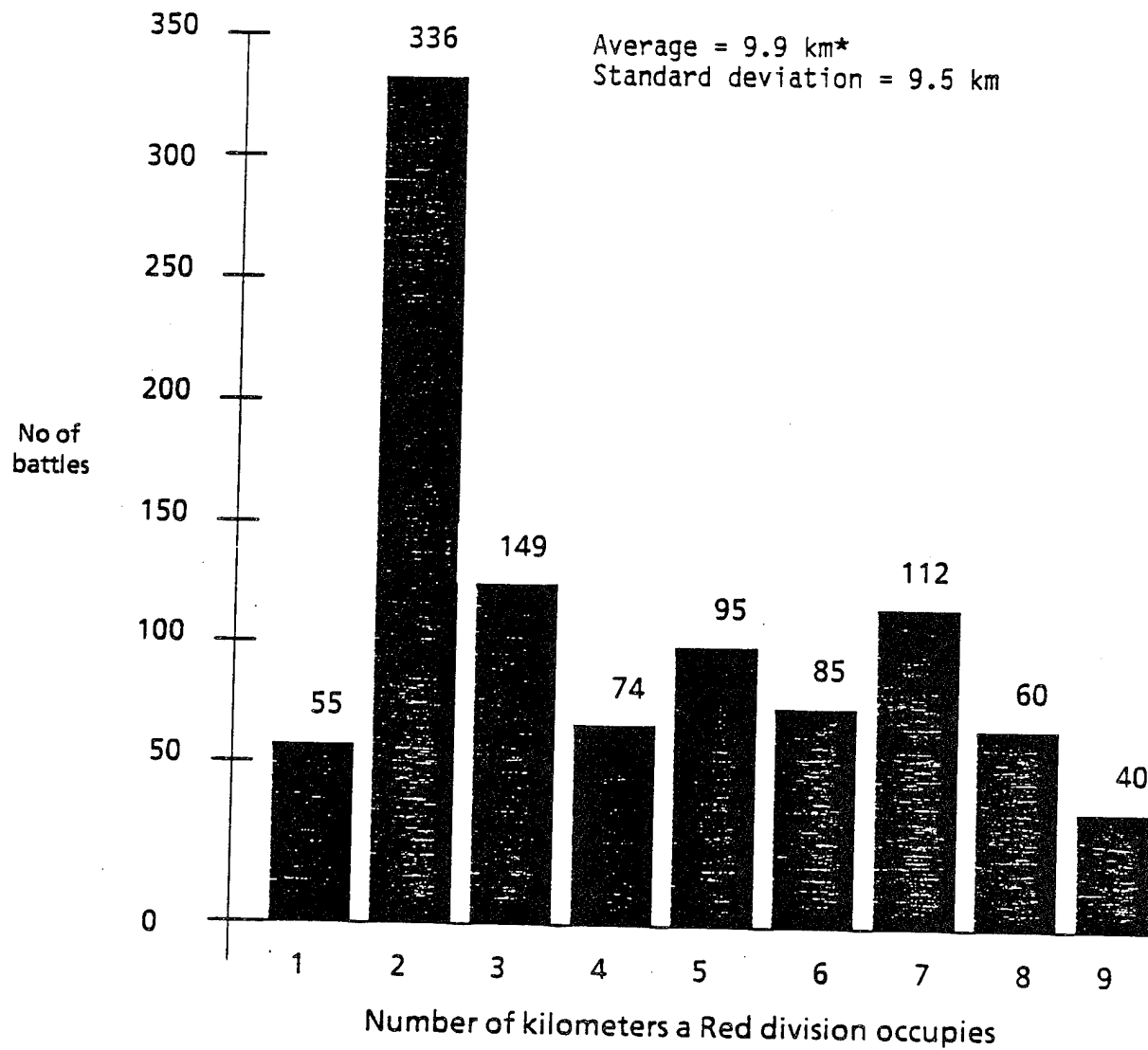

*NOTE: due to space limitations, only part of the complete distribution is pictured here.

Figure 4-2. Red Attacks Blue Defense Intense (posture 2)

a. These figures give credence to the fact that ATCAL is called on to assess battles on relatively small frontages. Figure 4-2 shows an average frontage of 9.9 km for Red divisions. Compare the results from Figure 4-1 (average of 1.8 km) with the frontages from the tactical simulation in Table 4-2. Notice that the average frontages show large differences between the theater and tactical applications. Further information on CEM subsector assessments can be found in the CEM User's Manual, CAA-D-85-1, page 1-7, Initial Deployments.

Table 4-2. COSAGE Frontages by Posture;
Based on a US or Non-US Division
(in kilometers)

Posture			
Blue attack, Red defend	Blue delay, Red attack	Static	Blue defend, Red attack
15	40	60	30

b. Again, although there is a large difference between what CEM uses and what COSAGE provides in terms of kilometer fronts, ATCAL takes this frontage change into consideration when computing target availabilities. Figure 4-3 graphically portrays the extent to which ATCAL must extrapolate from COSAGE down to substantially smaller CEM frontages. This figure can be thought of as the pictorial representation of the Blue defend, Red attack posture from Table 4-2.

Battles

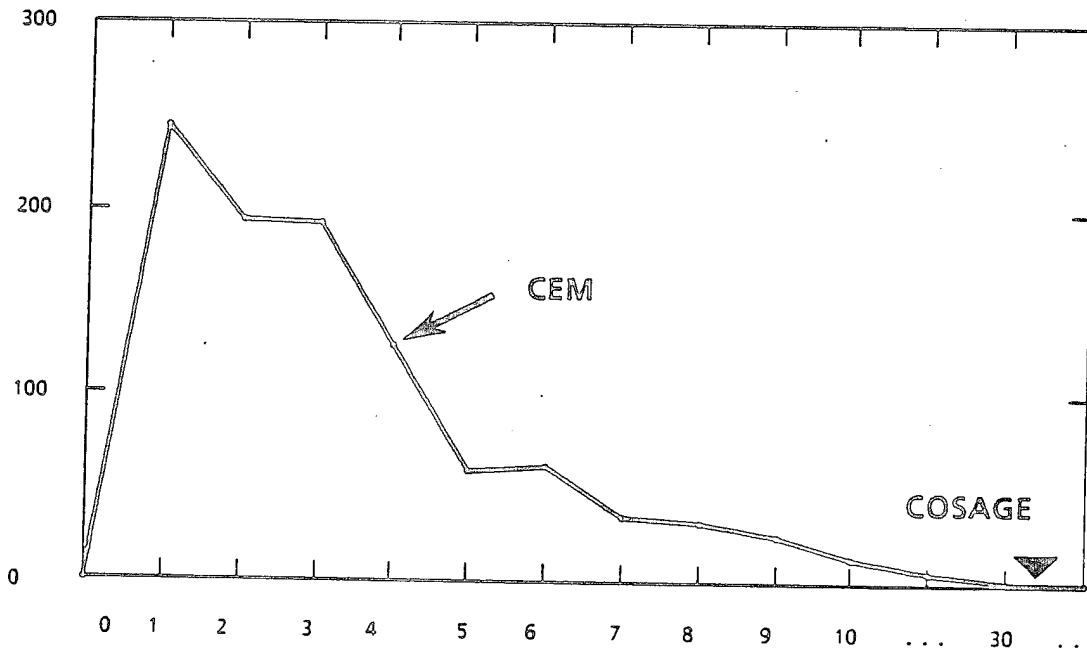

Source:
OMNIBUS 91E

Km front
(1 minisector = 1 km)

Figure 4-3. Force Frontage, CEM Subsectors vs COSAGE Frontage
(defense intense)

4-3. DEVELOPING BRIGADE SAMPLES. In order to answer the question of whether or not ATCAL extrapolates properly for different sizes of units, four postures of brigade-sized forces based on the OMNIBUS 91 Europe scenario were constructed.

a. The brigade tactical samples provide a touchstone by which comparisons to Standalone ATCAL results can be made. Again, the assumption is that if COSAGE were embedded within CEM, these brigade results could be counted as a solid benchmark by which to compare ATCAL. Figure 4-4 illustrates the size issue from the CEM perspective more clearly.

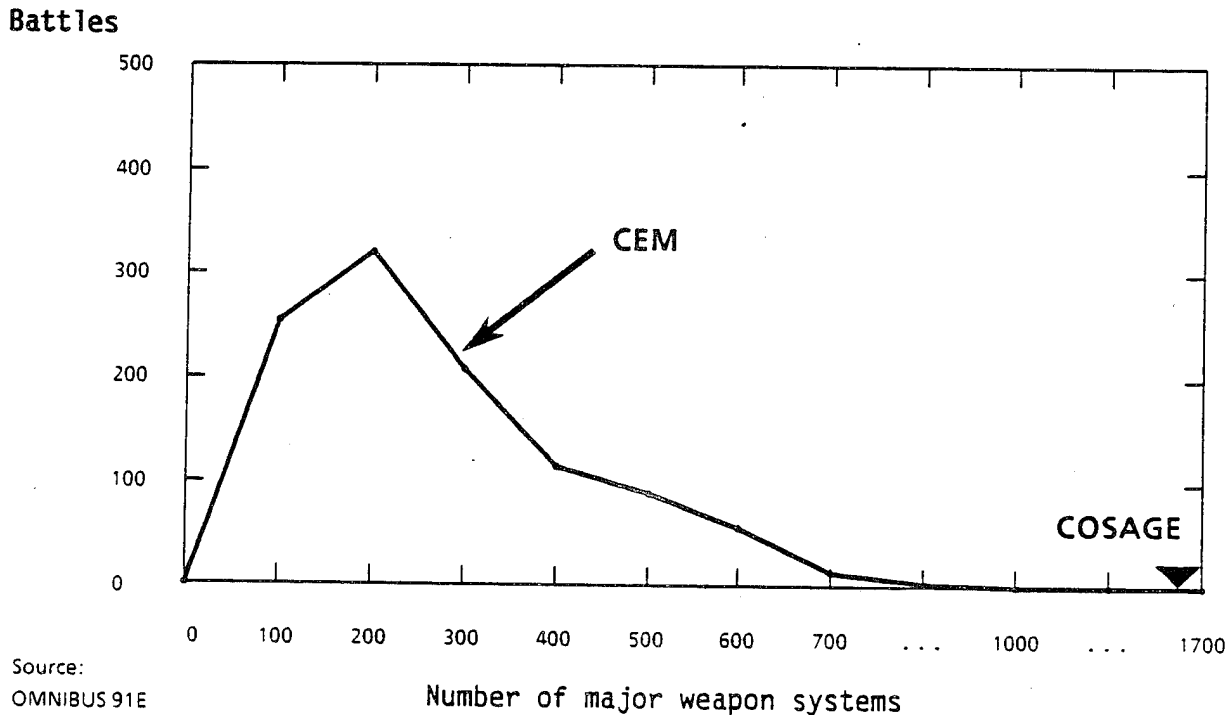

Figure 4-4. CEM Subsector: Numbers of Equipment per Battle

b. To this point, the difference in size that an independently created brigade-sized force affords has been discussed. However, downsizing the Blue force from division to brigade also allows a comparison of different frontages to the CEM frontages (see Figures 4-1 and 4-2). Table 4-3 lists the brigade frontages from COSAGE.

Table 4-3. COSAGE Frontages by Posture;
Based on a US or Non-US Brigade
(in kilometers)

Posture			
Blue attack, Red defend	Blue delay, Red attack	Static	Blue defend, Red attack
7	21	18	15

c. It is apparent that the frontages afforded by the brigade frontages in Table 4-3 are a closer fit to the CEM frontages within Figure 4-1. And, although it is not perfect, one suspects at this point that the frontage issue is better solved via a Blue brigade force laydown than by a Blue division laydown.

4-4. DEVELOPING HOMOGENEOUS SAMPLES. Figure 4-5 illustrates the frequency distribution of battles plotted against equipment types. Note that on average, there are 35 to 50 Blue and Red types of vehicles (i.e., M60A3, T80, BMP) in any given CEM subsector engagement. Compare this figure with the tactical simulation, COSAGE, having on average 85 types of systems.

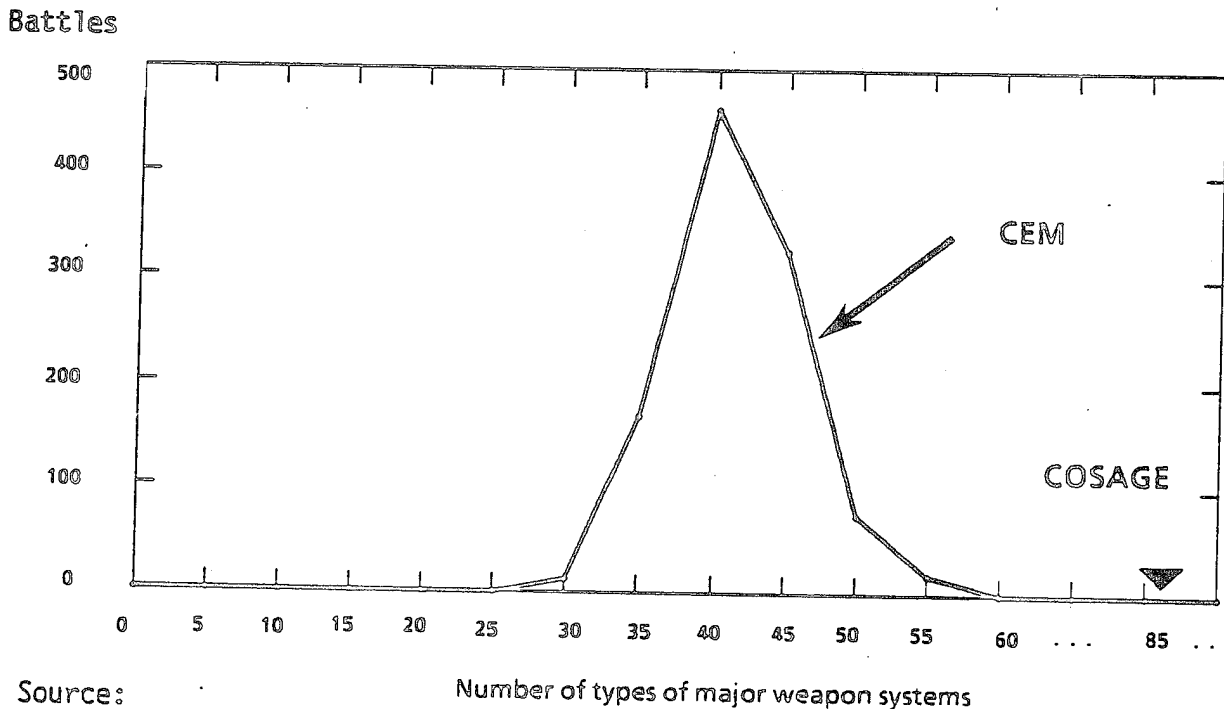

Source:
OMNIBUS 91E

Figure 4-5. Defense Intense Force Composition; CEM Weapon Composition
vs COSAGE Weapon Composition

a. In order to properly execute the force composition experiment, a calibrated sample was created with a mix of US tanks, but run through ATCAL with modified US tank composition. The phrase "modified US tank composition" means that all US tanks were reduced to a single type of tank. This process is identical to the way in which ATCAL within CEM normally assesses a situation. However, in the test case, only Blue tanks are modified. In actuality, many types of vehicles, all being some part of the calibrated sample, have to be evaluated by ATCAL. The point to underscore here is that although the calibrated sample is built to achieve interactions for all possible target combinations in theater, only a small subset of the calibrated sample is called by CEM-ATCAL at any given time. Certainly, it is recognized that single weapon replacement should not be a difficult test for ATCAL to perform. However, if ATCAL cannot successfully complete this simple force composition extrapolation, how can one expect ATCAL to work under more complex scenarios?

b. Once ATCAL is executed, using the mixed tank versus modified tank concept, the experiment calls for an independent evaluation upon which to judge the ATCAL result. This independent evaluation is output from COSAGE which was executed to answer the specific homogeneous ATCAL scenario. Later, two weapon systems at a time are also extrapolated for, giving ATCAL a much harder test to perform. Figure 4-6 graphically illustrates the test procedure for single replacement force composition extrapolation.

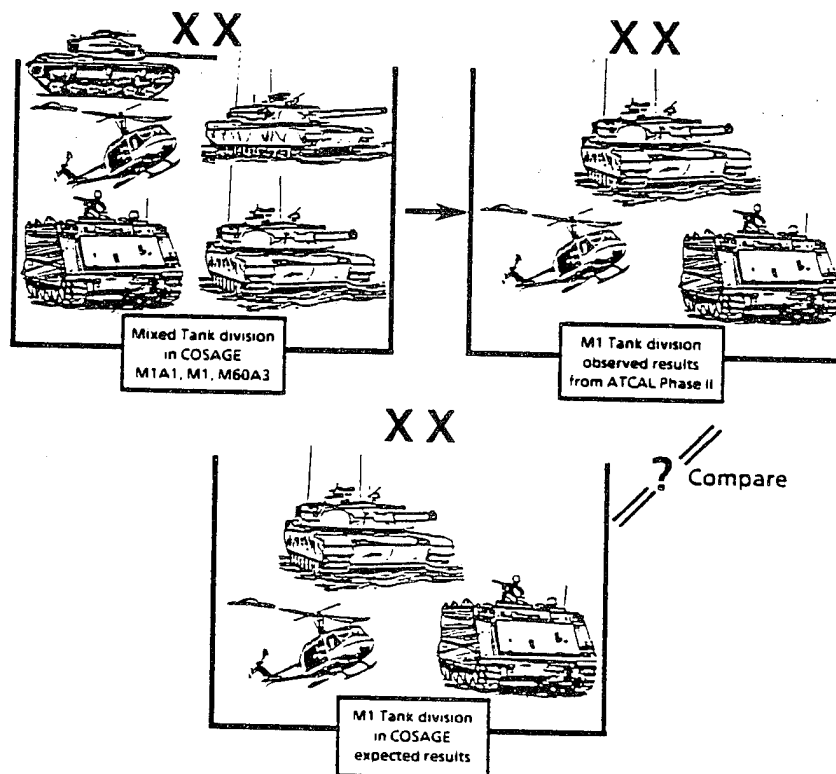

Figure 4-6. Test Procedure for Evaluating Force Composition Extrapolation

c. This brings one to the purpose of the homogeneous M1 tank division. This data is geared to answer the question, "What happens when COSAGE fights with a pure M1 force, just as would occur in CEM?" The answer to this question is compared to the ATCAL outputs. This comparison forms the basis to determine whether ATCAL does or does not extrapolate well for force composition. The same type of experiment to evaluate the force size issue is illustrated in Figure 4-7. Note that a Blue brigade in lieu of a Blue division is used to help judge the ATCAL extrapolation difference for force size.

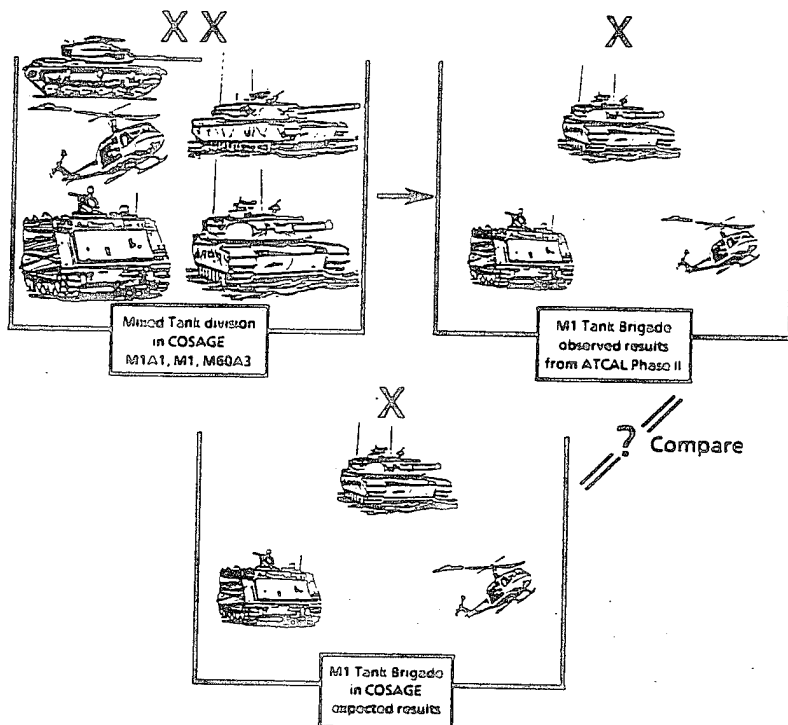

Figure 4-7. Test Procedure for Evaluating Force Size Extrapolation

4-5. DIVISION FRONT VERSUS BRIGADE FRONT IN ATCAL. The previous two paragraphs dealt with the issues of force size and force composition extrapolation. ATCAL also independently adjusts the density of targets through a process which evaluates the COSAGE and CEM frontages. To make this concept clearer, consider the following problem:

Two Blue forces in the theater model, each having the same size, the same force ratio, and the same composition both engage exactly the same Red enemy. The only difference between the two battles upon which the assessments take place is the frontage. ATCAL will compute quite different shots and kills simply as a result of the modified front. However, although showing some change, the tactical simulation is nowhere nearly as sensitive to frontage change as is ATCAL. The reason for this lies within the mathematical formulation within ATCAL to modify or transform COSAGE target densities on wide fronts (see Table 4-2) to those within CEM on narrow fronts (see Figure 4-1). For a detailed discussion on the ATCAL mathematical frontage transformation

of target availabilities, see ATCAL: An Attrition Model Using Calibrated Parameters, dated August 1983, by Alan Johnsrud; pages 6-8. For the purpose of this study, target availability can be thought of as the fraction of time that a target is available to be fired upon by a specific weapon system.

Likewise, an in-depth discussion on tactical simulation sensitivity to frontage is contained in the study report entitled Analysis of Barrier Systems Alternatives in Korea for ROK/US (ABAKUS), dated November 1989, by Charles A. Bruce; pages 1-7 through 1-9.

a. Another representation of the problem can be seen via the following two figures. The first, Figure 4-8, shows a generic 40-kilometer front depicting a COSAGE defense intense laydown of forces. This particular posture represents a Blue division being attacked by three Red divisions. Therefore, the frontage across which the COSAGE battle is gamed is 40 kilometers.

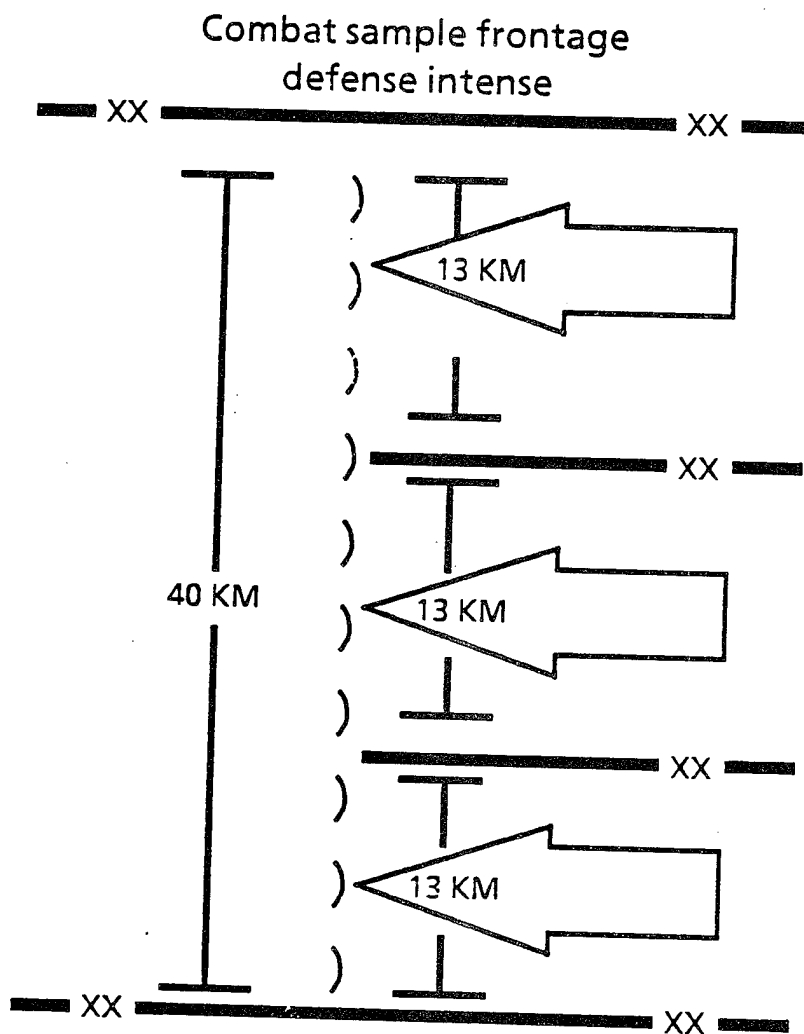

Figure 4-8. Example of Tactical Frontage Situation

On the other hand, Figure 4-9 illustrates the CEM subsector battle. Note that this assessment occurs between portions of a single Blue brigade and three attacking Red divisions. For each of the three subsectors within Figure 4-9, ATCAL has to extrapolate for weapon density from the COSAGE 40-kilometer "calibrated sample."

Example of three CEM subsectors

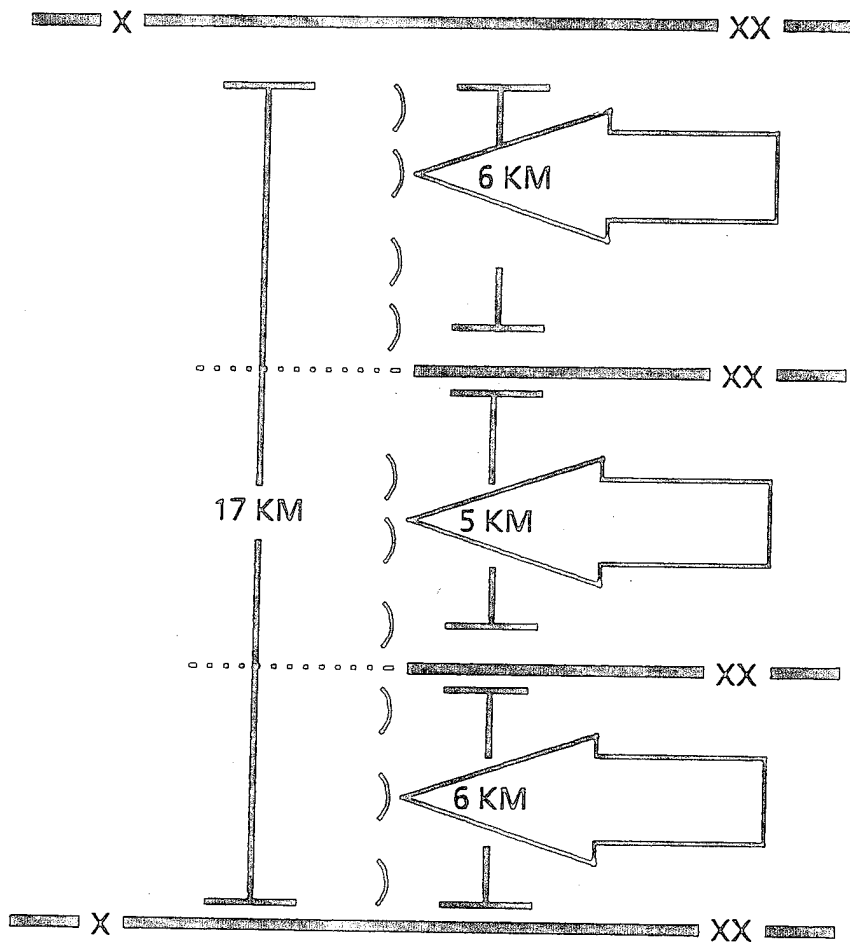

Figure 4-9. Example of Theater Frontage Situation

In this case, ATCAL extrapolation for force density actually transforms the calibrated target availabilities from COSAGE. CEM then operates off these modified target availabilities to assess shots fired and kills achieved. Research into this topic has yielded the following figure (Figure 4-10) which depicts the resultant ATCAL modifications to COSAGE target availabilities.

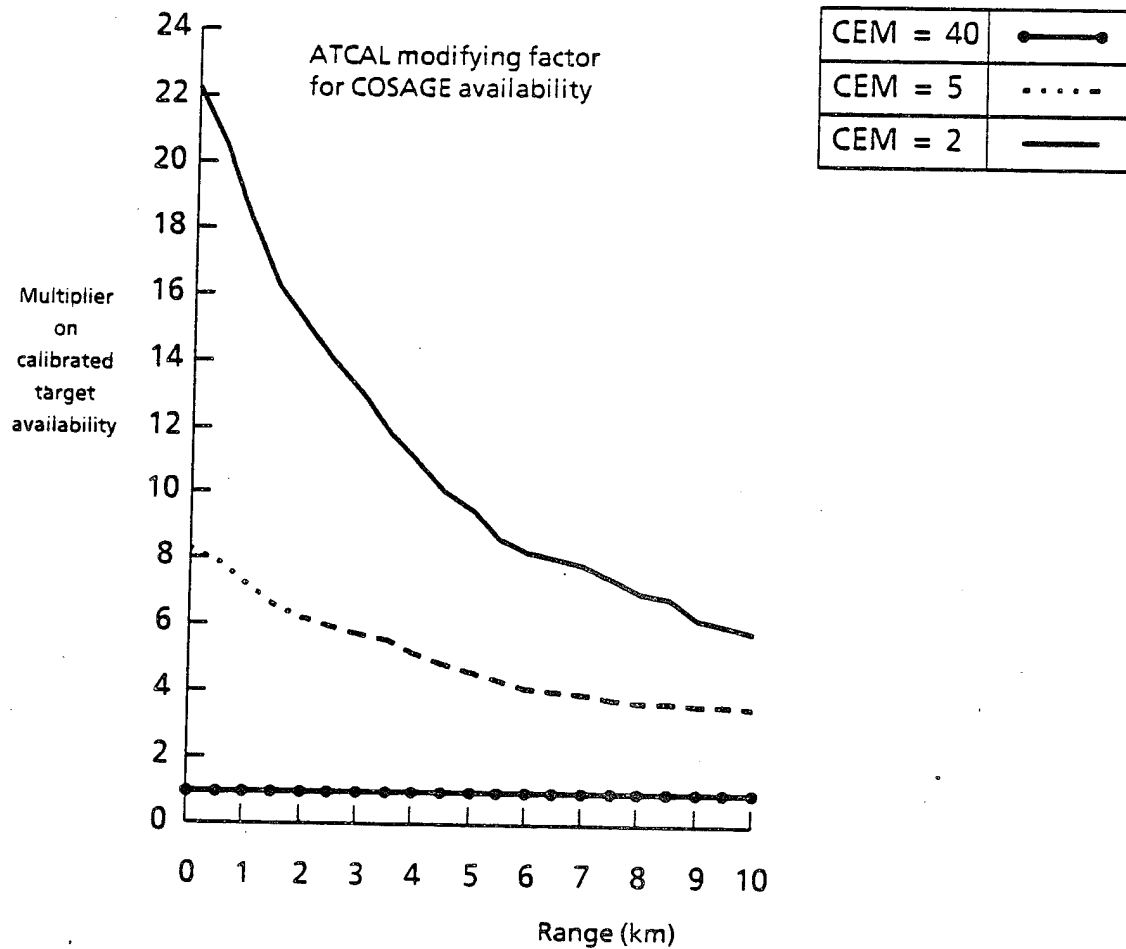

Figure 4-10. ATCAL Average Engagement Range (km) Relationship to Modify COSAGE Target Availabilities

b. Note that for CEM frontages equal to COSAGE frontages (i.e., 40 km), a modification factor of 1 is applied (no change from COSAGE). However, for CEM subsector assessments of 2 to 5 km, ATCAL modifies target availabilities up to 22 times the COSAGE sample for short range weapon systems. Clearly this method of mapping target availabilities from the tactical simulation to the theater subsector assessment is extremely subjective.

c. This frontage problem is further explored to better understand what the availability modifications are trying to accomplish. Practically, the three Red division battles in the COSAGE force laydown at Figure 4-8 individually add up to equal the sum of all the shots and kills over the whole battle. Ideally, one would hope that the same would be true for the CEM subsector assessment across the entire battle at Figure 4-9. Unfortunately, this is not true. Here, the Lanchester linear law (upon which the direct fire portion of ATCAL is built) takes effect. The linear law, simply stated, says that the number of kills is proportional to the product of the number of firers and targets. For example, if 1/3 the number of CEM firers engage 1/3 the number of CEM targets from COSAGE, then ATCAL will assess 1/9 the attrition. This is 1/9 the attrition observed from COSAGE calculated from 1/3 the COSAGE forces. ATCAL does not quite compute the attrition which COSAGE computes; therefore, the "modifying target availability factors" are an attempt to increase this attrition upward to COSAGE levels. Offline analysis illustrates this phenomena. Additionally, within this study, symptoms of this anomaly can be seen in the analysis in the next chapter. Specifically, ATVAL analysis reveals that COSAGE shoots more, and achieves more kills on the whole, than does ATCAL, even with the modification factors employed.

CHAPTER 5

EVALUATING THE EXPERIMENT

5-1. ATCAL EXTRAPOLATION FOR FORCE RATIO

a. **Extrapolation for Force Ratio.** This portion of the experiment is basically a two-step process. The first step is to see how well force ratios from the tactical simulation fit within the distribution of force ratios assessed at the theater level. The purpose of this test is to diagnose whether the COSAGE force ratio being used as the calibration is anywhere near that which the theater is assessing. The second case is to test Standalone ATCAL against perturbations in force ratio. The measure by which ATCAL is to be compared, comes from the tactical simulation.

(1) **Case 1.** This paragraph deals with examining how well the COSAGE posture fits within multiple CEM-generated force ratios for the same posture. CEM was run for the OMNIBUS 91 base case. This execution of the theater model provided both Detail and Movement Reports from which force exchange ratios (FER) and force ratios were extracted by posture. This data illustrates force ratio as a function of FER for many individual battles. The next step was to examine the posture-specific combat sample from the tactical simulation that produced the above-mentioned FERs through ATCAL. (CEM produces the force ratios.) One has to be careful during this process to reduce the tactical data representative of the number of systems in the same manner by which the theater game calculates force ratios. This is merely a multiplication of tactical numbers of equipment by the theater weapon values. Using this technique assures that both the force ratios obtained from the tactical and theater samples are measured on the same scale.

(2) **CEM/ATCAL versus COSAGE FER.** Figures 5-1, 5-2, and 5-3 show CEM runs by posture, illustrating (1) force ratio as a function of FER at theater level, (2) the number of battles for the posture, and, most important, (3) where the tactical force ratio is located with reference to all of the theater force ratios. The two dark lines come together at the point represented by the tactical combat sample. Force ratios are calculated as Red/Blue.

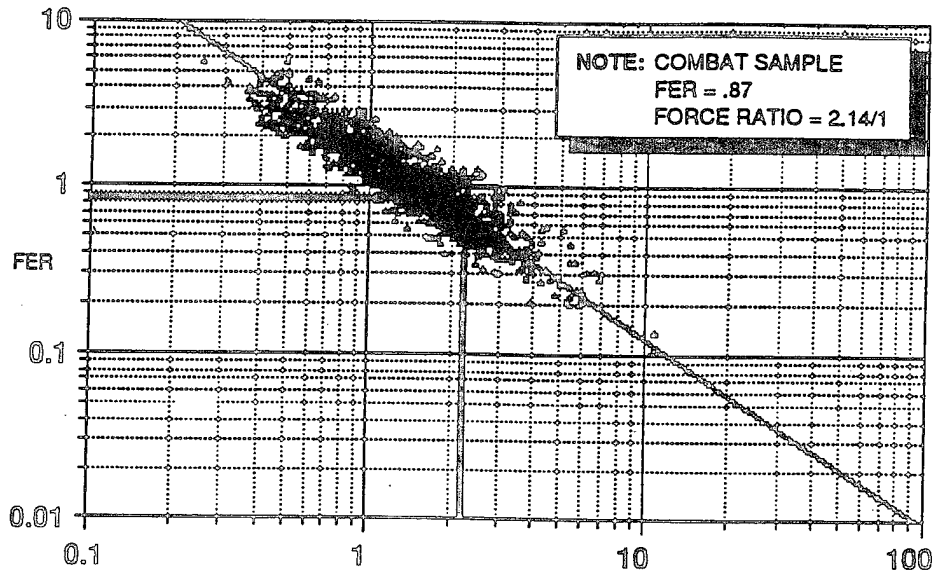

Figure 5-1. Force Ratio vs FER for Blue Defense Intense

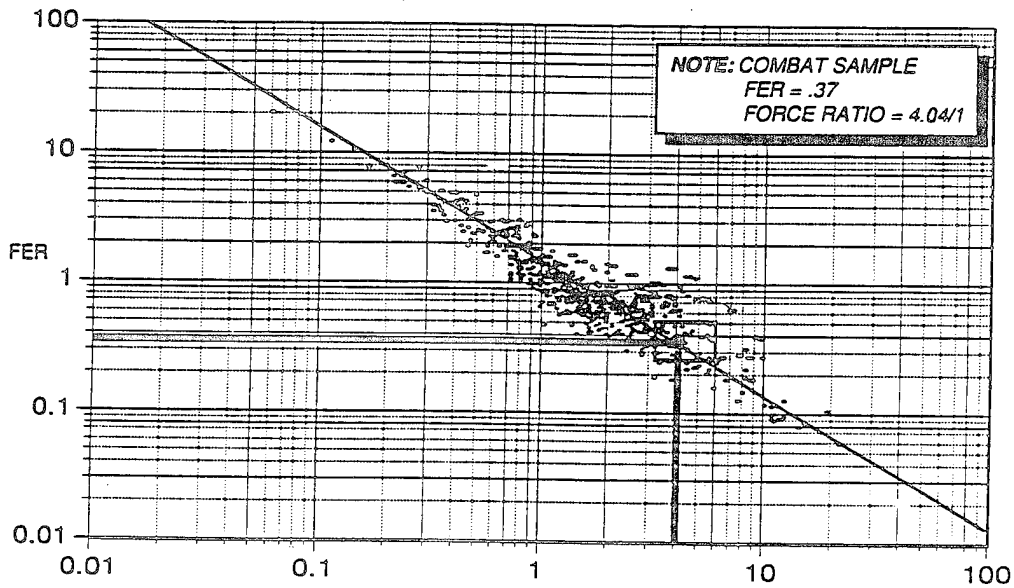

Figure 5-2. Force Ratio vs FER for Red Attack, Blue Hasty Defense

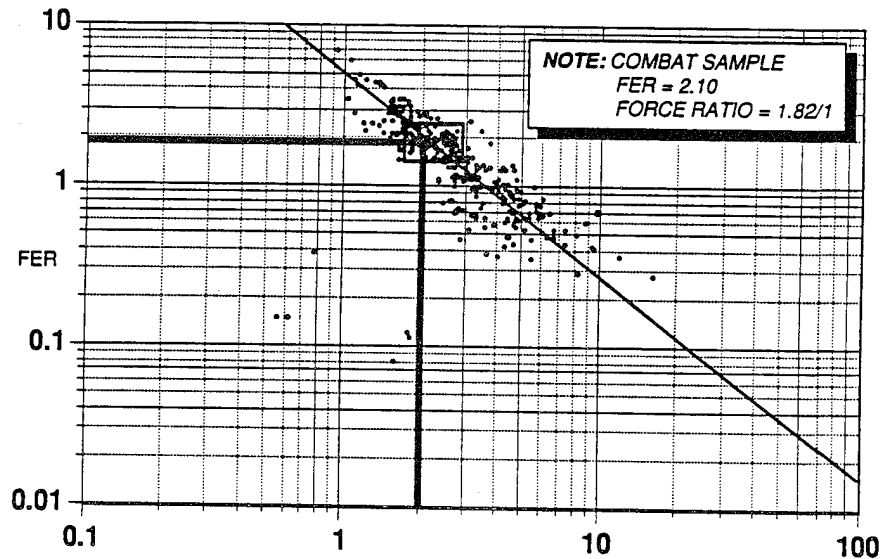

Figure 5-3. Force Ratio vs FER for Blue Attack,
 Red Hasty Defense

It is hoped in the construction of combat samples, that the application of the sample falls within a reasonable expectation of theater combat. As a function of posture, it can be seen from Figures 5-1 through 5-3 that the combat sample is a good single point estimator of the theater situation.

(3) **Case 2.** The next test on force ratio is accomplished by running a base case, calibrated posture (i.e., force ratio) through COSAGE. Standalone ATCAL is then executed with perturbations to the force ratio, but using the same calibration parameters as outlined in Chapter 2.

(4) **New COSAGE Data.** The following step is to rebuild new COSAGE data with force ratios other than the base calibration mentioned above. ATVAL used force ratios of 1.5:1, 3:1, 5:1, 7:1, and 10:1. Although the 7:1 and 10:1 scenarios were prepared, Figures 5-1 through 5-3 illustrate that there is little need for ATCAL to extrapolate for such extremes. Therefore, these data are omitted. Once this entire scenario is prepared, it, too, is executed; i.e., each separate force ratio is run through COSAGE. Both the Standalone ATCAL and COSAGE results are now compared. The results can be seen at Figures 5-4 (Blue ammo expenditures) and 5-5 (Red ammo expenditures)

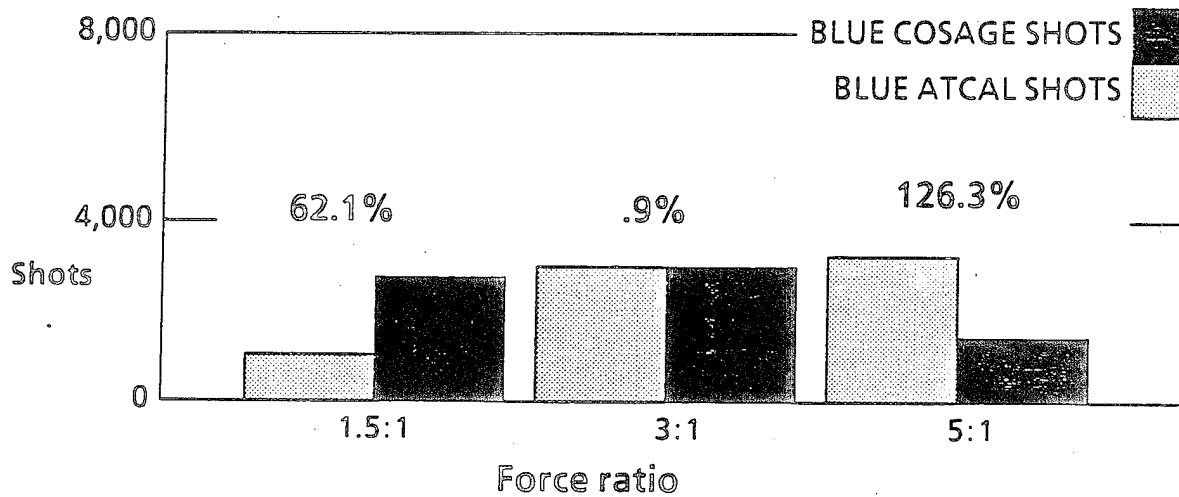

Figure 5-4. Blue Direct Fire Ammunition Expenditures (percent difference between ATCAL and COSAGE shots)

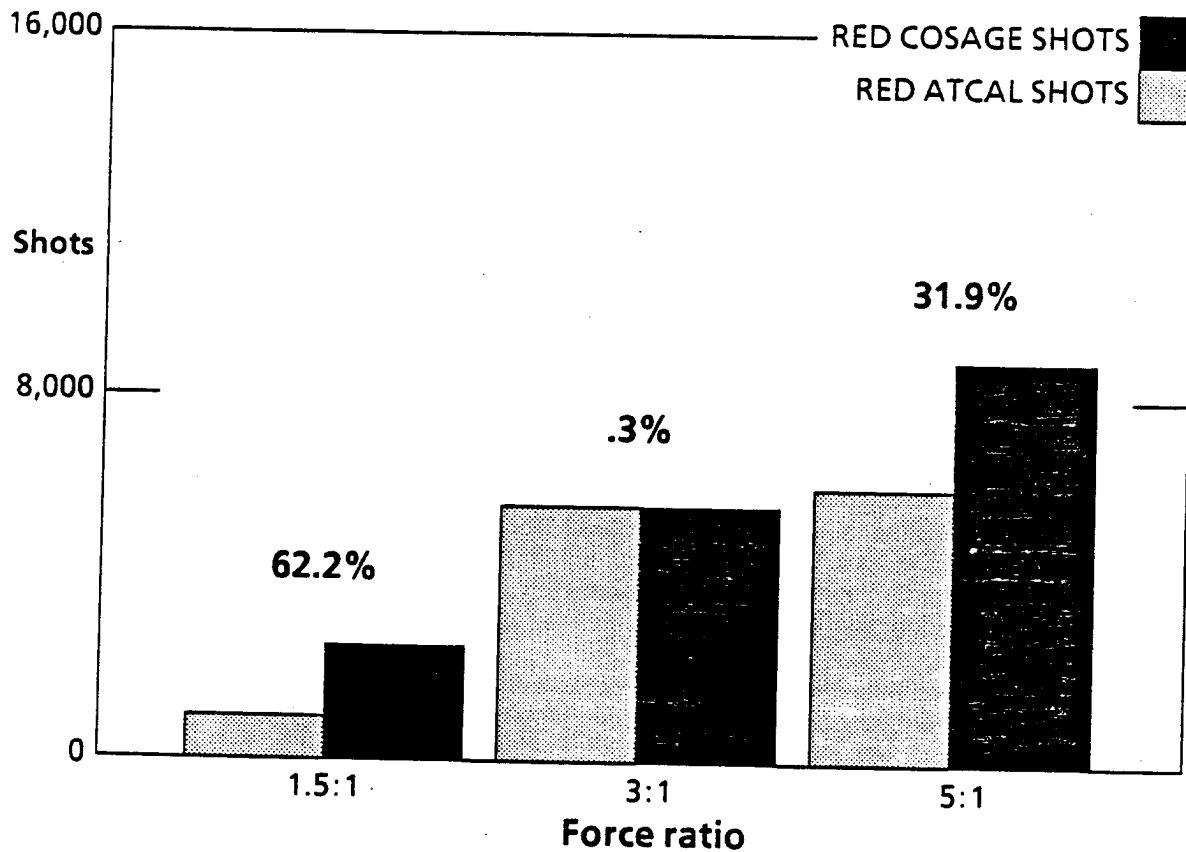

Figure 5-5. Red Direct Fire Ammunition Expenditures
(percent difference between ATCAL and COSAGE shots)

(a) For both of the above figures, the least amount of change occurs when the force ratio is 3:1. This should not be surprising, because this was the base calibration. All of the other force ratios were run from this base calibration, just as the theater model would attempt to do it. However, substantial differences can be seen for all other force ratios. This, at least on the surface, implies that ATCAL is not extrapolating well for force ratios other than 3:1. On the other hand, one must realize that the COSAGE shots come from a distribution of outcomes called replications. These replications are necessary within the stochastic environment upon which COSAGE is built. Therefore, it might not be fair to compare single values from ATCAL with average values from COSAGE without examining the ATCAL value as placed upon the COSAGE distribution.

(b) As further background, COSAGE is normally run for 16 to 20 replications to obtain killer/victim scoreboards. These outputs are then averaged and transmitted to the theater model (and to ATCAL) as averages. Therefore, this study determined each of the individual points from 16 to 20 COSAGE replications against which to plot the single ATCAL value. This answers the question, "Does ATCAL produce a value such that it would fall within the

COSAGE range of stochastic values?" Box and whisker plots (Figures 5-6 and 5-7) are used to portray the 16 independent values. All 16 tactical simulation data points are contained within the "whiskers" (or end points) of the plot.

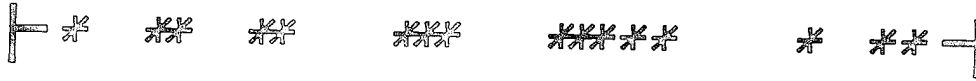

Figure 5-6. Whiskers of the Box and Whisker Plot

(c) Each asterisk within Figure 5-6 is a data point from one and only one COSAGE replication. Of course, the asterisks represent COSAGE shots fired or kills from one weapon system against all possible targets. Figure 5-7 shows the box from the same distribution of data.

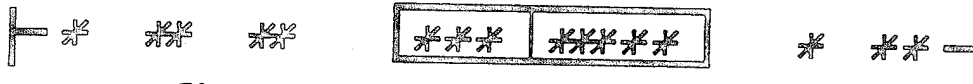

Figure 5-7. Box of the Box and Whisker Plot

(d) The box represents 50 percent of the data points. The vertical line separating the box is the median of the data. Additional information on the box and whisker technique can be found in the book entitled Application Basics And Computing of Exploratory Data Analysis by T. Belman and D. Hoaglin, Duxbury Press, page 69. Henceforth, all figures of box and whisker plots are to be thought of as the tactical simulation distribution of individual values. The ATCAL value is denoted as a separate down-arrow with the name "ATCAL (xxx)" over the arrow. For example: ATCAL (322).

↓

Asterisks found outside the whiskers can be thought of as "outside values," i.e., values greater than one box length away. Solid "dots" represent outliers greater than two box lengths away (as an example, see Figure F-9, Appendix F).

(e) The (xxx) symbolizes the values taken by the discussion; i.e., ATCAL (322) means 322 ATCAL shots to be compared against the range of COSAGE shots within the box and whisker plot.

(5) 1.5:1 Force Ratio Test. Figure 5-8 is an actual example whereby the above box and whisker method is applied. This box and whisker illustrates shots fired by ATCAL and shots fired by COSAGE. Note that the firing vehicle is the M1A1. Figure 5-9 shows kills for the same shooter.

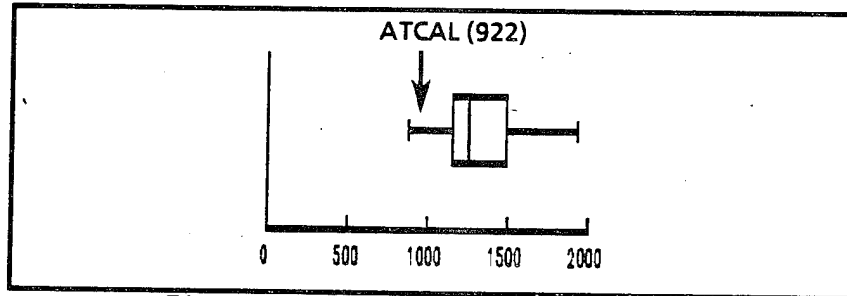

Figure 5-8. COSAGE Shots by M1A1,
1.5:1 Force Ratio

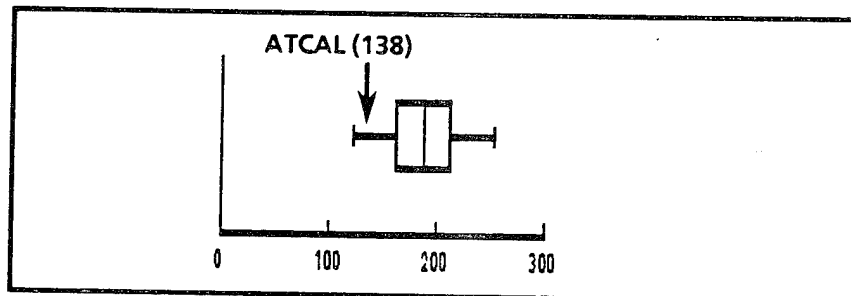

Figure 5-9. COSAGE Kills by M1A1,
1.5:1 Force Ratio

(a) The next graphic (Figure 5-10) outlines the system exchange ratio (SER) for the M1A1. Taken as a group, these three pictures outline a problem for ATCAL in extrapolating for force ratio when examining the M1A1 tank. Similar results were observed for various weapon systems at the 1.5:1 ratio. These results can be viewed within Appendix E of this document. Loss exchange ratio (Figure 5-11) and force exchange ratio (Figure 5-12) were also computed for the 1.5:1 case and are shown here.

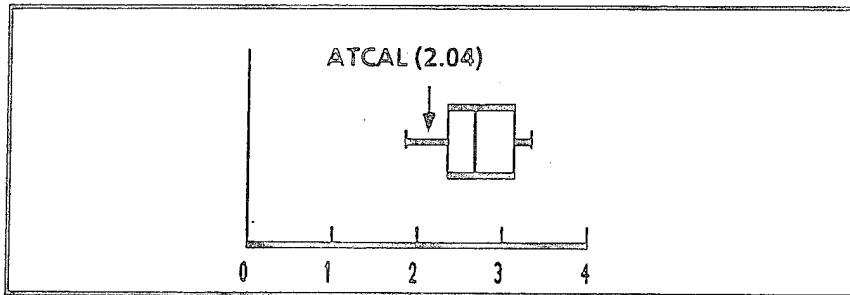

Figure 5-10. System Exchange Ratio for M1A1, 1.5:1 Force Ratio

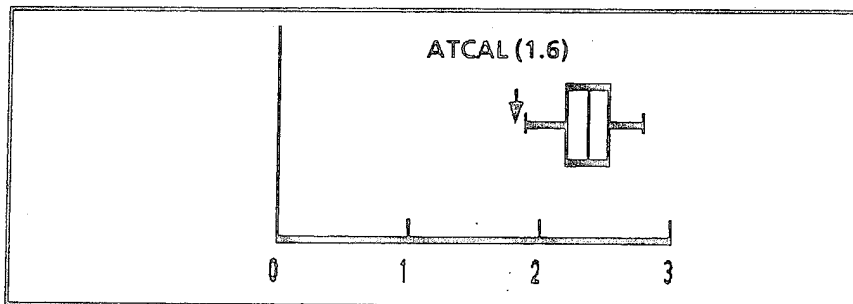

Figure 5-11. Loss Exchange Ratio, 1.5:1 Force Ratio

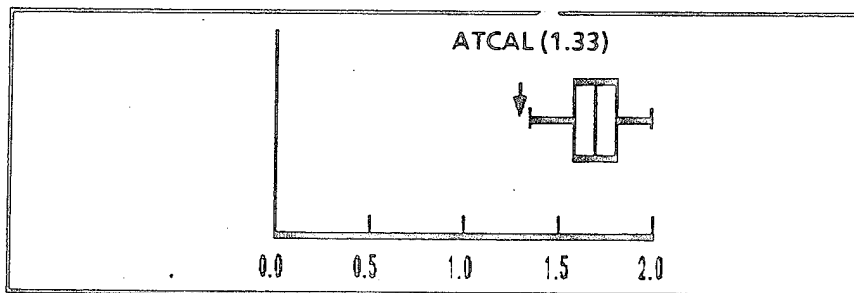

Figure 5-12. Force Exchange Ratio, 1.5:1 Force Ratio

(b) Note that in Figures 5-11 and 5-12, the ATCAL extrapolation is closer to the COSAGE range of values than any of the previous box plots. This is because LERs and FERs take into account the many-on-many situation and therefore can appear to be a better fit even though each individual system was not. One must recall that because of space limitations, only a few systems are illustrated in this report at the one-on-one, SER level. ATVAL does show box and whisker plots for the major system SERs: M1A1s, Bradley fighting vehicles, and specific Red tanks.

(6) 3:1 Force Ratio Test. Because all ATCAL values fell within the same distribution as COSAGE, no further analysis is shown here.

(7) 7:1 Force Ratio Test. This examination showed the opposite of the 1.5:1 force ratio case. M1A1 shots and kills exceeded those of the COSAGE distribution, but SER, LER, and FER fell within the distribution (Figures 5-13 through 5-17). (Although the actual whiskers do not include the ATCAL, the outside points do include ATCAL values.)

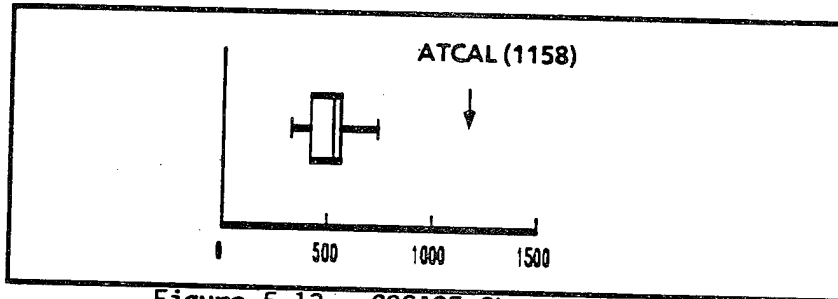

Figure 5-13. COSAGE Shots by M1A1,
7.0:1 Force Ratio

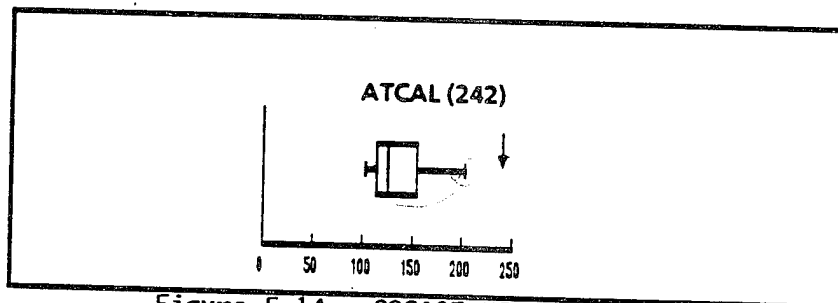

Figure 5-14. COSAGE Kills by M1A1,
7.0:1 Force Ratio

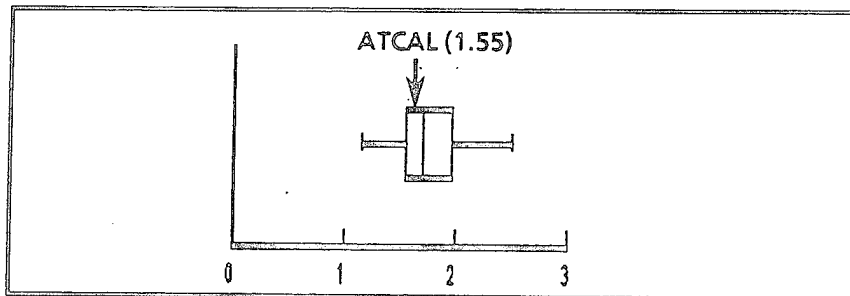

Figure 5-15. System Exchange Ratio for M1A1,
7.0:1 Force Ratio

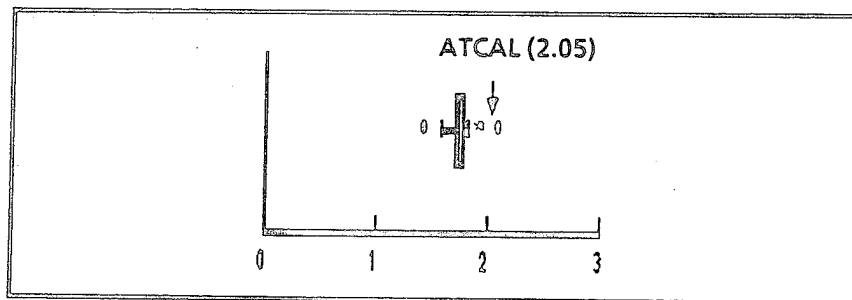

Figure 5-16. Loss Exchange Ratio,
7.0:1 Force Ratio

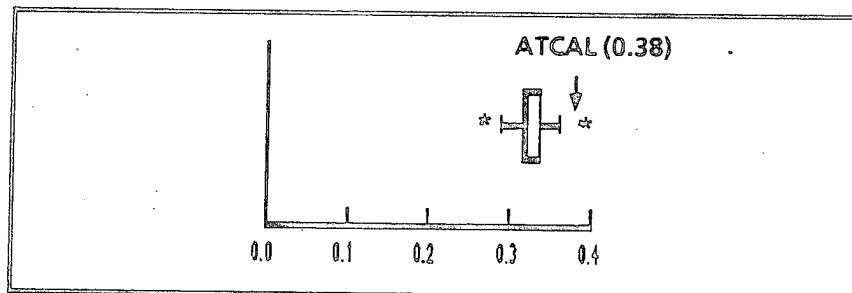

Figure 5-17. Fractional Exchange Ratio
7.0:1 Force Ratio

(a) Additional testing at higher force ratios reveals the same trends as outlined above; i.e., higher battle intensities for ATCAL than COSAGE and higher ATCAL values on the LER and FER box plots. This implies that ATCAL needs more samples closer to the one being assessed at theater level to get closer to the shots/kills produced by COSAGE.

(b) Overall, this experiment reveals that ATCAL would do a better job if only there were more combat samples present from which to extrapolate. This study illustrates the basic groupings of force ratios that CEM handles. Why not simply create more samples for these "extra" force ratios? Traditionally, the answer to this question has always been one of limited resources to produce the additional combat samples. However, experienced combat sample analysts, combat sample automation, and faster hardware to run test and production replications can make more samples possible.

5-2. ATCAL EXTRAPOLATION FOR FORCE SIZE

a. Chapter 4, paragraph 4-4c, outlined the procedure for testing ATCAL's extrapolation for force size. Recall that force size testing is one in which division versus brigade-sized calibrations are analyzed. Table 5-1 presents Blue and Red shooters from both ATCAL and COSAGE perspectives.

Table 5-1. Percent Differences of Direct Fire
Ammo Expenditures

Shooter	ATCAL Shots from M1 brigade	COSAGE shots from M1 brigade	Percent differences
M1A1	-----	-----	-----
M1	641	848	24.4
M60A3	-----	-----	-----
M21FV	128	135	5.2
ITV	90	131	31.2
AH64	91	159	42.8
AH1	22	37	40.5
Subtotal	972	1310	25.8
FST	220	319	31.0
T80	285	370	22.9
T72	167	441	62.1
BMP/AT-3	72	96	25.0
BMP/AT-5	165	321	48.6
HNDE	36	46	21.7
Subtotal	945	1,593	40.7
Grand total	1,917	2,903	34.0
	Based on a single value	Based on an ave- rage value from 16 replications	

b. Subtotal differences are substantial between the two methods: 25.8 percent versus 40.7 percent. The grand total is also very high. Therefore, this examination does not bode well for the ability of ATCAL to extrapolate for force size. However, as before, let us now examine the range of values produced by the numerous tactical simulation replications. Figures 5-18 through 5-20 represent the box and whisker analysis from the M1 shooter versus all targets. Insofar as the M1 tank is concerned, ATCAL does fit nicely within all three shot, kill, and system exchange distributions from COSAGE.

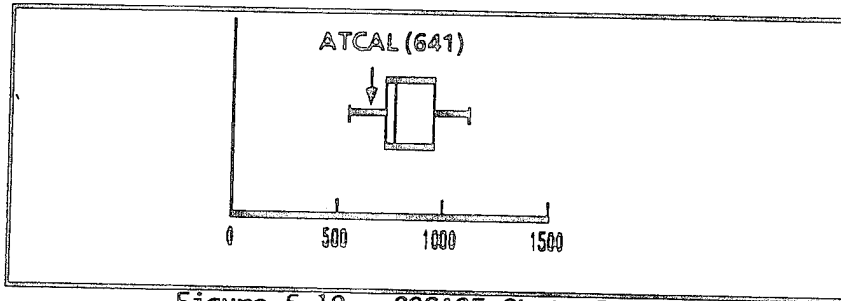

Figure 5-18. COSAGE Shots By M1 Brigade Level

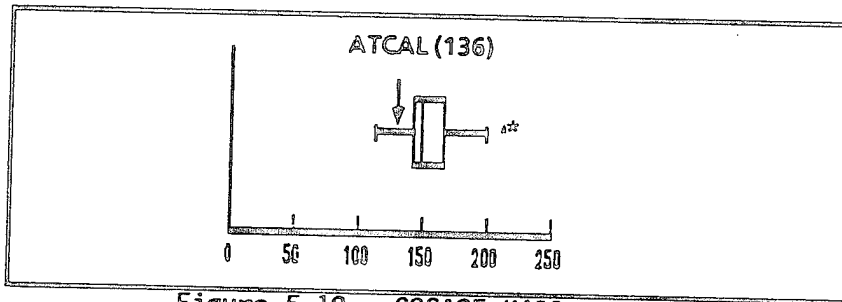

Figure 5-19. COSAGE Kills By M1 Brigade Level

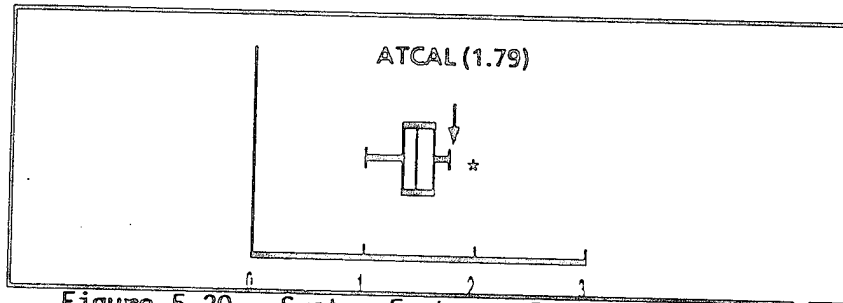

Figure 5-20. System Exchange Ratio For M1 Tank Brigade Level

c. Figures 5-21 and 5-22 show the LER and the FER, respectively. However, LER and FER look at all systems and not just the M1 tank. These figures show a mixed review between ATCAL and COSAGE.

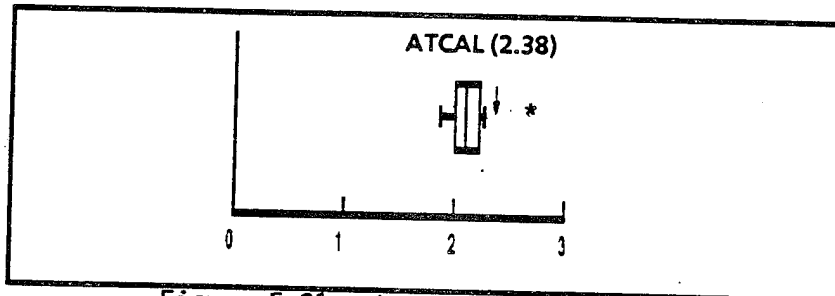

Figure 5-21. Loss Exchange Ratio for M1 Brigade

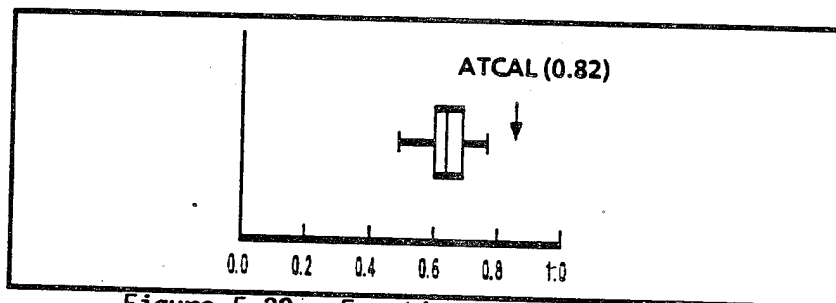

Figure 5-22. Fractional Exchange Ratio for M1 Brigade

d. In summary, it can be said that ATCAL, as employed in its current process, given the calibration parameters which it must use, is mixed in its ability to extrapolate to substantially different force sizes. Sometimes the extrapolation is close to COSAGE, while at other times, it is not.

5-3. ATCAL EXTRAPOLATION FOR FORCE FRONTAGE. Force frontage is in many ways related to other topics mentioned within this study report. It is discussed as a separate topic because of the unique way in which ATCAL modifies target availabilities (see paragraph 4-5, Chapter 4).

a. It is known that the extreme sensitivities involved with the current method for computing target availabilities at close ranges is not realistic. Furthermore, as a correction, steps have been taken to guarantee lower target availability via the calibration phase of the ATCAL process.

b. Currently, a number of alternatives are being researched to address this problem. One such example of ongoing adjudication lies within the so-called "Howard Equations." This acronym comes from a paper written by MAJ Joseph Howard in 1983. It is being evaluated to ascertain its usefulness as an alternate method for the modification of COSAGE-computed target availabilities. Inasmuch as ATVAL Phase II will include this topic, the treatise of this subject terminates here.

(¹) However, it is important to underscore the importance of the target availability transformation process. Certainly, as discussed in Chapter 3, brigade-sized samples help by initially making a closer fit to the battles which occur in CEM. To illustrate this point, Figures 5-23 and 5-24 show the number of CEM battles as a function of theater subsector width (battle frontage) and force ratio. Notice that the predominant number of battles occurs at force ratios less than 3:1 and within 1 to 10 kilometers of front.

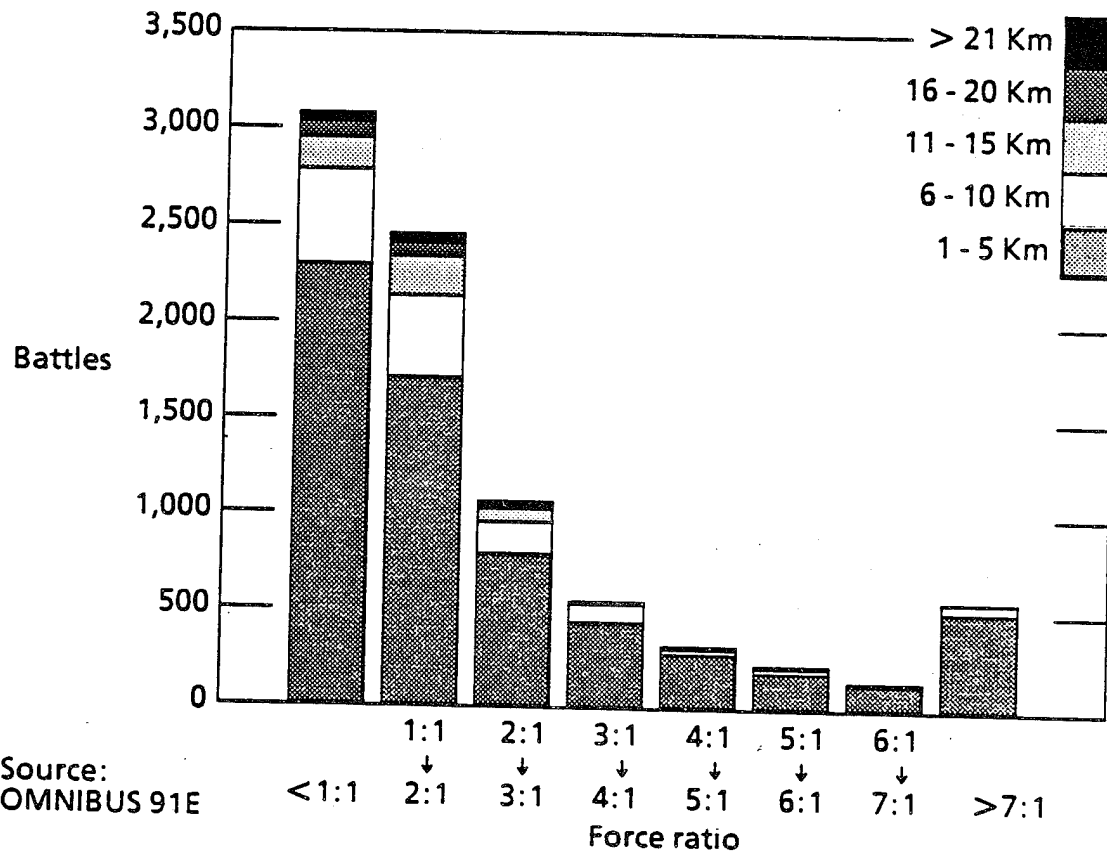

Figure 5-23. Theater Model, Battles by Force Ratio and Km Frontage (all postures)

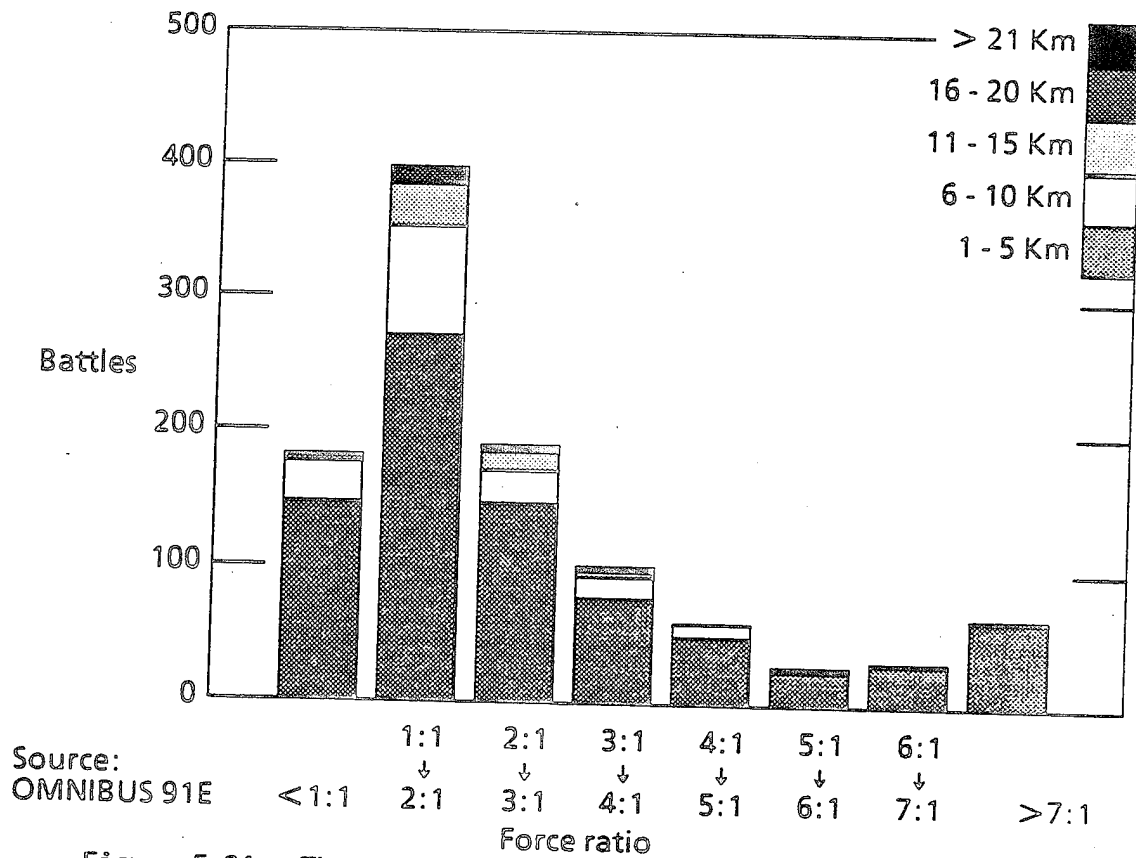

Figure 5-24. Theater Model Battles by Force Ratio and Km Frontage (defense intense)

(2) Examining the problem from the force size point of view shows the same result; many battlefield vehicles engaging each other between the ranges of 1 to 10 kilometers of front. Figures 5-25 and 5-26 are derived from theater subsector engagements and also illustrate the magnitude of the frontage extrapolation calculation. (The area within the dotted lines shows the area of interest where most of the CEM assessments occur.)

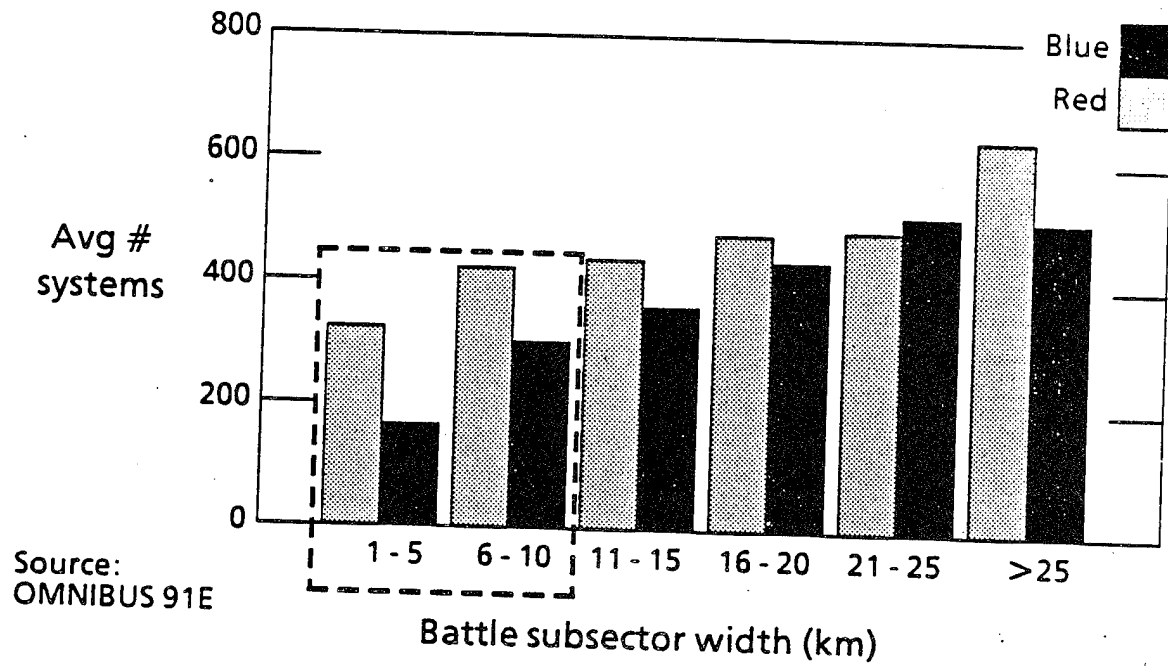

Figure 5-25. Theater Model, Equipment/Km Frontage (all postures)

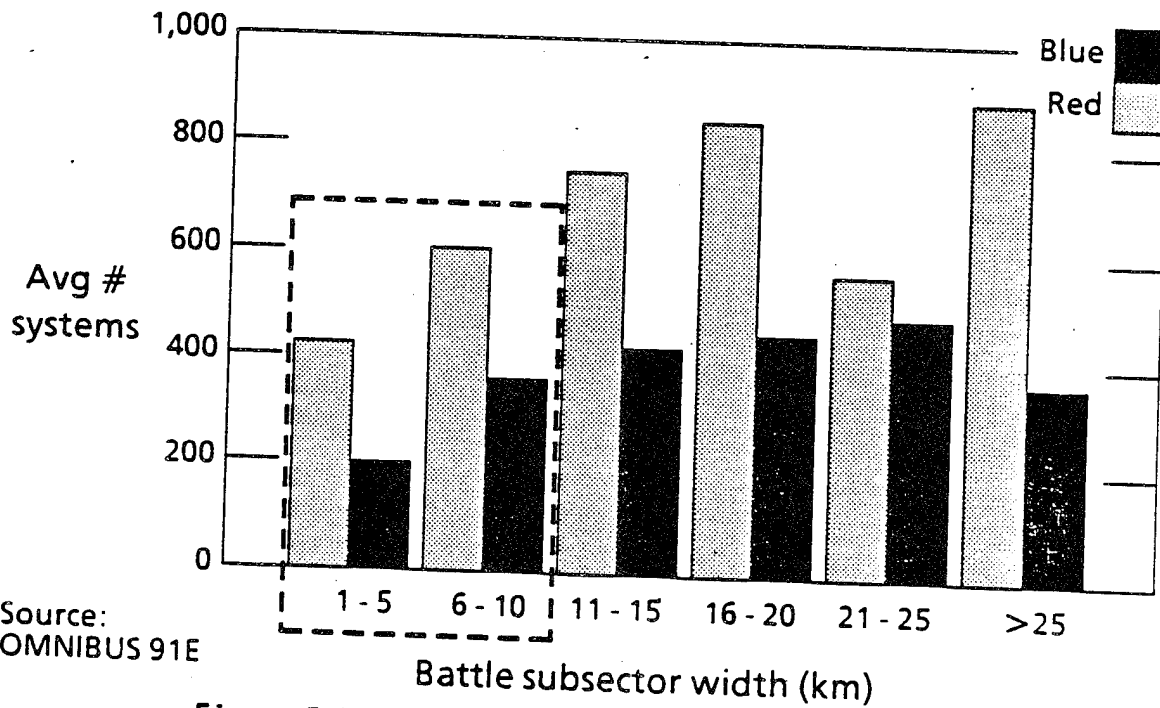

Figure 5-26. Theater Model, Equipment/Km Frontage (defense intense)

(3) These figures also show the crossover effect that frontage plays on the number of systems involved (see paragraphs 4-4 and 5-3). Currently, the Howard Equations and smaller brigade-sized samples hold much promise in providing a long-term, rigorous solution to this class of problem. ATVAL II can also continue to provide insight for alternatives in this arena.

5-3. ATCAL EXTRAPOLATION FOR FORCE COMPOSITION. Recall that the extrapolation for force composition involves all the types of vehicles within the calibrated sample and the subset of those vehicles requested by the theater model (thus not using all of the types that were calibrated). Again, just as was done for size extrapolation, COSAGE and Standalone ATCAL were run for various comparisons.

a. This experiment was performed at two levels. The first level involved single replacement of vehicles whereas the second level involved double replacement. Figures 5-27 through 5-41 show single replacement for vehicles such as the Bradley fighting vehicle, the M1A1 main battle tank, and the T80 main battle tank. The Bradley was run as the only type of infantry fighting vehicle in COSAGE. For comparison, Standalone ATCAL was run using the full calibration, having all of the Blue infantry fighting vehicles (i.e., Bradley, ITVs, HMMWVs) in the mix. The following figures show that ATCAL matches up very well for the single replacement Bradley.

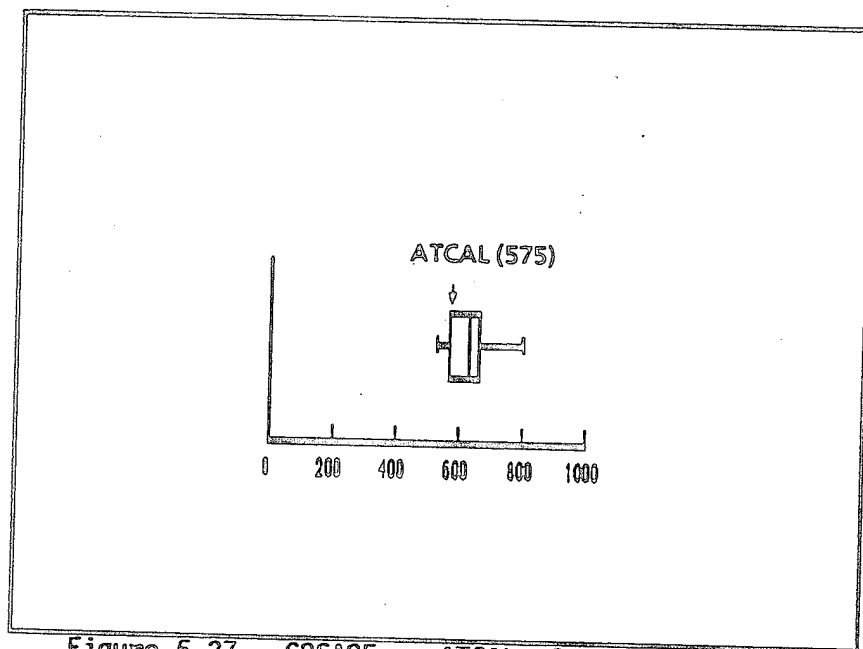

Figure 5-27. COSAGE vs ATCAL, Shots by Bradley Fighting Vehicles

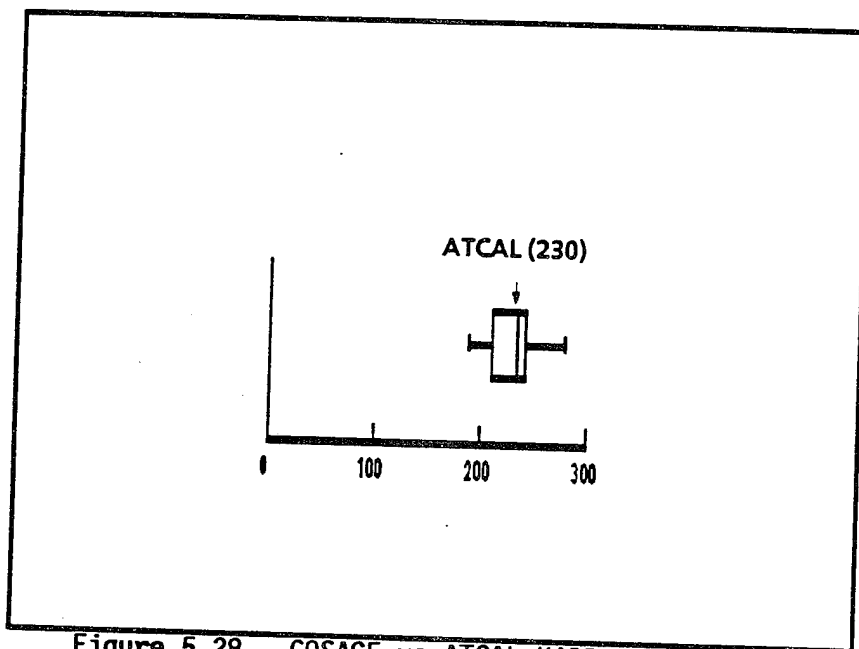

Figure 5-28. COSAGE vs ATCAL Kills by Bradley Fighting Vehicles

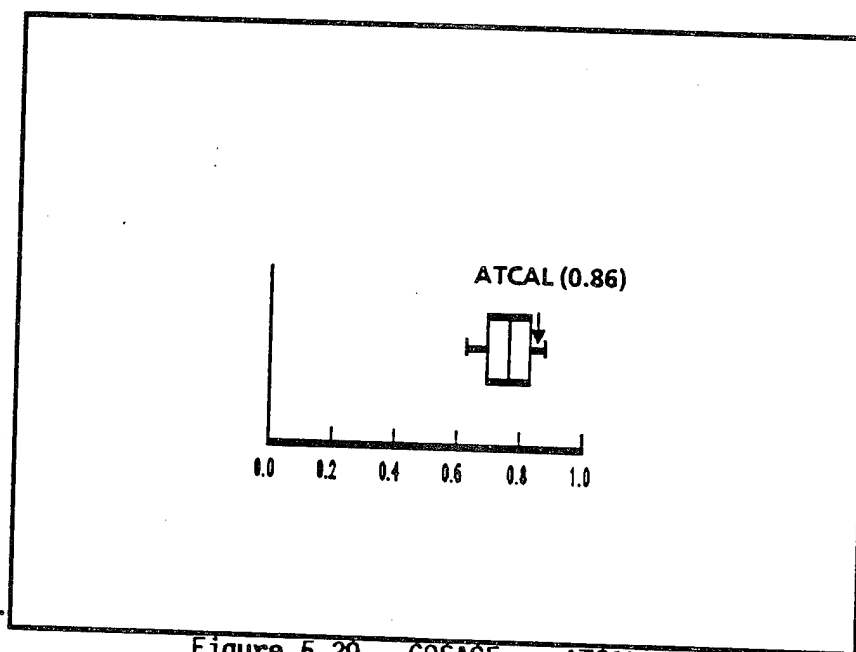

Figure 5-29. COSAGE vs ATCAL, SER for Bradley Division

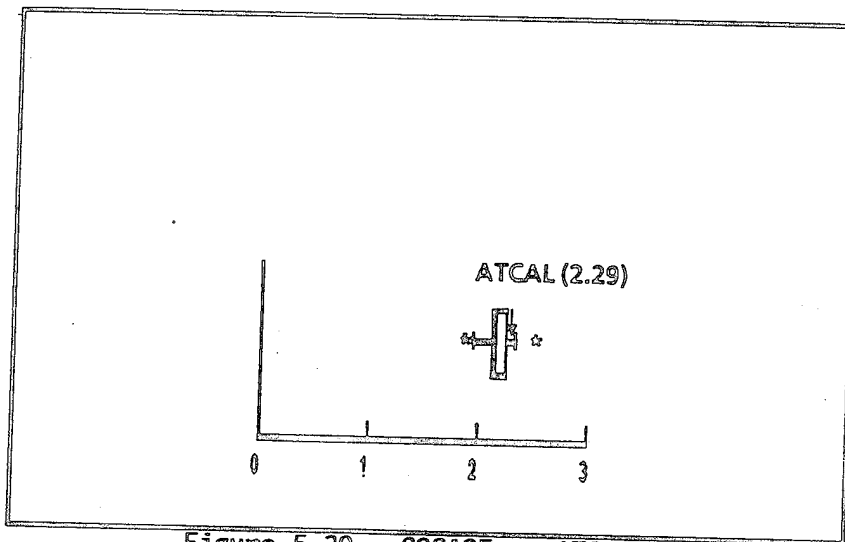

Figure 5-30. COSAGE vs ATCAL,
LER for Bradley Division.

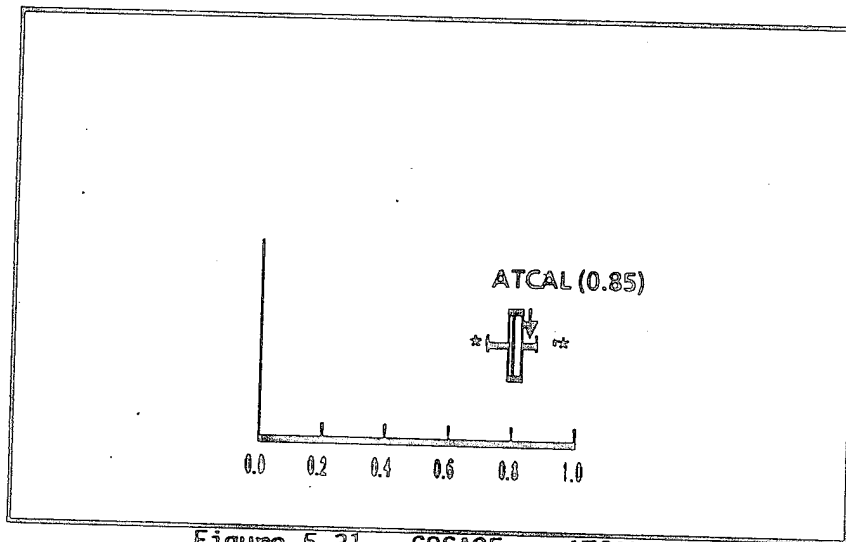

Figure 5-31. COSAGE vs ATCAL,
FER for Bradley Division

b. Figures 5-32 through 5-36 show that ATCAL performs very well for single replacement of MIAIs. In other words, the MIAI was run as the only Blue tank type in COSAGE comparison runs. It was then compared to ATCAL having been run with a calibration of all Blue tank types within the sample.

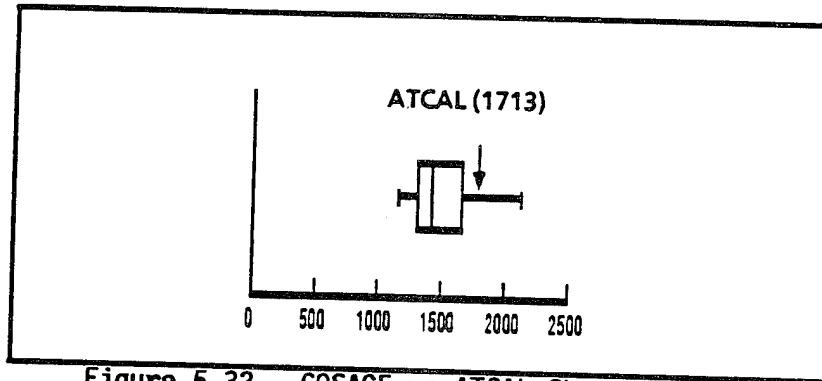

Figure 5-32. COSAGE vs ATCAL Shots by MIA1

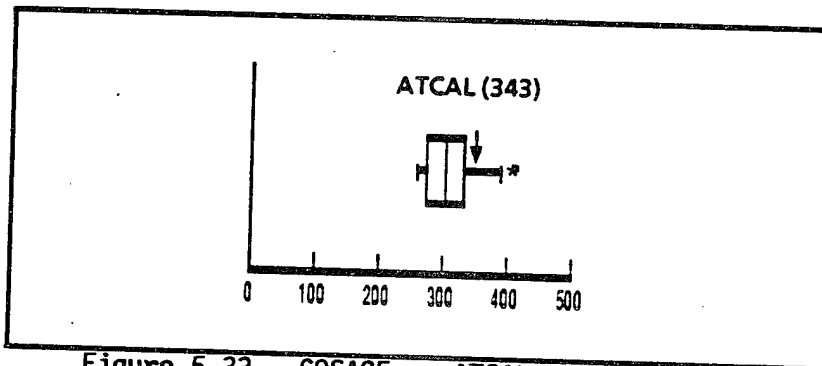

Figure 5-33. COSAGE vs ATCAL Kills by MIA1

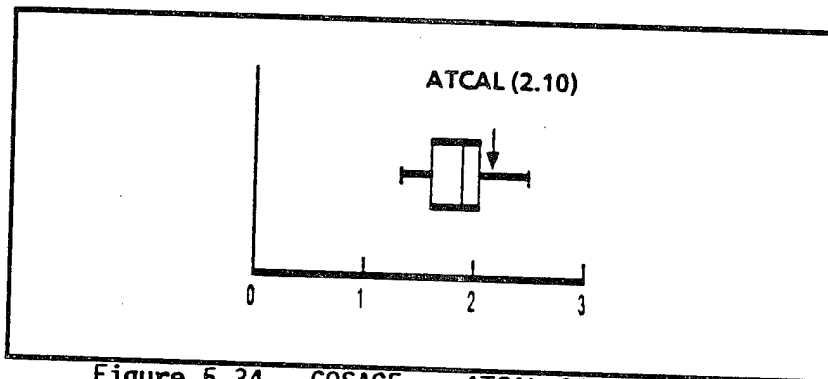

Figure 5-34. COSAGE vs ATCAL SER for MIA1

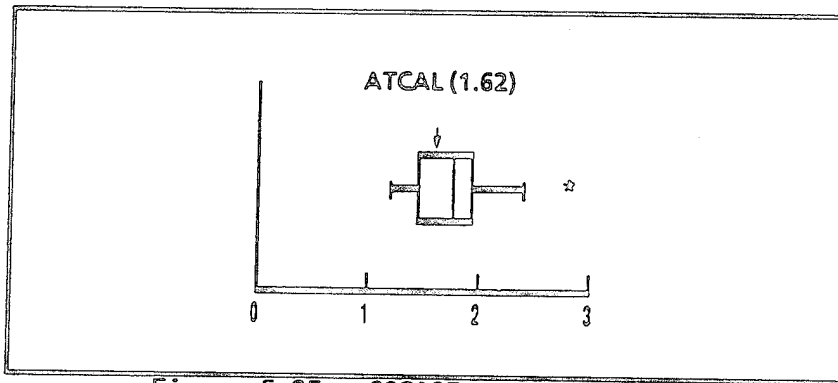

Figure 5-35. COSAGE vs ATCAL, LER for M1A1 Division

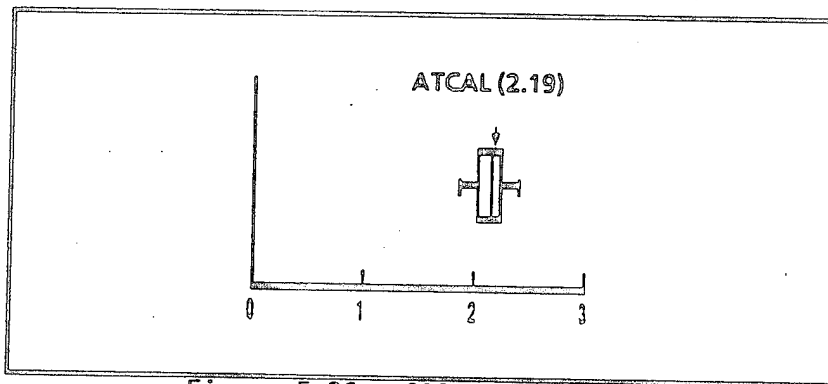

Figure 5-36. COSAGE vs ATCAL, FER for M1A1 Division

c. Single replacement of the T80 main battle tank looked just as favorable as for the above M1A1. Figures 5-37 through 5-41 illustrate this point.

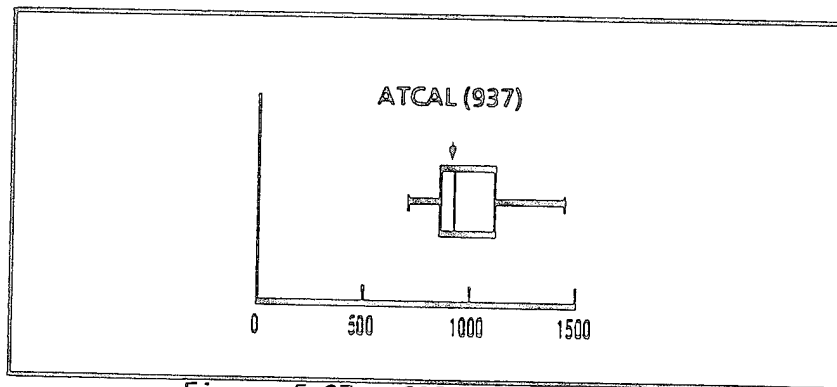

Figure 5-37. COSAGE vs ATCAL, Shots by T80

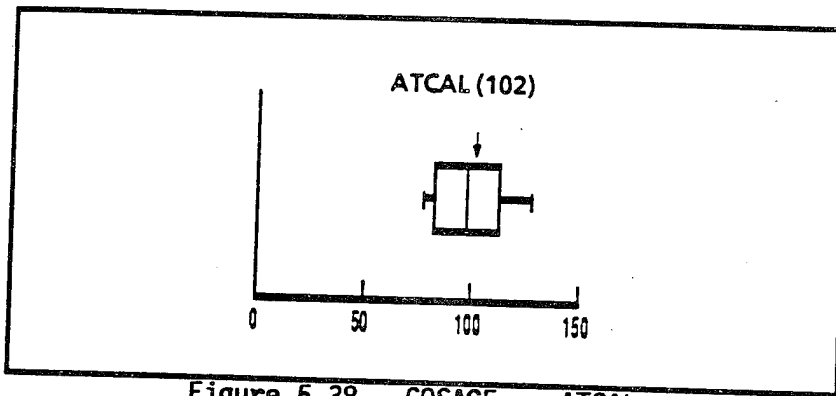

Figure 5-38. COSAGE vs ATCAL, Kills by T80

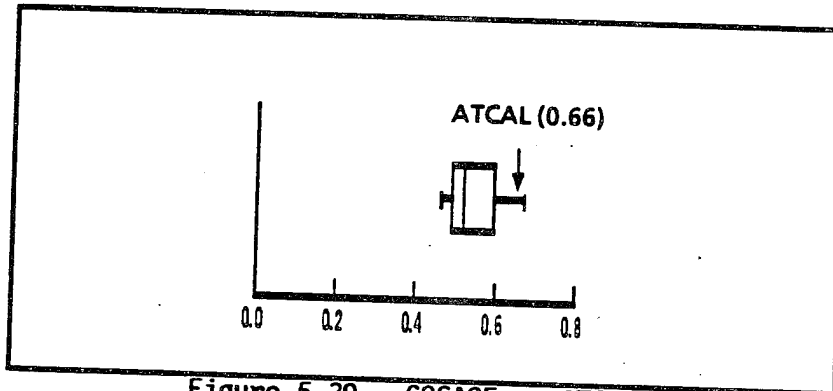

Figure 5-39. COSAGE vs ATCAL, SER for T80

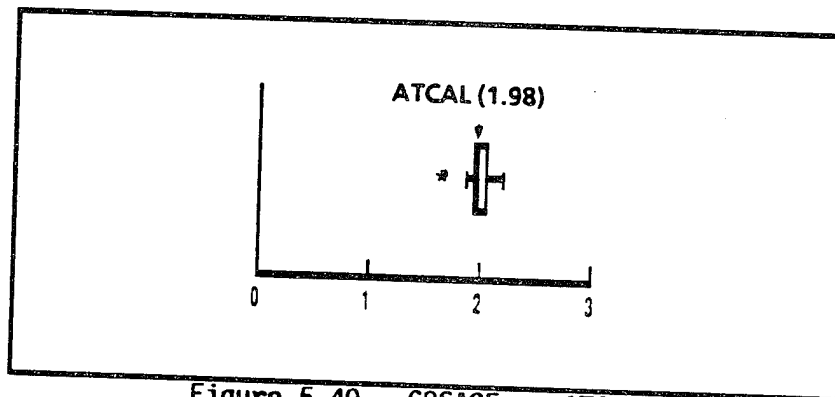

Figure 5-40. COSAGE vs ATCAL, LER for T80 Division

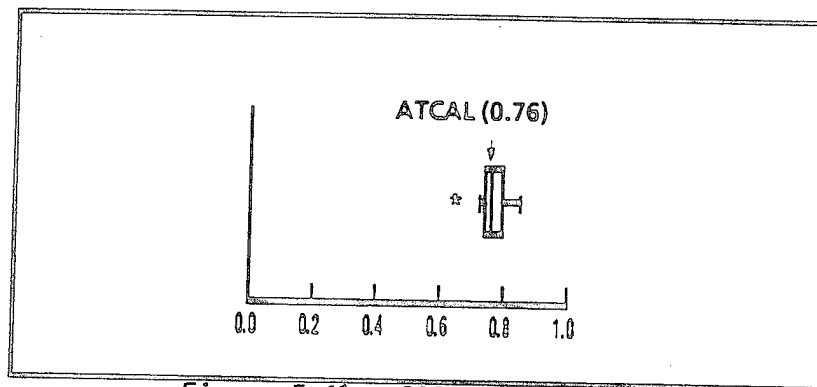

Figure 5-41. COSAGE vs ATCAL,
FER for T80 Division

d. The second level of replacement involved the T72 and M1 as the two tanks being replaced; hence the name, double replacement. Of course, as usual, the ATCAL value was run using the calibration with all tanks within the sample. Again, ATCAL is being compared as having been executed with all types of tanks involved in the calibration, to COSAGE with T72s and M1s as the only tanks having been gamed. Figures 5-42 through 5-46 again show good agreement between COSAGE and ATCAL at the two-replacement level.

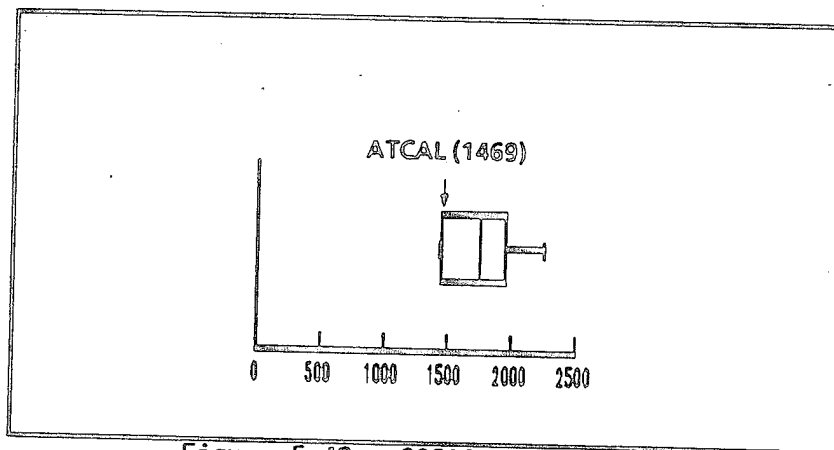

Figure 5-42. COSAGE vs ATCAL,
Shots by T72 (M1 replacement also)

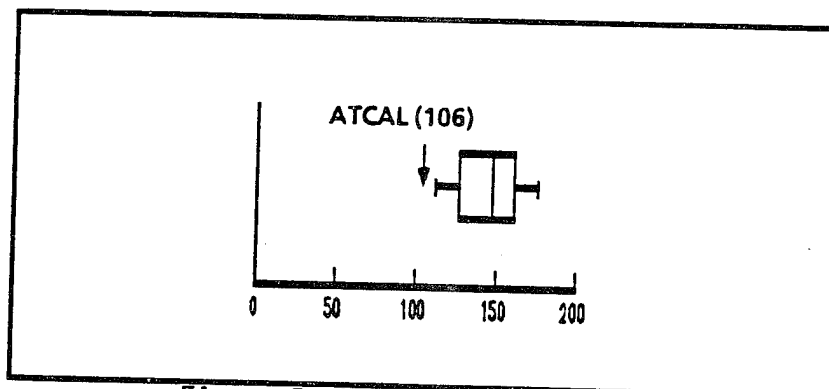

Figure 5-43. COSAGE vs ATCAL, Kills by T72 (M1 replacement also)

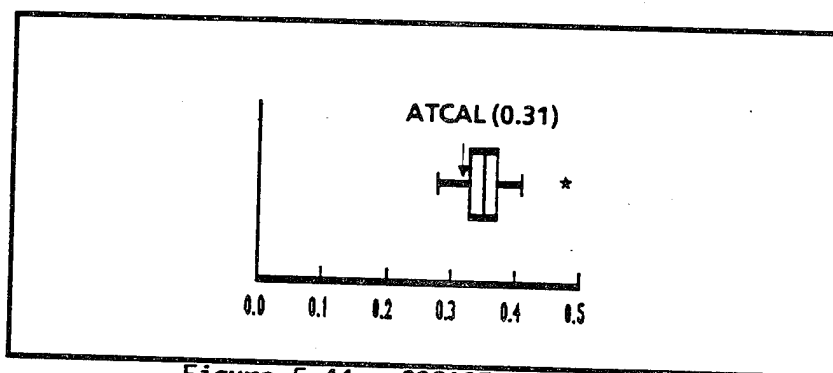

Figure 5-44. COSAGE vs ATCAL, SER for T72 (M1 replacement also)

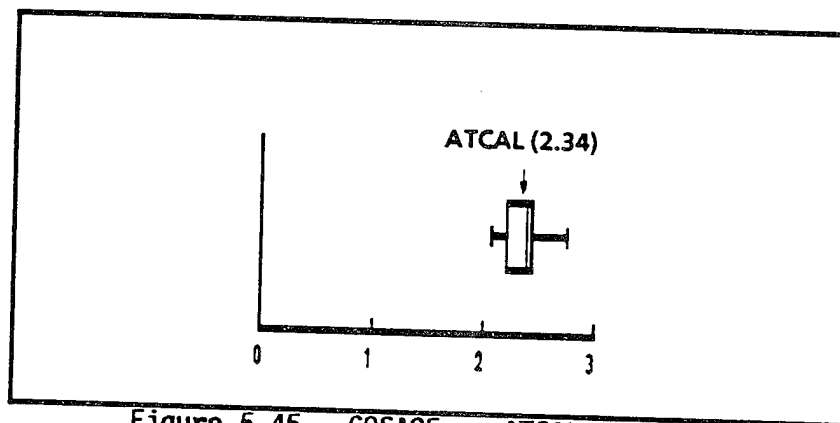

Figure 5-45. COSAGE vs ATCAL, LER for T72 Division (M1 replacement also)

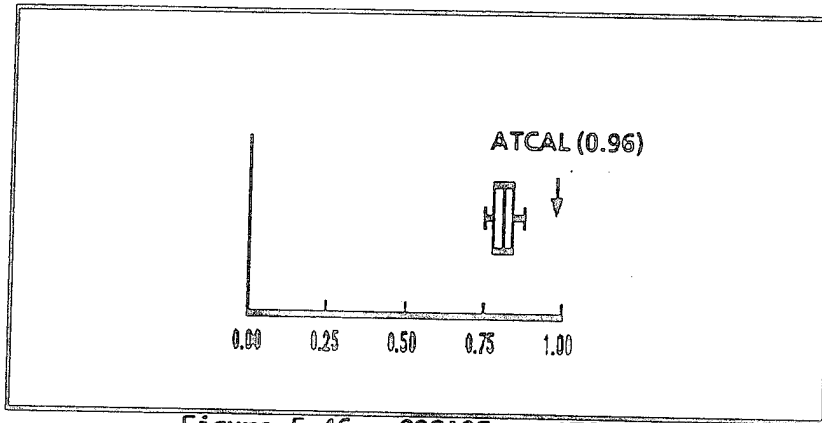

Figure 5-46. COSAGE vs ATCAL,
FER for T72 Division (M1 replacemnt also)

CHAPTER 6

OBSERVATIONS

During the course of this study, the ATCAL methodology and the ATCAL process were tested to illustrate both topics. This will have long range benefits both to users of ATCAL and to students of the ATCAL equations. It is quite possible that the tests devised within this experiment were too difficult for any single algorithm to endure. After all, the problem which ATCAL attempts to solve is indeed a difficult one. It might be too much to ask any single algorithm to take on the enormous task of computing theater level attrition starting from the confines of a few combat samples. However, ATCAL, in practice, is doing just that. Its performance in meeting this challenge forms the basis for the following observations:

a. This report recognizes that the ATCAL algorithm needs to be addressed in two areas: indirect fire and target availability transformations. Indirect fire will be dealt with in more detail within the follow-on ATVAL II study effort. The transformation issue involving the force frontage problem can be addressed by either the "Howard Equations" or by further research into target availability.

b. A tertiary issue worth mentioning is that during the process to download the ATCAL methodology to the personal computer, a number of code anomalies were recorded and forwarded to the appropriate model librarians. These "bugs" were found to give misleading output mainly in the area of indirect fire issues.

c. Another forum in which the ATCAL process is critically examined is in the area of process inputs. The ATCAL methodology relies heavily upon the combat samples used as calibration inputs or starting values for the iterative ATCAL methodology. The following discussion addresses the issue of appropriate inputs for extrapolation to theater force composition, force size, and force ratio.

(1) **Force Composition.** ATCAL does well in the area of force composition extrapolation and therefore needs no further discussion.

(2) **Force Size.** ATCAL approximations of shots and kills are closer to the tactical simulation when a brigade sized force is employed as the calibration instrument. This is because the brigade calibration (instead of division) is much closer in weapon system densities to the size of the CEM forces for which it is extrapolating.

(3) **Force Ratio.** ATCAL does not do a good job at extrapolating much beyond the limits of the force ratio of the calibrated sample. However, as seen in Chapter 5, ATCAL is called on to frequently extrapolate beyond the force ratio of the calibrated samples. Smaller-sized combat samples and more combat samples are definitely part of the solution to the extrapolation problem. However, building more samples will require an investment in computer technology which will better support this requirement. Current CAA computing capability will not suffice. Smaller sized samples will also require a retooling of the way in which combat samples are currently built

and utilized. For example, firer/target interactions provide the basic building blocks for the current ATCAL process. Smaller samples, on the other hand, will make it harder to achieve both the number and types of interactions needed. Therefore, some interactions will probably have to be manufactured offline.

d. Recommendations for this report are as follows.

(1) Indirect Fire and Force Frontage. This report suggests that research be continued into the indirect fire and force frontage areas of the ATCAL methodology. ATVAL II, indirect fire, and the "Howard Equations" for force frontage are appropriate beginnings in this endeavor.

(2) Force Size. Smaller-sized combat samples should be built for better extrapolation to force sizes expected at theater level. A research effort to measure this difference in calibration techniques is under way.

(3) Force Ratio. More combat samples should be built for better extrapolation to force ratios expected at theater level. This will also necessitate modifications to the theater model in order to accommodate the additional number of generated samples.

e. In conclusion, the ATCAL process and methodology are becoming better understood. It is hoped that this paper will serve as a guideline on how the ATCAL process works and how it can be improved. The continuing evaluation of the analytical tools used at CAA is often difficult to do because of other, more pressing issues. However, a continuing evaluation of the ATCAL process and methodology should be a high-priority effort because of ATCAL's strong impact on Army theater-level analysis.

APPENDIX A
STUDY CONTRIBUTORS

1. STUDY TEAM

a. Study Director

Hugh W. Jones, Forces Directorate

b. Team Members

LTC Jeanette Harris
Ms. Ann Michel
Mr. Craig Wilson

c. Other Contributors

Mr. R. Glenn Stockton
Mr. Richard Cobb
Mr. William T. Allison
Mr. Ron Bonniwell
MAJ Kenneth Wimmer
CPT Mike Rizzio

2. PRODUCT REVIEW BOARD

Mr. Ronald J. Iekel, Chairman
MAJ William Hudson Webb
Dr. Diego Roque

APPENDIX B
STUDY DIRECTIVE



REPLY TO
ATTENTION OF:

DEPARTMENT OF THE ARMY
US ARMY CONCEPTS ANALYSIS AGENCY
8120 WOODMONT AVENUE
BETHESDA, MARYLAND 20814-2797



CSCA-FOT/TAC

MEMORANDUM FOR ASSISTANT DIRECTOR, REQUIREMENTS DIRECTORATE

SUBJECT: Study Directive - ATCAL Evaluation (ATVAL)

1. **PURPOSE.** This directive provides guidance for the Division Operations Center to study and test the Attrition Calibration Model (ATCAL) as it pertains to the Combat Sample Generator (COSAGE) and the Concepts Evaluation Model (CEM).
2. **BACKGROUND.** CAA depends heavily upon ATCAL results for many CAA studies having a wide-ranging impact on Army programs. ATCAL is the attrition algorithm which, when calibrated by division level results, is used within the theater model to extrapolate for attrition levels given varying force ratios.
3. **STUDY PROPONENT.** Director, U.S. Army Concepts Analysis Agency.
4. **STUDY AGENCY.** Division Operations Center, Requirements Directorate.
5. **TERMS OF REFERENCE**
 - a. **Objectives.** Study ATCAL to learn its algorithms and hence, its limitations. Examine how appropriate the standard division samples are treated within the ATCAL context. Test ATCAL's ability to extrapolate to varying CEM force structure. Determine if alternative methods in lieu of combat samples can be developed which can also meaningfully drive the ATCAL process.
 - b. **Scope.** This study will encompass the entire CAA hierarchy of combat models (COSAGE, CEM and/or FORCEM). Existing OMNIBUS '91 combat sample and CEM/FORCEM runs and data will be used. Additional combat samples and CEM/FORCEM runs will be produced to test ATCAL extrapolation with different force ratios than those which currently exist in division samples. The scope will also include the range of combat activities incumbent with the study of these models.

CSCA-FOT/TAC

SUBJECT: Study Directive - ATCAL Evaluation (ATVAL)

c. Miscellaneous. Detail any processes which may prove to be alternatives to ATCAL. Additionally, outline any improvements and/or corrections to ATCAL that are determined to be of use.

6. RESPONSIBILITIES

a. Requirements Directorate (RQ):

- (1) Conduct the analysis.
- (2) Prepare and execute brigade combat samples.
- (3) Provide the study proponent with informal progress reports and emerging results.
- (4) Provide, as a final report, an analysis of the items as found in paragraph (5) above.

b. Research and Analysis Support Directorate (RS):

- (1) Provide assistance in the areas of running Stand-Alone ATCAL and in running CEM/FORCEM.
- (2) Provide statistical assistance in running an ATCAL killer/victim correlation analysis.

c. Model Validation Directorate (MV):

- (1) Provide general assistance in analyzing CEM/FORCEM outputs via MAPPER and/or other appropriate means.

d. Forces Directorate (FO):

- (1) Provide general consultation assistance as required.
- (2) Run CEM/FORCEM for Brigade Combat Sample experimentation.

7. REFERENCES

- a. AR 5-5, 15 October 1981, subject: The Army Study System.
- b. AR 10-38, 1 February 1981, subject: Organization and Functions, U.S. Army Concepts Analysis Agency
- c. Study Director's Guide, U.S. Army Concepts Analysis Agency, May 1986

CSCA-FOT/TAC
SUBJECT: Study Directive - ATCAL Evaluation (ATVAL)

8. ADMINISTRATION

Milestones:

Study Directive/Study Plan ARB	8 Mar 1990
1st IPR	15 May 1990
Complete COSAGE Runs	31 May 1990
Complete CEM/FORCEM Runs	30 Jun 1990
2nd IPR	7 Aug 1990
Examine Alternative(s) to Combat Samples	15 Aug 1990
Analysis Results ARB	28 Sep 1990
Complete Study Report	26 Oct 1990

9. CONTROL PROCEDURES. CAA Form 59 (Study Scheduling Report) is attached as Encl 1. Both the study directive and study plan (Encl 2) have been coordinated with FO, RS and MV directorates.

2 Encls

/s/
E. B. VANDIVER III
Director

APPENDIX C
BIBLIOGRAPHY

DEPARTMENT OF THE ARMY

Department of the Army Publications

US Army Concepts Analysis Agency (CAA)

ATCAL: An Attrition Model Using Calibrated Parameters, CAA-TP-83-3,
August 1983

Wartime Requirements for Ammunition, Materiel and Personnel (WARRAMP);
Volume V, Combat Sample Generator (COSAGE) User's Manual, CAA-D-81-2, October
1982

Combat Sample Generator (COSAGE) Input Data, CAA-D-87-1, March 1987

Analysis of Barrier Systems Alternatives in Korea for ROK/US (ABAKUS),
CAA-SR-89-22, November 1989

APPENDIX D

EXAMPLE OF CEM DETAIL BATTLE ANALYSIS FROM THE "DETAIL REPORT"

The data description in this appendix details the contents of the CEM output designated as the Detail Report. This data is illustrated because of the importance of theater subsector assessments to the ATCAL process.

Line 1

- Field 1 - division and brigade numerical identifiers
- Field 2 - FRONTF; percent of the brigade within this assessment
- Field 3 - STATE; percent of combat worth available
- Field 4 - ARTY = DS; number of artillery battalions in support of the brigade

Line 2

- Field 1 - CAS; number of Blue close air support squadrons in support of the brigade
- Field 2 - CAV PCT DIV; percent of divisional cavalry assets given to brigade
- Field 3 - CORPS; percent of corps cavalry assets to brigade

Line 3

- Field 1 - CAS; number of Red close air support squadrons in support of the brigade
- Field 2 - CW; Red combat worth of available assets
- Field 3 - EST BLUE CW; Red's estimate of Blue combat worth

Line 4

- Field 1 - WPN TYPE; CEM weapon type as numbered in sequence from the COSAGE → Ralph process
- Field 2 - TUBE TYPE; main or secondary gun
- Field 3 - allowable rate of fire per tube as calibrated by ATCAL, Phase I [X 10 built in except for arty] (measured in rounds per 12-hour time period)
- Field 4 - ON-HAND; available ammo onhand per tube to be fired (measured in rounds per 12-hour time period)
- Field 5 - TOTAL EXPENDED; actual total rounds expended
- Field 6 - ENGAGED; number of weapon types engaging targets
- Field 7 - HIT; number of weapon types hit

Line 5

- Field 1 - FINAL FORCE RATIO; attacker/defender
- Field 2 - combat worth of Red
- Field 3 - combat worth of Blue

Line 6

- Field 1 - ADA FU; fire units per brigade front
- Field 2 - SQDNS LOST THIS SECTOR; ATCAL computed losses to air squadrons

LINE #

- 1) BLUE DIV 20 BDE 60 FRONTF .92 STATE 93 ARTY=DS 2.65 GS= .02
- 2) CAS= 3.12 CAV PCT DIV .33 CORPS= .47
- 3) CAS= 2.34 CW=386.8426 EST BLUE CW= 576

ENGAGEMENT EXPENDITURE/ATTRITION

	BLUE SIDE		AMMO ROUNDS/WPN/TUBE			WEAPONS TOTAL	
	WPN TYPE	TUBE TYPE	ALLOWABLE	ON-HAND	TOTAL EXPENDED	ENGAGED	HIT
4)	1	1	.18	.18	.30	78.32	.01
		2	.00	.00	.00		
	3	1	.47	.47	.00	.00	.00
		2	1.59	1.59	.00	.00	.00
	4	1	.85	.00	.00	.00	.00
	7	1	.00	.00	.00	12.10	.15
	13	1	.57	.57	.31	42.77	.33
		2	.67	.67	.74		
	14	1	.71	.71	.82	36.11	.89
		2	1.33	1.33	1.27		
	15	1	.43	.43	.04	11.00	.01
		2	.05	.05	.02		
	17	1	.29	.29	.09	16.23	.00
		2	.04	.04	.02		
	18	1	4.49	4.49	.62	4.48	.01
		2	2.28	2.28	.28		
	19	1	.00	.00	.00	33.90	.44
		2	.44	.44	.29		
	20	1	.00	.00	.00	.00	.00
		2	1.60	.00	.00		
	21	1	.62	.00	.00	.00	.00
		2	1.91	.00	.00		
	25	1	1.16	1.16	.47	8.80	.00
		2	.06	.06	.00		
	26	1	2.18	2.18	.69	10.51	.07
		2	.47	.47	.09		
	27	1	.53	.53	.02	1.89	.00
		2	.00	.00	.00		

5) FINAL FORCE RATIO .4655 118.9085 255.4537 FEBA MOVEMENT BEFORE ADJUSTMENT 0

RED CAS SQRNS IN DS= 3.55 (WHOLE DIV), LOSS RATE= .0510 BLUE, ADA

6) FU= .000 SQRNS LOST THIS SECTOR= .0134

BLUE CAS SQRNS IN DS= 3.39 (WHOLE BDE), LOSS RATE= 0200 RED ADA FU= .000 SQRNS LOST THIS SECTOR= .0223

BLUE DIV 20 BDE 60 (cont)

ENGAGEMENT EXPENDITURE/ATTRITION

WPN TYPE	BLUE SIDE TUBE TYPE	AMMO ROUNDS/WPN/TUBE			WEAPONS TOTAL	
		ALLOWABLE	ON-HAND	TOTAL EXPENDED	ENGAGED	HIT
28	1	.18	.18	.30	78.32	.01
	2	.00	.00	.00		
30	1	.47	.47	.00	.00	.00
	2	1.59	1.59	.00	.00	.00
31	1	.85	.00	.00	.00	.00
	1	.00	.00	.00	12.10	.15
32	1	.57	.57	.31	42.77	.33
	2	.67	.67	.74		
33	1	.71	.71	.82	36.11	.89
	2	1.33	1.33	1.27		
36	1	.43	.43	.04	11.00	.01
37	2	.05	.05	.02		
	1	.29	.29	.09	16.23	.00
38	2	.04	.04	.02		
	1	4.49	4.49	.62	4.48	.01
40	2	2.28	2.28	.28		
	1	.00	.00	.00	33.90	.44
42	2	.44	.44	.29		
	1	.00	.00	.00	.00	.00
43	2	1.60	.00	.00		
	1	.62	.00	.00	.00	.00
45	2	1.91	.00	.00		
	1	1.16	1.16	.47	8.80	.00
51	2	.06	.06	.00		
		2.18	2.18	.69	10.51	.07

RED DIV 33 FRONTF .66 STATE 88 ARTY=DS 23.20 GS= .00
 RED DIV 33 FRONTF .66 STATE 88 ARTY=DS 23.20 GS= .00
 CAS= 3.12 CAV PCT DIV .33 CORPS= .47
 CAS= 2.34 CW = 386.8426 EST BLUE CW = 576

ENGAGEMENT EXPENDITURE/ATTRITION

WPN TYPE	RED SIDE TUBE TYPE	AMMO ROUNDS/WPN/TUBE			WEAPONS TOTAL	
		ALLOWABLE	ON-HAND	TOTAL EXPENDED	ENGAGED	HIT
1	1	.03	.03	.02	66.09	.30
	2	.14	.14	.15		
3	1	.84	.84	2.50	177.16	.77
	2	1.39	1.39	3.89		
4	1	.00	.00	.00	23.49	.00
	2	.00	.00	.00		
7	1	.00	.00	.00	.00	.00
	2	.00	.00	.00		
13	1	.00	.00	.00	47.53	.32
	2	2.42	2.42	1.56		
14	1	1.40	1.40	1.46	66.70	.97
	2	1.27	1.27	1.26		
15	1	.00	.00	.00	8.69	.04
	2	.00	.00	.00		
17	1	.00	.00	.00	.00	.00
	2	.00	.00	.00		
18	1	.00	.00	.00	.00	.00
	2	.00	.00	.00		
19	1	.00	.00	.00	.00	.00
	2	3.09	.00	.00		
20	1	.00	.00	.00	27.89	.23
	2	.48	.48	.18		
21	1	.00	.00	.00	10.53	.00
	2	.00	.00	.00		
25	1	.49	.00	.00	.00	.00
	2	.00	.00	.00		
26	1	1.92	1.92	.05	1.30	.02
	2	.00	.00	.00		
27	1	3.22	3.22	.03	.47	.01
	2	.00	.00	.00		

FINAL FORCE RATIO .4655 118.9085 255.4537 FEBA MOVEMENT BEFORE ADJUSTMENT
 O RED CAS SQRNS IN DS= 3.55 (WHOLE DIV), LOSS RATE= .0510 BLUE, ADA
 FU= .000 SQRNS LOST THIS SECTOR= .0134
 BLUE CAS SQRNS IN DS= 3.39 (WHOLE BDE), LOSS RATE= 0200 RED ADA FU= .000
 SQRNS LOST THIS SECTOR= .0223

RED DIV 33 FRONTF .66 STATE 88 ARTY=DS 23.20 GS= .00 (Cont)

ENGAGEMENT EXPENDITURE/ATTRITION

WPN TYPE	RED SIDE	ALLOWABLE	AMMO ROUNDS/WPN/TUBE		WEAPONS TOTAL	
	TUBE TYPE		ON-HAND	TOTAL EXPENDED	ENGAGED	HIT
28	1	.00	.00	.00	.00	.00
	2	.00	.00	.00	.00	.00
30	1	.00	.00	.00	29.76	.12
	2	1.35	1.35	1.00		
31	1	.00	.00	.00	11.50	.01
	2	.04	.04	.01		
32	1	.00	.00	.00	.00	.00
	2	.00	.00	.00	.00	.00
33	1	.00	.00	.00	.00	.00
	2	.00	.00	.00	.00	.00
36	1	.00	.00	.00	.00	.00
	2	.00	.00	.00	.00	.00
37	1	5.44	5.44	1.11	15.08	.03
	2	.00	.00	.00		
38	1	6.52	.00	.00	.00	.00
	2	.00	.00	.00	.00	.00
40	1	.25	.00	.00	.00	.00
	2	.00	.00	.00	.00	.00
42	1	.00	.00	.00	781.48	1.81
	2	.66	.66	13.07		
43	1	59.00	59.00	4.35	2.61	.00
	2	.00	.00	.00		
45	1	127.00	85.27	17.80	21.69	.00
	2	41.73	41.73	8.43		
51	1	.00	.00	.00	12.57	.01
	2	28.66	28.66	7.26		

APPENDIX E
BOX AND WHISKER PLOTS

This appendix presents all of the comparison plots between ATCAL and COSAGE done for this study. A brief explanation of the "box and whisker" technique is given on pages 5-7 and 5-8, Chapter 5, of this report.

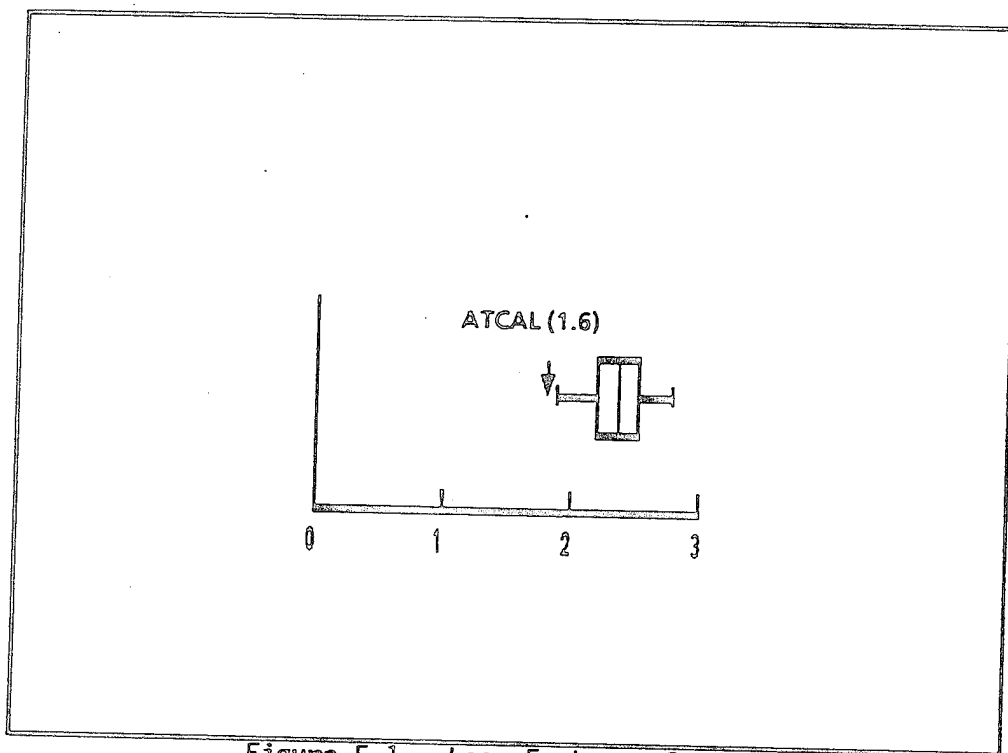

Figure E-1. Loss Exchange Ratio,
1.5:1 Force Ratio

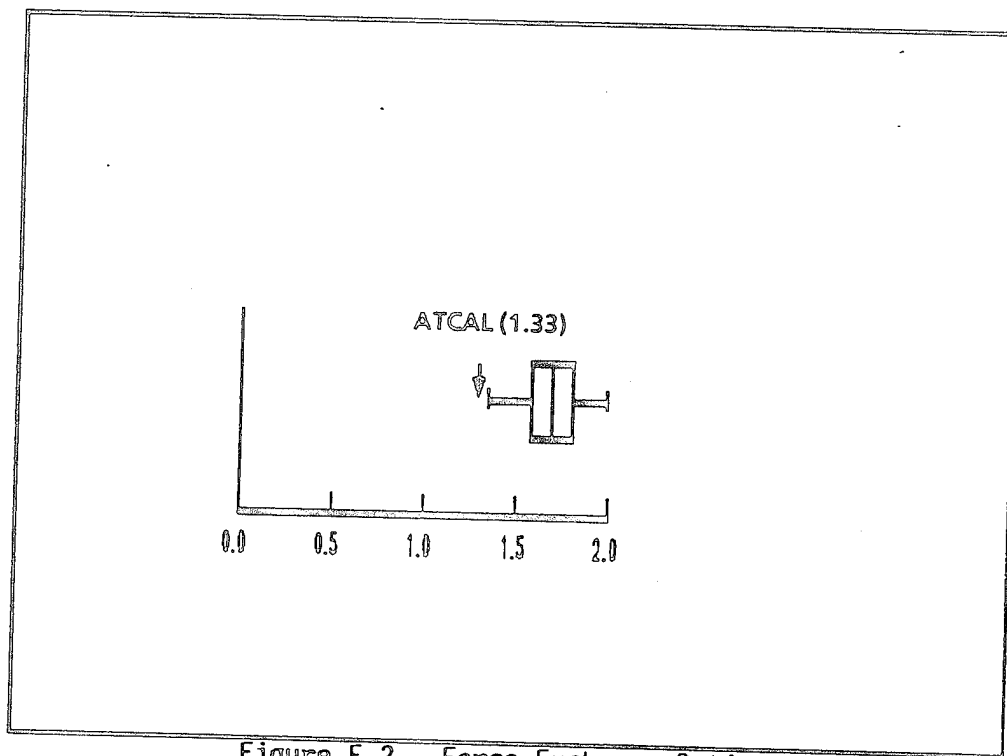

Figure E-2. Force Exchange Ratio,
1.5:1 Force Ratio

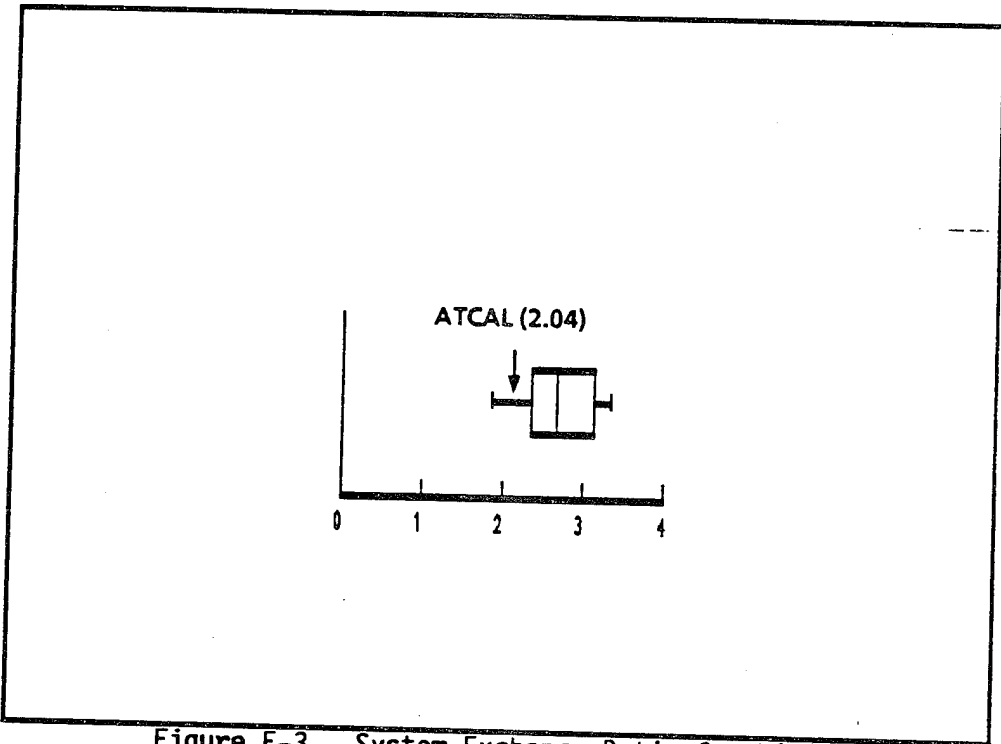

Figure E-3. System Exchange Ratio for MIA1, 1.5:1 Force Ratio

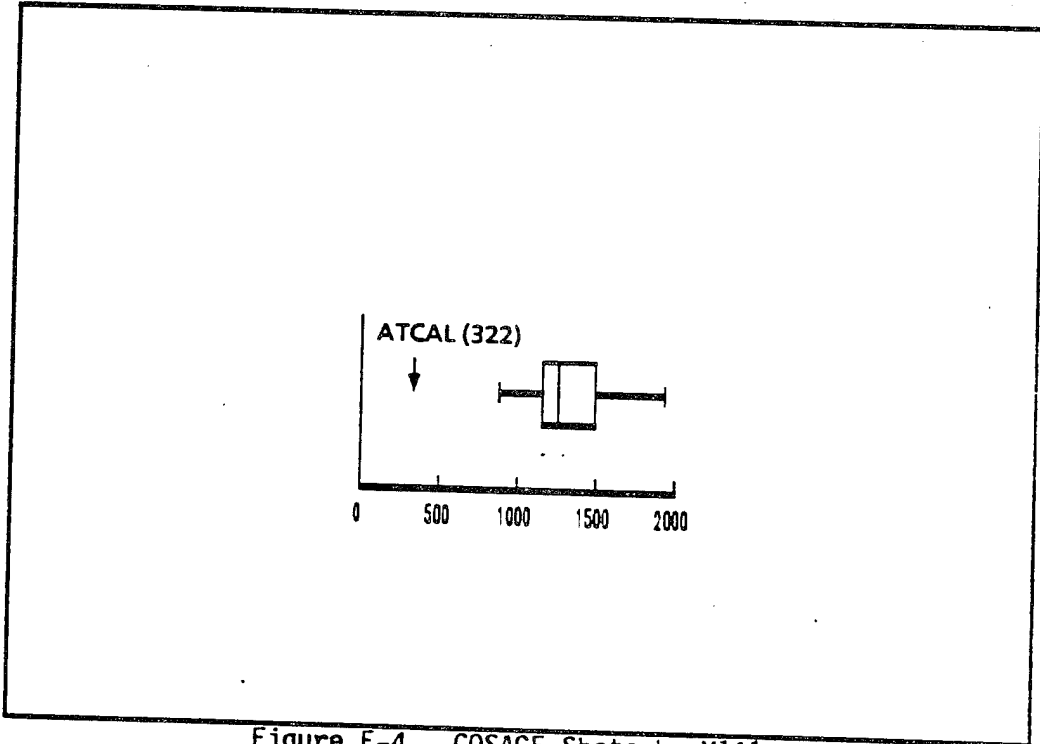

Figure E-4. COSAGE Shots by MIA1, 1.5:1 Force Ratio

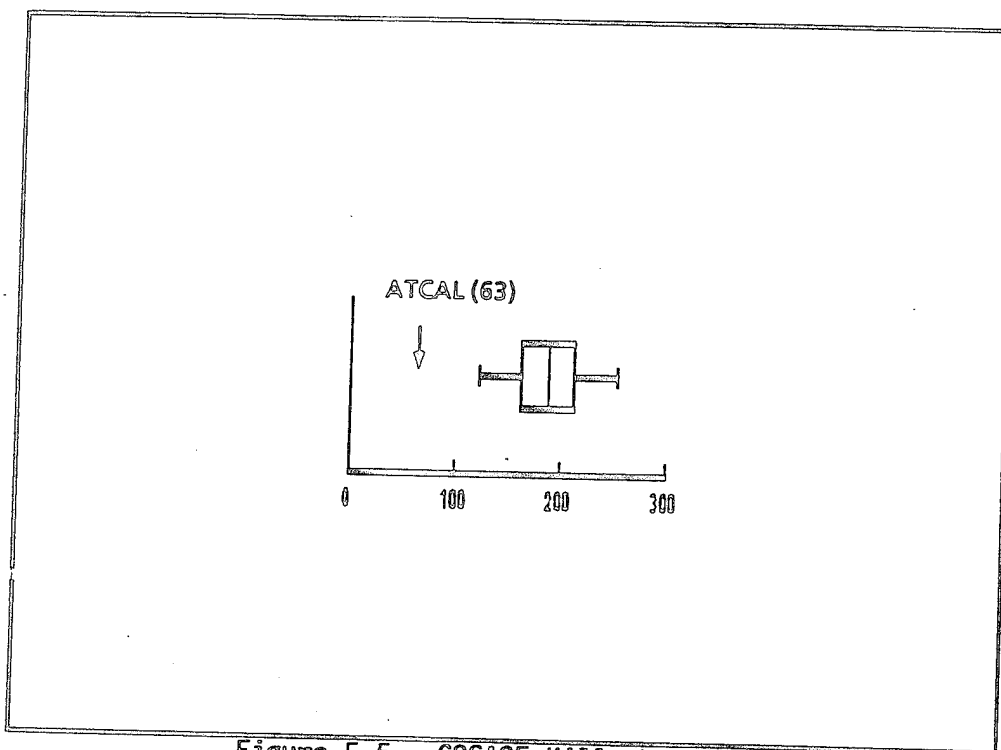

Figure E-5. COSAGE Kills by MIA1,
1.5:1 Force Ratio

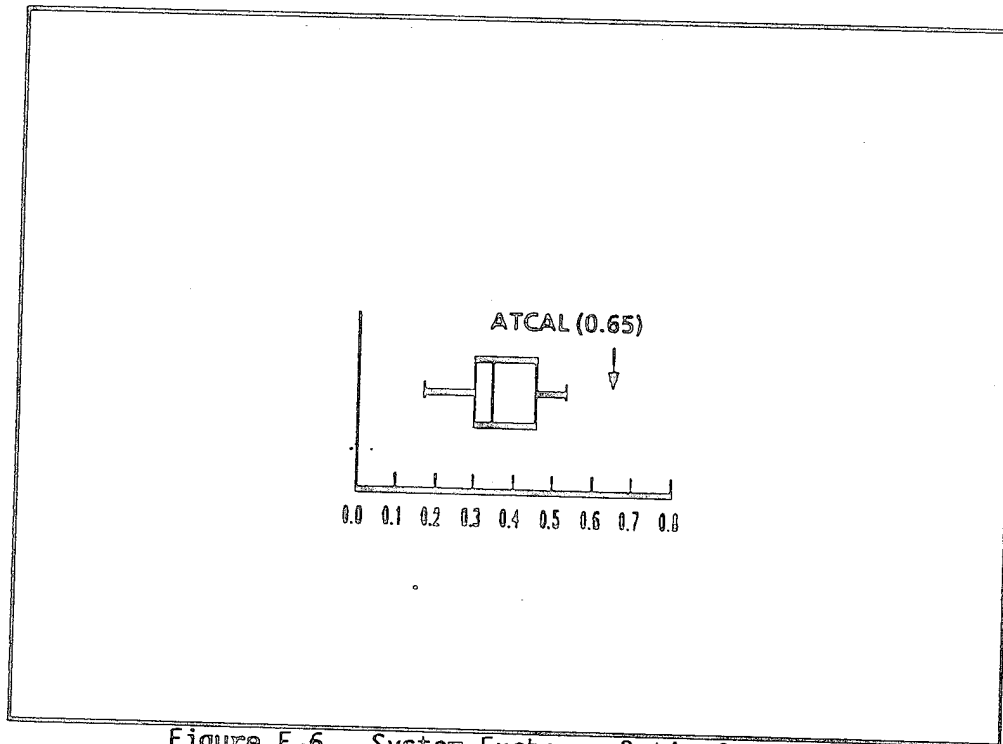

Figure E-6. System Exchange Ratio for T80,
1.5:1 Force Ratio

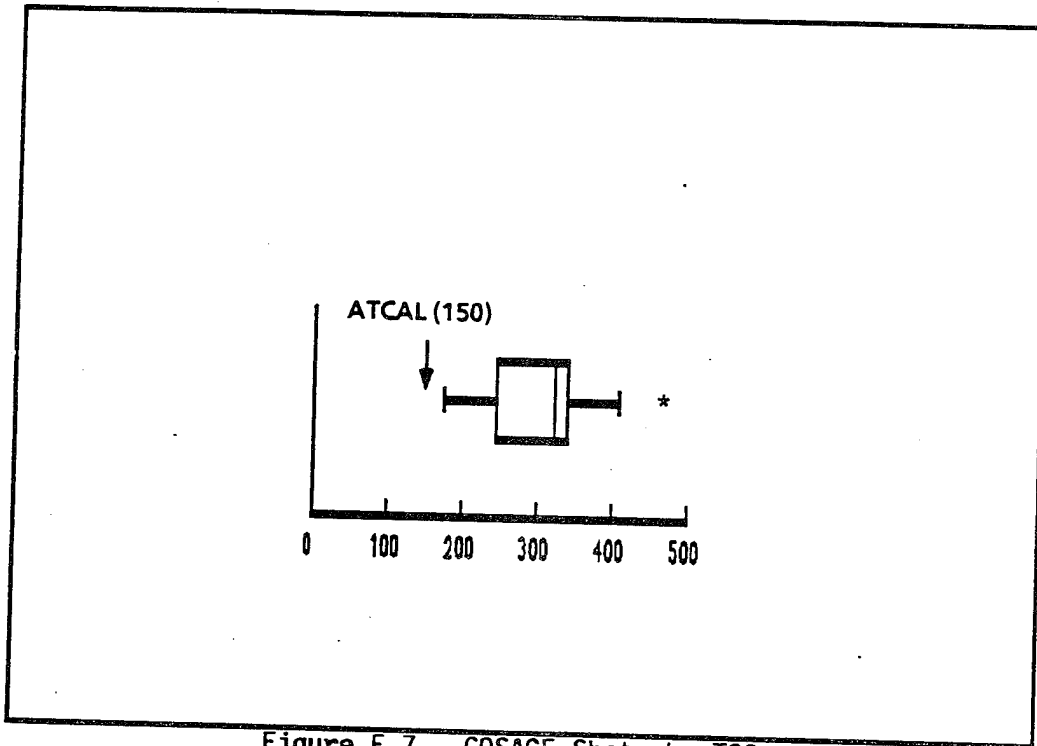

Figure E-7. COSAGE Shots by T80,
1.5:1 Force Ratio

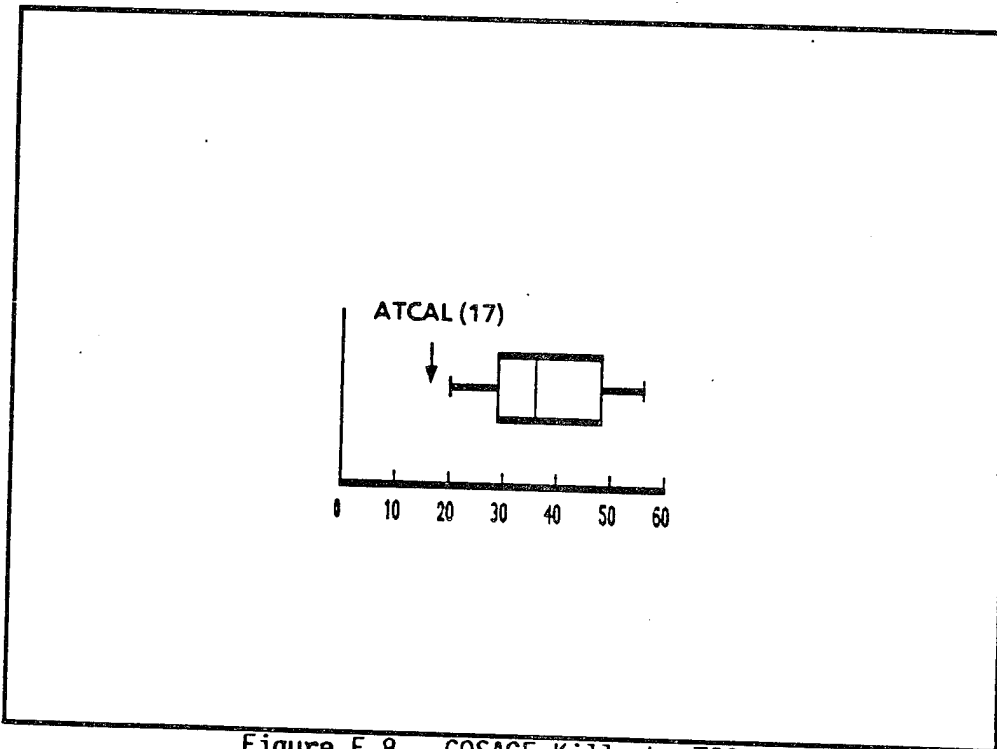

Figure E-8. COSAGE Kills by T80,
1.5:1 Force Ratio

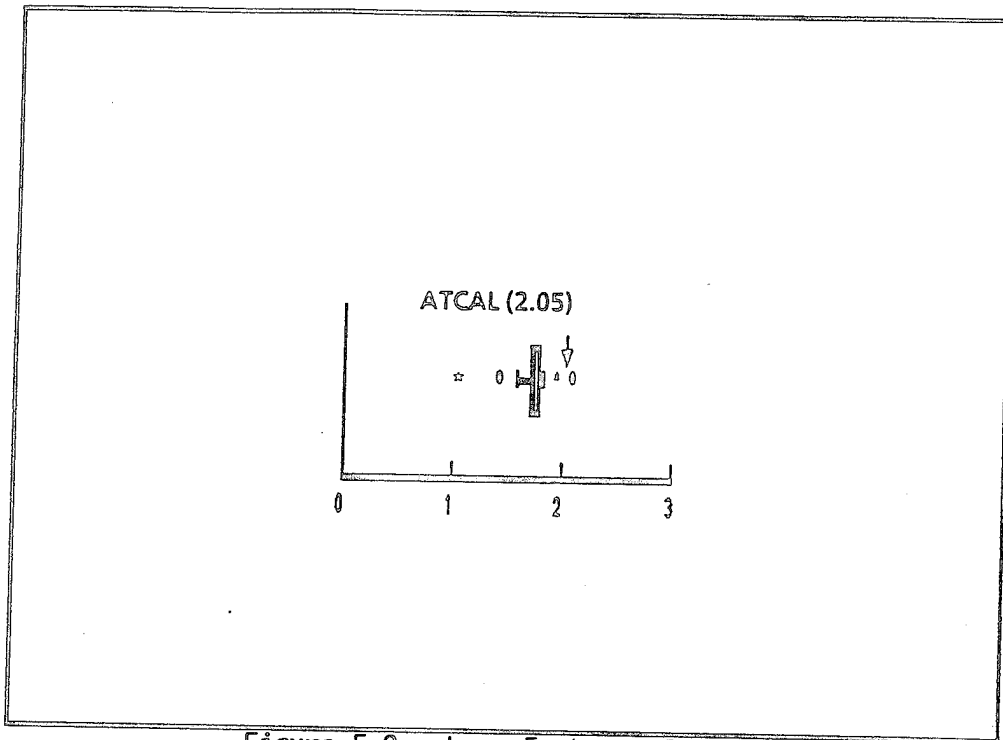

Figure E-9. Loss Exchange Ratio,
7.0:1 Force Ratio

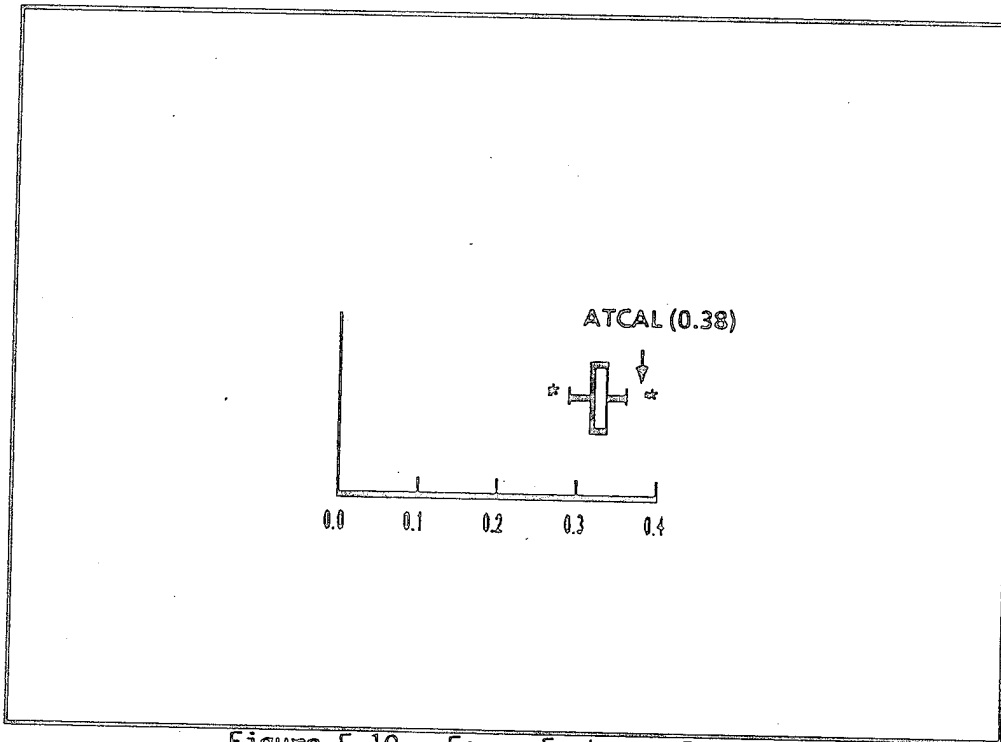

Figure E-10. Force Exchange Ratio,
7.0:1 Force Ratio

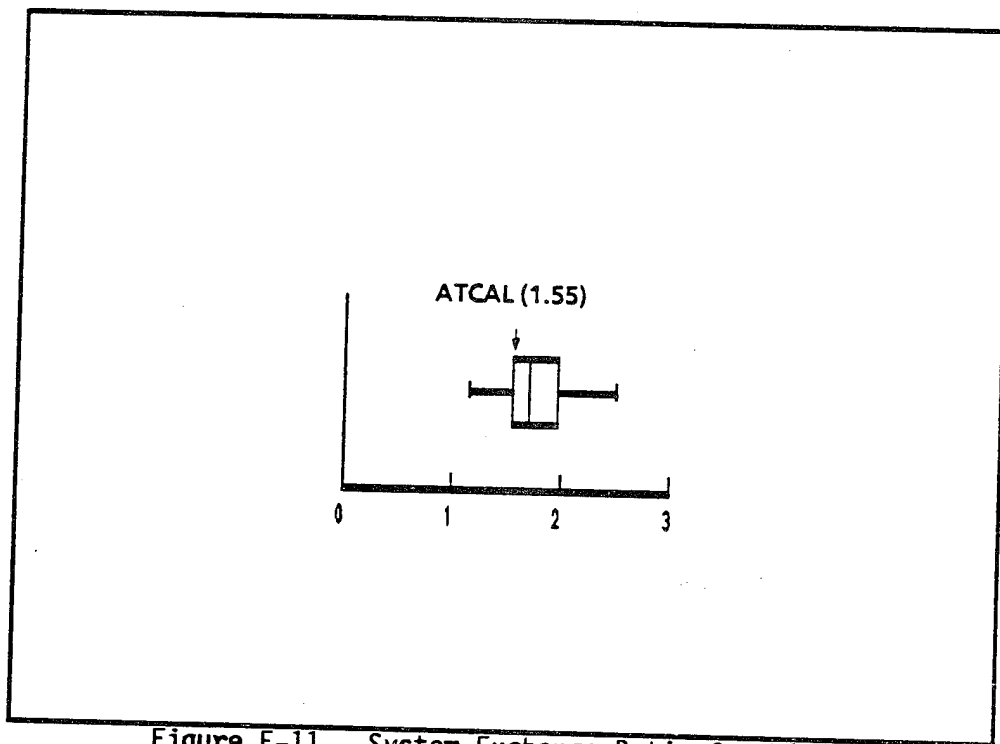

Figure E-11. System Exchange Ratio for MIAI,
7.0:1 Force Ratio

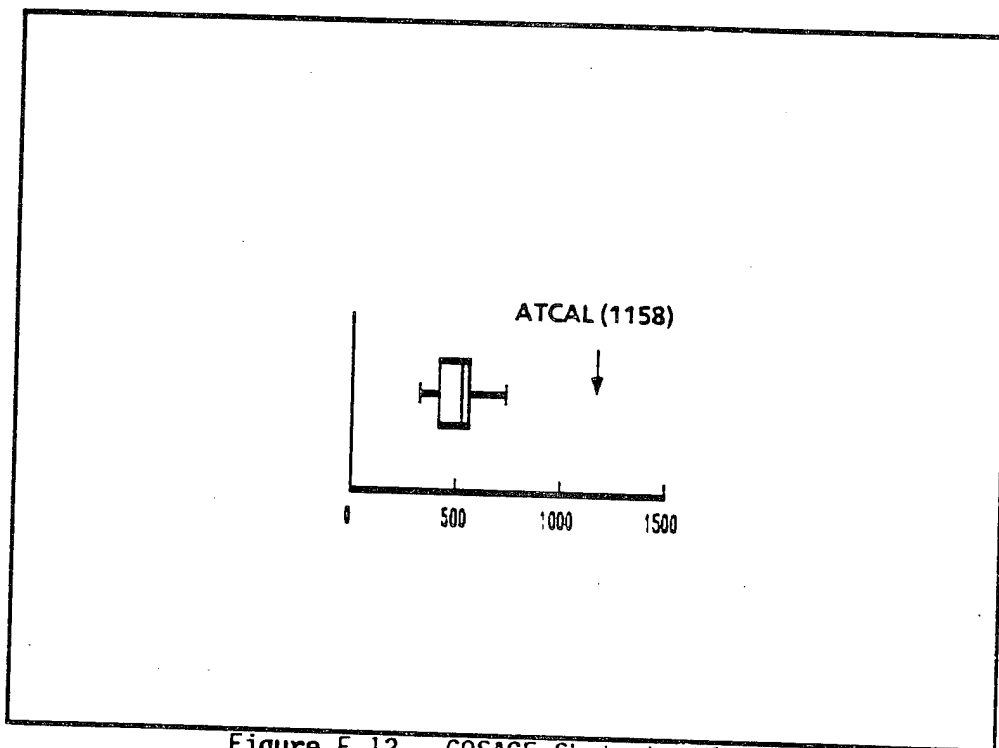

Figure E-12. COSAGE Shots by MIAI,
7.0:1 Force Ratio

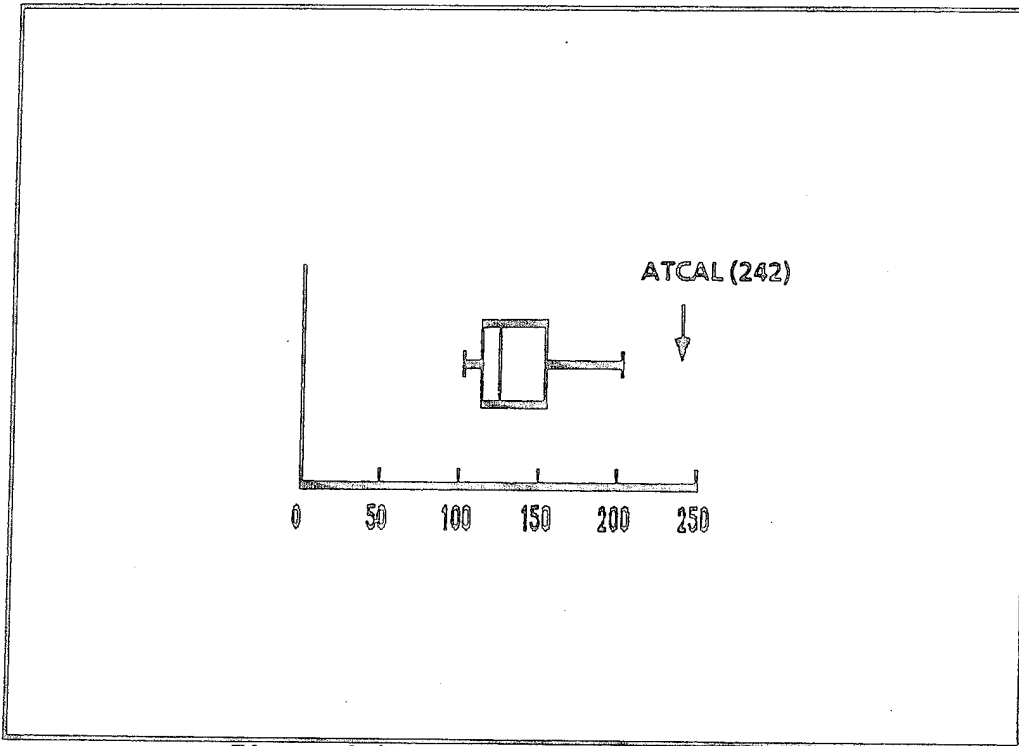

Figure E-13. COSAGE Kills by MIA1,
7.0:1 Force Ratio

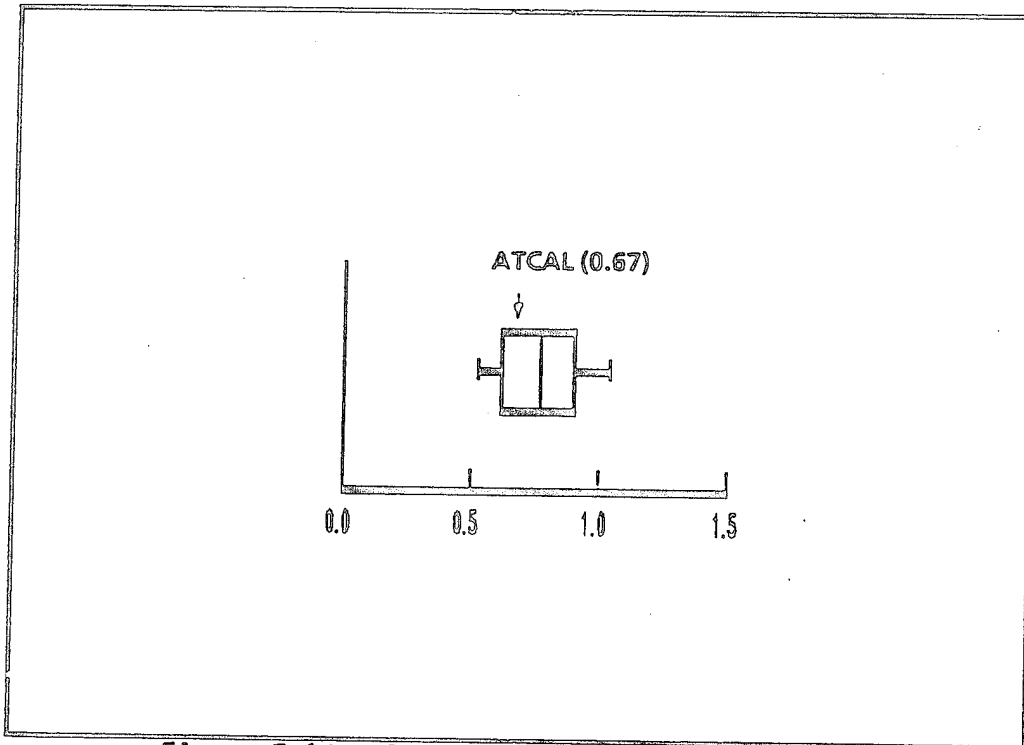

Figure E-14. System Exchange Ratio for T80,
7.0:1 Force Ratio

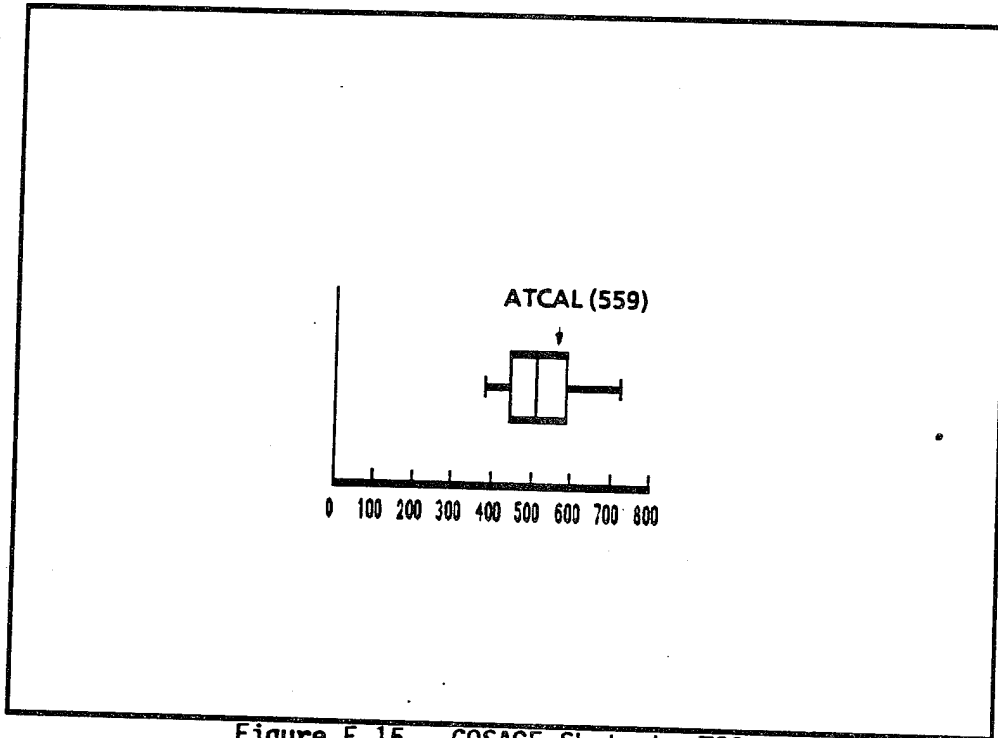

Figure E-15. COSAGE Shots by T80,
7.0:1 Force Ratio

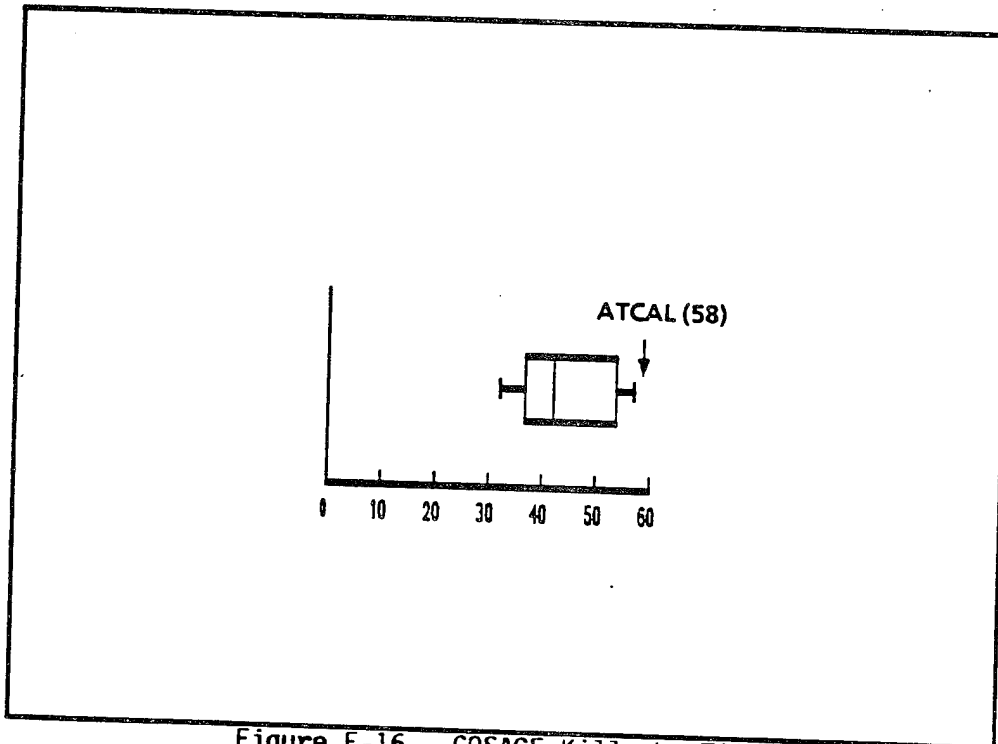

Figure E-16. COSAGE Kills by T80,
7.0:1 Force Ratio

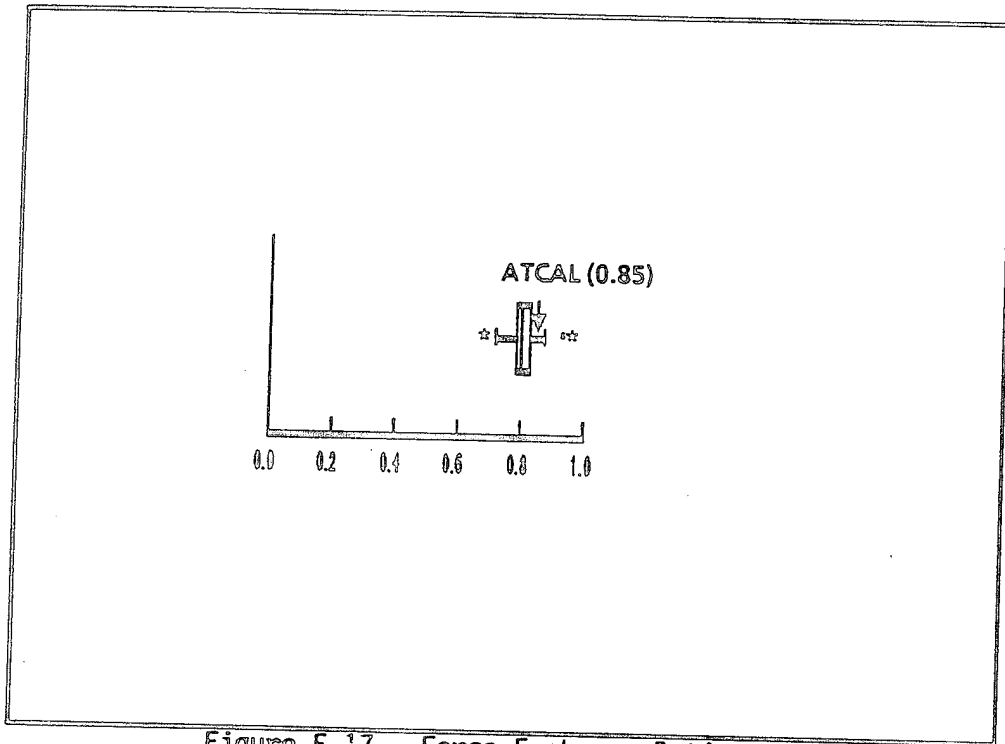

Figure E-17. Force Exchange Ratio for Bradley Division

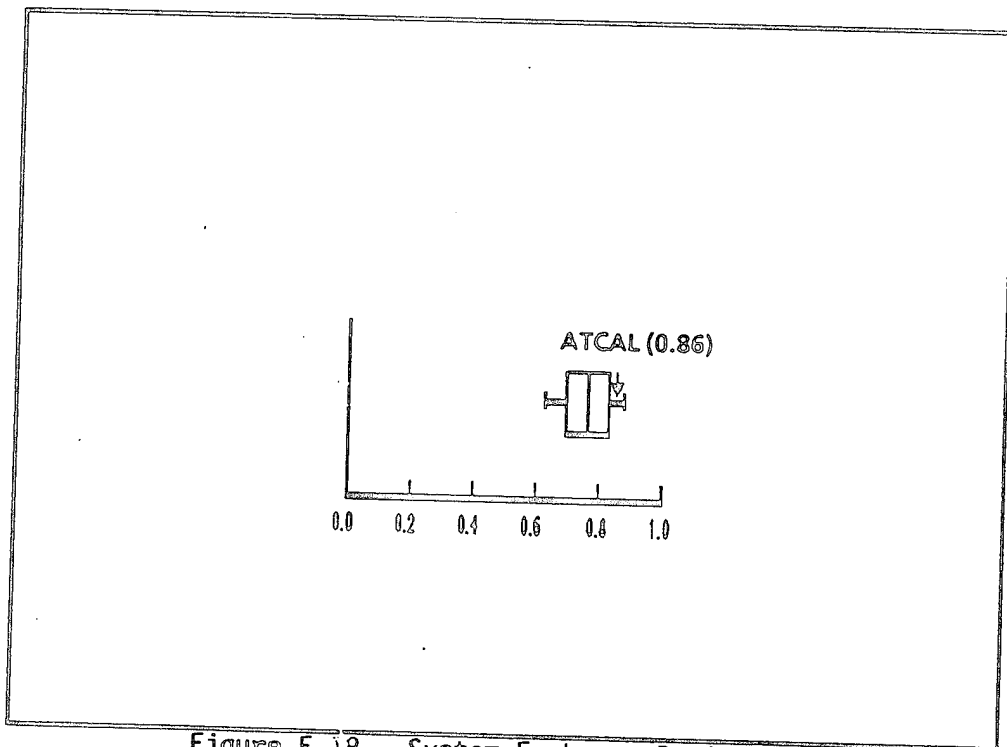

Figure E-18. System Exchange Ratio for Bradley Division

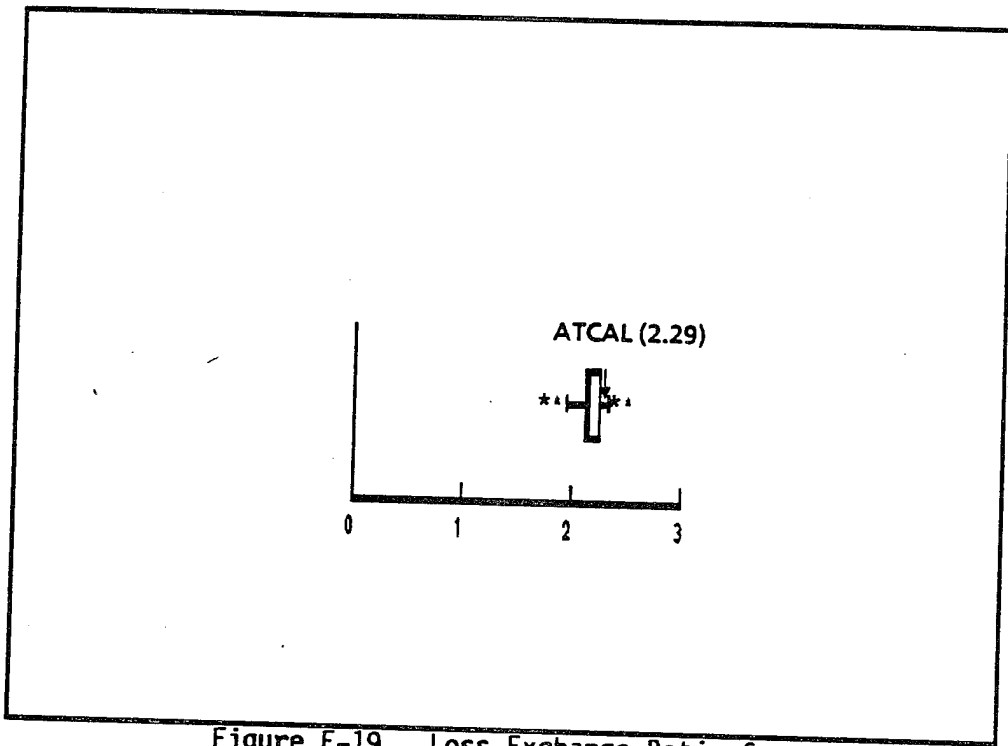

Figure E-19. Loss Exchange Ratio for Bradley Division

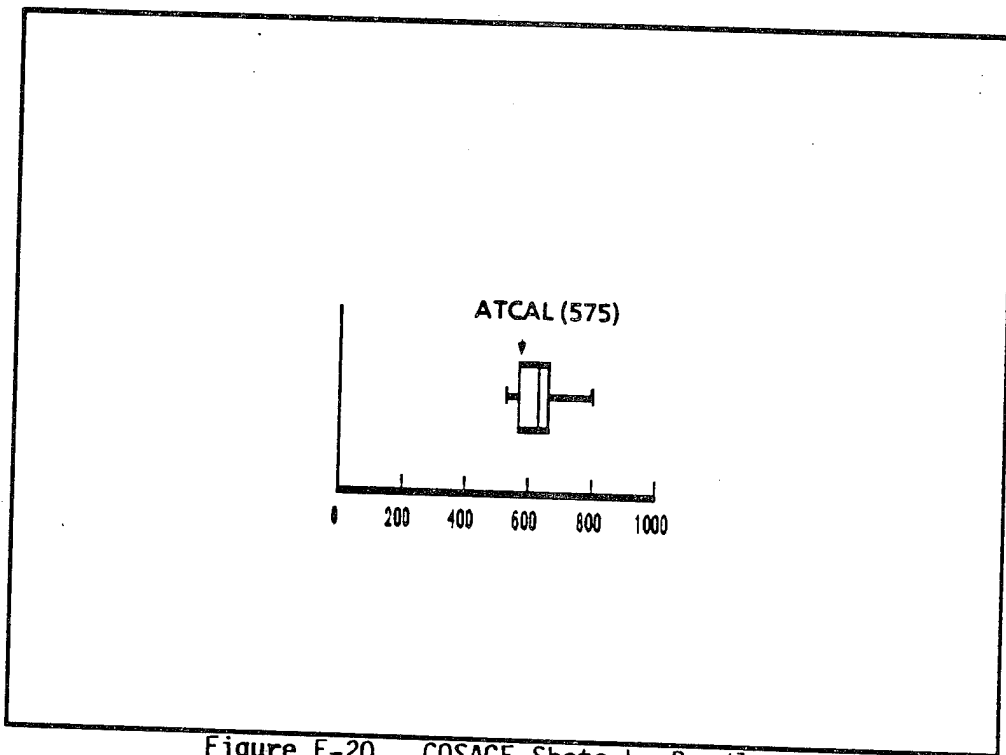

Figure E-20. COSAGE Shots by Bradley, Bradley Division

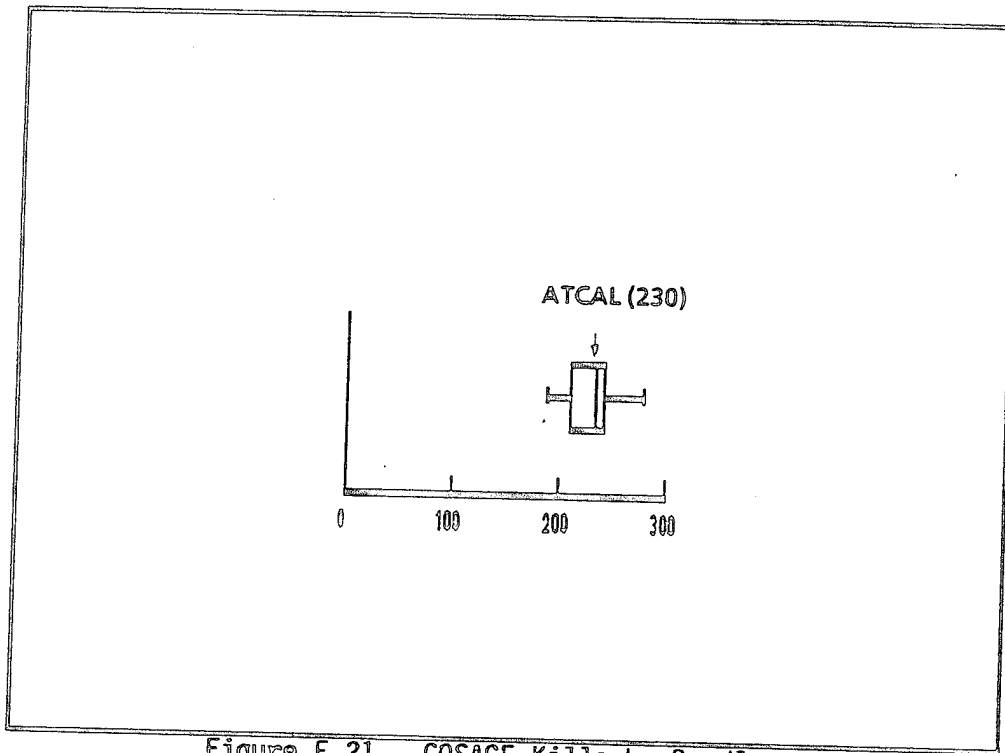

Figure E-21. COSAGE Kills by Bradley, Bradley Division

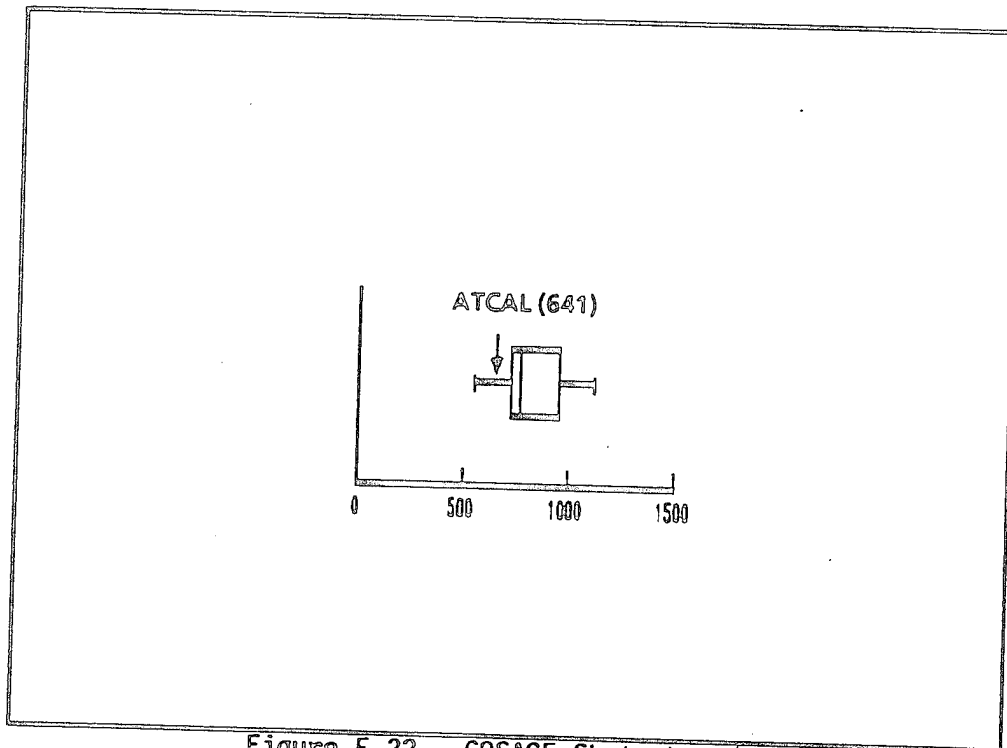

Figure E-22. COSAGE Shots by M1, Brigade Level

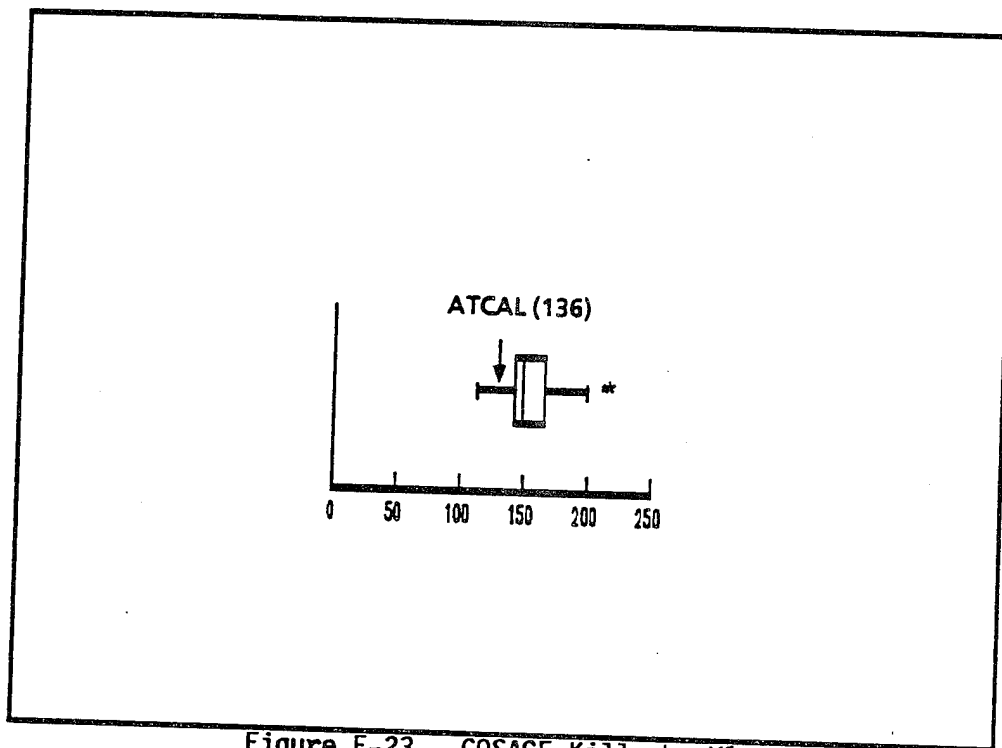

Figure E-23. COSAGE Kills by MI, Brigade Level

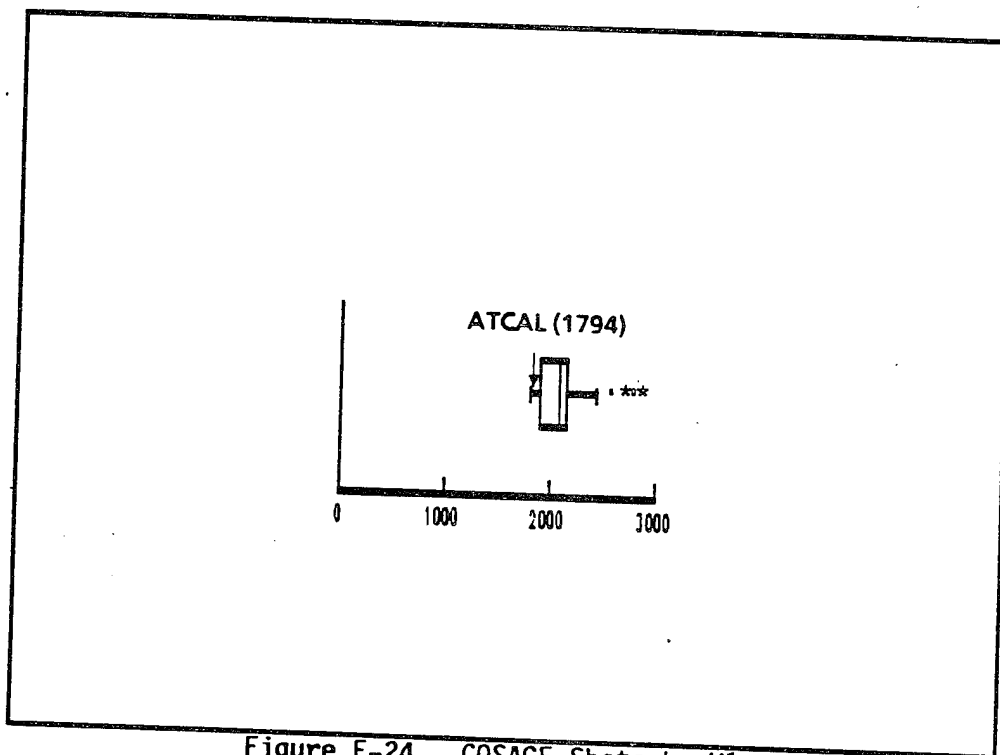

Figure E-24. COSAGE Shots by MI, Division Level

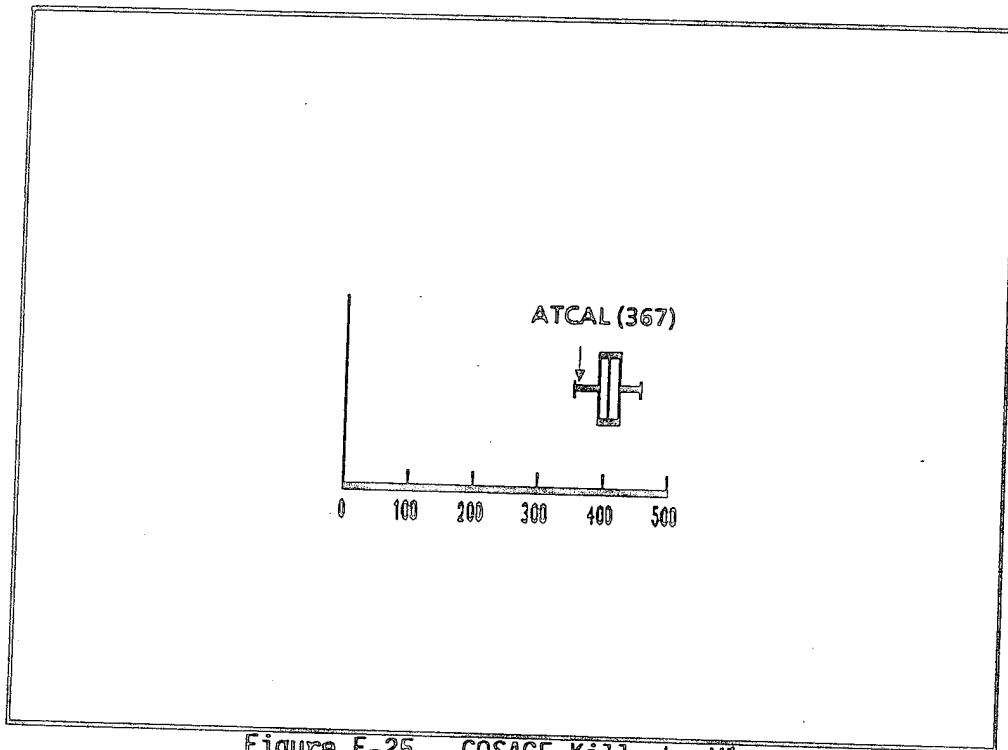

Figure E-25. COSAGE Kills by M1, Division Level

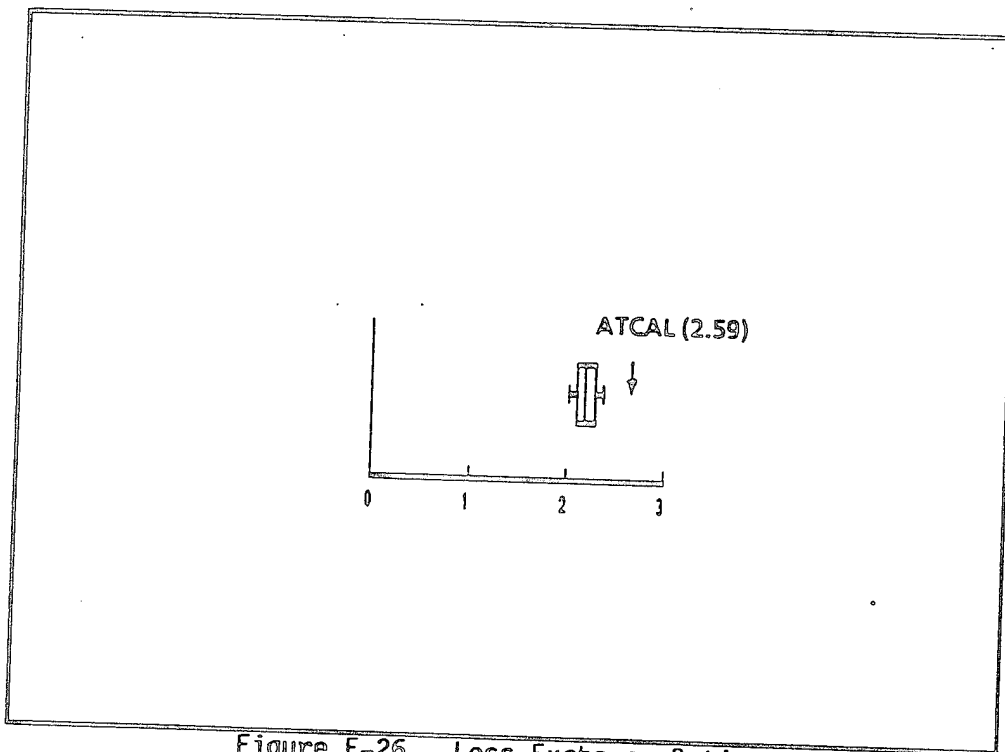

Figure E-26. Loss Exchange Ratio, M1/T72

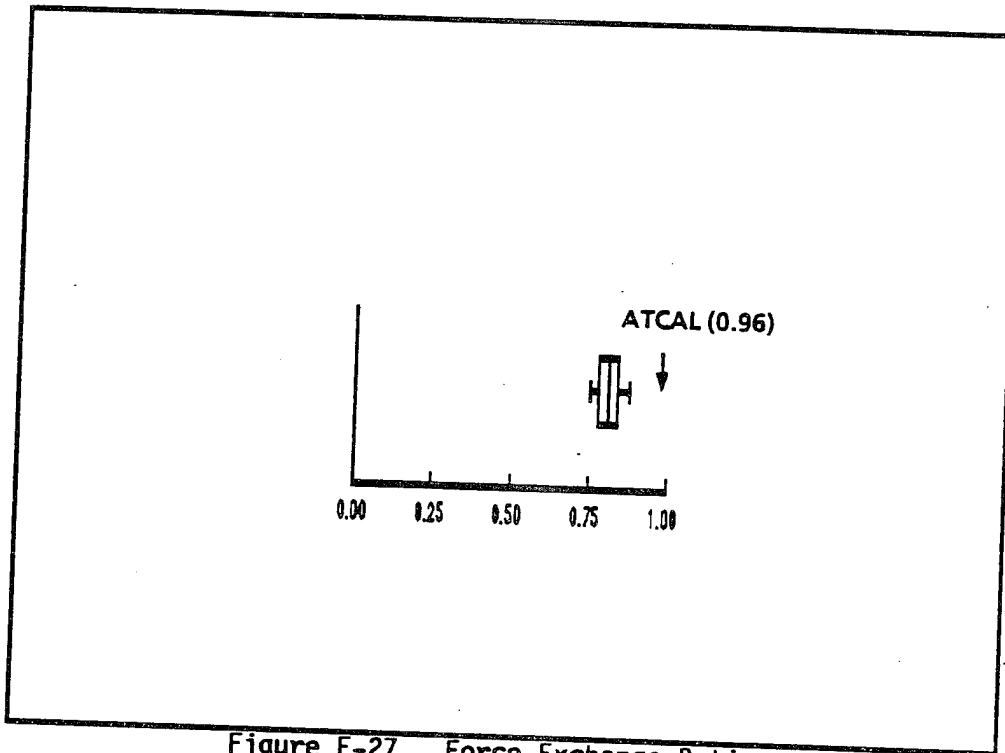

Figure E-27. Force Exchange Ratio, M1/T72

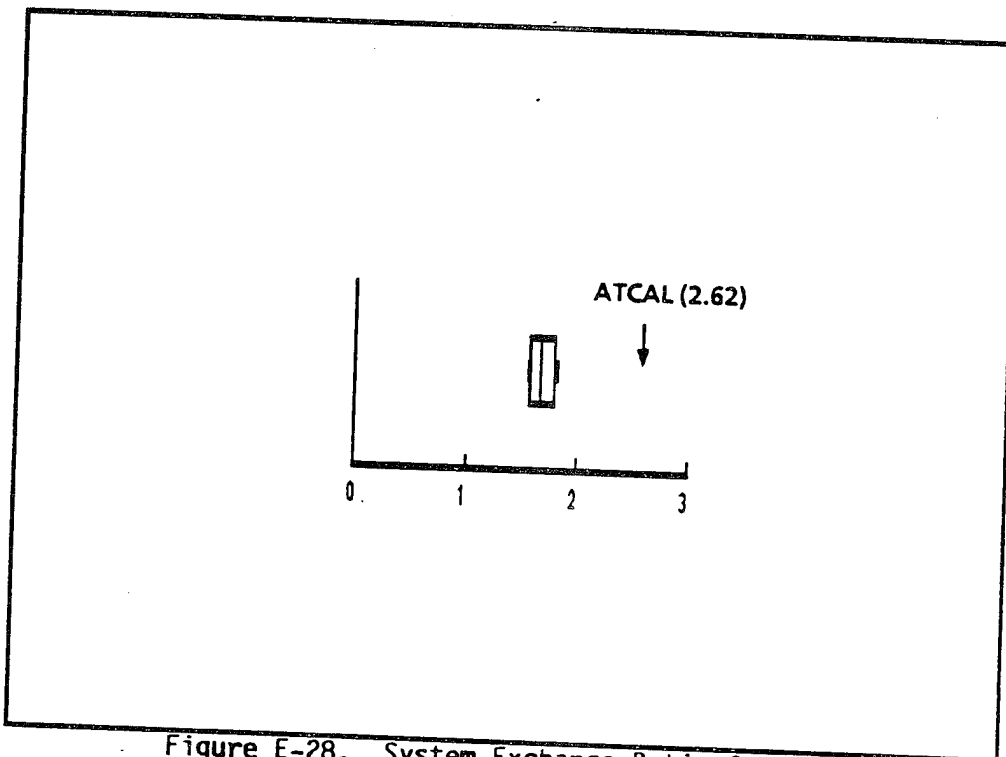

Figure E-28. System Exchange Ratio for M1, M1/T72

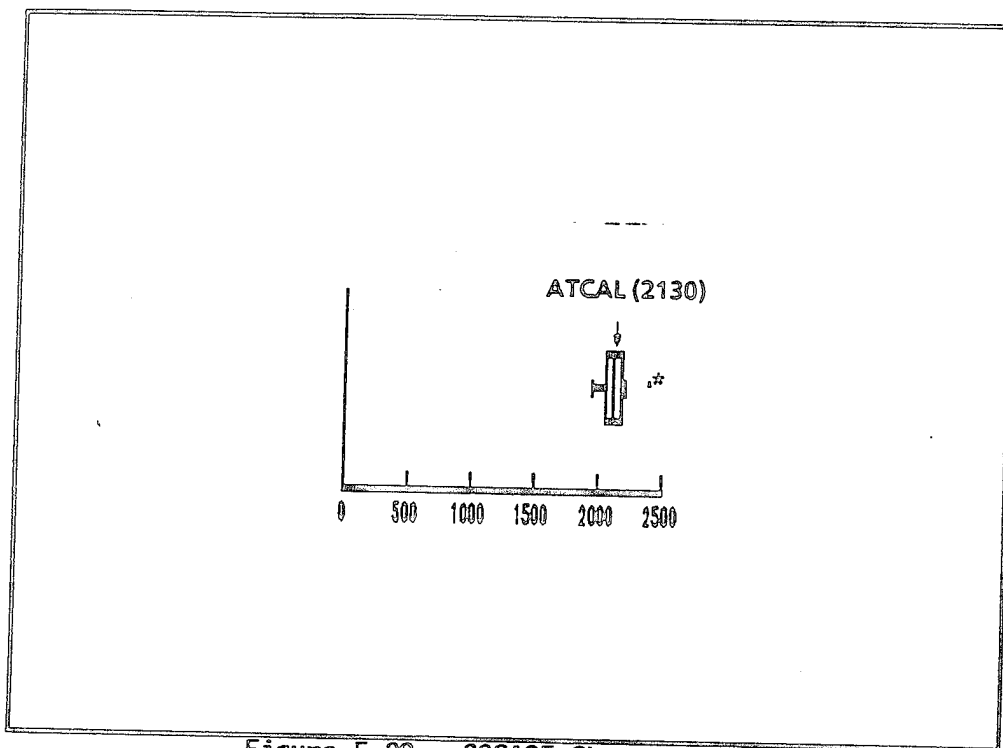

Figure E-29. COSAGE Shots by M1, M1/T72

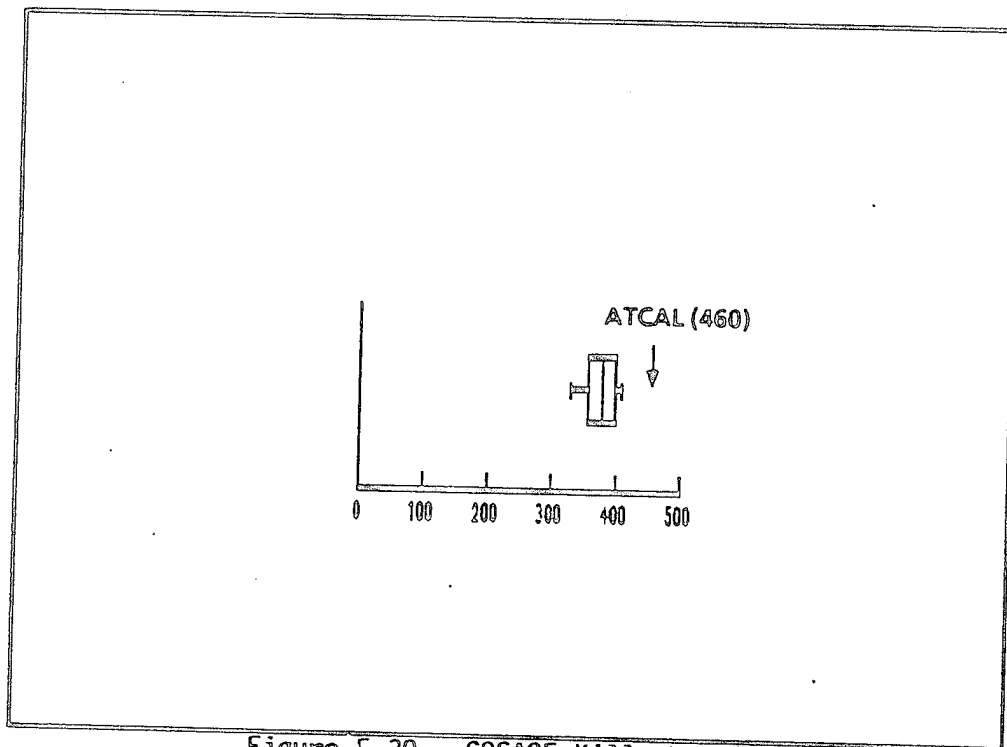

Figure E-30. COSAGE Kills by M1, M1/T72

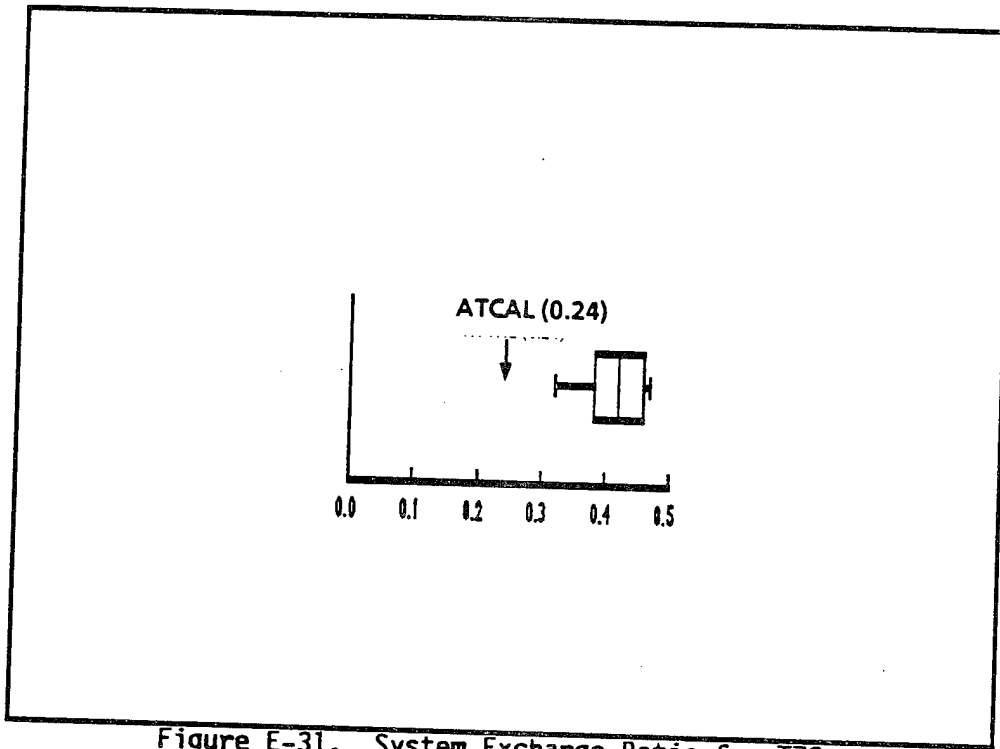

Figure E-31. System Exchange Ratio for T72, M1/T72

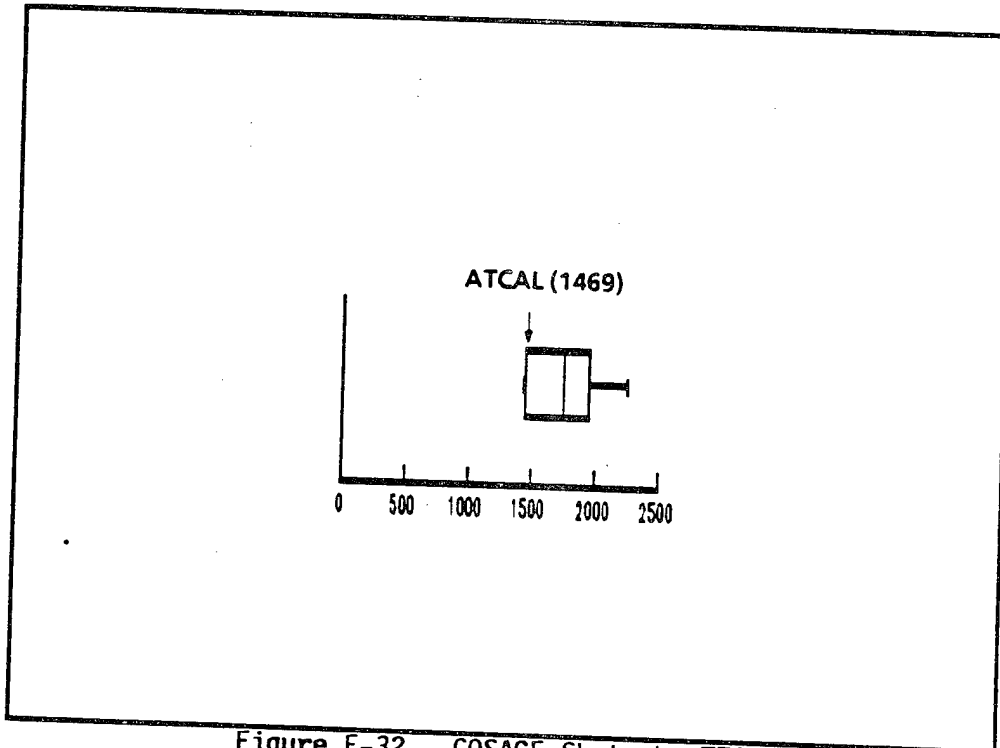

Figure E-32. COSAGE Shots by T72, M1/T72

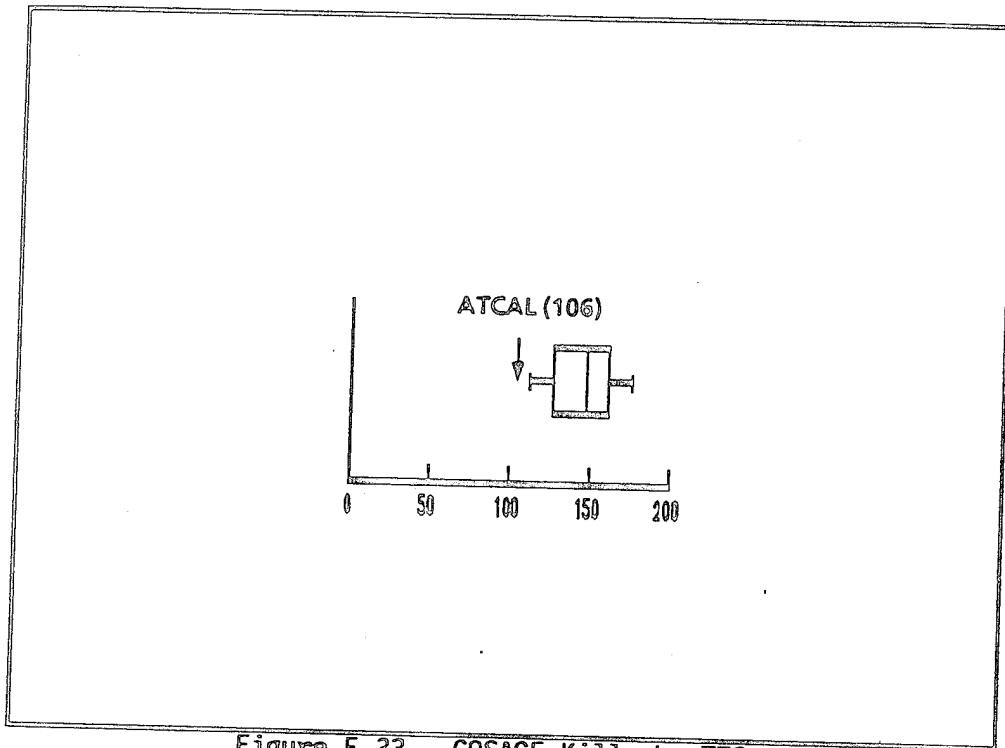

Figure E-33. COSAGE Kills by T72, M1/T72

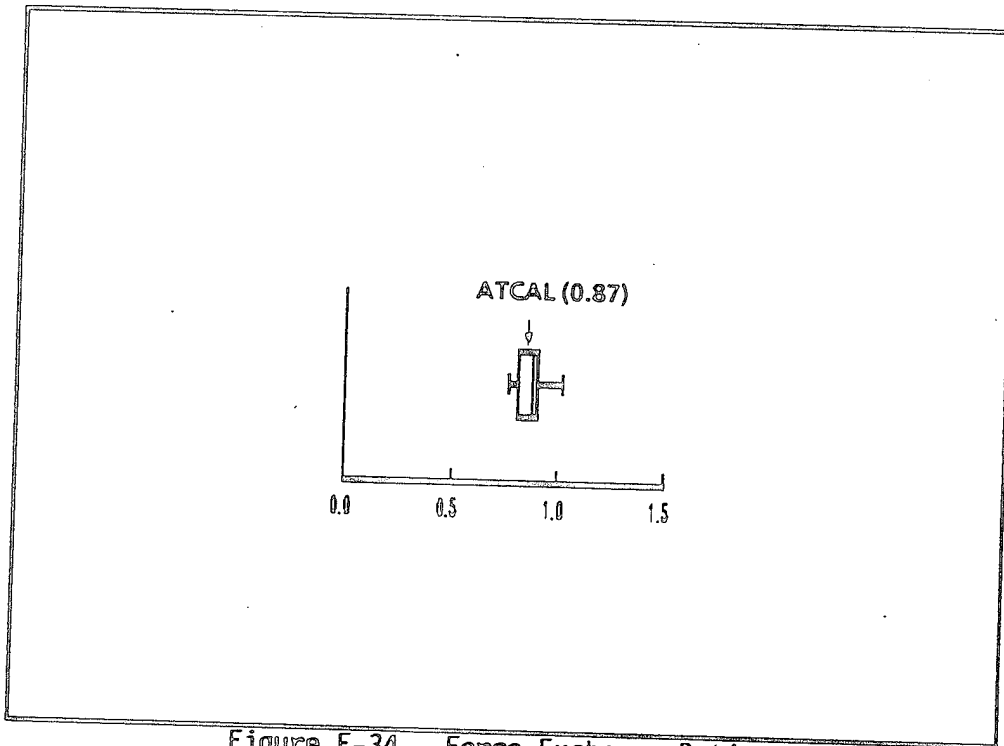

Figure E-34. Force Exchange Ratio, T72 Army

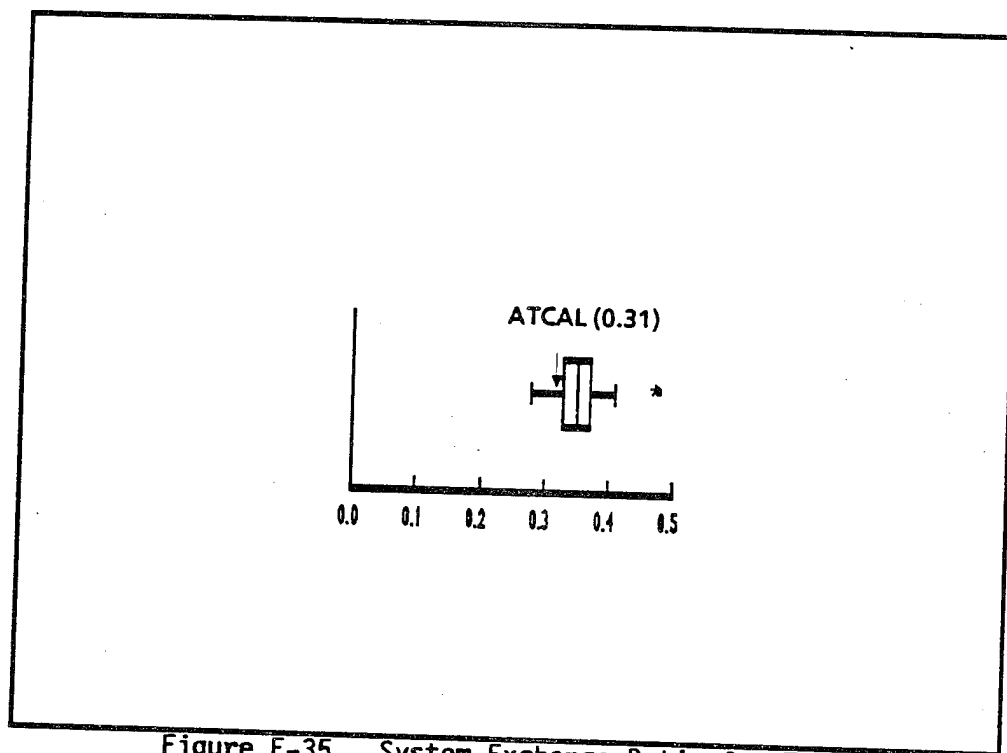

Figure E-35. System Exchange Ratio for T72,
T72 Army

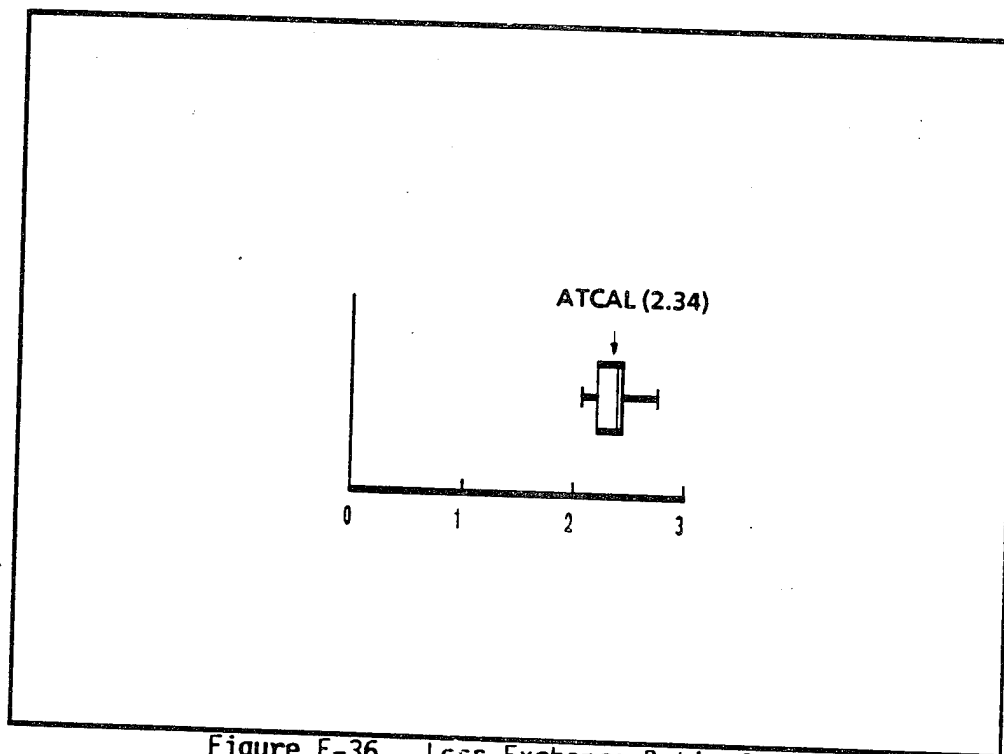

Figure E-36. Loss Exchange Ratio for,
T72 Army

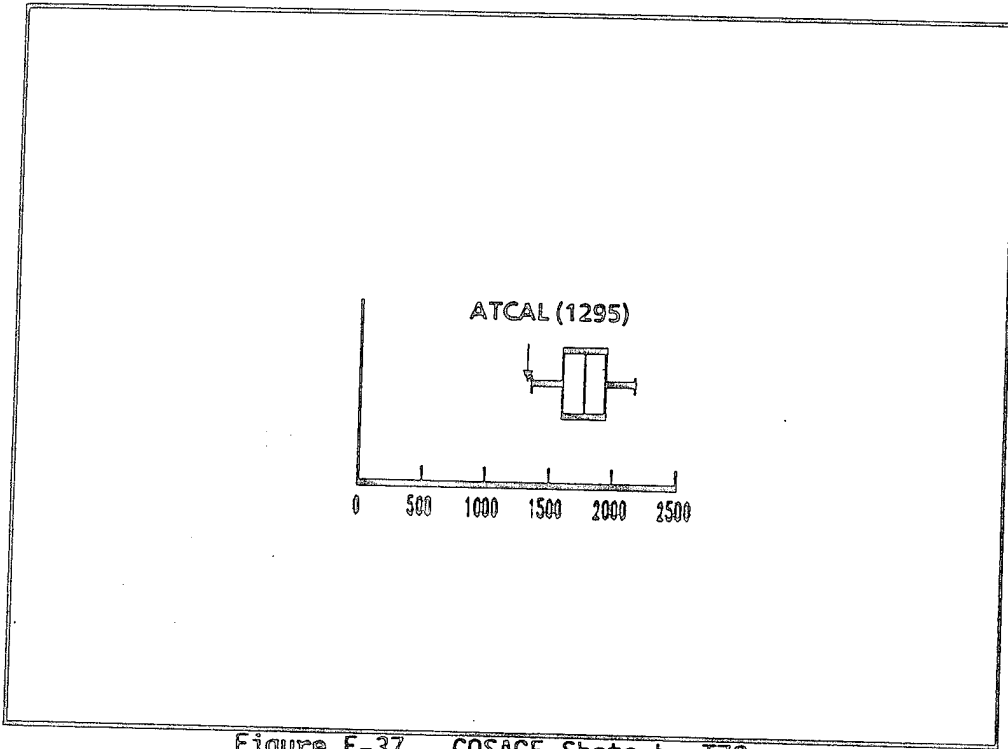

Figure E-37. COSAGE Shots by T72,
T72 Army

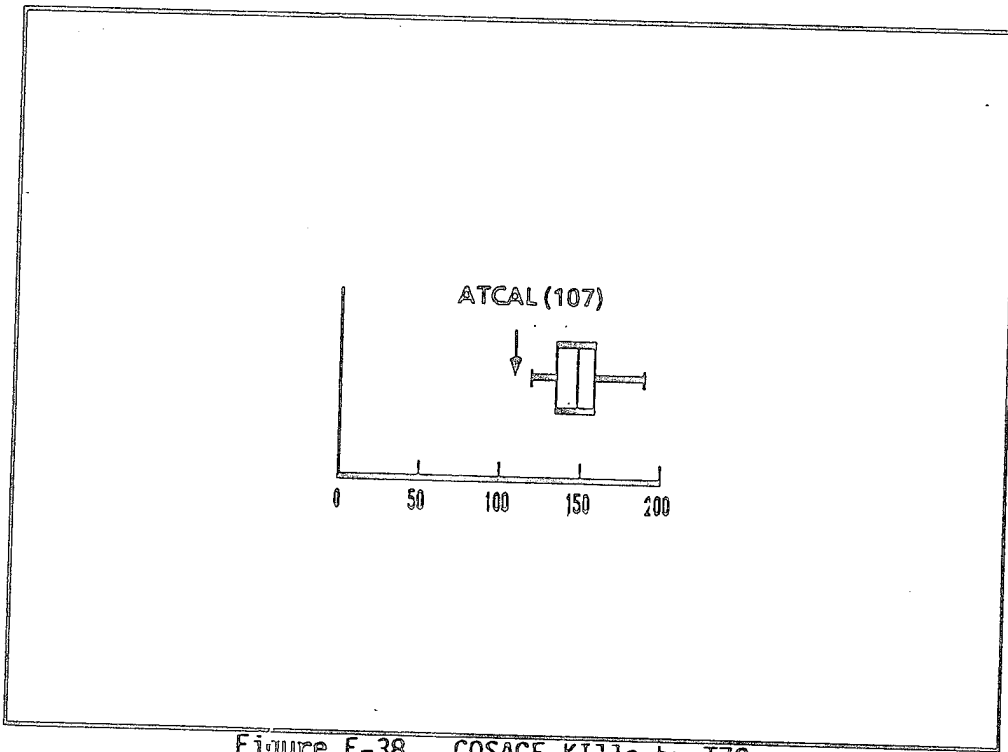

Figure E-38. COSAGE KILLS by T72,
T72 Army

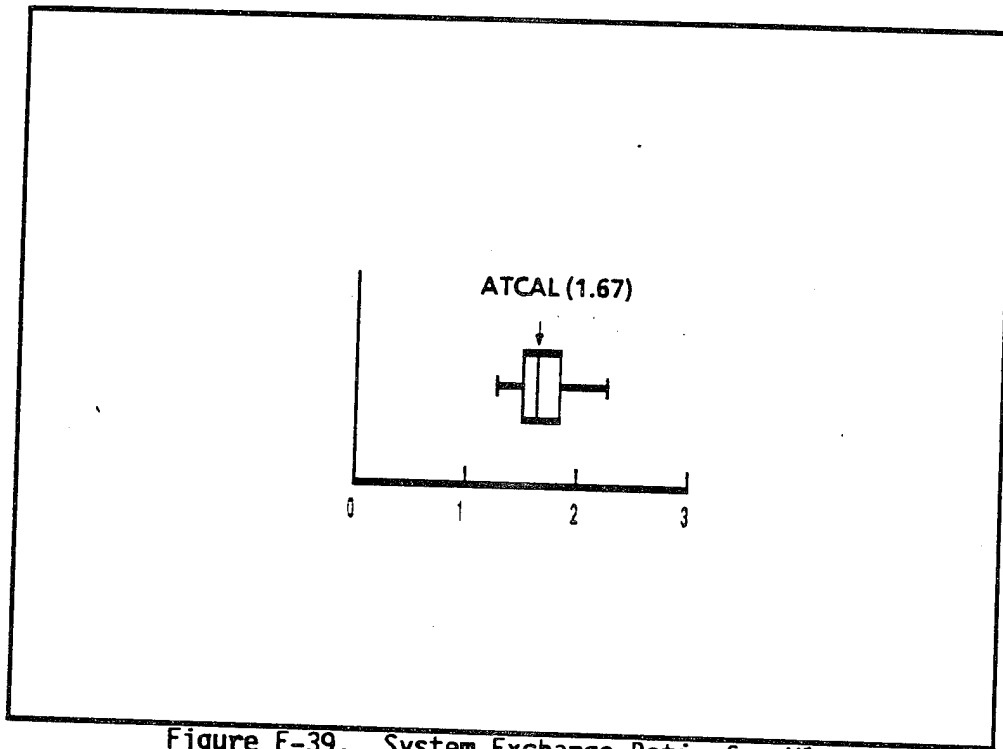

Figure E-39. System Exchange Ratio for M1, Division Level

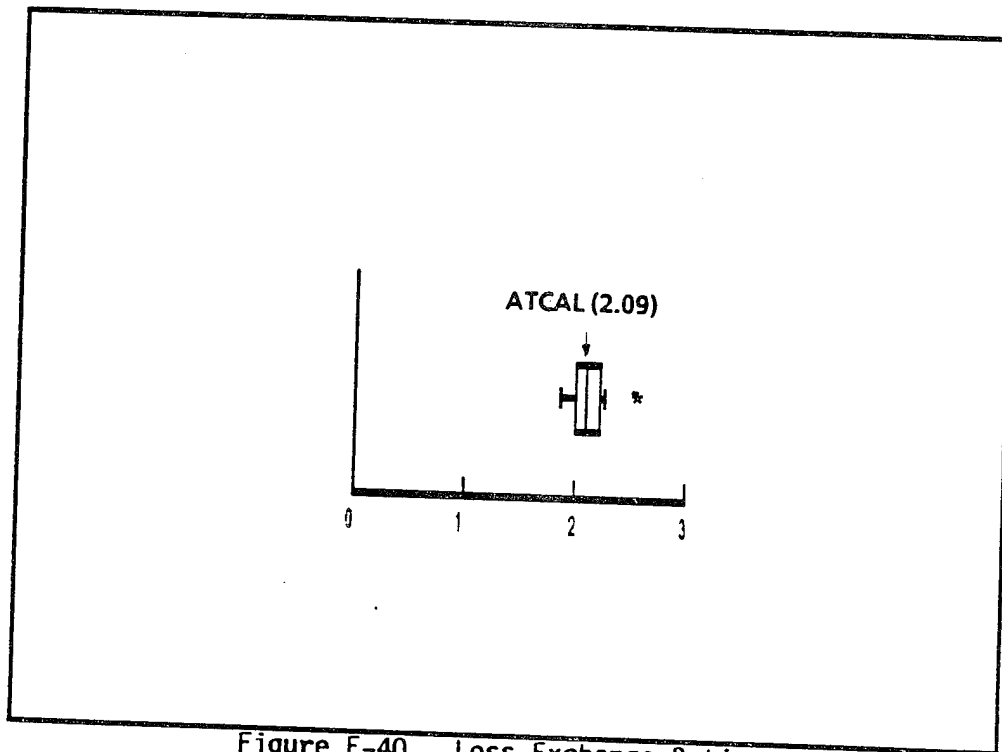

Figure E-40. Loss Exchange Ratio, Division Level

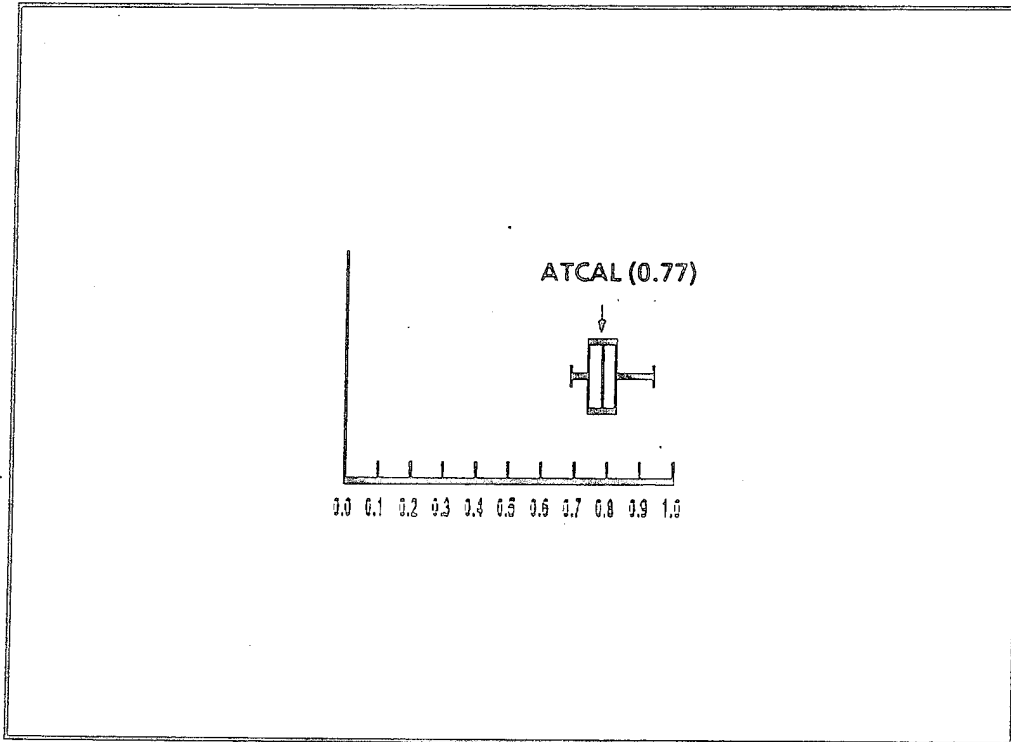

Figure E-41. Force Exchange Ratio,
Division Level

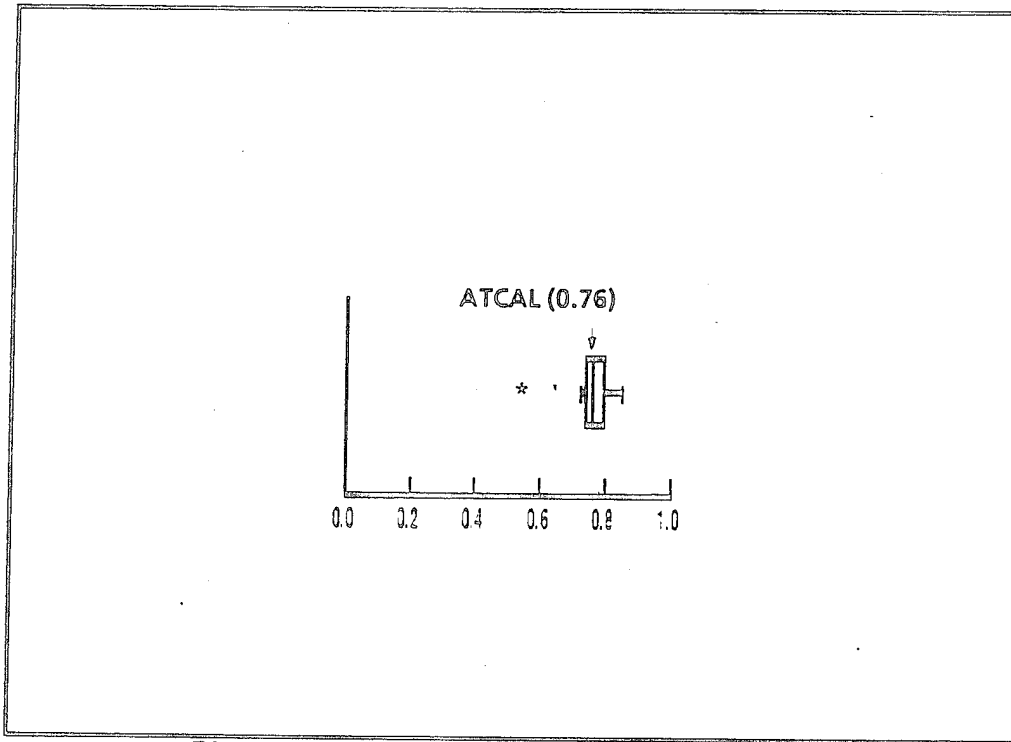

Figure E-42. Fractional Exchange Ratio,
FST/T80

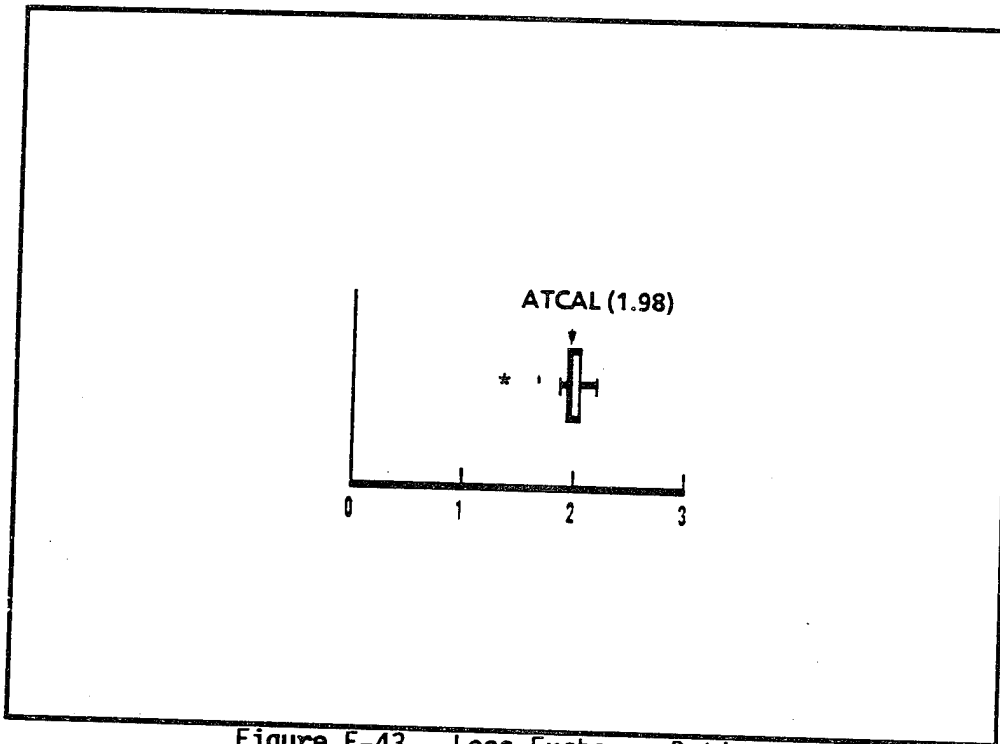

Figure E-43. Loss Exchange Ratio, FST/T80

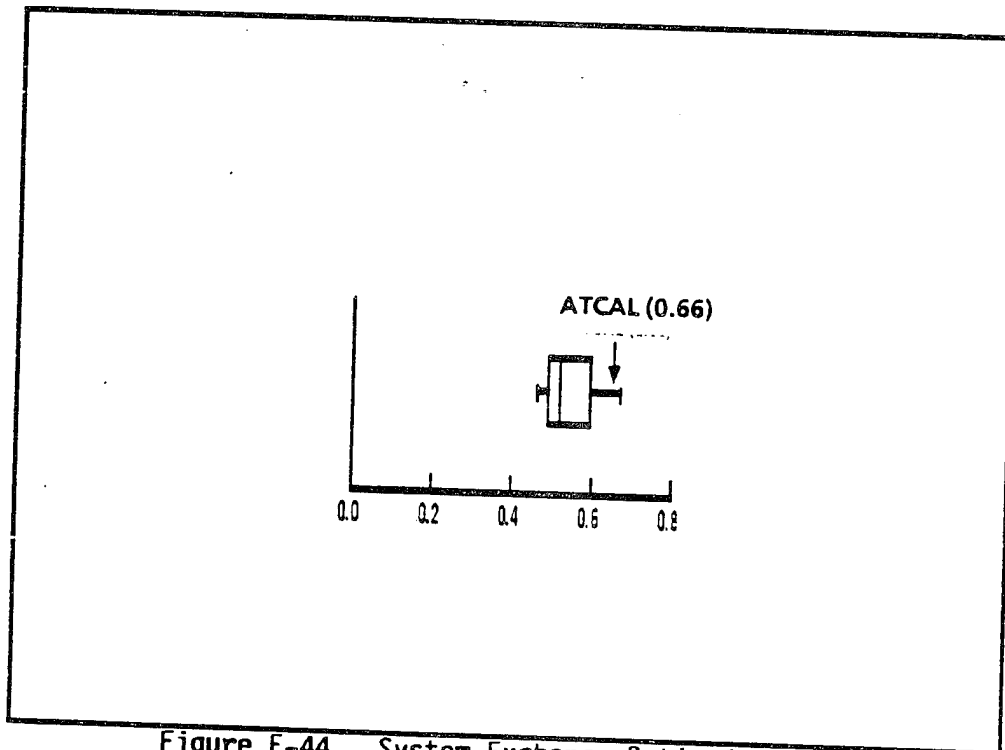

Figure E-44. System Exchange Ratio for T80, FST/T80

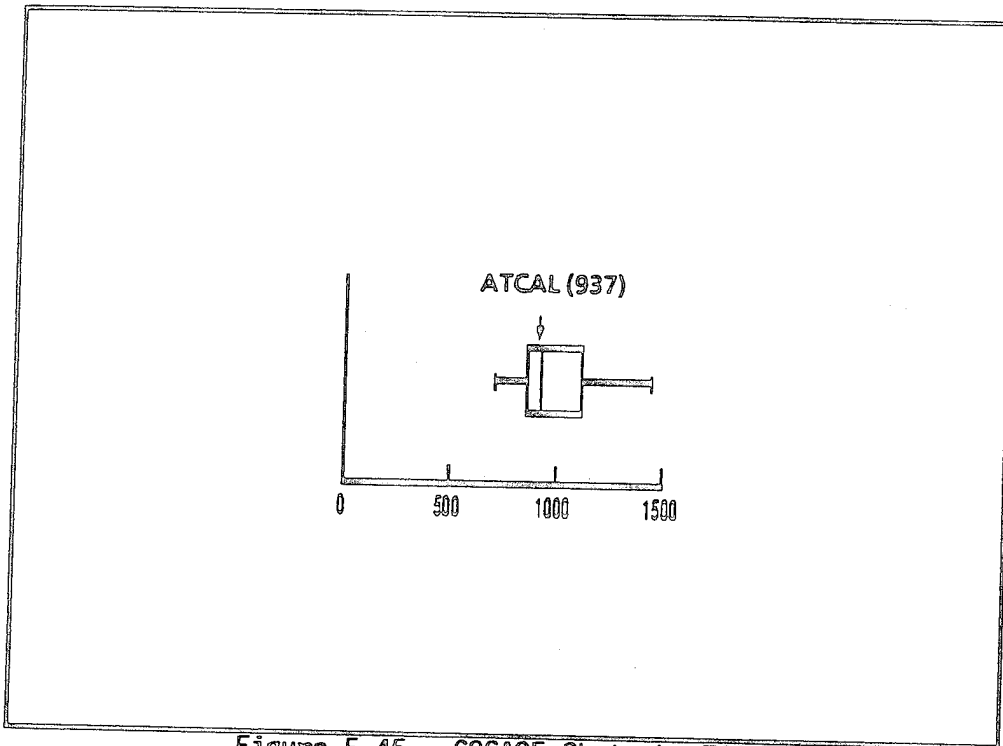

Figure E-45. COSAGE Shots by T80,
FST/T80

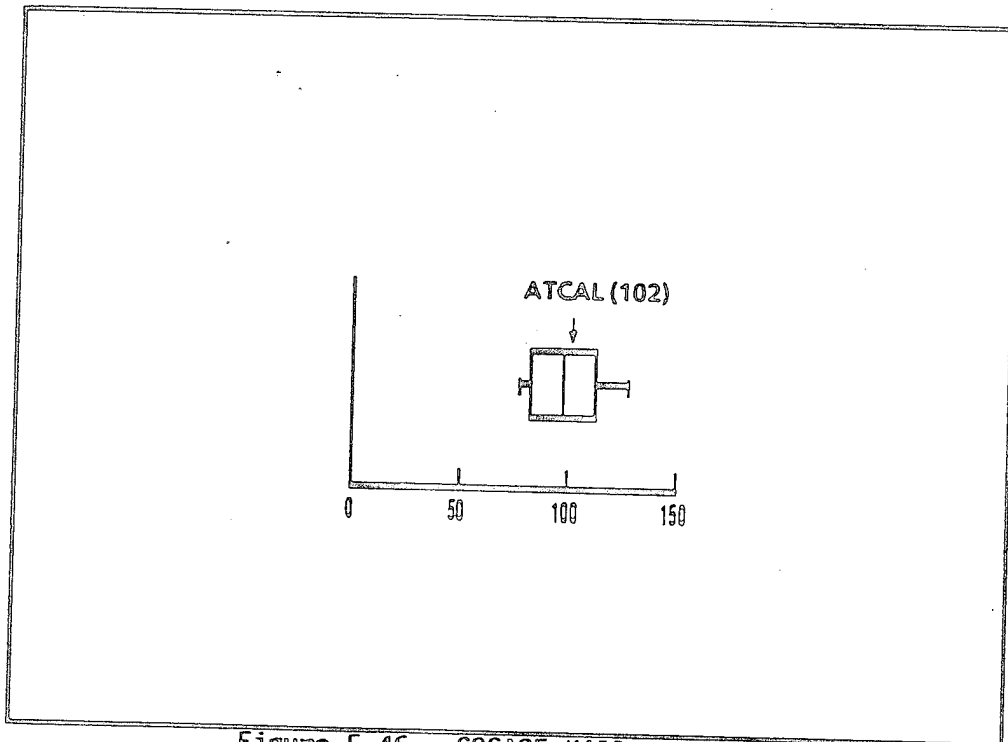

Figure E-46. COSAGE Kills by T80,
FST/T80

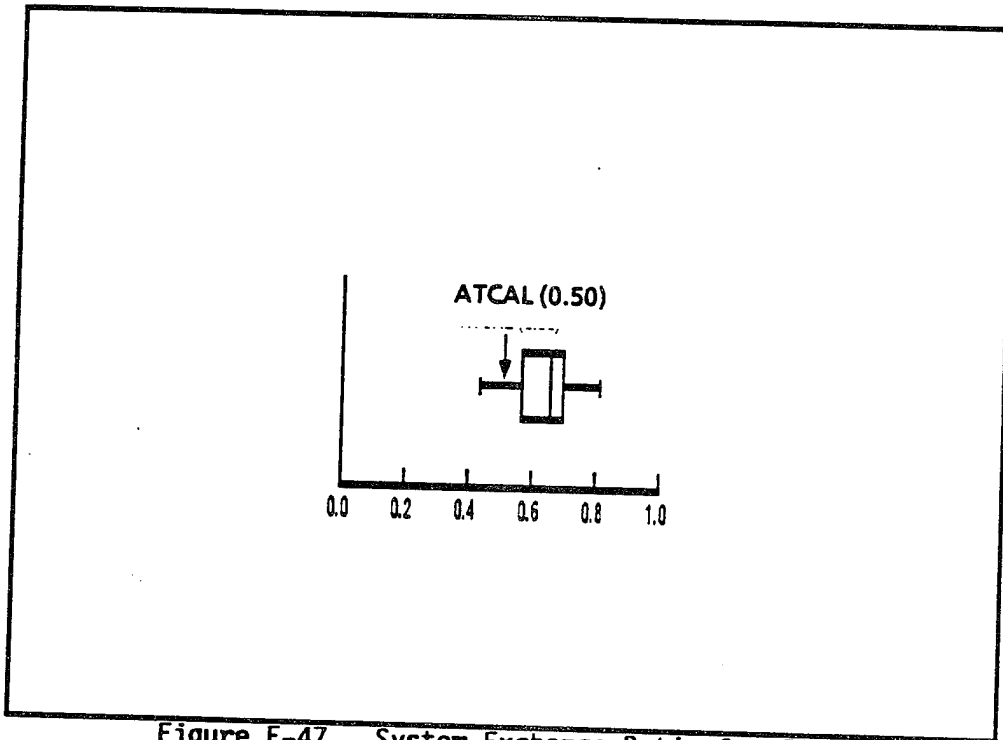

Figure E-47. System Exchange Ratio for FST, FST/T80

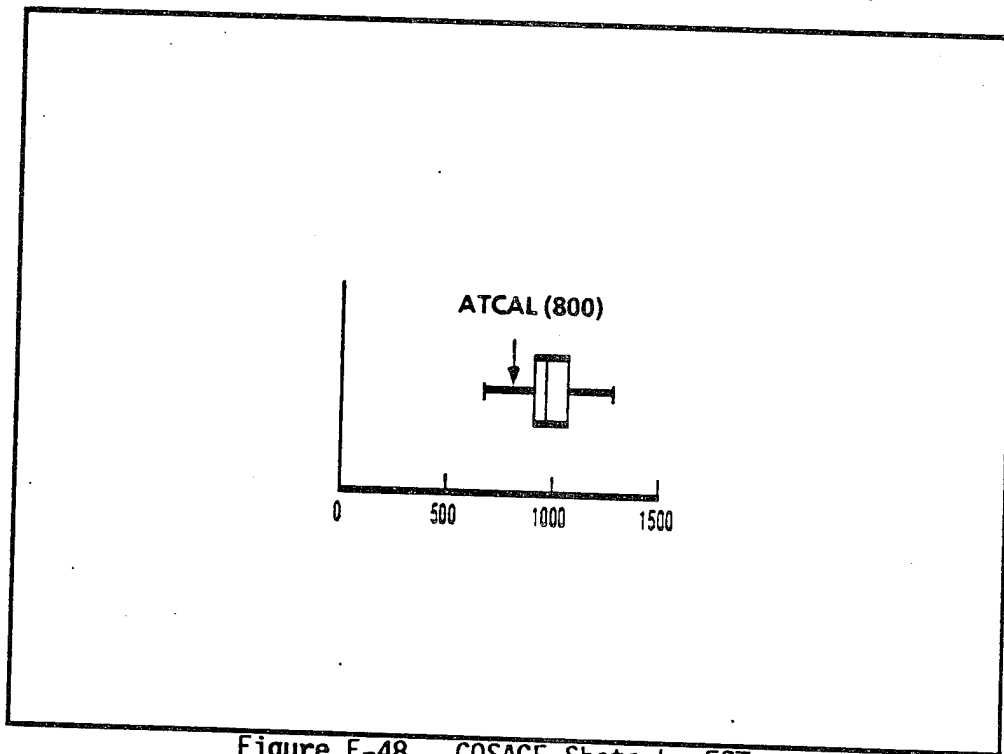

Figure E-48. COSAGE Shots by FST, FST/T80

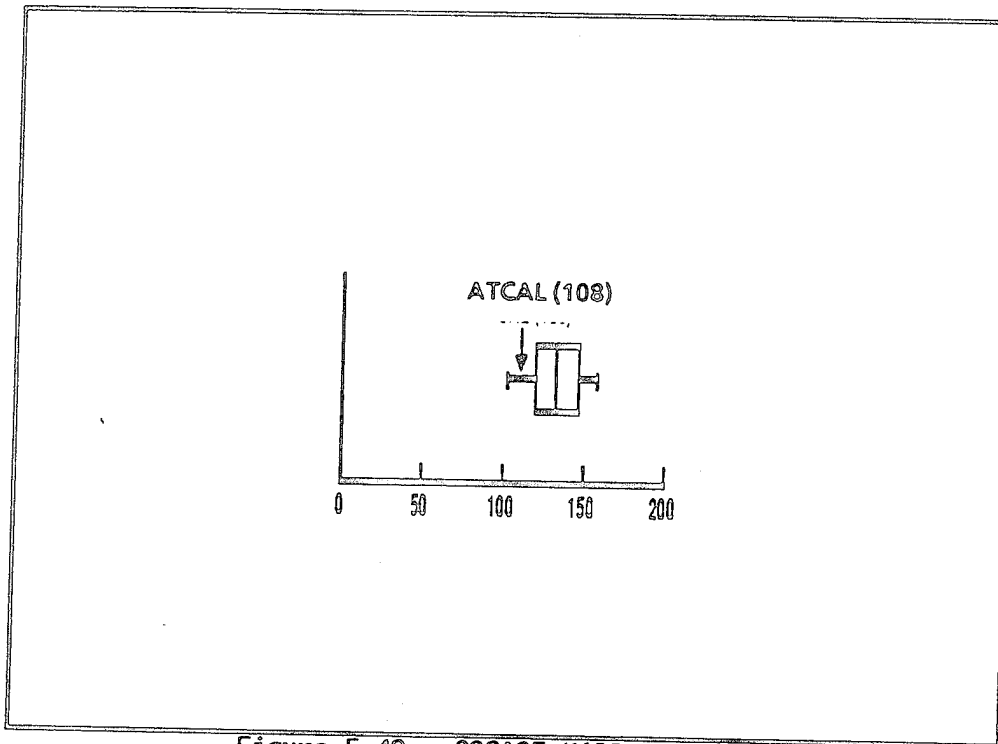

Figure E-49. COSAGE Kills by FST,
FST/T80

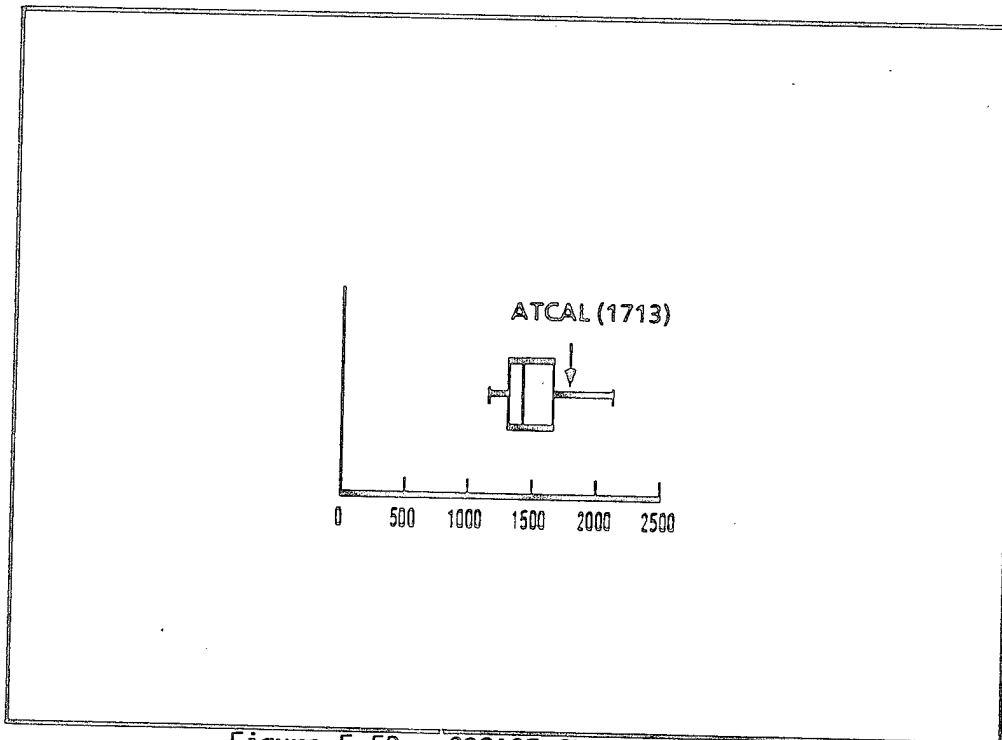

Figure E-50. COSAGE Shots by MIA1,
MIA1/M1

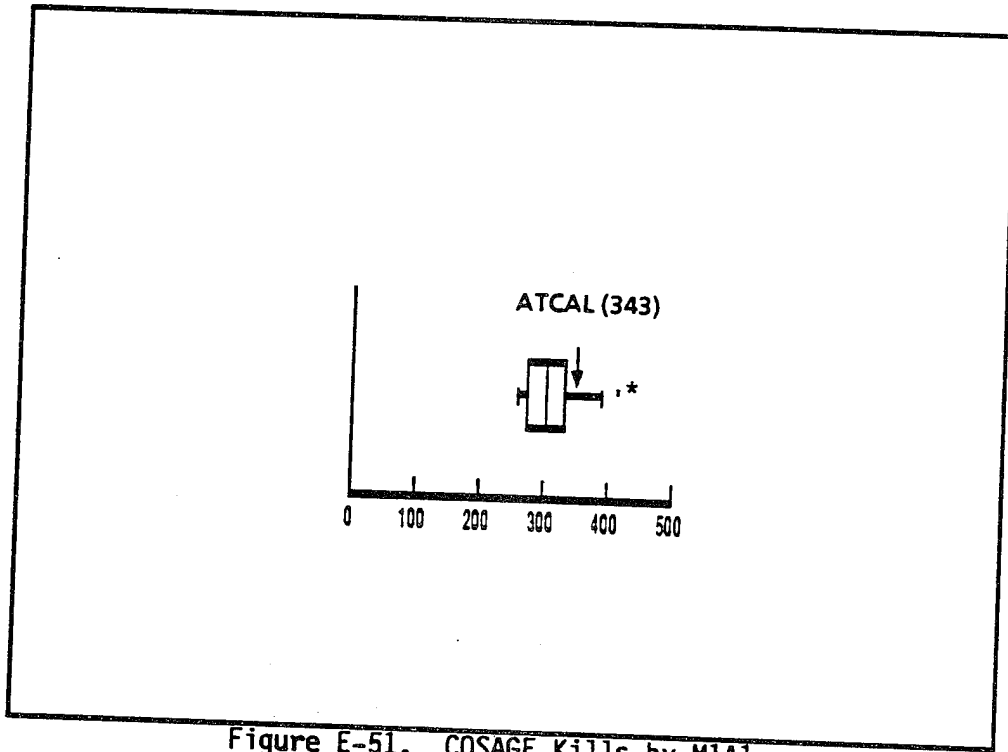

Figure E-51. COSAGE Kills by MIA1, MIA1/M1

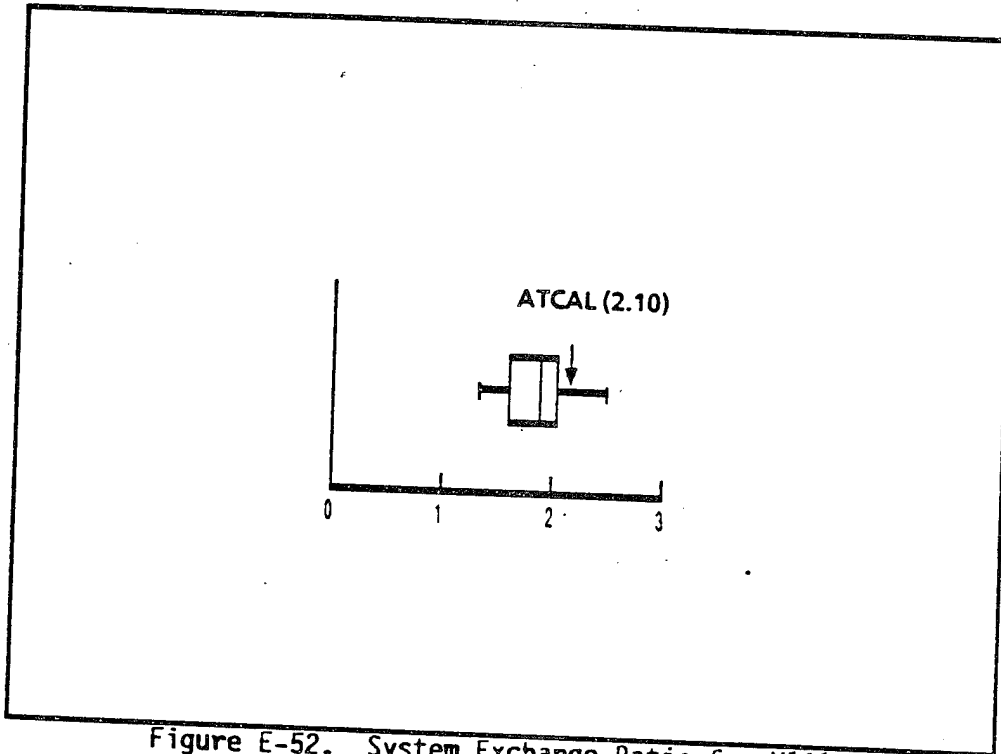

Figure E-52. System Exchange Ratio for MIA1, MIA1/M1

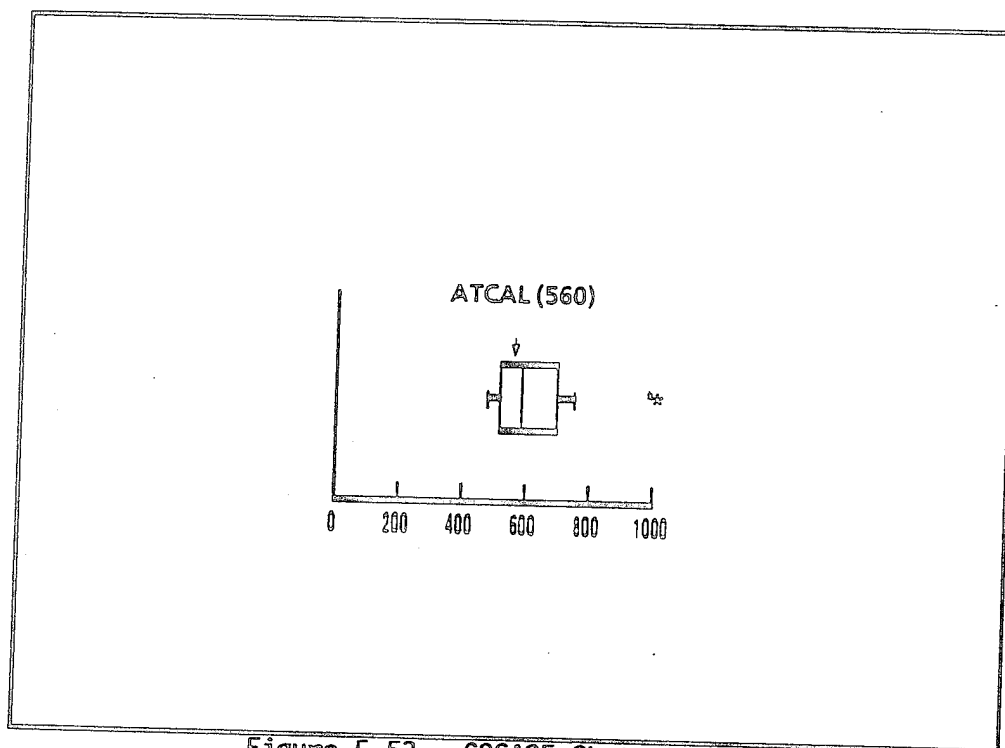

Figure E-53. COSAGE Shots by MI,
MIA1/MI

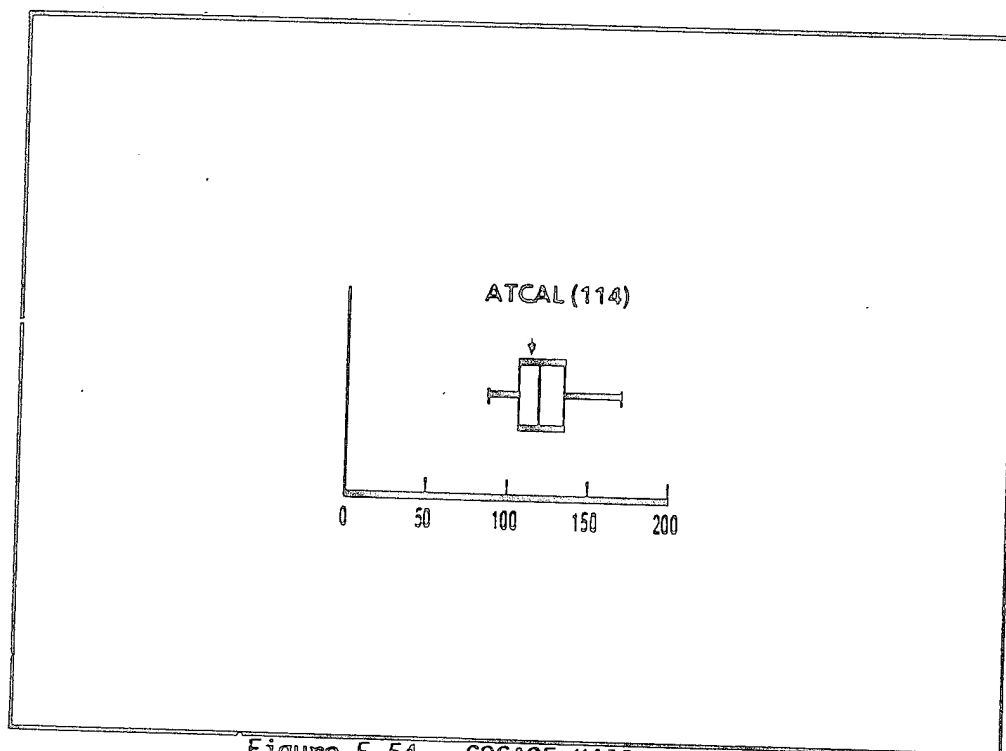

Figure E-54. COSAGE Kills by MI,
MIA1/MI

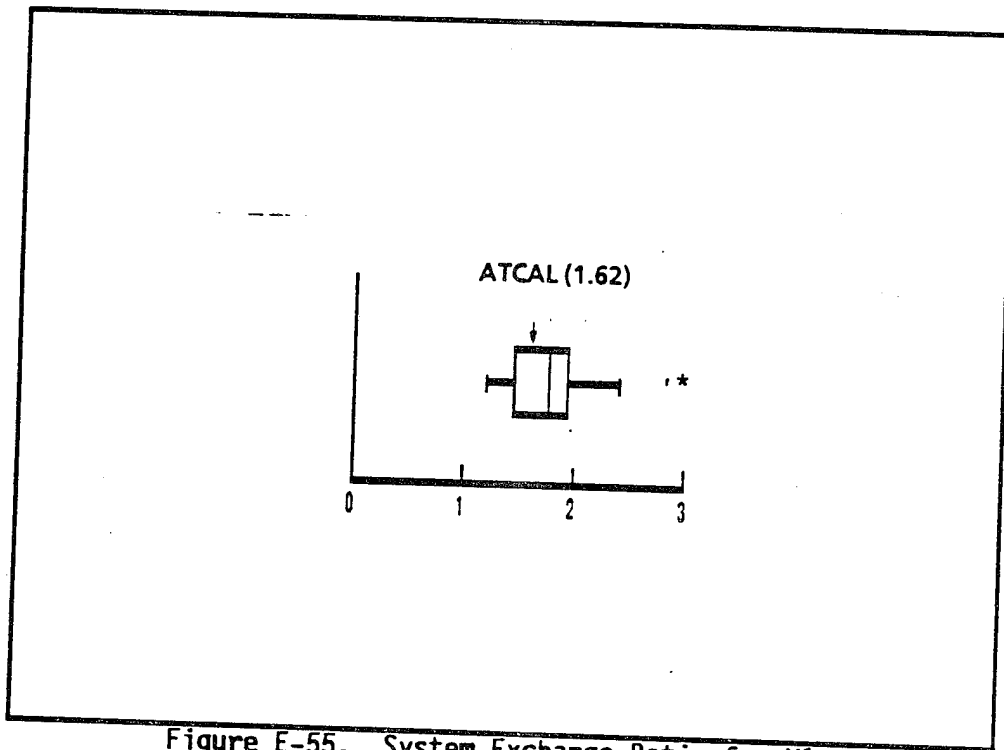

Figure E-55. System Exchange Ratio for M1, MIA1/M1

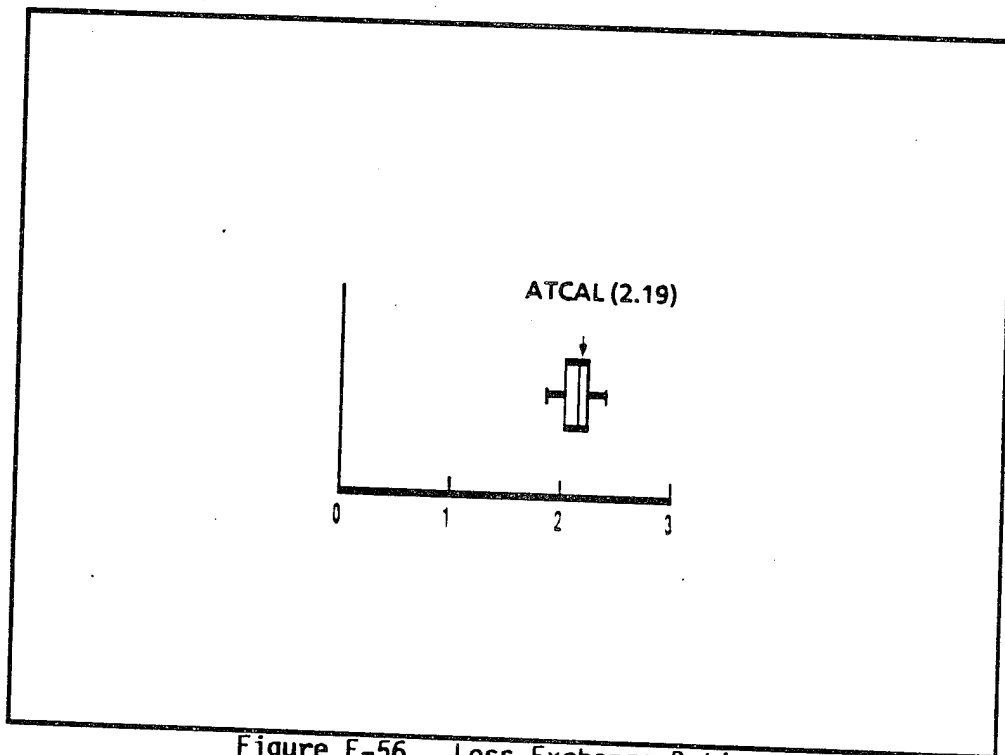

Figure E-56. Loss Exchange Ratio, MIA1/M1

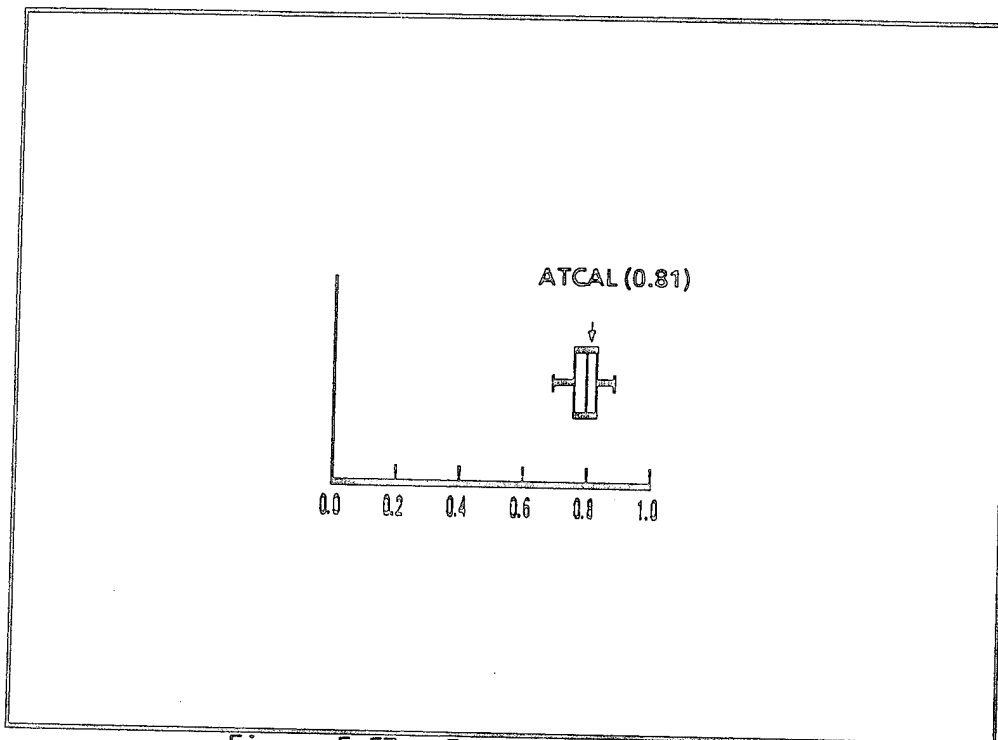

Figure E-57. Force Exchange Ratio,
MIA1/M1

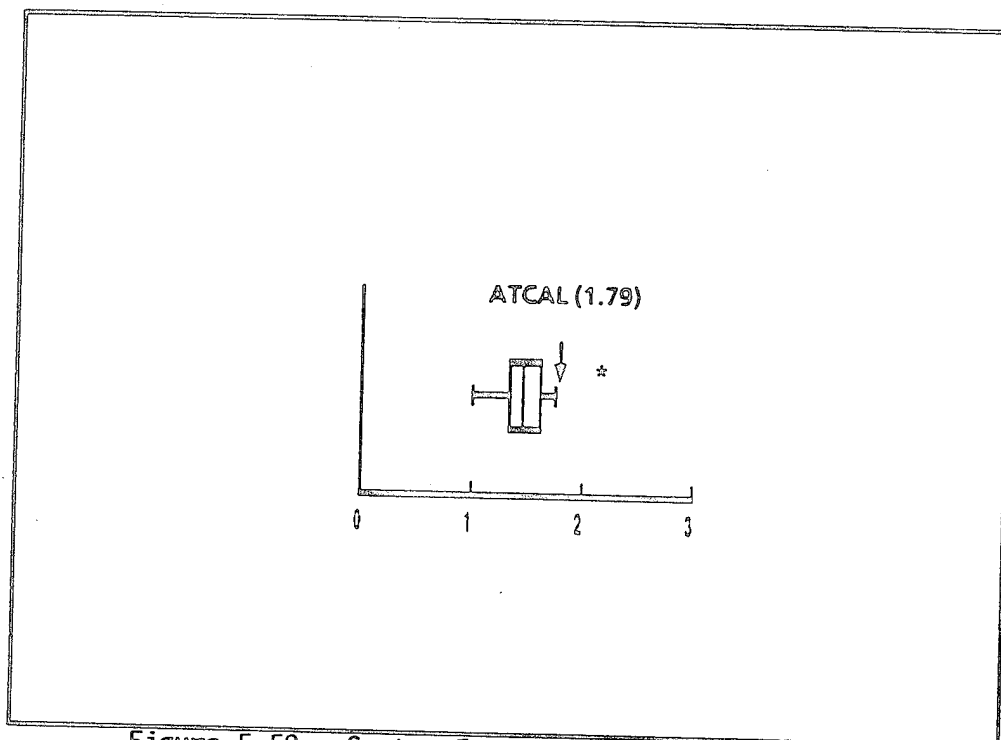

Figure E-58. System Exchange Ratio for M1 Tank,
Brigade Level

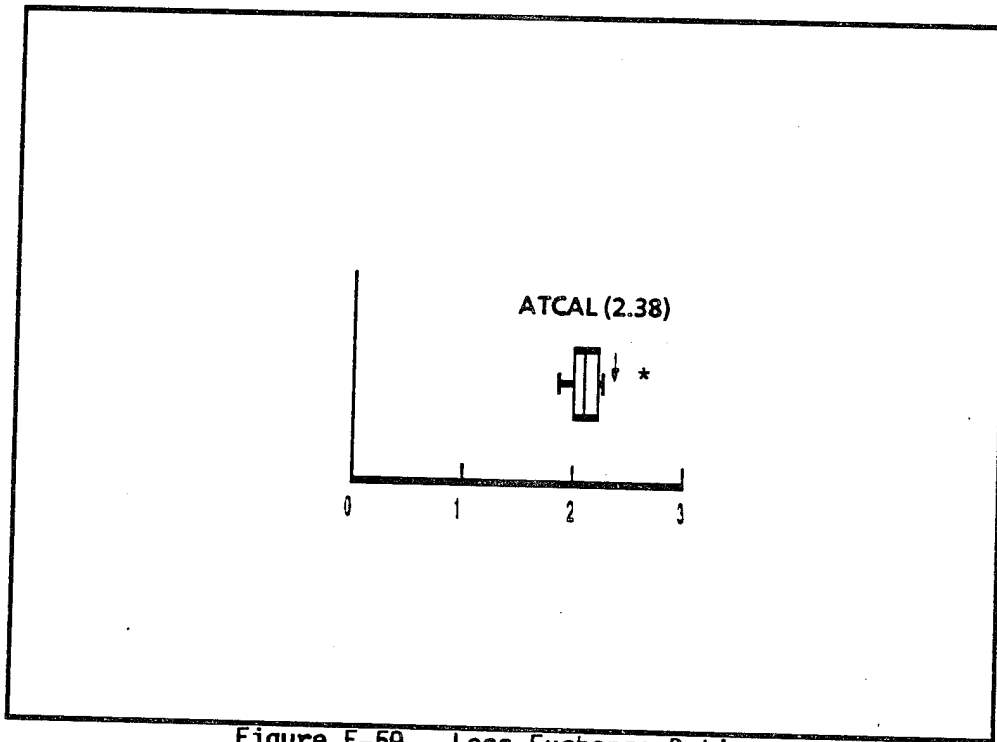

Figure E-59. Loss Exchange Ratio for M1 Brigade

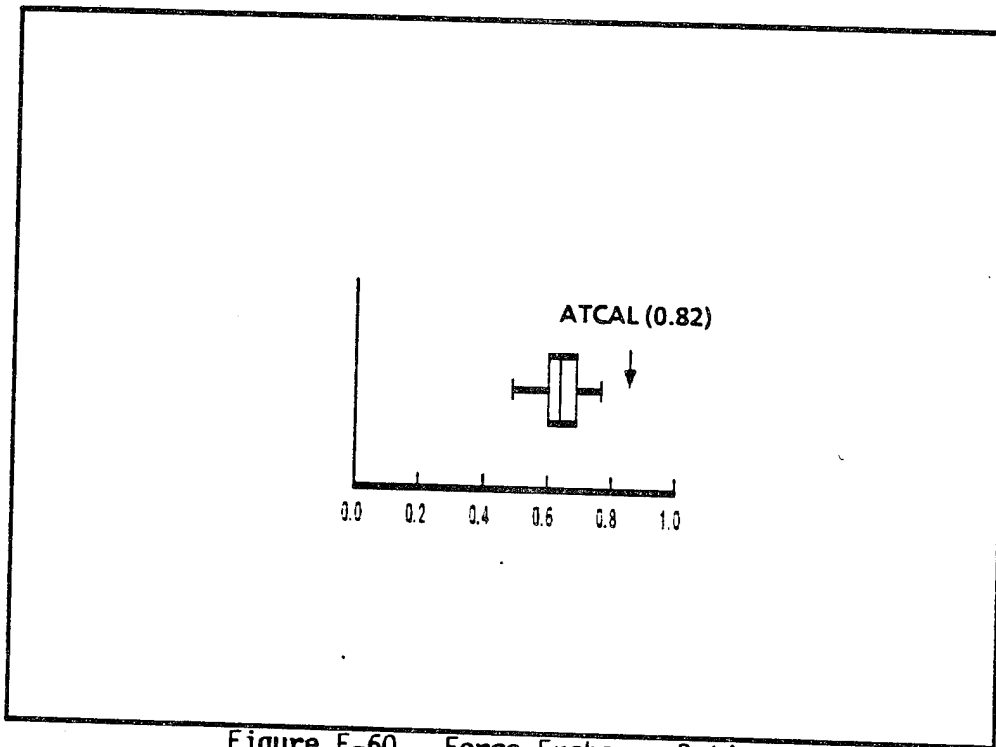

Figure E-60. Force Exchange Ratio for M1 Brigade

APPENDIX F
DISTRIBUTION

Internal distribution	Number of copies
Reference copy:	
Unclassified Library	2
Record copy:	
CSCA-FOT	25

GLOSSARY

1. ABBREVIATIONS, ACRONYMS, AND SHORT TERMS

ATCAL	An Attrition Model using Calibrated Parameters
ATVAL	the Evaluation of ATCAL (study)
FER	force exchange ratio (LER + force ratio)
LER	loss exchange ratio (loss of Blue ÷ loss of Red)
SER	system exchange ratio (kills by system ÷ kills of system)

2. MODELS, ROUTINES, AND SIMULATIONS

CEM VI	Concepts Evaluation Model Version VI - the theater model
COSAGE	Combat Sample Generator
FORCEM	Force Evaluation Model
QUICK SAMPLE	a shorthand surrogate for a combat sample
TAFSM	Field Artillery School Tactical Force Simulation Model

3. DEFINITIONS

calibrated sample

The posture-specific tactical simulation used by ATCAL.

combat sample

The posture-specific output developed by the tactical simulation.

extrapolation

The estimation of a value of a variable outside its tabulated or observed range.

force composition

The types of vehicles which comprise a fighting force, i.e., M1A1 tanks, M2A2 Bradley fighting vehicles, M109A2 howitzers, etc.

force frontage

The frontage shared in common by opposing forces.

force ratio

The fraction of equipment present for battle. Usually calculated as Red divided by Blue.

force size

Number of units per side. This is usually devoted by such names as corps, division, brigade, battalion, etc.

homogeneous

Referring to a force played with one specific type of vehicle as primary; i.e., the only tank type that the force had was the M1A1.

Howard Equations

Working papers written by MAJ Joe Howard in 1983 showing a theoretical alternative to the current method of target availability transformation as a function of changing force frontage.

interaction

The statistic gathered when a type shooter engages and fires at a type target and vice versa. The best interaction is one in which not only are shots exchanged, but one in which kills are also achieved by the firer/target, each to the other.

interpolation

To insert, estimate, or find an intermediate term in a sequence of numbers.

tactical simulation

Any simulation at the tactical level used to drive ATCAL calibration values. During the course of this study, the Combat Sample Generator was used as the simulation of choice.