



The contents of this report are not to be used for advertising, publication, or promotional purposes. Citation of trade names does not constitute an official endorsement or approval of the use of such commercial products.



PRINTED ON RECYCLED PAPER

Technical Report CERC-96-4  
February 1996

# **Redondo Beach, California, 1992-1994 Wave Data**

by Margaret A. Sabol

U.S. Army Corps of Engineers  
Waterways Experiment Station  
3909 Halls Ferry Road  
Vicksburg, MS 39180-6199

**Final report**

Approved for public release; distribution is unlimited

Prepared for U.S. Army Corps of Engineers  
Washington, DC 20314-1000



**US Army Corps  
of Engineers**  
Waterways Experiment  
Station

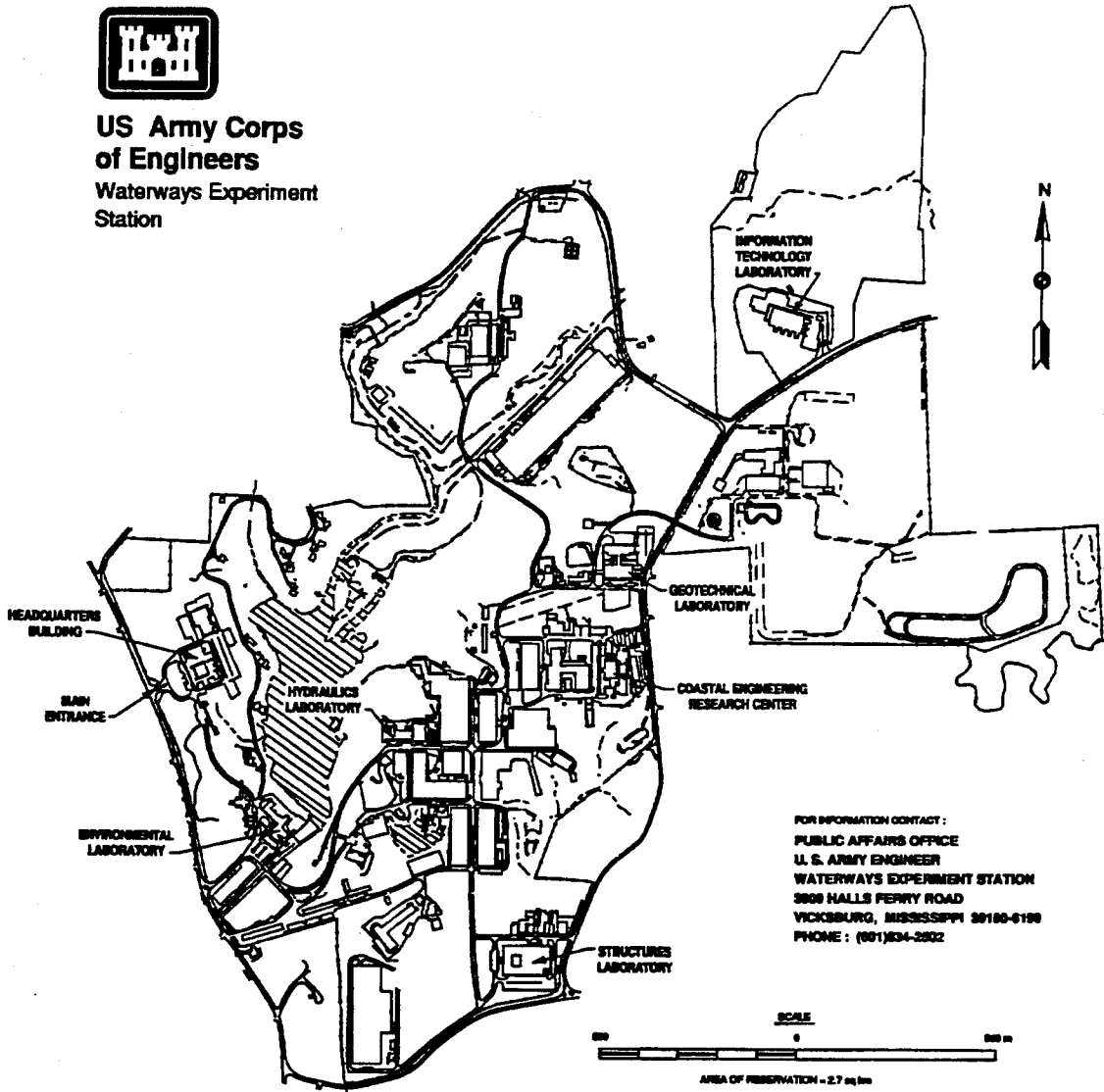

### Waterways Experiment Station Cataloging-in-Publication Data

Sabol, Margaret A.

Redondo Beach, California, 1992-1994 wave data / by Margaret A. Sabol ; prepared for U.S. Army Corps of Engineers.

140 p. : ill. ; 28 cm. — (Technical report ; CERC-96-4)

1. Ocean waves — Measurements. 2. RCPWAVE (Computer program) 3. Breakwaters — California — Redondo Beach. 4. Redondo Beach (Calif.) I. United States. Army. Corps of Engineers. II. U.S. Army Engineer Waterways Experiment Station. III. Coastal Engineering Research Center (U.S. Army Engineer Waterways Experiment Station) IV. Title. V. Series: Technical report (U.S. Army Engineer Waterways Experiment Station) ; CERC-96-4.

TA7 W34 no.CERC-96-4

# Contents

---

Preface .....	v
1—Introduction .....	1
Background .....	1
Nearshore Wave Conditions .....	1
Offshore Wave Conditions .....	1
2—Nearshore Wave Conditions .....	5
Nearshore Gage Description .....	5
Gage Deployment .....	5
3—Data Summary Products .....	7
Description of Parameters .....	7
Description of Products .....	7
Time Series Plots .....	8
Mean/Max Tables .....	8
Percent Occurrence Tables .....	9
Wave Rose Diagrams .....	11
Spectral Density Plots .....	11
Appendix A: North Site, First Deployment .....	A1
Appendix B: North Breakwater Site, First Deployment .....	B1
Appendix C: Near Breakwater Site, First Deployment .....	C1
Appendix D: South Breakwater Site, First Deployment .....	D1
Appendix E: Canyon Site, First Deployment .....	E1
Appendix F: Redondo Site, First Deployment .....	F1
Appendix G: Catalina Ridge Site, First Deployment .....	G1
Appendix H: North Breakwater Site, Second Deployment .....	H1
Appendix I: South Breakwater Site, Second Deployment .....	I1
Appendix J: Redondo Site, Second Deployment .....	J1
Appendix K: Catalina Ridge Site, Second Deployment .....	K1

Appendix L: Additional NDBC Time Series Plots . . . . . L1  
SF 298

# Preface

---

This report is a product of the Redondo Beach, CA, Work Unit of the Monitoring Completed Coastal Projects (MCCP) Program, prepared by the Coastal Engineering Research Center (CERC), U.S. Army Engineer Waterways Experiment Station (WES). The MCCP Program Manager is Ms. Carolyn M. Holmes. Technical monitors of the MCCP Program at Headquarters, U.S. Army Corps of Engineers, are Mr. John H. Lockhart, Jr., Mr. Charles Chesnutt, and Mr. Barry W. Holliday. Dr. Thomas E. White, Prototype Measurement and Analysis Branch (PMAB), Engineering Development Division (EDD), CERC, was the former Principal Investigator and Dr. Joon P. Rhee, PMAB, EDD, CERC is the current Principal Investigator.

This report was prepared by Ms. Margaret A. Sabol, PMAB, under the general supervision of Mr. William L. Preslan, Chief, PMAB, and Mr. Thomas W. Richardson, Chief, EDD. Mr. Charles C. Calhoun, Jr. and Dr. James R. Houston are Assistant Director and Director, respectively, of CERC. Director of WES is Dr. Robert W. Whalin, and Commander is COL Bruce K. Howard, EN.

*The contents of this report are not to be used for advertising, publication, or promotional purposes. Citation of trade names does not constitute an official endorsement or approval of the use of such commercial products.*

# 1 Introduction

---

## Background

Field wave data were acquired at Redondo Beach Breakwater, CA, by the Prototype Measurement and Analysis Branch of the U.S. Army Engineer Waterways Experiment Station Coastal Engineering Research Center as part of the Monitoring Completed Coastal Projects Program. This report summarizes data collected throughout the experiment. The purpose of this study was to provide actual field data to evaluate output from a numerical model, Regional Coastal Processes Wave Transformation Model, which predicts waves propagating through a coastal region of irregular bathymetry. This report contains brief descriptions of the monitoring effort and equipment and provides collected wave information in graphic and tabular form. Statistical analysis of wave data will be provided in a future report.

## Nearshore Wave Conditions

Nearshore and offshore wave conditions at Redondo Beach, CA, were monitored during a 2-year period beginning October 1992 and ending in June 1994. Nearshore gages were deployed at two separate times during the monitoring period in depths of 14 m - 18 m. The first gages were deployed October 1992 through April 1993 and the second deployment was from October 1993 through June 1994.

## Offshore Wave Conditions

Offshore wave conditions were collected from two National Data Buoy Center (NDBC) directional wave buoys. Conditions of waves in intermediate-depth water were provided by NDBC buoy 46045 (Redondo) located in approximately 80 m of water. Deepwater wave data were obtained from NDBC buoy 46025 (Catalina Ridge) at a nominal water depth of 840 m. Locations of the shallow-water gages and NDBC buoys are shown in Table 1 and in Figures 1 and 2.

**Table 1**  
**Gage Information**

<b>Gage Number</b>	<b>Site Designation</b>	<b>Location</b>
RB6	North	33.860 N 118.412 W
020	North Breakwater	33.848 N 118.406 W
153	South Breakwater (PUV)	33.843 N 118.404 W
RB4A	South Breakwater (DWG-1)	33.842 N 118.404 W
RB5	Canyon	33.830 N 118.399 W
030	Near Breakwater	33.846 N 118.401 W
46045	Redondo	33.839 N 118.447 W
46025	Catalina Ridge	33.747 N 119.068 W

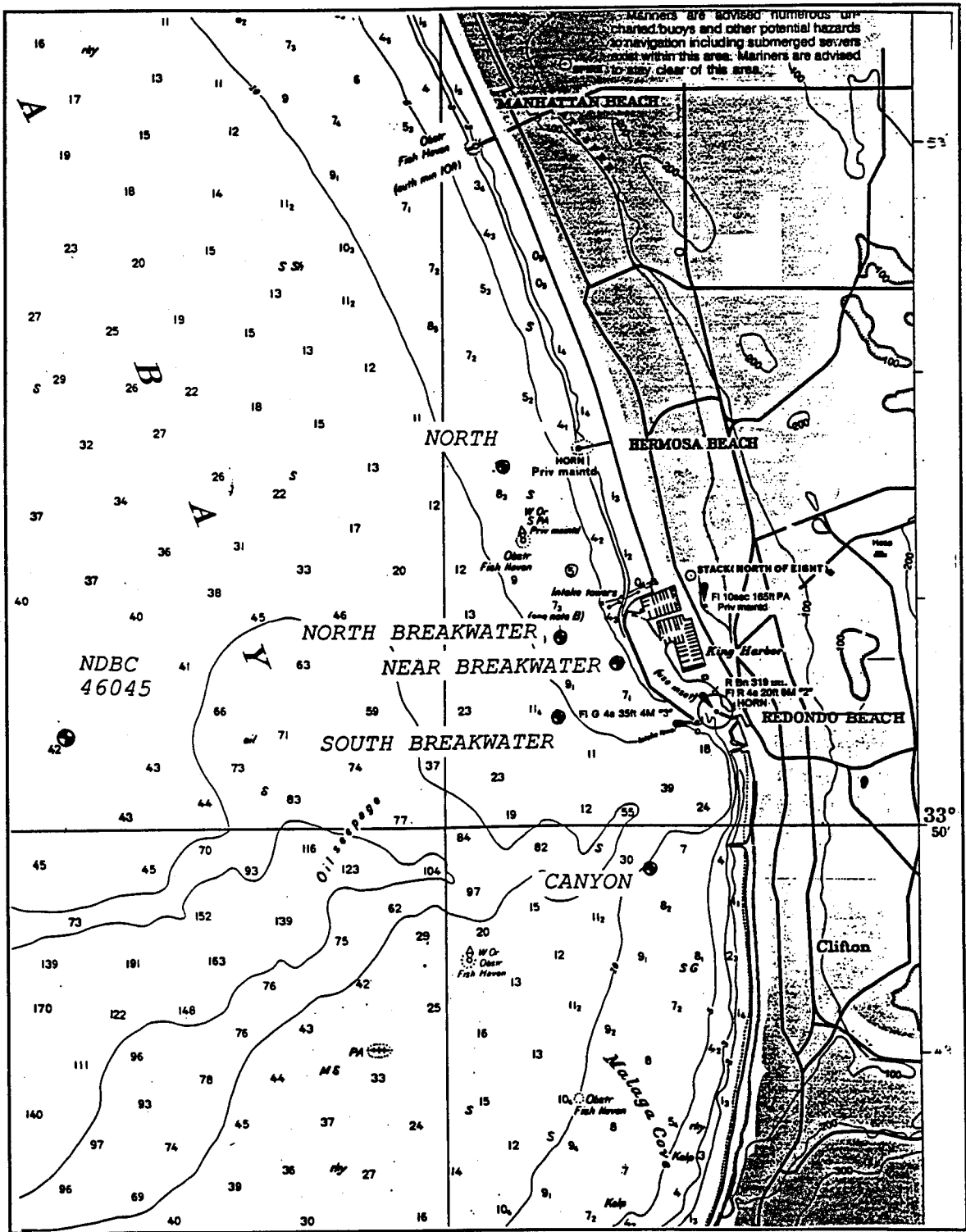

Figure 1. Location of shallow and intermediate-depth gages (soundings in fathoms)

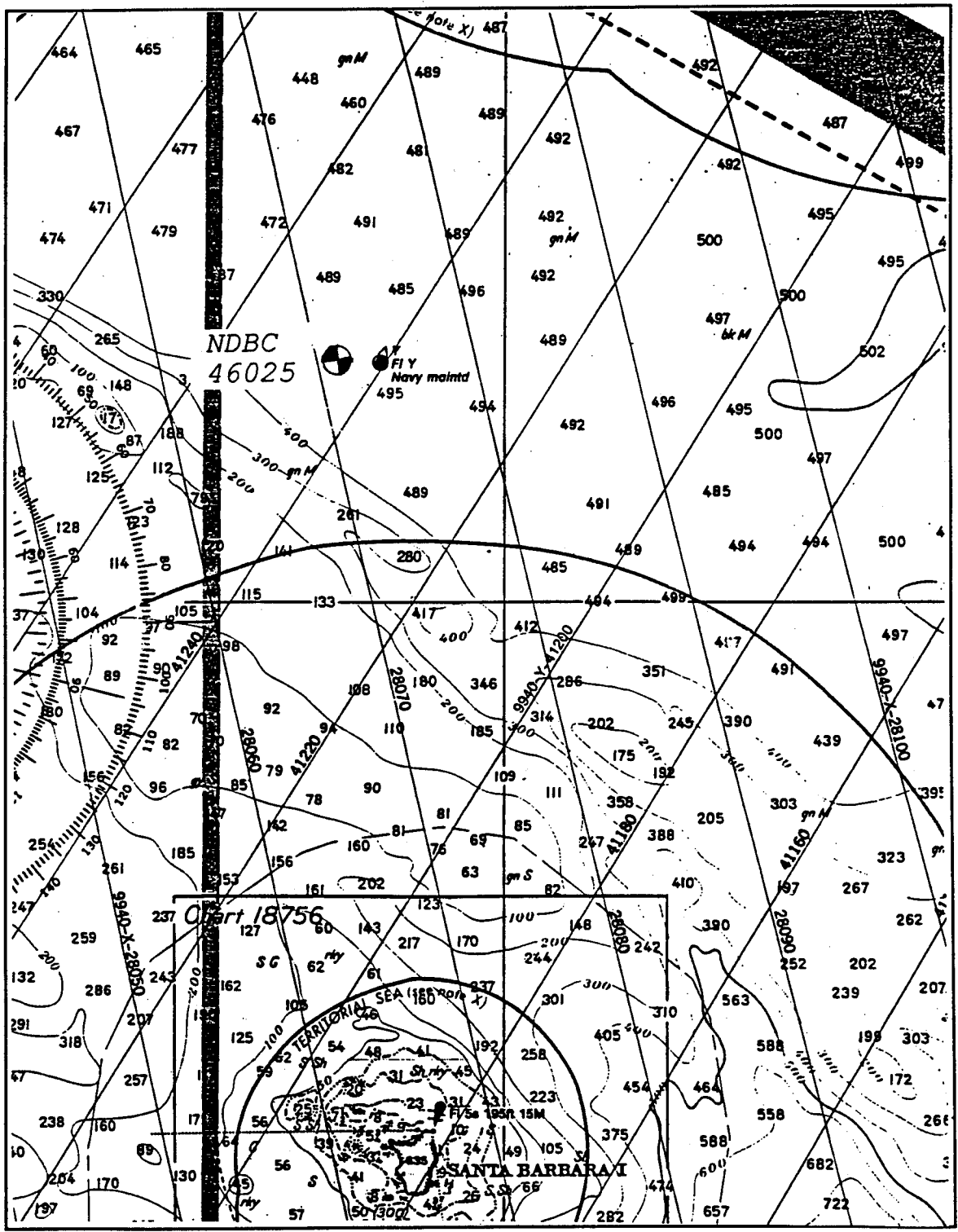

Figure 2. Location of deepwater gage (soundings in fathoms)

## 2 Nearshore Wave Conditions

---

### Nearshore Gage Description

Nearshore wave conditions were monitored using two different self-recording instruments: directional wave gages (DWG-1) and pressure/U-velocity/V-velocity (PUV) gages. Briefly, a DWG-1 simultaneously measures sea-bottom pressure at three locations, internally processes the data, and records cross-power spectra. The array used is a 1.6-m equilateral triangle with a pressure transducer at each corner. Detailed descriptions of the DWG-1 and comparisons of its performance with other directional wave gages can be found in Howell (1992).<sup>1</sup> A PUV stores simultaneous measurements of three time series, the sea bottom hydrodynamic pressure and the two horizontal cross-axis water-particle velocities. Both DWG-1 and PUV used Paroscientific pressure transducers and the PUVs also used Marsh-McBirney electromagnetic current meters.

### Gage Deployment

The first shallow-water gages were deployed in late October 1992 and recovered in mid-April 1993. A total of nine gages were deployed. Gage locations were selected to document variations in wave transformation throughout the area of interest. Site selection was guided by Hales (1987)<sup>2</sup> and U.S. Army Engineer District, Los Angeles (1988)<sup>3</sup>. Gage sites were designated as North (Appendix A), North Breakwater (Appendix B), Near Breakwater (Appendix C), South Breakwater (Appendix D), and Canyon (Appendix E), (see Table 1 for locations). The highest waves due to refraction

---

<sup>1</sup> Howell, G. L. (1992). "A new nearshore directional wave gage." *Proceedings, 23rd International Conference on Coastal Engineering, Venice, Italy*. Vol 1, 297-307.

<sup>2</sup> Hales, L. Z. (1987). "Water wave effects at Redondo Beach King Harbor, California," Miscellaneous Paper CERC-87-2, U.S. Army Engineer Waterways Experiment Station, Vicksburg, MS.

<sup>3</sup> U.S. Army Engineer District, Los Angeles. (1988). "Feasibility report storm damage reduction, Redondo Beach -- King Harbor Area, Los Angeles County, CA." Los Angeles, CA.

would be expected between the North breakwater site (west of the curved portion of the north breakwater) and the South Breakwater site (west of the south end of the north breakwater). The North Breakwater and South Breakwater sites were chosen to monitor this concentrated wave energy. The Canyon site (located near the tip of the Redondo Canyon) was selected to measure wave energy affected by divergence over the submarine canyon. The North site (north of the harbor) was chosen to measure waves at a great distance from the Redondo canyon.

Gages were set out in pairs, with one PUV and one DWG-1 gage at each site except at the Near Breakwater site, where only a PUV gage was deployed. Data were collected from both gage types and the gage type that produced the most data was chosen as the representative data set for that site. All sites with both DWG-1s and PUVs had at least one complete data set. Both NDBC buoys provided a complete data set for the first monitoring period. First deployment data can be found in Tables A1, A2, B1, B2, C1, C2, D1, D2, E1, E2, F1, F2, G1, and G2 and Figures A1-A6, B1-B7, C1-C4, D1-D6, E1-E6, F1-F7, and G1-G7.

The second gage deployment period was from mid-October 1993 through early June 1994. A pair of gages was installed at the South Breakwater site and single gages were installed at the North, North Breakwater, and Canyon sites. NDBC buoys 46045 and 46025 also provided data for most of the deployment period. Data from both NDBC buoys as well as from the South Breakwater and North Breakwater sites are provided to illustrate wave conditions during the second deployment period. Second deployment data are displayed in Tables H1, H2, I1, I2, J1, J2, K1, and K2 and Figures H1, H2, I1-I9, J1-J10, and K1-K6.

Data were obtained from both NDBC buoys during the entire 2-year period (October 1992 - September 1994). Time series plots of data not coincident with deployment of shallow-water gages may be found in Appendix L.

# 3 Data Summary Products

---

## Description of Parameters

The standard parameters reported in this document are wave height, period, and direction. These parameters are derived from a two-dimensional power density spectrum of the sea surface using spectral analysis of the sensors' output and linear wave theory. The parameters are defined as follows (see the *Shore Protection Manual*<sup>1</sup> for additional information):

- a. Wave Height,  $H_{m0}$ : Spectrally derived wave height, in meters; equivalent to time-domain-derived significant wave height in deep water.
- b. Wave period  $T_p$ : Peak spectral period, in seconds; inverse of the frequency of the peak (highest energy) of the one-dimensional power spectrum.
- c. Wave Direction,  $D_p$ : Peak spectral direction, in degrees clockwise from true North; mean direction *from which* energy is coming at the peak of the one-dimensional power spectrum.

Missing data and data that failed to pass quality control tests are excluded from the summaries.

## Description of Products

The following five types of data summary products are provided in this report:

- a. Time series plots.
- b. Mean/max tables.

---

<sup>1</sup> *Shore Protection Manual*. (1984). 4th Ed., 2 Vols., U.S. Army Engineer Waterways Experiment Station, Coastal Engineering Research Center, U.S. Government Printing Office, Washington, DC.

- c. Percent occurrence tables.
- d. Wave rose plots.
- e. Sample spectral density plots.

Descriptions and examples of products are presented in the following sections of the report.

## Time Series Plots

Time series plots included in this report indicate wave information collected for each gage and buoy. The plots consist of three separate sets of axes showing  $H_{m0}$ ,  $T_p$ , and  $D_p$  for a calendar month. Different gage types collected wave data on different time schedules. The DWG-1s and NDBC buoys collected data hourly. The PUV gages collected data every 3 hr. The plots of  $H_{m0}$  and  $T_p$  show these individual readings connected by a continuous line. The lines are continuous as long as the data were received at the expected time intervals. The line appears broken if there is one or more missed data point. For  $H_{m0}$  and  $T_p$ , isolated points of data appear as individual symbols. The plot of  $D_p$  shows individual readings designated with a plus (+) symbol instead of a continuous line.

Time series plots of NDBC data show an  $H_{m0}$  cutoff of 0.15 m and a  $T_p$  cutoff of 2.78 sec. This means that if the  $H_{m0}$  is less than 0.15 m, no  $T_p$  or  $D_p$  will be reported. When the  $T_p$  is less than 2.78 sec, no  $D_p$  will be reported. These limitations are imposed by NDBC.

## Mean/Max Tables

The mean/max tables indicate mean and maximum  $H_{m0}$  by month for the monitoring period. A mean  $H_{m0}$  is included. Other statistics listed in this table are mean  $T_p$  (in seconds); center of most frequent 22.5-deg direction band for directional gages (in degrees azimuth); standard deviation of  $H_{m0}$  and  $T_p$ ; and largest  $H_{m0}$  along with its associated  $T_p$ ,  $D_p$ , and the date of the occurrence.

The mean/max table for Gage RB6, North Site (Table A1) indicates that while the largest mean  $H_{m0}$ , 1.2 m, occurred in February 1993, the largest  $H_{m0}$ , 2.7 m, occurred on March 1993 at 600 hr Universal Coordinated Time (UTC), with an associated  $T_p$  of 8.0 sec and  $D_p$  of 260 deg.

## Percent Occurrence Tables

Percent occurrence tables indicate the percent (times 100) of the total number of wave records for a given site that have a specified  $H_{m0}$  and  $T_p$ . Tables that depict the heights and period occurrences irrespective of direction are provided for all wave gage stations. Each listed percent value reflects the percent occurrence of waves at a particular  $H_{m0}$  and  $T_p$  compared to all waves for which  $H_{m0}$  was computed. For nearshore gages, height bands are 0.5-m increments; period bands are ten uneven increments from below 4.5 sec to above 18.4 sec (Table 2). Offshore gages have height bands in 1-m increments (to account for larger waves found offshore) with ten period bands at

Table 2 Frequency Ranges Used In Nearshore Data Analysis			
Midband		Band Range for Period, sec	Grouping for Percent Occurrence Tables, sec
Frequency, Hz	Period, sec		
0.320	3.1	$3.0 \leq T_p < 3.1$	3.0 - 4.5
.	.	.	
0.222	4.5	$4.4 \leq T_p < 4.6$	4.6 - 5.6
0.213	4.7	$4.6 \leq T_p < 4.8$	
0.203	4.9	$4.8 \leq T_p < 4.9$	
0.200	5.0	$4.9 \leq T_p < 5.1$	
0.187	5.3	$5.1 \leq T_p < 5.4$	
0.182	5.5	$5.4 \leq T_p < 5.6$	5.6 - 8.0
0.175	5.7	$5.6 \leq T_p < 5.8$	
0.167	6.0	$5.8 \leq T_p < 6.1$	
0.161	6.2	$6.1 \leq T_p < 6.4$	
0.152	6.6	$6.4 \leq T_p < 6.8$	
0.143	7.0	$6.8 \leq T_p < 7.1$	
0.137	7.3	$7.1 \leq T_p < 7.5$	
0.128	7.8	$7.5 \leq T_p < 8.0$	8.0 - 10.6
0.120	8.3	$8.0 \leq T_p < 8.6$	
0.111	9.0	$8.6 \leq T_p < 9.2$	
0.105	9.5	$9.2 \leq T_p < 9.8$	
0.097	10.3	$9.8 \leq T_p < 10.6$	10.6 - 11.6
0.091	11.0	$10.6 \leq T_p < 11.6$	
0.082	12.2	$11.6 \leq T_p < 12.7$	
0.074	13.6	$12.7 \leq T_p < 14.1$	
0.066	15.1	$14.1 \leq T_p < 15.9$	
0.058	17.1	$16.0 \leq T_p < 18.3$	
0.050	19.8	$18.4 \leq T_p < 21.3$	
.	.	.	16.0 - 18.3
0.027	36.4	$32.0 \leq T_p < 40.9$	
.	.	.	18.4 - longer
.	.	.	

uneven increments from below 6.9 sec to above 18.2 sec (Table 3). Totals of the height category are provided at the right of each height row. Totals for each period range are at the bottom of each period column. Results are in summary form at the bottom of the tables showing the mean  $H_{m0}$  and  $T_p$ , the largest  $H_{m0}$ , and the total number of cases represented by the table.

<b>Table 3 Frequency Ranges Used In Offshore Data Analysis</b>			
<b>Midband</b>		<b>Band Range for Period, sec</b>	<b>Grouping for Percent Occurrence Tables, sec</b>
<b>Frequency, Hz</b>	<b>Period, sec</b>		
0.400	2.5	$2.22 \leq T_p < 2.86$	<6.9
0.160	4.5	$6.06 \leq T_p < 6.45$	
0.150	6.7	$6.45 \leq T_p < 6.90$	6.9 - 8.0
0.140	7.1	$6.90 \leq T_p < 7.41$	
0.130	7.7	$7.41 \leq T_p < 8.00$	
0.120	8.3	$8.00 \leq T_p < 8.70$	8.1 - 8.7
0.110	9.1	$8.70 \leq T_p < 9.52$	8.8 - 9.5
0.100	10.0	$9.52 \leq T_p < 10.53$	9.6 - 10.5
0.090	11.1	$10.53 \leq T_p < 11.76$	10.6 - 11.7
0.080	12.5	$11.76 \leq T_p < 13.33$	11.8 - 13.3
0.070	14.3	$13.33 \leq T_p < 15.38$	13.4 - 15.3
0.060	16.7	$15.38 \leq T_p < 18.18$	15.4 - 18.1
0.050	20.0	$18.18 \leq T_p < 22.22$	18.2 - longer
0.040	25.0	$22.22 \leq T_p < 28.57$	
0.030	33.3	$28.57 \leq T_p < 40.00$	

In order to determine what percent of the wave records from Gage 030, Near Breakwater, have an  $H_{m0}$  of 2.0 - 2.4 m with a  $T_p$  of 5.6 - 8.0 sec, the percent occurrence table for that station (Table C2) is consulted. The value 34 is found where the 2.0- to 2.4-m height row intersects with the 5.6- to 8.0-sec period column. Divide this number by 100 to get the percent. Thus, 5.6- to 8-sec waves from 2 to 2.4 m would be expected only about 0.34 percent of the time.

## Wave Rose Diagrams

The wave rose diagrams indicate mean  $H_{m0}$  and the compass direction from which the waves are coming. The scale of the rose is set so the outer edge

will be slightly larger than the largest mean wave height for the given wave gage station. Three evenly spaced concentric circles within the rose delineate lesser mean wave heights. The value indicated by each circle is differentiated through the use of a distinct line type. Wave directions are grouped in 22.5-deg bands centered on 0, 22.5, 45 deg, etc. Mean  $H_{m0}$  and percent of samples for each direction band are represented in the wedge-shaped portions of the rose plots. The length (or radius) of the wedge describes the mean  $H_{m0}$ , while the shading of the wedge tells what percent of the samples come from that direction. Only data records that have both  $D_p$  and  $H_{m0}$  are used in developing the wave roses.

The wave rose diagram for Gage RB5, Canyon (Figure E6), indicates a mean  $H_{m0}$  of 0.92 m for the azimuth band centered on 270 deg; and for this time interval, more than 15 percent of the  $D_p$  values are within the 270-deg azimuth band. This wave rose diagram also tells at a glance that no waves of any size occurred from the south through the southeast.

## Spectral Density Plots

Because of their bulk, all of the spectral data cannot be included in this report. Characteristic spectra are shown in Figure 3. The example provided illustrates characteristic long-period swell propagation from deep to shallow water. The three-dimensional axes show frequency (Hertz) on the x axis, elapsed time (hours) on the y axis and energy density ( $m^2/Hz$ ) on the z axis. Plots show spectral density for the deepwater NDBC buoy (46025) (North Breakwater site and Canyon site) for the period 1-10 February 1993.

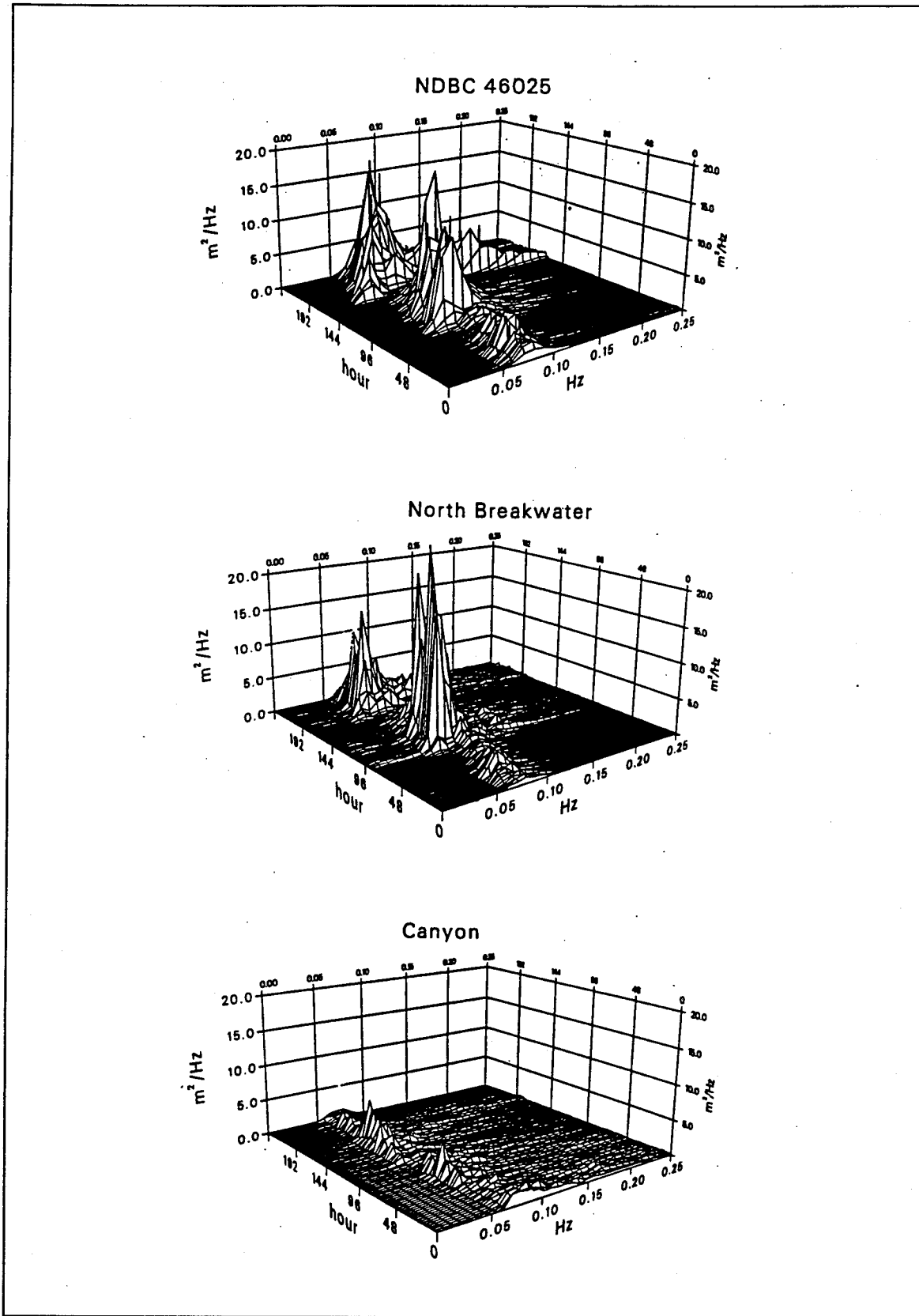

Figure 3. Example swell spectra, 1-10 February 1993

# **Appendix A**

## **North Site, First Deployment**

---

NORTH  
GAGE #RB6  
33.86 N 118.41 W

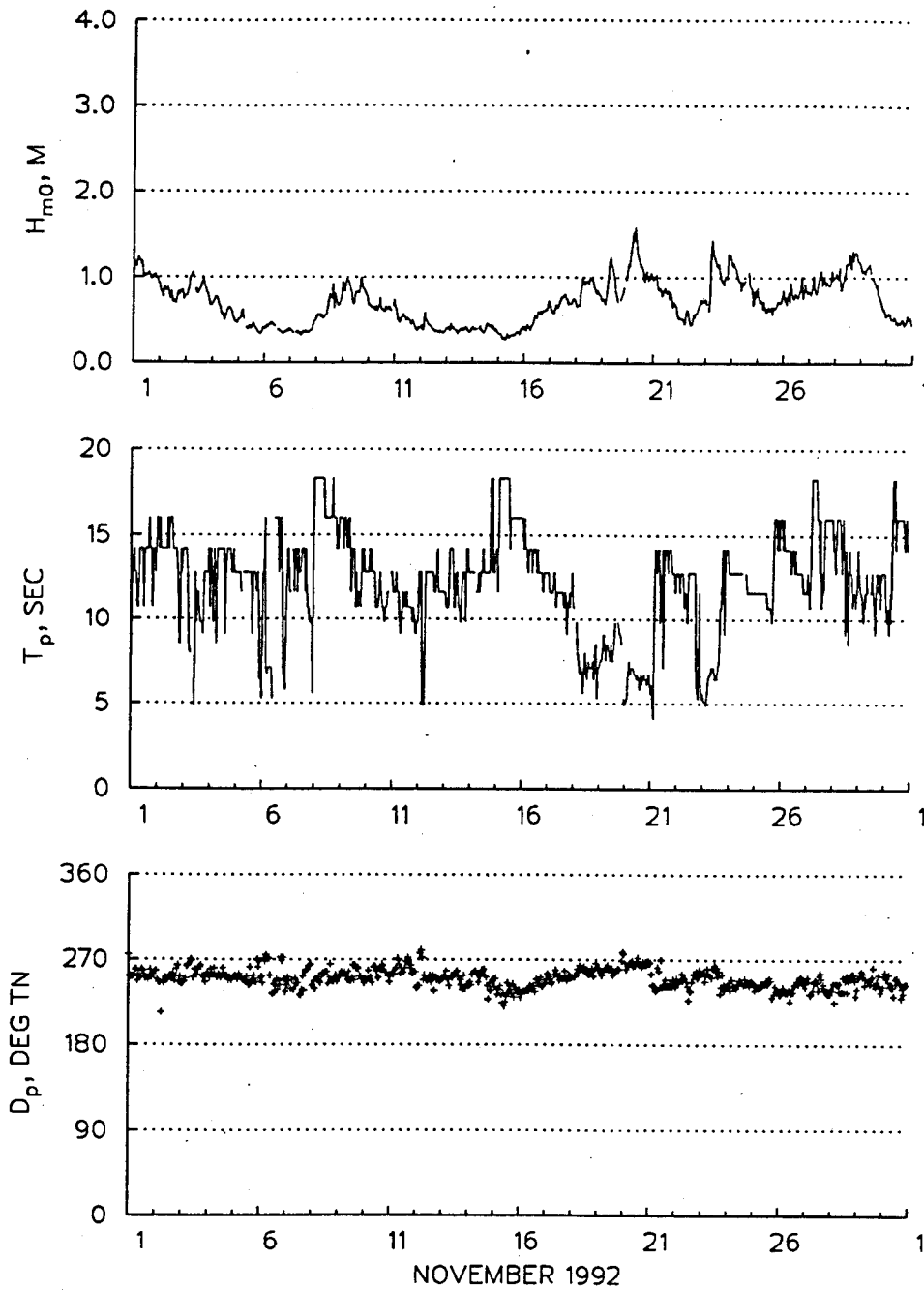

Figure A1. Time series plot for North (gauge RB6), November 1992, first deployment

A2

NORTH  
GAGE #RB6  
33.86 N 118.41 W

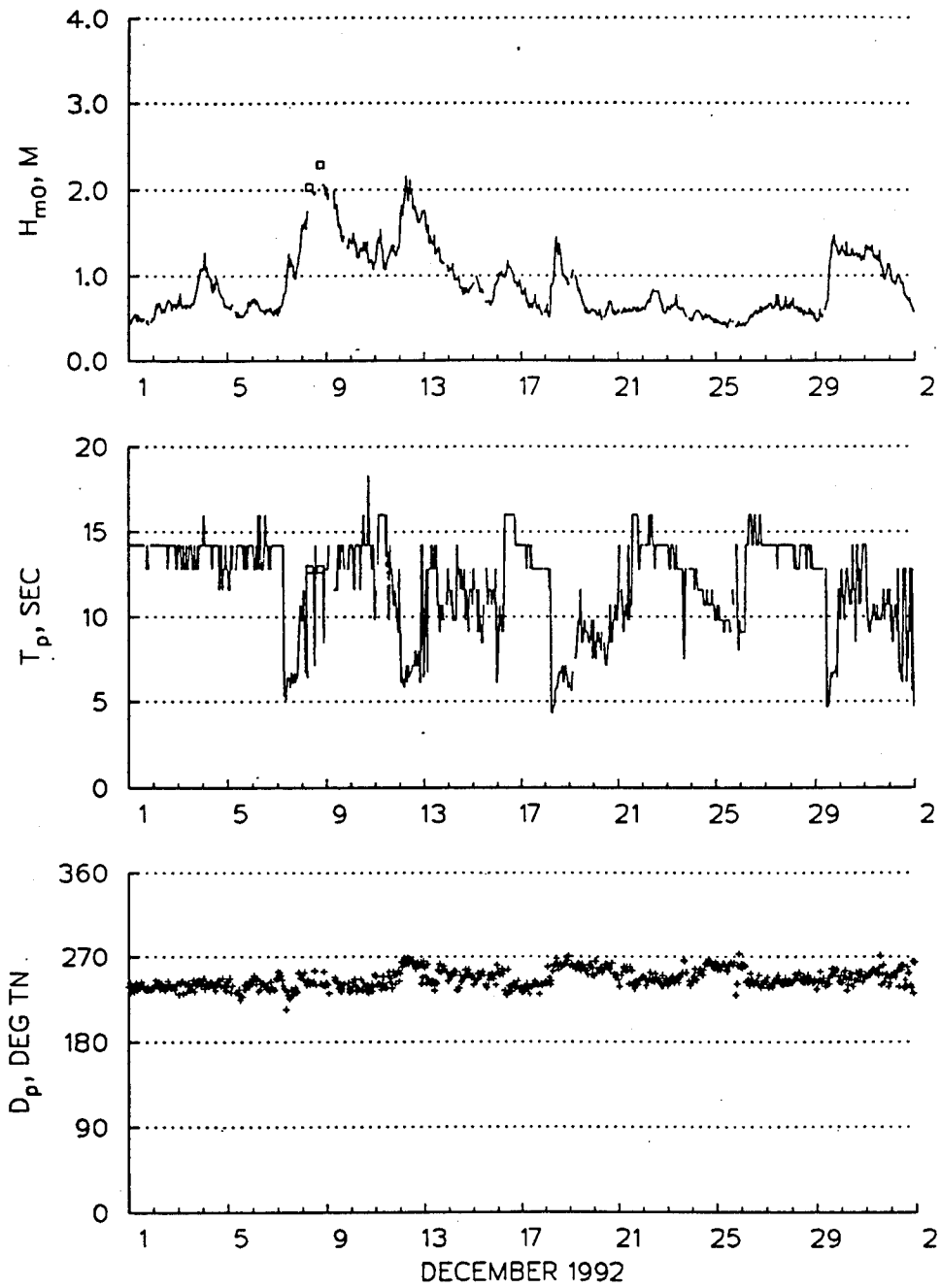

Figure A2. Time series plot for North (RB6) gage, December 1992, first deployment

NORTH  
GAGE #RB6  
33.86 N 118.41 W

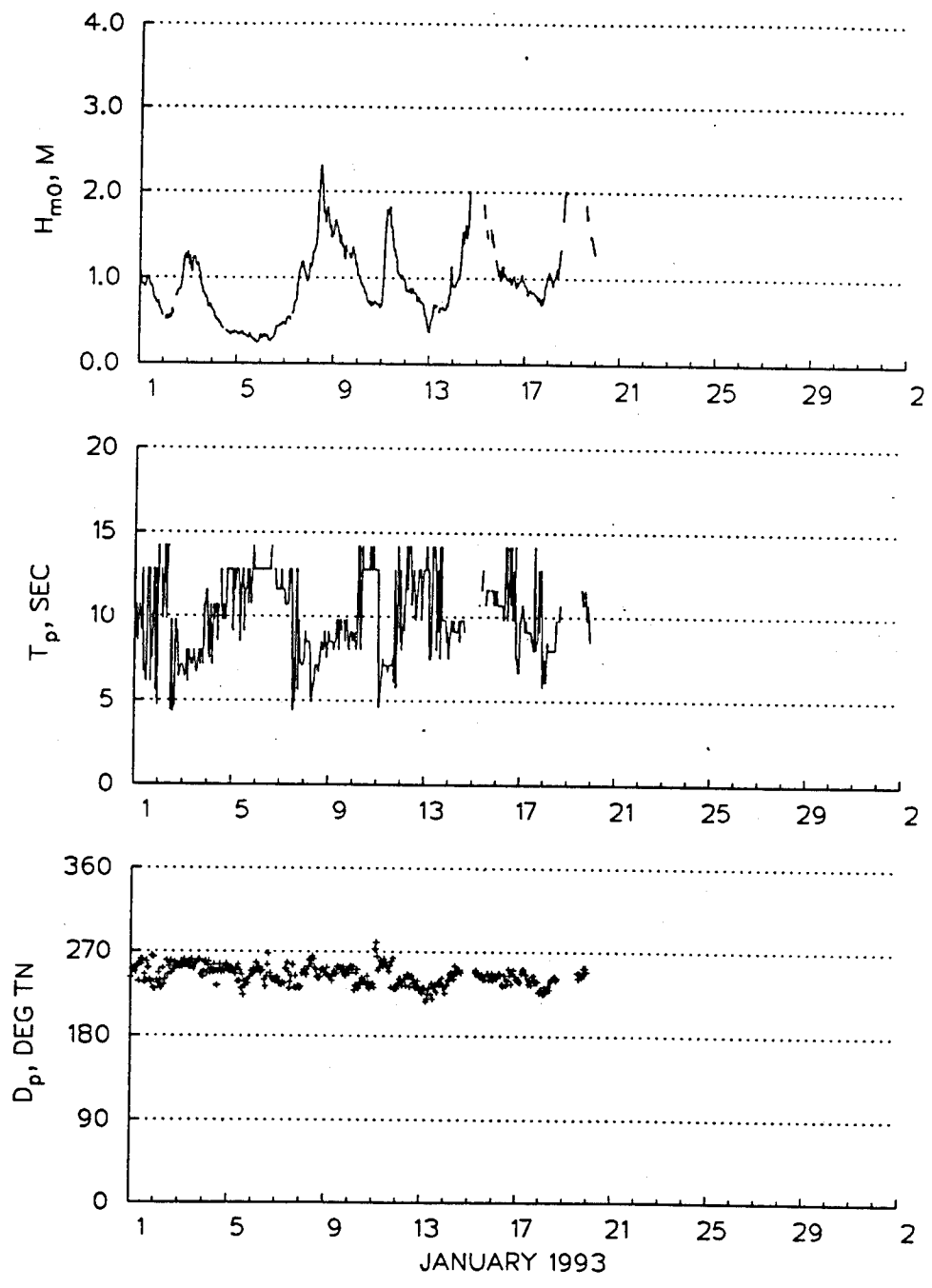

Figure A3. Time series plot for North (RB6) gage, January 1993, first deployment

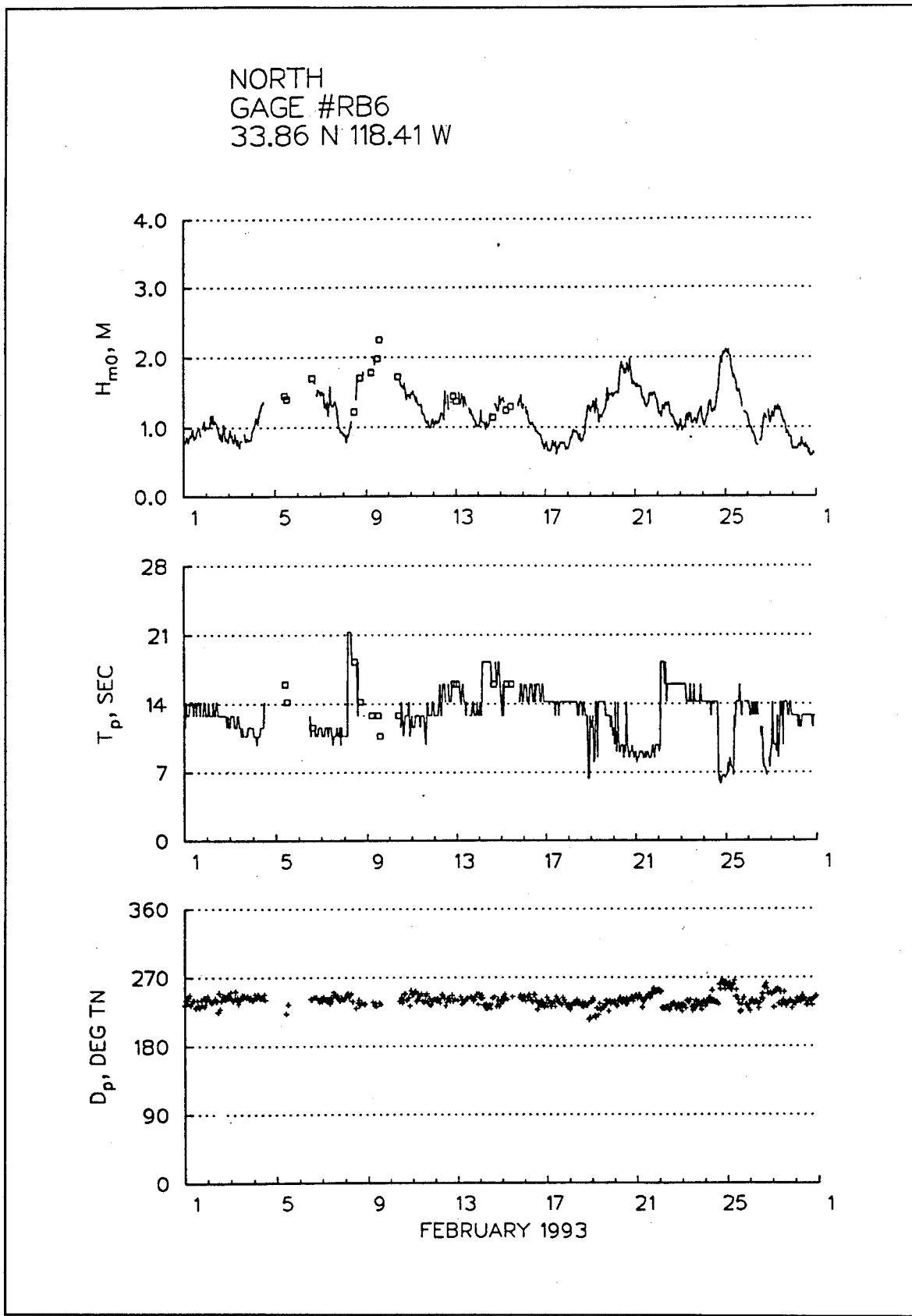

Figure A4. Time series plot for North (RB6) gage, February 1993, first deployment

NORTH  
GAGE #RB6  
33.86 N 118.41 W

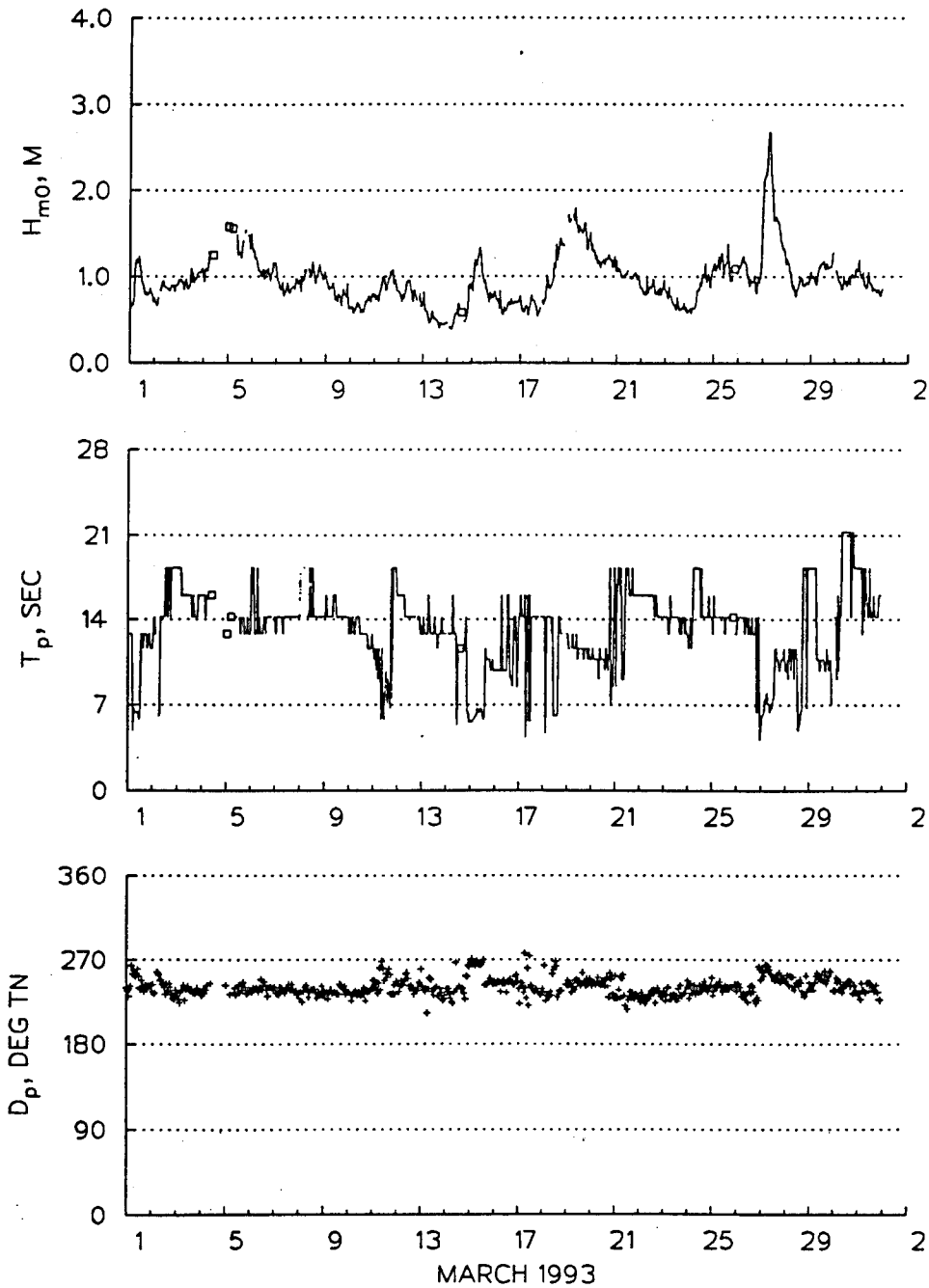

Figure A5. Time series plot for North (RB6) gage, March 1993, first deployment

A6

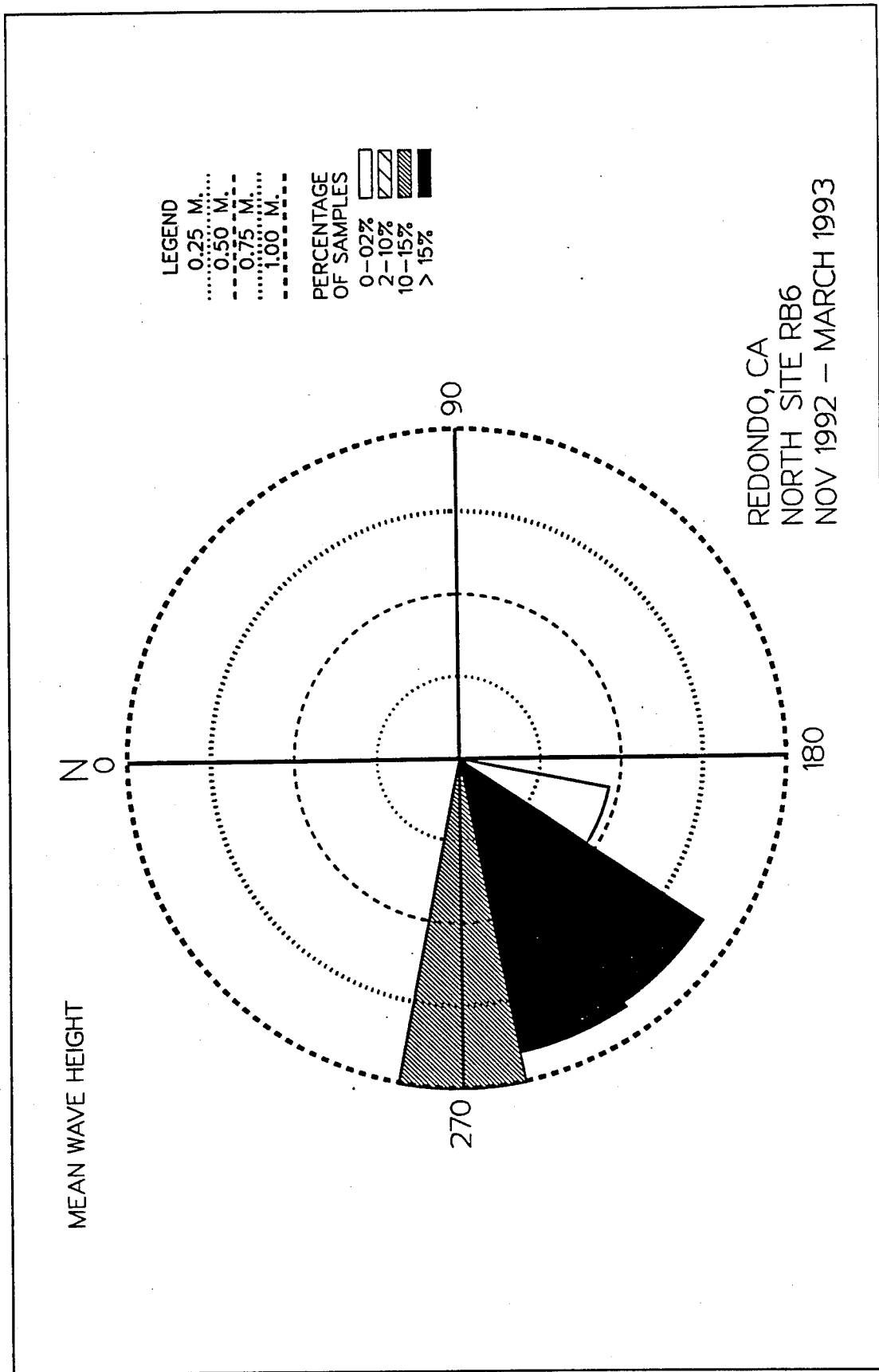

Figure A6. Wave rose for North (RB6) gage, first deployment

**Table A1**  
**Mean/Max Values for North (RB6)**  
**First Deployment**

MEAN Hm0(meters) BY MONTH AND YEAR  
 NORTH (33.86N 118.41W)

YEAR	MONTH												MEAN
	JAN	FEB	MAR	APR	MAY	JUN	JUL	AUG	SEP	OCT	NOV	DEC	
1992	.	.	.	.	.	.	.	.	.	.	0.7	0.9	0.8
1993	0.9	1.2	1.0	.	.	.	.	.	.	.	.	.	1.0
MEAN	0.9	1.2	1.0	.	.	.	.	.	.	.	0.7	0.9	

LARGEST Hm0(METERS) BY MONTH AND YEAR  
 NORTH (33.86N 118.41W)

YEAR	MONTH											
	JAN	FEB	MAR	APR	MAY	JUN	JUL	AUG	SEP	OCT	NOV	DEC
1992	.	.	.	.	.	.	.	.	.	.	1.6	2.3
1993	2.3	2.3	2.7	.	.	.	.	.	.	.	.	.

STATISTICS FOR NORTH (33.86N 118.41W)

THE MEAN SIGNIFICANT WAVE HEIGHT(METERS) =	0.9
THE MEAN PEAK WAVE PERIOD (SECONDS) =	12.2
THE MOST FREQUENT 22.5(CENTER) DIRECTION BAND (DEGREES) =	247.5
THE STANDARD DEVIATION OF Hm0(METERS) =	0.4
THE STANDARD DEVIATION OF TP(SECONDS) =	3.1
THE LARGEST Hm0(METERS) =	2.7
THE TP(SECONDS) ASSOC. WITH THE LARGEST Hm0 =	8.0
THE PEAK DIRECTION (DEGREES) ASSOC. WITH THE LARGEST Hm0 =	260.0
THE DATE OF LARGEST Hm0 OCCURRENCE IS	93032706

**Table A2**  
**Percent Occurrence for North (RB6)**  
**First Deployment**

NORTH		33.86N 118.41W IRRESPECTIVE OF DIRECTION									
		NOVEMBER 1992 - MARCH 1993									
		PERCENT OCCURRENCE(X100) OF HEIGHT AND PERIOD									
HEIGHT(METERS)	PEAK PERIOD(SECONDS)										TOTAL
	SHORTER- 4.5	4.6- 5.6	5.6- 8.0	8.0- 10.6	10.7- 11.6	11.6- 12.7	12.8- 14.1	14.2- 15.9	16.0- 18.3	18.4- LONGER	
0.0-0.4	.	9	38	142	87	161	417	171	97	.	1122
0.5-0.9	19	71	372	575	300	491	1132	1643	436	35	5074
1.0-1.4	6	38	427	494	287	213	452	744	333	48	3042
1.5-1.9	.	6	139	161	42	109	100	58	9	.	624
2.0-2.4	.	.	67	16	6	.	19	.	.	.	108
2.5-2.9	.	.	6	3	.	.	.	.	.	.	9
3.0-3.4	.	.	.	.	.	.	.	.	.	.	0
3.5-3.9	.	.	.	.	.	.	.	.	.	.	0
4.0-4.4	.	.	.	.	.	.	.	.	.	.	0
4.5-4.9	.	.	.	.	.	.	.	.	.	.	0
5.0+	.	.	.	.	.	.	.	.	.	.	0
TOTAL	25	124	1049	1391	722	974	2120	2616	875	83	

MEAN Hm0 (M) = 0.9    LARGEST Hm0 (M) = 2.7    MEAN TP (SEC) = 12.2    TOTAL CASES = 3091.

# **Appendix B North Breakwater Site, First Deployment**

---

NORTH BREAKWATER  
GAGE #020  
33.85 N 118.41 W

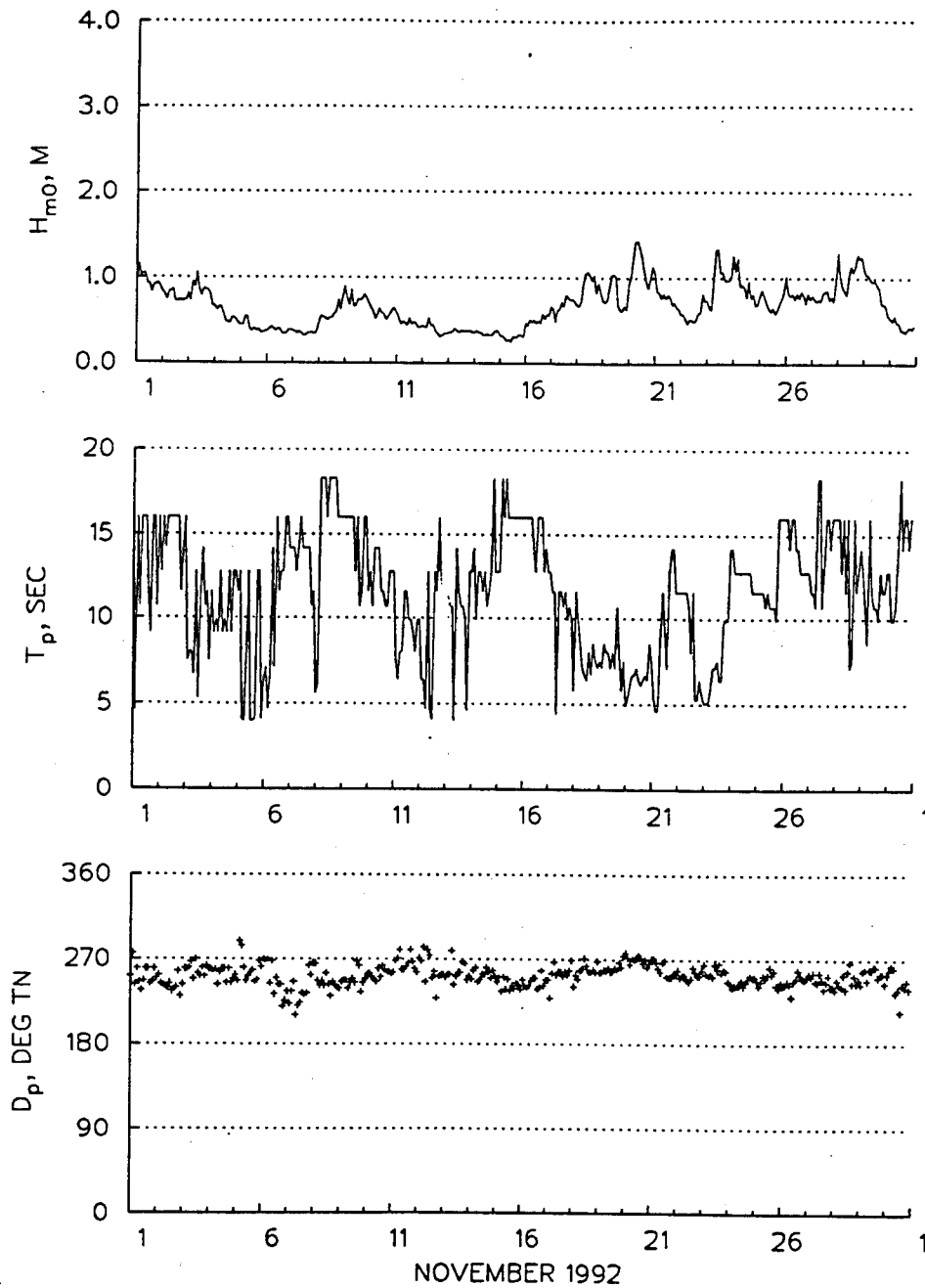

Figure B1. Time series plot for North Breakwater gage (020), November 1992, first deployment

B2

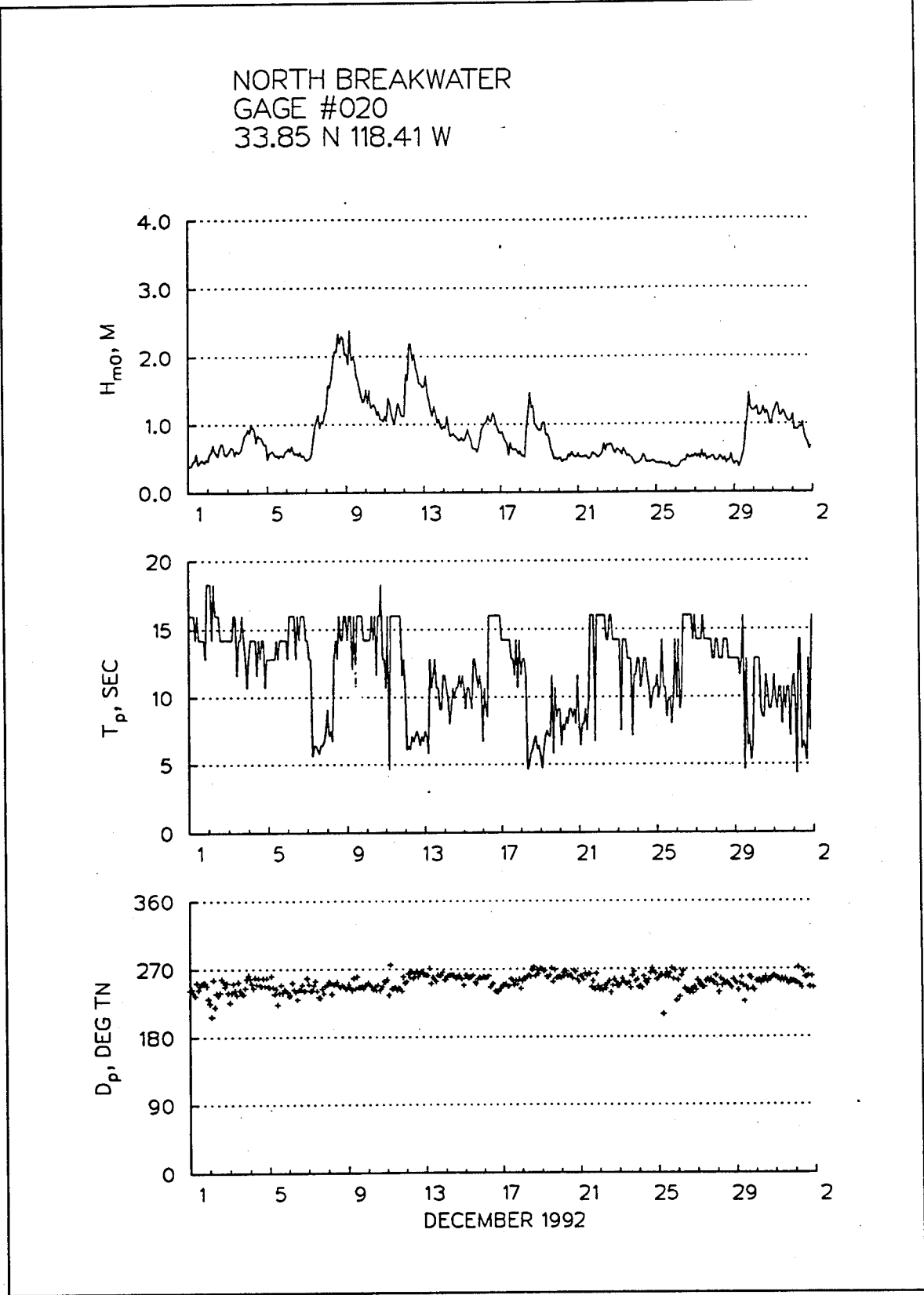

Figure B2. Time series plot for North Breakwater gage (020), December 1992, first deployment

NORTH BREAKWATER  
GAGE #020  
33.85 N 118.41 W

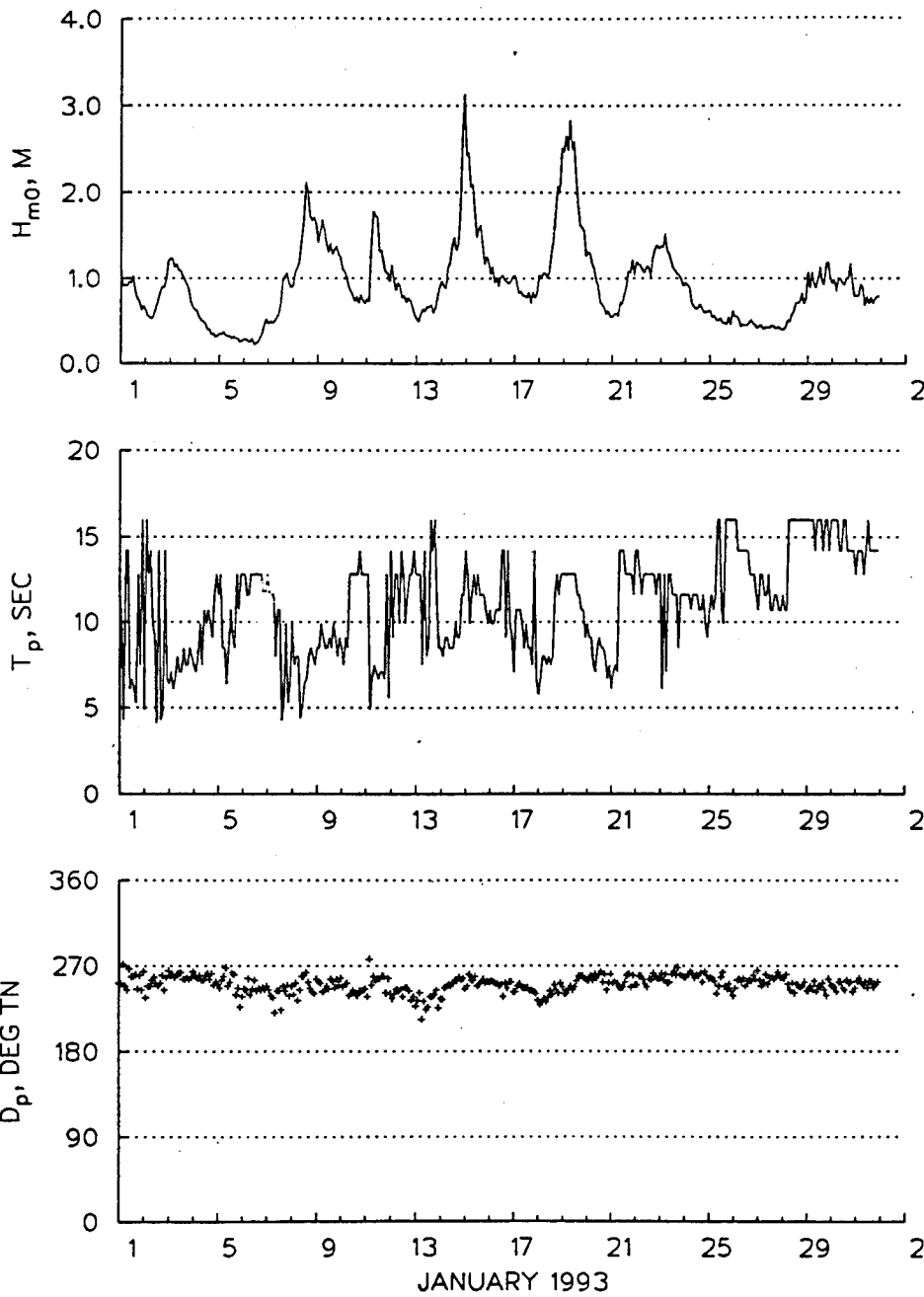

Figure B3. Time series plot for North Breakwater gage (020), January 1993, first deployment

B4

NORTH BREAKWATER  
GAGE #020  
33.85 N 118.41 W

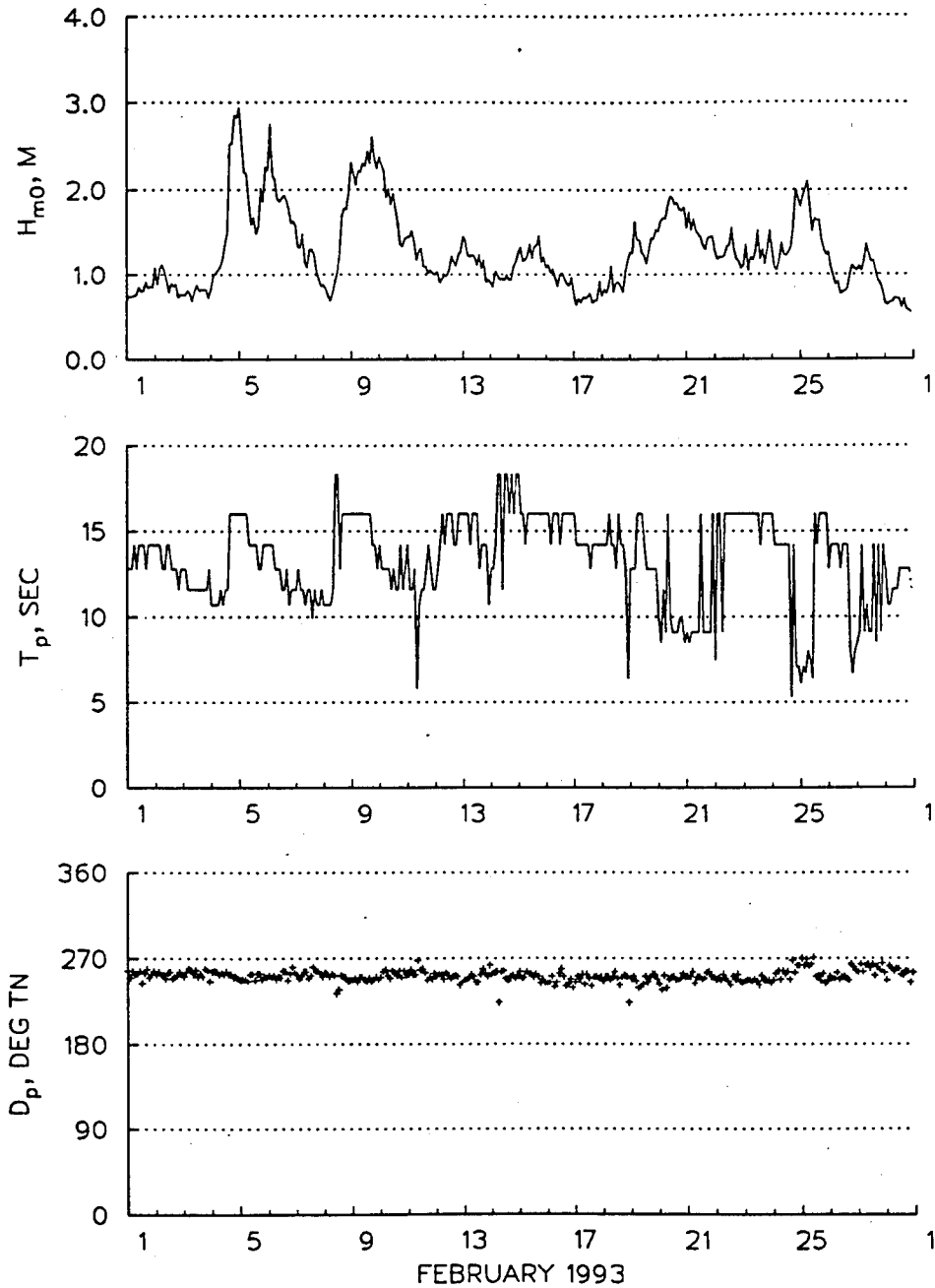

Figure B4. Time series plot for North Breakwater gage (020), February 1993, first deployment

NORTH BREAKWATER  
GAGE #020  
33.85 N 118.41 W

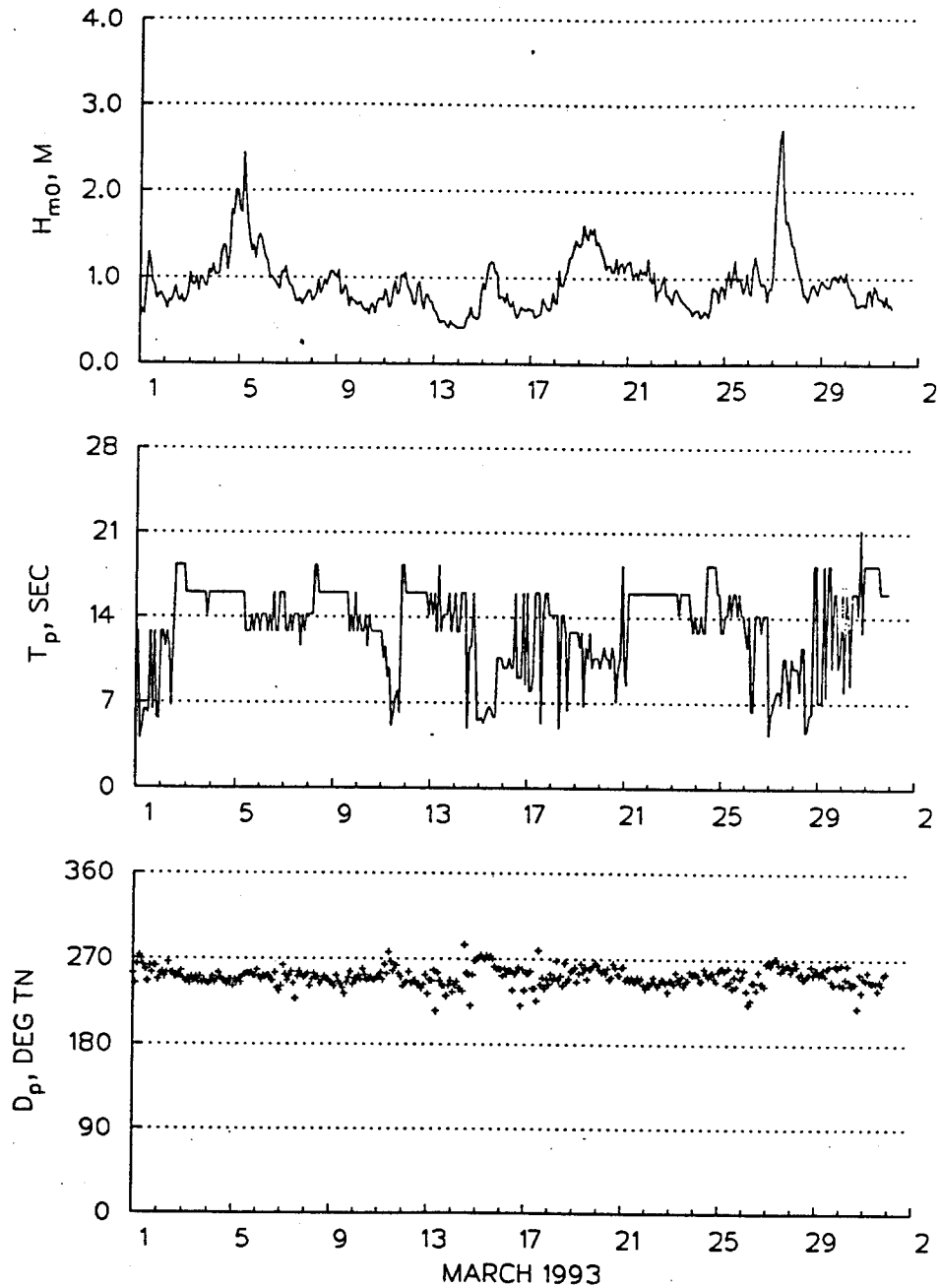

Figure B5. Time series plot for North Breakwater gage (020), March 1993, first deployment

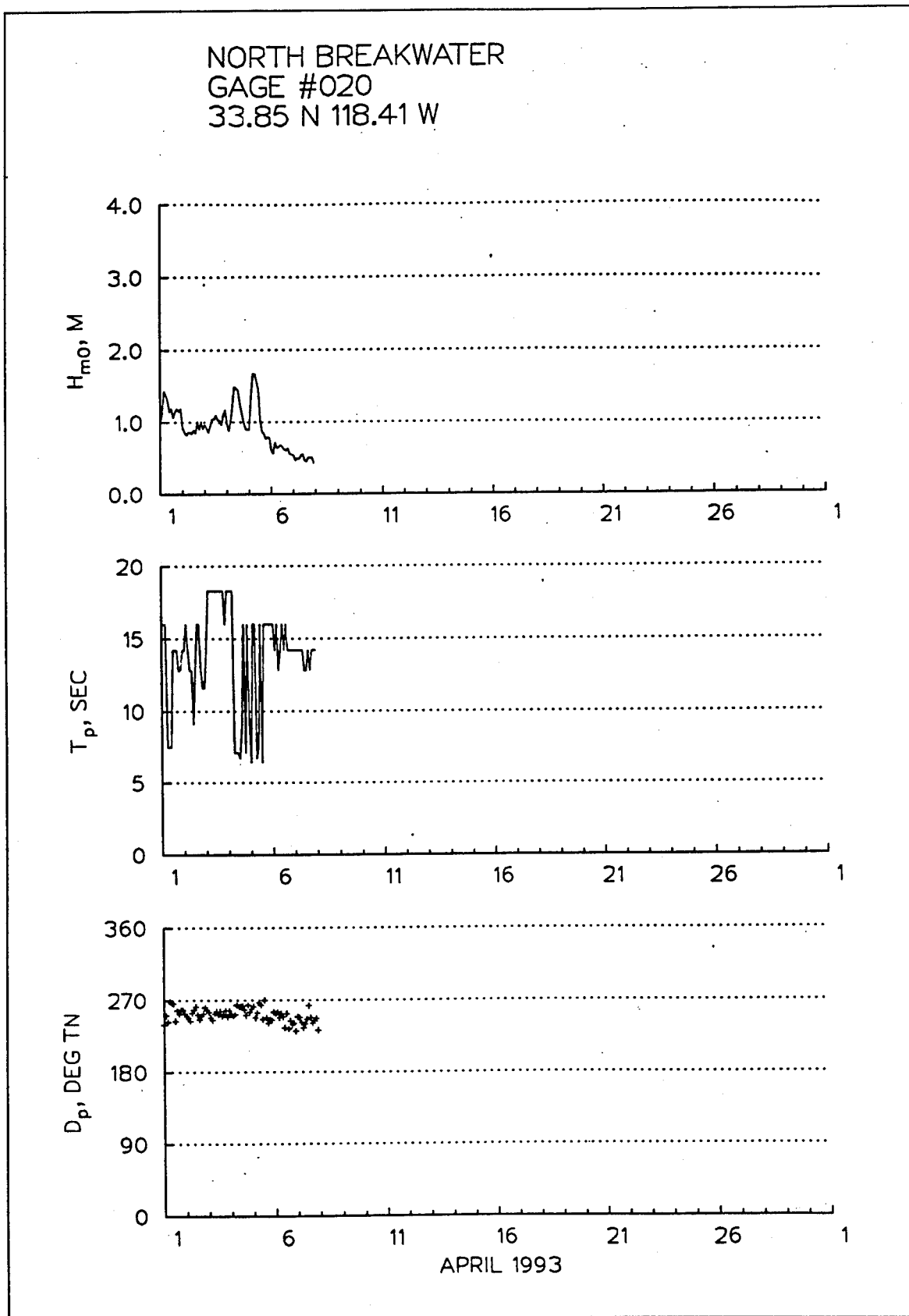

Figure B6. Time series plot for North Breakwater gage (020), April 1993, first deployment

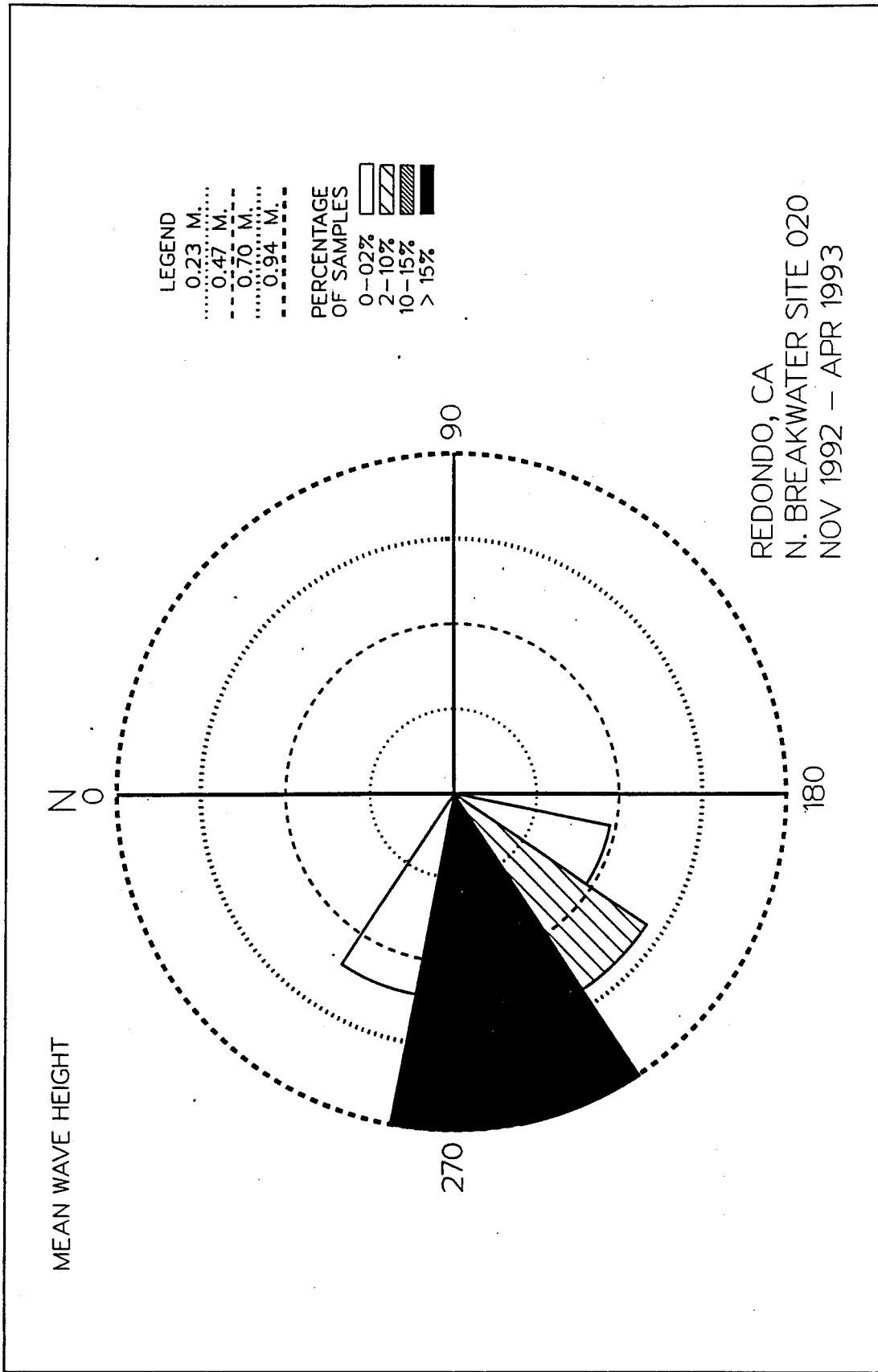

Figure B7. Wave rose for North Breakwater gage (020), first deployment

**Table B1  
Mean/Max Values for North Breakwater (020)  
First Deployment**

MEAN Hm0 (METERS) BY MONTH AND YEAR  
NORTH BREAKWATER (33.85N 118.41W)

YEAR	MONTH												MEAN
	JAN	FEB	MAR	APR	MAY	JUN	JUL	AUG	SEP	OCT	NOV	DEC	
1992	.	.	.	.	.	.	.	.	.	.	0.7	0.8	0.8
1993	0.9	1.3	0.9	0.9	.	.	.	.	.	.	.	.	1.0
MEAN	0.9	1.3	0.9	0.9	.	.	.	.	.	.	0.7	0.8	

LARGEST Hm0 (METERS) BY MONTH AND YEAR  
NORTH BREAKWATER (33.85N 118.41W)

YEAR	MONTH											
	JAN	FEB	MAR	APR	MAY	JUN	JUL	AUG	SEP	OCT	NOV	DEC
1992	.	.	.	.	.	.	.	.	.	.	1.4	2.4
1993	3.1	2.9	2.7	1.7	.	.	.	.	.	.	.	.

STATISTICS FOR NORTH BREAKWATER (33.85N 118.41W)

THE MEAN SIGNIFICANT WAVE HEIGHT (METERS) =	0.9
THE MEAN PEAK WAVE PERIOD (SECONDS) =	12.3
THE MOST FREQUENT 22.5 (CENTER) DIRECTION BAND (DEGREES) =	247.5
THE STANDARD DEVIATION OF Hm0 (METERS) =	0.4
THE STANDARD DEVIATION OF TP (SECONDS) =	3.4
THE LARGEST Hm0 (METERS) =	3.1
THE TP (SECONDS) ASSOC. WITH THE LARGEST Hm0 =	11.6
THE PEAK DIRECTION (DEGREES) ASSOC. WITH THE LARGEST Hm0 =	257.0
THE DATE OF LARGEST Hm0 OCCURRENCE IS	93011422

**Table B2**  
**Percent Occurrence for North Breakwater(020)**  
**First Deployment**

NORTH BREAKWATER, REDONDO BEACH 33.85N 118.41W FOR ALL DIRECTIONS  
 NOVEMBER 1992 - APRIL 1993  
 PERCENT OCCURRENCE(X100) OF HEIGHT AND PERIOD

HEIGHT(METERS)	PEAK PERIOD(SECONDS)										TOTAL
	SHORTER- 4.5	4.6- 5.5	5.6- 7.9	8.0- 10.6	10.7- 11.5	11.6- 12.7	12.8- 14.1	14.2- 15.9	16.0- 18.3	18.4- LONGER	
0.0-0.4	31	15	58	210	137	174	295	226	179	36	1361
0.5-0.9	42	131	385	527	321	474	785	975	1060	247	4947
1.0-1.4	10	47	453	416	179	179	321	327	675	84	2691
1.5-1.9	.	5	137	121	36	89	68	47	116	.	619
2.0-2.4	.	.	42	10	.	10	63	52	94	.	271
2.5-2.9	.	.	5	5	.	5	26	10	31	.	82
3.0-3.4	.	.	.	.	.	5	.	.	.	.	5
3.5-3.9	.	.	.	.	.	.	.	.	.	.	0
4.0-4.4	.	.	.	.	.	.	.	.	.	.	0
4.5-4.9	.	.	.	.	.	.	.	.	.	.	0
5.0+	.	.	.	.	.	.	.	.	.	.	0
TOTAL	83	198	1080	1289	673	936	1558	1637	2155	367	0

MEAN Hm0 (M) = 0.9    LARGEST Hm0 (M) = 3.1    MEAN TP (SEC) = 12.3    TOTAL CASES = 1896.

# **Appendix C Near Breakwater Site, First Deployment**

---

NEAR BREAKWATER  
GAGE #030  
33.85 N 118.40 W

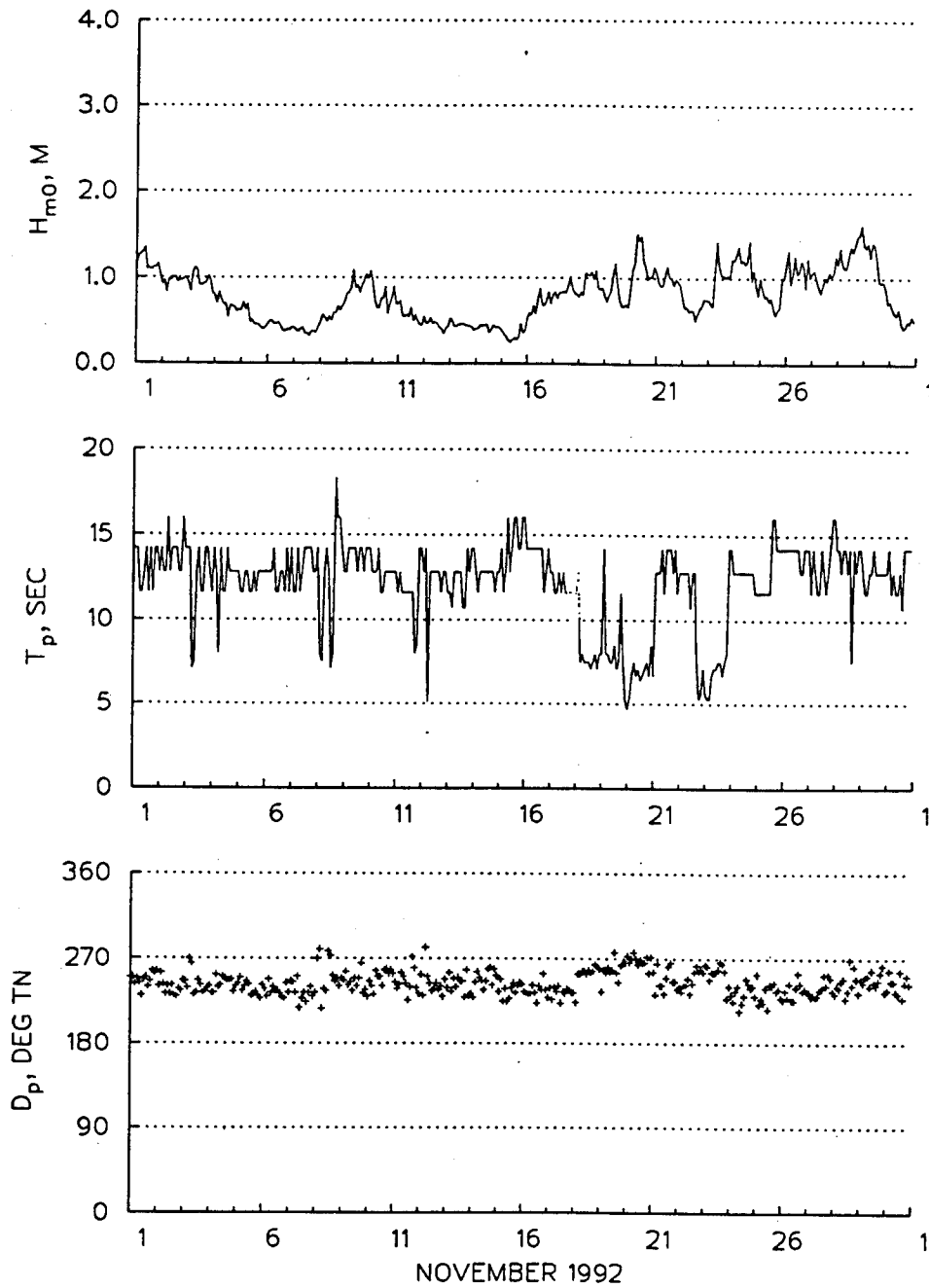

Figure C1. Time series plot for Near Breakwater gage (030), November 1992, first deployment

NEAR BREAKWATER  
GAGE #030  
33.85 N 118.40 W

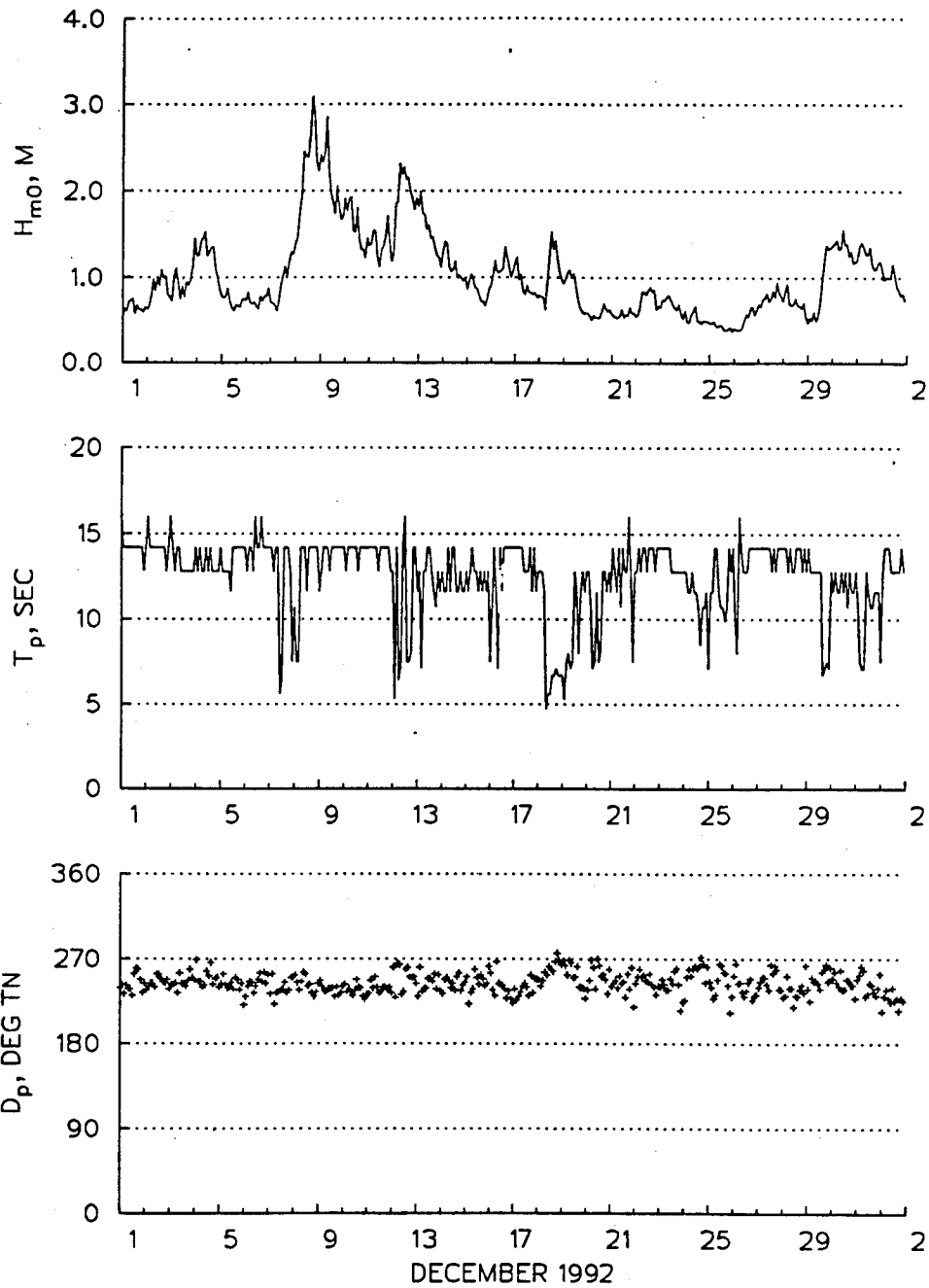

Figure C2. Time series plot for Near Breakwater gage (030), December 1992, first deployment

NEAR BREAKWATER  
GAGE #030  
33.85 N 118.40 W

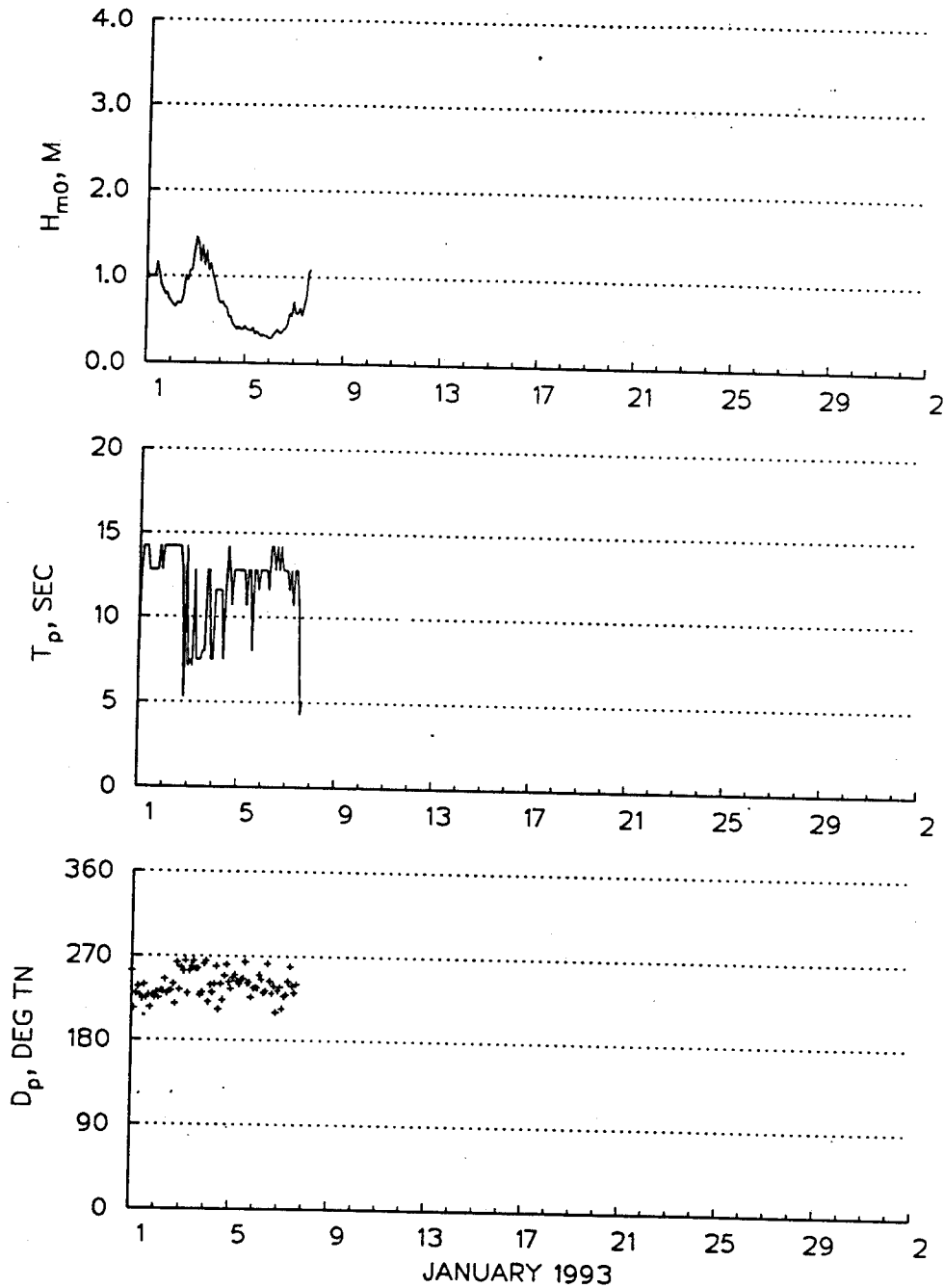

Figure C3. Time series plot for Near Breakwater gage (030), January 1993, first deployment

C4

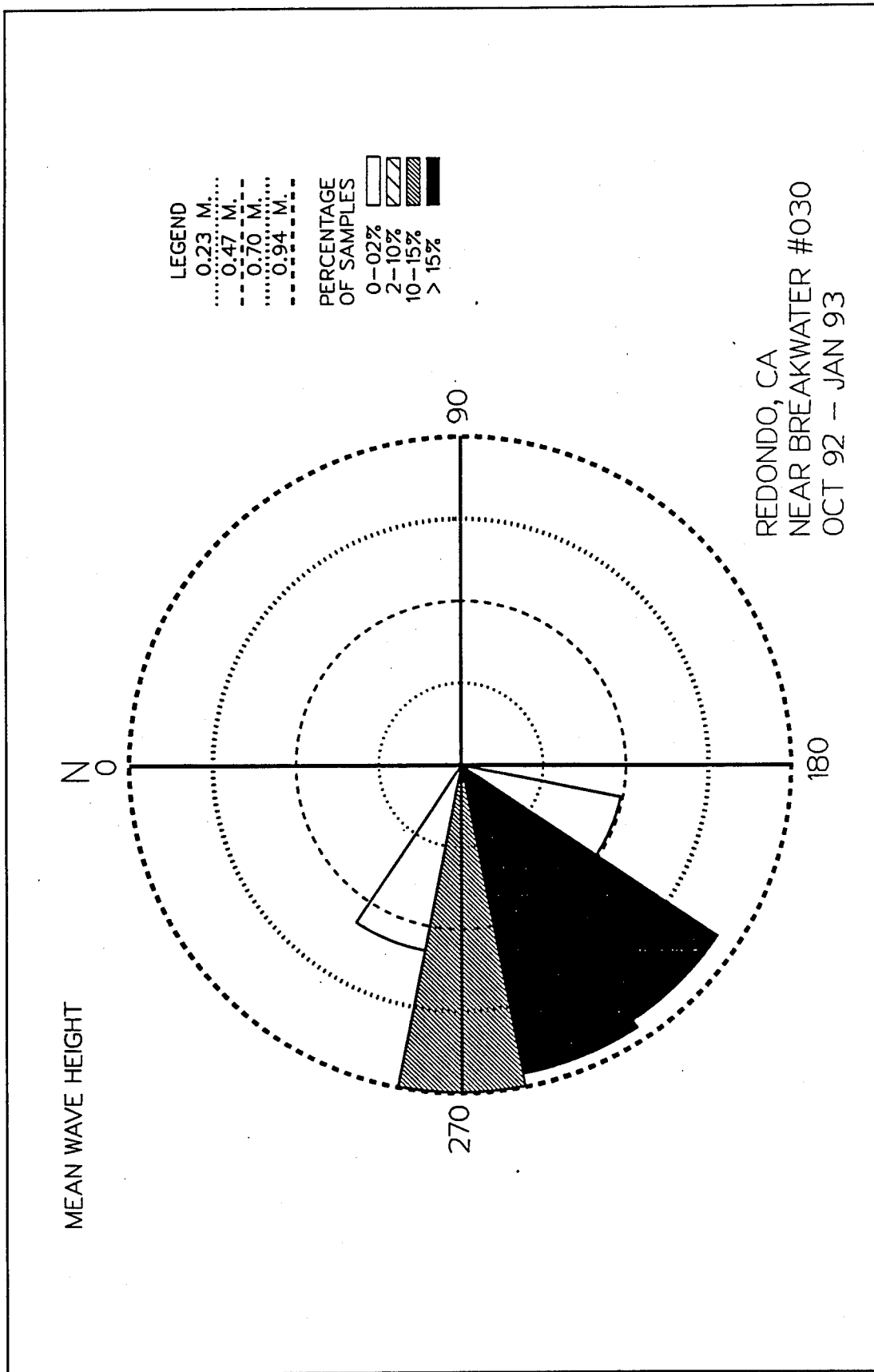

Figure C4. Wave rose for Near Breakwater gage (030), first deployment

**Table C1**  
**Mean/Max Values for Near Breakwater (030)**  
**First Deployment**

MEAN Hm0 (METERS) BY MONTH AND YEAR  
 NEAR BREAKWATER (33.85N 118.40W)

YEAR	MONTH												MEAN
	JAN	FEB	MAR	APR	MAY	JUN	JUL	AUG	SEP	OCT	NOV	DEC	
1992	.	.	.	.	.	.	.	.	.	1.0	0.8	1.0	0.9
1993	0.7	.	.	.	.	.	.	.	.	.	.	.	0.7
MEAN	0.7	.	.	.	.	.	.	.	.	1.0	0.8	1.0	

LARGEST Hm0 (METERS) BY MONTH AND YEAR  
 NEAR BREAKWATER (33.85N 118.40W)

YEAR	MONTH											
	JAN	FEB	MAR	APR	MAY	JUN	JUL	AUG	SEP	OCT	NOV	DEC
1992	.	.	.	.	.	.	.	.	.	1.4	1.6	3.1
1993	1.5	.	.	.	.	.	.	.	.	.	.	.

STATISTICS FOR NEAR BREAKWATER (33.85N 118.40W)

THE MEAN SIGNIFICANT WAVE HEIGHT (METERS) =	0.9
THE MEAN PEAK WAVE PERIOD (SECONDS) =	12.3
THE MOST FREQUENT 22.5 (CENTER) DIRECTION BAND (DEGREES) =	247.5
THE STANDARD DEVIATION OF Hm0 (METERS) =	0.4
THE STANDARD DEVIATION OF TP (SECONDS) =	2.5
THE LARGEST Hm0 (METERS) =	3.1
THE TP (SECONDS) ASSOC. WITH THE LARGEST Hm0 =	14.2
THE PEAK DIRECTION (DEGREES) ASSOC. WITH THE LARGEST Hm0 =	243.0
THE DATE OF LARGEST Hm0 OCCURRENCE IS	92120816

**Table C2**  
**Percent Occurrence for Near Breakwater(030)**  
**First Deployment**

NEAR BREAKWATER											33.85N 118.40W											IRRESPECTIVE OF DIRECTION													
OCTOBER 1992 - JANUARY 1993																																			
PERCENT OCCURRENCE(X100) OF HEIGHT AND PERIOD																																			
HEIGHT(METERS)											PEAK PERIOD(SECONDS)											TOTAL													
SHORTER-											4.6- 5.6- 5.6- 8.0- 10.7- 11.6- 12.8- 14.2- 16.0- 18.4-																								
4.5											5.6 8.0 10.6 11.6 12.7 14.1 15.9 18.3											LONGER													
0.0-0.4	.	.	11	69	127	254	694	335	57	.	1547	.	.	11	69	127	254	694	335	57	.	1547	.	.	11	69	127	254	694	335	57	.	1547		
0.5-0.9	.	115	289	150	69	775	1759	1666	138	.	4961	.	115	289	150	69	775	1759	1666	138	.	4961	.	115	289	150	69	775	1759	1666	138	.	4961		
1.0-1.4	11	57	590	69	104	381	625	972	34	.	2843	11	57	590	69	104	381	625	972	34	.	2843	11	57	590	69	104	381	625	972	34	.	2843		
1.5-1.9	.	11	57	11	.	11	92	231	.	.	413	.	11	57	11	.	11	92	231	.	.	413	.	11	57	11	.	11	92	231	.	.	413		
2.0-2.4	.	.	34	.	.	23	11	32	11	.	171	.	.	34	.	.	23	11	32	11	.	171	.	.	34	.	.	23	11	32	11	.	171		
2.5-2.9	.	.	.	.	.	.	.	34	.	.	34	.	.	.	.	.	.	.	34	.	.	34	.	.	.	.	.	.	.	.	34	.	.	34	
3.0-3.4	.	.	.	.	.	.	.	11	.	.	11	.	.	.	.	.	.	.	11	.	.	11	.	.	.	.	.	.	.	.	11	.	.	11	
3.5-3.9	.	.	.	.	.	.	.	.	.	.	0	.	.	.	.	.	.	.	.	.	.	0	.	.	.	.	.	.	.	.	.	.	.	0	
4.0-4.4	.	.	.	.	.	.	.	.	.	.	0	.	.	.	.	.	.	.	.	.	.	0	.	.	.	.	.	.	.	.	.	.	.	0	
4.5-4.9	.	.	.	.	.	.	.	.	.	.	0	.	.	.	.	.	.	.	.	.	.	0	.	.	.	.	.	.	.	.	.	.	.	0	
5.0+	.	.	.	.	.	.	.	.	.	.	0	.	.	.	.	.	.	.	.	.	.	0	.	.	.	.	.	.	.	.	.	.	.	0	
TOTAL	11	183	981	299	300	1444	3181	3341	240	0		11	183	981	299	300	1444	3181	3341	240	0		11	183	981	299	300	1444	3181	3341	240	0			
MEAN Hm0 (M) =	0.9	LARGEST Hm0 (M) =	3.1	MEAN TP (SEC) =	12.3	TOTAL CASES =	864.					0.9	3.1	12.3	864.									0.9	3.1	12.3	864.								

# **Appendix D South Breakwater Site, First Deployment**

---

SOUTH BREAKWATER  
GAGE #153  
33.84 N 118.40 W

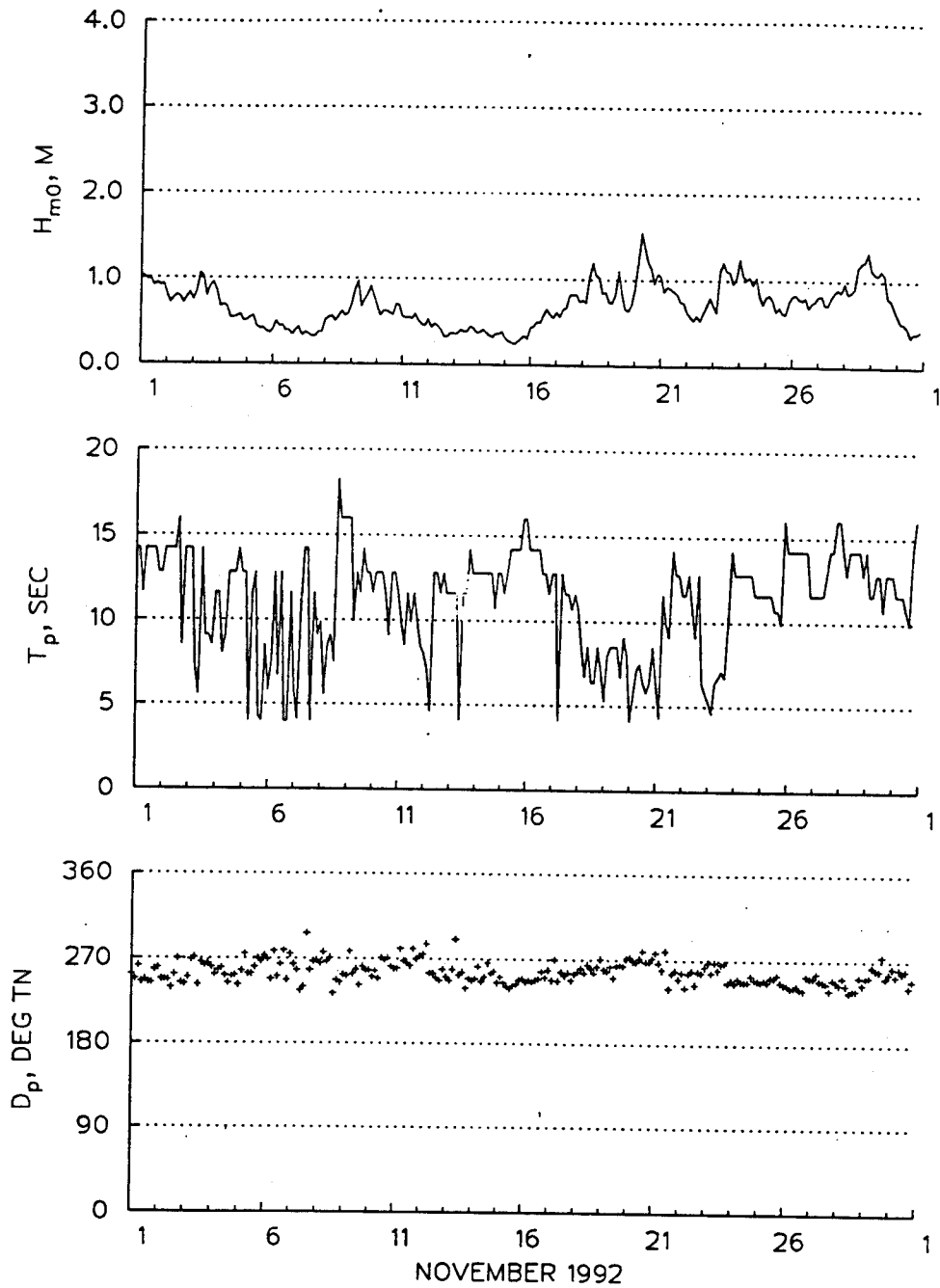

Figure D1. Time series plot for South Breakwater gage (153), November 1992, first deployment

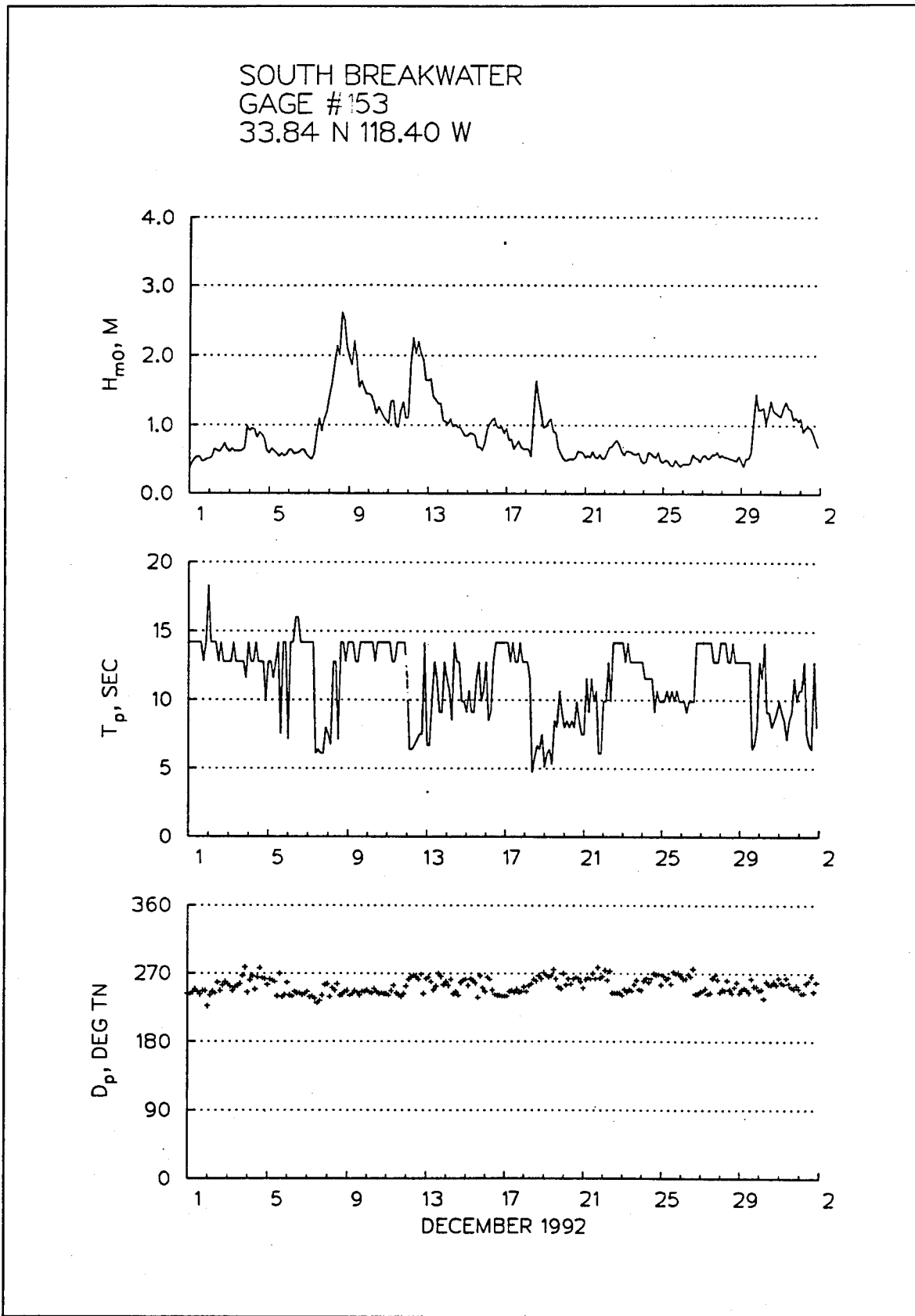

Figure D2. Time series for South Breakwater gage (153), December 1992, first deployment

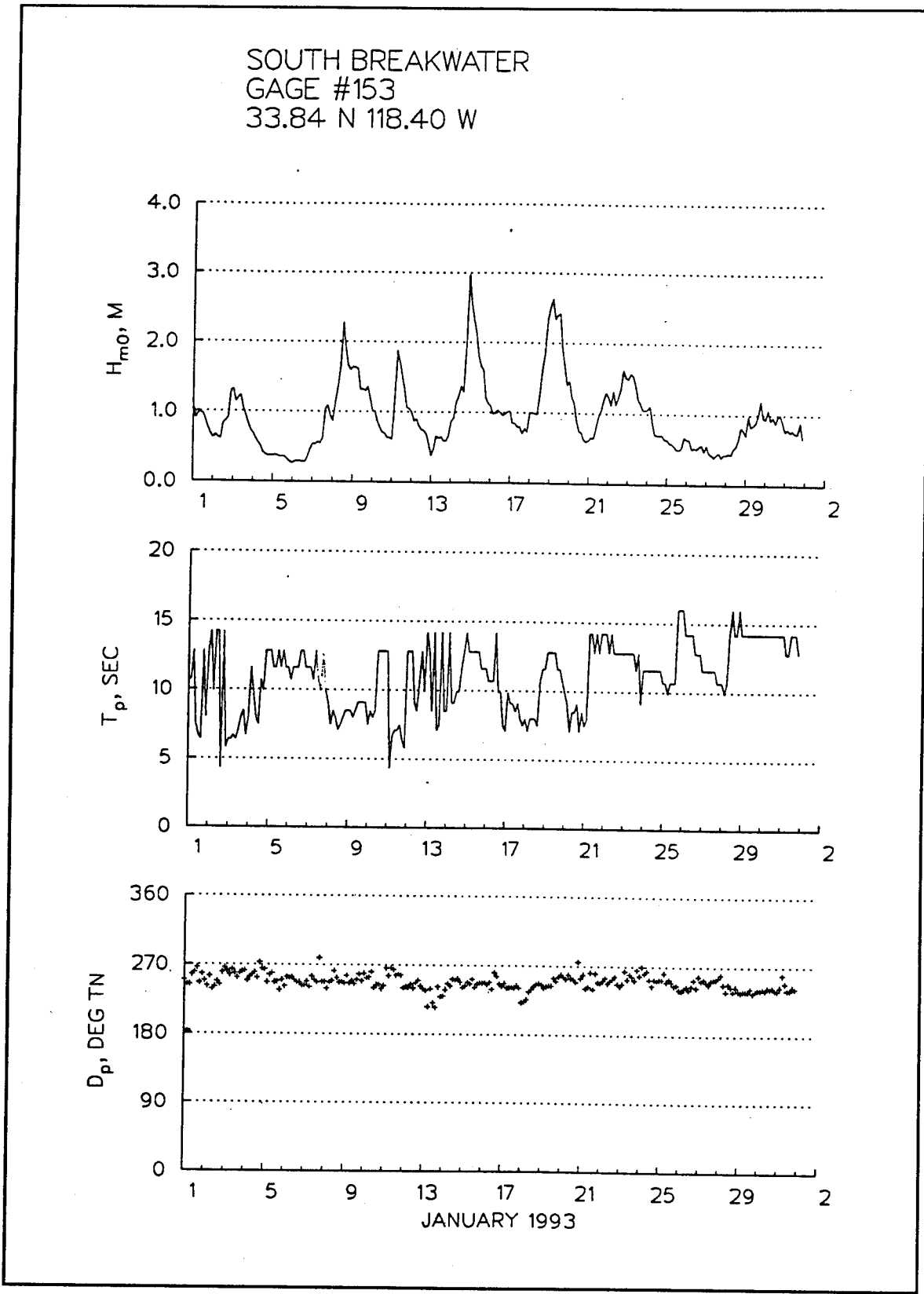

Figure D3. Time series plot for South Breakwater gage (153), January 1993, first deployment

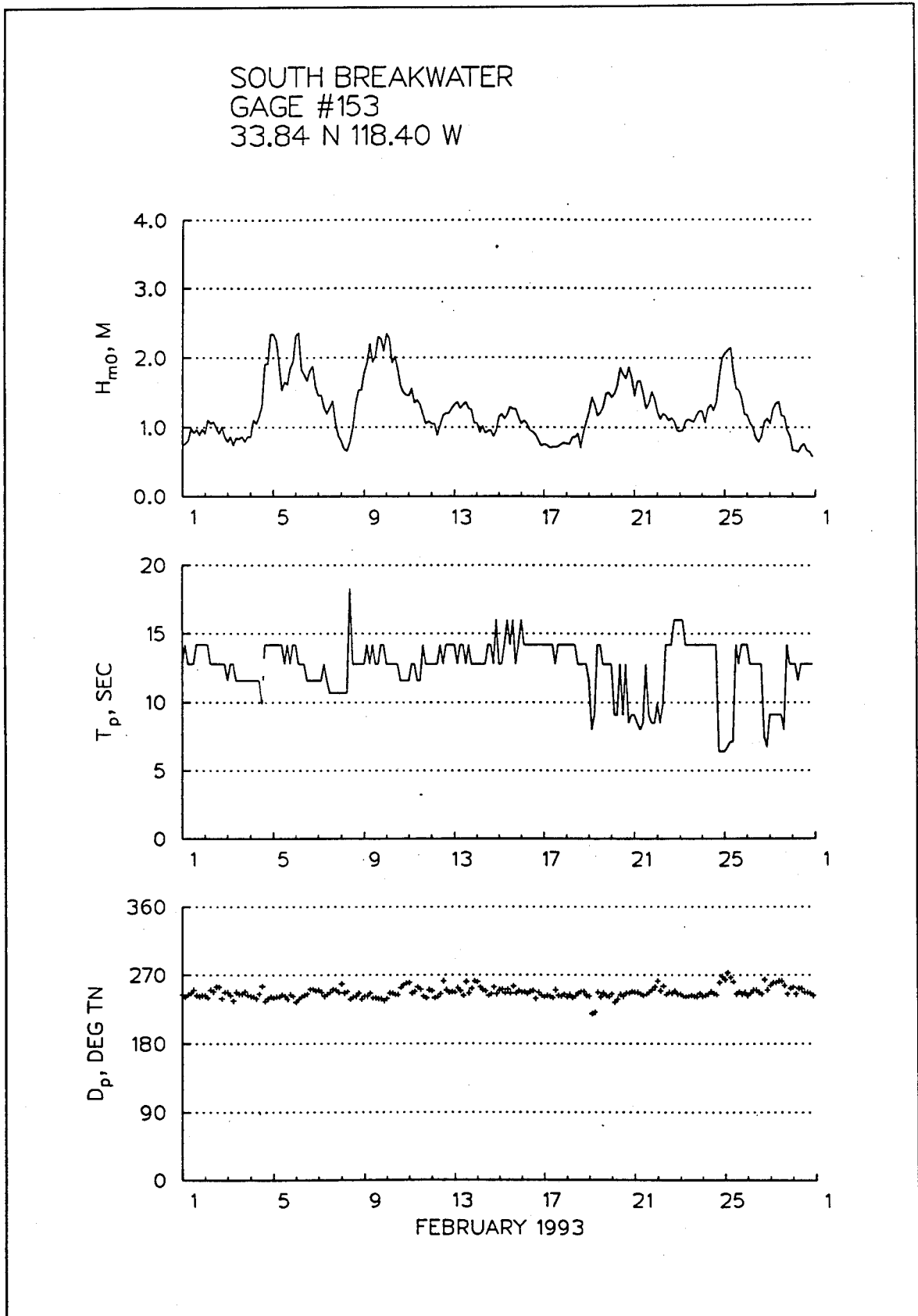

Figure D4. Time series for South Breakwater gage (153), February 1993, first deployment

SOUTH BREAKWATER  
GAGE #153  
33.84 N 118.40 W

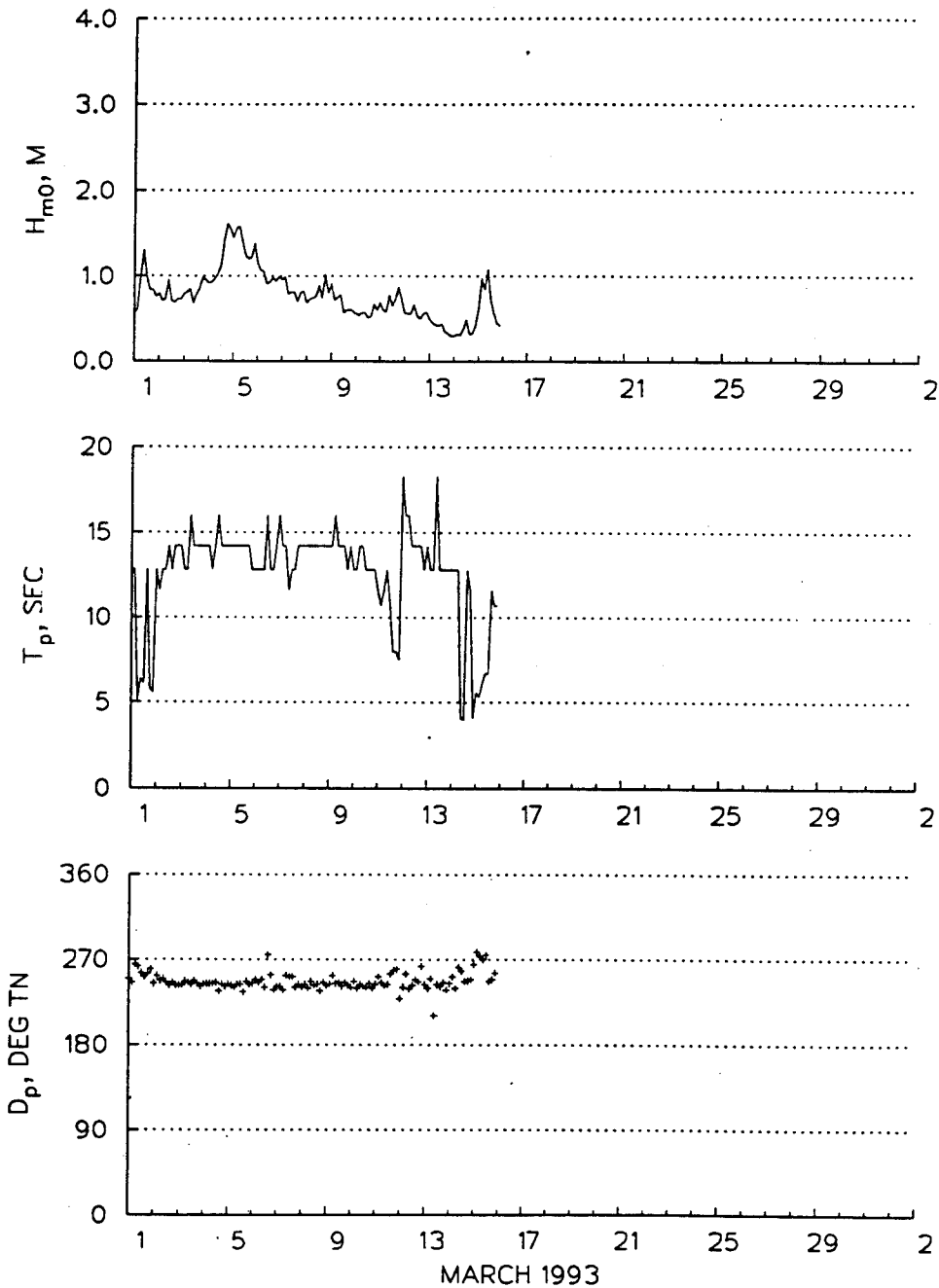

Figure D5. Time series for South Breakwater gage (153), March 1993, first deployment

D6

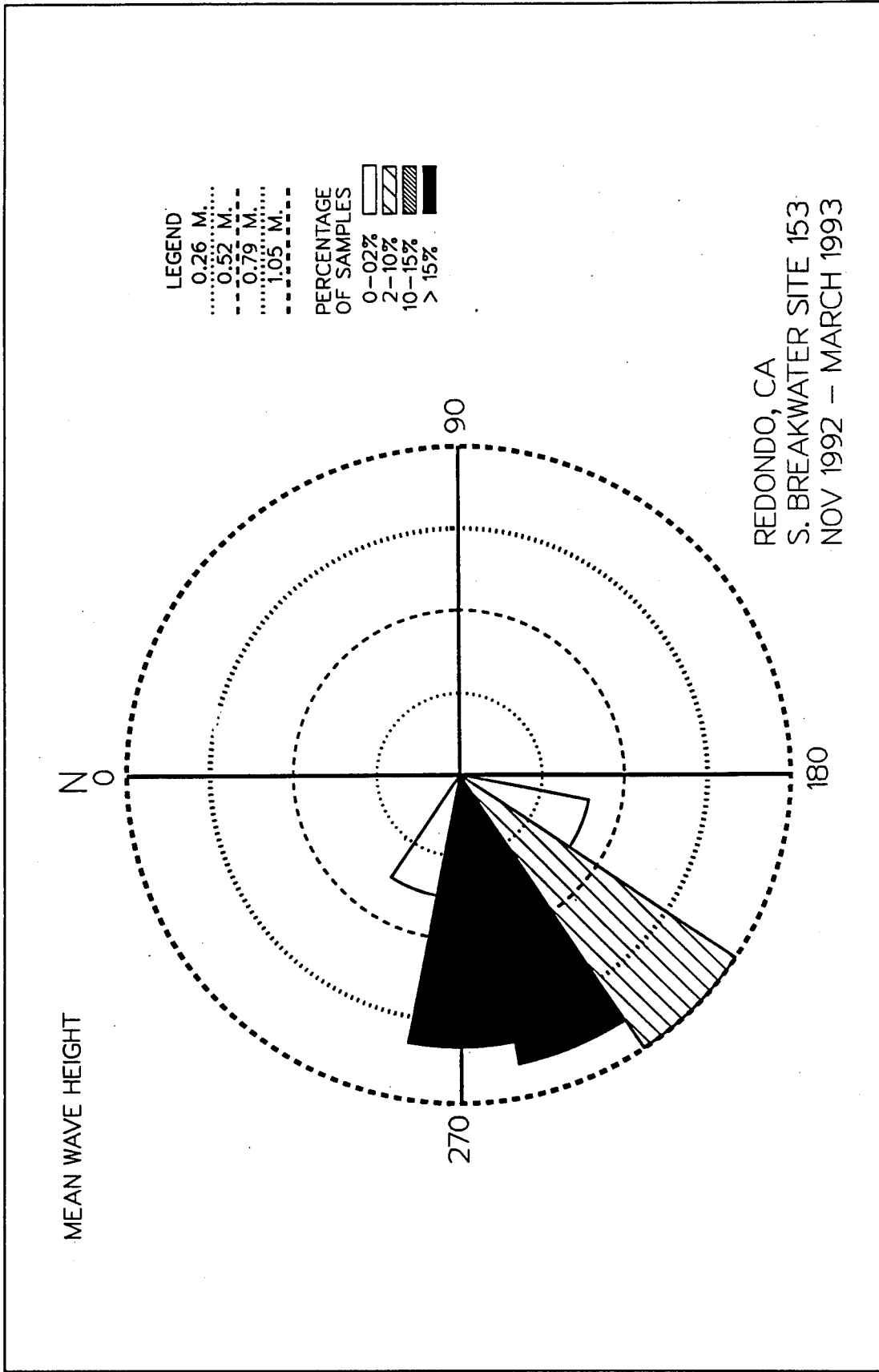

Figure D6. Wave rose for South Breakwater gage (153), first deployment

**Table D1**  
**Mean/Max Values for South Breakwater (153)**  
**First Deployment**

MEAN Hm0 (METERS) BY MONTH AND YEAR  
 SOUTH BREAKWATER (33.84N 118.40W)

YEAR	MONTH												MEAN
	JAN	FEB	MAR	APR	MAY	JUN	JUL	AUG	SEP	OCT	NOV	DEC	
1992	.	.	.	.	.	.	.	.	.	.	0.7	0.9	0.8
1993	1.0	1.3	0.8	.	.	.	.	.	.	.	.	.	1.0
MEAN	1.0	1.3	0.8	.	.	.	.	.	.	.	0.7	0.9	

LARGEST Hm0 (METERS) BY MONTH AND YEAR  
 SOUTH BREAKWATER (33.84N 118.40W)

YEAR	MONTH											
	JAN	FEB	MAR	APR	MAY	JUN	JUL	AUG	SEP	OCT	NOV	DEC
1992	.	.	.	.	.	.	.	.	.	.	1.6	2.6
1993	3.0	2.4	1.6	.	.	.	.	.	.	.	.	.

STATISTICS FOR SOUTH BREAKWATER (33.84N 118.40W)

THE MEAN SIGNIFICANT WAVE HEIGHT (METERS) =	0.9
THE MEAN PEAK WAVE PERIOD (SECONDS) =	11.7
THE MOST FREQUENT 22.5 (CENTER) DIRECTION BAND (DEGREES) =	247.5
THE STANDARD DEVIATION OF Hm0 (METERS) =	0.4
THE STANDARD DEVIATION OF TP (SECONDS) =	2.8
THE LARGEST Hm0 (METERS) =	3.0
THE TP (SECONDS) ASSOC. WITH THE LARGEST Hm0 =	12.8
THE PEAK DIRECTION (DEGREES) ASSOC. WITH THE LARGEST Hm0 =	248.0
THE DATE OF LARGEST Hm0 OCCURRENCE IS	93011421

**Table D2**  
**Percent Occurrence for South Breakwater (153)**  
**First Deployment**

SOUTH BREAKWATER		37.84N 118.40W										IRRESPECTIVE OF DIRECTION	
NOVEMBER 1992 - MARCH 1993													
PERCENT OCCURRENCE(X100) OF HEIGHT AND PERIOD													
HEIGHT(METERS)	PEAK PERIOD(SECONDS)										TOTAL		
	SHORTER- 4.5	4.6- 5.6	5.6- 8.0	8.0- 10.6	10.7- 11.6	11.6- 12.7	12.8- 14.1	14.2- 15.9	16.0- 18.3	18.4- LONGER			
0.0-0.4	92	9	46	148	138	259	388	138	27	.	1245		
0.5-0.9	46	55	324	824	259	564	1342	1564	231	.	5209		
1.0-1.4	9	18	398	509	64	222	500	685	46	.	2451		
1.5-1.9	.	.	129	120	9	83	222	166	.	.	729		
2.0-2.4	.	.	92	.	.	9	129	64	.	.	294		
2.5-2.9	.	.	.	.	.	9	18	27	.	.	54		
3.0-3.4	.	.	.	.	.	.	.	.	.	.	0		
3.5-3.9	.	.	.	.	.	.	.	.	.	.	0		
4.0-4.4	.	.	.	.	.	.	.	.	.	.	0		
4.5-4.9	.	.	.	.	.	.	.	.	.	.	0		
5.0+	.	.	.	.	.	.	.	.	.	.	0		
TOTAL	147	82	989	1601	470	1146	2599	2644	304	0			
MEAN Hm0 (M) = 0.9    LARGEST Hm0 (M) = 3.0    MEAN TP (SEC) = 11.7    TOTAL CASES = 1080.													

# **Appendix E**

## **Canyon Site, First Deployment**

---

CANYON  
GAGE #RB5  
33.83 N 118.40 W

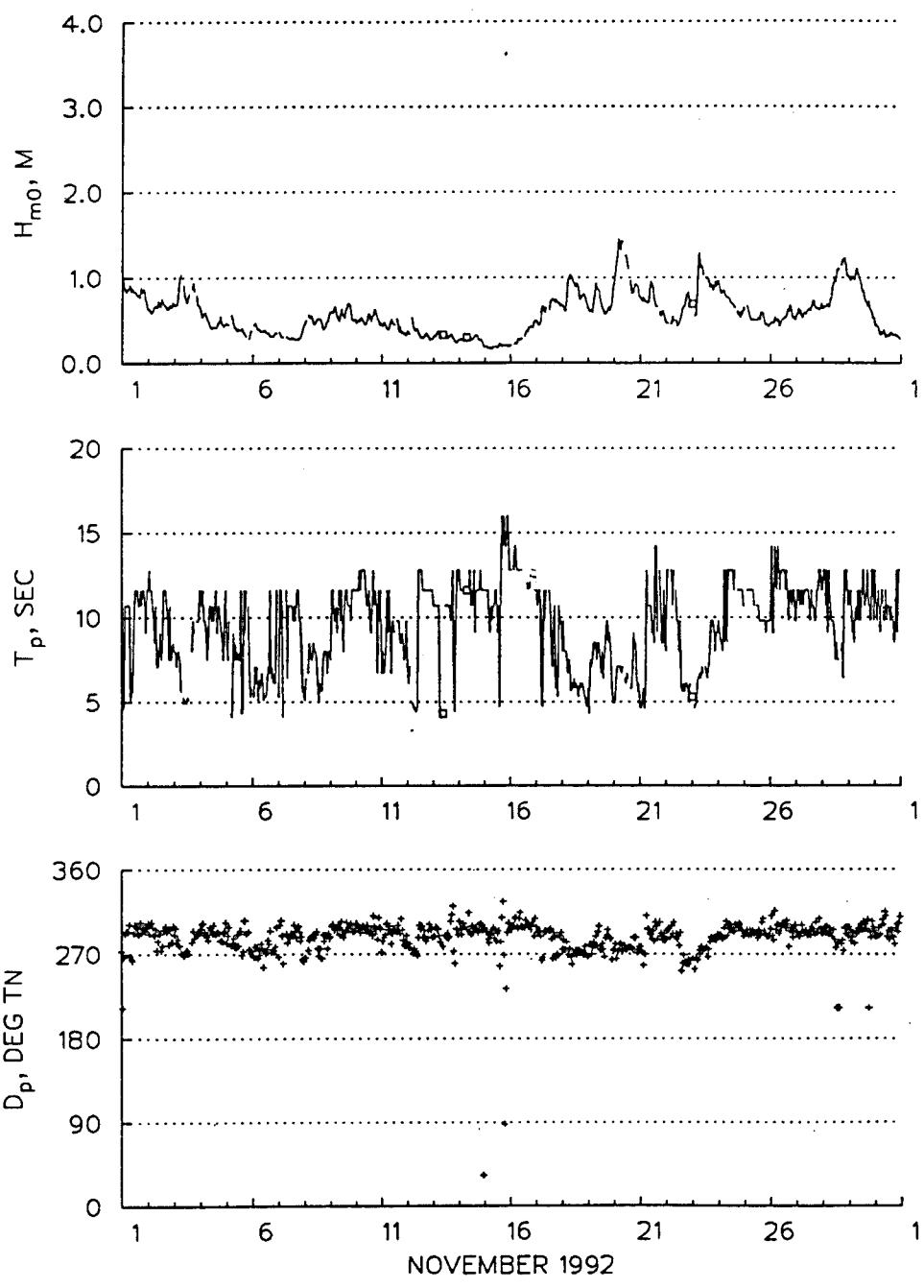

Figure E1. Time series plot for Canyon gage (RB5), November 1992, first deployment

E2

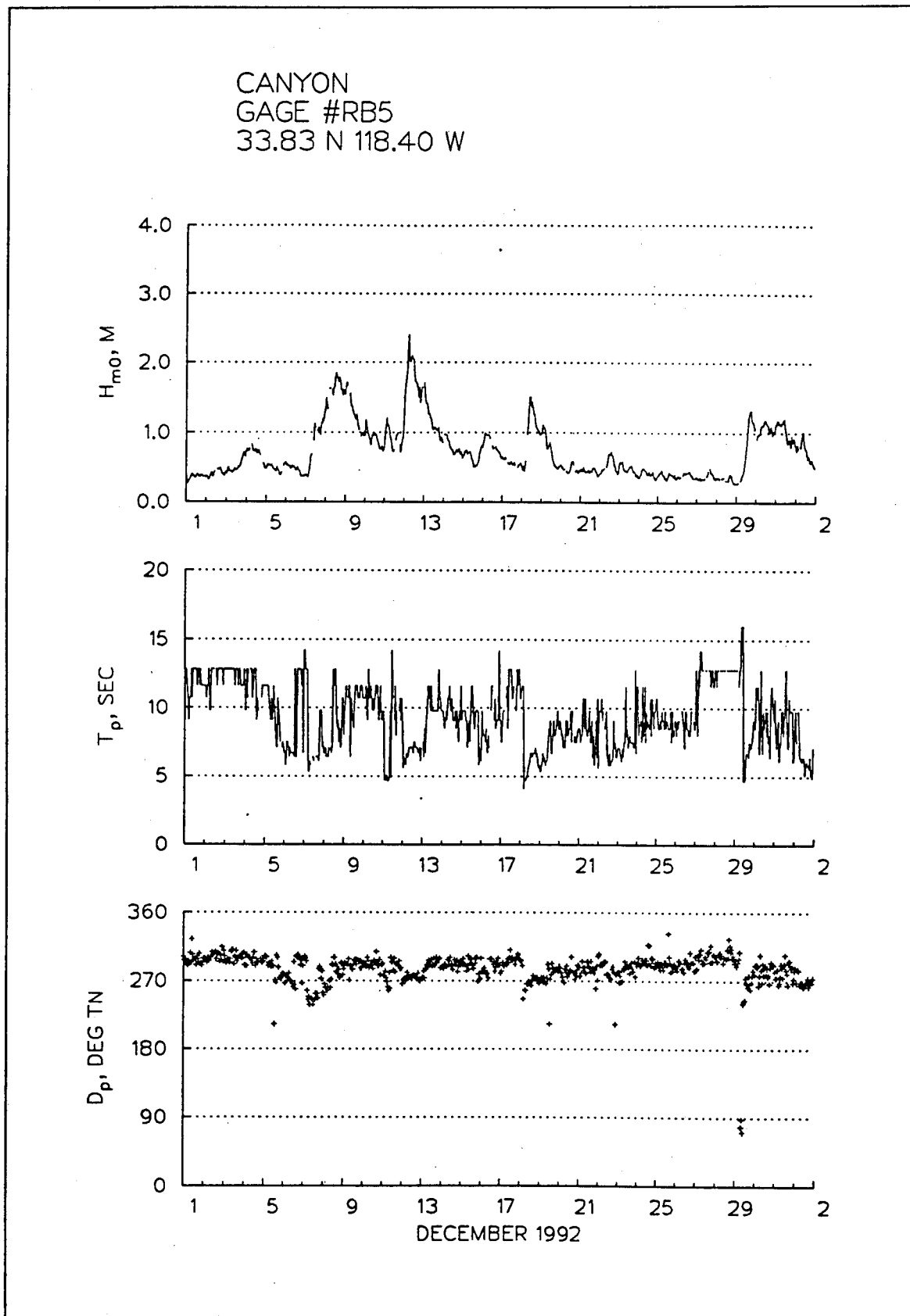

Figure E2. Time series plot for Canyon gage (RB5), December 1992, first deployment

CANYON  
GAGE #RB5  
33.83 N 118.40 W

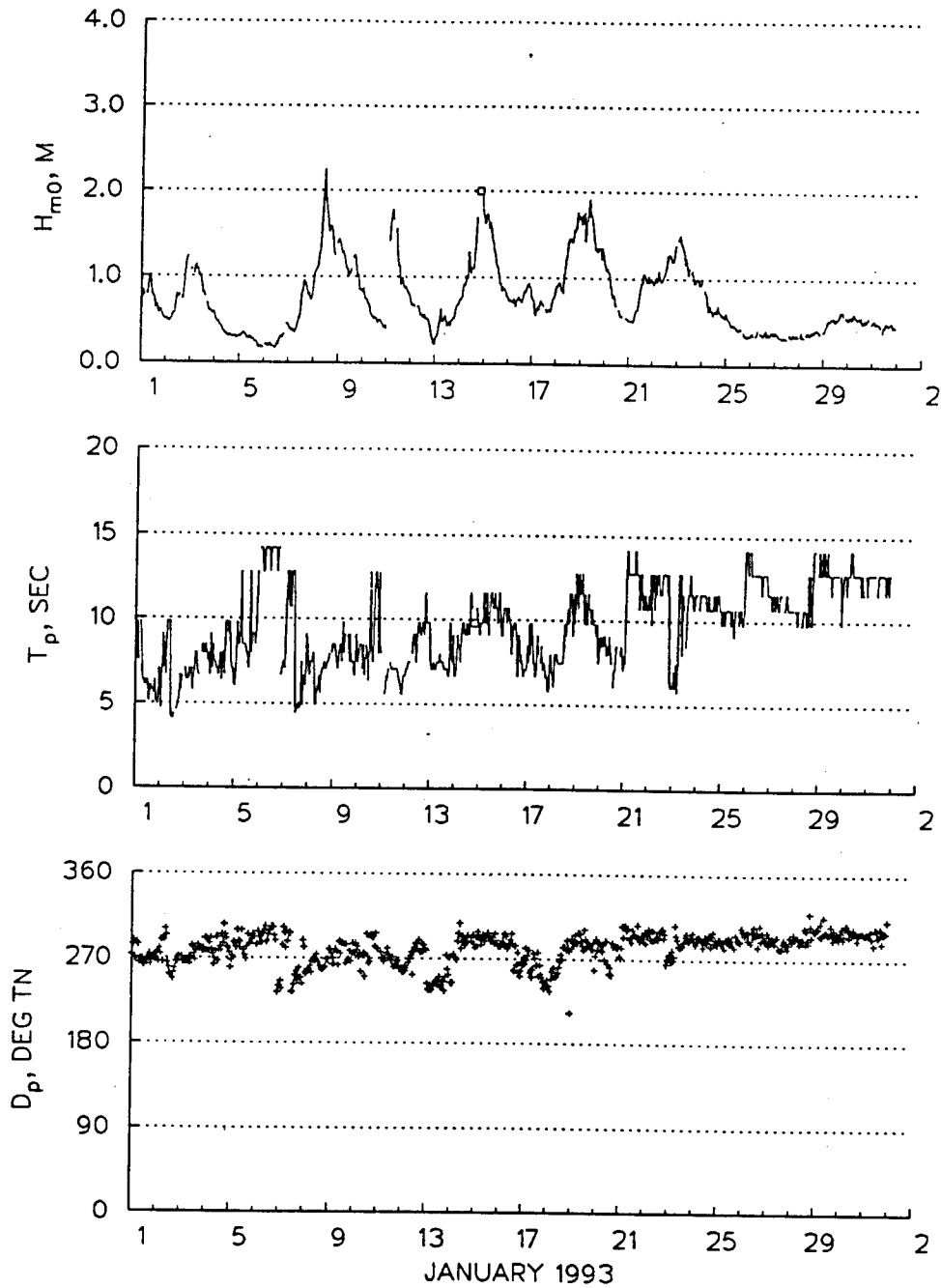

Figure E3. Time series plot for Canyon gage (RB5), January 1993, first deployment

E4

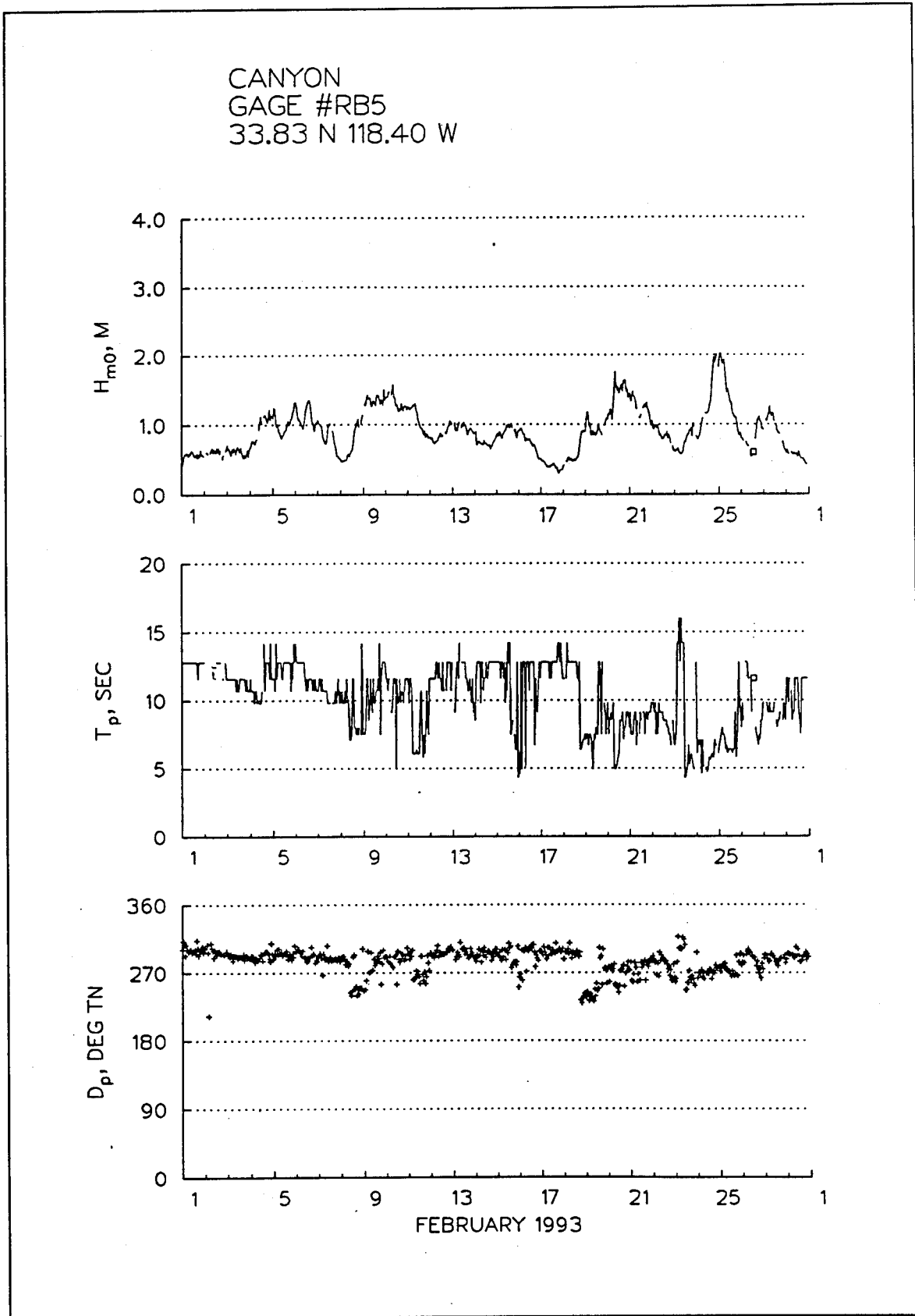

Figure E4. Time series plot for Canyon gage (RB5), February 1993, first deployment

CANYON  
GAGE #RB5  
33.83 N 118.40 W

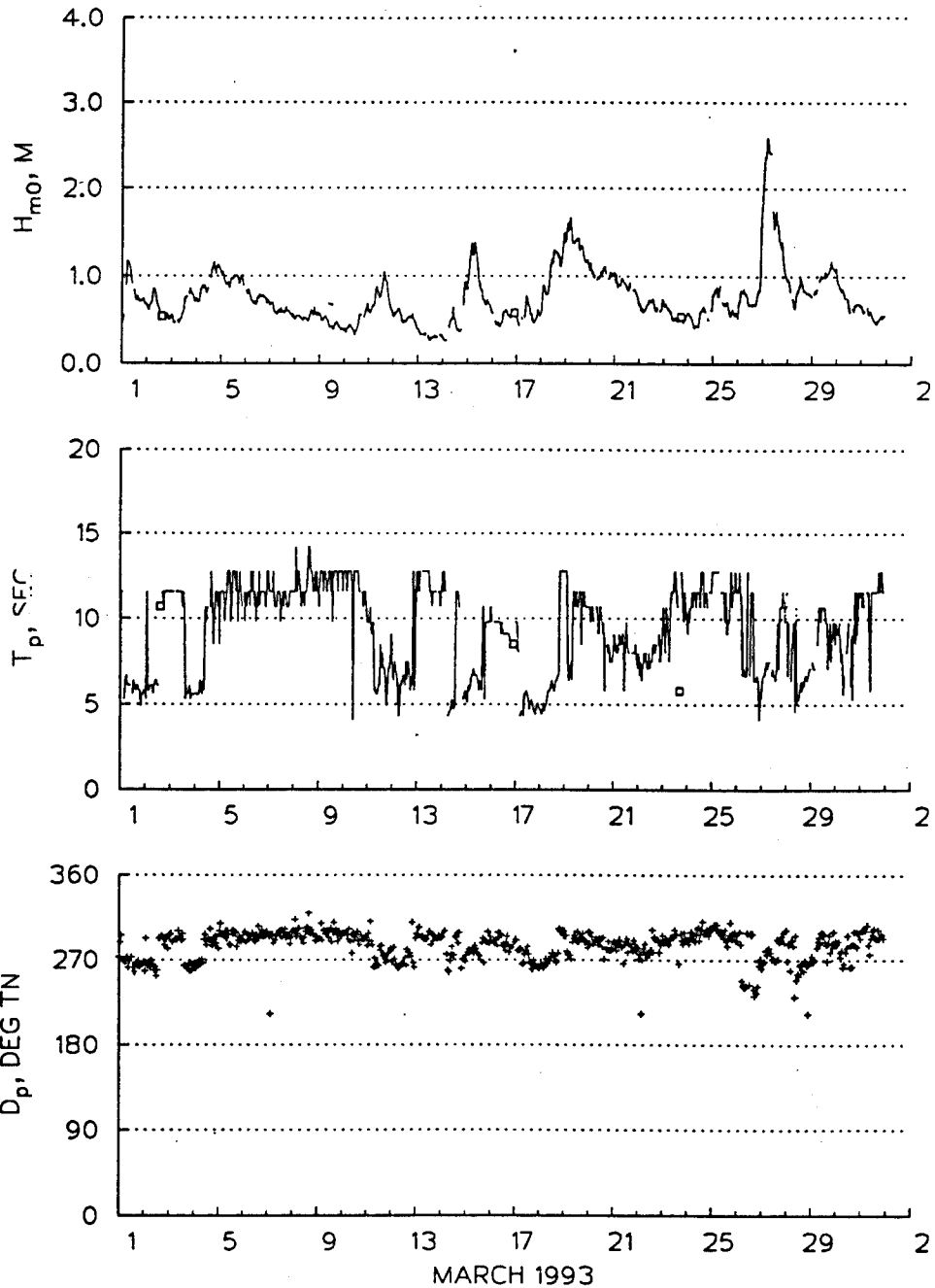

Figure E5. Time series plot for Canyon gage (RB5), March 1993, first deployment

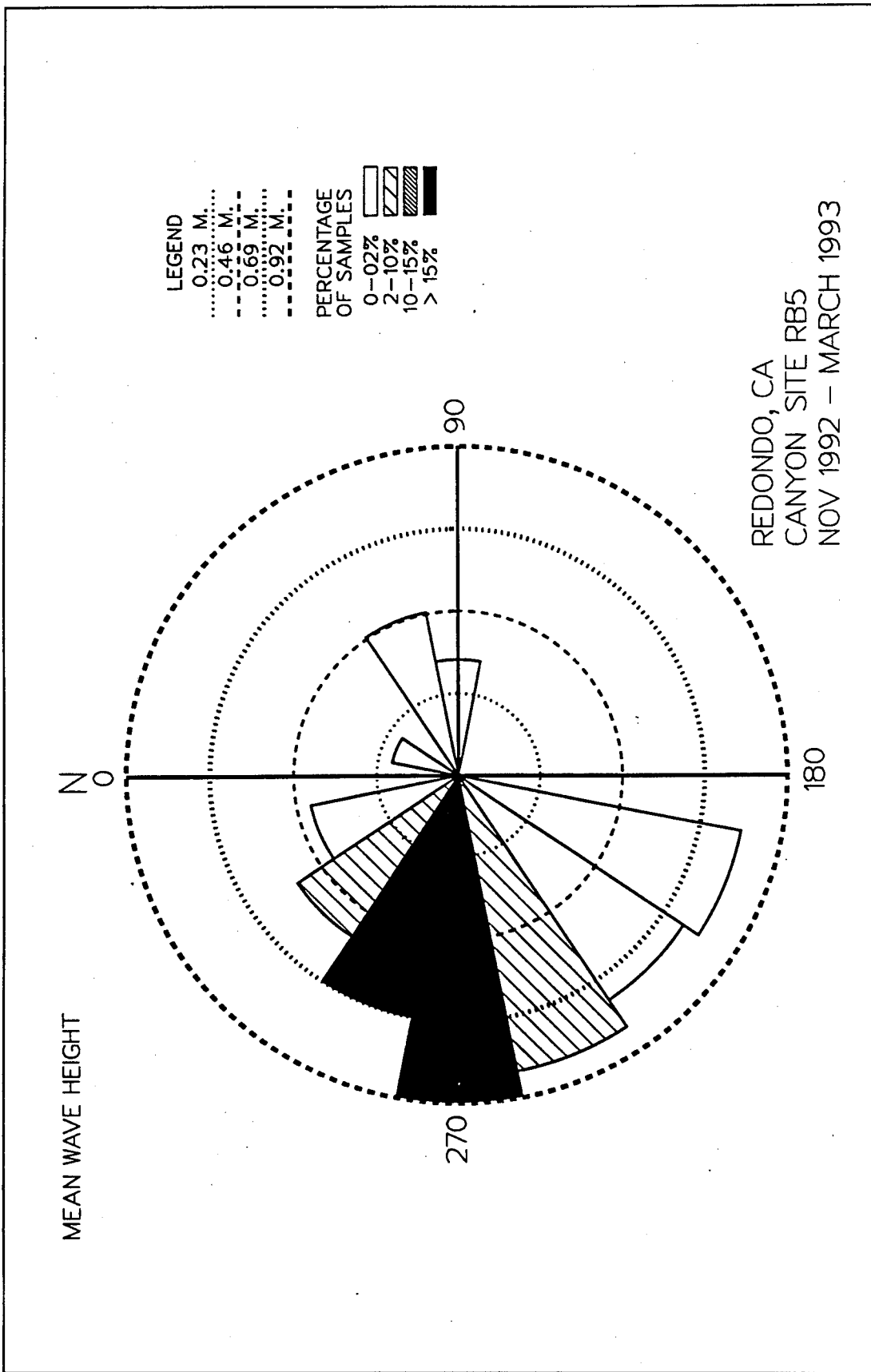

Figure E6. Wave rose for Canyon gage (RB5), first deployment

**Table E1**  
**Mean/Max Values for Canyon (RB5)**  
**First Deployment**

MEAN Hm0 (METERS) BY MONTH AND YEAR  
 CANYON (33.84N 118.40W)

YEAR	MONTH												MEAN
	JAN	FEB	MAR	APR	MAY	JUN	JUL	AUG	SEP	OCT	NOV	DEC	
1992	.	.	.	.	.	.	.	.	.	.	0.6	0.7	0.7
1993	0.8	0.9	0.8	.	.	.	.	.	.	.	.	.	0.8
MEAN	0.8	0.9	0.8	.	.	.	.	.	.	.	0.6	0.7	

LARGEST Hm0 (METERS) BY MONTH AND YEAR  
 CANYON (33.84N 118.40W)

YEAR	MONTH											
	JAN	FEB	MAR	APR	MAY	JUN	JUL	AUG	SEP	OCT	NOV	DEC
1992	.	.	.	.	.	.	.	.	.	.	1.5	2.4
1993	2.3	2.0	2.6	.	.	.	.	.	.	.	.	.

STATISTICS FOR CANYON (33.84N 118.40W)

THE MEAN SIGNIFICANT WAVE HEIGHT (METERS) =	0.7
THE MEAN PEAK WAVE PERIOD (SECONDS) =	9.6
THE MOST FREQUENT 22.5 (CENTER) DIRECTION BAND (DEGREES) =	292.5
THE STANDARD DEVIATION OF Hm0 (METERS) =	0.4
THE STANDARD DEVIATION OF TP (SECONDS) =	2.5
THE LARGEST Hm0 (METERS) =	2.6
THE TP (SECONDS) ASSOC. WITH THE LARGEST Hm0 =	7.1
THE PEAK DIRECTION (DEGREES) ASSOC. WITH THE LARGEST Hm0 =	268.0
THE DATE OF LARGEST Hm0 OCCURRENCE IS	93032704

**Table E2**  
**Percent Occurrence for Canyon (RB5)**  
**First Deployment**

CANYON		33.84N 118.40W IRRESPECTIVE OF DIRECTION									
		NOVEMBER 1992 - MARCH 1993									
		PERCENT OCCURRENCE(X100) OF HEIGHT AND PERIOD									
HEIGHT(METERS)	PEAK PERIOD(SECONDS)										TOTAL
	SHORTER- 4.5	4.6- 5.6	5.6- 8.0	8.0- 10.6	10.7- 11.6	11.6- 12.7	12.8- 14.1	14.2- 15.9	16.0- 18.3	18.4- LONGER	
0.0-0.4	28	52	347	668	298	463	683	109	17	.	2665
0.5-0.9	54	283	1143	1392	564	911	761	66	8	.	5182
1.0-1.4	2	57	552	515	188	228	147	26	.	.	1715
1.5-1.9	.	11	188	75	23	37	26	.	.	.	360
2.0-2.4	.	.	54	2	.	.	.	.	.	.	56
2.5-2.9	.	.	5	.	.	.	.	.	.	.	5
3.0-3.4	.	.	.	.	.	.	.	.	.	.	0
3.5-3.9	.	.	.	.	.	.	.	.	.	.	0
4.0-4.4	.	.	.	.	.	.	.	.	.	.	0
4.5-4.9	.	.	.	.	.	.	.	.	.	.	0
5.0+	.	.	.	.	.	.	.	.	.	.	0
TOTAL	84	403	2289	2652	1073	1639	1617	201	25	0	

MEAN Hm0 (M) = 0.7    LARGEST Hm0 (M) = 2.6    MEAN TP (SEC) = 9.6    TOTAL CASES = 3455.

# **Appendix F Redondo Site, First Deployment**

---

REDONDO  
NDBC 46045  
33.84 N, 118.45 W

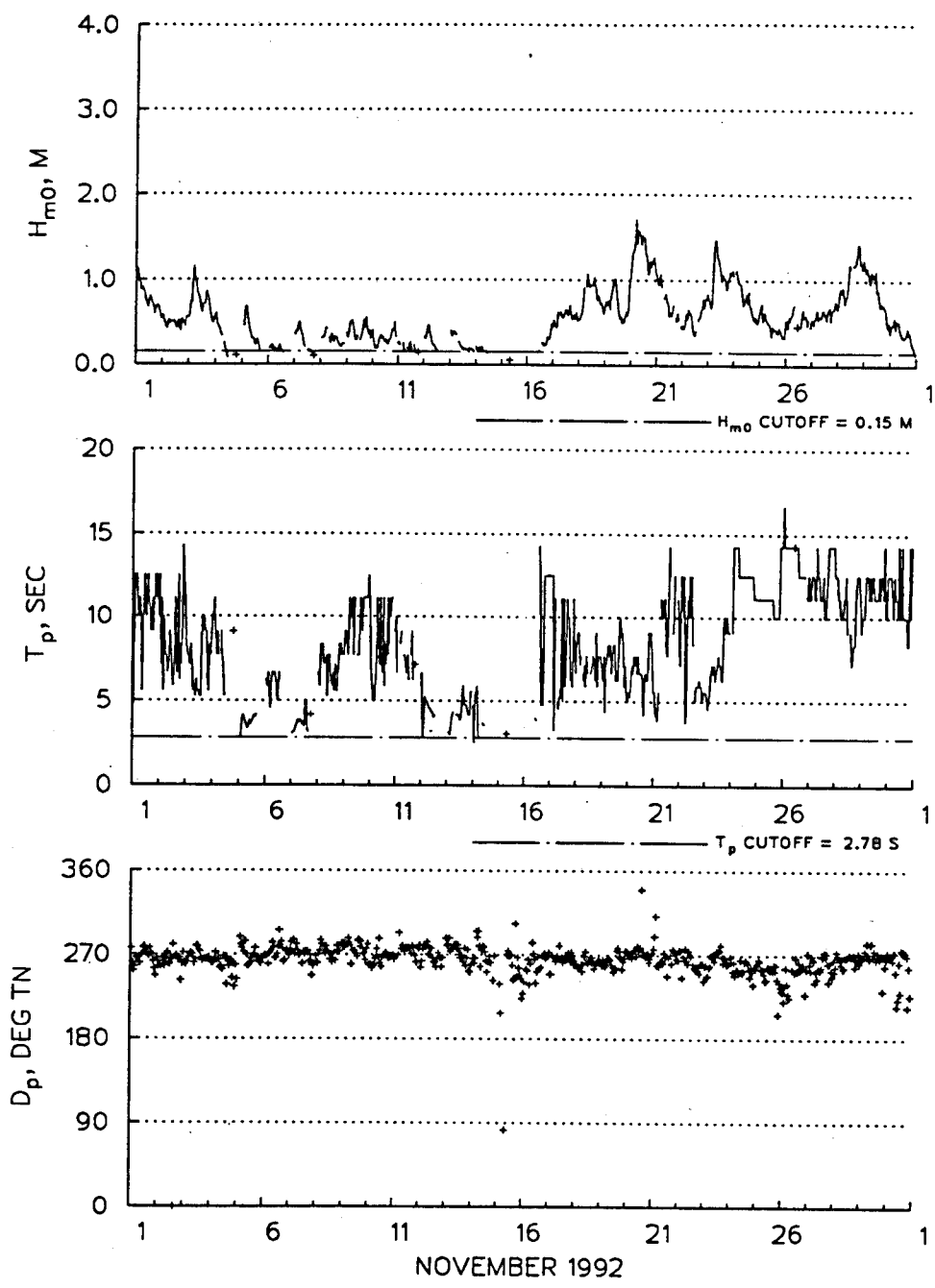

Figure F1. Time series plot for Redondo gage (NDBC 46045), November 1992, first deployment

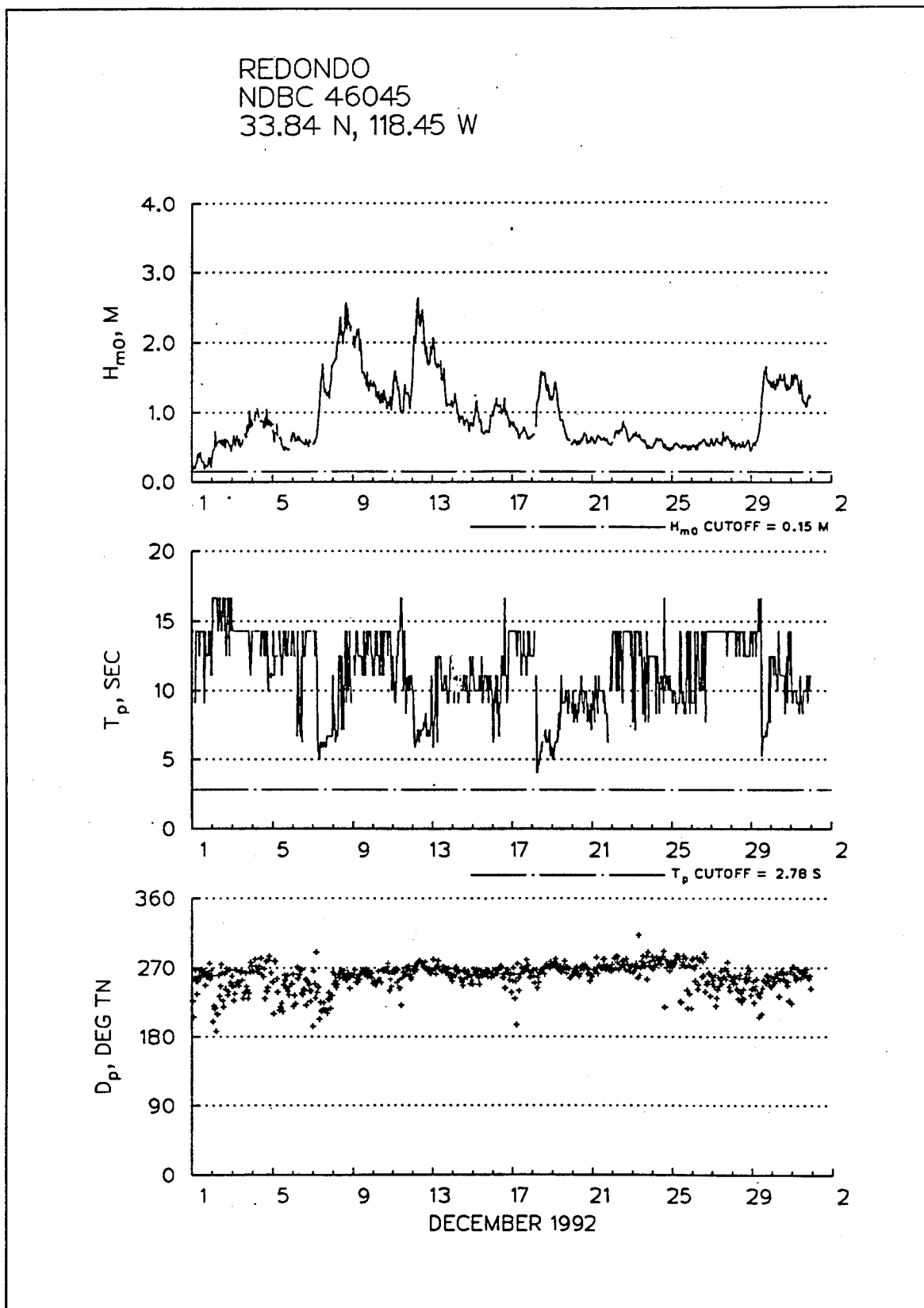

Figure F2. Time series plot for Redondo gage (NDBC 46045), December 1992, first deployment

REDONDO  
NDBC 46045  
33.84 N, 118.45 W

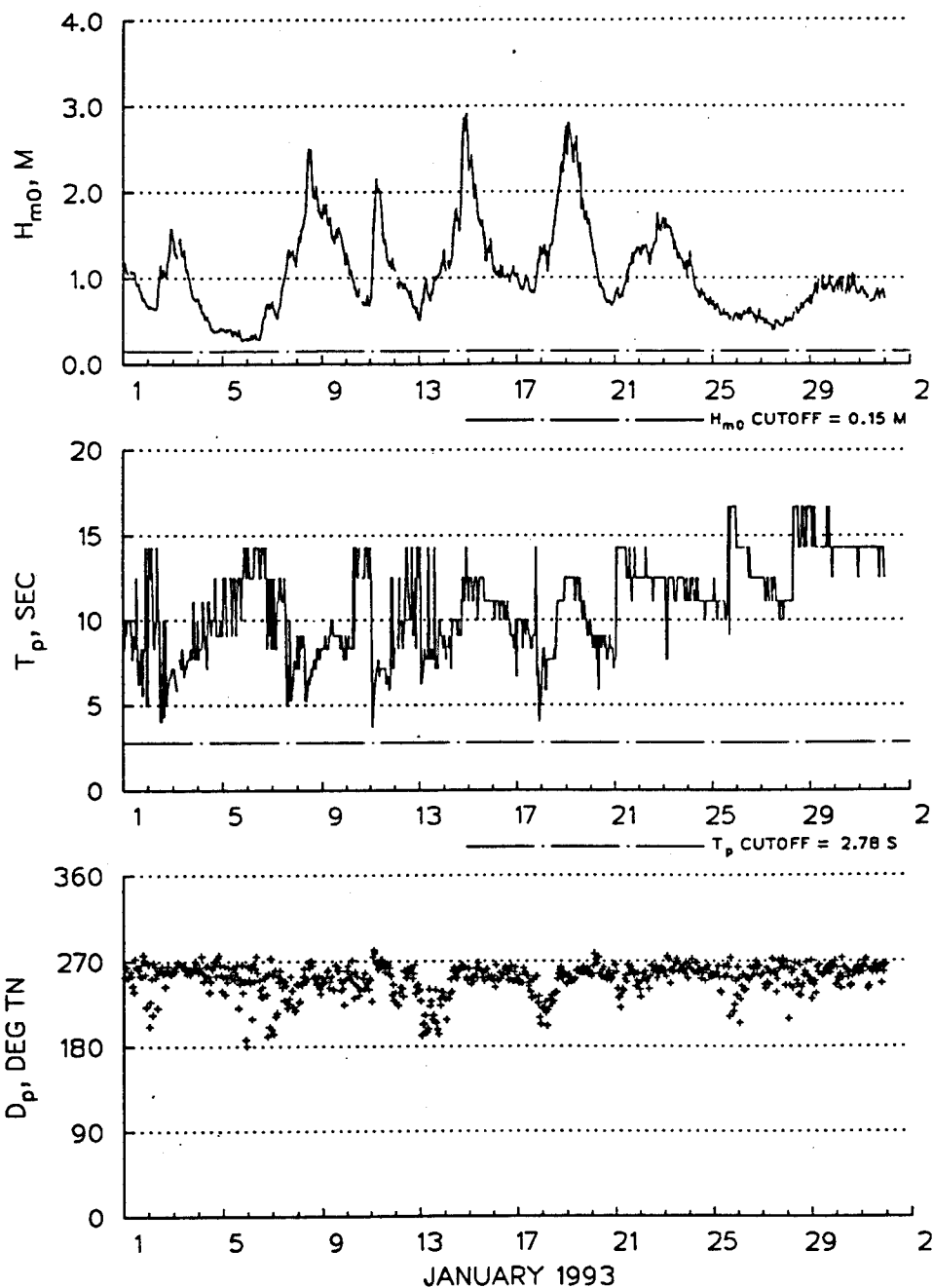

Figure F3. Time series plot for Redondo gage (NDBC 46045), January 1993, first deployment

F4

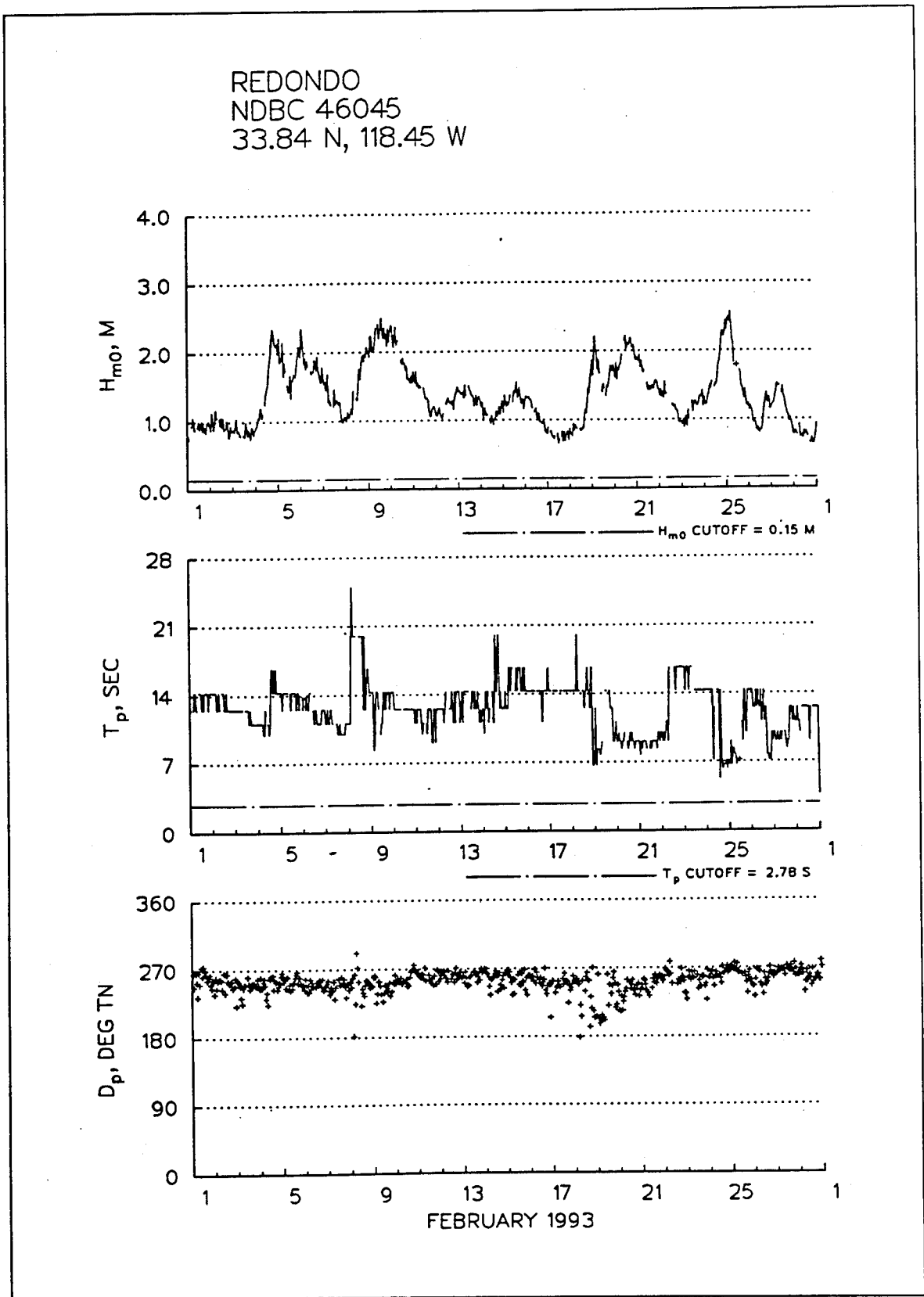

Figure F4. Time series plot for Redondo gage (NDBC 46045), February 1993, first deployment

REDONDO  
NDBC 46045  
33.84 N, 118.45 W

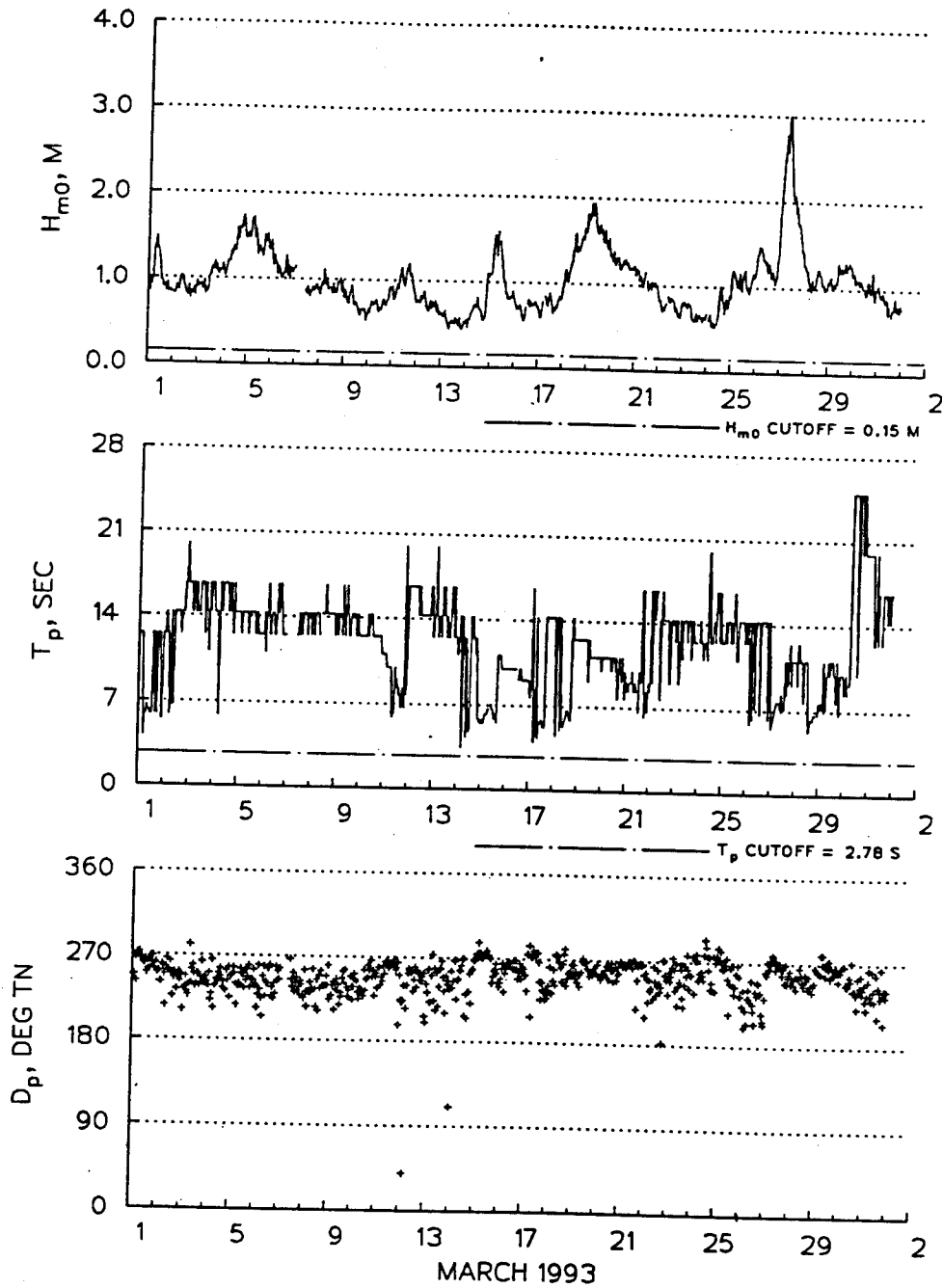

Figure F5. Time series plot for Redondo gage (NDBC 46045), March 1993, first deployment

F6

REDONDO  
NDBC 46045  
33.84 N, 118.45 W

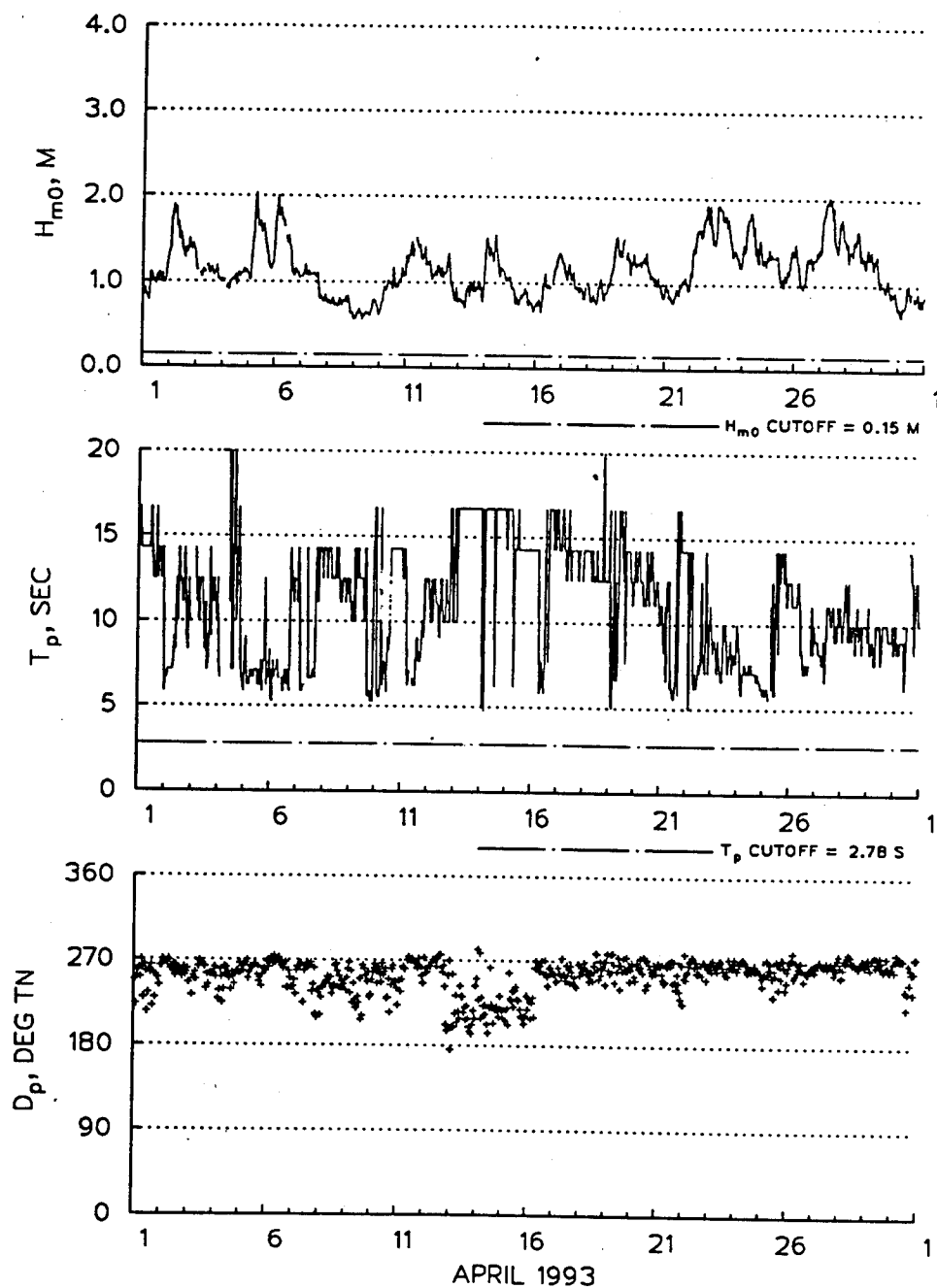

Figure F6. Time series plot for Redondo gage (NDBC 46045), April 1993, first deployment

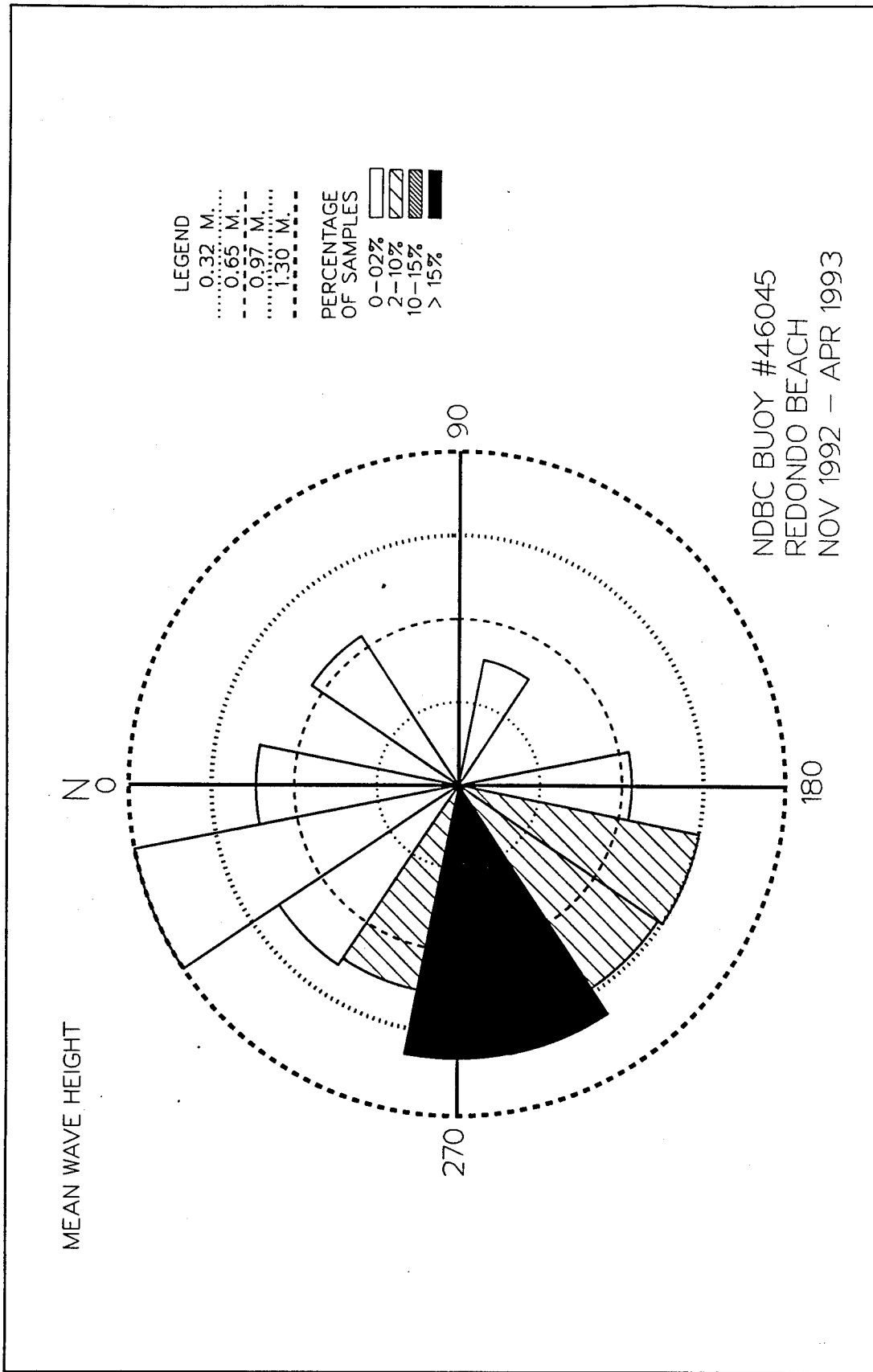

Figure F7. Wave rose plot for Redondo gage (NDBC 46045), first deployment

**Table F1  
Mean/Max Values for Redondo (NDBC 46045)  
First Deployment**

MEAN Hm0 (METERS) BY MONTH AND YEAR  
NDBC BUOY 46045 (33.84N 118.45W)

YEAR	MONTH												MEAN
	JAN	FEB	MAR	APR	MAY	JUN	JUL	AUG	SEP	OCT	NOV	DEC	
1992	.	.	.	.	.	.	.	.	.	.	0.6	1.0	0.8
1993	1.1	1.4	1.0	1.3	.	.	.	.	.	.	.	.	1.2
MEAN	1.1	1.4	1.0	1.3	.	.	.	.	.	.	0.6	1.0	

LARGEST Hm0 (METERS) BY MONTH AND YEAR  
NDBC BUOY 46045 (33.84N 118.45W)

YEAR	MONTH											
	JAN	FEB	MAR	APR	MAY	JUN	JUL	AUG	SEP	OCT	NOV	DEC
1992	.	.	.	.	.	.	.	.	.	.	1.7	2.6
1993	2.9	2.6	3.0	2.6	.	.	.	.	.	.	.	.

STATISTICS FOR NDBC BUOY 46045 (33.84N 118.45W)

THE MEAN SIGNIFICANT WAVE HEIGHT (METERS) =	1.1
THE MEAN PEAK WAVE PERIOD (SECONDS) =	11.2
THE MOST FREQUENT 22.5 (CENTER) DIRECTION BAND (DEGREES) =	270.0
THE STANDARD DEVIATION OF Hm0 (METERS) =	0.5
THE STANDARD DEVIATION OF TP (SECONDS) =	3.4
THE LARGEST Hm0 (METERS) =	3.0
THE TP (SECONDS) ASSOC. WITH THE LARGEST Hm0 =	7.7
THE PEAK DIRECTION (DEGREES) ASSOC. WITH THE LARGEST Hm0 =	279.0
THE DATE OF LARGEST Hm0 OCCURRENCE IS	93032707

**Table F2**  
**Percent Occurrence for Redondo (NDBC 46045)**  
**First Deployment**

BUOY STATION 46045 33.84 N 118.45 W FOR ALL DIRECTIONS  
 NOVEMBER 1992 - APRIL 1993  
 PERCENT OCCURRENCE(X100) OF HEIGHT AND PERIOD

HEIGHT (METERS)	PEAK PERIOD (SECONDS)										TOTAL
	<6.9	6.9- 8.0	8.1- 8.7	8.8- 9.5	9.6- 10.5	10.6- 11.7	11.8- 13.3	13.4- 15.3	15.4- 18.1	18.2- LONGER	
0.0-0.9	544	223	201	274	399	512	909	1331	291	36	4720
1.0-1.9	664	394	208	370	392	549	845	826	306	98	4652
2.0-2.9	90	125	31	34	24	58	142	102	7	.	613
3.0-3.9	.	2	.	.	.	.	.	.	.	.	2
4.0-4.9	.	.	.	.	.	.	.	.	.	.	0
5.0-5.9	.	.	.	.	.	.	.	.	.	.	0
6.0-6.9	.	.	.	.	.	.	.	.	.	.	0
7.0-7.9	.	.	.	.	.	.	.	.	.	.	0
8.0-8.9	.	.	.	.	.	.	.	.	.	.	0
9.0-9.9	.	.	.	.	.	.	.	.	.	.	0
10.0+	.	.	.	.	.	.	.	.	.	.	0
TOTAL	1298	744	440	678	815	1119	1896	2259	604	134	

MEAN Hm0 (M) = 1.1    LARGEST Hm0 (M) = 3.0    MEAN TP (SEC) = 11.2    TOTAL CASES = 4079.

# **Appendix G Catalina Ridge Site, First Deployment**

---

CATALINA RIDGE  
NDBC 46025  
33.75 N, 119.07 W

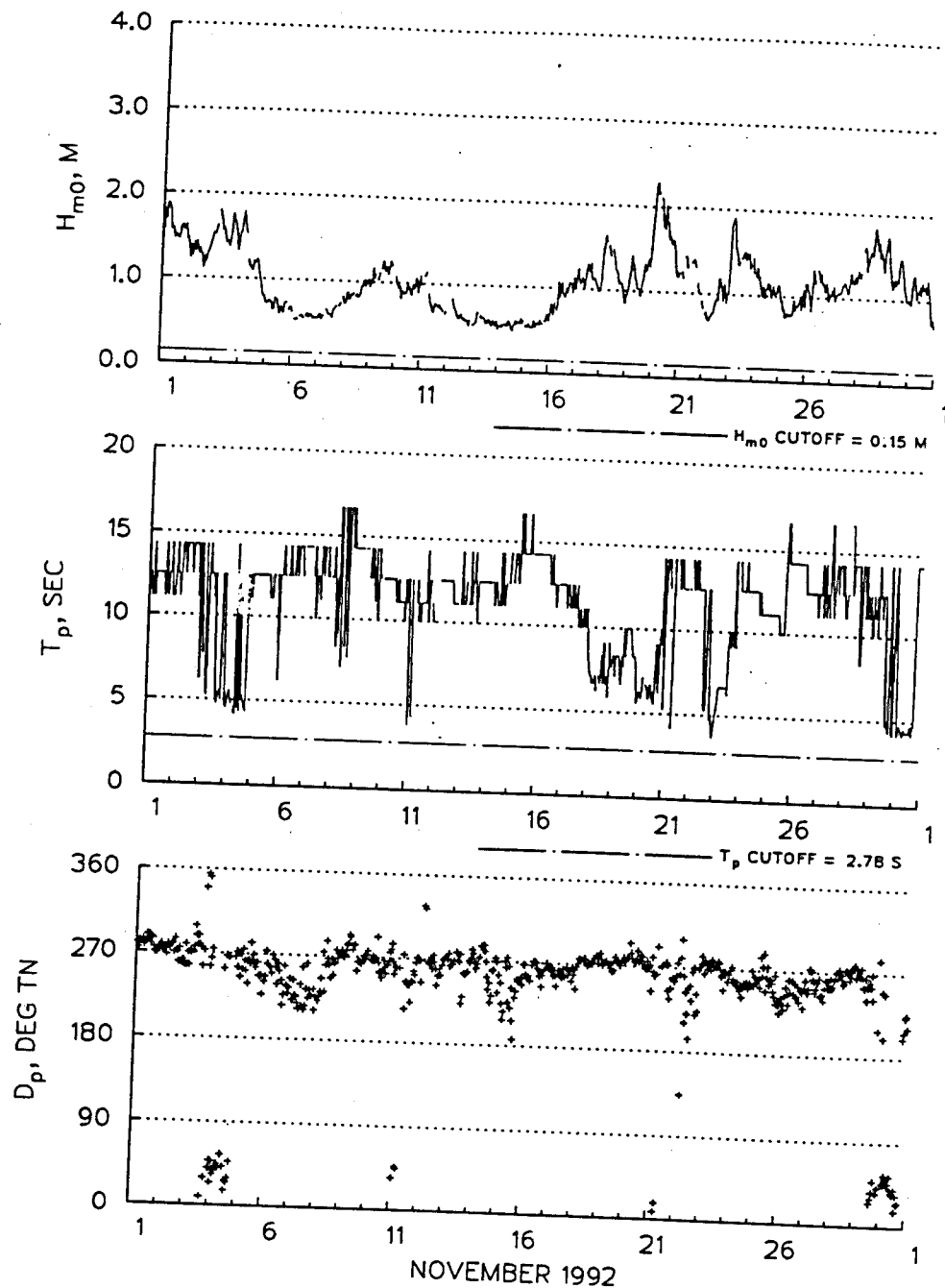

Figure G1. Time series plot for Catalina Ridge gage (46025), November 1992, first deployment

CATALINA RIDGE  
NDBC 46025  
33.75 N, 119.07 W

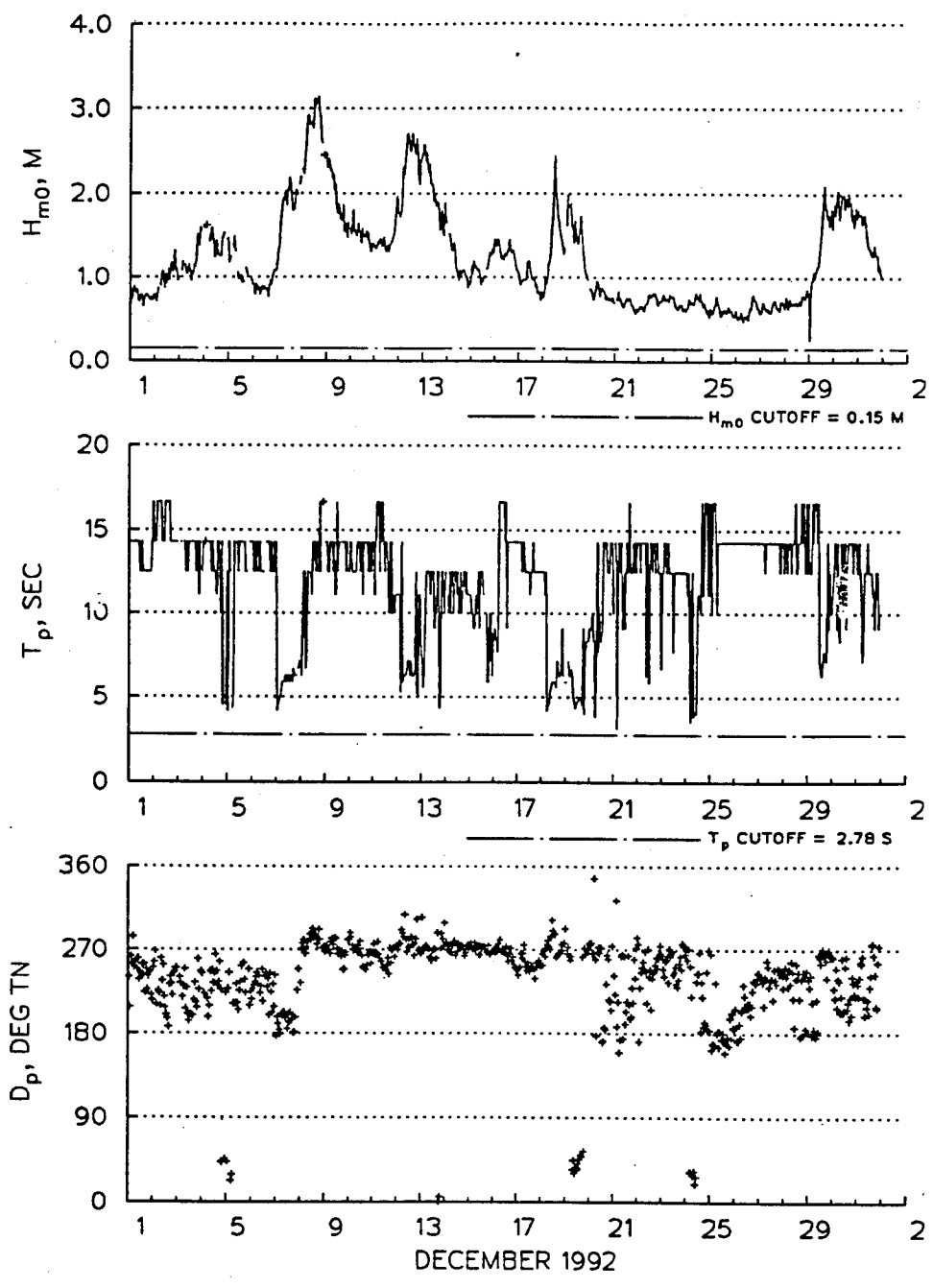

Figure G2. Time series plot for Catalina Ridge gage (46025), December 1992, first deployment

CATALINA RIDGE  
NDBC 46025  
33.75 N, 119.07 W

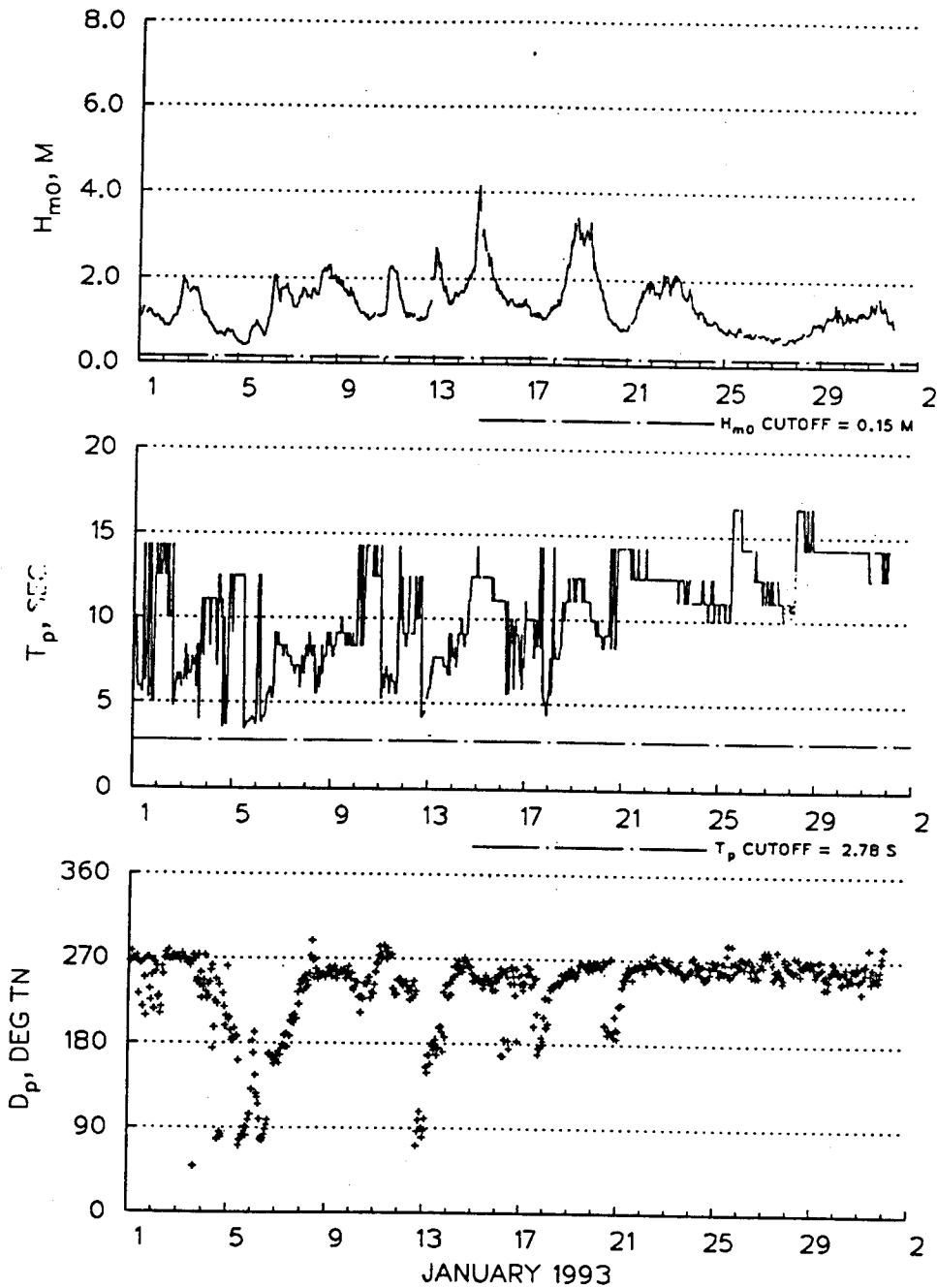

Figure G3. Time series plot for Catalina Ridge gage (46025), January 1993, first deployment

G4

CATALINA RIDGE  
NDBC 46025  
33.75 N, 119.07 W

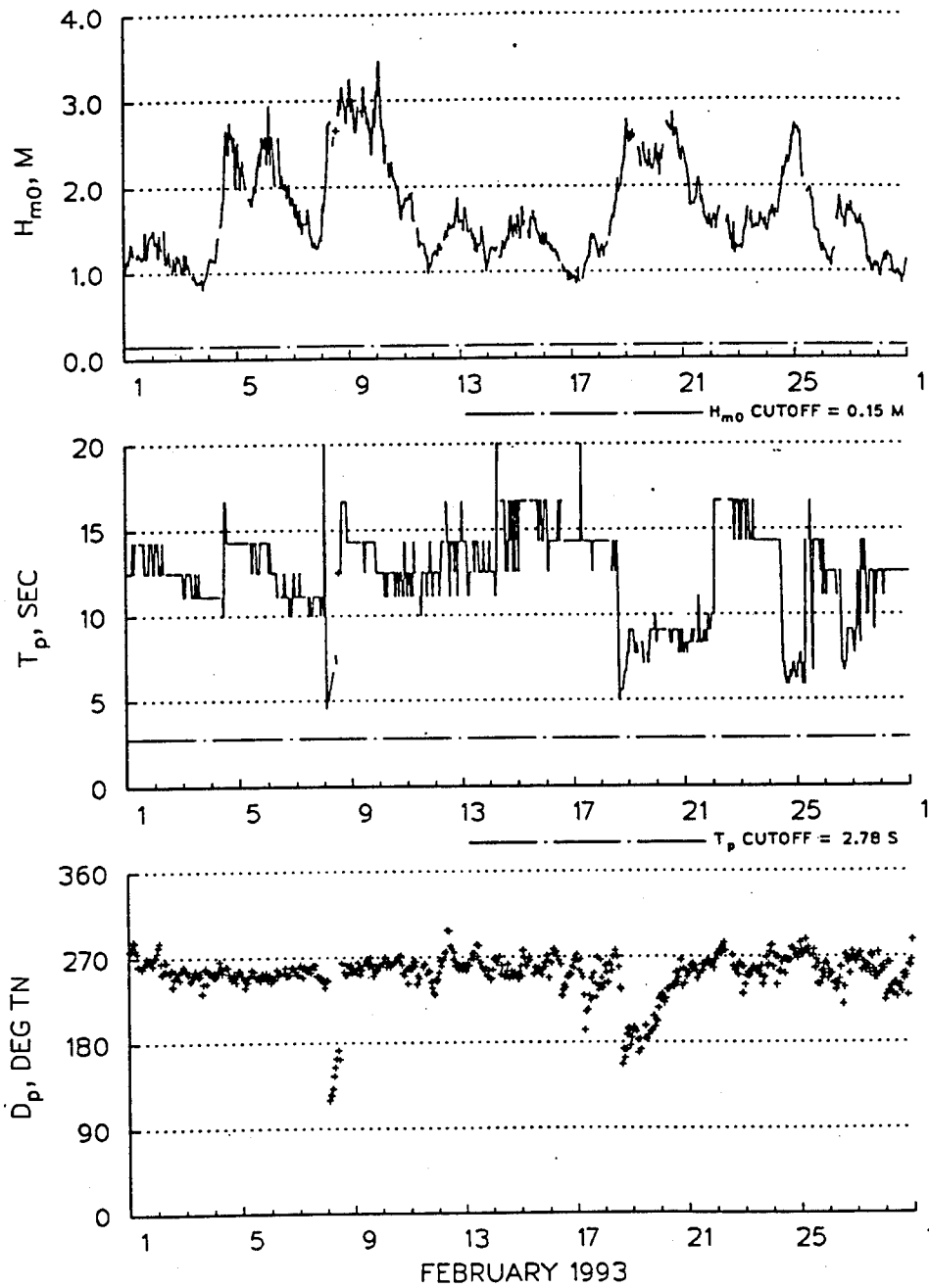

Figure G4. Time series plot for Catalina Ridge gage (46025), February 1993, first deployment

CATALINA RIDGE  
NDBC 46025  
33.75 N, 119.07 W

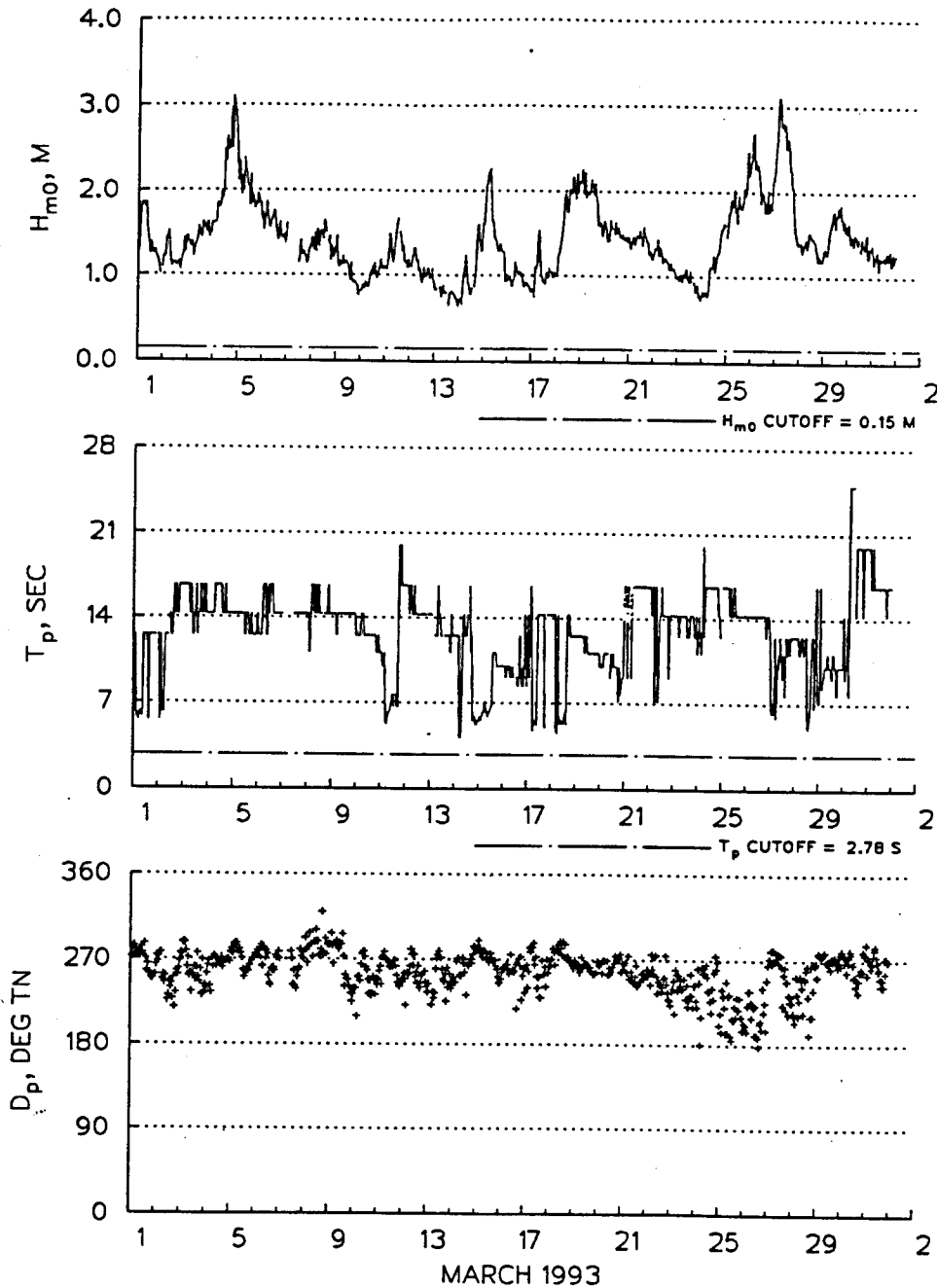

Figure G5. Time series plot for Catalina Ridge gage (46025), March 1993, first deployment

G6

CATALINA RIDGE  
NDBC 46025  
33.75 N, 119.07 W

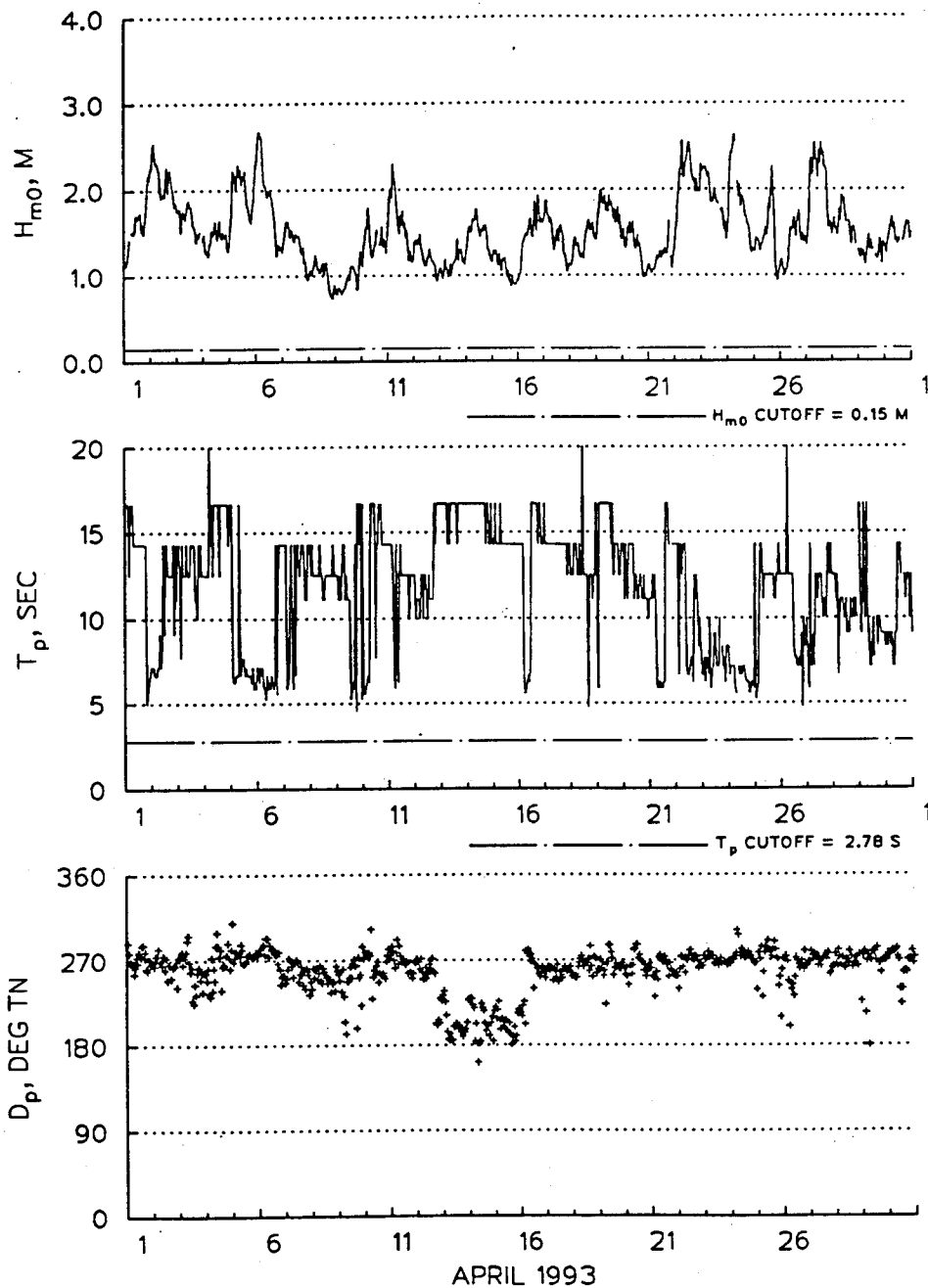

Figure G6. Time series plot for Redondo gage (46045), April 1993, first deployment

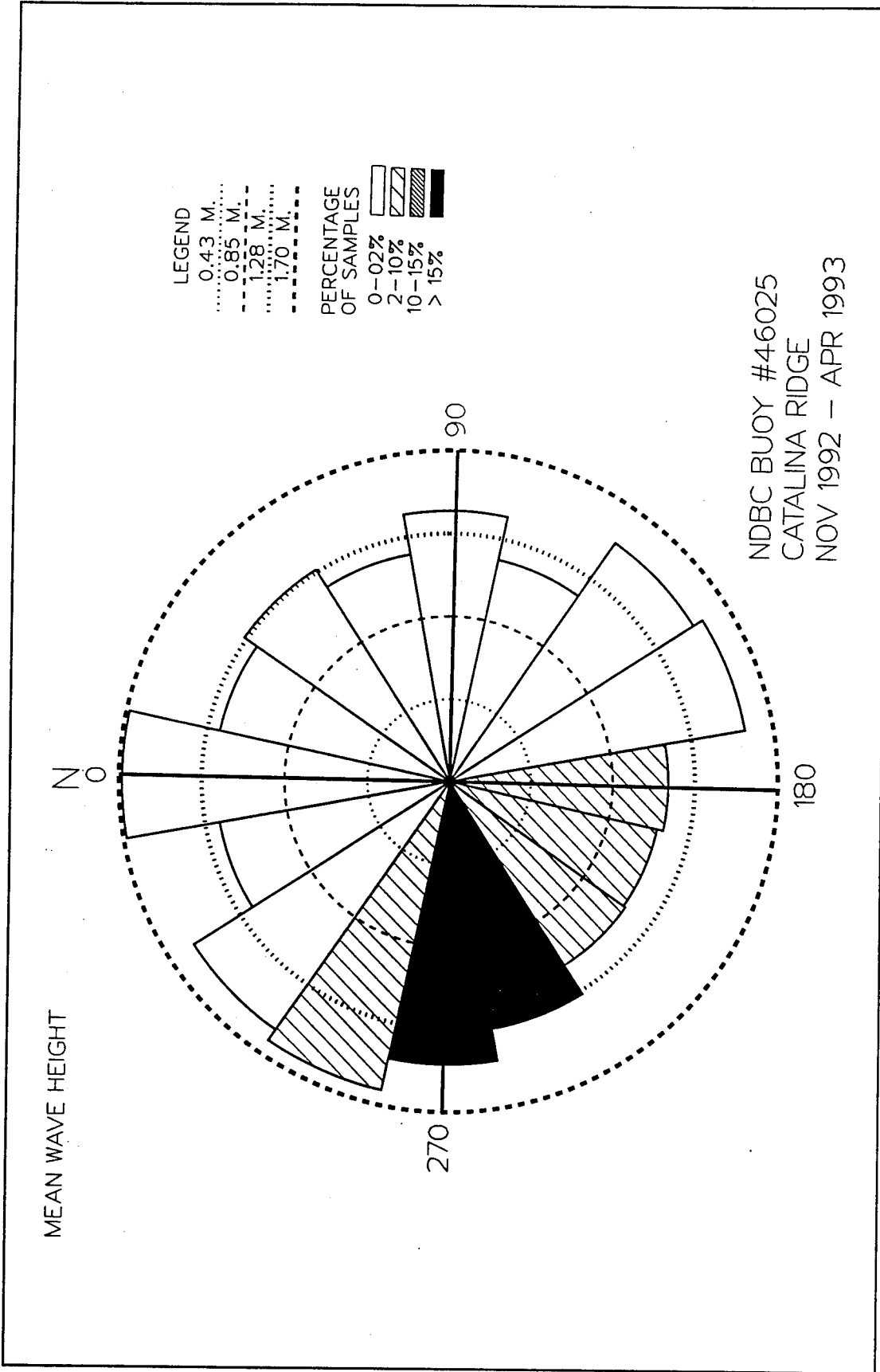

Figure G7. Wave rose plot for Catalina Ridge gage (NDBC 46025), first deployment

**Table G1**  
**Mean/Max Values for Catalina Ridge (NDBC 46025)**  
**First Deployment**

MEAN Hm0 (METERS) BY MONTH AND YEAR  
 NDBC BUOY 46025 (33.75N 119.07W)

YEAR	MONTH												MEAN
	JAN	FEB	MAR	APR	MAY	JUN	JUL	AUG	SEP	OCT	NOV	DEC	
1992	.	.	.	.	.	.	.	.	.	1.1	1.1	1.2	1.1
1993	1.4	1.7	1.4	1.5	.	.	.	.	.	.	.	.	1.5
MEAN	1.4	1.7	1.4	1.5	.	.	.	.	.	1.1	1.1	1.2	

LARGEST Hm0 (METERS) BY MONTH AND YEAR  
 NDBC BUOY 46025 (33.75N 119.07W)

YEAR	MONTH											
	JAN	FEB	MAR	APR	MAY	JUN	JUL	AUG	SEP	OCT	NOV	DEC
1992	.	.	.	.	.	.	.	.	.	2.2	2.3	3.2
1993	4.2	3.5	3.1	2.7	.	.	.	.	.	.	.	.

STATISTICS FOR NDBC BUOY 46025 (33.75N 119.07W)

THE MEAN SIGNIFICANT WAVE HEIGHT (METERS) =	1.3
THE MEAN PEAK WAVE PERIOD (SECONDS) =	11.9
THE MOST FREQUENT 22.5 (CENTER) DIRECTION BAND (DEGREES) =	270.0
THE STANDARD DEVIATION OF Hm0 (METERS) =	0.5
THE STANDARD DEVIATION OF TP (SECONDS) =	3.2
THE LARGEST Hm0 (METERS) =	4.2
THE TP (SECONDS) ASSOC. WITH THE LARGEST Hm0 =	12.5
THE PEAK DIRECTION (DEGREES) ASSOC. WITH THE LARGEST Hm0 =	263.0
THE DATE OF LARGEST Hm0 OCCURRENCE IS	93011418

**Table G2**  
**Percent Occurrence for Catalina Ridge (NDBC 46025)**  
**First Deployment**

BUOY STATION 46025 33.75 N 119.07 W FOR ALL DIRECTIONS  
 NOVEMBER 1992 - APRIL 1993  
 PERCENT OCCURRENCE (X100) OF HEIGHT AND PERIOD

HEIGHT (METRES)	PEAK PERIOD (SECONDS)										TOTAL
	<6.9	6.9- 8.0	8.1- 8.7	8.8- 9.5	9.6- 10.5	10.6- 11.7	11.8- 13.3	13.4- 15.3	15.4- 18.1	18.2- LONGER	
0.0-0.9	116	28	44	57	120	357	696	834	151	4	2407
1.0-1.9	722	251	159	246	328	647	1457	1720	687	65	6282
2.0-2.9	289	151	53	79	30	91	240	244	26	.	1203
3.0-3.9	2	2	.	.	.	14	34	28	8	.	88
4.0-4.9	.	.	.	.	.	.	4	.	.	.	4
5.0-5.9	.	.	.	.	.	.	.	.	.	.	0
6.0-6.9	.	.	.	.	.	.	.	.	.	.	0
7.0-7.9	.	.	.	.	.	.	.	.	.	.	0
8.0-8.9	.	.	.	.	.	.	.	.	.	.	0
9.0-9.9	.	.	.	.	.	.	.	.	.	.	0
10.0+	.	.	.	.	.	.	.	.	.	.	0
<b>TOTAL</b>	<b>1129</b>	<b>432</b>	<b>256</b>	<b>382</b>	<b>478</b>	<b>1109</b>	<b>2431</b>	<b>2826</b>	<b>872</b>	<b>69</b>	

MEAN Hm0 (M) = 1.3    LARGEST Hm0 (M) = 4.2    MEAN TP (SEC) = 11.9    TOTAL CASES = 4899.

# **Appendix H North Breakwater Site, Second Deployment**

---

NORTH BREAKWATER  
GAGE #020  
33.85 N 118.41 W

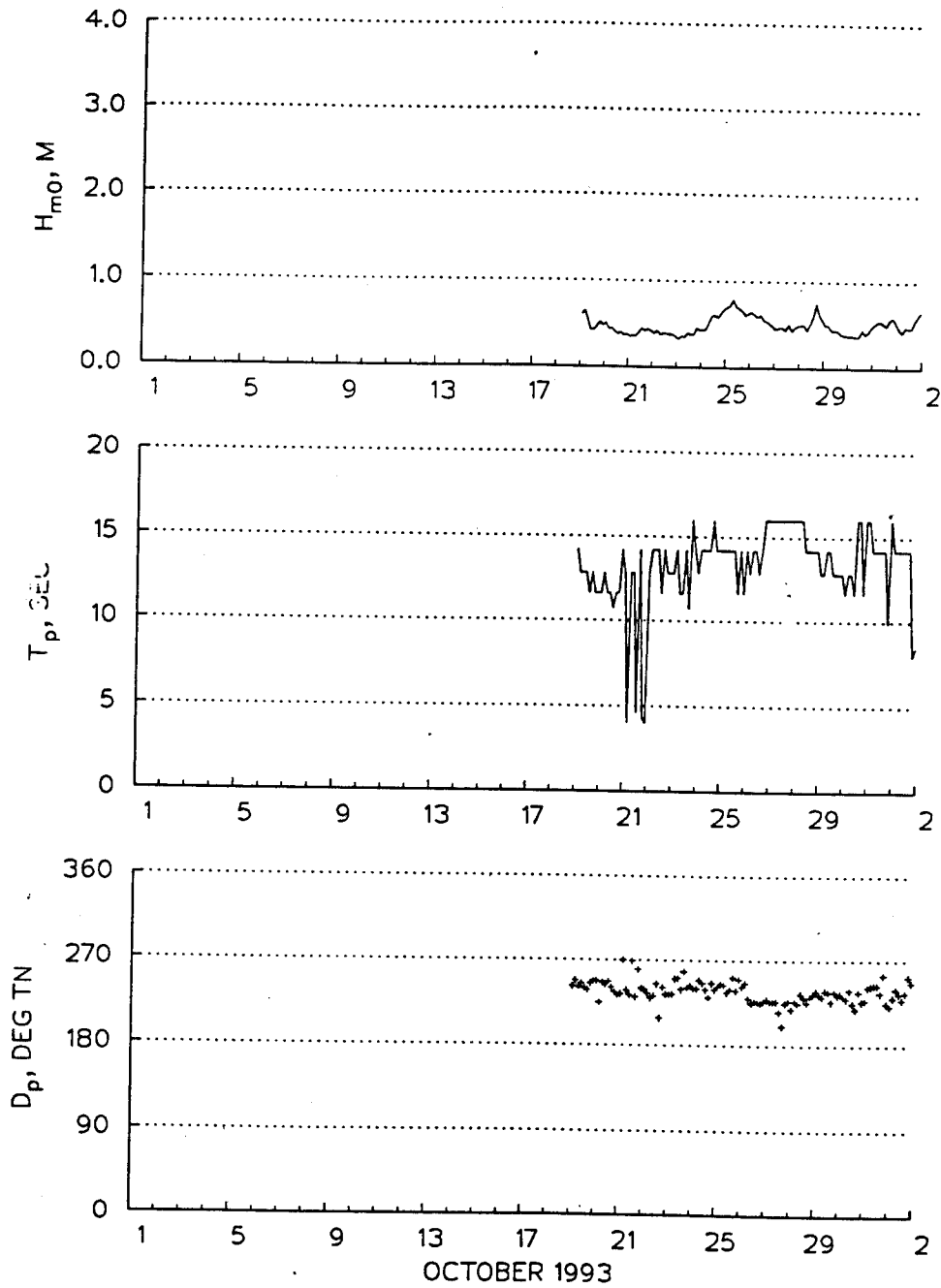

Figure H1. Time series plot for North Breakwater gage (020), October 1993, second deployment

H2

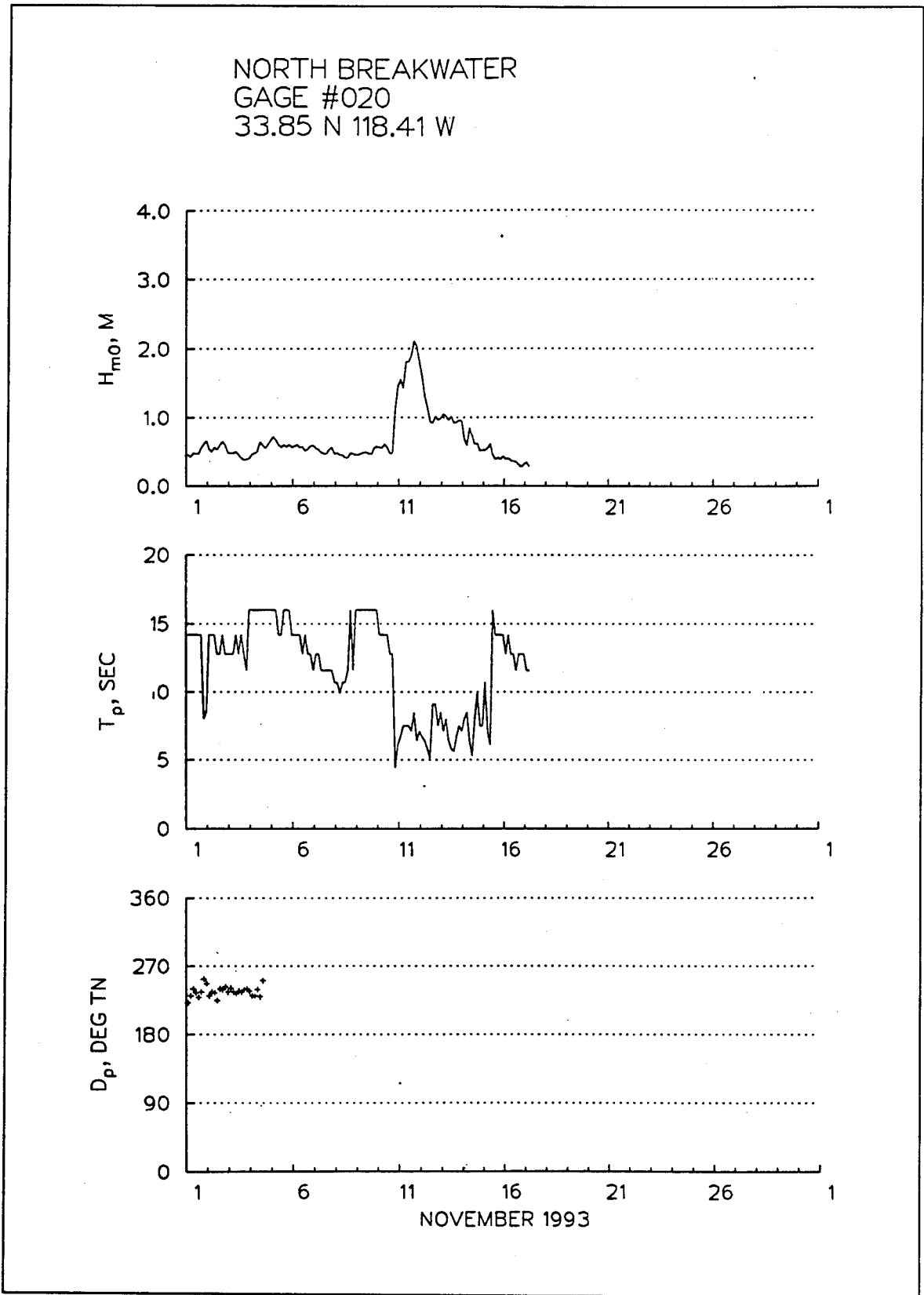

Figure H2. Time series plot for North Breakwater gage (020), November 1993, second deployment

**Table H1**  
**Mean/Max Values for North Breakwater (020)**  
**Second Deployment**

MEAN Hm0 (METERS) BY MONTH AND YEAR  
 NORTH BREAKWATER (33.85N 118.41W)

YEAR	MONTH												MEAN
	JAN	FEB	MAR	APR	MAY	JUN	JUL	AUG	SEP	OCT	NOV	DEC	
1993	.	.	.	.	.	.	.	.	.	0.5	0.7	.	0.6
MEAN	.	.	.	.	.	.	.	.	.	0.5	0.7	.	

LARGEST Hm0 (METERS) BY MONTH AND YEAR  
 NORTH BREAKWATER (33.85N 118.41W)

YEAR	MONTH											
	JAN	FEB	MAR	APR	MAY	JUN	JUL	AUG	SEP	OCT	NOV	DEC
1993	.	.	.	.	.	.	.	.	.	0.8	2.1	.

STATISTICS FOR NORTH BREAKWATER (33.85N 118.41W)

THE MEAN SIGNIFICANT WAVE HEIGHT (METERS) =	0.6
THE MEAN PEAK WAVE PERIOD (SECONDS) =	12.5
THE STANDARD DEVIATION OF Hm0 (METERS) =	0.3
THE STANDARD DEVIATION OF TP (SECONDS) =	3.1
THE LARGEST Hm0 (METERS) =	2.1
THE TP (SECONDS) ASSOC. WITH THE LARGEST Hm0 =	8.5
THE DATE OF LARGEST Hm0 OCCURRENCE IS	93111117

**Table H2**  
**Percent Occurrence for North Breakwater (020)**  
**Second Deployment**

NORTH BREAKWATER											33.85N 118.41W		IRRESPECTIVE OF DIRECTION																														
OCTOBER 1993 - NOVEMBER 1993											PERCENT OCCURRENCE(X100) OF HEIGHT AND PERIOD																																
HEIGHT(METERS)	PEAK PERIOD(SECONDS)										TOTAL																																
	SHORTER- 4.5	4.6- 5.6	5.6- 8.0	8.0- 10.6	10.7- 11.6	11.6- 12.7	12.8- 14.1	14.2- 15.9	16.0- 18.3	18.4- LONGER																																	
0.0-0.4	128	42	.	42	256	897	1282	982	1068	.	4697																																
0.5-0.9	.	85	470	384	42	299	598	1837	854	.	4569																																
1.0-1.4	42	.	256	85	.	.	.	.	.	.	383																																
1.5-1.9	.	.	256	.	.	.	.	.	.	.	256																																
2.0-2.4	.	.	42	42	.	.	.	.	.	.	84																																
2.5-2.9	.	.	.	.	.	.	.	.	.	.	0																																
3.0-3.4	.	.	.	.	.	.	.	.	.	.	0																																
3.5-3.9	.	.	.	.	.	.	.	.	.	.	0																																
4.0-4.4	.	.	.	.	.	.	.	.	.	.	0																																
4.5-4.9	.	.	.	.	.	.	.	.	.	.	0																																
5.0+	.	.	.	.	.	.	.	.	.	.	0																																
TOTAL	170	127	1024	553	298	1196	1880	2819	1922	0																																	
MEAN Hm0 (M) = 0.6											LARGEST Hm0 (M) = 2.1											MEAN TP (SEC) = 12.5											TOTAL CASES = 234.										

# **Appendix I South Breakwater Site, Second Deployment**

---

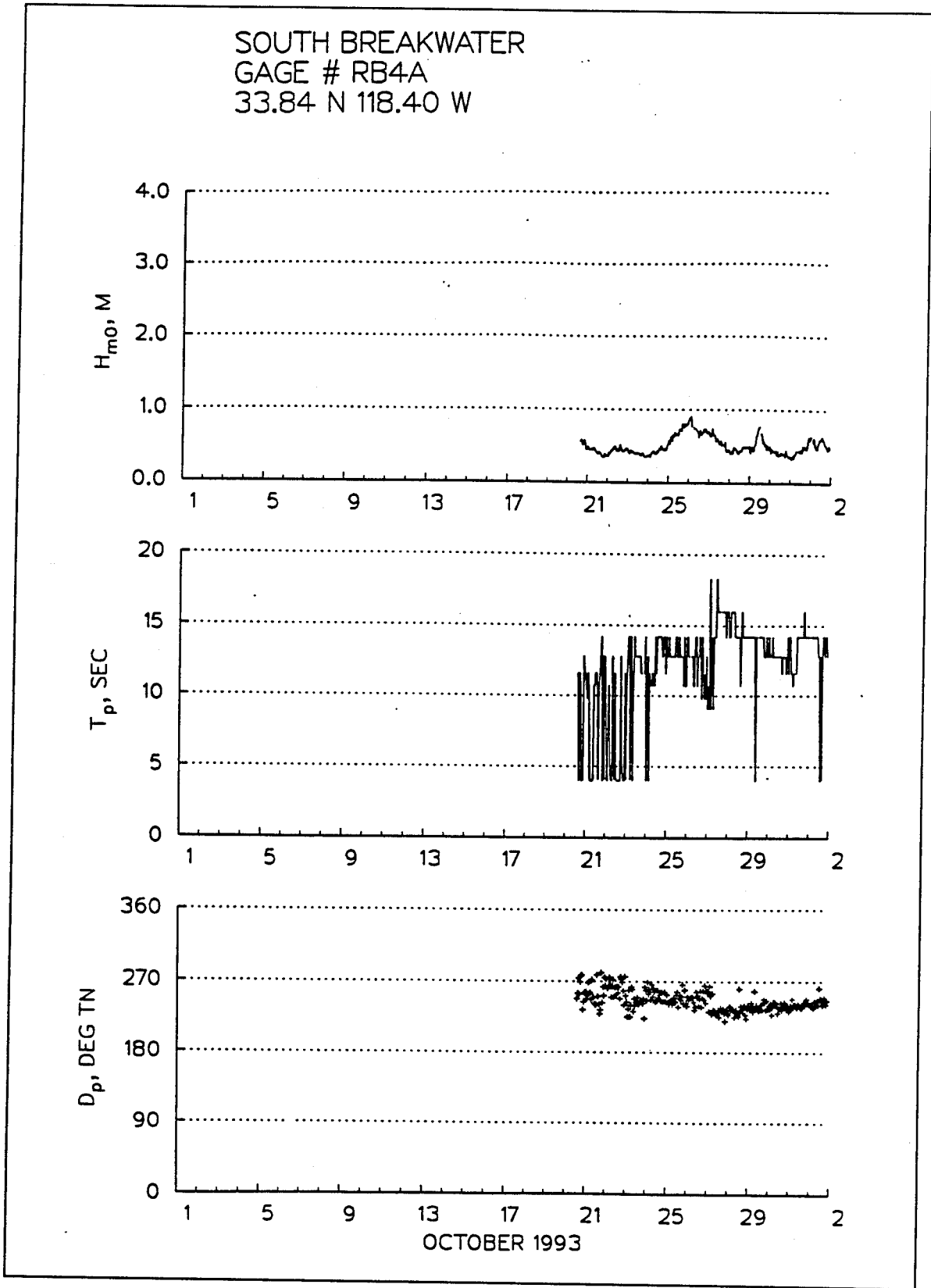

Figure 11. Time series plot for South Breakwater gage (RB4A), October 1993, second deployment

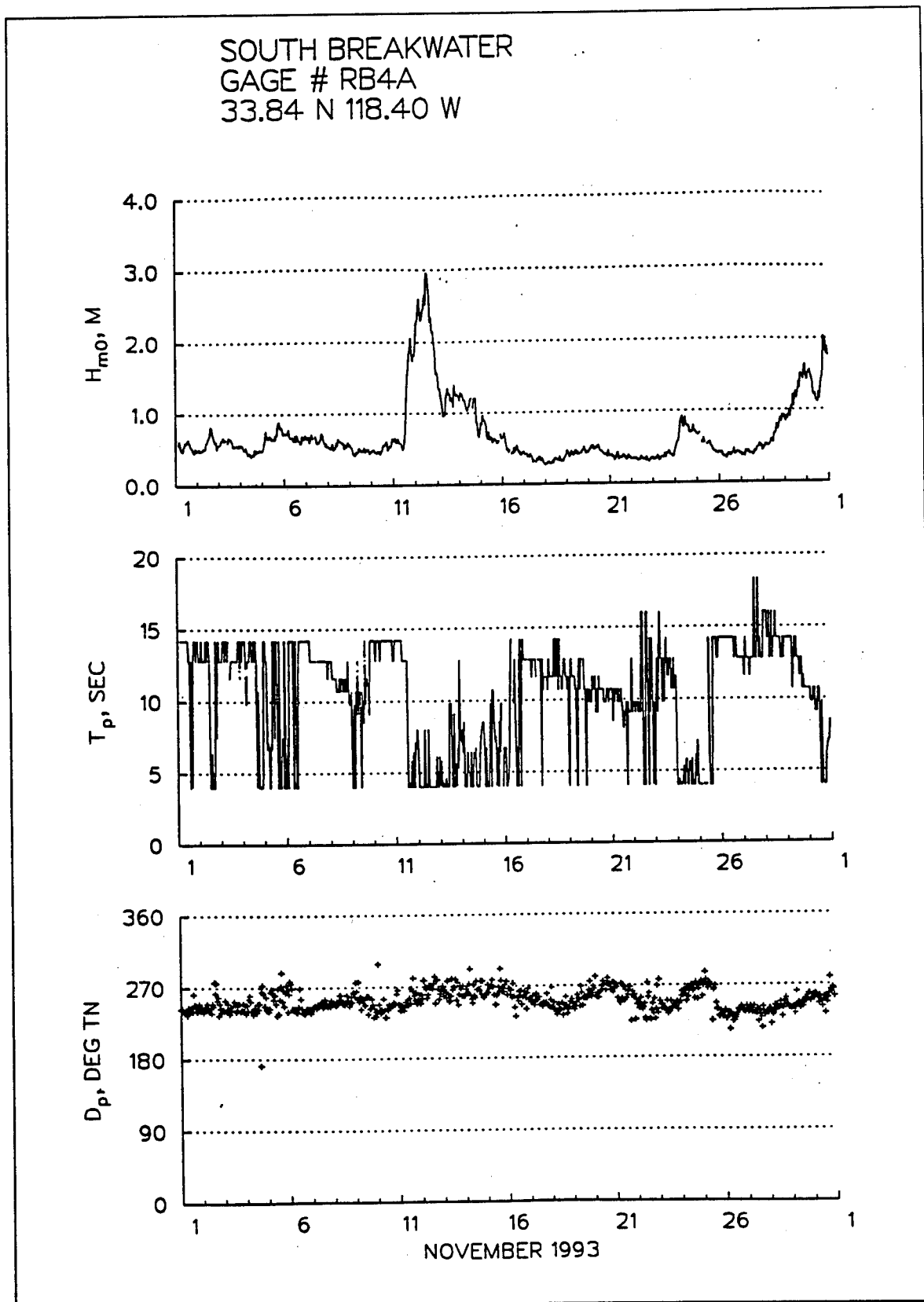

Figure 12. Time series plot for South Breakwater gage (RB4A), November 1993, second deployment

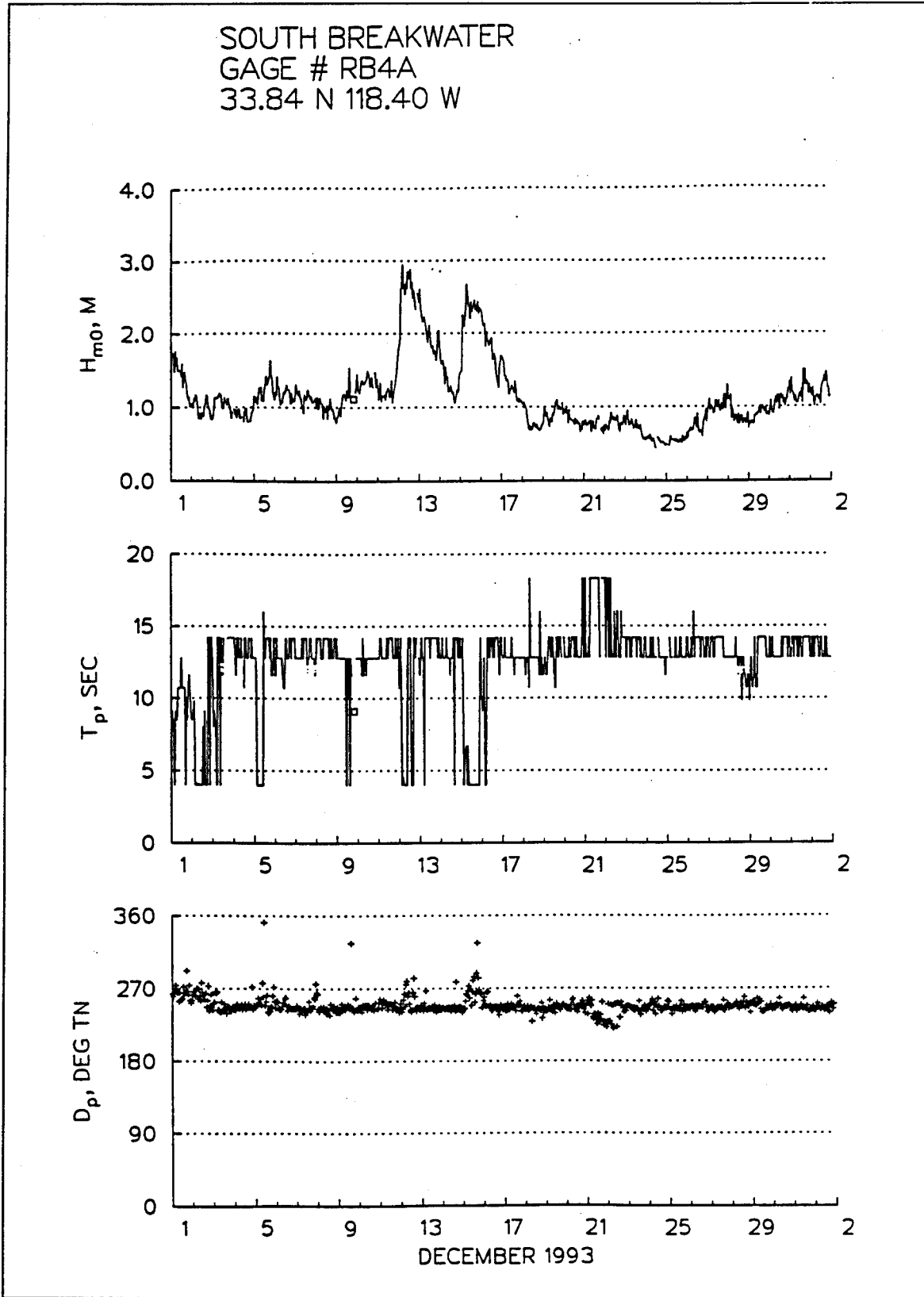

Figure 13. Time series plot for South Breakwater gage (RB4A), December 1993, second deployment

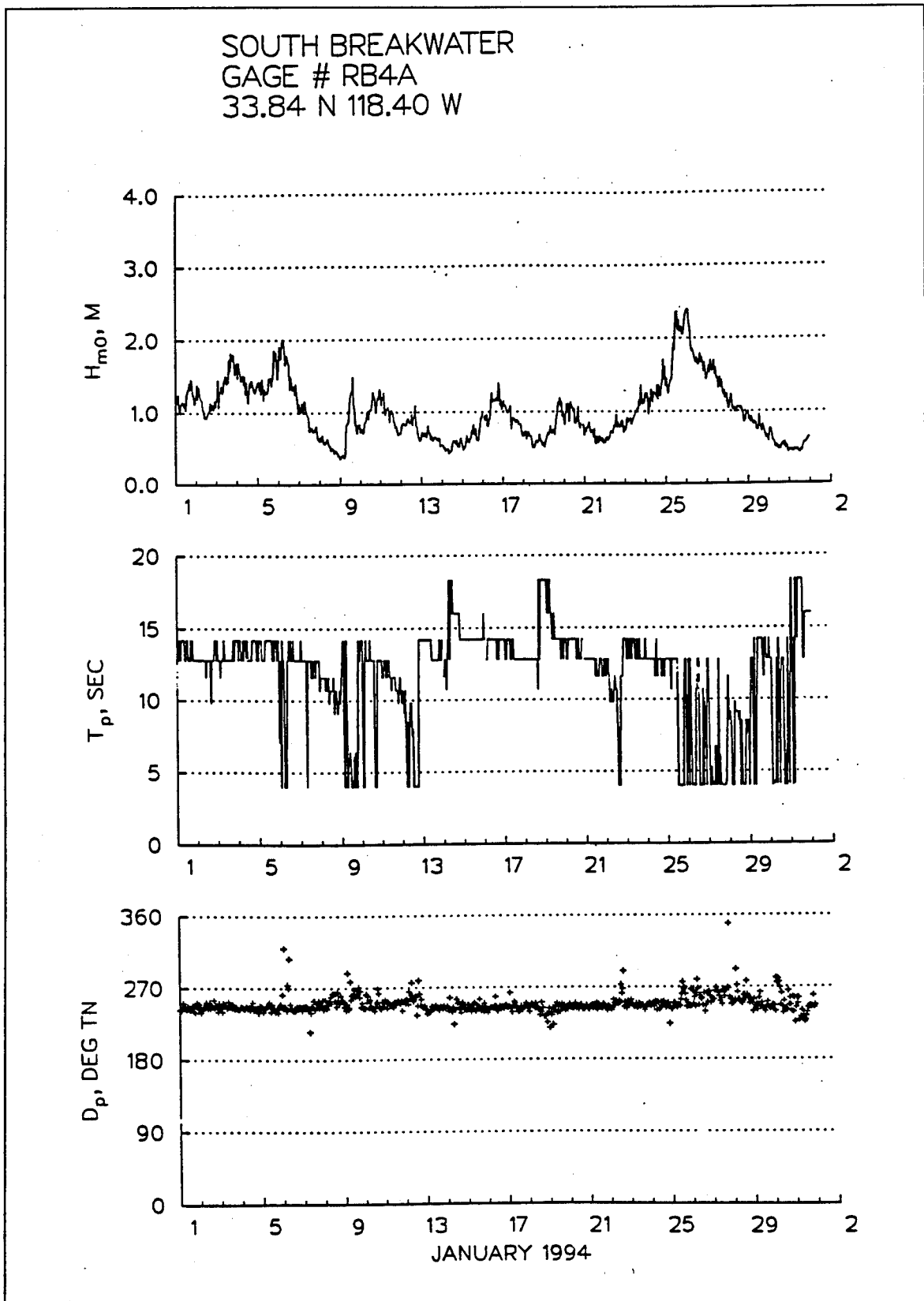
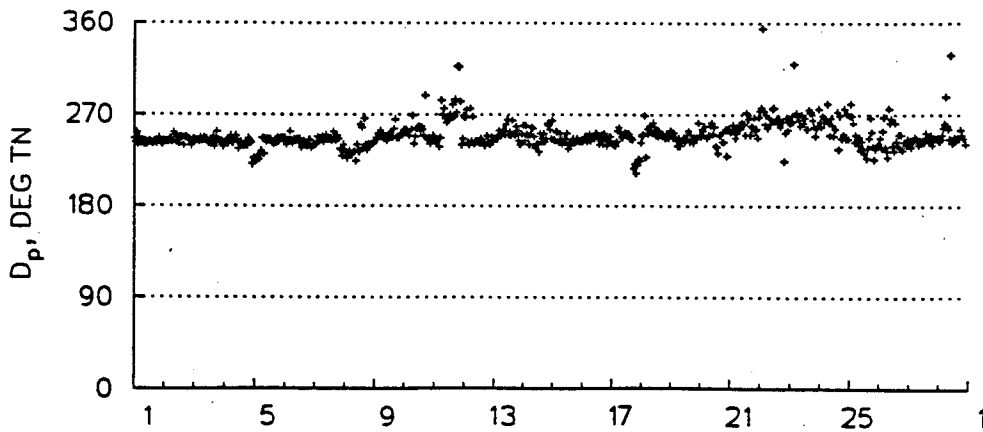
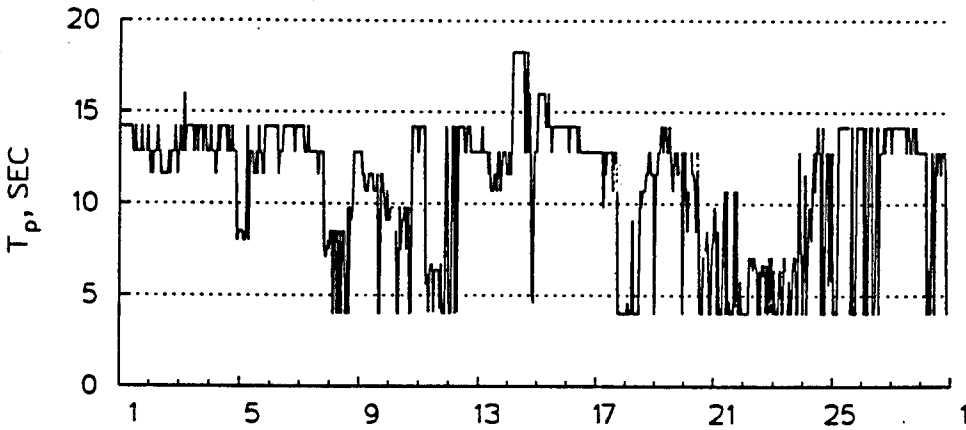
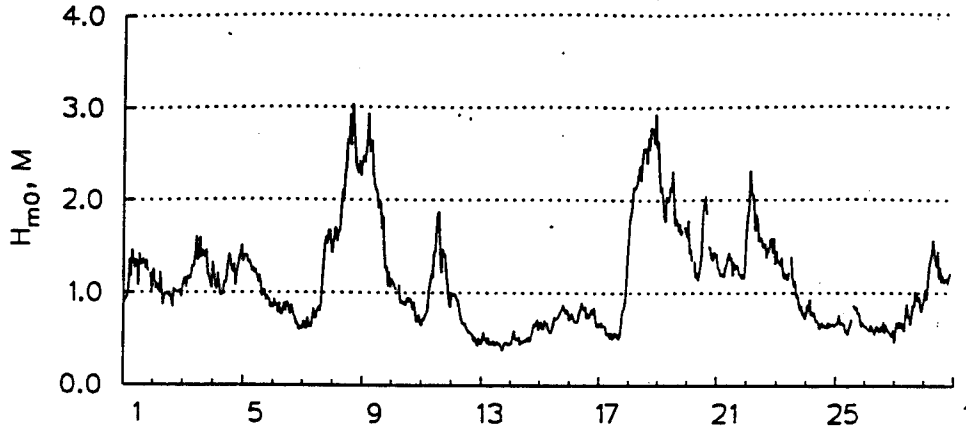

Figure 14. Time series plot for South Breakwater gage (RB4A), January 1994, second deployment

SOUTH BREAKWATER  
GAGE # RB4A  
33.84 N 118.40 W



FEBRUARY 1994

Figure 15. Time series plot for South Breakwater gage (RB4A), February 1994, second deployment

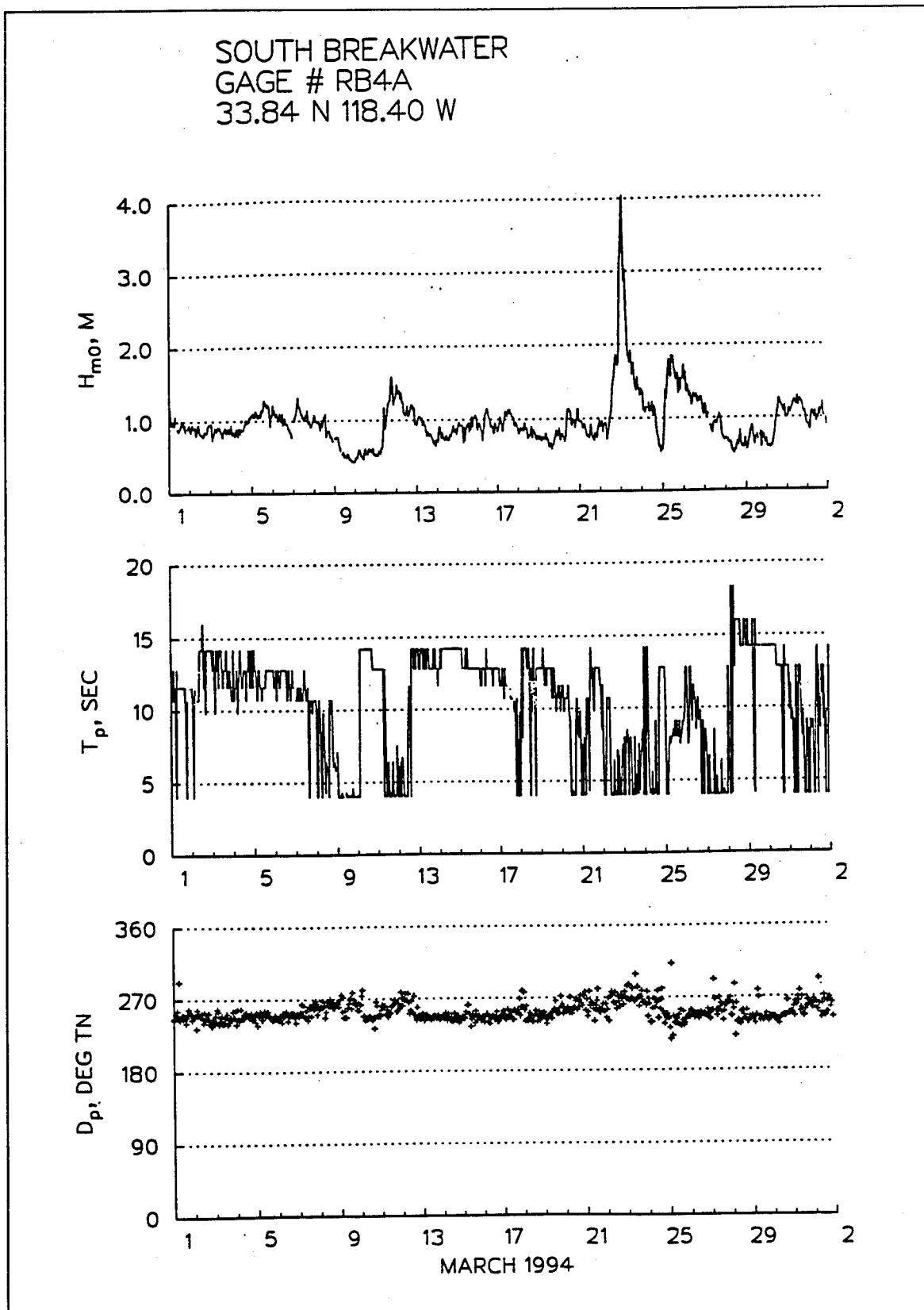

Figure 16. Time series plot for South Breakwater gage (RB4A), March 1994, second deployment

SOUTH BREAKWATER  
GAGE # RB4A  
33.84 N 118.40 W

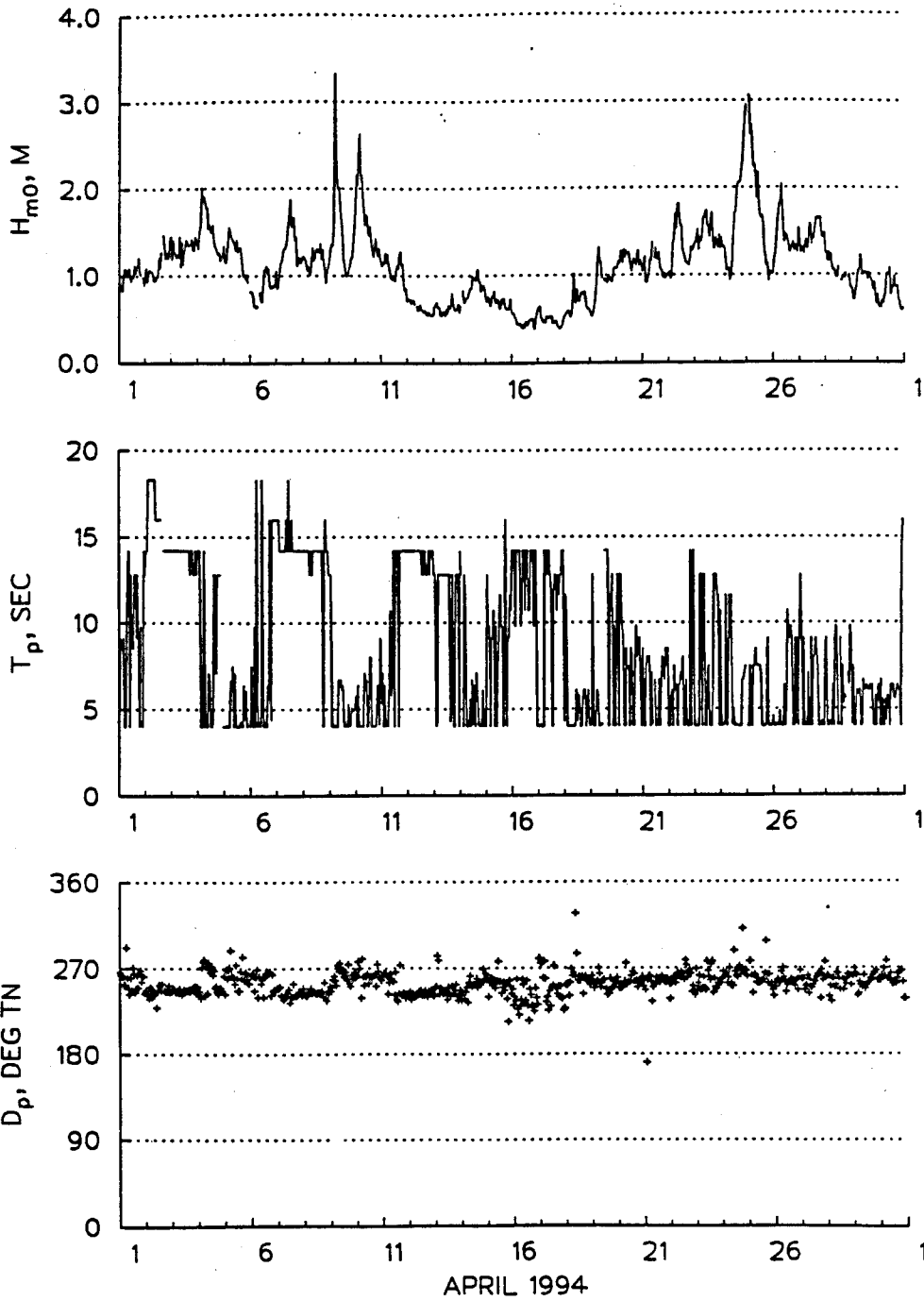

Figure 17. Time series plot for South Breakwater gage (RB4A), April 1994, second deployment

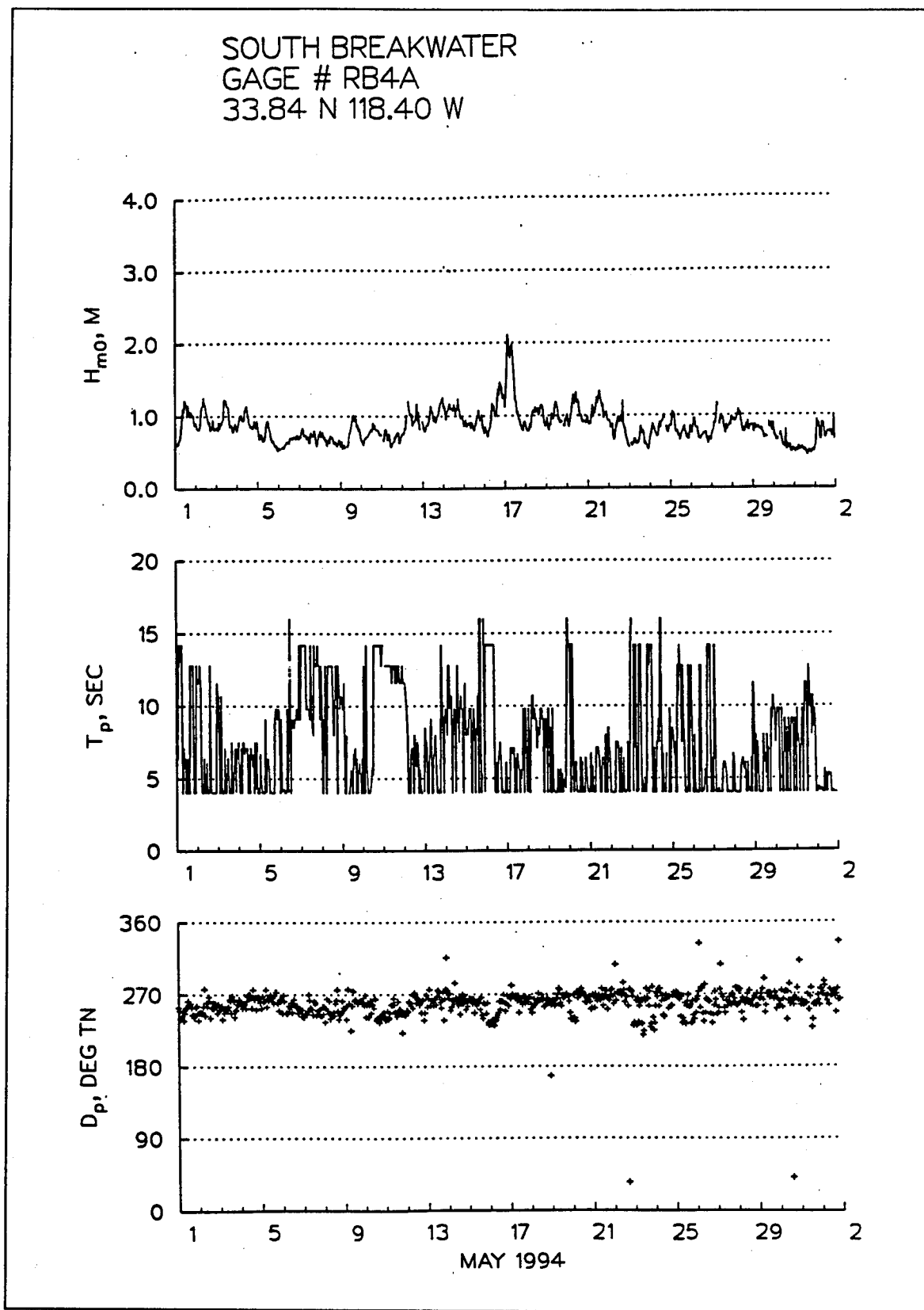

Figure 18. Time series plot for South Breakwater gage (RB4A), May 1994, second deployment

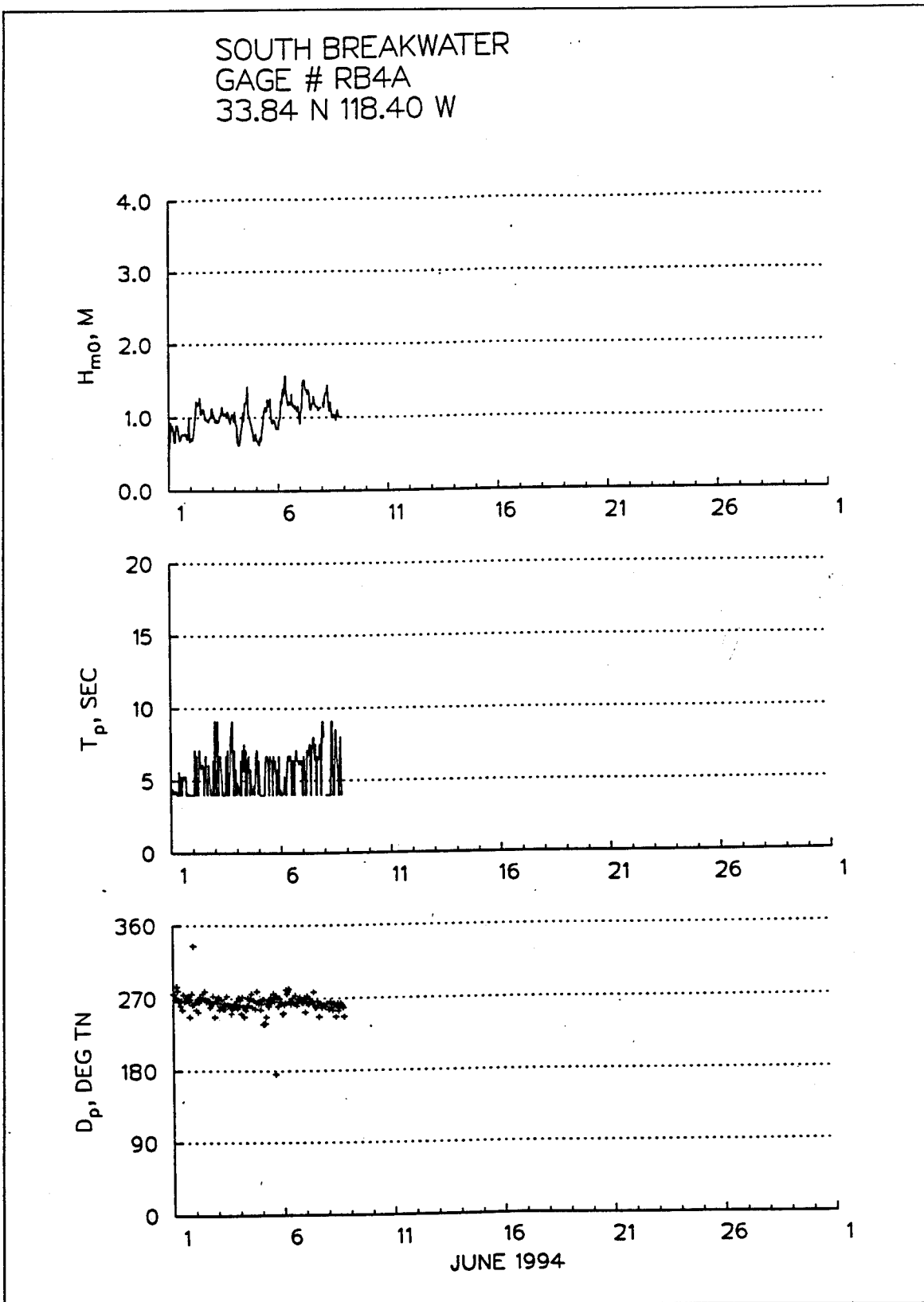

Figure 19. Time series plot for South Breakwater gage (RB4A), June 1994, second deployment

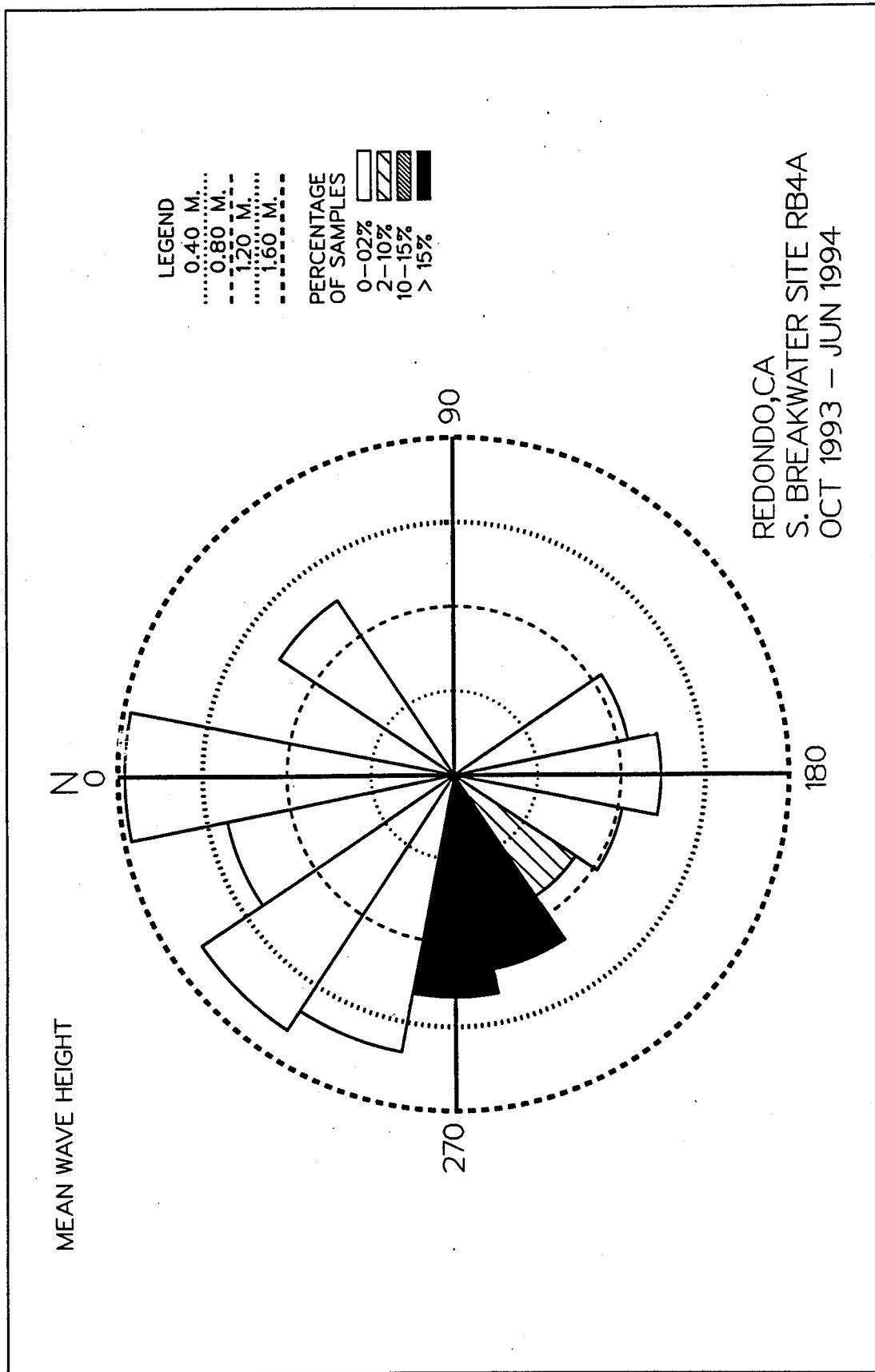

Figure 10. Wave rose for South Breakwater gage (RB4A), second deployment

**Table I1**  
**Mean/Max Values for South Breakwater (RB4A)**  
**Second Deployment**

MEAN Hm0 (METERS) BY MONTH AND YEAR

STATISTICS FOR SOUTH BREAKWATER (33.84 N 118.40 W )

YEAR	MONTH												MEAN
	JAN	FEB	MAR	APR	MAY	JUN	JUL	AUG	SEP	OCT	NOV	DEC	
1993	.	.	.	.	.	.	.	.	.	0.5	0.7	1.2	0.9
1994	1.0	1.1	1.0	1.1	0.9	1.0	.	.	.	.	.	.	1.0
MEAN	1.0	1.1	1.0	1.1	0.9	1.0	.	.	.	0.5	0.7	1.2	

LARGEST Hm0 (METERS) BY MONTH AND YEAR

STATISTICS FOR SOUTH BREAKWATER (33.84 N 118.40 W )

YEAR	MONTH											
	JAN	FEB	MAR	APR	MAY	JUN	JUL	AUG	SEP	OCT	NOV	DEC
1993	.	.	.	.	.	.	.	.	.	0.9	3.0	3.0
1994	2.4	3.0	4.0	3.3	2.1	1.6	.	.	.	.	.	.

STATISTICS FOR SOUTH BREAKWATER (33.84 N 118.40 W)

THE MEAN SIGNIFICANT WAVE HEIGHT (METERS) =	1.0
THE MEAN PEAK WAVE PERIOD (SECONDS) =	10.2
THE MOST FREQUENT 22.5 (CENTER) DIRECTION BAND (DEGREES) =	247.5
THE STANDARD DEVIATION OF Hm0 (METERS) =	0.4
THE STANDARD DEVIATION OF TP (SECONDS) =	4.0
THE LARGEST Hm0 (METERS) =	4.0
THE TP (SECONDS) ASSOC. WITH THE LARGEST Hm0 =	4.0
THE PEAK DIRECTION (DEGREES) ASSOC. WITH THE LARGEST Hm0 =	286.0
THE DATE OF LARGEST Hm0 OCCURRENCE IS	94032302

**Table I2**  
**Percent Occurrence for South Breakwater (RB4A)**  
**Second Deployment**

SOUTH BREAKWATER		33.84 N 118.40 W										FOR ALL DIRECTIONS	
		OCTOBER 1993 - JUNE 1994											
		PERCENT OCCURRENCE(X100) OF HEIGHT AND PERIOD											
HEIGHT(METERS)	PEAK PERIOD(SECONDS)												TOTAL
	SHORTER- 4.5	4.6- 5.6	5.6- 8.0	8.0- 10.6	10.7- 11.6	11.6- 12.7	12.8- 14.1	14.2- 15.9	16.0- 18.3	18.4- LONGER			
0.0-0.4	1170	36	36	1133	1261	1225	2798	2322	402	420	10803		
0.5-0.9	9253	841	4005	4005	2231	3017	11667	12179	1389	804	49391		
1.0-1.4	7187	274	3712	3035	987	1499	7809	5230	201	91	30025		
1.5-1.9	1682	73	1188	749	292	91	932	914	18	18	5957		
2.0-2.4	1207	.	310	146	54	128	457	219	.	.	2521		
2.5-2.9	420	18	91	128	109	146	109	73	.	.	1094		
3.0-3.4	91	.	36	18	.	.	.	.	.	.	145		
3.5-3.9	.	.	.	18	.	.	.	.	.	.	18		
4.0-4.4	18	.	.	.	.	.	.	.	.	.	18		
4.5-4.9	.	.	.	.	.	.	.	.	.	.	0		
5.0+	.	.	.	.	.	.	.	.	.	.	0		
TOTAL	21028	1242	9378	9232	4934	6106	23772	20937	2010	1333			
MEAN Hm0 (M) = 1.0		LARGEST Hm0 (M) = 4.0		MEAN TP (SEC) = 10.2				TOTAL CASES = 5468.					

# **Appendix J Redondo Site, Second Deployment**

---

REDONDO  
NDBC 46045  
33.84 N, 118.45 W

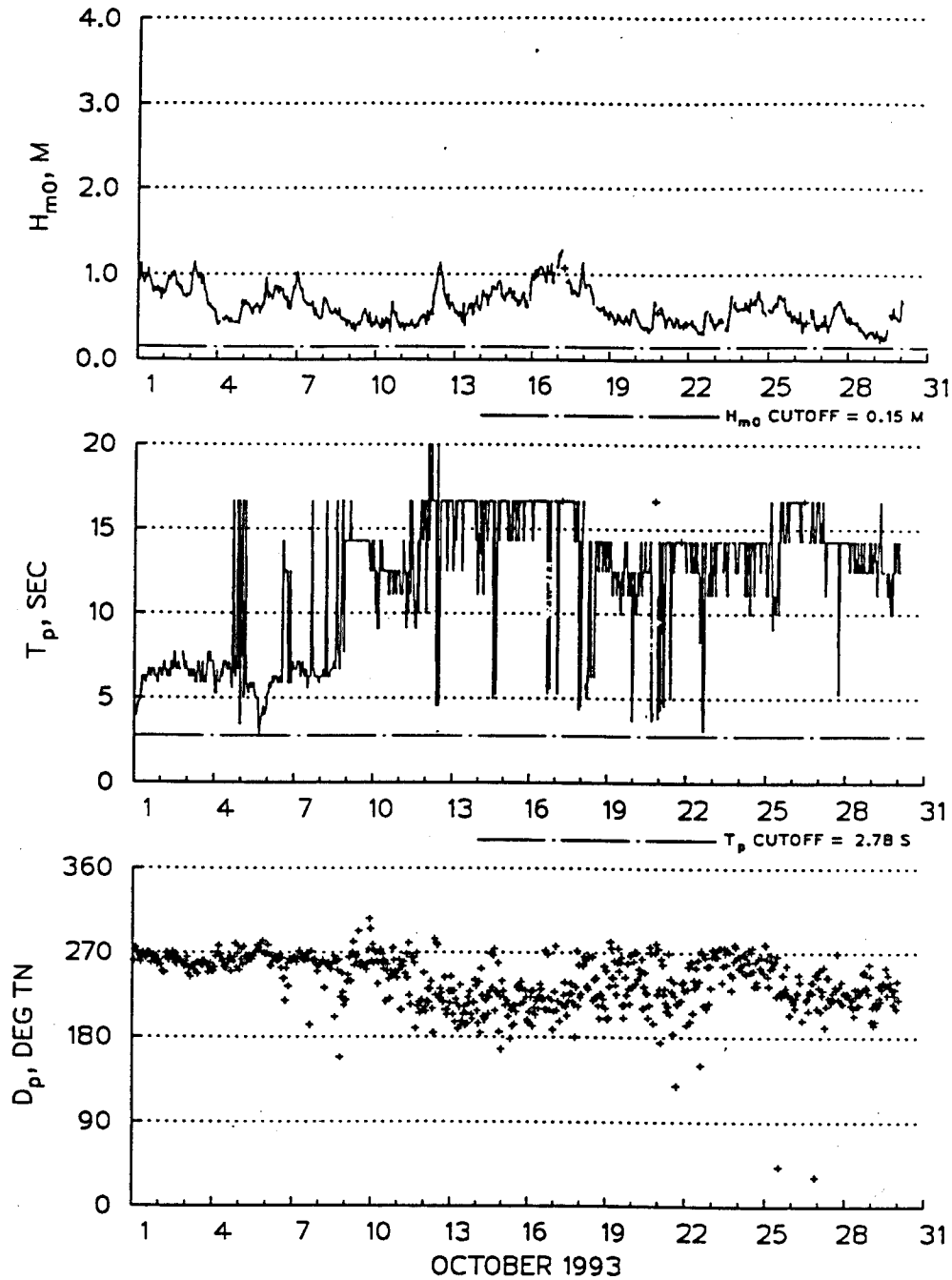

Figure J1. Time series plot for Redondo gage (NDBC 46045), October 1993, second deployment

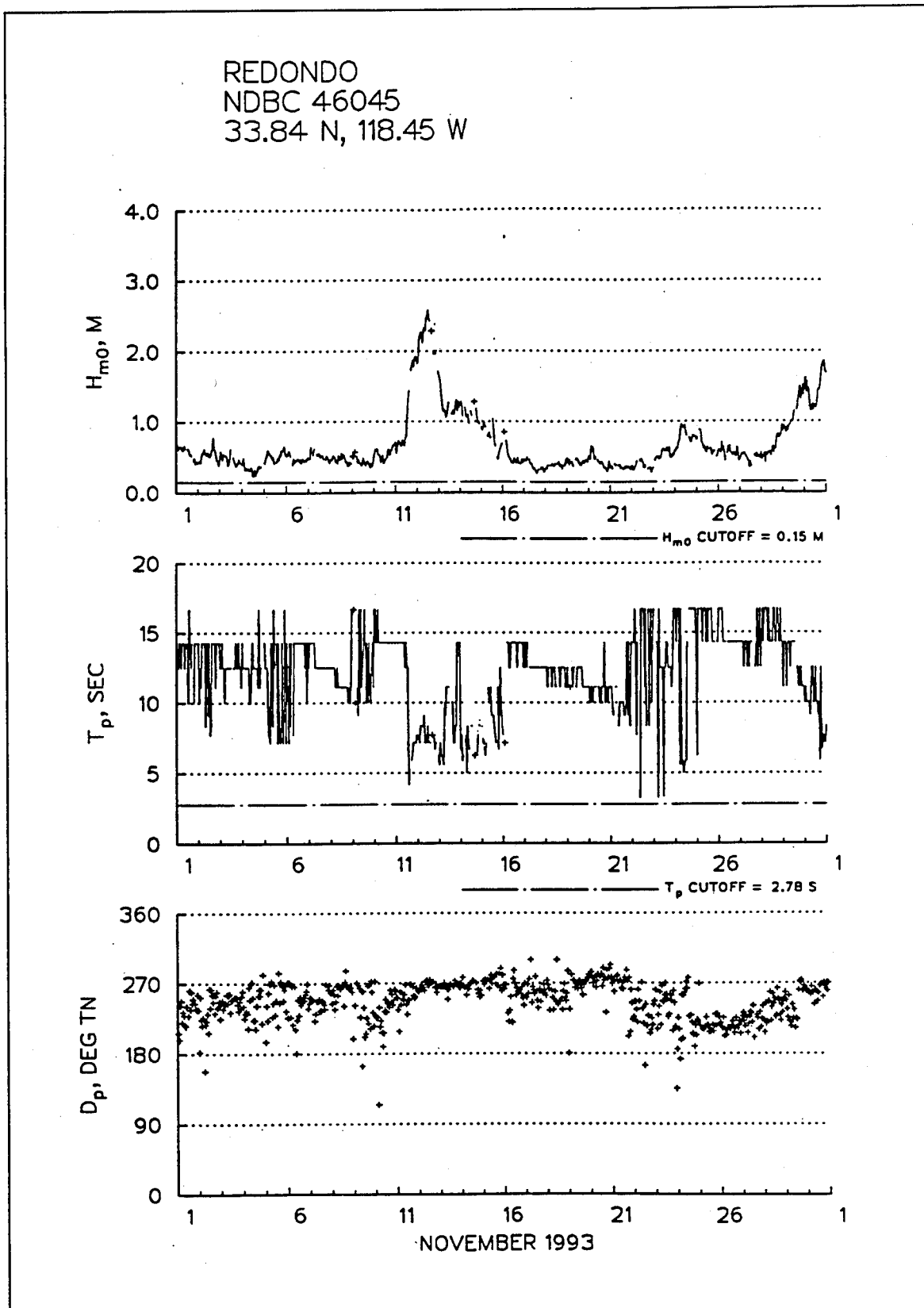

Figure J2. Time series plot for Redondo gage (NDBC 46045), November 1993, second deployment

REDONDO  
NDBC 46045  
33.84 N, 118.45 W

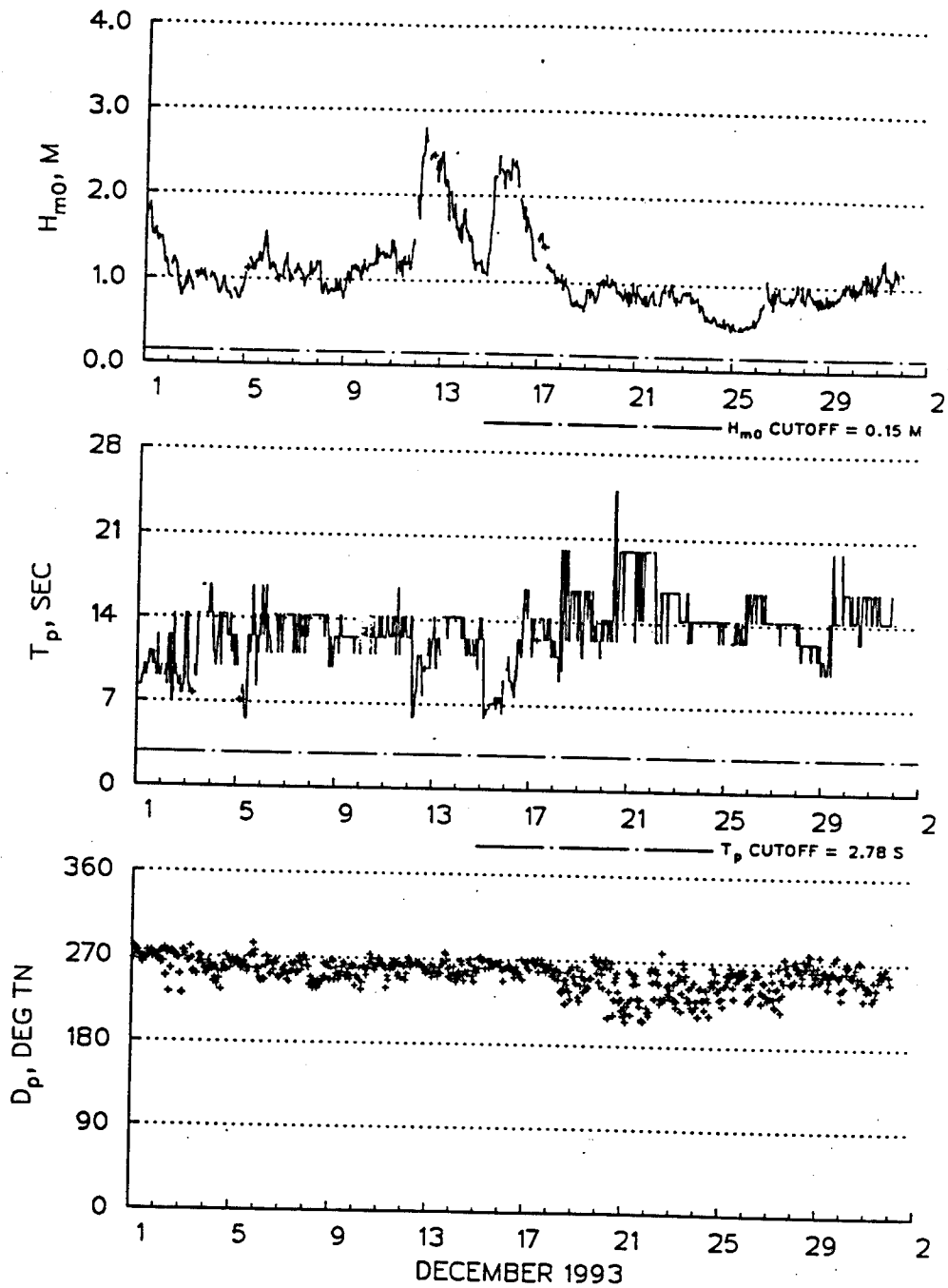

Figure J3. Time series plot for Redondo gage (NDBC 46045), December 1993, second deployment

REDONDO  
NDBC 46045  
33.84 N, 118.45 W

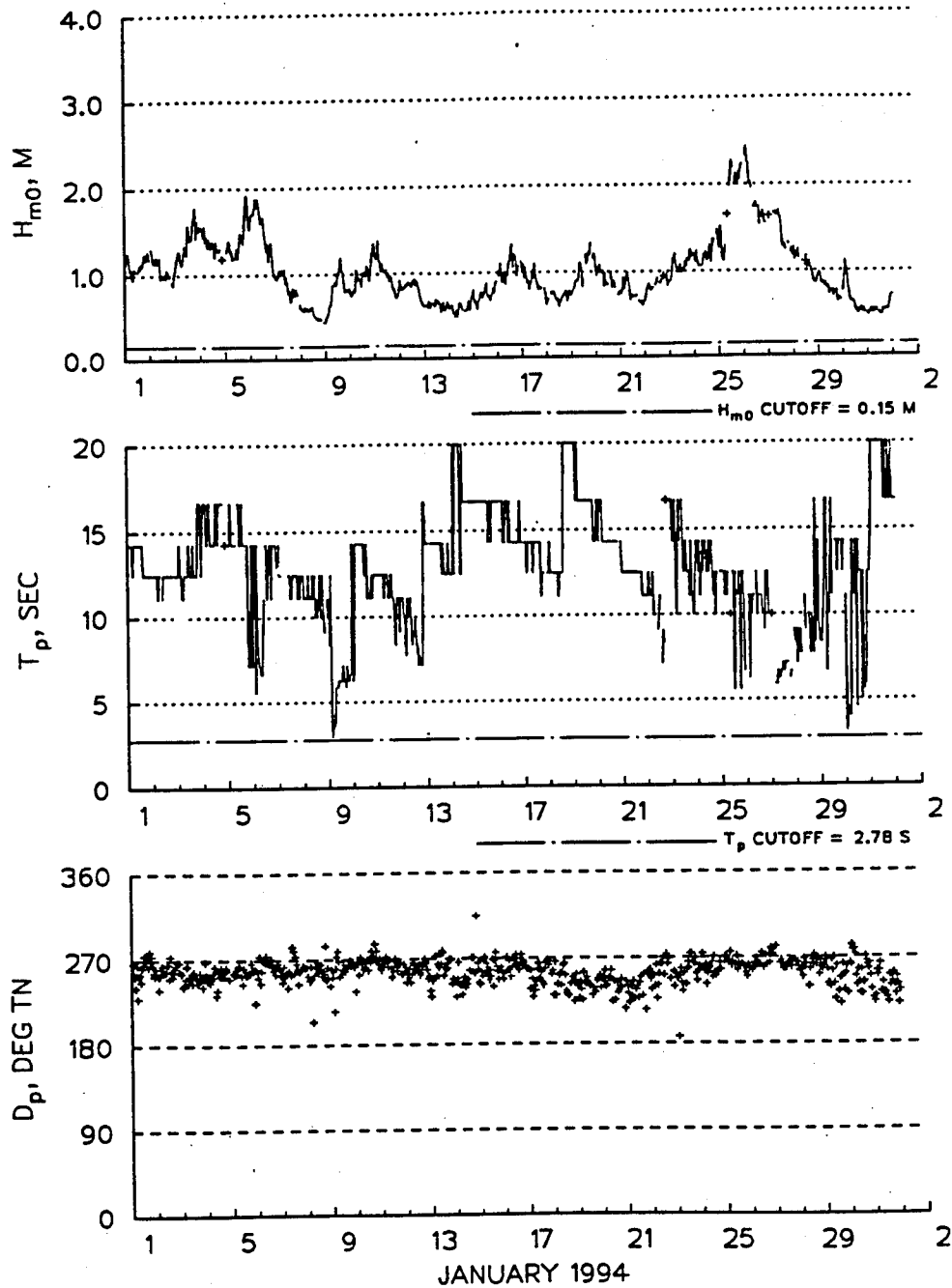

Figure J4. Time series plot for Redondo gage (NDBC 46045), January 1994, second deployment

REDONDO  
NDBC 46045  
33.84 N, 118.45 W

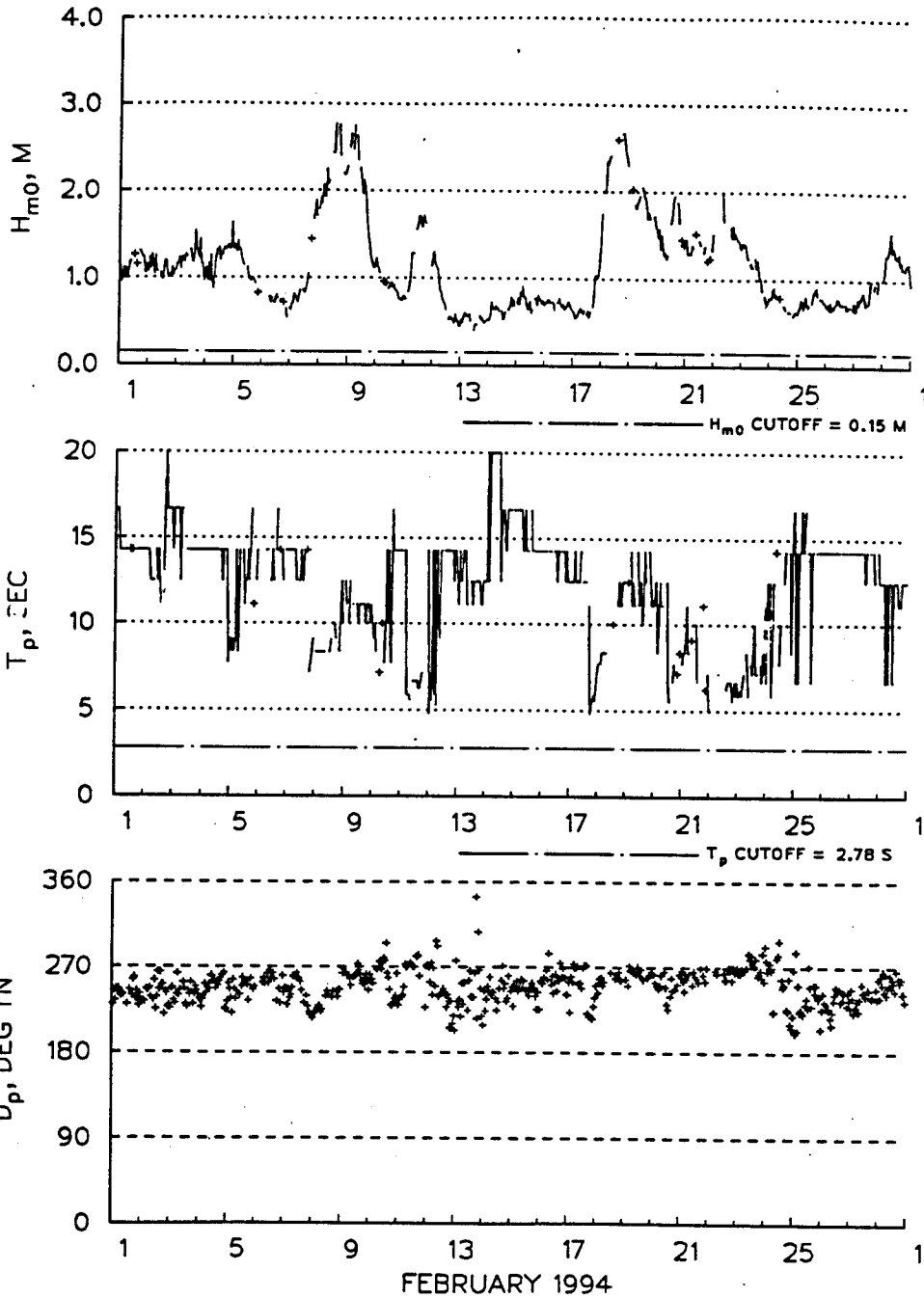

Figure J5. Time series plot for Redondo gage (NDBC 46045), February 1994, second deployment

REDONDO BEACH  
NDBC 46045  
33.84 N, 118.45 W

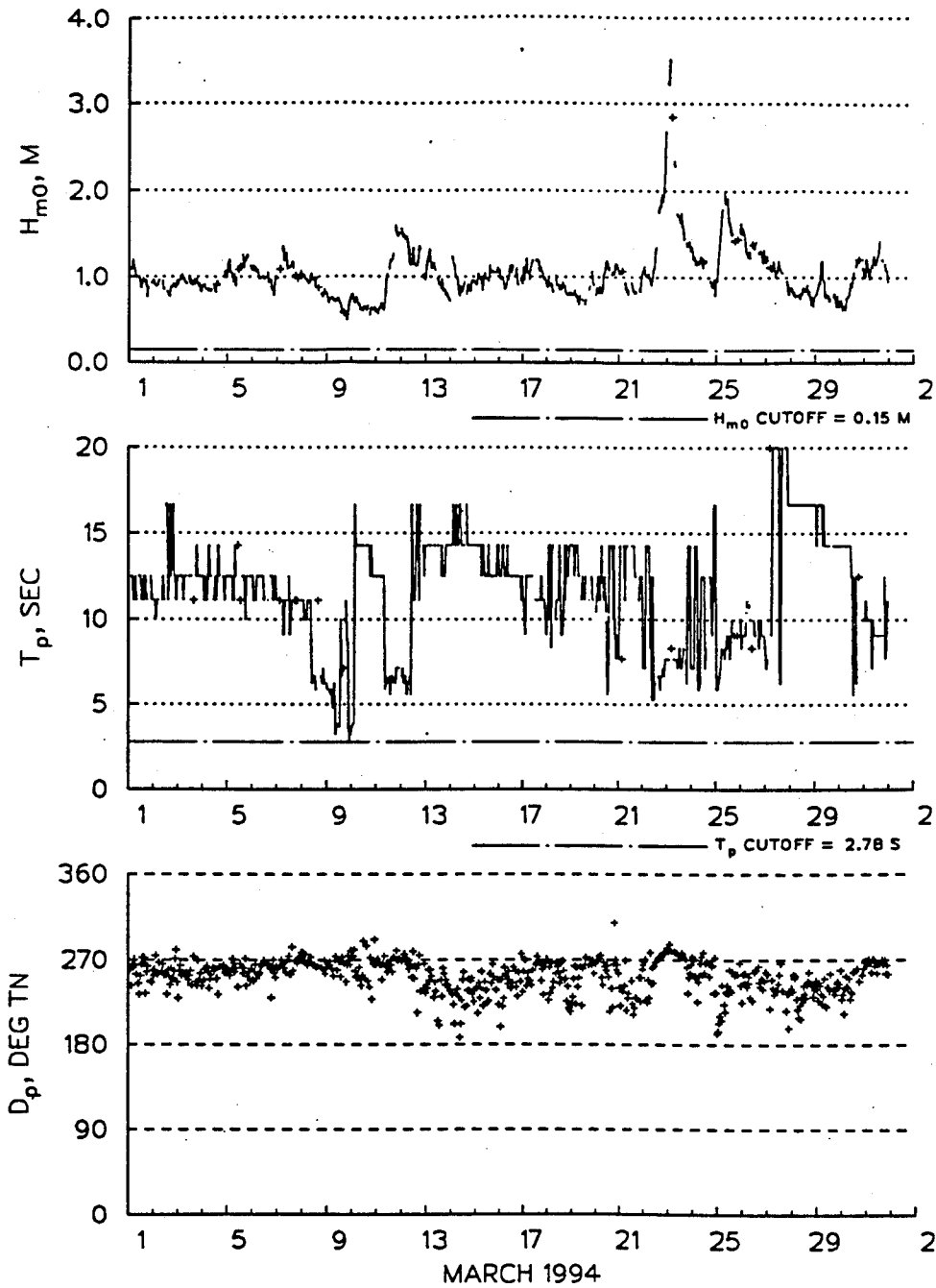

Figure J6. Time series plot for Redondo gage (NDBC 46045), March 1994, second deployment

REDONDO BEACH  
NDBC 46045  
33.84 N, 118.45 W

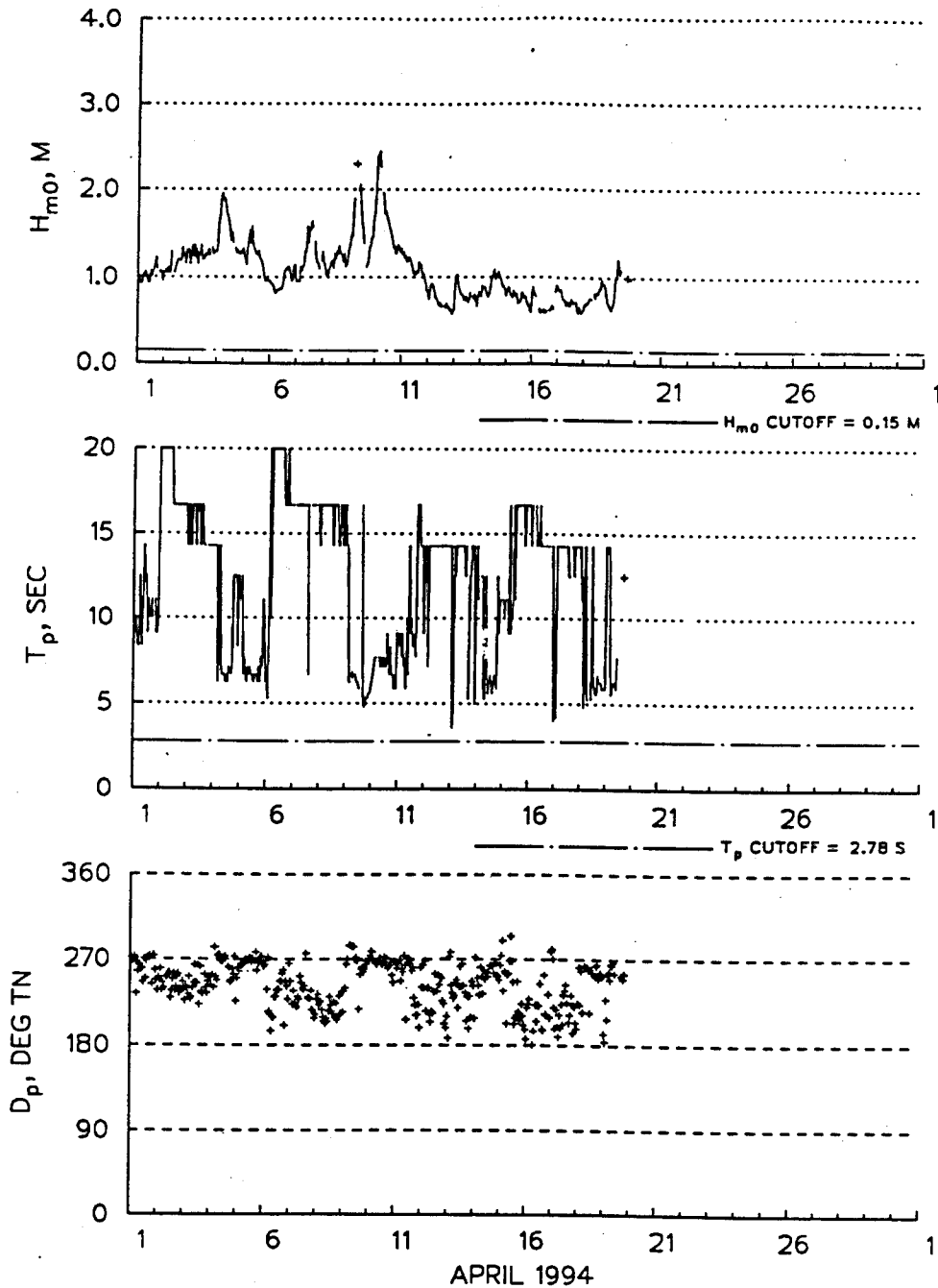

Figure J7. Time series plot for Redondo gage (NDBC 46045), April 1994, second deployment

REDONDO BEACH  
NDBC 46045  
33.84 N, 118.45 W

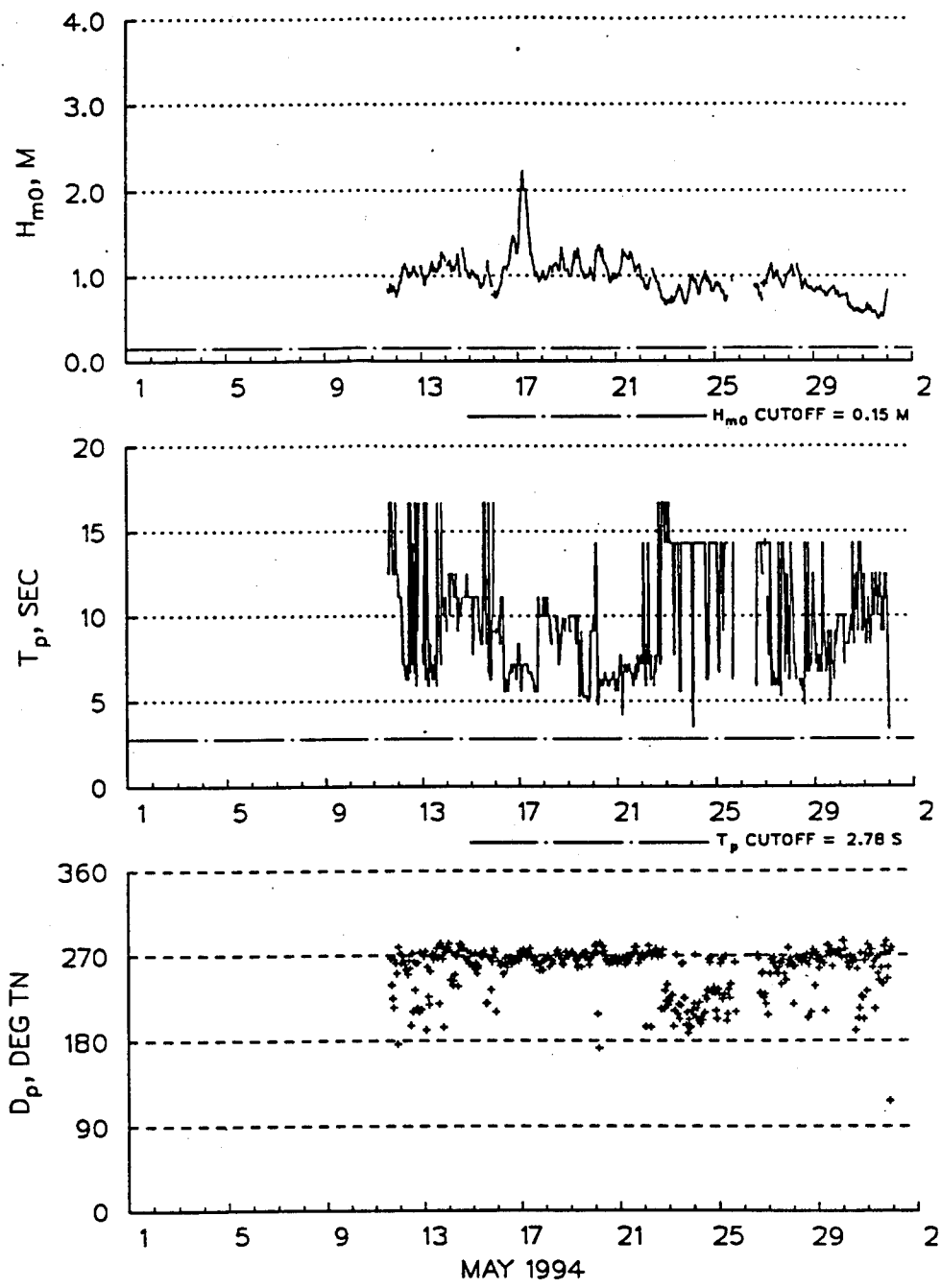

Figure J8. Time series plot for Redondo gage (NDBC 46045), May 1994, second deployment

REDONDO BEACH  
NDBC 46045  
33.84 N, 118.45 W

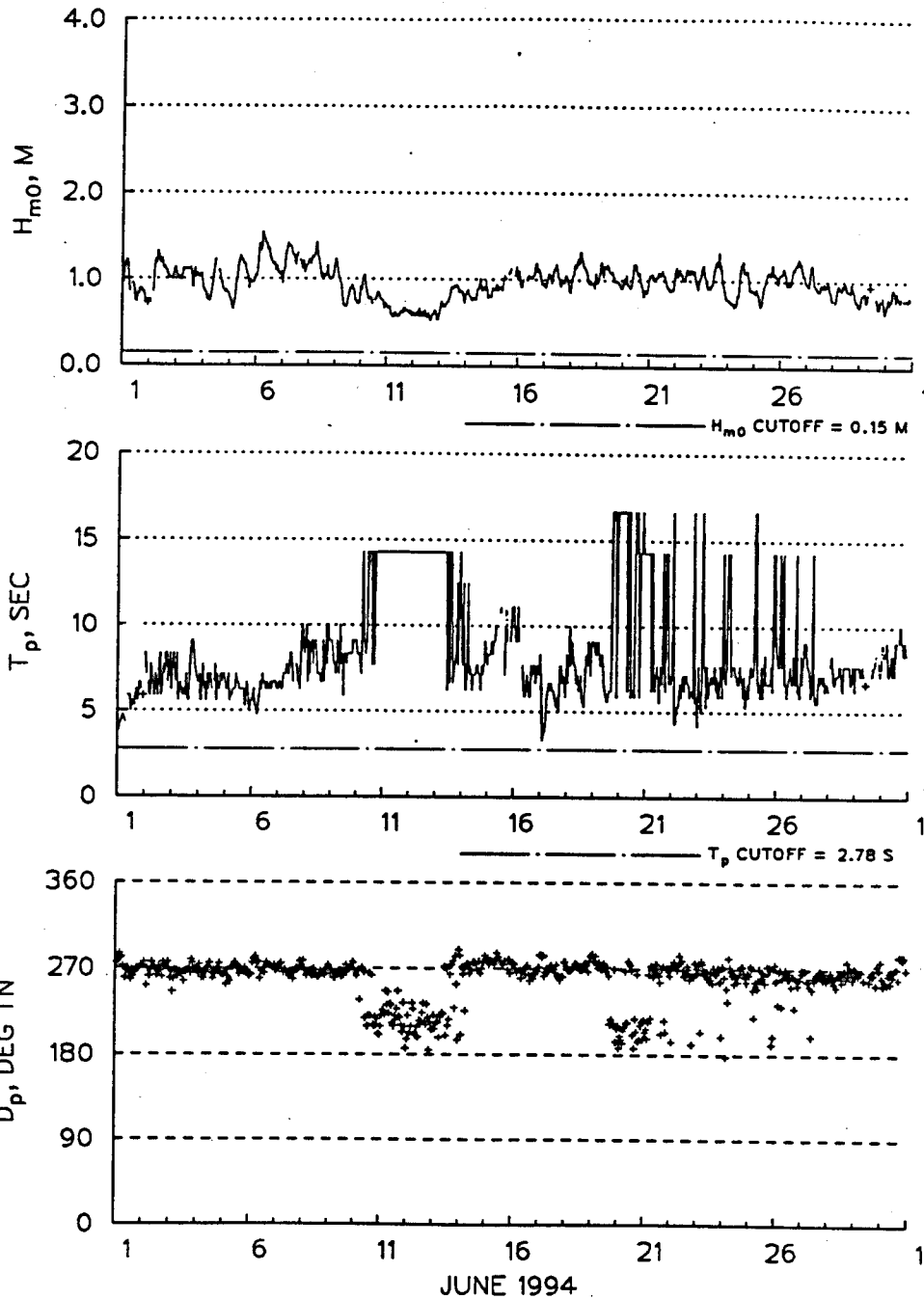

Figure J9. Time series plot for Redondo gage (NDBC 46045), June 1994, second deployment

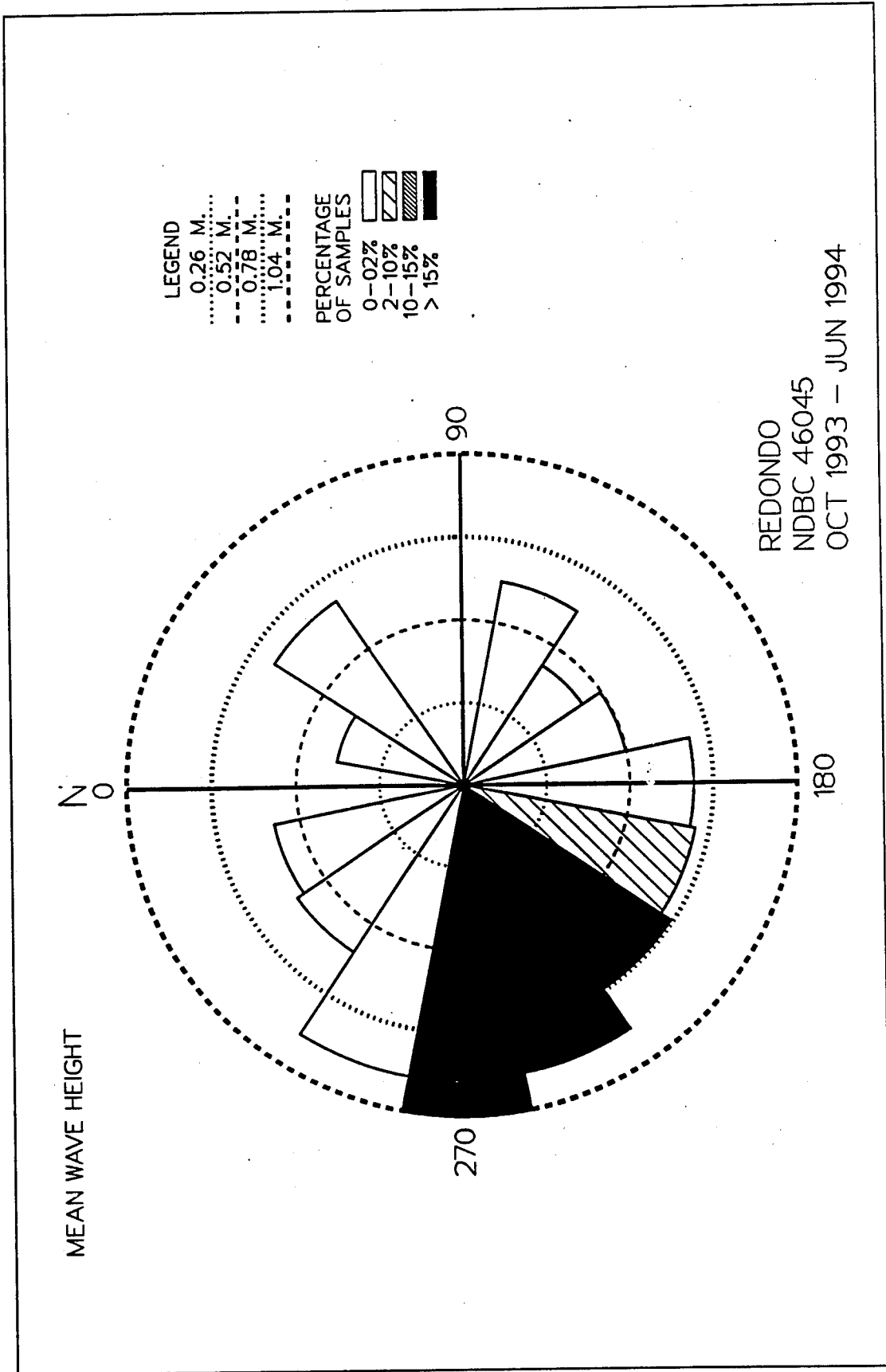

Figure J10. Wave rose for Redondo gage (NDBC 46045), second deployment

**Table J1**  
**Mean/Max Values for Redondo (NDBC 46045)**  
**Second Deployment**

MEAN Hm0 (METERS) BY MONTH AND YEAR  
 NDBC BUOY 46045 (33.84N 118.45W)

YEAR	MONTH												MEAN
	JAN	FEB	MAR	APR	MAY	JUN	JUL	AUG	SEP	OCT	NOV	DEC	
1993	.	.	.	.	.	.	.	.	.	0.6	0.7	1.1	0.8
1994	1.0	1.1	1.0	1.1	1.0	1.0	.	.	.	.	.	.	1.0
MEAN	1.0	1.1	1.0	1.1	1.0	1.0	.	.	.	0.6	0.7	1.1	

LARGEST Hm0 (METERS) BY MONTH AND YEAR  
 NDBC BUOY 46045 (33.84N 118.45W)

YEAR	MONTH											
	JAN	FEB	MAR	APR	MAY	JUN	JUL	AUG	SEP	OCT	NOV	DEC
1993	.	.	.	.	.	.	.	.	.	1.3	2.6	2.8
1994	2.4	2.8	3.5	2.5	2.2	1.5	.	.	.	.	.	.

STATISTICS FOR NDBC BUOY 46045 (33.84N 118.45W)

THE MEAN SIGNIFICANT WAVE HEIGHT (METERS) =	0.9
THE MEAN PEAK WAVE PERIOD (SECONDS) =	11.6
THE MOST FREQUENT 22.5 (CENTER) DIRECTION BAND (DEGREES) =	270.0
THE STANDARD DEVIATION OF Hm0 (METERS) =	0.4
THE STANDARD DEVIATION OF TP (SECONDS) =	3.7
THE LARGEST Hm0 (METERS) =	3.5
THE TP (SECONDS) ASSOC. WITH THE LARGEST Hm0 =	7.7
THE PEAK DIRECTION (DEGREES) ASSOC. WITH THE LARGEST Hm0 =	287.0
THE DATE OF LARGEST Hm0 OCCURRENCE IS	94032302

**Table J2**  
**Percent Occurrence for Redondo (NDBC 46045)**  
**Second Deployment**

BUOY STATION 46045 33.84 N 118.45 W FOR ALL DIRECTIONS  
 OCTOBER 1993 - JUNE 1994  
 PERCENT OCCURRENCE(X100) OF HEIGHT AND PERIOD

HEIGHT(METERS)	PEAK PERIOD(SECONDS)										TOTAL
	<6.9	6.9- 8.0	8.1- 8.7	8.8- 9.5	9.6- 10.5	10.6- 11.7	11.8- 13.3	13.4- 15.3	15.4- 18.1	18.2- LONGER	
0.0-0.9	632	314	136	143	224	435	974	1861	728	158	5605
1.0-1.9	902	440	179	212	206	348	620	742	399	55	4103
2.0-2.9	41	66	39	10	23	50	35	7	.	.	271
3.0-3.9	.	5	.	.	.	.	.	.	.	.	5
4.0-4.9	.	.	.	.	.	.	.	.	.	.	0
5.0-5.9	.	.	.	.	.	.	.	.	.	.	0
6.0-6.9	.	.	.	.	.	.	.	.	.	.	0
7.0-7.9	.	.	.	.	.	.	.	.	.	.	0
8.0-8.9	.	.	.	.	.	.	.	.	.	.	0
9.0-9.9	.	.	.	.	.	.	.	.	.	.	0
10.0+	.	.	.	.	.	.	.	.	.	.	0
TOTAL	1575	825	354	365	453	833	1629	2610	1127	213	

MEAN Hm0 (M) = 0.9    LARGEST Hm0 (M) = 3.5    MEAN TP (SEC) = 11.6    TOTAL CASES = 5561.

# **Appendix K Catalina Ridge Site, Second Deployment**

---

CATALINA RIDGE  
NDBC 46025  
33.75 N, 119.07 W

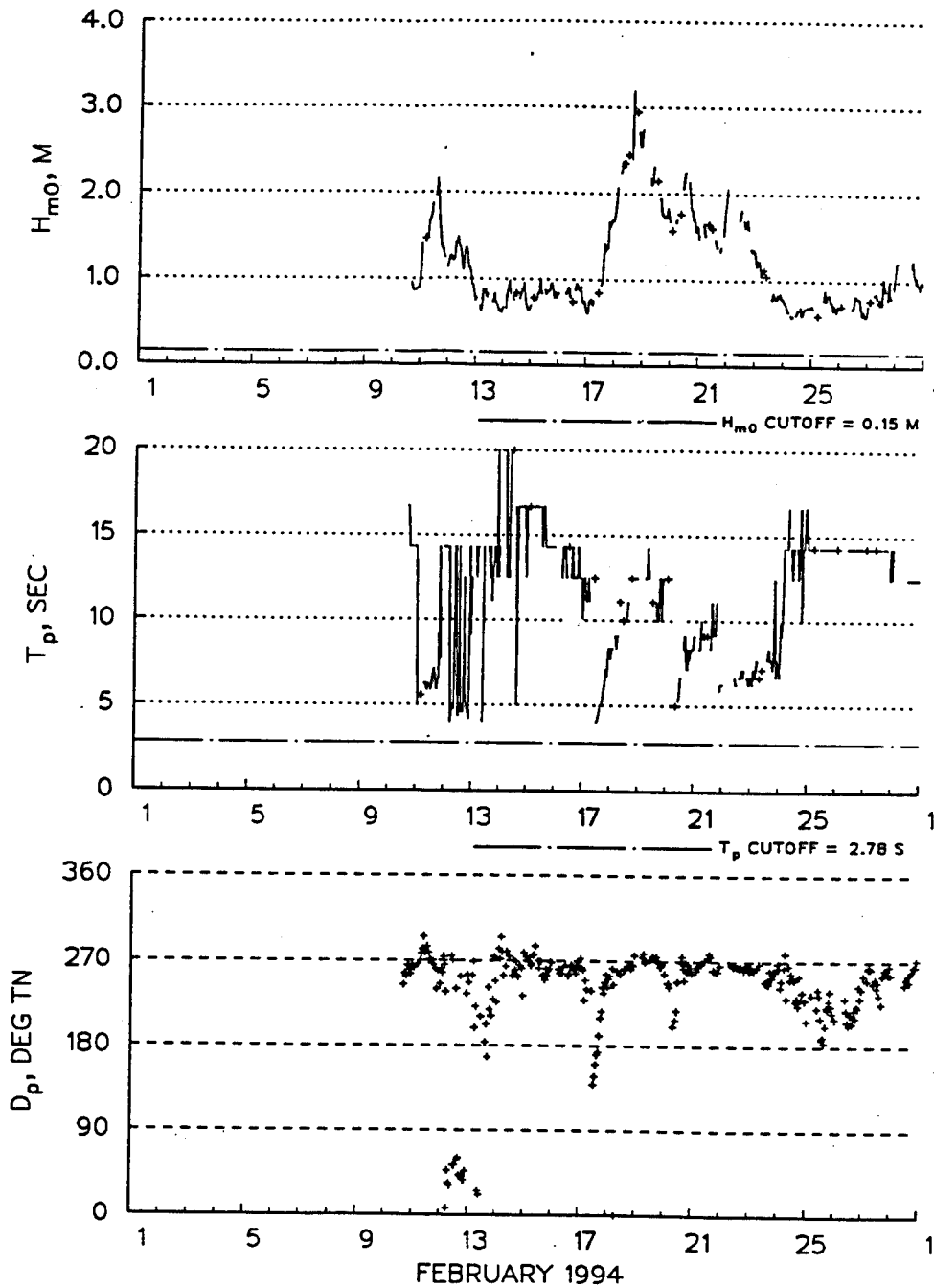

Figure K1. Time series plot for Catalina Ridge gage (NDBC 46025), February 1994, second deployment

CATALINA RIDGE  
NDBC 46025  
33.75 N, 119.07 W

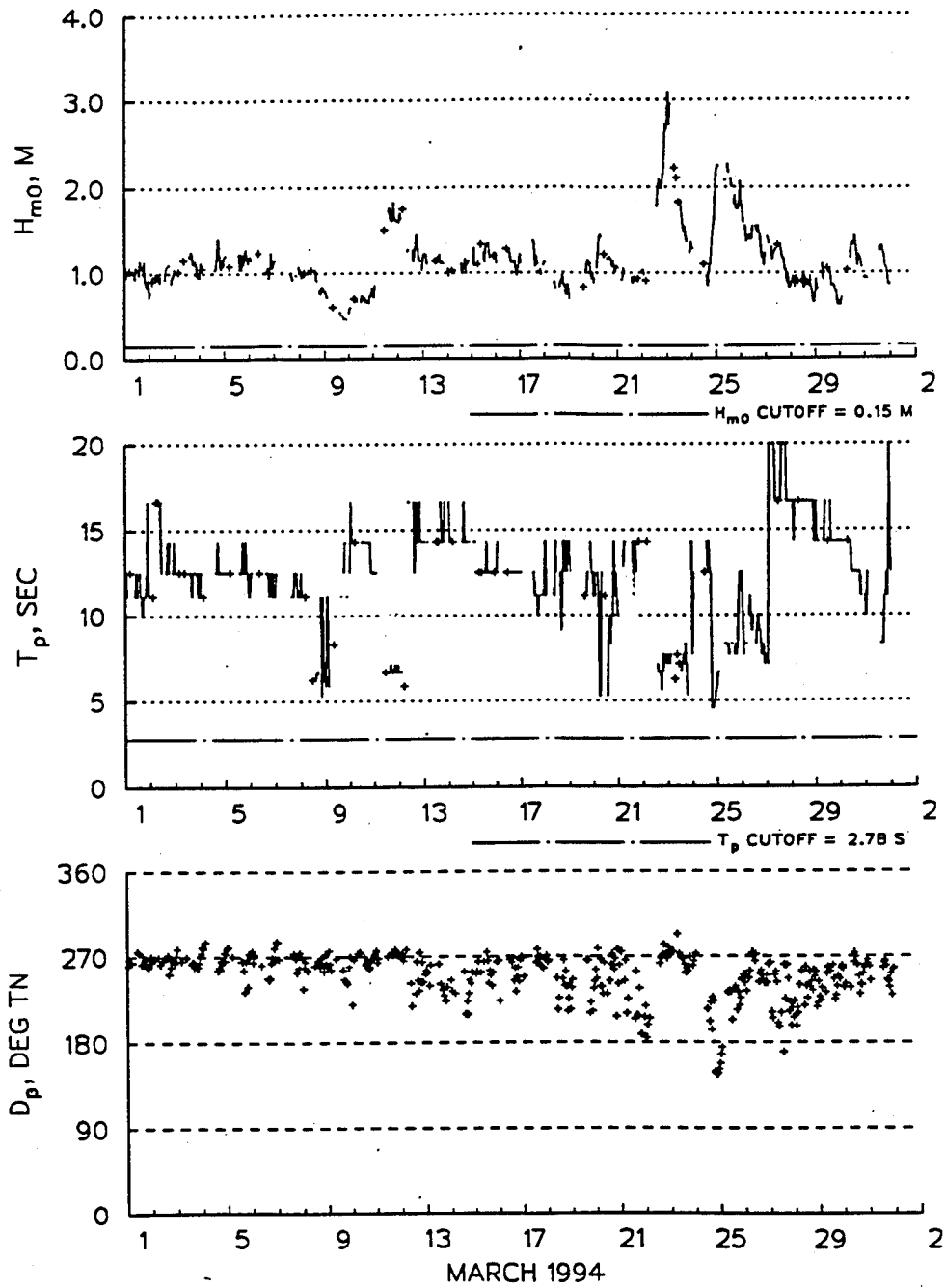

Figure K2. Time series plot for Catalina Ridge gage (NDBC 46025), March 1994, second deployment

CATALINA RIDGE  
NDBC 46025  
33.75 N, 119.07 W

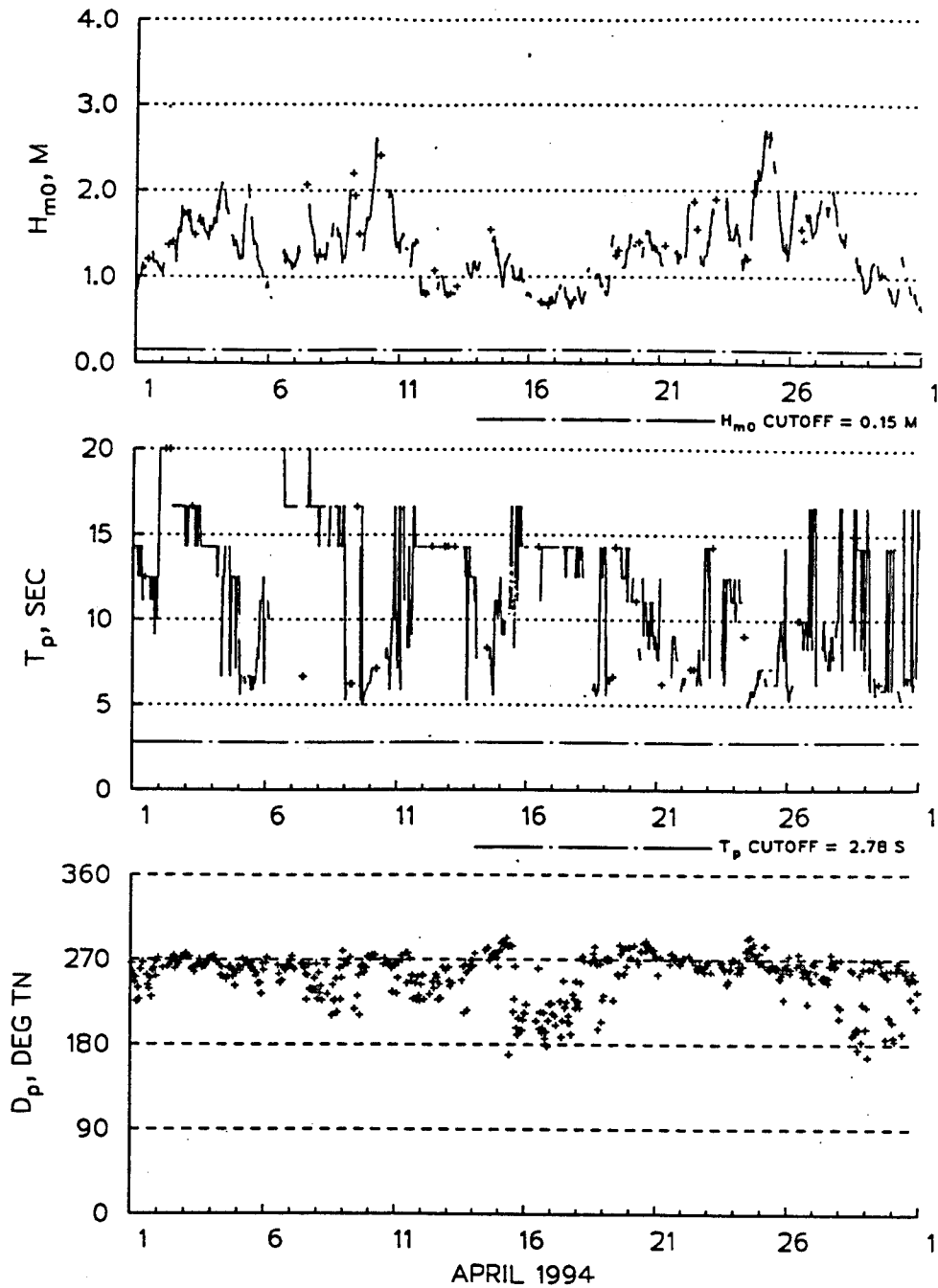

Figure K3. Time series plot for Catalina Ridge gage (NDBC 46025), April 1994, second deployment

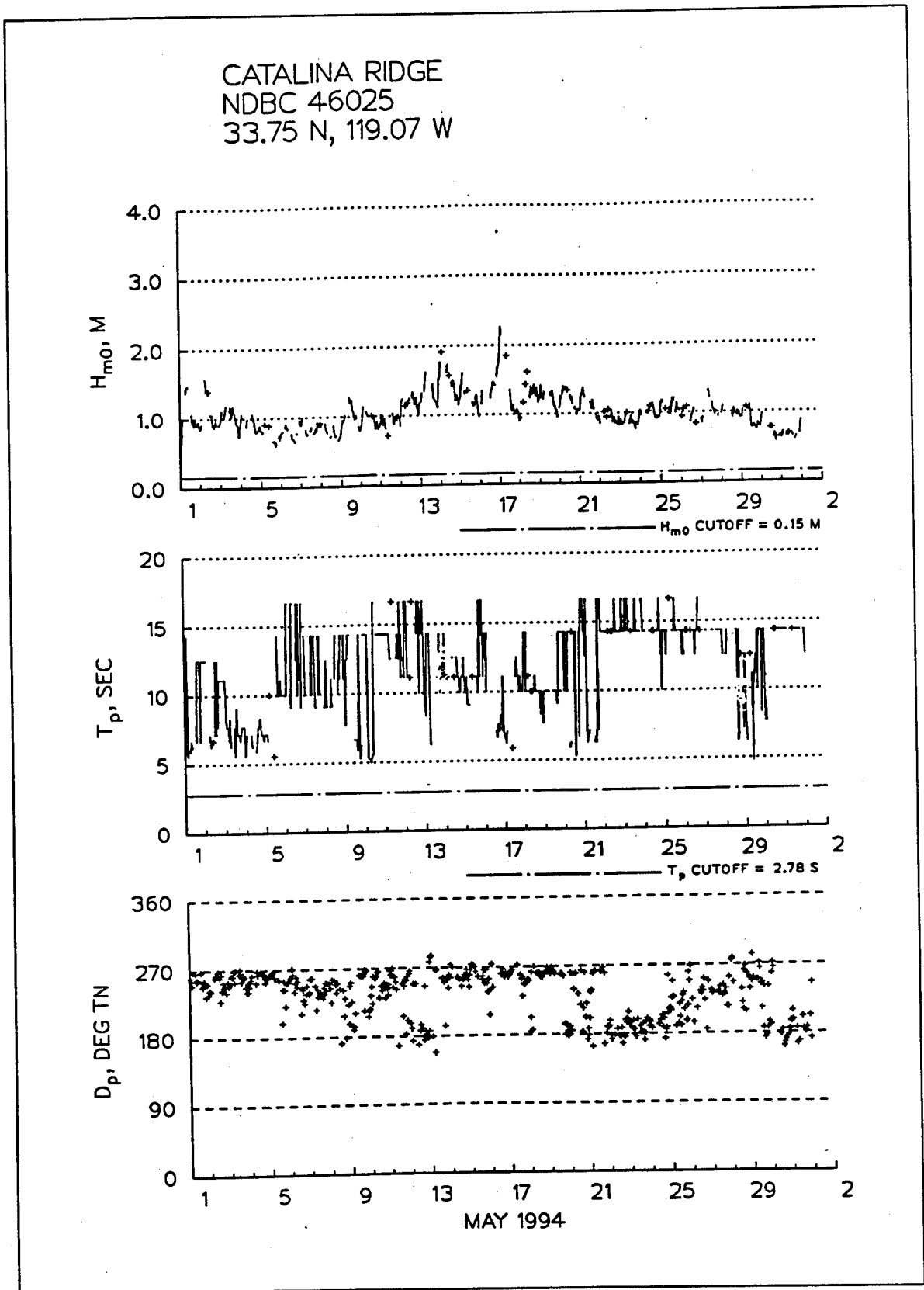

Figure K4. Time series plot for Catalina Ridge gage (NDBC 46025), May 1994, second deployment

CATALINA RIDGE  
NDBC 46025  
33.75 N, 119.07 W

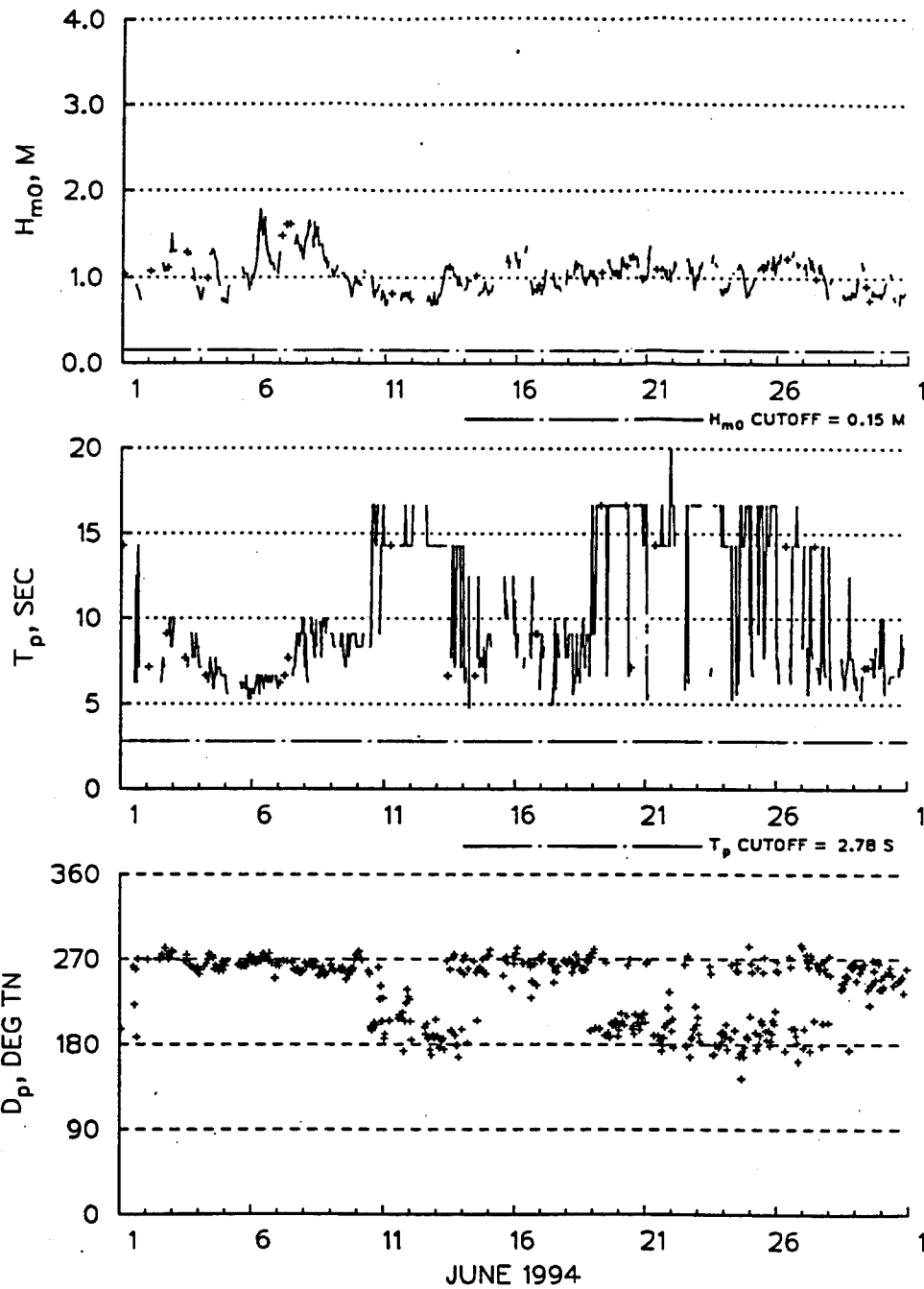

Figure K5. Time series plot for Catalina Ridge gage (NDBC 46025), June 1994, second deployment

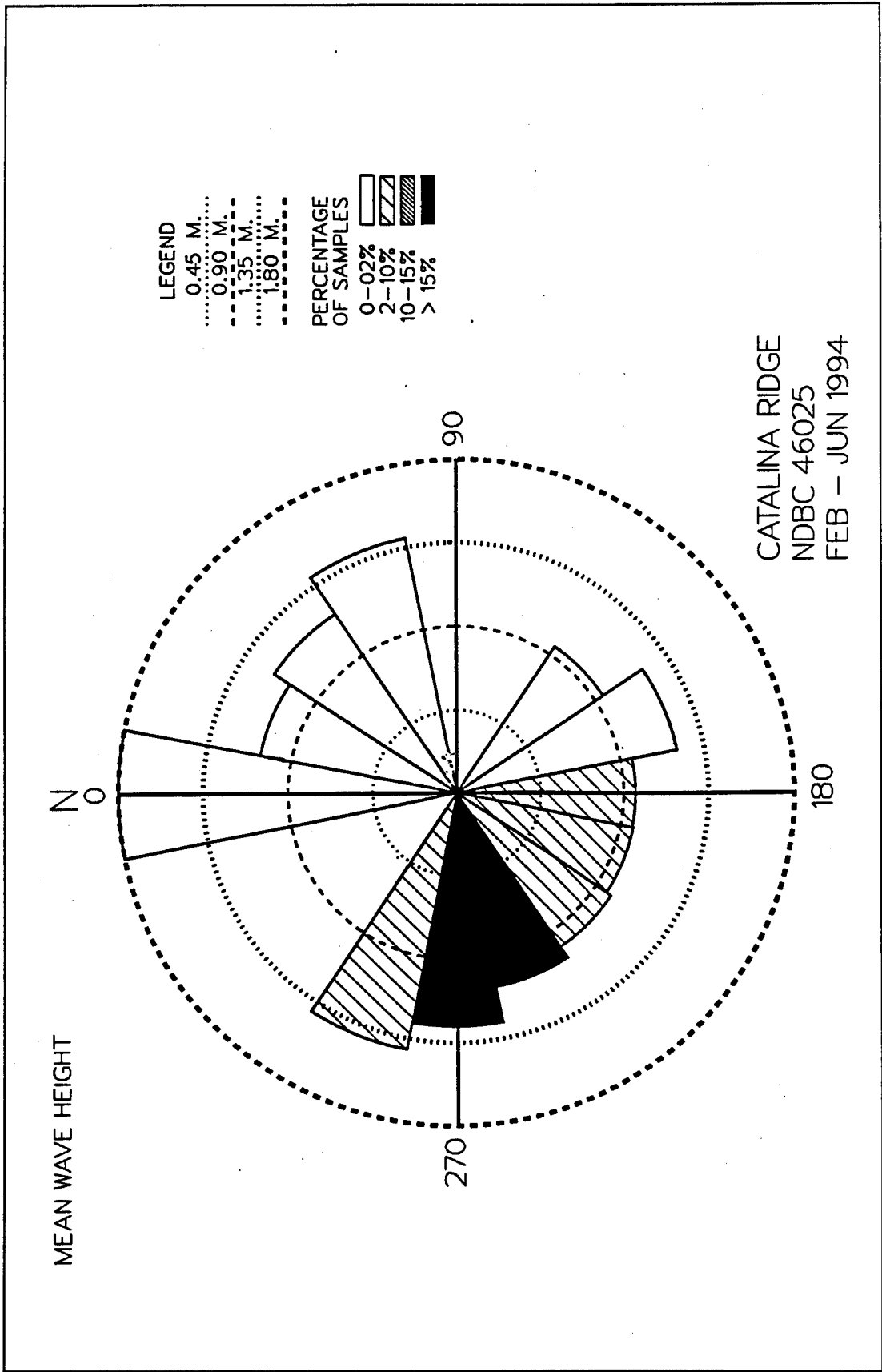

Figure K6. Wave rose for Catalina Ridge gage (NDBC 46025), second deployment

**Table K1**  
**Mean/Max Values for Catalina Ridge (NDBC 46025)**  
**Second Deployment**

MEAN Hm0 (METERS) BY MONTH AND YEAR  
 NDBC BUOY 46025 (33.75N 119.07W)

YEAR	MONTH												MEAN
	JAN	FEB	MAR	APR	MAY	JUN	JUL	AUG	SEP	OCT	NOV	DEC	
1994	.	1.2	1.2	1.3	1.0	1.0	.	.	.	.	.	.	1.1
MEAN	.	1.2	1.2	1.3	1.0	1.0	.	.	.	.	.	.	

LARGEST Hm0 (METERS) BY MONTH AND YEAR  
 NDBC BUOY 46025 (33.75N 119.07W)

YEAR	MONTH											
	JAN	FEB	MAR	APR	MAY	JUN	JUL	AUG	SEP	OCT	NOV	DEC
1994	.	3.2	3.1	2.7	2.3	1.8	.	.	.	.	.	.

STATISTICS FOR NDBC BUOY 46025 (33.75N 119.07W)

THE MEAN SIGNIFICANT WAVE HEIGHT (METERS) =	1.1
THE MEAN PEAK WAVE PERIOD (SECONDS) =	11.4
THE MOST FREQUENT 22.5 (CENTER) DIRECTION BAND (DEGREES) =	270.0
THE STANDARD DEVIATION OF Hm0 (METERS) =	0.4
THE STANDARD DEVIATION OF TP (SECONDS) =	3.7
THE LARGEST Hm0 (METERS) =	3.2
THE TP (SECONDS) ASSOC. WITH THE LARGEST Hm0 =	11.1
THE PEAK DIRECTION (DEGREES) ASSOC. WITH THE LARGEST Hm0 =	261.0
THE DATE OF LARGEST Hm0 OCCURRENCE IS	94021815

**Table K2**  
**Percent Occurrence for Catalina Ridge (NDBC 46025)**  
**Second Deployment**

BUOY STATION 46025 33.75 N 119.07 W FOR ALL DIRECTIONS  
 FEBRUARY 1994 - JUNE 1994  
 PERCENT OCCURRENCE (X100) OF HEIGHT AND PERIOD

HEIGHT(METERS)	PEAK PERIOD(SECONDS)										TOTAL
	<6.9 8.0	6.9- 8.0	8.1- 8.7	8.8- 9.5	9.6- 10.5	10.6- 11.7	11.8- 13.3	13.4- 15.3	15.4- 18.1	18.2- LONGER	
0.0-0.9	297	293	74	144	166	209	389	1517	363	30	3482
1.0-1.9	1211	529	314	323	415	472	791	1106	839	87	6087
2.0-2.9	174	96	43	13	8	13	39	13	.	.	399
3.0-3.9	.	8	.	.	.	4	4	.	.	.	16
4.0-4.9	.	.	.	.	.	.	.	.	.	.	0
5.0-5.9	.	.	.	.	.	.	.	.	.	.	0
6.0-6.9	.	.	.	.	.	.	.	.	.	.	0
7.0-7.9	.	.	.	.	.	.	.	.	.	.	0
8.0-8.9	.	.	.	.	.	.	.	.	.	.	0
9.0-9.9	.	.	.	.	.	.	.	.	.	.	0
10.0+	.	.	.	.	.	.	.	.	.	.	0
TOTAL	1682	926	431	480	589	698	1223	2636	1202	117	

MEAN Hm0 (M) = 1.1    LARGEST Hm0 (M) = 3.2    MEAN TP (SEC) = 11.4    TOTAL CASES = 2286.

# **Appendix L Additional NDBC Time Series Plots**

---

REDONDO  
NDBC 46045  
33.84 N, 118.45 W

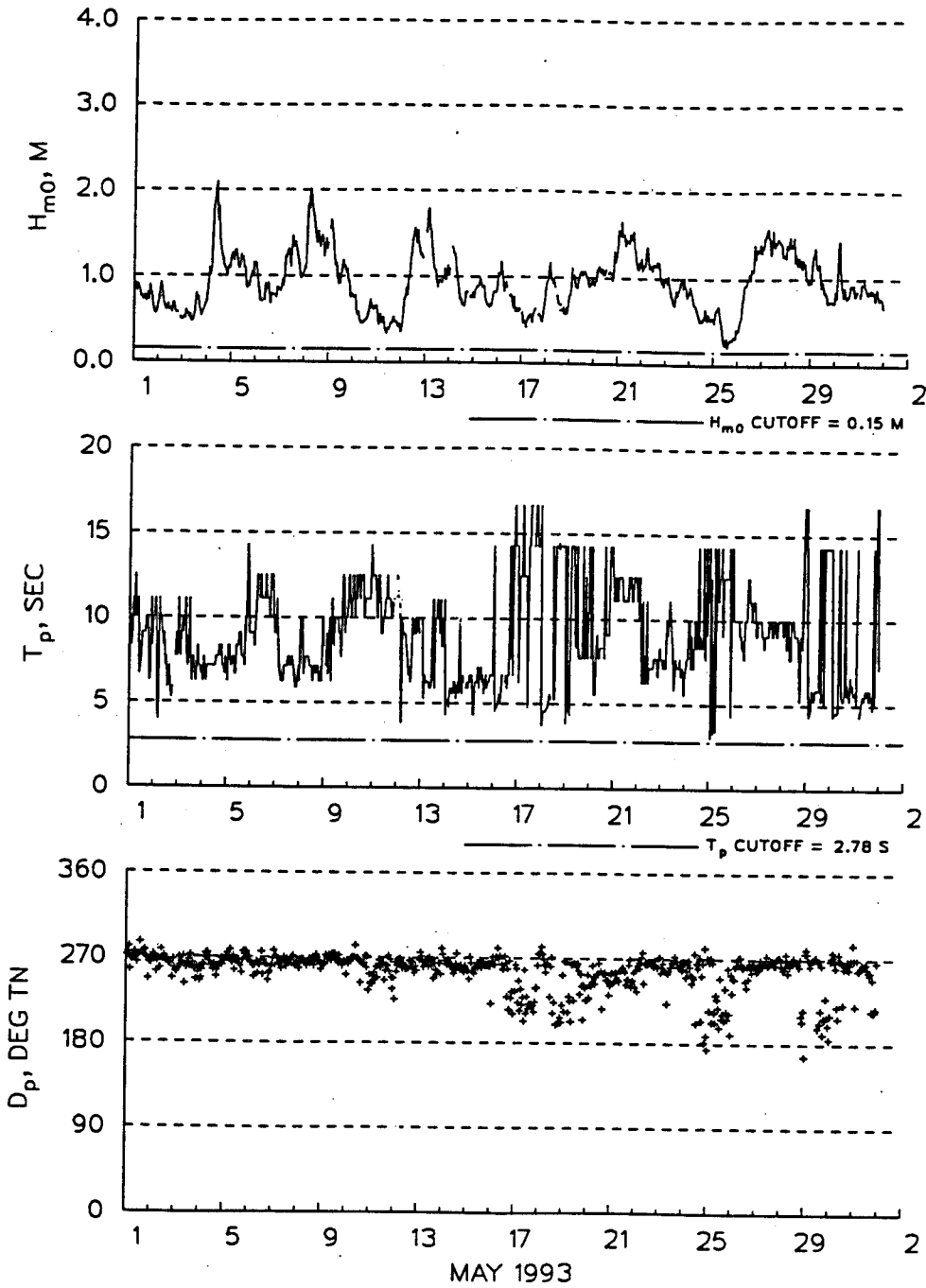

Figure L1. Redondo (NDBC 46045), May 1993

L2

REDONDO  
NDBC 46045  
33.84 N, 118.45 W

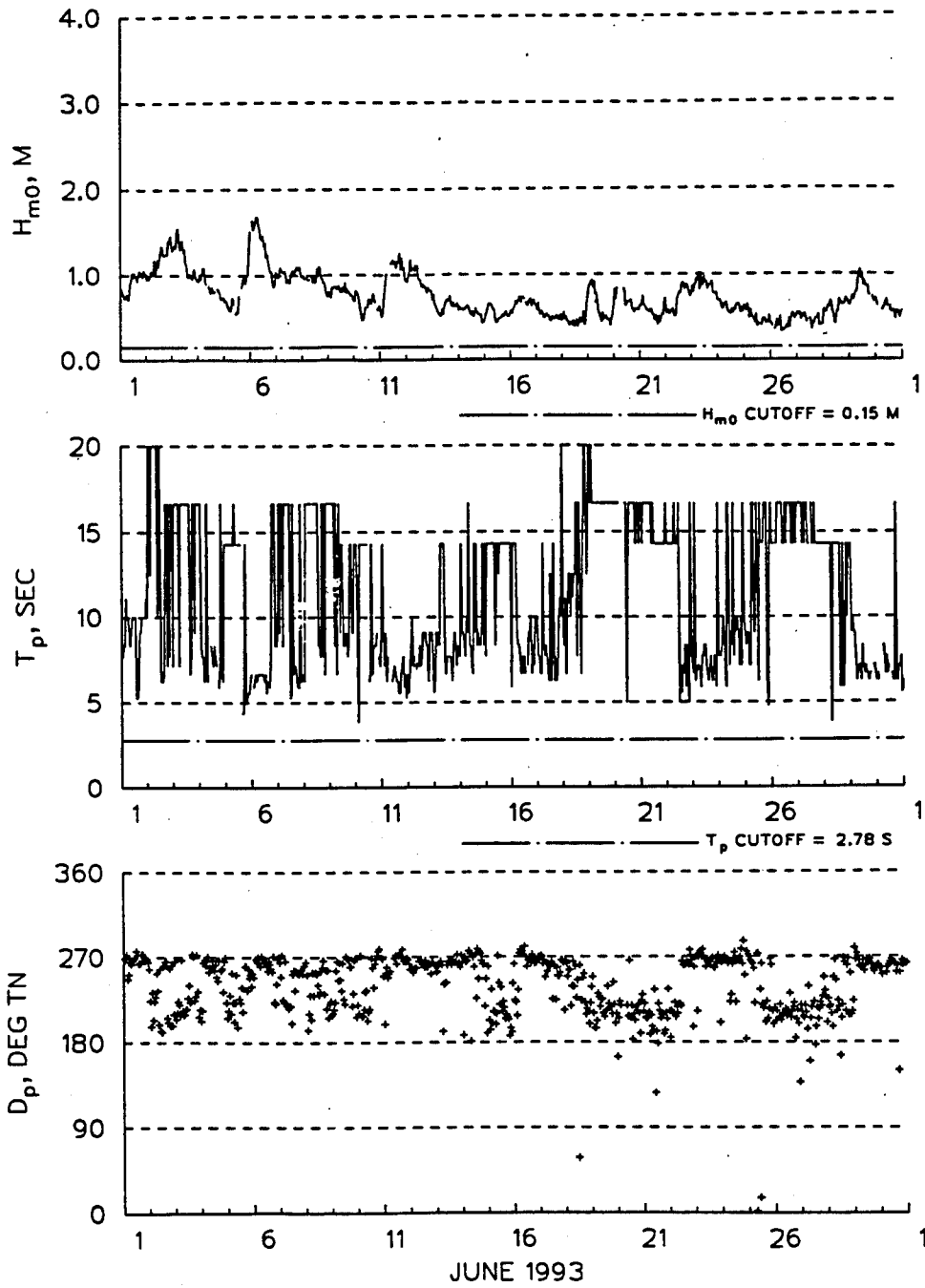

Figure L2. Redondo (NDBC 46045), June 1993

REDONDO  
NDBC 46045  
33.84 N, 118.45 W

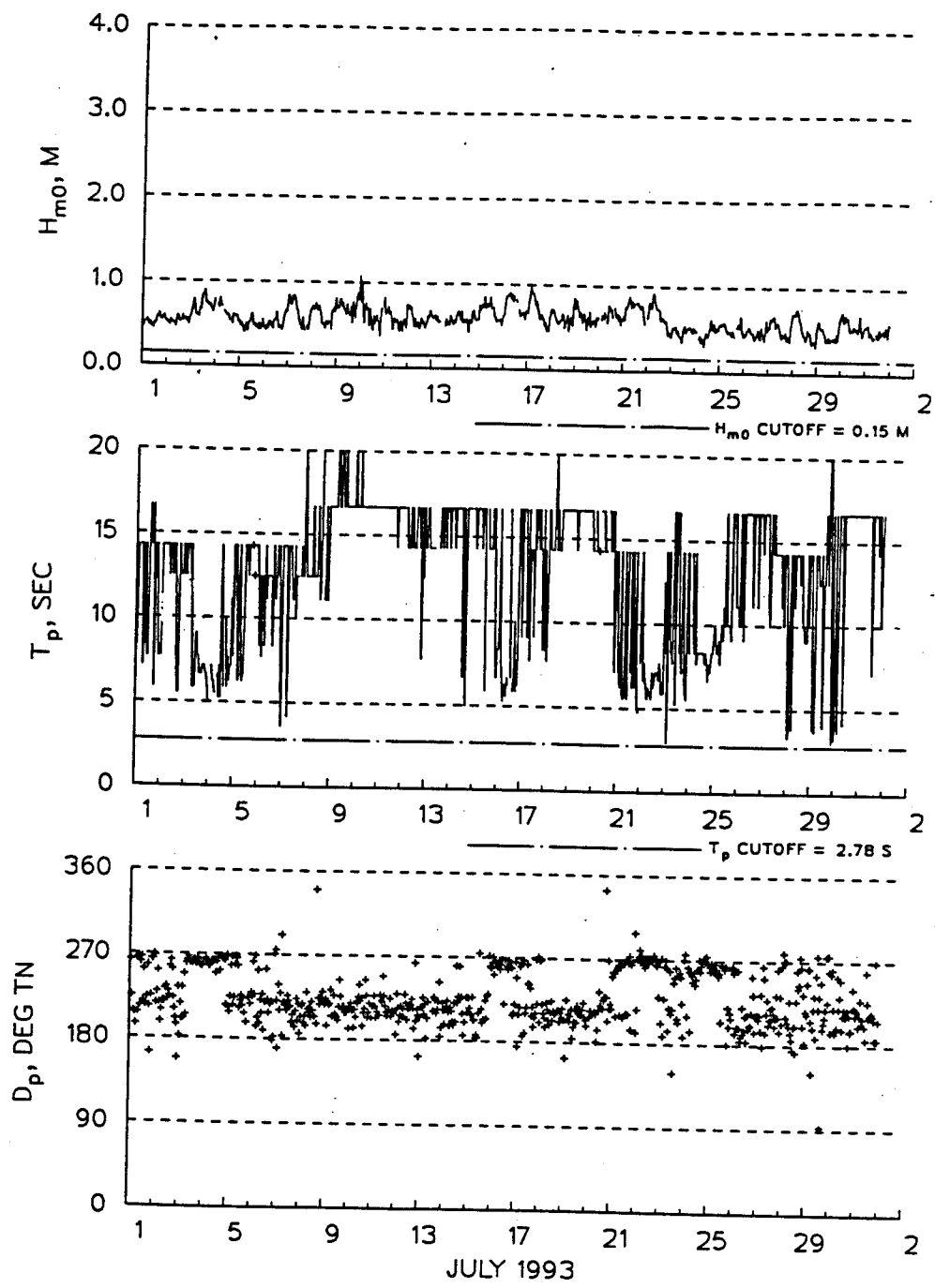

Figure L3. Redondo (NDBC 46045), July 1993

REDONDO  
NDBC 46045  
33.84 N, 118.45 W

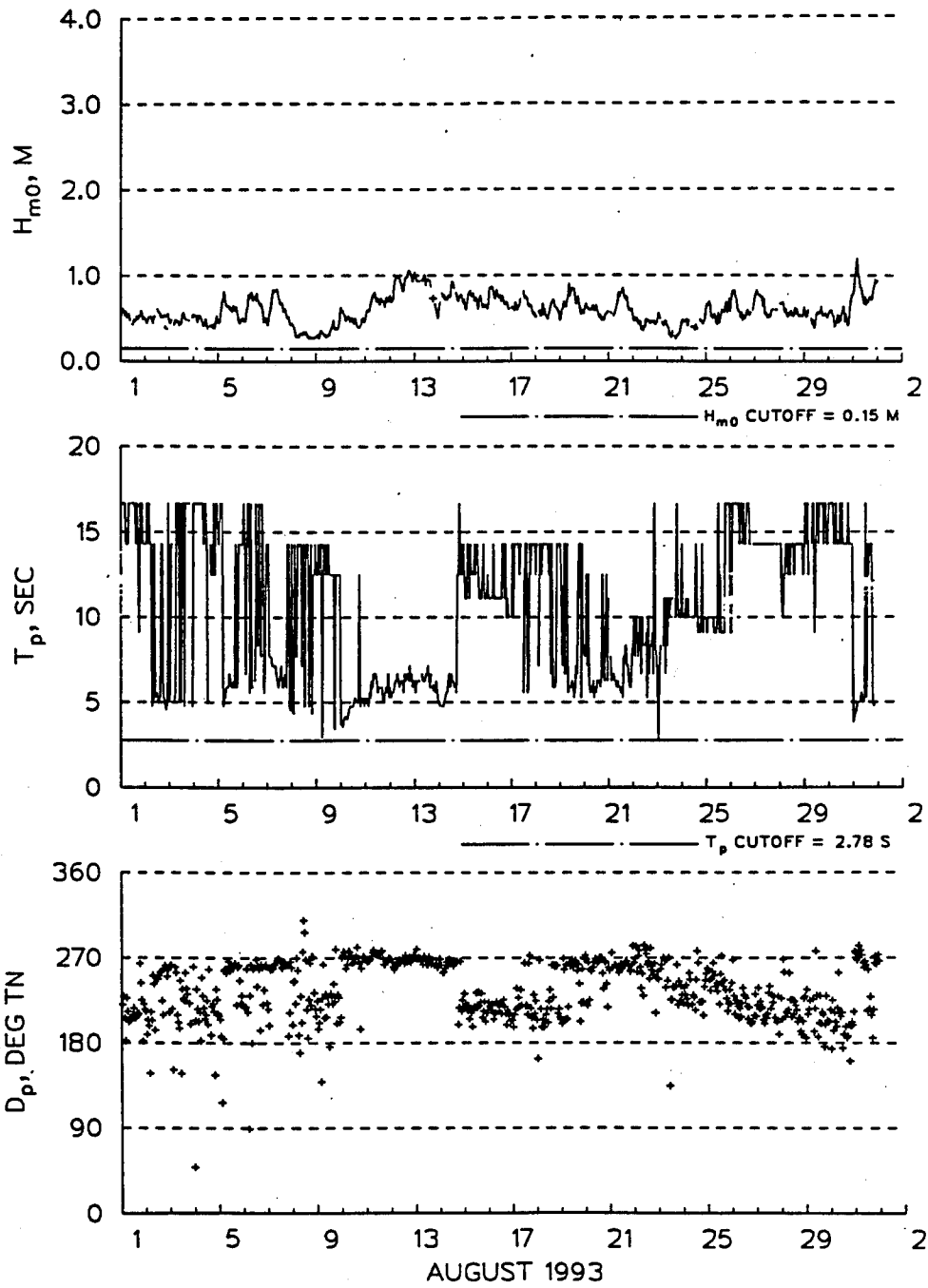

Figure L4. Redondo (NDBC 46045), August 1993

REDONDO  
NDBC 46045  
33.84 N, 118.45 W

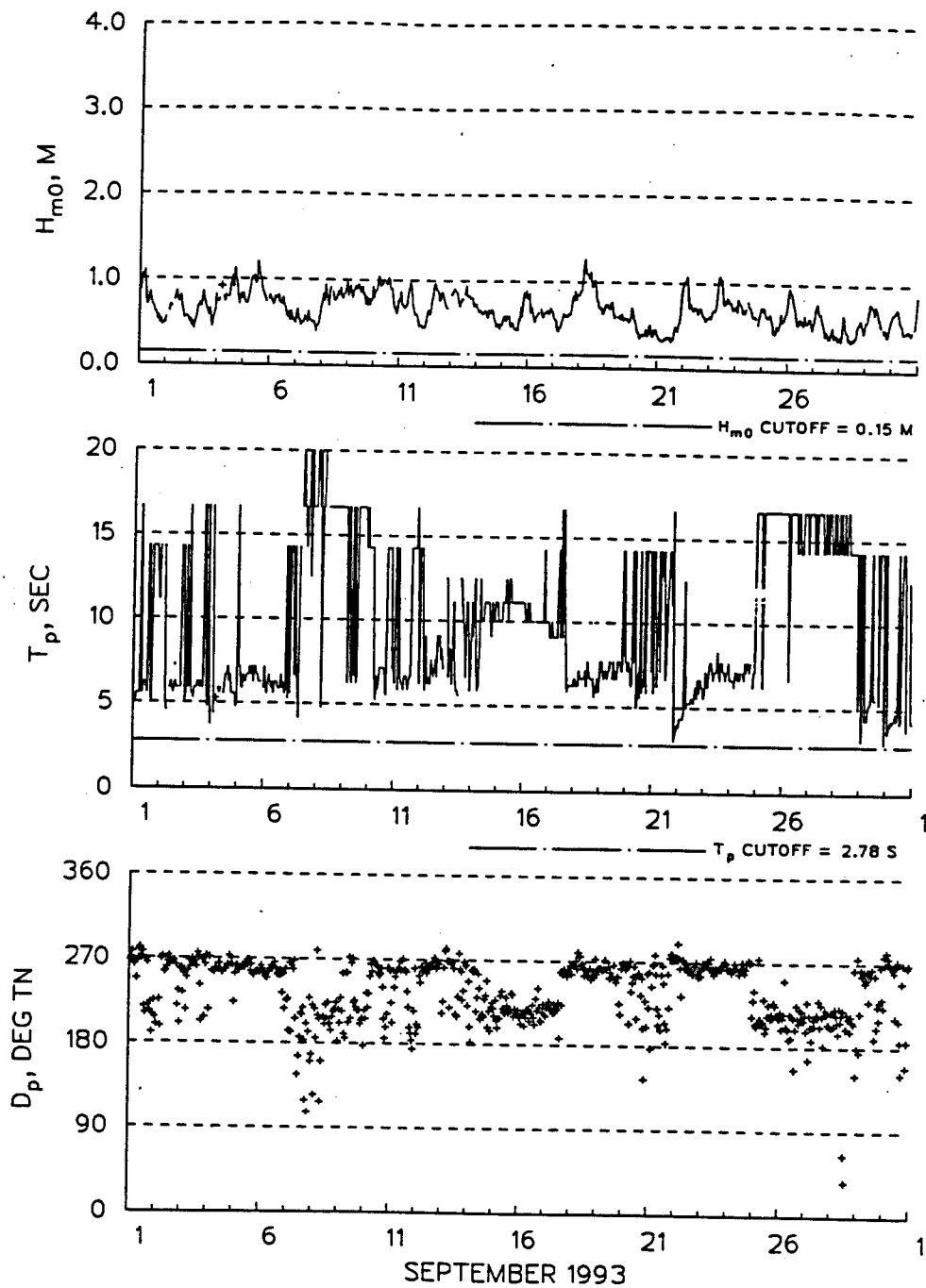

Figure L5. Redondo (NDBC 46045), September 1993

REDONDO  
NDBC 46045  
33.84 N, 118.45 W

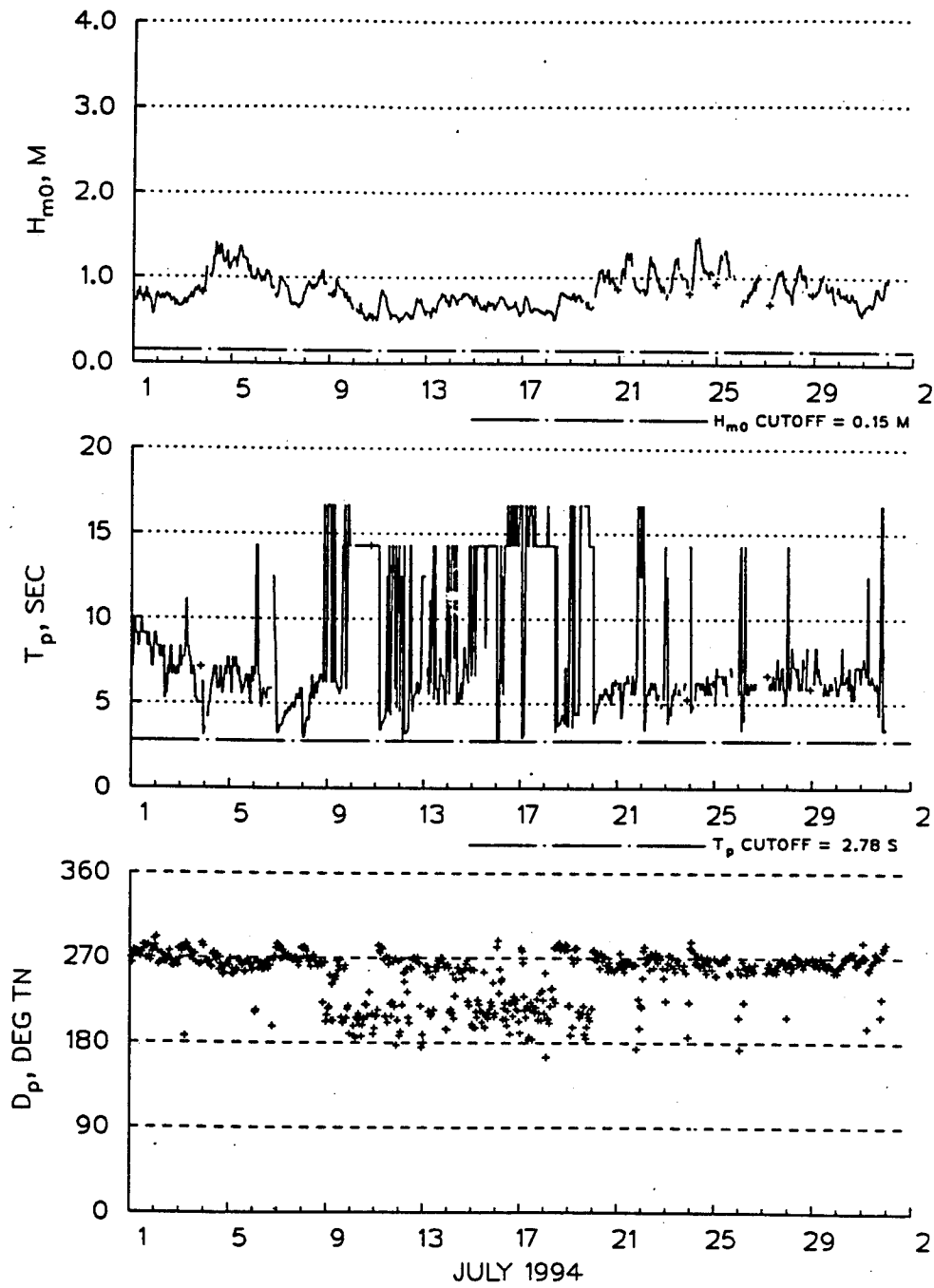

Figure L6. Redondo (NDBC 46045), July 1994

REDONDO  
NDBC 46045  
33.84 N, 118.45 W

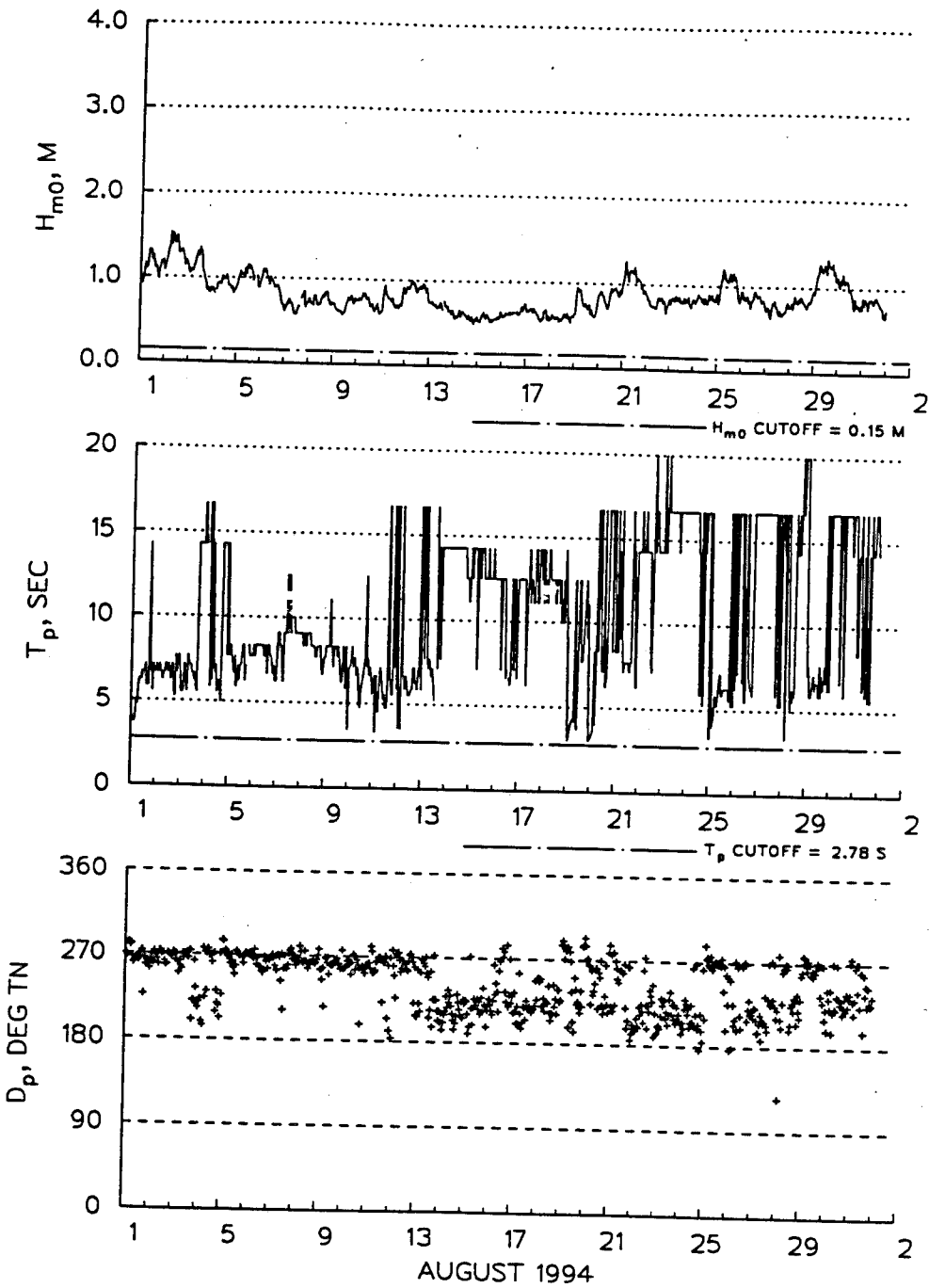

Figure L7. Redondo (NDBC 46045), August 1994

REDONDO  
NDBC 46045  
33.84 N, 118.45 W

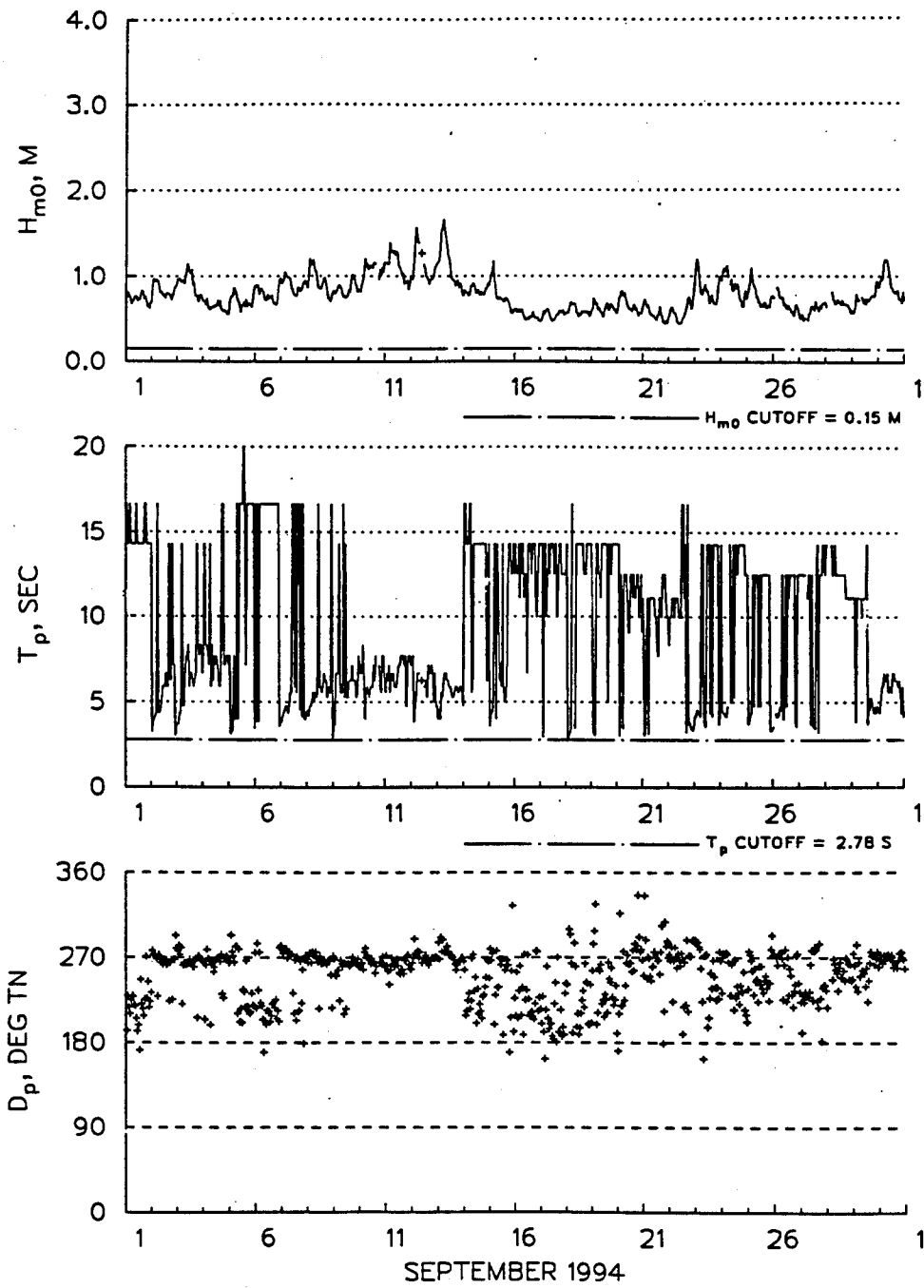

Figure L8. Redondo (NDBC 46045), September 1994

CATALINA RIDGE  
NDBC 46025  
33.75 N, 119.07 W

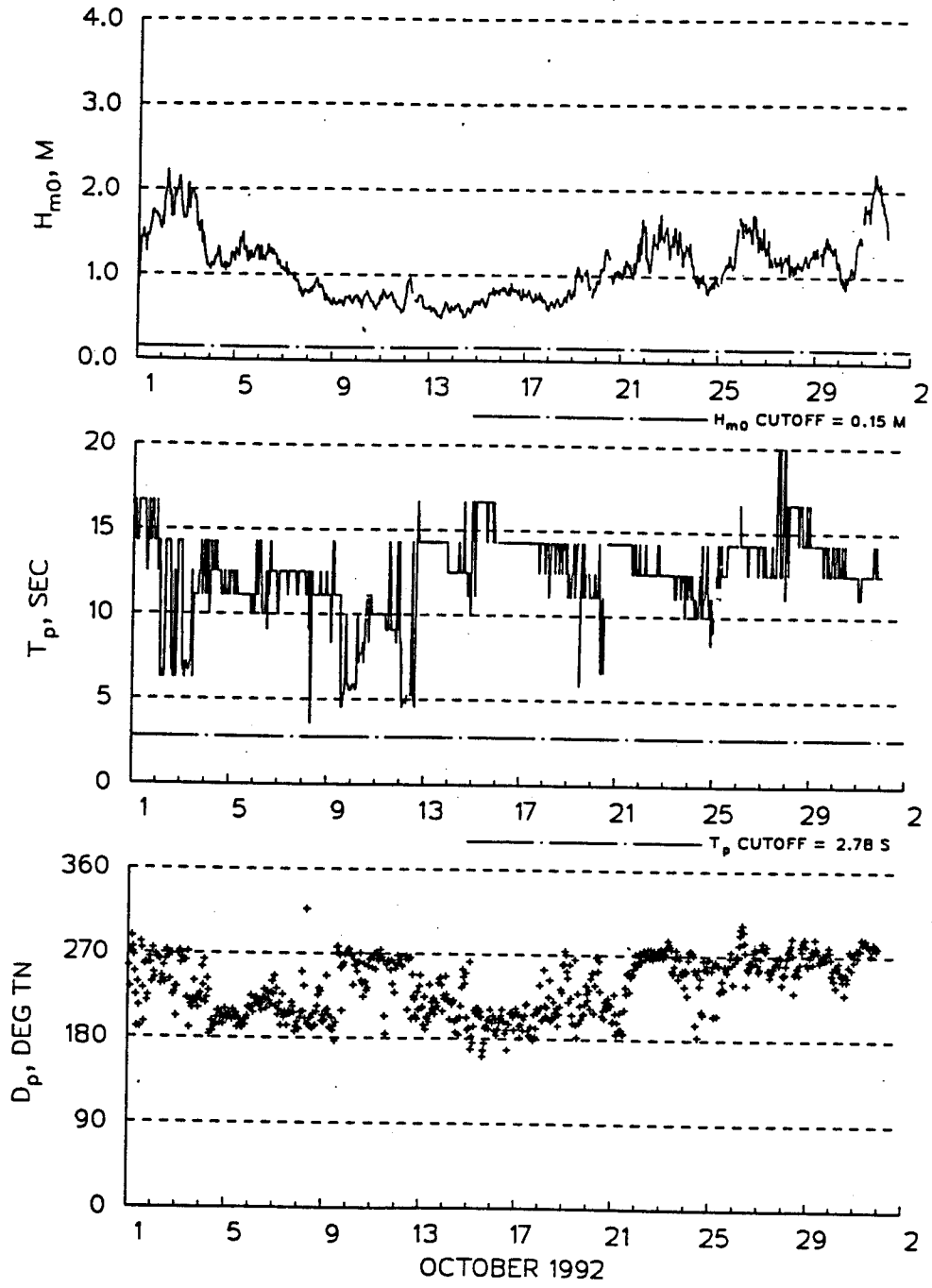

Figure L9. Catalina Ridge (NDBC 46025), October 1992

CATALINA RIDGE  
NDBC 46025  
33.75 N, 119.07 W

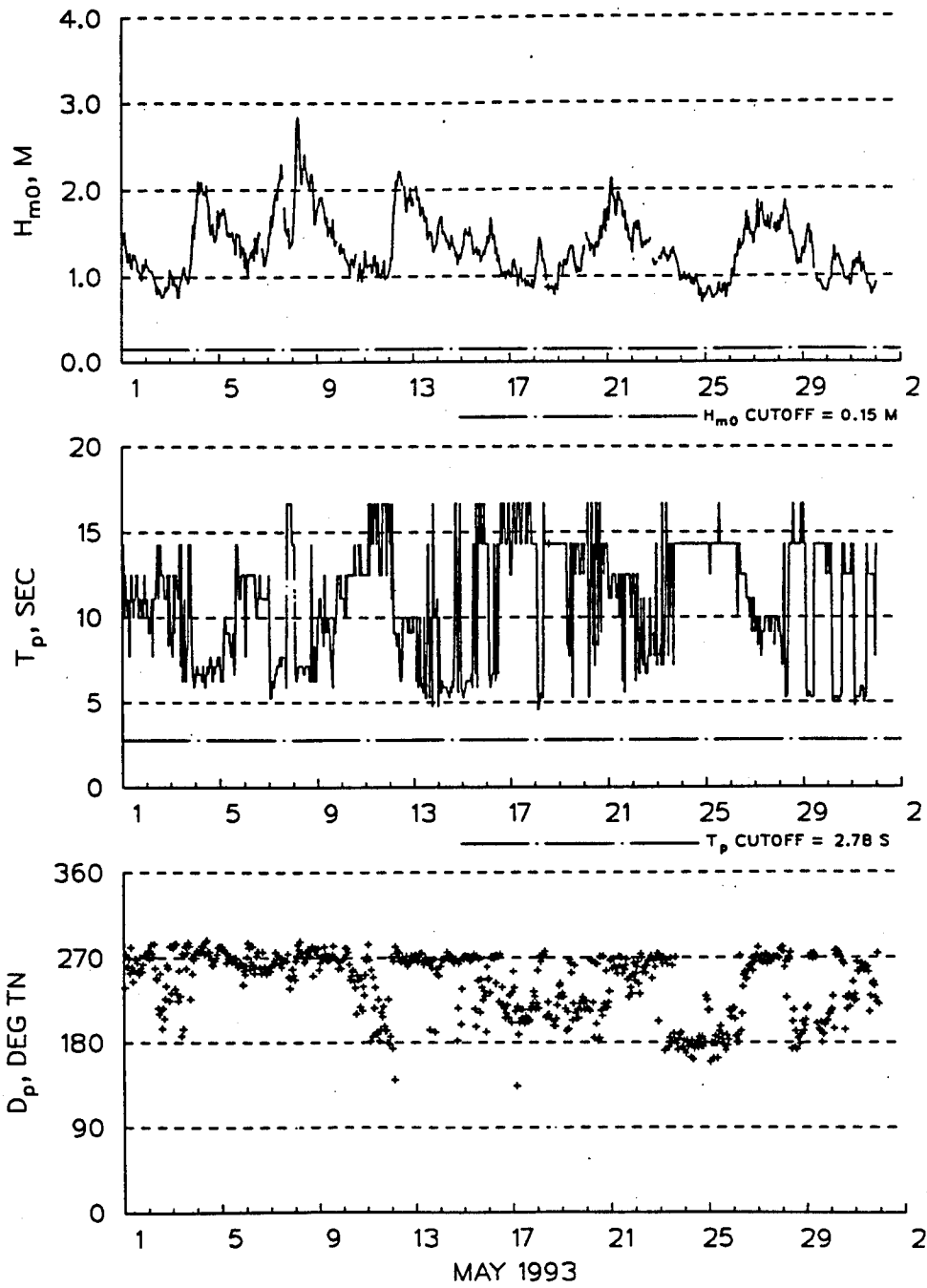

Figure L10. Catalina Ridge (NDBC 46025), May 1993

CATALINA RIDGE  
NDBC 46025  
33.75 N, 119.07 W

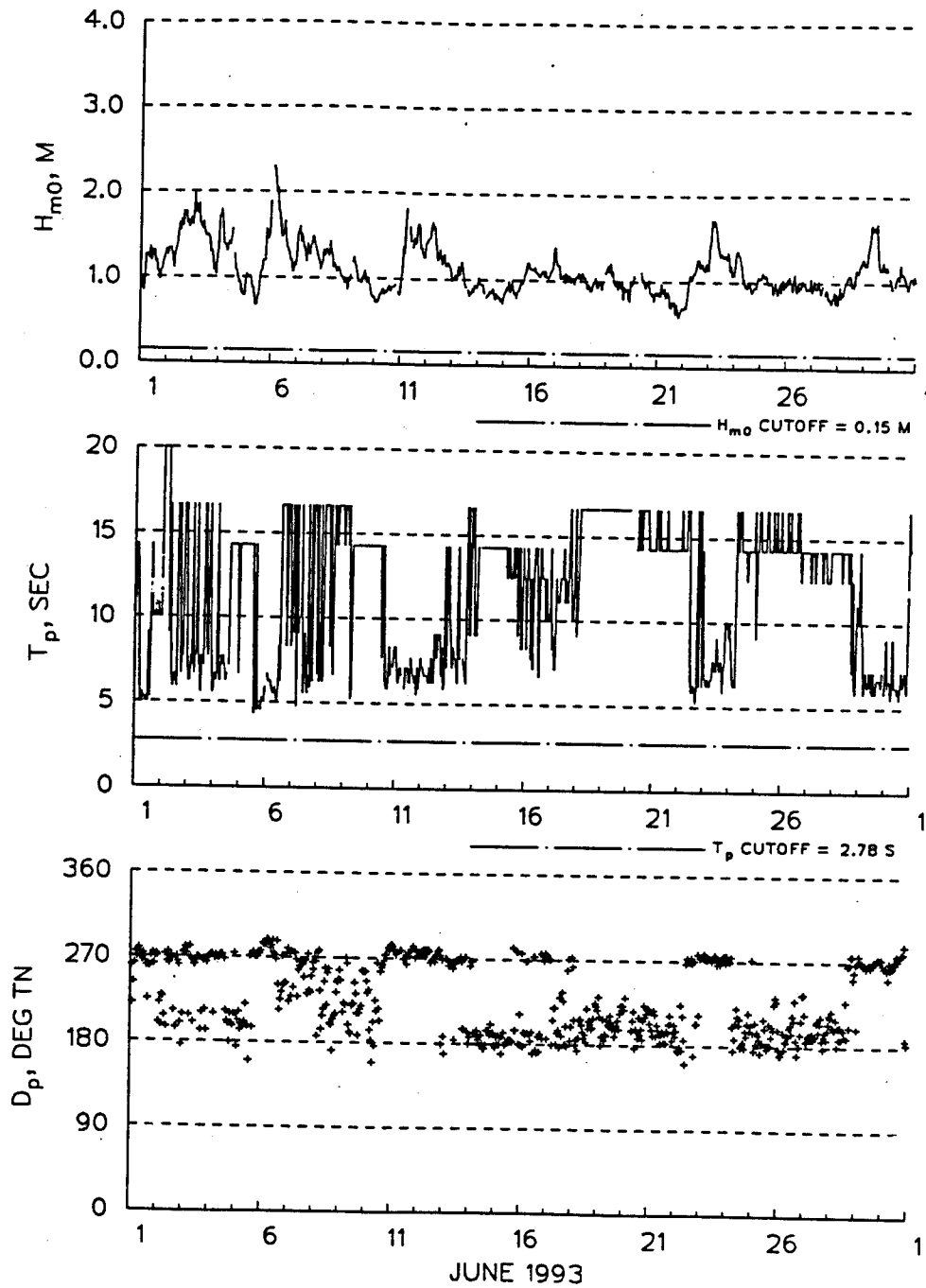

Figure L11. Catalina Ridge (NDBC 46025), June 1993

L12

CATALINA RIDGE  
NDBC 46025  
33.75 N, 119.07 W

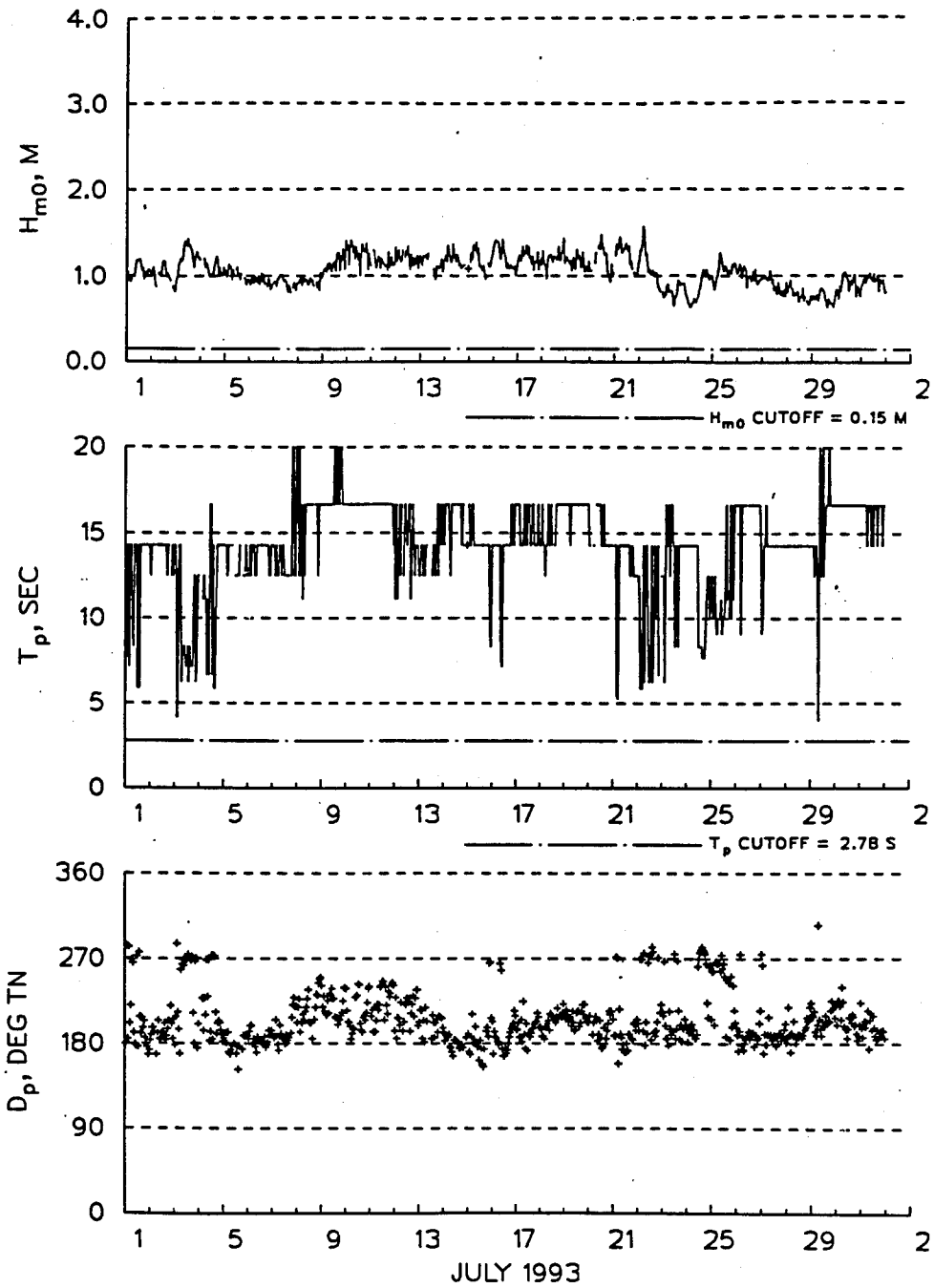

Figure L12. Catalina Ridge (NDBC 46025), July 1993

CATALINA RIDGE  
NDBC 46025  
33.75 N, 119.07 W

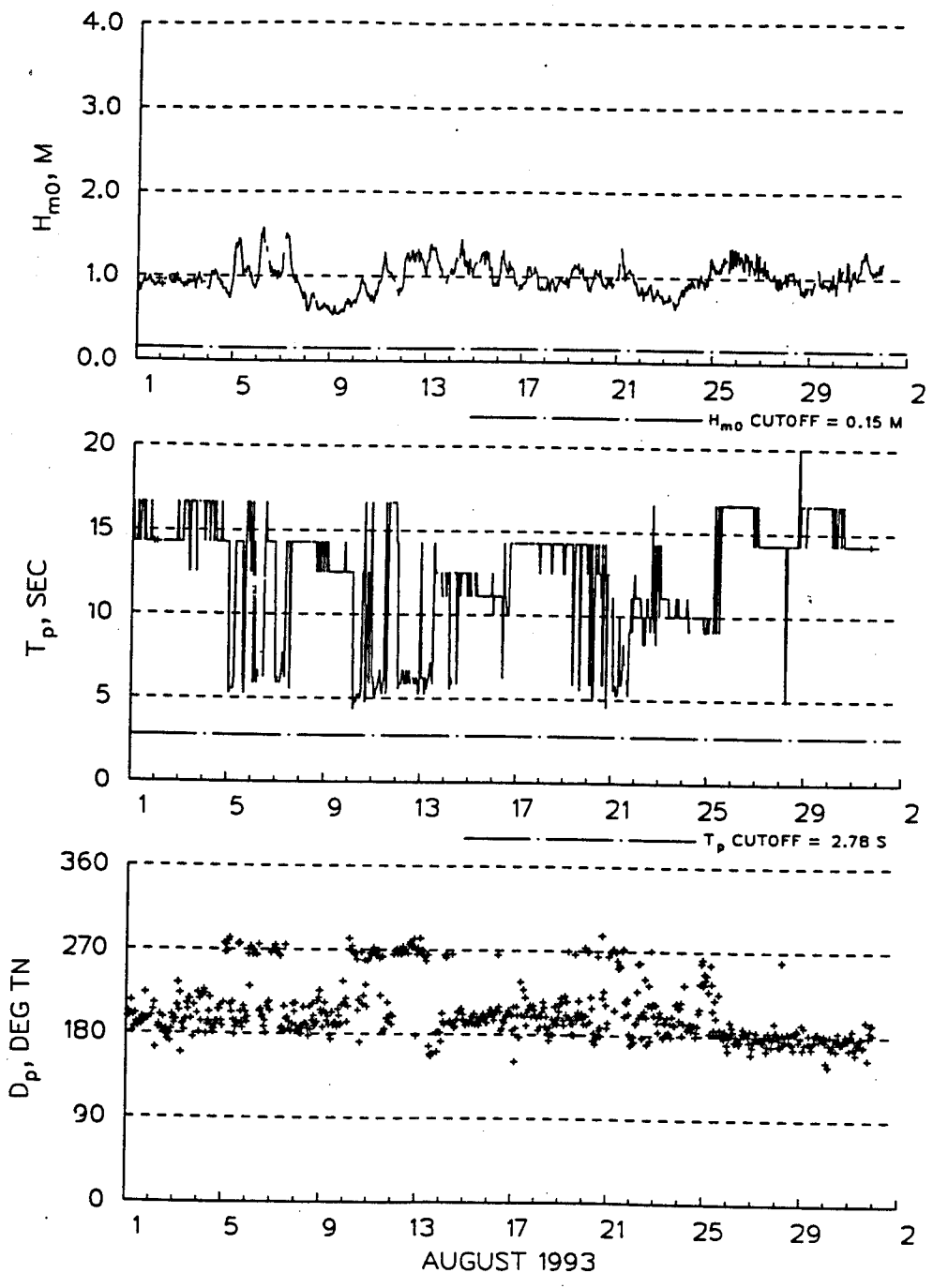

Figure L13. Catalina Ridge (NDBC 46025), August 1993

L14

CATALINA RIDGE  
NDBC 46025  
33.75 N, 119.07 W

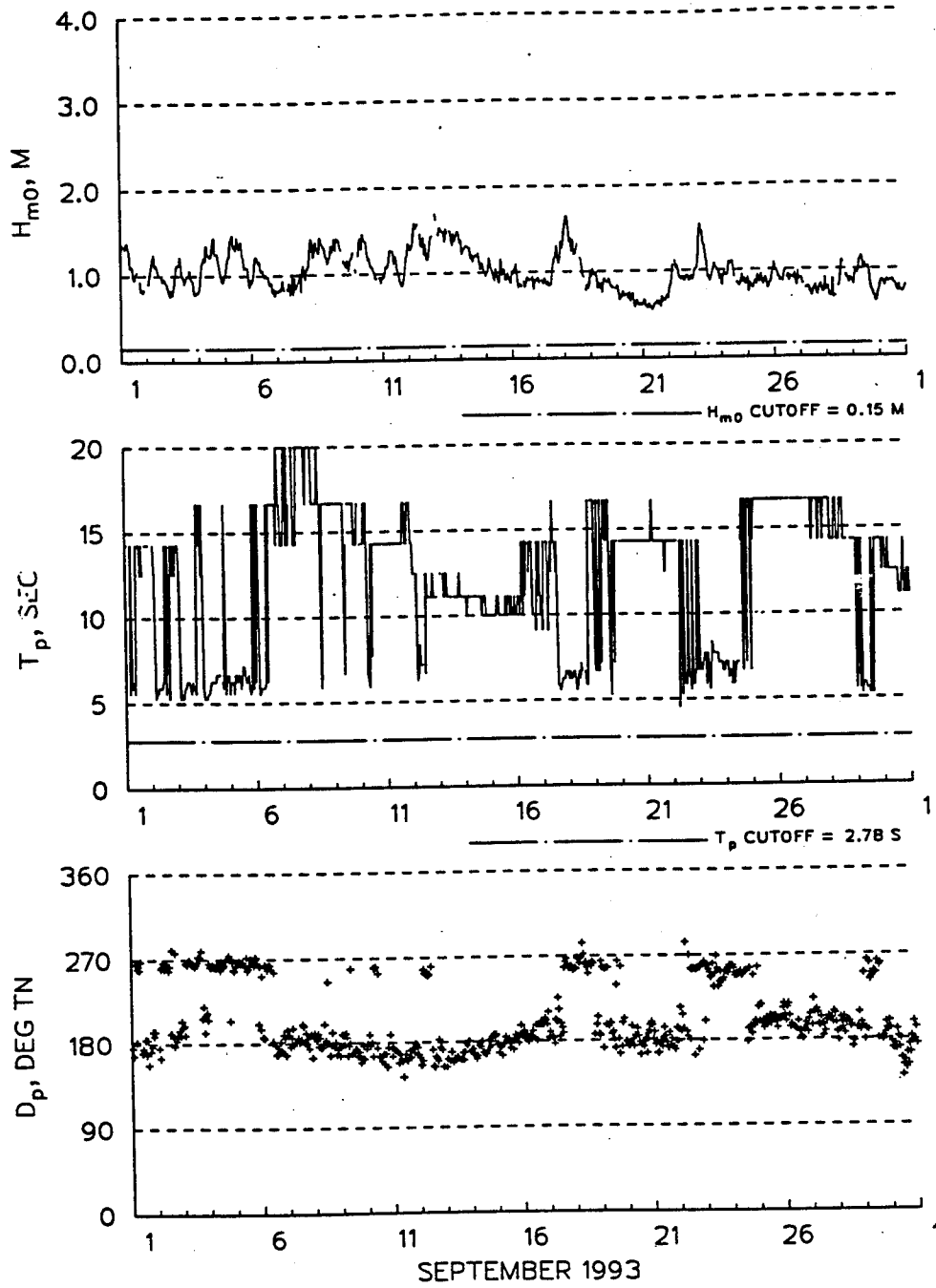

Figure L14. Catalina Ridge (NDBC 46025), September 1993

CATALINA RIDGE  
NDBC 46025  
33.75 N, 119.07 W

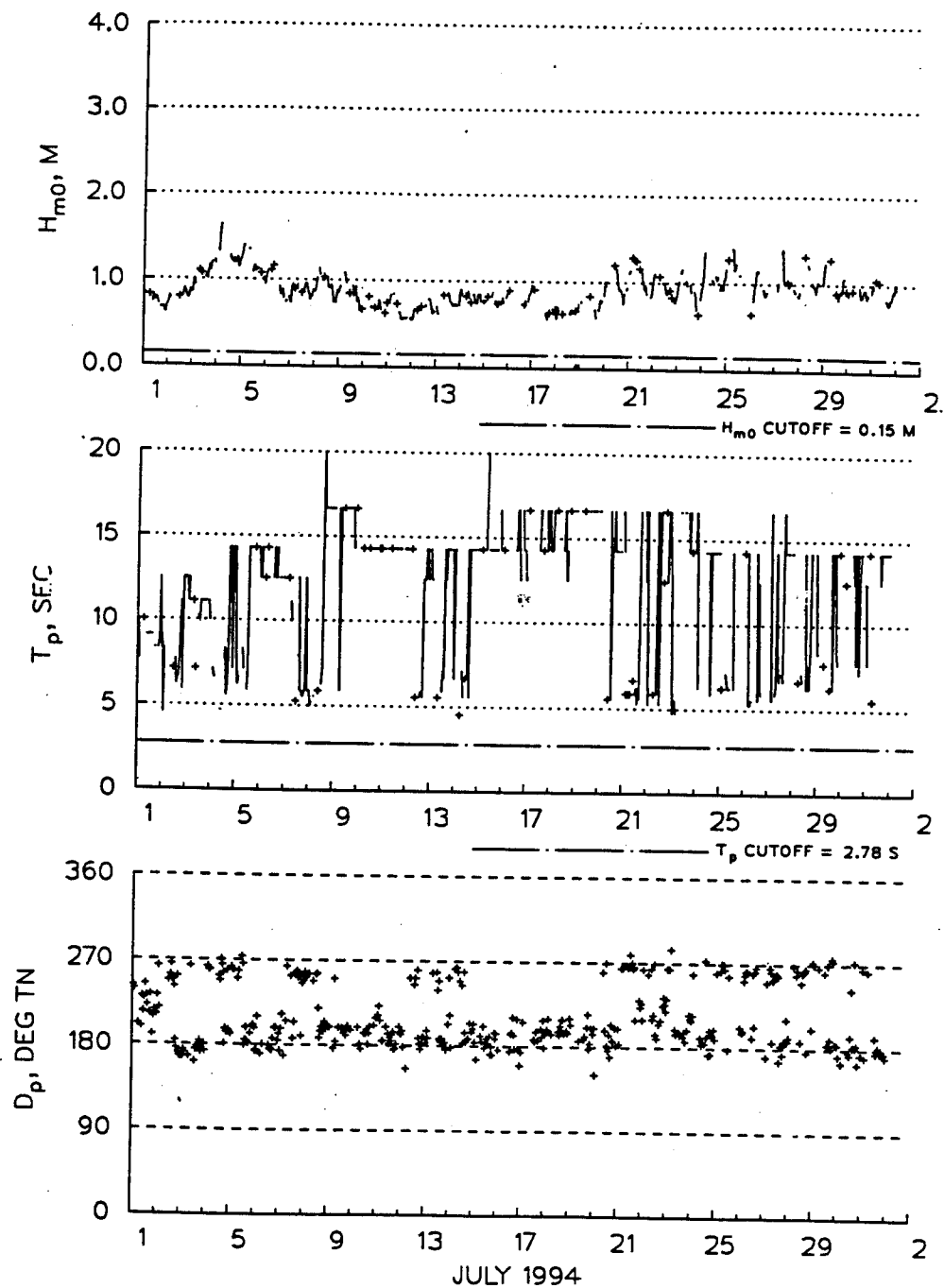

Figure L15. Catalina Ridge (NDBC 46025), July 1994

CATALINA RIDGE  
NDBC 46025  
33.75 N, 119.07 W

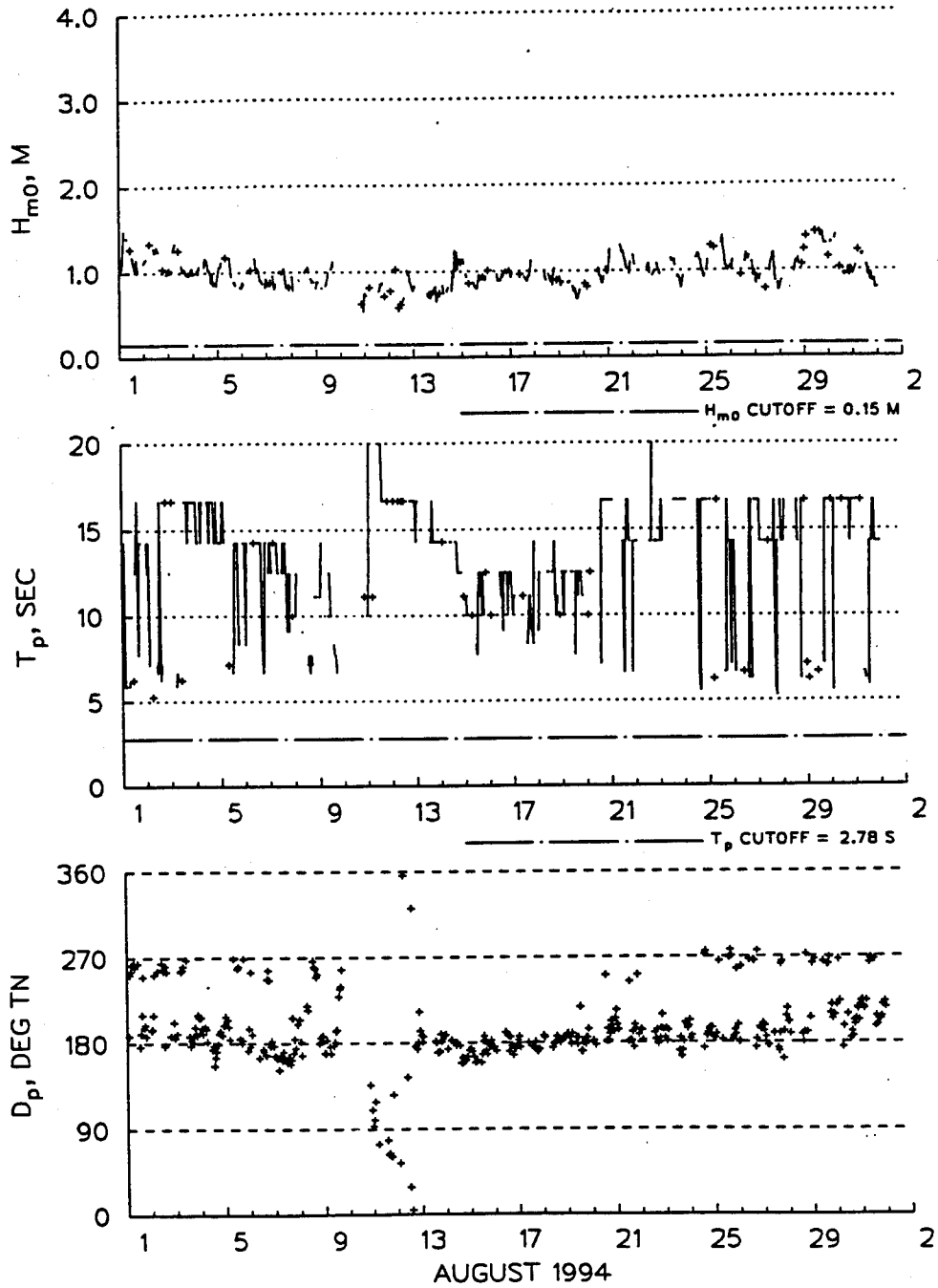

Figure L16. Catalina Ridge (NDBC 46025), August 1994

CATALINA RIDGE  
NDBC 46025  
33.75 N, 119.07 W

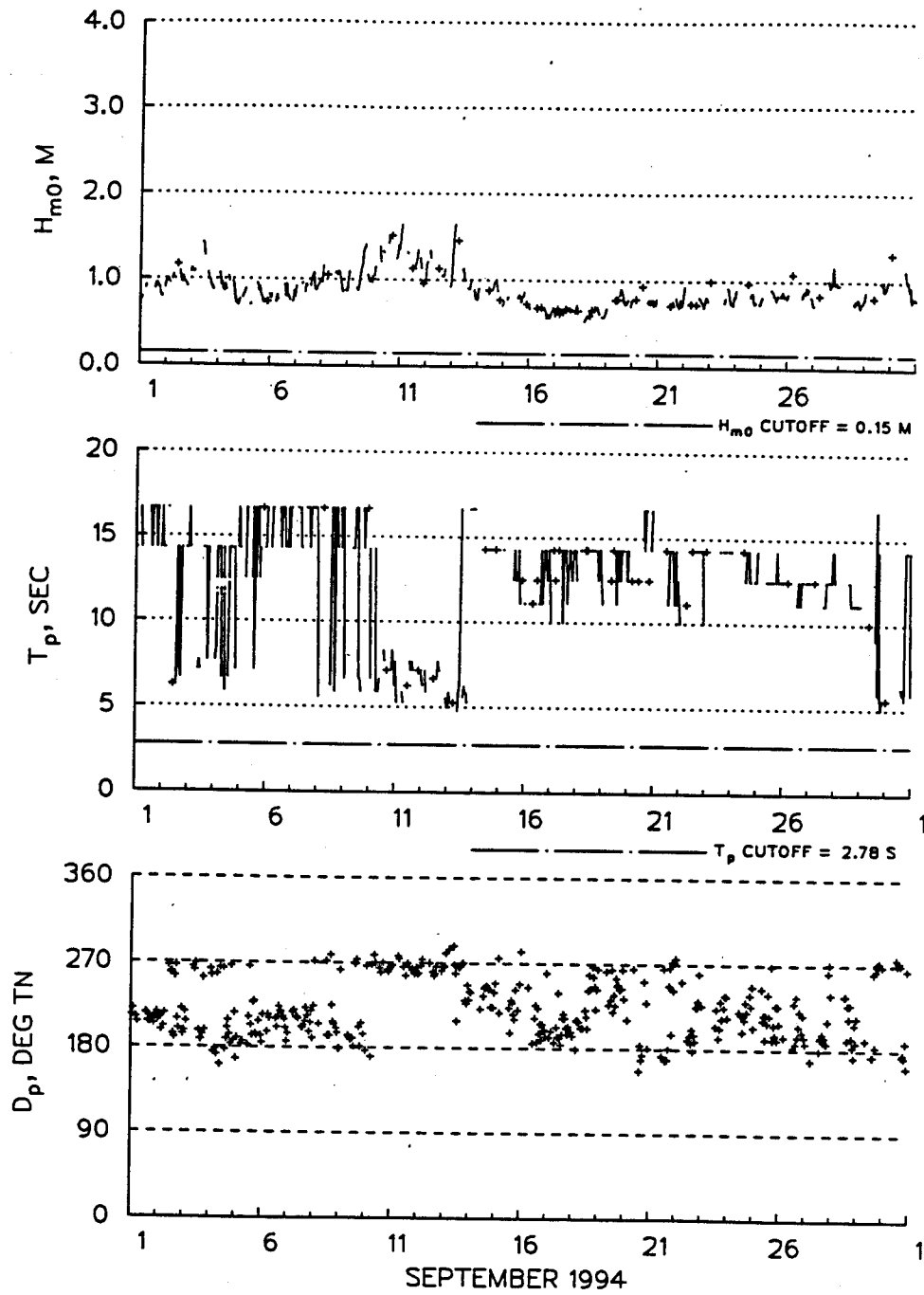

Figure L17. Catalina Ridge (NDBC 46025), September 1994

# REPORT DOCUMENTATION PAGE

Form Approved  
OMB No. 0704-0188

Public reporting burden for this collection of information is estimated to average 1 hour per response, including the time for reviewing instructions, searching existing data sources, gathering and maintaining the data needed, and completing and reviewing the collection of information. Send comments regarding this burden estimate or any other aspect of this collection of information, including suggestions for reducing this burden, to Washington Headquarters Services, Directorate for Information Operations and Reports, 1215 Jefferson Davis Highway, Suite 1204, Arlington, VA 22202-4302, and to the Office of Management and Budget, Paperwork Reduction Project (0704-0188), Washington, DC 20503.

<b>1. AGENCY USE ONLY (Leave blank)</b>		<b>2. REPORT DATE</b> February 1996	<b>3. REPORT TYPE AND DATES COVERED</b> Final report	
<b>4. TITLE AND SUBTITLE</b> Redondo Beach, California, 1992-1994 Wave Data			<b>5. FUNDING NUMBERS</b>	
<b>6. AUTHOR(S)</b> Margaret A. Sabol				
<b>7. PERFORMING ORGANIZATION NAME(S) AND ADDRESS(ES)</b> U.S. Army Engineer Waterways Experiment Station 3909 Halls Ferry Road, Vicksburg, MS 39180-6199			<b>8. PERFORMING ORGANIZATION REPORT NUMBER</b> Technical Report CERC-96-4	
<b>9. SPONSORING/MONITORING AGENCY NAME(S) AND ADDRESS(ES)</b> U.S. Army Corps of Engineers Washington, DC 20314-1000			<b>10. SPONSORING/MONITORING AGENCY REPORT NUMBER</b>	
<b>11. SUPPLEMENTARY NOTES</b> Available from National Technical Information Service, 5285 Port Royal Road, Springfield, VA 22161.				
<b>12a. DISTRIBUTION/AVAILABILITY STATEMENT</b> Approved for public release; distribution is unlimited.			<b>12b. DISTRIBUTION CODE</b>	
<b>13. ABSTRACT (Maximum 200 words)</b> This report summarizes field wave data acquired at Redondo Beach breakwater, CA, during a 2-year period beginning October 1992 and ending in June 1994. The purpose of this study was to provide actual field data to evaluate output from a numerical model which predicts wave propagating through a coastal region of irregular bathymetry. This report contains brief descriptions of the monitoring effort and equipment and provides collected wave information in graphic and tabular form. Statistical analysis of wave data will be provided in a future report.				
<b>14. SUBJECT TERMS</b> RCPWAVE Redondo Beach breakwater Wave data Wave gages			<b>15. NUMBER OF PAGES</b> 140	
			<b>16. PRICE CODE</b>	
<b>17. SECURITY CLASSIFICATION OF REPORT</b> UNCLASSIFIED	<b>18. SECURITY CLASSIFICATION OF THIS PAGE</b> UNCLASSIFIED	<b>19. SECURITY CLASSIFICATION OF ABSTRACT</b>	<b>20. LIMITATION OF ABSTRACT</b>	

Destroy this report when no longer needed. Do not return it to the originator.