

YKI
ADD
420718

NASA TECHNICAL NOTE

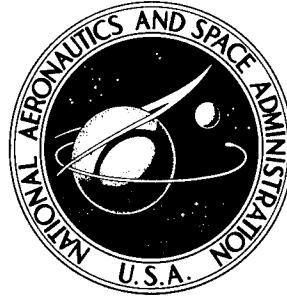

NASA TN D-8219

NASA TN D-8219

19960314 040

CHANGES IN BORON FIBER STRENGTH DUE
TO SURFACE REMOVAL BY CHEMICAL ETCHING

Robert J. Smith

Lewis Research Center

Cleveland, Ohio 44135

DEPARTMENT OF DEFENSE
PLASTICS TECHNICAL EVALUATION CENTER
PICATINNY ARSENAL, DOVER, N. J.



NATIONAL AERONAUTICS AND SPACE ADMINISTRATION • WASHINGTON, D. C. • APRIL 1976

DISTRIBUTION STATEMENT A

Approved for public release;
Distribution Unlimited

THIS DOCUMENT CONTAINS I

PLASTEC
23403

1. Report No. NASA TN D-8219		2. Government Accession No.		3. Recipient's Catalog No.	
4. Title and Subtitle CHANGES IN BORON FIBER STRENGTH DUE TO SURFACE REMOVAL BY CHEMICAL ETCHING				5. Report Date April 1976	
				6. Performing Organization Code	
7. Author(s) Robert J. Smith				8. Performing Organization Report No. E-8635	
9. Performing Organization Name and Address Lewis Research Center National Aeronautics and Space Administration Cleveland, Ohio 44135				10. Work Unit No. 506-16	
				11. Contract or Grant No.	
12. Sponsoring Agency Name and Address National Aeronautics and Space Administration Washington, D.C. 20546				13. Type of Report and Period Covered Technical Note	
				14. Sponsoring Agency Code	
15. Supplementary Notes					
16. Abstract The effects of chemical etching on the tensile strength of commercial boron/tungsten (B/W) fibers were investigated. Fibers with as-received diameters of 203, 143, and 100 μm (7.98, 5.64, and 3.95 mils) were etched to diameters as small as 43 μm (1.7 mils). The etchings generally resulted in increasing fiber tensile strength with decreasing fiber diameter. And for the 203- μm (7.98-mil) fibers there was an accompanying significant decrease in the coefficient of variation of the tensile strength for diameters down to 89 μm (3.5 mils). Heat treating the 203- μm (7.98-mil-) diameter fibers above 1173 K in a vacuum caused a marked decrease in the average tensile strength of at least 80 percent. But after the fibers were etched, their strengths exceeded the as-received strengths. Other 203- μm (7.98-mil) fibers, retrieved from an aluminum matrix, showed increases in strength due to etching that were somewhat similar to those of the etched as-received 203- μm (7.98-mil) fibers. The tensile strength behavior is explained in terms of etching effects on surface flaws and the residual stress pattern of the as-received fibers. This work shows that B/W fibers with diameters <165 μm (6.5 mils) can be obtained with average tensile strengths >4.83 GN/m ² (700 ksi) with a coefficient of variation of <5 percent.					
17. Key Words (Suggested by Author(s)) Boron fiber Composite (metal or resin matrix) Fiber strength			18. Distribution Statement Unclassified - unlimited STAR category 24		
19. Security Classif. (of this report) Unclassified		20. Security Classif. (of this page) Unclassified		21. No. of Pages 20	22. Price* \$3.25

* For sale by the National Technical Information Service, Springfield, Virginia 22161

CHANGES IN BORON FIBER STRENGTH DUE TO SURFACE REMOVAL BY CHEMICAL ETCHING

by Robert J. Smith

Lewis Research Center

SUMMARY

The effects of surface removal by chemical etching on the tensile strength of commercial boron/tungsten (B/W) fibers were investigated. The diameters of the as-received fibers were 203, 143, and 100 micrometers (7.98, 5.64, and 3.95 mils). Their average tensile strengths were approximately 3.45 giganewtons per square meter (500 ksi). In general, each group showed increasing fiber strength with decreasing fiber diameter due to etching. And for the 203- and 143-micrometer (7.98- and 5.64-mil) fibers, there were accompanying decreases in their coefficients of variation for diameters down to 89 and 102 micrometers (3.5 and 4.0 mils), respectively. For example, the as-received 203-micrometer (7.98-mil) fibers had an average tensile strength of 3.59 giganewtons per square meter (521 ksi) with a coefficient of variation of 23.5 percent. After these fibers were etched to approximately 165 micrometers (6.5 mils), the average tensile strength was 4.92 giganewtons per square meter (714 ksi) with a coefficient of variation of <5 percent.

Surface flaws were associated with some of the low tensile strengths of the as-received fibers. Also, surface flaws were either produced or intensified in the 203-micrometer (7.98-mil) fibers by heat treating above 1173 K in a vacuum. This effect caused their tensile strengths to decrease to <0.689 giganewton per square meter (100 ksi). However, after sufficient surface removal, the strengths of the heat-treated fibers approached or equaled the tensile strengths of other as-received fibers which had been etched to similar diameters. Composite fabrication may enhance or introduce additional surface flaws. However, those 203-micrometer- (7.98-mil-) diameter fibers which could be retrieved from an aluminum matrix, etched, and then tested showed increases in tensile strength similar to those of the etched as-received 203-micrometer (7.98-mil) fibers.

The rise in the average tensile strength with decreasing diameter due to etching is attributed to the alteration of the residual stress pattern of the fiber. That is, surface removal increases the compressive stresses in the tungsten boride core and the remaining bulk boron.

This work indicates that stronger B/W fibers with lower coefficients of variation can be made commercially.

INTRODUCTION

Boron fibers are used as reinforcement material in applications requiring high strength, high modulus, and low density. Boron has a modulus of approximately 400 giganewtons per square meter (58×10^3 ksi) and a density of 2.34 grams per cubic centimeter. Wawner (ref. 1) showed that the previously low average tensile strengths of 2.76 and 1.93 giganewtons per square meter (400 and 280 ksi) for fiber diameters of 76 and 254 to 305 micrometers (3 and 10 to 12 mils), respectively, were due to surface flaws. These surface flaws also limited the flexural strength to an average of 5.03 giganewtons per square meter (703 ksi) for the larger fibers. After removing 13 to 102 micrometers (0.5 to 4.0 mils) of surface by chemically polishing the fibers, Wawner attained average tensile and flexural strengths of 3.86 and 13.1 giganewtons per square meter (560 and 1900 ksi), respectively. The fibers used in Wawner's studies were formed by vapor deposition of boron on a 13-micrometer (0.5-mil) tungsten filament. Today, boron fibers formed on a tungsten wire substrate (B/W) can be produced with average tensile strengths of 3.45 to 3.79 giganewtons per square meter (500 to 550 ksi). These higher strengths are attained by optimizing the deposition temperature, adequately cleaning the tungsten substrate, and keeping impurities out of the gases used in the formation of the boron fiber (unpublished data obtained from Val Krukonis of AVCO). Usually the fractures are initiated in or near the tungsten boride core. Even so, there exists in the as-produced fibers a relatively large coefficient of variation (COV) of approximately 15 percent in the tensile strength (ref. 2).

Even though the fibers produced today are better than those produced in the early 1960's, the high flexural strength found by Wawner indicates that further improvements in tensile strength are possible. A higher average tensile strength and a smaller coefficient of variation would permit the use of boron fibers in applications not now considered. Boron fibers which were split longitudinally registered tensile strengths in excess of 6.89 giganewtons per square meter (1000 ksi) when the core was etched away (ref. 3). Also, 102-micrometer (4.0-mil) fibers with an average tensile strength of 4.14 giganewtons per square meter (600 ksi) were produced in a radiofrequency-heated reactor. Their highest tensile strength was >6.89 giganewtons per square meter (1000 ksi), and their lowest tensile strength was ~ 2.07 giganewtons per square meter (300 ksi) (ref. 4). In any case, boron fibers with average strengths in excess of 4.0 giganewtons per square meter (580 ksi) are possible. In this preliminary study, we investigated the possibility of obtaining improved strength with reduced coefficients of variation by surface removal through chemical etching. In this report we present results which show average fiber tensile strengths greater than 4.83 giganewtons per square meter (700 ksi) and coefficients of variation much less than those of the as-received fibers. Furthermore, the results may be interpreted to show that the surface of the as-received boron fiber does affect the initial range in strength. To support this interpretation, we show that low

fiber strengths caused by heating and/or fabrication into a metal matrix are due to surface degradation.

EXPERIMENT

All the fibers used in this work were obtained from the same manufacturer. The nominal diameters of the as-received fibers were 100, 143, and 203 micrometers (3.95, 5.64, and 7.98 mils). And their stated average tensile strengths were 3.46, 3.56, and 3.45 giganewtons per square meter (502, 516, and 500 ksi), respectively. The stated coefficient of variation was 15 percent (ref. 2). The fibers were produced by the vapor deposition of boron from the hydrogen reduction of boron trichloride (BCl_3) onto a 13-micrometer (0.5-mil) tungsten substrate. The deposition temperature was approximately 1573 K and was obtained by direct-current heating of the tungsten filament in a single-stage reactor. For the production of the 203-micrometer (7.98-mil) fiber, the direct-current heating was augmented by three very-high-frequency (vhf) (~ 63 MHz) power-tuned coupling loops spaced along the portion of the filament length approaching the exit end of the reactor. The use of the vhf power was needed to obtain the same strength properties in the 203-micrometer (7.98-mil) fibers as found in the 100- and 143-micrometer (3.95- and 5.64-mil) fibers. The fibers were wound on 0.2-meter- (8-in.-) diameter spools for shipping.

Another group of 203-micrometer- (7.98-mil-) diameter fibers was obtained by dissolving away the aluminum matrix of a 0.5-B-volume-fraction composite with a hot sulfuric acid and water solution ($\text{H}_2\text{SO}_4 + 2\text{H}_2\text{O}$). The fibers were then rinsed in distilled water. The composite had been formed at a temperature and pressure of at least 790 K and 34.48 meganewtons per square meter (5 ksi), respectively, with the fibers unidirectional. Additional details of the composite fabrication are not available. Sodium hydroxide (NaOH) had also been tried as a matrix solvent; but when the fibers were tested, they were much weaker than the fibers obtained by using the H_2SO_4 solution, and thus NaOH was not used in additional studies.

In order to obtain some information on the effects of temperature on fiber strength, six groups of the as-received 203-micrometer- (7.98-mil-) diameter fibers were heat treated in a vacuum of 1.33 micronewtons per square meter (10^{-8} torr) for 1.5 hours at 643, 673, 873, 1073, 1213, and 1263 K, respectively. Prior to heat treating, the fibers were successively rinsed in acetone, alcohol, and distilled water.

The fibers were prepared for etching by rinsing 10.16-centimeter (4-in.) lengths of each fiber successively in acetone, alcohol, and distilled water. Three etchants were tried: a nitric acid and water solution ($2\text{HNO}_3 + 1\text{H}_2\text{O}$); a saturated ferric chloride (FeCl_3) solution; and a 20 percent potassium hydroxide, 20 percent potassium

ferricyanide, and 60 percent water solution ($\text{KOH} + \text{K}_3\text{Fe}(\text{CN})_6 + \text{H}_2\text{O}$). The $2\text{HNO}_3 + 1\text{H}_2\text{O}$ solution, the etchant used in this work, was the most desirable, as shown in the RESULTS. The fibers were suspended through a perforated tetrafluoroethylene disk in a hot (~ 363 K) nitric acid solution as shown in figure 1. (Tetrafluoroethylene is not attacked by hot nitric acid vapors.) In the simple setup of figure 1 more than 30 fibers could be etched at one time. The etching times varied from 60 to 1800 seconds in order to remove from 5 to 70 micrometers (0.2 to ~ 2.7 mils) from the surface. After etching, the fibers were rinsed in distilled water and prepared for tensile testing.

The unetched portion of each fiber was removed. This left approximately 76.2 millimeters (3 in.) for the tensile tests (25.4 mm (1 in.) for the test section and 25.4 mm (1 in.) on each end for gripping). Aluminum foil approximately 127 micrometers (5 mils) thick was folded tightly around each end of the fiber. The foils overlapped by approximately 3.2 millimeters (~ 125 mils) in the test section, and thereby completely enclosed the fiber as shown in figure 2. This arrangement permitted the fractured fiber to be retained within the foils. Often a common cement containing acetone, butylacetate, and allyl isothiocyanate was used to help secure the fiber in the foils to facilitate handling. This procedure was done just prior to testing, and the cement did not harden. The cement was primarily in the gripping sections. However, tests showed that even if the foils appeared to be glued together, the tensile strengths were not affected. All fibers were tested to failure with a hard tensile testing machine at a crosshead speed of 0.846 micrometer per second (2.0 mils/min). The gage length was identical to the test section. The test temperature was approximately 295 K. These testing procedures were used for all the fibers: as-received, etched, heat treated, and removed from the aluminum matrix.

After the tensile tests, the diameter at the fracture surface of each fiber was measured twice with a micrometer. The measurements were made perpendicular to each other to check for asymmetry in etching. The tensile failure stresses were calculated from the load and cross section at fracture. The accuracy of determining the load was 2 percent or better; for most determinations the accuracy was better than 1 percent. The error in determining the diameter was less than 2.0 percent.

RESULTS

Figure 3 shows the results for the three etchants used to remove approximately 13 micrometers (0.5 mil) from the surface of 203-micrometer- (7.98-mil-) diameter fibers. The fibers etched in the 20 percent $\text{KOH} + 20$ percent $\text{K}_3\text{Fe}(\text{CN})_6 + 60$ percent H_2O solution showed strengths significantly lower than those of fibers etched by the other two etchants. The fibers etched in either the FeCl_3 or the $2\text{HNO}_3 + 1\text{H}_2\text{O}$ solution had similar strengths. However, a black deposit of undetermined composition was found on

the fibers when the FeCl_3 solution was used. This deposit inhibited the etching. The addition of a small quantity of sodium chlorate (NaClO_3) kept the deposit from forming. Nevertheless, the time for removing a given amount of surface was still considerably greater than that needed when the nitric acid solution was used. Thus, the nitric acid solution was used to obtain the following results.

Plots of tensile strength against fiber diameter are shown in figures 4 to 6 for fibers whose as-received diameters were 203, 143, and 100 micrometers (7.98, 5.64, and 3.95 mils) and in figure 7 for fibers whose diameters after retrieval from an aluminum matrix were 203 micrometers (7.98 mils). Table I gives a summary of the data shown in figures 4 to 7. Figure 4 shows that strength increased with decreasing diameter for diameters down to 69 micrometers (2.7 mils). Also, the COV for any diameter between about 89 and 191 micrometers (3.35 and 7.5 mils) was less than the COV for the as-received 203-micrometer (7.98-mil) fibers (also see table I(a)). However, for diameters between 64 and 74 micrometers (2.5 and 2.9 mils), the data show two distinct groupings: 2.31 to 3.25 and 5.14 to 5.75 giganewtons per square meter (335 to 472 and 745 to 834 ksi).

For the fibers which were initially 143 micrometers (5.64 mils) in diameter, figure 5 also shows that strength increased with decreasing diameter. The narrowest range of tensile failure stresses ($\sigma_{\text{max}} - \sigma_{\text{min}}$) occurred for diameters between 102 and 114 micrometers (4.0 and 4.5 mils) with a COV of approximately 5 percent (see table I(b)). The maximum failure stress for these etched fibers was only 4.4 giganewtons per square meter (640 ksi) at a diameter of 76 micrometers (3.0 mils). However, the average tensile stress for these as-received fibers was only 2.88 giganewtons per square meter (418 ksi).

For fibers which were initially 100 micrometers (3.95 mils) in diameter, figure 6 shows no obvious decrease in the range of tensile strength even for a relatively narrow region of fiber diameters. In fact, there was some increase in COV at two sampled diameter intervals (see table I(c)). However, the average failure tensile stress did increase with decreasing diameter.

Figure 7 shows the effect of diameter reduction on the tensile strength of 203-micrometer- (7.98-mil-) diameter B/W fibers which were removed from an aluminum matrix with the H_2SO_4 solution. While the failure tensile stress increased with decreasing fiber diameter, the range in failure stresses also increased with decreasing fiber diameter. The average failure stresses of these fibers after etching were quite similar to the average failure stresses of the as-received 203-micrometer (7.98-mil) fibers after etching (compare tables I(d) and (a)).

Figure 8 shows the results for the heat-treated 203-micrometer- (7.98-mil-) diameter fibers. There was little or no change in their tensile strengths up to 673 K. From 873 to 1213 K their tensile strengths decreased. At 1213 K their tensile strengths were less than 0.69 giganewton per square meter (100 ksi), and there were crystallites on the

surfaces; at 1263 K there were more crystallites, and the specimens broke while being clamped into the second grip. At the last moment of the gripping action, there was a slight compressive movement along the axis of the specimen, which caused fracture to occur next to one of the grips. Therefore, the actual strength of these specimens could not be determined. The final diameters of the fibers which were heat treated at 1263 K showed increases of 13 micrometers (0.5 mil) due to crystallite growth. However, when the fibers which were heat treated at 673, 1213, and 1263 K had 20 to 38 micrometers (0.8 to 1.5 mils) of surface removed by etching, their resultant strengths either approached or equaled the strengths of the as-received 203-micrometer (7.98-mil) fibers which were etched to similar diameters, as shown in figure 9. These strength increases ranged from 3.45 to 4.83 giganewtons per square meter (500 to 700 ksi).

Included in figure 9 are some preliminary results for 203-micrometer (7.98-mil) fibers which were etched to 112 micrometers (4.4 mils) and then heat treated at 800 K in a vacuum of 0.53 micronewtons per square meter for 1.5 hours prior to tensile testing. Their strengths were somewhat similar to those of the etched fibers which were not heat treated.

The COV of tensile strength was calculated for the as-received and some of the heat-treated and etched fibers in order to compare our results with the published data from the manufacturer (ref. 3). The results are shown in table I.

Figures 10 and 11 show scanning electron microscope (SEM) micrographs of un-etched and etched surfaces, respectively. The etched surfaces appear smoother than the unetched. However, there are some irregularities on some of the etched surfaces which were independent of the final diameter. There are regions or islands of apparent roughness which stand out in relief like bark on a tree which has been mostly stripped.

No detailed flexural strength measurements were made. However, a few simple measurements revealed that the flexural strengths were also enhanced when the fibers were etched (this was first shown by Wawner (ref. 1)). The as-received strengths were approximately 4.83 giganewtons per square meter (700 ksi), and the etched strengths were between 10.5 and 13.0 giganewtons per square meter (1500 and 1900 ksi).

DISCUSSION

We have shown that the tensile strength of commercial B/W fibers increases as the surface of the fiber is removed by chemical etching. Also, the range in strength of the 203-micrometer (7.98-mil) fibers decreases by as much as 75 percent after etching.

Our explanation for the increase in the average strength with etching is based on the nonuniform residual stress pattern of these fibers (ref. 5 and unpublished data obtained from D. R. Behrendt of the Lewis Research Center). The outer boron layers and the tungsten boride core are in longitudinal and circumferential compression. And the boron

which is between the outer layers and the core is in longitudinal and circumferential tension (ref. 5 and data from D. R. Behrendt). In this report only the changes in the longitudinal stresses are discussed. The summation of the tensile and compressive stresses must always equal zero. In the as-received condition, the radius of the outer boundary of the tensile region is approximately 0.75 of the fiber radius. For example, for a 203-micrometer- (7.98-mil-) diameter fiber ($101.5 \mu\text{m}$ (3.99 mil) radius), the radius of the outer boundary of the tensile region is 76 micrometers (3 mils). However, as the outer compressive layers are etched away, the fiber contracts in order to keep the longitudinal stresses in equilibrium. This contraction alters the compressive and tensile stresses in such a way that the tensile region is not exposed until the fiber radius is approximately 25.4 micrometers (1.0 mil) or less (data from D. R. Behrendt). This indicates that part of the original tensile region goes into compression during the etching process. Also, the compressive stresses are increased in the remaining outer compressive layers and the tungsten boride core. Therefore, for all fractures originating in or near the core and in the bulk fiber, an additional tensile stress is needed to initiate failure. However, once the compressive layers are removed, additional surface removal no longer causes an increase in the compressive stresses at the core. Moreover, we would expect the compressive stresses at the core to decrease eventually as the tensile boron layers are etched away. This would result in an increase in fiber length (ref. 7) and a possible decrease in fracture stress.

A reduction in the total test volume of the boron, through etching, may also give some contribution to the increased tensile strength simply by eliminating some low-strength bulk fracture sites. A more thorough study of the fracture surfaces may give some indication of the fractures that may actually originate in the bulk boron.

The reduction in the range of strength values after etching may be explained by the elimination or minimization of the effects of as-received surface flaws. The appropriate chemical etch either blunts the flaw or removes sufficient surface around it to eliminate it. The elimination of the adverse effects of the surface flaws is apparently complete after approximately 13 micrometers (0.5 mil) of surface has been removed since additional etching does not reduce the strength range. The fibers etched from the as-received 203- and 143-micrometer (7.98- and 5.64-mil) fibers (figs. 4 and 5) show this effect. In figure 4 we can draw an envelope enclosing the extremal points for diameters between 86 and 188 micrometers (3.4 and 7.4 mils). We suggest that this envelope encloses most of the fractures which originate in or near the boride core. Extrapolation of this envelope to 203 micrometers (7.98 mils) encloses those fibers with initial strengths of 3.52 to 4.55 giganewtons per square meter (510 to 660 ksi). And we tentatively suggest that those fracture strengths for the as-received fibers which are somewhat below 3.52 giganewtons per square meter (510 ksi) are associated with surface flaws. If the low-strength fracture sites are distributed throughout the bulk and the core, we should see no decrease in the range of fracture strengths. However, this does

not appear to be the case for the fibers etched from the as-received 203- and 143-micrometer (7.98- and 5.64-mil) fibers (figs. 4 and 5). Also, in figure 4, an extension of the envelope down to 64 micrometers (2.5 mils) completely encloses one group of fractures between 5.1 and 5.75 giganewtons per square meter (740 and 834 ksi). We may assume that the surface which is being removed is from the compression layer; and the compression at the core and in the remaining outer boron layers continues to increase. However, the second group of fractures is between 2.31 and 3.25 giganewtons per square meter (335 and 472 ksi) and is below the envelope. This is taken to indicate a possible exposure of the tension region along some portion of the boron fiber. The tension region may be more susceptible to surface flaws caused by handling or to the creation of small voids when this region is exposed. Also, preferential etching could be caused by variation in surface energy, boron density, or atom configuration. (However, the preferential etching shown in fig. 10 is not necessarily associated with low-strength breaks. Also, the occurrence of the barklike structure is independent of fiber diameter.)

The reduction in the range of strength values over the limited diameter interval for fibers etched from 143-micrometer (5.64-mil) diameters (fig. 5) and the absence of any reduction in strength range for fibers etched from 100-micrometer (3.95-mil) diameters (fig. 6) may be due to the small starting diameters. That is, when approximately 13 micrometers (0.5 mil) of surface is removed from these fibers, exposure of the tension region is approached. Also, the additional boron needed to form the 203-micrometer- (7.98-mil-) diameter fibers may affect the type of flaws and the flaw distribution throughout the bulk. The flaws may or may not be aggravated by possibly complex internal stresses (data from Val Krukonis), which are different for fibers of different diameters at a given radius. The use of augmented vhf heating for the 203-micrometer (7.98-mil) fibers may have some effect on the bulk flaws since it does alter the temperature profile in the reactor (data from Val Krukonis).

The changes in strength characteristics of the fibers removed from the aluminum matrix are quite similar to those of the as-received 203-micrometer (7.98-mil) fibers after both sets have been etched. However, unknown influences of the composite fabrication processes and the fiber retrieval technique may prevent detailed comparisons of the range of strengths for the various diameters. The temperature, pressure, possible use of binders, type of atmosphere, boron-aluminum interactions, and fabrication time may have some effect on surface and/or internal flaws. Our work has shown that the matrix solvent used for fiber retrieval affects the fiber strength: the NaOH solution produces a weaker fiber than the H₂SO₄ solution. Adverse preferential etching could result from somewhat varied surface conditions (boron and some aluminum borides). Any one or any combination of these effects may help produce an increase in the range of strength values.

The most dramatic changes in strength are realized when we consider the results

for fibers heat treated at 1213 and 1263 K in a vacuum and then etched in the $2\text{HNO}_3 + \text{H}_2\text{O}$ solution. We suggest that severe surface flaws form in the vicinity of the crystallites found on the surfaces of these fibers. The severity of the flaws would depend on the temperature and time in a given environment (type of atmosphere and pressure, including vacuum). However, after these degraded fibers are etched, the large increases in strength (fig. 9) show that the interior bulk boron may still have high strength even though the unetched fibers are practically useless. These results help demonstrate the importance of eliminating or minimizing surface flaws.

The heat-treatment results for the unetched and etched fibers in figures 8 and 9, respectively, show that heat treatment by itself will not degrade fiber strength for temperatures ≤ 800 K and for times ≤ 1.5 hours. This is important when considering the strength retention of the etched fibers during composite fabrication. In fact, some of the highest strengths are found for fibers which were etched and then heat treated (fig. 9, open circles). The three solid circles are for fractures of fibers from the same etched group, but they were not heat treated. Two of these circles indicate that this etched group had rather high fracture strengths. Also, these results point up the need for additional work in the area of etching and heat treating B/W fibers.

We assume that the area under the stress-strain curve is a direct measure of the amount of energy that may be absorbed by the material because of impact. Then if the fracture stress of an elastic material is increased by 50 percent and the modulus remains constant, the energy that may be absorbed because of impact is more than doubled. In this investigation, the etched and unetched boron fibers, whose diameters were approximately equal, have essentially the same slope for their load-elongation curves. Therefore, from the data in table I, the fibers etched to approximately 140 micrometers (5.5 mils) (table I(a)) should be able to absorb twice as much energy due to impact as the as-received 143-micrometer (5.64-mil) fibers (table I(b)). (The strength of the fibers etched to 140 micrometers (5.4 mils) is more than 50 percent greater than the strength of our as-received 143-micrometer (5.64-mil) fibers and is almost 50 percent greater than the manufacturer's quoted strength for the as-received fibers.)

CONCLUDING REMARKS

We feel that the primary result of this work shows that B/W fibers with diameters ≤ 165 micrometers (6.5 mils), an average tensile strength ≥ 4.83 giganewtons per square meter (700 ksi), and a COV ≤ 5 percent can be fabricated from 203-micrometer- (7.98-mil-) diameter fibers. (Higher average tensile strengths may be obtained by etching to smaller diameters.) This result is dependent upon taking advantage of the changes in the internal stresses caused by surface removal. Higher tensile strengths may be possible

if well made B/W fibers with initial diameters >203 micrometers (7.98 mils) are used as the starting material.

The decreased fiber strength caused by heat treating to temperatures between 873 and 1263 K in a vacuum is primarily associated with surface flaws. When heat-treated fibers were etched, they attained strengths which approached or equaled the strengths of as-received etched fibers.

Any loss of fiber strength in the composite seems to be due to boron interaction with the aluminum matrix and/or physical damage during the composite fabrication process. Fibers that remained intact after retrieval from the aluminum matrix had tensile strengths somewhat similar to those of the as-received fibers, for both the etched and unetched conditions.

It will be of interest to determine if the apparently enhanced tensile and flexural properties can be maintained to some degree in a metal or in a resin-matrix composite. For metal-matrix composites, it may be of value to investigate the combination of fiber etching with a final surface treatment such as nitriding. The nitrided surface may stop or limit any surface degradation due to a boron-aluminum interaction. Commercially produced boron fibers have registered an increase in strength after nitriding (data from Val Krukonis).

If the increases in strength shown in this work can be maintained in a metal matrix and/or resin matrix (with or without nitriding), additional applications of these composites may be possible. Also, if the etched fiber does indeed prove to have a higher impact strength than the as-received fiber, a composite of etched fibers would truly be a major improvement over the presently available composites.

Lewis Research Center,
National Aeronautics and Space Administration,
Cleveland, Ohio, March 4, 1976,
506-16.

REFERENCES

1. Wawner, F. E., Jr.: The Effect of Chemical Polishing on the Strength and Fracture Characteristics of Amorphous Boron Filaments. Boron. Volume 2 - Preparation, Properties, and Applications. G. K. Gaule, ed., Plenum Press, 1965, pp. 283-300.
2. (Advertisement) Boron Reinforced Materials. BP-1-874-5M, AVCO Systems Div.

3. Wawner, Franklin E., Jr.; and Satterfield, Dana B.: Observations on the Tensile Strength of "Amorphous" Boron. *App. Phys. Let.*, vol. 11, no. 6, Sept. 15, 1967, pp. 192-194.
4. Jacob, B. A.; Douglas, F. C.; and Galasso, F. S.: High Strength and Large Diameter Boron Fibers. *Amer. Cer. Soc. Bul.*, vol. 52, no. 12, Dec. 1973, pp. 896-897.
5. Line, L. E., Jr.; and Henderson, V. V., Jr.: Boron Filament and Other Reinforcements Produced by Chemical Vapor Plating. *Handbook of Fibreglass and Advanced Plastics Composites*. Polymer Tech. Ser. Soc. Plas. Engr. Inc., 1963, pp. 201-235.

TABLE I. - TENSILE STRENGTH AND COEFFICIENT OF VARIATION
FOR BORON-TUNGSTEN FIBERS

(a) Fiber diameter before etching, 203 micrometers (7.98 mils)

Fiber diameter after etching		Tensile failure stress, σ^a						Coefficient of variation, percent ^b
		GN/m ²			ksi			
μm	mils	σ_{av}	σ_{min}	σ_{max}	σ_{av}	σ_{min}	σ_{max}	
^c 203	^c 8.0	3.59	2.01	4.56	521	292	661	23.5
^d 203	^d 8.0	3.45	2.08	4.46	500	302	647	20.0
160-168	6.3-6.6	4.92	4.72	5.03	714	684	730	1.7
137-140	5.4-5.5	5.03	4.76	5.27	730	690	764	3.1
109-119	4.3-4.7	5.23	4.70	5.53	758	681	802	4.9
86-94	3.4-3.7	5.30	4.78	5.66	768	694	821	4.4

(b) Fiber diameter before etching, 143 micrometers (5.64 mils)

^c 143	^c 564	2.88	1.88	3.55	418	273	515	13.5
122-127	4.8-5.0	3.36	2.96	4.01	488	403	581	10.63
111-114	4.35-4.5	3.57	3.38	3.94	518	490	572	4.9
102-109	4.0-4.3	3.54	3.14	3.86	514	455	560	5.5

(c) Fiber diameter before etching, 100 micrometers (3.95 mils)

^c 100	^c 3.95	3.31	2.74	3.95	481	398	573	9.4
84-86	3.3-3.4	3.67	2.65	4.43	532	385	643	13.12
74-79	2.9-3.1	4.26	1.92	5.01	618	278	727	17.5
67-71	2.65-2.8	4.63	3.60	5.32	680	552	771	9.45

(d) Fiber diameter before etching, 203 micrometers (7.98 mils); fibers retrieved from an aluminum matrix

^c 203	^c 8.0	3.3	2.81	3.76	479	408	545	-----
147-183	5.8-7.2	4.67	3.74	5.1	678	543	739	-----
114-132	4.5-5.2	5.12	3.96	5.72	742	575	829	-----
76-102	3.0-4.0	5.3	3.79	5.96	770	550	865	-----

^aManufacturer's values for σ_{av} , σ_{min} , and σ_{max} , 3.57, 2.41, and 4.34 GN/m² (518, 350, and 630 ksi).

^bManufacturer's value, 15.

^cAs-received.

^dHeat treated at 640 K prior to tensile tests.

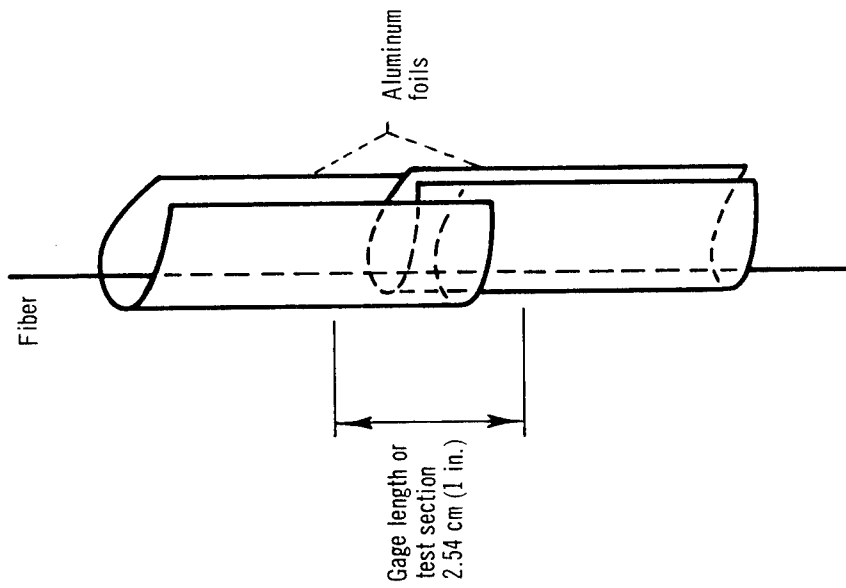

Figure 2. - Method for enclosing B/W fibers in aluminum foil in preparation for tensile tests.

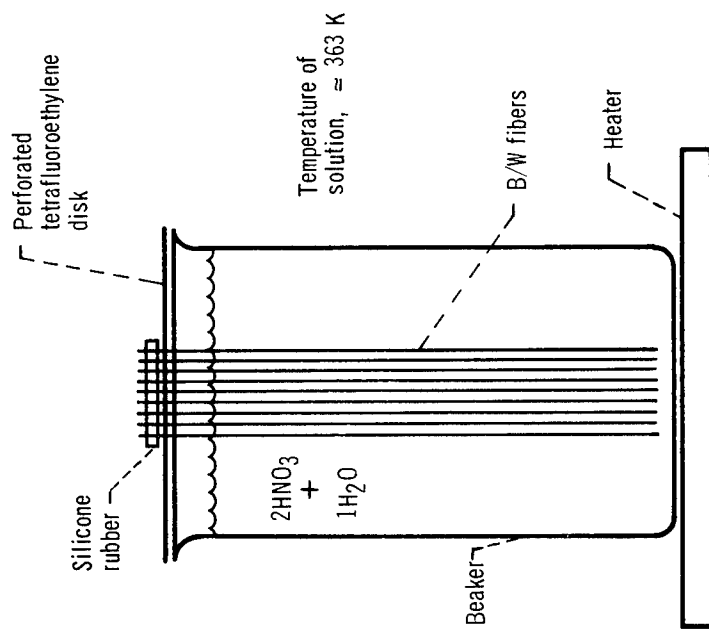

Figure 1. - Schematic of apparatus used for etching B/W fibers.

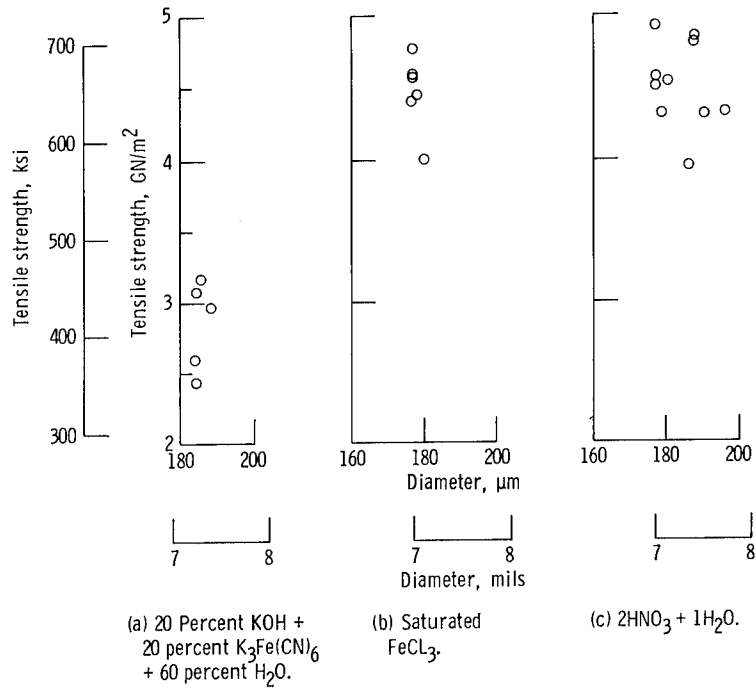

Figure 3. - Tensile strength for limited diameter range and three etchants.

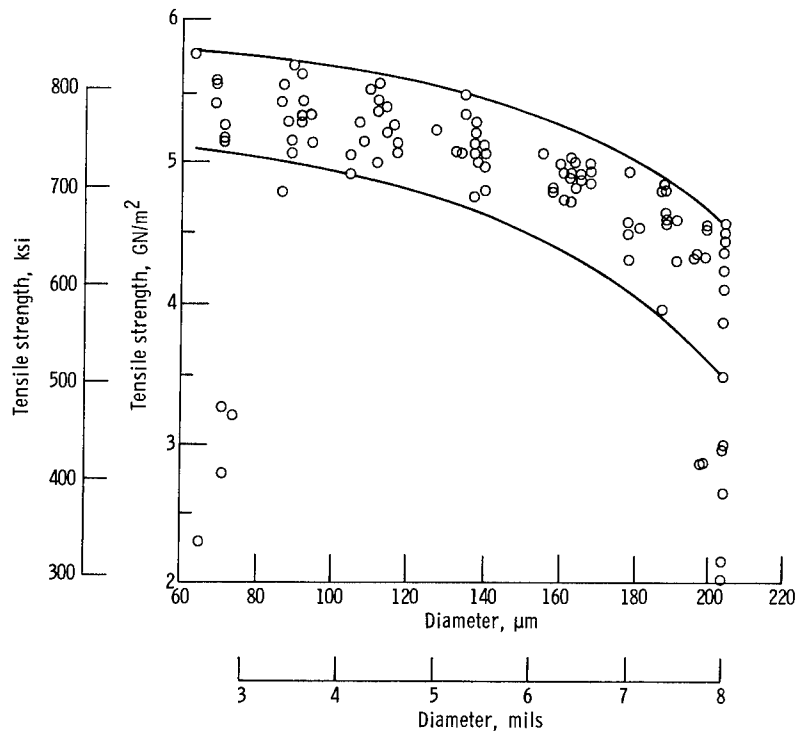

Figure 4. - Tensile strength as function of B/W fiber diameter after etching in hot $2HNO_3 + 1H_2O$. As-received diameter, 203 micrometers (7.98 mils).

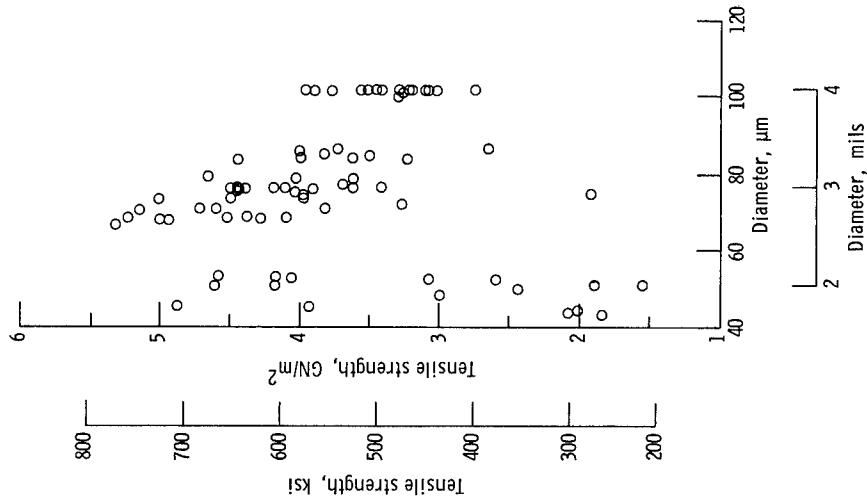

Figure 5. - Tensile strength as function of B/W fiber diameter after etching in hot 2HNO₃ + 1H₂O. As-received diameter, 143 micrometers (5.64 mils).

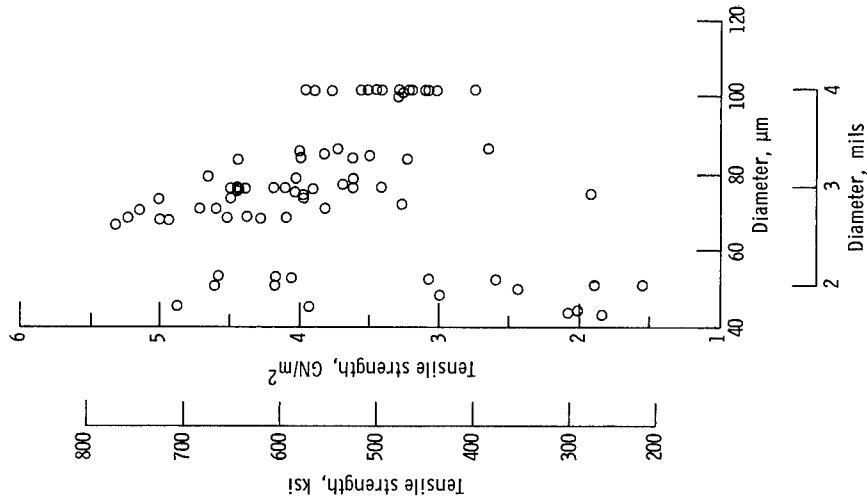

Figure 6. - Tensile strength as function of B/W fiber diameter after etching in hot 2HNO₃ + 1H₂O. As-received diameter, 100 micrometers (3.95 mils).

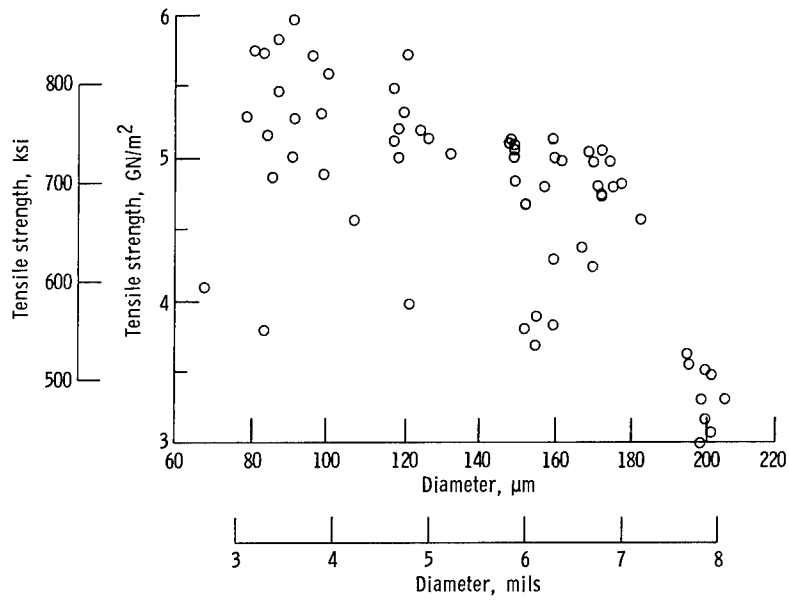

Figure 7. - Tensile strength as function of B/W fiber diameter after retrieval from aluminum matrix and etching in hot $2\text{HNO}_3 + 1\text{H}_2\text{O}$. Diameter prior to etching, 203 micrometers (7.98 mils).

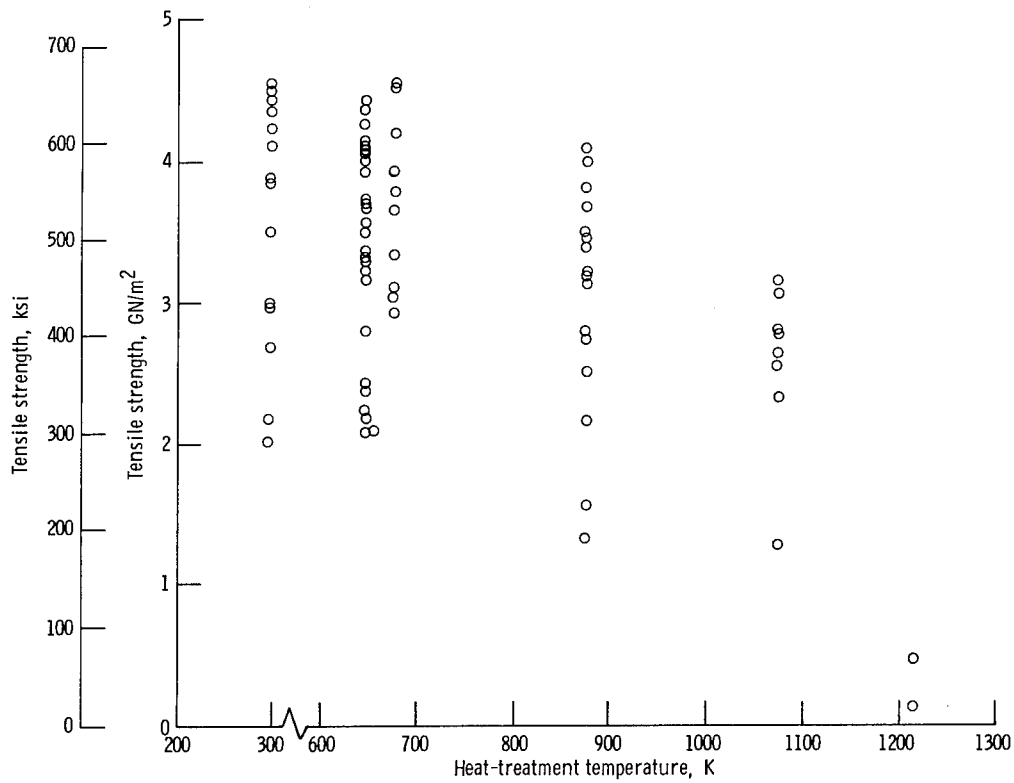

Figure 8. - Tensile strength of B/W fibers at 295 K as function of heat-treatment temperature. Heat treatment in vacuum of $\approx 10^{-6}$ newton per square meter for 1.5 hours; fiber diameter, 203 micrometers (7.98 mils).

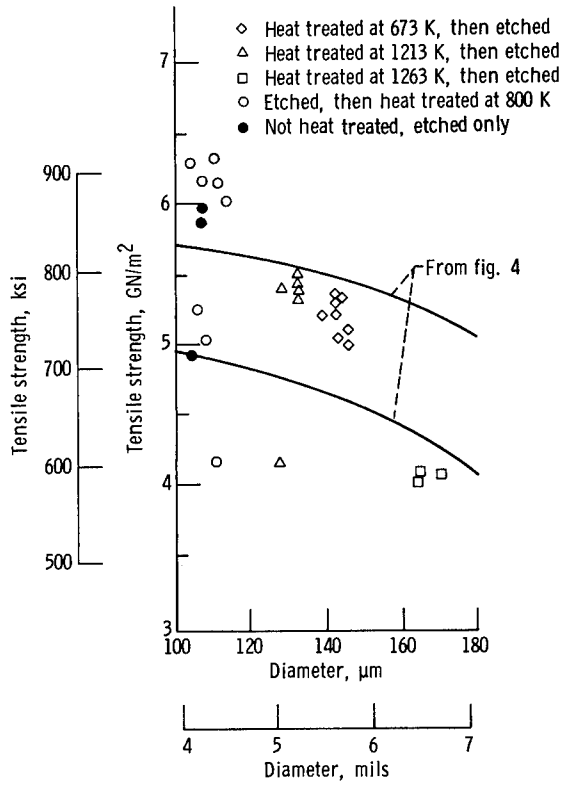

Figure 9. - Tensile strength as function of B/W fiber diameter after various heat treatments and etching in hot $2\text{HNO}_3 + 1\text{H}_2\text{O}$. As-received diameter, 203 micrometers (7.98 mils).

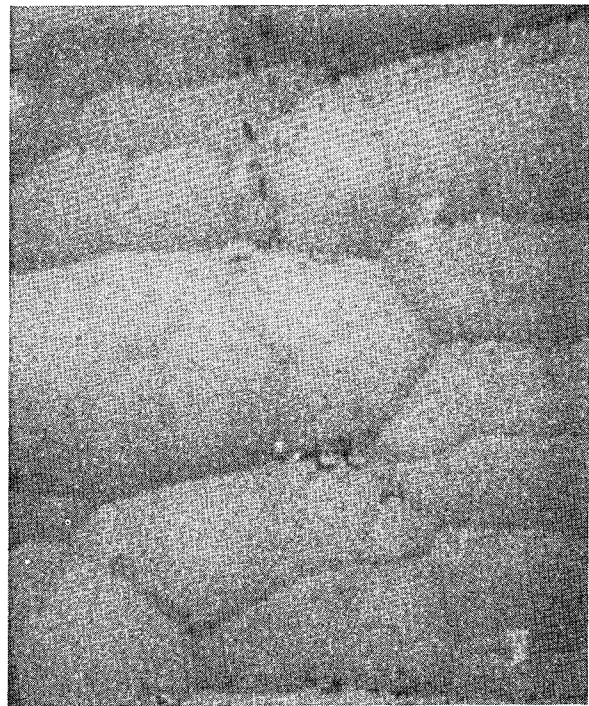
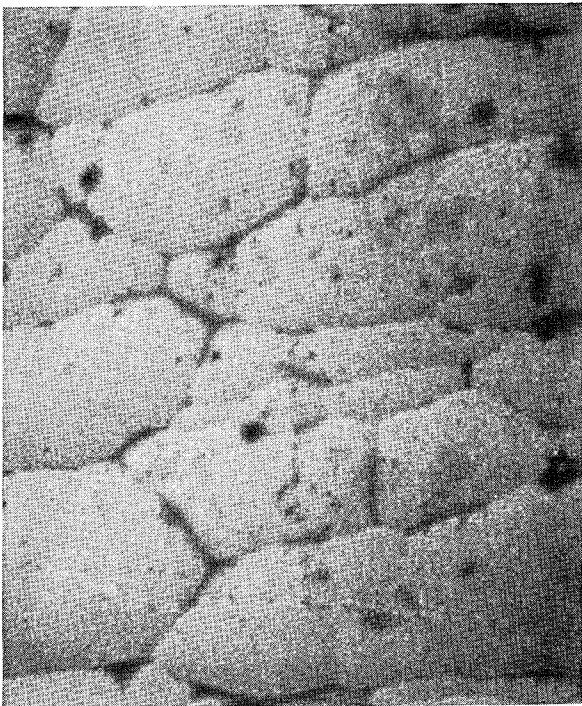

Figure 10. - SEM micrographs of surfaces of unetched B/W fibers. Diameter, 203 micrometers (7.98 mils). X3000.



(a) Diameter, 178 micrometers (7 mils).



(b) Diameter, 162 micrometers (6.4 mils).

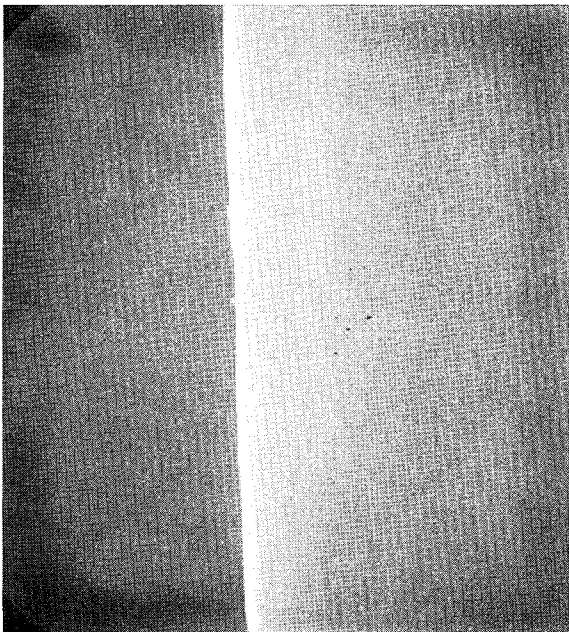

(c) Diameter, 46 micrometers (1.8 mils).

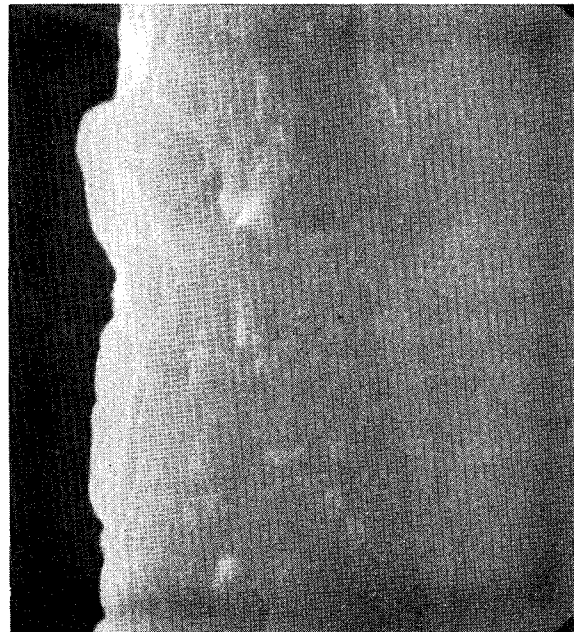

(d) Diameter, approximately 75 micrometers (3 mils); barklike effect is independent of diameter.

Figure 11. - SEM micrographs of surfaces of etched B/W fibers. As-received diameter, 203 micrometers (7.98 mils); etchant, hot $2\text{HNO}_3 + 1\text{H}_2\text{O}$. Surface becomes progressively smoother as diameter is reduced. X3000.

NATIONAL AERONAUTICS AND SPACE ADMINISTRATION
WASHINGTON, D.C. 20546

OFFICIAL BUSINESS
PENALTY FOR PRIVATE USE \$300

SPECIAL FOURTH-CLASS RATE
BOOK

POSTAGE AND FEES PAID
NATIONAL AERONAUTICS AND
SPACE ADMINISTRATION
451



474 001 C1 U C 760416 S00942DS
DEPT OF THE ARMY
PICATINNY ARSENAL, BLDG 176 3781
PLASTICS TECHNICAL EVALUATION CENTER
ATTN: A M ANZALONE, SARPA-FR-M-D
DOVER NJ 07801

POSTMASTER: If Undeliverable (Section 158
Postal Manual) Do Not Return

"The aeronautical and space activities of the United States shall be conducted so as to contribute . . . to the expansion of human knowledge of phenomena in the atmosphere and space. The Administration shall provide for the widest practicable and appropriate dissemination of information concerning its activities and the results thereof."

—NATIONAL AERONAUTICS AND SPACE ACT OF 1958

NASA SCIENTIFIC AND TECHNICAL PUBLICATIONS

TECHNICAL REPORTS: Scientific and technical information considered important, complete, and a lasting contribution to existing knowledge.

TECHNICAL NOTES: Information less broad in scope but nevertheless of importance as a contribution to existing knowledge.

TECHNICAL MEMORANDUMS: Information receiving limited distribution because of preliminary data, security classification, or other reasons. Also includes conference proceedings with either limited or unlimited distribution.

CONTRACTOR REPORTS: Scientific and technical information generated under a NASA contract or grant and considered an important contribution to existing knowledge.

TECHNICAL TRANSLATIONS: Information published in a foreign language considered to merit NASA distribution in English.

SPECIAL PUBLICATIONS: Information derived from or of value to NASA activities. Publications include final reports of major projects, monographs, data compilations, handbooks, sourcebooks, and special bibliographies.

TECHNOLOGY UTILIZATION PUBLICATIONS: Information on technology used by NASA that may be of particular interest in commercial and other non-aerospace applications. Publications include Tech Briefs, Technology Utilization Reports and Technology Surveys.

Details on the availability of these publications may be obtained from:

SCIENTIFIC AND TECHNICAL INFORMATION OFFICE

NATIONAL AERONAUTICS AND SPACE ADMINISTRATION

Washington, D.C. 20546