

NASA TECHNICAL NOTE

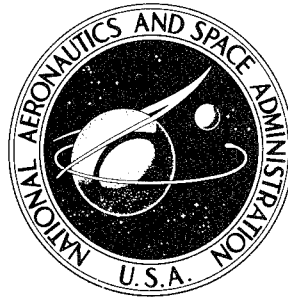

NASA TN D-5354

NASA TN D-5354

Approved for public release  
Distribution Unlimited

TENSILE AND CYCLIC FATIGUE  
PROPERTIES OF GRAPHITE  
FILAMENT-WOUND PRESSURE  
VESSELS AT AMBIENT AND  
CRYOGENIC TEMPERATURES

19960326 113

by *Morgan P. Hanson*  
*Lewis Research Center*  
*Cleveland, Ohio*

DEPARTMENT OF DEFENSE  
PLASTICS TECHNICAL EVALUATION CENTER  
PICATINNY ARSENAL, DOVER, N. J.

NATIONAL AERONAUTICS AND SPACE ADMINISTRATION • WASHINGTON, D. C. • JULY 1969

PLASTER / 12/23/77

NASA TN D-5354

TENSILE AND CYCLIC FATIGUE PROPERTIES OF GRAPHITE  
FILAMENT-WOUND PRESSURE VESSELS AT AMBIENT  
AND CRYOGENIC TEMPERATURES

By Morgan P. Hanson

Lewis Research Center  
Cleveland, Ohio

NATIONAL AERONAUTICS AND SPACE ADMINISTRATION

---

For sale by the Clearinghouse for Federal Scientific and Technical Information  
Springfield, Virginia 22151 - CFSTI price \$3.00

## ABSTRACT

Graphite fibers were fabricated into NOL rings and biaxial-wound cylinders. Filament tensile strengths of NOL rings were determined at 75<sup>o</sup>, -320<sup>o</sup>, and -423<sup>o</sup> F (297, 77, and 20 K). Comparisons were made of ambient-temperature fiber tensile strengths as obtained from NOL rings, strand tests, and biaxially wound cylinders. Fatigue characteristics of internally pressurized cylinders were determined at 75<sup>o</sup> and -320<sup>o</sup> F (297 and 77 K). Fatigue comparisons are made of graphite and glass-filament wound cylinders on the basis of specific strength.

# TENSILE AND CYCLIC FATIGUE PROPERTIES OF GRAPHITE FILAMENT-WOUND PRESSURE VESSELS AT AMBIENT AND CRYOGENIC TEMPERATURES

by Morgan P. Hanson

Lewis Research Center

## SUMMARY

< An experimental investigation was conducted to determine the tensile and fatigue properties of graphite-reinforced epoxy composites. Thornel-50 was used as the graphite-filament reinforcement. The graphite fibers were fabricated into Naval Ordnance Laboratory (NOL) rings and biaxial-wound cylinders. Filament tensile strengths of NOL rings were determined at 75<sup>o</sup>, -320<sup>o</sup>, and -423<sup>o</sup> F (297, 77, and 20 K). Comparisons were made of ambient-temperature fiber tensile strengths as obtained from NOL rings, strand tests, and biaxially wound cylinders. Fatigue characteristics of internally pressurized cylinders were determined at 75<sup>o</sup> and -320<sup>o</sup> F (297 and 77 K). Fatigue comparisons are made of graphite and glass filament-wound cylinders on the basis of specific strength. >

## INTRODUCTION

Graphite fibers having high specific-strength and modulus properties are of particular interest in aerospace applications. The use of graphite fibers in an epoxy matrix as a structural material has been demonstrated (refs. 1 and 2). As a structural material in filament-wound pressure vessels, graphite fibers should provide a solution to problems that are inherent to low-modulus reinforcements such as glass fibers. In high performance glass filament-wound pressure vessels, buckling and fatigue of metallic liners occur because of large plastic strains (2 to 3 percent) (ref. 3).

In a practical application, pressure vessels are subjected to long-term pressurization and periodic pressure cycling. Under these conditions at ambient temperature, the use of glass filament-wound pressure vessels has been found to be restricted because of the combined effects of low static fatigue and cyclic fatigue properties (refs. 4 and 5). Results in reference 6 show that the fatigue life of unidirectionally stressed graphite-

epoxy composites at ambient temperature is superior to that of glass fibers. In bi-axially stressed pressure vessels similar results may be expected. At cryogenic temperatures information on the static and cyclic fatigue behavior of filament-wound pressure vessels is limited. A review on the subject in reference 7 indicates that fatigue life of glass-filament composites may not be limited at cryogenic temperatures. However, from a practical consideration, good fatigue properties at ambient temperature would be required from the standpoint of reliability.

An investigation of the cyclic behavior of filament-wound graphite-reinforced cylinders was conducted at the NASA Lewis Research Center. Cylinders of Thornel-50 were pressure cycled at ambient temperature (75° F or 297 K) and in liquid nitrogen (-320° F or 77 K). The tensile strength of Thornel-50 was determined by means of NOL ring and strand tests. NOL rings were tested at 75°, -320°, and -423° F (297, 77, and 20 K). Strand tests were performed at ambient temperature.

## MATERIALS

The materials and specimens evaluated are listed in the following table:

Reinforcement	Test	Specimen	Resin system	Curing schedule
<sup>a</sup> Thornel 50 (PVA coated)	Tensile	NOL ring	ERL2256 ZZL0820 <sup>b</sup>	2 hr at 180° F (355 K) and 3 hr at 300° F (422 K)
	Tensile	Strand	↓	↓
	Cyclic	<sup>c</sup> Cylinder	↓	↓

<sup>a</sup>Carbon Products Division, Union Carbide Corp.

<sup>b</sup>Union Carbide epoxy resin, Union Carbide Corp.

<sup>c</sup>Cylinder liner to reinforcement adhesive -G207, Goodyear Aerospace Corp.

The graphite filaments (Thornel 50) were supplied in a two-ply yarn with a polyvinyl alcohol (PVA) coating. The yarn was fabricated into specimens in the as-received condition. The epoxy resin (ERL 2256/ZZL0820) used is a commercial formulation for use in filament winding.

## APPARATUS AND PROCEDURE

### Tensile Tests

NOL rings. - Naval Ordnance Laboratory (NOL) rings of two-ply graphite yarn were wet wound under 0.5-pound (2.22-N) tension with 100 turns per ring. The rings were then cured according to the schedule in the previous section. No surface machining was performed on the rings. Tensile strength tests were made at ambient and cryogenic temperatures using split disk fixtures. The cryogenic temperatures were established by submersion of specimens in liquid nitrogen ( $-320^{\circ}\text{F}$  or  $77\text{ K}$ ) or liquid hydrogen ( $-423^{\circ}\text{F}$  or  $20\text{ K}$ ) in special cryostats mounted in a universal tensile machine. The load was applied at crosshead rate of 0.1 inch (2.5 mm) per minute. The filament tensile strength of the composite was based on the load per unit area of the two-ply yarn. The fiber cross-sectional area was determined by dividing the average weight of a unit length of yarn by the density of the Thorne1-50 graphite ( $0.059\text{ lbm/in.}^3$  or  $1.63\text{ g/cm}^3$ ). An average 68-percent fiber volume was determined for the NOL rings. The burnout method used is described in reference 1.

Strand tests. - Individual strands of two-ply yarn were impregnated with resin and cured. Lengths of the impregnated yarn were placed in grooved metal end tabs, alined, and attached with an epoxy adhesive. The gage length was 2 inches (50.8 mm). The strands were tested in a universal tensile machine at a crosshead travel rate of 0.05 inch (1.27 mm) per minute. The filament tensile strength of the composite was determined using the method described in the previous section.

### Cyclic Tests of Filament-Wound Cylinders

The cylinders used for cyclic tests were right circular cylinders, 7.5 inches (19.1 cm) in diameter by 20 inches (50.8 cm) long. The cylinders were lined with 3-mil (0.076-mm) 1100-0 aluminum foil with a 0.25-inch (6.35-mm) adhesive-bonded lap seam. A polyester resin (G207) was used as the adhesive in the seam and between the liner and the adjacent hoop windings. The ratio of the hoop to longitudinal windings was 2 to 1 with an arrangement of inner and outer hoop windings and a single longitudinal layer in between. Both the hoop and longitudinal windings of two-ply yarn were spaced at 52 turns per inch (20.5 turns per centimeter). Resin was brushed on during winding.

The cylinders were fabricated on mandrels of thick-wall aluminum tubing. A slight diametral taper was provided to facilitate removal of the finished cylinder from the

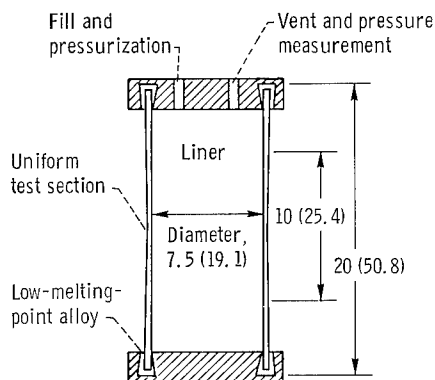

Figure 1. - Schematic diagram of biaxial cylinder with removable end caps used for cyclic tests. (Dimensions are in inches (cm).)

mandrel. Complete details of liner assembly and general construction are presented in reference 3.

The type of caps used for closing the ends of the cylinders is shown in figure 1. This method was also used and described in reference 3. A low-melting-point alloy filled the groove, effectively locking and sealing the end caps to allow pressurization. At ambient temperature, the cylinders were pressurized with oil and cycled at a rate of about 2 cycles per minute. In liquid nitrogen testing, both inner and outer surfaces of the cylinders were exposed to the cryogen. A liquid-nitrogen pump was used for pressurization. The cyclic rate was about 3 cycles per minute. In both the ambient and cryogenic cyclic testing, the pressure ranged from a low of about 50 psi ( $34.5 \text{ N/cm}^2$ ) to a maximum depending on the percent of predicted burst pressure required for the particular test. Maximum pressures ranged from 350 to 400 psi ( $241$  to  $276 \text{ N/cm}^2$ ).

Hoop and longitudinal strains were measured by means of electric resistance strain gages mounted on the cylinder surface and also by means of deflection transducers. The strain gages were of Nichrome V alloy and were used at both ambient and liquid-nitrogen temperatures. The adhesively bonded strain gage was used for precise strain measurement in the initial cycles. Under cyclic loading, the bonded strain-gage life was unpredictable. Therefore, the deflection transducers were used for continuous strain observations. The hoop strain was sensed by means of a 10-mil (0.25-mm) wire circumscribing the cylinder at the midpoint of the test section. The longitudinal strain was measured similarly between clips adhesively bonded to the cylinder wall. An installation is shown in figure 2.

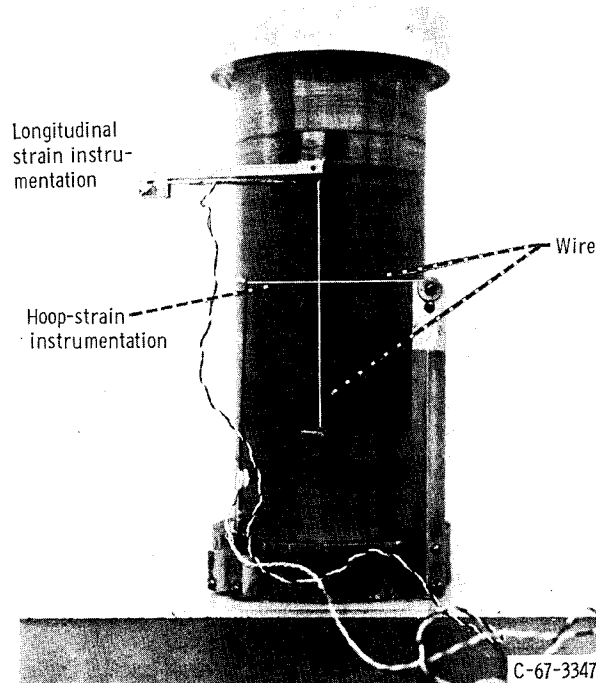

Figure 2. - Test cylinder with instrumentation for measuring longitudinal and hoop strains.

The filament stress of the composite was determined from the internal pressure, cylinder dimensions, and the cross-sectional area of the two-ply yarn. No fiber volume was determined for the cylinders; however, it is believed to be lower than that of the NOL rings because of the yarn spacing between hoop and longitudinal windings.

## RESULTS AND DISCUSSION

### Strength Characteristics of Graphite Filaments

Figure 3 shows the average filament tensile strength of composites of NOL rings as a function of temperature. The number of specimens tested at each temperature are indicated. Also shown is the range of the test data. No significant change in average strength is noted for the Thornel-50 throughout the temperature range investigated. A similar trend was noted for Thornel-25 in reference 3.

Table I lists composite filament tensile strength results of fiber, strand, NOL ring, and cylinder tests at ambient temperature. Single-fiber tensile strength of 293 000 psi ( $202\,000\text{ N/cm}^2$ ) agreed favorably with the strand tensile strength of 290 000 psi ( $200\,000\text{ N/cm}^2$ ). The filament strength of NOL rings was 229 000 psi ( $158\,000\text{ N/cm}^2$ ) and of cylinders was 219 000 psi ( $151\,000\text{ N/cm}^2$ ). The lower filament strength of rings

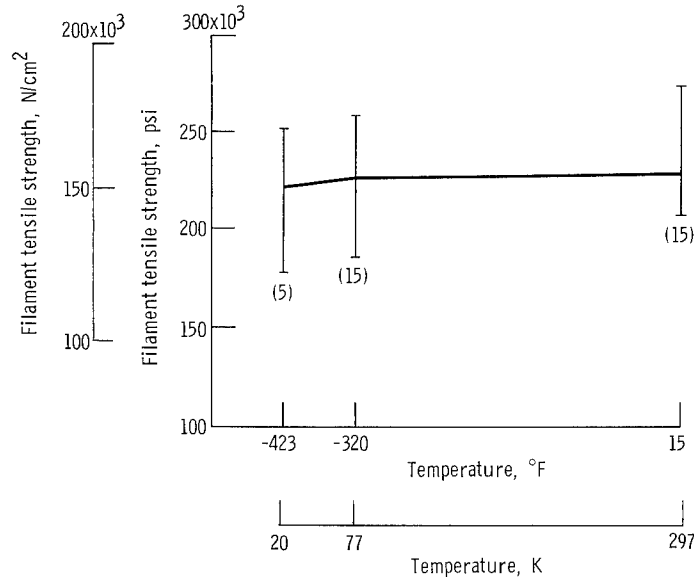

Figure 3. - Filament strength of graphite NOL rings as a function of temperature. Numbers in parentheses indicate the number of tests for each temperature.

TABLE I. - AMBIENT TEMPERATURE FILAMENT STRENGTH OF THORNEL-50 AS DETERMINED BY DIFFERENT TEST METHODS

Test	Tensile strength					
	Average		Maximum		Minimum	
	psi	N/cm <sup>2</sup>	psi	N/cm <sup>2</sup>	psi	N/cm <sup>2</sup>
<sup>a</sup> Fiber	293 × 10 <sup>3</sup>	202 × 10 <sup>3</sup>	327 × 10 <sup>3</sup>	226 × 10 <sup>3</sup>	225 × 10 <sup>3</sup>	155 × 10 <sup>3</sup>
<sup>b</sup> Strand	290	200	316	218	244	168
<sup>b</sup> NOL ring	229	158	274	189	207	143
<sup>b, c</sup> Cylinder	219	151	233	161	204	141

<sup>a</sup>Determined by the manufacturer on single fiber.

<sup>b</sup>Impregnated with epoxy resin and cured.

<sup>c</sup>Burst tests at -320<sup>o</sup> F (77 K) resulted in average tensile stress of 218 000 psi (150 000 N/cm<sup>2</sup>).

and cylinders possibly reflects the greater frequency of voids, flaws, and influence of low shear transfer between plies of yarn when the material is essentially in laminated form. Nevertheless, the filament translation efficiency of 77 percent is higher than that generally found in glass composites (for S/901 glass, 69 percent and for E glass, 61 percent (ref. 3)). NOL rings of Thornel-25 in reference 3 gave an average translation efficiency of 67 percent. Some of the scatter in strength data of the Thornel-50 investigated can be attributed to the variation in material properties from seven different spools.

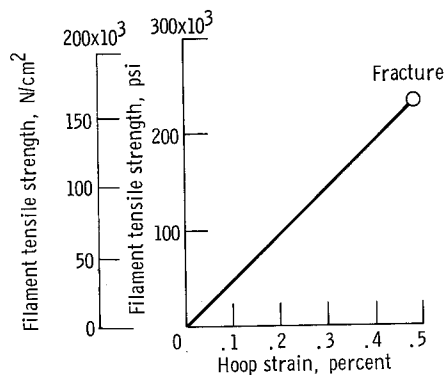

Figure 4. - Stress-strain diagram for single-cycle test of Thornel-50 epoxy resin cylinder. Filament tensile modulus,  $48.8 \times 10^6$  psi ( $33.5 \times 10^6$  N/cm<sup>2</sup>).

Figure 4 shows a typical filament stress-strain diagram of the hoop windings of a cylinder at ambient temperature. It is seen that the relation is linear up to a fracture strain of 0.48 percent. The filament tensile modulus was determined to be  $48.8 \times 10^6$  psi ( $33.5 \times 10^6$  N/cm<sup>2</sup>) which is in good agreement with the nominal modulus of Thornel-50. No significant change in tensile modulus was found at liquid-nitrogen temperature. All tensile moduli measurements were within manufacturing tolerance of the material.

## Cyclic Characteristics of Graphite-Filament Wound Cylinders

Cyclic fatigue degradation has been of concern in filament-wound pressure vessels. This has been particularly true of glass-filament-wound pressure vessels (ref. 4). The failure mechanism in cyclic loading of these vessels, however, may not be limited only to the accumulated number of cycles. The degradation effect of water vapor on glass has been shown to influence fatigue characteristics; in reference 7 it was pointed out that time under load may be the predominate cause of the failure of glass filaments. However, a normalization of the static and cyclic data in reference 7 indicate that combined effects of static and cyclic fatigue are responsible for the failure mechanism. In the present in-

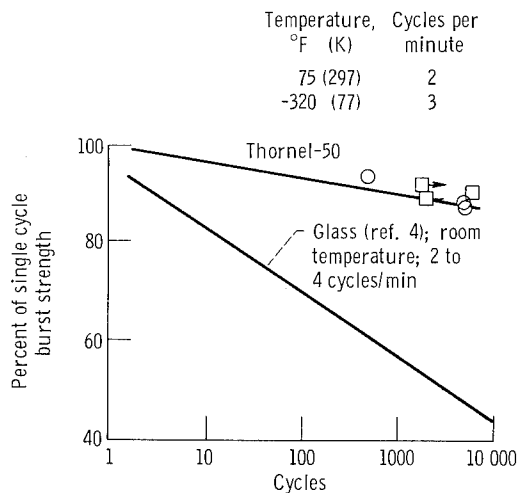

Figure 5. - Comparison of cyclic fatigue of glass and graphite filament-wound cylinders.

investigation, failure of the graphite cylinders is presented only on the basis of the number of cycles to failure. The mechanisms that influence fatigue in glass filaments may not be those operative in graphite. In reference 6 it was reported that prolonged water boil of Thornel-25 and Thornel-40 epoxy-resin composites did not result in substantial decrease in flexural properties.

In figure 5, cyclic fatigue is presented for Thornel-50 graphite filament-wound cylinders as a percent of the single-cycle burst strength. Data are shown at 75° F (297 K) and at -320° F (77 K). It is seen that fatigue life at -320° F (77 K) was similar to that at 75° F (297 K). Also shown is a comparison of the 75° F (297 K) fatigue life of glass-filament-wound pressure vessels from reference 4. Direct comparison of fatigue life appears to be reasonable since tests were performed at essentially the same cyclic rates (2 to 4 cycles per minute). The results are in good agreement to the superior uniaxial fatigue properties of graphite compared with those of glass as reported in reference 6.

The performance of the liner was relevant to the overall performance of the graphite-filament-wound cylinder. Visual examination of the 3-mil (0.076-mm) aluminum liners after cyclic failure showed no evidence of buckling even though the aluminum was strained plastically (about 0.4 percent under cyclic load). No termination of a cyclic test resulted from liner failure. Termination of cyclic tests was the result of failure of the hoop filaments. Some tests were discontinued because of time limitations.

Because of the inherent high strength of glass filaments, it is of interest to compare the ambient temperature fatigue characteristics of glass and graphite-filament-wound

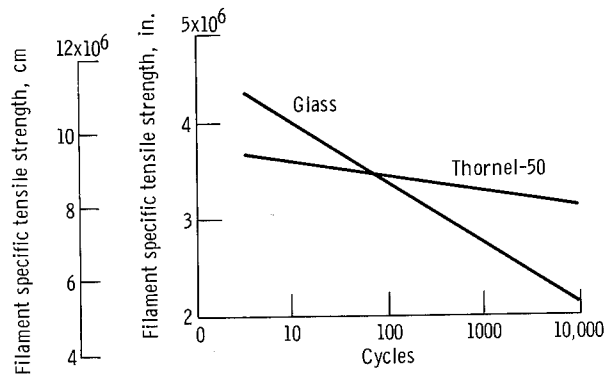

Figure 6. - Comparison of glass and graphite filament cylinder fatigue life on basis of specific strength.

vessels on the basis of specific strength. This comparison is shown in figure 6. The cyclic data are taken from figure 5. The fiber tensile strength values used were 447 000 psi ( $308\ 000\ \text{N/cm}^2$ ) for glass (ref. 3) and 219 000 psi ( $151\ 000\ \text{N/cm}^2$ ) for Thornel-50 (table I). For these particular values, above 80 cycles, the graphite filament-wound cylinders have superior fatigue properties to that of glass filament-wound cylinders.

## SUMMARY OF RESULTS

The following results were obtained from an investigation of NOL ring, strand, and cylinder tests of Thornel-50 graphite yarn at ambient and cryogenic temperatures:

1. The average filament tensile strength of composites of NOL rings was 229 000 psi ( $158\ 000\ \text{N/cm}^2$ ) at  $75^\circ\ \text{F}$  (297 K), 226 000 psi ( $156\ 000\ \text{N/cm}^2$ ) at  $-320^\circ\ \text{F}$  (77 K), and 221 000 psi ( $152\ 000\ \text{N/cm}^2$ ) at  $-423^\circ\ \text{F}$  (20 K).

2. Strand tests of yarn resulted in an average filament tensile strength of 290 000 psi ( $200\ 000\ \text{N/cm}^2$ ) at  $75^\circ\ \text{F}$  (297 K) as compared with single-fiber tensile strength of 293 000 psi ( $202\ 000\ \text{N/cm}^2$ ) as determined by the manufacturer.

3. Single-cycle burst tests of internally pressurized cylinders resulted in an average filament tensile strength of 219 000 psi ( $151\ 000\ \text{N/cm}^2$ ) at  $75^\circ\ \text{F}$  (297 K) and at a strain of 0.48 percent. The filament tensile modulus was  $48.8 \times 10^6$  psi ( $33.5 \times 10^6\ \text{N/cm}^2$ ).

4. Single cycle burst tests at  $-320^\circ\ \text{F}$  (77 K) gave an average filament strength of 218 000 psi ( $150\ 000\ \text{N/cm}^2$ ).

5. The fatigue life of graphite filament-wound cylinders at comparable percent of static burst strength was greater than that reported for glass filament-wound cylinders at  $75^\circ\ \text{F}$  (297 K).

6. At  $-320^{\circ}$  F (77 K) the fatigue life of graphite cylinders was similar to that at  $75^{\circ}$  F (297 K).

7. No failures resulted in the aluminum liners due to cycling. Cyclic failures resulted from failure of hoop filaments.

8. On the basis of specific tensile strength comparison, graphite-filament-wound cylinders were superior to glass-filament-wound cylinders above 80 cycles.

Lewis Research Center,  
National Aeronautics and Space Administration,  
Cleveland, Ohio, May 13, 1969,  
124-08-08-15-22.

## REFERENCES

1. Hoggart, J. T.; Burnside, J. Y.; and Bell, J. E.: Development of Processing Techniques for Carbon Composites in Missile Interstage Application. Rep. D2-125559-4, Boeing Co. (AFML-TR-68-155, DDC No. AD-839857L), June 1968.
2. Blakslee, O. L.; Pallozzi, A. A.; Doig, W. A.; Spence, G. B.; and Hanley, D. P.: Fabrication, Testing, and Design Studies with "Thornel" Graphite-Fiber, Epoxy-Resin Composites. Advances in Structural Composites. Vol. 12 of SAMPE Science of Advanced Materials and Process Engineering. Western Periodicals Co., 1967, paper AC-6.
3. Hanson, Morgan P.: Glass-, Boron-, and Graphite-Filament-Wound Resin Composites and Liners for Cryogenic Pressure Vessels. NASA TN D-4412, 1968.
4. Wolff, Frank; and Siuta, Theodore: Factors Affecting the Performance and Aging of Filament Wound Fiberglass Structures. ARS J., vol. 32, no. 6, June 1962, pp. 948-950.
5. Morris, Edgar E.: Design and Qualification Test Procedures for Filament-Wound Pressure Vessels. Conference on Structural Plastics, Adhesives, and Filament Wound Composites. Rep. ASD-TDR-63-396, Plastics and Composites Branch, Nonmetallic Materials Lab., AF Systems Command, Apr. 1963, pp. 289-309.
6. Dauksys, R. J.; Pagano, N. N.; and Spain, R. G.: Graphite Fiber/Epoxy Resin Matrix Composites. Rep. AFML TR-67-367, Air Force Systems Command, Apr. 1968. (Available from DDC as AD-670597).
7. Soltysiak, D. J.; and Toth, J. M., Jr.: Static Fatigue of Fiber Glass Pressure Vessels from Ambient to Cryogenic Temperatures. Reinforced Plastics International, Proceedings of the 22nd Annual Technical Conference. Society of the Plastics Industries, Inc., 1967, pp. 14-E.1 to 14-E.10.