

**NAVAL POSTGRADUATE SCHOOL
MONTEREY, CALIFORNIA**

19960430 054



THESIS

**SOF AND CONVENTIONAL FORCE
INTEROPERABILITY THROUGH
SOF RECONFIGURATION**

by

Edward J. McHale

March, 1996

Thesis Advisor:

Dana P. Eyre

Approved for public release; distribution is unlimited.

DTIC QUALITY INSPECTED 1

REPORT DOCUMENTATION PAGE

Form Approved OMB No. 0704-0188

Public reporting burden for this collection of information is estimated to average 1 hour per response, including the time for reviewing instruction, searching existing data sources, gathering and maintaining the data needed, and completing and reviewing the collection of information. Send comments regarding this burden estimate or any other aspect of this collection of information, including suggestions for reducing this burden, to Washington Headquarters Services, Directorate for Information Operations and Reports, 1215 Jefferson Davis Highway, Suite 1204, Arlington, VA 22202-4302, and to the Office of Management and Budget, Paperwork Reduction Project (0704-0188) Washington DC 20503.

1. AGENCY USE ONLY <i>(Leave blank)</i>	2. REPORT DATE March 1996	3. REPORT TYPE AND DATES COVERED Master's Thesis	
4. TITLE AND SUBTITLE SOF AND CONVENTIONAL FORCE INTEROPERABILITY THROUGH SOF RECONFIGURATION		5. FUNDING NUMBERS	
6. AUTHOR(S) Edward J. McHale			
7. PERFORMING ORGANIZATION NAME(S) AND ADDRESS(ES) Naval Postgraduate School Monterey CA 93943-5000		8. PERFORMING ORGANIZATION REPORT NUMBER	
9. SPONSORING/MONITORING AGENCY NAME(S) AND ADDRESS(ES)		10. SPONSORING/MONITORING AGENCY REPORT NUMBER	
11. SUPPLEMENTARY NOTES The views expressed in this thesis are those of the author and do not reflect the official policy or position of the Department of Defense or the U.S. Government.			
12a. DISTRIBUTION/AVAILABILITY STATEMENT Approved for public release; distribution is unlimited.		12b. DISTRIBUTION CODE	
13. ABSTRACT <i>(maximum 200 words)</i> <p>The goal of this thesis was to decide what environmental variables affected past SOF attempts at achieving interoperability with the conventional military, to examine the status of SOF and conventional forces interoperability as it exists today, and to explain why now is the time for SOF to engage in the reconfiguration of its forces to achieve an optimal level of interoperability.</p> <p>Five variables were used in the examination of SOFs organizational evolution toward interoperability with conventional forces. The interplay of these variables showed that environment changes combined with the sponsorship of civilian leadership had a dominant, yet, short-lived effect on SOF attempts at achieving interoperability with the conventional military, and that the incremental gains in structural and organizational aspects of SOF created conditions for achieving interoperability in the future. This window of opportunity is temporary, since SOF exists in an environment of competitive bureaucracies. Recommendations for SOF leaders in their pursuit of interoperability with conventional forces are presented. An opinion on how SOF might reconfigure itself to engage interoperability is provided.</p>			
14. SUBJECT TERMS Special Operations Forces		15. NUMBER OF PAGES 92	
		16. PRICE CODE	
17. SECURITY CLASSIFICATION OF REPORT Unclassified	18. SECURITY CLASSIFICATION OF THIS PAGE Unclassified	19. SECURITY CLASSIFICATION OF ABSTRACT Unclassified	20. LIMITATION OF ABSTRACT UL

NSN 7540-01-280-5500

Standard Form 298 (Rev. 2-89)
Prescribed by ANSI Std. Z39-18 298-102

Approved for public release; distribution is unlimited.

**SOF AND CONVENTIONAL FORCE INTEROPERABILITY THROUGH
SOF RECONFIGURATION**

Edward J. McHale
Major, United States Army
B.A., University of South Carolina, 1984

Submitted in partial fulfillment
of the requirements for the degree of

MASTER OF ARTS IN NATIONAL SECURITY AFFAIRS

from the

NAVAL POSTGRADUATE SCHOOL

March 1996

Author:



Edward J. McHale

Approved by:

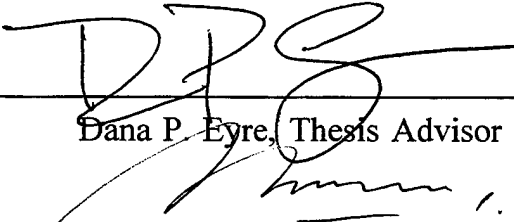

Dana P. Eyre, Thesis Advisor

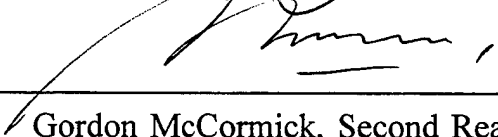

Gordon McCormick, Second Reader

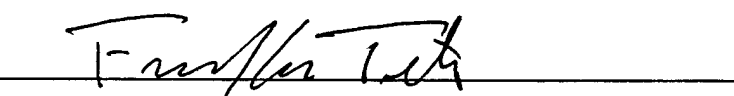

Frank Michael Teti, Chairman
Department of National Security Affairs

ABSTRACT

The goal of this thesis was to decide what environmental variables affected past SOF attempts at achieving interoperability with the conventional military, to examine the status of SOF and conventional forces interoperability as it exists today, and to explain why now is the time for SOF to engage in the reconfiguration of its forces to achieve an optimal level of interoperability.

Five variables were used in the examination of SOFs organizational evolution toward interoperability with conventional forces. The interplay of these variables showed that environment changes combined with the sponsorship of civilian leadership had a dominant, yet, short-lived effect on SOF attempts at achieving interoperability with the conventional military, and that the incremental gains in structural and organizational aspects of SOF created conditions for achieving interoperability in the future. This window of opportunity is temporary, since SOF exists in an environment of competitive bureaucracies. Recommendations for SOF leaders in their pursuit of interoperability with conventional forces are presented. An opinion on how SOF might reconfigure itself to engage interoperability is provided.

TABLE OF CONTENTS

I. INTRODUCTION	1
II. THE THEORETICAL FRAMEWORK	5
A. THE THEORETICAL FRAMEWORK	5
B. THE CASES	5
III. CASE ONE: THE FORMATION AND DEMISE OF THE OFFICE OF STRATEGIC SERVICES	7
A. INTRODUCTION	7
B. ENVIRONMENT CHANGES	9
C. TECHNOLOGY CHANGES	11
D. ORGANIZATION GROWTH	12
E. POLITICAL LEADERSHIP	15
F. MILITARY LEADERSHIP	16
G. CONCLUSIONS	17
IV. CASE TWO: SOF AND THE KENNEDY INITIATIVE	19
A. INTRODUCTION	19
B. ENVIRONMENT CHANGES	22
C. TECHNOLOGY CHANGES	23
D. ORGANIZATION GROWTH	24
E. POLITICAL LEADERSHIP	27
F. MILITARY LEADERSHIP	28
G. CONCLUSIONS	30

V. CASE THREE: SURVIVAL WITHOUT A POLITICAL GUARDIAN	31
A. INTRODUCTION	31
B. ENVIRONMENT CHANGES	33
C. TECHNOLOGY CHANGES	34
D. ORGANIZATION GROWTH	34
E. POLITICAL LEADERSHIP	35
F. MILITARY LEADERSHIP	35
G. CONCLUSIONS	36
VI. CASE FOUR: OPERATION DESERT ONE--A NEW LEASE FOR SOF . . .	37
A. INTRODUCTION	37
B. ENVIRONMENT CHANGES	41
C. TECHNOLOGY CHANGES	41
D. ORGANIZATION GROWTH	42
E. POLITICAL LEADERSHIP	42
F. MILITARY LEADERSHIP	43
G. CONCLUSIONS	43
VII. SOF INTEROPERABILITY WITHIN THE MILITARY	45
A. INTRODUCTION	45
B. INTEROPERABILITY IN THE PRESENT	47
C. OPERATIONS OTHER THAN WAR	51
1. Environment Changes	51
2. Technology Changes	53
3. Organization Growth	54
4. Political Leadership	55
5. Military Leadership	55

D. JOINT AND COMBINED OPERATIONS	55
1. Environment Changes	55
2. Technology Changes	59
3. Organization Growth	59
4. Political Leadership	60
5. Military Leadership	60
E. CONCLUSIONS	62
VIII. RECOMMENDATIONS FOR SUCCESSFUL SOF INTEROPERABILITY WITH THE CONVENTIONAL MILITARY	63
APPENDIX	67
A. AN OPINION ON RECONFIGURATION SOF FOR THE 21ST CENTURY	67
B. SUPER SOCs	71
C. JOINT SPECIAL ACTION FORCE (JSAF)	72
D. LESSONS LEARNED TEAMS	74
E. INFORMATION WARFARE SQUADRON (IWS)	75
F. MARINE EXPEDITIONARY UNIT SPECIAL OPERATIONS CAPABLE (MEUSOC)	76
BIBLIOGRAPHY	79
INITIAL DISTRIBUTION LIST	81

I. INTRODUCTION

The Question: Is now the time to reconfigure Special Operations Forces (SOF) for the purpose of achieving better interoperability with conventional forces? The Argument: Special Operations Forces should engage in organizational reconfiguration, stressing its unique qualities, and enhancing its interoperability with the conventional forces. "This involves the creation of units that are able to learn--to collect information, and to reflect on the consequences of their actions, and to gain insight. It requires units that have the ability to act on their learning, either through continuous improvement or through large 'leaps' of redesign."¹ Reconfiguration is not merely the adjustment of the organizational structure, it also includes how an organization interacts internally and externally in approaching challenges.

SOF should use the reconfiguration of its forces as the vehicle for achieving interoperability with the conventional forces. The enhancement of the interoperability between conventional forces and SOF will greatly contribute to the national military strategy. Throughout the spectrum of conflict, SOF and conventional forces have roles and missions that can complement each other. In the field of operations other than war, SOF and conventional forces should operate as one composite unit--a truly joint force.

The evolution of Special Operations Forces efforts to achieve interoperability with the conventional military is the subject examined in this thesis. First, I examine the evolutionary process of SOF and conventional military interoperability. I highlight the dominant variables essential for achieving the optimal level of interoperability. Four historical cases were dissected and examined using five environmental variables. I examine a set of variables that have traditionally influenced SOF efforts toward interoperability within the United States military's paradigm of war. The variables are: environment changes, technology changes, organization growth, political leadership, and

¹ David A. Nadler, Marc S. Gerstein, Robert B. Shaw, Organizational Architecture, Jossey-Bass Publishers, San Francisco, 1992, pp. 122-123.

military leadership changes. Second, I examine how the present arrangement of the variables favor SOF reconfiguration to enhance interoperability. Third, I form conclusions and offer recommendations for SOF leadership on interoperability with the conventional forces.

Achieving interoperability between SOF and the conventional force is the underpinning of SOF as an effective contributor to national security efforts. The precursor to discussing a reconfiguration of SOF is understanding the evolutionary process of SOFs major attempts at gaining interoperability within the military's paradigm of war. SOFs quest for interoperability with conventional forces is not a singular event; it is an evolutionary process. Organizations desire a degree of interoperability that allows a seamless coordination of effort and yet also allow considerable autonomy at the operational level.

Imagine SOF and the conventional force as a combination computer graphics and word processing program. The word processing program is an efficient collector and organizer of text (conventional force). The graphics program (SOF) produces slides that get the attention of the target audience. By combining these unique capabilities, one produces a synergistic effect in a briefing. For this interoperability to succeed, the graphics program must be compatible with the operating system of the computer (conform to general organizational conventions). The program must be user friendly (interoperable). It must also be able to translate the main ideas to be briefed into clear expressions (contribute to mission success), or it will be deleted from the computer (conventional bureaucracy). This is a simple evolutionary process that is complicated, in reality, by a multitude of strong variables, particularly the aspect of conforming to the host organizational conventions.

Since World War II and until the DoD Reorganization Act of 1986, as amended by the National Defense Authorization Act of 1987, Special Operations Forces were not resourced or structured to engage the environment they operated in. SOF must chart a course that is buttressed by its unique capabilities and interoperability with the

conventional force. SOF must remain operationally different, mastering those skills not trained on by general purpose forces. At the same time SOF must remain organizationally and psychologically interoperable with the conventional forces complementing each others efforts not complicating them.

Why is the conventional military restructuring? It is restructuring because the gap between the conventional military paradigm and emerging military requirements have widened. Restructuring has been a typically uncomfortable remedy for organizations that recognize environmental change and seek to close the performance gap between environmental requirements and the organization's capacity to engage the new requirements.

The framing of the argument is covered in the introduction. Chapter one describes the theoretical framework of variables influencing reconfiguration and their effects on the dependent variable, and SOF interoperability within the military. The framework helps draw conclusions about the variables affecting SOFs attempts at interoperability within the military. The four cases are examined using the five factors that usually effect organizational reconfiguration: environmental changes, technology changes, organization growth, political leadership, and military leadership changes.

The evolution of SOFs attempt to achieve interoperability is covered by Chapters II, III, IV, V, and VI. Chapter II provides the theoretical framework for this study. Chapter III will apply the theoretical framework to the first of four cases: the formation and demise of the Office of Strategic Services (OSS) during the second world war. In Chapter IV, the theoretical framework is applied to the second of four cases: SOP and the Kennedy initiative. In Chapter V, the theoretical framework was applied to the third of four cases: Survival without a political guardian. In Chapter VI, the theoretical framework is applied to the last of the four cases: Operation Desert One--A new lease for SOF.

Chapter VII draws conclusions from the four cases to examine the evolution of SOFs attempts at interoperability. The period examined begins with World War II and

ends in the late 1980s. Using the conclusions from Chapter VII, the following argument is examined: Now is the time for the reconfiguration of SOF, a fleeting window of opportunity is open. The dominant variables that act as drivers for SOF/conventional integration and SOFs reconfiguration, are today more amenable to such change. Some of the factors are supportive of SOF and some are less supportive. Chapter VIII lists recommendations for SOF leadership to follow in their efforts toward interoperability with the conventional force. The appendix provides an opinion on how SOF might reconfigure.

II. THE THEORETICAL FRAMEWORK

A. THE THEORETICAL FRAMEWORK

The theoretical framework used to examine the predominant variables influencing organizational reconfiguration was derived from organizational studies literature. Five variables were used to narrow the broad spectrum of "change" and their affect on the military as an organization. These variables assist in the dissection of the cases in determining which variables were most influential to interoperability. "Sometimes several of these variables converged at the same time"; thus, the interplay of the variables resembled a combination lock. As the environmental variables changed, so did the combination for achieving SOF and conventional forces interoperability.

B. THE CASES

- The formation and demise of the Office of Strategic Services (OSS).
- Kennedy's initiatives for a flexible response capability with SOF as the centerpiece.
- Survival without a political guardian. Even a military defeat fails to cause a paradigm shift among the conventional military bureaucracy.
- Operation Desert One, a failure of interoperability, Special Operations Forces are given a new organizational lease with which to grow and restructure.

Each of the four cases were examined in accordance with the changes that lead to reconfiguration, including the following variables:

- Environment Changes. What was the geopolitical environment during each case? How did this environment effect the military with respect to SOF interoperability with conventional forces?

- **Technology Changes.** What was the general focus of technology during the case? How did technology effect SOF interoperability with conventional forces?
- **Organization Growth.** What was the structural growth or decline of the SOF and the conventional force organization during the case? What effect did this have on the SOF organization's interoperability with conventional forces?
- **Political Leadership.** What was the external civilian leadership and the political climate? How did the political leadership effect SOF interoperability with conventional forces?
- **Military Leadership.** What were the conventional force and SOF leaders' impact on interoperability between SOF and the conventional forces?

III. CASE ONE: THE FORMATION AND DEMISE OF THE OFFICE OF STRATEGIC SERVICES

A. INTRODUCTION

The case of the Office of Strategic Services (OSS) is the first significant attempt at achieving interoperability between SOF and the American conventional military. From June 1941 through October 1945, the OSS conducted guerrilla and unconventional warfare in support of the conventional force's strategic objectives. On the eve of World War II, the Army had no special operations capabilities for unconventional warfare, guerrilla warfare, counterinsurgency, strike operations, psychological operations, or civil affairs. In June 1941, President Franklin D. Roosevelt established the Coordinator of Information (COI). The COI charter included the waging of psychological warfare and the gathering and analysis of information. President Roosevelt also persuaded Wall Street republican lawyer, World War I Medal of Honor winner and political power from New York City, William "Wild Bill" Donovan to create a unified intelligence gathering organization. On 11 July 1941, Donovan was appointed by Roosevelt as Coordinator of Information (COI).² As Coordinator of Information, Mr. William Donovan was convinced that guerrilla warfare could cripple a modern nation's ability to wage war. In July 1941, the Office of Strategic Services was established under BG William Donovan. The OSS undertook a variety of unconventional warfare missions throughout World War II. Of note were the Jedburgh teams which aided the French resistance in support of D-Day operations. The Operational Groups' (OG) 356 U.S. Army-French speaking volunteers parachuted in after D-Day and assisted with the coordination of guerrilla activities. In August 1944, the Operational Groups were expanded and placed under the 2671st Special Reconnaissance Battalion, Separate (Provisional). By spring of 1945, over 75 OG teams assisted French

² United States Army Special Operations Command, Directorate of History and Museums, *To Free From Oppression*, 1994, pp. 21-22.

partisans in blocking the retreat of the Germans. OGs fought in Italy and throughout the Mediterranean. OSS-led partisans took the islands of Sardinia and Corsica. OG-teams operated inside German-occupied Greece, assisting partisans in unconventional warfare against the Germans. General Douglas MacArthur, having barred the OSS from operating in his Southwest Pacific jurisdiction, did not stop the OSS from successfully operating in other theaters such as Burma. Detachment 101 operations in northern Burma proved to be both operationally profitable and challenging. Three hundred Americans and 3,200 Burmese tribesmen harassed Japanese occupation forces by blowing up bridges, supply dumps, ambushing convoys and capturing prisoners. Detachment 101 and the "Kachin Rangers" were instrumental in the clearing of the Burma road to China, against a superior Japanese occupation force. Other operations can be credited to the OSS in China, Thailand, Indochina, Indonesia, and Malaya. The OSS also established the U.S. Army Civil Affairs Division in 1943. Overall, the OSS distinguished itself in the missions it was permitted to conduct.

In this case we see several interesting conclusions. First, the conceptual lenses used by civilian and military leadership formed different views of what all the requirements needed to be in war. Demonstrating that one organization's environment assessment does not always lead to clear requirements, the requirements were manipulated by organizations and their respective leaders. The geopolitical environment for the United States of America saw its politically uncomfortable emergence from the isolationism of the 1930s into a position of global military and economic dominance in the 1940s. Roosevelt wanted intelligence to be useful to his strategic decision making. One implication of this request was that the gathering of this intelligence would be integrated with the military. Unfortunately for the OSS, the priority and the execution of this request was subject to different assessments between civilian and conventional military leaders. Second, the technological focus of the day was geared toward the conventional paradigm of warfighting, not unconventional warfare. In 1939, "The central focus of the American

war paradigm was on production."³ The prevailing logic was: winning big wars requires mass production, not Special Operations. The effects of technology on OSS interoperability were neutral due to the conceptual view of war by the conventional leadership. The proponents of unconventional warfare did not require high end technology. The OSS paradigm of war was low production, no mass, high quality, and socially and politically astute forces. Hence, technology was of little impact. Third, the external efforts of civilian leadership to prod the military bureaucracy into shifting its paradigm of warfighting toward SOF and conventional force interoperability were ineffective.

B. ENVIRONMENT CHANGES

Unlike a statistical assessment which has rules for producing findings, assessments of environmental realities have no standard set of rules in determining the requirements for dealing with an environment. The civilian assessment of the geopolitical environment favored political strategies, while conventional military leaders assessment tended, expectedly, to favor military solutions. The environment in which the OSS existed had three distinct phases: the pre-war, wartime, and post-war geopolitical environments. No matter what the environment, the fate of the OSS was always determined by how either civilian or military leadership chose to view OSS utility, not necessarily how well they functioned within the environment.

The pre-war environment saw the United States trying to prepare for its unavoidable entry into the war. The formation of the Office of Strategic Services was a result of President Roosevelt's desire for a unified intelligence gathering organization that was not provided by the existing military. The military leadership and the civilian leadership viewed the changes in the environment through different conceptual viewpoints.

³ Guilmartin, John F., Jr., Technology and Strategy: What are the Limits? Strategic Studies Institute, Monograph, 20 July 1994.

The OSS was supported by civilian leadership and their assessment of the changes in the environment. However, the conventional military leadership was opposed to the OSS being integrated into the military. Like any organization the conventional military leadership's view of the OSS was as tainted by organizational bias, as was the OSS view of the conventional military. The philosophy of the OSS was not within the teachings of the conventional paradigm of war. For this reason many leaders and soldiers were resistant to a brand of warfare they were not trained to understand. Second, the OSS was an organization of war with a direct line of communication to the president outside the military's bureaucracy. This was a thorn in the side of the conventional military leaders.

The wartime environment created the strategic space for the operational employment of the OSS. A condition of slack resources existed, opening a niche in the spectrum of warfighting that was neither a threat to conventional force priority efforts or their resources. From July 1943 through October 1945, the OSS was permitted to operate on the margins of the war.

The post-war geopolitical environment generally viewed all forces, both conventional and unconventional, as machines no longer required to operate at full capacity in the production of U.S. global power. This, in concert with the arrival of the atomic paradigm of war, made conventional war fighting irrelevant in the popular American paradigm of war. At the end of the war, the military's conventional mindset had to defend itself from other assaults on its paradigm. The most persistent assault was the formulation of a strategic Nuclear Policy imposed on the military institution. Speculation at the time was that atomic weapons would keep the peace, thus large conventional conflicts between industrial nations less likely to occur. Unconventional warfare was of minor significance in comparison to the decisive impact of the conventional paradigm of war or the promises of a nuclear deterrence strategy. The sustainment of the OSS was seen as a waste of resources by conventional leaders who were trying to determine the requirements of a nuclear battlefield.

The conclusion about the effect of environment change on interoperability is that it was not a dominant influencing factor. The environment was subject to varied assessments of what the requirements should be, depending on the agenda of the organization making the assessment.

C. TECHNOLOGY CHANGES

Technology was of minor influence on OSS interoperability with the conventional force. The type of technologies being exploited for war were mainly those dealing with the mass production of items that enhanced firepower and mobility. These principles of war were not usually as important to the OSS as, say, cross-cultural skills and psychological warfare. Donovan's message called for minimizing the massing of troops and maximizing economy of force missions. Thus, technology-based mass production to facilitate conventional force on force operations were not needed. This is evident when we compare the techniques of day and night allied bombing against German railroads to the operations of partisan sabotage of German rail lines and engines. The allied bombing campaigns against German lines of communication were a showcase for high-end technology and mass production combined to produce thousands of aircraft and their supporting systems. The partisans and resistance, on the other hand, used low technology techniques, e.g., camouflaged explosives as chunks of coal thrown into railroad engines by their unsuspecting crews. The preceding examples represent the difference between conventional force use of high technology and OSS ability to operate without it. OSS would find little to no support from defense production institutions since they would not be requesting defense contracts involving mass production, as did the conventional forces. The technological focus was on the production of aircraft, tanks, and ship items that enhanced allied abilities to move, shoot and communicate. The OSS could operate with the existing technologies provided by the conventional force; no substantial change in technology was needed. The OSS depended upon human factors for mission success,

gaining rapport with indigenous peoples, and cross-cultural skills often dominated a Jedburgh teams formula for operational success.

After the war, the American paradigm of war was validated. The combination of firepower and mass production was concluded to be the way to win wars, period. The creation after World War II and continued existence of the Industrial College of the Armed Forces provide eloquent testimony to that emphasis, an emphasis that is deeply imbedded in the U.S. military services' corporate memories and thought processes. John Patrick has neatly encapsulated that reality in his perceptive description of the U.S. Army, Navy, and Air Force as "classic industrial institutions."⁴

"The fundamental underpinnings of the paradigm, however, were shaken by the advent of the nuclear age. After a brief period of unexploited monopoly, nuclear proliferation set in. The United States and its allies faced the reality of the Cold War. They also faced a situation in which their industrial bases were secure from direct attack, save by massive nuclear strike which would surely have been answered in kind."⁵

The relationship between technology and SOF achieving interoperability with the conventional military was not a strong one. The OSS could function without nuclear technology, mass production, and technologies that enhanced firepower and maneuver warfare. For this reason technological changes were not a dominant factor in this case.

D. ORGANIZATION GROWTH

The relationship between organizational growth and OSS-conventional force interoperability was not substantial. The OSS organization existed only as long as the short-lived support of its political sponsor. In pre-war 1940 with no great wars to fight, the standing military bureaucracy turned its focus inward to fight the parochial war for

⁴ Howard, Sir Michael and John F. Guilmartin, Jr., Two Historians In Technology and War, Strategic Studies Institute, Monograph.

⁵ Ibid., p. 22.

resources. The effect on OSS interoperability was that the prewar military bureaucracy saw itself becoming vulnerable to the OSS as a bureaucratic competitor. The internal military organizational climate in the prewar military provided the catalyst for change. Thus, the staff set out to disembowel the OSS as a bureaucratic competitor in the American paradigm of war. "In the ensuing months the Army, the Navy and the State Department, far more familiar with the maze and manipulation of Washington's bureaucracy, siphoned off many of the COI's original functions. Indeed, some Washington observers at the time wondered if the fledgling COI itself were doomed."⁶ What saved Donovan's OSS? The dominant reason was disinterest on the part of the military in a minor bureaucratic battle. Since, the Japanese had just attacked Pearl Harbor, there were now more pressing problems for the conventional military. After the war started, Donovan seized the opportunity for organizational growth by seeking the external support of the President. Donovan's request for resources at a time when military institutions had bigger problems enabled the OSS to get started. "Finally, in June 1942, the Office of Strategic Services (OSS), directly responsible to the war department but stripped of most of its psychological warfare responsibilities, emerged from the bureaucratic wars."⁷ The OSS operated in an diminished form, with considerable positive effects and few failures. The civilian leadership could demand that the OSS be established, but the military in the long run, showed that it would determine the fate of military matters. With the end of the war came the resurgence of conventional military parochialism, and the disbanding of the OSS.

The OSS had its operational successes, enough to bolster the arguments of its supporters to push for an institutionalized unconventional warfare capability within the U.S. military. For most World War II leaders, both military and civilian, the efforts of specialized units were viewed as marginal at best in the grand scheme of war. The other

⁶ Ibid.

⁷ United States Army Special Operations Command, Directorate of History and Museums, *To Free From Oppression*, 1994.

part of the problem was the growth of an organization that was networked directly to the President outside military bureaucratic control. In the conventional military leaders' opinion creating an organization that increased the civilian leadership's capability to "mettle in military matters," was a mistake. The structural growth of the OSS can be partly described by the organizational theory phenomenon of "slack resources," the availability of unused resources. This was due to the rapid growth of the military as it prepared for war. As stated by Colonel Aaron Bank: "I had noted that often logistic and air support for OSS had not been given a high level of priority by the military. Rather its priority was on the low end of the scale. If there were an abundance of what had been requested or requisitioned on hand OSS got a break otherwise It didn't."⁸

In the end, the military saw fit to disband OSS operation in October of 1945. Its organizational existence, successes, and growth were not influential enough to aid in interoperability within the military. In the words of Colonel (Ret.) Aaron Bank: "What concerned me was whether or not the vacuum left by blindly dismantling an organization that had proved itself so indispensable as an essential component of total warfare would be properly filled. I was convinced that there was a requirement for an organization such as OSS preferably within the military-the Army."⁹ There were persons who agreed with Colonel Bank, but most of these people were not in the Army's leadership. The OSS was reestablished outside the military in 1947; it would be called the Central Intelligence Agency.

⁸ Bank, Aaron, From OSS to Green Berets: The Birth of Special Forces, Presidio Press, CA.

⁹ Ibid., p.130.

E. POLITICAL LEADERSHIP

Political leadership and its relationship with military leadership were the dominant variables in the fate of OSS and conventional force interoperability. The external civilian political leadership saw a different set of political-military requirements in comparison with the military. Roosevelt's administration, like others, was not always satisfied with the military establishment's apparent lack of responsiveness to an administration's political requirements in war. All good commanders understand that political and military affairs are inexorably connected; but like all professional persons, military leaders are cautious of guidance from outside agencies. In response to this dilemma, Roosevelt sought solutions from William Donovan, someone more sensitive to both the political and military side of strategy. Roosevelt's appointment of William Donovan to lead this unconventional organization was a good one. In the end, however, it was not an influential variable for interoperability. To expect Donovan to triumph against the current of conventional warfare was tantamount to having him swim across the Atlantic Ocean.

Most democratic leaders base their successes in their ability to reach a compromise on most issues. While the military leaderships' tendency has been one of staying on course, to compromise might be seen as less than victory. Military men have been historically judged on their ability to achieve victory, usually after the failure of some sort of political compromise. The political leader tends to shift his emphasis on issues in accordance to the rate of changes in the geopolitical environment. Military leadership wants precision gained through routinization, thus facilitating the management of large military organizations during the confusion of warfare.

The differing mindsets of Roosevelt and the conventional military caused a self-fulfilling prophecy of failure for OSS and conventional force interoperability. Roosevelt wanted an OSS capability. Since he thought it must logically be military in nature, he directed its establishment. He also established a revolution from above. Military leaders

had their paradigm for war and did not appreciate the forced incorporation of an organization that did not fit their model for war.

Initially the OSS received civilian support. This support, however, faded as other major issues emerged, taking the civilian sponsors attention from the OSS. For an American president to go to war and not let the military make military decisions was often viewed as imprudent. First, Roosevelt was not a military professional or expert. Second, it is not politically wise for politicians to set themselves up for all the blame should military options fail. Support from the political leadership was a short-run benefit for the OSS. The fact that it was externally imposed sowed the seeds for long term military resentment.

F. MILITARY LEADERSHIP

Military leadership was the dominant variable in the case of the OSS and its attempts for interoperability with the conventional force during the war. From the assessment of the conventional military leadership, the war was to be won by conventional force-on-force operations. For conventional forces the subject of unconventional warfare was not part of their education, training, technological focus, or mythos. There were, in fact, good reasons in 1940 for military leaders to be unimpressed by the forced inclusion of the OSS. The conventional military leaders, such as General MacArthur in one theater and Lieutenant General Patton in the other, were unanimous in their disapproval of the OSS. Lieutenant General Patton once commented after an encounter with Donovan that "I really do like and respect Donovan. His men have conducted some courageous missions. However, the OSS for the most part are of little impact to the final outcome of the War."

At the end of the war, it was easy for the conventional military leadership to assess that the OSS helped at the margins. It did not achieve the final victory in the manner that the conventional forces had. Given the assumptions of the post-World War II period, the military leadership was correct in viewing the OSS as not worthy of integration into the

military. The conventional military faced downsizing and an uncomfortable transition to atomic warfare, making unconventional warfare seemed like a frivolous issue.

G. CONCLUSIONS

The dominant variable in this case was military leadership. It was the conventional military leaderships' disagreement with the political leaderships' directives that determined the fate of the OSS's hope for interoperability with the conventional forces. The variable of military leadership proved more resilient than the influence of the variable of political leadership.

The effect of environment change on interoperability was not a dominant factor influencing interoperability. The environment was subject to varied assessments of what the requirements should be depending on the agenda of the organization making the assessment.

The relationship between technology and SOF achieving interoperability with the conventional military was not a strong one. The OSS could function without nuclear technology, mass production, and technologies that enhanced firepower and maneuvered warfare. For this reason technological changes were not a dominant factor in this case.

The relationship between organizational growth and OSS and conventional force interoperability was not substantial. The OSS organization existed only as long as the short lived support of its political sponsor. Support from the political leadership was a short-run benefit for the OSS. The fact that it was externally imposed sowed the seeds of long-term military resentment. Military leadership was the dominant variable in the case of the OSS in its attempt for interoperability with the conventional force during the war. The result was that forced integration by military outsiders failed to induce integration or the sustainment of SOF and conventional force interoperability.

IV. CASE TWO: SOF AND THE KENNEDY INITIATIVE

A. INTRODUCTION

This case represents the second significant attempt at SOF and Conventional Force interoperability. It also represents the second significant sponsorship of SOF and conventional force interoperability by a political leader. President John F. Kennedy's influence in this case spans from 1960 through 1963. This case illustrates that achieving interoperability between SOF and the conventional force will be a matter of winning by increments, since both the SOF and conventional viewpoints perceive the changes as beneficial. An evolutionary process of integration leading to interoperability rather than politically sponsored revolution from above seems to be the path for SOF. The Kennedy administration faced a problem similar to that faced by the Roosevelt administration--a military bureaucracy that did not want to change according to the civilian leadership's view of the national military requirements.

A solid bipolar geopolitical system was firmly established by the time Kennedy took control of the Presidency. With the advent of a nuclear stalemate between the Soviets and the U.S., other strategies for achieving international dominance were developed. The Americans sought to use capitalism as the vehicle for achieving world dominance. The Soviets countered with an international campaign of wars of national liberation and targeted countries on the perimeters of western influence. This situation negated the policy of mutually assured destruction and gave birth to the idea of a flexible response to international and regional threats.

In 1960, the proponents for SOF received new life under the auspices of Kennedy and his need for politically soluble solutions to military confrontation in a bipolar world, a world in which a balance of power existed due to nuclear parity between the two hegemonies. The worst case scenario of nuclear war was a warm bedfellow for the military organization's tendency to resist change. "Nuclear weapons technology has proven to be

remarkably resistant to innovation. The advantage still clearly lies with military forces oriented neither to disarming nor denial operations, but to punishment."¹⁰ The Soviet Union created a significant environmental change with a strategy designed to dilute the nuclear technological edge of its enemies. The Soviets embarked on a strategy involving wars of national liberation at the margins of their opponents' areas of influence, usually in the non-aligned nation-states.

Kennedy wanted his perception of a flexible response capability instituted in the military to counter Soviet sponsored wars. On the other hand, the conventional military leadership viewed conflicts like Vietnam as a sideshow in comparison to preparations for the Soviet threat in Europe. Like the OSS case study, civilian leadership would not force a substantial degree of SOF interoperability with the conventional forces. The variable of technology, as well, will not influence SOF and conventional force interoperability as profoundly as it will the conventional forces ability to enhance firepower and mobility. This case does show the raw building blocks being laid for future interoperability. Small incremental gains would be made in the sustainment of SOF structure even after Kennedy was gone.

Nuclear age pentomic divisions and the flexible response Reorganization of Army Divisions (ROAD) were the competing Army force structures of the 1950s and 1960s. In comparison the structural growth of SOF was an exercise in window dressing. The Army leadership was at best insulted by the directive to establish units tailored to meet the president's requirement for a flexible response capability. The creation of such units meant the disbanding of other units, units that fit the paradigm, agenda, or assessments of the conventional military.

Due to President John Kennedy's personal affinity for Special Forces "it was a foregone conclusion that the Army would seek to give the president what he wanted: a counterinsurgency force structure based on the Special Forces. This is not to say that the

¹⁰ Posen, Barry R., The Sources of Military Doctrine: France Britain and Germany Between the World Wars, Cornell University Press, London, 1984.

brass was enthusiastic about developing such a capability--they were not. Rather, it was a case of the Army satisfying a requirement using the 'parts on hand' in such a way as to disrupt as little as possible the essence of the organization: the heavy (armor and mechanized infantry) division."¹¹ Thus, the reconfiguration of SOF was presented:

In a speech at the Army War College on 8 June 1961 General Decker outlined the concept around which these four Special Forces Groups (1st SFG Southeast Asia, 5th SFG Africa, 7th SFG Latin America, and 10th SFG Middle East) would operate. They would form the core elements of U.S. free world liaison and assistance groups, or FLAGs. Each FLAG would include an SFG, a psychological warfare battalion, and civil affairs, engineer, signal, military intelligence, and medical detachments. FLAGs would be deployed at the direction of the president to assist friendly governments threatened with Communist-inspired insurgencies. Once deployed they would be responsible to the U.S. ambassador through his senior military advisor (presumably the MAAG chief). In the Army study outlining the FLAG concept an annex focusing on a "mini-FLAG" for Vietnam recommended that if the GVN requested military assistance, a 311-man force should be dispatched immediately. The mini-FLAG would contain personnel from all the components of the projected FLAG but at reduced levels. The Army also set about drawing plans for sending FLAGs to Columbia and Nicaragua.¹²

On 17 August, the President signed the DoD Appropriations Act for 1962 for an additional 3,000 spaces for Army counterinsurgency forces. From the army staff's point of view, everything appeared to be right on track; however, the formation of FLAGs as the Army's force structure for counterinsurgency contingencies was not to be.¹³ The United States geopolitical involvement in Vietnam both militarily and politically can be characterized by the phrase: "Since we did not know what to do we did what we knew."

¹¹ Krepinevich, Andrew F., Jr., The Army in Vietnam, Johns Hopkins, Baltimore, 1986, p. 103.

¹² Ibid., p. 104.

¹³ Ibid., p. 105.

Dr. Larry Cable, in his book Conflict of Myths, summarizes the prosecution of this conflict as a product of past military experiences interpreted through a particular intellectual lens that created a seemingly logical path toward the miscalculation of the events in southeast Asia during the 1950s and 1960s. The military leadership maintained their belief in the strategy that the enemy would soon fight the conventional conflict that the United States military was hoping for. SOF was a secondary effort that was increasingly made to conduct missions that supported the conventional operations, such as reconnaissance and direct actions, over their intended counterinsurgency role. Operations that attacked the infrastructure of the insurgency, such as the Phoenix Project, were misunderstood and under-resourced. The SOF role during the early 1960s as advisors and unconventional warriors shifted by the 1970s to that of a Commando- or Ranger-like role.¹⁴ Again this case supports the theory that interoperability between SOF and the conventional force will only work as an evolution from within the military, not as a revolution from above.

B. ENVIRONMENT CHANGES

As in the case of the OSS, the variable of the environment was manipulated by the biased assessments of both the dominant variable of military conventional leaders and political leadership. The effect of the environment on the promotion of SOF interoperability in theory was supportive and promising. But in an environment dominated by a highly competitive conventional military bureaucracy, many promises of SOF integration with the conventional forces were not honored. Incremental gains beyond those of the OSS case were realized, due in part, to the fact that the nuclear deterrent proved not to be the solution for all geopolitical conflicts. In addition, conventional leaders recognized that SOF capabilities had at least a degree of usefulness in addressing those problems viewed as existing outside the responsibility of the conventional forces.

¹⁴ Ibid.

C. TECHNOLOGY CHANGES

The effect of technology on SOF and conventional force interoperability was moderate at best. SOF operations in Vietnam for the most part used existing conventional force technologies but nothing that was closely linked to enhancing SOF and conventional force interoperability. SOF did seek to emulate and blend in with the conventional technological band wagon in an effort to prove itself worthy of organizational survival by the conventional force. An example of this would be the insertion of nuclear warheads against communist block targets by Special Forces teams.

The general state and focus of technology was marked by the United States military becoming entranced with the ideal of new technologies as more than just enhancers but as veritable solutions to military problems. "In this century, as the United States has had a resource advantage over each of her adversaries, firepower and technology have evolved as substitutes for precious manpower. Indeed, the Army even has a statement for it: 'It is better to send a bullet than a man.'" The transition considered most important by the military leaders was from pentomic to ROAD ground forces geared to the worst case nuclear battlefield. Long-run technology defense programs and the prevailing conventional mindset was facing pressure from the administration to incorporate the capability of flexible response to regional contingencies. The friction occurred due to the Army's bureaucracy thriving on the production of long-run technologically-based procurement programs. They wanted heavy divisions with high mobility and firepower potential. The military leadership believed that the problem of engagement of small wars and wars of liberation was well within the capabilities of a force constructed to win the "big one." The conventional paradigm of firepower and mass production was accepted by conventional wisdom as being validated by World War II. Besides, the defense industry, another organization resistant to change, was both entrenched and profitable within the military and political decision making circles. During this period even conventional proponents for

new technologies like the helicopter were heavily resisted because airmobile divisions would cut into the funding for armored divisions.

The effect of technology on SOF interoperability was not overwhelming. SOF forces simply did not require the American focus of technology like the conventional forces did.

D. ORGANIZATION GROWTH

The effect of organizational growth on SOF and conventional force interoperability was dominated by its relationship to the variables of political and military leadership. In this case the variable, political leadership, indirectly resulted in SOF organizations not being completely disbanded by the dominance and endurance of the conventional military leadership. Presidential directive dictated the growth of counterinsurgency forces causing the military leadership to be involved in how the force would be formed. The Army viewed this as a resource allocation problem: how much would they be forced to divert from their preferred contingency of a war in Europe. The Army leadership was faced with more than a straight-forward development of a counterinsurgency capability within the Army. The FLAG concept of U.S. Army Chief of Staff, General Decker, was authorized by the Department of Defense in 1962. The original concepts of counterinsurgency and SOF-like growth degraded as shown in Table 1.

Table 1. Projected Increases in Special Forces from April 1961 to June 1962

<u>Unit</u>	<u>Current Strength</u>	<u>Projected Strength</u>	<u>Orientation</u>
1st SFG	364	1,262	Southeast Asia
5th SFG	0	1,262	Africa
7th SFG	0	1,262	Latin America
10th SFG	364	1,262	Middle East ¹⁵

Two months later a report by General Stilwell questioned the workability of the FLAG concept, citing a variety of organizational problems. In its footsteps came the Howze Board directed by LTG Hamilton H. Howze, see Table 2. It evaluated the Stilwell Report and came up with its answer to counterinsurgency, Special Warfare and interoperability.

¹⁵ Ibid, p. 105.

Table 2. The Howze Board's Counterinsurgency Force Structure

	<u>Primary Mission</u>	<u>Secondary Mission</u>
Divisions	1st Infantry	82 Airborne
	2nd Infantry	101 Airborne
	25th Infantry	4 Infantry
Battle Groups	2 Panama	Pacific ¹⁶

The Army, having failed to localize force structure development for counterinsurgency within the special warfare units, was now faced with some very unwelcome recommendations and suggestions from the Howze Board. The diversion of over three divisions to the counterinsurgency mission was not what Decker and the DCSOPS had in mind when they drew up the FLAG proposal. The Army Staff was particularly irked by the board's thinly veiled attempt to call for the development of three airmobile divisions to meet the threat, since the board's chairman, Lt. Gen. Howze, was a prime mover in a group of high-ranking officers calling for the formation of air assault divisions for conventional warfare.¹⁷

By 1965, the actual growth of Special Forces and SOF-like organizations was comprised of seven SFGs, backed up by five infantry brigades with little counterinsurgency training. The post-war saw massive troop reductions and a transition to a Volunteer Army. The SOF community saw the deactivation of four Special Forces

¹⁶ Ibid., p. 109.

¹⁷ Ibid., p. 109.

Groups and the consolidation of Special Warfare, Civil Affairs and Psychological Operations (PSYOPS) schools.

In the end, the effect of organizational growth permitted SOF to operate only as sideshow to the true priorities of the conventional force leadership. SOF survival of post-war reductions was also a demonstration of conventional force determination to show that they had still "checked the box" for the counterinsurgency requirement. The SOF sponsorship by Kennedy never resulted in an organization capable of conducting his concept of a flexible politically-attuned military response. The organizational growth or decline of the conventional force and SOF had little positive effect on interoperability.

E. POLITICAL LEADERSHIP

Civilian leaders do affect military doctrine. Their intervention is often responsible for the level of innovation and integration achieved in a given military doctrine. Leadership was the dominant variable, when compared to the influence of environment changes and national requirements. It took the outside influence of the civilian leadership to enact even limited change in the powerful military bureaucracy. Kennedy and his proponents in support of SOF were not entirely comfortable with the dilemma of following military advice when it came to situations involving the use of coercive force or following a purely diplomatic course of action. In support of bureaucratic parochialism and in light of the Kennedy counterinsurgency/SOF initiative, the military leadership at large represented a closing of the ranks. Among the Army leadership, "it was felt that the reorganization from Pentomic Divisions into the ROAD structure would permit standard units 'to meet the needs of the many variables of limited war.'" Thus the ROAD division, through use of its brigades, would provide the nucleus for upgrading what had been the FLAG.¹⁸

¹⁸ Krepinevich, Andrew F., Jr., The Army in Vietnam, Johns Hopkins, Baltimore, 1986, p. 107.

The overall effect of political leadership on interoperability was a predictable moderate effectiveness in the short run. The divergence from case one was its long-run marginal effectiveness in SOF organizational persistence.

F. MILITARY LEADERSHIP

The effect of military leadership on the interoperability of SOF with the conventional forces was the dominant variable in preventing long run interoperability. The mindset of the military leaders was that they would be ultimately judged by their ability to win in the advent of total war. The popular assessment was that a nuclear conflict against the Soviet block forces was the most probable and most deadly contingency in the 1960s and 1970s. With this focus influencing all strategic considerations, it is understandable that conventional military leaders would dismiss the importance of counterinsurgency or special operations. The key feature of the political climate within the Army was the lack of change. Not unreasonably, military leaders tend to need undeniable evidence, such as a substantial defeat or victory, before engaging in doctrinal change. To the conventional leaders the conventional paradigm of war was validated by World War II. The doctrine for the nuclear battlefield had yet to be tested. Small wars like Vietnam simply fell under the conventional paradigm of war. Despite the warnings from the field and lower echelon political leaders, the American military closed ranks in support of the pre-Vietnam paradigm of war.

Thus, in Vietnam the Army ended up trying to fight the kind of conventional war that it was trained, organized, and prepared (and that it wanted) to fight instead of the counterinsurgency was it was sent to fight. By focusing on perceived civilian shortcomings to the exclusion of a hard look at its own failures in the war, the Army is perpetuating the fiction that its concept of war remains valid in all conflict environments and that the problem in future FID conflicts will come from a weak-kneed American public, a foppish Congress, and an indecisive chief executive. The blame for this perpetuation of the concept cannot, however be laid entirely at the doorstep of a myopic military leadership. For if the Army is still naively attempting to set the same kind of conditions for intervention that it did in

the decade following the Korean War, it has received (when compared with the effort made during the Kennedy years) little incentive to change its organizational bias. Indeed, it seems that the civilian leadership has endorsed its viewpoint rather than challenged it.¹⁹

The prevailing view of Vietnam as not the "big one," but one more domino, displayed how the military does not need to adjust to every low priority conflict. This mindset was blind to the combination of societal, political, and military ramifications that would later collide to make Vietnam a devastating psychological failure for the nation. Being good soldiers, the military leaders sought to satisfy the President's directives in a subject they did not fully understand and had assessed as a low priority in the big picture of national security.

The Army Staff's reaction to the integration of the Special Warfare Division, as explained in the findings of the Stilwell Report, was not focused on interoperability. The report pointed out deficiencies in planning, the understaffed Special Warfare Division of DCSOPS led only by a Colonel, and "the reluctance of the other staff sections to perform duties which [were] properly theirs" in order to assist the Special Warfare Division. This was, in part, attributable to the desire of other staff elements to focus on "normal" Army functions. According to Stilwell, "Instead of designing the FLAG with primary emphasis on its utility in waging counterinsurgency, the Army staff was engaged in 'fierce intrastaff arguments that developed...over the size and composition of the various blocks on the organizational chart.' The emphasis was on expanding the domain of one's own branch rather than on structuring the FLAG to fit an overall strategy for its use."²⁰

The military leadership in this case did not hold SOF and conventional force interoperability as a high priority. They sought to marginalize counterinsurgency organizations and they succeeded. However, over time and at the pace of change deemed

¹⁹ Krepinevich, Andrew F., Jr., The Army in Vietnam, Johns Hopkins, Baltimore, 1986, p. 271.

²⁰ Ibid., p. 106.

acceptable to the evolution of the conventional forces, the utility of SOF was seen fit for survival in the eyes of at least some of the military leadership.

G. CONCLUSIONS

The Kennedy administration faced a problem similar to that faced by the Roosevelt administration--a military bureaucracy that did not want to change according to the civilian leaderships' view of the national military requirements. Kennedy wanted his perception of a flexible response capability instituted in the military to counter Soviet sponsored wars of liberation. On the other hand, the conventional military leadership viewed conflicts like Vietnam as a sideshow in comparison to preparations for the Soviet threat in Europe. Like the OSS case study, civilian leadership would not achieve a substantial degree of SOF interoperability with the conventional forces. This case does show the raw building blocks being laid for future interoperability. Small incremental gains were made in the sustainment of SOF structure even after Kennedy's death. The variable of his leadership in championing the cause of SOF was the catalyst for change. The incremental gain for SOF and conventional force interoperability in this case was analogous to Infantry seizing a foothold in a building at the edge of the town. Infantry must then consolidate and hold until a superior force arrives to exploit the breach. There remained enough SOF structure and credibility to allow Special Forces, Civil Affairs, and Psychological Operations to survive until the variables of military leadership, political leadership, environment change, and technology change could align themselves in support of SOF and conventional force interoperability. Again this case supports the theory that interoperability between SOF and the conventional force will only work as an evolution from within the military, not as a revolution from above.

V. CASE THREE: SURVIVAL WITHOUT A POLITICAL GUARDIAN

A. INTRODUCTION

After Vietnam, the political and military consternation over counterinsurgency faded quickly. There were too many other military, political, and societal wounds to be licked. In the aftermath of Vietnam, the dominant variables of military and political leadership interacted in such a way as to stifle interoperability issues. This case centers around the selective amnesia that occurred in regard to lessons learned in Vietnam. The time frame of this case starts with the conclusion of the Vietnam War in 1973 until 1980, before Operation Desert One.

In the military, bureaucracy is a good thing; it promotes the routinization of tasks to allow complex organizations to flow and operate within the decision cycle of its opponents. However, when the organization's bureaucratic leadership ignores ground truth provided by junior leaders, the leaders have failed. The leaders are wrong because they then fail to engage in organizational corrective actions. During the Vietnam War an undercurrent of opinions opposed to the strategies used to prosecute the War were purposely filtered out. Most disturbing was the fact that the complaints came from the Military Advisory Group Vietnam, the very men who were executing the strategies. The American military's ability to be self-correcting was clouded by conventional military and the political leadership's desire to fight their kind of war, thus negating the military's ability to learn from its defeats.

The civilian leadership's effect on interoperability, under President Kennedy, was of great assistance to the SOF cause. But, political sponsorship can be fickle and not very successful at encouraging the support of conventional military leaders. All men, including military officers, make their own cost benefit analysis of situations. Those officers who supported or served the SOF cause had to have been mindful of the fact that their livelihood still depended on their allegiance to the conventional bureaucracy. A reasonable belief of organizational survival for SOF had to exist before many would

attempt to cut across the grain of the conventional bureaucracy. The perception of low percentage of promotions given to SOF experienced officers was an indicator of the conventional leadership's prognosis for SOF as a viable career path and its suitability for increased interoperability with the conventional force. BG Peter Dawkins surveyed 509 officers who served as advisors during January 1962 and again in September 1965 (see Table 3). The survey gives further evidence of conventional military disinterest in interoperability with SOF. To the Army's junior officers pursuing interoperability issues were increasingly viewed as unimportant to their careers.

Table 3. Officer Perceptions of Advisory Duty²¹

<u>War period</u>	<u>Career Advantage</u>	<u>Career Detriment</u>
January 1962-September 1965	54.4 %	26.5 %
October 1965-June 1967	36.0 %	49.5 %
July 1967- January 1970	36.1 %	48.3 %

After John F. Kennedy's death, the military continued its prosecution of the conflict in Vietnam. The military leadership maintained their belief in the strategy that the enemy would soon fight the conventional conflict that the United States military was hoping for. SOF was a secondary effort that was increasingly made to conduct missions that supported the conventional operations, such as reconnaissance and direct actions, over and above their original unconventional warfare and counterinsurgency role. Operations that attacked the infrastructure of the insurgency, such as the Phoenix Project, were misunderstood and under resourced.

The stain of Vietnam on American civilian and military institutions caused a regrettable lack of will to analyze the lessons learned, much like a person burned on a

²¹ Krepinevich, Andrew F., Jr., The Army in Vietnam, Johns Hopkins, Baltimore, 1986, p. 208.

stove who then refuses to reexamine the stove in order to learn how to turn it off. The conventional military had for a time chosen to engage in revisionist type theories that did not challenge their paradigm of war. With the distasteful conclusion of the conflict the geopolitical environment was still ripe for SOF involvement around the world. However, the political climate that gripped both the civilian and military communities caused a self-imposed state of selective amnesia in regard to the study of the lessons learned in Vietnam.

The effect on SOF and conventional force interoperability at the conclusion of Vietnam was the widening of an emotional rift between SOF and conventional forces. That rift was not unlike the rift between the military and the civilian population during the same period in that it was based on mutual misunderstanding on the part of all parties. Even some officers in the SOF community wanted to forget, rather than build on the lessons in Vietnam. In the early 1970s most of the archives and lessons learned documents on Vietnam, stored at the John F. Kennedy Special Warfare Center and School, were stacked in hallways where anyone interested in these document could take them before they were thrown the trash.

B. ENVIRONMENT CHANGES

The geopolitical environment was manipulated by the assessments of both the military and political leaders. America had been handed a rather inconclusive military defeat. The civilian leaderships assessment of the environment blamed the military. The military leaderships assessment of the environment blamed the civilian leadership. The American society in general blamed both the civilian and military leadership. The desire of all parties involved was to sweep Vietnam under the rug, to simply let it fade from the national memory as was done with the Korean War. The environmental realities may have determined that SOF and conventional force interoperability was needed. But the institutional scars received by the lessons of Vietnam caused other variables like leadership to make the variable of environment not a dominant factor for post-Vietnam attempts at SOF and conventional force interoperability.

C. TECHNOLOGY CHANGES

The general focus of military technology was primarily the improvement of lethality through firepower, mobility, and communications where it improves the ability to bring about a synergistic effect on the battlefield.

The effect of technology on SOF interoperability with conventional forces saw limited initiatives toward interoperability in communications. For the most part SOF research and development floundered without adequate funding. For SOF, many of the producers of technologies would have to redirect research and development to a genre of warfare that was more social than firepower-related. There were existing technologies that did enhance SOF communications and mobility, such as long range radios and airframes capable of deep penetrations into enemy airspace. In general the effect of technology as an enhancer for SOF interoperability with the conventional forces was marginal at best.

D. ORGANIZATION GROWTH

The effect of organization growth and reduction as a variable in this case acts as a yardstick for the measurement of an evolutionary process interoperability between SOF and conventional forces in the American military. The wartime organizational growth was attributed to outside political leadership. However, when SOF organizational reduction in this instance is compared to the case of the OSS, it shows a higher tolerance toward the institutionalization of SOF by the dominant variable, conventional military leadership. SOF was reduced but not disbanded in the wake of Vietnam. To a small degree SOF had become institutionalized within the military, but not interoperable. During Vietnam, organization studies were written and excellent concepts developed that fashioned SOF into functional military units. To some extent, these units were formed but only as emasculated organizations not in keeping with the original concepts that prompted their formation. The leaders of these Special Forces Groups did not waste the organizational tablescraps given to them. The key factor that the guardian conventional military bureaucracy allowed SOF

to control was: quality recruiting, imbuing SOF with an organizational mindset based on operational creativity above a reliance on firepower, and technology. SOF organizations would exist at the margins of operations other than war for more than a decade. In missions such as Foreign Internal Defense, Humanitarian Assistance, and Strategic Reconnaissance, even as a method of delivery of tactical nuclear devices, SOF forces had to continually strive to stay relevant enough to merit organizational survival under the stewardship of the conventional military.

E. POLITICAL LEADERSHIP

The effect of political leadership on SOF and conventional force interoperability in this case was a useful, but short-lived experience. President Kennedy's political leadership and assessment of the military and political requirements set the stage for a SOF attempt at interoperability with conventional forces. When Kennedy passed away, so did SOF's protection from the existing military leadership. From that point on the realization of SOF's integration with the conventional force would fade. President Johnson would not be as much a protector of SOF as was Kennedy; however, he did not support SOFs abolishment either. The support of civilian leadership has short-term benefit and limited long-term protection from the control of military leadership. Revolution from above does not work in favor of SOF and conventional force interoperability--the matter of interoperability must be championed by military leaders.

F. MILITARY LEADERSHIP

As in the preceding case, the variable of military leadership was the dominant variable in the interoperability of SOF and conventional forces. Military leaders within the American military bureaucracy proved more resistant to change than the variables of political leadership and environment change. In the post Vietnam era the military shelved the concepts of counterinsurgency and SOF interoperability with it. Focusing on the redirection of the American paradigm for the prosecution of regional conflicts paled in

comparison to the cold war priorities. The military leadership reacts to change at its own relatively organized rate of acceptance. The military as an organization can accept dramatic change when the military leadership views the change as internally produced. The changes in military matters were externally prompted by civilian leadership. The changes ran counter to their paradigm of war, and military leaders resisted the change. Whether the military leaders are conventional force or SOF they have historically engaged in a bureaucratic style of defensive posture and wait on a favorable change in the political wind. The mindset of the military leadership did not positively influence interoperability.

G. CONCLUSIONS

The effect of the variable of environment was like the preceding cases. The geopolitical environment was manipulated by the assessments of both the conventional military and political leaders. As in the preceding case the variable of military leadership was the dominant variable when in the interoperability of SOF and conventional forces. Military leaders within the American military bureaucracy proved more resistant to change than the variables of political leadership and environment change. The military leadership reacts to change at its own relatively organized rate of acceptance. The support of civilian leadership has short-term benefit and limited long-term protection from military leadership control. Revolution from above does not work in favor of SOF and conventional force interoperability. The matter of interoperability must be championed by military leaders. The effect of organization growth as a variable in this case acts as a yardstick for the measurement of institutionalization of SOF, not the evolutionary process of interoperability between SOF and conventional forces in the American military. SOF organizational survival in this case compared to the case of the OSS, shows a higher tolerance toward the existence of SOF by the dominant conventional military leadership. In general the effect of technology as an enhancer for SOF interoperability with the conventional forces was marginal at best.

VI. CASE FOUR: OPERATION DESERT ONE--A NEW LEASE FOR SOF

A. INTRODUCTION

The creation of Special Forces as a branch of the Army in 1986 was an extraordinary evolutionary leap in favor of SOF and conventional force interoperability. The significant evolutionary change in SOF and conventional force interoperability can be traced to the failure of the hostage rescue mission called Operation Desert One. With all due respect to the professionals who fell during the ill fated operation, Desert One was the best thing to happen to SOF and conventional force interoperability since President Kennedy. The fact is, if Operation Desert One had not been such a complete political and military failure, SOF would not possess many of the organizational strengths it has today.

To the existing military bureaucracy it was analogous to an organizational insurgency progressing from the latent phase of passive resistance to active resistance. SOF received a joint headquarters, a separate budget program, and was organized by law as a truly joint force. These very real organizational changes empowered SOF with a degree of strategic space to compete within the military at large for its proper niche in the spectrum of conflict. Prior to the failed Operation Desert One, special operations units existed at the discretion of their parent services. They survived on the fringes of military doctrine and often were not included in joint planning or contingency plans. Even though Operation Desert One involved primarily inextremis type forces. The corrective actions in its aftermath gave a new lease on life for both unconventional warrior types as well as the special mission units. As in the previous cases, the push to accept SOF and conventional force interoperability came from the civilian leadership. A major difference was that the residual effects of military failure were not transferable as it was in Vietnam. The military had to succumb to improving interoperability between armed services including SOF.

The United States with respect to the geopolitical and military environment was not defeated, just embarrassed. But, in an election year, the effect on the Carter administration was tantamount to losing a world war. A joint operation of immense political importance had failed. The effect of this failure on SOF interoperability with the conventional force, strangely enough would be a positive one. President Ronald Reagan had everything to gain by exploiting "Carter's failure." Subsequently, Reagan capitalized on the event by devoting resources toward a solution, to correct a problem he blamed on the previous administration. Hence, institutional changes to permanently promote interoperability in the conventional military would finally include the incorporation of SOF. Yet again, SOFs structure was rescued by civilian leadership. "For several years a small group in Congress, including senators William S. Cohen and Sam Nunn and congressmen Dan Daniel, Earl Hutto, and John R. Kasich, had studied the problems of U.S. special operations. Among their chief concerns were the fragmentation of the command of special operations forces and what they viewed as the services' halfhearted commitment to improving these forces--even though the administration viewed the upgrading of special operations forces as a priority."²² The reconfiguration of SOF had been slow, lacking the personal support of a president such as existed with John Kennedy. The aftermath of Operation Desert One was an acceleration toward interoperability; however, this time it was less of a revolution from above and more of an evolutionary corrective action involving military leaders.

Shaken by the fiasco in Iran and spurred by the Special Operation Review Group that investigated it, which recommended creating a counterterrorist joint task force with a permanent staff and forces, in 1982 the Department of Defense created the Joint Special Operations Command (JSOC)...In 1984 the Department of Defense created an additional special operations body, which, according to its charter, advised the JCS in all matters pertaining to special operations...Concurrently with the creation of

²² Vanderbroucke, Lucien S., Perilous Options: Special Operations as an Instrument of U.S. Foreign Policy, Oxford University Press, New York, 1993, p. 155.

JSOC and JSOA, the Reagan administration embarked on a program of 'revitalization' of U.S. special operations forces.²³

Desert One was not a failure of technology; it was a failure in joint interoperability.

"Lack of compatible equipment has been one source of difficulties; in the Iran rescue mission, many of the Air force, Marine Corps, and Army Units at Desert One did not have radios allowing them to talk to one another. In addition, the personnel who have come together to plan and execute strategic operations had difficulty understanding one another's standard operating procedures."²⁴ In one aspect the misguided application of military intelligence gathering technology proved to be a serious shortfall. "For most of the past three decades, the United States has, according to students of the U.S. Intelligence community, placed far greater emphasis on technical intelligence gathering than on collection by human agents. TECHINT spending has generally outstripped HUMINT spending by a ratio of about seven to one."²⁵ Rehashing the difficulties encountered in Operation Desert One is not the main point to be made. The important fact is that these and other problems related to interoperability are now being addressed and corrected over time. Technological innovations for SOF have recently begun to originate from SOF. The military's Planning, Programming, and Budgeting System (PPBS) may not provide the innovative edge that SOF needs to organizationally survive the information age.

By focusing preemptively on rigorous quantitative analysis of cost benefit effectiveness, PPBS subtly inhibited technological innovation...advantage in the PPBS arena accrued to systems which offer incremental improvements of tried and true technologies whose effect could be predicted with reasonable accuracy. Should anyone be surprised, then,

²³ Vanderbroucke, Lucien S., Perilous Options: Special Operations as an Instrument of U.S. Foreign Policy, Oxford University Press, New York, 1993, p. 171.

²⁴ Ibid., p. 155.

²⁵ Ibid.

that an extraordinary high proportion of weapons systems procurement programs which yielded major advances in military capability were the product of 'black' programs, originated and managed outside the PPBS mainstream? The bureaucracies that blossomed throughout the defense establishment were managed by military accountants who, in addition to confusing efficiency with effectiveness, also inhibited imagination and innovation. One should not be surprised that black programs, on the other hand seemed to have been more successful than those which have had to run the entire PPBS gauntlet.²⁶

SOF leadership now had a stake in the organizational game. The integration of SOF was not institutionalized within conventional planning at all levels, nor were SOF concepts integrated fully into the curriculums of conventional officer education and training schools. SOF leadership began making inroads for SOF integration or at least cooperation with the conventional force.

Examining the Reagan administration's push to have the Army generate Special Operations Forces (SOF) as they are now called, gives one a strong sense of *deja vu*. This time around however, the revolution from above is being led without the strong presidential personal interest evinced by John Kennedy. Nor is there anything resembling the Special Group (Counterinsurgency), which, while flawed, at least provided a sense of high-level concern for low-intensity conflict and a mechanism for linking together the numerous departments and agencies that would have to work together in any future U.S. involvement in foreign internal defense. Today oversight of Army special operations is carried out by only a handful of civilians in the Pentagon with the verbal blessing, but not the direct involvement of the Secretary of Defense Weinberger.²⁷

The SOF leadership pushed the SOF bureaucratic agenda, yet kept mindful of the fact that SOF is not the flagship, but a supporting combat arm to the conventional force.

²⁶ Guilmartin, John F., Jr., Technology and Strategy: What are the Limits? Strategic Studies Institute, Monograph, 20 July 1994, p. 23.

²⁷ Vanderbroucke, Lucien S., Perilous Options: Special Operations as an Instrument of U.S. Foreign Policy, Oxford University Press, New York, 1993, p. 271.

B. ENVIRONMENT CHANGES

The effect of the environment as a variable on SOF and conventional force interoperability was dominant in this case. The environment was the catalyst that caused the normally dominant variable of military leadership to trash its flawed assessments of military requirements. Military leadership had assessed a low priority to interoperability issues between services and SOF and conventional force operations. The environmental reality of the military's inability to operate jointly was rewarded by a clear and painful military defeat. The continued building of military requirements founded in inaccurate assessments of what the military geopolitical environment was, led to the military propagating its own interoperability problems.

For the first time the relationship between environment change and technology change would display an exponentially increasing effect of SOF and conventional force interoperability. As a matter of fact, the variables of environment, leadership, and organizational growth had begun to be pulled in the direction that information technology decided to take them.

C. TECHNOLOGY CHANGES

For the first time the variable of technology started to positively effect SOF and conventional force interoperability. Two important differences in technology existed in this case that significantly influenced the evolutionary process for SOF and conventional force interoperability. First, the focus of technology had transitioned from industrial production to information manipulation, e.g., the digitization of the battle field. The conventional force has increasingly tapped into technologies that bleed over into the more human or social concerns that SOF has typically been involved in. An example is the use of computers and databases for population control measures, potentially useful in counterinsurgency operations. Second, SOF has been endowed with its own research and development capabilities coupled with a SOF agenda for the development of technologies.

The key factor for SOF and conventional force interoperability has been the conventional military leadership as the sponsor of this technological focus on connectivity and information control that has pulled SOF into the fold as a usable product for the conventional force.

D. ORGANIZATION GROWTH

Organizational growth in SOF can prove to be a detriment to SOF and conventional force interoperability. For example, the Special Forces branch can barely maintain enough officers to keep operational slots filled. The accession rate is low due to a policy of admitting only high quality soldiers into the active Special Forces. To fill the operational slots by lowering the standards for admittance to the force could cause the force to become less effective. On the other hand the lack of organizational growth holds long-term problems for Special Forces branch. For example, the present compliment of Special Forces colonels and lieutenant colonels is too small a pool of Army-wide competitive officers for the rank of general officer. Thus, the opportunity for the future SOF community to be led by SOF experienced general officers is not likely.

E. POLITICAL LEADERSHIP

The effect of political leadership on SOF and conventional force interoperability in this case was substantial. The key component was the change in the interplay between the military and political leadership. The combination of a military defeat and the lack of heavy support for SOF from President Reagan made the application of political pressure on the military less like a revolution from above. The military's resistance to accepting guidance from the political leadership in regard to military matters was reduced by the fact that the blame for the failed mission in Iran could not be easily transferred to the political leadership, the media nor the enemy. Because of this combination of the variables, political leadership in this case was able to break the pattern of being only a short-term benefit to SOF and conventional force interoperability. A marked difference in the

geopolitical environment contributed to an increase in the political leaderships' demands for political objectives over military objectives when employing the military in the emerging genre of operations other than war.

F. MILITARY LEADERSHIP

The effect of the variable of military leadership remained the dominant variable in whether or not SOF and conventional force interoperability can be achieved. The key in this case for the conventional military leadership was the failure of Operation Desert One. If the operation had been conducted without SOF involvement, the previous cases would indicate that SOFs interoperability with the conventional force would have been ignored. The shortfalls in interservice joint operations would have been addressed. However, SOF would not have been highlighted and targeted for corrective actions or enhancement.

The subsequent ample resourcing of military programs during the Reagan and Bush administrations assisted in lowering the resource competitive mindset between conventional forces and SOF. This moderate level of evolution toward SOF and conventional force interoperability must not give birth to arrogance within SOF. SOF must use each new organizational capability to engender further interoperability between SOF and conventional forces. The conventional force initiatives in information warfare promise a multitude of SOF opportunities to prove itself interoperable with the conventional forces without sacrificing SOFs uniqueness.

G. CONCLUSIONS

Operation Desert One was the best thing to happen to SOF since President Kennedy. The fact is that if Operation Desert One had not been such a complete political and military failure, SOF would not exist in its present form. If the operation been conducted without SOF involvement, the previous cases would indicate that SOFs interoperability with the conventional force would have been ignored. The corrective actions in its aftermath gave a new lease on life for the unconventional warrior-type units

as well as the special mission units. As in the previous cases, the push to accept SOF and conventional force interoperability came from the civilian leadership. A major difference was that the stink of military failure was not transferable as it was in Vietnam. The military had to succumb to improving interoperability with SOF. The effect of civilian sponsorship had succeeded where it had previously failed. In this case some sustainment of SOF interoperability was achieved by acts of law that prevented the conventional bureaucracy from diverting SOF efforts at interoperability. A definite change in the application and the acceptance of guidance from the political leadership had occurred. This time it was less of a revolution from above.

VII. SOF INTEROPERABILITY WITHIN THE MILITARY

Once we had achieved our goals, bureaucracy took over. We became top heavy, and as an institution we forgot how to test, experiment and learn new ideas. We began to prefer analysis and debate to experimentation. It is time to remind ourselves that today's "profits" are traceable to wise and bold decisions made many years ago. If we are to profit in the future, we must continue to focus on what is to be rather than on what has been.²⁸

Sidney Shachnow, Major General (Ret)

A. INTRODUCTION

Chapters III, IV, V, and VI examined four cases of the SOF evolution toward an optimal form of integration with the conventional force. Chapter VII will present conclusions on the four cases as a whole, identify the recurring dominant variables that helped SOF interoperability with conventional forces and also identify those variables that over time had a minimal effect on SOF interoperability with conventional forces.

The recurring situation in all four cases was the forced innovation on the military by civilian leadership. That external pressure was met each time by a corresponding resistance by the conventional military leadership. In every case, there was substantial short-term organizational growth and a short-lived period of civilian political support. When civilian leadership support began to wane, the conventional military bureaucracy cut back SOFs organizational gains. SOFs receipt of external support from civilian leadership often saved the day during organizational low points. However, external support never made SOF a contender for adequate levels of interoperability into the military. U.S. Special Operations Forces can not depend upon external political leadership to ensure

²⁸ MG (Ret) Sidney Shachnow, Notional 'X' Command, Special Warfare Magazine, October 1995, p.16-17.

organizational survival within the military bureaucracy. For SOF to survive, it must foster the support of the conventional military leadership. Environmental realities and even military failure, at times, did not sway the power of the U.S. military bureaucracy to follow its own agenda. Operation Desert One was the best thing to happen in respect to Special Operations Forces organizational survival. The corrective actions in the aftermath of Desert One provided the strategic space for Special Operations Forces to grow organizationally and resist being marginalized by the military's conventional bureaucracy.

The following are conclusions drawn from the impact of the five variables on interoperability:

- Environmental reality was not always the dominant variable in determining whether or not SOF and conventional force interoperability was important. The geopolitical environment was continuously subjected to differing political and military assessments of what the military requirements should be.
- Technology, as a variable effecting SOF and conventional force interoperability, has changed more than any of the other variables effecting SOF. Until the mid-1980s, technology played a minor role in the promotion of SOF and conventional force interoperability. Over time the technological focus of the conventional force has begun to shift from production for the enhancement of firepower to the manipulation of information. This change has made the abilities of SOF to gather information, conduct population control measures, and coordinate with foreign services more interoperable with the conventional force.
- The variable of organizational growth has not been a good indicator of SOF and conventional force interoperability. At best it shows the level of tolerance by conventional military leaders toward SOF existence within the military.
- The variable of political leadership has been consistently good for the short-term organizational survival of SOF. Political sponsorship of SOF has been consistently less resilient to waffling over time. The political leaders may have made the correct assessment of the geopolitical military requirements; but, the imposition of their SOF requirements on the military leadership did not endure over time.

- Military leadership was the dominant variable in the viability of SOF and conventional force interoperability. When pressured by the political leadership to enhance SOF and conventional force interoperability, the military leadership reacted with a bunker mentality, to wait it out until the political luster of the idea had faded. This had worked until the failed Iranian rescue in Operation Desert One. The undeniable shortcomings of the military, both SOF and interservice interoperability, forced the conventional military leaders to accept a degree of unpalatable change in favor of SOF and conventional force interoperability.

B. INTEROPERABILITY IN THE PRESENT

Much like the tumblers in a lock must be aligned, the five factors influencing organizational reconfiguration must be aligned in favor of SOF before it can restructure to engage future requirements and promote SOF's interoperability within the conventional military bureaucracy. Conclusions will be formed about the following:

- Why now is the best time to engage in reconfiguration SOF. Examining what we think the future holds in store.
- What SOF must do to succeed in maintaining relevance in the next century.

The factors of environment change, technology change, organization growth, political leadership changes, and military leadership changes have converged like the tributaries of a river, providing the organizational strategic space for SOF to attempt a cooperative unification with its guardian bureaucracy, the conventional military.

As stated by Former Secretary of Defense Les Aspen, the U.S. will be faced with four pre-eminent challenges: the challenges of the proliferation of nuclear weapons, the threat of regional conflicts, the dangers to newly emerging democracies, and the threats to the global economy. The National Military Strategy of the United States envisions four principal means of countering these dangers and achieving our national security objectives. Through strategic deterrence and defense, forward stationing, and being capable of crisis

response, the United States prepares to achieve its national security objectives in an unsettled and dangerous world.²⁹

Radical changes in the global geopolitical environment have sparked a frenzied discussion of the concept of reconfiguration throughout the military services. SOF leadership has the ominous tasks of structuring a force to engage emerging military requirements, and simultaneously chart a course that will provide organizational survival within the military institution.

Currently, the military has espoused a concept of a "Revolution in Military Affairs" and every service is talking of reconfiguration to varied extents. It is, however, a reconfiguration tainted with downsizing.

The United States would be ill-served by forces that represent nothing more than a scaled-back or shrunken-down version of the ones we possess at present. If we simply prorate our reductions-cut equally across the board-we could easily end up with more than we need for contingencies that are no longer likely-and less than we must have to meet new challenges. What we need are not merely reductions- but restructuring.

President Bush, Aspen Institute, August 2, 1990

Will the military take heed of President Bush's advice and not reduce a SOF force that has come of age, just because the conventional force must reduce? The priority should now shift to the forces most relevant to the environment. The United States military is presently experiencing culture shock over some of the recent recommendations for major reconfiguration. "In fact, Miller and Friesen (1984) argue that organizations typically go for fairly long periods of time with relatively little structural change but then experience intervals of major reconfiguration. Organizations try to retain their existing form as long

²⁹ Steven L. Arnold and Christopher Allen Yuknis, *Ethnic Conflict: Force Structure and Training Requirements*, Strategic Studies Institute, Monograph, 1993, p. 329.

as possible in order to maintain internal consistency and to avoid upsetting the existing equilibrium. But, if the environment changes while the organization remains static, the structure gets more and more out of touch with the environment. Eventually, the gap becomes so wide that the organization is forced to do a major overhaul. Reconfiguration in this view is like spring cleaning: We accumulate debris over months or years, and finally we have to face up to the mess."³⁰

In the real world of competing bureaucracies, political shifts, and diminishing resources, there is a historical precedence for militaries to be reformers and not innovators. The long view of the peacetime military centers on fighting the parochial fight for turf and resources.

Organization theory explains a great deal about general tendencies within the military organizations that affect military doctrine and grand strategy...Often, militaries prefer offense, yet defensive strategies emerge. Militaries oppose innovation. Military organizations attempt to go their own way and avoid the setting of priorities. Services avoid cooperation with each other. In spite of such tendencies priorities get set, the military organizations are deflected from their preferred course.³¹

Paul Bracken recommends:

From many years of experience in long-range planning at the Hudson Institute came some difficult lessons learned. The hardest single feature in conducting long-range planning and brainstorming sessions for both government and private sector clients was to divorce oneself from current conditions...With the end of the cold War it is understandable that immediate issues would be analyzed as future signposts. In the absence of other guidance there is not much else on which to base planning. But if anything seems certain it is that in not too many years a new equilibrium

³⁰ Lee G. Bolman and Terrence E. Deal, Reframing Organizations: Artistry, Choice, and Leadership, Jossey-Bass Publishers, San Francisco, 1991, p. 95.

³¹ Barry R. Posen, The sources of Military Doctrine: France Britain and Germany Between the World Wars, Cornell University Press, London, 1984, p. 227.

in U.S. military spending will be established, the situation in Bosnia will be accepted, and the new dangers will loom on the nation's horizon.³²

The trends that have a profound influence on SOF are the gravitation of the military toward Joint and Combined Operations combined with the national leaderships' increased engagement of operations other than war. The criteria used in selecting these particular trends were:

- These were the most often referred to in current publications concerning the future of military organizations.
- Operations other than war are predicted to be the preeminent military requirement of the next century.
- The trend of Joint and Combined operations represent the internal organizational attempt at adaptation to new environmental requirements, and constraints.
- These trends combined present a better picture of SOF's future configuration for their niche in the spectrum of conflict.

The trends of U.S. involvement in operations other than war and Joint or Combined Operations should be capitalized on by SOF. I used as an outline, the five variables typically influencing organizational reconfiguration: environment changes, technology changes, organization growth, political leadership changes, and military leadership changes. Using this outline, I examined why SOF and conventional forces should integrate.

³² Paul Bracken, Whither the RMA: Two perspectives on tomorrow's Army, Strategic Studies Institute, Monograph, pp.1-2.

SOF must act as the testbed, not just emulate conventional force structures. As the organizational testbed, SOF will be positioned to present another reason for its organizational importance within the rubric of the American military paradigm of war.

C. OPERATIONS OTHER THAN WAR

Prior to every major conflict and in its aftermath, operations other than war have and will always exist. Often, whether or not the military has a taste for these operations other than war, they will not prevent our national involvement in these operations.

1. Environment Changes

The Cold War notion of conflict short of war is obsolete. Politically and militarily, the Third World of the future will be full of danger. The future will most likely be dominated by peace enforcement in failed states, new forms of insurgency and terrorism, and 'gray area phenomena.' Many if not most Third World states will fragment into smaller units. Ungovernability and instability will be the norm with power dispersed among warlords, primal militias, and well-organized politico-criminal organizations. U.S. Policy in the Third World is likely to be more selective and the U.S. homeland may no longer provide sanctuary. Renewed external support will restore the lagging proficiency of insurgents and terrorists.³³

If this scenario of a twenty-first century environment is correct then SOF is already relevant with respect to the basic skills they possess. Since World War II, SOF type forces have worked the "gray area phenomena" on the margins of the spectrum of conflict. In the Cold War, Special Forces units were relegated to Foreign Internal Defense operations, Joint combined exercises for training, humanitarian assistance missions, and others.

The Army has on average 18,000 soldiers deployed in over 1000 operational missions in some 60 countries. This represents about a 300

³³ Steven Metz, The Revolution in Military Affairs and Conflict Short of War, Strategic Studies Institute, Monograph, July 25, 1994, p. V.

percent increase from 1990, just prior to the Persian Gulf War. These soldiers are performing humanitarian operations in Somalia, Northern Iraq, and the Pacific; peacekeeping in Sinai, Cambodia, the western Sahara, Syria, and Macedonia; training exercises in Italy, Saudi Arabia and Kuwait; counterdrug and nation assistance operations in Latin America, Africa, and the Pacific Rim; and medical support of UN forces in Croatia. With little publicity and attention, America's Army executes these new missions as well as our traditional military-to-military relationships to secure our interests and mitigate conflicts in ways that no other military formation can.³⁴

One factor not highlighted in the preceding citation was the presence of SOF in all of the operations mentioned. SOF personnel fulfilled many tasks, including: medical specialists, civil affairs coordinators, de-mining operations trainers, advisors, Direct Action operators, and other activities. They were the key rapport builders due to their cultural training. SOF have skills that are the keystone in approaching conflicts requiring political, cultural, and economic solutions, conflicts in which firepower or overuse of coercive force exacerbates the problem.

If strategy could ever be approached as a straightforward technical exercise in the movement of military formations across country, war on the map as Jomini put it, followed by an equally straight forward, though considerably bloodier, exercise in fire and maneuver on the battle field, that time is long past. Similarly, of there was ever a time when war could be approached as an exercise in production line engineering, as the U.S. Army Air Forces did in preparation for World War II, that time is long past, as well. The maneuver of conventional forces and industrial production will remain important integers in the strategic equation, but they are no long preeminent.³⁵

³⁴Steven L. Arnold and Christopher Allen Yuknis, *Ethnic Conflict: Force Structure and Training Requirements*, Strategic Studies Institute, Monograph, 1993, p. 1.

³⁵ Sir Michael Howard and John F. Guilmartin, Jr., *Two Historians in Technology and War*, Strategic Studies Institute, Monograph, pp. 39-40.

SOF comes to the new strategic environment with a few organizational advantages:

- Indoctrination to a new paradigm of warfare is not required, being mindful of the political, cultural, military implications are institutionalized in SOF.
- The value of maturity, interpersonal skills, and cross-cultural communication are as much a part of their organizational mythos as their commando skills.
- SOF does not require retraining to engage this category of operations, while the conventional force wrestles with how, and questioning the benefits of retraining and reconfiguration warfighting units for these tasks.

The capability which SOF lacks is a structure that contains the force capabilities required to conduct these regionally specific operations. However, the events of Haiti, Somalia, Desert Shield and Desert Storm, Sierra Leone, and soon Bosnia Herzegovina makes SOF utility clear. What it does require is the structure empowered with the key components used in operations other than war.

2. Technology Changes

Martin van Creveld suggests that technology plays an increasingly chaotic influence on trends. "Given the sheer number of the points of contact between technology and war, it is exceedingly difficult to discern long-term trends," especially because the nature of technology and its relationship to war "are connected, interacting, and interchangeable." In addition "the interaction of technology and war at any given time has been as much the product of arbitrary and the accidental as it was of the inevitable and the necessary."³⁶

Accepting the above assumption leads to the recommendation that SOF should stay abreast of the last technology surge, such as information warfare, but not to bank on a technology for organizational survival. SOF needs to stay with timeless strengths, such

³⁶ Michael J. Mazarr, The Revolution in Military Affairs: A Framework for Defense Planning, Strategic Studies Institute, Monograph, June 10, 1994, p. 7.

as, high quality personnel possessing maturity, cross-cultural skills, and precision oriented warfighting skills that are not as susceptible to technological change. "Emerging technology may improve the application of force in conflict short of war, but there is probably no imminent RMA in this arena. The changes in conflict short of war will be considerably less dramatic than in those projected for mid- to high-intensity combat, particularly when possible constraints or countermeasures are considered."³⁷ Technological innovations are only useful for as long as it takes your enemies to match it or develop an inexpensive countermeasure. "Because U.S. engagement in conflict short of war will continue to have weak domestic support, opponents will not have to match us innovation for innovation, but only increase the cost of American engagement beyond the low limits of public and congressional tolerance."³⁸

3. Organization Growth

A guiding principle is the evolution and empowerment of the SOF organizations within Joint operations and operations other than war. Growth in the number of personnel and headquarters is not the objective. The objective is the strategic positioning of SOF within their regions of orientation under a flatter command structure suited to CINCs geographic warfighting requirements. Organizational growth and decline in the conventional force or SOF has previously been of little benefit toward interoperability. SOF could potentially grow in size and still not enhance its interoperability with the conventional force efforts. Given the high probability that conventional forces will continue to be drawn into operations other than war, to separate and not be interoperable with SOF would be a waste of limited resources.

³⁷ Steven Metz, *The Revolution in Military Affairs and Conflict Short of War*, Strategic Studies Institute, Monograph, July 25, 1994, p. 12.

³⁸ *Ibid.*, p. 13.

4. Political Leadership

Now is the time for SOF to restructure. As in politics, timing is everything when attempting organizational change. The combination of the following sets the stage for interoperability with the conventional force: flux in the global economy, military downsizing, and changing regional balances of power, push the military to selling itself on the idea of changing with the environment. SOF as a branch is in its infancy. But now it possesses a stake in the game and a bureaucratic agenda with some strategic space provided by the Nunn-Cohen amendments.

5. Military Leadership

The most poignant variable for SOF leadership will be that unless SOF can change the existing bureaucratic rules by which its officers are managed, SOF will never grow its own General Officers to lead Special Operations Forces. The self inflicted wound of low accessions and retention of junior officers is unavoidable due to the pursuit of maintaining high quality officers to fill operational slots. Some gains have been achieved in the percentage of SOF officer promotions. These gains do not balance the existing long range detriment caused by an insufficient pool of competitive SOF officers to vie for general officer ranks. SOF may well have to suffer the fate of suppression from its own future general officers who were indoctrinated to conduct warfare with a strictly conventional paradigm of warfare.

D. JOINT AND COMBINED OPERATIONS

1. Environment Changes

For the foreseeable future, the U.S. must retain its unequalled military capability to fight and win wars decisively and to deter nuclear attack. Moreover, we cannot relinquish our capacity to act unilaterally with decisive military force. However, unilateral military force, even when applied by a superpower such as the U.S. is insufficient to address the cumulative effect of numerous regional, ethnic, and civil wars accompanied

by countless refugees, mass starvation, disease, the breakdown of civil order, and anarchy.³⁹

Barry McCaffrey, Lieutenant General

Two points that can be extrapolated from the above citation are: first, that the best organizational method geared to maintaining a unilateral capability is the further integration of Joint Operations within the military system; second, that combined operations will become commonplace in addressing regional problems. Coalitions with strange bedfellows such as the Syria and U.S. cooperation during Operation Desert Storm will continue, especially at a time in which defense planning in general and Alliance commitments in particular are attracting diminished support from publics which perceive no direct "threats" to their national or regional security interests. In many cases these publics seek to pay for domestic social programs--from unification costs in Germany to health care reform in the United States--out of what they widely perceive as "excess" defense funds. As a result, this is universally viewed as a good thing or even as a "necessary evil." Moreover, decades of old fights over "burden-sharing," combined with recent economic disputes ranging from Maastricht's effect on U.S. industry to trade disputes with Japan, have a negative effect on the American public view of our traditional security relationships with our traditional allies.⁴⁰

Such a trend calls for the U.S. military to quickly form ad hoc coalition support teams, or units possessing the capability to ensure unity of effort and connectivity across potentially wide cultural and technological gaps between us and our potential coalition

³⁹ Barry McCaffrey, Military Support for Peacekeeping Operations, Strategic Studies Institute, 1993, Monograph, p. 246.

⁴⁰ Jacquelyn K. Davis, Refocusing Traditional Alliances and Establishing New Ones, Strategic Studies Institute, Monograph, 1993, p. 202.

partners. SOF coalition support teams (CST) have championed this field of endeavor, in Desert Storm, Somalia, Bosnia, and other combined operations.

The following lessons learned recommendations recorded by the Center for Army Lessons Learned (CALL) depict an environment that demands SOF's integration into the joint and combined operations. These recommendations are from three operations other than war: (1) Operation Just Cause, a predominantly unilateral military undertaking; (2) the combined deployment of United Nations, NGOs, and US military; and (3) Operation Uphold Democracy, in Haiti, SOF shows its mental flexibility and flare for being innovative.⁴¹ The new joint and combined operations environment has fostered more opportunities for SOF and conventional force integration. Even the conventional force lessons learned publications repeatedly cite the complimentary effect of SOF when combined with conventional operations.

- Operation Just Cause Lessons Learned⁴²

1. Following initial combat operations, the language capabilities and regional expertise of SF, civil affairs (CA) and psychological operations (PSYOPS) units were critical to stability operations.
2. Intelligence sharing between SOF and the conventional forces is absolutely critical.
3. SOF units often formed the nucleus of the operational element which was reinforced with conventional Infantry acting in direct support or on stand-by as a quick reaction force.
4. SF A Detachments formed liaison teams to interface between conventional force area commanders and the local civilian government and police officials.
5. SF conducted preliminary medical and engineer assessments and surveys for use in establishing the baseline CMO plan.

⁴¹ Operation Just Cause Lessons Learned, Center for Army Lessons Learned Volume II, CAC, Fort Leavenworth, Kansas, October 1990, p. II-4.

⁴² Operation Just Cause Lessons Learned, Center for Army Lessons Learned Volume II, CAC, Fort Leavenworth, Kansas, October 1990, p. II-4.

- Operation Restore Hope and UNOSOM II Somalia Lessons Learned⁴³
 1. CINC consider the capability of SF as a HUMINT collection asset early in the strategic planning cycle, prior to a decision to commit conventional forces in a humanitarian relief role.
 2. SOCCE should deploy with the supported unit; consider attaching it to the supported unit.
 3. Strategic planners recognize and plan the use of CA assets to facilitate the development of theater-level themes, command relationships, missions, and priorities-- and then publish CA initiatives in the OPLAN/OPORD.
 4. Planners anticipate employment of PSYOPS organizations during Humanitarian Assistance mission planning. PSYOPS teams operation, including post-testing.
 5. Include the application of PSYOPS and Special Operations in Peace Operations into U.S. doctrine.
 6. In these cases, give careful consideration as to how SOF will be integrated in the overall theater effort.
 7. Include a SOF planning element in any U.S.-sponsored theater headquarters or JTF.
 8. FM 100-23, Peace Operations, must address separately and collectively the unique and essential aspects of civil affairs, PSYOPS, intelligence, and counterintelligence. Efforts must be coordinated at the highest headquarters to support the campaign plan.

- Operation Uphold Democracy Haiti Lessons Learned⁴⁴
 1. The SFODA commanders are breaking ground in operations other than war that could easily become a part of conventional operations in the future. The

⁴³ Operation Restore Hope Lessons Learned Report, 3 Dec 1992 - 4 May 1993, Operations Other Than War, Center for Army Lessons Learned, CAC, Fort Leavenworth Kansas, CH. IX-1.

⁴⁴ Operation Uphold Democracy Initial Impressions Volume II, December 1994, Operations other Than War, Center for Army Lessons Learned.

lessons and work-arounds that the ODAs have employed when dealing with NGOs and PVOs, USAID and IOMs are applicable to all forces and present an area that is grey and not clearly defined.

2. Based on lessons learned from operation "Desert Shield/Storm," Major General Byron (USACOM) directed the formulation of three CSTs to assist the newly forming coalition forces to "lash-up" with American forces.
3. Consider forming Mobile Coordination Teams (MCTs) to act as liaison between SFODAs and governmental organizations, non-governmental organizations, and private volunteer organizations with funds for civil projects.

2. Technology Changes

The application of new technologies in the arena of operations other than war will assist our joint forces in their ability to achieve a greater degree of connectivity in communications and procedures. Due to better communications technology, combined operations with allies will be afforded more opportunities to ensure reliable coordination. The business of cross-cultural relations will always be a low technology messy job. Unless the gaining of rapport between allied forces can be obtained through a new technology, SOF will need to maintain its Desert Shield example of basic cross-cultural and interpersonal skills.

3. Organization Growth

A feasible best scenario for SOF would be one of relatively little growth. Considering the present downsizing of the military, no decrease of SOF force structure is a mark of organizational success. But, meeting the national military requirements and organizational growth in terms of size is not important. The reconfiguration of SOF units to have the capabilities that joint or combined operations need, is the organizational growth that will be important.

4. Political Leadership

The reliance on external civilian political support for SOF will not ensure the interoperability of SOF with the conventional force. However, it is a bonus for SOF that the geopolitical environment in the 1990s continues to lean in SOFs favor as the politicians force of choice for regional military problems. The politically low profile operational style of SOF type forces has engendered the continued support of the political leadership. The ability to project force in a non-coercive manner has held great political leverage in the application of United States foreign policy. The recent shift of political leadership away from imposing SOF-related changes on the conventional military leadership to the application of interoperability by military leadership at the military's pace, is a hopeful sign for SOF and conventional force interoperability.

5. Military Leadership

A slow change in attitude in favor of SOF has begun within some of the conventional military. This favorable trend must be encouraged, but it must emphasize SOF's ability to compliment conventional forces, not emulate them. The JFK Special Warfare Center continues to ensure the inclusion of SOF in new doctrinal publications wherever possible. The intellectual literature on military affairs continually raises the priority of SOF participation in joint and especially combined operations with allies. In his book, The United States Army in Transition, 1973, LTC Fredric J. Brown wrote: "Certainly our Special Forces personnel performed magnificently in Vietnam, but their example merely illustrates the point that a great deal of time and effort are needed to produce a competent guerilla leader. And it is of course true that while the indigenous efforts were important, they were decidedly subsidiary to the overall main force effort."⁴⁵ His current book, The U.S. Army in Transition II, 1993, shows a marked difference in his perception of SOFs role:

⁴⁵ Zeb B. Bradford, Jr. and Fredric J. Brown, The United States Army in Transition, Sage Publications, Beverly Hills/London, 1973, p. 65.

It may be useful to create regional institutes at Fort Leavenworth tied to regional Special Operations Forces (SOF) Groups, to provide area expertise. Regional Institutes could also assess, as an element of contingency planning, national military comparative ability of potential allies by battlefield functions. In a multinational force, national contributions would take advantage of national military strengths. For, example, the United States clearly has dominant intelligence capabilities, and the U.S. contribution would exploit this fact. Then, if the planning results in an actual contingency operation, SOF could facilitate the introduction of BOS into the particular region. This could be quite similar to SOF training responsibilities with allies in Operation Desert Shield. The issue is not regional alignment, as during the Cold War, but the development of local military associations in step with political, economic, and social realities of the information age as they evolve with these places...The global 'victory' of democracy underscores the importance of the Army's (particularly SOF's) role in encouraging competence and developing equal opportunity. Because forward-presence operations seem to offer great peacetime opportunities, an institutional structure would be needed to focus these efforts.⁴⁶

The progress in changing the mindset of the military leadership is slow. But the fact that many military leaders are talking of adjusting the forces to the environment, the information age, and that SOF should have a definitive role in combined and joint operations is a hopeful sign. However, when it comes to the nuts and bolts of who will pay for jointness, or who will not get the resources, bureaucratic parochialism will raise its head. There is of course considerable political clout to be relinquished or gained by a services' participation or abstinence from Joint Operations.

SOF leaders have a relatively good understanding of what SOF does operationally and generally understand what the conventional forces are taught to do. The problem for SOF leadership in a joint or combined operation is that conventional forces do not understand the full capacity of SOF to assist the conventional force. The cornerstone of

⁴⁶ LTG Fredric J. Brown, Ph.D., USA (Ret.), The U.S. Army in Transition II: Landpower in the Information Age, Brassey's (US), Inc., Washington, New York, London, 1993, p. 35.

the solution to the problem is education; specifically the interoperability of joint operations education with SOF, the conventional force, and allied forces. Conventional leader development schools must integrate more hours into their curriculums focusing on SOF integration.

E. CONCLUSIONS

The present United States military operational environment does not require the application of mid- or high-intensity warfare. Today's mix of low-intensity conflicts and emerging mission that fall short of war, make the use of set piece warfighting units not an efficient use of available resources.

SOF being endowed with the basic cultural and interpersonal skills required for the spectrum of operations other than war can easily transition to engage these threats. As a byproduct, immersion in their respective regions has value in the field of human intelligence HUMINT, and enhances SOF ability to perform warfighting requirements in their respective regions. Conversely, this supports the sustainment of conventional force warfighting skills by allowing large units to stay out of long-duration operations other than war.

The environment of the 1990s is full of operations that give evidence of SOFs usefulness in regional conflicts of a wide variety. Operations other than war will be a factor no matter what type of conflict emerges in the early twenty-first century.

The military's mindset in regard to Joint and Combined Operations is becoming receptive to change. SOF should lead the way in developing command and control systems that exploit its inherent abilities to increase the rapport between services and allies.

The conventional military leadership at the CINC level has become more likely to request SOF capabilities in their respective regions than ever before.

VIII. RECOMMENDATIONS FOR SUCCESSFUL SOF INTEROPERABILITY WITH THE CONVENTIONAL MILITARY

The following recommendations are for SOF leaders contemplating reconfiguration. These recommendations are derived from the previous chapters examination of the process of SOF organizational development and interoperability efforts under the rubric of the conventional military.

- SOF must recognize the organizational tendencies of the military bureaucracy to resist change. With this recognition SOF must emulate appropriate conventional staff and coordination functions. The purpose being to create a level of connectivity that is "comfortable" and effective for both SOF and conventional forces. This does not mean that SOF will emulate conventional forces at an operational level. SOF must not be interpreted as being interchangeable with the conventional forces.
- SOF should continue to pursue close relationships with civilian leadership. Though, their assistance does not always have a lasting effect on SOF integration with the conventional force, external political support has been a pivotal organizational shot in the arm on several occasions. A Special Operations Panel or Subcommittee in each Armed Services Committee could provide useful forums for such purposes and simultaneously facilitate congressional oversight. However, the garnering of political support that goes against the grain of the general purpose force leadership can potentially alienate SOF issues.
- SOF should become the testbed for joint operations. USSOCOM is currently conducting Force XXI experiments in the 7th Special Forces Group in which PSYOPS, Civil Affairs, and Military Intelligence Units are organic to the Group. SOF due to its lack institutional strength, must innovate in more ways than just tactically to survive within the military. Acting as the organizational testbed for future military organizations is one avenue for vying for relevance in the coming century. SOF as it exists today is truly a joint organization, but, it should now evolve to a new level of jointness at the operational level of the

organization. The next step may be the formation of combined services SOF units.

- SOF units need to be forward based to ensure regional expertise through multiple low cost deployments into their regions. As a byproduct, immersion in their respective regions has value in the field of human intelligence HUMINT, and enhances SOF ability to perform warfighting requirements in their respective regions. SOF being endowed with the basic cultural and interpersonal skills required for the spectrum of operations other than war can easily transition to engage these threats.
- The present priorities United States military operational environment does not require the application of mid or high intensity warfare. Today's mix of low intensity conflicts and a broad spectrum of emerging mission that falls short of war, make the use of set piece warfighting units not an efficient use of available resources. In operations other than war SOF supports the sustainment of conventional force warfighting skills by allowing large units to stay out of long duration operations other than war. While SOF stays for the duration, or prepares to handoff the mission to some other agencies or coalitions.
- CINCSOC, his component commanders, regionally oriented CINCs, theater SOC Commanders, and their staffs all believe an undesirable imbalance exists between Active and Reserve Component (AC/RC) Civil Affairs and PSYOP forces. Continued reliance on RC volunteers might be budgetarily advantageous but has practical drawbacks. Active duty personnel risk burnout, possibly followed by mission failure. Alter the AC/RC mix in favor of active duty forces; or authorize the National Command Authorities to active reserve civil Affairs units that total up to 25,000 personnel, as the outgoing CINCSOC recently recommended in his *End of Tour Report* (Annex A); establish an Individual Ready Reserve for Civil Affairs and PSYOP.⁴⁷

⁴⁷ Collins, John M., *Special Operations Forces: An Assessment 1986-1993*, Congressional Research Service, Library of Congress, Washington, D.C. 20540-7000, July 1993.

- Information Warfare promises many interesting capabilities that possess amazing potential for SOF. Unfortunately, the field is still in its infancy and not fully understood by all. SOF should actively engage this evolving capability with caution. SOF can not afford to become enthralled with interesting shiny objects that do not directly enhance SOF mission capabilities, yet, devour its budget. The manipulation of information between the SOF and the conventional force is the key to interoperability. SOF can not fall behind in those area of information warfare that will bind it closer to the operations of the conventional force. The future Information Warfare environment can not be ignored, but, participation in it will be analogous to riding a tidal wave, SOF may have to keep up or be made not relevant in the coming century.
- Personnel management rules at the Department of Defense must change to assist SOF. SOFs pursuit of quality personnel hinders its ability to compete in the current bureaucracy. For example, Army Special Forces have low levels of accessions of junior officers. Making the special forces branch hard pressed to compete with other branches of the Army when trying to fill key higher staff positions with Special Forces officers. Officers with little or no special operations experience continue to occupy key command and staff positions within USSOCOM Headquarters and AFSOC. CINCSOC could refuse to accept unqualified designers, instruct his component commanders to do likewise, and inform the Secretary of Defense if results remain unsatisfactory. Also, the Special Forces pool of Lieutenant Colonels is too small to be competitive for future general officer boards. The Army Lieutenant General who commands USASOC occupies the only three-star billet within the U.S. special operations community. Navy and Air Force flag officers, whose opportunities for promotion therein terminate at two stars, can aspire to assignment as CINCSOC only if parent Services put them into a three-star conventional space. That never happens in the Navy and seldom in USAF. The two SEALs who enjoy flag rank never can serve on the Joint Staff or command a theater SOC, because they always must fill two SEAL slots within USSOCOM. Legislation that authorized a three-star Deputy CINCSOC and permanently allocated one star to every theater SOC would enhance the professional development of SOF flag officers and expand the pool of candidates who are well qualified to become CINCSOC.⁴⁸

⁴⁸ Ibid.

The evolution of the U.S. Marine Corps contains a lessons learned in how to survive organizationally within the military. SOF leaders should study the evolution of the Marine Corps to understand both the positive aspects and the pitfalls when competing for organizational survival in the U.S. military.

Since the 1800s the Marines have acted as a suitable force for the prosecution of "small wars" around the world. They might have developed into our premier force for operations other than war. However, they, like SOF, have faced extinction at the hands of their parent bureaucracies in the military over the last 150 years or so.

The Marine Corps chose to emulate the conventional forces, they emphasized their similarities, as we should. The Marines cultivated outside political support as we should do as well. They integrated themselves into joint service staff positions, as we need to do. The negative aspect of their example may be that they have lost certain aspects of their unconventional doctrine for regional operations. They made themselves fit the conventional mold, as we should not do. SOF needs to be connected to, but not become the conventional force.

The yoke of successful interoperability between SOF and the conventional force will vest on the shoulders of both SOF and conventional force military leaders. SOF must successfully continue to sell itself as an indispensable part of the combined arms team. Conventional leaders must voluntarily see profit in retaining and integrating SOF capabilities. Interoperability will only persist if both parties are persistent in its enforcement.

APPENDIX

A. AN OPINION ON RECONFIGURATION SOF FOR THE 21ST CENTURY

The recommendations presented were based on the original concepts conceived in the flexible response planning of the 1960s. Concepts such as the Free World Liaison and Assistance Group (FLAG) mutated into an emasculated form known as a Special Action Force (SAF) in 1964. The organizational concepts of the FLAG, the SAF, joint interservice operations, and the evolving rubric of Information Warfare can be combined into a synergistic effect against a wide spectrum of contingencies. These organizations support Special Operations Forces in the Engagement of Operations other than war and other emerging missions of the twenty-first century. The following model is a recommendation for SOF reconfiguration as a whole. Recommendations for reconfiguration of the Regional Force are more specific. This is in contrast to the large grained reconfiguration of the National Force. The emphasis on the regional (white-side SOF) is due to the lack of unclassified data on SMU organizational structure, and the fact that most operations other than war may not require the SMUs. There will be some degree of mission overlap between the Regional and National Force in the area of operations other than war and joint and combined operations. However, the lions share of engagement of regional operations will be handled by the regional SOF Force. For this reason most of the recommendations will focus on the Regional Force.

Every theater special operations command currently depends extensively on reserve component augmentation packets for major exercises and emergencies. All SOCs are waiting for USSOCOM to complete the formation of two Battle Staffs (one primary, one alternate) that could reinforce SOC headquarters faster and more effectively. Both staffs presently are manned but lack essential weapons. Intensified efforts by

CINCSOC to outfit Battle Staffs at the earliest possible date would ease the anxieties of SOC Commanders and garner good will for USSOCOM.⁴⁹

The organizational characteristics sought by this form of reconfiguration are: a divisional form of SOF structure empowering the geographic warfighting CINCs with joint SOF capability as forward based and tailored to their regional requirements (refer to Figure 1). The empowerment of "Super SOCs" can be accomplished by the recreation of Joint Special Action Forces (JSAF), the integration of Information Warfare Squadrons, Lessons Learned Teams, and the Special Operations MEUSOC. Within the organization a dichotomy will exist between units designated as part of the permanent core and those units established as the temporary project teams (refer to Figure 2). A force that by continuous exposure to their war time regions of responsibility, uses operations other than war as the vehicle to gain both the peacetime national objectives and gather intelligence in preparation for future conflicts. These Super SOCs and JSAFs will evolve into a force that obtains the maximum operational leverage out of joint operations, while each specialist within SOF retains his unique esprit de corps and unit mythos. Hence, whether a member is Special Forces, SEAL, or PSYOPS they conduct missions appropriate to their respective lineage.

Henry Mintzberg, 1983, developed a set of pictures by which to represent the basic components of an organization. This contingency framework, in which the politics of organizations are pervasive, has been adjusted to represent a model of SOF organization in 2010 (See Figure 3). Figure 1 depicts a SOF structure in which higher headquarters, the permanent core, in a divisionalized form exists to sustain and control an adhocracy at the operational level, Figure 2.

⁴⁹ Collins, John M., *Special Operators Forces: An Assessment 1986-1993*, Congressional Research Service, Library of Congress, Washington, D.C. 20540-7000, July 1993, p. 82.

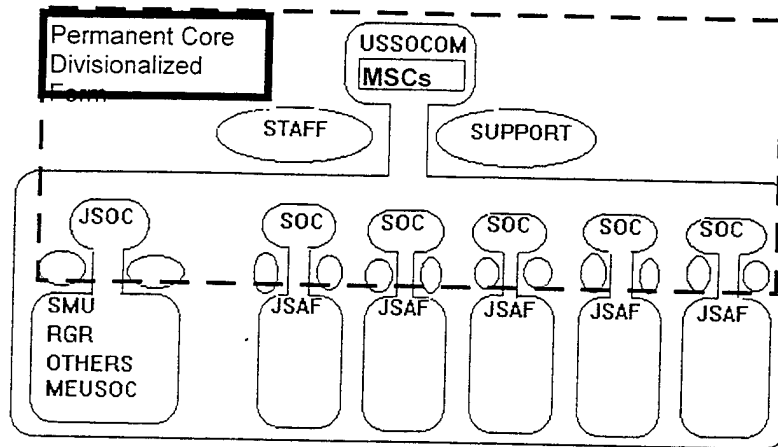

Figure 1. SOP Permanent Core in a Divisionalized Form

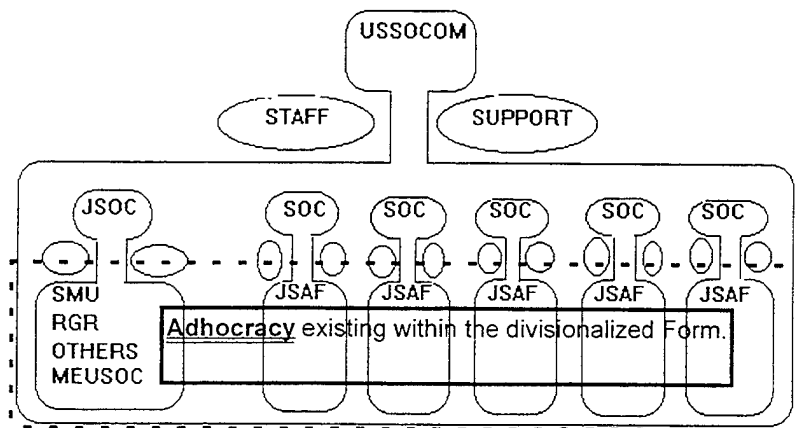

Figure 2. Adhocracy Existing Within the Divisionalized Form

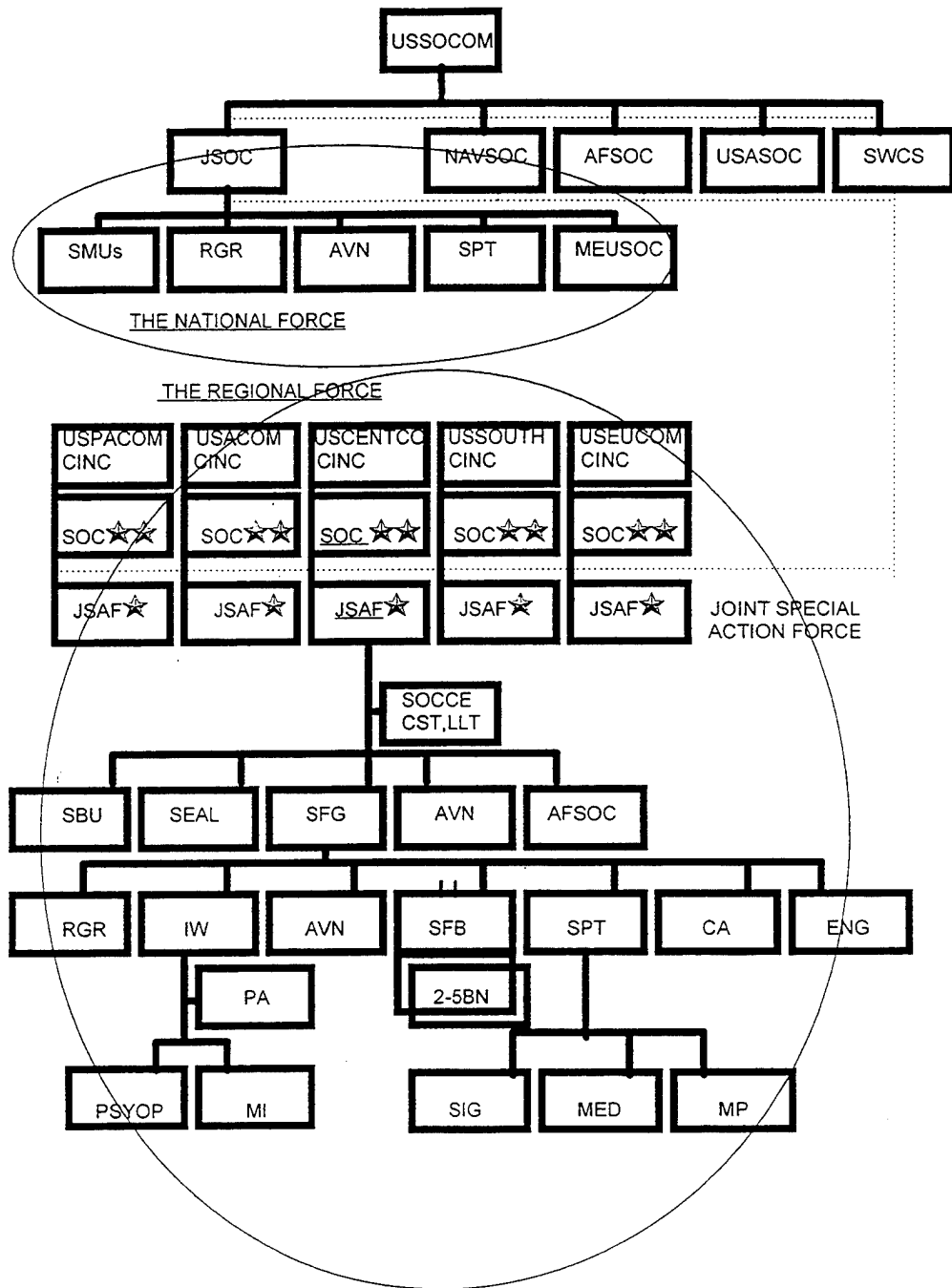

Figure 3. Special Operations Forces 2010

"In this organizational form, the bulk of work is done in quasi-autonomous units..." or Special Operations Commands (SOC). The structures of the SOCs themselves may represent any of the other possible configurations. The SOCs serve specific geographical warfighting CINCs and house their own functional units. The strategic apex, USSOCOM, strikes a deal with each SOC. The SOCs get considerable autonomy, but they are responsible for achieving certain measurable results: operational success, politically acceptable, and adherence to SOF imperatives. The operational commanders of the Joint Special Action Force, although subordinate to the SOC commander, are given wide latitude as long as they deliver results. USSOCOM and major subordinate commands usually give SOCs and JSAFs relatively free rein as long as they perform at preset levels. Headquarters manages the strategic portfolio and allocates resources based on its assessment of the appropriate mix for each region based on CINCs assessment of regional requirements for the respective geographic warfighting.⁵⁰

The empowerment of "Super SOCs" will be accomplished by the re-creation of Joint Special Action Forces (JSAF), and the integration of Information Warfare Squadrons, Lessons Learned Teams, and the Special Operations MEUSOC. Most of the force reconfiguration recommendations made concern the regional SOF force, since they bear the brunt of the operations other than war.

B. SUPER SOCs

A Super SOC is an empowered regional SOC. The five regional warfighting CINCs each possesses a Special Operations Command. They are traditionally understaffed, and commanded by one (O-7) flag officer. The command from an organizational perspective, is strategically positioned to serve the five regional warfighting CINCs requirements. I propose empowering the SOC with the following: the SOC Commander will be a Major General, preferably with special operations experience.

⁵⁰ Lee G. Bolman and Terrence E. Deal, Reframing Organizations: Artistry, Choice, and Leadership, Jossey-Bass Publishers, San Francisco, 1991, p. 89.

However, given the realities of a limited SOF officer pool of potential general officers, it may be difficult to expect a SOF experienced general officer to fill this position.

The staff and support personnel of selected CONUS headquarters will be dispersed to beef up the five SOCs. For example, Special Forces Command and selected parts of all the services and Major Subordinate Commands under USSOCOM will contribute to building "Super SOCs." The regional SOC will be part of the organizational Permanent Core. It will service all staff and command functions required by the conventional CINC to create a stable bureaucratic connectivity with the CINC's conventional staff. The SOC must shield the JSAF from unnecessary downward flow of bureaucratic operational requirements that the JSAF will not be staffed to support.

C. JOINT SPECIAL ACTION FORCE (JSAF)

The recreation of the Joint Special Action Force is based on an Army organization designed to engage operations such as insurgencies or other operations that presently fall under the title of Operations Other Than War.

I take the concept of a SAF a step further and make it an Interservice Joint Special Action Force. USSOCOM is already a joint organization. The formation of JSAFs would only be the next evolutionary step, rather than a revolutionary organizational testbed.

The Joint Special Action Force will be commanded by a SOF (O-7) general officer. His staff and support services will be staffed by SOF personnel from all services. Each JSAF under the direction of their respective SOC will organize and train specifically to their CINC's region and the requirements as specified by the CINC. The JSAF must be forward based for maximum immersion with host nation militaries and to facilitate (HUMINT) ground truth assessments. The JSAF will exist as an adhococracy in which there will be few rules guiding structure and procedures on how it employs its assets. (Refer to Figure 2). The organization is best perceived as a collection of temporary project teams.

A project team might be comprised of a Group headquarters, two Special Forces Battalions, one engineer battalion, three SEAL platoons, Civil Affairs, and a medical company. It can also be part of a Joint Task Force with an Infantry brigade on an operation that might last a day or as long as two years. On the other hand, a project team might be one Special Forces Operational Detachment Alpha and an Engineer Section. Duration of the mission and size of the elements will not be of high priority. The only organizational structures whose integrity must be respected are the Special Forces Operational Detachment Alpha, the SEAL platoon, and the Ranger Company. The operational cornerstone of the JSAF will be a Special Forces Group Headquarters. It will act as the operational hub for coordination, command and control all temporary project teams. It will accomplish this Herculean task with technological upgrades in communications, buttressed by high quality personnel at the operator level that hold a clear understanding of the commander's intent, both operational and strategic. Of note will be the integration of Information Warfare Squadrons, Lessons Learned Teams, and the Special Operations MEUSOC.

Unit sizes dedicated to each JSAF will vary with CINCs and USSOCOMs warfighting requirements. The standard JSAF would be comprised of the following, minimum capabilities:

1. Special Boat Unit.
2. SEAL platoons.
3. Army Aviation.
4. AFSOC Aviation.
5. JSAF Special Staff to include, Lessons Learned Teams.
6. Special Forces Group Headquarters.
7. Rangers.
8. Information Warfare Squadron (IWS).
9. Military Intelligence.

10. Psychological Operations.
11. Public Affairs\Media Affairs
12. Rotary wing Aviation Section.
13. Special Forces Battalions.
14. Support Battalion.
 - Signal.
 - Medical.
 - Military Police.
15. Civil Affairs.
16. Engineers.

D. LESSONS LEARNED TEAMS

The mission of these teams is the maintenance of a central database accessible by all SOF organizations who are "on-line" in the information net. Within the JSAF special staff sections will be multiple Lessons Learned Teams (LLTs). An LLT may be only one person with a computer. LLTs will accompany all project teams for the duration of the mission. They will not be operators or planners. Their function is to record all pertinent lessons learned and after action reports. They will record the information that operators do not record. Most operators become engrossed in operational matters, consequentially the most innovative techniques may be lost after the mission becomes a fuzzy memory.

The database the LLTs build will be a living database. For example: A project team on short notice must commence operations in a country. Two days prior a separate project team had completed an unrelated operation in the same area. The new project team LLT can access the other teams after action report submitted to the database that same day. The report will give the new operators almost real time tips and techniques pertinent to their Joint Special Operations Area (JSOA). The report will contain information such as how to gain rapport with indigenous peoples, which names to drop into conversations, topics to avoid discussing, and so forth.

E. INFORMATION WARFARE SQUADRON (IWS)

Information Warfare Squadron promises to be an invasive factor on the development of all future organizations. It promises to increase an organization's decision cycle through the proper utilization of enhancements, such as, Digitization of the battlefield. Perhaps the use of information warfare systems that aid in population control measures, or track economic and social trends will be of some benefit in operations other than war. At present much of Information warfare seems to be directed at supporting the old paradigm of increasing lethality; whereas, SOF often requires techniques that manipulate the target audience as in psychological operations.

To inject this possibly formidable capability into the Joint Special Action Force, structure could evolve as follows: the Information Warfare Squadron will become the headquarters and consolidator of all Military intelligence, Psychological operations, and Public Affairs/Media Affairs operations, refer to Figure 3. The assumptions, campaign plans, products to be implement in operations, from these three units can be cross checked and meshed with each other for a synergistic effect. In no way should this organization inhibit the flow of intelligence to the operational project teams. The IW squadron will have the dual requirement of satisfying the standard intelligence requirements and keeping pace with an information battle that may travel at the speed of light.

The Psychological Operations Unit will gauge the impact of information warfare on the target populations. It will also conduct control, or damage control, of the information released to open media sources and military families.

The Public Affairs element will submit timely interviews and updates to the press. Their objective will be to stay ahead of the press reporter's timeline requirements for news reports and to provide as much information to somewhat influence their reporting in a way that is in line with the overarching Psychological and Information Warfare Campaign. This will not always work, but neither does "no comment" and "we have no further information on that matter at this time." These statements simply motivate the

press to make their own uninformed interpretations or satellite-linked investigations. Public Affairs will assist Operational Project teams with media campaign portfolios that advise operators what to talk to reporters about. Today, the act of a special operator refusing to speak to a reporter can do more damage than giving them information. The Public Affairs unit will also control the morale of stateside service members' families by keeping them informed and providing advice to family members when faced with the news media.

F. MARINE EXPEDITIONARY UNIT SPECIAL OPERATIONS CAPABLE (MEUSOC)

The Marine Expeditionary Unit Special Operations Capable is a valuable asset that has not been used to its fullest capability. By incorporating the MEUSOC into the operations of the SOF National Force, a more timely and efficient application of force can be applied during certain Special Operations. The Special Operations Capable MEU (MEU [SOC]) concept emerged in 1985. The intent of the concept was not to compete with or replace "Special Operations Forces" but to field a more capable forward deployed MEU. The unit contains a reinforced infantry battalion for its ground combat element, a composite helicopter squadron for its aviation combat element, a combat service support group, and a command element commanded by a Colonel (O-6). The MEU(SOC)'s greatest advantage is its responsiveness and limited forcible entry capability. Although the actual size of a MEU(SOC) is largely determined by the number and type of amphibious ships available, the average size is about 2,200 Marines and Sailors (Medical Personnel). MEU(SOC)s are trained to execute 24 missions to include Non-Combatant Evacuations (NEO), Humanitarian Assistance, Amphibious Raids, In-Extremis Hostage Rescue (IHR), and Airfield Seizures.⁵¹ The Navy will typically deploy a MEU(SOC) to regions in which the application of force is likely to occur.

⁵¹ Anthony E. Van Dyke, MEU(SOC)s and the CINC's, Naval War College, Unpublished Paper, 22 February 1993, p. 3.

Presently there is "no early interface between the CINC and the MEU(SOC)...Thus, the MEU(SOC) enters the theater with few remaining opportunities for additional training in specific areas identified in briefings"⁵² with the CINCs. There exists a need to plug in the MEU(SOC)'s capabilities with a Special Operations Force that has current intelligence and good connectivity with the CINCs. "Operation Eastern Exit brought to light certain deficiencies that existed in the Somalian NEO. Embassy location, lack of secure communications links and an outdated NEO package were some of the deficiencies. It is likely that similar deficiencies exist in other countries as well."⁵³ Since MEU(SOC), a special operations capable unit, is on the scene already it should be ready to mesh with elements of the SOF National and Regional Forces, who already possess the necessary intelligence data. An example: A MEU(SOC) located off shore of a nation requiring the evacuation of U.S. nationals is also tasked with a Personnel Recovery Mission of high political importance. A Special Mission Unit (SMU) of the National Force should be able, on short notice, to land on a MEU(SOC) vessel. The Marine and SOF Command and Control apparatus should mesh before the SMU conducts its recovery operation. The Marines, already rehearsed, are prepared to conduct the external security operations (along with a small National Force Ranger contingent), in support of the operation.

⁵² Ibid., p. 13.

⁵³ Ibid., p. 15.

BIBLIOGRAPHY

Arnold, Steven L. and Christopher Allen Yuknis, Ethnic Conflict: Force Structure and Training Requirements, Strategic Studies Institute, Monograph, 1993.

Bank, Aaron, From OSS to Green Berets: The Birth of Special Forces, Presidio Press, CA.

Bolman, Lee G. and Terrence E. Deal, Reframing Organizations: Artistry, Choice, and Leadership, Jossey-Bass Publishers, San Francisco, 1991.

Bracken, Paul, Whither the RMA: Two Perspectives on Tomorrow's Army, Strategic Studies Institute, Monograph.

Bradford, Zeb B., Jr., and Fredric J. Brown, The United States Army in Transition, Sage Publications, Beverly Hills/London, 1973.

Brown, Fredric J., Ph.D. USA (Ret.), The U.S. Army in Transition II: Landpower in the Information Age, Brassey's (US), Inc., Washington, New York, London, 1993.

Cable, Larry E., Conflict of Myths: The Development of the American Counterinsurgency Doctrine and the Vietnam War, New York University Press, New York and London, 1986.

Collins, John M., Special Operations Forces: An Assessment 1986-1993, Congressional Research Service, Library of Congress, Washington, D.C. 20540-7000, July 1993.

Davis, Jacquelyn K., Refocusing Traditional Alliances and Establishing New Ones, Strategic Studies Institute, Monograph, 1993.

Guilmartin, John F., Jr., Technology and Strategy: What are the Limits? Strategic Studies Institute, Monograph, 20 July 1994.

Howard, Sir Michael and John F. Guilmartin, Jr., Two Historians in Technology and War, Strategic Studies Institute, Monograph.

Krepinevich, Andrew F., Jr., The Army in Vietnam, Johns Hopkins, Baltimore, 1986.

Mazarr, Michael J., The Revolution In Military Affairs: A Framework for Defense Planning, Strategic Studies Institute, Monograph, 10 June 1994.

Metz, Steven, The Revolution in Military Affairs and Conflict Short of War, Strategic Studies Institute, Monograph, 25 July 1994.

McCaffrey, Barry, Military Support for Peacekeeping Operations, Strategic Studies Institute, Monograph, 1993.

Nadler, David A., Marc S. Gerstein, and Robert B. Shaw, Organizational Architecture, Jossey-Bass Publishers, San Francisco, 1992.

Operation Just Cause Lessons Learned, Center for Army Lessons Learned Volume II, CAC, Fort Leavenworth, Kansas, October 1990.

Operation Restore Hope Lessons Learned Report, 3 Dec 1992-4 May 1993, Operations Other Than War, Center for Army Lessons Learned, CAC, Fort Leavenworth, Kansas.

Operation Uphold Democracy Initial Impressions, Volume II, Operations Other Than War, Center for Army Lessons Learned, Fort Leavenworth, Kansas. December 1994.

Posen, Barry R., The Sources of Military Doctrine: France Britain and Germany Between the World Wars, Cornell University Press, London, 1984.

Shachow, Sidney, Notional 'X' Command, Special Warfare Magazine, October 1995.

Toffler, Alvin and Hiedi, War and Anti-War: Survival at the Dawn of the 21st Century, Little, Brown and Company, Boston, 1993.

U.S. Army Operations In Support Of UNISOM II, 4 May 1993-31 March 1994, Lessons Learned Report, Center For Army Lessons Learned, Fort Leavenworth Kansas.

United States Army Special Operations Command, Directorate of History and Museums, To Free From Oppression, 1994.

Vanderbroucke, Lucien S., Perilous Options: Special Operations as an Instrument of U.S. Foreign Policy, Oxford University Press, New York, 1993.

Van Dyke, Anthony E., MEU(SOC)s and the CINC's, Naval War College, Unpublished Paper, 22 February 1993.

INITIAL DISTRIBUTION LIST

	No. Copies
1. Defense Technical Information Center 8725 John J. Kingman Road, STE 0944 Alexandria, VA 22060-6218	2
2. Dudley Knox Library Naval Postgraduate School 411 Dyer Road Monterey, California 93943-5101	2
3. Dr. Dana P. Eyre, Code NS/EY Naval Postgraduate School Monterey, CA 93943-5002	1
4. Dr. Gordon McCormick, Code NS/MC Naval Postgraduate School Monterey, CA 93943-5002	1
5. MAJ Edward McHale 1025 Halsey Drive Monterey, CA 93940	1
6. Craig Johnson c/o Dr. Marvin Johnson 2309 West Fourth Street Terrace Chanute, KS 66720	1
7. Eric Wendt 207 Ardennes Circle Seaside, CA 93955	1