

# REPORT

CONTRACT/ORDER NO. F0960390D2217/Q802

Removal of Polar Organics

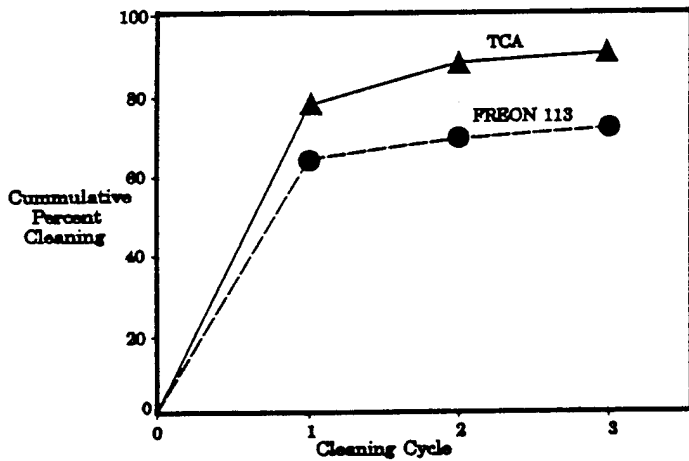

**DISTRIBUTION STATEMENT A**  
Approved for public release  
Distribution Unlimited

## A METHOD FOR CLEANING PERFORMANCE EVALUATION USING STABLE ISOTOPES

To

THE AEROSPACE GUIDANCE AND

METROLOGY CENTER

NEWARK AIR FORCE BASE

AUGUST 31, 1992

19960520 010



**Battelle**

Putting Technology To Work

DTIC QUALITY INSPECTED 1

**CONTRACT SUMMARY REPORT  
(DATA ITEM A0005)**

**Contract No. F09603-90-D-2217-Q802**

**A METHOD FOR CLEANING PERFORMANCE  
EVALUATION USING STABLE ISOTOPES**

**TO**

**THE AEROSPACE GUIDANCE AND METROLOGY CENTER  
NEWARK AIR FORCE BASE**

**AUGUST 31, 1992**

**BY**

**S. P. CHAUHAN, P. SCHUMACHER, AND J. C. CHUANG**

**BATTELLE  
505 KING AVENUE  
COLUMBUS, OH 43201**

*This report is a work prepared for the United States Government by Battelle. In no event shall either the United States Government or Battelle have any responsibility or liability for any consequences of any use, misuse, inability to use, or reliance upon the information contained herein, nor does either warrant or otherwise represent in any way the adequacy, efficacy, or applicability of the contents hereof.*

---

"Approved for public release; distribution is unlimited."

## EXECUTIVE SUMMARY

The Aerospace Guidance and Metrology Center (AGMC) at Newark Air Force Base (NAFB), Ohio, has been using cleaning agents such as 1,1,1-Trichloroethane (TCA) and 1,1,2-Trichloro 1,2,2-trifluoroethane (Freon 113) for repair of inertial guidance equipment. Both of these cleaning agents have been classified as stratospheric ozone layer depleting substance (OLDS). Therefore, AGMC is interested in replacing these with other cleaning agents such as aqueous detergents. In order to assure that reliability and maintainability levels are not degraded when OLDS are phased out, a method is required to validate that the cleaning capability of the suggested alternative is at least as good as that of an existing, proven cleaning agent. The current methods used by AGMC to evaluate cleanliness are not effective when the parts being cleaned are composed of irregular or severe geometrics as is the case for precision gyroscopes and accelerometers repaired at AGMC. Therefore, AGMC funded Battelle to develop and demonstrate a suitable procedure for quantifying cleanliness. This report describes a cleaning performance evaluation procedure (CPEP) based on the use of stable isotopes.

The CPEP developed and demonstrated in this project involved two phases. In Phase I, the contaminants which are present in the current cleaning processes were identified to select synthetic inorganic particulate and organic contaminants. In Phase II, unique, stable-isotopes of these contaminants were introduced into the parts followed by cleaning of these parts with various cleaning agents. The amounts of these unique isotopes extracted, as determined by mass spectroscopy (MS) provides a measure of cleaning efficiency. The advantages of this technique are that the analysis is not complicated by introduction or presence of native or air-borne contaminants and no safety precautions needed for work with radioisotopes are necessary. However, the method is complex and requires well-trained staff.

The results of Phase I studies showed that silica was the predominant particulate impurity, followed by compounds of calcium and carbon. Compounds of other elements, such as iron, sodium, magnesium, and tin were also found. Based on these analyses, prices and availability stable isotopes of silicon (present as silica) and iron were selected for Phase II studies. Iron was later dropped from cleaning performance testing since it could not be dispersed well in cleaning agents. The silica could be dispersed well, as determined by visual examination, but its recoveries were poor

(25-50 percent). The problem was judged to be due to incomplete mixing of silica suspensions and presence of a few large ( $>5 \mu\text{m}$ ) particles of silica. It is believed that this problem can be solved with additional work, where feedstock control and suspension handling is more carefully regulated.

The results of Phase I also showed the presence of a series of organic contaminants derived from the decomposition of the flurolube fill fluids or from contamination of the cleaning system. These compounds were classified in terms of their polarity since the cleaning efficiency is greatly affected by the polarity of the cleaning agent. Three organic compounds--octadecanoic acid (polar), phenanthrene (non polar), and dimethylphthalate (intermediate polarity)--were selected as synthetic contaminants. Each compound was obtained in two isotope forms. One isotope form of each was used as a contaminant (used to challenge a part) and the second isotope form was used as an analytical calibrant. This dual isotope approach allowed for any analyte losses in the sample workup.

In Phase II, a series of CPEP validation criteria were defined against which the CPEP was experimentally evaluated. First, the organic analyses of standard mixtures were found to be accurate and precise (repeatable) within about 1.5 percent. Second, the organic compounds were shown to be unaltered due to the cleaning process (ultrasonic cleaning with TCA or Freon 113) itself. Then a series of eight cleaning performance evaluation tests with three cleaning agents -- TCA, Freon 113, and an aqueous detergent -- were performed using A200D accelerometer parts. Each test involved three cleaning cycles.

The results of the cleaning performance testing were used to develop cleaning efficiency curves for removal of the organic contamination. The initial cleaning rates were high followed by much lower, continuously declining rates. The cleaning curves did not appear to follow a simple rate law. The final cleanliness was high (e.g., 90+ percent cleaning levels) with extensive cleaning, even though very small amounts (less than 10 atomic layers) of contaminants were employed.

The CPEP was found to have a precision (repeatability) of  $\pm 10$  percent for the organic contamination portion. This error band can be reduced with more testing. But, even at the  $\pm 10$  percent precision level, the CPEP repeatably differentiated between TCA and Freon 113. For example, Freon 113 was shown at 95 percent confidence level, to be better than TCA for removal of less polar impurities such as dimethylphthalate.

A few cleaning performance tests were also performed with an aqueous cleaner. In this case, the concentrated detergent solution did not allow direct analysis of organics. Therefore, an "extended analysis" procedure involving rinsing the part after aqueous cleaning and then recleaning in TCA was satisfactorily demonstrated. The results showed that the aqueous cleaner was more effective than TCA or Freon 113.

The results of this study have validated the CPEP for removal of organic impurities. The stable-isotope CPEP is the first method available for quantifying the cleanliness of intricate parts without resorting to the use of radioisotopes, which requires extensive safety precautions. The procedure should, in principle, be applicable to removal of inorganic particulates, though additional testing is needed to demonstrate this with acceptable error bands. Additional work is also recommended to develop a method for analysis of organics in concentrated detergent solution. Finally, some additional testing is needed to better quantify the precision of the CPEP.

## ACKNOWLEDGEMENT

The authors greatly appreciate the many suggestions and reviews provided during the project by Mr. Donald Hunt, Captain George Letourneau, and Ms. Madeleine Johnson of the Aerospace Guidance and Methodology Center (AGMC) at Newark Air Force Base. The authors also appreciate the efforts of Mr. David Burgoon and Ms. Priti Kumar in carrying out statistical analyses of the data.

## TABLE OF CONTENTS

	<u>Page</u>
1.0 INTRODUCTION AND BACKGROUND .....	1
2.0 OBJECTIVES .....	2
3.0 CPEP APPROACH, REQUIREMENTS, ADVANTAGES, AND DISADVANTAGES .....	3
3.1 CPEP Approach .....	3
3.2 CPEP Requirements .....	4
3.3 CPEP Advantages .....	4
3.4 CPEP Disadvantages .....	5
4.0 RESULTS AND DISCUSSION .....	5
4.1 Outline of CPEP .....	5
4.2 Identification of Contaminant .....	7
4.2.1 Sampling .....	7
4.2.2 Analysis .....	9
4.3 Selection of Isotopes .....	14
4.3.1 Inorganic Isotopes Selection/Suppliers .....	14
4.3.2 Organic Isotopes Selection/Suppliers .....	14
4.4 Preparation of Isotope Stock Solutions/Suspensions .....	17
4.4.1 Organics Stock Solutions .....	17
4.4.2 Inorganic Stock Suspensions .....	18
4.5 Isotope Analysis .....	20
4.5.1 Organic Analysis .....	20
4.5.2 Silica Analysis .....	21
4.6 Isotope Stability and Recovery .....	24
4.6.1 Stability of Organic Contaminants .....	24
4.6.2 Recovery of Organic Contaminants Nonaqueous Cleaning Agents .....	25
4.6.3 Recovery of Organic Contaminants from Aqueous Cleaning Agent .....	27
4.6.4 Recovery of Silica from Nonaqueous Cleaning Agents .....	29
4.6.5 Recovery of Silica from Detergent Water .....	31
4.7 Cleaning Performance Evaluation .....	32
4.7.1 Parts Doping .....	32
4.7.2 Cleaning Tests .....	39
4.7.3 Cleaning Extract Analysis .....	40
4.7.4 Cleaning Efficiency Calculations and Errors .....	41
4.7.5 Time Required for CPEP Testing .....	55
5.0 CONCLUSIONS .....	55
6.0 RECOMMENDATIONS .....	56
7.0 DEFINITION OF TERMS .....	57

**TABLE OF CONTENTS**

(Continued)

	<u>Page</u>
APPENDIX A. CLEANING PERFORMANCE EVALUATION PROCEDURE . . . . .	
APPENDIX B. ELECTRON MICROGRAPHS AND MULTIELEMENT X-RAY MAPS OF CONTAMINANTS . . . . .	
APPENDIX C. CONTAMINANT PARTICLE SIZE ANALYSIS . . . . .	
APPENDIX D. IDENTIFICATION OF ORGANIC CONTAMINANTS BY GC/MS ANALYSIS .	
APPENDIX E. CLEANING PERFORMANCE EVALUATION TESTS AND RESULTS . . . . .	

## LIST OF TABLES

	<u>Page</u>
TABLE 1. SAMPLES COLLECTED .....	8
TABLE 2. NATIVE CONTAMINANT PARTICLE SIZE DISTRIBUTION .....	11
TABLE 3. STABLE INORGANIC ISOTOPE COSTS .....	15
TABLE 4. SILICON ISOTOPE ABUNDANCES .....	16
TABLE 5. IRON ISOTOPE ABUNDANCES .....	16
TABLE 6. STABLE ORGANIC ISOTOPE COSTS .....	17
TABLE 7. ORGANIC ISOTOPE STOCK CONCENTRATIONS .....	18
TABLE 8. SILICA SIZE DISTRIBUTION .....	19
TABLE 9. ORGANIC ANALYSIS ACCURACY AND PRECISION .....	22
TABLE 10. SILICA STOCK ANALYSES .....	24
TABLE 11. ORGANIC CONTAMINANTS STABILITY AND RECOVERY FROM NONAQUEOUS CLEANING AGENT .....	26
TABLE 12. RECOVERY OF ORGANIC CONTAMINANTS IN NONAQUEOUS CLEANING AGENT .....	27
TABLE 13. CONTAMINANT RECOVERY FROM DISTILLED WATER .....	28
TABLE 14. SILICON ISOTOPE ABUNDANCES IN TCA PREQUALIFYING TESTS .....	30
TABLE 15. RECOVERY OF SYNTHETIC SILICA CONTAMINANT FROM TCA IN PREQUALIFYING TESTS .....	30
TABLE 16. SILICON ISOTOPE RECOVERY FROM AQUEOUS MEDIUM .....	33
TABLE 17. TEST MATRIX FOR CLEANING .....	34
TABLE 18. TEST DEVICE SYNTHETIC CONTAMINANT LOADING .....	38
TABLE 19. COLD TRAP AND TEFLON TAPE RESIDUE ORGANIC CONTAMINANT ANALYSIS .....	39
TABLE 20. STATISTICAL ANALYSIS OF DIFFERENCES IN CUMULATIVE PERCENT CLEANING WITH TCA AND FREON 113 .....	52

## LIST OF FIGURES

	<u>Page</u>
Figure 1. Cleaning Performance Evaluation Procedure Outline . . . . .	6
Figure 2. Schematic Diagram of Test Device for Inorganics Doping . . . . .	36
Figure 3. Schematic Diagram of Test Device for Organics Doping . . . . .	37
Figure 4. Organic Compound Removal with TCA (Test 2R) . . . . .	42
Figure 5. Removal of Dimethylphthalate with TCA . . . . .	43
Figure 6. Removal of Phenanthrene with TCA . . . . .	44
Figure 7. Removal of Octadecanoic Acid with TCA . . . . .	45
Figure 8. Removal of Dimethylphthalate with Freon 113 . . . . .	48
Figure 9. Removal of Phenanthrene with Freon 113 . . . . .	49
Figure 10. Removal of Octadecanoic Acid with Freon 113 . . . . .	50
Figure 11. Comparison of Cleaning Efficiency of TCA with Freon 113 . . . . .	51
Figure 12. Repeatability of Removal of Dimethylphthalate by TCA and Freon 113 . . . . .	53
Figure 13. Comparison of Cleaning Efficiency of TCA with an Aqueous, Detergent Cleaner . . . . .	54

CONTRACT SUMMARY REPORT  
Data Item A005  
Contract No. F09603-90-D2217-Q802

A METHOD FOR CLEANING PERFORMANCE EVALUATION  
USING STABLE ISOTOPES

TO

THE AEROSPACE GUIDANCE AND METROLOGY CENTER  
NEWARK AIR FORCE BASE

AUGUST 31, 1992

1.0 INTRODUCTION AND BACKGROUND

The Aerospace Guidance and Metrology Center (AGMC), located at the Newark Air Force Base (NAFB), OH, repairs inertial navigation and guidance equipment for the United States (US) Air Force and other Department of Defense (DoD) components. The Center repairs thousands of these delicate, sophisticated electromechanical devices each year. The critical tolerances of many of these devices and other considerations mandate extensive precision cleaning during the repair process. The principle solvents used for this cleaning are 1,1,2-Trichloro 1,2,2-trifluoroethane (Freon 113)\* and 1,1,1-Trichloroethane (TCA). Both of these solvents have been classified as stratospheric ozone layer depleting chemicals under the 1987 international treaty "Montreal Protocol on Substances that Deplete the Ozone Layer". Commonly known as the "Montreal Protocol", the treaty was ratified by the US Senate in December 1988. The Environmental Protection Agency (EPA) has since developed domestic regulations to insure the reduction and eventual elimination of the production and use of various ozone depleting chemicals. AFR 19-15 implements DoD Directive 6050.9 and directs compliance with the Clean Air Act Amendments of 1990 and EPA regulations relating to chlorofluorocarbons (CFCs), halons, and other ozone layer depleting substances (OLDS). Based on this direction and a recent supplemental direction to accelerate the timetable for compliance, the Center has initiated a policy to achieve total elimination of OLDS from its industrial cleaning processes by the end of fiscal year 1993.

---

\* Freon 113 is a registered trademark of DuPont.

In order to assure reliability and maintainability levels are not degraded when OLDS are phased out, a method is required to validate that the cleaning capability of the suggested alternative is at least as good as that of an existing, proven process. The current methods used by AGMC to evaluate cleanliness include, but are not limited to, unaided visual examination, microscopic visual examination, solvent filtering with analysis of filter residue, and deionized water break test. However, these methods are not as effective as desired when the item being cleaned is composed of irregular or severe geometries as is the case in many of the parts and assemblies composing the precision gyroscopes and accelerometers repaired at AGMC.

Recent advances in analytical precision, coupled with stable isotope technology, offer a safe and potentially improved approach to measure cleaning effectiveness. By identifying common contaminants, doping components under test with stable isotopes of these contaminants, and then measuring the effectiveness of various cleaning processes to remove these isotopes, a relative measure of cleaning process effectiveness can be established. The first demonstration of this cleaning performance evaluation procedure (CPEP) concept for precision cleaning of inertial guidance system parts was attempted by Battelle under this contract for AGMC. This report provides the details of the CPEP, its advantages and disadvantages, its precision, and the developmental needs to expand its applicability.

## 2.0 OBJECTIVES

The objective of this study was to develop, validate and document a stable-isotope-based cleaning performance evaluation procedure (CPEP) which can be used to quantify the relative cleaning effectiveness of various precision cleaning processes used to clean items composed of irregular or severe geometries. The CPEP is to provide a method to verify whether or not a proposed cleaning process cleans as effectively as the existing process. This validation method will help insure that, at the time of selection, a cleaning process change will not have an adverse impact on reliability and maintainability (R&M).

### 3.0 CPEP APPROACH, REQUIREMENTS, ADVANTAGES, AND DISADVANTAGES

#### 3.1 CPEP Approach

This project employed a two-phase approach to the development and validation of a stable-isotope-based CPEP. In Phase I (development phase), the current cleaning processes (CCP) was examined to identify possible contaminants. Samples of cleaning residue at several points in the CCP were analyzed for inorganic particulates and organic compounds. The analytical results were used to select synthetic contaminants for validation (Phase II) of CPEP.

The synthetic contaminants were not required to be identical to the contaminants found in the samples, but they needed to be representative of those contaminants and to respond to the same adherence mechanisms. Some of the mechanisms considered were: surface chemical; magnetic; electrostatic; stickiness (or tendency to leave a coating); and trapping in surface irregularities. For the particulate contaminants, the particle size and chemical form were considered, because particle removal is strongly dependent on the size of the particles and some particle adherence mechanisms are dependent upon the chemical form of the particles. For the organic compounds, a key characteristic of the synthetic contaminant was the polarity since the cleaning effectiveness for the organic contaminants is strongly dependent upon the solubility of the contaminant in the cleaning solvent.

In Phase II, an extended isotope dilution method was adapted for CPEP. This method consisted of challenging a test component (part) with a synthetic contaminant which is isotopically different from any native or airborne contaminant. The test component was then cleaned using the cleaning process being evaluated and the cleaning residues were saved. A synthetic calibrant solution containing a different isotope than the synthetic contaminant was then added to the cleaning residue in a known amount. The resulting mixture containing any native contaminant and the two synthetic isotope forms was then analyzed by mass spectral (MS) and gas chromatographic (GC) techniques to determine the isotopic ratios of the contaminants. The isotope ratios and the amount of calibrant material added were used to determine the quantity of synthetic contaminant (challenge material) removed during the cleaning process. The effectiveness of the cleaning process, e.g., ultrasonic cleaning with TCA, was then calculated based on the amount of contaminant it removed.

### 3.2 CPEP Requirements

The CPEP is based on an accurate determination of a synthetic contaminant removed from a test component during cleaning since a method for analyzing the residue on the test component is not available. The following three specific requirements must be met for this method of analysis to be successful.

- (1) Isotopic contaminants (challenge materials) should not be altered or lost during cleaning process, i.e., the synthetic contaminant should either be in the cleaning extract or as residue on the test component.
- (2) Synthetic contaminants as well as the calibrants should be equally well dispersed in the cleaning extract as well as any sampling/analytical aliquots.
- (3) The analytical methods for isotope analysis should be accurate and precise (repeatable).

These requirements were tested during prequalifying tests prior to cleaning performance testing in the field, as discussed in Section 4.5 and 4.6.

### 3.3 CPEP Advantages

The following are the advantages of the CPEP developed in this project:

- (1) The safety precautions required when using radioisotopes are not needed since the CPEP uses stable isotopes.
- (2) The stable isotopes uniquely identify the synthetic contaminants, even in the presence of significant amounts of native contaminants.
- (3) The GC/MS, isotope dilution technique is a well tested and sensitive method for analysis of trace quantities of inorganic and organic species.

### 3.4 CPEP Disadvantages

The following are the disadvantages of the CPEP:

- (1) The inorganic particulate isotopic materials are expensive and suppliers are limited. The cost is further increased due to the requirements for having two isotopically labeled samples of each contaminant as well as due to the need to use a mass spectrometer to analyze the isotopes.
- (2) The procedure is complex and requires well-trained staff.

## 4.0 RESULTS AND DISCUSSION

The demonstration of the various non-standard analytical and cleaning process analysis steps concerning the CPEP are discussed in the following sections. The results are discussed in the following sequence: (a) identification of contaminants; (b) selection of isotopes; (c) preparation of stock solutions/suspensions; (d) prequalifying tests for isotope analysis, stability, and recovery; and (e) cleaning performance evaluation. The discussion focuses on the CPEP, i.e., its logic, methodology, and validation, rather than on its exhaustive application for various current and future applications. The future developmental needs to further improve the value, i.e., the applicability, of the CPEP are also discussed.

### 4.1 Outline of CPEP

The CPEP involves the 11 generic steps shown in Figure 1. A detailed, step-by-step description of CPEP is provided as Appendix A as a separate, bound volume. The CPEP was modified throughout the development and demonstration stages and the level of written, procedural detail was adjusted to conform to the experience level of AGMC scientists and technicians most likely to use it. The CPEP is written in the style of ASTM procedures and is sufficiently detailed to allow "round-robin" testing and use by researchers outside of AGMC. The sections below are organized primarily along the outline of the CPEP.

FIGURE 1. CLEANING PERFORMANCE EVALUATION PROCEDURE OUTLINE

- 
- (1) Examine current cleaning processes (CCP) and identify known and suspected contaminants.
  - (2) Sample CCP at beginning, end, and in between if possible.
  - (3) Analyze for organic plus particulate contaminants.
  - (4) Select candidate isotopic simulants for contaminants.
    - Stable isotopes for organics
    - > 2 stable isotopes for inorganics
  - (5) Dissolve/suspend synthetic contaminant isotope in volatile organic liquid.
  - (6) Dope test parts with synthetic contaminant, evaporate liquid carrier, trap exhaust gases for analysis, analyze exhaust gas trap, and calculate contaminant quantity retained in the part.
  - (7) Clean parts using candidate processes.
  - (8) Collect samples in suitable containers.
  - (9) Add second, calibrant isotope.
  - (10) Analyze for contaminants by GC/MS.
  - (11) Conduct data analysis to compare cleaning effectiveness.
-

## 4.2 Identification of Contaminant

As part of the first phase--methodology development--two meetings were held at AGMC to acquaint the Battelle project personnel with current cleaning processes (CCP). At the first meeting, AGMC personnel described the known contaminants and their sources. They identified three main sources of contamination:

- (1) Debris produced during use until failure
- (2) Contamination produced during disassembly and repair
- (3) Contamination introduced during reassembly.

The principal contaminants produced during disassembly and repair included fill fluid residues, solder/flux, metal chips and epoxy chips. During reassembly common contaminants were fibers, hair and skin from personnel, and airborne dust. The first meeting also included a tour of the clean room and repair facilities to aid selection of appropriate samples which were needed to determine the contaminants present in the accelerometers and gyros. Specially cleaned sample containers were provided to AGMC to minimize the likelihood of contamination by organic compounds. A second meeting was held to retrieve primarily requested samples and to obtain additional samples from an incoming device.

### 4.2.1 Sampling

Seven Freon 113, a common cleaning agent, and seven fill fluid samples were obtained for identification of contaminants in the three guidance components: A200D accelerometer and G200/280 and G300 gyros. Four filters containing particulate were also obtained from the G300 gyro fill station. The sample points chosen are given in Table 1. The sampling locations were selected to allow identification of contaminants present in incoming units as well as contaminants introduced during disassembly, repair and reassembly. Samples of used Fluorolube fill fluid drained from A200D accelerometers, G200/280 gyros and G300 gyros were collected to measure the contaminants in incoming devices. These samples were taken from bottles which contained fill fluid drained from many units of each type. The fluid was also drained from an incoming G300 gyro. The Freon 113

flush of this unit was collected as a separate sample. Freon 113 samples were collected at the G200/280 and G300 gyro flushing stations, the G300 supercleaning station and the A200D flushing station.

The samples taken from the gyro flushing stations were from the Freon 113 supply line, which means that the liquid had not passed through the gyros. The sample from the A200D station had passed through the accelerometer. The supercleaning station is the site of the final cleaning of the G300 gyros. Samples of virgin Freon 113 and fill fluids and the recycled Freon 113 were examined to determine the contaminants in those materials.

TABLE 1. SAMPLES COLLECTED

Type	Description
Freon	Virgin (unfiltered)
"	Recycle
"	A200D Flush before fill
"	G200/280 Initial flush supply
"	G300 Initial flush supply
"	G300 Initial flush of incoming unit*
"	G300 Superclean tank
Fluorolube	A200D virgin
"	G200/280 virgin
"	G300 virgin
"	A200D used (multiple units)
"	G200/280 used (multiple units)
"	G300 used (multiple units)
"	G300 used fill fluid drained from incoming unit*
Filters	G300 fill fluid station particulate

\*Same G300 gyro

#### 4.2.2 Analysis

**4.2.2.1 Inorganic Particulate.** The chemical identification and the size distribution of the inorganic particulate was performed using Battelle's JEOL 733 Superprobe electron probe microanalyzer (EPMA) and Noran 8502 Image Analysis system. Samples were prepared for EMP analysis by filtering an aliquot of the sample through a 0.2  $\mu\text{m}$  Anopore alumina filter (Altech) in a 25 mm Millipore vacuum filtration apparatus. The vacuum ranged from 5 in. Hg to 15 in. Hg depending upon the viscosity of the liquid. The filters were washed with three, 3 to 5 ml portions of filtered dichloromethane to remove residual fill fluid. After washing, the filters were dried at elevated temperature in a vacuum oven. The dried filters were attached to a graphite planchette to prevent curling of the filters, a conductive carbon coating was deposited on the filters by evaporative coating and the filter-planchette assembly was loaded into the EMP for analysis.

The EPMA was operated at 15 kV accelerating voltage and  $\sim 700$  pA beam current. The filters were examined manually to identify the composition of the particulate on the filters and to locate representative areas on them. Since the purpose of this analysis was identification and sizing of the particulate, regions of interest were not selected randomly. Regions of the blank filters without particles were excluded. Since these clean areas comprised the bulk of the filter, the particulate loadings for these filters are artificially high. Many of the sample filters contained very large ( $> 50$   $\mu\text{m}$ ) particles. When large particles were present, at least one was included in one of the fields so that the range of particle sizes would reflect its presence. Since the size distribution was based on the number average, a few large particles did not seriously alter the average values.

The X-ray analysis showed that Si (silicon) was the most common element, followed by Ca and C. However, Na, Mg, S, Cl, K, Fe, Zn, and Sn were also found in some of the particles. The image analyzer was set to acquire multielement X-ray maps for these elements. The map resolution was 128x128 points and the dwell time was 0.2 sec. The operator-selected areas for each sample were mapped overnight under computer control. Micrographs showing a typical field and corresponding multielement X-ray maps for each sample are presented in Appendix B.

The A200D Freon flush before fill sample, the A200D used fill sample and the G300 initial flush of the incoming unit sample were examined at 2000X in addition to the standard 400X

examination. At 2000X the 0.2  $\mu\text{m}$  pores of the underlying alumina filter were easily seen for the A200D used fill fluid sample and the G300 initial Freon flush sample; however, the pores of the A200D Freon flush before fill filter were obscured by a thin coating. This coating was observed to a lesser extent on some of the other Freon sample filters. The organic analyses described below detected dioctyl phthalate at a very high concentration in the A200D Freon flush before fill sample. Since dioctyl phthalate is a nonvolatile organic compound, the coating seen on the A200D Freon flush before fill filter was suspected to be due to it.

The particle size distribution was determined by image analysis techniques using four fields for each sample except for the two blank samples and the virgin Freon sample. Two fields were used for the blank filter and virgin Freon samples while three fields were used for the dichloromethane blank. The size distribution was determined for all of the samples using the 400X magnification and for three samples at 2000X magnification. Table 2 gives major characteristics of the particle size distribution as well as an estimate of the filter loading assuming a particle density of 2.5 and an estimate of the sample particle loadings based on the sample volumes which were filtered. The size analysis summaries and plots showing the frequency distribution for maximum projection, mean projection and area are provided in Appendix C.

**4.2.2.2 Organic Compounds.** The seven Freon samples and seven fill fluid samples were stored at room temperature in the dark. An aliquot (1 ml) of each Freon sample was transferred to a sample vial for gas chromatography/mass spectrometry (GC/MS) analysis. Preliminary analysis showed that there were a lot of organic compounds present in the undiluted fill fluid samples, and the GC column was overloaded. Therefore, the diluted fill fluid samples (1-0.5%) in dichloromethane (DCM) were used for GC/MS analysis.

The sample extracts were analyzed by 70 ev electron impact GC/MS. A Finnigan TSQ-45 GC/MS/MS operated at GC/MS mode by passing all masses through Q1 and Q2 and scanning from m/z 30 to m/z 650 at Q3. The data acquisition and processing systems were controlled by an INCOS-2300 data system. The GC column was an DB-5 fused silica capillary column (30 m x 0.25 mm I.D.). Helium was used as carrier gas, the column temperature was set at 40°C for 1 min, then programmed to 290°C at 8°C/min. Identification of unknown components was accomplished by manual interpretation of background-corrected spectra, together with an on-line computerized library

TABLE 2. NATIVE CONTAMINANT PARTICLE SIZE DISTRIBUTION

Sample	Sample Volume ml	Number of Particles	Average Mean Projection $\mu\text{m}$	Estimated Mass Loading	
				$\mu\text{g}$	$\mu\text{g/ml}$
Blank Filter		4	$3.3 \pm 3.7$	$0.5 \mu\text{g}$	
Dichloromethane Blank		9	$5.1 \pm 4.3$	2.9	
Virgin Freon (unfiltered)	20	283	$1.8 \pm 2.6$	6.6	0.33
Recycle Freon	20*	56	$2.6 \pm 6.3$	1.7	0.085
A200D Freon Flush Before Fill	1	194	$1.7 \pm 2.4$	1.7	1.7
G200/280 Initial Freon Flush Supply	10*	49	$1.7 \pm 1.5$	0.39	0.039
G300 Initial Freon Flush Supply	10	72	$3.0 \pm 2.4$	3.6	0.36
G300 Initial Freon Flush (incoming unit)	1	109	$2.3 \pm 3.5$	2.3	2.3
G300 Superclean Tank Freon	10	66	$2.1 \pm 2.1$	1.1	0.11
A200D Virgin Fluorolube (Fill fluid)	10	79	$2.3 \pm 1.9$	1.8	0.18
G200 Virgin Fluorolube	10	543	$1.8 \pm 1.2$	5.5	0.55
G300 Virgin Fluorolube	10	550	$1.4 \pm 1.3$	2.4	0.24
A200D Used Fill Fluid (multiple units)	1	844	$1.5 \pm 3.0$	4.6	4.6
G200/280 Used Fill Fluid (multiple units)	2	82	$2.7 \pm 5.0$	2.8	1.4
G300 Used Fluorolube (multiple units)	10	4641	$1.7 \pm 1.5$	42.2	4.2
G300 Used Fill Fluid (incoming units)	5	256	$2.0 \pm 2.3$	3.8	0.76

\* The volume is uncertain

search. The library used was the most currently available EPA/NIH mass spectral data base containing 42,197 unique reference spectra. The GC/MS results of the non-diluted Freon samples are summarized in Appendix D in Tables D-1 through D-6. The total ion current chromatograms of these samples are given in Figures D-1 through D-6.

Analysis of the Freon samples showed that Freon 113 was the major component for all but one (G-300 initial Freon flush of incoming unit) sample. Because the undiluted Freon samples were analyzed by GC/MS, the filament and electron multiplier of MS were turned on only after the elution of Freon 113 (b.p. 46°C) from GC column to MS ion source. Only trace amounts of most identified contaminants (<1% of total sample extract) were present in each sample. Benzaldehyde, alkylphenol-substituted benzenes, fatty acids, and fatty acid esters were found in Freon 113 recycle samples. Fewer contaminants, including benzaldehyde, substituted benzene, and fatty acid ester, were found in virgin Freon 113. The contaminants present in the Freon 113 recycle sample were also present in the treated Freon samples. Aliphatic hydrocarbons also were formed in the three treated Freon samples (G-300 superclean Freon sample, initial Freon flush G-300 of clean unit, and flush before fill A200D). Among these three samples, the flush before fill A 200D sample contains relatively more contaminants, including alkyl benzenes, alkyl biphenyls, and a series of polyhalogenated compounds containing Cl and F, which were also found in virgin fill fluid A200D sample, as compared to the other two samples. The major contaminant was phthalate in the Freon flush before fill A200D sample (see Figure D-3 for details). This compound, phthalate, was also present in other Freon samples but at lower levels.

The Freon sample (G-300 initial Freon flush of incoming unit) contained a lot of organic components. This sample was therefore diluted with DCM and analyzed by GC/MS. The total ion current chromatogram of 5% G-300 initial Freon flush (incoming unit) is given in Appendix D in Figure D-7. Analysis of this sample revealed that a series of polyhalogenated compounds containing Cl, F, and Br were the major contaminants in this sample. These compounds accounted for more than 90% of the total chromatographable peaks in the sample. These compounds were the same components found in G-300 virgin fill fluid. The analysis of fill fluid samples is described in the following paragraphs.

The total ion current chromatograms of seven fill fluid samples are given in Figures D-8 through D-14. Analysis of GC/MS data showed that a series of polyhalogenated compounds containing F, Cl, and Br were present in virgin fill fluid G-300 and G-200/280. The virgin fill fluid A200D was comprised of different types of polyhalogenated compounds containing F and Cl.

The mass spectra of all the compounds in virgin fill fluid G-300 and G-200/280 were very similar. The molecular ion of each compound cannot be obtained because the GC/MS operated at EI condition. However, the characteristic fragment ions with isotope patterns of Cl and Br were obtained. Due to the lack of a molecular ion, the structure of these compounds cannot be assigned. The characteristic fragment ions commonly found in each compound present in virgin fill fluid G-300 and G-200/280 are summarized in Table D-7.

The mass spectra of all the compounds in virgin fill fluid A200D were very similar to the characteristic isotope patterns for Cl but not for Br. The molecular ion of each compound cannot be obtained under EI conditions. The characteristic fragment ions commonly found in each compound present in virgin fill fluid A200D are given in Table D-8.

Similar polyhalogenated compounds were observed in used fill fluid G-300 samples as compared to virgin fill fluid G-300. It was noted that C<sub>2</sub>-alkyl benzenes were present in used fill fluid G-300 from multiple units but not in used fill fluid G-300 from a single unit. The used fill fluid A200D from multiple units was comprised of similar polyhalogenated compounds as those in the virgin fill fluid A200D. The major components in used fill fluid G-200/280 from multiple units were the same type of polyhalogenated compounds which were found in virgin fill fluid A200D but not in the virgin fill fluid G-200/280. In addition, C<sub>2</sub>-alkyl benzenes were also found in this sample. It is possible that the bottle from which this sample was taken did not contain used G200/280 gyro fill fluid.

### 4.3 Selection of Isotopes

#### 4.3.1 Inorganic Isotopes Selection/Suppliers

Based on the inorganic analytical results, prices were obtained for isotopes of Ca, Fe, Si, and Sn from two suppliers: Oak Ridge National Laboratory (ORNL), Oak Ridge, TN; and Merck & Co., Inc./ Isotopes (MSD Isotopes), St. Louis, MO. The Ca isotopes were the most expensive and, therefore, were not included in this initial R&D program; however, since Ca is a common contaminant, it should be considered in a follow-on program after validation of the CPEP. The Sn isotopes were the least expensive but were also of the least interest, since Sn was not found in samples from all three devices. Silicon dioxide (Silica;  $\text{SiO}_2$ ) was selected as a contaminant because it was one of the most frequently detected particulate contaminants. It is an unreactive particle which may be subject to electrostatic attractive forces, since it is nonconductive and non-magnetic. Metallic iron was also selected because it is ferromagnetic and therefore should be strongly attracted to the permanent magnets in the accelerometer. In devices without magnets, the iron particles would behave as electrically conductive particles with a density roughly three times that of silicon dioxide.

The iron available from MSD Isotopes was in foil form and  $^{29}\text{SiO}_2$  was not available. ORNL had both the Si and Fe isotopes in stock, but the Fe was stocked as  $\text{Fe}_2\text{O}_3$ . The charge to reduce the iron oxide to metal was \$830 per isotope. ORNL was chosen as the isotope supplier because they had stocks of the required isotopes and could provide them in the desired chemical forms. However, ORNL was unable to specify the particle size of the materials. The quantities and costs of the isotopes are shown in Table 3.

The isotope abundances of the native, calibrant and contaminant isotope materials are given in Table 4 for silicon and in Table 5 for iron.

#### 4.3.2 Organic Isotopes Selection/Suppliers

The cleaning effectiveness for the organic contaminants is strongly dependent upon the solubility of the contaminant in the cleaning solvent. This solubility is related to the polarity of the solvent and contaminant. Polar contaminants are removed most effectively by a polar solvent while

nonpolar contaminants are best removed with nonpolar solvents. The organic analysis (Section 4.2) identified contaminants which were polar, nonpolar and intermediate in polarity. Since no basic compounds were detected, no isotopes of basic compounds were considered in this study. To match the polarity range observed in the samples, three synthetic contaminants were selected: polar; nonpolar; and intermediate polarity. Octadecanoic acid was chosen to represent the polar fatty acid impurities. Dimethylphthalate, which is of intermediate polarity, was chosen to represent the phthalate compounds which were the major contaminants in several of the Freon samples. Dimethylphthalate was selected despite its higher volatility because it was the only phthalate readily available, labeled in two different ways. For future work, a second labeled phthalate of low volatility could be custom ordered. Phenanthrene was chosen to simulate the nonpolar compounds.

TABLE 3. STABLE INORGANIC ISOTOPE COSTS

Form	Price (\$/mg of isotope)	Quantity Needed (mg)	Total Cost
$^{29}\text{SiO}_2$	95.05	10	950.50
$^{30}\text{SiO}_2$	138.25	20	2765.00
$^{54}\text{Fe}_2\text{O}_3$	17.15	50	857.50
$^{57}\text{Fe}_2\text{O}_3$	39.80	45	1791.00
Cost to Reduce $^{54}\text{Fe}_2\text{O}_3$ to $^{54}\text{Fe}$ Metal Powder			830.00
Cost to Reduce $^{57}\text{Fe}_2\text{O}_3$ to $^{57}\text{Fe}$ Metal Powder			830.00
Packing Cost			210.00
<b>TOTAL</b>			<b>\$8234.00</b>

The organic isotopic materials were obtained from MSD Isotopes, Inc., which was selected because two labeled forms of compounds with different polarities were in stock in the necessary quantities. The compounds chosen for the study and their costs are shown in Table 6. In each pair of labeled compounds, the compound with the highest degree of substitution was chosen as the synthetic contaminant. The second compound of the pair was used as the calibrant compound. Since only one deuterium labeled phenanthrene compound was available, a  $^{13}\text{C}$  labeled compound was used as the calibrant.

TABLE 4. SILICON ISOTOPE ABUNDANCES

ISOTOPE	ISOTOPE ABUNDANCE		
	NATIVE <sup>a</sup>	CONTAMINANT <sup>b</sup>	CALIBRANT <sup>b</sup>
<sup>28</sup> Si	0.9221	0.0440	0.0412
<sup>29</sup> Si	0.0470	0.0032	0.9565
<sup>30</sup> Si	0.0309	0.9528	0.0023
Atomic Weight	28.086	29.8827	28.9376
Gravimetric Factor <sup>c</sup>	2.13932	2.07081	2.10579

- a. CRC Handbook of Chemistry and Physics, 49 Ed.  
 b. Oak Ridge National Laboratory isotopic analysis  
 c. Gravimetric factor for conversion from metal to oxide

TABLE 5. IRON ISOTOPE ABUNDANCES

ISOTOPE	ISOTOPE ABUNDANCE		
	NATIVE <sup>a</sup>	CONTAMINANT <sup>b</sup>	CALIBRANT <sup>b</sup>
<sup>54</sup> Fe	0.0584	0.0010	0.9720
<sup>56</sup> Fe	0.9196	0.0745	0.0275
<sup>57</sup> Fe	0.0220	0.9245	0.0005
Atomic Weight	55.847	56.8579	53.9960

- a. CRC Handbook of Chemistry and Physics, 49 Ed.  
 (0.33% <sup>58</sup>Fe excluded from the abundance calculation since it was not present in synthetic isotopes).  
 b. Oak Ridge National Laboratory isotopic analysis.

TABLE 6. STABLE ORGANIC ISOTOPE COSTS

COMPOUND	STANDARD PACKAGE	COST
Octadecanoic - 18, 18, 18-d <sub>3</sub> acid	0.1 g	\$125
Octadecanoic - d <sub>35</sub> acid <sup>a</sup>	1 g	260
Phenanthrene - d <sub>10</sub> <sup>a</sup>	1 g	100
Phenanthrene - 9, 10 - 13C <sub>2</sub> <sup>b</sup>	0.01 g	385
Dimethylphthalate - 3, 4, 5, 6 - d <sub>4</sub> <sup>a</sup>	0.1 g	230
Dimethyl - d <sub>6</sub> Phthalate <sup>b</sup>	0.01 g	145
TOTAL		\$1245

- a. Contaminant  
b. Calibrant

#### 4.4 Preparation of Isotope Stock Solutions/Suspensions

##### 4.4.1 Organics Stock Solutions

Stock solutions were prepared for each organic compound at a 1.0 mg/ml concentration in filtered dichloromethane. A 10  $\mu$ l aliquot of each stock solution was diluted 1000 fold with filtered dichloromethane. The diluted solutions were analyzed by GC/MS to determine the detection limit of the analysis for each compound. The detection limit for the phthalate and phenanthrene were 1 ng, on column in full scan mode. The detection limit for the octodecanoic acid was 10 ng, on column in the full scan mode. The full scan mode was used despite its lower sensitivity, because degradation of the compounds can be detected in full scan mode. The selected ion mode is more sensitive, but since the full mass spectrum is not recorded, it cannot identify instances when decomposition of the compounds occurs. The concentrations of the fatty acids were increased to compensate for their lower sensitivity. The stock solutions were prepared with the concentrations shown in Table 7.

TABLE 7. ORGANIC ISOTOPE STOCK CONCENTRATIONS

COMPOUND	CONCENTRATION ( $\mu\text{g/ml}$ )
Dimethylphthalate - $\text{d}_6$	50.0
Dimethylphthalate - 3, 4, 5, 6, - $\text{d}_4$	50.0
Phenanthrene - $\text{d}_{10}$	50.0
Phenanthrene - 9, 10 $^{13}\text{C}_2$	50.0
Octadecanoic acid - $\text{d}_{35}$	500.0
Octadecanoic acid - 18, 18, 18, - $\text{d}_3$	500.0

The organic working solutions were placed in glass bottles wrapped with aluminum foil to protect the compounds from ultraviolet light. The solutions were stored at  $-20\text{ C}$  between use. When transported to NAFB, the solutions were cooled to dry ice temperature.

#### 4.4.2 Inorganic Stock Suspensions

**4.4.2.1 Silica Stock Suspensions.** The  $^{30}\text{SiO}_2$  material was selected as the synthetic contaminant while the  $^{29}\text{SiO}_2$  material was chosen as the calibrant. The contaminant suspension was prepared by transferring 2.08 mg of the  $^{30}\text{SiO}_2$  into a 100 ml volumetric flask. The calibrant suspension was prepared by transferring 2.11 mg of the  $^{29}\text{SiO}_2$  into another 100 ml volumetric flask. Each flask was then filled to the mark with filtered dichloromethane. The flasks were placed into an ultrasonic bath (Cole-Parmer Model 8845-40) and sonicated for 10 minutes. Both silica materials agglomerated and could not be dispersed. The silica also could not be completely removed from the volumetric flasks. Dichloromethane was therefore not a suitable dispersing medium for silica.

A second attempt was made to prepare the silica suspensions using filtered ethanol in place of the dichloromethane. The contaminant suspension was prepared by transferring 2.60 mg of the  $^{30}\text{SiO}_2$  into a cleaned 4 oz. glass bottle. The calibrant suspension was prepared by transferring 2.08 mg of the  $^{29}\text{SiO}_2$  into a second bottle. Each bottle was then filled with 100 ml of filtered ethanol. Approximately half of the silica in each bottle dispersed following the addition of the ethanol. The bottles were sonicated and the remainder of the silica was dispersed.

Even with ethanol as a dispersant, some settling of both (contaminant and calibrant) silica suspensions occurred after 5 minutes. The settled silica could be visibly redispersed by rapidly swirling the bottle; however, it is advised that the stock suspension be sonicated before withdrawing a sample for contaminant doping or calibrant addition for sample workup. It is suspected that the prequalifying tests on silica, discussed in Section 4.6.4, failed since the contaminant and calibrant suspensions had unknown, but very likely different amounts of settling. The amount of settling is likely to have been different because the calibrant isotope sample had a lower mass mean average particle size than the contaminant sample. This fact was not discovered until after the prequalifying tests had been performed. Prior to performing the prequalifying tests, only the number mean average particle sizes, which were within 10 percent of each other, had been examined.

The particle size distributions were determined using a coulter counter. The results for the contaminant and calibrant samples compared against the native inorganic particulate matter are shown in Table 8.

TABLE 8. SILICA SIZE DISTRIBUTION

	Inorganic Particulates Found in Contaminated Parts	Synthetic Silica Contaminant	Silica Calibrant
(A) Number mean, $\mu\text{m}$			
Mean	1.7 (typical part)	1.128	1.233
Mode	ND	0.811	0.857
Std. Dev.	ND	0.170	0.168
(B) Mass (volume) mean, $\mu\text{m}$			
Mean	ND	8.499	4.607
Mode	ND	21.68	15.12
Std. Dev.	ND	0.422	0.374

ND: Not determined

**4.4.2.2 Iron Stock Suspensions.** The  $^{57}\text{Fe}$  material was chosen as the synthetic contaminant while the  $^{54}\text{Fe}$  material was chosen as the calibrant. Approximately 2 mg of each Fe isotope was transferred to each of two 100 ml volumetric flasks. To each flask, 100 ml of filtered dichloromethane was added. Both Fe materials contained large ( $> 100 \mu\text{m}$ ) particles. Attempts to reduce the particle size by grinding the powder in a boron carbide mortar and pestle were unsuccessful because the Fe powder was very ductile. The powder tended to flatten into flakes rather than into smaller particles.

A sample of the  $^{57}\text{Fe}$  material was placed into the mortar in a dry nitrogen filled dry box. The mortar was placed under liquid nitrogen ( $\text{LN}_2$ ) to cool the iron below the ductile-brittle transition temperature. Grinding was performed in the dry box to reduce the frosting of the mortar and sample at  $\text{LN}_2$  temperatures. Several milligrams of  $^{57}\text{Fe}$  were ground then sieved with a 325 mesh Nylon sieve. No Fe particles passed the sieve. Since the material could not be reduced to sufficiently small particle size, the iron contaminant was not included in further testing. After the CPEP is validated with silica or any other inorganic particles, additional work to improve the iron particle size is recommended.

## **4.5 Isotope Analysis**

The methods for isotope analysis, including prequalifying tests related to Requirement No. 3 for CPEP (Section 3.2), used in this study are discussed in this section.

### **4.5.1 Organic Analysis**

The organic analyses were performed on the Finnigan TSQ-45 GC/MS. The native contaminants, the synthetic contaminant and the calibrant (i.e., analytical spike) compounds do each produce distinct mass spectral signatures. The quantity of calibrant recovered in the analysis is used to correct the analysis of the synthetic contaminant for losses during sample preparation. For example, if the GC/MS analysis finds  $0.4 \mu\text{g/ml}$  of synthetic contaminant and  $0.8 \mu\text{g/ml}$  of calibrant in a sample and the calibrant spike concentration was  $1 \mu\text{g/ml}$ , then the sample preparation procedure recovered 80 percent of the analytes. Assuming a well dispersed system, the true synthetic contaminant concentration was  $0.5 \mu\text{g/ml}$ . Thus, the calibrant is used to determine the efficiency of

the sample preparation techniques and to correct for analyte losses. The details of sample preparation and analysis are given in Sections 7.6, 7.8, 8.2, and 9.2 of CPEP (Appendix A). These procedures are satisfactory for analysis of isotopes present in a nonaqueous medium or in a deionized (DI) rinse water, but not in detergent water, as discussed in Section 4.6.

The GC/MS system was found to be quite accurate and precise. The results of 19 replicate analyses of standard mixtures are shown in Table 9. A minimum precision of 90 percent had been set for these prequalifying tests to validate Requirement No. 3 for CPEP (see Section 3.2). As seen from Table 9, the requirements were met.

#### 4.5.2 Silica Analysis

The inorganic isotope analysis procedure uses a different approach than used for organic isotope analysis. For inorganic particulates, the native contaminant, synthetic contaminant and calibrant, all contain the same isotopes; however, the relative abundances of the isotopes are different for each contaminant system. The synthetic contaminant contains mostly atoms of a low abundance in the natural element, while the calibrant contains mostly atoms of a second low abundance isotope. Using elements with three or more isotopes allows the determination of all three components with a single mass spectral analysis. Elements with two stable isotopes, such as Cu or Cl can be used if two mass spectral analyses are employed. Two mass analyses also permit use of a single isotopically labeled material as both the simulated contaminant and the analytical spike; however, this approach is not recommended when a unique simulant and spike can be employed. The cost of the analyses quickly exceeds the savings gained from use of a single isotopic material. The accuracy expected from two analyses is poorer as well.

The mass spectrograph determines the isotopic abundances of all elements in the sample in a single run. The measured isotopic abundances for each element are then combined with knowledge of the isotopic abundances of each component to determine the mole fraction of each component in the sample. Since the quantity of calibrant (spike) material added before analysis is known, the amount of both native and simulated contaminants can be determined. The isotope

TABLE 9. ORGANIC ANALYSIS ACCURACY AND PRECISION

	No. of Analyses	Recovery, Percent		
		Mean	Std. Error of Mean	95% C.L. <sup>a</sup>
Dimethylphthalate-d <sub>6</sub>	19	100.37	± 0.65	100.37 ± 1.37
Phenanthrene-d <sub>10</sub>	19	99.47	± 0.99	99.47 ± 2.09
Octadecanoic Acid-d <sub>35</sub>	19	101.53	± 1.45	101.53 ± 3.04

(a) C.L.: Confidence Limit

abundances for all of the isotopes to be measured in the native contaminant, analytical spike and simulated contaminant are used to form the column vectors of a matrix  $M$ . The isotope abundances of the mixture measured by the mass spectrograph form a column vector  $a$ . The solution vector,  $c$ , of the matrix equation

$$M c = a \quad \text{Eq. (1)}$$

is the mole fraction of each component contributing to the observed isotope pattern. The atomic weight and spiked mass of the analytical spike are used with the mole fraction of the analytical spike determined above to calculate the total number of moles of the element present in the analyzed sample. The mass of the native and simulated contaminants are then calculated using the total number of moles and the mole fractions of each component. To find the mass of a contaminant which is not a pure element, a correction is made based on the compound's molecular weight and the atomic weight of the element alone. For the simulated contaminant and analytical spike, the atomic weight is calculated as the weighted average of all isotopes present. Additional details for calculating the solution vector along with a software package for calculations is provided in Section 9.0 of CPEP (Appendix A).

A key assumption in this procedure is that both the synthetic contaminant and the calibrant are equally well dispersed in the stock solution as well as throughout the sample workup. This requires frequent sonication of suspensions containing inorganic particulates.

The mass spectral analyses were performed by Evans East Co., NJ, using a spark-source mass spectrograph. A comparison of ORNL analyses and Evans East analyses is given in Table 10. The data in Table 10 show that the Evans East values for the dominant isotopes are within 2 percent of ORNL values. And, since the ORNL analyses are believed to be more accurate, because of the use of a more sophisticated mass spectrometric method, these were used to calculate the matrix  $M$  in Eq. (1).

TABLE 10. SILICA STOCK ANALYSES

Isotope	Synthetic Contaminant Abundance, %		Calibrant Abundance, %	
	ORNL	Evans East	ORNL	Evans East
<sup>28</sup> Si	4.40	2.7	4.12	2.4
<sup>29</sup> Si	0.32	0.02	95.65	97.6
<sup>30</sup> Si	95.28	97.2	0.23	ND

ND: Not detected.

#### 4.6 Isotope Stability and Recovery

A series of prequalifying tests were conducted to further validate that the CPEP requirements stated in Section 3.2 are satisfied.

##### 4.6.1 Stability of Organic Contaminants

The stable isotope method assumes that the isotopes will not be altered or lost during a cleaning test. The inorganic contaminant cannot be altered by chemical processes; however, the organic compounds are labeled by substitution of deuterium atoms for hydrogen atoms in the molecules, and can be altered by chemical processes. Therefore, the stability of the organic compounds under the cleaning conditions must be determined.

Of the cleaning processes used at AGMC, ultrasonic cleaning was selected as the process most likely to cause alteration of the synthetic organic contaminants. To test the stability of organic compounds, a series of 6 tests were conducted at AGMC using a Magnekleen MK-1000-10A single bath ultrasonic cleaner. The cleaner's water tank was filled with cold tap water and the tank heaters were turned off. Typical AGMC sonication conditions were 20 kHz for 15 minutes at 6 watts/in<sup>2</sup>.

A 200  $\mu$ l aliquot of the organic synthetic contaminant solution was injected into 100 ml of filtered Freon 113 cleaning agent in each of six 250 ml beakers. Two of the beakers were used as controls and were not sonicated. Two of the remaining beakers were sonicated for 15 minutes, while

the other two beakers were sonicated for 30 minutes (i.e., twice the normal cleaning cycle time). All of the beakers were covered with domed aluminum foil covers to reduce evaporative losses of the test compounds. During the 30 minute test, refluxing was observed in the beakers due to the heat produced by the transducers. After the sonication cycle, a 200  $\mu$ l aliquot of the organic calibrant solution was injected into each beaker before the contents were transferred to 4 oz. glass bottles. The bottles were labeled, the caps were sealed with Teflon tape and the bottles were returned to Battelle for analysis. The analytical results are given in Table 11.

These results show that the recoveries of all three synthetic contaminants were close to 100 percent. Furthermore, the GC/MS analyses did not indicate that the test compounds had degraded during sonication.

These tests also demonstrated the validity of CPEP for organic contaminant isotope recovery from nonaqueous cleaning agents. For example, it was observed that nearly half of the Freon 113 had evaporated during the 30 minute test, and only a small aliquot of the solution was used for GC/MS analysis. This shows that the use of a calibrant allows for losses of cleaning extract during sample workup; the only requirement is uniform dispersion of the contaminant and calibrant isotopes in the cleaning agent.

#### 4.6.2 Recovery of Organic Contaminants Nonaqueous Cleaning Agents

The satisfactory recovery of organic contaminants from Freon 113 was demonstrated in the previous section. Three additional tests in TCA were also conducted, this time in the presence of isotopic silica and the absence of sonication. To each of three beakers containing 400 ml of TCA, 200  $\mu$ l of organic contaminant solution, 200  $\mu$ l of organic calibrant solution, 1 ml of silica contaminant suspension and 0.5 ml of silica calibrant suspension were added with swirling. A 200 ml aliquot of each sample was K-D concentrated to 10 ml and the concentrate was analyzed for the organic contaminants by GC/MS. The results of the GC/MS analyses are given in Table 12.

TABLE 11. ORGANIC CONTAMINANTS STABILITY AND RECOVERY FROM NONAQUEOUS CLEANING AGENT (CONTAMINANT ADDED TO FREON 113 BATH; NO PARTS BEING CLEANED)

Sonication Conditions	Recovery, percent		
	Dimethylphthalate-d <sub>6</sub>	Phenanthrene-d <sub>10</sub>	Octadecanoic acid-d <sub>35</sub>
Control A (No Sonication)	98.9	102.0	92.9
Control B (No Sonication)	94.6	95.3	107.0
15 min 6W/in <sup>2</sup> A	102.0	109.0	111.0
15 min 6W/in <sup>2</sup> B	97.0	110.0	80.1
30 min 6W/in <sup>2</sup> A	98.1	96.6	106.0
30 min 6W/in <sup>2</sup> B	97.5	105.0	98.1
Average	98.2	103.0	99.2 (103.0) <sup>b</sup>
Lower 95% C.L. <sup>a</sup>	95.5	96.5	87.2 (94.6) <sup>b</sup>
Upper 95% C.L.	100.6	109.5	111.2 (111.4) <sup>b</sup>

a. C.L. = Confidence Limit

b. Based on deleting data point for 15 min. 6W/in<sup>2</sup> B test condition.

TABLE 12. RECOVERY OF ORGANIC CONTAMINANTS IN  
NONAQUEOUS CLEANING AGENT (ORGANIC AND SILICA CONTAMINANTS  
ADDED TO TCA SOLUTION; NO PARTS BEING CLEANED; NO SONICATION)

Test No.	Recovery, percent		
	Dimethylphthalate-d <sub>6</sub>	Phenanthrene-d <sub>10</sub>	Octodecanoic acid-d <sub>35</sub>
8.2.1	103	88.5	91.6
8.2.2 (Repeat of 8.2.1)	102	85.8	88.7
8.2.3 (Repeat of 8.2.1)	101	91.6	95.4
Mean ± 95% C.L. <sup>a</sup>	102 ± 2.5	88.6 ± 7.2	91.9 ± 8.4

a. C.L. = confidence limit

Again, the tests met the requirement for high (about 95 ± 10 percent) recovery of synthetic contaminant. The recoveries appeared to be somewhat better for the Freon 113 tests which could be because of better homogenization of the Freon 113 sample due to sonication.

#### 4.6.3 Recovery of Organic Contaminants from Aqueous Cleaning Agent

The AGMC is planning to substitute Freon 113 and TCA with aqueous cleaners, including detergent water cleaners. Therefore, it was necessary to demonstrate the CPEP for aqueous cleaning agents. To do this, possible methods for direct analysis of organics in aqueous medium were searched. Methods for recovery of organics from non-detergent aqueous medium (e.g., DI water) and from detergent rinse water were demonstrated. However, no method for direct analysis in concentrated detergent water has yet been demonstrated. The results of the tests and a potential method for future investigation are discussed below.

**4.6.3.1 Recovery of Organic Contaminants from Distilled Water.** The efficiency of the recovery of the organic contaminant compounds was determined by injecting 200 µl of the organic contaminant solution into each of two beakers containing 200 ml of distilled water. The pH of the water was adjusted to 2 by addition of 3N HCl as measured by a strip of pH paper. The organic

contaminants were extracted from the water phase three times using 100 ml aliquots of dichloromethane. The dichloromethane extracts were combined and 200  $\mu$ l of the organic calibrant solution was added to the extract. The extract was dried with anhydrous  $\text{Na}_2\text{SO}_4$  and filtered through a coarse fiber filter to remove water from the sample. The extract was K-D concentrated to 10 ml for GC/MS analysis. The recovery of each compound during extraction is shown in Table 13. The extraction efficiency was worst for the octadecanoic acid, which is the most polar compound tested. The extraction efficiency of the less polar compounds was nearly 100 percent in all cases. The lower extraction efficiency observed for the octadecanoic acid will not introduce errors into the cleanliness tests, because the calibrant solution will be added to the aqueous phase prior to the dichloromethane extractions. The presence of both isotopic forms of each compound in the aqueous phase provides a straightforward correction for losses which occur during sample preparation.

TABLE 13. CONTAMINANT RECOVERY FROM DISTILLED WATER

Compound	Recovery Efficiency (%)	
	Test 1	Test 2
Dimethylphthalate-d <sub>6</sub>	99.6	100.0
Phenanthrene-d <sub>10</sub>	99.5	99.6
Octadecanoic acid-d <sub>35</sub>	66.1	83.6

**4.6.4.3 Recovery of Organic Contaminants from Detergent Water.** The difficulty with analysis of organics in concentrated detergent water is that there is no proven analytical method available to determine the target spiked organic contaminants in the detergent matrix and because the large organic background from the detergent overloads the analytical equipment. Therefore, an alternate method for calculating effectiveness of detergent water cleaning was developed. This required rinsing the detergent-cleaned part in deionized water followed by cleaning in a nonaqueous cleaning agent, such as TCA, for which a cleaning efficiency versus cleaning cycle has already been determined. This can help quantify the cleaning efficiency of detergent water with respect to TCA.

For example, let us assume that the incremental and cumulative percent contaminant removals are as follows:

<u>Cycle</u>	<u>TCA Incremental Cleaning, %</u>	<u>TCA Cumulative Cleaning, %</u>
1	60	60
2	20	80
3	10	90
4	5	95
5	3	98

Now, let us assume that after one detergent water cleaning cycle followed by a quick rinse, a part is recleaned in TCA and the incremental cleaning efficiency is 5 percent. This will mean that one cycle of detergent water cleaning is as effective as three cleaning cycles with TCA.

While demonstrating the above extended procedure for concentrated detergent water cleaning, it was decided to see if the organics in the dilute rinse water could be extracted and analyzed using the method described in the previous section. It was indeed possible to carry out this analysis for water containing small amounts of residual detergent. As a matter of fact, in all the rinse water samples, foaming was observed during sample workup, indicating the presence of trace amount of detergent. This provides hope for a potential method for direct analysis of organics in concentrated detergent water. The method would require an appropriate amount of dilution of the detergent water before solvent extraction. Such a method should be attempted in the future.

#### **4.6.4 Recovery of Silica from Nonaqueous Cleaning Agents**

To demonstrate the CPEP for recovery of silica from nonaqueous medium, the samples prepared for tests in Section 4.6.2 were utilized for silica analysis. A 100 ml aliquot of each sample was transferred into cleaned porcelain crucibles containing 5 mg of high-purity graphite powder (Ultracarbon USP-1). The TCA was evaporated at room temperature. The silicon isotope abundances in the graphite powder samples were analyzed by spark-source mass spectrography (SSMS) by Evans East Co. in New Jersey. The isotope abundances were used as input in the MATRIX program [Eq (1)] with the abundance information in Table 4 to calculate the mole fraction

of each of the types of silicon present in the sample. The sample calculations described in Appendix A, Section 8.1, were used to determine the amount of native silica and synthetic contaminant silica present.

The isotopic abundances determined by SSMS are shown in Table 14. These are averages of 4 or 5 analyses performed on different parts of the same graphite powder sample. The mean and standard errors of the calculation values of silica recovery are shown in Table 15.

TABLE 14. SILICON ISOTOPE ABUNDANCES IN TCA PREQUALIFYING TESTS

Test	Isotope Abundance (Averages)		
	<sup>28</sup> Si	<sup>29</sup> Si	<sup>30</sup> Si
8.2.1	0.775	0.114	0.111
8.2.2	0.811	0.089	0.100

TABLE 15. RECOVERY OF SYNTHETIC SILICA CONTAMINANT FROM TCA IN PREQUALIFYING TESTS

Test	No. of Analysis	Recovery, %	
		Mean, %	Standard Error of the Mean, %
8.2.1	5	45.4	± 13.4
8.2.2	4	60.2	± 11.4

As seen in Table 15, the poor recoveries of silica were unacceptable. However, the relatively low standard error suggested that there was possibly a systematic error which caused the low recovery of the silica. To help understand the potential causes for the poor recoveries, the particle size distribution of the two isotopic silica samples were analyzed more closely, as discussed previously (Section 4.5). It is suspected that the stock samples and cleaning workup samples were not adequately mixed and that the synthetic contaminant isotope had preferentially greater settling, due to its higher mass mean particle size, than the calibrant isotope. Unfortunately, this potential problem was not recognized until after the cleaning performance tests (Section 4.7) had already been

completed. As a consequence the silica analysis for the cleaning performance tests was curtailed and the CPEP methods relating to inorganic particulates removal efficiency remained unproven.

In the future, the following two methods should be investigated to demonstrate a satisfactory method for silica doping and removal due to cleaning:

- (1) Take extra care in keeping the stock solutions and workup samples well mixed. The specific techniques and steps to achieve this have already been incorporated in the CPEP (Appendix A).
- (2) Request the isotope suppliers to eliminate particles larger than about  $5 \mu\text{m}$ . If this is not possible, then a method to eliminate particles larger than  $5 \mu$  should be investigated.

#### 4.6.5 Recovery of Silica from Detergent Water

The ability of the inorganic analytical technique to measure the quantity of synthetic contaminant silica in the presence of a potentially large interference from sodium metasilicate in the detergent formulation was evaluated by this test. Three 400 ml samples of 2 volume percent Liquid Detergent 2 in distilled water were prepared in 16 oz. glass bottles. To each bottle, 1.0 ml of silica contaminant and 0.5 ml of silica calibrant was added.

Early experimental plans were based on drying the aqueous detergents onto high-purity graphite powder for the silica analyses; however, Liquid Detergent 2 contains sodium metasilicate at less than 5 percent concentration. Since even 0.1 percent of the sodium metasilicate ( $\sim 8 \text{ mg}$ ) would mask the microgram quantities of the isotopic materials used as synthetic contaminants and calibrants, a filtration step was included in the procedure to separate the silica particulates from the soluble sodium metasilicate. A 150 ml aliquot of each aqueous detergent sample was filtered through  $0.22 \mu\text{m}$  pore size, 25 mm diameter Millipore type GS membrane filters on a 25 mm Millipore filtration apparatus.

After filtration of 75 ml of detergent solution through the  $0.22 \mu\text{m}$  filter, the filtration rate had become slow. Filtered ethanol was added to the filtration apparatus to wash the detergent from the filter so that the filter could be replaced with a clean one. The addition of the ethanol nearly

stopped the filtration. The remaining ethanol was discarded and the filter was removed from the apparatus. A gelatinous coating was observed on the filter. A new filter was placed in the apparatus and filtration was resumed. This filter and all the remaining filters were washed with distilled water to remove the detergent. None of these filters exhibited the coating observed on the first filter.

During filtration of the second and third samples, a large quantity of foam was produced below the filter apparatus frit. The foam eventually filled the filtration flask and had to be removed from the flask before it was drawn into the vacuum pump. The foam did not otherwise affect the filtration.

As in the case of silica recovery from TCA, the silica recovery from metasilicate detergent water were quite poor despite low standard errors (Table 16). It is believed that the recoveries can be improved with the two potential methods suggested in the previous section.

#### **4.7 Cleaning Performance Evaluation**

To further validate the CPEP as well as to determine the precision (repeatability), a test matrix consisting of 8 tests, shown in Table 17, was designed and implemented. All tests were carried out at AGMC using A-200D accelerometers employing three different cleaning agents. In the following sections, the doping procedures, test details, and cleaning efficiency results are discussed.

##### **4.7.1 Parts Doping**

The contaminant doping procedure will vary depending on the type of test device chosen for the cleaning evaluation. The cleaning performance evaluations were performed using A-200D accelerometers; however, a similar procedure would be applicable to other devices where the contaminants can be deposited inside a sealed enclosure, such as a gyro. Prior to contaminant doping, the seal integrity of a sample accelerometer was tested at Battelle by injecting several milliliters of ethanol into the unit through one of the fill tubes. Leakage was observed between the halves of the case. Initially, the doping procedure used a supply of filtered nitrogen flowing through the device to remove the ethanol and dichloromethane carrier liquids in the contaminant suspension

TABLE 16. SILICON ISOTOPE RECOVERY FROM AQUEOUS MEDIUM

Test No.	No. of Analyses	Silica Recovery, %	
		Mean	Std. Error of the Mean
8.3.1	5	37.1	$\pm 0.8$
8.3.2	4	55.1	$\pm 6.1$
8.3.3	4	25.7	$\pm 4.6$

and solution. Since the positive internal pressure produced by the nitrogen flow would increase leakage from the device, the procedure was modified to use a vacuum pump to pull air through the test device. The pump produced a negative pressure in the device and stopped or reduced the leakage. To further control any remaining leakage, the joint of the case halves was wrapped with Teflon tape. The tape served to improve the seal and collect any contaminants which escaped from the device. After the doping was completed, the tape was removed from the device and saved. The tape was extracted with dichloromethane and the extract was combined with the contents of the cold trap used to collect volatile organic contaminants escaping from the test device during the solvent evaporation step. Prior to doping, test devices were fitted with 1/16" copper fill tubes and any internal parts needed to allow sealing of the device were attached. The parts were thoroughly cleaned using the current cleaning procedure. The parts were then vacuum dried and the case halves were reassembled.

TABLE 17. TEST MATRIX FOR CLEANING

Test No.	Part <sup>a</sup>	Cleaning Agent <sup>b</sup>	No. of Cleaning Cycles <sup>c</sup>	Comments
1,2,3	A1, A2, A3	T	3	Tests 2 and 3 are repeats of Test 1
4,5,6	A4, A5, A6	C	3	Tests 5 and 6 are repeats of Test 4
7,8	A7, A8	W	<sup>d</sup>	Test 8 is a repeat of Test 7

- a. A: Accelerometer (A-200D)
- b. T: 1,1,1-trichloroethane (TCA); C: Freon-113; W: aqueous detergent
- c. Each cycle with an equal volume of cleaning agent, with collection and analysis of the cleaning residue from each cycle.
- d. One cycle in aqueous detergent followed by a 11 second sonication in deionized water and one cycle in cleaning agent T. The extract from the deionized water rinse was analyzed as a separate sample.

A dry ice-acetone (-78C) cold bath was prepared to contain the cold trap used to collect any volatile organic compounds which escape from the device during evaporation of the carrier liquid. The dry ice - acetone bath was chosen over a liquid nitrogen (LN<sub>2</sub>) bath, because the -78C temperature was sufficiently low to condense the dichloromethane without freezing it.

The inorganic and organic contaminants were introduced into the test devices in two separate steps so that the ethanol in the inorganic suspension could be removed and the silica distributed before the organic contaminant was introduced. The schematics of the doping apparatus for the two steps are shown in Figures 2 and 3. Since the silica was not volatile, there was no danger of it escaping during drying and the cold trap was not attached during that step. A contaminant injection volume of 1.0 ml (26.0 μg of silica) was used for the TCA and detergent water cleaning tests based on the particulate concentration of 1 to 5 μg per milliliter observed in the used fill fluid samples analyzed in Phase I (Section 4.2). The contaminant loading was chosen to be similar to the observed loadings to approximate actual quantities of contaminants. The initial results from the prequalifying tests showed that the amounts of native silicon contamination can exceed 100 μg in 400 ml of cleaning agent without a test device present. The contaminant volume was then increased to 3.0 ml(78.0 μg of silica).

The vacuum pump was connected to one of the fill tubes and turned on prior to injection of the contaminant. An aliquot of silica contaminant suspension was injected into the test device using a 1000 μl hypodermic syringe. The fill tube was washed with filtered ethanol to transfer the contaminant into the device. After the liquid was injected, the device was tilted so that the contaminant could wet the interior surfaces of the device. The tilting was performed slowly to allow the particulate contaminant to be distributed without producing strong turbulence in the liquid. Tilting continued for all but the last 5 minutes of the liquid drying time.

After evaporation of the ethanol, the pump was stopped and the cold trap was inserted in the line between the test device and the vacuum pump. The trap was lowered into the cold bath and held in position with a ring stand clamp. The pump was restarted and the injection of the organic contaminant performed. A 200 μl aliquot of the organic contaminant solution was injected using a 250 μl hypodermic syringe. Two 1 ml injections of filtered dichloromethane were used to wash the contaminants into the device and to increase the liquid volume so that the contaminants would cover

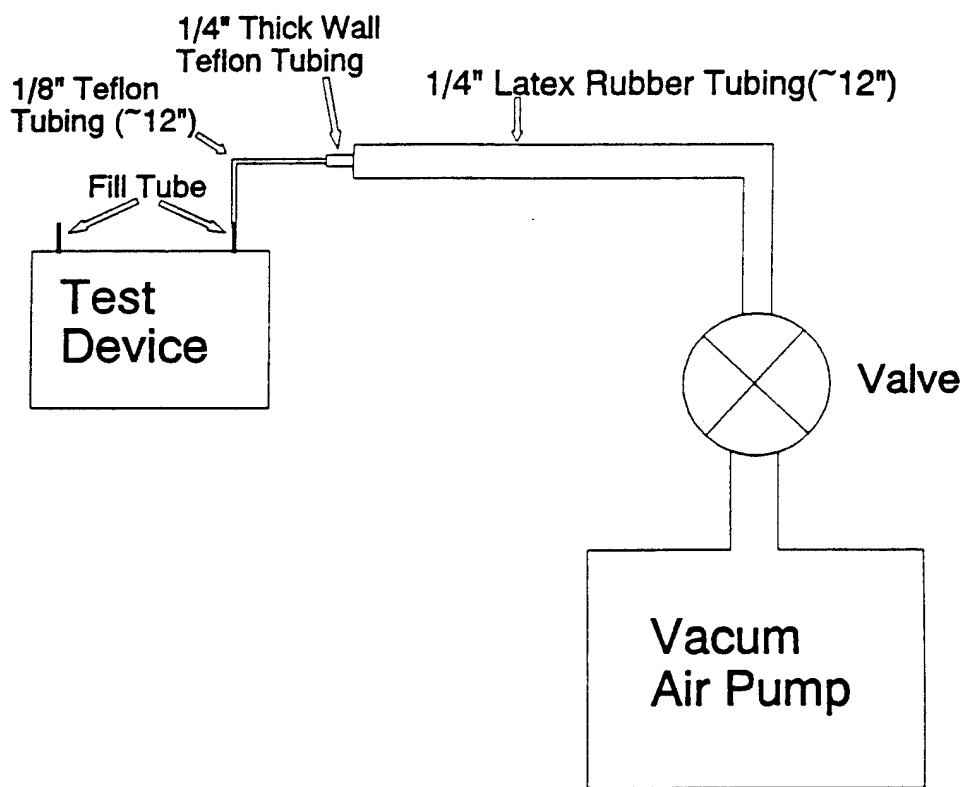

Figure 2. Schematic Diagram of Test Device for Inorganics Doping

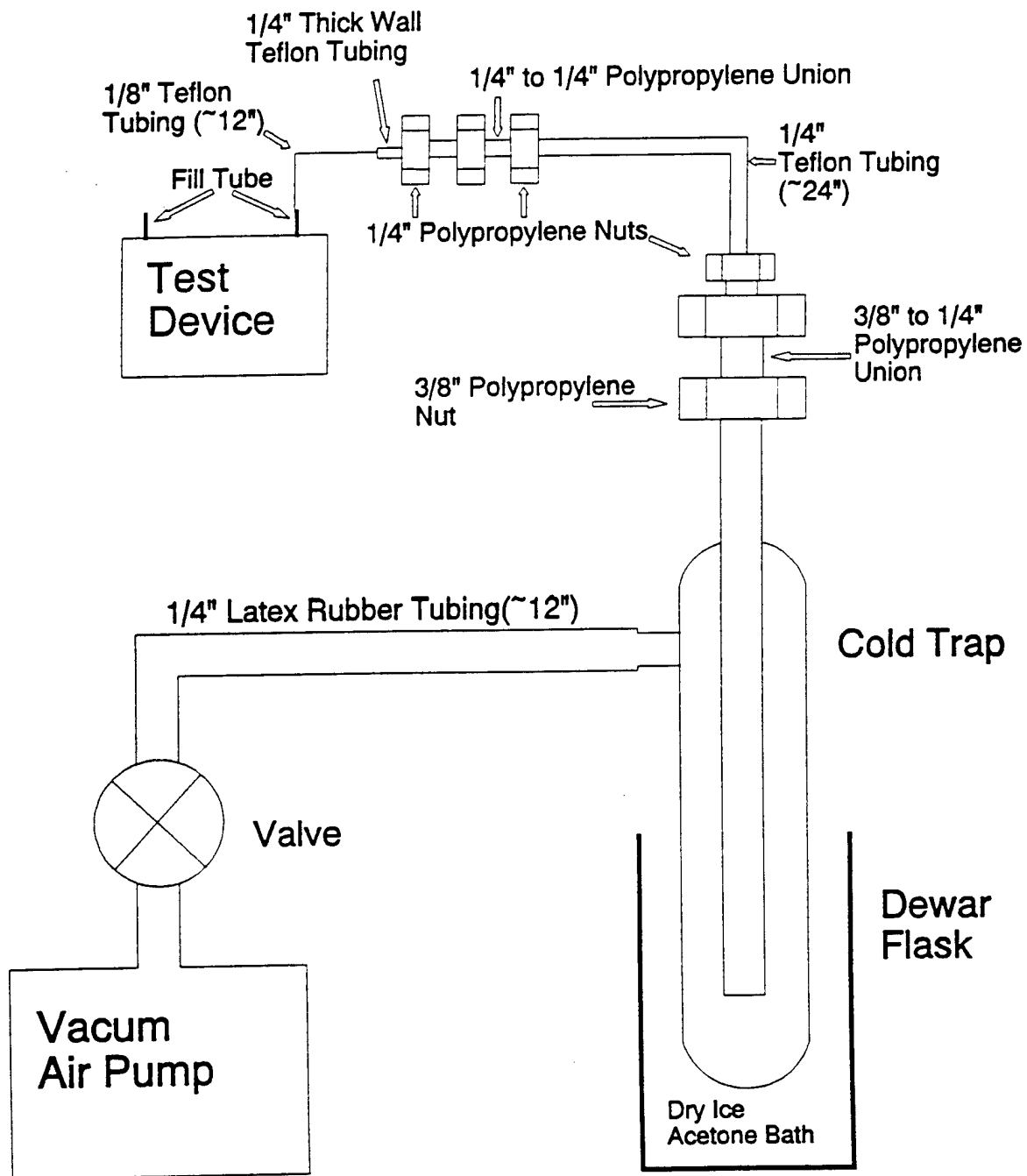

Figure 3. Schematic Diagram of Test Device for Organics Doping

the interior of the device more uniformly. The larger liquid volume also increased the drying time so that tilting of the device could distribute the contaminants on the internal surfaces of the test device. After evaporation of the dichloromethane carrier the pump was stopped and the test device was disconnected and set aside. The contaminant loadings and drying times for the test devices are given in Table 18.

TABLE 18. TEST DEVICE SYNTHETIC CONTAMINANT LOADING  
(A-200D ACCELEROMETERS)

Test	Device ID	Inorganic Contaminant (ml)	Ethanol Rinse (ml)	Drying Time (min)	Organic Contaminant ( $\mu$ l)	DCM* Rinse (ml)	Drying Time (min)	Remarks
1	400222	1.0	2.0	20	200	2.0	10	Leaked. Cold trap fitted 4 min late
2	00230	1.0	2.0	15	200	2.0	10	
2R <sup>b</sup>	450416	3.0	1.0	20	200	2.0	10	
3	400500	1.0	2.0	15	200	2.0	10	Leaked.
4	450626	3.0	1.0	20	200	2.0	10	
5	400561	3.0	1.0	20	200	2.0	10	Leaked. Vacuum hose pinched.
6	1012T	3.0	1.0	20	200	2.0	10	
7	10025	1.0	2.0	15	200	2.0	10	
8	10417	1.0	2.0	15	200	2.0	10	

Notes: (a) Dichloromethane

(b) Test repeated because organic calibrant was not added to the first cleaning cycle residue.

The cold trap was removed from the cold bath and warmed to room temperature. If leakage was observed on the Teflon tape during drying of the ethanol carrier, an aliquot of the inorganic calibrant was added to the contents of the cold trap. A 200  $\mu$ l aliquot of organic calibrant was injected into the cold trap and the contents were transferred to a labeled sample bottle. The Teflon tape was removed from the devices and saved. The tape was extracted with dichloromethane to remove any leaked organic contaminants and the extract was combined with the cold trap residue for analysis. The results of the organic analyses of the cold trap residues are presented in Table 19.

The data in Table 19 show that about 10 to 20 percent of the dimethylphthalate contaminant escapes from the test devices during the drying step. Loss of this compound was expected due to its moderate vapor pressure at room temperature and is the reason for use of the cold trap during drying of the organic contaminants. The other compounds escape when the device leaks, but do not appear to be lost significantly by evaporation. In all cases, the losses from the accelerometer were determined to calculate the amounts of various contaminants actually present during the cleaning tests (Section 4.7.2).

TABLE 19. COLD TRAP AND TEFLON TAPE RESIDUE ORGANIC CONTAMINANT ANALYSIS

Test	Recovery, percent		
	Dimethylphthalate-d <sub>6</sub>	Phenanthrene-d <sub>10</sub>	Octodecanoic acid-d <sub>35</sub>
1 <sup>a</sup>	7.0	2.9	12.3
2	14.5	2.0	0.8
2R <sup>b</sup>	9.7	2.8	0.14
3 <sup>c</sup>	11.7	6.0	5.8
4	23.3	5.7	0.24
5 <sup>c</sup>	9.1	12.5	10.5
6	20.1	5.8	1.9
7	15.3	3.7	0.8
8	10.8	2.7	0.6

Notes: (a) The device leaked and the cold trap was fitted 4 min after drying started.  
 (b) Test repeated because organic calibrant was not added to the first cleaning cycle residue.  
 (c) The device leaked.

#### 4.7.2. Cleaning Tests

All of the cleaning performance evaluation tests were performed at NAFB using a Branson Ultrasonic Cleaning System Model BCR-1824-36 with an ultrasonic generator Model EMIX 70 36. The generator operating frequency was 25KHz and the output power was 1260 Watts. The dimensions of the bottom of the ultrasonic bath were 18" x 24". Ultrasonic cleaning was chosen as

the cleaning process for validation testing because ultrasonic cleaning could be performed more repeatably than other cleaning processes, such as liquid impingement. A cleaning cycle time of 15 minutes was used for all cleaning cycles except the deionized water rinse cycle of the aqueous detergent cleaning tests, 7 and 8 which was only 11 seconds long. The details of the cleaning performance evaluation tests performed during this program are shown in Table E-1 (Appendix E). For the validation tests, each doped test device was opened and placed into a 600 ml Pyrex glass beaker containing 400 ml of the cleaning agent indicated in Table E-2. Aluminum foil covers were used to reduce cleaning agent evaporation from the beakers. The covered beakers were placed on racks in the cleaning bath and the cleaning cycle was begun. The beakers were removed from the bath at the end of the cleaning cycle and the devices were transferred to a new beaker containing 400 ml of the cleaning agent for the next cleaning cycle. During the following cleaning cycle, the aluminum foil covers of the previous cycle's beakers were washed with fresh cleaning agent. The wash was added to the corresponding beaker. The inorganic and organic calibrants were injected into the beakers using separate hypodermic syringes. The contents of each beaker were quantitatively transferred to labeled 16 oz. glass bottles. The bottle caps were sealed with Teflon tape and the samples were returned to Battelle for analysis.

#### **4.7.3 Cleaning Extract Analysis**

The cleaning extracts described in the previous section were analyzed by Evans East for silicon isotope abundances by spark-source mass spectrography (SSMS) and at Battelle for the organic contaminant concentrations by GC/MS analysis. The inorganic samples were prepared for SSMS analysis by drying a 100 ml aliquot of the cleaning agent residue onto 5 mg of high-purity graphite in precleaned porcelain crucibles. A 150 ml aliquot of the aqueous detergent residue and the aqueous rinse samples were filtered through 0.22  $\mu\text{m}$  pore size filters (Multipore Type GS) to avoid contamination by sodium metasilicate in the detergent. The filters were ashed for 2 hours at 600 C. The ash was mixed with high-purity graphite and submitted for SSMS analysis.

The organic samples from Test 1 through 3 were prepared for analysis by Kuderna-Danish (K-D) concentration of 200 ml of the organic cleaning agent residues to 2 ml. Residues which contained 0.5 ml of inorganic calibrant were handled without difficulty. The samples from Test 4 through Test 6 were concentrated by K-D evaporation to 2 ml, and evaporated to dryness by nitrogen

and then redissolved in 1 ml of dichloromethane. The step of evaporation to dryness was necessary because all samples contained 2 ml of ethanol. The presence of ethanol in the sample can cause degradation of the GC column. Note that all these redissolved samples exhibited a cloudy appearance. The suspended particles were settled down to the bottom of the sample vials and only the clean solutions were used for GC/MS analysis. A 1  $\mu$ l aliquot of each concentrate was analyzed by GC/MS. The aqueous rinse samples were extracted three times with dichloromethane. The aqueous layer was saturated with sodium chloride to drive the organic compounds into the dichloromethane.

#### **4.7.4 Cleaning Efficiency Calculations and Errors**

As discussed in Section 4.6, the silica recovery prequalifying tests failed resulting in unacceptable low recoveries. Therefore, only a few of the samples from cleaning performance testing were processed for silica analysis. These results also showed poor recoveries. Therefore, in the following discussion, the results for organic contaminant removal are emphasized to demonstrate the validity of CPEP. In a future phase, when the silica sample preparation and handling procedure is refined, the CPEP can be validated for inorganic particulate removal.

The cleaning extract analyses were used to calculate percent cleaning, defined as percent of a contaminant extracted. The results are tabulated in Tables E-3, E-4, and E-5 (Appendix E).

**4.7.4.1 General Cleaning Efficiency Curves.** The results showed that all organic contaminants were removed rapidly in the first cycle and at much slower rates in the second and third cycles. A typical set of test data are shown in Figure 4, which corresponds to Test 2R, conducted with TCA. The results do not appear to follow a simple, e.g., first order, rate law. It will be necessary to shorten the cleaning cycle and increase the total number of cycles to derive a satisfactory cleaning efficiency model.

The data from three replicates with TCA were analyzed to determine the 95 percent confidence limits for cumulative percent cleaning as a function of cleaning cycle. The results for TCA for the three contaminants are shown in Figures 5, 6, and 7. The results show that the 95 confidence bounds are within 10 percent of the mean. This means that the CPEP can distinguish, at a

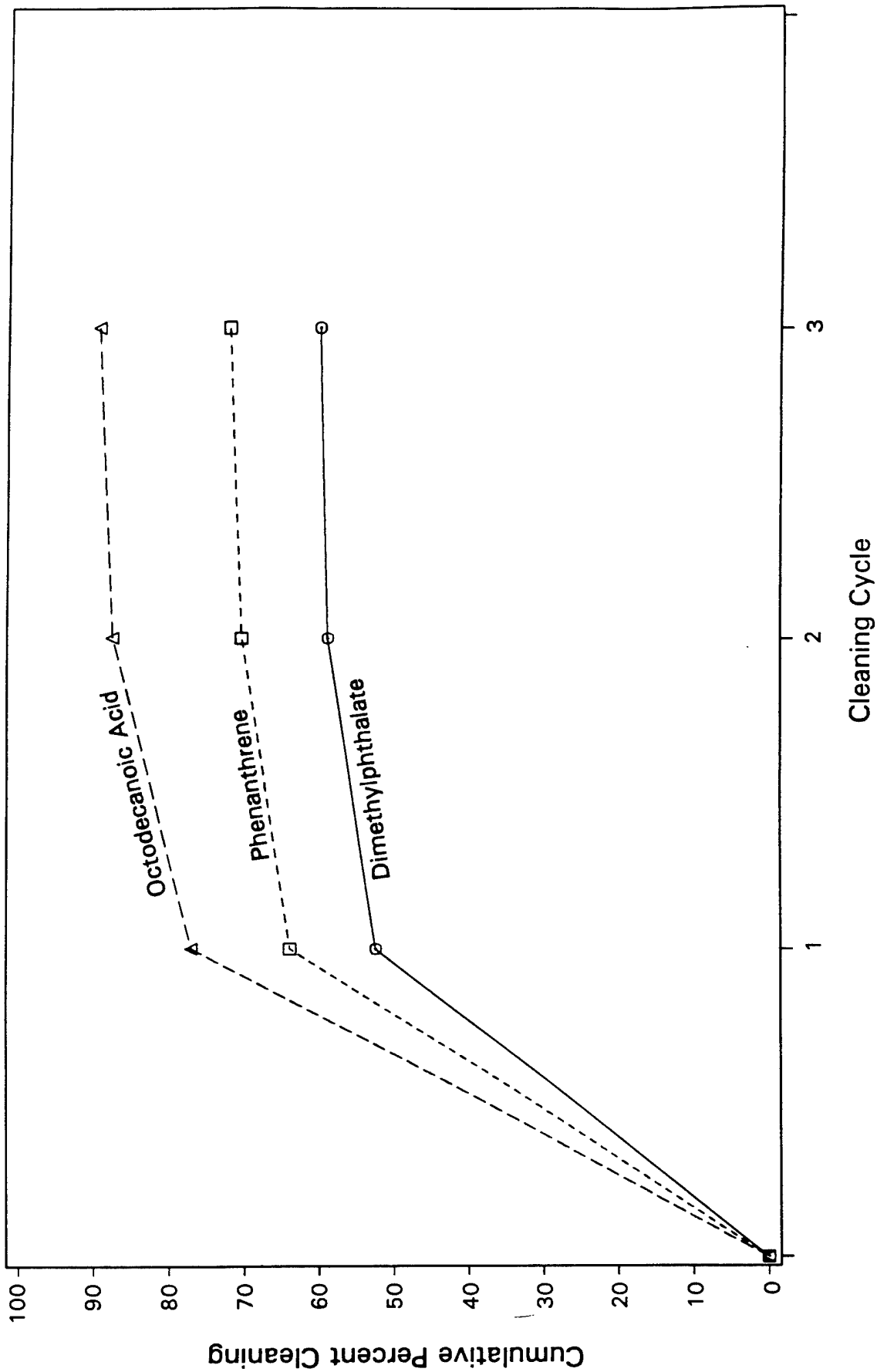

Figure 4. Organic Compound Removal with TCA (Test 2R)

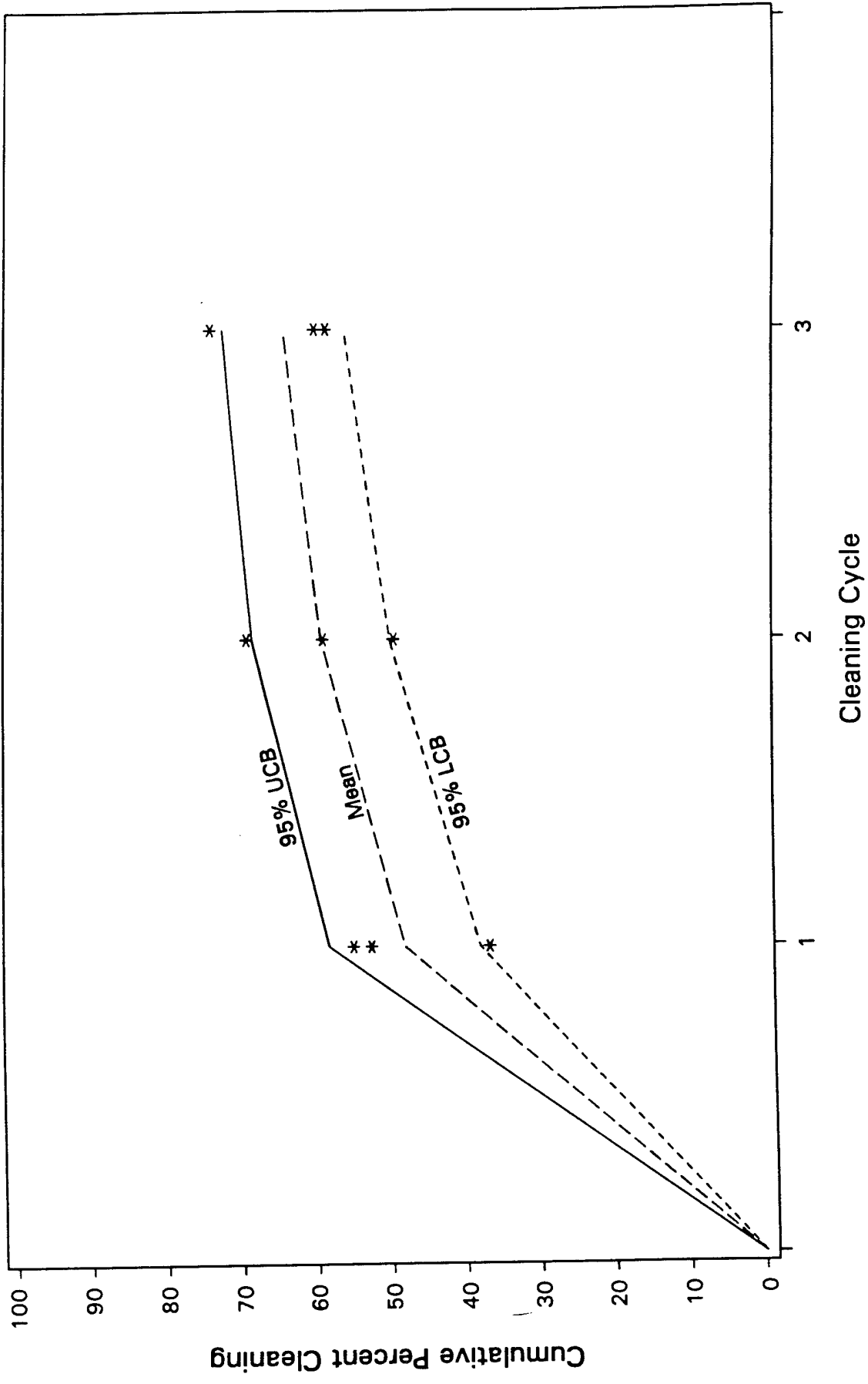

Figure 5. Removal of Dimethylphthalate with TCA. (The UCB and LCB are upper and lower confidence bounds, respectively, for a data set of three replicates).

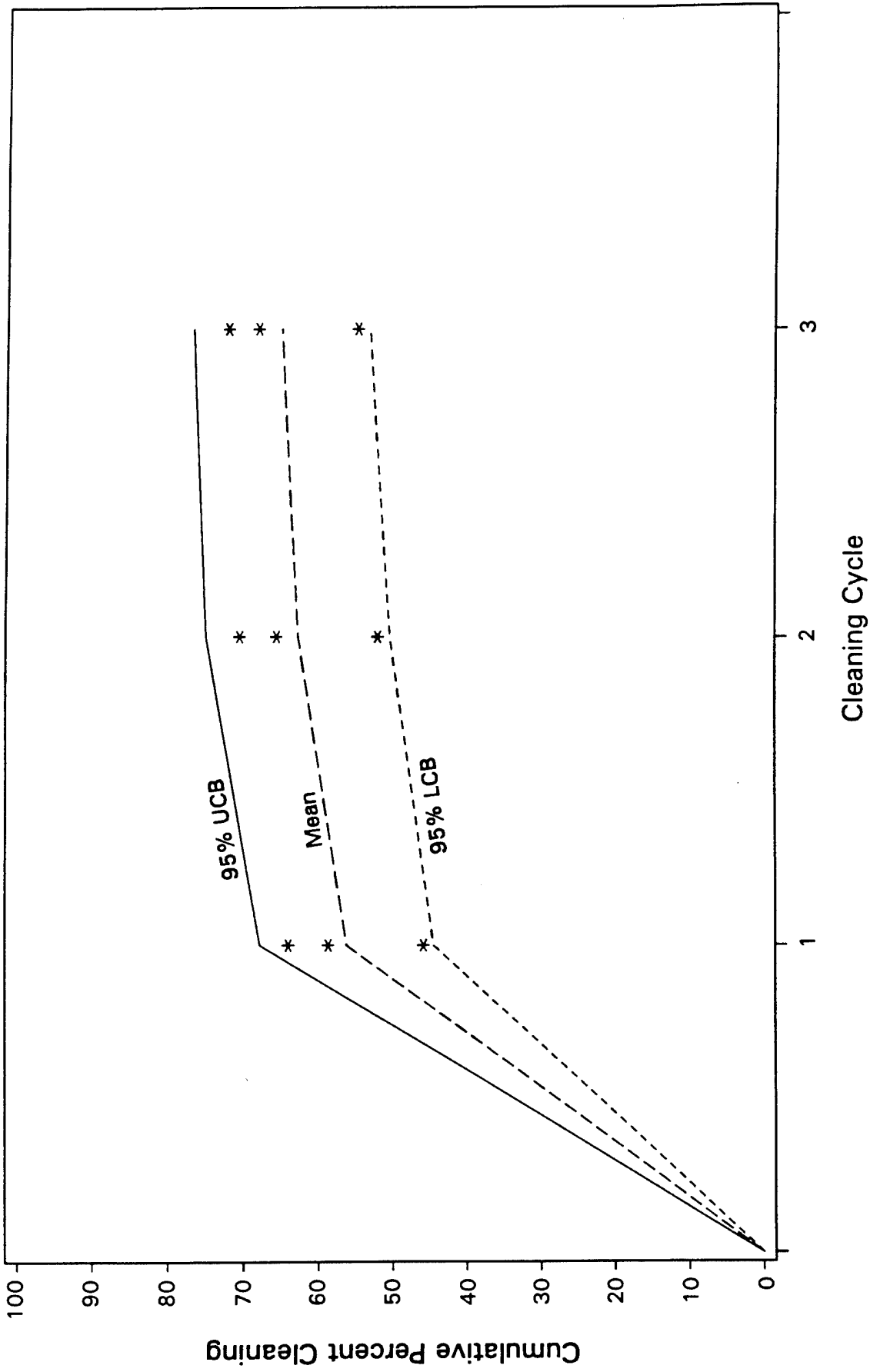

Figure 6. Removal of Phenanthrene with TCA. (The data are a set of three replicates).

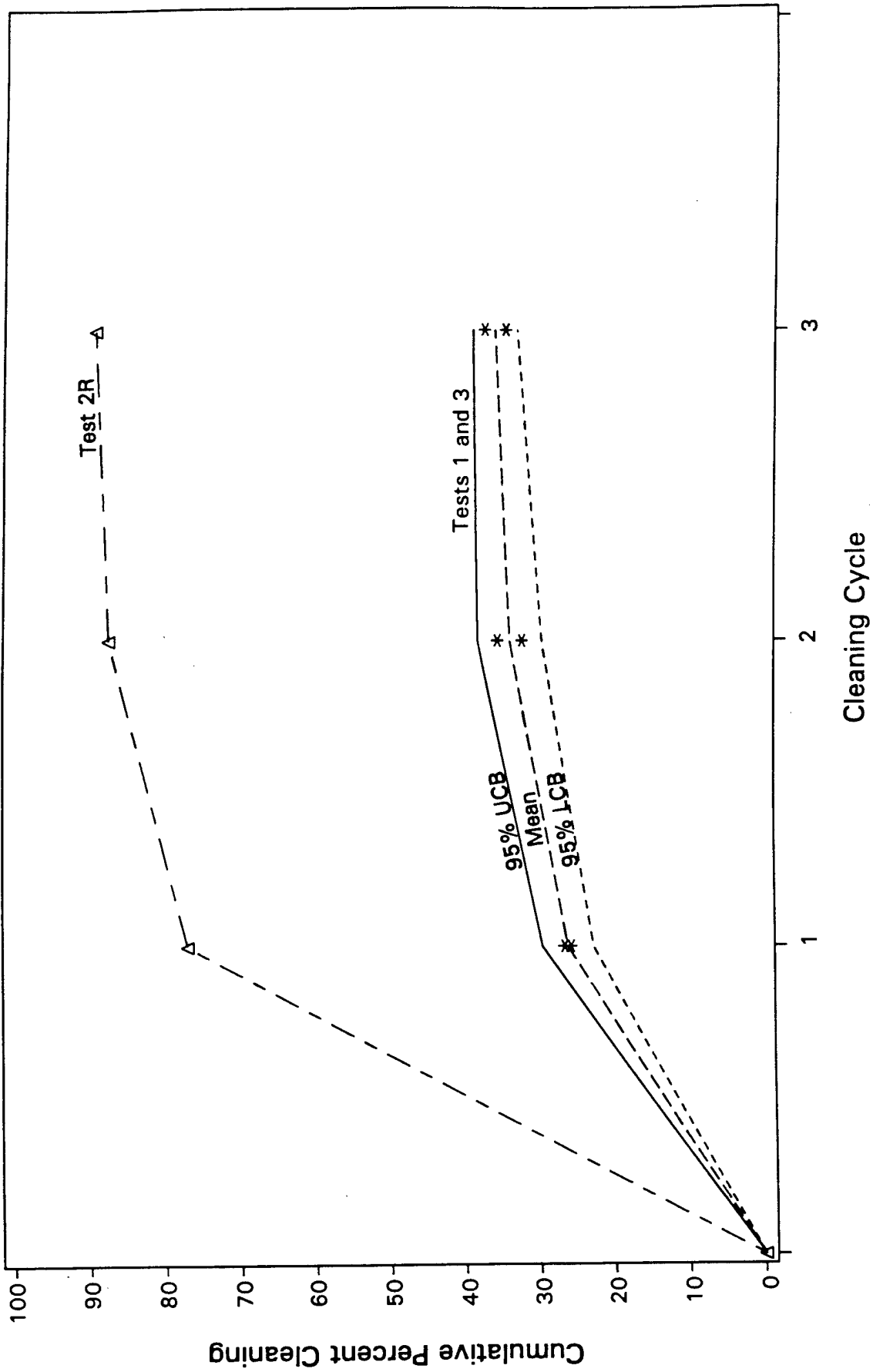

Figure 7. Removal of Octadecanoic Acid with TCA.

95 percent confidence level, between two cleaning agents that differ by at least 20 percent in cleaning efficiency.

It is believed that as more experience is gained with CPEP, and when more replicate tests are carried out, the error bounds will be compressed. Such errors can be better quantified, for example, through an ASTM-style, "round-robin" testing.

In the case of octadecanoic acid tests with TCA, the results for Tests 1 and 3 were quite different from Test 2R (repeat of Test 2, which was incomplete). This is because the stock solution for Tests 1 and 3 was too cold to retain all the acid in solution. On the other hand, in Test 2R with TCA, as well as in all the tests with Freon 113 or aqueous cleaner, the stock solution had been allowed to warm up. This apparently caused the cleaning efficiencies in Tests 1 and 3 to be artificially low; the results for Test 2R should actually be representative of TCA performance with octadecanoic acid.

As regards to the absolute performance of TCA, the cleaning efficiencies are probably quite high since we used a very small amount of the organic contaminants. In fact, if we assume that the total surface area is ten times the surface area based on the gross internal dimensions of the A200D accelerometer, then the doping amount corresponds to less than 10 atomic layers. Such a thin film of contaminants would tend to strongly adsorb on the part surfaces. Even then, in some cases, high cumulative efficiencies, i.e., greater than 90 percent, were observed after 3 cycles.

Overall, the TCA cleaning efficiency curves, as well as the Freon 113 cleaning curves, which are discussed in the next section, appear to be generally what was expected:

- A high initial rate of cleaning
- A declining rate of cleaning with cumulative cycle time
- An approach to 100 percent cleaning level with extensive cleaning.

The ability of CPEP to repeatably quantify the cleaning efficiency of a cleaning agent should lead to the quick adaptation of the technique.

**4.7.4.2 TCA vs. Freon 113 Cleaning.** The cleaning efficiency curves for Freon 113 were found to be similar in shape to the curves for TCA. The results are shown in Figures 8, 9, and 10. However, the cleaning efficiency of TCA relative to Freon 113 varied with the type of organic contaminant being removed. For example, Freon 113 was more efficient than TCA in removing dimethylphthalate, but less efficient than TCA in removing octadecanoic acid, the latter being a much more polar compound. This, in fact, was expected since Freon 113 is less polar than TCA and polar solvents perform better on polar contaminants. The results for TCA and Freon 113 are graphically compared in Figure 11.

The data for TCA and Freon 113 were also analyzed for statistically significant differences between the two. The data, summarized in Table 20, show that after 2 or 3 cycles of cleaning, Freon 113 was superior to TCA for removal of dimethylphthalate. At the 95 percent confidence (5 percent significance) level, there were no differences between the two, however, for phenanthrene removal. Such an analysis could not be completed for octadecanoic acid because of the limited data for TCA.

Two important objectives in cleaning performance testing were to show that CPEP is precise (repeatable) and it can repeatedly show one cleaning agent to be better than another one. This is demonstrated in Figure 12 for octadecanoic acid removal by TCA and Freon 113. These results give confidence in the CPEP.

**4.7.4.2. TCA Versus Aqueous Cleaning.** As discussed earlier, the AGMC is implementing the substitution of TCA and Freon 113 with aqueous (detergent water) cleaners. A comparison of TCA with an aqueous cleaner was therefore carried out. The results are shown in Figure 13. Here, as discussed in Section 4.6.3, it was not possible to determine the cleaning efficiency of detergent water in the first cycle. Therefore, an "extended analysis" procedure was adopted. Accordingly, the once-cleaned part was quickly rinsed in DI water followed by cleaning in TCA. These two additional steps for aqueous cleaning are shown as Cycles 2 and 3, respectively, in Figure 13. Now, to compare TCA with aqueous cleaning, the incremental cleaning for Cycle 2 for TCA should be compared with Cycle 3 for aqueous cleaning. Such a comparison shows that the aqueous cleaner removed more contaminant in Cycle 1 than TCA regardless of the type of organic

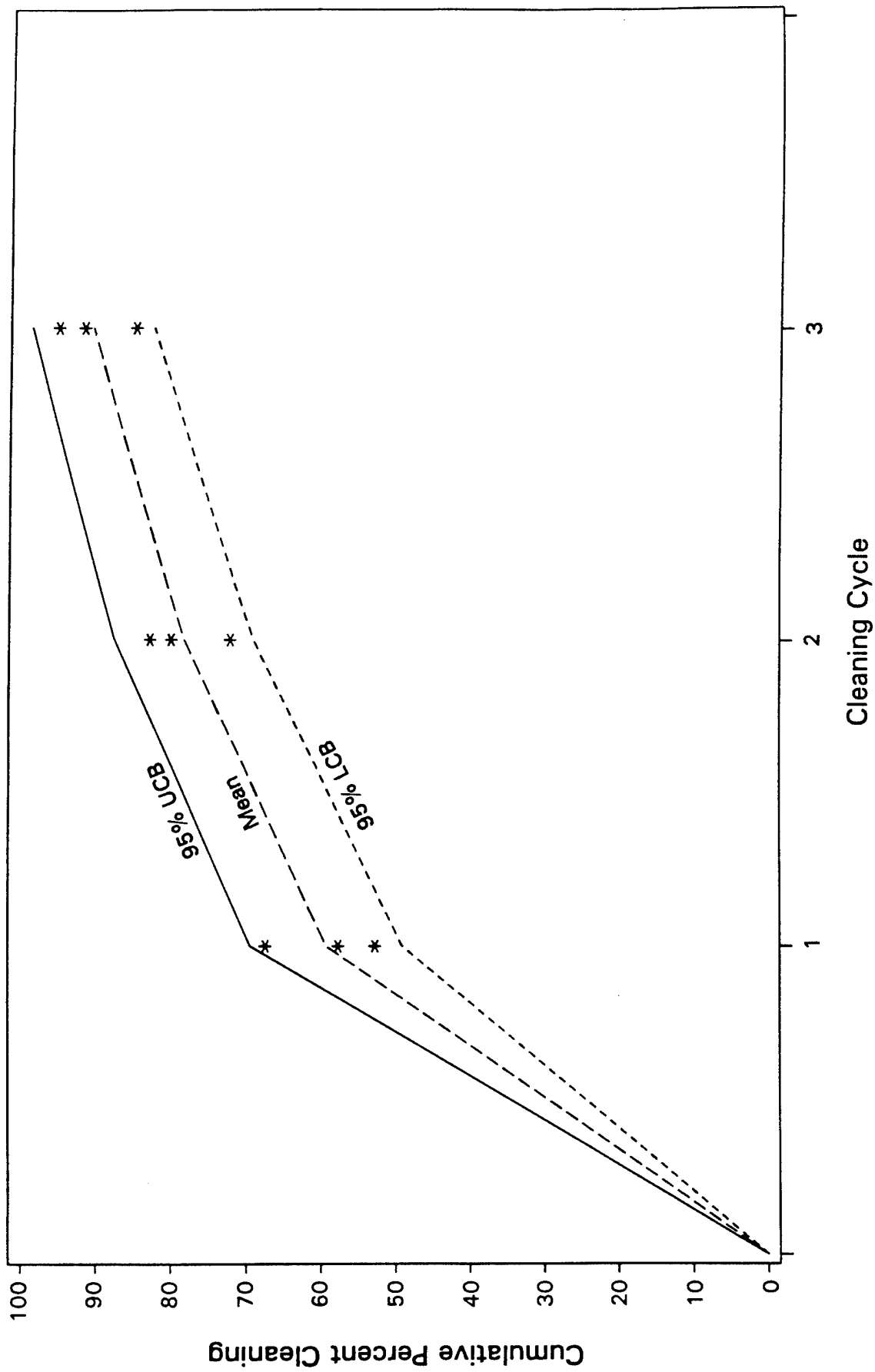

Figure 8. Removal of Dimethylphthalate with Freon 113. (The data are a set of three replicates).

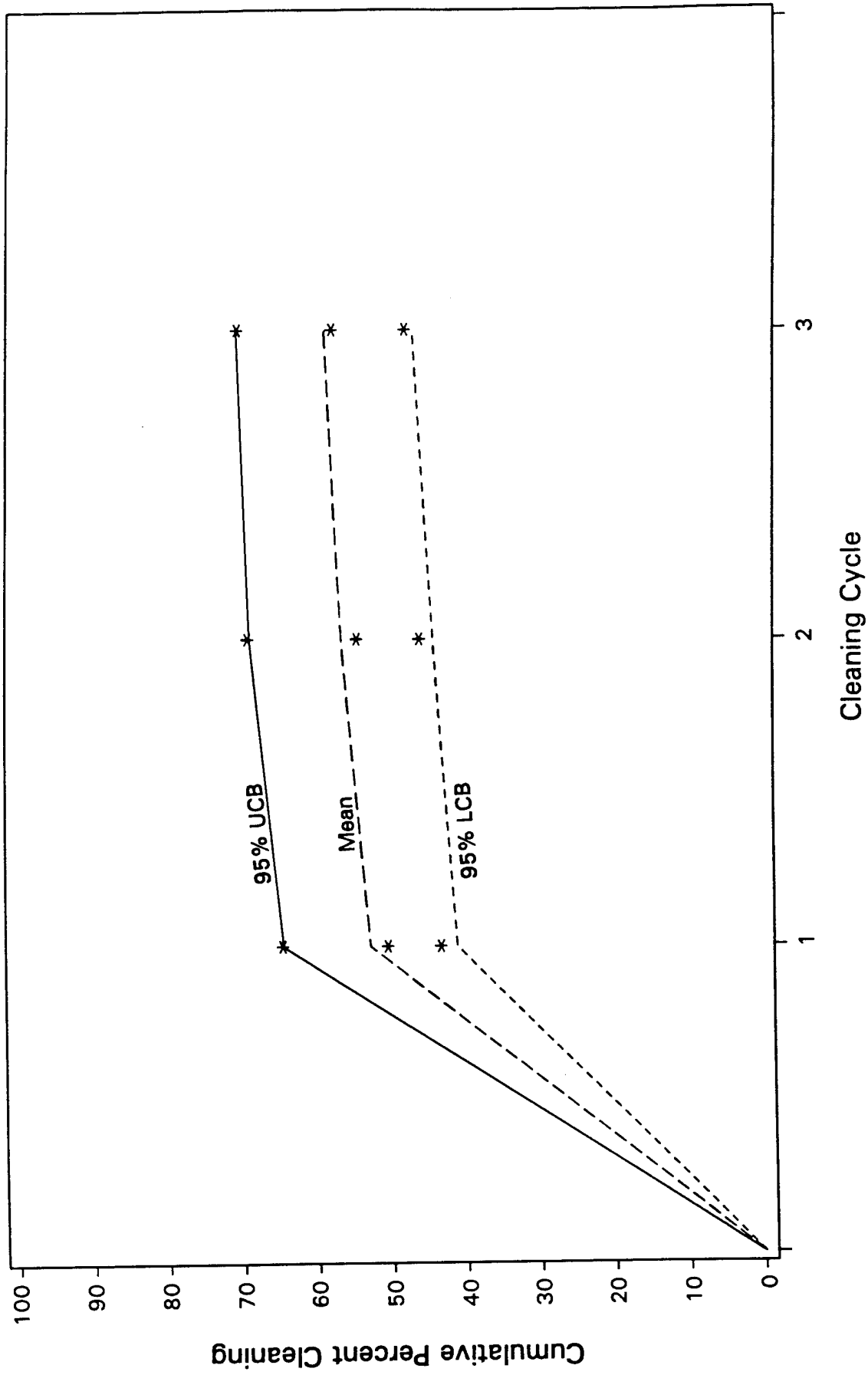

Figure 9. Removal of Phenanthrene with Freon 113. (The data are a set of three replicates).

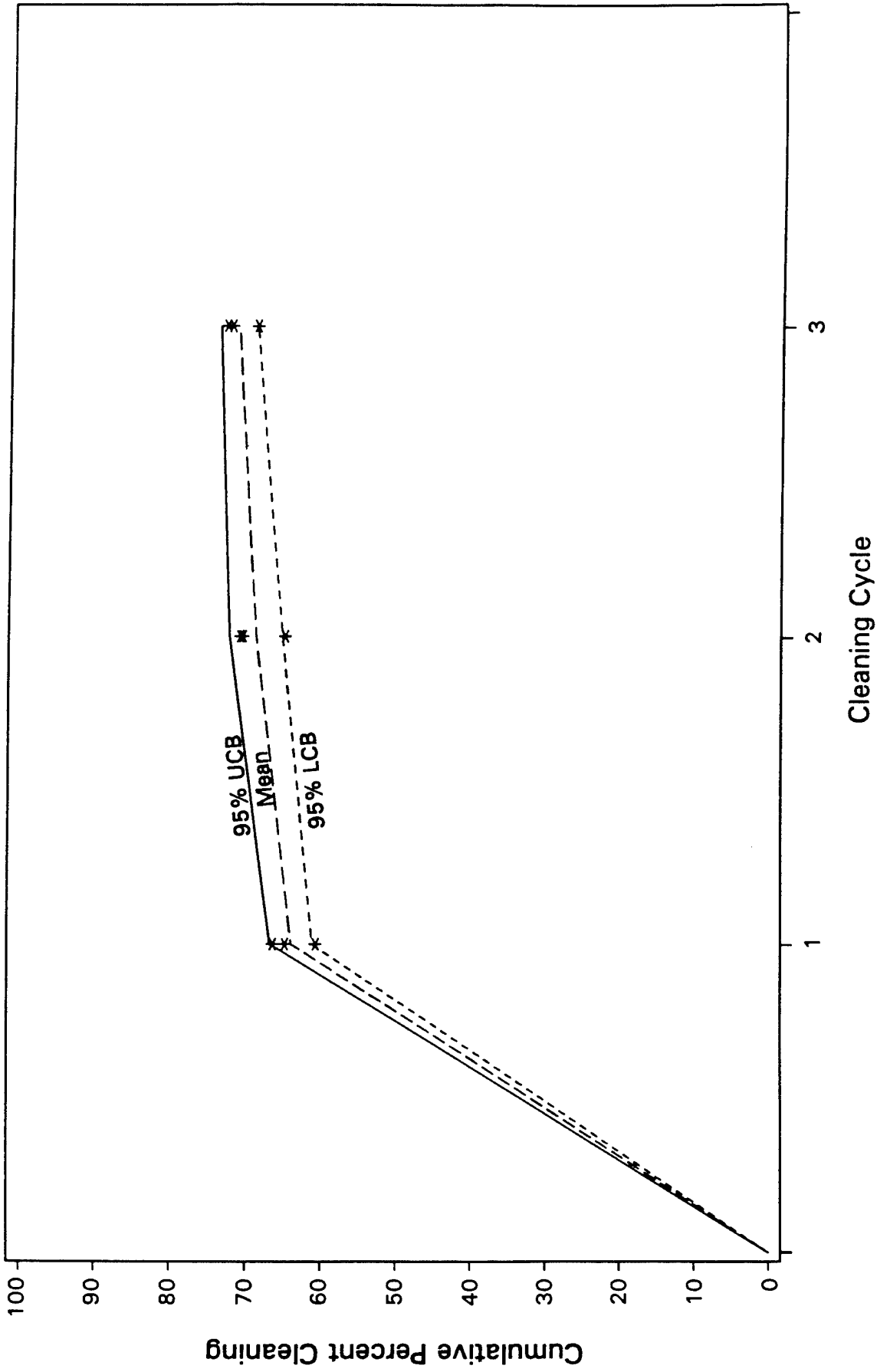

Figure 10. Removal of Octadecanoic Acid with Freon 113. (The data are a set of three replicates).

1 2 3 4 5 6 7 8 9 10 11 12 13 14 15 16 17 18 19 20 21 22 23 24 25 26 27 28 29 30 31 32 33 34 35 36 37 38 39 40 41 42 43 44 45 46 47 48 49 50 51 52 53 54 55 56 57 58 59 60 61 62 63 64 65 66 67 68 69 70 71 72 73 74 75 76 77 78 79 80 81 82 83 84 85 86 87 88 89 90 91 92 93 94 95 96 97 98 99 100

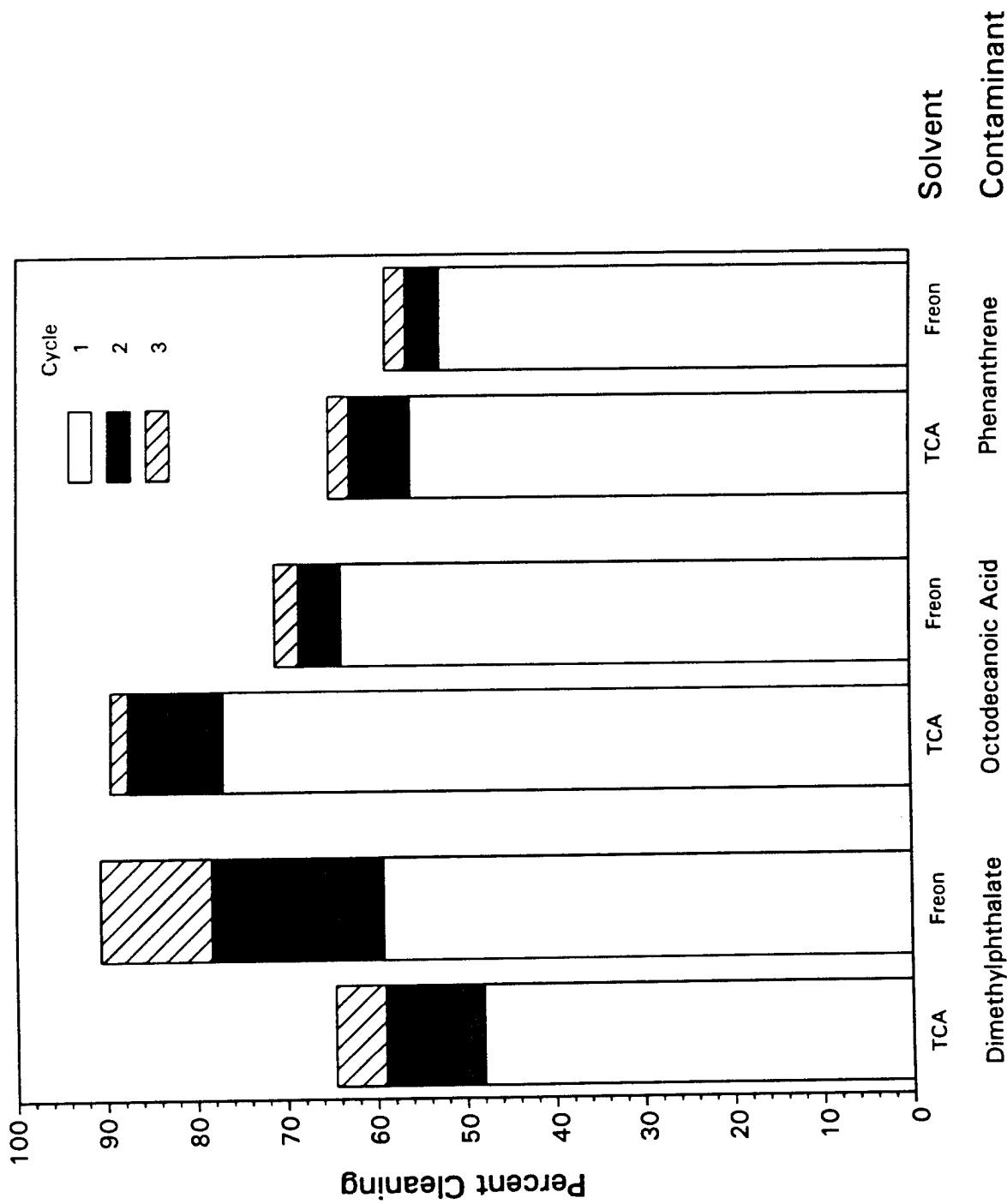

Figure 11. Comparison of Cleaning Efficiency of TCA with Freon 113. (The TCA data for octadecanoic acid is for Test 2R only; all other data from replicates have been averaged for each cycle).

TABLE 20. STATISTICAL ANALYSIS OF DIFFERENCES IN CUMULATIVE PERCENT CLEANING WITH TCA AND FREON 113

Organic Contaminant	Cleaning Cycle	Freon 113			TCA			Statistically Significant <sup>a</sup>
		No. of Tests	Mean	SD	No. of Tests	Mean	SD	
Dimethylphthalate	1	3	59.22	7.45	3	47.99	9.98	No
	2	3	78.29	5.55	3	59.16	9.92	Yes
	3	3	90.59	5.26	3	64.16	8.52	Yes
Phenanthrene	1	3	52.75	10.84	3	56.04	9.33	No
	2	3	56.54	11.70	3	62.53	9.62	No
	3	3	58.84	11.33	3	64.86	9.13	No
Octodecanoic Acid	1	3	63.57	2.94	1	77.08	N/A	N/A
	2	3	68.57	3.36	1	87.52	N/A	N/A
	3	3	71.19	2.17	1	89.42	N/A	N/A

a. Based on an F-test at the 5% level of significance.

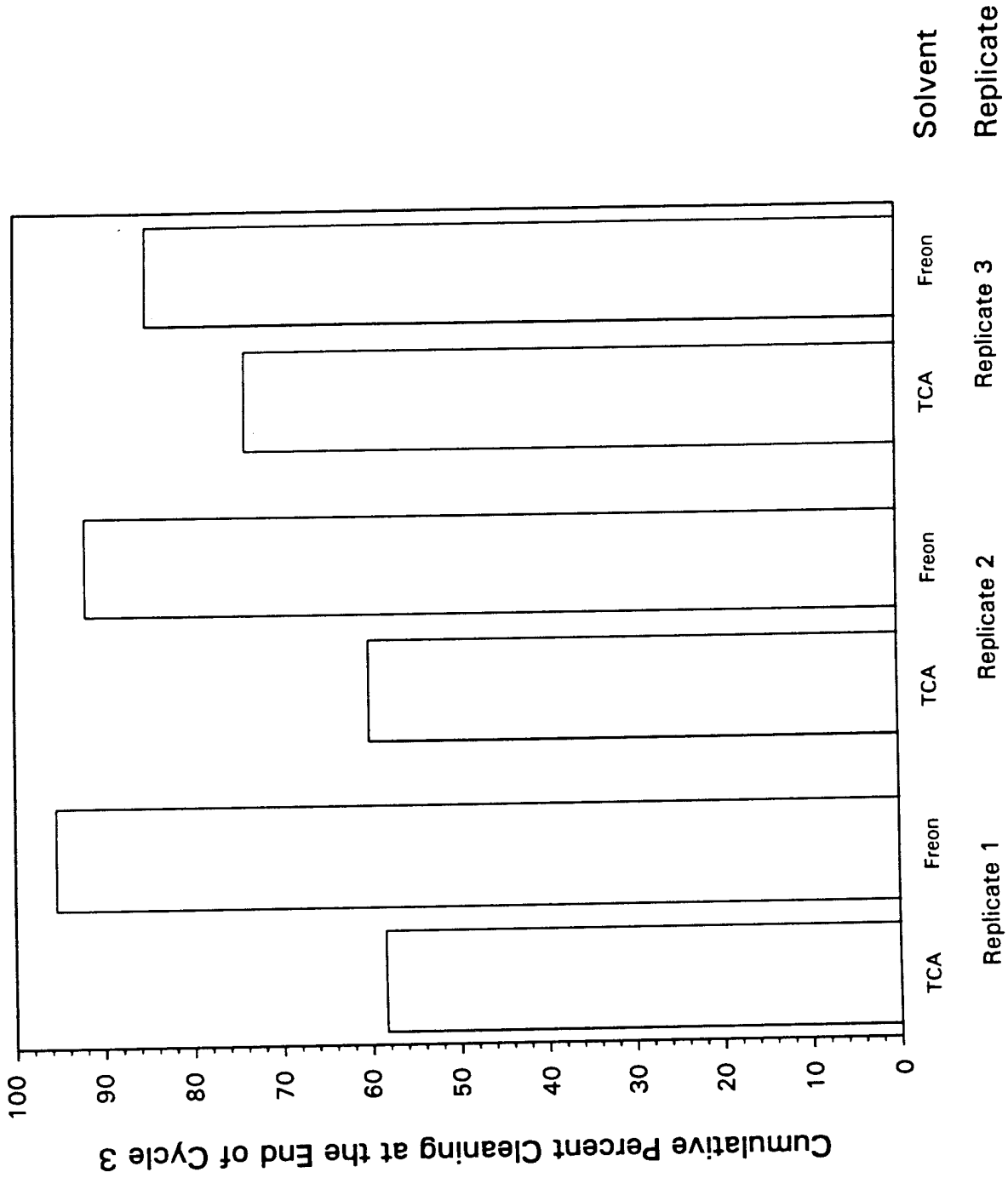

Figure 12. Repeatability of Removal of Dimethylphthalate by TCA and Freon 113.

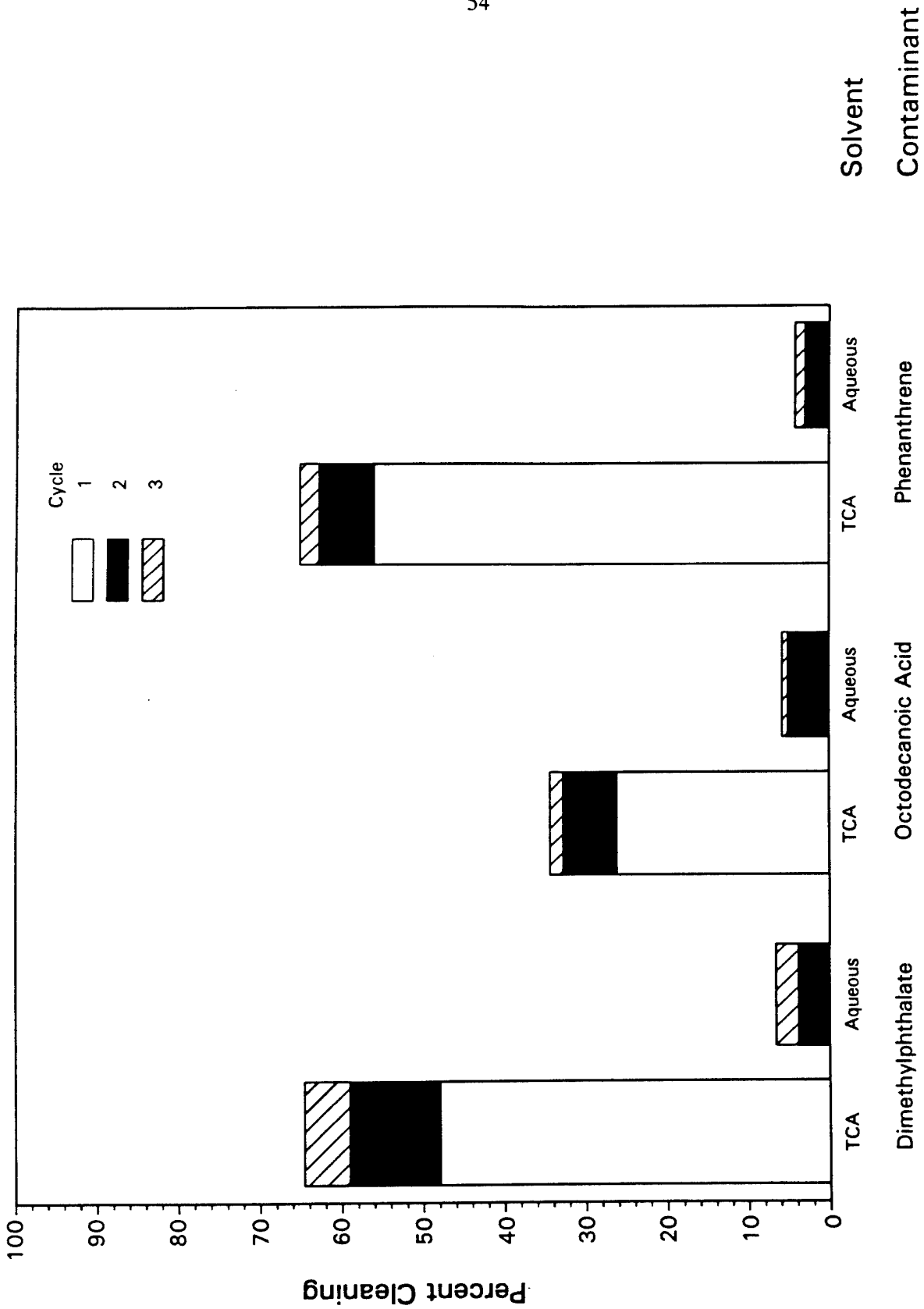

Figure 13. Comparison of Cleaning Efficiency of TCA with an Aqueous, Detergent Cleaner. (The Cycle 2 for aqueous cleaning is actually a very quick rinse; data from replicates for each cycle have been averaged).

contaminant. Similarly the data showed that the aqueous cleaner removed more contaminant than Freon 113.

The above "extended analysis" method for quantifying cleaning efficiency of aqueous cleaners can be made more accurate if a mathematical model can be fitted to the TCA cleaning efficiency data. As mentioned earlier, this will require conducting more cycles of shorter durations. In any case, until a method for direct analysis of organics in surfactant water is developed, the "extended analysis" method can be used satisfactorily.

#### **4.7.5 Time Required for CPEP Testing**

An estimate of times required for performance testing are as follows:

- Preparation of stock solutions: 1 day
- Carrying out of 3 tests (3 cycles each): 1 day
- Organic analyses (at AGMC): < 1 week
- Particulate (spark source MS) sample preparation: 1 day
- Particulate isotope analysis (at Evans East): 1 week

### **5.0 CONCLUSIONS**

The results of this initial investigation of the CPEP have led to the following conclusions:

- (1) The CPEP provides for a valid method for quantifying the efficiency of cleaning agents for removal of organic contaminants.
- (2) The CPEP can repeatedly differentiate between two cleaning agents provided that they are at least 20 percent different from each other; the true sensitivity of the CPEP is probably better than this, but additional test replicates are needed to further quantify the error bands and sensitivities of CPEP.

- (3) In principle, the CPEP should be valid for quantifying particulate removal efficiencies of various cleaning agents; however, this validation must await further testing with better preparation and handling of stock solutions and analytical samples.

## 6.0 RECOMMENDATIONS

The following recommendations are made for future work to increase the value of CPEP for AGMC and other users:

- (1) The inorganic isotope technique should be further developed with better control of isotope feedstocks and handling of suspensions during testing and sample workup. Also, substitutes to silica should be considered.
- (2) The development of a method for direct analysis of organics in detergent water should be considered.
- (3) More testing should be done to better quantify the error bands and sensitivity of CPEP; this will give more confidence in differentiating among various cleaning agents.

**7.0 DEFINITION OF TERMS**

Calibrant	The solution or suspension which contains the calibration isotopes in known concentration.
Contaminant, native	Naturally occurring contaminant material composed of atoms or molecules in the normal abundances.
Contaminant, synthetic	The isotopically altered material placed onto the test devices prior to cleaning. The concentrations of these compounds in the cleaning residues are used to determine cleaning efficiencies.
Doping	Application of a known quantity of synthetic contaminant to the test devices prior to cleaning tests.
Gas Chromatography/ Mass Spectrometer (GC/MS)	A chemical analysis instrument which uses a gas chromatograph to separate mixtures of volatile organic compounds and a mass spectrometer which identifies the separated compounds.
Gravimetric factor	The ratio of the molecular weights of a measured chemical species and a sought species. Gravimetric factors are frequently used to determine the weight of a metal present in an oxide sample.
Image analyzer	A computer system designed for manipulation and analysis of digitized images. In this program the analyzer was used to count and measure the size distribution of particles collected on filters.
Overdetermined equation system	A system of linear equations which contains more equations than unknown quantities. In general, such systems of equations have no exact solution; however, various approximate solutions can be found. The approximation which minimizes the sum of the squares of the errors between the given equations and the approximation is called the least squares solution. Program MATRIX finds a least squares solution.
Spark-source mass spectrograph (SSMS)	A chemical analysis instrument which uses a high voltage, radio frequency spark to ionize a nonvolatile sample. The mass spectrum is recorded on an ion sensitive photographic plate.

**Kuderna-Danish (K-D) Concentration**

A method which concentrates solutions by evaporating the solvent at a temperature below its boiling point. A condenser is used to trap the solute compounds while allowing the solvent to escape slowly.

STABLE ISOTOPE CLEANING  
PERFORMANCE EVALUATION PROCEDURE (CPEP)

APPENDIX A  
OF THE  
CONTRACT SUMMARY REPORT,  
"A METHOD FOR CLEANING PERFORMANCE EVALUATION  
USING STABLE ISOTOPES"

Contract No. F09603-90-D-2217  
Delivery Order Q802

to

THE AEROSPACE GUIDANCE AND METROLOGY CENTER  
NEWARK AIR FORCE BASE  
Newark, OH

August 31, 1992

by

S. P. CHAUHAN, P. SCHUMACHER, AND J. C. CHUANG

BATTELLE  
505 King Avenue  
Columbus, Ohio 43201-2693

## TABLE OF CONTENTS

	<u>Page</u>
1.0 SCOPE AND GENERAL DESCRIPTION . . . . .	1
2.0 ADVANTAGES AND DISADVANTAGES . . . . .	2
2.1 Advantages . . . . .	2
2.2 Disadvantages . . . . .	2
3.0 LIMITATIONS . . . . .	3
3.1 Inorganic Simulants . . . . .	3
3.2 Organic Simulants . . . . .	3
4.0 APPARATUS . . . . .	4
5.0 REAGENTS . . . . .	5
6.0 PHASE I PROCEDURE -- IDENTIFY CONTAMINANTS AND SELECT ISOTOPES . . . . .	5
6.1 Glassware Cleaning Procedure . . . . .	6
6.2 Examine Current Cleaning Procedure (CCP) . . . . .	6
6.3 Inorganic Particulate Analysis . . . . .	6
6.4 Organic Compound Identification . . . . .	7
6.5 Selection of Simulated Contaminants . . . . .	8
6.6 Preparation of Contaminant and Calibrant . . . . .	9
6.7 Organic Compound Stability Test . . . . .	10
7.0 PHASE II PROCEDURES - CLEANING PERFORMANCE EVALUATION . . . . .	12
7.1 Test Matrix . . . . .	13
7.2 Cleaning of Apparatus . . . . .	15
7.3 Test Part Contaminant Doping . . . . .	15
7.4 Cleaning Tests . . . . .	22
7.5 Addition of Calibrant to the Cleaning Residue . . . . .	23
7.6 Analytical Sample Preparation . . . . .	23
7.7 Isotope Abundances . . . . .	26
7.8 Organic Analysis Peak Intensities . . . . .	26
7.9 Cleaning Efficiency . . . . .	26
7.10 Comparison of Cleaning Efficiencies . . . . .	26

## TABLE OF CONTENTS

	<u>Page</u>
8.0 CALIBRATION . . . . .	27
8.1 Inorganic Calibration . . . . .	27
8.2 Organic Calibration . . . . .	28
9.0 CALCULATIONS . . . . .	29
9.1 Inorganic Data Reduction . . . . .	29
9.2 Organic Data Reduction . . . . .	31
9.3 Cumulative Percent Cleaning Efficiency . . . . .	32
10.0 REFERENCES . . . . .	33
ATTACHMENT A. FORTRAN PROGRAM MATRIX . . . . .	

## LIST OF TABLES

TABLE 1. APPARATUS FOR PHASE I PROCEDURES . . . . .	5
TABLE 2. GAS CHROMATOGRAPH OPERATING CONDITIONS . . . . .	7
TABLE 3. ORGANIC MASS SPECTROMETER OPERATING CONDITIONS . . . . .	7
TABLE 4. APPARATUS FOR PHASE II PROCEDURES . . . . .	12
TABLE 5. SAMPLE TEST MATRIX FOR CLEANING PERFORMANCE EVALUATION . . . . .	13
TABLE 6. SAMPLE ISOTOPE ABUNDANCE MATRIX FOR SILICON . . . . .	28

## LIST OF FIGURES

Figure 1. Schematic Diagram of Test Device Inorganic Doping Interconnections . . . . .	18
Figure 2. Schematic Diagram of Test Device Organic Doping Interconnections . . . . .	20

STABLE ISOTOPE CLEANING  
PERFORMANCE EVALUATION PROCEDURE (CPEP)

to

THE AEROSPACE GUIDANCE AND METROLOGY CENTER  
NEWARK AIR FORCE BASE

from

BATTELLE

August 31, 1992

**1.0 SCOPE AND GENERAL DESCRIPTION**

This document\* describes a procedure which employs stable isotopes to quantify the effectiveness of a cleaning procedure. The procedure is applied in two phases. In Phase I, the contaminants which are present in the cleaning system are identified and simulants selected. The second phase uses the simulants chosen in Phase I to compare cleaning procedures.

At the beginning of Phase I, the current cleaning process (CCP) is examined to identify possible contaminants. Samples of cleaning residue at several points in the CCP are analyzed for inorganic particulates and organic compounds. The analytical results are used to select synthetic contaminants for Phase II. For the particulate contaminants, the particle size and chemical form are also considered, because particle removal is strongly dependent on the size of the particles and some particle adherence mechanisms are dependent upon the chemical form of the particles.

A synthetic contaminant spike solution is prepared and a known amount of synthetic contaminant is deposited on the test components. The test components are cleaned using the cleaning procedures being evaluated and the cleaning residues are saved. A calibrant solution containing a different isotope than the synthetic contaminant is added to the

---

\* This document is Appendix A of the Contract Summary Report, "A Method for Cleaning Performance Evaluation Using Stable Isotopes".

cleaning residue in a known amount. The cleaning residue containing both isotope forms is analyzed by mass spectral methods to determine the isotopic ratios of the contaminants. The isotope ratios and the amount of calibrant material added are used to determine the quantity of synthetic contaminant removed during the cleaning procedure. The effectiveness of a cleaning procedure is calculated based on the amount of contaminants it removes.

## **2.0 ADVANTAGES AND DISADVANTAGES**

### **2.1 Advantages**

This method uses isotopically altered materials as simulated contaminants. Since the isotopes used are stable, the safety precautions required when using radioisotopes are not needed. The stable isotopes uniquely identify the simulated contaminants, even in the presence of significant amounts of native contaminants. The gas chromatography/mass spectroscopy (GC/MS) technique is a commonly available and sensitive method for analysis of trace quantities of organic compounds.

Two isotopically labeled forms of each simulant are employed. One of the isotopic forms is used as the simulated contaminant, applied in a known amount to the test parts before cleaning. The remaining isotopic form is added to the cleaning residue after cleaning. The mass spectral analysis of the cleaning residue is used to determine the quantity of simulated contaminant removed during cleaning.

Phase I need be performed only once for a type of part to be cleaned; however, the Phase II cleaning performance evaluation procedure should be carried every time a cleaning step or procedure, e.g. method for cleaning or cleaning agent, is changed.

### **2.2 Disadvantages**

The isotopic materials are expensive and suppliers are limited. To use the method to best effect, two isotopically labeled samples of each simulant are required; this

further increases the costs. Mass spectral techniques must be used for analysis, because other chemical analysis techniques cannot distinguish the isotopes.

The procedure is very complex and requires well-trained staff. The selection of synthetic contaminant compounds requires advanced knowledge of chemistry to ensure selection of representative contaminants.

### **3.0 LIMITATIONS**

#### **3.1 Inorganic Simulants**

For best results, the elements chosen as inorganic simulants should have three or more stable isotopes. Elements with two isotopes can be used by performing a mass spectral analysis before and after addition of the isotopically labeled calibrant but many benefits of the isotope method are lost. Mononuclidic elements, such as, aluminum, beryllium, phosphorous and sodium, cannot be used as simulants. If the simulant element is not available from stock in the desired chemical form or particle size distribution, additional expense will be incurred to alter the chemical form or the particle size distribution.

#### **3.2 Organic Simulants**

Each organic simulant must be available in two labeled forms. Since most organic compounds are deuterium labeled and the deuterium atoms can be removed from the molecule by chemical reactions, the organic simulants must be stable under the cleaning conditions or the decomposition products must also be determined.

At present, the quantification of the effectiveness of aqueous detergents for cleaning organics requires two additional steps consisting of rinsing with deionized water and a nonaqueous cleaning agent. This is necessary as there is no proven analytical method available to determine the target spiked organic contaminants in the detergent matrix and because the large organic background from the detergent overloads the analytical equipment.

4.0 APPARATUS

Bottles, glass, 2 oz, 4 oz, 16 oz	Beakers, 250 ml, 600 ml, 2000 ml
Balance, analytical	Brush, beaker
Coater, vacuum	Coulter counter
Electron probe microanalyzer	Filter, Anopore, 0.2 $\mu$ m pore, 25 mm and 37 mm
Filter, cellulose acetate, 0.2 $\mu$ m pore, 37 mm	Flask, Dewar (3" dia x 6" high)
Flask, filter, 25 mm, 37 mm	Flask, round bottom
Flask, volumetric, 100 ml	Forceps
Gas chromatograph	Image analyzer
Mass spectrometer, inorganic	Mass spectrometer, organic
Pipettes, Eppendorf	Foil, aluminum, heavy duty
Polypropylene nut, 1/4", 3/8"	Polypropylene union 1/4" to 3/8"
Planchette, carbon, 25 mm	Porcelain crucible
Furnace, muffle, small 600 C	Furnace, muffle, large, 450 C
Nitrogen evaporator	Pump, vacuum, with flow valve
Ring stand with clamp	Flask, Kuderna-Danish
Recliner, Kuderna-Danish	Funnel, separatory, 1000 ml
Filter, quartz, 104 mm	Funnel, glass
Spatula	Syringe, hypodermic, 250 $\mu$ l (2)
Syringe, hypodermic, 1000 $\mu$ l (3)	Trap, cold, glass
Tape, Teflon	Tubing, 1/4" Teflon
Timer	Tongs
Thermometer, dial	Ultrasonic bath
Snyder distilling column	Vials, glass, 10 dram, 40 dram
Vials, polystyrene, 2 ml	Cap liners, Teflon
Polypropylene Union 1/4" to 1/4"	Scissors

**5.0 REAGENTS**

Acetone	Alconox detergent
Dichloromethane, distilled in glass	Dry ice
Ethanol	Hydrochloric acid, 3N
Methanol	Nitric acid
Sodium chloride (muffled 450 C)	Sodium sulfate (muffled 450 C)
Graphite powder (ultracarbon UCP-1)	Water, tap
Water, distilled	

**6.0 PHASE I PROCEDURE --  
IDENTIFY CONTAMINANTS AND SELECT ISOTOPES**

The apparatus needed for Phase I is listed in Table 1.

**TABLE 1. APPARATUS FOR PHASE I PROCEDURES**

Brush, beaker	Coater, vacuum
Electron probe microanalyzer	Filter, Anopore, 0.2 $\mu$ m pore, 25 mm, 37 mm
Flask, filter, 25 mm, 37 mm	Forceps
Flask, Kuderna-Danish	Gas chromatograph
Image analyzer	Furnace, muffle, large, 450 C
Receiver, Kuderna-Danish	Vials, glass, 10 dram, 40 dram
Planchette, carbon, 25 mm	Beakers, 250 ml, 2000 ml
Balance, analytical	Bottles, glass, 4 oz
Snyder distilling column	Ultrasonic bath
Vials, glass, 10 dram, 40 dram	Cap liners, Teflon
Coulter counter	Foil, aluminum, heavy duty
Flask, round bottom	Flask, volumetric, 100 ml
Mass spectrometer, organic	

### **6.1 Glassware Cleaning Procedure**

- 6.1.1 Rinse with 10 percent nitric acid in distilled water.
- 6.1.2 Rinse with acetone.
- 6.1.3 Wash with Alconox (1 g/l) in hot tap water.
- 6.1.4 Rinse with distilled water.
- 6.1.5 Sonicate 5 minutes in methanol.
- 6.1.6 Rinse with prefiltered dichloromethane.
- 6.1.7 Muffle at 450 C for at least 2 hours unless the glassware is volumetric. Dry volumetric glassware at 180 F for at least 1 hour.

### **6.2 Examine Current Cleaning Procedure (CCP)**

- 6.2.1 Obtain samples of used working fluids from incoming components.
- 6.2.2 Obtain samples of flushing liquids from cleaned and reassembled components.
- 6.2.3 Obtain samples of virgin cleaning solutions.
- 6.2.4 Obtain additional samples from the CCP as appropriate. Possible sample sites include supply taps for cleaning agents, supercleaning sonication tanks and virgin fill fluids.

### **6.3 Inorganic Particulate Analysis**

- 6.3.1 Filter appropriate volume of samples from Section 6.2 through 25 mm, 0.2  $\mu\text{m}$  pore size Anopore filter (1 ml-contaminated samples, 10 ml-clean samples).
- 6.3.2 Rinse filter with 5 ml prefiltered dichloromethane.
- 6.3.3 Attach filter to a carbon planchette, vapor deposit a conductive carbon film on the filter surface and load in the electron probe microanalyzer (EPMA).
- 6.3.4 Acquire multielement X-ray maps for Na, Mg, Si, P, S, Cl, K, Ca, Cr, Fe, Cu, Zn, Al, Sn, C, and O at 400 X with the EPMA (4 fields).

- 6.3.5 Acquire secondary electron images at 400 X with the EPMA (4 fields).
- 6.3.6 Identify the most common particle compositions based on the X-ray map results.
- 6.3.7 Use the image analyzer to determine the particle size distribution. Other methods of particle size analysis such as a coulter counter device can also be used.

#### **6.4 Organic Compound Identification**

- 6.4.1 Dilute samples containing more than 5 percent high boiling point compounds (i.e., above 60 C), such as fill fluids, by 100 times using dichloromethane. Low concentration samples can be run neat.
- 6.4.2 Inject a 1  $\mu$ l aliquot of the sample from 6.4.1 into the gas chromatograph (GC). The GC operating conditions are given in Table 2.
- 6.4.3 Perform the GC/MS analysis. MS operating conditions are given in Table 3.
- 6.4.4 Identify the major types of organic compounds present in the samples.

TABLE 2. GAS CHROMATOGRAPH OPERATING CONDITIONS

Column Type	DB-5 fused silica or equivalent
Column Length	30 m
Column Diameter	0.25 mm I.D.
Carrier Gas	Helium
Oven Program	40 C one min programmed to 290 C at eight C per min

TABLE 3. ORGANIC MASS SPECTROMETER OPERATING CONDITIONS

Mode	GC/MS
Ionization	70 ev Electron impact
Scan Mode	Full scan
Scan Range	m/z 30 to m/z 650
Scan Start	After elution of solvent peak

### 6.5 Selection of Simulated Contaminants

- 6.5.1 Selection of inorganic simulated contaminants.
- 6.5.1.1 Examine the list of the most common inorganic particulate compositions for the five major elements.
  - 6.5.1.2 Choose the most common element which has three or more stable isotopes to represent the bulk of the particulate.
  - 6.5.1.3 Choose any element which is susceptible to special particle adherence mechanisms (i.e., iron metal--magnetism) of interest, and has three or more stable isotopes.
  - 6.5.1.4 Choose the next most common element which has three or more stable isotopes.
  - 6.5.1.5 Determine the cost and availability of isotopes of the selected elements. The preferred isotopes are those with natural abundances between 0.5 and 10 percent enriched to more than 90 percent. Isotopes with natural abundances above 10 percent yield poorer sensitivity while isotopes below 0.5 percent abundance are very expensive when enriched to high concentrations. Do **not** use the major isotope. Two enriched isotopes are needed for each element. The isotope with the lowest natural abundance will be used as the simulated contaminant. The second isotope, the calibrant, will be used in the analytical procedure to correct for losses during analysis.
- 6.5.2 Selection of organic simulated contaminants
- 6.5.2.1 Examine the list of the most common organic compounds for the different classes of organic compounds (i.e., acids, bases, esters, aliphatic and aromatic hydrocarbons, alcohols, aldehydes, etc.).
  - 6.5.2.2 Select candidate compounds with a range of polarity, since a molecule's polarity has a strong influence on its solubility. A close match between the polarity of a solute and solvent results in good solubility, while a polarity mismatch produces poor solubility.
  - 6.5.2.3 The selected compounds should have low volatility so that they will remain on the parts until the cleaning is performed. Significant fractions of volatile compounds may be lost by evaporation.

- 6.5.2.4 Determine the cost and availability of the candidate contaminants. Two isotopic forms of each compound are needed, one as the simulated contaminant and the second as the analytical calibrant. The most commonly available compounds are deuterium labeled; however,  $^{13}\text{C}$  labeled compounds can also be used if two deuterium labeled compounds are not available.

### **6.6 Preparation of Contaminant and Calibrant**

6.6.1 Clean all containers as in 6.1.

6.6.2 Preparation of inorganic suspensions.

- 6.6.2.1 Both the contaminant and calibrant suspension are prepared in the same manner. The contaminant suspension is prepared using the isotope material chosen to be the contaminant in 6.5.1.5. The calibrant suspension is prepared using the isotope material chosen to be the calibrant in 6.5.1.5.
- 6.6.2.2 Weigh a known quantity (approximately 2 mg) of each (if more than one) inorganic isotopic material into precleaned labeled 4 oz glass bottles. Add 100 ml of filtered ethanol. Sonicate to disperse the particles. These are stock suspensions.
- 6.6.2.3 Measure the particle size distribution of the particulate suspension using a Coulter counter. If the average diameter of the contaminant suspension does not match the size distribution determined in 6.3.7 to within a factor of 5, grind or sieve the isotope material to improve the size distribution match. It is especially important to eliminate/minimize the number of oversized, e.g., about 5 micron-size, particles to assure there is no settling.
- 6.6.2.4 Prepare a working contaminant suspension using an equal volume of each contaminant suspension prepared in 6.6.2.2. Sonicate the stock suspensions for at least 5 minutes prior to transferring them.
- 6.6.2.5 Prepare a working calibrant suspension using an equal volume of each calibrant suspension prepared in 6.6.2.2. Sonicate the stock suspensions for at least 5 minutes prior to transferring them.

**Note:** *The suspension must be used within 5 minutes of sonication to insure uniform dispersion of particles.*

### 6.6.3 Preparation of organic solutions.

- 6.6.3.1 Both the contaminant and calibrant solutions are prepared in the same manner. The contaminant solution is prepared using the most highly deuterated material for each compound selected in 6.5.2.4. The calibrant solution is prepared from the other material.
- 6.6.3.2 Prepare separate stock solutions of each compound with a concentration of 1 mg/ml in filtered dichloromethane.
- 6.6.3.3 Determine the relative sensitivities of each organic compound by analysis of 1  $\mu$ l of each stock solution from 6.6.3.2 in the GC/MS instrument.
- 6.6.3.4 Prepare 10 ml of a working contaminant solution containing 500  $\mu$ l of the most easily detected compound stock solution from 6.6.3.2 and proportionately higher concentrations of the remaining contaminant compound stock solutions in filtered dichloromethane.
- 6.6.3.5 Wrap the labeled container in aluminum foil to protect the compounds from light and store at -20 C or less.
- 6.6.3.6 Prepare 10 ml of a working calibrant solution containing concentrations of each compound equal to those of the contaminants in 6.6.3.4. Use filtered dichloromethane as the solvent.
- 6.6.3.7 Wrap the labeled container in aluminum foil to protect the compounds from light and store at -20 C or less.

Note: *Prior to use of the organic solutions, remove them from the freezer and allow them to return to room temperature. Slide the container from the aluminum foil wrapper and examine the solution to ensure complete dissolution of the compounds.*

### 6.7 Organic Compound Stability Test

- 6.7.1 The stable isotope method assumes that the isotopes will not be altered during the cleaning test. While the inorganic contaminant isotopes cannot be altered by chemical processes, the organic compounds are labeled by substitution of deuterium atoms for hydrogen atoms in the molecules. The stability of the organic compounds under the cleaning conditions must be determined.

- 6.7.2 Test the stability of the organic compounds by sonication at the standard cleaning power density for the standard cleaning cycle time, at twice the standard power density for the standard time and at twice the standard power density for twice the standard time. If the ultrasonic cleaner does not provide a power adjustment, perform the stability test for the standard sonication time and twice the standard sonication time.
- 6.7.3 Place 200  $\mu\text{l}$  of the working organic contaminant solution prepared in 6.6.3.4 and 100 ml Freon 113, or a suitable substitute, such as a perfluorocarbon, into each of 8 cleaned 250 ml beakers. Cover the beakers with aluminum foil covers to minimize evaporation losses.
- 6.7.4 Select the contents of two beakers as control samples. Sonicate the contents of the 6 remaining beakers in duplicate using the conditions of 6.7.2.
- 6.7.5 Add 200  $\mu\text{l}$  of the working organic calibrant solutions prepared in 6.6.3.6 to the contents of each beaker.
- 6.7.6 Wash the inside surface of the aluminum foil covers with clean Freon 113. Allow the wash to fall into the beaker.
- 6.7.7 Transfer the Freon 113 to cleaned, labeled bottles.
- 6.7.8 Analyze the solutions to determine whether the organic compounds are altered by sonic energy.

**7.0 PHASE II PROCEDURES - CLEANING PERFORMANCE EVALUATION**

The apparatus needed for Phase II is listed in Table 4.

TABLE 4. APPARATUS FOR PHASE II PROCEDURES

Beakers, 600 ml, 2000 ml	Bottles, glass, 2 oz, 16 oz.
Brush, beaker	Filter, cellulose acetate, 0.2 $\mu\text{m}$ pore, 37 mm
Flask, Dewar (3" dia x 6" high)	Flask, filter, 37 mm
Flask, Kuderna-Danish	Flask, round bottom
Filter, quartz, 104 mm	Funnel, glass
Funnel, separatory, 1000 ml	Forceps
Gas chromatograph	Mass spectrometer, inorganic
Mass spectrometer, organic	Foil, aluminum
Furnace, muffle, small, 600 C	Furnace, muffle, large, 450 C
Porcelain crucible	Nitrogen evaporator
Pump, vacuum, with flow valve	Ring stand with clamp
Receiver, Kuderna-Danish	Snyder distilling column
Spatula	Syringe, hypodermic, 250 $\mu\text{l}$ (2)
Syringe, hypodermic, 1000 $\mu\text{l}$ (3)	Trap, cold, glass
Tape, Teflon	Tubing, 1/8" Teflon
Tubing, 1/4" Teflon thick wall	Tubing, 1/4" Teflon
Polypropylene nut, 1/4", 3/8"	Polypropylene union, 1/4" to 3/8"
Timer	Tongs
Thermometer	Ultrasonic bath
Cap liners, Teflon	Vials, glass, 10 dram
Vials, polypropylene, 2 ml	Polypropylene union 1/4" to 1/4"
Scissors	

### 7.1 Test Matrix

Prepare a test matrix which includes the parts to be cleaned, the cleaning steps and cleaning agents to be evaluated and the number of cleaning cycles required. An example test matrix is shown in Table 5.

TABLE 5. SAMPLE TEST MATRIX FOR CLEANING PERFORMANCE EVALUATION

Test No.	Part <sup>(a)</sup>	Cleaning Agent <sup>(b)</sup>	No. of Cleaning Cycles <sup>(c)</sup>	Comments
1,2,3	A1,A2,A3	T	3	Tests 2 and 3 are repeats of Test 1
4,5,6	A4,A5,A6	C	3	Tests 5 and 6 are repeats of Test 4
7,8,9	A7,A8,A9	W	(d)	Tests 8 and 9 are repeats of Test 7
10,11,12	B1,B2,B3	T	3	Tests 10 and 11 are repeats of Test 9

(a) A: Accelerometer (A-200D); B: Gyroscope (G200/280)

(b) T: 1,1,1-trichloroethane; C: Freon-113; W: aqueous detergent

(c) Each cycle with an equal volume of cleaning agent, with collection and analysis of the cleaning residue from each cycle.

(d) One cycle in aqueous detergent followed by a 10 second sonication in deionized water and one cycle in cleaning agent T or C whichever proves most effective in Tests 1 through 6. The extract from the deionized water rinse will be analyzed as a separate sample.

7.1.1 At present, no direct methods are available for determination of organic contaminants in aqueous detergent cleaning agents; therefore, two extra steps--rinse with deionized water and cleaning with an organic cleaning agent for which the cleaning performance versus the extent of cleaning has been established--are required. The evaluation of cleaning of inorganic contaminants is, however, possible if the detergent does not introduce analytical interferences.

- 7.1.2 The simplest test plan would be set up to compare the cleaning performance of two cleaning agents - the currently used or baseline cleaning agent and a candidate replacement cleaning agent for one type of test device. A minimum of three test devices should be cleaned in each cleaning agent to permit statistical estimates of the cleaning performance to be made. For cleaning agents in which the contaminant compounds can be determined, three cleaning cycles should be performed on each test part. This will permit a determination of the length of cleaning time needed to achieve a desired level of cleanliness.
- 7.1.3 Additional candidate cleaning agents can be added to the test matrix by including parts which will be cleaned by that cleaning agent.
- 7.1.4 If a cleaning agent residue cannot be directly analyzed, e.g., in cleaning with aqueous detergents, an alternate method may be employed. The alternate cleaning method uses three cleaning steps. In the first cleaning step, the test parts are cleaned one time using the candidate cleaning process. The candidate cleaning agent is then rinsed off. For aqueous detergents, rinse with distilled water at the same temperature as the cleaning agent. After rinsing, the test parts are cleaned one time in a baseline cleaning agent for which the cleaning performance, using sonication, as a function of cleaning cycle is known. The amount of contaminant thus removed by the baseline cleaning agent can provide a quantitative assessment of the cleaning effectiveness of the candidate cleaning agent. For example, let us assume that the incremental and cumulative percent contaminant removals are as follows:

<u>Cycle</u>	<u>TCA Incremental Cleaning, %</u>	<u>TCA Cumulative Cleaning, %</u>
1	60	60
2	20	80
3	10	90
4	5	95
5	3	98

Now, let us assume that after one detergent water cleaning cycle followed by a quick rinse, a part is recleaned in TCA and the incremental cleaning efficiency is 5 percent. This will mean that one cycle of detergent water cleaning is as effective as three cleaning cycles with TCA.

- 7.1.5 Additional cleaning steps can be added to the test matrix in the same manner as cleaning agents in 7.1.3. If the cleaning residue cannot be easily collected, an alternate method, similar to 7.1.4 can be employed. In the alternate method, the

test part is cleaned through one cycle using the candidate cleaning method, such as liquid spray. The part is then cleaned through one cycle in an ultrasonic bath using a baseline cleaning agent. A calculation similar to the example in 7.1.4 can provide a quantitative assessment of the cleaning effectiveness of the candidate cleaning method.

## 7.2 Cleaning of Apparatus

- 7.2.1 Clean all sample containers as described in 6.1.
- 7.2.2 Form beaker covers from heavy duty aluminum foil. The covers can be formed by wrapping the foil on the outside of a suitably sized round bottom flask, placing the foil and flask over the mouth of the beaker, trimming the foil 1/2 inch to 1 inch beyond the lip of the beaker, then bending the foil down the sides of the beaker to hold it to the beaker.
- 7.2.3 Wash the foil covers in filtered dichloromethane and muffle as for the glassware.
- 7.2.4 Wash the inside of the 1/8 inch and 1/4 inch teflon tubing three times with filtered ethanol, then three times with filtered dichloromethane. Air dry the tubes.
- 7.2.5 Wash the polypropylene fittings using 6.1.3 through 6.1.6. Air dry.
- 7.2.6 Clean the hypodermic syringes by filling them 5 times with filtered ethanol. After each filling, discard the ethanol. Operate the syringe several times in air. In the same manner, fill the syringe 5 times with filtered dichloromethane. After each filling, discard the dichloromethane.
- 7.2.7 The filtered ethanol and dichloromethane are prepared by filtering each reagent through a 0.2  $\mu\text{m}$  pore size Anopore filter. Store the reagents in bottles cleaned as in 6.1.

## 7.3 Test Part Contaminant Doping

- 7.3.1 The contaminant doping procedure will vary depending on the type of test device chosen for the cleaning evaluation. This procedure is designed for A-200D accelerometers; however, a similar procedure would be applicable to other devices where the contaminants can be deposited in a sealed enclosure such as a gyro.

7.3.2 Prior to contaminant doping, test the seal integrity of a sample test device by injecting several milliliters of ethanol into it through one of the fill tubes. Change the orientation of the part so that the seal regions are below the liquid level inside the part. Examine the seals for leakage. If leakage occurs, steps must be taken to eliminate or minimize it.

7.3.3 Preparation of test parts/devices.

7.3.3.1 Attach two 1/16" copper fill tubes to each test device.

7.3.3.2 Add additional parts to the interior of the device so that it can be sealed.

7.3.3.3 Thoroughly clean the test devices using the current cleaning procedure.

7.3.3.4 Dry the parts after cleaning.

7.3.3.5 Reassemble the cases of the test parts. The case halves should fit well. If a loose fit occurs and several parts are being doped, try to rearrange the halves to obtain good fits for all of the devices.

7.3.4 Preparation of the cold bath.

A dry ice bath is recommended over a liquid nitrogen bath because the liquid nitrogen bath will freeze the dichloromethane and condense atmospheric oxygen in the cold trap. A dry ice + acetone bath produces a temperature of -78 C which is sufficiently low to effectively condense dichloromethane without freezing it.

Caution: Acetone produces volatile, flammable vapors. The cold bath must be set up in a fume hood away from flames and sparks.

7.3.4.1 Fill a small (3 inch diameter x 6 inch tall) Dewar flask half full with dry ice pellets. Slowly and carefully add acetone to within 1 inch of the top of the flask.

7.3.4.2 The cold bath is now ready for use. During the doping, monitor the amount of dry ice remaining in the Dewar flask. Add dry ice pellets as needed.

- 7.3.4.3 If all of the dry ice sublimates, the temperature of the bath will begin to increase. Add dry ice one pellet at a time until the violent bubbling stops, then add excess pellets. If dry ice is added to an over temperature bath too quickly, the acetone will boil out of the Dewar flask.
- 7.3.5 Wrap seal regions of the parts with at least three layers of Teflon tape. The tape reduces the probability and amount of leakage at the seals and serves to collect the leaked contaminants. Record a characteristic number on the device for identification.
- 7.3.6 Attach a length of 1/8" Teflon tubing to one of the fill tubes. Attach the free end of the Teflon tubing, cleaned as in 7.2.4, to a length of 1/4" latex rubber tubing using a short (~ 2 inch) piece of 1/4" thick wall Teflon tubing as an adapter. Attach the free end of the latex tubing to a small metal bellows air pump (or equivalent). A valve can be fitted on the pump inlet to permit control of the air flow rate. See Figure 1 for a schematic diagram of the interconnections.
- 7.3.7 Attach a second length of 1/4" latex rubber tubing to the side arm of the cold trap. Attach a length (~ 2 feet) of 1/4" Teflon tubing to the inlet of the cold trap using a 1/4" to 3/8" polypropylene union and 1/4" and 3/8" polypropylene nuts. Place a 1/4" nut and union on the free end of the 1/4" Teflon tube. See Figure 2 for a schematic diagram of the interconnections. Clamp the cold trap to a ring stand.
- 7.3.7.1 Remove the organic solutions prepared in 6.6.3.5 and 6.6.3.7 from the freezer and allow it to return to room temperature.
- 7.3.8 Inorganic contaminant doping.
- 7.3.8.1 Sonicate the inorganic contaminant suspension for 5 minutes to disperse the particles. The suspension must be used with 5 minutes of sonication to insure adequate suspension.
- 7.3.8.2 Start the vacuum pump and open the flow valve, if present.
- 7.3.8.3 Inject two 1.0 ml aliquots of the inorganic contaminant suspension through the fill tube using a 1 ml hypodermic syringe.
- 7.3.8.4 Rinse the fill tube by injecting two 1 ml aliquots of filtered (0.2  $\mu\text{m}$ ) ethanol into the device, using the same syringe as in 7.3.8.3.
- 7.3.8.5 Start a timer to measure the drying time.

Figure 1: Schematic Diagram of Test Device Inorganic Doping Interconnections

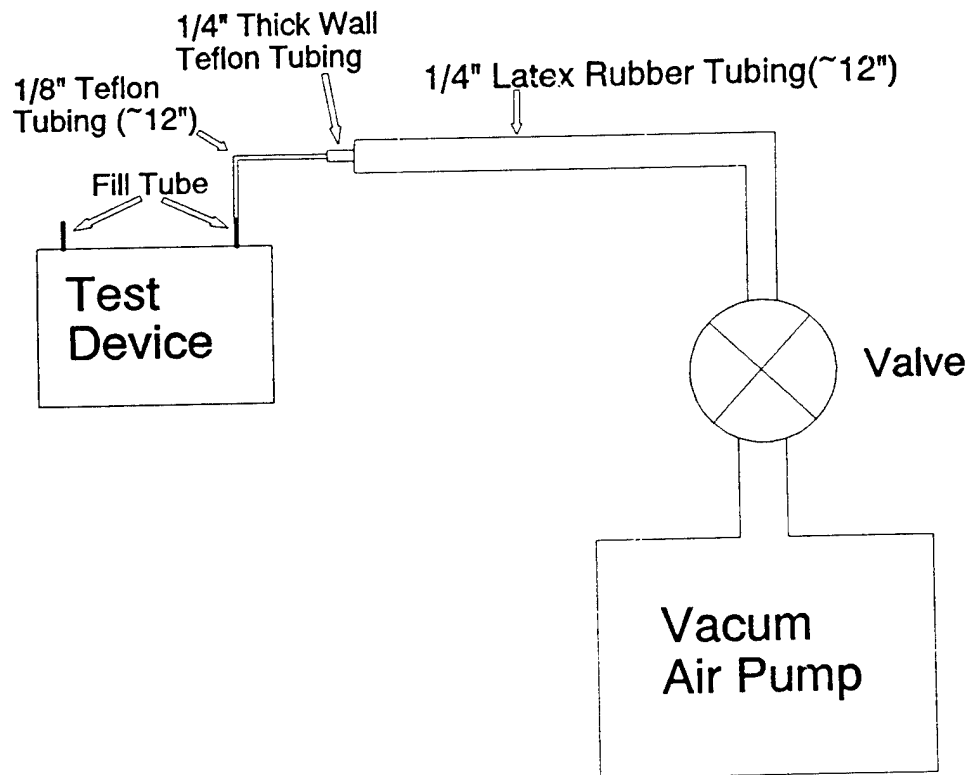

- 7.3.8.6 Change the orientation of the part during drying so that the liquid pool inside can wet as much of the internal surfaces as possible. Insure that the liquid does not come close enough to the exit fill tube to be pumped out of the test device. Examine the Teflon tape for evidence of liquid leakage.
- 7.3.8.7 Hold the device in both hands during the drying step to aid evaporation.
- 7.3.8.8 The ethanol dries in approximately 15 minutes. Continue the air flow 5 additional minutes to provide a safety factor; no change of orientation of part during this, final drying step is necessary.
- 7.3.8.9 Stop the vacuum pump leaving the flow valve open, if present.
- 7.3.9 Check the dry ice-acetone bath for sufficient dry ice. Add dry ice as in 7.3.4.3, if required, and allow bubbling to subside.
- 7.3.10 Remove the latex tube between the 1/4" Teflon tube adapter and the vacuum pump. Attach the 1/4" Teflon tube adapter to the free end of the 1/4" Teflon tube on the inlet of the cold trap using a polypropylene 1/4" to 1/4" union and 1/4" nut. Attach the free end of the latex tube on the cold trap to the inlet of the vacuum pump. See Figure 2 for a schematic diagram of the interconnections.
- 7.3.11 Slowly lower the cold trap into the cold bath.
- 7.3.12 Organic contaminant doping.
  - 7.3.12.1 Examine the organic solutions for complete dissolution of the organic compounds.
  - 7.3.12.2 Start the vacuum pump.
  - 7.3.12.3 Inject 200  $\mu$ l of the organic contaminant solution through the fill tube using a 250  $\mu$ l hypodermic syringe.
  - 7.3.12.4 Rinse the fill tube by injecting two 1 ml aliquots of filtered dichloromethane into the device using a 1 ml hypodermic syringe.
  - 7.3.12.5 Start a timer to measure the drying time.

Figure 2: Schematic Diagram of Test Device Organic Doping Interconnections

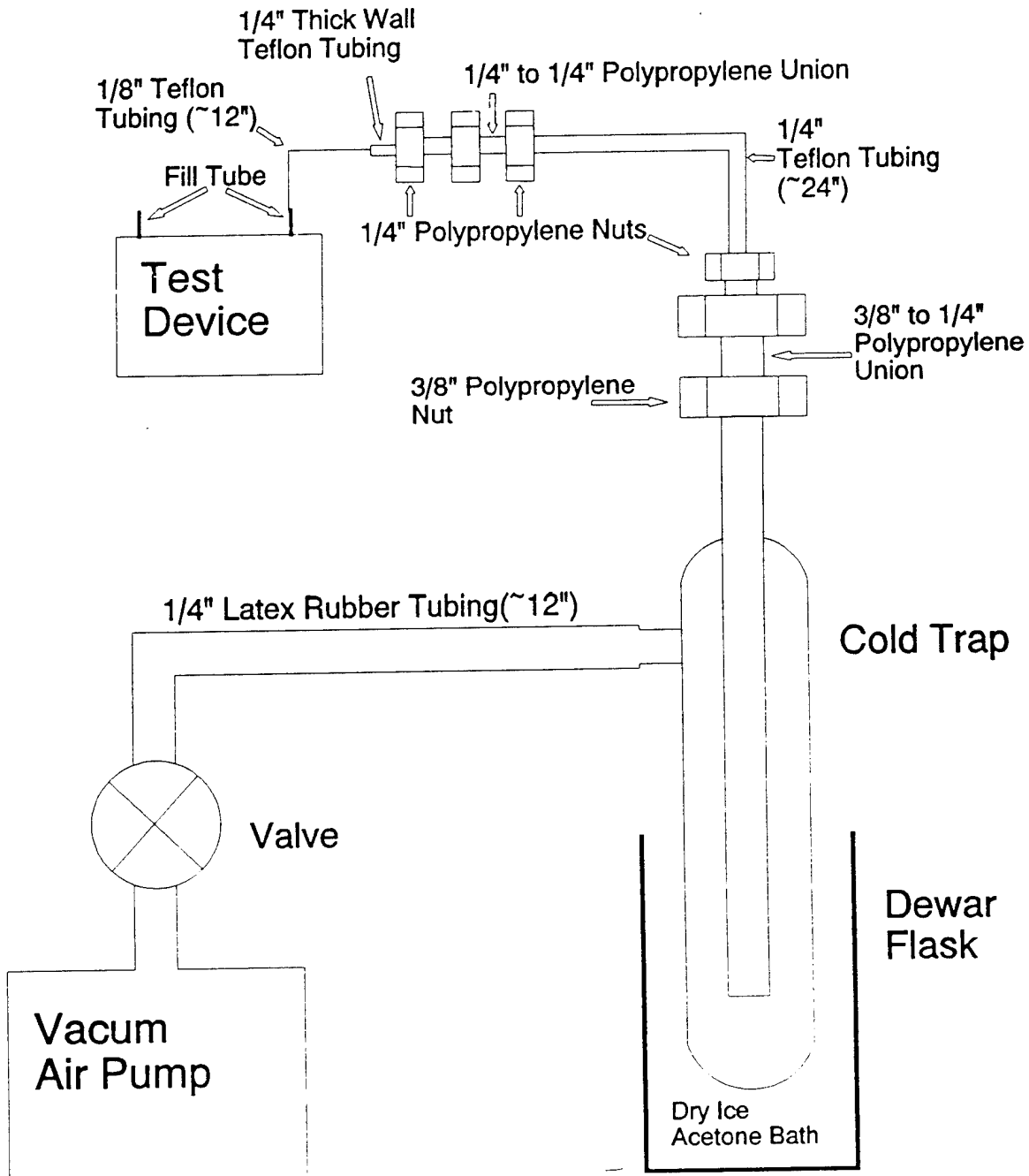

- 7.3.12.6 Change the orientation of the part during drying so that the liquid pool inside can wet as much of the internal surface as possible. Insure that the liquid is not pumped out of the test device. Examine the Teflon tape for evidence of liquid leakage.
- 7.3.12.7 Hold the device in both hands during the drying step to aid evaporation. The device will cool significantly during evaporation of the dichloromethane.
- 7.3.12.8 The dichloromethane dries in approximately 5 minutes. Continue the air flow 5 additional minutes to provide a safety factor; no change of orientation of part during this, final drying step is necessary.
- 7.3.12.9 Stop the vacuum pump.
- 7.3.13 Disconnect the test device from the 1/8" Teflon tube and set the device on a clean surface. Keep the part closed until ready to perform the cleaning.
- 7.3.14 Remove the cold trap from the cold bath. Check the dry ice level in the cold bath. If additional parts are to be doped, add dry ice as in 7.3.4.3, if required.
- 7.3.15 Disconnect the latex tube and 1/4" Teflon tube and polypropylene fittings from the cold trap.
- 7.3.16 Capture cold trap contents for analysis.
  - 7.3.16.1 If liquid leakage was detected during the inorganic contaminant doping, sonicate the calibrant suspension for at least 5 minutes to disperse the particles, then inject 1 ml of the inorganic calibrant suspension into the top of the cold trap using a hypodermic syringe. Wash the syringe with 1 ml of filtered ethanol. Add the wash to the cold trap. Record the addition of the inorganic calibrant for the organic analyst. Inject 200  $\mu$ l of the organic calibrant solution into the top of the cold trap. Mix the calibrant with the condensed dichloromethane. Wash the center tube with several milliliters of filtered dichloromethane.
  - 7.3.16.2 Transfer the contents of the cold trap to a 2 oz precleaned glass bottle by pouring the contents out the side arm. Pour slowly so liquid does not escape through the top opening in the trap.

- 7.3.16.3 Wash the trap twice with several milliliter portions of filtered dichloromethane. Add the rinses to the trap's original contents. Label the bottle as the cold trap collection sample. Seal the bottle cap with Teflon tape. Prepare the cold trap sample for analysis as in 7.6.3.4.
- 7.3.17 Remove the Teflon tape from the test device using a clean forceps. Place the tape in a suitable, labeled container. The Teflon tape will be washed and combined with the cold trap sample as in 7.6.3.4.
- 7.3.18 The contaminant doping is complete.

#### **7.4 Cleaning Tests**

- 7.4.1 Prepare the cleaning device for operation. Bring the cleaning device to the desired operating temperature. Obtain racks to hold the cleaning containers, as needed.
- 7.4.2 Mark the cleaning containers with the test identifier and cycle number. Cleaning must be performed in an enclosed container so that all of the cleaning residue can be collected. An aluminum foil cover prepared as in 7.2.2 can be used to close the top of a beaker.
- 7.4.3 Fill the containers with the proper volume of cleaning agent.
- 7.4.4 Open the test device and place the test device into the container of cleaning agent using clean tongs. Position the part so that the cleaning agent has good access to the contaminated surfaces.
- 7.4.5 Place the containers into the cleaning device and perform the cleaning cycle for the desired time.
- 7.4.6 Label and fill the containers for the next cleaning cycle during the current cycle.
- 7.4.7 At the end of the cleaning cycle, remove the container from the cleaning device. Using the tongs, transfer the test device to the container as in 7.4.4 for the next cleaning cycle, if appropriate. Repeat steps 7.4.5 to 7.4.7 for each additional cleaning cycle.

### 7.5 Addition of Calibrant to the Cleaning Residue

- 7.5.1 The addition of a known quantity of calibrant compounds to the cleaning residue is the basis of the isotope cleaning evaluation method. The calibrant mixture must be placed into the container in which cleaning was performed.
- 7.5.2 Sonicate the inorganic calibrant suspension from 6.6.2.5 for at least 5 minutes before use. The suspension should be used within 5 minutes of sonication to insure uniform distribution of particles.
- 7.5.3 Warm the organic calibrant solution from 6.6.3.7 to room temperature and ensure that the compounds are completely dissolved.
- 7.5.4 Wash the inside surface of the aluminum foil covers with fresh cleaning agent. Allow the wash to fall into the cleaning residue container.
- 7.5.5 Inject 1 ml of inorganic calibrant suspension into the cleaning residue. Wash the hypodermic syringe with two 1 ml portions of filtered ethanol.
- 7.5.6 Inject 200  $\mu$ l of organic calibrant solution into the cleaning residue; there is no need to rinse.
- 7.5.7 Transfer the cleaning residue into cleaned, labeled sample containers. Wash the container walls with fresh cleaning agent. Add the wash to the cleaning residue.
- 7.5.8 Return the organic solutions to the freezer after cleaning is completed.

### 7.6 Analytical Sample Preparation

- 7.6.1 Separation of inorganic particulate and organic compounds.
  - 7.6.1.1 Clean, as in 6.1, a vacuum filtration apparatus for a 37 mm diameter filter.
  - 7.6.1.2 Filter the entire sample through a 0.2  $\mu$ m pore size cellulose acetate filter. Agitate the sample bottle before transferring liquid into the filter funnel to resuspend particulate which may have settled to the bottom of the bottle.
  - 7.6.1.3 Wash the interior of the bottle with clean, filtered cleaning agent or distilled water in the case of aqueous cleaning agent. Filter the wash liquid.

7.6.1.4 After filtration is complete, remove the filter from the apparatus and place it into a precleaned porcelain crucible. Return the filtrate to the original sample bottle for organic analysis.

## 7.6.2 Preparation of inorganic sample for analysis

7.6.2.1 In a fume hood, wet the filter with 3 ml of filtered ethanol. Ignite the ethanol with a flame to char the filter. Allow the ethanol to burn completely.

7.6.2.2 Cover the crucible and place it in a muffle furnace at 200 C. Increase the furnace temperature to 600 C over 1 hour. Hold for 2 hours at 600 C.

7.6.2.3 Remove the crucible from the furnace and cool it to room temperature.

7.6.2.4 Add 10 mg of high-purity graphite powder (ultracarbon UCP-1) or a suitable quantity of high-purity silver powder to the residue in the crucible.

7.6.2.5 Mix the residue and powder with a noncontaminating spatula. Transfer the mixture to a labeled 2 ml polystyrene vial.

7.6.2.6 The inorganic sample is now ready for submittal to the inorganic mass spectral analytical laboratory.

## 7.6.3 Preparation of organic sample for analysis

7.6.3.1 Pre-prep of aqueous cleaning agent sample.

This procedure only applies to the deionized water rinse sample; a potential, related procedure for detergent cleaning solution may be possible, but has not yet been validated. If the cleaning agent is nonaqueous, proceed to 7.6.3.2. A special procedure for the cold trap samples is given in 7.6.3.4.

7.6.3.1.1 Transfer a 200 ml aliquot of the distilled water rinse sample to a 1000 ml separatory funnel, and add 1 ml of 3N HCl to adjust the sample's pH value to 2. Add 50 ml of dichloromethane and shake the funnel to extract the organic contaminants into the dichloromethane layer.

7.6.3.1.2 If the dichloromethane layer becomes cloudy, add 1 g of muffled (4 hrs, 500 C) NaCl solid crystals. Shake, then allow the two layers to separate.

7.6.3.1.3 Remove the bottom layer (dichloromethane) into a round bottom flask. Extract the aqueous layer with 50 ml of dichloromethane and repeat the extraction process with another aliquot of 50 ml of dichloromethane. Place all dichloromethane aliquots into the same round bottom flask and process the extract as described in 7.6.3.2.

### 7.6.3.2 Pre-prep of cloudy organic sample.

If the organic liquid is cloudy, dry the sample over anhydrous  $\text{Na}_2\text{SO}_4$ . If the layer appears clear, go to 7.6.3.3.

7.6.3.2.1 To a 200 ml aliquot of the sample or extract from 7.6.3.1.3 in a round bottomed flask, add ~ 20 g of muffled (4 hrs, 500 C) reagent  $\text{Na}_2\text{SO}_4$  powder. Stopper the flask and shake the contents to mix the liquid and  $\text{Na}_2\text{SO}_4$ .

7.6.3.2.2 If the liquid layer remains cloudy, indicating that water is still present in the liquid, add more  $\text{Na}_2\text{SO}_4$  and mix again. Continue adding  $\text{Na}_2\text{SO}_4$  until the liquid layer clears.

7.6.3.2.3 Place a clean, muffled 104 mm diameter quartz filter into a glass funnel. Wet the filter with dichloromethane, then filter the sample. Wash the round bottom flask and the  $\text{Na}_2\text{SO}_4$  with dichloromethane to quantitatively transfer the liquid. Discard the filter and  $\text{Na}_2\text{SO}_4$ .

### 7.6.3.3 Concentrate organic sample for analysis.

7.6.3.3.1 Use Kuderna-Danish (K-D) concentration to reduce the 200 ml liquid volume to approximate 2 ml. Set the water bath temperature to 15 C to 20 C above the boiling point of the organic liquid being concentrated.

7.6.3.3.2 Concentrate the K-D residue to 10  $\mu\text{l}$  by nitrogen evaporation. Make up the residue to 1 ml with dichloromethane. This step is only required while there is ethanol or methanol present in the sample.

- 7.6.3.3.3 The concentrated sample is ready for GC/MS analysis.
- 7.6.3.4 Preparation of cold trap sample and Teflon tape.
  - 7.6.3.4.1 Wash the Teflon tape two times with 5 ml of filtered dichloromethane. Combine the wash with the corresponding cold trap sample.
  - 7.6.3.4.2 If inorganic calibrant was added to the cold trap, filter the combined sample as in 7.6.1. Process the resulting filtrate as in 7.6.3.2 with a reduced sample volume.
  - 7.6.3.4.3 If inorganic calibrant was not added to the cold trap, process the combined sample as in 7.6.3.2 with a reduced sample volume.

### **7.7 Isotope Abundances**

The isotope abundances for each element determined by the inorganic analysis form the elements of the column vector  $a$  used in 9.1.

### **7.8 Organic Analysis Peak Intensities**

The organic analysis yields the peak intensity ratio:

$$\text{PIR} = \frac{\text{Synthetic contaminant response}}{\text{Analytical calibrant response}}$$

This ratio is used in 9.2.1.

### **7.9 Cleaning Efficiency**

Calculate the percent cleaning efficiency as described in Section 9.3.

### **7.10 Comparison of Cleaning Efficiencies**

Compare the cleaning efficiencies of the candidate cleaning procedures.

## 8.0 CALIBRATION

### 8.1 Inorganic Calibration

- 8.1.1 Measure the isotope abundances for the simulated contaminant and analytical calibrant for each inorganic element selected in 6.5.1.
- 8.1.2 Normalize the sum of isotope abundances to 1 for each material. Use these abundances and the natural abundances of the elements as the column vectors of a matrix M which has as many rows as the element has stable isotopes and 3 columns. An example matrix for silicon is shown in Table 4.
- 8.1.3 Calculate the atomic weight of the synthetic contaminant and calibrant materials. The atomic weights can be calculated as follows:

$$\text{Atomic weight} = \sum A_i W_i$$

where

Atomic weight = atomic weight of the isotope mixture

$W_i$  = weight of the isotope in atomic mass units (from a handbook)

$A_i$  = abundance fraction of the isotope in the mixture.

- 8.1.4 Calculate the gravimetric factor to convert from weight of element to weight of compound. The factor is calculated by taking the reciprocal of the weight fraction of the element in the compound.

For example, to calculate the atomic weight of the synthetic contaminant shown in Table 6:

$$\begin{aligned} \text{Atomic weight} &= 0.0440 * 27.97693 + .0032 * 28.97649 + .9528 * 29.97376 \\ &= 29.8827 \end{aligned}$$

The corresponding gravimetric factor for conversion from Si to SiO<sub>2</sub> is:

$$G = \frac{29.8827 + 2 * 15.9994}{29.8827}$$

$$= 2.07081$$

TABLE 6. SAMPLE ISOTOPE ABUNDANCE MATRIX  
(M IN EQUATION 1 IN SEC. 9.1) FOR SILICON

Isotope	Isotope Weight (amu)	Abundance		
		Natural Element	Analytical Calibrant	Synthetic Contaminant
<sup>28</sup> Si	27.97693	0.9221	0.0412	0.0440
<sup>29</sup> Si	28.97649	0.0470	0.9565	0.0032
<sup>30</sup> Si	29.97376	0.0309	0.0023	0.9528

## 8.2 Organic Calibration

- 8.2.1 Measure the mass spectrum of each organic material selected in 6.5.2.
- 8.2.2 For each organic compound, prepare a solution which contains an equal concentration of each of the synthetic contaminant labeled compounds and the analytical calibration labeled compounds.
- 8.2.3 Measure the area count of the molecular ion current response for each analyte.
- 8.2.4 Calculate an instrument response factor, Rf for each organic synthetic contaminant.

$$Rf = \frac{\text{Synthetic contaminant area counts}}{\text{Analytical calibrant area counts}}$$

Rf corrects for differences in instrument response between each set of synthetic contaminant and analytical calibrant with different isotopic labels.

## 9.0 CALCULATIONS

### 9.1 Inorganic Data Reduction

- 9.1.1 The elemental isotope abundances measured by the mass spectrograph form the elements of a column vector **a**.
- 9.1.2 The vector **a** and the isotope abundance matrix **M** form parts of a matrix equation:

$$\mathbf{Mc} = \mathbf{a} \qquad \text{Eq (1)}$$

The solution of this equation, the column vector **c** gives the mole fraction of each component, native contaminant, synthetic contaminant and analytical calibrant contributing to produce the observed isotope abundances **a**. The FORTRAN program MATRIX is provided to solve the matrix equation. For example, a mixture of equal mole fractions of natural, analytical calibrant and synthetic contaminant silicon having the isotope abundances shown in Table 6, would contain 33.58% <sup>28</sup>Si, 33.56% <sup>29</sup>Si and 32.87% <sup>30</sup>Si. Substituting in the matrix equation gives:

NATURAL	CALIBRANT	CONTAMINANT	MOLE FRACTION	OBSERVED
0.9221	0.0412	0.0440	$C_{\text{natural}}$	0.3358
0.0470	0.9565	0.0032	$C_{\text{cal}}$	0.3356
0.0309	0.0023	0.9528	$C_{\text{contaminant}}$	0.3287

The program MATRIX yields the solution:

$$\begin{aligned} C_{\text{natural}} &= 0.333366 \\ C_{\text{cal}} &= 0.333366 \\ C_{\text{contaminant}} &= 0.333367 \end{aligned}$$

which is correct to the accuracy of the data supplied.

MATRIX also calculates the quantities of natural and synthetic contaminants in the cleaning residue using the calculated mole fractions and the amount of calibrant added to the residue after cleaning. A description of MATRIX is contained in Appendix A.

9.1.3 Calculate the total moles of each element:

$$T_{\text{element}} = S_{\text{cal}} / (C_{\text{cal}} * G_{\text{cal}} * \text{AtWt}_{\text{cal}})$$

where

$$T_{\text{element}} = \text{total element moles}$$

$$S_{\text{cal}} = \text{the mass of the analytical calibrant added to the sample } (\mu\text{g})$$

$$\text{AtWt}_{\text{cal}} = \text{atomic weight of calibrant element}$$

$$C_{\text{cal}} = \text{the analytical calibrant mole fraction from 9.1.2}$$

$$G_{\text{cal}} = \text{gravimetric factor} = \text{molecular weight of calibrant compound} / \text{AtWt}_{\text{cal}}$$

Using the information in Table 6 and the formulas in 8.1.3 and 8.1.4, the atomic weight of the calibrant silicon is 28.9376 and the gravimetric factor is 2.10579. If 10  $\mu\text{g}$  of calibrant silica was added to the cleaning residue whose isotopic analysis and mole fraction are shown in 9.1.2, the total moles of silicon are:

$$\begin{aligned} T_{\text{element}} &= \frac{10\mu\text{g}}{.333366 * 2.10579 * 28.9376\mu\text{g}/\mu\text{mole}} \\ &= 0.49227 \mu\text{mole} \end{aligned}$$

9.1.4 Calculate the amount of contaminant removed by cleaning:

$$W_{\text{contaminant}} = T_{\text{element}} * C_{\text{contaminant}} * \text{AtWt}_{\text{contaminant}} * G_{\text{contaminant}}$$

where

$$\begin{aligned} W_{\text{contaminant}} &= \text{mass of contaminant removed } (\mu\text{g}) \\ C_{\text{contaminant}} &= \text{the contaminant mole fraction from 9.1.2} \\ \text{AtWt}_{\text{contaminant}} &= \text{atomic weight of contaminant element} \\ G_{\text{contaminant}} &= \text{gravimetric factor} = \text{molecular weight of} \\ &\quad \text{contaminate compound} / \text{AtWt}_{\text{contaminant}} \end{aligned}$$

Using the results of the preceding example calculations the weight of synthetic contaminant is:

$$W_{\text{contaminant}} = .49227 \mu\text{moles} * .333367 * 29.882 \mu\text{g}/\mu\text{mole} * 2.07081 = 10.15 \mu\text{g}$$

## 9.2 Organic Data Reduction

9.2.1 The Response factor from 8.2.4 and the peak intensity ratio measured for each organic compound by the mass spectrometer in 7.8 are used to calculate the mass of contaminant removed:

$$W_{\text{contaminant}} = \frac{\text{PIR} * \text{Calibrant}}{\text{Rf}}$$

where

$$\begin{aligned} W_{\text{contaminant}} &= \text{mass of contaminant removed } (\mu\text{g}) \\ \text{PIR} &= \text{area intensity ratio between the synthetic} \\ &\quad \text{contaminant and the analytical calibrant} \\ \text{Calibrant} &= \text{the mass of the analytical calibrant added to the} \\ &\quad \text{sample } (\mu\text{g}) \\ \text{Rf} &= \text{the response factor for the synthetic contaminant} \end{aligned}$$

For example, assuming that 10  $\mu\text{g}$  of calibrant compound was added to the cleaning residue, the response factor was 0.980 and the measured peak intensity ratio was 0.650, the weight of contaminant in the cleaning residue is:

$$\begin{aligned} W_{\text{contaminant}} &= \frac{0.650 \cdot 10 \mu\text{g}}{0.980} \\ &= 6.63 \mu\text{g} \end{aligned}$$

### 9.3 Cumulative Percent Cleaning Efficiency

9.3.1 Determine the initial contaminant loading:

$$\text{Load}_I = (\text{Injected mass}) - (\text{Lost mass})$$

where

$$\begin{aligned} \text{Injected mass} &= \text{the mass of contaminant put into the test part} \\ \text{Lost mass} &= \text{the mass of contaminant found in the dry ice cold trap} \end{aligned}$$

9.3.2 Calculate the total amount of contaminant removed:

$$\sum \text{Clean} = \text{the summation of contaminant removed by previous cleaning cycles}$$

9.3.3 Calculate the cumulative percent cleaning efficiency for a given number of cleaning cycles:

$$E (\%) = \frac{\sum \text{Clean}}{\text{Load}_I}$$

10.0 REFERENCES

Carter, J. A., Franklin, J. C., and Donohue, D. L., Multielement Isotope Dilution Techniques for Traces Analysis, p 299, High Performance Mass Spectrometry: Chemical Applications, Gross, M.L., ed., American Chemical Society, Washington, D.C., 1978.

Isenhour, T. L. and Jurs, P. C., Introduction to Computer Programming for Chemists, Allyn and Bacon, Inc., Boston, MA, 1972.

Ralson, A. and Rabinowitz, P., A First Course in Numerical Analysis, 2nd ed., McGraw-Hill, New York, 1978.

## EXAMPLE CHECK LIST FOR TEST PART CONTAMINANT DOPING

Test Device; A-200D Accelerometer.

Test seal integrity.

Attach fill tubes.

Attach yoke assembly.

Preclean.

Reassemble case halves-check fit.

Prepare cold bath—Add acetone slowly to control bubbling.

Record device identification.

Wrap part with Teflon tape.

Connect part to vacuum pump.

Set up cold trap and clamp above cold bath.

Remove the organic solutions from the freezer and warm to room temperature.

Start vacuum pump.

Sonicate the inorganic contaminant 5 minutes.

Inject 2.0 ml inorganic contaminant - record volume.

Inject 2 ml filtered ethanol rinse - record volume.

Start timer.

Rock part, check for leakage, keep part warm for 15 minutes.

Dry 5 additional minutes.

Stop pump - record drying time and leakage.

Check the dry ice level in the cold bath - add dry ice if needed.

Insert the cold trap into the vacuum line.

Slowly lower cold trap into cold bath.

Start vacuum pump.

Check organic solutions for complete dissolution.

Inject 200  $\mu$ l organic contaminant - record volume.

Inject 2 ml filtered dichloromethane - record volume.

Start timer.

Rock part, check for leakage, keep part warm for 5 minutes.

Dry 5 additional minutes.

Stop pump - record drying time and leakage.

Disconnect test device from Teflon tubing - set aside.

Remove cold trap from cold bath.

Disconnect tubing from cold trap.

If leakage occurred during inorganic doping, sonicate the inorganic calibrant 5 minutes, inject 1 ml of inorganic calibrant into cold trap, inject 1 ml of filtered ethanol - record volume and inform organic analyst.

Inject 200  $\mu$ l organic calibrant into cold trap - record volume.

Rinse with filtered dichloromethane.

Transfer contents of cold trap to labeled bottle.

Rinse cold trap twice with filtered dichloromethane - combine rinses with cold trap's original contents.

Remove Teflon tape from device - place in labeled container.

Doping complete.

## EXAMPLE CHECK LIST FOR ULTRASONIC CLEANING

Prepare and clean the cleaning containers and sample bottles, etc.

Prepare the cleaning device for operation.

Bring the cleaning device to the desired operating temperature.

Obtain racks to hold the cleaning containers, as needed.

Mark the containers to identify the test device and cleaning cycle.

Fill the containers with the proper amount of cleaning agent.

Place the test part into the cleaning agent using clean tongs. Position the part for good access by the cleaning agent to the contaminated surfaces.

Place the containers into the cleaning device.

Measure and record the initial temperature.

Begin the first cleaning cycle.

Label and fill containers for the second cleaning cycle during the current cycle.

At the end of the cycle, record the final temperature.

Remove the containers from the cleaning device.

Transfer the test devices to the appropriate Cycle 2 containers for the next cleaning cycle.

Place the containers for the second cycle into the cleaning device.

Measure and record the initial temperature.

Begin the second cleaning cycle.

Wash each container cover from the first cycle with clean cleaning agent. Allow the wash to fall into the corresponding container.

Sonicate the inorganic calibrant for at least 5 minutes before use.

Inject 1.0 ml of inorganic calibrant into the cleaning residue with a hypodermic syringe.

Wash the syringe with two 1 ml portions of filtered ethanol. Add the wash to the cleaning residue.

Inject 200  $\mu$ l of organic calibrant solution into the cleaning residue.

Transfer the cleaning residue to labeled sample bottles.

Wash the cleaning container with clean cleaning agent. Add the wash to the cleaning residue.

Label and fill containers for the third cleaning cycle during the current cycle.

At the end of the second cycle, record the final temperature.

Remove the containers from the cleaning device.

Transfer the test devices to the appropriate Cycle 3 containers.

Place the containers for the third cycle into the cleaning device.

Measure and record the initial temperature.

Begin the third cleaning cycle.

Wash each container cover with clean cleaning agent. Allow the wash to fall into the corresponding container.

Sonicate the inorganic calibrant at least 5 minutes before use.

Inject 1.0 ml of inorganic calibrant into the cleaning residue with a hypodermic syringe.

Wash the syringe with two 1 ml portions of filtered ethanol. Add the wash to the cleaning residue.

Inject 200  $\mu$ l of organic calibrant solution into the cleaning residue.

Transfer the cleaning residue to labeled sample bottles.

Wash the cleaning container with clean cleaning agent. Add the wash to the cleaning residue.

At the end of the third cycle, record the final temperature.

Remove the containers from the cleaning device.

Remove the test devices from the containers. Set the test devices aside.

Wash each container cover with clean cleaning agent. Allow the wash to fall into the corresponding container.

Sonicate the inorganic calibrant for at least 5 minutes before use.

Inject 1.0 ml of inorganic calibrant into the cleaning residue with a hypodermic syringe.

Wash the syringe with two 1 ml portions of filtered ethanol. Add the wash to the cleaning residue.

Inject 200  $\mu$ l of organic calibrant solution into the cleaning residue.

Transfer the cleaning residue to labeled sample bottles.

Wash the cleaning container with clean cleaning agent. Add the wash to the cleaning residue.

Wrap the caps of all sample bottles with Teflon tape.

Submit the samples for isotope analyses.

ATTACHMENT A  
FORTRAN PROGRAM  
MATRIX

ATTACHMENT A  
FORTRAN PROGRAM MATRIX

The program MATRIX is written in FORTRAN77 to solve the matrix equation:

$$Mc = a$$

- where
- M = A matrix of coefficients whose columns represent the isotopic abundances of the components of a mixture. The components for this problem are the native and synthetic contaminants and the analytical calibrant.
  - c = A column solution vector which gives the mole fraction of each component in the mixture.
  - a = A column vector of isotope abundances measured by the mass spectrograph.

MATRIX uses both keyboard input, which selects the input file and output device, and an input file which provides the input data for the program. The matrix equation, which may be overdetermined, is solved using Householder transformation matrices to transform the given matrix to upper triangular form. The upper triangular matrix is solved by back substitution in subroutine OVERD. OVERD functions as a driver routine for the Householder transformation process. It accepts the input information from the main program, initializes array P to a suitably sized identity matrix, then calls the transformation subroutine HOUSEH which replaces array P with the Householder transformation of the original matrix. The right hand vector a is also transformed by multiplying by P to yield an upper triangular matrix equation. The transformed system is solved by back substitution. The Householder transformation procedure is an accepted method for the solution of least squares fit problems, and is more computationally stable than the commonly used least squares normal equations. The Householder transformation approach was chosen because it can solve both 'square' (N equations, N unknowns) and overdetermined (N equations, M unknowns,  $M < N$ ) systems of equations. An overdetermined system would result when more than three isotopes of an element can be determined by the mass spectrograph while a 'square' system results when three isotopes are used. If only two isotopes are available the system is underdetermined and the program will fail.

MATRIX was written on an ATARI ST computer and contains some nonstandard code. The output device names PRN: and CON: may need to be changed for a different computer. The date and time subroutine PDATE also contains machine dependent code to get the date and clock time. The device names and time function calls must be changed to match the requirements of the system on which the program will be run.

The contents of the input file are described in Table A1 below. An example input file is shown in Table A2. All of the numeric input variables are list directed so that the variables on each line may be separated by spaces or a comma.

The program output is comprised of four parts. The first part contains the date and time of the computation, the name of the input file, and the title line from the input file. This information is provided to identify the source of the input data. The second portion of the output gives the solution of the matrix equation. The solution shows the mole fraction of each component comprising the analyzed mixture. The column of the solution corresponds to the identification of the columns in matrix M. The third portion of the output shows the residuals of the right hand vector A not accounted for by the least squares solution of the matrix equation. The residuals are nonzero only for the overdetermined matrices and zero for square matrices. The last output section gives the mass of the contaminant species, native and synthetic, present in the sample, based on the mass of calibrant added to the sample after cleaning. The units are the same as the units of the input variable CALWT. The mass of element and compound are given. The compound weight is calculated from the element weight and the user supplied gravimetric factors.

The program output produced using the input data given in Table A2 is shown in Table A3.

The program source code is contained in the file MATRIX.FOR on the 5-1/2" floppy disk included with this procedure. The sample input data is on file TEST821.DAT.

TABLE A1. MATRIX PROGRAM INPUT VARIABLES

Line	Variable	Type	Description
1	TITLE	Character *80	Descriptive identifier for the problem
2	NR	Integer	Number of rows in the matrix
2	NC	Integer	Number of columns in the matrix
3	A(1,NC)	Real*8	First row of the coefficient matrix
4	A(2,NC)	Real*8	Second row of the coefficient matrix
2+NR	A(NR,NC)	Real*8	Last row of the coefficient matrix
3+NR	ATOMWT(NC)	Real*8	Atomic weight for each mixture component. Use the column order of the coefficient matrix.
4+NR	GRAVP(NC)	Real*8	Gravimetric factor for conversion from element to compound for each mixture component. Use the column order of the coefficient matrix.
5+NR	NCAL	Integer	Column in the coefficient matrix corresponding to the calibrant component of the mixture
5+NR	CALWT	Real*8	Weight of the calibrant compound added to the sample. The output weights will be in the same units (i.e., $\mu\text{g}$ ).
6+NR	B(NR)	Real*8	Measured isotope abundances determined by mass spectrometric analysis in 9.1.1. Use the row order of the coefficient matrix.

TABLE A2. PROGRAM MATRIX SAMPLE INPUT

---

---

Silicon isotope analysis - Test 8.2.1

3 3

.9221 .0412 .0440

.0470 .9565 .0032

.0309 .0023 .9528

28.086 28.9376 29.8827

2.13932 2.10579 2.07081

2 10.4

.775 .114 .111

---

---

TABLE A3. PROGRAM MATRIX SAMPLE OUTPUT

5/ 5/92 20: 6:56

FILE - f:test921.dat

Silicon isotope analysis - Test 0.2.1

COLUMN	SOLUTION
1	8.32728E-01
2	7.79676E-02
3	8.93046E-02

ROW	RESIDUALS
1	0.00000E+00
2	0.00000E+00
3	0.00000E+00

COLUMN	ELEMENT	COMPOUND
1	51.20	109.52
3	5.84	12.10

**LISTING A**  
**FORTRAN PROGRAM MATRIX**

PROGRAM MATRIX

C USES THE HOUSEHOLDER TRANSFORMATION MATRIX METHOD TO SOLVE A  
 C SYSTEM OF EQUATIONS. THE SYSTEM MAY BE OVERDETERMINED.

PARAMETER (NS=100,NCC=13)  
 IMPLICIT REAL\*8(A-H,O-Z)  
 CHARACTER TITLE\*80,NAMEV\*7,NAMEF\*9,NAMEEX\*4,FILENM\*19  
 COMMON /STORE/ A(NS,NCC),B(NS),C(NS,NCC),P(NS,NS),R(NS),  
 1 U(NS),W(NS),GRAVF(NCC),ATOMWT(NCC)  
 DATA LFILE,LP/5,6/

C

NCOL=NCC

C

OPEN PRINTER  
 OPEN(LP,FILE='PRN:')

C

OPEN SCREEN  
 OPEN(0,FILE='CON:')

10 WRITE(\*,500) ' VOLUME NAME? '

500 FORMAT(A)

READ(\*,500) NAMEV

WRITE(\*,500) ' FILE NAME? '

READ(\*,500) NAMEF

WRITE(\*,500) ' EXTENSION NAME? '

READ(\*,500) NAMEEX

LENV=INDEX(NAMEV,' ')-1

LENF=INDEX(NAMEF,' ')-1

LENEX=INDEX(NAMEEX,' ')-1

FILENM=NAMEV(1:LENV)//'://'//NAMEF(1:LENF)//'.'//NAMEEX(1:LENEX)

LENFIL=LENV + LENF + LENEX + 2

OPEN(LFILE,FILE=FILENM(1:LENFIL),STATUS='OLD',

1 IOSTAT=IERR,ERR=1000)

C

C

INPUT MATRIX VALUES

C

READ(LFILE,500) TITLE  
 READ(LFILE,\*) NR,NC

C

CALL INPUT(LFILE,NC,NR,A,B,GRAVF,ATOMWT,NCAL,CALWT)

C

WRITE(\*,\*) 'SOLVING..'  
 CALL OVERD(NC,NR,A,B,P,U,W,R)

C

C

OUTPUT RESULTS

C

5 WRITE(\*,\*) 'ENTER 0 FOR CRT, 6 FOR PRINTER OUTPUT '

READ(\*,\*) LUNIT

CALL PDATE(LUNIT)

WRITE(LUNIT,590) FILENM(1:LENFIL)

590 FORMAT(' FILE - ',A/)

WRITE(LUNIT,600) TITLE

600 FORMAT(1X,A//3X,'COLUMN',3X,'SOLUTION')/

C

DO 11 I=1,NC

```

11  WRITE(LUNIT,610) I,W(I)
610 FORMAT(4X,I5,5X,1PE14.5)
    PAUSE 'CONTINUE?'
    WRITE(LUNIT,620)
620 FORMAT(//1X,5X,'ROW',5X,'RESIDUALS'/)
    DO 22 I=1,NR
22  WRITE(LUNIT,610) I,R(I)
C
C  CALCULATE THE AMOUNTS OF NATIVE AND SYNTHETIC CONTAMINANTS
C
    CMOLE=CALWT/(GRAVF(NCAL)*ATOMWT(NCAL))
    TMOLE=CMOLE/W(NCAL)

    WRITE(LUNIT,630)
630 FORMAT(//1X,2X,'COLUMN',5X,'ELEMENT',5X,'COMPOUND'/)
    DO 33 I=1,NC
        IF(I.NE.NCAL) THEN
            CONWT=TMOLE*W(I)*ATOMWT(I)
            WRITE(LUNIT,640) I,CONWT,CONWT*GRAVF(I)
640  FORMAT(1X,I7,2(6X,F6.2))
        ENDIF
33  CONTINUE

    STOP 'DONE'
C
1000 WRITE(*,1010) FILENM(1:LENFIL),IERR
1010 FORMAT(' CAN''T OPEN ',A,' - ERROR ',I5/
1     ' TRY ANOTHER FILE NAME?')
    READ(*,500) FILENM
    IF(FILENM(1:1).NE.'N') GO TO 10
    STOP
    END

*****
    SUBROUTINE PDATE(LUN)
C  WRITES CURRENT DATE TO LUN
    INTEGER*4 YR,MO,DY,HR,MIN,SEC,FRAC
C
    CALL DATE(YR,MO,DY)
    CALL TIME(HR,MIN,SEC,FRAC)
    YR=MOD(YR,100)
    WRITE(LUN,600) MO,DY,YR,HR,MIN,SEC
600  FORMAT(1X,2(I2,'/'),I2,5X,2(I2,':'),I2/)
    RETURN
    END
*****
    SUBROUTINE INPUT(LIN,NC,NR,A,B,GRAVF,ATOMWT,NCAL,CALWT)
    IMPLICIT REAL *8(A-H,O-Z)
    DIMENSION A(NR,NC),B(NR),GRAVF(NC),ATOMWT(NC)
C
    DO 11 I=1,NR
11  READ(LIN,*) (A(I,J),J=1,NC)

```

```
C
  READ(LIN,*) (ATOMWT(I),I=1,NC)
  READ(LIN,*) (GRAVF(I),I=1,NC)
  READ(LIN,*) NCAL,CALWT
  READ(LIN,*) (B(I),I=1,NR)
```

```
C
  RETURN
  END
```

```
*****
```

```
  SUBROUTINE OVERD(NC,NR,A,B,P,U,X,Y)
  C  DRIVER ROUTINE FOR SOLUTION OF OVERDETERMINED SYSTEMS OF
  C  EQUATIONS USING HOUSEHOLDER TRANSFORMATIONS
  C  SEE DISCUSSION OF OVERDETERMINED SYSTEMS IN RALSTON &
  C  RABINOWITZ (SECTION 9.9)
```

```
  C
  C  INPUTS :
```

```
  C  NC      - NUMBER OF COLUMNS IN A
  C  NR      - NUMBER OF ROWS IN A AND B
  C  A(NR,NC) - COEFFICIENT MATRIX
  C  B(NR)    - VECTOR OF RIGHT HAND SIDES
  C  U(NR)    - WORKING STORAGE
```

```
  C
  C  OUTPUTS :
```

```
  C  A(NR,NC) - TRANSFORMED COEFFICIENT MATRIX (P*A)
  C  P(NR,NR) - HOUSEHOLDER TRANSFORMATION MATRIX
  C  X(NC)    - SOLUTION VECTOR
  C  Y(NR)    - VECTOR OF RESIDUALS
```

```
  C
  C  IMPLICIT REAL*8 (A-H,O-Z)
  C  DIMENSION A(NR,NC),P(NR,NR),B(NR),U(NR),X(NR),Y(NR)
```

```
  C
  C  INITIALIZE P TO I MATRIX
```

```
  DO 11 J=1,NR
    DO 11 I=1,NR
      IF(I.EQ.J) THEN
        P(I,J)=1.
      ELSE
        P(I,J)=0.
      ENDIF
```

```
  11 CONTINUE
```

```
  C  GENERATE HOUSEHOLDER TRANSFORMATION MATRIX
  CALL HOUSEH(NC,NR,A,P,U,X,Y)
```

```
  C  TRANSFORM B
```

```
  I=1
  CALL MMULT(NR,NR,I,P,B,X)
```

```
  C  PERFORM BACK SUBSTITUTION
```

```
  X(NC)=X(NC)/A(NC,NC)
  DO 33 K=NC-1,1,-1
    DO 22 J=K+1,NC
```

```

22   X(K)=X(K) - A(K,J)*X(J)
    IF(ABS(A(K,K)).GT.1.E-10) THEN
      X(K)=X(K)/A(K,K)
    ELSE
      X(K)=0.
    ENDIF
33   CONTINUE
C   CALCULATE RESIDUALS
DO 55 I=1,NR
  IF(I.LE.NC) THEN
    U(I)=0.
  ELSE
    U(I)=X(I)
  ENDIF
55   CONTINUE
C   MULTIPLY BY P TRANSPOSE FOR RESIDUALS
DO 66 I=1,NR
  Y(I)=0.
  DO 66 J=1,NR
66   Y(I)=Y(I) + P(J,I)*U(J)
RETURN
END
C*****
SUBROUTINE HOUSEH(NC,NR,A,P,U,X,Y)
C   GENERATE HOUSEHOLDER TRANSFORMATION MATRIX TO TRIANGULARIZE A
IMPLICIT REAL*8 (A-H,O-Z)
DIMENSION A(NR,NC),P(NR,NR),U(NR),X(NR),Y(NR)
C
C   FIND THE HOUSEHOLDER MATRIX FOR EACH COLUMN OF A
DO 111 K=1,NC
  DO 11 I=1,NR
  11   X(I)=A(I,K)
C   DETERMINE U VECTOR
  CALL UFIND(NR,K,U,X,D)
C   CALCULATE UT*P
  DO 22 I=1,NR
  22   X(I)=0.
  DO 33 J=1,NR
  DO 33 I=1,NR
  33   X(J)=X(J) + U(I)*P(I,J)
C   COMPLETE CALCULATION OF P-D*U*UT*P
DO 55 I=1,NR
  UU=U(I)
  IF(UU.NE.0.) THEN
    DO 44 J=1,NR
  44   P(I,J)=P(I,J) - D*UU*X(J)
    ENDIF
  55   CONTINUE
C   CALCULATE UT*A
DO 66 I=1,NR
  66   X(I)=0.
C ** NR CHANGED TO NC TO MATCH A ARRAY BOUNDS 7/6/90 **

```

```

        DO 77 J=1,NC
          DO 77 I=1,NR
77      X(J)=X(J) + U(I)*A(I,J)
C     COMPLETE CALCULATION OF A-D*U*UT*A
        DO 99 I=1,NR
          UU=U(I)
          IF(UU.NE.0.) THEN
C ** NR CHANGED TO NC TO MATCH A ARRAY BOUNDS 7/6/90 **
          DO 88 J=1,NC
88      A(I,J)=A(I,J) - D*UU*X(J)
          ENDIF
99     CONTINUE
111    CONTINUE
        RETURN
        END
C*****
        SUBROUTINE MMULT(N1,N2,N3,A,B,C)
C     MATRIX MULTIPLICATION
        IMPLICIT REAL*8(A-H,O-Z)
        DIMENSION A(N1,N2),B(N2,N3),C(N1,N3)
C
        DO 11 I=1,N1
          DO 11 J=1,N3
            C(I,J)=0.
            DO 11 K=1,N2
11      C(I,J)=C(I,J) + A(I,K)*B(K,J)
          RETURN
        END
C*****
        SUBROUTINE UFIND(NR,K,U,X,D)
C     DEVELOP THE VECTOR U FOR THE HOUSEHOLDER TRANSFORMATION GIVEN
C     THE COLUMN VECTOR X. D=2/UT*U
        IMPLICIT REAL*8 (A-H,O-Z)
        DIMENSION U(NR),X(NR)
C
        SUM1=0.
        SUM2=SUM1
        SA=X(K)
        DO 11 I=1,NR
          XX=X(I)*X(I)
          SUM1=SUM1 + XX
          IF(I.LT.K) THEN
            U(I)=0.
            SUM2=SUM2 + XX
          ELSE
            U(I)=X(I)
          ENDIF
11     CONTINUE
C     CHOOSE SIGN = MINUS SIGN OF X(K)
        IF(SA.LT.0.) THEN
          SA=1.
        ELSE

```

```
    SA=-1.  
ENDIF  
U(K)=X(K) - SQRT(SUM1-SUM2)*SA  
SUM1=0.  
DO 22 I=1,NR  
22  SUM1=SUM1 + U(I)*U(I)  
D=2./SUM1  
RETURN  
END
```

**APPENDIX B**

**ELECTRON MICROGRAPHS AND  
MULTIELEMENT X-RAY MAPS OF CONTAMINANTS**

**(This appendix is not included, but is  
available for examination upon request)**

**APPENDIX C**

**NATIVE CONTAMINANT PARTICLE SIZE ANALYSIS**

**(This appendix is not included, but is  
available for examination upon request)**

**APPENDIX D**  
**IDENTIFICATION OF ORGANIC CONTAMINANTS**  
**BY GC/MS ANALYSIS**

**(This appendix is not included, but is  
available for examination upon request)**

**APPENDIX E**  
**CLEANING PERFORMANCE EVALUATION TESTS**  
**AND RESULTS**

TABLE E-1. CLEANING PERFORMANCE VALIDATION TESTS

Test	Date	Cleaning Cycle	Cleaning Agent	Cleaning Time	Calibrant (μl)		Bath Temperature
					Inorganic	Organic	
1	20 Mar 1992	1	TCA <sup>a</sup>	15 min	500	200	58 F to 66 F
"	"	2	"	"	"	"	64 F to 74 F
"	"	3	"	"	"	"	74 F to 84 F
2	20 Mar 1992	1	TCA	15 min	500	None	58 F to 66 F
"	"	2	"	"	"	200	64 F to 74 F
"	"	3	"	"	"	"	74 F to 84 F
3	20 Mar 1992	1	TCA	15 min	500	200	58 F to 66 F
"	"	2	"	"	"	"	64 F to 74 F
"	"	3	"	"	"	"	74 F to 84 F
4	21 Apr 1992	1	Freon 113	15 min	2000	200	70 F to 78 F
"	"	2	"	"	"	"	78 F to 82 F
"	"	3	"	"	"	"	82 F to 87 F
5	21 Apr 1992	1	Freon 113	15 min	2000	200	70 F to 78 F
"	"	2	"	"	"	"	78 F to 82 F
"	"	3	"	"	"	"	82 F to 87 F
6	21 Apr 1992	1	Freon 113	15 min	2000	200	70 F to 78 F
"	"	2	"	"	"	"	78 F to 82 F
"	"	3	"	"	"	"	82 F to 87 F
7	27 Mar 1992	1	Aqu. Deter.	15 min	500	None	155 F to 160 F
"	"	2	Deionized Water	11 sec	500	200	160 F
"	"	3	TCA	15 min	"	"	74 F to 70 F
8	27 Mar 1992	1	Aqu. Deter.	15 min	500	None	155 F to 160 F
"	"	2	Deionized Water	11 sec	500	200	160 F
"	"	3	TCA	15 min	"	"	74 to 70 F
2R	21 Apr 1992	1	TCA	15	2000	200	70 F to 78 F
"	"	2	"	"	"	"	78 F to 82 F
"	"	3	"	"	"	"	82 F to 87 F

Notes: TCA - 1,1,1-trichloroethane

TABLE E-2. REMOVAL OF ORGANIC CONTAMINANTS WITH TCA

Test	Cycle	Cleaning, Percent		
		Dimethylphthalate-d <sub>6</sub>	Phenanthrene-d <sub>10</sub>	Octadecanoic Acid-d <sub>35</sub>
1	1	36.6	45.7	26.6
1	2	12.8	6.1	5.7
1	3	9.2	2.8	2.3
2	1	(a)	(a)	(a)
2	2	10.9	7.8	4.2
2	3	7.0	2.2	0.7
2R	1	52.5	63.9	77.0
2R	2	6.4	6.5	10.5
2R	3	1.1	1.6	1.9
3	1	54.9	58.5	25.7
3	2	14.3	6.9	9.9
3	3	4.8	2.6	1.8

a. No calibration standard added to the cleaning residue.

TABLE E-3. REMOVAL OF ORGANIC CONTAMINANTS WITH FREON 113

Test	Cycle	Cleaning, Percent		
		Dimethylphthalate-d <sub>6</sub>	Phenanthrene-d <sub>10</sub>	Octadecanoic Acid-d <sub>35</sub>
4	1	57.6	40.3	62.7
4	2	25.2	2.8	6.0
4	3	12.4	2.0	2.1
5	1	67.3	64.6	60.6
5	2	12.7	4.6	4.1
5	3	11.8	1.5	4.0
6	1	52.7	50.4	56.3
6	2	19.4	4.0	4.1
6	3	12.8	3.4	1.7

TABLE E-4. REMOVAL OF ORGANIC CONTAMINANTS WITH AQUEOUS CLEANER

Test	Cycle	Cleaning, Percent		
		Dimethylphthalate-d <sub>6</sub>	Phenanthrene-d <sub>10</sub>	Octadecanoic Acid-d <sub>35</sub>
7	1	(c)	(c)	(c)
7	2 <sup>a</sup>	3.8	2.3	2.2
7	3 <sup>b</sup>	3.1	1.4	0.9
8	1	(c)	(c)	(c)
8	2 <sup>a</sup>	3.8	3.6	7.8
8	3 <sup>b</sup>	2.5	1.0	0.5

- a. DI water rinse after aqueous cleaning.
- b. TCA cleaning after rinse.
- c. Percent cleaning numbers not available since no analytical method for direct analysis of these organics in concentrated detergent water was available.