

DOT/FAA/AR-95/91

Office of Aviation Research
Washington, D.C. 20591

Characterization of an Oxygen/Nitrogen Permeable Membrane System

Allan Abramowitz
Paul Boris

Airport and Aircraft Safety
Research and Development Division
FAA Technical Center
Atlantic City International Airport, NJ 08405

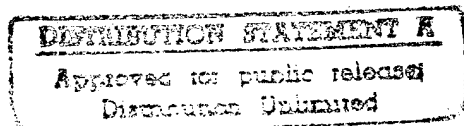

April 1996

Final Report

This document is available to the U.S. public
through the National Technical Information
Service, Springfield, Virginia 22161.

19960520 074



U.S. Department of Transportation
Federal Aviation Administration

DITC QUALITY INSPECTED 1

NOTICE

This document is disseminated under the sponsorship of the U.S. Department of Transportation in the interest of information exchange. The United States Government assumes no liability for the contents or use thereof. The United States Government does not endorse products or manufacturers. Trade or manufacturer's names appear herein solely because they are considered essential to the objective of this report.

1. Report No. DOT/FAA/AR-95/91		2. Government Accession No.		3. Recipient's Catalog No.	
4. Title and Subtitle CHARACTERIZATION OF AN OXYGEN/NITROGEN PERMEABLE MEMBRANE SYSTEM				5. Report Date April 1996	
				6. Performing Organization Code AAR-423	
7. Author(s) Allan Abramowitz and Paul Boris				8. Performing Organization Report No. DOT/FAA/AR-95/91	
9. Performing Organization Name and Address Airport and Aircraft Safety Research and Development Division FAA Technical Center Atlantic City International Airport, NJ 08405				10. Work Unit No. (TRAIS)	
				11. Contract or Grant No.	
12. Sponsoring Agency Name and Address U.S. Department of Transportation Federal Aviation Administration Office of Aviation Research Washington, D.C. 20591				13. Type of Report and Period Covered Final Report	
				14. Sponsoring Agency Code	
15. Supplementary Notes					
16. Abstract <p>The Federal Aviation Administration is investigating the use of alternate technologies for fire suppression aboard aircraft. A system was built using hollow fiber permeable selective membranes to separate air into its two major constituent gasses, namely oxygen and nitrogen. System performance was characterized with regard to pressure, flow, temperature, and their affects on the nitrogen enriched stream. Test results indicate that nitrogen stream purity varies directly with air pressure and temperature and inversely with flow rate. The test data also indicate that there is an optimum combination of flow and nitrogen purity for inerting a fixed volume.</p>					
17. Key Words Nitrogen, Inerting, Fire suppression Permeable membrane			18. Distribution Statement This document is available to the public through the National Technical Information Service (NTIS), Springfield, Virginia 22161.		
19. Security Classif. (of this report) Unclassified		20. Security Classif. (of this page) Unclassified		21. No. of Pages 28	22. Price

TABLE OF CONTENTS

	Page
EXECUTIVE SUMMARY	vii
INTRODUCTION	1
Purpose	1
Background	1
Method of Approach	1
Instrumentation	2
TEST PROCEDURE	5
DISCUSSION	5
Test Series I—Constant Membrane Temperature and Pressure	5
Test Series II—Constant Inerting Stream Flow and Temperature	13
CONCLUSIONS	16
APPENDIX—CALIBRATION PROCEDURES	

LIST OF FIGURES

Figure		Page
1	Oxygen/Nitrogen Membrane System	2
2	Schematic of Oxygen/Nitrogen Membrane System	3
3	Typical Flow vs. Nitrogen Purity Curve	6
4	Chart Depicting the Repeatability of the Permeable Membrane System	7
5	Variation of Flow with Nitrogen Purity at Membrane Temperatures of 70, 90, and 110°F and a Constant Membrane Pressure of 60 psig	8
6	Variation of Flow with Nitrogen Purity at Membrane Temperatures of 70, 90, and 110°F and a Constant Membrane Pressure of 70 psig	8
7	Variation of Flow with Nitrogen Purity at Membrane Temperatures of 70, 90, and 110°F and a Constant Membrane Pressure of 80 psig	9
8	Variation of Flow with Nitrogen Purity at Membrane Temperatures of 70, 90, and 110°F and a Constant Membrane Pressure of 90 psig	9
9	Variation of Flow with Nitrogen Purity at Membrane Temperatures of 70, 90, and 110°F and a Constant Membrane Pressure of 100 psig	10
10	Variation of Flow with Nitrogen Purity at Membrane Temperatures of 70, 90, and 110°F and a Constant Membrane Pressure of 110 psig	10
11	Variation of Flow with Nitrogen Purity at a Constant Membrane Temperature of 110°F and Different Membrane Pressures	11
12	Variation of Flow with Nitrogen Purity at a Constant Membrane Temperature of 90°F and Different Membrane Pressures	11
13	Variation of Flow with Nitrogen Purity at a Constant Membrane Temperature of 70°F and Different Membrane Pressures	12
14	Effect of Membrane Temperature and Pressure On O ₂ /N ₂ Separator System Performance	12
15	Typical Curve Showing Variation of Nitrogen Purity with Membrane Pressure at Constant Flow and Temperature	13

16	Variation of Nitrogen Purity with Membrane Pressure at a Constant Inerting Stream Flow Rate For a Membrane Temperature of 70°F	14
17	Variation of Nitrogen Purity with Membrane Pressure at a Constant Inerting Stream Flow Rate For a Membrane Temperature of 90°F	14
18	Variation of Nitrogen Purity with Membrane Pressure at a Constant Inerting Stream Flow Rate For a Membrane Temperature of 110°F	15
19	Effect of Membrane Temperature On Nitrogen Purity at a Constant Inerting Stream Flow of 9 CFM	15

EXECUTIVE SUMMARY

The Federal Aviation Administration is investigating the use of alternate technologies for fire suppression on aircraft. To investigate the use of hollow fiber permeable membrane separation technology, an in-house system was designed and built using commercially available membranes. The system separates air into its two major constituent gasses, namely oxygen and nitrogen. The nitrogen could be used to provide an inerted atmosphere to suppress a fire while the oxygen could potentially be used during emergency situations.

The purpose of this series of tests was to characterize the performance of the system with regard to pressure, flow, temperature, and their affects on the nitrogen enriched stream.

Families of performance curves were developed to show the relationships of flow rate, pressure, and temperature on nitrogen enrichment. Test results indicate that nitrogen stream purity varies directly with air pressure and temperature and inversely with flow rate. The test data also indicate that there is an optimum combination of flow and nitrogen purity for inerting a fixed volume.

INTRODUCTION

PURPOSE.

The purpose of this test series was to characterize the performance of a nitrogen gas generating system using permeable membrane separation technology. A secondary purpose was to address the feasibility of such a device for fire suppression aboard civil aircraft.

BACKGROUND.

The Federal Aviation Administration (FAA) is investigating the use of alternate technologies for fire suppression on aircraft to reduce and perhaps eventually eliminate the use of those materials which are found to be destructive to the stratospheric ozone layer. One such technology being investigated is that of hollow fiber permeable membranes or more commonly referred to as an air separation module (ASM). This technology involves the separation of a stream of air into an oxygen enriched air stream (OEA) and a nitrogen enriched air stream (NEA) via the difference of the characteristic permeation rates of the two gases (ability to be absorbed in and diffuse through the membrane material). The military is currently using ASM's on some aircraft to supply emergency oxygen to the flight crews and to inert fuel tanks for explosion protection during critical military missions. While fuel tank explosion protection is not required for civil aviation, the concept of inerting an aircraft compartment for fire protection via nitrogen inerting or a hybrid nitrogen system may have merit. Nitrogen inerting may be suitable for cargo compartments. Another possible benefit may also be realized; i.e., the oxygen rich stream could be used to supplement or, perhaps, as an alternative to bottled oxygen normally carried aboard commercial aircraft.

The system involved in this study is an in-house designed and fabricated device and is described in more detail under "Instrumentation." Its function is to separate a supply of air into two streams: one oxygen rich and the other nitrogen rich. For the purpose of these studies the nitrogen rich stream is the product and the oxygen rich stream is the by-product. The associated calibration procedures for the permeable system is contained in the appendix as well as the equations for determining flow rates.

METHOD OF APPROACH.

In order to meet the purpose of this project, a series of tests were formulated and conducted, within the limitations of the equipment, to achieve this goal. There were essentially two distinct series of tests from which all data were obtained. The first of these was conducted under the conditions whereby the membrane temperature and membrane pressure were kept constant and the percent oxygen in the NEA stream (nitrogen purity) was varied. This was accomplished in succeeding steps by closing down a valve (back-pressure valve) in the inerting stream line to decrease flow and by adjusting supply pressure to maintain a constant membrane pressure. Decreasing the flow of air through the membrane effectively increases the "linger" time and results in a higher purity nitrogen stream. The test was terminated when either a low practical limit on the visually read flow meters was reached or fluctuations of the flow meter float made it

difficult to obtain a stable reading. This test procedure was accomplished for membrane temperatures of 70, 90, and 110°F. For membrane temperatures of 90 and 110°F, constant membrane pressure tests were not conducted below levels of 60 psig.

The second series of tests was conducted under the conditions whereby the membrane temperature and inerting stream flow were maintained at constant levels and the membrane pressure was varied from a high of 110 to a low of 40 psig in increments of 10 psig. For each succeeding test, the supply pressure to the system was reduced and the back-pressure valve adjusted accordingly to maintain a constant inerting stream flow rate. The test was terminated when the lower limit of 40 psig was attained.

INSTRUMENTATION.

The oxygen/nitrogen permeable membrane system was designed and assembled in-house to provide a nitrogen rich air supply for ground-based laboratory inerting tests (figure 1). Its major components consist of two PERMEA Prism Alpha membrane separators, flow meters, and oxygen analyzers. Its constituent parts are tied together with copper tubing and instrumentation wiring. The system plumbing as well as the membrane columns were insulated to improve temperature stability. Several valves were placed throughout to control the flow as were pressure gages and pressure transducers to monitor performance and set parameters. All components were attached to a standard 19-inch instrument rack that was nominally 6 ft high and 2 ft deep. A schematic of the separator device is shown in figure 2.

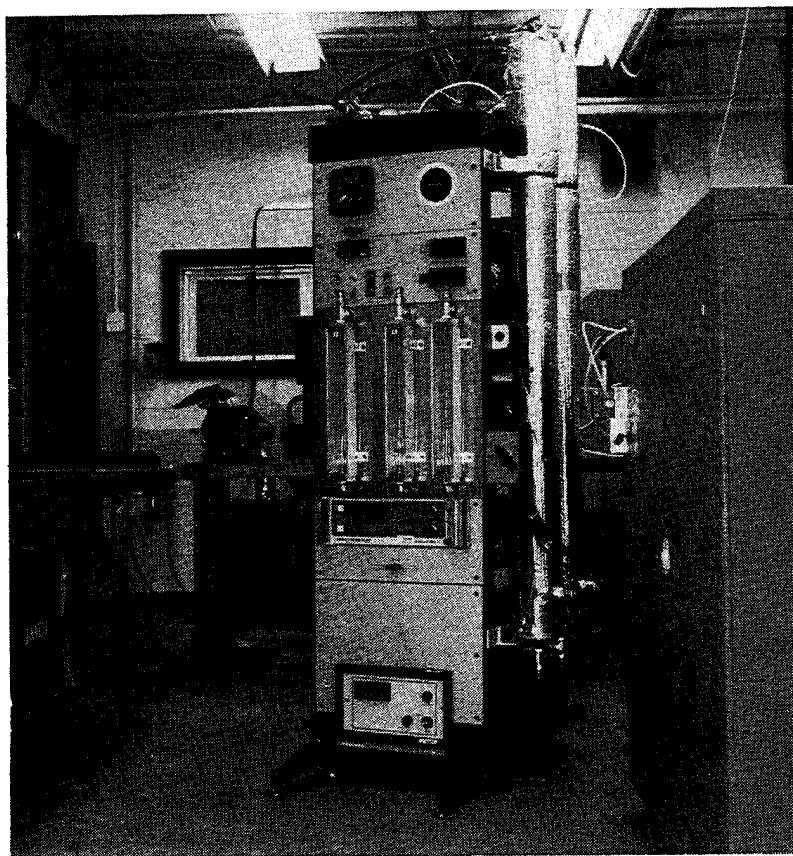
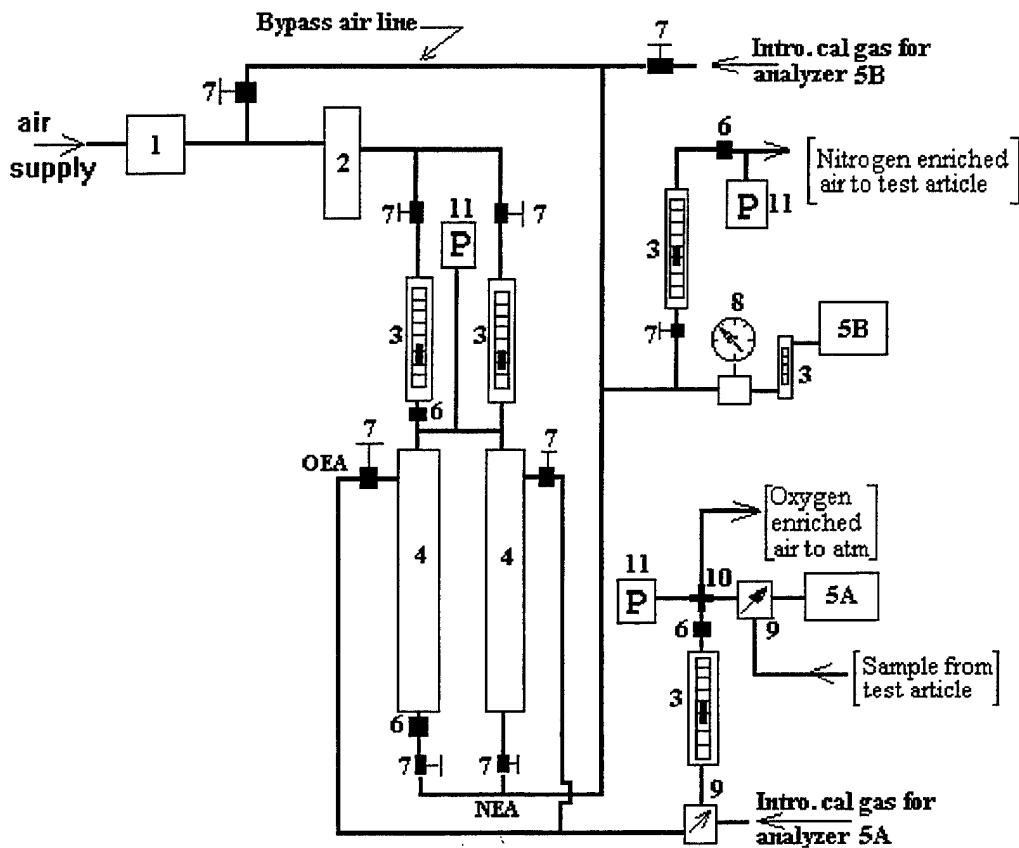

FIGURE 1. OXYGEN/NITROGEN MEMBRANE SYSTEM



Legend

- | | |
|------------------------|-----------------------------------|
| 1 - Filter/water trap | 7 - Hand valve |
| 2 - Pressure regulator | 8 - Press. gage/regulator |
| 3 - Flow meter | 9 - 2-way selector valve |
| 4 - Permeable membrane | 10 - 4-way coupler |
| 5 - Oxygen analyzer | 11 - Pressure transducer |
| 6 - Temperature sensor | OEA: Oxygen enriched atmosphere |
| | NEA: Nitrogen enriched atmosphere |

FIGURE 2. SCHEMATIC OF OXYGEN/NITROGEN MEMBRANE SYSTEM

The building compressed air supply was the source air for the system. This was supplied by a Norwalk nonlubricated 1000 psig/100 scfm compressor. The air was filtered and dried using a Zander coalescing filter near the compressor and a Devilbiss filter in the test area. System requirements for supply air varied throughout the test program and were a function of membrane temperature and pressure, NEA purity and flow. Typical supply air flows ranged from 2 to 22 scfm, while typical flows in the NEA and OEA streams ranged from 0.4 to 11 scfm and 1.2 to 11 scfm, respectively; NEA purities ranged from approximately 85 to 98 percent.

The membrane separators are cylindrical columns whose outside dimensions are 4 in. diameter by 64 in. long and are capable of supplying an NEA stream of 98 percent nitrogen at working temperatures of up to 175°F and supply pressures up to 250 psig. Exploiting the full range of the

membranes, however, was not within the scope of these tests. The incoming supply of air was divided into two equal streams and ducted to the two cylindrical membrane columns. The flow of air to each was measured and monitored with an Omega Rotameter Model FL1501A. The oxygen rich air was vented to atmosphere through an Omega Rotameter Model FL1502A. The nitrogen rich air, directed to the test article, was measured and monitored via the Omega Rotameter Model FL1503A.

The performance of the membrane separators is a function of pressure, flow, and temperature. It was, therefore, necessary to control and measure these parameters to obtain accurate profiles of their effects on performance. Dynisco pressure transducers, Model HLD-5V-100 (range: 0-100 in. water), were used to measure the pressure at the outlet of the oxygen and nitrogen rotameters. Dynisco pressure transducers, Model PT150-1.5C-H38 (range: 0-150 psig), were used to measure the pressure at the outlet of the air rotameters and at the inlet and outlet of the membranes. The pressure measured at the inlet to the membranes was used as the reference pressure. Temperatures were measured and recorded using Type T (copper constantan) thermocouples. Manually operated valves were located at various points within the system to control flow through the membranes, isolate portions of the flow circuit for calibration, provide a back pressure, and isolate a membrane column as needed. Decreasing the flow through or increasing the supply pressure to the membranes increases the percentage of nitrogen (purity) in the NEA stream.

Oxygen concentration in the NEA stream was measured using a Beckman OM11EA oxygen analyzer. A pressurized line from the NEA stream was plumbed into this analyzer to sense oxygen concentration. This analyzer was set to the range of zero to 25 percent volumetric concentration of oxygen and calibrated at zero and 20.9 percent and checked at a midpoint volumetric concentration of approximately 10 percent. The oxygen concentration of the OEA stream was measured using a Beckman OM11 oxygen analyzer. This oxygen analyzer has a built-in vacuum pump and flow meter. To measure the pressurized OEA stream required setting the built-in flow meter to the designated flow reading (250 cc/min). This analyzer was internally switched to set its range to 100 percent volumetric concentration of oxygen, since oxygen levels were expected to significantly exceed atmospheric. This analyzer was calibrated at zero and 40 percent volumetric concentration of oxygen and checked at a midpoint volumetric concentration of approximately 21 percent. Due to the sensitivity of the oxygen analyzers to changes in sampling pressure, precautions had to be taken to minimize the effect of pressure variation from the calibration procedure to the test and during a test when changes were made that affected the pressure in a stream. For the NEA stream, a sample line was plumbed to a Fischer-Governor Type 67R pressure regulator (set to 5 psig), and then plumbed through a Dwyer flow meter (set to flow 2.75 L/min) and then to the OM11EA oxygen analyzer. Pressure variations on the OEA stream were significantly smaller than those measured in the NEA stream. Compensation for changes in pressure, and hence flow, were achieved by adjusting the needle valve on the OM11 analyzer as to maintain a constant flow of 250 cc/min. This was accomplished prior to testing and during testing if needed.

When required, the supply of air was preheated with temperature control being effected through the use of three thermostatically controlled Omega 720 watt electric heating cables wrapped

around a 50-foot coil of 5/8-inch copper tubing. This 50-foot coil of tubing was installed into the air supply line and used to conduct tests at 90 and 110°F and to maintain 70°F, if needed.

Data were collected and processed using an AT&T 386/33 MHz IBM compatible computer. Ancillary equipment included Burr Brown data acquisition hardware and Labtech data acquisition software. The data were reduced, analyzed, and displayed using a Microsoft Excel spreadsheet.

TEST PROCEDURE

All equipment, including the data acquisition system, was turned on and allowed to warm up for at least one-half hour. A system calibration was performed per the appendix and any necessary adjustments were made. The system was configured to initial test conditions and allowed to stabilize (at least one minute at required conditions).

For Test Series I, the membrane pressure was held constant and the nitrogen purity was varied. This was accomplished by adjusting the back-pressure valve 7 (refer to figure 2) located in the NEA stream and the source pressure at the supply air regulator 2. Note that all valves are numbered 7 but the one to which is referred is closest to the oxygen analyzer 5B. Other pertinent data were recorded either via the data acquisition system or was manually recorded, including the NEA and OEA stream pressures, temperatures, and flow meter readings. Actual flows were later calculated and recorded. For Test Series II, the same procedure was used except the inerting stream (NEA) flow was held constant and the membrane pressure varied. The same pertinent data were recorded. Each of these test series was conducted at 70, 90 and 110°F. An event mark was manually entered into the computer to signal the beginning of data collection. Following the completion of a test, the system was adjusted to set the parameters for the next test condition. This was repeated until all predetermined testing conditions were completed.

DISCUSSION

TEST SERIES I—CONSTANT MEMBRANE TEMPERATURE AND PRESSURE.

In this first series of tests, the membrane temperature was held constant at a nominal 70°F, i.e., room temperature. For each individual test within this series, the membrane pressure was held constant, but increased for each succeeding test by 10 psig from 40 to 110 psig. Thus, the first test within this series was conducted at a membrane temperature of 70°F and a membrane pressure of 40 psig, the second at 50 psig, etc. There were several runs within each test beginning at some maximum flow rate and decreasing until reaching the minimum practical reading on the flow meter in the inerting stream. Decreasing the flow of air through the system increased the amount of time it took for the air to pass through the membranes and allowed for more oxygen to be extracted from the air stream. Thus, of the two streams exiting the system, i.e., oxygen rich and oxygen deficient, the one of interest in this study, oxygen deficient, had a higher nitrogen content. The level of nitrogen in this stream will be referred to as nitrogen purity and the stream itself referred to as the inerting stream or NEA.

Flow through the system was controlled with the use of a back-pressure valve and by adjusting the source pressure. When the desired level of flow and nitrogen purity was attained, the data were recorded and conditions established for the next run. A typical chart generated from these series of tests is shown in figure 3. As the flow is decreased, the nitrogen purity increases.

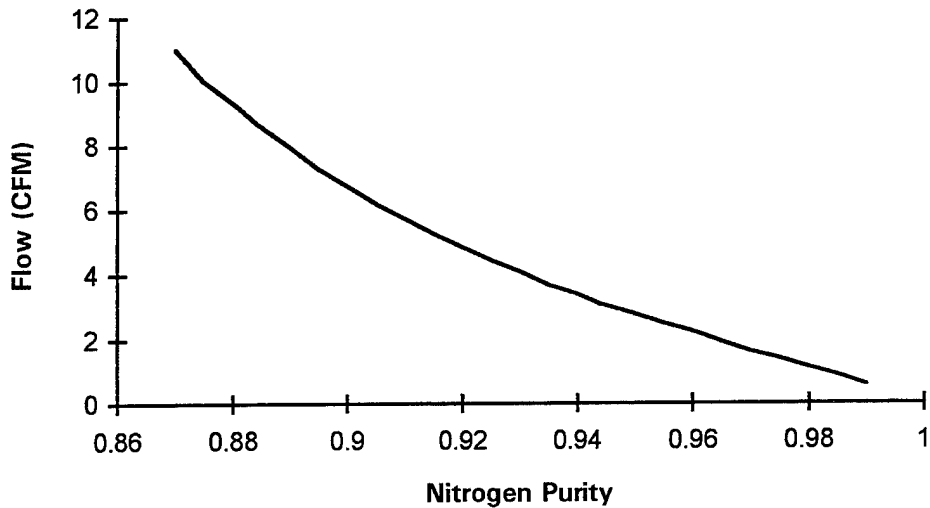

FIGURE 3. TYPICAL FLOW VS. NITROGEN PURITY CURVE

For the purpose of inerting a test volume, it is advantageous for the inerting stream to have the highest level of nitrogen purity possible. However, as figure 2 indicates, the inerting stream flow decreases as nitrogen purity increases. This suggests that there may be an optimum combination of flow and nitrogen purity for each membrane pressure to result in the fastest possible inerting of a fixed volume.

The first of these series of tests, i.e., where the membrane temperature was constant at 70°F, was repeated four times. This procedure was performed at this membrane temperature for the purpose of establishing the level of repeatability. After completing the 70°F membrane temperature tests it was determined that the repeatability from test to test was sufficiently consistent that this method of approach was not necessary for subsequent tests. Figure 4 demonstrates this repeatability. For the data shown, at the test condition of 90 psig and 70°F for membrane pressure and temperature, respectively, the individual tests track closely enough to preclude multiple testing at other test conditions.

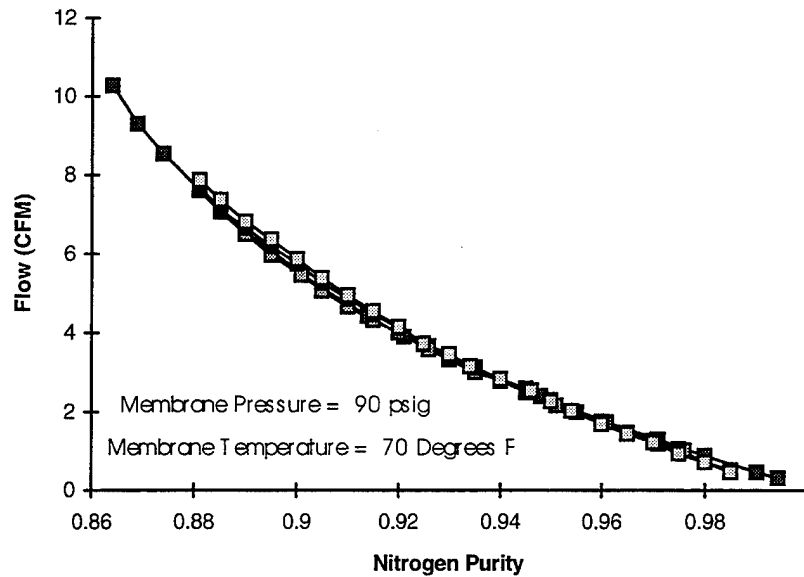

FIGURE 4. CHART DEPICTING THE REPEATABILITY OF THE PERMEABLE MEMBRANE SYSTEM

Figures 5 through 10 are similar in nature. Each individual curve was obtained by conducting a test at constant membrane temperature and pressure. Each of the individual figures 5 through 10 differs in that each indicates the data with the membrane pressure being held constant during the individual test but increased by 10 psig from 60 to 110 psig for each succeeding test. In the first of this series of tests, the membrane temperature was held constant at a nominal 70°F, i.e., room temperature. There were several runs within each test beginning at some maximum flow rate and decreasing until reaching the minimum practical reading on the flow meter in the inerting stream. This was repeated for 90 and 110°F, except at 40 and 50 psig. These low pressures and elevated temperatures resulted in relatively low flows with fluctuating flow readings and was therefore deemed impractical to test.

An obvious conclusion when comparing all of these figures is that the performance of the permeable membrane system improves with increasing membrane temperature. In each of the figures 5 to 10, when considering a line of constant nitrogen purity, the flow is higher at the higher membrane temperature. Conversely, when considering a line of constant flow, the nitrogen purity is higher at the higher membrane temperature.

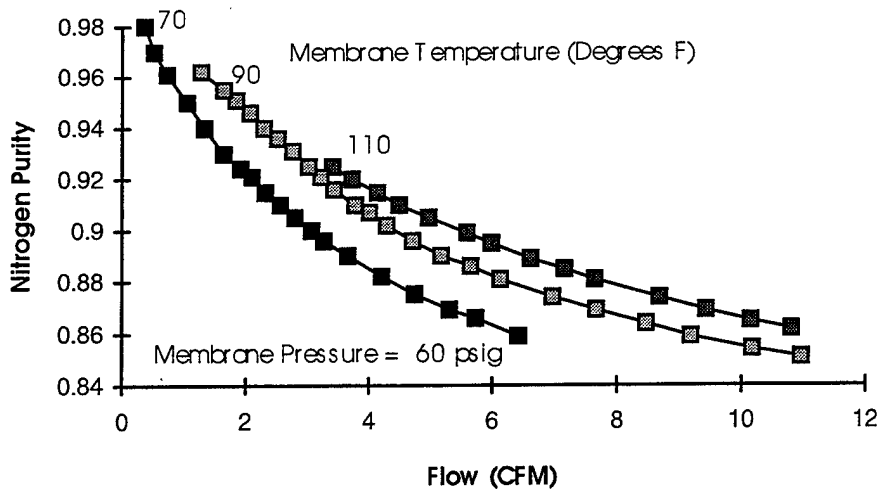

FIGURE 5. VARIATION OF FLOW WITH NITROGEN PURITY AT MEMBRANE TEMPERATURES OF 70, 90, AND 110°F AND A CONSTANT MEMBRANE PRESSURE OF 60 PSIG

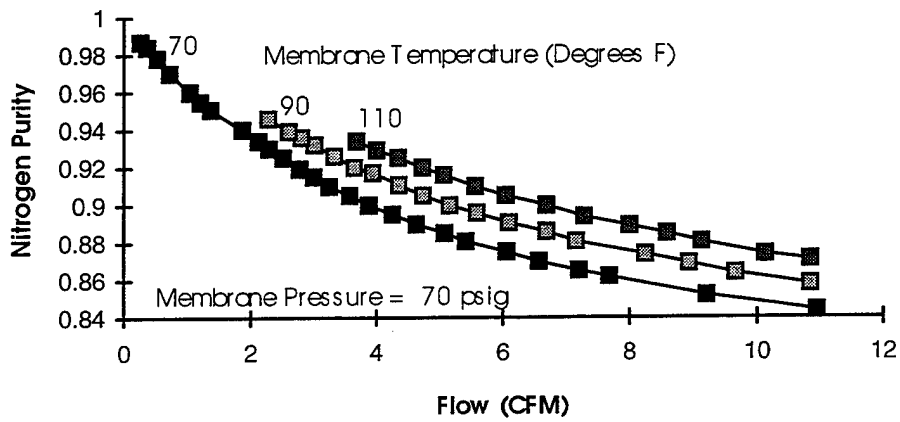

FIGURE 6. VARIATION OF FLOW WITH NITROGEN PURITY AT MEMBRANE TEMPERATURES OF 70, 90, AND 110°F AND A CONSTANT MEMBRANE PRESSURE OF 70 PSIG

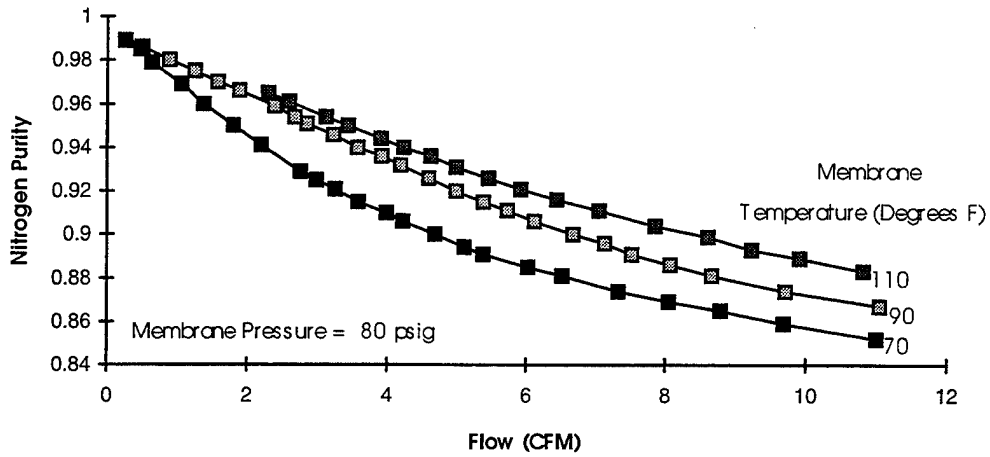

FIGURE 7. VARIATION OF FLOW WITH NITROGEN PURITY AT MEMBRANE TEMPERATURES OF 70, 90, AND 110°F AND A CONSTANT MEMBRANE PRESSURE OF 80 PSIG

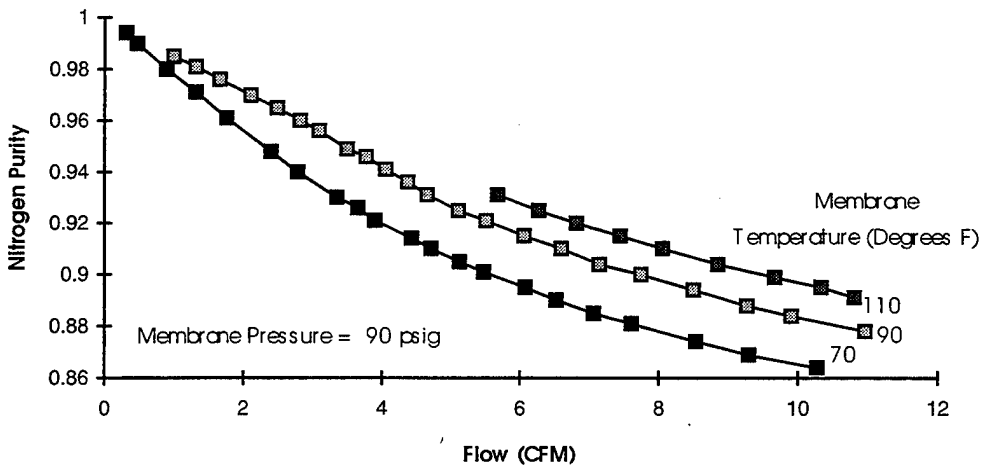

FIGURE 8. VARIATION OF FLOW WITH NITROGEN PURITY AT MEMBRANE TEMPERATURES OF 70, 90, AND 110°F AND A CONSTANT MEMBRANE PRESSURE OF 90 PSIG

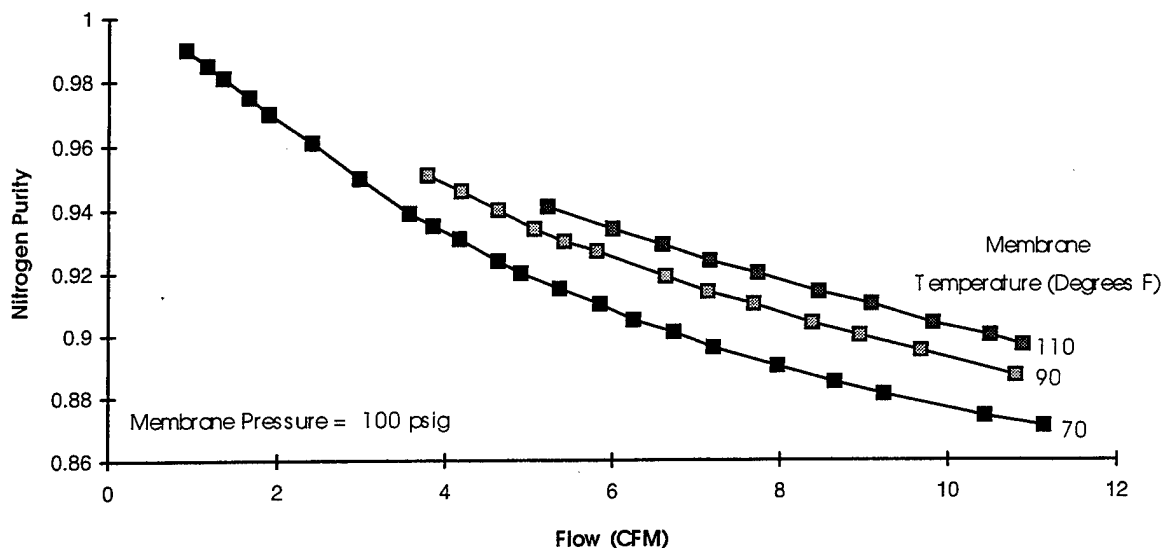

FIGURE 9. VARIATION OF FLOW WITH NITROGEN PURITY AT MEMBRANE TEMPERATURES OF 70, 90, AND 110°F AND A CONSTANT MEMBRANE PRESSURE OF 100 PSIG

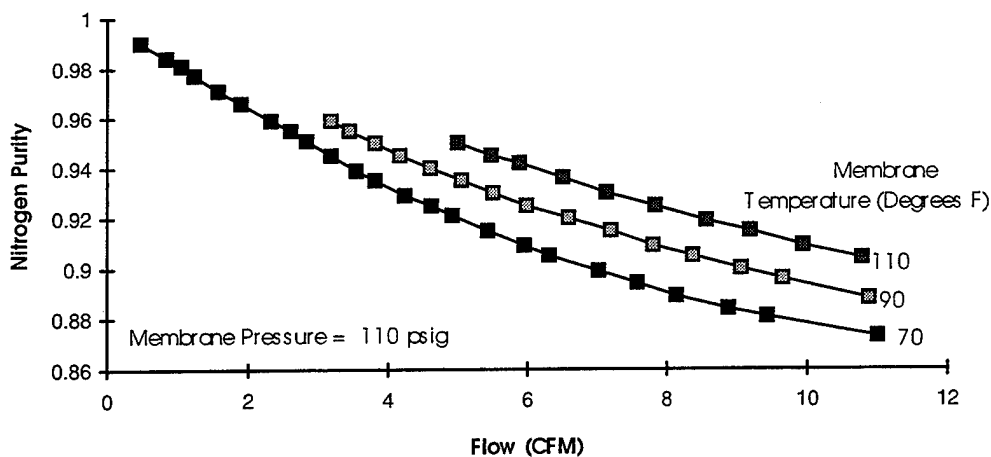

FIGURE 10. VARIATION OF FLOW WITH NITROGEN PURITY AT MEMBRANE TEMPERATURES OF 70, 90, AND 110°F AND A CONSTANT MEMBRANE PRESSURE OF 110 PSIG

Another characteristic not as readily obvious from these figures is that the performance of the permeable membrane system improves with increasing membrane pressure. With the data rearranged, figures 11, 12, and 13 more readily show this characteristic. These figures are similar except that each curve is characteristic of what occurs at a constant membrane pressure with

membrane temperatures at 110, 90, and 70°F, respectively. When considering either a line of constant flow or nitrogen purity in these figures, both of these parameters increase with increasing membrane pressure. Figure 14 was configured to more readily show the influence both of these system affecting parameters, i.e., membrane pressure and membrane temperature. The data are displayed as curves of various membrane pressures, each held constant, at common test conditions of 110 and 70°F. A membrane temperature of 90°F was not included in this graphical depiction for the purpose of clarity. It would, however, have fallen between 70 and 110°F.

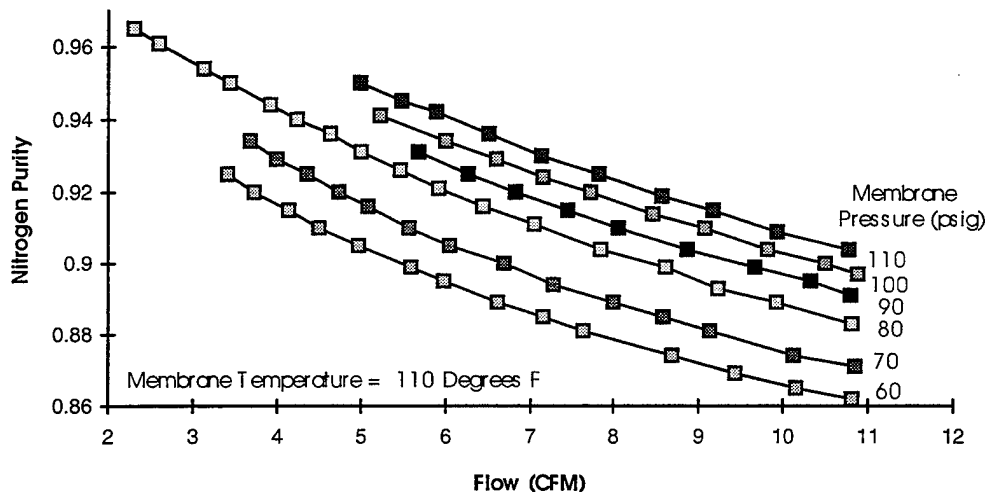

FIGURE 11. VARIATION OF FLOW WITH NITROGEN PURITY AT A CONSTANT MEMBRANE TEMPERATURE OF 110°F AND DIFFERENT MEMBRANE PRESSURES

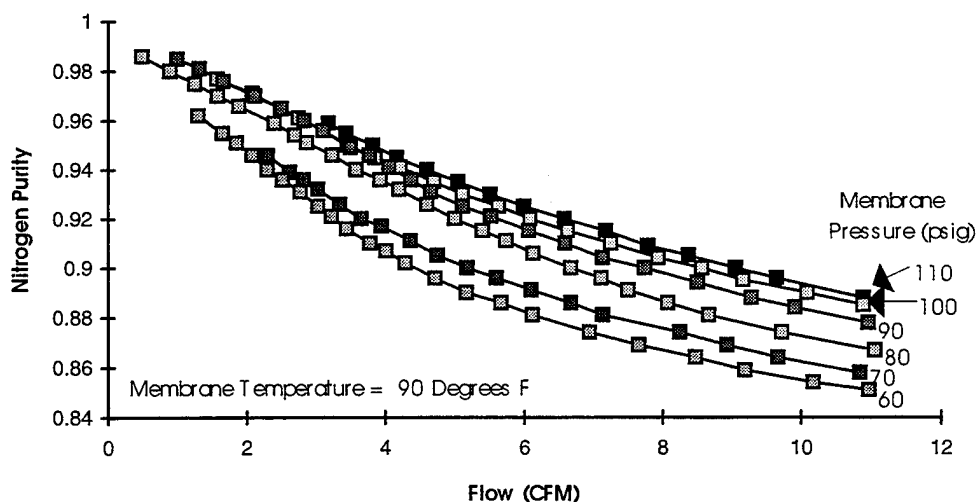

FIGURE 12. VARIATION OF FLOW WITH NITROGEN PURITY AT A CONSTANT MEMBRANE TEMPERATURE OF 90°F AND DIFFERENT MEMBRANE PRESSURES

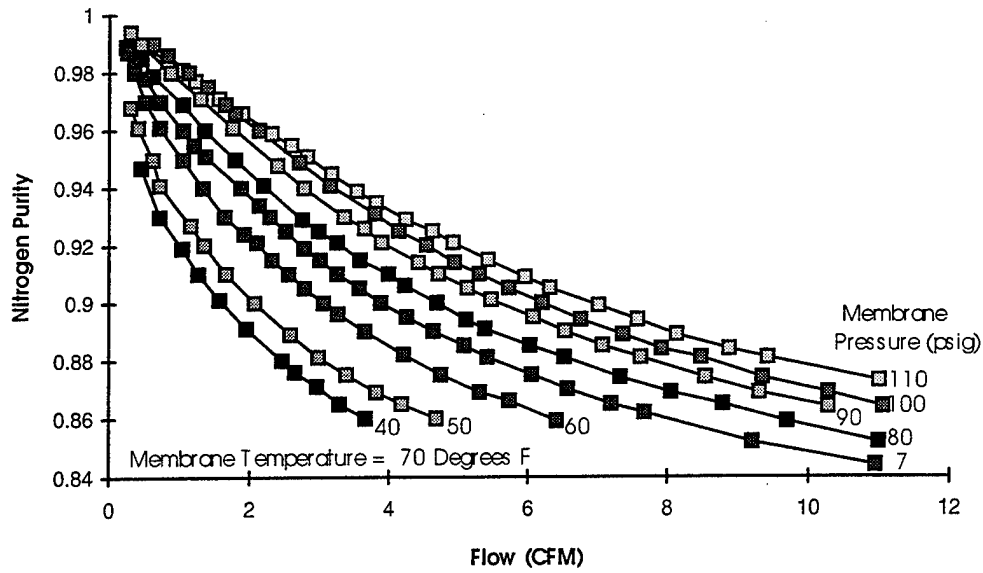

FIGURE 13. VARIATION OF FLOW WITH NITROGEN PURITY AT A CONSTANT MEMBRANE TEMPERATURE OF 70°F AND DIFFERENT MEMBRANE PRESSURES

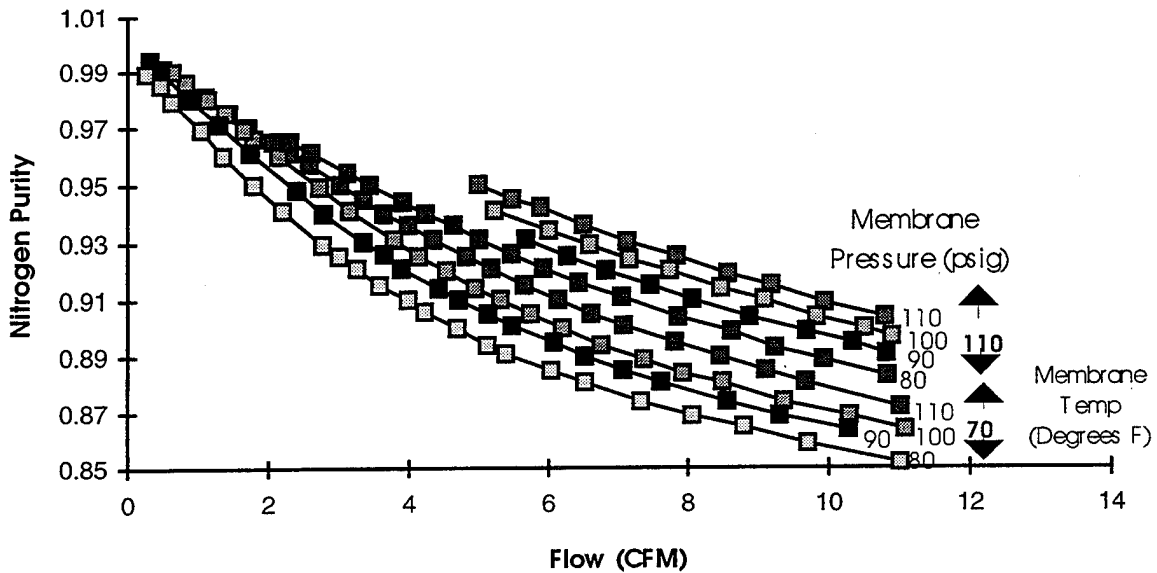

FIGURE 14. EFFECT OF MEMBRANE TEMPERATURE AND PRESSURE ON O₂/N₂ SEPARATOR SYSTEM PERFORMANCE

TEST SERIES II—CONSTANT INERTING STREAM FLOW AND TEMPERATURE.

For this series of tests, the inerting stream flow (and membrane temperature) were held constant; membrane pressure was varied. This procedure was followed for each run from the maximum of 110 psig membrane pressure to a minimum of 40 psig. A typical chart generated from this series of tests is shown on figure 15.

Figures 16, 17, 18, and 19 show the results of tests conducted under this portion of the program. These figures indicate that the nitrogen purity of the inerting stream increases with increasing membrane pressure. Supporting the conclusion made previously that the efficiency of the permeable membrane system improves as the membrane pressure increases. Further indicated by these figures, as the inerting stream flow is reduced, the nitrogen purity increases.

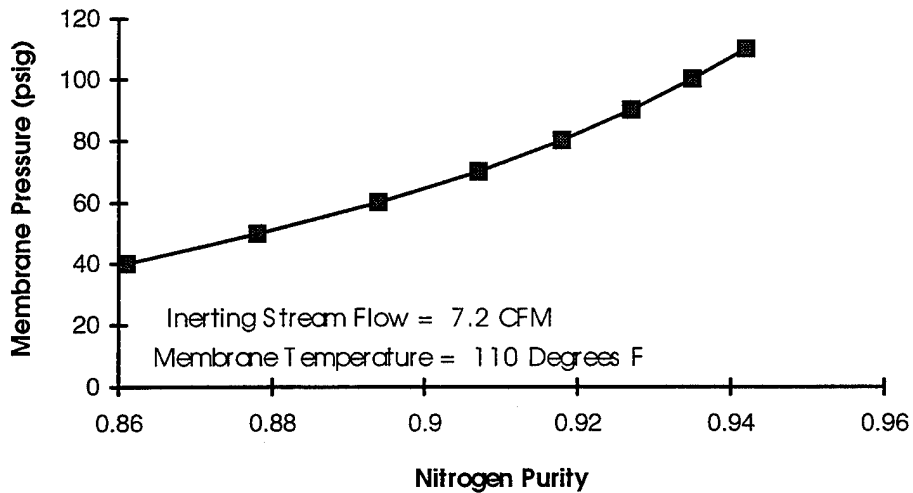

FIGURE 15. TYPICAL CURVE SHOWING VARIATION OF NITROGEN PURITY WITH MEMBRANE PRESSURE AT CONSTANT FLOW AND TEMPERATURE

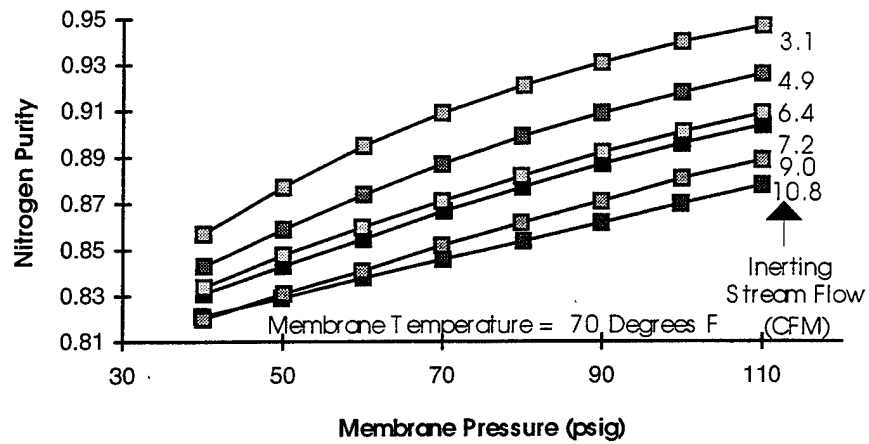

FIGURE 16. VARIATION OF NITROGEN PURITY WITH MEMBRANE PRESSURE AT A CONSTANT INERTING STREAM FLOW RATE FOR A MEMBRANE TEMPERATURE OF 70°F

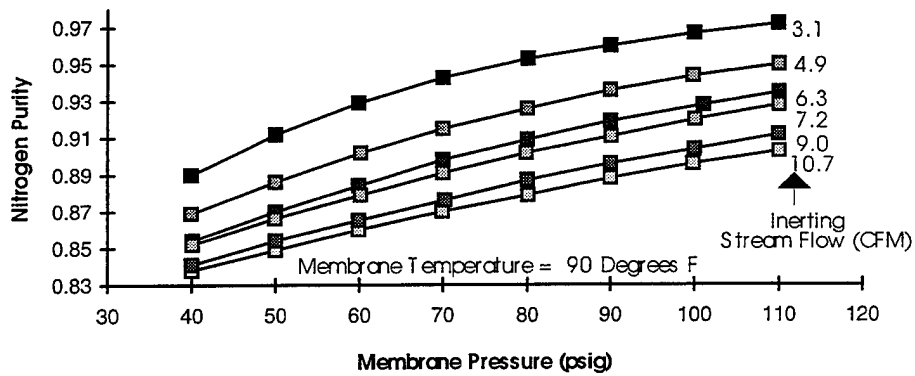

FIGURE 17. VARIATION OF NITROGEN PURITY WITH MEMBRANE PRESSURE AT A CONSTANT INERTING STREAM FLOW RATE FOR A MEMBRANE TEMPERATURE OF 90°F

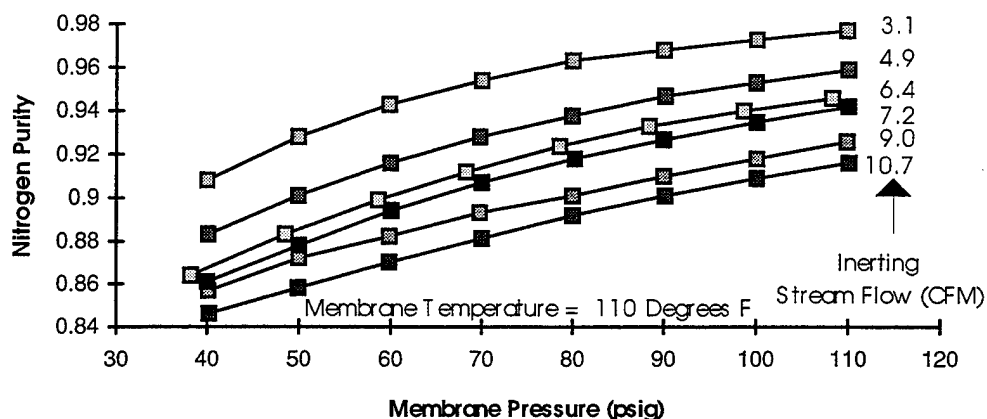

FIGURE 18. VARIATION OF NITROGEN PURITY WITH MEMBRANE PRESSURE AT A CONSTANT INERTING STREAM FLOW RATE FOR A MEMBRANE TEMPERATURE OF 110°F

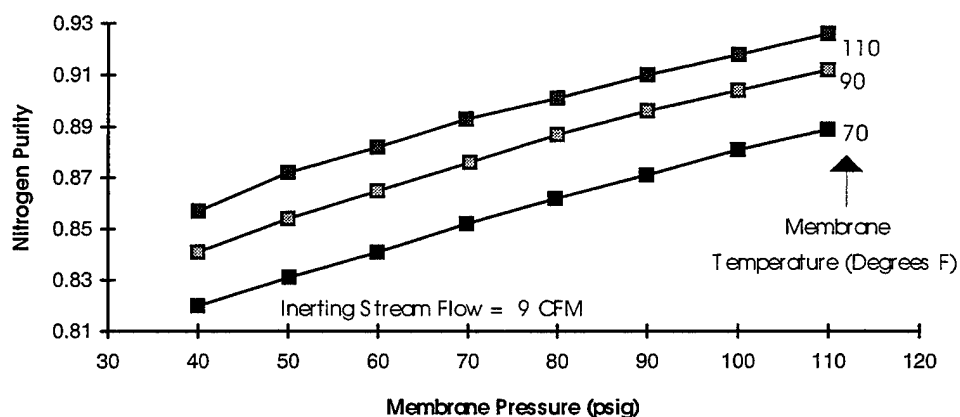

FIGURE 19. EFFECT OF MEMBRANE TEMPERATURE ON NITROGEN PURITY AT A CONSTANT INERTING STREAM FLOW OF 9 CFM

These figures further illustrate the effect that membrane temperature has on the efficiency of the membrane system. In figure 19 at a line of constant membrane pressure, nitrogen purity is increased at higher membrane temperatures. Limitations of the laboratory instrumentation and equipment precluded testing at a higher membrane temperature. However, the trend suggests that membrane temperatures in excess of 110°F would improve efficiency of the membrane system further. Additionally, these figures indicate that membrane performance would be increased with increasing membrane pressure. In this case limitations of the laboratory instrumentation and equipment precluded testing at a higher membrane pressure.

CONCLUSIONS

1. In the permeable membrane system the nitrogen purity of the inerting stream increases with increasing membrane pressure.
2. In the permeable membrane system the nitrogen purity of the inerting stream increases with increasing membrane temperature.
3. In the permeable membrane system the nitrogen purity of the inerting stream increases as the flow through the membrane decreases.

APPENDIX

CALIBRATION PROCEDURES

Calibration procedure the for oxygen/nitrogen separator device:

Oxygen Analyzer 5A (Note: refer to figure A-1)

1. Turn on analyzer (analyzer has internal pump and will begin to draw sample immediately), range internally set to 0-100 percent volumetric concentration of oxygen at full-scale output of 5 volts; allow 30 minutes for instrumentation warm-up time.
2. Place SV1 in the "OEA" position. Disconnect analyzer sample line from 4-way coupling (10).
3. Place analyzer sample line in a plastic sample bag (or similar size plastic bag) along with the zero-calibration gas (greater than 99.95 percent nitrogen purity) supply line.
4. Open valve on calibration gas tank and allow calibration gas to fill the bag and maintain bag volume.
5. Set instrument flow meter to read 250 cc/min.
6. After the display stabilizes, the observed reading should indicate $0\% \pm 0.2\%$. If not, see the operator's manual.
7. Close valve on the calibration gas supply tank, attach high-calibration gas (approximately 50 percent oxygen) to the calibration gas supply line.
8. Repeat steps 4 through 6.
9. Adjust the gain control until the oxygen analyzer display indicates calibration gas specification.
10. Close valve on the calibration gas supply tank.
11. Allow analyzer to draw ambient air; set instrument flow meter to read 250 cc/min.
12. Oxygen reading should indicate $20.9\% \pm 0.1\%$. If not, see the operator's manual.
13. Reconnect sample line to 4-way coupling.

Oxygen Analyzer 5B (Note: refer to figure A-1)

1. Turn on analyzer by switching from standby mode to range equals "25" (sets range equal to 0-25 percent volumetric percent oxygen for full-scale output of 5 volts), allow 30 minutes for instrumentation warm-up time.
2. Close valves V5, V6, V7, V8, and V9.
3. Attach zero-calibration gas to input of valve V8 and open the valve.
4. Pressure should be approximately 5 psi as indicated on pressure gage/regulator P1; adjust needle valve on flow meter (3) to indicate 2.75 L/min.
5. After display stabilizes, the observed reading should indicate $0\% \pm 0.2\%$. If not, see the operator's manual.
6. Turn off zero-calibration gas and valve V8.
7. Open valve V7 and repeat step 3.
8. After display stabilizes, adjust the gain control until analyzer indicates 20.9 percent.
9. Close valve V7 and attach midrange calibration gas (approximately 10 percent oxygen) to input of valve V8 and open the valve.
10. Repeat step 3.
11. Oxygen reading should indicate midrange calibration value $\pm 0.2\%$. If not, see the operator's manual.
12. Turn off high-calibration gas and valve V8.

Pressure Transducers

1. Turn on and adjust the power supplies to the pressure transducers. Allow at least one-half hour for them to warm up and stabilize.
2. Without any air flow, record "zero" voltage from transducer output via voltmeter or calibration program.
3. Set all pressure calibration switches to the high-calibration position. Record voltage from transducers using voltmeter or calibration program.
4. The gain multiplication factor is calculated by dividing the theoretical value (80 percent of full-scale voltage) by the actual reading.

5. Use the zero and gain values as offset and scale factors in data acquisition program.
6. All zero readings should fall within 0.0 ± 0.1 volt and gain readings 4.0 ± 0.1 volt.

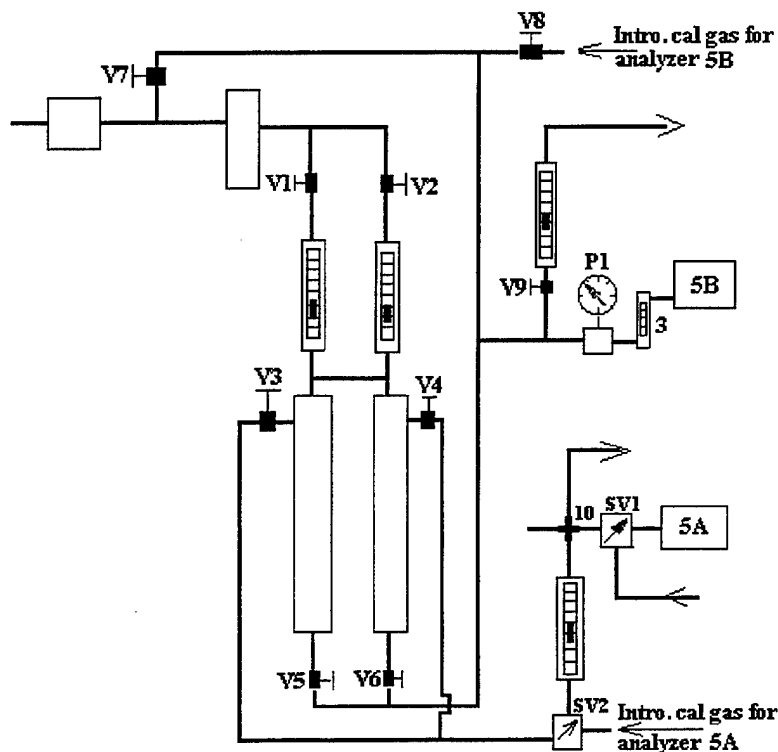

FIGURE A-1. SCHEMATIC OF OXYGEN/NITROGEN MEMBRANE SYSTEM SHOWING VALVE LOCATIONS

Expressions for Determining Flows Using the Permeable Membrane System

Definition of Symbols:

- T_o - absolute temperature, °R
- P_o - absolute pressure (psi for air, H_2O for NEA and OEA)
- F - measured temperature, °F
- P - measured pressure (psig for air, H_2O gage for NEA and OEA)
- CF - flow correction factor
- SG - specific gravity
- Reading - float level of flow meter

For air using flow meter (FL-1501A)

$$Flow = \frac{0.19 \times Reading}{\sqrt{T_0/P_0}} \text{ SCFM} \quad (1)$$

For nitrogen using flow meter (FL-1503A)

$$Flow = \frac{0.119 \times Reading}{\sqrt{T_0/P_0}} \text{ SCFM} \quad (2)$$

For oxygen using flow meter (FL-1502A)

$$Flow = \frac{0.064 \times Reading}{\sqrt{T_0/P_0}} \text{ SCFM} \quad (3)$$

Determination of expression for calculating flow of air using flow meter FL-1501A (SG = 1.0).

$$\begin{aligned} CF &= \left[\frac{(SG)(T_0)(14.7)}{(1.0)(530)(P_0)} \right]^{1/2} \\ &= \left(\frac{T_0}{P_0} \right)^{1/2} \left(\frac{14.7}{530} \right)^{1/2} \\ &= 0.166 \sqrt{T_0/P_0} \end{aligned}$$

$$Flow = \frac{Reading \times 0.0317}{CF} \quad 0.0317 = \text{Scale Factor for flow meter model FL-501A}$$

$$Flow = \frac{0.19 \times Reading}{\sqrt{T_0/P_0}}$$

Determination of expression for calculating flow of nitrogen enriched air using flow meter FL-1503A (SG = 1.0).

$$CF = \left[\frac{(SG)(T_0)(406.8)}{(1.0)(530)(P_0)} \right]^{1/2}$$

$$= \left(\frac{T_0}{P_0} \right)^{1/2} \left(\frac{406.8}{530} \right)^{1/2}$$

$$= 0.876 \sqrt{T_0/P_0}$$

$$Flow = \frac{Reading \times 0.1045}{CF} \quad 0.1045 = \text{Scale Factor for flow meter model FL-1503A}$$

$$Flow = \frac{0.119 \times Reading}{\sqrt{T_0/P_0}}$$

Determination of expression for calculating flow of oxygen enriched air using flow meter FL-1502A.

$SG_{(O_2)} = 1.166$
 Assume 50/50 mix, air/oxygen, for flow calculation purposes
 $\therefore SG \cong 1.08$

$$CF = \left[\frac{(1.08)(T_0)(406.8)}{(530)(P_0)} \right]^{1/2}$$

$$= \left[\frac{(1.08)(406.8)}{(530)} \right]^{1/2} \left(\frac{T_0}{P_0} \right)^{1/2}$$

$$= 0.910 \sqrt{T_0/P_0}$$

$$Flow = \frac{Reading \times 0.0588}{CF} \quad 0.0588 = \text{Scale Factor for flow meter model FL-1502A}$$

$$Flow = \frac{0.064 \times Reading}{\sqrt{T_0/P_0}}$$

Sample Calculations

Using equation (1) to determine the flow of air:

$$Flow = \frac{0.19 \times Reading}{\sqrt{T_o/P_o}}$$

Measured parameters: $P_o = 100.4 + 14.7 = 115.1$ psig.
 $T_o = 72.8 + 460 = 532.8^\circ\text{R}$
Flow meter Reading = 55

$$\begin{aligned} Flow &= \frac{0.19(55)}{\sqrt{\frac{532.8}{115.1}}} \\ &= 4.86 \text{ (per flow meter)} \\ &= 4.86 \times 2 \text{ (flow meters)} \\ &= 9.7 \text{ CFM—total flow of air entering membrane system} \end{aligned}$$

Using equation (2) to determine the flow of NEA:

$$Flow = \frac{0.119 \times Reading}{\sqrt{T_o/P_o}}$$

Measured parameters: $P_o = 12.8 + 406.8 = 419.6$ H₂O gage
 $T_o = 72.8 + 460 = 532.8^\circ\text{R}$
Flow meter Reading = 48.9

$$\begin{aligned} Flow &= \frac{0.119(48.9)}{\sqrt{\frac{532.8}{419.6}}} \\ &= 5.16 \text{ CFM inerting stream flow (NEA)} \end{aligned}$$