

Final Technical Report

on

**FUNDAMENTAL STUDIES ON THE CORROSION BEHAVIOR OF
WELDMENTS IN MARINE MICROBIAL ENVIRONMENTS**

by

R. A. Buchanan,* C. D. Lundin,* P. J. Angell,**
J. C. Danko,* A. L. Kovacs,* and K. K. Kahn*

*Department of Materials Science and Engineering

**Center for Environmental Biotechnology

The University of Tennessee

Knoxville, TN 37996-2200

under

Grant No. N00014-92-J-4116

for the

OFFICE OF NAVAL RESEARCH

800 North Quincy Street

Arlington, Virginia 22217-5000

Scientific Officer: Dr. A. John Sedriks

April, 1996

19960517 067



THE UNIVERSITY OF TENNESSEE

Department of Materials Science and Engineering

Center for Materials Processing

Knoxville, Tennessee 37996-2200

DISTRIBUTION STATEMENT A

Approved for public release;
Distribution Unlimited

DTIC QUALITY INSPECTED 1

REPORT DOCUMENTATION PAGE

FORM APPROVED
OMB No. 0704-0188

Public reporting burden for this collection of information is estimated to average 1 hour per response, including the time for reviewing instructions, searching existing data sources, gathering and maintaining the data needed and completing and reviewing the collection of information. Send comments regarding this burden estimate or any other aspect of the collection of information, including suggestions for reducing the burden to Washington Headquarters Services, Directorate for Information Operations and Reports, 1215 Jefferson Davis Highway, Suite 1204, Arlington, VA 22202-4302 and to the Office of Management and Budget, Paperwork Reduction Project (0704-0188), Washington, DC 20503

1. AGENCY USE ONLY (Leave blank)		2. REPORT DATE April 1996	3. REPORT TYPE AND DATES COVERED Final 9/30/92 to 1/31/96	
4. TITLE AND SUBTITLE OF REPORT Fundamental Studies on the Corrosion Behavior of Weldments in Marine Microbial Environments			5. FUNDING NUMBERS N00014-92-J-4116	
6. AUTHOR(S) R. A. Buchanan, C. D. Lundin, P. J. Angell, J. C. Danko, A. L. Kovacs and K. K. Kahn				
7. PERFORMING ORGANIZATION NAME(S) AND ADDRESS(ES) The University of Tennessee Dept. of Materials Science and Engineering Knoxville, TN 37996-2200			8. PERFORMING ORGANIZATION REPORT NUMBER:	
9. SPONSORING/MONITORING AGENCY NAME(S) AND ADDRESS(ES) Office of Naval Research 800 N. Quincy Street Arlington, VA 22217-5660 ATTN: Code 3310			10. SPONSORING/MONITORING AGENCY REPORT NUMBER:	
11. SUPPLEMENTARY NOTES:				
12a. DISTRIBUTION AVAILABILITY STATEMENT Unlimited			12b. DISTRIBUTION CODE	
13. ABSTRACT (Maximum 200 words) Weldments representative of a range of marine structural materials, in both creviced and non-creviced conditions, were exposed to a natural marine environment at a University of Delaware site on the Delaware Bay, Lewes, Delaware. Companion laboratory control tests were conducted at the University of Tennessee in 0.2 µm filtered Delaware Bay water and in synthetic seawater. The weldments studied were: 304L, 316L and AL-6XN stainless steels; HY-80 and HSLA-80 low-alloy steels; Alloy 400 Ni-Cu alloy; 90-10 Cu-Ni alloy; 5086 aluminum alloy; and unalloyed titanium. Open-circuit potentials (OCPs) and corrosion rates were evaluated for all tests. In the non-creviced condition, ennoblement of the OCP, relative to the laboratory control tests, occurred for all weldments. Clearly, a microbial effect at the Delaware Bay site was responsible for this ennoblement. For the creviced condition, in most cases, the OCPs in the natural microbial environment were less than those in the laboratory control environments -- a result likely due to the higher crevice-corrosion rates in the natural microbial environment. With regard to corrosion rates, the microbial influence resulted in significant corrosion acceleration for the 304L, 316L, Alloy 400, and 90-10 Cu-Ni weldments, and moderate acceleration for the low-alloy steel weldments, HY-80 and HSLA-80. On the other hand, the microbial influence resulted in corrosion inhibition for the aluminum alloy and titanium weldments. For the AL-6XN weldments, the microbial influence produced corrosion inhibition in the non-creviced condition, but corrosion acceleration in the creviced condition. A microbially influenced corrosion (MIC) factor was defined and used to quantify the corrosion results. Based on results of this study, a new, simple, abiotic laboratory screening test for MIC was proposed.				
14. SUBJECT TERMS Microbially influenced corrosion, weldments, marine corrosion			15. NUMBER OF PAGES: 84	
			16. PRICE CODE	
17. SECURITY CLASSIFICATION OF REPORT: Unclassified	18. SECURITY CLASSIFICATION OF THIS PAGE Unclassified	19. SECURITY CLASSIFICATION OF ABSTRACT Unclassified	20. LIMITATION OF ABSTRACT Unlimited	

Final Technical Report

on

**FUNDAMENTAL STUDIES ON THE CORROSION BEHAVIOR OF
WELDMENTS IN MARINE MICROBIAL ENVIRONMENTS**

by

R. A. Buchanan,* C. D. Lundin,* P. J. Angell,**
J. C. Danko, A. L. Kovacs,* and K. K. Khan*

* Department of Materials Science and Engineering

** Center for Environmental Biotechnology

The University of Tennessee

Knoxville, TN 37996-2200

under

Grant No. N00014-92-J-4116

for the

OFFICE OF NAVAL RESEARCH

800 North Quincy Street

Arlington, Virginia 22217-5000

Scientific Officer: Dr. A. John Sedriks

April, 1996

Table of Contents

	<u>Page</u>
Abstract	iv
Introduction	1
Background Information	2
Microorganisms and Their Relation to Corrosion	2
Microbially Influenced Corrosion of Weldments	3
Corrosion in the Marine Environment	4
MIC Studies Under Controlled Laboratory Conditions	7
Procedures	7
Overview	7
Crevice Immersion Testing	10
Electrochemical Testing	13
Results and Discussion	14
Crevice Immersion Testing	14
Electrochemical Testing	18
MIC Studies in a Natural Marine Microbial Environment	23
Procedures	23
Overview	23
Sample Preparation	28
Testing Apparatus	29
OCP Measurements and Polarization Resistance Tests	31
Microbiological Analysis and Surface Examination	32
Results and Discussion	33
OCP Measurements and Surface Examination	33
Platinum Electrodes	33
Stainless Alloys	33
HY-80 and HSLA-80 Steels	40
Alloy 400	40
90-10 Cu-Ni	43
Aluminum 5086	43
Titanium	46
Microbiological Analysis	48
Polarization Resistance Tests	52
Comparison of Weldments	53
Summary and Conclusions	61

Recommended Additional Research	64
Summary of Tasks and Objectives	64
Task I -- Collection of Missing Data and Replication of Critical Results	64
Task II -- Evaluation of Anodic Polarization Behaviors	65
Task III -- Development of an Abiotic Laboratory Screening Test for MIC	69
References	72
Distribution List	75

FUNDAMENTAL STUDIES ON THE CORROSION BEHAVIOR OF WELDMENTS IN MARINE MICROBIAL ENVIRONMENTS

R. A. Buchanan, C. D. Lundin, P. Angell, J. C. Danko, A. Kovacs, and K. K. Kahn

April, 1996

Abstract

This project started with efforts to achieve microbially influenced corrosion (MIC) under controlled laboratory conditions for prototype 304L/308L weldments. The attempts were not successful, in spite of the employment of different cultured marine microbial consortia, dilution rates, degrees of aeration, exposure times, and methods of analysis. Although localized corrosion occurred, results of the bacterial tests were basically indistinguishable from results of the control tests. It was concluded that the cultured marine bacterial consortia employed simply did not replicate all of the critical features of a natural marine consortium of microorganisms. Consequently, it was decided to alter significantly the project design.

In the altered project design, weldments representative of a range of marine structural materials were exposed to a natural marine environment which was known from previous studies to induce MIC. The natural environment was at a University of Delaware site on the Delaware Bay, Lewes, Delaware, with the kind cooperation of Dr. Stephen C. Dexter. Companion laboratory control tests were conducted at the University of Tennessee in 0.2 μ m filtered Delaware Bay water and in synthetic seawater. The natural and control tests were conducted with weldments in both creviced and non-creviced conditions. Open-circuit potentials (OCPs) and corrosion rates (polarization-resistance measurements and microscopic examinations) were evaluated for all tests. The weldments studied were: 304L, 316L and AL-6XN stainless steels; HY-80 and HSLA-80 low-alloy steels; Alloy 400 (Monel 400) Ni-Cu alloy; 90-10 Cu-Ni alloy; 5086 aluminum alloy; and unalloyed titanium. This altered project design proved to be very successful. Tentative results included the following. In the non-creviced condition, ennoblement of the OCP, to varying degrees, occurred for all weldments relative to the laboratory control tests. Clearly, a microbial effect at the Delaware Bay site was responsible for this ennoblement (higher OCP values). For the creviced condition, in most cases, ennoblement did not occur. Rather, the OCPs in the natural microbial environment were less than those in the laboratory control environments -- a result that can be rationalized in terms of higher crevice-corrosion initiation rates in the natural microbial environment. Of the weldments tested, those where corrosion was preferential to the weld-modified region included 304L, 316L, AL-6XN, Alloy 400, and 5086. Those weldments that did not experience preferential attack of weld-modified regions included HY-80, HSLA-80, 90-10 Cu-Ni, and titanium. On comparison of corrosion rates in the natural Delaware Bay water with those in the laboratory control tests, it was determined that the microbial influence was one of significant corrosion acceleration for the 304L, 316L, Alloy 400, and 90-10 Cu-Ni weldments, with Alloy 400 experiencing the greatest degree of acceleration. Corrosion acceleration also occurred for the low-alloy steel weldments, HY-80 and HSLA-80, but to a

lesser extent. On the other hand, the microbial influence resulted in corrosion inhibition for the aluminum alloy, 5086, and titanium weldments. For the AL-6XN weldment, the microbial influence produced corrosion inhibition in the non-creviced condition, but corrosion acceleration in the creviced condition.

With respect to recommended additional research, the activities are organized into the following three sets of tasks and objectives: (1) collection of data to fill "missing gaps" and to provide replication of critical results in the present study, (2) evaluation of anodic polarization behaviors of weldments to provide the necessary link between the observed increased, or decreased, corrosion rates in the natural biotic environment (relative to the control values) and the observed microbial ennoblement of open-circuit potentials in the natural biotic environment, and (3) based on the information and insights gained in the present study, development of an abiotic laboratory screening test for microbially influenced corrosion. The results of these efforts will provide closure to the project, in that: (1) mechanistic interrelationships of significant parameters will be established for MIC of weldments in a marine environment, (2) a definitive and quantitative ranking of MIC resistances will be produced, and (3) a practical laboratory screening test for MIC will be developed.

FUNDAMENTAL STUDIES ON THE CORROSION BEHAVIOR OF WELDMENTS IN MARINE MICROBIAL ENVIRONMENTS*

R. A. Buchanan, C. D. Lundin, P. Angell, A. Kovacs, and K. K. Kahn

April, 1996

Introduction

Corrosion is a serious concern in marine environments. With the extensive use of welds in marine service, having an understanding of the corrosion behavior of weldments is of the utmost importance to the performance of ships, offshore structures, and support systems. Within the past few decades, microorganisms have received increasing amounts of attention over the possible effects that they can have on the corrosion behavior of metals and alloys. As microorganisms are present in all naturally occurring water environments, this effect, which has been termed microbially (or microbiologically) influenced corrosion (MIC), is a serious concern in both freshwater and marine systems. There are numerous case studies on the subject, covering a wide range of materials that includes iron, steels, stainless steels, nickel alloys, aluminum and its alloys, and copper and its alloys. Several comprehensive reviews exist as well (1,2) containing information about the basic characteristics of microorganisms, possible mechanisms whereby these microorganisms could have an effect on the corrosion behavior of metals and alloys, and measures to delay or prevent associated attack.

One common observation from the literature is that when welds are present in association with MIC, weld areas often show the greatest susceptibility to attack. There is much information available on this phenomenon in a general sense in the form of case studies, but very little specific to marine conditions. Since the seas are veritable broths of microbial activity, and considering that welds are used extensively in marine service, it is desirable to gain a better understanding of the microbial factor in the corrosion of weldments used in marine service. There are numerous questions that arise in consideration of this problem, including the following:

- What specific microorganisms attach/colonize and play a part in the corrosion mechanisms of weldments commonly used in marine service?
- How do microorganisms affect the overall corrosion behavior of particular weldments?
- Which areas, if any, are more susceptible to MIC, or show greater attack?
- What factors contribute to improved or decreased susceptibility to MIC for weldments of interest?

* Portions of this report were adapted from the M. S. thesis "Fundamental Studies on the Corrosion Behavior of Weldments in Marine Microbial Environments" by Annette L. Kovacs, The University of Tennessee, Knoxville, June, 1995.

- In terms of resistance to MIC, how do weldments used in marine service compare to each other?

The list of questions continues, illustrating the broad nature of this problem. A literature review was conducted to find relevant information on the fundamentals of MIC, weldments, and marine corrosion. This information, which is briefly discussed in the following sections, proved very helpful when considering how to approach testing of weldments in order to assess their susceptibility to MIC. The majority of the work in the initial stages was aimed at developing a set of controlled conditions and microorganisms capable of causing MIC in the laboratory. Although much was learned about the difficulties of this endeavor, this approach did not give the desired results. Reevaluation of the project and its goals led to a new direction for testing. It was decided to expose a range of weldments to a natural marine microbial environment. Similar tests conducted in the laboratory, but under quasi-sterile control conditions, would allow comparison of the corrosion behavior of weldments, with and without the presence of microbial activity. This method of testing proved very useful in gaining information about the corrosion behavior of weldments and holds promise for further testing.

Background Information

Microorganisms and Their Relation to Corrosion

When metal surfaces are present in a water environment, they often serve as a source of nutrients in often nutrient-scarce surrounding waters. Therefore, these surfaces present a favorable site for colonization of microorganisms, eventually leading to the formation of a biofilm. This process can begin in a matter of hours, and involves certain steps common to all biofilm formation (3). First comes adsorption of a conditioning film. Organisms are not directly involved in this step, but naturally occurring layers of polymers are deposited on the metal surface from the surrounding waters. After this conditioning film has formed, pioneer species of microorganisms attach and colonize within a matter of hours. Once established, these microorganisms produce extracellular polymers, and in a matter of days, other microorganisms attach and colonize. Afterwards, the biofilm enters a state of constant change and development, as it collects particles, debris, corrosion products, and other microorganisms. Old inhabitants die, new ones take their place. The biofilm community often functions synergistically, with one type of organism having a direct bearing on the well-being of another type of organism.

Many factors are involved in the formation of a biofilm, including water chemistry, temperature, pressure, shear stress, metal surface composition, and various mechanical factors including surface roughness, orientation, and geometry. Once established, the biofilm has the possibility of affecting the corrosion rates of the material with which it is in contact. The most frequently cited effects in terms of corrosion include: (1) the production of corrosive metabolites, (2) the formation of colonies that can cause metal ion and/or oxygen concentration cells, (3) the influence of anodic and/or cathodic reaction rates, (4) the disruption of films protecting the material, and (5) the breakdown of natural corrosion inhibitors and coatings (3).

The biofilm community is diverse in nature, serving as a home to a variety of organisms. Certain microorganisms have repeatedly been cited in conjunction with MIC. These include fungi, algae, and bacteria (1). Fungi (ex. mold) are important because they can form large masses that trap other materials as well as produce organic acids. Algae can also form large masses. Because algae are photosynthetic, they can lead to oxygen concentration cells. Indirectly, but very importantly, they are major suppliers of food for bacteria and fungi. Like fungi, some algae are able to produce organic acids (1).

Bacteria have received the most attention with regard to MIC. They are a widely diverse group, able to function over a wide range of pH and temperature. They are small, often grow in colonies, and can produce enormous numbers in a short time. If conditions are favorable, one bacterium can turn into one million bacteria within the space of about seven hours (4). Bacteria can be obligate anaerobes (function only in the absence of oxygen), microaerophiles (use oxygen, but prefer minute levels), facultative anaerobes (function both with or without oxygen), or aerobes (require oxygen to function) (5).

Certain types of bacteria have repeatedly been cited in conjunction with MIC. The most often documented occurrence is that of sulfate reducing bacteria (SRB) on iron. SRB are sessile in nature, thriving in colonies attached to the surface. They are anaerobes, but can live in seemingly oxygenated conditions, as long as they are provided the anaerobic microenvironments they need (found underneath the biofilm). SRB can reduce sulfate to sulfide, which reacts with hydrogen to form hydrogen sulfide (5), giving the characteristic "rotten egg" odor often associated with their presence. If iron is present, the sulfide can take the form of ferrous sulfide. Many SRB are able to produce hydrogenase, an enzyme that catalyses the oxidation of cathodic H_2 (2).

Another group often associated with MIC are the sulfur oxidizing bacteria. These bacteria are aerobic and are able to oxidize sulfide to sulfur and sulfate. A well-known species, *Thiobacillus*, can oxidize sulfur to sulfuric acid (H_2SO_4) and amounts up to 10% have been found in conjunction with this bacteria (6).

Iron/Manganese bacteria represent yet another group, and include *Gallionella*, *Sphaerotilus*, *Crenothrix*, and *Leptothrix*. These bacteria can oxidize iron and manganese ions to obtain energy. They leave deposits, which can create oxygen concentration cells. The metal ions they leave behind attract an accumulation of chloride ions, creating an acidic chloride environment. Another group of bacteria linked to corrosion of stainless steels are the aerobic slime formers, such as Pseudomonads. Details of their effect on stainless steels are not fully understood, but it is known that they can deplete the area of oxygen and shelter SRB. Also included in the list of bacteria are the methane producers and organic acid producers (5).

Microbially Influenced Corrosion of Weldments

As stated earlier, biofilm formation is dependent on many factors. Surface roughness has been shown to be an important factor in initial biofilm formation, with increased roughness leading to increased colonization (2,3,7). This may play an important role in the disproportionate number of case studies involving MIC of weldments. One of the most commonly cited MIC failures has been that of stainless steels pipes, with prevalent attack of the weld metal, fusion zone, and heat affected zone (8-12).

Welding is a severe process for a metal to undergo, and it alters many characteristics of the surrounding metal, providing unique environments for microbial colonization. Welding

serves to increase surface area, providing a roughened surface, which as stated earlier, can have an effect on the degree of biofilm colonization. Solute distribution is changed as well, as the molten metal of the weld does not solidify homogeneously. Dendrites and interdendritic regions can have dramatically different compositions. Residual stress exists in and around the weld region. Other changes incurred from the welding process include phase boundaries, grain size effects, localized melting, and the number and distribution of precipitates and inclusions (7, 12).

When stainless alloys are welded, an oxide, called a heat tint, can form on the surface. The heat tint region has great bearing on the corrosion resistance of the weldment, as the discontinuous oxide leaves a chromium-depleted material underneath. The susceptibility of various regions of weldments to MIC, including the weld metal, fusion line, heat affected zone, and base metal, has been the subject of various studies. What has been found is that generally regions in or near the fusion zone are most susceptible (7). It has also been shown that surface condition has a pronounced effect on microbial attack, with increased attack in weldments left in an as-welded condition (13).

Corrosion in the Marine Environment

Corrosion is a crucial concern in the performance of ships, offshore structures, and support equipment used in the marine service. As in fresh water, the potential for MIC is ever-present. But seawater presents additional problems not encountered in freshwater systems. These are briefly discussed in the following paragraphs.

It is well accepted that natural seawater is more corrosive than either artificial or filtered seawater. This has been accredited to the full range of organisms that reside in the oceans. In addition to biological activity, some of the factors affecting the corrosivity of seawater are oxygen content, temperature, velocity, salinity, and pH (3). Salinity, which is the most commonly measured property of seawater, is given in parts per thousand (ppt). It is defined as the total weight in grams of inorganic salts in one kilogram of seawater, when all bromides and iodides are replaced by an equal amount of chlorides and all carbonates are replaced by equivalent quantities of oxides (14). The main effects of salinity on corrosion deal with the destructive effects that chlorides can have on the breakdown of oxide films responsible for passivity and corrosion resistance. The higher the salinity, the more readily chloride ions can penetrate passive films (15). Seawater can be up to 250 times as conductive as fresh water. This plays a dangerous role in localized corrosion, as it lets large cathodic areas participate in supporting small anodic pit areas in localized corrosion.

Many of the factors affecting the corrosivity of seawater, such as temperature, oxygen content, salinity, and biological activity, interact with each other, and cannot be discussed independently. There is a delicate balance that exists among these variables; no simple relationship exists among them. If all factors were held constant, corrosivity would increase with increasing temperature. However, oxygen concentration, which generally has a greater effect on seawater corrosion than temperature, varies with temperature and salinity, increasing as salinity and temperature decrease. Microorganisms play an integral part in this balance. During growth periods (which occur in the summer months when temperatures increase) photosynthesis can produce oxygen concentration as high as 200% saturation for periods up to a few weeks (14) (these periods are called 'blooms'). During decomposition of organisms, oxygen is consumed and CO₂ is produced. Since the most important cathodic reaction in

seawater is oxygen reduction, this oxygen production is one direct and important way that corrosion can be influenced by microorganisms.

The pH of seawater is also directly affected by the actions of microorganisms, as it is lower in areas where oxygen is consumed, higher in areas of photosynthesis where oxygen is produced. The effect that the amount of oxygen has on the corrosion of metals cannot be singly defined, as it varies from metal to metal. But this shows that corrosion behavior for metal at the water surface, where oxygen content is relatively high, can be completely different from the corrosion behavior for that metal in the bottom layers, where conditions are highly oxygen depleted due to organism decay.

When exposed to seawater, metals quickly develop biofilms, which are noted as being quite thick when compared to freshwater biofilms (3). As described earlier, these biofilms can have a variety of effects. SRB are extremely important in marine MIC, and they thrive in anaerobic conditions such as under the often massive corrosion products that form on iron in seawater. The deposits commonly associated with microorganisms can cause crevices and lead to concentration cells. These concentration cells can be of the metal-ion type or of the oxygen type. In the former, metal ions can accumulate within a crevice, and inner surfaces become cathodic to surfaces just outside the crevice, which suffer accelerated attack. Oxygen concentration cells behave in the opposite manner. They can lead to crevice corrosion of metals and alloys that depend on a healthy oxide film for their resistance to corrosion, such as the stainless steels (15).

When a crevice is present, oxygen becomes depleted in the area of the crevice. Oxygen reduction no longer takes place in the crevice, but dissolution of the metal in the crevice continues. This dissolution, which causes a net positive charge, attracts negatively charged chloride ions into the crevice, thus increasing the concentration of metal chlorides which typically dissociate into insoluble hydroxides and free acids. As metal dissolution in the crevice increases, so does the rate of oxygen reduction in areas outside the crevice, and attack is localized within the obstructed areas. Crevice corrosion has been termed an autocatalytic process. That is, the corrosion process within a crevice produces conditions necessary for continuation of the crevice corrosion process. A related autocatalytic process is that of pitting, which has frequently been cited in conjunction with biological deposits on stainless steels. The mechanism is like that for crevice corrosion, where dissolution takes place within the pit, and oxygen reduction takes place on areas outside the pit. Pitting is an extremely dangerous version of localized corrosion; the extent of attack is often difficult to detect, as there may be severe subsurface damage, not expected from surface appearances (16).

Pollution is another factor that has a bearing on the corrosivity of seawater. The amount of pollution (of seawater) has come to mean the amount of sulfides that waters contain. It is directly affected by the action of microorganisms, as the majority of sulfides results from the decay of organisms. It is well documented that these sulfides, which occur to greater extents in harbors and estuaries, have a powerfully detrimental effect on the corrosion of copper and its alloys (1,2,13,14,17).

There has been a large amount of work directed towards the study of passivating metals in the presence of a marine biofilm. Natural seawater shows its more corrosive nature as compared to filtered or artificial seawater when observing passivating metals, such as the stainless alloys, which often show greater corrosion in the natural environment. Some occurrences of effects in natural seawater as compared to either artificial seawater or filtered

seawater are: (1) decreased initiation time for localized corrosion of stainless steels (18), and (2) increased propagation rates for crevice corrosion of stainless steels (19).

For metals that remain in their passive state, there has been a documented effect of an increase in the open-circuit potentials. This increase, referred to as ennoblement, has been documented for stainless alloys, titanium, and platinum. Much work has been performed in this area, some of which is summarized below:

- Ennoblement in the presence of marine biofilms has been observed by many investigators (20-24).
- Ennoblement has not been observed in all cases of exposure to marine biofilms. In one study by Little et al. (1), coupons which had a metal/biofilm surface that was anaerobic did not show ennoblement, and (2) coupons which had a metal/biofilm surface that was aerobic, with photosynthetic activity and light, did show ennoblement. This suggests that light and photosynthetic activity are necessary for ennoblement (25).
- Conversely, in a study by Dexter and Zhang (26), samples with biofilms that had developed in a darkened room showed ennoblement, while samples with biofilms that had developed in a natural cycling of light and dark did not show ennoblement. It was proposed that if photosynthetic algae are present as a significant portion of the biofilm, ennoblement is less likely to occur.
- Scotto showed that with the addition of sodium azide, a microbial respiration suppresser, ennobled potentials took a nose-dive, leveling off to control values. This indicated that the mere presence of a biofilm is not enough to cause ennoblement, but rather, active metabolism is required (23).
- Mollica and Trevis showed that the onset of ennoblement decreased by increasing the flow speed of water past the metal surfaces, which slows formation of a microbial film (27).
- Mollica, et al. showed that by raising the temperature to 40°C, ennoblement was prevented (28).
- Work by Chandrasekaran and Dexter proposes the necessity of a bacterial consortium, rather than a monoculture, for ennoblement to occur (29).

Although many theories for this phenomenon exist, a well-accepted explanation is not yet available.

MIC Studies Under Controlled Laboratory Conditions

Procedures

Overview

The initial stages of this overall project concentrated on developing a set of laboratory testing conditions sufficiently aggressive to initiate MIC on a prototype weldment of intermediate resistance. This set of conditions would in turn be used on a range of weldments in order to assess their susceptibility to MIC. Table 1 shows a list of weldments commonly found in marine service, and served as a tentative list of possible subjects for testing and study, following the development of a suitable set of laboratory testing conditions.

Initial attempts in the laboratory began with (1) deciding on the material parameters, such as the prototype weldment and its condition, and (2) designing a set of conditions (such as dilution rate, aeration, length of exposure, nutrient content, and microbial consortia) that would most likely initiate MIC on the chosen prototype. Due to its intermediate corrosion resistance and its well-documented involvement with MIC, 304L with 308L filler was chosen as the prototype weldment. It was decided to leave the test coupons in the as-welded condition, and intentionally impose a crevice, which lends itself to providing anaerobic microenvironments favored by some bacteria. The assembly used to create the creviced condition is shown in Figure 1. By placing equal torques on each of the four screws, weldments were held in place and creviced by two low-halide silicone rubber rods. Ideally, equal torques would cause uniform compression of the rods, and therefore create a uniform crevice between the rods and the coupon surfaces. By imparting a crevice in this manner, one can study the effects of a preexisting uniform crevice on the corrosion behavior of various regions of the weldment, including the weld metal, heat-affected zone, and base metal.

In the development of a microbial consortium, it was desired to incorporate microorganisms that had been documented in relation to MIC, such as SRB, algae, and Pseudomonads. Under the guidance of the UTK Center for Environmental Biotechnology (CEB), several consortia were selected for use. These are given in Table 2. The CEB also provided instructions and suggestions for dilution rate, nutrient levels, length of exposure, and aeration in hopes of finding a set of conditions that would reliably and repeatedly produce MIC in the laboratory. Testing followed the same basic format. Each set of tests lasted two weeks, involving a bacterial test cell and a control test cell. In all tests, coupons were exposed to a constant supply of fresh medium, which consisted of synthetic seawater, with or without nutrients, depending on the test. Dilution rate, nutrient levels, aeration, and microbial consortia were varied from test to test. Bacterial test cells were inoculated with the chosen consortium, flow was shut off to allow for biofilm establishment on the metal surface, and flow was restarted. Following the tests, open-circuit potentials were taken, and weldments from the bacterial and control tests were examined for signs of corrosion.

Table 1. Tentative list of weldments for evaluation.

Carbon and Low-Alloy Steels

1. HY-80
2. HY-100
3. HY-130
4. HSLA-80

Suitable consumables chosen, depending on the welding process used.

Austenitic Stainless Steels

1. AISI 304L
2. AISI 316L
3. AISI 347

Consumables - 308, 316, 347

Copper Alloys

1. Phosphor Bronze (CDA 534) - ERCuSn-A (Filler)
2. High Silicon Bronze A (CDA 655) - ERCuSi-A (Filler)
3. 90-10 Cu-Ni (CDA 706) - ERCuNi (Filler)
4. 80-20 Cu-Ni (CDA 710) - ERCuNi (Filler)
5. 70-30 Cu-Ni (CDA 715) - ERCuNi (Filler)
6. Cu-Ni-Zn (65-18) (CDA 752) - ERCuNi (Filler)

Aluminum Alloys

1. 5052 - 5556 (Filler)
2. 5083 - 5556 (Filler)
3. 5086 - 5556 (Filler)
4. 5456 - 5556 (Filler)
5. 6061 - 4043/5556 (Filler)

Titanium Alloys

1. Ti-6Al-4V (ELI) - ERTi-6Al-4V (b) (Filler)
2. Ti-6Al-2Nb-1Ta-0.8Mo - ERTi-6Al-2Nb-1Ta-1Mo (Filler)
3. Unalloyed Ti (35A-100) - ERTi-1 (b) (Filler)

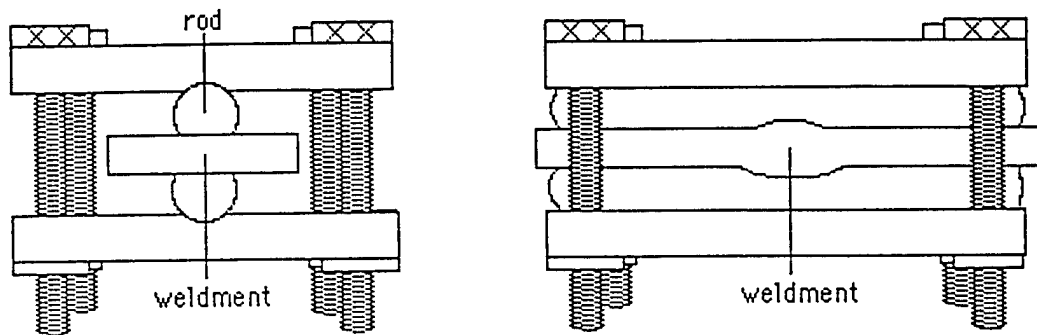

Figure 1. Assembly used to impart crevice on weldments.

Table 2. Microbial consortia selected for use.

Consortium A*	Consortium B	Consortium C**
<ul style="list-style-type: none"> - wild type - known to contain SRB 	<ul style="list-style-type: none"> - <i>Vibrio horveyi</i> - <i>Vibrio natriegens</i> - <i>Deleya marina</i> (wild type) - 2 unknowns 	<ul style="list-style-type: none"> - wild type - known to contain algae - known to contain SRB

* A natural consortium from Newport News, VA coastal region.

** A natural consortium kindly supplied by Dr. Stephen Dexter from the Lewes, DE coastal region.

After this set of immersion-type tests, the next batch of tests used electrochemical methods to monitor the activity in the test cells. Since the corrosive effect that microorganisms have on metal surfaces is electrochemical in nature, electrochemical methods can be used to monitor the changes occurring at the metal/biofilm interface. Plans included exposing the weldment to artificial seawater for a period of time in order to establish a stable potential. Consortia were then inoculated into the cell. After another period of time to allow the potential to restabilize, a potential corresponding to the original stabilized potential was applied while monitoring the current. A corresponding control cell was run in the same manner, but without the intermediate step of bacterial inoculation. Results of the tests were then compared to note any differences in current due to the bacterial effect. In order to establish breakdown potentials of the samples, anodic polarization tests also were run.

Crevice Immersion Testing

Austenitic stainless steel coupons were cut from full penetration welds on 12-inch diameter pipe sections of 304L base metal, 308L weld metal. Coupons measuring approximately 2.5 by 1.0 inch with the weld region centered on, and perpendicular to the length of the coupon, were mounted in the crevice assemblies, as shown in Figure 1-2, with a torque of 2 in-lb applied to each screw. Backing plates, screws, and nuts were also made of stainless steel. The silicone rods (GE RTV 664) were cast in molds, cut to fit the crevice assembly, and sterilized by boiling in distilled water for 30 minutes. Two of these crevice assemblies were placed in each 2-liter test cell, which was also fitted with flow inlets and outlets, filters, and in some cases, air spargers. Cells were sterilized at the UTK hospital with ethylene oxide gas.

The base medium used in the immersion tests consisted of artificial seawater, prepared under the guidelines of ASTM D 1141-90 for substitute ocean water (minus Solution III), with and without nutrient additions. Nutrients were always added to the seawater used in the bacterial cells, but not always added to the seawater used in the control cells. The nutrients consisted of yeast extract, sodium lactate and ascorbic acid. The resulting base medium, along with tubing to connect the test cells with the base medium supply, was sterilized by steam autoclaving.

The sterile base medium was pumped into the test cells. Bacterial solution, which had been incubated for 1-2 days in 10 ml of sterile solution plus nutrients, was injected into the bacterial cell and allowed to grow under no-flow conditions for 2 days. It was anticipated that within this time, a biofilm would be established, providing the SRB with a deaerated niche before flow and aeration began. The control cell also remained under no-flow conditions for 2 days. Following this period, flow was restarted and a constant supply of sterile base medium was supplied to each cell at a predetermined dilution rate.

Experimental parameters varied from run-to-run in attempts to find that set of conditions that unequivocally initiated MIC on the bacterial test samples. The various runs involved individual and combinations of bacterial consortia. Dilution rate, which is defined as the rate at which the base medium is supplied to each cell, divided by the working solution volume in the cell, was another factor taken into consideration with regard to microbial activity. If the dilution rate is too low, insufficient nutrients are supplied to support biofilm growth on the specimen surface, i.e., the biofilm starves. If the dilution rate is too high, planktonic bacteria in the solution are unduly washed out of the cell, and the resulting biofilm attachment is minimal.

Another consideration involved aeration of the cell electrolyte. Initially, cells were directly exposed to air through 0.2 μm filters; the purpose of these filters was to filter out air-borne bacteria, thus minimizing chances of contamination. Therefore, the cells were naturally aerated. Later, natural aeration was enhanced by directly and continuously sparging the cells with air. A total of 6 runs was conducted in this initial stage of testing; experimental parameters are summarized in the following paragraphs and in Table 3.

Run 1 employed consortium A (Table 2) for the bacterial cells. Dilution rate was set at 10 vol. %/hour and air was not sparged into the cells. Medium for the bacterial cell consisted of seawater plus nutrients: 1 g/L yeast extract, 0.1 g/L ascorbic acid, and 0.5 mL/L sodium lactate. Medium for the control cell consisted of seawater only, with no added nutrients, in order to minimize chances of contamination from air-borne bacteria.

Run 2 had two bacterial test cells. One of them employed consortium B (Table 1-1) only. The other test cell employed a combination of consortia A and B. Dilution rate was set at 10 vol. %/hour and air was not sparged into the cells. Medium for bacterial cells and control cells was the same as in Run 1.

Run 3 used a combination of consortia A and B for the bacterial cells. Dilution rate was set at 10 vol. %/hour for one of the bacterial cells and 30 vol. %/hour for the other bacterial cell. Air was sparged into the cells to enhance the development of oxygen-concentration cells. Media for the bacterial cells and control cells were the same, differing slightly from the first two runs. The yeast content was reduced ten-fold; the other nutrient amounts remained the same.

Run 4 employed consortium C (Table 2) for the bacterial cell. Dilution rate was set at 30 vol. %/hour. Air was sparged into the cells. Media for the bacterial cell and control cell were the same as in Run 3.

Run 5 employed consortium C for the bacterial cell. Dilution rate was set at 10 vol. %/hour. Air was sparged into the cells. Media for the bacterial cell and control cell were the same as in Runs 3 and 4.

Run 6 employed consortium C for the bacterial cell. Dilution rate was set at 10 vol. %/hour. Air was sparged into the cells. The base medium for the cells was the same as in Runs 3, 4, and 5, except that 0.5 mL/L biocide (Kathon 886 MW, Rohm and Haas) was added to the control cell to reduce the probability of contamination from air-borne bacteria.

Tests were stopped two weeks after starting the constant flow through the cells. The cells were opened, open-circuit potentials of weldment coupons and bright platinum electrodes were measured in the control and bacterial solutions. The crevice assemblies were dismantled and the coupons were photographed, cleaned in a dilute nitric acid solution, and examined for signs of corrosion. Control and bacterial coupons from Run 4 were examined with scanning electron microscopy and energy dispersive spectroscopy (EDS). Following Run 6, laboratory methods turned more towards electrochemical testing in order to monitor cell activity.

Table 3. Summary of procedures for laboratory MIC tests.

Cell (No. of samples)	Medium	Bacteria 1 Consortium	Dilution Rate (vol. % per hour)	Air Sparg ing
RUN 1				
Control (2)	ASTM seawater	--	10	NO
Bacterial (2)	ASTM seawater + nutrients	A	10	NO
RUN 2				
Control (4)	ASTM seawater	--	10	NO
Bacterial (2)	ASTM seawater + nutrients	B	10	NO
Bacterial (2)	ASTM seawater + nutrients	A+B	10	NO
RUN 3				
Control (2)	ASTM seawater + nutrients	--	30	YES
Bacterial (2)	ASTM seawater + nutrients	A+B	30	YES
Bacterial (2)	ASTM seawater + nutrients	A+B	10	YES
RUN 4				
Control (2)	ASTM seawater + nutrients	--	30	YES
Bacterial (2)	ASTM seawater + nutrients	C	30	YES
RUN 5				
Control (2)	ASTM seawater + nutrients	--	10	YES
Bacterial (2)	ASTM seawater + nutrients	C	10	YES
RUN 6				
Control (2)	ASTM seawater + nutrients + biocide	--	10	YES
Bacterial (2)	ASTM seawater + nutrients	C	10	YES

Electrochemical Testing

Brass screws were soldered to the outer diameter (OD) surfaces of coupons of the prototype weldment. The sides of the coupon and the OD surface were painted with Amercoat epoxy (Ameron Co.) and allowed to dry. Samples were fitted with small O-rings and screwed into electrode holders, which were placed into 2-liter cells along with a platinum electrode to act as the counter electrode. Cells were also fitted with a reference electrode holder, flow inlets and outlets, and an air sparger. The cells were sealed, and sterilized with ethylene oxide gas. The medium used in the tests was ASTM synthetic seawater plus nutrients, sterilized by steam autoclaving.

For the first test, medium was pumped into the cells, and E_{corr} was allowed to stabilize for approximately two days, after which incubated bacteria were injected into the cell. After waiting two days, in order to let the potential reestablish, a series of potentials was potentiostatically applied to the sample while monitoring the current. A potential of +91 mV vs. SHE (-150 mV vs. SCE) which corresponded to the potential without bacteria, was applied for two days. A second potential of +241 mV vs. SHE (0 mV vs. SCE) which corresponded to average values in the literature of ennobled stainless steel was applied for twelve hours, after which the test was stopped. The same-type test was run with a control sample, but without the intermediate potential step.

In order to establish pitting potentials for the weldment, anodic polarization tests were run in the bacterial and control media. The procedure for the test cell preparation was the same as for the previously described applied potential tests. After the medium was pumped into the cell, a period of approximately two days was allowed for initial stabilization of potential. When bacteria were involved, another period of approximately two days was allowed for potential re-establishment, after which the anodic polarization tests were conducted.

In final attempts to initiate MIC in the laboratory, experimental parameters were drastically altered. It was suggested by the CEB to use a dilution rate of 100 vol. %/hour in order to better the chances of feeding the biofilm, rather than the abundant planktonic bacteria that did not get flushed quickly enough using the lower dilution rates. Another change involved the addition of silica standard (1 mL/L) to the medium, along with daily cycling of ultraviolet lighting. Both of these measures were taken in hopes of promoting algal growth. In this run, both creviced and non-creviced coupons were tested, with cell conditions summarized in Table 4. For the creviced coupons, plastic coated electrical leads were soldered onto one side. The electrical leads were coated with Amercoat and allowed to dry. Cells for both creviced and non-creviced coupons were prepared as those previously discussed.

One coupon from Cell 5 was submitted to the CEB for microbiological analysis. Anodic polarization tests were run on coupons from Cells 1, 2, and 3. After exposing coupons from Cells 4 and 5 for the period of time specified in Table 4, coupons were prepared so that biofilm establishment could be examined with the SEM. Preparation involved placing the coupons in 3% glutaraldehyde in 0.1M phosphate buffer solution for at least one hour. Biofilms/coupons were then dehydrated in a graded series of acetone rinses (25, 50, 75, 95, and 100%) for at least 15 minutes per dilution. Samples were critical-point dried in liquid carbon dioxide and examined with the SEM.

Table 4. Summary of Cell Conditions.

Cell Number	Condition	Dilution Rate	Comments
1	Creviced	10	Anodic polarization was performed following 2-week exposure.
2	Non-creviced	10	Anodic polarization was performed following 2-week exposure.
3	Creviced	100	Anodic polarization was performed following 2-week exposure.
4	Creviced	100	Test stopped at 5 days for SEM examination.
5	Creviced	100	2 samples. 1 used for SEM examination after 2-week exposure. 1 used for microbiological analysis.

Results and Discussion

Creviced Immersion Testing

As described previously, the immersion tests used a variety of conditions, changing such variables as dilution rate, aeration, nutrient content, and bacterial consortium. Results of the individual runs are described separately in the paragraphs to follow, and summarized in Table 5.

Run 1 used Consortium A. Bacterial-cell coupons showed definite biofilm formation, but visual and microscopic examination failed to reveal any evidence of pitting or crevice corrosion. SRB were present in the original consortium and from the strong 'rotten egg' odor characteristic of SRB, there was definite microbial activity occurring in the bacterial cell. But the lack of desired corrosion confirmed that just because there are SRB producing sulfide does not mean that corrosion is occurring. Although the bacterial cells did not show corrosion, the control cell coupons did, with pitting occurring within the heat tint, in areas of the intentional crevice. Corrosion potentials were approximately -280 mV (SHE) for the bacterial cell coupons and ranged from +80 to +112 (SHE) for the control-cell coupons. The low potentials of the stainless steels in the bacterial cell indicate a large degree of deaeration. Run 1 did not give the desired results, and it was decided that the next run would include two bacterial cells, one using Consortium B, and one using a combination of A and B.

Run 2 employed both Consortium A and Consortium B. Again, there was a distinct rotten egg odor, indicative of SRB activity. The coupons exposed to consortium B alone showed no visible biofilm formation, but those exposed to a combination of A and B did show biofilm formation. Examination revealed no signs of pitting or crevice corrosion on any of the coupons exposed to the bacterial solutions. Once again, however, pitting did occur in the control coupons, located in the heat tint region in areas of the intentional crevice. Corrosion potentials were again low for the bacterial cell coupons, indicating that deaeration occurred in these test cells as well.

In Run 3, several of the variables were changed. Dilution rates of 10 % per hour and 30 % per hour were used with a combination of bacterial consortium A and B. In addition, nutrients were added to the medium for the control cells, thereby making bacterial and control cell media identical in composition. Another change involved aeration; in this run, all cells

were sparged with air. The presence of dissolved oxygen in the solution is a necessity for development of oxygen-concentration cells. Cells develop by having oxygen available away from the crevice site for the cathodic reaction which in turn can support a high anodic reaction rate at the crevice site. The development of oxygen-concentration cells is thought to be of major importance in the MIC mechanism, and sparging with air seemed logical in bettering the chances for these concentration cells to occur.

In Run 3, once again, there was definite SRB activity, noted by the strong sulfide odor present in the waste fluid from the bacterial cells. Examination of the coupons revealed a few small pits at HAZ crevice locations, with the 10% dilution rate appearing to work best. With the addition of nutrients to the control cell as well as the bacterial cell, there was no longer corrosion apparent in the control coupons. However, the nutrients promoted contamination which occurred readily in the control cells. Corrosion potential readings were very low for the bacterial cell coupons, indicating that even though the solution was sparged with air, the solution/metal interface was still deaerated. There was a major difference in the corrosion potentials for the control coupons in comparison to the control coupons for the runs where no nutrients were included, approximately a 200 mV difference in the negative direction with the addition of nutrients.

Run 4 employed a different bacterial consortium than had been used previously. Consortium C was used in conjunction with a 30% dilution rate. The cells were sparged with air. This consortium proved to be very active, with a thick biofilm forming in the first few days of exposure. Within two days of starting the flow, the bacteria started to back up into the inflow tubing and the carboy that contained the sterile base-medium supply (which then became contaminated). On replacing the supply with new, sterile medium, the same thing happened. The control cells became contaminated with air-borne bacteria within the first three days of testing. It was unknown if there was any SRB activity in the bacterial cell -- no sulfide smell was detected.

Run 4 marked the first use of consortium C. This consortium, supplied by Dr. Stephen Dexter of the University of Delaware, was a naturally occurring wild-type consortium, derived from scrapings of metal samples that had undergone exposure to the Delaware Bay. There was a distinct advantage in using this consortium. Documented results already existed on the effect that this microorganism community could have on various metals. The ennoblement effect, discussed earlier, had been documented with this consortium for platinum and stainless steel samples. These naturally occurring results provided a basis for comparison with laboratory work using the same consortium.

Following Run 4, examination revealed small pits at the heat affected zone and fusion line crevice locations on one of the bacterial coupons. The pits were examined by SEM and EDS analysis. SEM results revealed nothing conclusive; appearance of the bacterial sample strongly resembled that of the control sample. EDS was performed inside and outside the pit on the bacterial sample, revealing increased chloride and chromium concentration, and decreased iron concentration, inside the pit. This was thought to be encouraging, since these trends are often found in association with MIC. However, upon EDS analysis of the control coupon in areas of apparent corrosion, the same trends were discovered. The control cell coupons underwent general corrosion at fusion zone crevice locations. Corrosion potentials were in the range of -265 to -282 (SHE) for the bacterial cell coupons.

Run 5 gave what appeared to be promising results. Consortium C was used again, but with a 10% dilution rate. The cells were sparged with air. Within the first two days of

testing, a heavy biofilm formed on the coupons in the bacterial cell. There was black corrosion product underneath the biofilm at the metal surface, and a slight sulfide smell was detected, indicating SRB activity. The control cell was contaminated with air-borne bacteria within the first 3 days of flow.

Examination of the bacterial cell coupons after testing revealed large pits at the heat affected zone crevice locations and general corrosion found at the fusion zone crevice locations. The control-cell coupons underwent corrosion, with general corrosion and pitting occurring at the fusion line crevice locations. Corrosion potential readings were low for both cells, around -275 mV for the bacterial cell coupons and in the range of -197 to -236 for the control cells coupons. The platinum potential was considerably lower in the bacterial solution.

Run 5 had given the most promising results up to this point in the project, and it was decided to duplicate the test, in hopes of achieving the same results. In order to avoid contamination of the control cells, a biocide was added to the control-cell medium. Other than the introduction of a biocide, all conditions were the same as in Run 5. There was biofilm formation on the bacterial cell coupons, with black corrosion products underneath the biofilm adjacent to the metal surface. There was a slight sulfide smell, indicating SRB activity. Examination of the bacterial cell coupons showed no signs of corrosion. However, there was one large pit on each of the control cell coupons. The pit on one of the coupons was located at the fusion line crevice location. The pit on the other coupon was located at the HAZ crevice location.

In reviewing the overall results obtained at this point, it was concluded that in the as-welded condition, as the coupons were tested in, the weld-modified surface regions were least resistant to crevice corrosion under the conditions of these experiments. Other results of this set of tests were inconclusive, as they varied from test to test, even under seemingly identical conditions.

Additional discouraging results came when microbiological analysis was performed on one of the exposed metal samples. When a sample was characterized by the CEB to determine what had grown in the laboratory as compared to what was supposed to grow, results differed. The laboratory sample showed no signs of algae or SRB both of which had been in the original sample. There was a large population of general bacteria, but the problem of contamination was also at hand. If control cells had consistently become contaminated with air-borne bacteria, then perhaps some of the population of general bacteria could be due to air-borne contamination as well.

Table 5. Summary of results for laboratory tests.

Cell (No. of samples)	Medium	Bacteria I Consortium	Dilution Rate (vol. % per hour)	Air Sparging	Platinum Potential (mV vs. SHE)	Corrosion Potential (mV vs. SHE)	Results
RUN 1							
Control (2)	ASTM seawater	--	10	NO	+41	1. +112 2. +80	Pits at HAZ crevice locations.
Bacterial (2)	ASTM seawater + nutrients	A	10	NO	-109	1. -280 2. -278	No apparent signs of corrosion.
RUN 2							
Control (4)	ASTM seawater	--	10	NO	--	1. +57 2. +98 3. +112 4. +115	Pits at HAZ crevice locations.
Bacterial (2)	ASTM seawater + nutrients	B	10	NO	-113	1. -249 2. -249	No apparent signs of corrosion.
Bacterial (2)	ASTM seawater + nutrients	A+B	10	NO	-136	1. -279 2. -289	No apparent signs of corrosion.
RUN 3							
Control (2)	ASTM seawater + nutrients	--	30	YES	--	1. -188 2. -76	Contaminated. No apparent signs of corrosion.
Bacterial (2)	ASTM seawater + nutrients	A+B	30	YES	--	1. -270 2. -242	No apparent signs of corrosion.
Bacterial (2)	ASTM seawater + nutrients	A+B	10	YES	--	1. -262 2. -268	Very small pits at HAZ crevice locations.
RUN 4							
Control (2)	ASTM seawater + nutrients	--	30	YES	+261	1. -9 2. -32	Contaminated. General corrosion at FZ crevice locations
Bacterial (2)	ASTM seawater + nutrients	C	30	YES	-114	1. -265 2. -282	Small pits at HAZ and FZ crevice locations.

Table 5 cont.

RUN 5							
Control (2)	ASTM seawater + nutrients	--	10	YES	+281	1. -236 2. -197	Contaminated. General corrosion and pitting at FZ crevice locations.
Bacterial (2)	ASTM seawater + nutrients	C	10	YES	-139	1. -272 2. -276	General corrosion at FZ crevice locations. Pits at HAZ crevice locations.
RUN 6							
Control (2)	ASTM seawater + nutrients + biocide	--	10	YES	+288	1. +103 2. +95	Large pits at HAZ and FZ crevice locations.
Bacterial (2)	ASTM seawater + nutrients	C	10	YES	-99	1. -253 2. -279	No apparent signs of corrosion.

The major difficulty up to this point was the inadequate differentiation between the control cell and bacterial cell results. There had been just as much or more corrosion in the so-called control cells as in the bacterial cells. It is thought that aeration could have been a major contributor. It is noted that both the corrosion potentials and platinum potentials were considerably higher in the control cells without added nutrients. This result suggests that the control cell solutions were sufficiently aerated, but that the bacterial cell solutions at the specimen surfaces were highly deaerated due to the metabolic actions of the bacterial consortia in the biofilms. Thus, oxygen concentration cells were available to drive the crevice corrosion in the control cells but not in the bacterial cells. For the bacterial cells, the lack of dissolved oxygen over the entire small-specimen surface (due to a nutrient-rich medium, a high concentration of bacteria, and a resulting uniform biofilm -- all intended to accelerate the MIC process) does not represent a normal, natural condition where large regions of a structure would contain little or no biofilm and would therefore constitute a large cathodic surface for oxygen reduction, thereby driving the corrosion under deaerated biofilm deposits. It was at this time that various electrochemical tests were performed in order to simulate the effect of a large cathodic surface.

Electrochemical Testing

As described in the procedure, two cells were used initially, a bacterial cell and a control cell. These studies were designed to replicate the situation whereby nonuniform biofilms are naturally produced on metal/alloy surfaces, creating differential aeration cells, as well as differences in electrolyte chemistry. The tests involved: (1) monitoring the corrosion potential of a non-creviced weldment in the air-sparged sterile base medium until a steady-state value was obtained, (2) inoculating the solution with bacterial consortium C while the corrosion potential continued to be monitored, (3) after the potential had decreased to a low steady-state value, representing biofilm formation and deaeration at the specimen surface, the potential of the specimen was potentiostatically increased to its initial value, and (4) while

under potentiostatic potential control, the external current was monitored -- initiation of localized corrosion would be implicated by a rise in original current values. Control experiments were conducted in the same manner.

It was hoped that on application of the original potential, in the presence of bacteria, a notable current increase would occur, and not occur in the control cells. By this rationale, one could say that a rise in current was due to the presence of bacteria. However, specific results from this test were rather inconclusive.

For the bacterial cells, a plot of potential vs. time is shown in Figure 2. As the graph indicates, initial values for the 304L weldment stabilized at approximately 100 mV SHE. On bacterial inoculation, values plummeted to about -200 mV SHE. When this inoculation period was over, a potential of +91 mV SHE (-150 mV SCE) was applied potentiostatically. As shown in Figure 3, there was no current increase. It was decided to apply a higher potential. If at this higher potential, current increased for the bacterial sample but did not for the control, one could still conclude that this current increase was due to the bacteria. A value of +241 mV SHE was chosen from literature pertaining to the ennoblement effect for stainless steels in natural marine environments. Upon applying this potential, the sample immediately began to pit. As shown in Figure 3, the current dramatically increased. The program used to monitor the current had a 'roof' of 25000 μ A, which was quickly reached in this test. A control sample was tested in the same manner, but without the intermediate potential step. It was hoped that the current increase incurred in the bacterial test cell, would not occur, or at least not to the same extent. Figure 4 shows initial OCP measurements for the control sample. As shown in Figure 5, upon applying the +241 mV SHE potential, current increased until the roof of the program was reached.

In order to avoid randomly trying potentials that would initiate a current increase in the bacterial cells but not in the control cells, anodic polarization tests were run for coupons in the bacterial cell and control cell in order to establish a breakdown potential. Then after having obtained a range of potentials to work with, the applied potential vs. current tests would be run with a better idea of ranges that might show a notable difference in current. However, as shown in Figure 6, anodic polarization tests showed that plots for bacterial and control samples were distinctly similar, with the only apparent difference being the initial potential values. These results suggest that beyond deaeration, indicated by the low E_{corr} value, the presence of the biofilm at the surface did not create conditions different from normal conditions. It has repeatedly been documented that biofilms can modify the environment at the biofilm/metal surface interface; however, this was not the case for these tests.

One final set of tests was run in attempts to initiate MIC in the laboratory. Several suggestions had been made, such as perhaps the brevity of the tests had not allowed sufficient biofilm growth to affect the environment at the biofilm/metal surface interface. Another suggestion was that by adding silica standard to the medium and daily cycling with an ultraviolet light, chances of obtaining algae would increase. It was also suggested to incorporate a much higher dilution rate, in order to flush planktonic bacteria out of the cell quicker, thereby providing more nutrients to the biofilm. As described earlier in Table 4, five cells were run in this test. Anodic polarization tests were run on creviced and non-creviced samples that had run for two weeks, both at 10% dilution rate. An anodic polarization test was also run on a creviced specimen that had run for two weeks, at 100% dilution rate.

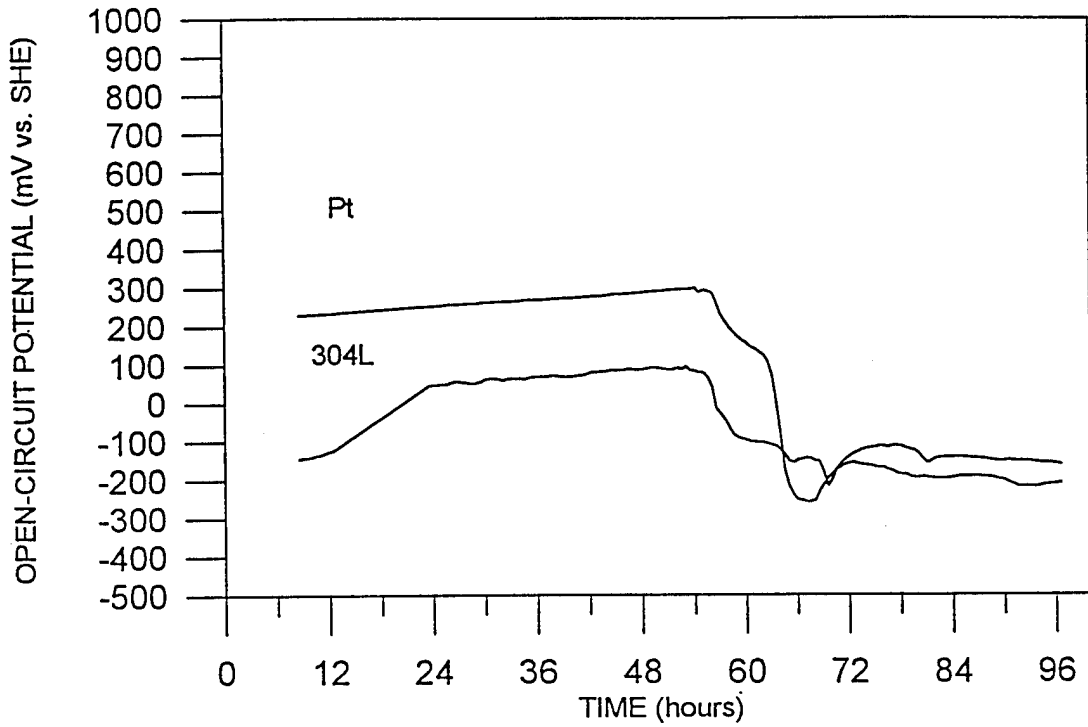

Figure 2. Open-circuit potential vs. time for the bacterial cell.

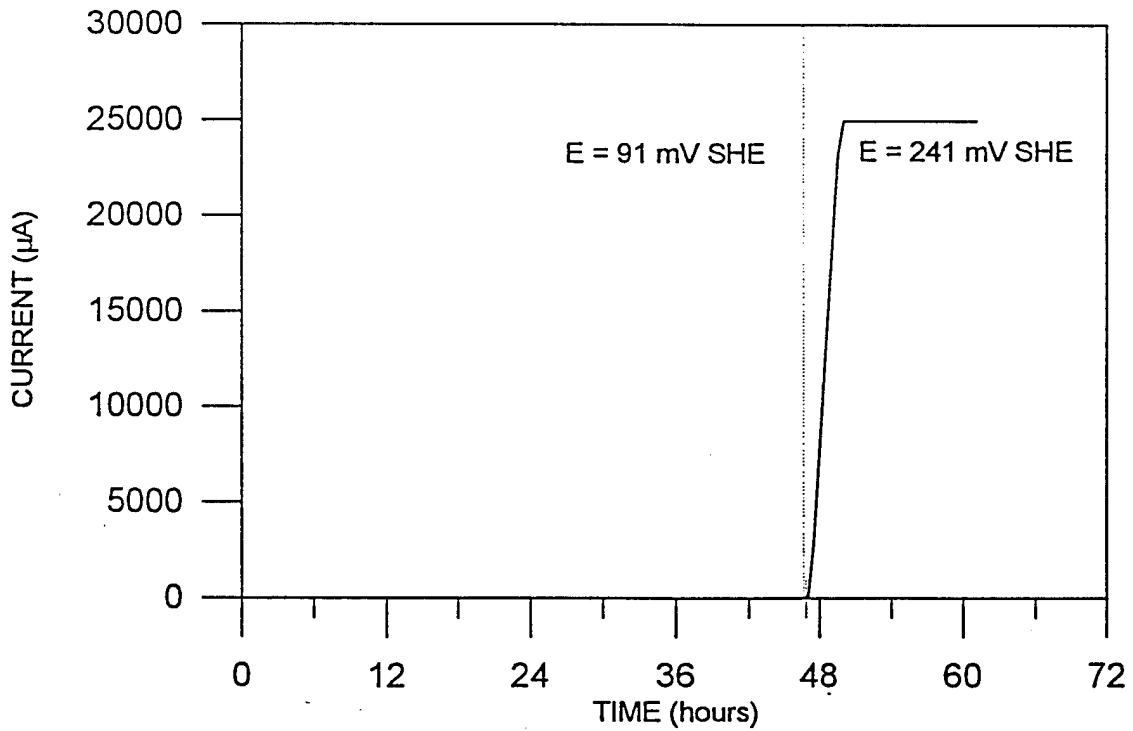

Figure 3. Current vs. time for the bacterial cell.

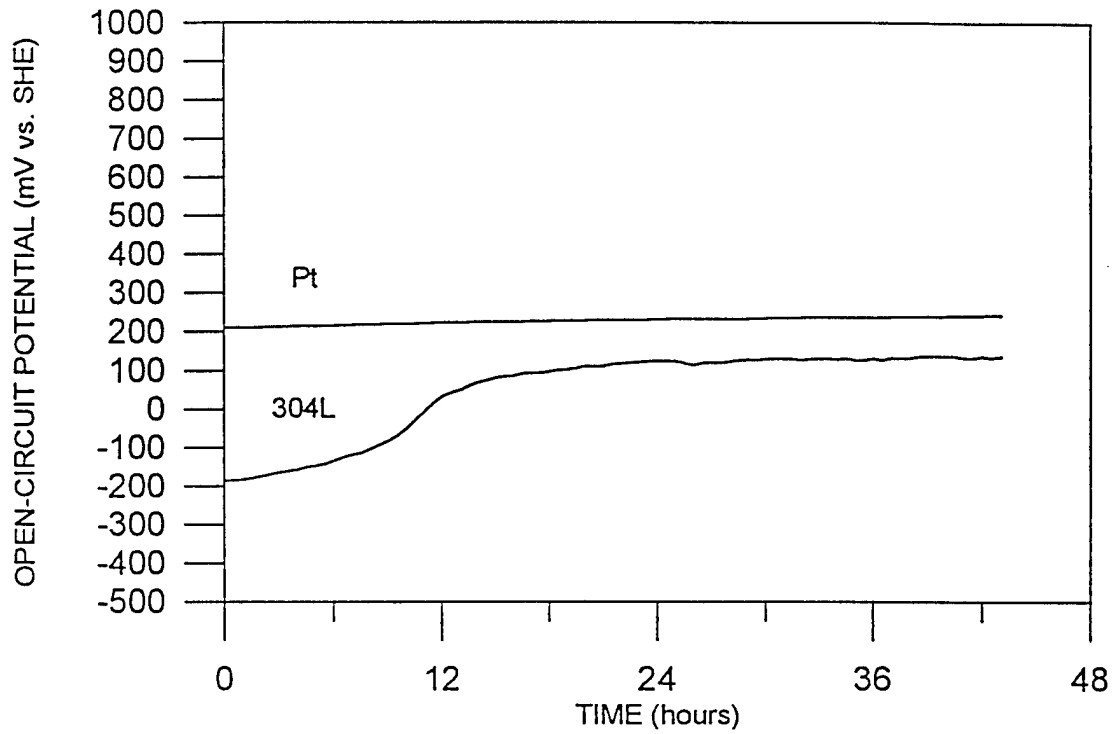

Figure 4. Open-circuit potential vs. time for the control cell.

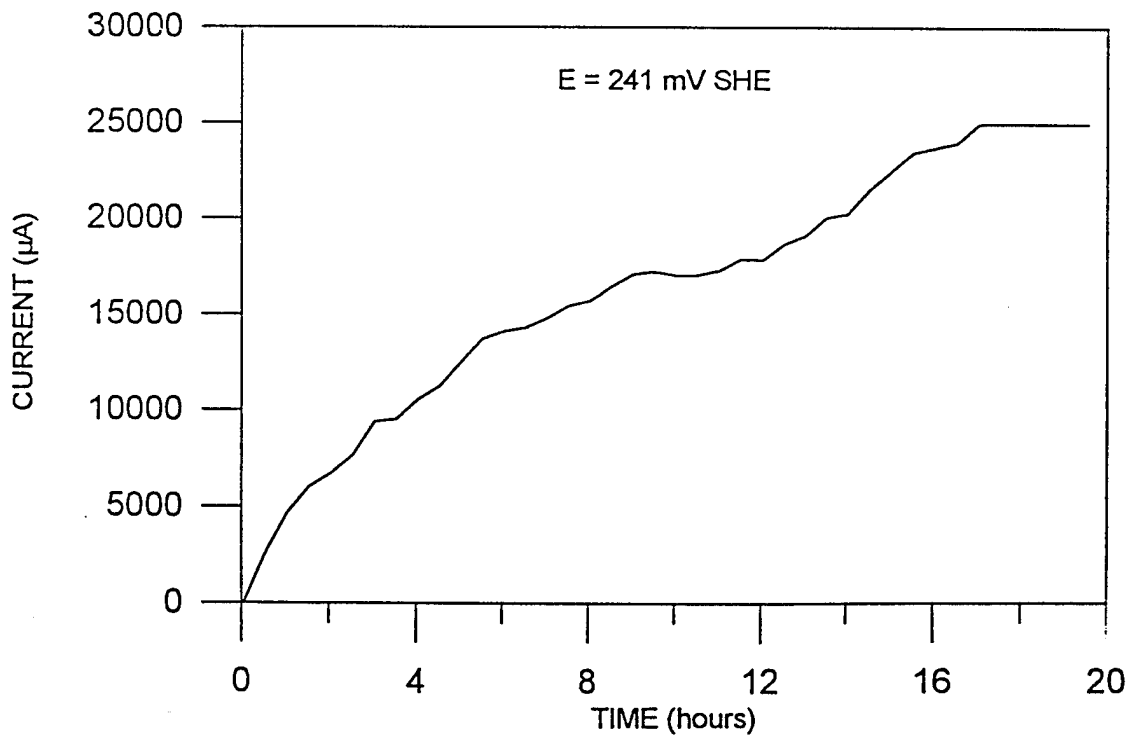

Figure 5. Open-circuit potential vs. time for the bacterial cell.

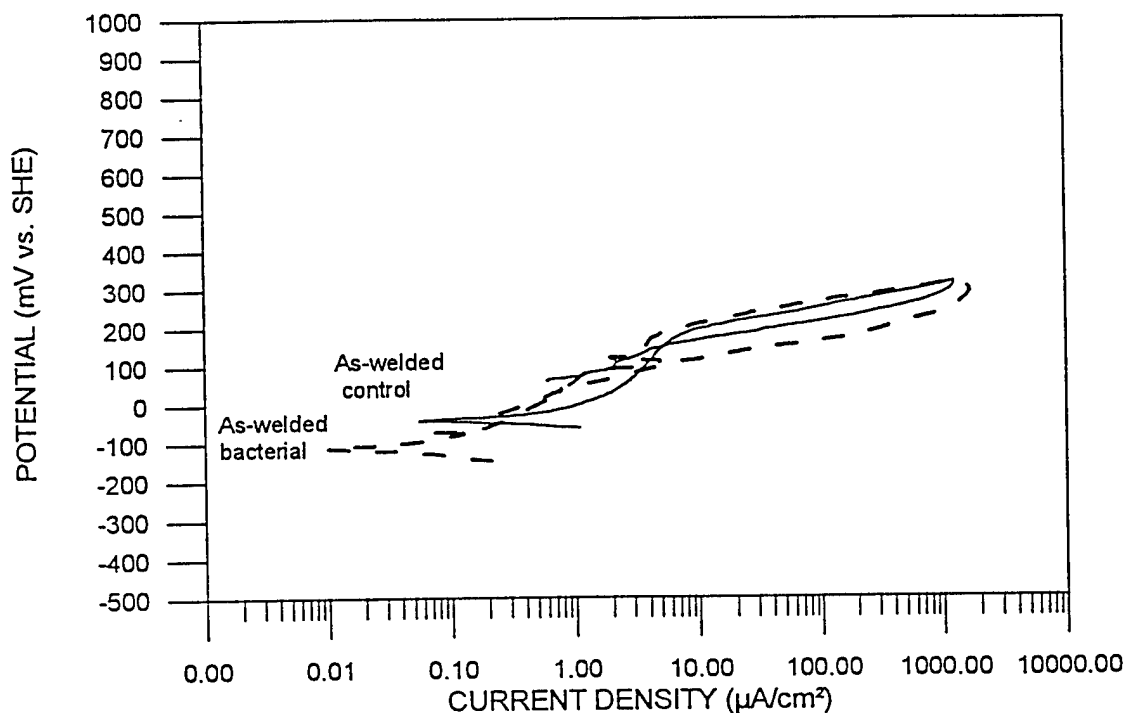

Figure 6. Anodic polarization tests for bacterial and control samples.

Results were basically the same as observed earlier, with the only differences between these bacterial cell results and the control cell results being the initial potential values.

Two creviced samples, one run for 5 days at 100% dilution rate and the other run for 2 weeks at 100% dilution rate, were fixed in glutaraldehyde in order to examine biofilm formation after two weeks as opposed to 5 days. Both coupons did have biofilm establishment. The biofilm on the 2-week sample was more diverse. The 5-day sample showed more formation of extracellular polymer.

One creviced sample that had run for two weeks was submitted for microbiological analysis. As experienced earlier, no SRB or algae were detected. The lack of these constituents, along with whatever else was missing from the original consortium, might have had a major effect on the lack of differentiation between bacterial and control cell results. If the necessary ingredients are not present, it does not matter how long the tests are run -- desired results will not be achieved.

At this point, plans involving initiation of MIC in the laboratory were halted. A biofilm that functioned as it did in natural conditions was never satisfactorily achieved. It has been cited that laboratory studies are often misleading. Organisms frequently behave differently in their natural environments than they do in the laboratory. Microorganisms generally coexist in natural environments in symbiotic relationships with other organisms. There is a delicate balance in nature, not often achieved in the laboratory. Without the initial step of attaining a community of microorganism that acts as it would in natural conditions, any further attempts at testing would have been futile.

MIC Studies in a Natural Marine Microbial Environment

Procedures

Overview

Due to inconsistencies experienced in the laboratory MIC tests previously described, design of the project was thoroughly reevaluated. The majority of work thus far had been performed using consortium C, which had been derived from metal scrapings at an exposure site on the Delaware Bay. There was a major problem in achieving the original consortium components, known to exist under natural conditions. Several alternative test methods were discussed, the most promising being a direct exposure to a marine environment with identified microbial activity. Consortium C had originated in the Delaware Bay waters. This was a site of documented microbial activity, with evidence of the ennoblement effect discussed earlier. Permission to expose a selected range of weldments to this natural environment was requested from Dr. Stephen Dexter of the College of Marine Studies, University of Delaware. Dr. Dexter kindly agreed to this request. It was then necessary to decide such factors as the type, number, and surface condition of weldments to be exposed, the length of exposure, any additional parameters (creviced vs. non-creviced), and tests to be performed following the exposure.

Due to the time and space available for testing, it was not possible to test all of the weldments from the original list (Table 1). Much consideration was given to the decision of which weldments to include in the exposure. It was desired to represent the original range of weldments, selecting those used most in marine service. The final list included nine weldments, which along with chosen surface conditions, are given in Table 6. This list includes three stainless alloys, with base metals of 304L, 316L, and AL-6XN; two carbon/low alloy steels, with base metals of HY-80 and HSLA-80; one nickel alloy, with base metal of Alloy 400; one copper alloy, with base metal of 90-10 Cu-Ni; one aluminum alloy, with base metal of AL 5086; and one unalloyed titanium weldment. Some background information is given on the choice of weldments in the paragraphs that follow.

The choice of stainless alloys included two austenitic stainless steels, 304L and 316L, and one non-traditional high-nickel superaustenitic stainless steel, AL-6XN. Because of its susceptibility to pitting and crevice corrosion in chloride containing waters, 304L is not recommended for use in underwater applications, especially in stagnant waters. However, it is used in topside marine hardware (30). 316L, which contains molybdenum for increased resistance to pitting and crevice corrosion, has been used extensively in marine service, with certain precautionary measures, such as cleanliness and weld quality. It has been used in condenser tubing, heat exchangers, cooling coils, waterboxes, instrument housings, and submarine masts. AL-6XN is a relatively new high performance stainless alloy, designed for increased corrosion resistance to chloride environments. AL-6XN is the nitrogen-containing version of AL-6X, which has been used in condenser tubing and heat exchangers.

HY-80 and HSLA-80 were chosen as representatives of the carbon/low-alloy steel group. HY-80 is a quenched and tempered steel that has found its traditional use in submarine hull plates (3,15). HSLA steels are designed to provide better mechanical properties than conventional carbon steels. HSLA-80 is a low carbon, copper bearing steel with good

weldability. Typical applications of HSLA-80 include hatch covers, and main hull structures (3,15,31).

Table 6. Weldments and surface conditions selected for testing.

Weldment Number	Base Metal	Filler Metal	Coupon Designation	Surface Treatment
1	304L	308L	a	No treatment
			b	Brushed (manual)
2	316L	316L	a	No treatment
			b	Brushed (manual)
3	AL-6XN	Hastelloy, C-22	a	No treatment
			b	Brushed (manual)
4	HY-80	E10018	a	Brushed (power)
			b	Ground (80-grit)
5	HSLA-80	E10018	a	Brushed (power)
			b	Ground (80-grit)
6	Alloy 400	Alloy 400	a	Brushed (power)
			b	Ground (80-grit)
7	90-10 Cu-Ni	70-30 Cu-Ni	a	Brushed (power)
			b	Ground (80-grit)
8	Aluminum 5086	Aluminum 5556	a	No treatment
			b	Brushed (manual)
9	Unalloyed Titanium	Unalloyed Titanium	a	No treatment
			b	Brushed (manual)

Alloy 400 (Monel 400) was chosen to represent nickel alloys used in marine service. Alloy 400 performs well in highly aerated, fast moving seawater environments. It has been used in heat exchangers, turbine blades, pump shafts, and water boxes (1,15).

90-10 Cu-Ni (CDA 706) is widely used in seawater applications, and is the predominant choice for seawater piping systems (15,31). It is the standard for condenser tubes in naval vessels. This alloy is resistant to pitting, general corrosion, and fouling, while providing good weldability. It has traditionally been used in water boxes, heat exchangers, and covering for wood hulls to prevent macrofouling.

Aluminum alloys used in marine service are mainly of the 5000 series, with magnesium being the major alloying element. The main advantage of using aluminum and its alloys rather than steels, is aluminum's high strength-to-weight ratio. AL 5086 has been used extensively in yacht and large vessel (tankers and ore carriers) hulls, as well as submersible pressure hulls (3,15).

Unalloyed titanium was chosen as a base comparison for the other metals and alloys. Titanium is unique in comparison to all the metals/alloys previously discussed in that there are no case histories of MIC reported. Titanium has outstanding corrosion resistance in seawater, due to a tenacious oxide film. In various exposures to seawater that have lasted as long as 20 years, titanium has shown immunity to effects from micro and macrobiological growth. It has been used in coastal power plant surface condensers, heat exchangers, seawater piping systems, and hulls for submarines and submersibles (32). With its outstanding properties,

however, titanium has one main disadvantage -- its cost. It is mainly for this reason that titanium does not see greater use than it does.

Compositions for the base metals and filler metals chosen for exposure are given in Table 7. Two samples of each weldment type were prepared for exposure, one in basically an as-welded condition, and one in a condition comparable to that used in service. Throughout this thesis, weldments will be referred to interchangeably by the designation shown in Table 6 and by the metal/alloy. The number designates the weldment type and the letter designates the surface condition. For example, #1-a signifies the weldment 304L/308L (#1) in the untreated/as-welded condition (a). The range of weldments were exposed for one month, with open-circuit potential (OCP) measurements taken periodically. OCP measurements generally do not change appreciably for active alloys such as iron and steels. However, in regards to passive metals and alloys, OCP values can tell what is happening in relation to passivity. A small corrosion current can polarize these materials and produce a large change in potential. For the first test, coupons were exposed in a creviced condition, using the same assembly as shown in Figure 1. At a later time, tests were conducted on non-creviced coupons as well.

The exposure site was located on the Roosevelt Inlet of the lower Delaware Bay, Lewes, DE. A mechanical pump system pumped water from the inlet into the test building. Water was collected in large troughs for the purpose of conducting tests on various metals and alloys. It is in these troughs that weld coupons were placed for the duration of the exposure. At very low velocity, water flowed down the troughs, continually exposing the weld coupons to a fresh supply of water. High and low tides occurred twice daily. On the incoming tide, nutrient-poor water from the Delaware Bay, which in turn was fed by the Atlantic Ocean, flowed through the Roosevelt Inlet towards the salt marshes. On the outgoing tide, nutrient-rich water flowed back from the salt marshes, again past the test site, eventually reaching the Atlantic Ocean. The average seawater characteristics, taken from previous studies performed at the exposure site (19, 24) were as follows: temperature, 22 to 26 °C; pH, 7.7 to 8.1; and salinity, 25 to 31 ppt. At the end of the troughs was a flow outlet where water was pumped back into the Roosevelt Inlet.

In order to characterize the microbial community, microbiological analysis was performed on several samples from the natural exposure, using Phospholipid Fatty Acid (PLFA) analysis. This technique identifies "families" of bacteria by analyzing signature fatty acids (lipids) left behind. Although some types of bacteria, such as iron oxidizers, do not have distinctive phospholipids, and therefore cannot be detected, PLFA analysis works well in identifying various other microbes, including algae, SRB, and Pseudomonads.

Following the exposure, polarization resistance tests were conducted in order to determine corrosion rates for the weld coupons. Due to the time and space available for testing, polarization resistance tests were the most logical choice. Each test takes about ten minutes to complete, and provides a surface-average corrosion rate for the sample that is being tested.

Table 7. Nominal compositions for base metals and filler metals.

	Cr	Ni	Fe	Mo	Cu	Al	Mg	Mn	Ti	C	Si	P	S	Others
304L	18-20	8-12	bal.	---	---	---	---	2.0	---	.03	1.0	.045	.03	---
308L	19-21	10-12	bal.	---	---	---	---	2.0	---	.03	1.0	.045	.03	---
316L	16-18	10-14	bal.	2-3	---	---	---	2.0	---	.03	1.0	.045	.03	---
AL-6XN	20-22	23.5-25.5	bal.	6-7	---	---	---	2.0	---	.03	1.0	.045	.03	N, .18-.25
Hastelloy C-22	20-22.5	bal.	2-6	12.5-14.5	---	---	---	.5 max	---	.015 max	.08 max	.02 max	.02 max	W, 2.5-3.5 max Co, 2.5 max V, .35 max
HY-80	0-1.5	0-3.4	bal.	0-5	---	---	---	.20-1.5	---	.10-.30	.20-.35	.04 max	.05 max	0-.04 Nb 0-.05 V
HSLA-80	.6-.9	.7-1.5	bal.	.15-.25	1.0-1.3	---	---	.4-1.65	---	.07 max	---	.025 max	.15-.4	Nb, .02
Alloy 400	---	bal.	---	---	31.5	---	---	---	---	.15	2	---	---	---
90-10 Cu-Ni (CDA 706)	---	10	1.4	---	bal.	---	---	1	---	---	---	---	---	---
70-30 Cu-Ni (CDA 715)	---	30	---	---	bal.	---	---	---	---	---	---	---	---	---
Aluminum 5086	.05-.25	---	.5	---	.1	bal.	3.5-4.5	.2-7	.15	---	.4	---	---	Zn, .25
Aluminum 5556	.05-.20	---	.4	.1	---	bal.	3.5-4.5	.5-1.0	.05-.2	---	.25	---	---	Zn, .25
Unalloyed Ti, Grade 2	---	---	.3	---	---	---	---	---	bal.	.10	---	---	---	H, .015 O, .25 N, .03

The polarization resistance technique proceeds as follows (16,33). In the immediate range of E_{corr} , the slope of ΔE vs. ΔI has a linear relationship, called the polarization resistance, or R_p . The polarization resistance technique performed by the computer software (1) evaluates that slope, (2) determines the i_{corr} (corrosion current density) value, and (3) calculates a corrosion rate in mpy (mils per year). The equations used are shown below:

$$\frac{\Delta E}{\Delta I} = R_p$$

$$i_{\text{corr}} = \frac{\beta_a \beta_c}{2.3 R_p (\beta_a + \beta_c) A}$$

$$\text{C. R.} = \frac{(0.13)(i_{\text{corr}})(\text{E. W.})}{\rho}$$

where β_a = Tafel constant for the anodic reaction in mV
 β_c = Tafel constant for the cathodic reaction in mV
 A = area in cm^2
 C. R. = corrosion rate in mpy
 0.13 = metric and time conversion factor
 E. W. = equivalent weight in grams
 ρ = density in grams/cm^3

In order to determine the effect that microorganisms have on the weldments, it was necessary to run control tests under the same conditions. It is difficult, however, to run true control tests. Ideally, a control test should be run at the same time as the exposure test, under the same conditions, and with the same water, but free of the microorganisms. Two approaches to this problem were considered. One could either use water from the Delaware Bay that had been taken through an appropriate filtration process, or one could use sterile synthetic seawater. Each approach bears advantages and disadvantages with respect to representing a true control test, as discussed in the following paragraphs.

By using water from the Delaware Bay, one could be sure that initially, the water from the control tests was similar in composition to the water from the natural exposure tests. However, even filtration through 0.2 micron pore size still allows dwarf cells (resultant from low-nutrient conditions in the open seas) and small spherical bacteria to remain in the water. In addition, since control tests were to be conducted at the University of Tennessee (Knoxville, TN) and the natural tests were conducted at the University of Delaware (Lewes, DE), using bay water in the control tests would require collecting enough water for a one-month control test and storing until needed. It has been cited that stored seawater, separated from the parent water body, often displays corrosive effects different from the parent water (14). This statement indicates that upon storing for any significant length of time, make-up of the water changes; therefore, water no longer replicates that used in the natural exposure.

The alternative approach involved using sterile synthetic seawater. By conducting the control tests with this medium, one could eliminate the problem of a residual microbial factor,

such as encountered in the filtered bay water. However, synthetic seawater does not replicate water used in the natural exposure.

As a compromise to the problem just discussed, two quasi-control tests were run simultaneously. One test used water from the exposure site that had been filtered through a 0.2 micron filter. The other test used sterile synthetic seawater as prepared under ASTM guidelines, D 1141-90. All control tests were conducted in the laboratory, where temperature was maintained at approximately 25 °C. For the ASTM water, salinity was 35 ppt and pH was 8.0 to 8.2 (adjusted with NaOH).

After conducting the tests in the creviced condition, it was decided to run the same tests, with the weldments in the non-creviced condition. Due to the time of year that control tests were conducted for the non-creviced coupons, only ASTM seawater was available as a control medium.

Sample Preparation

The first step in preparation for the natural exposure was fabrication of the chosen list of weldments. Weldments #1 (304L/308L) and #2 (316L/316L) were full-penetration welds on 12-inch diameter pipe sections. The remaining welds were bead-on-plate welds. Weldments #1 (304L/308L), #2 (316L/316L), #8 (AL 5086/AL 5556), and #9 (titanium/titanium) were gas-tungsten arc welded. The remainder of the alloys were shielded metal arc welded. Following the welding procedure, the pipe sections and plates were cut into coupons measuring approximately 1.0 in. by 2.5 in., with the weld region centered on, and perpendicular to, the length of the coupon. Thicknesses of the coupons varied.

In total, five month-long exposures were conducted with the range of weldments, as summarized in Table 8. Coupons in Test 1 were exposed to the Delaware Bay in the creviced condition. Coupons in Test 2 were also exposed to the Delaware Bay, but in the non-creviced condition. Tests 3 and 4 were laboratory counterpart quasi-control tests for the creviced Delaware Bay exposure. Test 3 used water from the exposure site that had been taken through a 0.2 micron filtration process (with prefiltration through 1 micron). Test 4 used synthetic seawater prepared under ASTM guidelines D 1141-90. Test 5 was the laboratory counterpart quasi-control test for Test 2, and used ASTM synthetic seawater as the control medium. Aluminum weldments were not included in Test 5 with the other weldments, but rather, were tested separately at a later time.

Table 8. Summary of month-long exposure tests.

Test Number	Test Description	Weldment Condition
1	Delaware Bay	Creviced
2	Delaware Bay	Non-creviced
3	Delaware Bay water, filtered through 0.2 micron	Creviced
4	ASTM synthetic seawater	Creviced
5	ASTM synthetic seawater	Non-creviced

In each of the exposures, two coupons of each weldment type, except weldments #4 (HY-80) and #5 (HSLA-80), were tested. One coupon of each weldment type was left in

basically an untreated condition. For weldments #1, #2, #3 (stainless alloys), #8 (AL 5086) and #9 (titanium), this merely involved filing off the shear edges that had formed during the cutting process. Weldments #4, #5 (carbon/low alloy steels), #6 (Alloy 400), and #7 (90-10 Cu-Ni) were briefly brushed with a stainless steel power brush to remove bits of slag that remained from the welding process. In cases where no slag remained, no treatment was used. In each of the exposures, one coupon of each weldment was prepared to match surface conditions used in service. Weldments #1, #2, #3, #8, and #9 were brushed manually with a stainless steel brush. Weldments #4, #5, #6, and #7 were ground with a flapper wheel (80-grit). As an example, Figure 7 shows the surface conditions for weldment #1 (304L/308L).

For all of the exposures, electrical connections were made to each coupon. In Test 1, wires of 308L were spot-welded onto the stainless alloy and carbon steel coupons, wires of Alloy 400 were spot-welded onto the Alloy 400 coupons, and wires of titanium were spot-welded onto the titanium coupons. Wires of AL 5556 were welded onto the aluminum alloy coupons and wires of 70-30 Cu-Ni were welded onto the copper alloy coupons. In the other exposures, the wires varied slightly from those listed above. The use of nickel wires replaced both the use of 308L wires on the stainless alloy coupons, as well as the use of Alloy 400 wires on the Alloy 400 coupons. The rest of the wires remained the same.

In order to eliminate any galvanic effects from compositional differences of the wires and weldments, all wire and wire/coupon connections, excluding those of the titanium coupons, were coated prior to testing. Wires and wire connections for Test 1 were coated several times with Gluvit (Travaco Laboratories, Inc.), a marine epoxy. Due to the degradation of the coating, however, wires and wire connections of the other four tests were coated with Amercoat epoxy.

Tests 1, 3, and 4 used coupons in the creviced condition, employing the assembly shown in Figure 1 to impart a crevice on the coupons. Backing plates, nuts and screws were fabricated from unalloyed titanium. The same procedure was used in putting together the crevice assemblies, as described previously. Silicone rubber rods were sterilized prior to each test by boiling in distilled water for 30 minutes. Coupons were mounted with the weld face positioned upwards (ID surface for 304L and 316L weldments). Prior to testing, titanium wires were spot-welded onto the top backing plate of each assembly.

Testing Apparatus

Tests 1 and 2 were conducted at the University of Delaware exposure site. For Test 1, a rigid polyvinyl chloride (PVC) holder with holes drilled in the bottom was used to hold the crevice assemblies stationary and elevate them out of the mud layer present on the bottom of the troughs. Coupons were positioned so that water flow ran parallel to the length of the coupons. In Test 2, coupons were in the non-creviced condition. They were hung from a PVC strip into the seawater so that the weld face (ID surface for 304L and 316L coupons) was directed towards the oncoming water. The entire weldment was submerged. Two platinum electrodes were left in the troughs for the duration of the exposures.

Tests 3, 4, 5, and the test involving only the aluminum weldments, were conducted in the laboratory as quasi-control tests. A Plexiglas box able to hold all the coupons was constructed for Tests 3 and 4. Test 5 was conducted at a later time and simply used one of the boxes already existent. The lid was designed so that once the assemblies were placed in the boxes, wires from the coupons and backing plates could emerge through the lid, held in place by rubber stoppers. Or in the case of Test 5, coupons could be hung into the solution

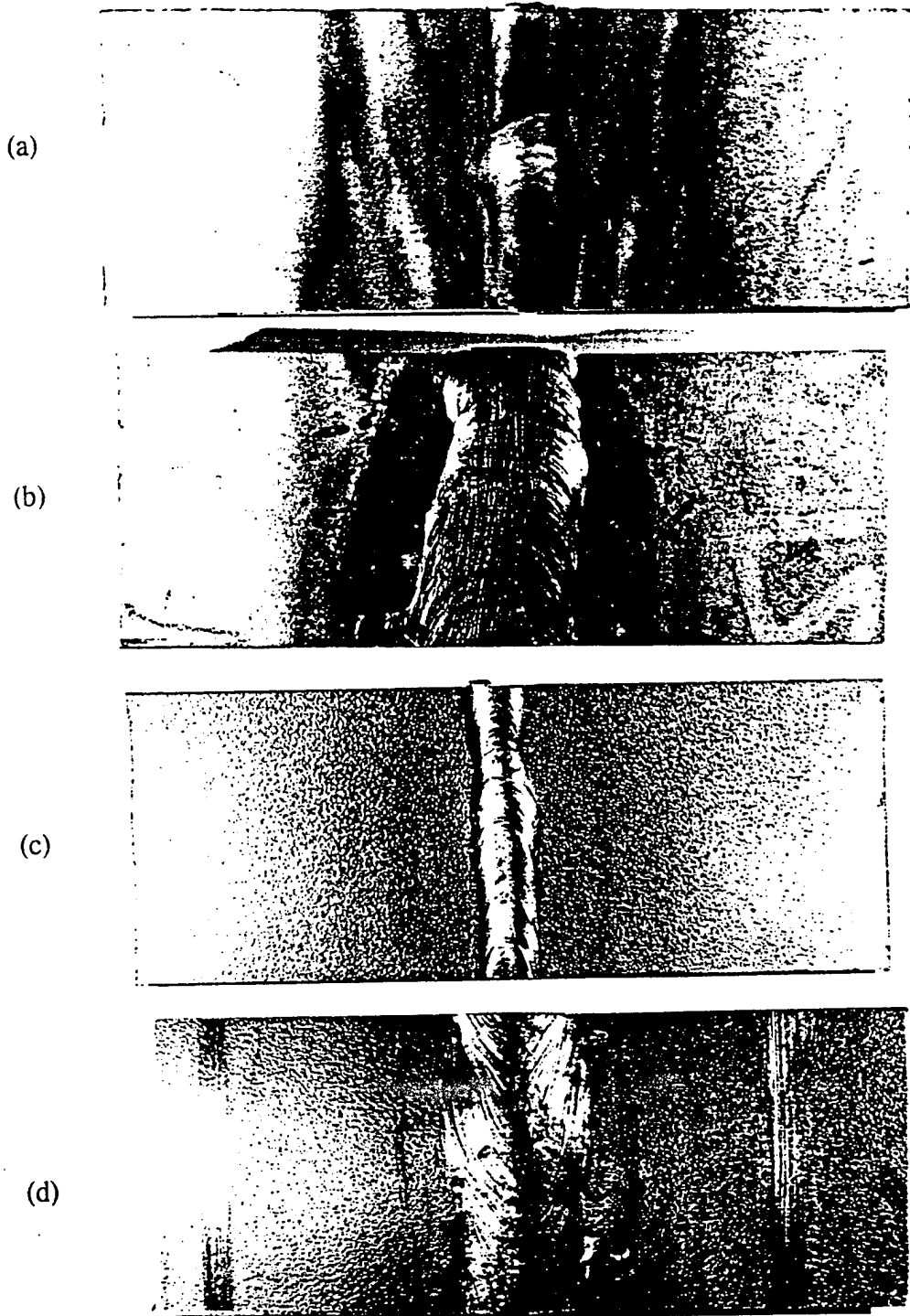

Figure 7. Surface conditions for weldment #1 (304L/308L) : (a) #1-a, ID surface, no treatment (b) #1-a, OD surface, no treatment (c) #1-b, ID surface, brushed (d) #1-b, OD surface, brushed.

from the lid, with the wires held in place by rubber stoppers. For Tests 3, 4, and the test involving only aluminum weldments, one platinum electrode was placed in each box. Test 5 used two platinum electrodes. The test boxes were fitted with flow inlets, outlets, electrode holders, and 0.2 micron air filters. The entire box assembly for each test was sterilized with ethylene oxide gas. Flow was supplied to the boxes using a mechanical pump system. Test 3 used water from the Delaware Bay that had been taken through a 0.2 micron filtration step (with prefiltration through 1 micron) in order to eliminate most of the biofilm-forming bacteria. Tests 4 and 5 used sterile synthetic seawater, prepared under the guidelines of ASTM D1141-90, and sterilized by steam autoclaving. The test involving only aluminum coupons also used ASTM synthetic seawater.

OCP Measurements and Polarization Resistance Tests

Throughout the exposures, OCP measurements were taken for each of the coupons, backing plates, and platinum electrodes. Two weeks into Test 1, electrical contact to the stainless alloy coupons was broken due to corrosion. OCP measurements for these coupons were made by touching the tip of a glass-enclosed platinum wire to the coupon surfaces. All exposures lasted approximately one month. Following the exposures, polarization resistance tests were performed on the coupons (that still had wires attached). For the creviced tests, the titanium backing plates served as the counter electrodes. In the non-creviced tests, a platinum electrode served as the counter electrode.

The theory in which the polarization resistance method determines a corrosion rate involves the input of Tafel constants (β_a and β_c). No values were input and the computer software (PARC 342, EG&G, Princeton Applied Research) assumed a value of 100 mV for both β_a and β_c , which according to the software supplier, gives accuracy within a factor of two. Calculation of a corrosion rate also required an input of densities, equivalent weights, and areas for the coupons undergoing testing. The equivalent weight of a metal equals the atomic weight of that metal divided by the oxidation state. Using iron as an example,

$$\begin{aligned}\text{Atomic Weight of iron} &= 55.847 \\ \text{Oxidation State of iron} &= +2\end{aligned}$$

$$\text{Equivalent Weight} = \frac{\text{Atomic Weight}}{\text{Oxidation State}} = \frac{55.847}{2} = 27.923$$

In cases that involved an alloy comprised of metals with different oxidation states, such as 304L, the equivalent weight can be calculated by taking into account the atomic fractions of the various elements along with their oxidation states. Densities were taken from various literature sources, and areas of each coupon were measured prior to testing. Equivalent weights and densities used throughout the tests are given in Table 9.

Table 9. Equivalent weights and densities used in corrosion rate calculations.

Weldment Number	Equivalent Weight	Density
1	25.6	7.94
2	25.6	7.98
3	25.9	8.04
4	27.7	7.87
5	27.7	7.87
6	30.0	8.83
7	31.4	8.94
8	9.18	2.66
9	12.0	4.50

Due to the high humidity of the trough-room where Tests 1 and 2 were conducted, polarization resistance tests could not be performed at the exact location of testing. Weld coupons were moved to an adjacent room and placed in a polypropylene bin that had been filled with seawater from the site. After E_{corr} values had stabilized, polarization resistance tests were performed.

Test 5 is the only control counterpart test for the non-creviced weldments of Test 2. It was not possible to obtain water from the Delaware Bay at the time control tests were run for the non-creviced coupons. Test 5 did not include the aluminum weldments. These coupons, along with replicate crevice samples, were tested separately from the other coupons due to unusual corrosion behavior experienced in Tests 3 and 4, when in the presence of the other corroding weldments.

Microbiological Analysis and Surface Examination

Following exposure and testing, all coupons from all tests were examined with a stereomicroscope, noting the location and appearance of the corrosion that occurred. In attempts to preserve a biofilm from Test 1, #2-a (316L/316L, no treatment) was fixed in a glutaraldehyde solution, taken through a series of dehydration steps in ethyl alcohol (50%, 75%, 85%, 95%, 100%), and critical-point dried in liquid carbon dioxide. Several samples from Test 2 were submitted to the CEB for microbiological analysis. These samples included one platinum electrode and weldments of HY-80 (brushed), HSLA-80 (brushed), 304L (no treatment), 304L (brushed), and 316L (brushed). Analysis was also performed on mid-high tide and mid-low tide water samples.

Several coupons were examined with scanning electron microscopy and energy dispersive spectroscopy (EDS), including five from Test 1 (#1-b, 304L/308L; #2-a, 316L/316L; #3-a, AL-6XN/C-22; #6-b, Alloy 400/Alloy 400; and #7-a, 90-10 Cu-Ni/70-30 Cu-Ni) and one from Test 4 (#8-a, AL 5086/AL 5556). Due to nonconductive particulate matter on the surfaces of #2-a (316L/316L) and #8-a (AL 5086/AL 5556), these coupons were sputtered with gold before examining with the SEM. The other samples were examined as is. EDS analysis was performed on #2-a and #6-b of Test 1 (Delaware Bay, creviced) and #8-a of Test 4 (ASTM synthetic seawater, creviced).

Results and Discussion

Results from the natural exposure proved much more helpful in understanding factors related to the corrosion behavior of weldments in marine microbial environments. A total of five tests have been conducted. Conditions were summarized in Table 8. Open-circuit potential (OCP) measurements were taken throughout all of the tests. Following exposure, all coupons were examined with a stereomicroscope, noting the appearance and location of the corrosion that occurred. Examination was taken a step further for several samples, with microscopic examination. In order to characterize the microbial community of the natural exposure, microbiological analysis was performed on several samples from Test 2 (Delaware Bay, non-creviced). In all tests, polarization resistance tests were conducted following exposures in order to determine corrosion rates for the various weldments. Finally, weldments were compared based on visual examination and results from the polarization resistance tests.

OCP Measurements and Surface Examination

Platinum Electrodes

OCP measurements for the platinum electrodes are shown in Figure 8. As shown in the graph, platinum electrodes from Test 1 and Test 2, those conducted in the Delaware Bay, showed the highest potentials as compared to the other tests. It is unknown why there was such a fluctuation in readings from Test 1. OCP values for Test 3, conducted in filtered Delaware Bay water are about 50-100 mV higher than those for Test 4, conducted in ASTM artificial seawater. It is unknown for certain why this occurred, but a possible explanation is that some microbial factor was still present in the water that had been filtered. Studies have shown that even filtration through 0.1 μm filters does not remove certain types of bacteria. In addition, when water has been stored for any amount of time before final filtration, bacteria that would have initially been caught by the filters, are now in a starved state and can more readily pass through.

Any method used in attempts to sterilize seawater also changes the water chemistry in some way. Autoclaving is the most reliable method for killing bacteria, but precipitates form that do not redissolve when the seawater is cooled. Although filtration does not cause precipitates to form, significant amounts of some compounds may be retained by membrane filters. Another technique involving a combination of pasteurization and filtration has proven effective in obtaining sterile conditions with best results from a pasteurization at 70°C for 2 hours and immediate filtration through 0.1 mm filter. This method, however, also changes the chemistry of the water, such as increasing the dissolved organic carbon (34). It would be interesting to run further tests in a medium prepared in this manner, and compare the results to those obtained from tests using regular filtered water and ASTM water.

Stainless Alloys

OCP measurements for the stainless alloys are shown in Figures 9 through 14. As shown in Figures 9 and 10, values for weldments #1-a and #1-b (304L/308L) of Test 1 (Delaware Bay, creviced) were approximately in the same range as for the laboratory control counterparts of Tests 3 and 4. As expected, because of the intentional crevice, values in Test 1 were lower than in Test 2, which was also conducted in the Delaware Bay, but with non-

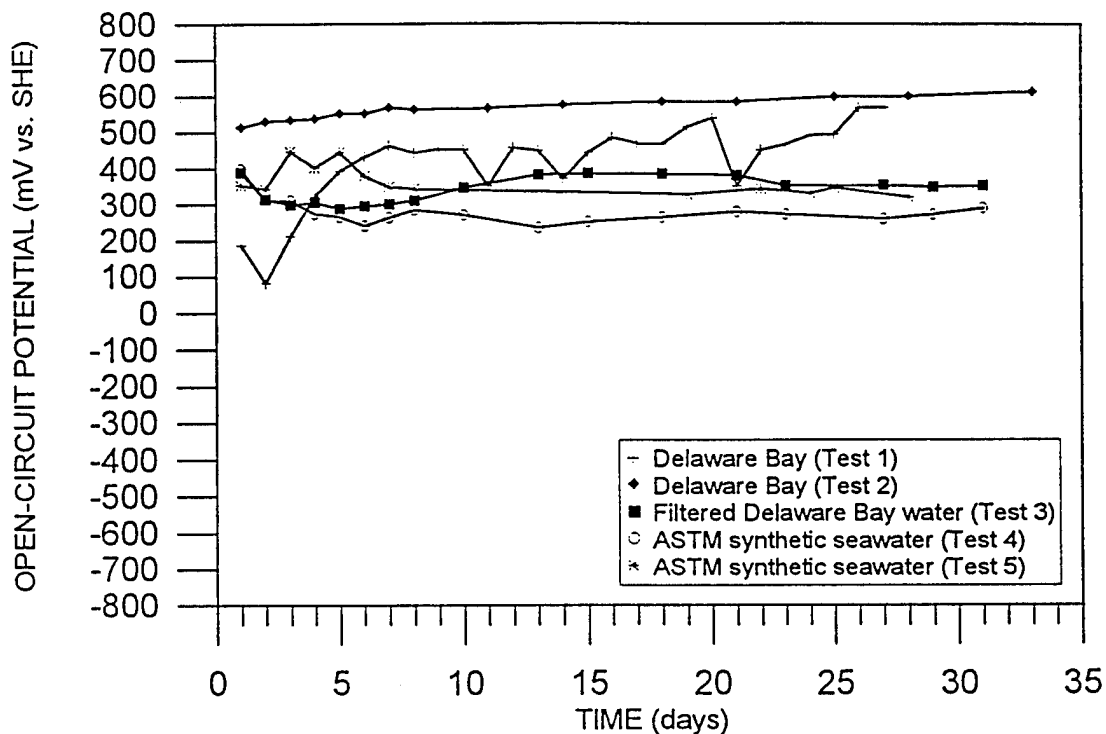

Figure 8. Open-circuit potential vs. time for platinum electrodes.

creviced coupons. Coupons from Test 2 ennobled slightly from initial values, and on average, were higher than for those in Test 5, the laboratory control counterpart test. Of the stainless alloy weldments tested, weldment #1 (304L/308L) showed the least difference in OCP results for creviced and non-creviced coupons tested in the Delaware Bay (Tests 1 and 2).

OCP measurements for weldments #2-a and #2-b (316L/316L) are shown in Figures 11 and 12. Values for Test 1 were approximately in the same range as for the laboratory control counterparts of Test 3 and Test 4. The differences between creviced and non-creviced values for the same environment were more pronounced with this weldment than they were for weldment #1 (304L/308L). A definite ennoblement was experienced for the coupons in Test 2, showing a 500-600 mV increase from initial potential values. In comparison to Test 5, OCP measurements for Test 2 were approximately 300 mV higher.

As shown in Figures 13 and 14, weldments #3-a and #3-b (AL-6XN/C-22) of Test 2 (Delaware Bay, non-creviced) had the highest potentials of all the stainless alloys. They also showed the greatest difference in potentials between creviced and non-creviced coupons in the Delaware Bay exposures. As shown in Figure 13 for #3-a, values for Test 1 (Delaware Bay, creviced) and Test 3 (filtered Delaware Bay water, creviced) were similar to each other. This would seemingly make sense, since both were in contact with Delaware Bay water. However, values from Test 4, which used ASTM seawater, were about 200 mV higher. This effect is opposite to that shown in Figure 14 (for #3-b), where the highest values of the creviced tests are those of Test 3. In this case, values for Test 1 and Test 4 were similar.

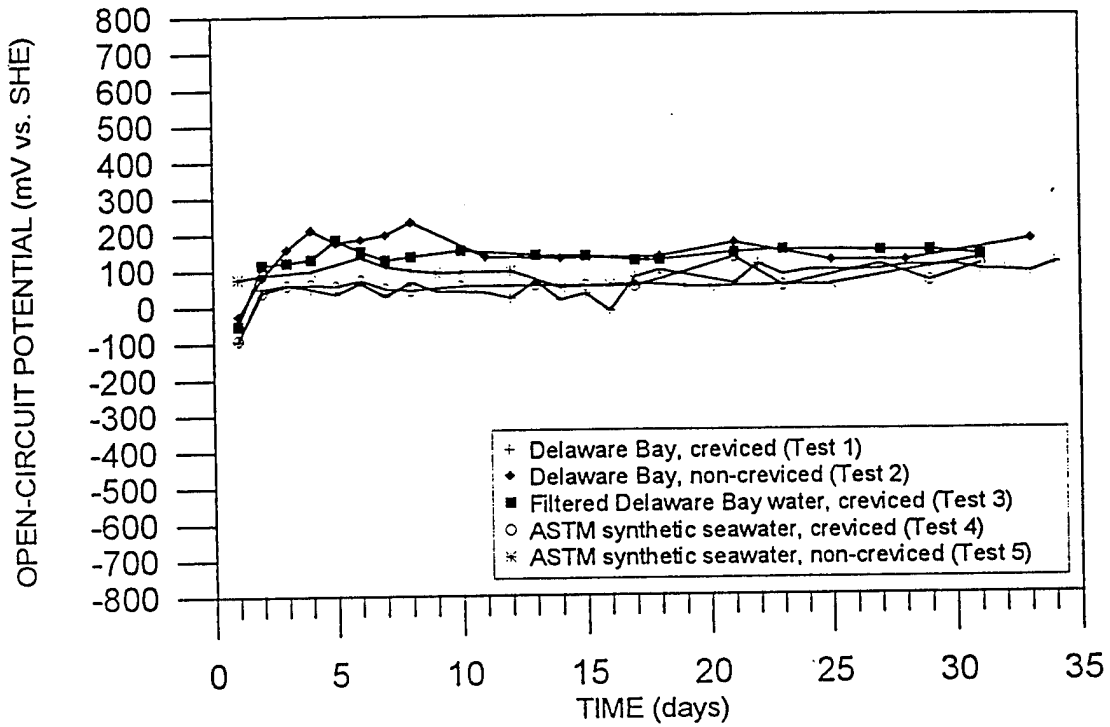

Figure 9. Open-circuit potential vs. time for weldment #1-a (304L/308L, no treatment).

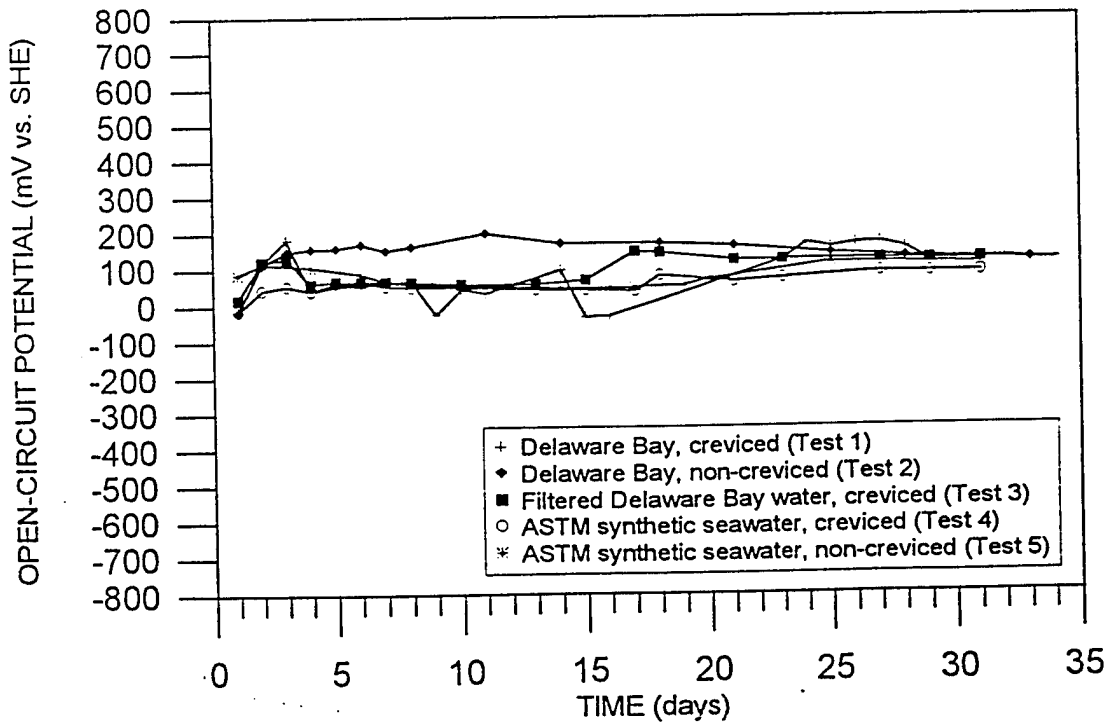

Figure 10. Open-circuit potential vs. time for weldment #1-b (304L/308L, brushed).

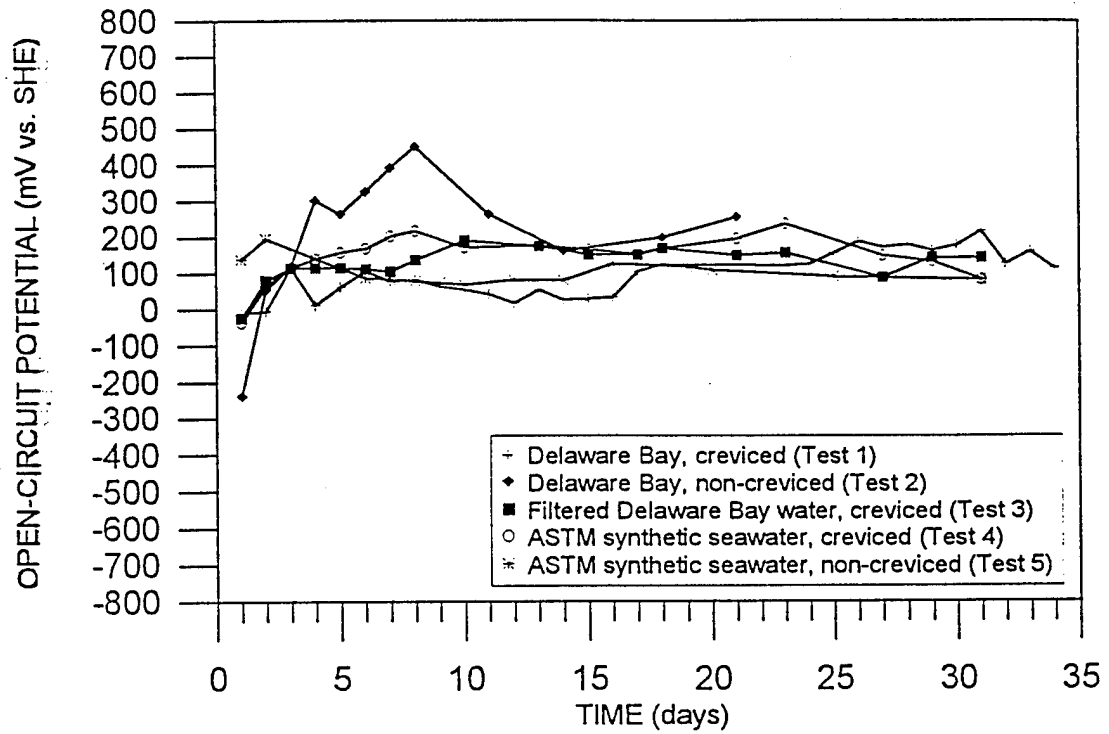

Figure 11. Open-circuit potential vs. time for weldment #2-a (316L/316L, no treatment).

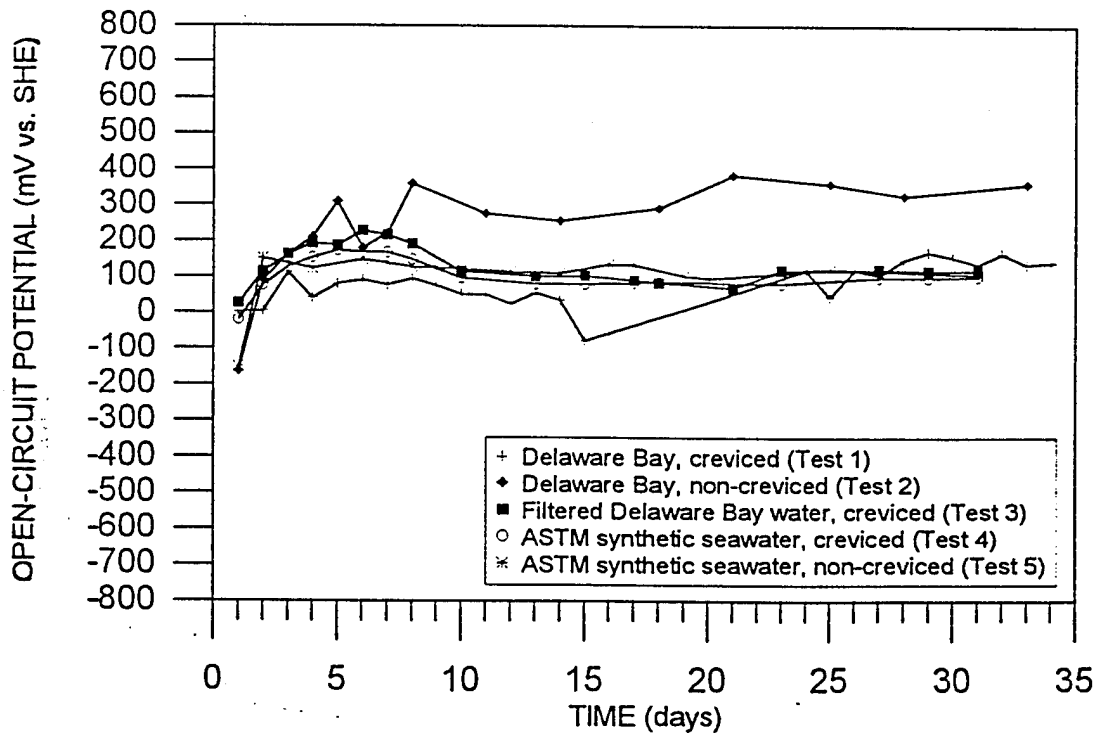

Figure 12. Open-circuit potential vs. time for weldment #2-b (316L/316L, brushed).

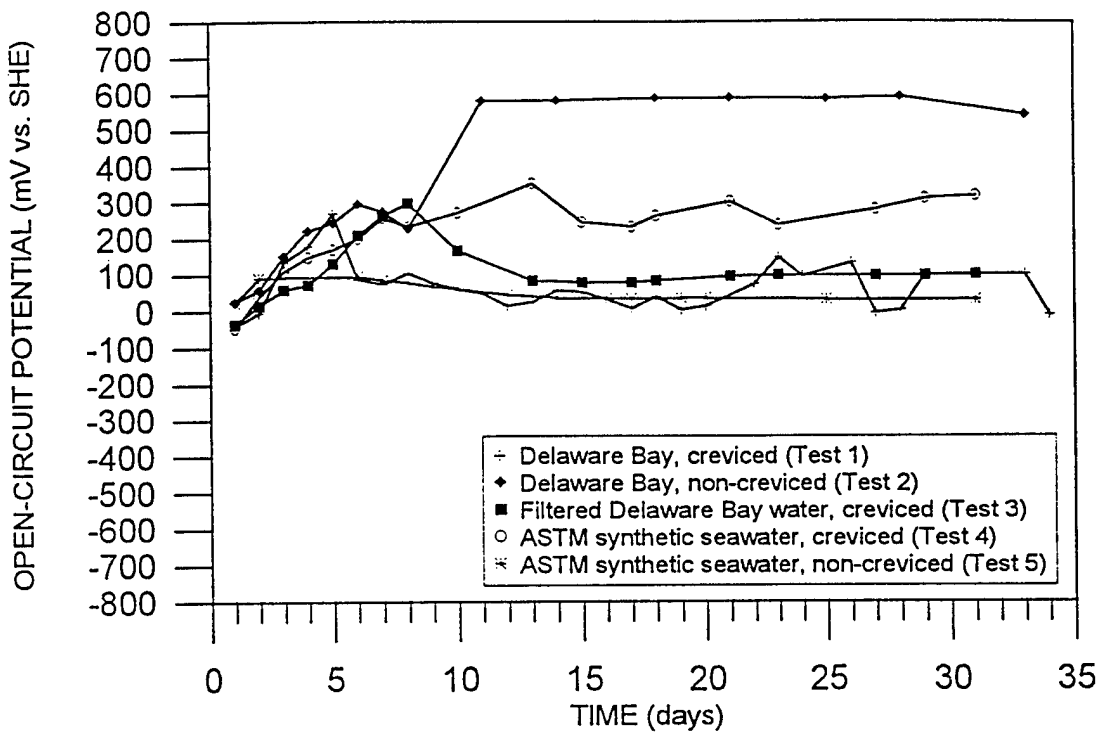

Figure 13. Open-circuit potential vs. time for weldment #3-a (AL-6XN/C-22, no treatment).

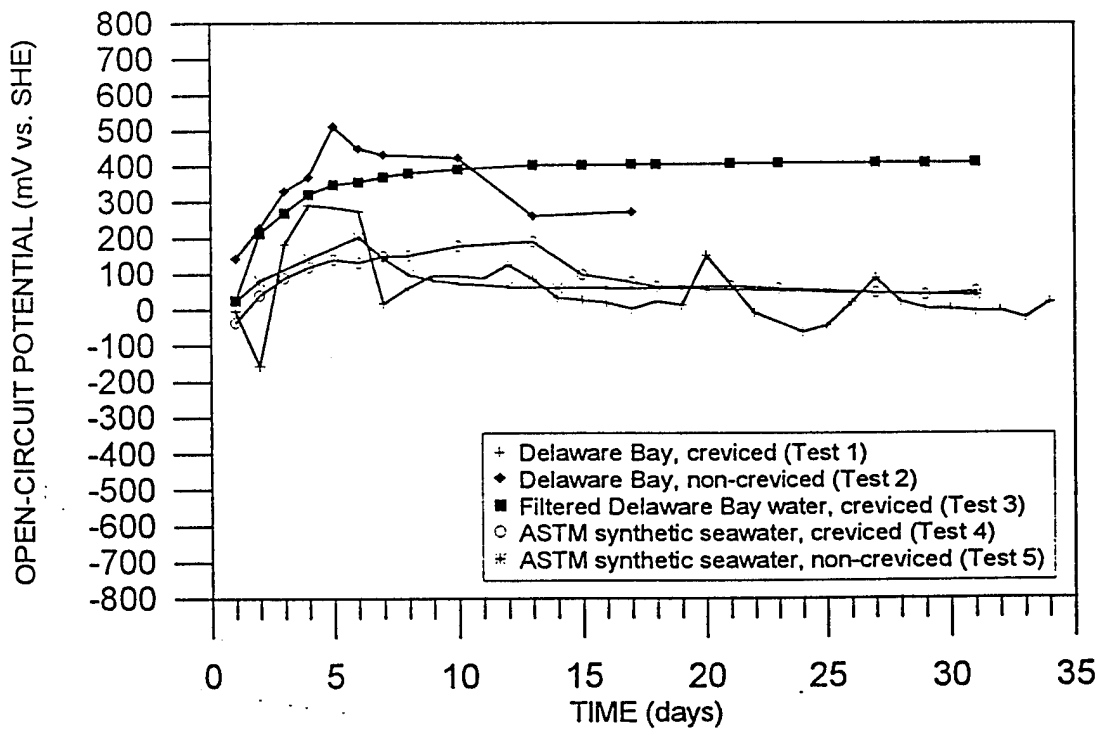

Figure 14. Open-circuit potential vs. time for weldment #3-b (AL-6XN/C-22, brushed).

Although ennoblement, as shown by the various stainless steels, does not indicate corrosion, it does increase the probability of localized corrosion as the potential reaches the critical pitting potential. If localized corrosion begins, E_{corr} moves in the active, or negative direction. It is interesting to note that in the coupons of Test 2 where wires became detached due to corrosion, potentials rose, hit a peak value, began to fall, after which the wires detached.

During Test 1, the wires or the wire connections of all the stainless steels experienced enough corrosion so that contact with the coupons was broken. A coating had been applied in hopes to avoid this problem, but even minor cracks in the coating can lead to extensive crevice corrosion of the exposed areas. This break in electrical connection occurred 10-15 days into the test for all of the coupons. The 304L and 316L weldments lost their leads at the connection. Figures 9 through 12 show that after this detachment occurred, potentials were higher at the next data point. This seems to indicate that the monitored potential for these coupons around the time of detachment was affected by the corrosion that was occurring in the immediate vicinity of the connection. This trend was not evident for the AL-6XN weldment OCP values, shown in Figures 13 and 14, which experienced their breaks in electrical contact part way up the wire.

Examination of the coupons revealed that when corrosion occurred, it did so to greater extents in Test 1 (Delaware Bay, creviced). Although definite pits did not occur on #1-a (304L/308L, no treatment) of Test 1, #1-b (304L/308L, brushed) had the largest pit encountered throughout the tests, affecting the weld metal, fusion line, and HAZ. Pitting also occurred in the laboratory control counterpart tests, but not as extensively as for the natural exposure. #1-a (304L/308L, no treatment) of Test 3 (filtered Delaware Bay water, creviced) had a pit located in the heat tint crevice location. #1-a (304L/308L, no treatment) of Test 4 (ASTM synthetic seawater, creviced) also had a pit located in the heat tint crevice location. Figure 15 shows the pits that occurred for the 304L/308L weldments in the creviced tests.

The effect of surface treatment on the 304L weldments was questionable, as corrosion was not particular to as-welded samples. The effect of surface treatment was more evident in areas adjacent to the fusion line, where oxide scale that remained from the welding process produced preexisting crevices, sites for crevice corrosion. It would be appropriate to say that removal of this oxide scale would serve to increase resistance to crevice corrosion at these sites; however, whether this scale could be effectively removed by manual wire brushing is questionable. Although the effects of surface treatment were questionable, effects of surface quality were not. Undesirable effects resulted from weld spatter, which in these cases served as preexisting sites for crevice corrosion.

The 316L weldments also showed pitting, with the largest pit found on #2-a (no treatment) of Test 1 (Delaware Bay, creviced). #2-a of Test 3 (filtered Delaware Bay water, creviced) also had a pit, located in the HAZ crevice location. In regards to surface treatment of coupons, oxide scale remnants on the OD surfaces of many of the coupons served as preexisting crevices for crevice corrosion. Therefore, it would be appropriate to say that removal of the scale would serve to decrease the likelihood that crevice corrosion would occur. However, manual brushing was not adequate in removing all the oxide scale left on the coupons.

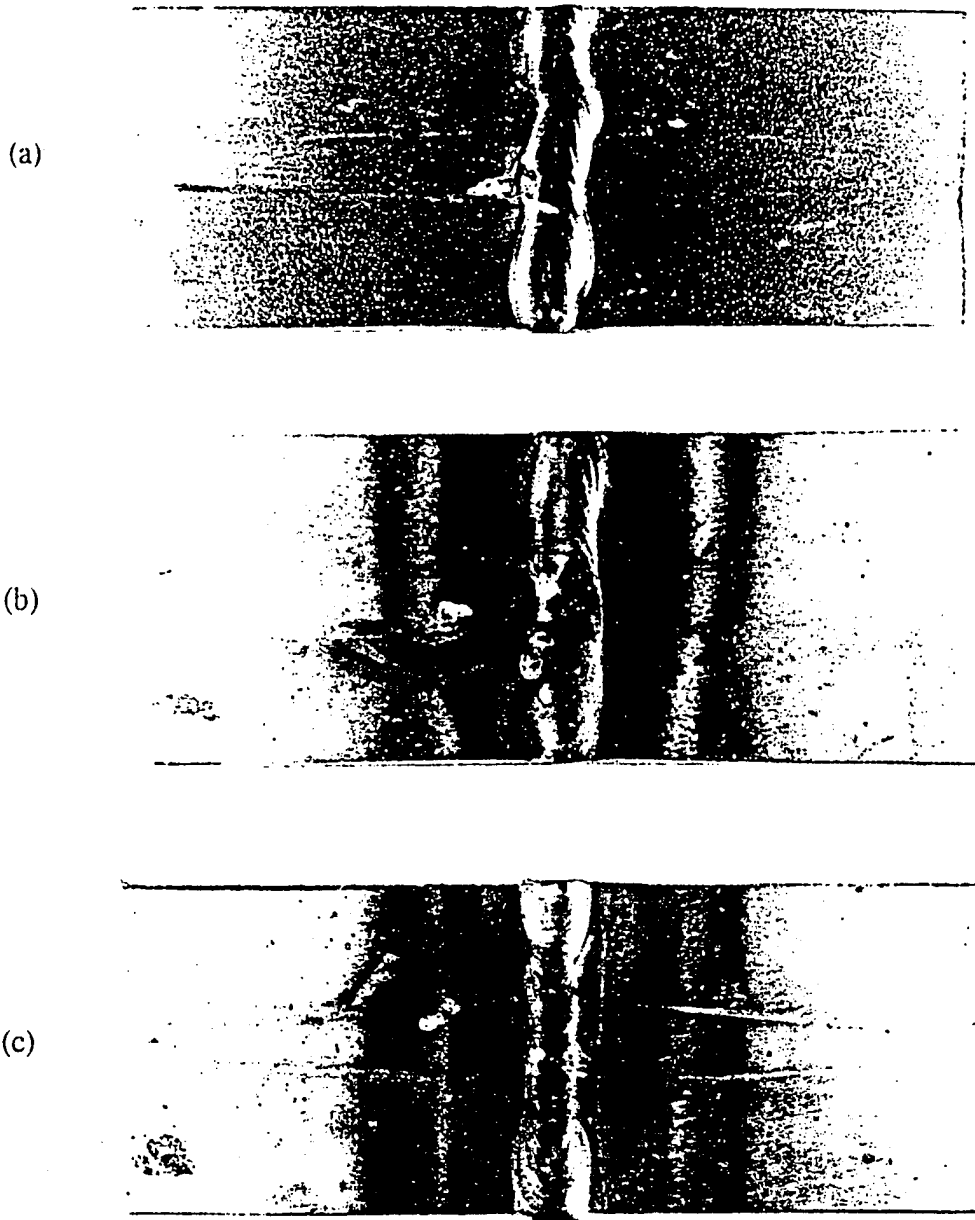

Figure 15. Photographs showing pits that occurred on creviced weldment #1 (304L/308L) coupons: (a) #1-b (brushed) of Test 1 (Delaware Bay, creviced) (b) #1-a (no treatment) of Test 3 (filtered Delaware Bay water, creviced) (c) #1-a (no treatment) of Test 4 (ASTM synthetic seawater).

#2-a of Test 1 was sputtered with gold and examined with the SEM. EDS analysis was performed inside the pit, and outside the pit on an adjacent unaffected area. Certain trends associated with MIC attack are increased chloride and chromium concentration and decreased nickel and iron concentration (in the affected area). None of these relationships were indicated by the EDS analysis.

For the AL-6XN weldments, the corrosion behavior and appearance were different from either of the other stainless alloys tested (304L and 316L). Previous studies performed in the Delaware Bay by Zhang and Dexter showed that even after exposure lasting over two months, crevice corrosion did not initiate for AL-6XN samples in either natural or control seawater, with a conclusion that biofilms did not seem to affect crevice corrosion of AL-6XN (19). However, AL-6XN weldments tested in this study behaved completely differently, showing extensive crevice corrosion in the heat tint region, underneath the silicone rod. Only in Test 1 (Delaware Bay, creviced), where the combined effects of welding, the creviced geometry, and microorganisms were present, did this extent of corrosion occur. When one of these factors was missing, the extent of corrosion was also missing. Slight underrod corrosion did occur for #3-a of Test 3, and #3-b of Test 4, but not penetrating into the metal.

On a side note, there did seem to be some effect of surface treatment on the corrosion behavior of the weld metal. On all of the 3-a (AL-6XN, no treatment) samples, there was distinct (although still minimal) general corrosion of the weld metal, not apparent in the 3-b samples that had been brushed prior to testing.

HY-80 and HSLA-80 steels

Open-circuit potential measurements for weldments #4-b (HY-80, ground) and #5-b (HSLA-80, ground) are shown in Figures 16 and 17. Only data from the ground samples are presented. Data for the brushed samples of HY-80 are not available for Tests 3, 4, and 5 (laboratory control tests). Data for brushed samples of HSLA-80 are not available for Tests 3 and 4. The data that was available for the brushed samples of the various tests were nearly identical to the data shown in Figures 16 and 17.

All plots show an initial drop in potential and then a steady-state corrosion potential value. After this initial drop, a black film formed on the weldment surfaces, and a steady-state corrosion potential existed afterwards. This effect occurred for all the HY-80 and HSLA-80 coupons. In most of the exposures, there was only general corrosion of the weld and base metals. Corrosion was greater in areas of film breakage. Film thickness was greatest for coupons of Test 1 and Test 2 (Delaware Bay exposures). For the HY-80 weldments, corrosion appeared greatest in Test 2 (Delaware Bay, non-creviced). #4-b had two pits located on the weld metal. #4-a had a very non-uniform film, with tiny pits all along the area adjacent to the fusion line, in the HAZ. Of major bearing on the corrosion behavior of the coupons was the extent to which the films formed -- the thicker the film, as in Tests 1 and 2, the more pronounced the corrosion in areas where the film had spalled.

Alloy 400

OCP measurements for the Alloy 400 weldments are shown in Figures 18 and 19. Visual examination showed great differences in the corrosion behavior of the coupons exposed to the Delaware Bay vs. coupons exposed to either of the control media. Coupons from Test 1 and 2 (Delaware Bay) showed extensive attack of the weld metal and fusion line. Coupons from Test 1 showed the same extensive attack of the weld metal, along with areas of

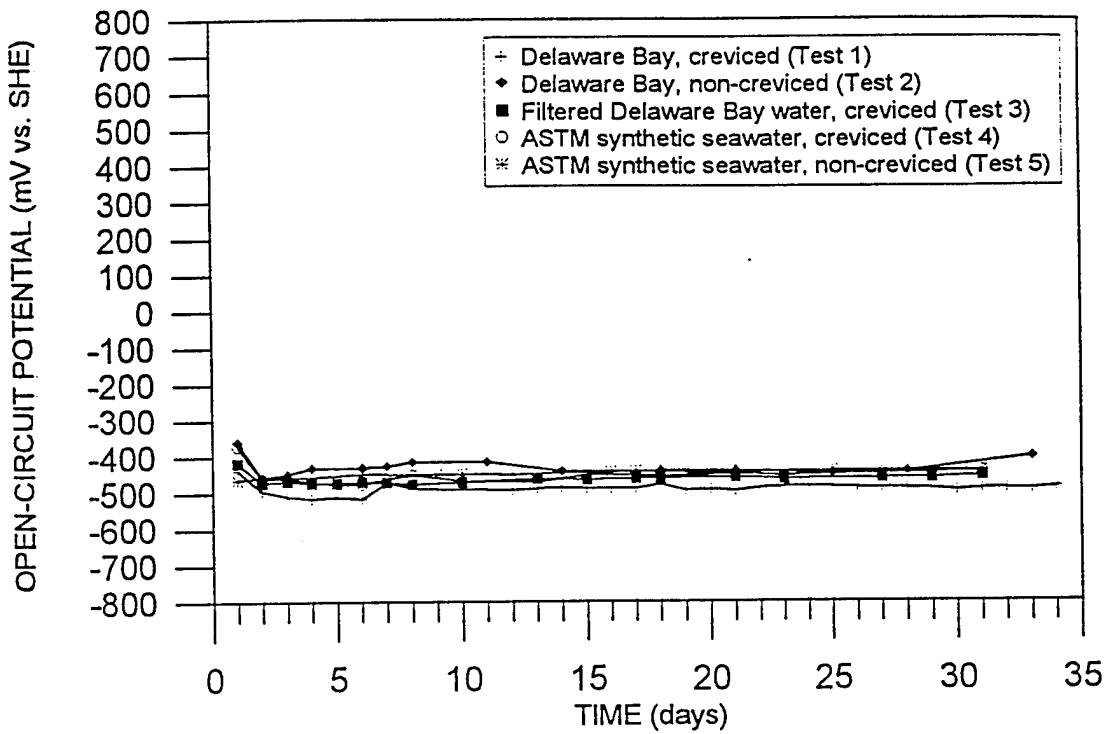

Figure 16. Open-circuit potential vs. time for weldment #4-b (HY-80/E10018, ground).

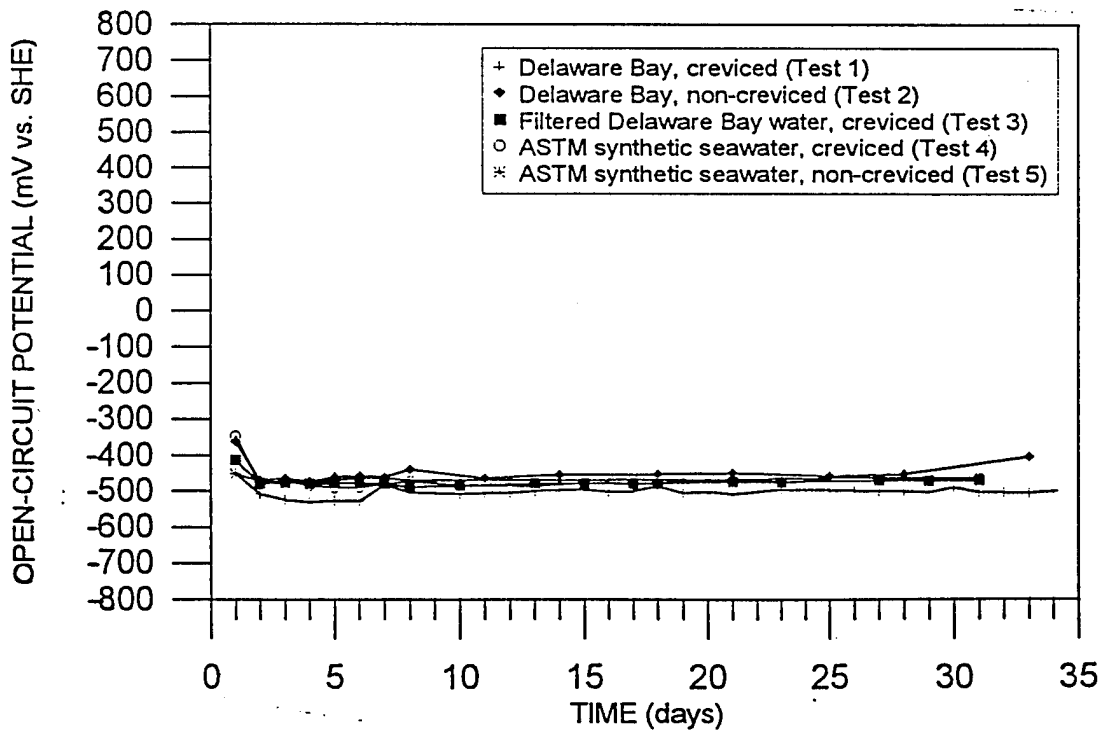

Figure 17. Open-circuit potential vs. time for weldment #5-b (HSLA-80/E10018, ground).

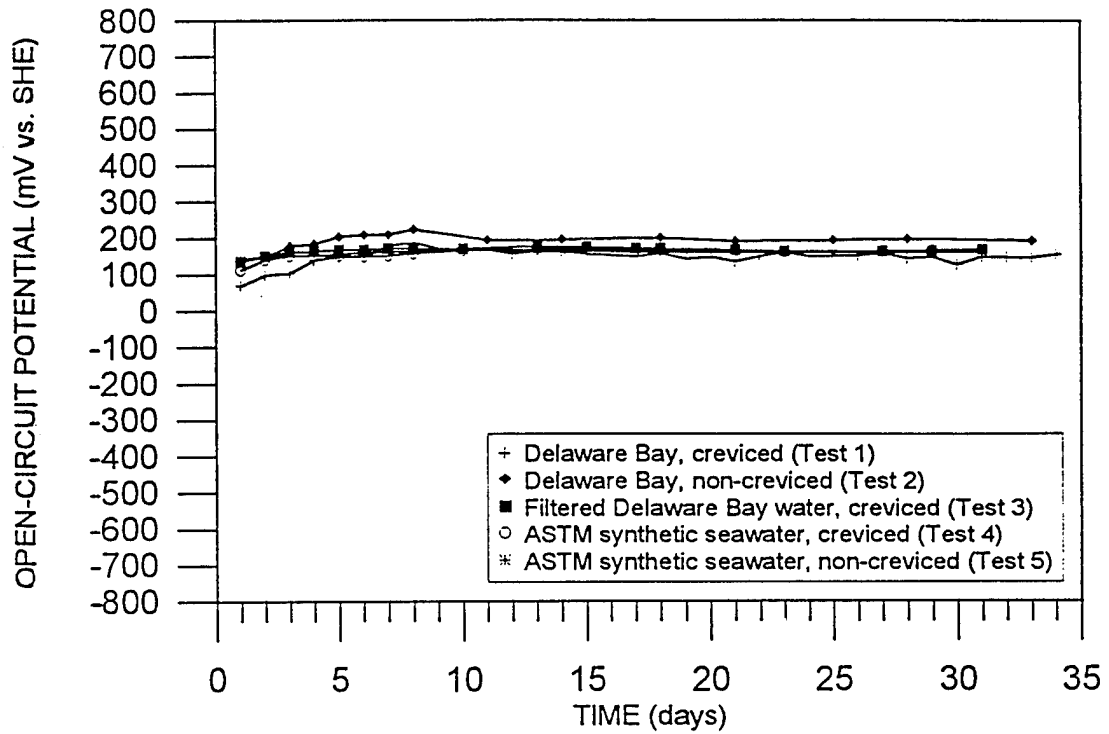

Figure 18. Open-circuit potential vs. time for weldment #6-a (Alloy 400/Alloy 400, brushed).

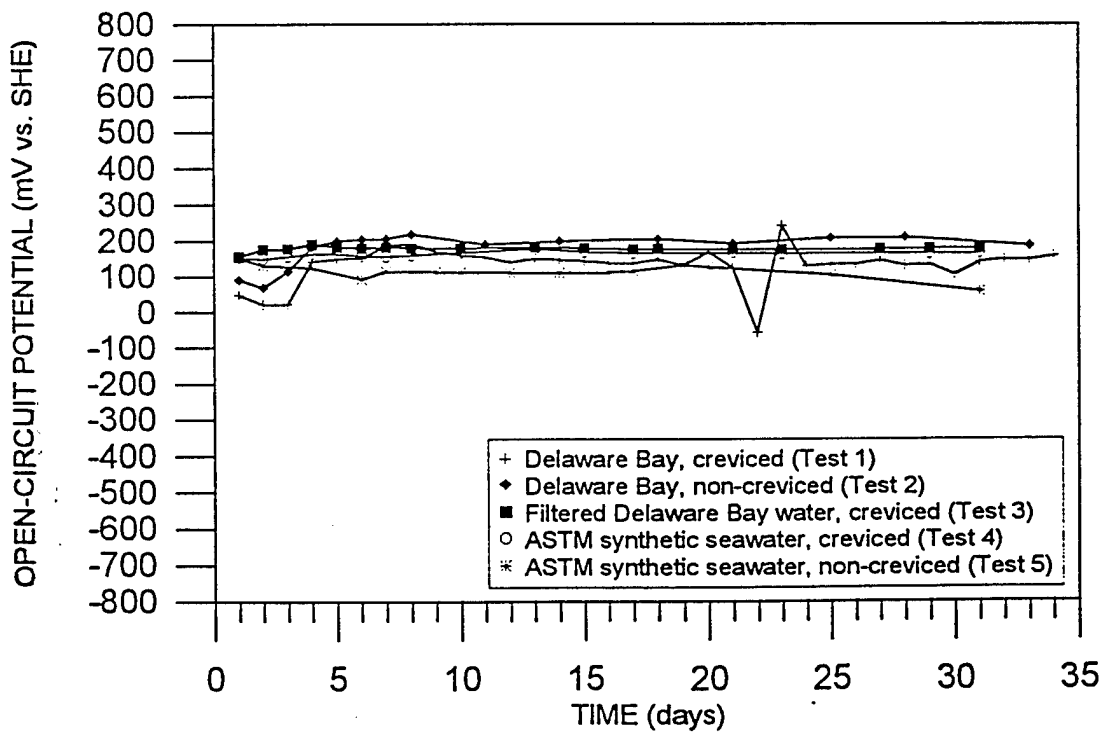

Figure 19. Open-circuit potential vs. time for weldment #6-b (Alloy 400/Alloy 400, ground).

intergranular attack in the base metal where chlorides had built up due to nonuniform crevice conditions that existed across the weldment (this problem will be addressed in a later section). Very tiny pits were evident in all of the ground samples. Due to the surface appearance of the brushed samples, it is unknown whether pits occurred in these samples as well. When corrosion occurred in the laboratory control tests (Tests 3, 4, and 5), it did so at the weld metal, or at areas of chloride buildup in the base metal, but to a much lesser extent than in the natural exposures. For Tests 1 and 2, surface treatment did not play an important role; ground and brushed samples seemed equally attacked. For laboratory tests, however, corrosion seemed to occur more so in preexisting grooves in the weld metal. When these were removed by grinding, the extent of corrosion of the weld metal seemed to diminish.

Alloy 400 has been documented as susceptible to pitting and crevice corrosion attack where chlorides penetrate the passive film. Sulfides present from pollution can cause modification or breakdown of oxide layers. Intergranular attack has been cited in association with SRB (35).

90-10 Cu-Ni

Open-circuit potential data for the 90-10 Cu-Ni weldments are shown in Figures 20 and 21. Coupons from the Delaware Bay exposures (Tests 1 and 2) experienced a slight drop in potential, followed by a slight climb to a steady-state corrosion potential. In both of the Delaware Bay exposures, a heavy dark green-black sulfide film formed on the surfaces. It has been cited that this sulfide film, which forms in waters where sulfides are present, is in most cases, cathodic to the underlying copper or copper alloy. It is in areas of film breakage that corrosion occurs. Indeed, coupons from the natural exposures showed extensive corrosion in the areas where the film was missing. In Delaware Bay exposures, surface treatment seemed to have a large effect on adherence of the sulfide film, with the film being more adherent on the ground surface.

#7-a of Test 1 (Delaware Bay, creviced) was further examined with the SEM. EDS was performed on the film and on an adjacent naked area. Results confirmed the presence of sulfide in the film, and showed a very strong chloride peak as well. Breaks in the sulfide film occurred on the weld metal as well as on the base metal. The film appeared more adherent on the weld metal, as compared to the often flaky appearance of the film on the base metal.

Laboratory exposures did not show the extent of the sulfide film formation or corrosion apparent in the natural exposures. The films that were present appeared light green in some areas, translucent bluish-white in others. Laboratory tests did not show the dependence on surface conditions apparent in the natural exposures.

It was formerly believed that copper-based alloys were toxic to microorganisms. Indeed, copper has proven antifouling properties in relation to macroorganisms. However, studies have shown SRB to be tolerant at least in some levels to copper corrosion products (36). Copper alloys present unique problems in terms of MIC. Corrosion is not merely a problem when bacteria are living, but also when they die. In fact, conditions for corrosion are worsened. Even if cleaned, traces of sulfide can still lead to major corrosion problems (15).

Aluminum 5086

OCP measurements for the aluminum 5086 weldments are shown in Figures 22 and 23. Problems were experienced with regard to testing the aluminum coupons in Tests 3 and 4 (laboratory control tests). Comparison of the results from the first four tests indicated that

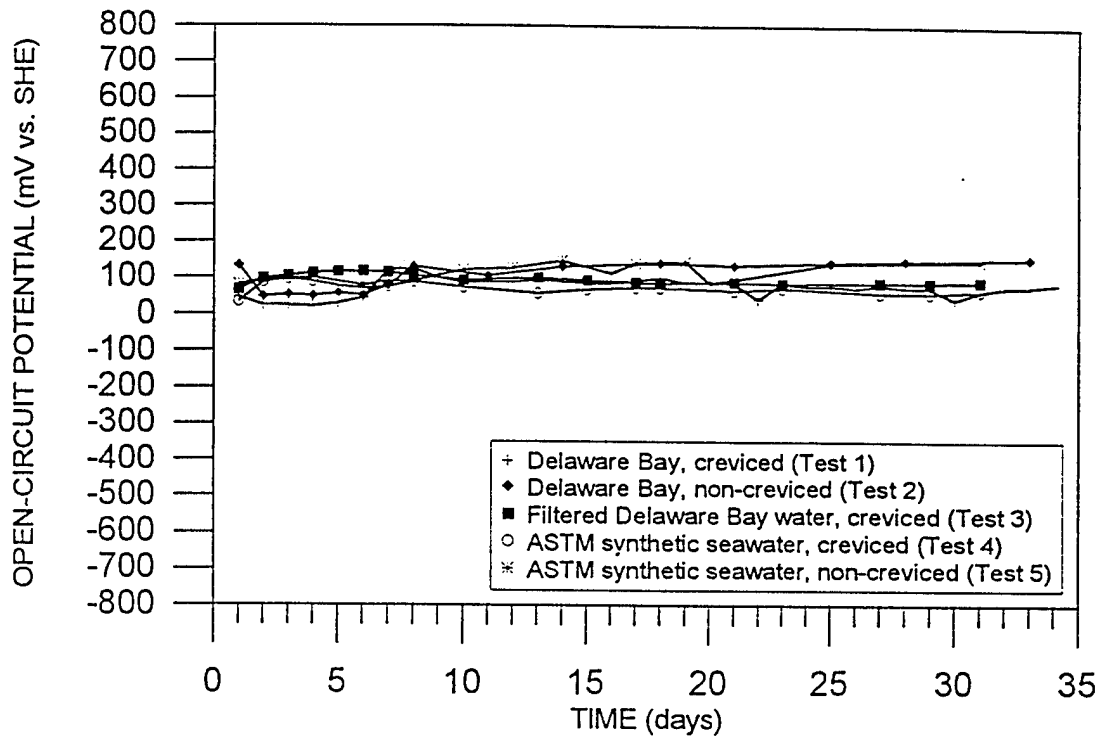

Figure 20. Open-circuit potential vs. time for weldment #7-a (90-10 Cu-Ni/70-30 Cu-Ni, brushed).

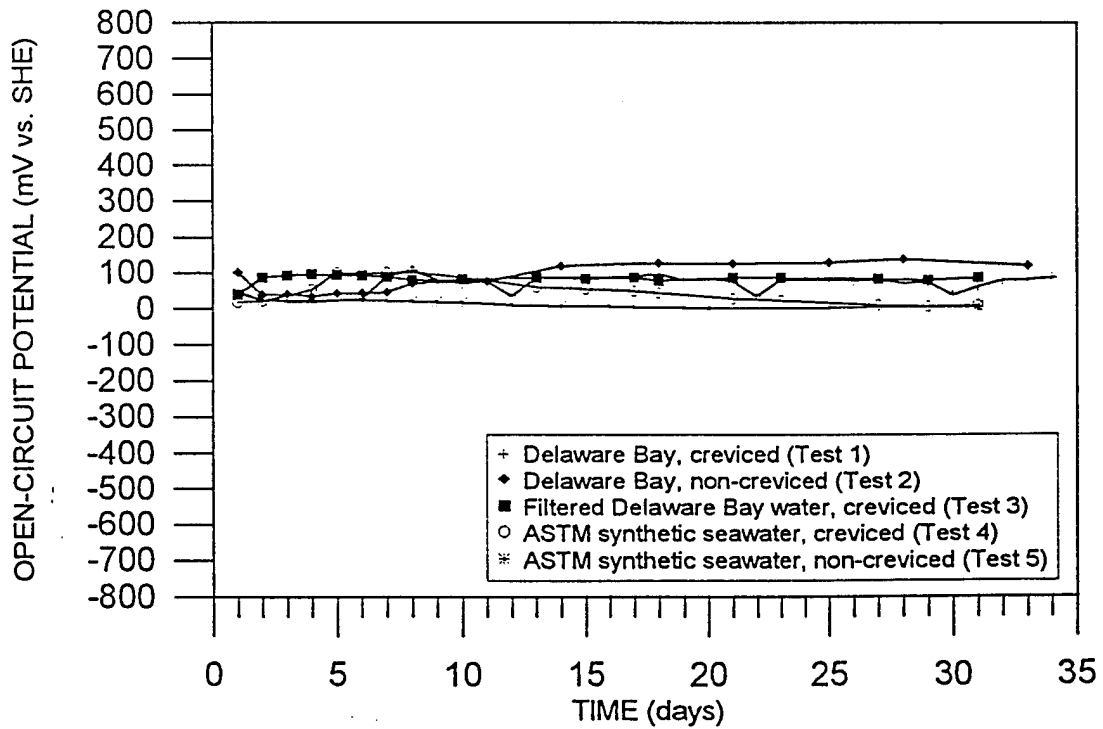

Figure 21. Open-circuit potential vs. time for weldment #7-b (90-10 Cu-Ni/70-30 Cu-Ni, ground).

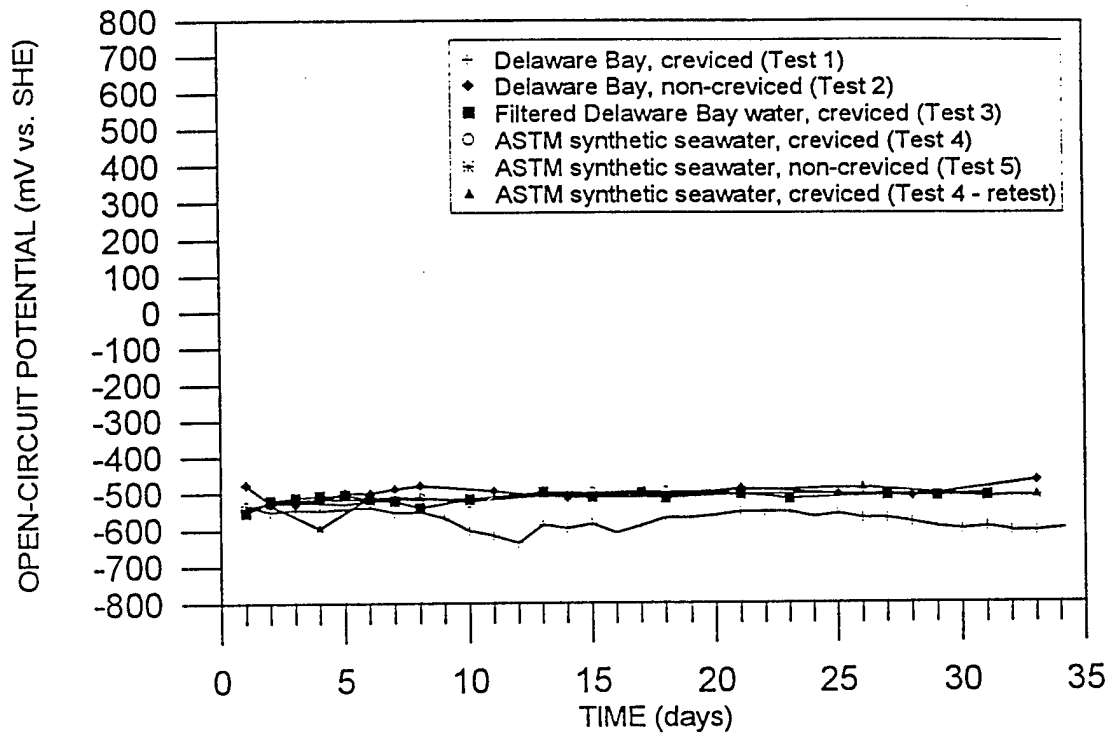

Figure 22. Open-circuit potential vs. time for weldment #8-a (AL 5086/AL 5556, no treatment).

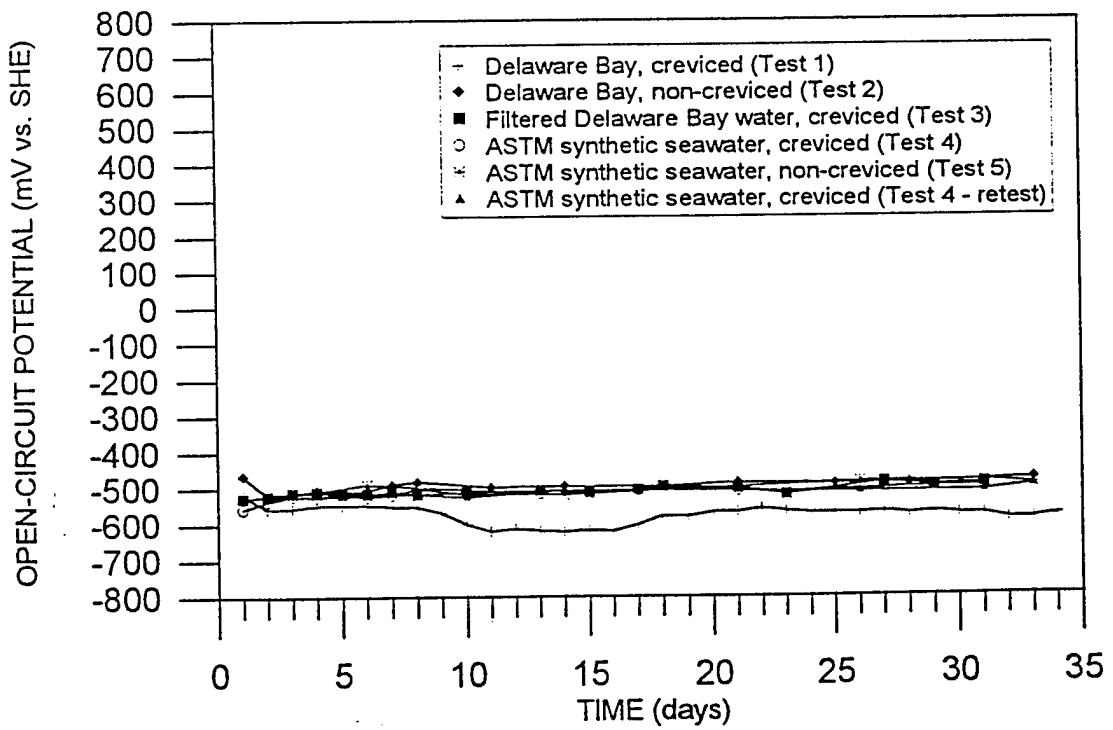

Figure 23. Open-circuit potential vs. time for weldment #8-b (AL 5086/AL 5556, brushed).

corrosion was least in the natural exposures, and greatest in the laboratory tests, in direct contrast to expected results. It was suspected that results from Tests 3 and 4 were misleading, due to the nature of the testing apparatus, which housed the full range of weldments undergoing testing. It is known that aluminum can experience accelerated corrosion in the presence of copper corrosion products, even when copper concentration is as low as 0.2 ppb. This effect has been documented in seawater piping systems with copper alloy pumps (14,15). Copper electrochemically deposits on the aluminum surface and acts as a cathode to the underlying aluminum, leading to pitting and crevice corrosion. This effect has also been documented with iron corrosion products on aluminum (14,15).

In the lab boxes, aluminum weldments were positioned directly next to 90-10 Cu-Ni weldments. There were numerous iron-based weldments in the box as well. Although in the Delaware Bay exposures, copper and iron samples were also present, it is probable that flow in the troughs was great enough to alleviate this problem, unlike the extremely low-flow conditions of the lab boxes.

#8-a of Test 4 was examined with the SEM. EDS analysis was performed on various areas of the weldment, in search of a copper or iron peak. None were found. A possible explanation is that concentrations of iron and copper were low enough to blend in with the background of the EDS scan.

Aluminum weldments were not included in Test 5. These weldments, along with retests of creviced weldments of Test 4 were tested separately from the other weldments. After testing, they appeared to have much less corrosion than for the samples tested in the presence of the full range of weldments.

In relation to tests conducted in the Delaware Bay, minor pitting and crevice corrosion did take place for the coupons in Test 1 (creviced). However, corrosion appeared to take a greater toll on coupons of Test 2 (non-creviced), where there was substantial corrosion of the weld metal. Corrosion was always located at preexisting crevices, such as the grooves that form during the welding passes, and the junction of the weld metal and base metal. Areas of greater attack were marked with small white volcano-like mounds. For Test 1, corrosion was not preferential towards any region of the weldment, occurring at crevice locations along the length of the weldment. For the creviced control tests (Tests 3 and 4) where the coupons showed unexpected severity of attack, corrosion was not specific to any particular regions of the weldment. For the retest, however, the corrosion that occurred did so at the weld metal.

Titanium

Open-circuit potential data for the titanium weldments are presented in Figures 24 and 25. All weldments from Tests 1 and 2 (Delaware Bay) ennobled, with about a 200-300 mV difference as compared to values obtained from the laboratory tests. Unlike the stainless alloy weldments, the presence of a crevice did not serve to lower the potential. Similar to results for the platinum electrodes, measurements for Test 3 (filtered Delaware Bay water, creviced) were slightly higher than for Test 4.

Examination of the titanium weldments revealed no detrimental effects from any of the exposures. All areas of the weldment proved resistant to pitting and crevice corrosion. Schutz, in his review of titanium's resistance to MIC attack, lists several reasons why MIC has not been associated with titanium and its alloys (32). Titanium has an extremely high pitting potential, and therefore, pitting is not a concern. Titanium and its alloys are resistant to ammonia, sulfides, and ferrous ions, all commonly associated with anaerobic activity. They

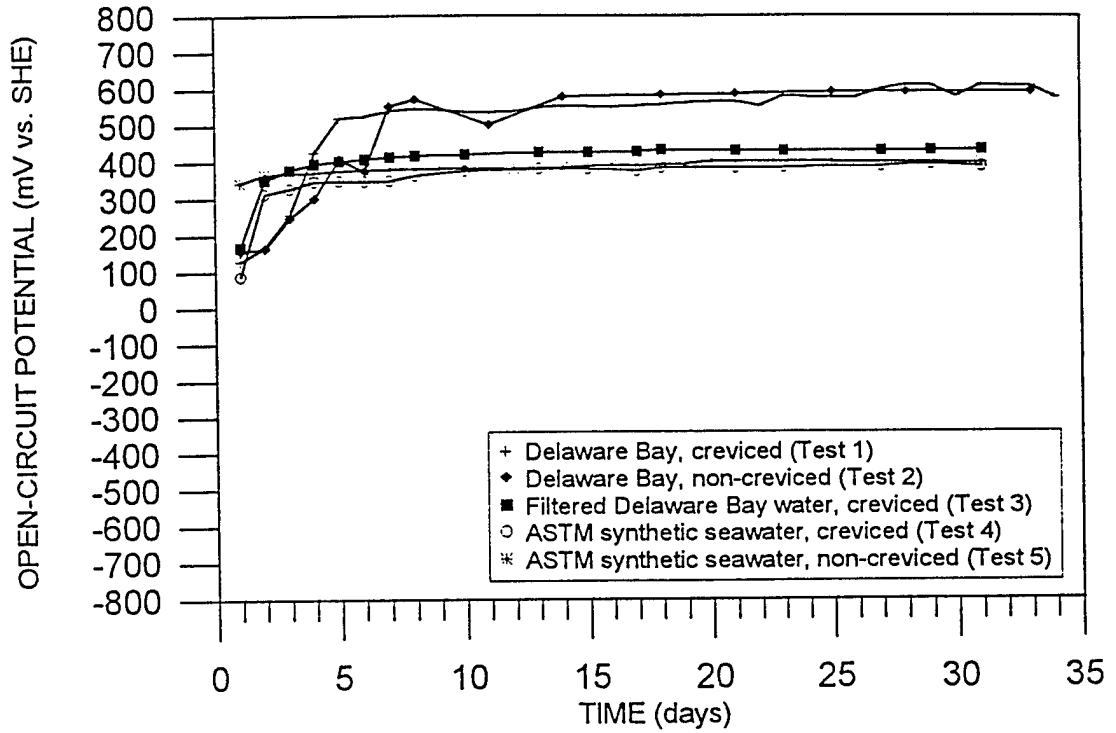

Figure 24. Open-circuit potential vs. time for weldment #9-a (Ti/Ti, no treatment).

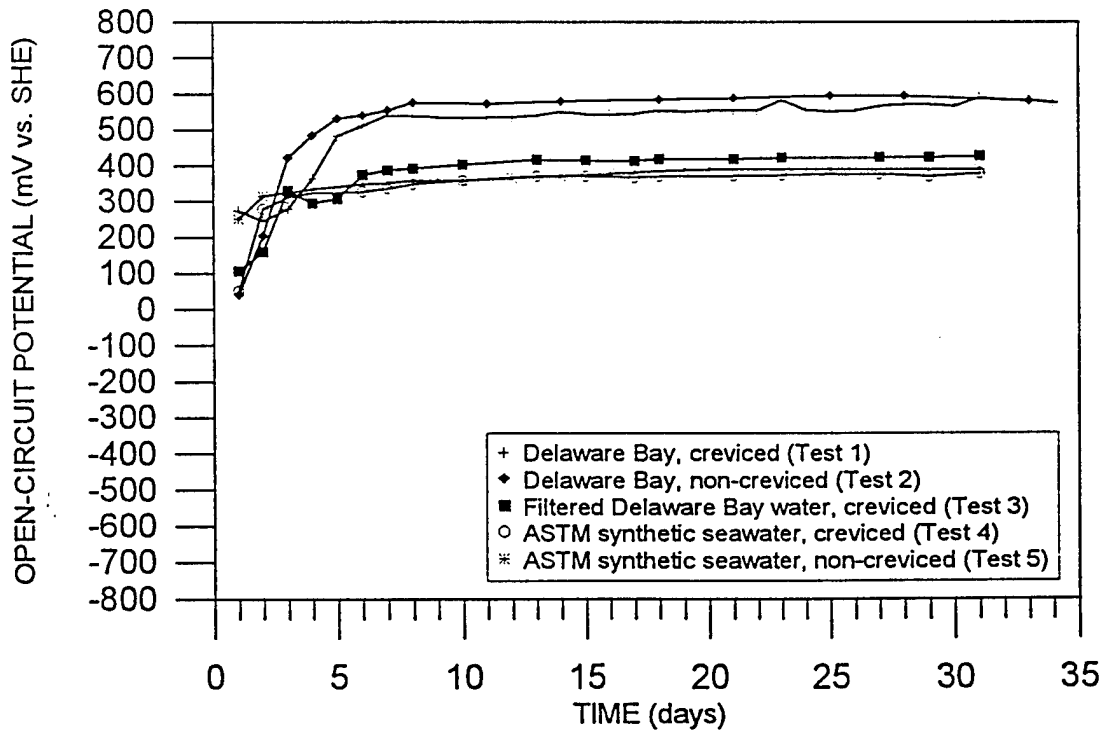

Figure 25. Open-circuit potential vs. time for weldment #9-b (Ti/Ti, brushed).

are also extremely resistant to oxidizing and acidic conditions associated with aerobic activity. Crevice corrosion is not a concern until 75°C, which is above the temperature range for normal microbial activity (although thermophiles can survive in this temperature range).

Microbiological Analysis

Microbiological analyses were performed on several of the non-creviced coupons from Test 2. The samples included HY-80 (brushed), HSLA-80 (brushed), 304L (no treatment), 304L (brushed), 316L (brushed), and one platinum electrode. Analysis was also performed on two water samples, one from mid-high tide (incoming water) and one from mid-low tide (outgoing water).

Biofilms were extracted from the coupons for Phospholipid Fatty Acid (PLFA) analysis. Water samples were filtered through 0.2 micron filters; bacteria that collected on the filter membranes were analyzed. Several notable observations were made from the analysis. Figure 26 shows total biomass estimates, normalized with respect to sample areas. Values from water samples were too small in comparison to be plotted on this graph. They are shown separately in Figure 27. Figure 26 indicates that total biomass was greatest for the carbon/low alloy steel weldments, followed by the platinum electrode, and finally the stainless steels. Biomass estimates for the water samples showed that the outgoing tide from the salt marshes had about twice the total mass as compared to the incoming tide from the Atlantic Ocean.

Figure 28 shows eukaryotic cell numbers that have been normalized with respect to sample areas. Eukaryotes are characterized as having a true cell wall, and include algae, fungi, and higher organisms. The numbers shown in this figure indicate mainly an algal population. Steel weldments showed the greatest numbers, followed by the platinum electrode, and finally the stainless steels. Figure 29 shows a comparison of eukaryotic cell numbers for mid-high and mid-low tides, consistent with results for total biomass estimates; the number for the mid-low tide sample is about twice that for the mid-high tide sample.

Figure 30 shows prokaryotic cell numbers normalized with respect to sample area (prokaryotes include bacteria). The platinum coupons showed the highest prokaryotic cell numbers, followed by the steel weldments, and finally the stainless steel weldments. Water samples showed the same trend previously indicated. As shown in Figure 31, the number for the mid-low tide sample was about twice that of the mid-high tide sample.

HY-80, HSLA-80, and 304L (brushed) gave indications of a strong gram-negative bacterial population. Gram negative refers to bacteria that do not have a double cell membrane and therefore cannot retain the gram stain that is applied. This group which includes the general bacterial population, is indicative of Pseudomonads, a commonly found bacteria, known for its slime-forming abilities, and linked to MIC of stainless steels.

Markers for SRB were identified in the samples, but not at substantial percentages. Due to the relative areas of aerobic vs. non-aerobic portions in the biofilm, SRB input was minor in comparison to the Pseudomonads. The platinum electrode, 316L (brushed), and 304L (brushed) showed the highest markers of SRB. Characteristic markers were found for two commonly known species of SRB, *Desulfovibrio* and *Desulfobacter*, both of which have been linked to MIC of iron and steels. The water samples differed in terms of SRB; the mid-low tide sample contained markers while the mid-high tide sample did not.

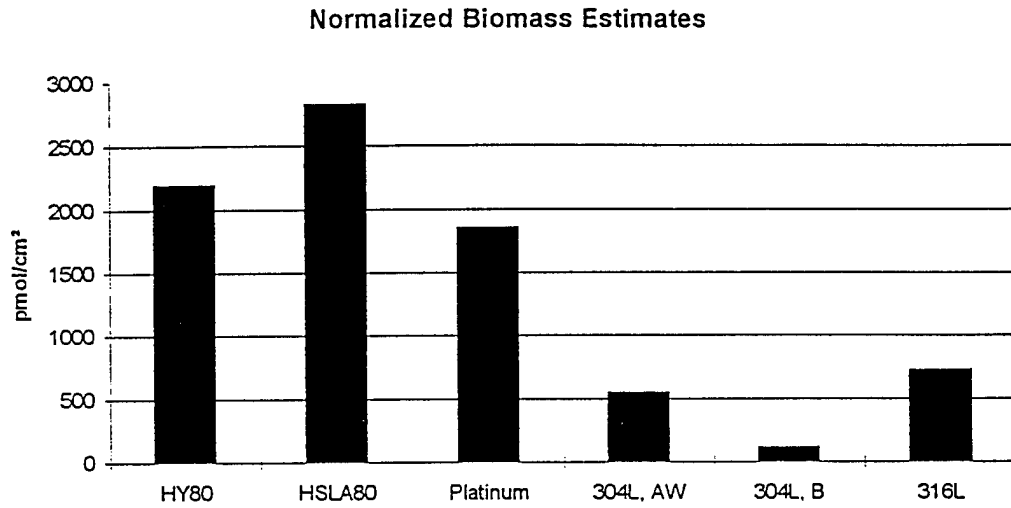

Figure 26. Total biomass estimates for coupons of Test 2 (Delaware Bay, non-creviced).

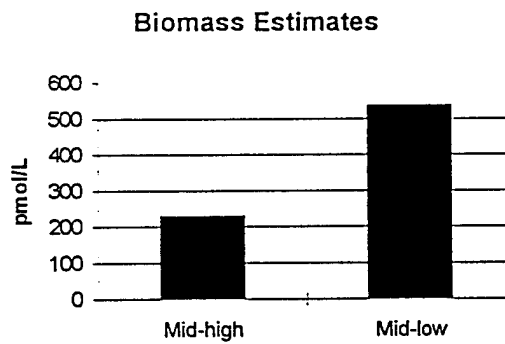

Figure 27. Total biomass estimates for water samples from the Delaware Bay.

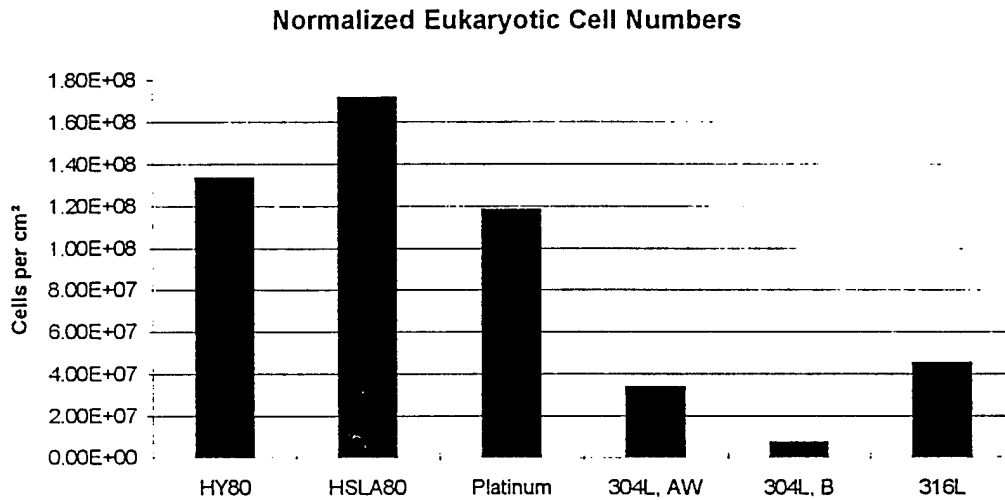

Figure 28. Eukaryotic cell numbers for coupons of Test 2 (Delaware Bay, non-creviced).

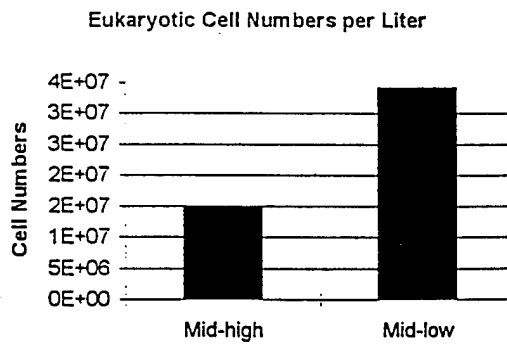

Figure 29. Eukaryotic cell numbers for water samples from the Delaware Bay.

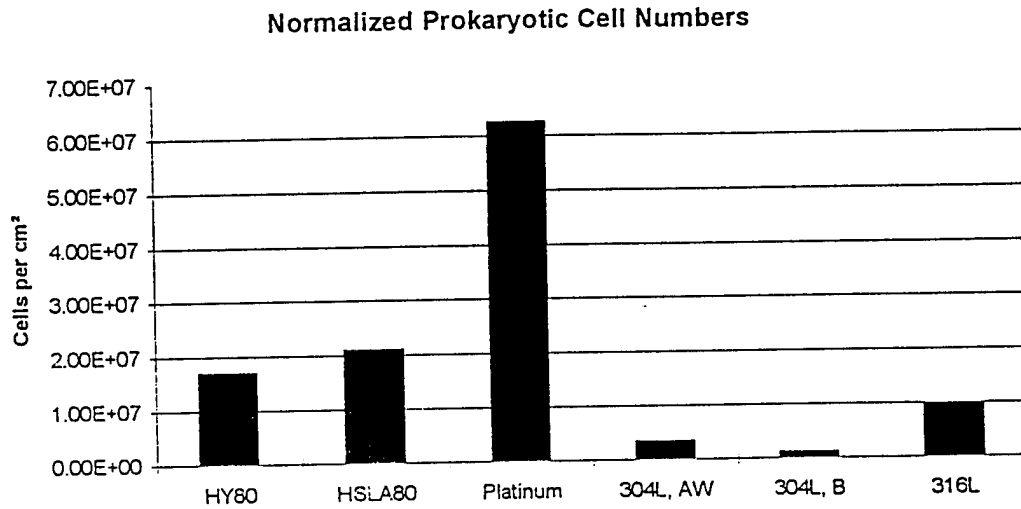

Figure 30. Prokaryotic cell numbers for coupons of Test 2 (Delaware Bay, non-creviced).

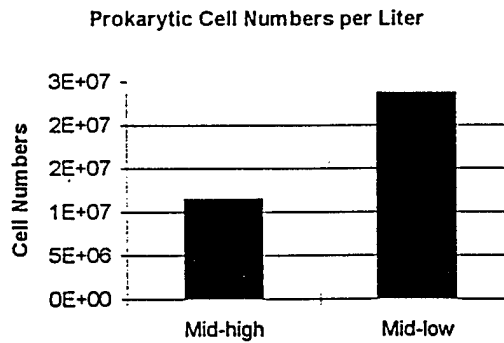

Figure 31. Prokaryotic cell numbers for water samples from the Delaware Bay.

Biofilms were also analyzed for markers of *Thiobacillus*. PFLA analysis gave possible indications of their presence, but showed nothing definitive. Another series of tests called Hydroxy Fatty Acid (OHFA) analysis was performed as well. These tests were performed in order to possibly substantiate the presence of *Thiobacillus*. Results gave many indications that *Thiobacillus* could have been present, but again, nothing conclusive.

It is very interesting to note that in all samples (including water), eukaryotic numbers were greater than prokaryotic numbers. It has been proposed that if algae are present as a substantial percentage of the biofilm, ennoblement should not occur as it would with mainly a bacterial population (26). In these tests, one of the analyzed samples was a platinum electrode, which had ennobled during Test 2. Since algae made up a substantial part of the biofilm, this seems to indicate that the presence of algae in substantial percentages does not hinder ennoblement as has been suggested. It is unknown from these tests whether algal presence enhances ennoblement.

Polarization Resistance Tests

Following exposures, polarization resistance tests were performed on each of the coupons. Surface average corrosion rates obtained from these tests are given in Table 10. Since the wire leads of all stainless alloys in Test 1, and two of the stainless alloys in Test 2, were not functional at the time of testing, no data is available for these coupons. This is unfortunate, as of all the stainless alloys tested, those in Test 1 experienced the most pronounced corrosion. The lack of polarization resistance data for these samples makes it difficult to compare corrosion rates to the other weldments.

It has been cited that the polarization resistance technique may be too simple a model for metals in contact with a biofilm (37). Alteration of the immediate environment, as from a biofilm, may cause nonlinear behavior. Another consideration involves the input of a Tafel constant. No experimental Tafel constants were determined in these runs, and a value of 100 mV was assumed.

However, even in considering these factors, polarization resistance still proved to be the method of choice. Because of the small voltage changes, coupon surfaces are not significantly altered as they are with tests that deviate substantially from E_{corr} values, such as anodic polarization tests. Thereby, surfaces are left in tact for further examination. On a final note, the humidity of the test conditions and the number of samples dictated that tests be made as quickly as possible, a requisite met by the polarization resistance method. It was desired to determine whether results from polarization resistance tests were consistent with results from visual examination. This was relatively easy in some cases, such as the titanium and Alloy 400 weldments, but difficult in the case of the stainless alloys.

Generally, results obtained from polarization resistance tests were consistent with visual examination. For instance, surface-average corrosion rates for Alloy 400 weldments in the Delaware Bay were several orders of magnitude higher than those obtained for laboratory tests. This is consistent with visual examination; the Alloy 400 coupons from the Delaware Bay exposures showed a much greater degree of corrosion than the laboratory tests did. The fact that corrosion of Alloy 400 is so much greater in natural seawater as compared to sterile seawater has been documented by Mollica, et al. (weight losses of specimens immersed for forty days in the two environments were 6 ± 2 mg in sterile and 570 ± 30 mg in natural seawater) (22).

Table 10. Surface average corrosion rates (mpy) obtained from polarization resistance tests.

Weldment Type	Sample Number	Test 1 - Delaware Bay, creviced	Test 2 - Delaware Bay, non-creviced	Test 3 - Filtered Delaware Bay water, creviced	Test 4 - ASTM synthetic seawater, creviced	Test 5 - ASTM synthetic seawater, non-creviced
304L	1-a	---	0.27	0.033	0.086	0.043
	1-b	---	0.22	0.030	0.045	0.043
316L	2-a	---	---	0.081	0.13	0.11
	2-b	---	0.66	0.058	0.065	.063
AL-6XN	3-a	---	0.01	0.036	0.030	.052
	3-b	---	---	0.0035	0.16	.033
HY-80	4-a	2.8	---	---	---	---
	4-b	2.6	4.12	2.43	2.39	2.86
HSLA-80	5-a	2.8	---	---	---	3.57
	5-b	2.5	4.25	2.47	3.05	3.40
Alloy 400	6-a	2.18	4.47	0.058	0.16	0.075
	6-b	2.93	4.75	0.053	0.022	0.024
90-10 Cu-Ni	7-a	0.38	1.01	0.43	0.56	0.79
	7-b	0.48	0.64	0.20	0.20	0.30
AL 5086	8-a	0.15	0.32	0.55	0.59, 0.43*	0.91*
	8-b	0.2	0.17	0.43	0.92, 0.77*	0.53*
Titanium	9-a	0.0015	0.0013	0.0026	0.0017	0.0019
	9-b	0.0009	0.0013	0.0046	0.0031	0.0029

* Indicates surface average corrosion rates obtained from AL 5086 tested separately from the other weldments.

There were, however, some discrepancies in relating surface average corrosion rates to visual examination. For instance, the aluminum weldments showed much greater corrosion in the laboratory tests than in the Delaware Bay exposures. This was consistent with visual examination. However, aluminum weldments were tested again, separately from the other weldments. Although visual examination revealed much less corrosion on the creviced AL 5086 weldments of the retest (as compared to weldments of Test 4), surface average corrosion rates were approximately in the same range.

For AL-6XN and titanium coupons, it was difficult to relate surface average corrosion rates with visual examination. The data obtained for these weldments indicates that corrosion rates were higher for the laboratory tests than for the Delaware Bay tests. The corrosion rates for both of these are so small, however, it is difficult to relate rates to visual examination.

Comparison of Weldments

From the problems discussed earlier (no data available for some samples) and the number of samples tested in each test (2 for each weldment type, one for each surface condition) it is inappropriate to list a definitive ranking of relative resistances to MIC at this time. However, it is possible to compare weldments and their responses to the various testing conditions by showing open-circuit potential data and corrosion-rate data in graphical form.

The final open-circuit potential values for the creviced weldments of Tests 1, 3, and 4 are shown in Figure 32. When possible, the two values per weldment type (per test) were averaged. The final OCP values for the non-creviced coupons of Test 2 and Test 5 are shown in Figure 33.

To conveniently show whether ennoblement occurred for the various weldments in the natural Delaware Bay exposure, differences in final OCP values were determined as the Delaware Bay values minus the laboratory quasi-control values, i.e., the biotic OCP values minus the abiotic OCP values. "Ennoblement" is therefore defined here as a higher OCP in the microbial environment as compared to that in the sterile (or quasi-sterile) environment. Thus, a positive difference indicates ennoblement. These differences in OCP values are shown in Figure 34 for the creviced tests and in Figure 35 for the non-creviced tests.

It is apparent in Figure 35 that ennoblement occurred, at various degrees, for all materials evaluated, even though these materials were widely different and included carbon and low-alloy steels, stainless alloys, a nickel-base alloy, a copper-base alloy, an aluminum-base alloy, and titanium. Clearly, a microbial effect at the Delaware Bay site is responsible for this ennoblement.

Conversely, on inspection of Figure 34, it is seen for the creviced specimens that, in most cases, ennoblement did not occur, i.e., the final OCPs for the creviced Delaware Bay specimens were less than those of the creviced laboratory quasi-control specimens. In a crevice corrosion test, the OCP is a mixed potential between that of the non-creviced surface area and that of the creviced surface area, where the latter is generally deoxygenated, more acidic, contains a higher chloride concentration, and may be undergoing active, localized corrosion. The local OCP at the creviced area is expected to be lower, and increasingly lower with increasing localized corrosion, than the local OCP at the non-creviced area. Therefore, one would expect lower mixed OCPs for the creviced specimens with greater degrees of localized crevice corrosion. Thus the negative OCP differences in Figure 34 could well reflect higher crevice-corrosion rates in the microbial Delaware Bay environment than in the laboratory quasi-sterile environments.

The surface-average corrosion rates for the various weldments, as measured by the polarization resistance method (Table 10), are plotted in Figure 36 for the creviced tests and in Figure 37 for the non-creviced tests. No polarization-resistance data are available for the creviced stainless alloys of Test 1 (these specimens lost their electrical leads during exposure). However, it was possible to measure pit depths (or depths of penetration) for these specimens, which are listed in Table 11, and plotted in Figure 38.

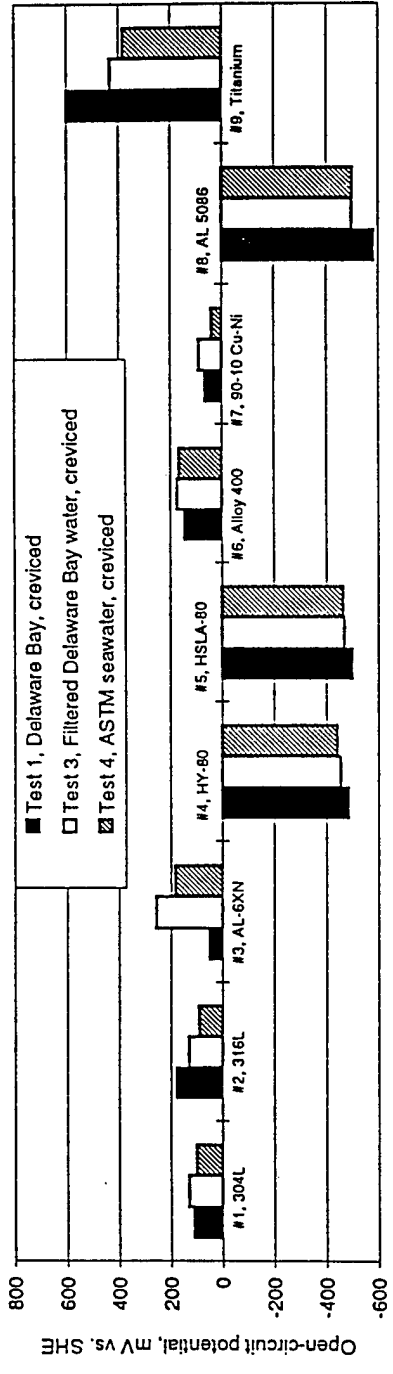

Figure 32. Final open-circuit potential values for the creviced tests.

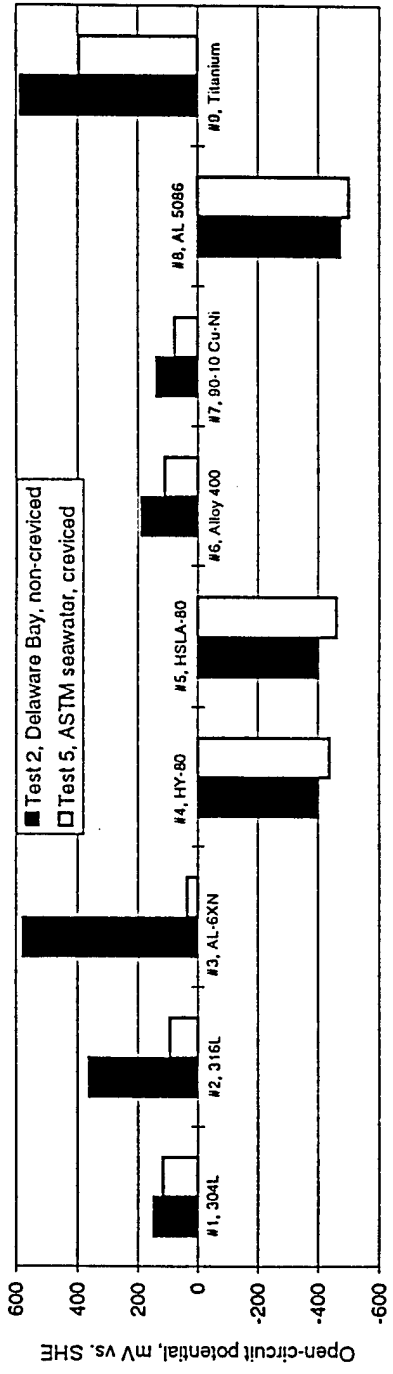

Figure 33. Final open-circuit potential values for the non-creviced tests.

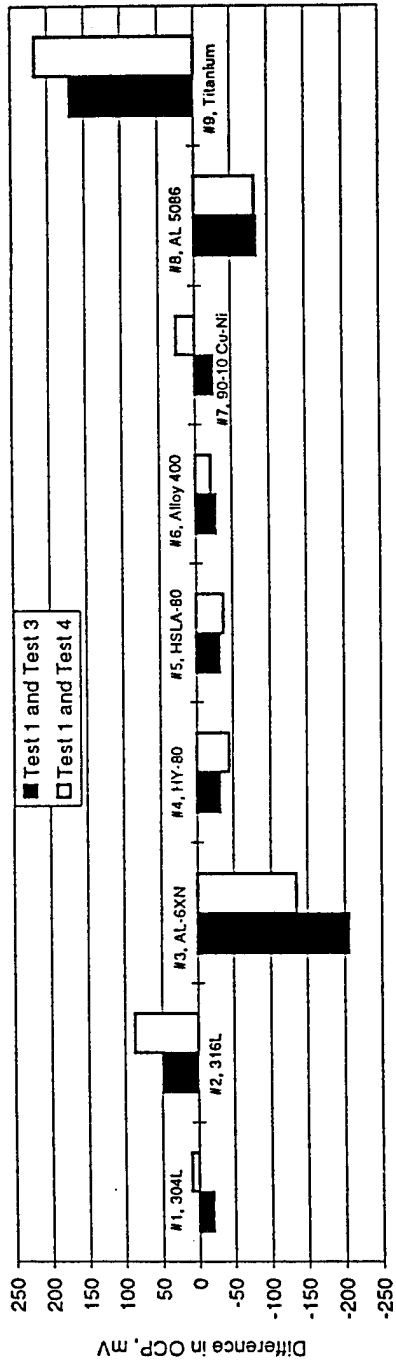

Figure 34. Differences in final open-circuit potential values between the creviced test of the Delaware Bay and its laboratory counterpart tests.

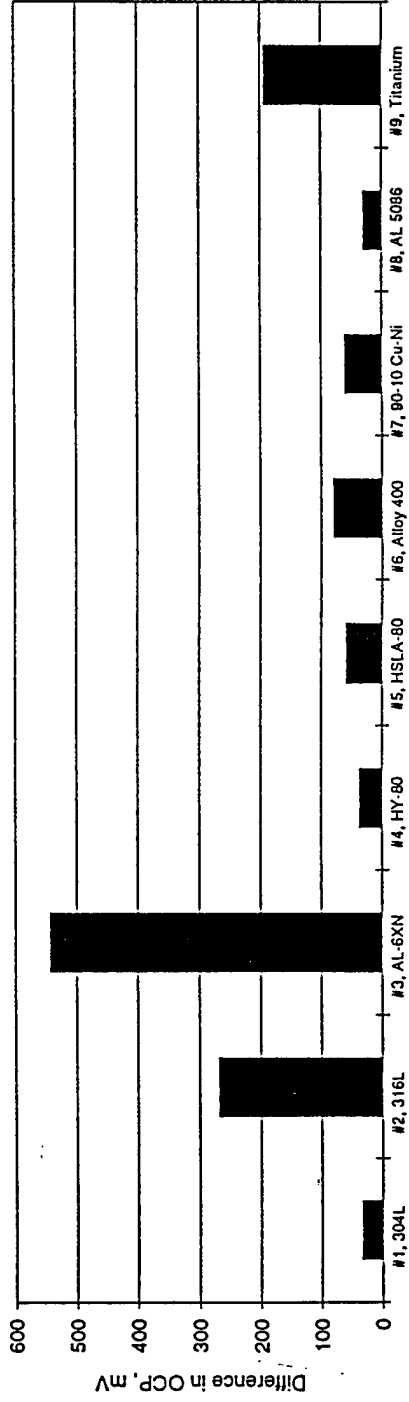

Figure 35. Difference in final open-circuit potential values between the non-creviced test of the Delaware Bay and its laboratory counterpart test.

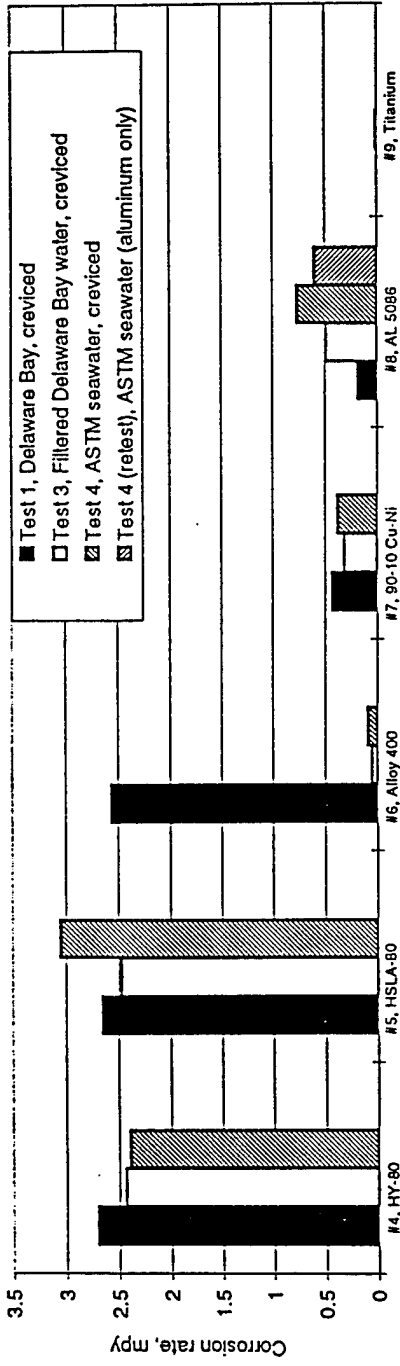

Figure 36. Surface-average corrosion rates obtained from the creviced tests.

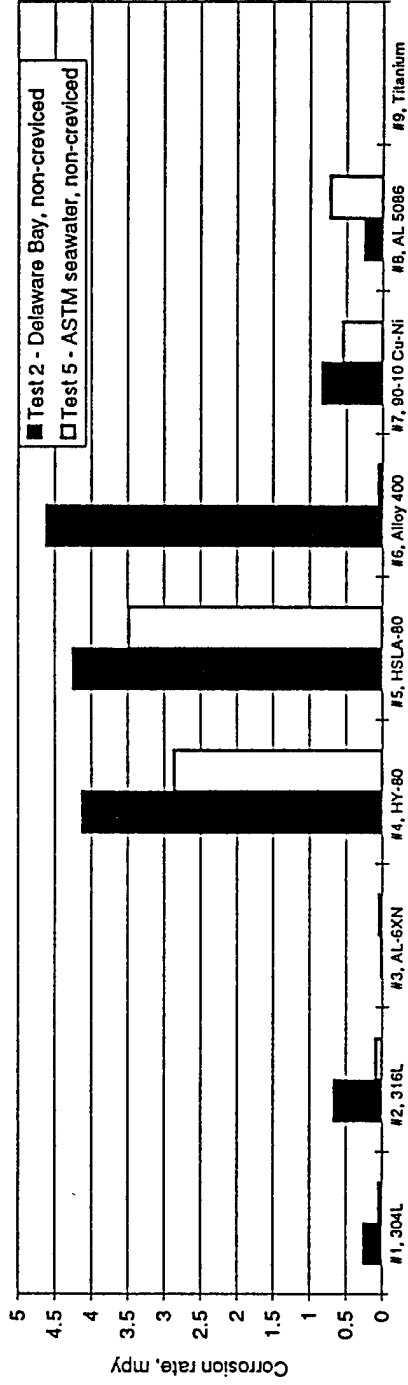

Figure 37. Surface-average corrosion rates obtained from the non-creviced tests.

Table 11. Penetration depths for the stainless alloy weldments.

Sample	Test	Pit or Penetration Location	Penetration Depth (mils)
#1-b (304L)	1 - Delaware Bay, creviced	HAZ, weld metal, fusion line	32
#1-a (304L)	3 - Filtered Delaware Bay water, creviced	HAZ	11
#1-a (304L)	4 - ASTM synthetic seawater, creviced	HAZ	12
#2-a (316L)	1 - Delaware Bay, creviced	HAZ	14
#2-a (316L)	3 - Filtered Delaware Bay water, creviced	HAZ	6
#3-a (AL-6XN)	1 - Delaware Bay, creviced	Heat tint, underneath rods, back surface of coupon	3

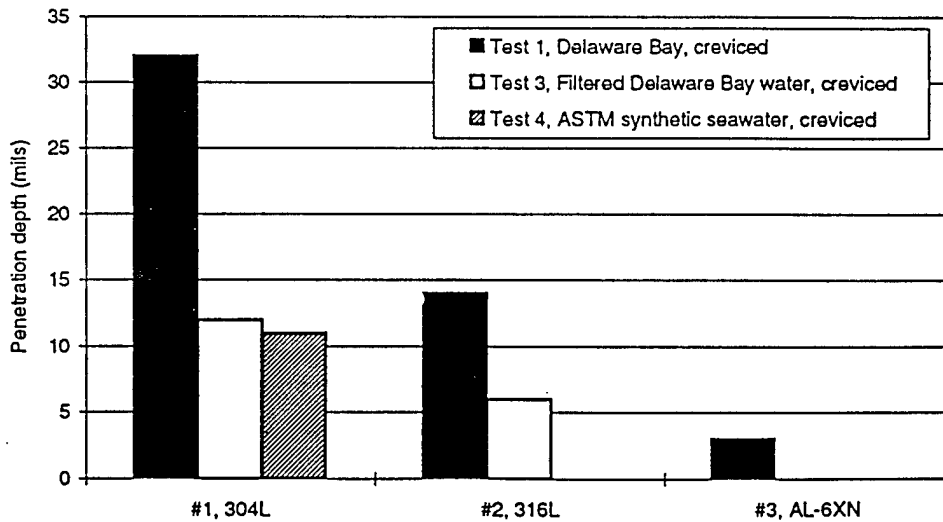

Figure 38. Penetration depth for the stainless alloy weldments.

In order to more conveniently evaluate and show the effects of the microbial environment on the corrosion behaviors of the various weldments, a MIC factor, f_{mic} , is defined as follows:

$$f_{mic} = CR_{biotic} / CR_{abiotic}$$

where CR_{biotic} is the corrosion rate in the biotic environment (natural Delaware Bay water) and $CR_{abiotic}$ is the corrosion rate in the abiotic environment (laboratory quasi-sterile controls). From the present data, f_{mic} values were calculated, and are shown in Figures 39 and 40 for the creviced and non-creviced weldments, respectively. In most cases, the f_{mic} calculations were based on the polarization-resistance surface-average corrosion-rate results of Table 10. For each creviced weldment, CR_{biotic} was taken as the average of the results for the two surface conditions in the Delaware Bay (Test 1) and $CR_{abiotic}$ was taken as the overall average of the results for the two surface conditions in the filtered Delaware Bay water (Test 3) and the ASTM synthetic seawater (Test 4). For each non-creviced weldment, CR_{biotic} was taken as the average of the results for the two surface conditions in the Delaware Bay (Test 2) and $CR_{abiotic}$ was taken as the average of the results for the two surface conditions in the ASTM synthetic seawater (Test 5). However, polarization-resistance results were not available for the 304L, 316L and AL-6XN weldments in the creviced condition. In these cases, f_{mic} values were calculated based on the as-measured maximum corrosion penetration depths of Table 11.

Normally, with regard to MIC (microbially influenced corrosion), one thinks of the influential effect as being corrosion acceleration. However, the influential effect may also be corrosion inhibition. With reference to Figures 39 and 40, when $f_{mic} = 1$, there is no microbial influence. When $f_{mic} > 1$, the microbial influence is one of corrosion acceleration; and when $f_{mic} < 1$, the microbial influence is one of corrosion inhibition. It is seen in Figures 39 and 40 that, for both the creviced and non-creviced conditions, the microbial influence produced significant corrosion acceleration for the 304L, 316L, Alloy 400 (Monel 400), and 90-10 Cu-Ni weldments. The greatest acceleration occurred for the Alloy 400 weldments. Also, generally, the microbial influence produced corrosion acceleration for the carbon steels, HY-80 and HSLA-80, but to a smaller degree than the previously-listed alloys. On the other hand, for both the creviced and non-creviced conditions, the microbial influence produced corrosion inhibition for the aluminum alloy, 5086, and for titanium. The AL-6XN showed different responses in the creviced and non-creviced conditions. In the non-creviced condition, AL-6XN remained passivated and the microbial influence produced corrosion inhibition. However, in the creviced condition, the microbial influence produced corrosion acceleration. In the creviced condition, localized corrosion occurred in the biotic Delaware Bay water, but did not occur in the nominally abiotic laboratory control tests. Hence, f_{mic} was some number greater than one, and is shown as a vertical arrow in Figure 39.

In order to further the process of developing a definitive ranking of the MIC susceptibility of the various weldments, it is necessary to continue this testing program, collect missing critical data, and provide more replication of results. However, the results just discussed indicate trends that occurred in the tests performed thus far, and serve as initial results in the development of a ranking of weldments in terms of their susceptibility to MIC under marine conditions.

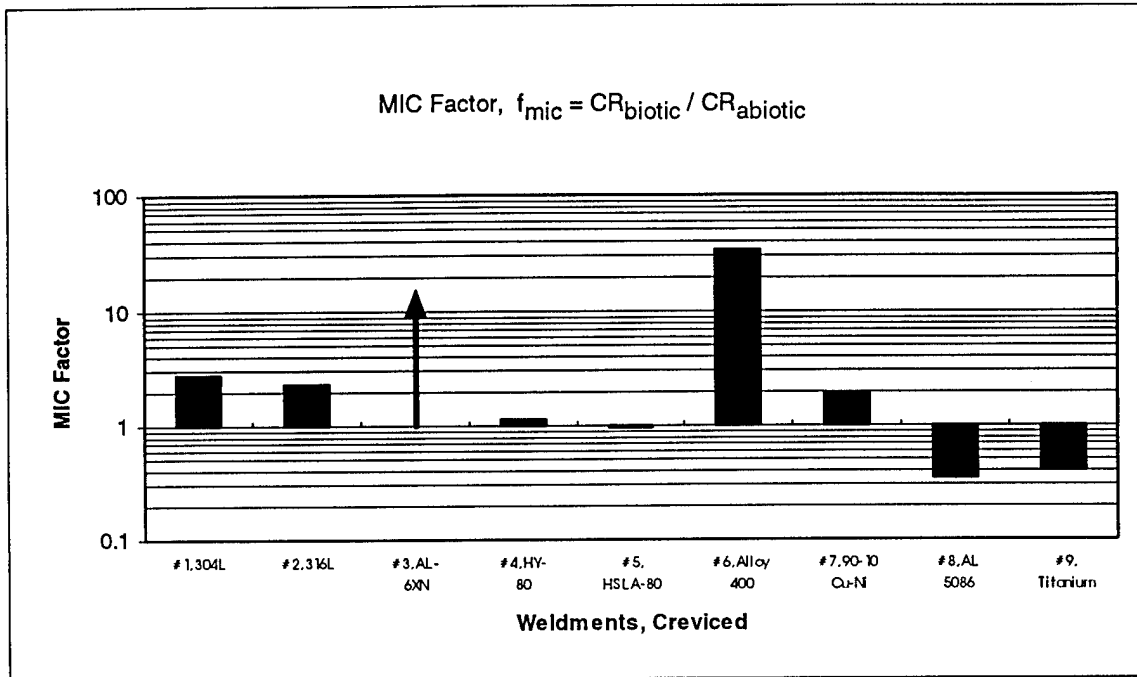

Figure 39. MIC factors for creviced weldments.

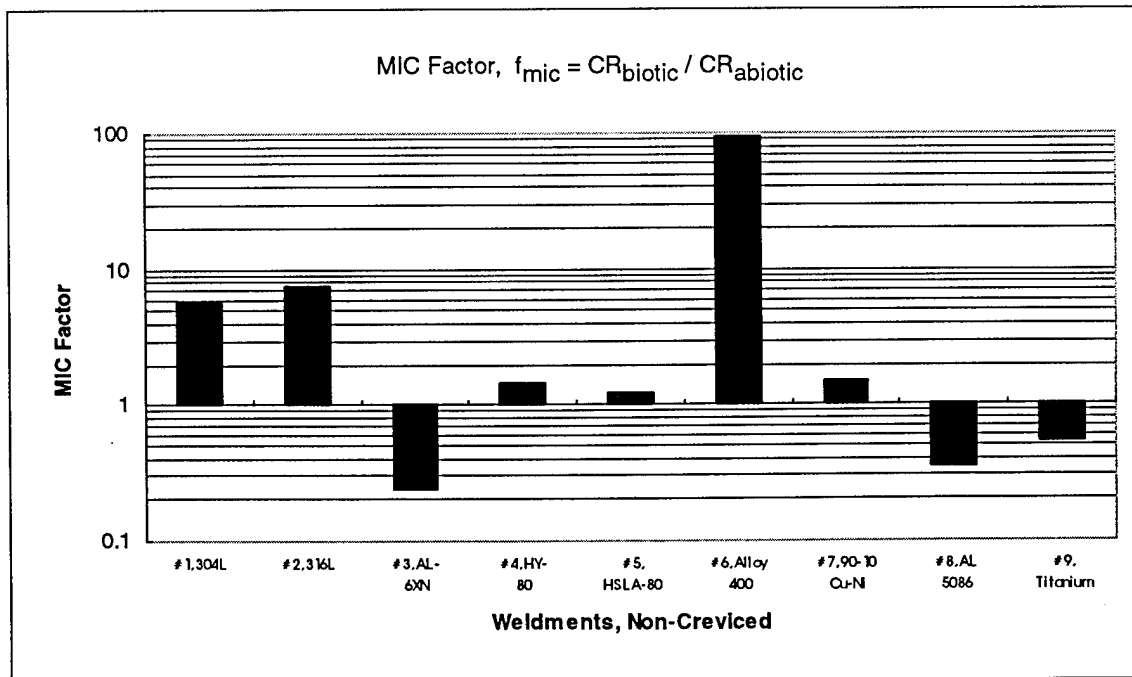

Figure 40. MIC factors for non-creviced weldments.

Summary and Conclusions

- Weldments representative of a range of marine structural materials were exposed to a natural marine environment which was known from previous studies to induce microbially influenced corrosion (MIC). The natural environment was at a University of Delaware site on the Delaware Bay, Lewes, Delaware, with the kind cooperation of Dr. Stephen C. Dexter. Companion laboratory control tests were conducted at the University of Tennessee in 0.2 μm filtered Delaware Bay water and in synthetic seawater. The natural and control tests were conducted with weldments in both creviced and non-creviced conditions. Corrosion rates (polarization-resistance measurements and microscopic examinations) and open-circuit potentials (OCPs) were evaluated for all tests. The weldments studied were: 304L, 316L and AL-6XN stainless alloys; HY-80 and HSLA-80 low-alloy steels; Alloy 400 (Monel 400) Ni-Cu alloy; 90-10 Cu-Ni alloy; 5086 aluminum alloy; and unalloyed titanium. This project design for studying MIC proved to be very successful. A ranking of alloy susceptibility to the enhancement of corrosion by microbial effects was developed. This ranking methodology presents a unique means of comparing alloy response in MIC environments. In addition, the following tentative conclusions are drawn concerning the corrosion behavior of the weldments:
 - 1) On comparison of the corrosion rates in the natural Delaware Bay water with those in the laboratory control tests, it was determined that the microbial influence was one of significant corrosion acceleration for the 304L, 316L, Alloy 400, and 90-10 Cu-Ni weldments, with Alloy 400 experiencing the greatest degree of acceleration. Corrosion acceleration also occurred for the low-alloy steel weldments, HY-80 and HSLA-80, but to a smaller degree. On the other hand, the microbial influence resulted in corrosion inhibition for the aluminum alloy, 5086, and titanium weldments. For the AL-6XN weldment, the microbial influence produced corrosion acceleration in the creviced condition, but corrosion inhibition in the non-creviced condition. The microbial influence was quantified by means of a MIC factor, f_{mic} , which was defined as the ratio of the biotic corrosion rate in the natural Delaware Bay water over the abiotic corrosion rate in the laboratory control tests. Depending on the weldment, the MIC factor ranged from 1.1 to 92 when corrosion acceleration occurred, and from 0.3 to 0.5 when corrosion inhibition occurred.
 - 2) Of the weldments tested, those where corrosion was preferential to the weld-modified region included 304L, 316L, AL-6XN, Alloy 400, and AL 5086 (in retests). Those weldments that did not experience preferential attack of weld-modified regions included HY-80, HSLA-80, 90-10 Cu-Ni, and titanium.
 - 3) In the non-creviced condition, ennoblement of the open-circuit potential (OCP), at various degrees, relative to the laboratory control tests, occurred for all weldments. Clearly, a microbial effect at the Delaware Bay site was responsible for this ennoblement (higher OCP values). For the creviced condition, in most cases (with the major exception of titanium), ennoblement did not occur. Rather,

the OCPs in the natural microbial environment were less than those in the laboratory control environments -- a result that could be rationalized in terms of higher crevice-corrosion rates in the natural microbial environment.

- 4) Titanium weldments proved most corrosion resistant, regardless of the environment, presence or absence of a crevice geometry, or surface condition.
- 5) Alloy 400 weldments experienced the greatest difference in corrosion behavior for the Delaware Bay exposures vs. the laboratory control tests. Corrosion occurred to much greater extents in the samples exposed to the natural environment. The majority of corrosion took place on the weld metal and fusion line. Grinding the surfaces seemed to have a beneficial effect only in the laboratory tests.
- 6) AL-6XN weldments displayed corrosion behavior completely different from non-welded AL-6XN coupons that had previously been tested by the University of Delaware. Significant corrosion occurred at crevice locations, confined to the heat affected zone. A combination of welding, a crevice geometry, and microorganisms was necessary for the extent of corrosion that occurred. When any of these factors was missing, the extent to which corrosion occurred was minimal.
- 7) 90-10 Cu-Ni weldments formed heavy sulfide films in the natural waters, but not in the control tests. Films covered all regions of the weldment. It was in places where the film had spalled that very noticeable corrosion occurred. Corrosion did not appear to be preferential to any particular region. Surface condition seemed to have an important effect. Grinding the surfaces allowed better adherence of the sulfide film; less spalling, and therefore, less corrosion occurred for these samples.
- 8) Pitting occurred on 304L and 316L creviced samples, regardless of whether or not a microbial factor was present. Pits were confined to the crevice location, in either the heat affected zone, weld metal, or fusion line. The largest pits occurred in the samples that had been exposed to the Delaware Bay.
- 9) In the Delaware Bay, weldments were exposed to a full range of organisms, including SRB, Pseudomonads, and algae, with a possibility of *Thiobacillus* present as well. Microbiological analysis revealed that the ratio of eukaryotic biomass to prokaryotic biomass was always greater than one. This implies that the presence of photosynthetic microorganisms does not hinder ennoblement. It is unknown from these tests whether algal presence enhances ennoblement.
- 10) In order to further the process of developing a definitive ranking of the MIC susceptibility of the various weldments, it is necessary to continue this testing program, collect missing critical data, and provide more replication of results. However, the present results indicate trends that occurred in the tests performed

thus far, and serve as initial results in the development of a ranking of weldments in terms of their susceptibility to MIC under marine conditions.

- The initial efforts to achieve MIC under controlled laboratory conditions for the prototype 304L/308L weldment were not successful, in spite of numerous variations in experimental procedures, including different cultured marine microbial consortia, nutrients, dilution rates, degrees of aeration, exposure times, and methods of analysis. The results of the bacterial tests were basically indistinguishable from the results of the control tests. It was concluded that the cultured marine bacterial consortia employed simply did not replicate all of the critical features of a natural marine consortium of microorganisms.

Recommended Additional Research

Summary of Tasks and Objectives

The recommended additional research activities are organized into the following three sets of tasks and objectives. Each will be discussed and justified in the following sections.

- I. Collection of data to fill critical "missing gaps" in the present study and replication of critical results.
- II. Evaluation of anodic polarization behaviors of weldments to provide the necessary link between the observed increased, or decreased, corrosion rates in the natural biotic environment (relative to quasi-sterile control values) and the observed microbial ennoblement of open-circuit potentials (i.e., corrosion potentials, E_{corr}) in the natural biotic environment.
- III. Based on the information and insights gained in the present study, development of an abiotic laboratory screening test for microbially influenced corrosion (MIC).

Task I -- Collection of Missing Data and Replication of Critical Results

It is recalled that certain polarization-resistance corrosion-rate data are missing because of the loss of electrical contact to the weldment coupons due to crevice corrosion of the epoxy-coated electrical contact leads. This occurred during the first Delaware Bay exposure involving creviced weldment coupons, and specifically for the stainless steel specimens, i.e., the 304L, 316L and AL-6XN weldments. The problem was solved and polarization-resistance data were collected for essentially all weldments in all subsequent tests. However, this missing data made the subsequent corrosion-rate data analysis in terms of the MIC factor, f_{mic} , somewhat questionable. Recall that f_{mic} was defined as the biotic corrosion rate (Delaware Bay) over the abiotic corrosion rate (quasi-sterile controls). For all weldment materials except the stainless steels, f_{mic} was based on polarization-resistance corrosion rates. However, for the stainless steels, f_{mic} had to be based on microscopically-measured maximum corrosion penetration values (localized corrosion in these cases). Therefore, over the full range of weldments, the calculated MIC factors were based on two different types of corrosion-rate measurements. This fact could raise questions as to the validity of the overall weldment comparisons in terms of the relative influence of the microbial environment on corrosion rate. Consequently, we believe it absolutely necessary to repeat Test 1 (Delaware Bay exposure, creviced weldments) and collect the missing polarization-resistance data.

Furthermore, because some of the corrosion-rate results in the Delaware Bay exposures were somewhat unexpected, we believe it would be wise to replicate these tests for the rest of the weldment materials (in addition to the stainless steels) in both the creviced and non-creviced conditions (i.e., complete replication of Tests 1 and 2 of the present study).

After the exposures and polarization-resistance testing, all weldment coupons will be examined for type, location and extent of corrosion. Methods will include visual examination, light optical microscopy and scanning electron microscopy (with energy dispersive spectroscopy, as needed).

Task II -- Evaluation of Anodic Polarization Behaviors

Even with the "missing data" problem described above, this project has, nevertheless, resulted in quantitative descriptions of the effects of the natural microbial environment on corrosion rates for a range of weldment materials (i.e., the MIC factors, f_{mic}) and a corresponding collection of open-circuit potentials (i.e., corrosion potentials, E_{corr}) for these weldments showing that, for the non-creviced condition, ennoblement occurred in every case (i.e., E_{corr} in the natural biotic environment was always higher than E_{corr} in the control abiotic environment). It should be noted here that, although microbial ennoblement occurred for all non-creviced weldment materials, the microbial effect caused corrosion acceleration for some materials ($f_{mic} > 1$) and corrosion inhibition for other materials ($f_{mic} < 1$). To provide physical explanations for these results, and a corresponding link between the microbial ennoblement and microbial corrosion-rate results, it will be necessary to examine the anodic polarization behaviors of the weldment materials.

As a first step in this activity, the anodic polarization behaviors for the weldment materials will be evaluated in the non-creviced and creviced conditions in the abiotic synthetic seawater environment. These results will be analyzed in terms of the higher corrosion potentials measured in the biotic natural seawater. Schematic illustrations of this approach are given in Figure 41(a) and (b) for an active-passive material and an active material (no passive film), respectively.

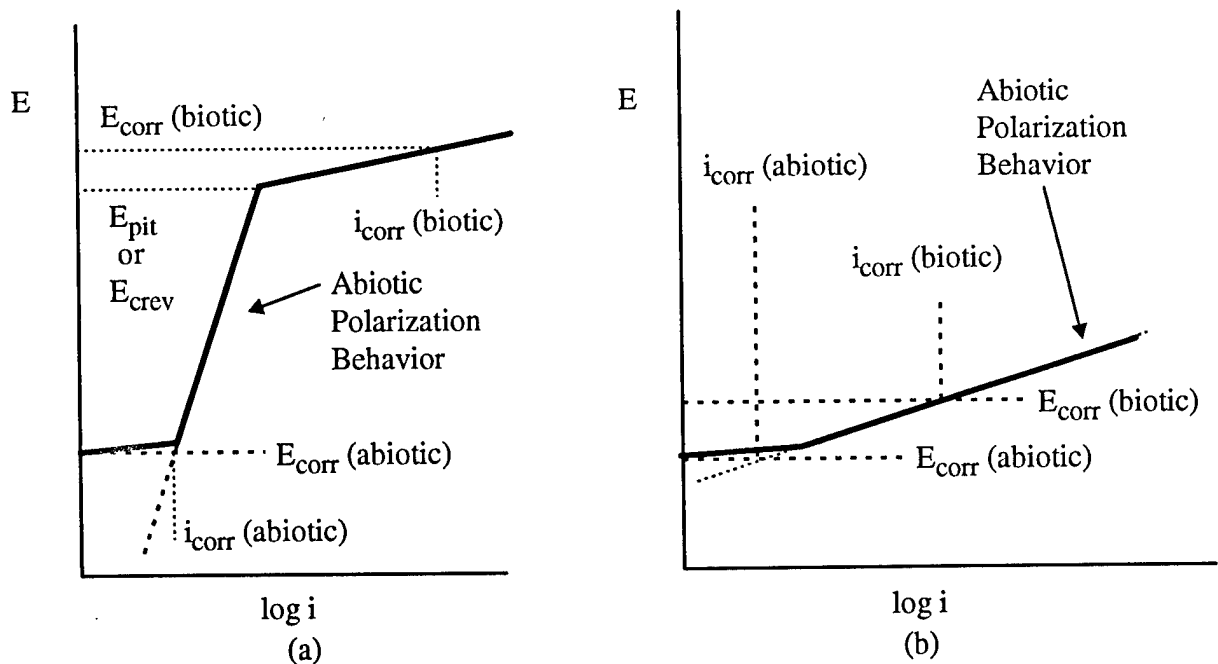

Figure 41. Schematic anodic polarization curves: (a) active-passive material, and (b) active material.

For the active-passive material, the higher biotic corrosion potential, E_{corr} (biotic), could approach or exceed a critical potential for the initiation of localized corrosion, e.g., the critical pitting potential (non-creviced condition), E_{pit} , or the critical crevice potential (creviced

condition), E_{crev} . Thus, the more aggressive natural environment, with a greater oxidizing power (higher E_{corr}), could initiate pitting and/or crevice corrosion, thereby producing a much higher corrosion current density or corrosion rate ($i_{\text{corr}}(\text{biotic}) \gg i_{\text{corr}}(\text{abiotic})$). For the active material, and for an individual sample, the higher corrosion potential for the biotic natural environment would cause an increase in uniform corrosion rate, i.e., again $i_{\text{corr}}(\text{biotic}) > i_{\text{corr}}(\text{abiotic})$. It is noted that for active materials, because of the shallower slope of the anodic curve, the degree of microbial ennoblement is smaller than for passive materials. Therefore, the effect is more difficult to statistically characterize.

Although the analysis just described represents a reasonable first-step in the overall understanding of the MIC effect on weldments, it is recognized that it does not convey the entire picture. In fact, the biotic natural environment not only changes the corrosion potential, but also probably changes the anodic polarization characteristics of the weldments relative to the abiotic environment, e.g., the passive current density (i_p), pitting potential (E_{pit}), and crevice potential (E_{crev}) for active-passive materials, and the exchange current density (i_0) and Tafel slope (β) for active materials. These possible effects also must be explored. As an example, the present results indicate that for non-creviced AL-6XN and creviced and non-creviced Ti (all of which remained passive in the biotic and abiotic environments), although ennoblement occurred in the biotic natural environment, the corrosion rates decreased in this environment. As shown schematically in Figure 42(a) and (b), this effect is consistent with the natural environment causing a decrease in the passive current density for these materials. The decrease in passive current density would be due to corrosion inhibitive effects associated with biofilm coverage of the surfaces in the natural environment.

Continuing with this rationale, it is recalled that in the present study the AL-6XN weldment did not undergo localized corrosion in the non-creviced nor the creviced condition in the abiotic laboratory environment. Nor did it undergo localized corrosion in the non-creviced condition in the natural biotic environment. However, it did undergo localized crevice corrosion in the creviced condition in the natural biotic environment. Proposed anodic polarization behaviors to account for these results are shown schematically in Figure 43. The critical potentials for localized corrosion are E_{pit} for the non-creviced condition and E_{crev} for the creviced condition. The anodic polarization curves in the biotic environment are shown with a lower passive current density (consistent with Figure 42) and higher E_{pit} and E_{crev} values than in the abiotic environment. On examining the effects at the corrosion potentials, it is seen that $E_{\text{corr}}(\text{abiotic})$ is below both $E_{\text{crev}}(\text{abiotic})$ and $E_{\text{pit}}(\text{abiotic})$. Therefore, neither form of localized corrosion is predicted to occur in the abiotic environment, i.e., the weldments remain passivated. In the biotic environment, the higher $E_{\text{corr}}(\text{biotic})$ is below $E_{\text{pit}}(\text{biotic})$ but above $E_{\text{crev}}(\text{biotic})$. Therefore, localized corrosion (pitting) is predicted not to occur in the non-creviced condition, but localized corrosion (crevice corrosion) is predicted to occur in the creviced condition.

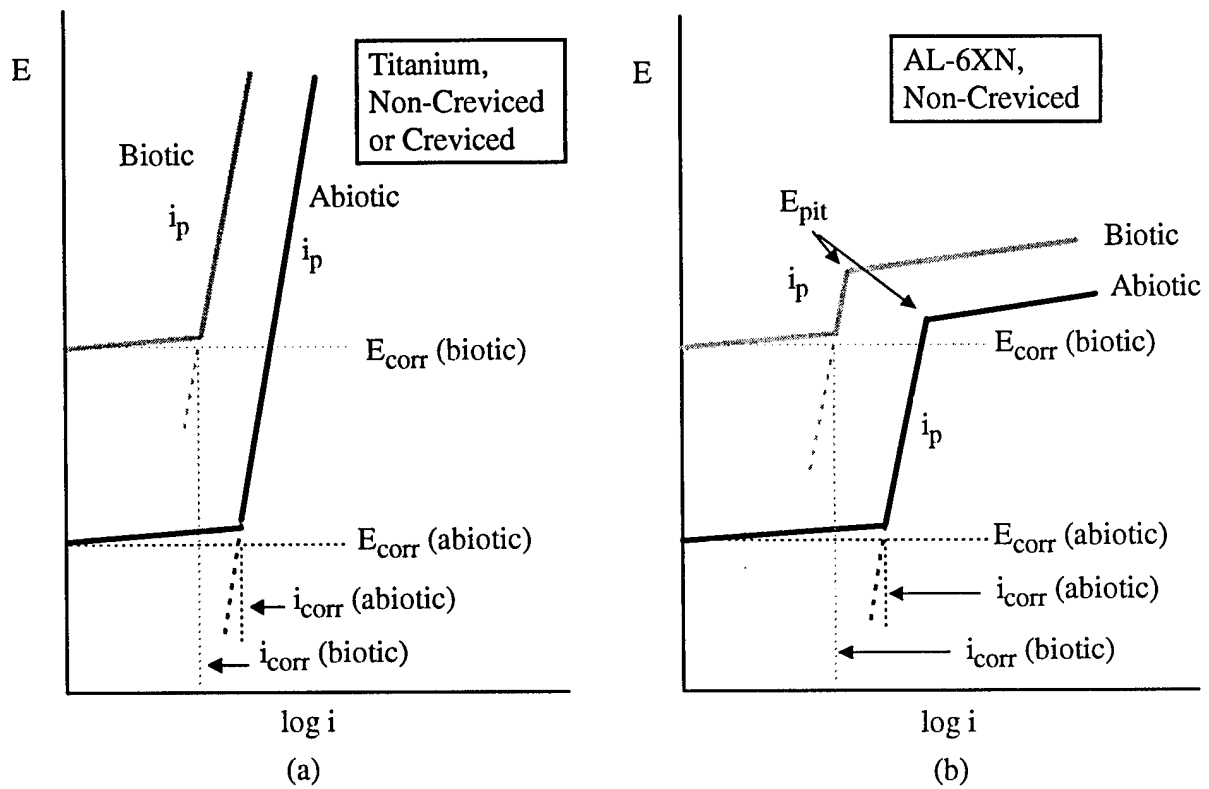

Figure 42. Schematic, proposed anodic polarization behaviors in abiotic and biotic environments for (a) non-creviced and creviced Ti weldments, and (b) non-creviced AL-6XN weldments.

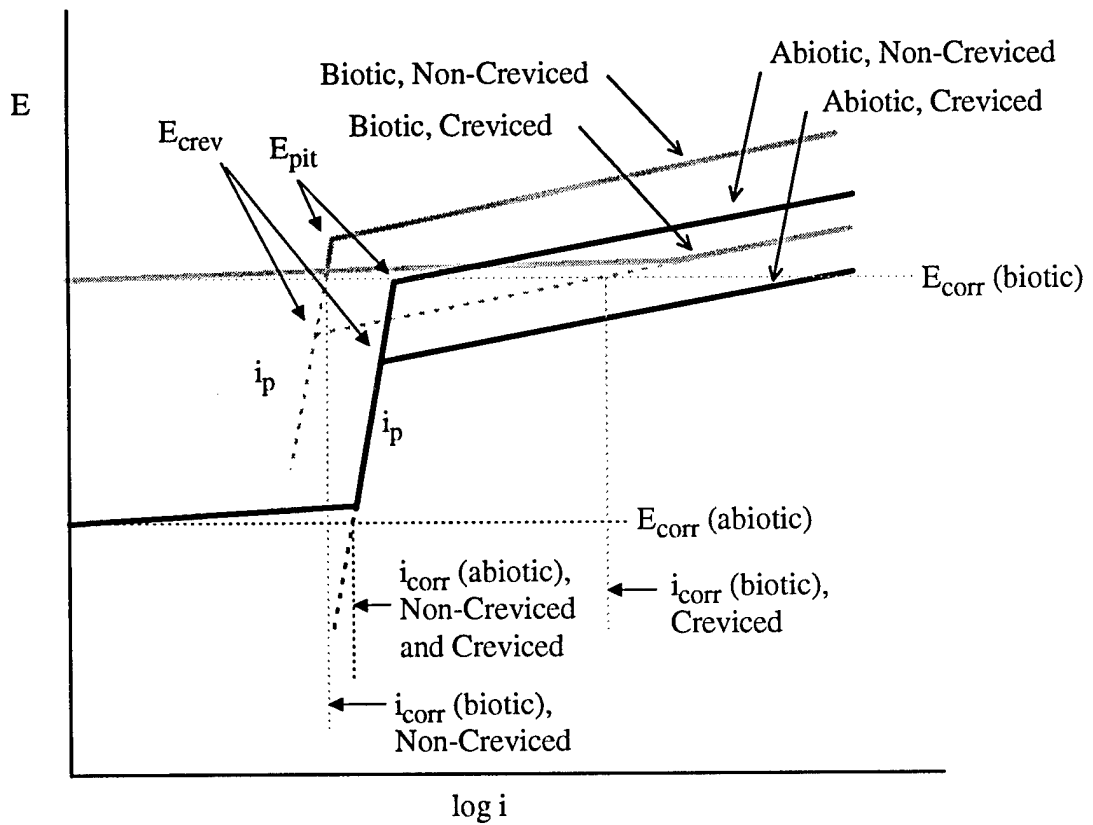

Figure 43. Schematic, proposed anodic polarization behaviors of non-creviced and creviced AL-6XN weldments in abiotic and biotic environments.

It should be noted that when critical localized-corrosion potentials (E_{pit} and E_{crev}) were shown in Figures 42 and 43, the biotic values were proposed to be higher than the abiotic values. The results of a recent study by Zhang and Dexter are consistent with this hypothesis (38). Also in Figures 42 and 43, the biotic passive current density (i_p) was proposed to be lower than the abiotic value (based on results of the present study). *Overall then, it is being hypothesized that the microbial effect on anodic polarization behavior for active-passive alloys is generally one of corrosion inhibition, i.e., an alloy becomes more corrosion resistant with higher E_{pit} and E_{crev} values and lower i_p values due to the production of corrosion-inhibiting species within the biofilm. At the same time, it is being hypothesized that the microbial effect responsible for corrosion acceleration is the higher oxidizing power of the biotic, biofilm environment, thereby producing higher E_{corr} values. With this combination, depending on the material (and therefore the specific values of i_p , E_{crev} and E_{pit}), the corrosion rate may decrease in the biotic environment (if the alloy remains passive, e.g., Figure 42) or the corrosion rate may increase dramatically in the biotic environment (if the higher oxidizing power initiates localized corrosion (e.g., as in Figure 43 when $E_{corr} (biotic) > E_{crev} (biotic)$).*

Since the natural biotic environment most likely changes the anodic polarization behaviors of the weldments of interest, as illustrated in Figures 42 and 43, in order to elucidate the overall microbial effects, it will be necessary not only to evaluate anodic polarization behaviors in the laboratory abiotic environment but also in the natural biotic environment. Only then can the true significance of the higher oxidizing power of the natural biotic environment be determined.

Task III -- Development of an Abiotic Laboratory Screening Test for MIC

A laboratory test that would simulate the effects of MIC, without the introduction of microorganisms per se, would be extremely valuable to anyone concerned about corrosion in natural aqueous environments. In terms of justification for an abiotic test, it is our opinion, based on research experience (including our experience with this ONR project), that attempted laboratory MIC simulations with cultured microbial consortia simply do not work. They produce corrosion-potential and corrosion-rate results that bear little resemblance to the results of field studies conducted in the natural biotic environment. The cultured microbial consortia simply do not replicate the natural environment. In our proposed screening test, we intend to concentrate on replicating the major effects of the natural environment, and not so much on replicating the natural environment itself. The proposed abiotic laboratory screening test for MIC and its justifications are described in the following paragraphs.

It is proposed that the major microbial effects related to corrosion response that an abiotic laboratory test must produce are:

1. Both aerobic and anaerobic areas on the specimen surface, as produced by colonies of aerobic and anaerobic microorganisms in the natural biotic environment,
2. The high oxidizing power of the natural biotic environment,
3. The chloride concentration of the natural biotic environment, and
4. An appropriate sulfide concentration as produced by sulfate reducing bacteria (SRB) in the natural biotic environment.

To accomplish the effects listed above, first, the crevice geometry employed in the present study and shown in Figure 1 will be employed to produce an anaerobic region (the creviced region) and an aerobic region (the non-creviced region) on the specimen surface. The creviced region is expected to undergo acidification with time due to metal-ion hydrolysis. Second, the oxidizing power of the natural biotic environment of concern (in the present case, the biofilm produced at the natural Delaware Bay site) will be measured and then produced in the laboratory screening test. The natural oxidizing power will be measured in situ as the stable open-circuit potential (OCP) of a bright-platinum electrode (in the present study at the Delaware Bay site, this OCP, or redox potential, was measured to be +600 mV(SHE)). In the laboratory screening test, this OCP will be produced (and measured against a bright-platinum electrode) by an appropriate addition of hydrogen peroxide (H_2O_2), a strong oxidizer. As justification for this oxidizer selection, work by Chandrasekaran and Dexter has shown that the presence of hydrogen peroxide in the biofilms produced at the Delaware Bay site is responsible, in part, for the observed corrosion-potential ennoblement (24, 29). Third, the sodium chloride concentration of the natural biotic environment will be replicated in the laboratory screening test (in the present study at the Delaware Bay site, this concentration was, on average, 28 ppt). And fourth, in the laboratory screening test, a small concentration of sulfide, in the form of sodium sulfide, will be employed to replicate the metabolic products of SRB in the natural biotic environment. This is the only one of the four solution variables described above that is somewhat unknown. It is known that S^{2-} concentrations as low as 10 ppm can adversely affect passive-film stability of stainless steels in acid solution (39). In the proposed laboratory screening test, initially, a higher concentration of 100 ppm S^{2-} , or 244 ppm Na_2S , will be employed. Depending on the results, this concentration may be adjusted. In summary, the proposed laboratory abiotic screening test for MIC, with reference to that observed at the natural, biotic Delaware Bay site of the present study, will employ a crevice geometry and a distilled-water-based solution containing H_2O_2 at a concentration necessary to produce a bright-platinum OCP of +600 mV(SHE), NaCl at a concentration of 28 ppt, and Na_2S at a concentration of 244 ppm.

The success of the laboratory abiotic screening test will be evaluated based on the biotic MIC results of the present study. Specifically, the laboratory abiotic test should produce results equivalent to those of the natural Delaware Bay exposures. As examples, two of the most dramatic MIC results of the present study involved AL-6XN and Alloy 400 (Monel 400) weldments. The creviced AL-6XN weldment underwent crevice corrosion in the natural microbial environment but not in the quasi-sterile control environments. Therefore, the proposed abiotic laboratory screening test for MIC should produce crevice corrosion on the AL-6XN weldment. The Monel 400 weldment exhibited corrosion rates up to 90 times higher in the natural microbial environment than in the quasi-sterile control environments. Therefore, the proposed abiotic laboratory screening test for MIC should produce corrosion rates equivalently high for the Monel 400 weldment.

It is noted that the proposed laboratory abiotic screening test for MIC does not simulate the hypothesized biotic corrosion-inhibitive effects on anodic polarization behavior, as discussed in Task II. Rather, it simulates the corrosion-acceleration effects, i.e., simultaneous presence of aerated and deaerated surface regions, the high oxidizing power of the natural, biotic environment, chlorides and sulfides. Therefore, the laboratory screening test should produce results of a conservative nature. That is, if accelerated corrosion does not occur in the screening test, it will not occur under the natural MIC conditions. Alternately, if

accelerated corrosion does occur in the screening test, it may or may not occur under the natural MIC conditions.

Assuming that this new laboratory abiotic screening test for MIC works as anticipated, it easily can be reduced to engineering practice. It is a low-cost test and applicable to any aqueous environment, regardless of whether the MIC effects are severe, moderate or negligible. The screening test first would require simple measurements to characterize the natural environment, i.e., measurements of the bright-platinum OCP, chloride concentration, and temperature. Then, the laboratory abiotic screening test would be conducted on creviced specimens at the same bright-platinum OCP (through H_2O_2 additions), chloride concentration, and temperature (with sulfide additions as explained above). Since the laboratory test would be abiotic, there would no need for extraction of microorganisms from the natural environment, preservation of cultures, or elaborate sterilization procedures, thus, greatly simplifying the test. There is no need for these experimental complications anyway, since, as previously concluded, laboratory tests using extracted microbial consortia simply do not replicate MIC effects in the natural environment. With the guidance of a detailed set of procedures, engineering technicians could quickly and competently perform the proposed abiotic laboratory screening test for MIC on a given material (either in the welded or non-welded condition).

References

1. D. H. Pope, D. Duquette, P. Wayner, and A. Johannes, *Microbiologically Influenced Corrosion: A State of the Art Review*, 2nd ed., publication no. 13 (St. Louis, MO: MTI, 1989).
2. B. Little, P. Wagner, and F. Mansfeld, "Microbiologically Influenced Corrosion of Metals and Alloys", *International Materials Reviews* 36,6 (1991): p. 253.
3. D. F. Hasson and C. R. Crowe, eds., *Treatise on Materials Science and Technology*, Vol. 28, (Boston, MA: Academic Press, Inc., 1988).
4. S. C. Dexter, "Appendix: Biological Effects," *Metals Handbook*, 9th ed., Vol. 13, (Metals Park, OH: ASM International, 1987): p. 41.
5. R. E. Tatnall, "Introduction - Part 1," *A Practical Manual on Microbiologically Influenced Corrosion*, (Houston, TX: NACE, 1993): p. 1.
6. S. C. Dexter, "Localized Biological Corrosion," *Metals Handbook*, 9th ed., Vol. 13, (Metals Park, OH: ASM International, 1987): p. 114.
7. D. Walsh, E. Willis, T. VanDiepen, and J. Sanders, "The Effect of Microstructure of Microbial Interaction with Metals - Accent Welding," *CORROSION/94*, paper no. 612, (Houston, TX: NACE, 1994).
8. J. G. Stoecker, "Penetration of Stainless Steel Following Hydrostatic Test," *A Practical Manual on Microbiologically Influenced Corrosion*, (Houston, TX: NACE, 1993): p. 167.
9. A. A. Stein, "Microbiological Corrosion of Type 316L Stainless Steel," *A Practical Manual on Microbiologically Influenced Corrosion*, (Houston, TX: NACE, 1993): p. 183.
10. A. A. Stein, "MIC in Type 316L Stainless Steel Pipe with Alloy 625 Weld Metal," *A Practical Manual on Microbiologically Influenced Corrosion*, (Houston, TX: NACE, 1993): p. 185.
11. S. W. Borenstein and P. B. Lindsay, "MIC Failure Analyses," *A Practical Manual on Microbiologically Influenced Corrosion*, (Houston, TX: NACE, 1993): p. 189.
12. K. Krysiak, ch., "Corrosion of Weldments," *Metals Handbook*, 9th ed., (Metals Park, OH: ASM International, 1987), p. 344.

13. N. J. Dowling, M. Franklin, D. C. White, C. H. Lee, and C. D. Lundin, "The Effect of Microbiologically Influenced Corrosion on Stainless Steel Weldments in Artificial Seawater," *CORROSION/89*, paper no. 187, (Houston, TX: NACE, 1989).
14. S. C. Dexter, "Marine Corrosion," *Metals Handbook*, 9th ed., Vol. 13, (Metals Park, OH: ASM International, 1987): p. 893.
15. F. L. Laque, *Marine Corrosion; Causes and Preventions*, (New York, NY: John Wiley & Sons, 1975).
16. M. G. Fontana, *Corrosion Engineering*, 3rd ed., (New York, NY: McGraw-Hill Book Company, 1986).
17. B. Little, P. Wagner, and J. Jacobus, "The Impact of Sulfate-Reducing Bacteria on Welded Copper-Nickel Seawater Piping Systems," *Materials Performance* 27, 8(1988): p. 57.
18. S. C. Dexter and G. Y. Gao, "Effect of Seawater Biofilms on Corrosion Potential and Oxygen Reduction of Stainless Steel," *Corrosion* 44 10(1988): p. 717.
19. H. -J. Zhang and S. C. Dexter, "Effect of Biofilms on Crevice Corrosion of Stainless Steels in Coastal Seawater," *Corrosion* 1(1995): p. 56.
20. A. Mollica, "Biofilm and Corrosion on Active-Passive Alloys in Seawater," *International Biodeterioration & Biodegradation* 29 (1992): p. 213.
21. V. Scotto, G. Alabiso, and G. Marcenaro, "The Behaviour of Stainless Steels in Natural Seawater," *Bioelectrochemistry and Bioenergetics*, 16 (1986): p. 347.
22. A. Mollica, G. Ventura, E. Traverso, and V. Scotto, "Cathodic Behaviour of Nickel and Titanium in Natural Seawater," *International Biodeterioration*, 24 (1988): p. 221.
23. V. Scotto, R. Di Cintio, and G. Marcenaro, "The Influence of Marine Aerobic Microbial Film on Stainless Steel Corrosion Behaviour," *Corrosion Science* 25 3(1985): p. 185.
24. P. Chandrasekaran and S. C. Dexter, "Mechanism of Potential Ennoblement on Passive Metals by Seawater Biofilms," *CORROSION/93*, paper no. 493 (Houston, TX: National Association of Corrosion Engineers, 1993).
25. B. Little, R. Ray, P. Wagner, Z. Lewandowski, W. C. Lee, W. G. Characklis, and F. Mansfeld, "Impact of Biofouling on the Electrochemical Behaviour of 304 Stainless Steel in Natural Seawater," *Biofouling* 3(1991): p. 45.
26. S. C. Dexter, "Role of Microfouling Organisms in Marine Corrosion," *Biofouling*, 7(1993), p. 97.

27. A. Mollica and Trevis, ref. in no. 26.
28. A. Mollica, A. Trevis, E. Traverso, G. Ventura, G. De Carolis, and R. Dellapiane, "Crevice Corrosion Resistance of Stainless Steels in Natural Seawater in the Temperature Range of 25 to 40°C," *Corrosion*, 44 (4)1988, p. 195.
29. P. Chandrasekaran and S. C. Dexter, "Bacterial Metabolism in Biofilm Consortia: Consequences for Potential Ennoblement," CORROSION/94, paper no. 276 (Houston, TX: National Association of Corrosion Engineers, 1994).
30. Nickel Development Institute, *Guidelines for Selection of Nickel Stainless Steels for Marine Environments, Natural Waters, and Brines*, (Toronto, ON: Nickel Development Institute, 1987).
31. A. H. Tuthill and C. M. Schillmoller, *Guidelines for Selection of Marine Materials*, (The International Nickel Company, Inc., 1966).
32. R. W. Schutz, "A Case for Titanium's Resistance to Microbiologically Influenced Corrosion," *Materials Performance*, 30 1(1991), p. 58.
33. E. E. Stansbury and R. A. Buchanan, *Fundamentals of Electrochemical Corrosion*, (Knoxville, TN: Center for Materials Processing): ch. 7.
34. B. Little, S. Gerchakov, and L. Udey, "A Method for Sterilization of Natural Seawater," *Journal of Microbiological Methods* 7(1987) p. 193
35. V. K. Gouda, I. M. Banat, W. T. Rlad, and S. Mansour, "Microbial-Induced Corrosion of Monel 400 in Seawater," CORROSION/90, paper no. 107, (Houston, TX: National Association of Corrosion Engineers, 1990).
36. A. H. L. Chamberlain, S. E. Simmonds, and B. J. Garner, "Marine 'Copper-Tolerant' Sulphate Reducing Bacteria and Their Effects on 90/10 Copper-Nickel (CA 706)," *International Biodeterioration* 24 (1988): p. 213.
37. S. C. Dexter, D. J. Duquette, O. W. Siebert, and H. A. Videla, "Use and Limitations of Electrochemical Techniques for Investigating Microbiological Corrosion," *Corrosion* 47 4 (1991), p. 308.
38. Hong-Ji Zhang and Stephen C. Dexter, "The Effects of Biofilms on Critical Pitting Potentials for Stainless Steels S30400 and S31600 in Seawater," *Proceedings of the 1995 International Conference on Microbially Influenced Corrosion*, pp. 70/1-70/8 (Houston, TX: National Association of Corrosion Engineers, 1995).
39. E. E. Stansbury, *Applied Metallography*, (New York, NY, Van Nostrand Reinhold, 1988): pp. 21-39

Distribution List

<u>Organization</u>	<u>Number of Copies</u>
Dr. Stephen C. Dexter College of Marine Studies University of Delaware 700 Pilottown Rd. Lewes, Delaware 19958	1
Defense Technical Information Center Cameron Station Alexandria, VA 22304-6145	2
Office of Naval Research 800 N. Quincy Street Arlington, VA 22217-5660 ATTN: Code 3310	3
Naval Research Laboratory 4555 Overlook Ave., S.W. Washington, DC 20375 ATTN: Code 6000	1
Code 6300	1
Code 5227	1
Naval Air Warfare Center White Oak Detachment Silver Spring, MD 20903-5000 ATTN: Library	1
Code R33	1
Naval Postgraduate School Monterey, CA 93940 ATTN: Mechanical Engineering Dept.	1
Naval Air Systems Command Washington, DC 20361 ATTN: Code5304	1
Naval Sea Systems Command Washington, DC 20362 ATTN: Code 05M	1
Code 05R	1
Naval Air Warfare Center Aircraft Division, Trenton Trenton, NJ 08628 ATTN: Code Library	1
Naval Facilities Engineering Service Center Port Huenene, CA 94043 ATTN: Materials Div.	1

Naval Surface Warfare Center Carderock Division Bethesda, MD 20084 ATTN: Library	1
Naval Underwater Warfare Ctr. Newport, RI 02840 ATTN: Library	1
Naval Air Warfare Center Weapons Division China Lake, CA 93555-6001 ATTN: Library	1
NASA Lewis Research Center 21000 Brookpark Road Cleveland, OH 44135 ATTN: Library	1
National Institute of Standards and Technology Gaithersburg, MD 20899 ATTN: Metallurgy Division	1
Ceramics Division	1
Fracture and Deformation Division	1
Naval Command, Control and Ocean Surveillance Center R&D Division San Diego, CA 92152-5000 ATTN: Library	1
Office of the Assistant Commander HQ Marine Corps 2 Navy Annex Washington, DC 20380-1775 ATTN: Scientific Advisor	1
Army Research Office P.O. Box 12211 Research Triangle Park, NC 27709 ATTN: Metallurgy and Ceramics Program	1
Army Materials Technology Laboratory Watertown, MA 02172-0001 ATTN: SLCMT-TMM	1
Air Force Office of Scientific Research Building 410 Bolling Air Force Base Washington, DC 20332 ATTN: Electronics & Materials Science Directorate	1

NASA Headquarters Washington, DC 20546 ATTN: Code RN	1
Naval Surface Warfare Center Port Hueneme Division 4363 Missile Way Port Hueneme, CA 93043-4307 ATTN: Library	1
Metals Information Analysis Center Purdue University 2595 Yeager Road West Lafayette, IN 47906	1
Naval Facilities Engineering Command Alexandria, VA 22331 ATTN: Code 03	1
Oak Ridge National Laboratory Metals and Ceramics Div. P.O. Box X Oak Ridge, TN 37380	1
Los Alamos Scientific Lab. P.O. Box 1663 Los Alamos, NM 87544 ATTN: Report Librarian	1
Argonne National Laboratory Metallurgy Division P.O. Box 229 Lemont, IL 60439	1
Brookhaven National Laboratory Upton, Long Island NY 11973 ATTN: Research Library	1
Lawrence Berkeley Lab. 1 Cyclotron Rd. Berkeley, CA 94720 ATTN: Library	1
Naval Surface Warfare Center Annapolis Detachment Annapolis, MD 21402-5067 ATTN: Code 61	1
Code 613	1
Code 0115	1