

NASA TECHNICAL NOTE

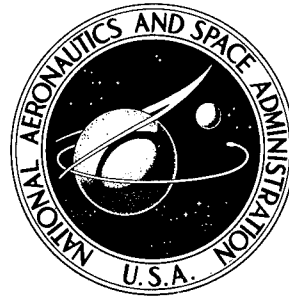

NASA TN D-4810

NASA TN D-4810

DISTRIBUTION STATEMENT A
Approved for public release
Distribution Unlimited

19960607 120

EXPERIMENTAL INVESTIGATION AND
ANALYSIS OF DIELECTRIC BREAKDOWNS
INDUCED BY ELECTRON IRRADIATION
IN POLYMER FILMS

DEPARTMENT OF DEFENSE
PLASTICS TECHNICAL EVALUATION CENTER
PICATINNY ARSENAL, DOVER, N. J.

by George M. Storti
Langley Research Center
Langley Station, Hampton, Va.

DTIC QUALITY INSPECTED 3

PLASTEC
11514

DISCLAIMER NOTICE

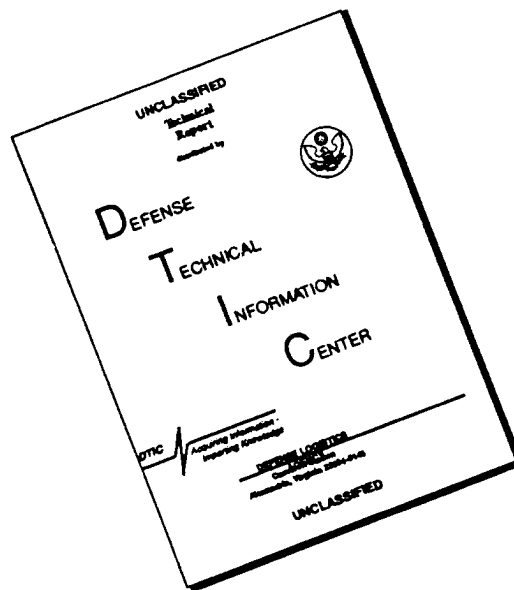

THIS DOCUMENT IS BEST QUALITY AVAILABLE. THE COPY FURNISHED TO DTIC CONTAINED A SIGNIFICANT NUMBER OF PAGES WHICH DO NOT REPRODUCE LEGIBLY.

NASA TN D-4810

EXPERIMENTAL INVESTIGATION AND ANALYSIS OF
DIELECTRIC BREAKDOWNS INDUCED BY ELECTRON IRRADIATION
IN POLYMER FILMS

By George M. Storti

Langley Research Center
Langley Station, Hampton, Va.

NATIONAL AERONAUTICS AND SPACE ADMINISTRATION

~~For sale by the Clearinghouse for Federal Scientific and Technical Information
Springfield, Virginia 22151 - GPO price \$3.00~~

EXPERIMENTAL INVESTIGATION AND ANALYSIS OF
DIELECTRIC BREAKDOWNS INDUCED BY ELECTRON IRRADIATION
IN POLYMER FILMS

By George M. Storti
Langley Research Center

SUMMARY

[The phenomenon of dielectric breakdowns caused by electron irradiation was investigated in several polymeric materials. The frequency of occurrence of the breakdowns (as measured by the number of breakdowns occurring for a given fluence of electrons) was dependent on factors such as the electron kinetic energy, electron flux, sample radiation history, and sample temperature. Also, some materials (for example, Teflon) were found to be more susceptible to the dielectric breakdowns than others (for example, polyethylene).

These results were interpreted in terms of a modified band model for organic insulators. This modified band model successfully explained many of the experimental observations. ~~Consequently, relative depths of electron traps in some of the materials were surmised from the experimental data.~~ (author, modified)

INTRODUCTION

Spontaneous electrical discharges frequently occur in organic dielectrics when exposed to high-intensity electron irradiation. Visible patterns caused by the breakdowns (Lichtenberg figures) are often produced in materials such as Lucite, Mylar, and polystyrene. This behavior is due to trapping of the electrons with subsequent charge buildup until the electric field within the material exceeds the dielectric strength. Because the phenomenon of dielectric breakdowns is dependent on the trapping characteristics, the frequency of occurrence is indicative of some of the basic processes occurring in the material.

Previous test programs have investigated the breakdown phenomenon in systems and electronic components containing organic insulators that were to be used in the space environment (refs. 1 to 4). However, because of their componential nature and complicated geometries, no completely satisfactory basic comparison could be made between the materials tested. Also, little information and understanding of the physical processes

involved was available. At most, some general trends in the dependence of the breakdown frequency on a number of variables were observed. In addition to this experimental work, some recent theoretical work has been done to explain the phenomenon (ref. 5). In particular, a physical model was developed to explain charge storage, transport, and release in a common organic dielectric, Mylar. This model was found to be consistent with the experimental information obtained from capacitor-type meteoroid detectors exposed to electron irradiation (ref. 5).

The purpose of the present experiment is to obtain information concerning the breakdown frequency from uniform samples (having simple electrode geometries) as a function of the electron kinetic energy, the electron flux, and the sample temperature. A direct comparison between the different materials is made and the results are compared with results that are expected if the physical model developed in reference 5 is applicable.

SYMBOLS

C_n	capture coefficient
e	electrons
E_k	electron kinetic energy
E_t	energy level of trap below conduction band
\vec{F}	electric field
G	charge-carrier-generation rate per unit volume
k	Boltzmann constant
n	free-electron density
n_0	initial free-electron density
n_t	trapped-electron density
Δn_t	trapped-electron density in energy interval ΔE at energy E_t below conduction band
n_{t0}	initial trapped-electron density

ΔN_T	trap density in energy interval ΔE
q	unit charge
S_n	attempt to escape frequency
t	time
T	temperature
x	distance
ϵ	dielectric constant
μ	mobility of electron in material

APPARATUS AND TESTS

Accelerator and Target Chamber Systems

Samples of insulating materials were irradiated with a beam of monoenergetic electrons produced by a cascaded-rectifier potential-drop accelerator (ref. 6). Incident kinetic energies ranged from 20 keV to 190 keV. These energies were calibrated with a solid-state radiation detector which had been previously calibrated with suitable radioactive isotopes. The energy as determined by this method is estimated to be within 1 percent of the nominal value stated.

Energetic electrons produced by the accelerator were directed onto targets by suitable beam-handling equipment (fig. 1). In particular, quadrupole and steering magnets were used to position and spread the beam uniformly, and collimators were used to limit the area of beam impingement. The collimator nearest the target restricted the area of impingement to a square cross section, 10 cm by 10 cm. The target samples were mounted on a temperature-control bucket in a vacuum chamber (10^{-6} torr or 1.33×10^{-4} N/m²). The temperature-control bucket was either filled with liquid nitrogen or left empty. A thermocouple was attached to the bucket to measure the temperature near the samples.

Devices for monitoring the electron current were also located in the vacuum chamber. An aluminum monitor plate, 1 cm wide by 2 cm long by 1.25 cm thick, was located directly above the target sample. Also, a rotatable support containing 13 aluminum current monitors could be positioned between the collimator and the target to measure the

beam-current uniformity (fig. 2). The multiple-current monitor plates were rotated into the area covered by the beam immediately before and after the tests on a target material.

Beam Characteristics

Current collected by monitor plates was fed through an integrating electrometer to the ground so that both the flux and the fluence (integrated flux) could be determined. In this way, the uniformity of the beam over the target area was found to be within ± 10 percent of the average value of the readings obtained from the multiple-current monitors. Although some error existed in the measurement of the actual current impinging on the target, the difference between the actual and measured current was not significant in affecting the interpretation of the results. The main source of error was the difference in backscatter of the aluminum monitors and the target sample.

Target Samples

The samples used in these tests were prepared by vapor deposition of two thin coatings ($0.3 \mu\text{m}$ thick) of aluminum on both sides of a target sample. (See fig. 3.) On the back side, the vapor-deposited area was a square approximately 7.6 cm on a side. The same size area was deposited on the front side and a tab was included so that electrical connection could be made to the sample from the test circuit. The back side of the sample was then bonded to an aluminum plate by using silver-loaded epoxy. This plate in turn was attached to the bucket in the vacuum chamber with the sample facing the incident beam. The materials used in these tests, their corresponding thicknesses, and characteristic values of some physical constants are given in table I. All polymers used were commercial films with the exception of the Pyrrone (PMDA-DAB) which is described in reference 7.

Test Circuit

A simple circuit was used for the detection of dielectric breakdowns in the insulating materials. This circuit consisted of the test sample, a battery, an oscilloscope, and a scaler, as depicted schematically in figure 4. The battery provided a 15-volt bias across the sample while the oscilloscope allowed the display of the breakdown pulses. The scaler recorded the number of breakdown pulses having an amplitude greater than 1 volt. The use of a bias across the dielectric is not necessary to observe the breakdown behavior of the dielectrics. The effects of battery voltage on the dielectric-breakdown phenomenon have been studied in reference 2.

RESULTS

Nature of Breakdown Pulses

Photographs of the oscilloscope traces produced by the breakdown pulses were taken, typical examples of which are shown in figure 5. The pulses were characterized by a fast rise time (on the order of a few nanoseconds) and a resistance-capacitance decay typical for the detection circuit. Some slight ringing appeared on the front edge of the pulses. This ringing is believed to be attributable to small inductances in the sample and the detection circuit. Most pulses had amplitudes less than 15 volts.

Effect of Incident Electron Kinetic Energy and Sample Temperature

The number of dielectric breakdowns occurring in the target materials for a given electron fluence was monitored as a function of incident electron kinetic energy and temperature. The dielectric breakdowns were observed during the irradiation. In every case, the flux used was 10^{10} e/cm²-sec and the fluence received by the samples was 2×10^{13} e/cm². The results are shown in figures 6 to 11. The symbols in the figures represent results from different samples. Results were obtained for a sample temperature of either 298° K or for both 77° K and 298° K.

After initially obtaining many breakdowns at the lower energies, the number of breakdowns decreased sharply as the electron kinetic energy was increased. The greatest number of dielectric breakdowns occurred in the Teflon (FEP) samples (fig. 6). No breakdowns occurred in the polyethylene samples (fig. 11). However, both polyethylene and polypropylene samples were tested only at 298° K. (Shrinkage of both of these materials prevented tests at 77° K.) For those materials tested at both 77° K and 298° K, the effect of the sample temperature was significant. Noticeably fewer breakdowns were obtained at 298° K than at 77° K. In the case of the Teflon (FEP) samples, the change in temperature caused at least an order of magnitude change in the number of dielectric breakdowns.

Quite noticeable in the results is the wide variation in the number of breakdowns occurring in different samples of the same material. This behavior may have been due to either the variation in the intrinsic properties of the samples, or the test conditions, or a combination of both effects. In particular, conditions such as the amount of charge in the material before irradiation and the accumulated fluence received by the samples (that is, radiation-history effects) may have been important. These effects are discussed subsequently. However, these variations do not mask the trends caused by the effects of electron flux and temperature.

Effect of Electron Flux and Temperature

The results obtained from the target samples when the electron flux was varied are shown in figures 12 to 17. The number of breakdowns occurring for a given fluence was recorded for either a sample temperature of 298° K or for both 77° K and 298° K. All tests were made by using an incident beam having a kinetic energy of 30 keV with the exception of tests on the Teflon (FEP) samples. The kinetic energy used on Teflon was 40 keV. These energies were chosen because the greatest number of breakdowns occurred under these conditions. Hence, the effects being observed were expected to be more apparent than those in which an energy was chosen at which few breakdowns occurred.

If the electron flux was decreased, the number of dielectric breakdowns tended to decrease. This tendency was more apparent at 298° K than at 77° K. The Pyrrone data (fig. 15), however, did not show this trend at 77° K. Fewer breakdowns occurred at the higher temperature for those materials in which measurements were made at both 77° K and 298° K. This result is in agreement with tests reported in the previous section.

Other Effects

As previously discussed, results obtained from different samples of the same material varied widely. Part of the variation can probably be ascribed to differences in the quality of the samples tested and the statistical variations in the number of breakdowns. These variations are shown in figure 6. However, the radiation history of the sample is believed to have a significant effect on the data. For example, both the fluence received by the sample and the amount of charge stored in the material before irradiation affected the breakdown frequency.

The effect of fluence is demonstrated by the following typical observations: For a test in which the sample was irradiated continuously to a fluence of 2×10^{13} e/cm², noticeably fewer breakdowns were recorded in the first half of the irradiation than in the second half. For example, in one test using Teflon, 85 breakdowns occurred in the first half of the irradiation and 122 breakdowns in the second half (T = 77° K; Electron kinetic energy = 50 keV). Similar results were obtained for the other materials and were especially evident in the case of previously unirradiated samples.

An example of the effect of the amount of charge stored in the material before irradiation on the breakdown frequency is observed in results of tests on polypropylene (fig. 16). The seven data points shown in figure 16 were obtained in succession with a 30-minute period or less of no irradiation occurring between each period of irradiation. The lower curve was obtained first, the order of irradiation being from the highest to the lowest flux. The tests were repeated in the same order, and the upper curve was generated. A greater number of breakdowns occurred at each flux level in the repeat testing.

This result is most likely attributable to a large number of trapped charges that remained in the material even after irradiation ceased. Consequently, fewer trapped charges were needed to initiate a breakdown when electron irradiation was resumed. This result is discussed in somewhat greater detail subsequently.

Even though the results vary considerably because of the sample variability or radiation-history effects, these effects do not mask those of sample temperature, flux, and incident kinetic energy on the breakdown frequency. Hence, in figure 16, a flux dependence is evident even though the radiation-history effect exists.

DISCUSSION

Physical Model

Certain trends appear in the behavior of the breakdown frequency, or the number of breakdowns occurring for a given fluence, as a result of varying the investigated parameters. These trends can be interpreted from the phenomenological model developed for inorganic insulators and semiconductors and extended to organic insulators by Monteith and Hauser (ref. 5).

The model assumes the following processes: space-charge buildup in the material during irradiation, charge transport, and space-charge decay. A band model, with provision for trapping sites for electrons below the conduction band, may be applied. (See following sketch.)

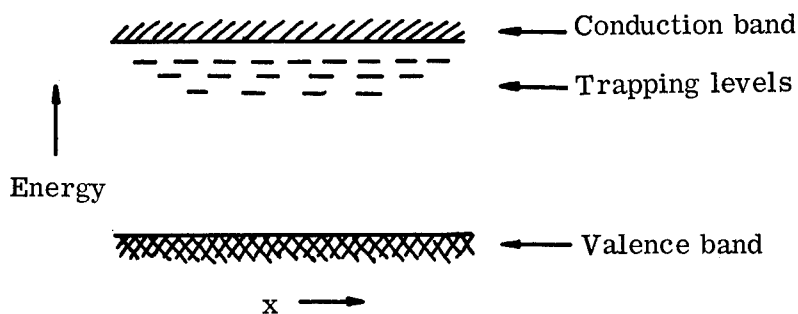

Although it is not certain that a band model gives the best description of the charge-transport processes occurring in organic dielectrics, it is the only model which has been developed sufficiently for use here. The distribution of traps as a function of the energy interval below the conduction band is complex, in that the energy necessary to release electrons from the trapping levels into the conduction band may range from low (shallow levels) to high values (deep levels). It is assumed that there are more trapping sites available than there are filled sites necessary to cause a breakdown.

During irradiation, electrons are injected into the insulating material and generate additional electron-hole pairs. The discussion is confined to what happens to the electrons. The electrons may be either transported to the electrodes by the applied field or may be trapped in the material. Electrons that are trapped are subject to release by thermal stimulation and, hence, may be transported at some later time to the electrodes. (In refs. 1, negligible retrapping is assumed.) These processes can be described by the following equations:

$$\frac{\partial(\Delta n_t)}{\partial t} = C_n n (\Delta N_T - \Delta n_t) - S_n \Delta n_t \exp\left(\frac{-E_t}{kT}\right) \quad (1)$$

$$\frac{\partial n}{\partial t} = G - \frac{\partial n_t}{\partial t} + \frac{\partial}{\partial x} (\mu n |\vec{F}|) \quad (2)$$

$$\vec{\nabla} \cdot \vec{F} = \frac{q}{\epsilon} [(n - n_0) + (n_t - n_{t0})] \quad (3)$$

(The symbols C_n and S_n are assumed to be constants.)

Equation (1) gives the charge-storage rate. The charge-storage rate is dependent on the charge-capture rate $C_n n (\Delta N_T - \Delta n_t)$ and the release rate $S_n \Delta n_t \exp\left(\frac{-E_t}{kT}\right)$. Equation (2) gives the rate of change in the number of free carriers. This rate is dependent on the carrier-generation rate, the charge-storage rate, and an electric-field dependent term. Finally, equation (3) is a source equation dependent on the number of free and trapped carriers.

Implicit in equations (1) to (3) are three time constants of importance:

- (1) The transport time for free carriers out of the material
- (2) The trapping time for free electrons
- (3) The release time of electrons from traps

Generally, the release-time constant is considerably greater than the others. However, all three are difficult to determine.

Another problem associated with the solution of equations (1) to (3) is the distribution of traps as a function of energy. Little or no information is available on trap distribution in many of these organic insulators. As a consequence, trap distributions have to be assumed to solve the equations (1) to (3). (Monteith and Hauser have made this assumption for Mylar in ref. 5.) In spite of the complexity involved, much useful information and some insight can be gathered by analyzing the results of the present experiment using this model.

Dielectric-Breakdown Phenomenon

Charge buildup occurs when the capture-rate term exceeds the release-rate term in equation (1). If a sufficient number of traps exist and if these are filled to the extent that an electric field can no longer be supported, a discharge occurs. Varying amounts of charge may be released in these discharges. This result indicates that the volume drained by the discharge may be somewhat localized; that is, all trapped charges are not released in the breakdown.

Kinetic-Energy Effects

The effect of the incident kinetic energy is equivalent to the effect of varying the number of electrons injected into the dielectric material. For instances where the sample thickness exceeds the range of electrons in the sample, many of the injected electrons remain trapped. However, as kinetic energy is increased, an increasingly greater number of electrons pass through the material and are never trapped. Consequently, the charge-buildup rate decreases significantly, and eventually no breakdowns occur.

Temperature Dependence

When the temperature of a sample is changed, the charge-buildup rate is significantly affected. The release term of equation (1) is strongly dependent on the temperature. For E_t on the order of 0.1 eV or greater, the release term may differ by several orders of magnitude for temperatures of 77° K and 298° K. Consequently, the charge-storage rate is greater at the lower temperatures than at the higher temperatures.

Information concerning the distribution of traps in the materials tested may be extracted from the behavior of the breakdown frequency with temperature. The results from the Teflon samples indicate that the charge-buildup rate decreases substantially between 77° K and 298° K – much more so than is the case for the other materials. Therefore, it appears that there are a large number of traps in the material with activation temperatures between 77° K and 298° K. In analyzing the polyethylene data, a considerable number of shallow traps may exist because no breakdowns were obtained at room temperature for a flux of 10^{10} e/cm²-sec. (However, some breakdowns occurred at the higher flux levels.) This result indicates that either the charge-buildup rate was very slow or that there was no charge buildup at room temperature. No outstanding characteristics in the data for the other materials exist to indicate prominent features in the distribution of traps.

Flux Effects

The charge-storage rate decreases with a decrease in electron flux. This decrease is primarily due to the decrease in the number of carriers available for trapping in a

given period of time. However, the charge-storage rate is also decreased by the relatively greater contribution of the release-rate term. Because a longer time is required for the sample to receive a given fluence at a lower flux, there is a greater probability that relatively more electrons will be thermally released from traps; that is, the release-time constant has a relative significance at the lower fluxes because the time necessary to obtain a given fluence is greater.

Because of the significance of the release-rate term, information concerning trapped-electron distribution can be roughly deduced from the breakdown frequency as a function of flux. If little or no decrease of the breakdown frequency as a function of flux exists, many of the trapped electrons are probably sufficiently deep so as not to be thermally stimulated into the conduction band. However, if a sharp decrease of the breakdown frequency with a decrease in flux exists, many shallow traps in the material are highly probable. Hence, the results obtained in the experiment lead to the conclusion that the traps in polyethylene are shallow and a large number of those in Teflon are deep. However, in the other materials, a broad energy distribution of traps is most likely to occur.

Other Effects

The effect of fluence on the breakdown frequency may be ascribed to incomplete emptying of traps when a breakdown occurs. The trap emptying may possibly be complete in a localized area; whereas, in other areas, few traps would be emptied. As a consequence, less fluence is needed in those regions of incomplete emptying to initiate a breakdown.

As was mentioned previously, the breakdown frequency appeared to be somewhat dependent on the charge storage in the material before irradiation on the same sample because the electrons remain trapped for several minutes after cessation of irradiation. Because the release-rate term in equation (1) becomes dominant after irradiation ceases, the time constant that affects the process is the time necessary for the release of electrons from traps. For deep traps, this time may be quite long, and, consequently, a considerable number of electrons may still be trapped when the material is reirradiated. Hence, fewer electrons would be needed to initiate a discharge. This circumstance would tend to increase the breakdown frequency.

Finally, a potentially important factor may have been neglected in this model. This factor is the creation of traps by the irradiation itself. The creation of traps may have an important effect on both the charge and the breakdown that result. Little information is available on this phenomenon although suggestions have been made that it is a potentially significant process (refs. 5 and 8).

CONCLUDING REMARKS

The experimental results showed the dependence of electron kinetic energy, electron flux, and sample temperature on the production of dielectric breakdowns in several organic insulators. In addition, some effect is found to be due to the fluence received by the sample and the charge stored in the material before irradiation. These results were found to be compatible with a band model for organic insulators with an allowance for traps. By using this model, relative-depth characteristics of electron traps as a function of energy were surmised for some of the materials. A potentially important factor may have been neglected in the model. This factor is the creation of traps by the irradiation.

Teflon was found to be by far the most susceptible material to the radiation-induced breakdowns at 77° K; however, it was noticeably less susceptible at 298° K and suffered fewer breakdowns than several of the other materials. Polyethylene was the most immune material to the breakdown phenomenon at 298° K. The other materials tested had properties between those of Teflon and polyethylene.

Langley Research Center,
National Aeronautics and Space Administration,
Langley Station, Hampton, Va., June 11, 1968,
124-09-12-01-23.

REFERENCES

1. Res. Triangle Inst.: Study on the Electronic Irradiation Effects on Capacitor-Type Micrometeoroid Detectors. NASA CR-312, 1965.
2. Storti, George M.; Phillips, Donald H.; and Frank, Clifford S.: Experimental Study of Transient Effects in Dielectric Materials Caused by Electron Irradiation. NASA TN D-3032, 1965.
3. James, Thomas G.; Heyson, Harry H.; and Frank, Clifford S.: Experimental Study of Effects of Electron Irradiation From 20 keV to 1 MeV on a Polyethylene Terephthalate Capacitor-Type Meteoroid Detector. NASA TN D-3682, 1966.
4. Anon.: The Meteoroid Satellite Project Pegasus - First Summary Report. NASA TN D-3505, 1966.
5. Monteith, L. K.; and Hauser, J. R.: Space-Charge Effects in Insulators Resulting From Electron Irradiation. J. Appl. Phys., vol. 38, no. 13, Dec. 1967, pp. 5355-5365.
6. Cleland, M. R.; and Morganstern, K. H.: A New High-Power Electron Accelerator. IRE, Trans. Ind. Electron., vol. IE-7, no. 2, July 1960, pp. 36-40.
7. Pezdirtz, George F.; and Bell, Vernon L.: An Exploratory Study of a New Class of Stepladder and Ladder Polymers-Polyimidazopyrrolones. NASA TN D-3148, 1965.
8. Yahagi, Kichinosuke; and Shinohara, Kenichi: Effect of Carrier Traps in Polyethylene Under Gamma-Ray Irradiation. J. Appl. Phys., vol. 37, no. 1, Jan. 1966, pp. 310-315.

TABLE I.- SOME TYPICAL PHYSICAL PARAMETERS OF MATERIALS INVESTIGATED

Material	Generic name	Thickness, μm	Specific gravity	Dielectric constant at kHz	Dielectric strength, V/m
Teflon	Polytetrafluoroethylene	51	2.14 to 2.17	2.0	2.0×10^8
Kapton	Polypyromellitimide	51	1.42	3.5	2.8×10^8
Parylene-N	Poly(p-xylene)	51	1.10 to 1.12	2.6	2.5×10^8
Parylene-C	Poly(monochloro-p-xylene)	51	1.29	3.1	1.5×10^8
Polyethylene	Polyethylene	51	0.95	2.3	2.0×10^7
Polypropylene	Polypropylene	51	0.92	2.1	2.4×10^7
Pyrrone (PMDA-DAB)	Polyimidazopyrrolone	59	1.45	Unknown	6.0×10^7

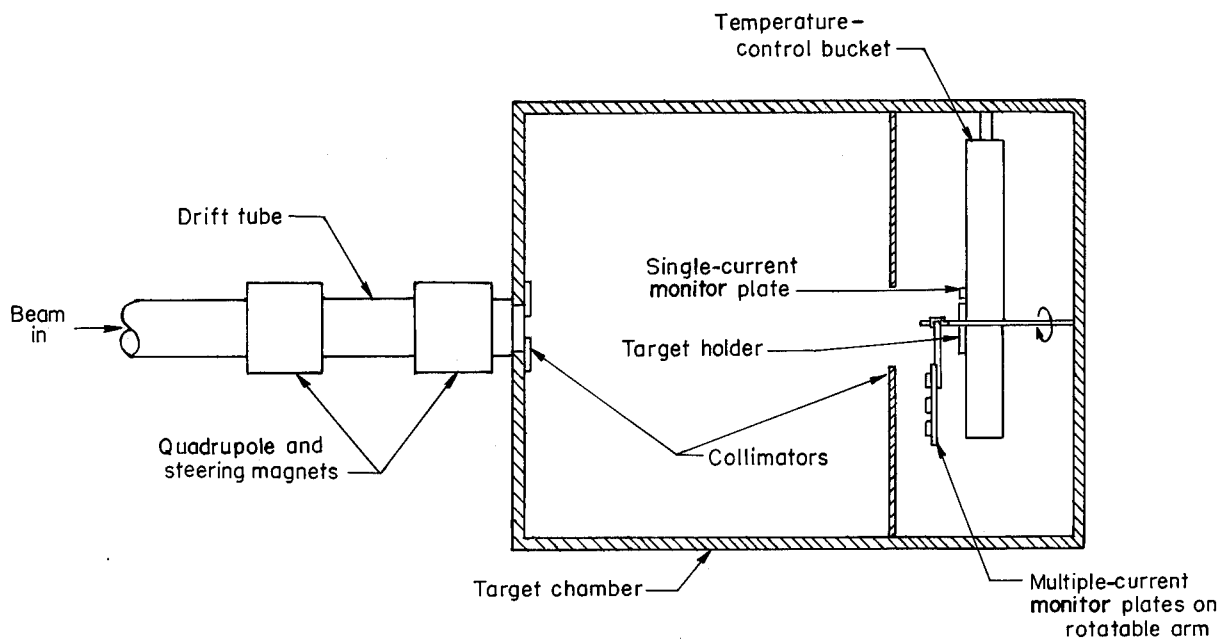

Figure 1.- Beam handling and target chamber system.

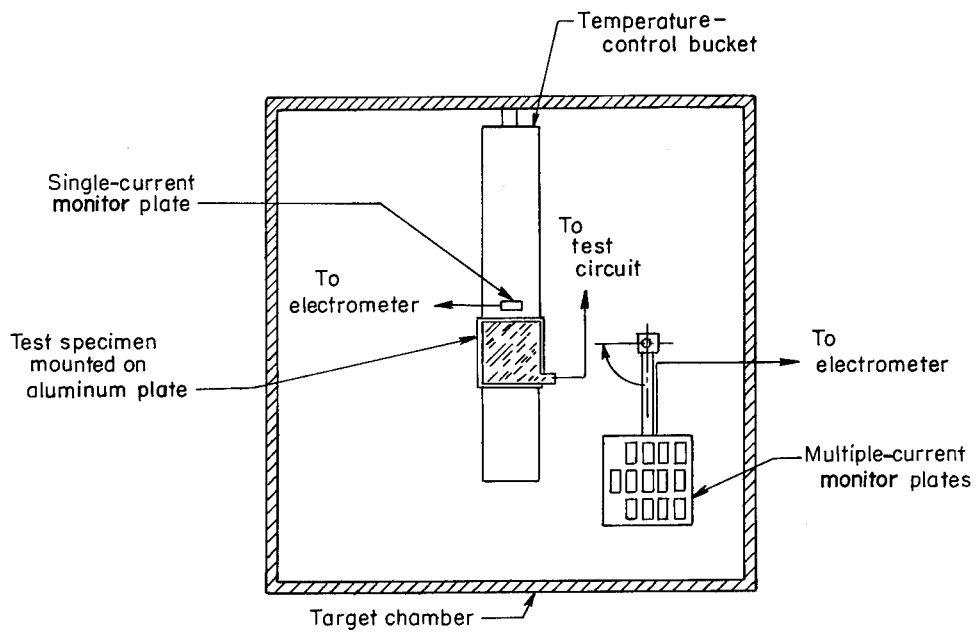

Figure 2.- Sample mounting and beam monitoring apparatus.

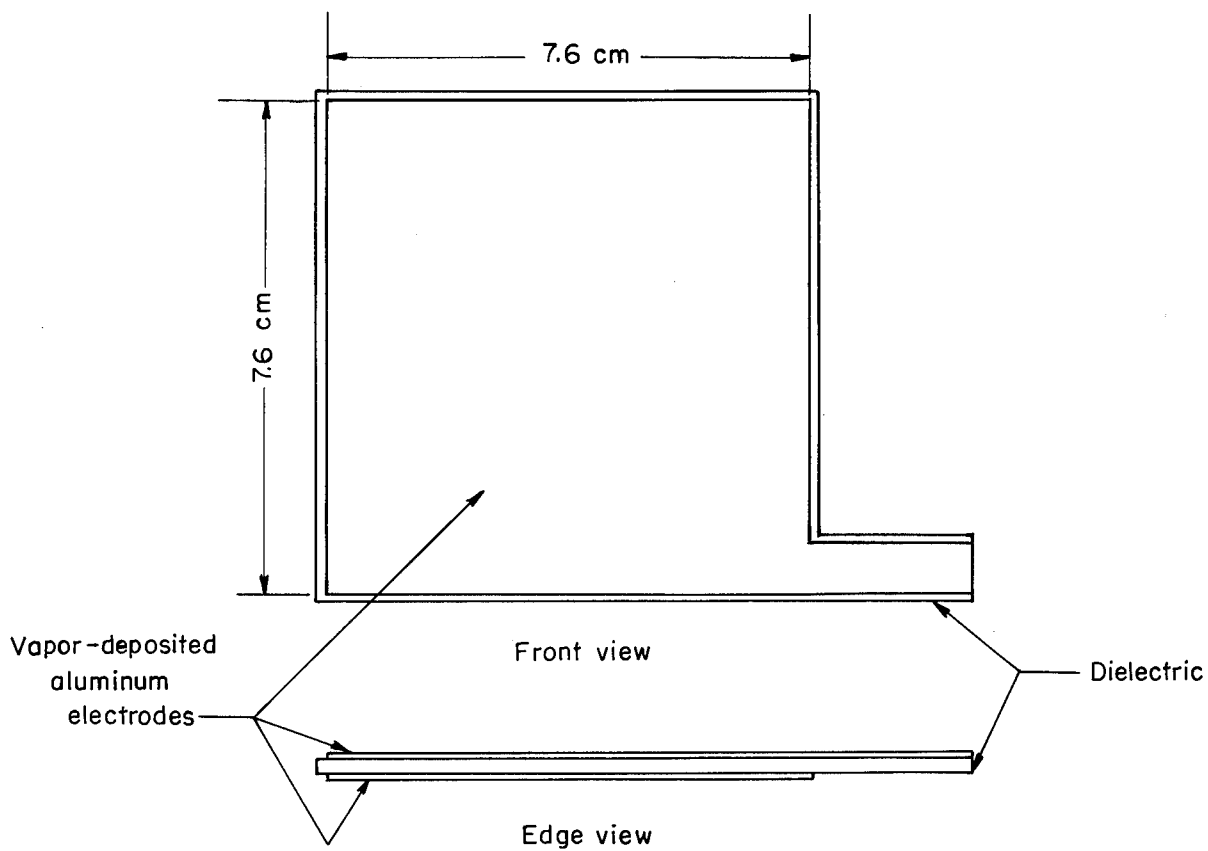
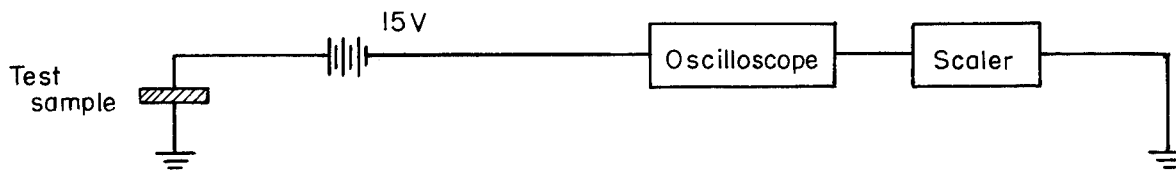

Figure 3.- Target sample configuration.



Test circuit

Figure 4.- Test circuit.

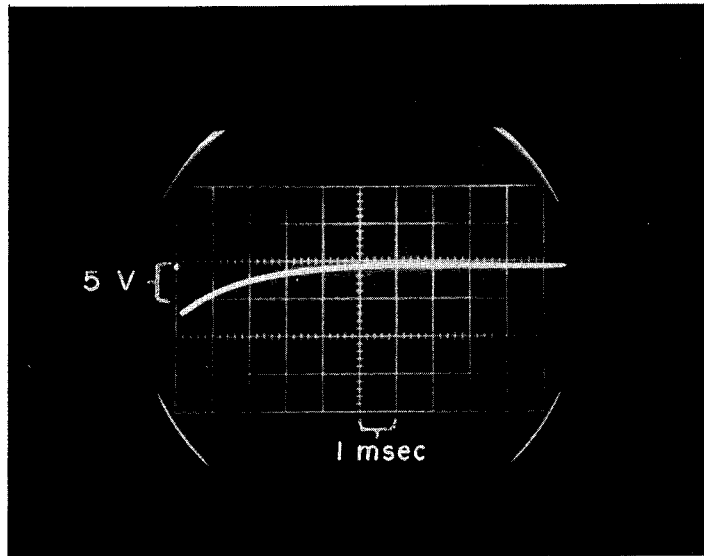
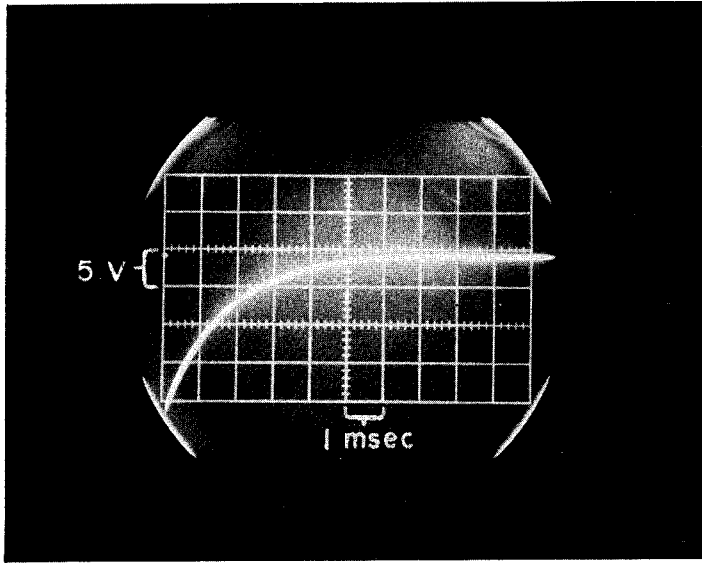
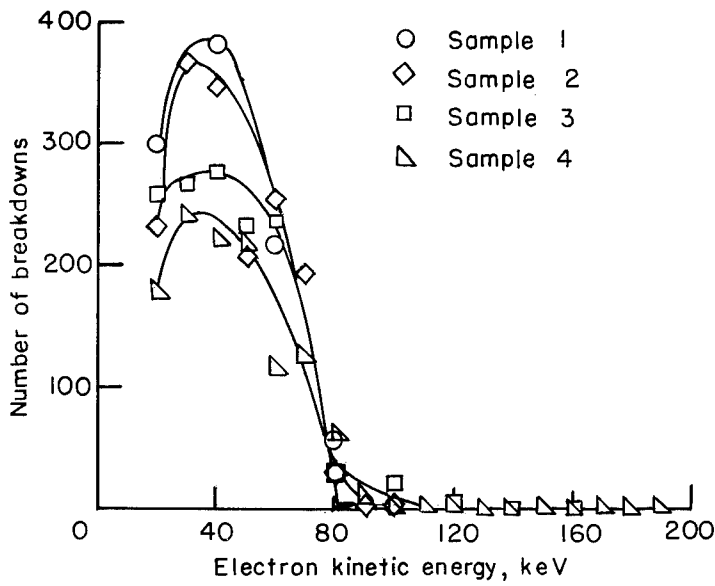
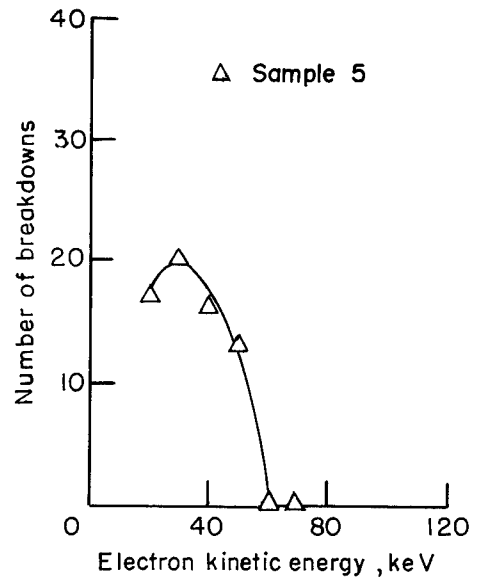

Figure 5.- Photographs of typical breakdown discharges in organic dielectrics. L-68-5645



(a) $T = 77^{\circ} \text{ K.}$



(b) $T = 298^{\circ} \text{ K.}$

Figure 6.- Dependence of breakdown frequency on kinetic energy for Teflon (FEP). Electron fluence for each data point = $2 \times 10^{13} \text{ e/cm}^2$.

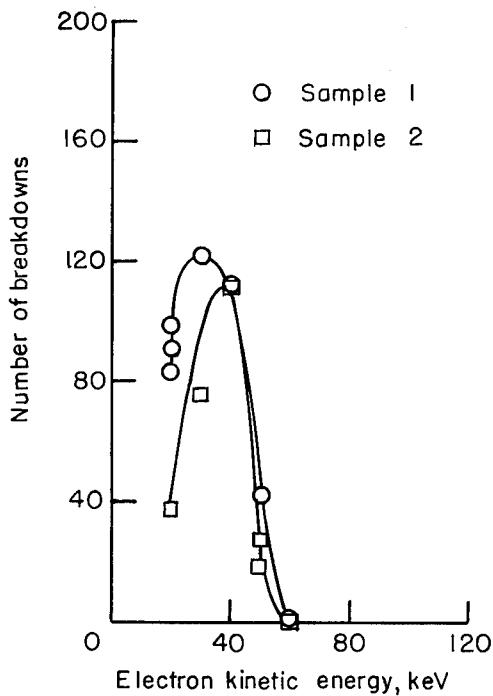

(a) $T = 77^{\circ} \text{ K.}$

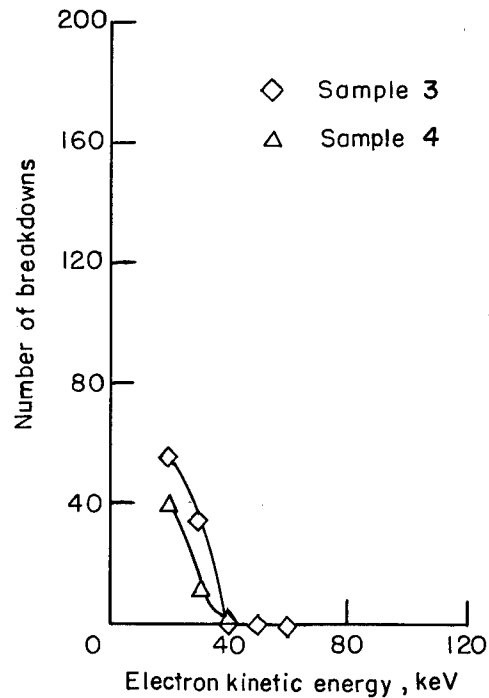

(b) $T = 298^{\circ} \text{ K.}$

Figure 7.- Dependence of breakdown frequency on kinetic energy for Kapton. Electron fluence for each data point = $2 \times 10^{13} \text{ e/cm}^2$.

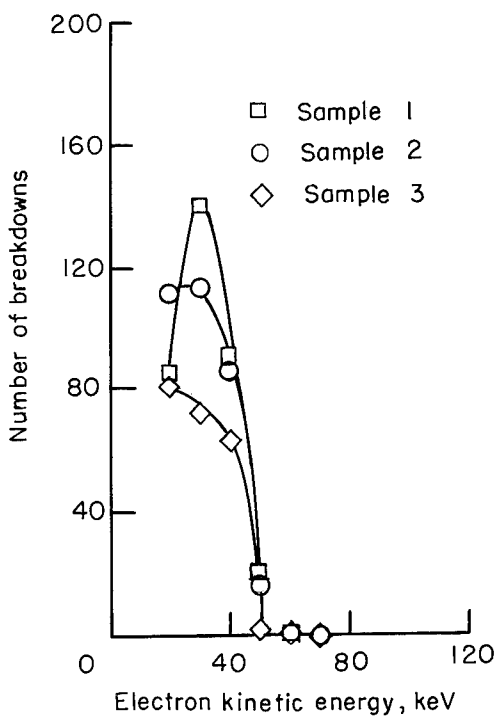

(a) $T = 77^{\circ} \text{K}$.

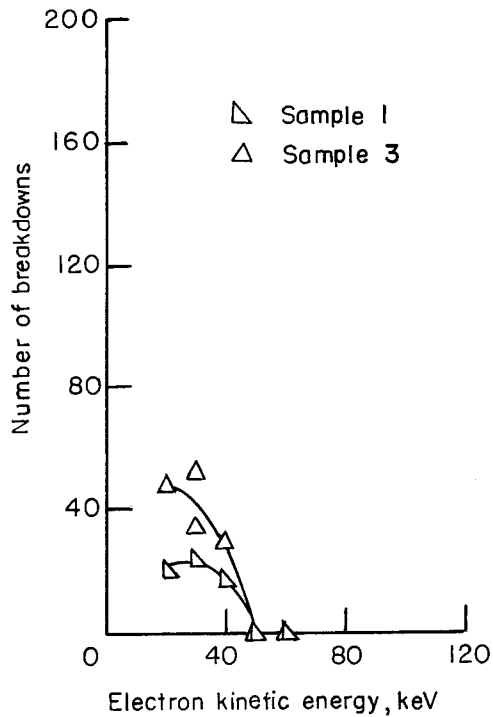

(b) $T = 298^{\circ} \text{K}$.

Figure 8.- Dependence of breakdown frequency on kinetic energy for parylene-C. Electron fluence for each data point = $2 \times 10^{13} \text{ e/cm}^2$.

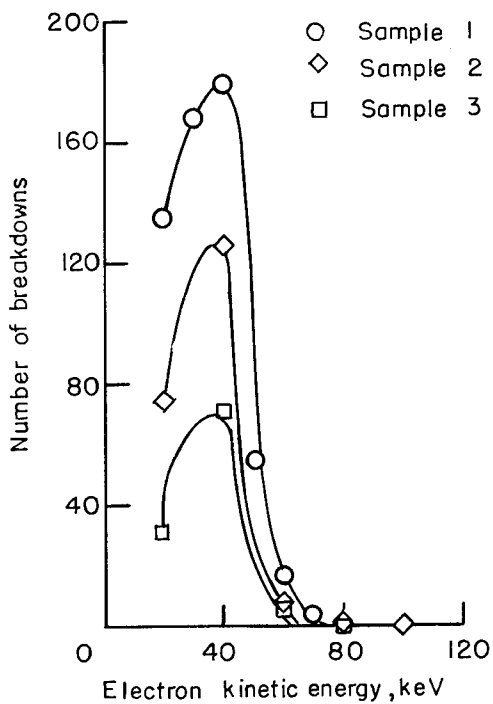

(a) $T = 77^{\circ} \text{K}$.

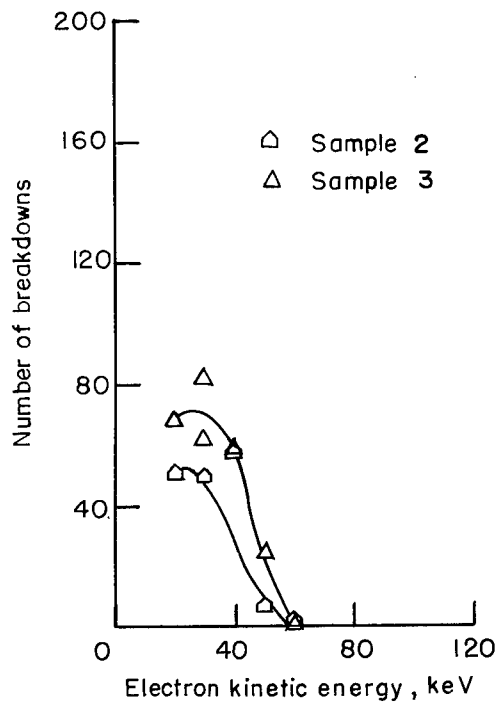

(b) $T = 298^{\circ} \text{K}$.

Figure 9.- Dependence of breakdown frequency on kinetic energy for parylene-N. Electron fluence for each data point = $2 \times 10^{13} \text{ e/cm}^2$.

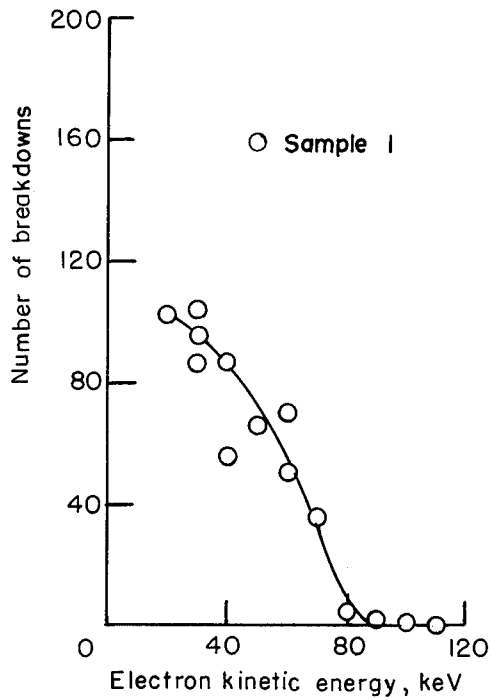

(a) T = 77° K.

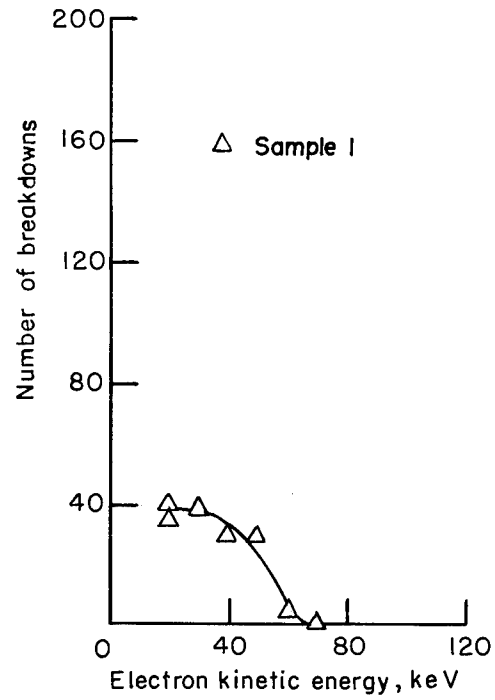

(b) T = 298° K.

Figure 10.- Dependence of breakdown frequency on kinetic energy for Pyrrone. Electron fluence for each data point = $2 \times 10^{13} \text{ e/cm}^2$.

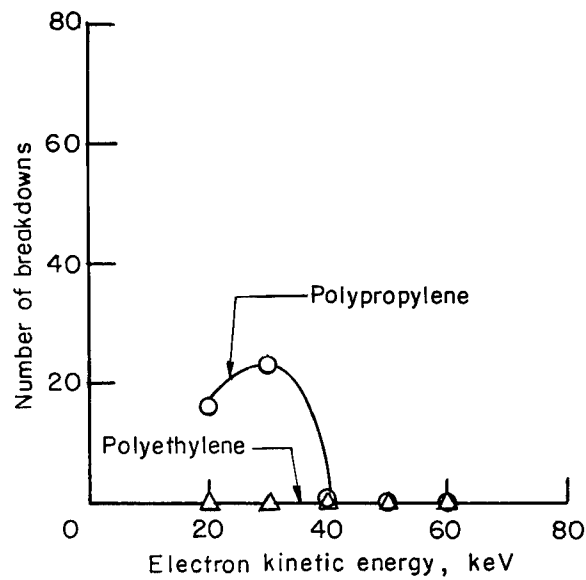

Figure 11.- Dependence of breakdown frequency on kinetic energy for polyethylene and polypropylene. Electron fluence for each data point = $2 \times 10^{13} \text{ e/cm}^2$. T = 298°.

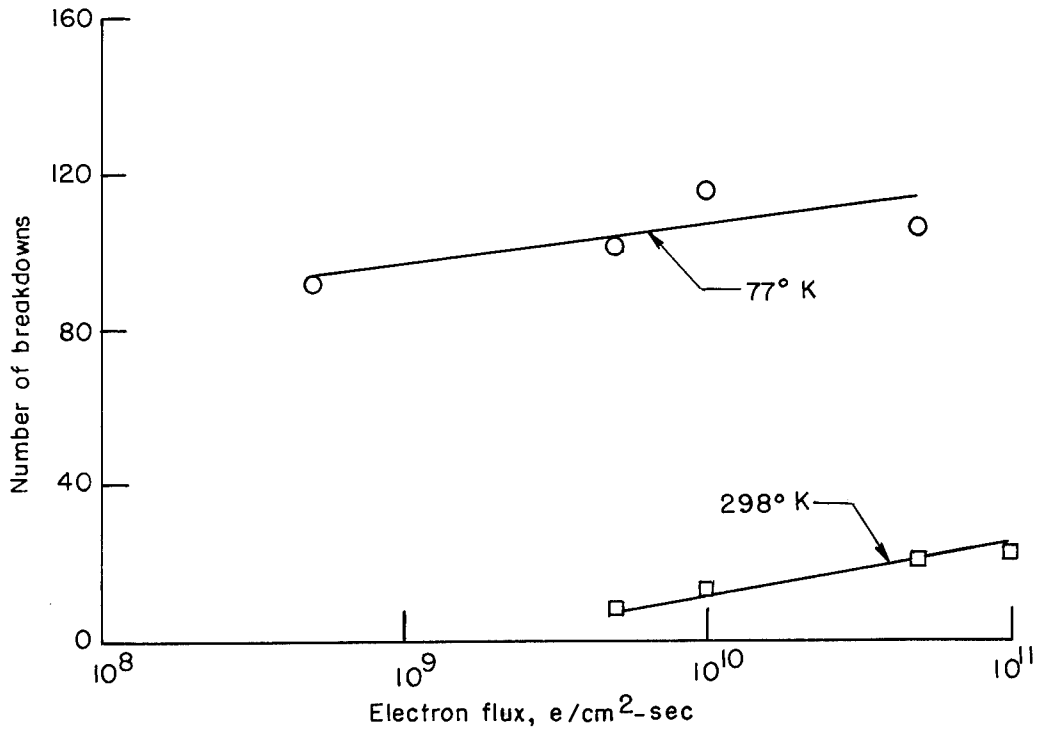

Figure 12.- Dependence of breakdown frequency on flux for Teflon (FEP). Electron fluence for each data point = 1×10^{13} e/cm²; $E_k = 40$ keV.

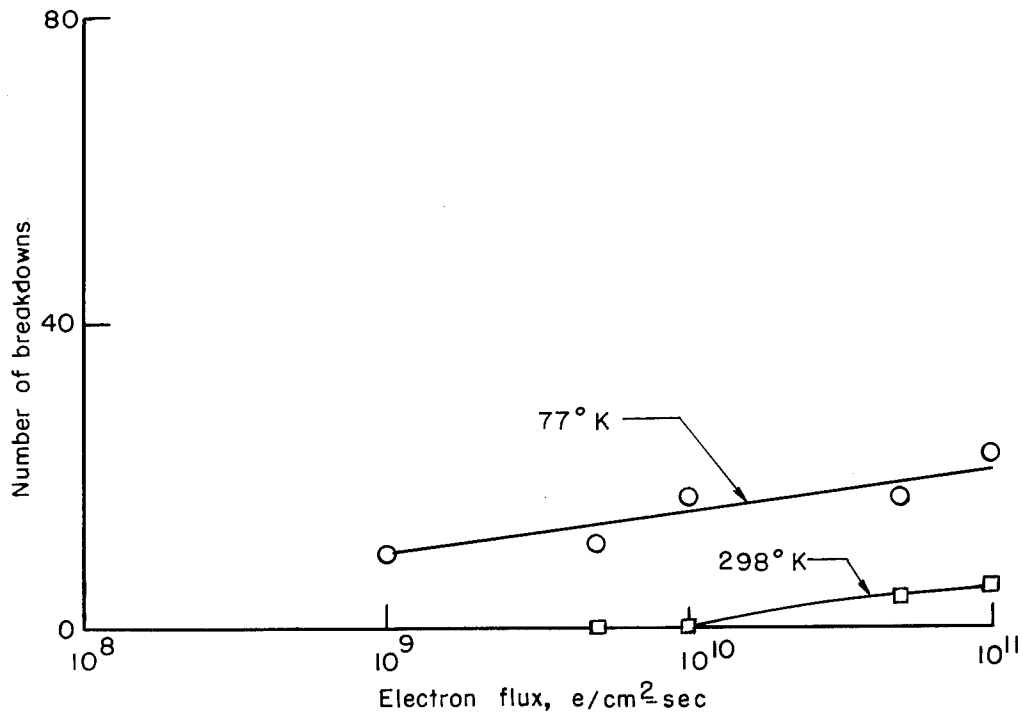

Figure 13.- Dependence of breakdown frequency on flux for Kapton. Electron fluence for each data point = 1×10^{13} e/cm²; $E_k = 30$ keV.

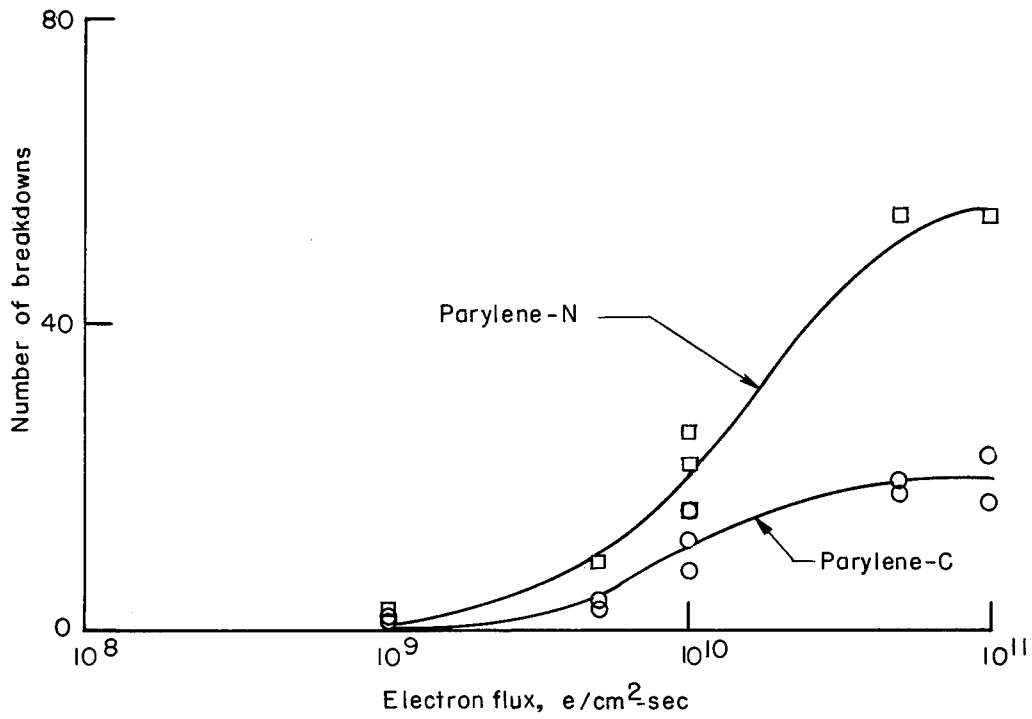

Figure 14.- Dependence of breakdown frequency on flux for parylene-C and parylene-N. Electron fluence for each data point = 1×10^{13} e/cm²; $E_k = 30$ keV; $T = 298^\circ$ K.

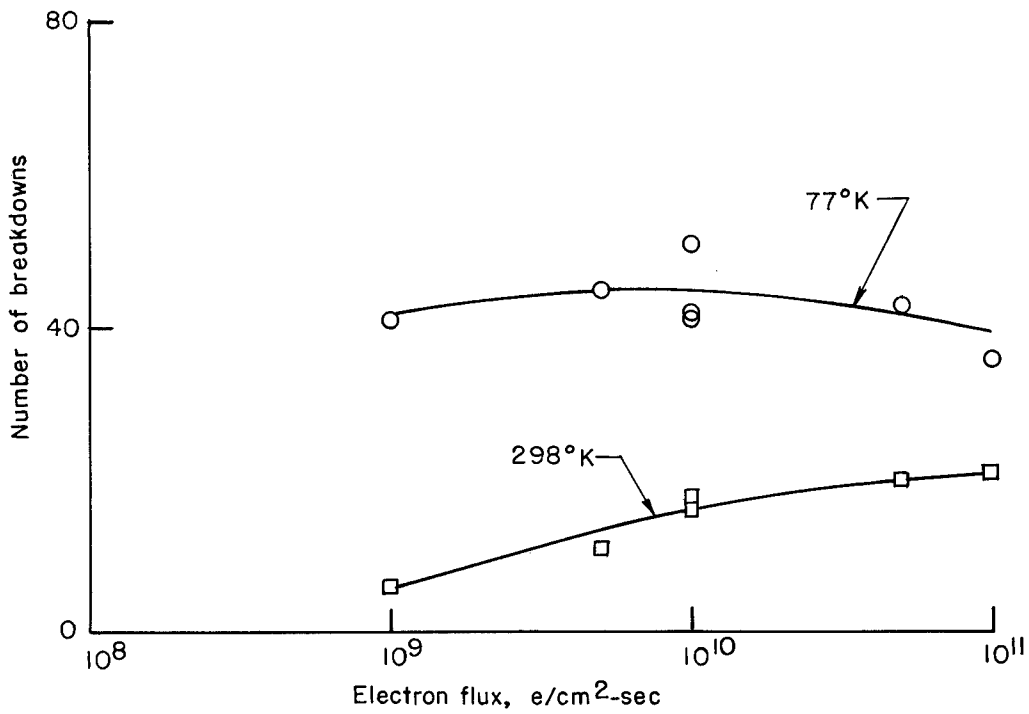

Figure 15.- Dependence of breakdown frequency on flux for Pyrrone. Electron fluence for each data point = 1×10^{13} e/cm²; $E_k = 30$ keV.

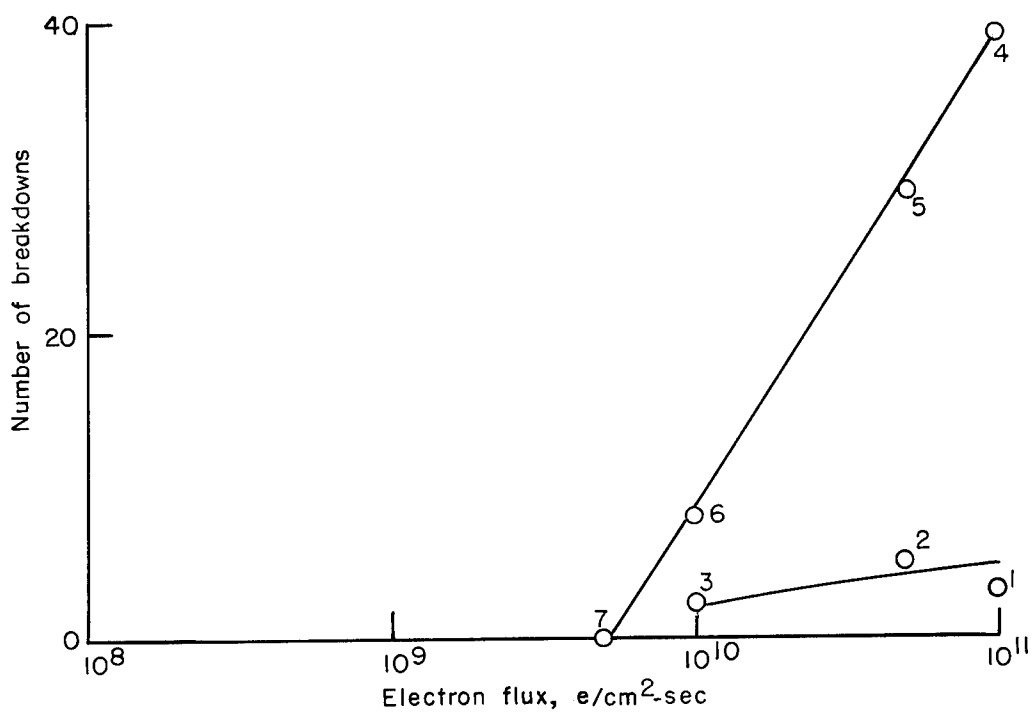

Figure 16.- Dependence of breakdown frequency on flux for polypropylene. Electron fluence for each data point = $5 \times 10^{13} e/cm^2$; $E_k = 30 \text{ keV}$; $T = 298^\circ \text{ K}$. The numbers by the data points correspond to order in which data were taken.

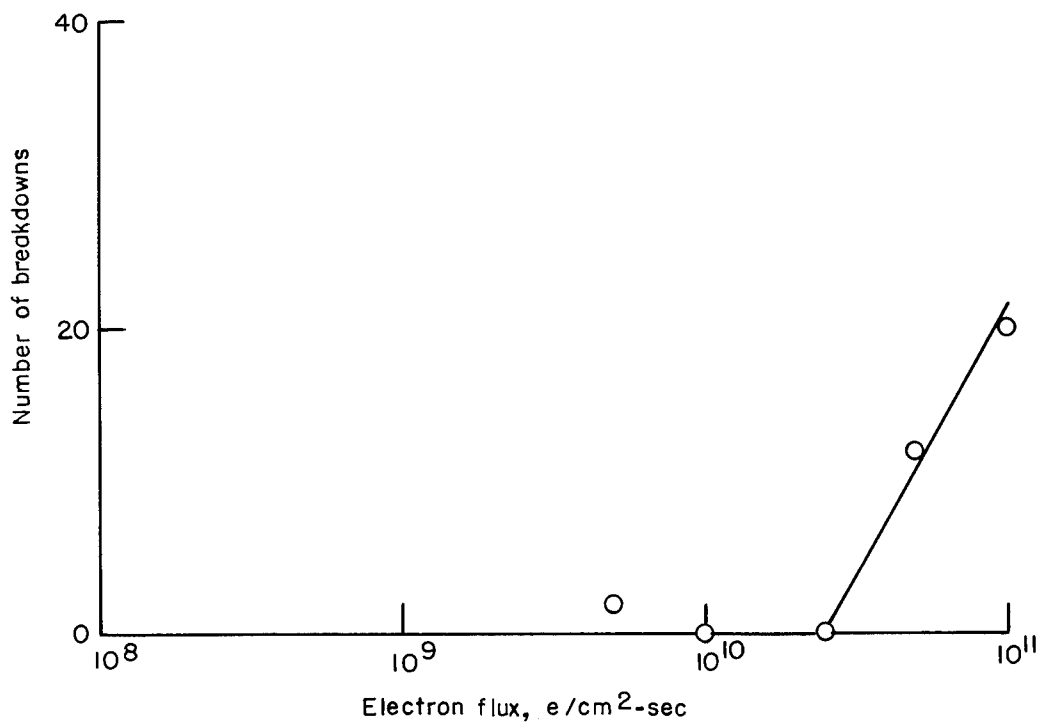

Figure 17.- Dependence of breakdown frequency on flux for polyethylene. Electron fluence for each data point = 2×10^{13} e/cm²; $E_k = 30$ keV; $T = 2980$ K.

NATIONAL AERONAUTICS AND SPACE ADMINISTRATION
WASHINGTON, D. C. 20546
OFFICIAL BUSINESS

POSTAGE AND FEES PAID
NATIONAL AERONAUTICS AND
SPACE ADMINISTRATION

FIRST CLASS MAIL

07U 001 43 50 3DS 68257 00942
PICATINNY ARSENAL
PLASTICS TECHNICAL EVALUATION CENTER
DOVER, NEW JERSEY 07801

3501

ATT SMUPA-VP3

POSTMASTER: If Undeliverable (Section 158
Postal Manual) Do Not Return

"The aeronautical and space activities of the United States shall be conducted so as to contribute . . . to the expansion of human knowledge of phenomena in the atmosphere and space. The Administration shall provide for the widest practicable and appropriate dissemination of information concerning its activities and the results thereof."

— NATIONAL AERONAUTICS AND SPACE ACT OF 1958

NASA SCIENTIFIC AND TECHNICAL PUBLICATIONS

TECHNICAL REPORTS: Scientific and technical information considered important, complete, and a lasting contribution to existing knowledge.

TECHNICAL NOTES: Information less broad in scope but nevertheless of importance as a contribution to existing knowledge.

TECHNICAL MEMORANDUMS: Information receiving limited distribution because of preliminary data, security classification, or other reasons.

CONTRACTOR REPORTS: Scientific and technical information generated under a NASA contract or grant and considered an important contribution to existing knowledge.

TECHNICAL TRANSLATIONS: Information published in a foreign language considered to merit NASA distribution in English.

SPECIAL PUBLICATIONS: Information derived from or of value to NASA activities. Publications include conference proceedings, monographs, data compilations, handbooks, sourcebooks, and special bibliographies.

TECHNOLOGY UTILIZATION PUBLICATIONS: Information on technology used by NASA that may be of particular interest in commercial and other non-aerospace applications. Publications include Tech Briefs, Technology Utilization Reports and Notes, and Technology Surveys.

Details on the availability of these publications may be obtained from:

SCIENTIFIC AND TECHNICAL INFORMATION DIVISION
NATIONAL AERONAUTICS AND SPACE ADMINISTRATION
Washington, D.C. 20546