

~~CONFIDENTIAL~~

WT-1490

UNIQUE DOCUMENT # SAC 20008875-0000

This document consists of 32 pages.
No. 123 of 175 copies, Series A

OPERATION PLUMBBOB

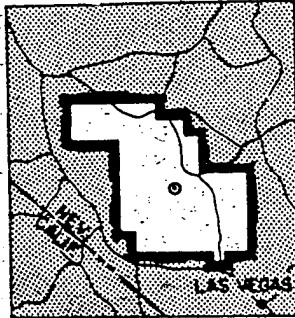

NEVADA TEST SITE
MAY-OCTOBER 1957

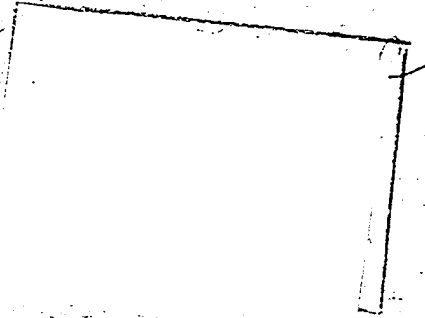

Project 62.4b

DISTRIBUTION STATEMENT A
Approved for public release
Distribution Unlimited

ROCKET FIRING TONE SYSTEM

Declassified under NTPR Program.
Distribution Statement "A" Applies

19960702 082

DNA OPSSI *Robert L. [unclear]* DATE 3/25/92

Issuance Date: July 25, 1958

SANDIA CORPORATION · ALBUQUERQUE, NEW MEXICO



~~FORMERLY RESTRICTED DATA~~

the national defense, or the United States
with [unclear] of the espionage laws
Title 18, U.S.C. [unclear]
[unclear] of which in any
manner to an unauthorized person is pro-

~~CONFIDENTIAL~~

DEPARTMENT OF ENERGY DECLASSIFICATION REVIEW	
1. REVIEW DATE: 2/27/96	2. DETERMINATION (CIRCLE NUMBER(S))
3. AUTHORITY: [unclear]	1. CLASSIFICATION RETAINED
4. NAME: [unclear]	2. CLASSIFICATION CHANGED TO: TOP SECRET
5. 2ND REVIEW DATE: 2/1/96	3. CONTAINS NO DOE CLASSIFIED INFO
6. AUTHORITY: [unclear]	4. COORDINATE WITH: [unclear]
7. NAME: [unclear]	5. CLASSIFICATION CANCELLED
	6. CLASSIFIED INFO BRACKETED
	7. OTHER (SPECIFY):

A [unclear] ons.

DISCLAIMER NOTICE

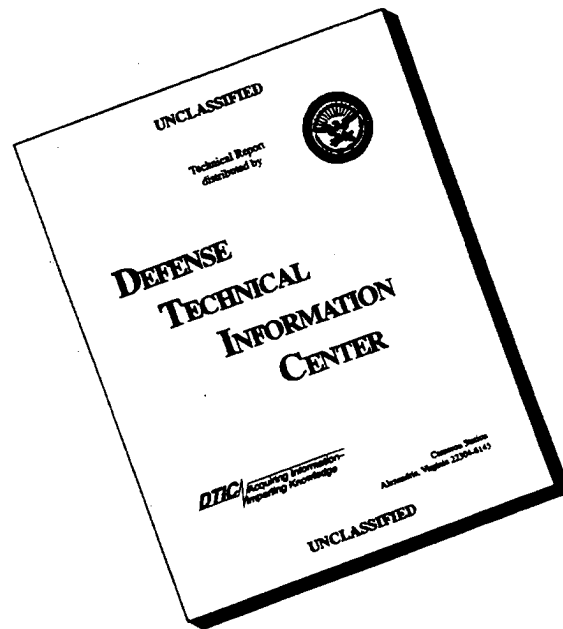

THIS DOCUMENT IS BEST QUALITY AVAILABLE. THE COPY FURNISHED TO DTIC CONTAINED A SIGNIFICANT NUMBER OF PAGES WHICH DO NOT REPRODUCE LEGIBLY.



Defense Nuclear Agency
6801 Telegraph Road
Alexandria, Virginia 22310-3398

ISST

28 May 1996

MEMORANDUM FOR DEFENSE TECHNICAL INFORMATION CENTER
ATTENTION: OCD (Mr. Bill Bush)

SUBJECT: Declassification of Technical Report WT-1490

The Defense Nuclear Agency Security Office (OPSSI) has declassified and approved for public release the following report:

WT-1490
Operation PLUMBBOB, Project 62.4b
Rocket Firing Tone System
Issuance Date: July 25, 1958.

Since this office shows no record of DTIC receiving a copy of this report, a copy is enclosed for inclusion into the DTIC system.

We would appreciate notification of your accession number.

Enclosure:
A/S

for Thomas J. Fields
ARDITH JARRETT
Chief, Technical Support

DTIC QUALITY INSPECTED 4

UNCLASSIFIED

When no longer required, this document may be destroyed in accordance with applicable security regulations.

DO NOT RETURN THIS DOCUMENT

UNCLASSIFIED

UNCLASSIFIED

~~CONFIDENTIAL~~

Report to the Test Director

ROCKET FIRING TONE SYSTEM

By

R. J. Scussel

and

R. J. Rudolph

Sandia Corporation
Albuquerque, New Mexico
December 1957

~~FORMERLY RESTRICTED DATA~~

~~Formerly Restricted Data in accordance with the provisions of the Espionage Act of 1954.~~

~~This material contains information relating to the defense of the United States within the meaning of the espionage laws, Title 18, U.S.C., Secs. 793 and 794, the transmission or revelation of which in any form is prohibited by law.~~

UNCLASSIFIED

~~CONFIDENTIAL~~

ABSTRACT

This report describes in detail the operation and components of a frequency-shift, frequency-modulation system that telemeters rocket firing time from an aircraft to a ground control station.

~~CONFIDENTIAL~~

CONTENTS

ABSTRACT	3
1 OBJECTIVE	9
2 BACKGROUND	9
3 DESCRIPTION	9
3.1 General	9
3.2 System Delays	13
3.3 Advantages of an FS-FM System	13
4 OPERATIONS	15
4.1 Installation of Airborne Equipment	15
4.2 Checkout	15
4.3 Practice Missions	15
4.4 John Shot Live Run	18
5 INSTRUMENTATION	18
5.1 Airborne Equipment	18
5.2 Ground-Station Equipment	18
6 RESULTS	21
6.1 Conclusions and Recommendations	21
APPENDIX A EQUIPMENT	25
A.1 Airborne Equipment	25
A.2 Ground-Station Equipment	26
ILLUSTRATIONS	
1 Airborne Transmitter	10
2 Microswitch in Fired Position	11
3 Ground Station	12

ILLUSTRATIONS (Continued)

4	System Delay	14
5	Microswitch Chatter	14
6	Diagram of Aircraft Installation	16
7	Aircraft Antenna	17
8	Time of Flight: John Shot	19
9	Antenna Installation at Control Point	20
10	Release Tone Rack Equipment Layout	22

~~CONFIDENTIAL~~

ROCKET FIRING TONE SYSTEM

1 OBJECTIVE

In John shot of Operation Plumbbob, an MB-1 air-to-air rocket was fired with a nuclear device. This weapons test report describes the release tone system that measured the time of flight of the rocket and provided a signal to begin a sequence timer at the ground control point.

The firing tone system—a frequency shift, frequency modulation (FS-FM) system—consisted of an airborne transmitter, a receiver at the ground station, recorders, and a relay system that started an Edgerton, Germeshausen and Grier (EG&G) sequence timer at the moment of rocket release. By recording detonation time in addition to release, the system provided time of flight.

2 BACKGROUND

The system used for Plumbbob is almost identical to the Redwing system as described in WT-1358, Release Tone System. The system was tested extensively in 1956 and 1957 in many types of aircraft under varying environmental conditions. Since no failures occurred during these tests, this system was adapted to meet the needs required for the air-to-air rocket firing project of Operation Plumbbob.

3 DESCRIPTION

3.1 General

The transmitting system consists of a standard telemetering unit; details of this unit are given in Appendix A. The system indicates firing by a shift in the frequency of a subcarrier oscillator whose output modulates an airborne transmitter (Figure 1). A microswitch in the aft end of the rocket pylon (Figure 2) initiates this frequency shift when the rocket leaves the pylon. At the ground station (Figure 3), an FM receiver delivers this shifted signal to a subcarrier discriminator. The discriminator, in turn, feeds a biased, polarized relay which responds only to a positive discriminator output. The system is so designed that neither noise in the receivers nor an RF failure in the aircraft will operate the ground station. The system will also respond only to a fire signal. Block diagrams of the system are given in Figures 5, 10, and 11 of WT-1358.

3.1.1 Ready Condition

Before firing, approximately 3 volts is continuously applied to the voltage-controlled oscillator (VCO) in the airborne unit. This voltage causes the transmission of an FM signal

~~CONFIDENTIAL~~
~~FORMERLY-RESTRICTED DATA~~

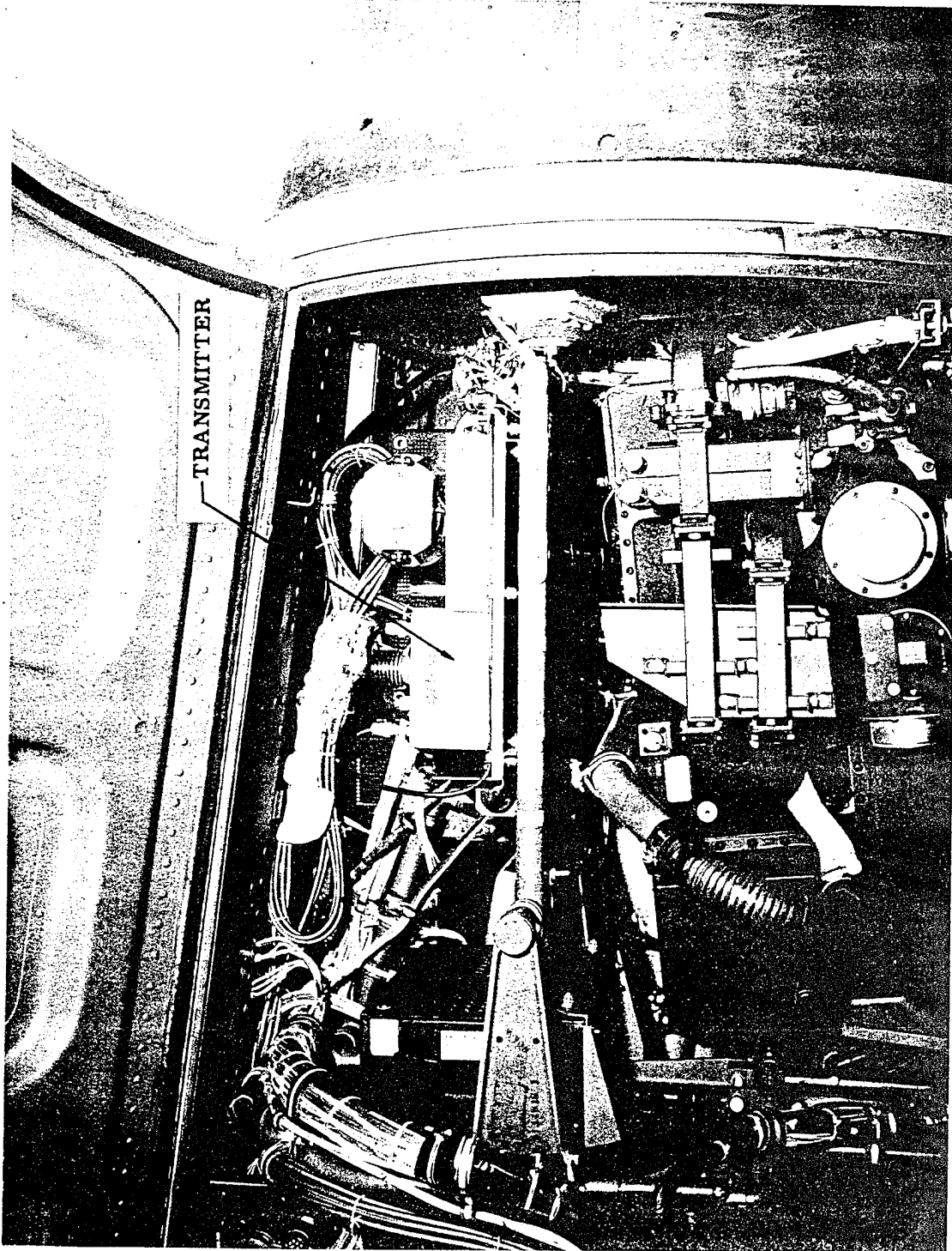

Fig. 1—Airborne transmitter.

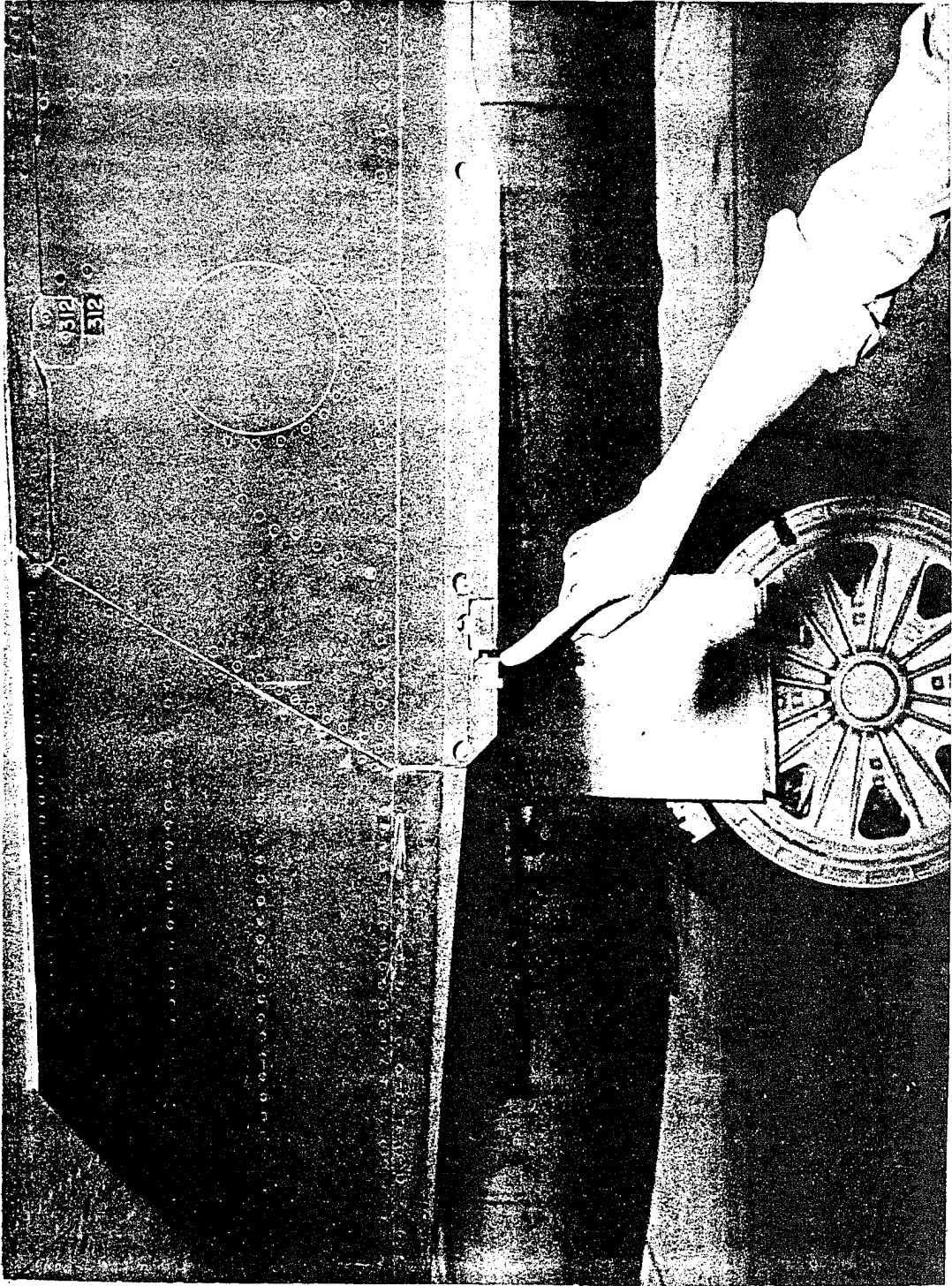

Fig. 2—Microswitch in fired position.

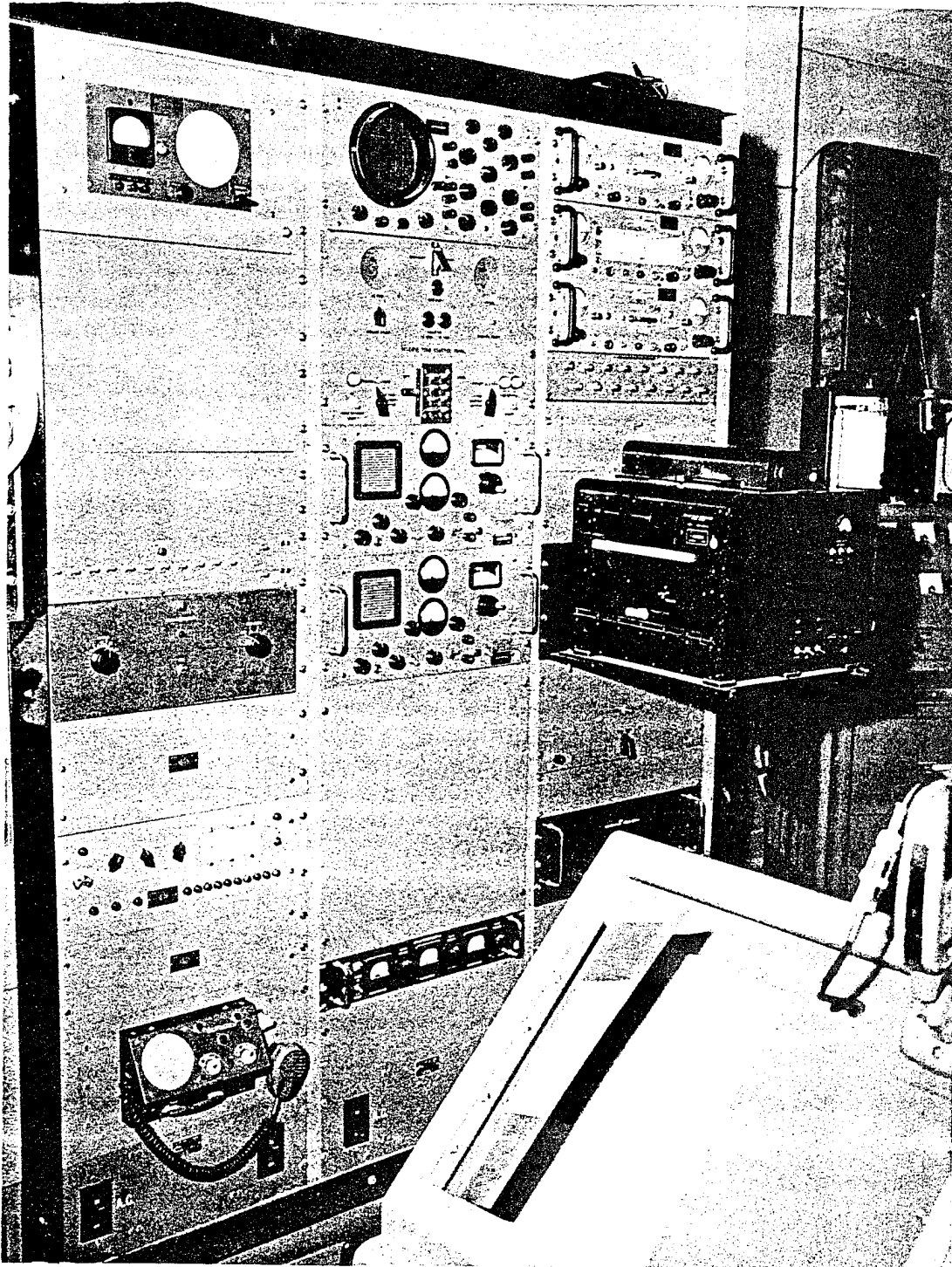

Fig. 3—Ground station.

modulated by 5000 cycles. Reception of this signal by the ground FM receiver results in negative output from the subcarrier discriminator which reinforces the holding force of the normally open, biased, polar relay used to start the sequence timer. Thus, the timer-start relay contact remains in its normal open condition. An ordinary relay in series with the polar relay coil is also energized by the discriminator current and gives an indication of readiness on panel lamps and on a loudspeaker. Concurrently, an oscilloscope shows 3 cycles of the FM receiver output.

If desired, the 5000-cycle signal from the airborne transmitter may be monitored directly if the receiver gain is increased.

3.1.2 Channel Failure

If the RF signal is lost, the discriminator output drops to zero (average), and the polarized timer-start relay remains in its normal open condition, since it responds only to positive current. Noise alone does not start the timer. However, in the absence of a signal, the indicating relay drops out, chatters, and causes noise in the loudspeaker and flickering of the ready lamps. The scope pattern will also change to noise. Since channel failure is clearly indicated, the danger of false operation is negligible.

3.1.3 Release Condition

When the rocket fires, the microswitch drops down, grounding the 3 volts to the VCO and causing the VCO to shift to 5800 cycles. At the ground station, the shift to 5800 cycles causes the discriminator to apply positive current to the polar relay. As the polar relay operates, it closes the timer-start circuit and lights the fire lamp. Operation of the polar relay also interrupts the ordinary relay, extinguishing the ready lamps and muting the speaker on the control panel. At the same time, the oscilloscope pattern shifts from 3 cycles to 4 cycles. The shift can also be heard over the loudspeaker if desired.

3.2 System Delays

A delay of 50 ± 3 milliseconds exists between grounding of VCO voltage and closing of the polar relay. The EG&G system uses an adjustable electronic sequence timer for air drops or rockets with an interval of 38 msec between switch closure and timer start. The complete system delay is therefore 88 msec (Figure 4).

However, the records of the six trial rockets and the live rocket show a system delay of from 138 to 140 msec. This delay is the result of chatter in the microswitch because of rocket blast, which pushes the microswitch up to the prerelease position (Figure 5). The records indicate that the switch remained in the prerelease position and oscillated for about 30 msec, an interval that is not sufficiently long for the polar relays to lock in and to start the electronic timer. Therefore, to ensure accurate instrumentation, 130 msec was subtracted from the time of flight setting on the timer.

The time delay is negligible (less than 1 msec) between removal of VCO voltage and frequency shift in the FM receiver output signal.

3.3 Advantages of an FS-FM System

3.3.1 Signal-to-Noise Ratio

Frequency shift has a theoretical advantage of 10 to 14 db in signal-to-noise ratio over an AM system, and comparative field tests have borne out the theory.

~~CONFIDENTIAL~~

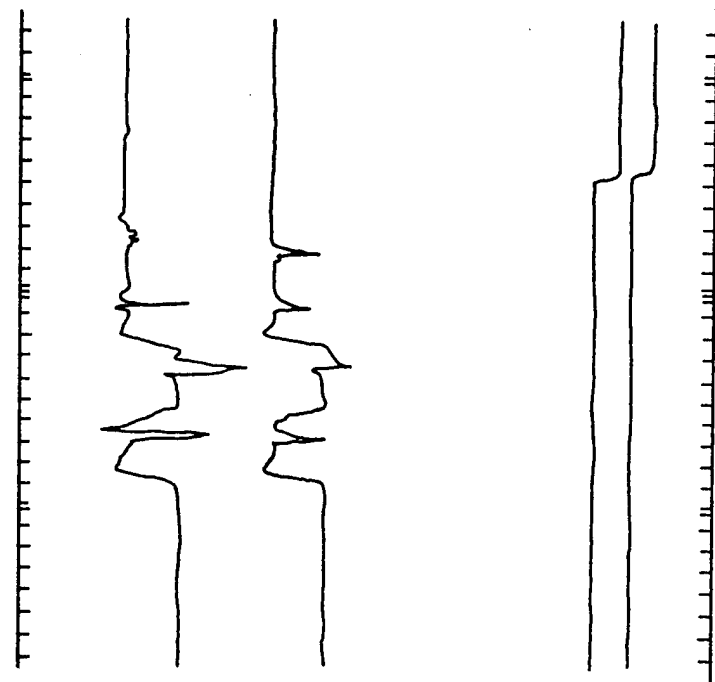

Fig. 5—Microswitch chatter.

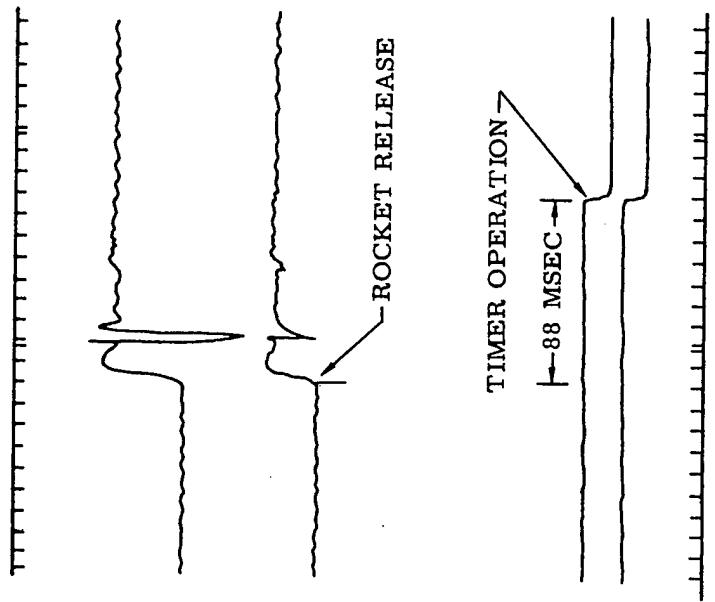

Fig. 4—System delay.

CONFIDENTIAL

3.3.2 Relative Insensitivity to Noise

The relative insensitivity to noise in the absence of signal is due to the averaging effect of the discriminator. Within the pass band of the discriminator, random noise tends to produce as many components below the center frequency of the discriminator as above center. The integrated results, therefore, tend toward zero.

Since the polar relay in the discriminator output circuit is biased to the off position, its operation is enhanced by the noise-averaging characteristics of the subcarrier discriminator. Thus, the relay does not operate in the presence of full receiver noise.

4 OPERATIONS

4.1 Installation of Airborne Equipment

Because of the great importance of proper instrumentation of full-scale weapons, back-up equipment has always been used to ensure greater reliability. In previous operations, large bombers were used for weapon carriage, and the installation of back-up equipment created no problem. For Plumbbob, however, the rockets were carried on two F-89 fighters, each of which had sufficient space for only one transmitter installation.

The necessary equipment, diagrams, and instructions were sent to Northrup Aircraft Company for installation (Figure 6). The transmitting antenna (AN-95-C) was modified for 220 mc and was mounted on the nose section of the aircraft (Figure 7). Spare equipment was available and ready should the need arise.

4.2 Checkout

The aircraft and equipment were given a preliminary checkout at Kirtland Air Force Base, Albuquerque, New Mexico, early in the summer of 1957. After satisfactory checkout, the aircraft flew to Indian Springs Air Force Base in Nevada for basing and operations.

In past operations, more than one switching system was used to ensure reliability of breakaway signal. Generally, two microswitches were used in series, either of which triggered the transmitter. As a further back-up, a cable disconnect was tied into the switching system. If both switches failed, cable disconnect gave a positive indication, although action was somewhat slower. Because of the physical structure of the rocket pylon, however, not more than one microswitch could be used.

The equipment was checked and serviced daily to ensure satisfactory flyaround tests.

4.3 Practice Missions

4.3.1 Six Rocket Firings

During numerous orientation flyarounds of the F-89's throughout June 1957, manually controlled tests were conducted from the aircraft to simulate rocket firings. During the tests, it was possible to plot signal strength, study aircraft keying, check the receiving station, monitor the operation of the sequence timer, and observe ground range instrumentation. All operations were satisfactory. One dry-run was erratic, both fire and no-fire signals being produced rapidly. Closing the arm-safe switch at H minus 1.5 sec resulted in a successful run.

CONFIDENTIAL

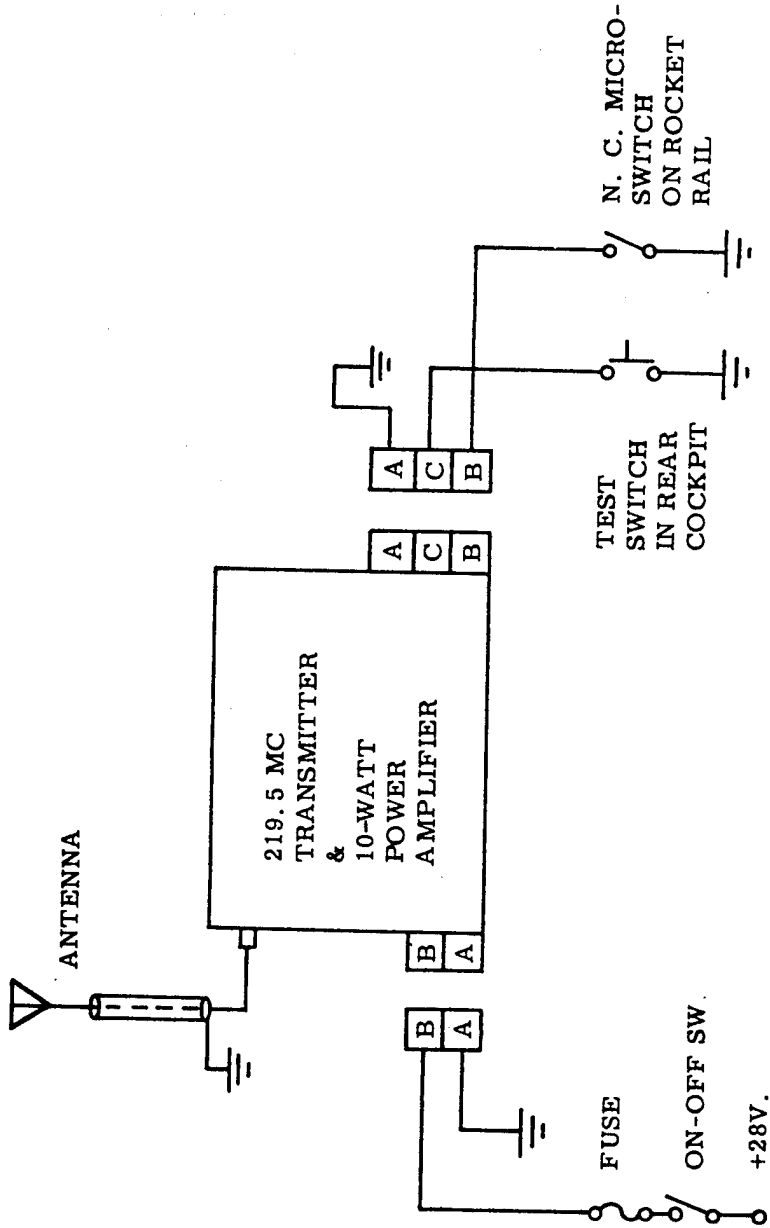

Fig. 6—Diagram of aircraft installation.

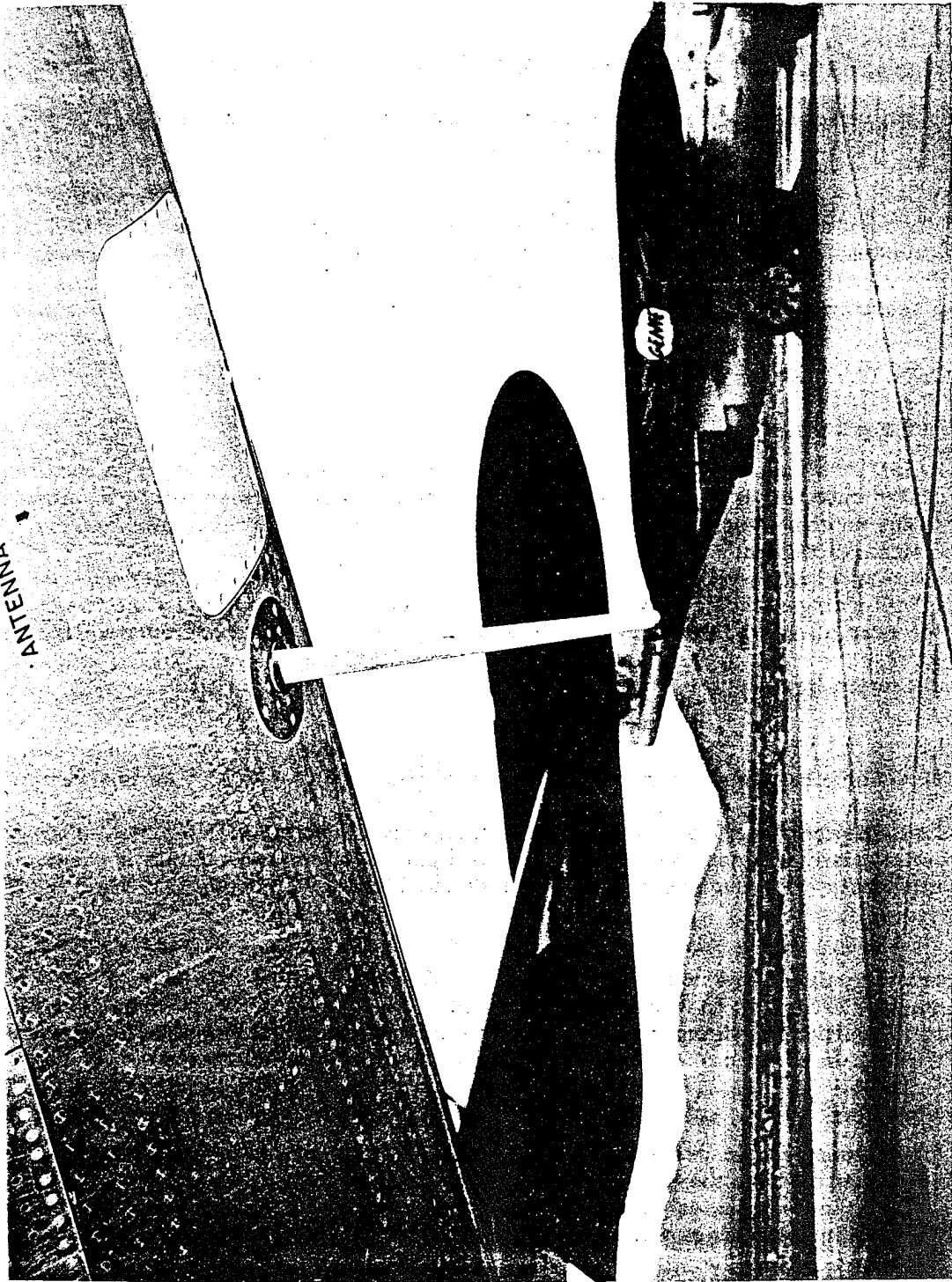

Fig. 7—Aircraft antenna.

During July, six prototype MB-1 rockets were fired to obtain ballistic data. The entire system worked satisfactorily.

4.4 John Shot Live Run

On July 19, 1957, at the Nevada Test Site, an F-89D fired a full-scale nuclear rocket.

In preparation for this test, the aircraft instrumentation was checked out at 3:00 AM, and the rocket loading was finished by 5:00 AM. The final checkout was performed after the rocket installation was completed.

The equipment at the control point was turned on at H minus 45 minutes and trimmed up at H minus 5 minutes. At H minus 30 seconds, the arm-safe switch was manually closed. At zero time the circuits operated normally. Oscillograph records (Figure 8) show time of flight to be 4.440 seconds.

5 INSTRUMENTATION

5.1 Airborne Equipment

Each F-89D airplane carried one transmitter in the radar compartment, with the blade antenna mounted underneath the nose section. This antenna was trimmed to $1/4$ wavelength at 220 mc. The antenna shock-excited the aircraft, which acted as a reradiator and produced good signal strength regardless of attitude.

Except for turning of the equipment on and off, a procedure controlled by the radar operator from the rear cockpit of the aircraft, the airborne system operated automatically.

5.2 Ground-Station Equipment

5.2.1 Receiving Instruments

One EG&G "blue box" was mounted on the control point roof. This device is a remote triggering instrument designed to operate electrical equipment at the instant of a high-intensity flash. As used for the rocket test, it pulsed the oscillograph record at detonation. The thyatron output of this instrument was brought into two galvanometer movements in the oscillograph and attenuated to produce about a $3/8$ -inch deflection on the record.

5.2.2 Antennas

Two cardioid unipole antennas were secured to a T-shaped pole on the roof of the control point (Figure 9). These antennas were then oriented to receive a maximum signal when the aircraft was in position for firing the rocket. The cardioid unipole antenna has a forward gain of 3 db, a front-to-back ratio of 15 db, and a half-power angle of 180 degrees.

5.2.3 Preamplifier

Since the antenna lead-ins were short (approximately 100 feet) the preamplifiers were rack-mounted indoors where they could be easily bypassed or replaced in case of a failure. Unshielded multiconductor cables were connected to the preamplifier power supplies. After a few trial runs, the preamplifiers were found to be unnecessary because signal strength was sufficiently strong.

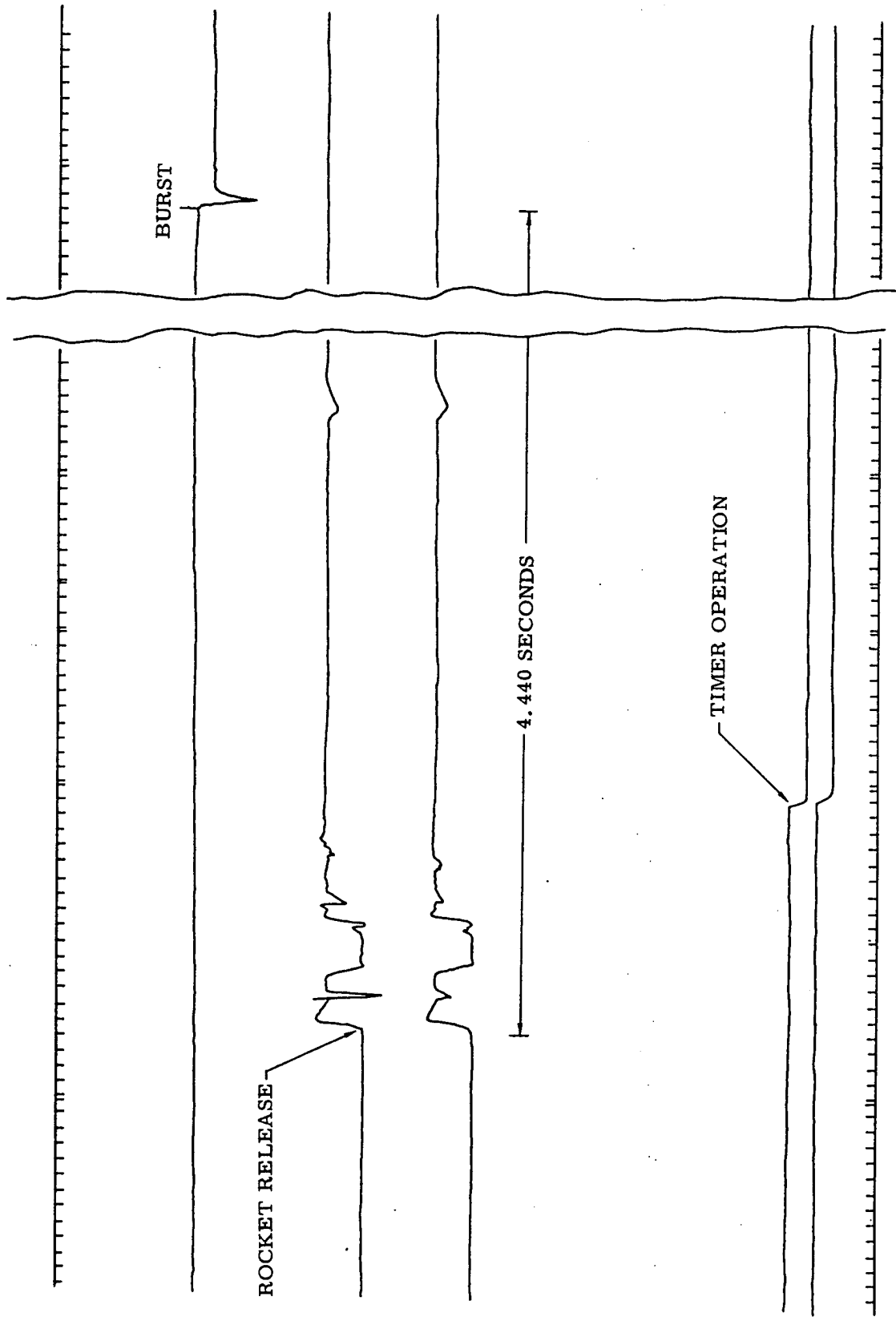

Fig. 8—Time of flight: John shot.

~~CONFIDENTIAL~~

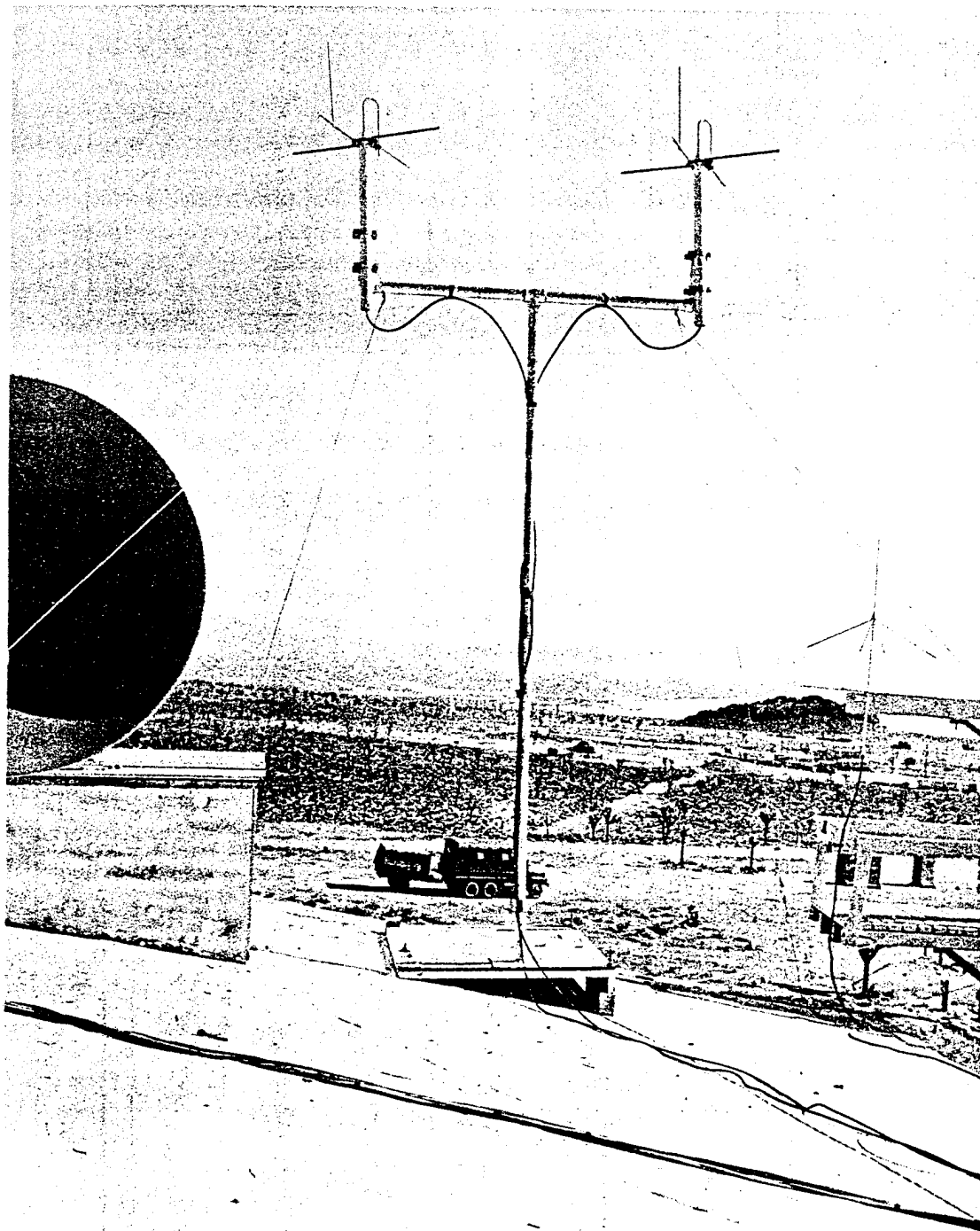

Fig. 9—Antenna installation at control point.

5.2.4 Rack Assembly

Units were installed according to the rack equipment layout schematic (Figure 10). The preformed rack cables and interrack cable were installed, and the external connections were made. Since the aircraft used only one transmitting channel, the amount of receiving-station equipment was reduced by half, as compared to previous full-scale tests.

5.2.5 Oscillograph

After installation, the oscillograph galvanometers were adjusted for proper swing. The first pair of galvanometers received a return pulse from the EG&G sequence timer to indicate switch closure and timer start, the second pair indicated the 1000-cycle reference sources, the third pair indicated the discriminator outputs, the fourth pair indicated the receiver outputs, and the last pair indicated the "blue box" thyratron pulse output at detonation.

5.2.6 Discriminators

The output voltage control was set to 15 volts with the vernier control full counterclockwise. The zero signal balance control was adjusted after warmup with the input control at zero. The balance control was set for equal positive and negative swing of the output meter while receiving a keyed firing signal. The push-for-amplitude-balance control was adjusted for zero on the output meter.

5.2.7 Receiver

Four new Clark Type 1501 AM-FM receivers were purchased for this operation. The receiver outputs were connected into the attenuator panel and to the discriminators.

5.2.8 Oscillograph Attenuator

Front panel potentiometers were set for 1/4- to 3/8-inch deflections of the galvanometers.

5.2.9 Oscilloscopes

Two Dumont Type 304AR rack-mounted oscilloscopes were used to observe the receiver output. These oscilloscopes were adjusted to display three cycles of the receiver output waveform with the system in the prefired condition and four cycles with the system in the fired condition.

5.2.10 Control Panel

The arm-safe switch was closed and the 1000-cycle tone level was adjusted to a comfortable audio monitoring level while a prefired signal was being received. Since the arm-safe switch started the recorder, recorder power was turned off while this adjustment was being made. The arm-safe switch was opened and the recorder power was switched on.

5.2.11 Test Transmitter

An AC-operated transmitter (identical to the aircraft installation) was also rack-mounted with the receiving equipment. In this way, it was possible to check out the ground station without the use of the airplane.

6 RESULTS

6.1 Conclusions and Recommendations

A better microswitch should be used in any future operation similar to the John shot. The design could be improved by designing a heavier spring and a positive lock-out. The Douglas

~~CONFIDENTIAL~~

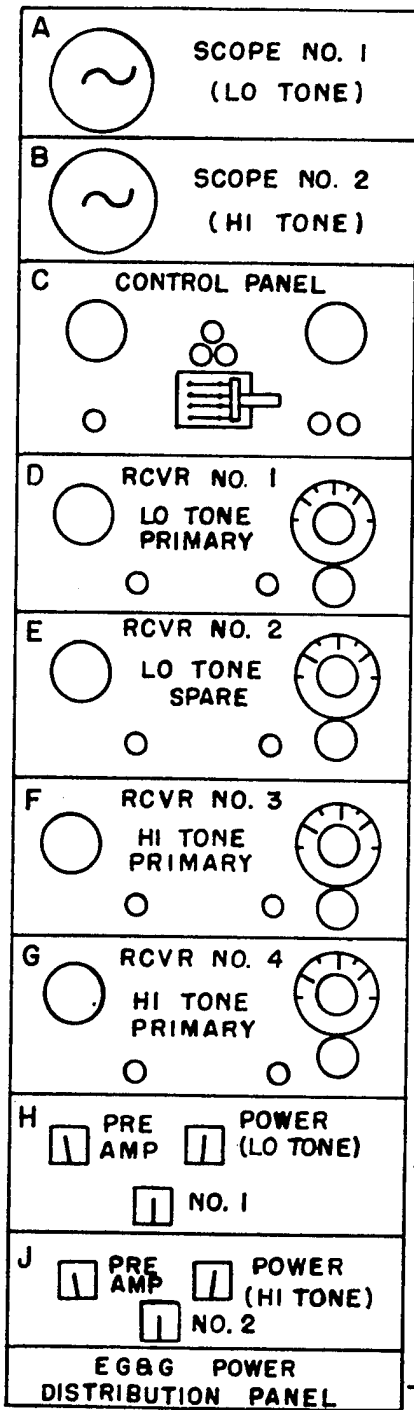

Z TERM. STRIP

FRONT VIEW

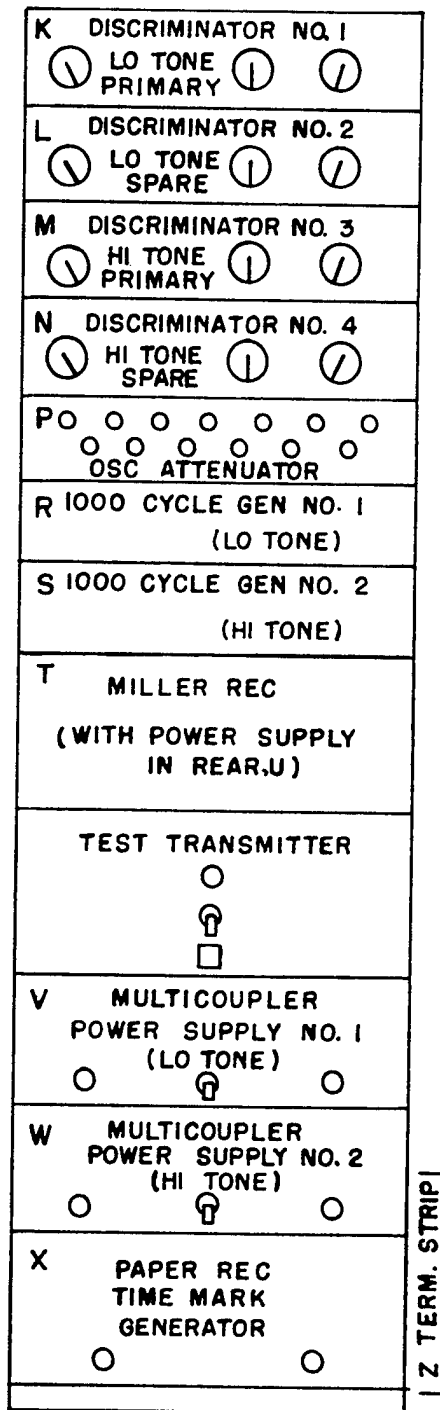

Z TERM. STRIP

FRONT VIEW

Fig. 10—Release tone rack equipment layout.

Aircraft Company is known to have successfully used a microswitch with these improvements to eliminate microswitch chatter.

Some liaison should be initiated between the rocket manufacturer and the instrumentation agency. If this had been done, it might have been possible to wire the trigger system through the shear plug on the nose of the rocket and, thus, both obtain a more accurate indication of breakaway and eliminate microswitch vibration.

~~CONFIDENTIAL~~

APPENDIX A EQUIPMENT

A.1 AIRBORNE EQUIPMENT

A.1.1 Transmitter Power Amplifier: Rheem RF Amplifier REL-09

Frequency range: 215-235 mc
Power output: 12 watts minimum
Impedance: 52 ohms input and output
Input drive: 1.4 watts for rated output
Power input: 90 ma at 250 volts direct current plus 0.41 amp at 12.6 volts alternating current or direct current or 0.82 amp at 6.3 volts alternating current or direct current

A.1.2 Transmitter: Bendix-Pacific TXV-13 Crystal-Controlled, PM

Frequency range: 215-235 mc
Power output: 2 watts
Load impedance: 50 ohms
Modulation input impedance: 270,000 ohms, shunted by 200,000 ohms in series with 200 μ f
Deviation sensitivity: 12 kc/kc/volt $\pm 15\%$ (for 0.4 - 4.0 kc)
50 kc/volt $\pm 15\%$ (for 4.0 - 85.0 kc)
Frequency stability: Within 0.01%, -40° to 185° F
Within 0.02% for $\pm 10\%$ E_p and $\pm 13\%$ - 6% filament change, taken simultaneously
Vibration: Less than 1% peak carrier deviation for 10 g up to 1000 cycles, in any plane
Power input: 85 ma at 180 volts direct current
1.2 amp at 6.0 volts alternating current or direct current

A.1.3 Voltage-Controlled Oscillator: Audio Products Corporation

Frequency: 5400 cycles
Deviation: 15% (± 7.5)
Input for full deviation: 0 to +5 volts direct current; or 5 volts p-p (alternating current) superimposed on +2.5 volts direct current
Output: At least 2.0 volts rms
Output impedance: Approximately 300 ohms
Linearity: Not more than 3% deviation from straight line
Frequency stability: Within 2% for filament change of $\pm 10\%$ or a plate voltage change of $\pm 3\%$
Power input: 7 ma at 150 volts direct current; 28-volt filaments

~~CONFIDENTIAL~~

A.1.4 Power Supply: Gothard Dynamotor GY-25

Output: 0.5 amp at 250 volts direct current
Input: 28 volts direct current

A.1.5 Shift Circuit:

This consists of four normally closed switching components in series. These are (1) a spring-loaded, momentary-contact test switch mounted under a red safety cover; (2, 3) two microswitches which operate on release; and (4) a cable pullout connector in the unit to act as backup in the event of microswitch failure.

A.2 GROUND-STATION EQUIPMENT

A.2.1 Antenna: Two 4-turn helices mounted on folded ground plane

Beam width: Approximately 45 degrees vertical and approximately 100 degrees horizontal

Mounts: Vertically adjustable from approximately 20 to 40 degrees above horizon; horizontal, approximately ± 30 degrees

Gain: Approximately 7 db

Bandwidth: Approximately 160 to 260 mc

A.2.2 Preamplifier: Ascop (Applied Science Corp. of Princeton, N. J.)
APA-2 Radio Frequency Preamplifier

Bandwidth: 215-235 mc

Gain: 15 db minimum

Noise figure: 2.5 db

Impedance: 52 ohms input and output

Power input: 115 volts 60 cycles

Enclosure: Weather resistant (NOTE: Control panel is indoor-mounted on 19 x 3-1/2-in. panel)

A.2.3 Multicoupler: Ascop (Applied Science Corp. of Princeton, N. J.)
AMC-2 Multicoupler

Bandwidth: 215-235 mc

Gain: 9 db

Noise figure: 9.5 db

Impedance: 52 ohms input and output

Number of outputs: 4

Isolation between outputs: 34 db minimum

Power input: 115 volts 50 cycles

Panel size: 19 x 7 in.

A.2.4 Receiver: Nems-Clarke Type 167-J-1 FM-AM Receiver

Tuning range: 55-260 mc

Noise figure: 11 db below 245 mc

Sensitivity: 8 μ v for 22-1/2 db signal-to-noise ratio

IF bandwidth: 300 kc

Discriminator linearity: ± 150 kc

Output: 0.08 volt/kc (FM)

Limiting: Output constant within 2 db for inputs above 4 μ v (FM)

Signal level indication: 0-10 ma direct current, inversely related to signal strength

Power input: 117 volts 60 cycles, 65 watts

Panel size: 19 x 8-3/4 in.

A.2.5 Discriminator: EMR (Electro-Mechanical Research, Inc.)
Model 67 D Subcarrier Discriminator

Frequency: 5400 cycles (available from 400 cycles to 70 kc)
Deviation: $\pm 7.5\%$ and $\pm 15\%$; approximately $\pm 10\%$ used on this system
Input impedance: 0.5 megohm shunted by approximately 20 $\mu\mu\text{f}$
Sensitivity: 10 mv minimum potentiometer input
Dynamic range: 30 db for any input level setting
Output: Single ended, referred to ground; variable from ± 6.6 volts to ± 90 volts
with maximum of ± 25 ma
Output impedance: Less than 10 ohms
Output stability: $\pm 0.5\%$ of full bandwidth in a 15-hr period after 15-min warmup
Panel size: 19 x 5-1/4 in.
Power input: 105-125 volts 60 cycles, 200 watts; no external regulation required

A.2.6 Control Panel: Sandia Corporation manufacture in accordance with drawing
SK(5222)55731

This unit contains the biased polar relays. These are energized by the discriminator outputs which, in turn, close the sequence-timer start circuit. A seal-in relay is included to ensure a continuous closure to the timer start, even though other components might fail or operate intermittently.

Other relays are included for indication only. These relays mute the 1000-cycle speaker signal on release and also change lamp indication from green to red.

Two transfer switches are provided, one for each tone. These allow for switching to the standby equipments.

An arm-safe switch is on the front panel to provide single point deactivation of the entire system until the desired moment. A spring-loaded, momentary contact emergency start button, under a protective cover, is also on the front panel. Panel size: 19 x 12-1/4 in.

A.2.7 Oscilloscope: Dumont Type 304AR Cathode Ray Oscilloscope (rack-mounted)

Vertical sensitivity: 0.025 peak-peak volt/in. (amplifier)
32-39 peak-peak volt/in. (direct)
Frequency response: Down not more than 50% at 300 kc
Rise time: 2 μsec or less
Input impedance: 2 meg, 50 $\mu\mu\text{f}$ (amplifier)
1.5 meg, 20 $\mu\mu\text{f}$ (direct)
Internal sweep: 2-30,000 cycles
Rack size: 19 x 8-3/4 in.
Power input: 115 or 230 volts 50-400 cycles, 110 watts

A.2.8 Paper Recorder: William Miller Model J Multi-Channel Oscillograph (Plus
Model JP2 Power Supply)

Number of channels: 30 (16 used in this system)
Paper speeds, in./sec: 3/8, 3/4, 1-1/2, 3 (low speed)
6, 12, 24, 48 (high speed)
Timing-line intervals (after modification for use with paper recorder time
mark generator): 1/10 sec, 1 sec (low speed)
1/100, 1/10, 1 sec (high speed)

~~CONFIDENTIAL~~

Paper capacity: 12 in. x 200 ft
 Recommended paper: Eastman Linagraph 809 (low speed)
 Eastman Linagraph 1057 (high speed)

<u>High-sensitivity galvanometers:</u>	<u>Nat freq</u>	<u>Ma/in.</u>	<u>Ext damping resistance</u>	<u>Galvanometer resistance</u>
	35	0.005	1000	45
	75	0.02	500	45
	100	0.035	350	45
	120	0.05	250	45
	140	0.065	200	45
	180	0.17	None	45
	230	0.17	100	45
	340	0.6	130	45
	460	1.0	35	45
	1000	6.0	None	45
	1900	18.0	None	45
	3200	50.0	None	45

Recorder size: 16-1/2 in. wide x 12-1/2 in. high x 15-3/4 in. long

Power pack size: Approximately 8 x 10 x 14 in.

Power input: 110 volts 60 cycles

Timing input: Paper recorder time mark generator (Tech Memo 134-53-52), driven by 1000-cycle source

A.2.9 Paper Recorder Time Mark Generator: Sandia Corporation manufacture per drawing SK(5226)24614

Input: 1000 cycles, 0.5 to 2 volts

Output pulse rate: 1000, 100, 10, 1 per sec

Output pulse shape: Differentiated square waves; i. e., alternately positive and negative pulses

Output pulse amplitude: Approximately 2 volts

Rack size: 19 x 8-3/4 in.

Power input: 115 volts 60 cycles

A.2.10 Generator, 1000-cycle: Sandia Corporation manufacture

Frequency standard: American Time Products Type 2001-2 Frequency Calibrator, 1000 cycles

Output: Approximately 1 watt

Output impedance: 500 ohms

Rack size: 19 x 5-1/4 in.

A.2.11 Oscillograph Attenuator: Sandia Corporation manufacture; contains galvanometer damping resistors and attenuator potentiometers

Rack size: 19 x 3-1/2 in.

A.2.12 Test Transmitter: Sandia Corporation assembly consisting of the following:

Transmitters (2): Bendix-Pacific TXV-13 crystal-controlled, PM

Transmitter frequencies: 117.5 and 220.5 mc

~~CONFIDENTIAL~~

Power amplifier: None
Voltage-controlled oscillator: Audio Products, 5400 cycles
Rack size: 19 x 8-3/4 in.
Power input: 115 volts 60 cycles
Keying means: Test switch and motor-drive cam switch

A.2.13 Cables: Prefabricated cables are employed so that field installation consists of setting up the units and plugging in the cables.

~~CONFIDENTIAL~~

UNCLASSIFIED

DISTRIBUTION

Military Distribution Category 2

ARMY ACTIVITIES

- 1 Asst. Dep. Chief of Staff for Military Operations, D/A, Washington 25, D.C. ATTN: Asst. Executive (R&SW)
- 2 Chief of Research and Development, D/A, Washington 25, D.C. ATTN: Atomic Division
- 3- 4 Chief of Ordnance, D/A, Washington 25, D.C. ATTN: ORDTX-AR
- 5 Chief Signal Officer, D/A, P&O Division, Washington 25, D.C. ATTN: SIGRD-8
- 6 The Surgeon General, D/A, Washington 25, D.C. ATTN: MEDNS
- 7- 8 Chief Chemical Officer, D/A, Washington 25, D.C.
- 9 The Quartermaster General, D/A, Washington 25, D.C. ATTN: Research and Development
- 10- 11 Chief of Engineers, D/A, Washington 25, D.C. ATTN: ENGBE
- 12- 13 Chief of Transportation, Military Planning and Intelligence Div., Washington 25, D.C.
- 14- 16 Commanding General, Headquarters, U. S. Continental Army Command, Ft. Monroe, Va.
- 17 President, Board #1, Headquarters, Continental Army Command, Ft. Sill, Okla.
- 18 President, Board #2, Headquarters, Continental Army Command, Ft. Knox, Ky.
- 19 President, Board #4, Headquarters, Continental Army Command, Ft. Bliss, Tex.
- 20 Commanding General, Headquarters, First U. S. Army, Governor's Island, New York 4, N.Y.
- 21 Commanding General, Headquarters, Second U. S. Army, Ft. George G. Meade, Md.
- 22 Commanding General, Headquarters, Third U. S. Army, Ft. McPherson, Ga. ATTN: ACofS, G-3
- 23 Commanding General, Headquarters, Fourth U. S. Army, Ft. Sam Houston, Tex. ATTN: G-3 Section
- 24 Commanding General, Headquarters, Fifth U. S. Army, 1660 E. Hyde Park Blvd., Chicago 15, Ill.
- 25 Commanding General, Headquarters, Sixth U. S. Army, Presidio of San Francisco, San Francisco, Calif. ATTN: AMGCT-4
- 26 Commanding General, U.S. Army Caribbean, Ft. Amador, C.Z. ATTN: Cnl. Off.
- 27 Commander-in-Chief, European Command, APO 128, New York, N.Y.
- 28- 29 Commandant, Command and General Staff College, Ft. Leavenworth, Kan. ATTN: ALLIS(AS)
- 30 Commandant, Army War College, Carlisle Barracks, Pa. ATTN: Library
- 31 Commandant, The Artillery and Missile School, Ft. Sill, Okla.
- 32 Secretary, The U.S. Army Air Defense School, Ft. Bliss, Texas. ATTN: Maj. Ergen V. Roth, Dept. of Tactics and Combined Arms
- 33 Commandant, The Armored School, Ft. Knox, Ky.
- 34 Director, Special Weapons Development Office, Headquarters, CONARC, Ft. Bliss, Tex. ATTN: Capt. T. E. Skinner
- 35 Superintendent, U.S. Military Academy, West Point, N. Y. ATTN: Prof. of Ordnance
- 36 Commanding General, Aberdeen Proving Grounds, Md. ATTN: Director, Ballistics Research Laboratory
- 37 Commanding Officer, Engineer Research and Development Laboratory, Ft. Belvoir, Va. ATTN: Chief, Technical Intelligence Branch
- 38 Commanding Officer, Chemical Warfare Laboratories, Army Chemical Center, Md. ATTN: Tech. Library
- 39 Director, Technical Documents Center, Evans Signal Laboratory, Belmar, N.J.

- 40 Operations Research Office, Johns Hopkins University, 6935 Arlington Rd., Bethesda 14, Md.
- 41 Commanding Officer, U.S. Army Signal Engineering Labs., Ft. Monmouth, N.J.
- 42 Commanding General, Quartermaster Research and Development, Command, Quartermaster Research and Development Center, Natick, Mass. ATTN: CBR Liaison Officer
- 43 Commanding General, Quartermaster Research and Engineering Command U.S. Army, Natick, Mass.
- 44- 48 Technical Information Service Extension, Oak Ridge, Tenn.

NAVY ACTIVITIES

- 49 Director, USMC Educational Center, Marine Corps Schools, Quantico, Va.
- 50 Chief of Naval Operations, D/N, Washington 25, D. C. ATTN: OP-36
- 51 Chief, Bureau of Medicine and Surgery, D/N, Washington 25, D.C. ATTN: Special Weapons Defense Div.
- 52 Chief of Naval Personnel, D/N, Washington 25, D.C.
- 53 Chief, Bureau of Ships, D/N, Washington 25, D.C. ATTN: Code 348
- 54 Chief, Bureau of Yards and Docks, D/N, Washington 25, D.C. ATTN: D-440
- 55 Chief, Bureau of Supplies and Accounts, D/N, Washington 25, D.C.
- 56 Chief, Bureau of Aeronautics, D/N, Washington 25, D.C.
- 57 Chief of Naval Research, Department of the Navy Washington 25, D.C. ATTN: Code 811
- 58 Commander-in-Chief, U.S. Atlantic Fleet, U.S. Naval Base, Norfolk 11, Va.
- 59 Commandant, U.S. Marine Corps, Washington 25, D.C. ATTN: Code A03H
- 60 Director, USMC Development Center, USMC Schools, Quantico, Va.
- 61 Commander, U.S. Naval Ordnance Laboratory, Silver Spring 19, Md. ATTN: EE
- 62 Commander, U.S. Naval Ordnance Laboratory, Silver Spring 19, Md. ATTN: R
- 63 Director, U.S. Naval Research Laboratory, Washington 25, D.C. ATTN: Mrs. Katherine H. Cass
- 64 Commanding General, Fleet Marine Force, Atlantic, Norfolk, Va.
- 65 Commanding Officer, U.S. Naval Radiological Defense Laboratory, San Francisco, Calif. ATTN: Technical Information Division
- 66 Commanding Officer and Director, David W. Taylor Model Basin, Washington 7, D.C. ATTN: Library
- 67 Commanding General, Fleet Marine Force, Pacific, Fleet Post Office, San Francisco, Calif.
- 68 Commander-in-Chief Pacific, Pearl Harbor, TH
- 69- 73 Technical Information Service Extension, Oak Ridge, Tenn. (Surplus)

AIR FORCE ACTIVITIES

- 74 Asst. for Atomic Energy Headquarters, USAF, Washington 25, D.C. ATTN: DCS/O
- 75 Director of Operations, Headquarters, USAF, Washington 25, D.C. ATTN: Operations Analysis
- 76 Director of Plans, Headquarters, USAF, Washington 25, D.C. ATTN: War Plans Div.
- 77 Director of Research and Development, DCS/D, Headquarters, USAF, Washington 25, D.C. ATTN: Combat Components Div.
- 78- 79 Director of Intelligence, Headquarters, USAF, Washington 25, D.C. ATTN: AFOIN-IE2

UNCLASSIFIED

CONFIDENTIAL

~~CONFIDENTIAL~~

80 The Surgeon General, Headquarters, USAF, Washington 25, D.C. ATTN: Bio. Def. Br., Pre. Med. Div.

81 Asst. Chief of Staff, Materiel Headquarters, U.S. Air Forces-Europe, APO 633, New York, N.Y. ATTN: EMPSA

82 Commander-in-Chief, Strategic Air Command, Offutt AFB, Omaha, Nebraska. ATTN: OAWS

83 Commander, Tactical Air Command, Langley AFB, Va. ATTN: Documents Security Branch

84 Commander, Air Defense Command, Ent AFB, Colo.

85 Commander, Air Research and Development Command, Andrews AFB, Washington 25, D.C. ATTN: RDDW

86 Commander, Air Proving Ground Command, Eglin AFB, Fla. ATTN: Adj./Tech. Report Branch

87-88 Director, Air University Library, Maxwell AFB, Ala.

89-94 Commander, Air Training Command, Randolph AFB, Tex.

95-96 Commandant, Air Force School of Aviation Medicine, Randolph AFB, Tex.

97-98 Commander, Wright Air Development Center, Wright-Patterson AFB, Dayton, Ohio. ATTN: WCOSI

99-100 Commander, Air Force Cambridge Research Center, IG Hanscom Field, Bedford, Mass. ATTN: CRQST-2

101-103 Commander, Air Force Special Weapons Command, Kirtland AFB, N. Mex. ATTN: Tech. Information Office

104 Commander, Lowry AFB, Denver, Colo. ATTN: Department of Special Weapons Training

105-106 The RAND Corporation, 1700 Main Street, Santa Monica, Calif. ATTN: Nuclear Energy Division

107 Commander, Western Development Div. (ARDC), PO Box 262, Inglewood, Calif. ATTN: WDSIT, R. C. Weitz

108-112 Technical Information Service Extension, Oak Ridge, Tenn. (Surplus)

OTHER DEPARTMENT OF DEFENSE ACTIVITIES

113 Asst. Secretary of Defense, Research and Engineering, D/D, Washington 25, D.C. ATTN: Tech. Library

114 U.S. Documents Officer, Office of the U.S. National Military Representative, SHAPE, APO 55, New York, N.Y.

115-116 Director, Weapons Systems Evaluation Group, OSD, Rm 2E1006, Pentagon, Washington 25, D.C.

117 Chairman, Armed Services Explosives Safety Board, D/D, Building T-7, Gravelly Point, Washington 25, D.C.

118 Commandant, Armed Forces Staff College, Norfolk 11, Va. ATTN: Secretary

119 Commander, Field Command, Armed Forces Special Weapons Project, PO Box 5100, Albuquerque, N. Mex.

120 Commander, Field Command, Armed Forces Special Weapons Project, PO Box 5100, Albuquerque, N. Mex. ATTN: Technical Training Group

121-122 Commander, Field Command, Armed Forces Special Weapons Project, P.O. Box 5100, Albuquerque, N. Mex. ATTN: Deputy Chief of Staff, Weapons Effects Test

123-133 Chief, Armed Forces Special Weapons Project, Washington 25, D.C. ATTN: Documents Library Branch

134 Commanding General, Military District of Washington, Room 1543, Building T-7, Gravelly Point, Va.

135-139 Technical Information Service Extension, Oak Ridge, Tenn. (Surplus)

ATOMIC ENERGY COMMISSION ACTIVITIES

140-142 U.S. Atomic Energy Commission, Classified Technical Library, Washington 25, D.C. ATTN: Mrs. J. M. O'Leary (For DMA)

143 U. S. Atomic Energy Commission, Classified Technical Library, Washington 25, D.C. ATTN: Mrs. J. M. O'Leary (For R. L. Corsbie, CETG)

144-145 Los Alamos Scientific Laboratory, Report Library, PO Box 1663, Los Alamos, N. Mex. ATTN: Helen Redman

146-160 Sandia Corporation, Classified Document Division, Sandia Base, Albuquerque, N. Mex. ATTN: H. J. Smyth, Jr.

161-165 University of California Radiation Laboratory, PO Box 808, Livermore, Calif. ATTN: Clovis G. Craig

166 Weapon Data Section, Technical Information Service Extension, Oak Ridge, Tenn.

167-175 Technical Information Service Extension, Oak Ridge, Tenn. (Surplus)

~~CONFIDENTIAL~~