

NASA Contractor Report 198446
DOT/FAA/AR-95/50

Army Research Laboratory
Contractor Report ARL-CR-289

Feasibility Study of a Rotorcraft Health and Usage Monitoring System (HUMS): Results of Operator's Evaluation

Raylund Romero and Harold Summers
Petroleum Helicopters Inc.
Lafayette, Louisiana

James Cronkhite
Bell Helicopter Textron Inc.
Fort Worth, Texas

February 1996

Prepared for
Lewis Research Center
Under Contract NAS3-25455



National Aeronautics and
Space Administration



U.S. Department
of Transportation
**Federal Aviation
Administration**



19960709 102

DISTRIBUTION STATEMENT A

Approved for public release;
Distribution Unlimited

DEIG QUALITY INSPECTED 1

Trade names or manufacturers' names are used in this report for identification only. This usage does not constitute an official endorsement, either expressed or implied, by the National Aeronautics and Space Administration.

Feasibility Study of a Rotorcraft Health and Usage Monitoring System (HUMS): Results of Operator's Evaluation

by

R. Romero, H. Summers, and J. Cronkhite

Abstract

The objective of this study was to evaluate the feasibility of a state-of-the-art health and usage monitoring system (HUMS) to provide monitoring of critical mechanical systems on the helicopter, including motors, drive train, engines and life-limited components. The implementation of HUMS and cost integration with current maintenance procedures was assessed from the operator's viewpoint in order to achieve expected benefits from these systems, such as enhanced safety, reduced maintenance cost and increased availability. An operational HUMS was used as a basis for this study that was installed and operated under an independent flight trial program. The HUMS equipment and software were commercially available.

Based on the results of the feasibility study, the HUMS used in the flight trial program generally demonstrated a high level of reliability in monitoring the rotor system, engines, drive train and life-limited components. The system acted as a sentinel to warn of impending failures. A worn tail rotor pitch bearing was detected by HUMS, which had the capability for self testing to diagnose system and sensor faults. Examples of potential payback to the operator with HUMS were identified, including reduced insurance cost through enhanced safety, lower operating costs derived from maintenance credits, increased aircraft availability and improved operating efficiency. The interfacing of HUMS with current operational procedures, was assessed to require only minimal revisions to the operator's maintenance manuals. Finally the success in realizing the potential benefits from HUMS technology was found to depend on the operator, helicopter manufacturer, regulator (FAA), and HUMS supplier working together.

A companion activity was also accomplished as a second phase of this project and is contained in NASA CR198447 (ARL-CR-290; DOT/FAA/AR-95/9). In that report two techniques are used to assess data gathered under an independent flight study as it related to rotorcraft health and usage monitoring.

TABLE OF CONTENTS

	<u>Page</u>
ABSTRACT	iii
TABLE OF CONTENTS	iv
LIST OF FIGURES	vi
LIST OF TABLES	vii
ABBREVIATIONS	viii
FOREWARD	ix
1. INTRODUCTION	1
2. HUMS DESCRIPTION AND OPERATING PROCEDURES	4
2.1 HUMS Equipment	4
2.2 Monitored Parameters	6
2.2.1 Rotor System Monitoring	6
2.2.2 Engine Monitoring	8
2.2.3 Drive Train Monitoring	9
2.2.4 Usage Monitoring	12
2.2.5 Flight Data Recorder Integration with HUMS	14
2.3 Data Retrieval, Transfer and Analysis Procedures	15
2.4 Data Analysis	16
3. OPERATIONAL ASSESSMENT OF EXISTING HUMS	17
3.1 Training	17
3.2 Daily Maintenance	17
3.3 Inspections	19
3.4 Accuracy	19
3.5 Timeliness of Data	19
3.6 Data Security	20
4. INTEGRATION OF HUMS WITH CURRENT PROCEDURES	21
4.1 Revisions to the Operators Maintenance Manual	22
4.2 Integration of HUMS into PHI's Organizational Structure	24

TABLE OF CONTENTS CONTINUED

	<u>Page</u>
5. ASSESSMENT OF BENEFITS / CREDITS ASSOCIATED WITH HUMS —	25
5.1 Maintenance Benefits / Credits —————	25
5.2 Procedures for Impementation of Maint. Benefits / Credits —————	27
5.3 Life Limited Parts Retirement - HUMS Usage Data Vs Time Life ————	28
5.4 Impact on Parts Inventory / Tracking / Ordering —————	30
5.5 Cost Effectiveness of HUMS —————	30
5.6 Components with Highest Cost Effectivity —————	33
5.7 Economic Impact of Extensions of Maintenance Acitvity & Retirements --	33
5.8 Other Benefits of HUMS —————	34
6. RECOMMENDED PROCEDURES FOR OBTAINING MAINT. CREDITS --	35
6.1 Operator - Manufacturer - Regulator (FAA) Interaction —————	35
6.2 Proceures for Obtaining Minor & Major Credits —————	35
6.3 Type and Quantity of Data Required —————	38
7. RECOMMENDED HUMS IMPROVEMENTS —————	39
8. SUMMARY AND CONCLUSIONS —————	40
9. REFERENCES —————	41

LIST OF FIGURES

FIGURE NO.	TITLE	Page
Figure 1.	HUMS Monitoring Functions _____	2
Figure 2.	Integrated FDR/HUMS _____	5
Figure 3.	Rotor System Monitoring Parameters and Sensors _____	7
Figure 4.	Engine Monitored Parameters _____	8
Figure 5.	Drive Train Vibration Sensors _____	10
Figure 6.	Transmission Gears and Shafts _____	11
Figure 7.	HUMS Data Transfer and Analysis Process _____	15
Figure 8.	HUMS Training Program _____	18
Figure 9.	Integration of HUMS with Operator's Maint. Management System-	21
Figure 10.	Revisions to the Operator's Maint. Manual for HUMS Integration --	23
Figure 11.	Potential Benefits Provided by Usage Monitoring with HUMS ----	26
Figure 12.	HUMS Retirement Credit Procedure _____	29
Figure 13.	Interaction _____	35
Figure 14.	Procedure to Obtain FAA & Mfr. Maintenance Credit Concurrence	36

LIST OF TABLES

TABLE NO.	TITLE	Page
Table 1.	HUMS Trial Aircraft Description _____	3
Table 2.	Drive Train Monitoring Parameters _____	10
Table 3.	HUMS Usage Parameters _____	13
Table 4.	Table of FDR Parameters _____	14
Table 5.	Direct Operating Cost Estimates _____	32

ABBREVIATIONS

A/C = Aircraft

CASP = Continuing Analysis and Surveillance Program

CG = Center of Gravity

DRU = Data Retrieval Unit

FAA = Federal Aviation Administration

FAR = Federal Aviation Regulations

FDR = Flight Data Recorder system

FSDO = Flight Standards District Office of the FAA

G = units of acceleration, $1G = 386 \text{ in/sec}^2$

GSC = Ground Station Computer

GW = Gross Weight

HUMS = Health Usage Monitoring System

in = inches

IPS = unit of vibration, in/sec

kt = knots

MDAU = Modular Data Acquisition Unit

MEL = Minimum Equipment List

Mfr. = Manufacturer

OAT = Outside Air Temperature

PMI = Principal Maintenance Inspector for the FAA

QAR = Quick Access Recorder

RADS = Rotor Analysis and Diagnostics System (Ref 1)

RPM = Revolutions Per Minute

sec = seconds

STC = Supplemental Type Certificate

UI = Usage Index

VMADS = Vibration Monitoring, Acquisition and Diagnostics System (Ref 2)

FOREWORD

This report presents the results of Phase 1 of Contract NAS3-25455 which included an evaluation of HUMS from the operator's viewpoint. This research was co-sponsored by the U.S. Army Propulsion Directorate, Aviation Research and Technology Activity and NASA Lewis Research Center in Cleveland, Ohio, and the Federal Aviation Administration (FAA) Technical Center, Atlantic City International Airport, New Jersey. The U.S. Army Contracting Officer's Technical Representative at NASA Lewis was Dr. Robert Handschuh and FAA Technical Cognizance was under the direction of Mr. Wayne Shade at the FAA Technical Center.

This study was conducted by Petroleum Helicopters Inc. (PHI) under subcontract to Bell Helicopter Textron Inc. (BHTI). Mr. Harold Summers led the PHI study team including Messrs. Raylond Romero, Britt Hanks and Donnie Doucet, along with the maintenance and pilot's staff at PHI's Morgan City, LA base where the HUMS trial aircraft was operated. The principal author of this report was Mr. Romero. The BHTI project engineer was Mr. Jim Cronkhite.

1. INTRODUCTION

This Feasibility Study was conducted for, and under the cognizance of the Federal Aviation Agency (FAA), the U.S. Army, and NASA under Contract No. NAS3-25455. The primary objective of this phase 1 study was to evaluate the feasibility of HUMS for monitoring critical helicopter components in an operational and maintenance environment.

HUMS provides diagnostic and usage information to the maintenance and flight crews on the condition of critical components in the rotors, engines and drive train. The HUMS monitoring functions and parameters are summarized in figure 1. HUMS offers the potential benefits to the operator of enhanced safety, reduced maintenance costs and increased availability. This technology has been rapidly developing over the past several years in large part due to the efforts of HUMS developers and operators in the North Sea arena. HUMS technology has reached a level of maturity such that helicopter operators supporting offshore oil companies have fitted their fleet with production monitoring systems. Today, these systems are expensive and provide primarily safety benefits. To broaden the application of HUMS and give wider acceptance there is a need to provide systems that are more cost effective to the operator. This can be accomplished by providing monitoring that offers payback to the operator, such as maintenance credits, and optimizing the system to meet the specific needs of each helicopter type, thus reducing the costs of systems. The benefits promised by the application of HUMS technology are of great interest to the helicopter operator, because of the potential to enhance safety while reducing operating costs that is greatly needed to continue to operate profitably.

This report contains the results of an evaluation of a state-of-the-art HUMS from the operator's viewpoint and an assessment of the implementation and integration of HUMS with current maintenance procedures in order to achieve expected benefits. The monitoring system that provided the basis for this study was operated under an independent flight trial program that began in November 1993. The HUMS was installed on a BHTI model 412SP helicopter (described in Table 1) and operated by PHI in the Gulf of Mexico in an offshore oil support mission.

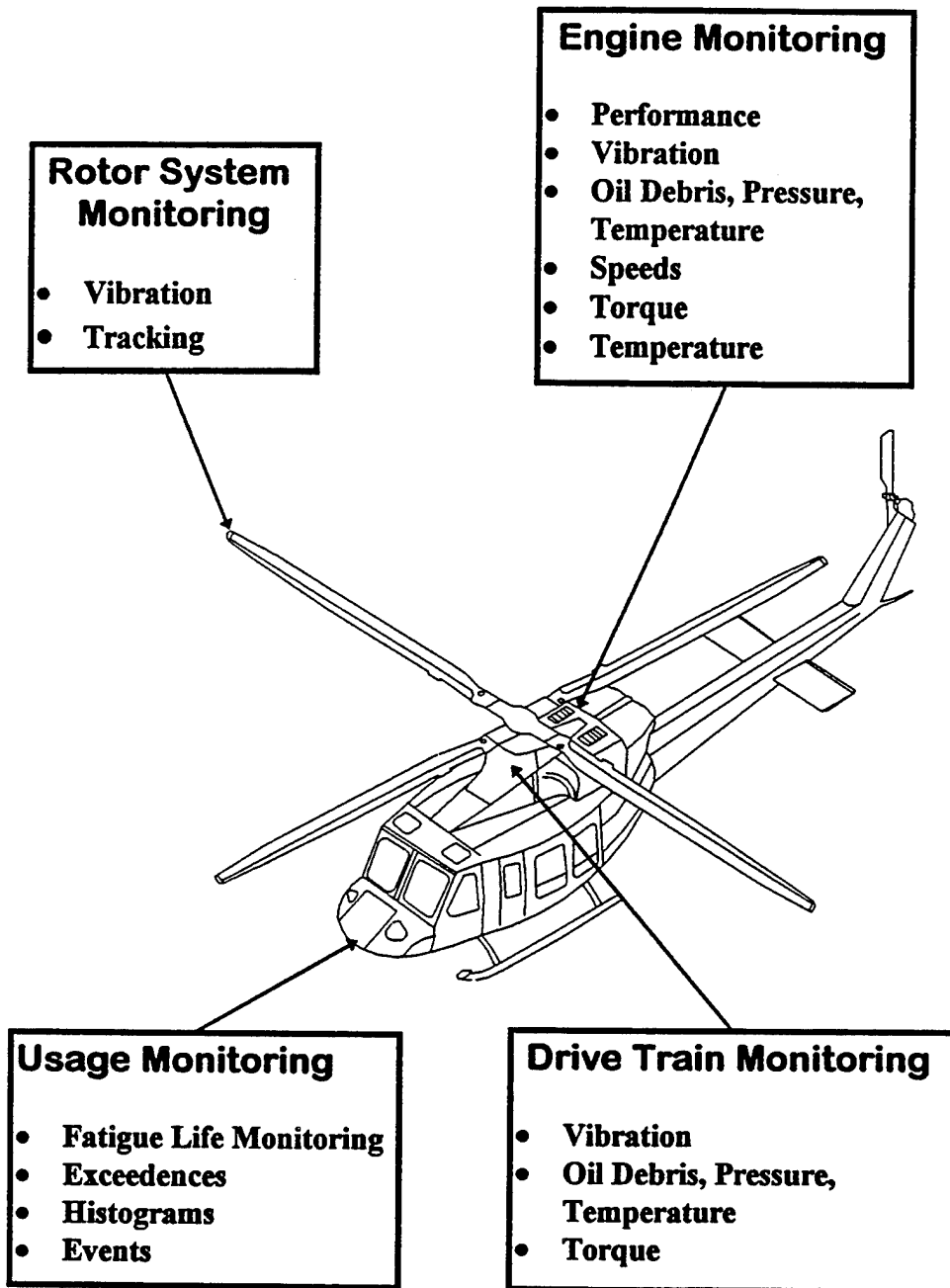

Figure 1. HUMS Monitoring Functions

Table 1. HUMS Trial Aircraft Description

- General

Model 412SP helicopter, S/N 36007, N7128R operated by PHI in the Gulf of Mexico to provide offshore support for the oil industry.

- Powerplant

The engine installed in the Model 412SP is the Pratt and Whitney PT6-3B Twin Pac with 1800 installed horsepower (hp).

- Airspeed

With internal loading, 140 kt Vne (Vne = never exceed velocity) from sea level to 3000 ft Hd (Hd = density altitude) decreasing linearly 2.5 kt per 1000 ft Hd above 3000 ft.

- Gross Weight and Seating Capacity

Maximum internal and external loading = 11,900 lbs. Seating capacity of 14 passengers and 2 crew.

- Rotor Limits

The rotor system consists of a 4-bladed main rotor and a 2-bladed tail rotor.

(rpm = revolutions per minute)

260 rpm - power off, minimum

314 rpm - power on, minimum

339 rpm - power off to 319.5 ft-lb. engine torque, maximum

324 rpm - power on (1661 rpm tail rotor), maximum

- Power Limits (Transmission)

(shp = shaft horsepower)

1134 shp - maximum continuous

1400 shp - 5-minute takeoff

2. HUMS DESCRIPTION AND OPERATING PROCEDURES

The HUMS equipment, monitored parameters and data retrieval and analysis procedures are described in this section.

2.1 HUMS Equipment

The FDR/HUMS components are illustrated in Figure 2. The HUMS is integrated into the existing mandatory flight data recording (FDR) system to reduce cost and redundancy. The FDR sensors and processor are utilized with the addition of HUMS sensors (primarily vibration sensors, tachometers and a rotor tracker) and HUMS data acquisition and analysis cards. The onboard processor is called the Modular Data Acquisition Unit (MDAU) and the additional HUMS cards are the Vibration Analysis Computer, and the Control and Storage Computer. The MDAU, was mounted on the top avionics rack in the nose compartment of the aircraft. The items in Figure 2 with broken-lined boxes were installed for the trial for validation purposes and are not part of the basic FDR/HUMS. In addition, a cockpit panel and external connector port are provided for crew and maintainer interface. System status is relayed to the flight crew through an integrated FDR/HUM panel mounted in the center console. Along with displaying system fault status, the flight crew can use the panel to manually initiate data collection and analysis. A data retrieval unit (DRU) uploads configuration data to the aircraft, collects HUMS data from the onboard modular data acquisition unit (MDAU), and obtains GO/NO-GO information concerning the aircraft mechanical systems being monitored.

The Data Retrieval Unit (DRU) is a ruggedized laptop computer that can be thumb operated by the maintainer. The DRU can collect data from several aircraft and download to a PC-based Ground Station Computer (GSC). The GSC provides for data storage, trending, and control for each aircraft that is maintained within the GSC and uploaded to the DRU and onboard MDAU.

A total of twenty-eight sensors are added to the aircraft for the HUMS, including;

- Eight strain gauges are added for the purpose of the usage portion of the HUMS.
- Fifteen accelerometers are added; three for main rotor track and balance, two for tail rotor track and balance, and the remainder for vibration analysis of single load path components in the drive train.
- Two magnetic azimuth markers are added for main mast and main driveshaft tachometer sensors.
- An optical azimuth marker is used as the tail rotor tachometer sensor.
- A permanent day/night blade tracker is installed for main rotor track and balance.
- An outside air temperature (OAT) probe was added for engine power assurance checks.

Other parameters monitored by the installed HUMS are provided by existing systems that are standard in the aircraft with the Flight Data Recorder System installed.

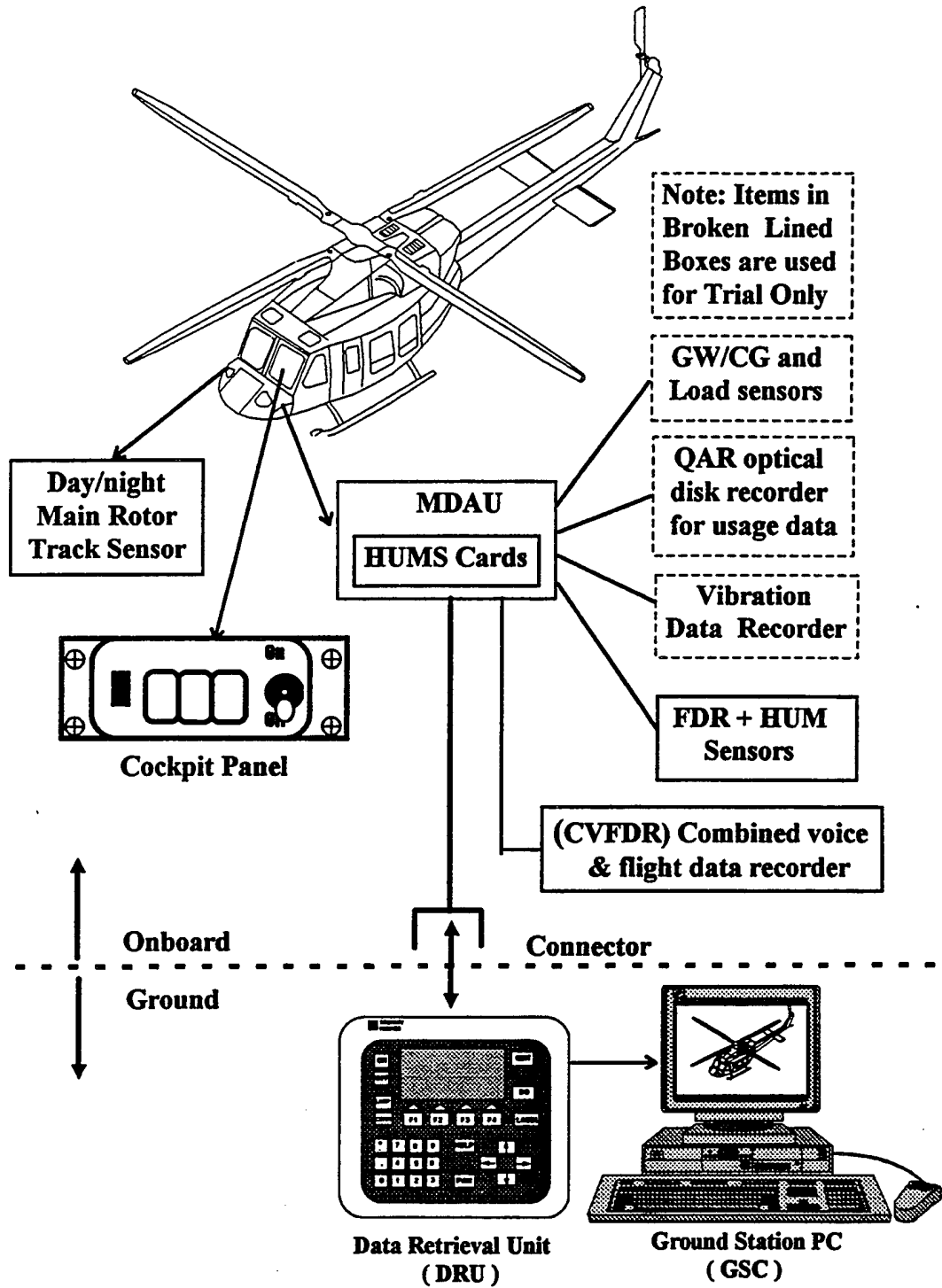

Figure 2. Integrated FDR/HUMS

Fatigue life monitoring based on actual usage is not intergrated into the current HUMS system. Usage monitoring algorithms are being evaluated off-line using data gathered from the HUMS flight trial program. A Quick Access Recorder (QAR) with optical disk is used to continuously record flight parameters and other usage data.. Gross weight (GW) and center-of-gravity (CG) measurements are recorded using instrumented attach fittings on the forward crosstube and strain gages on the aft landing gear crosstube that are processed through one of the two instrumentation boxes installed on the aircraft. In addition, direct loads are measured for correlation purposes at four locations and processed through a second aircraft instrumentation box. The GW and CG data and direct measured loads are then processed through the MDAU to be recorded in the QAR.

A test panel is installed that provides a connector to which accelerometer and tachometer signals under operator test conditions can be routed and a connector for the down loading of data from the Modular Data Acquisition Unit (MDAU).

2.2 Monitored Parameters

The categories of HUMS parameters available on the aircraft are: 1) Rotor System, 2) Engines, 3) Drive Train, 4) Usage, and 5) Flight Data Recorder. Additional recorded load parameters for usage are gross weight and center-of-gravity, collective boost load, right-hand cyclic boost load, left-hand cyclic boost load and a uniaxial strain gage located on the left hand fin spar at the base of the fin. The oscillatory values of load or strain for these parameters are digitized prior to recording, through an instrumentation box.

2.2.1 Rotor System Monitoring

The HUMS has onboard rotor track and balance and monitors the parameters shown in Figure 3. Automatic data acquisition and analysis is performed during revenue flights thus reducing flight crew tasks and maintenance cost. The rotor track and balance analysis is based on the existing RADS technology (Ref. 1). The RADS is also used to independently validate the HUMS.

The sensors required for main rotor track and balance include three accelerometers, an azimuth marker and a blade tracker. Longitudinal, lateral and vertical accelerometers are mounted on the bottom port-side of the instrument panel, near the location called out by the aircraft maintenance and overhaul manual for rotor track and balance accelerometer location. A magnetic azimuth marker is located on the main rotor mast. Mounted in the port-side access panel, on the nose of the aircraft is a permanent day/night optical blade tracker.

The MDAU performs data acquisition and analysis once the rotor track and balance function is initiated by the flight crew. Prior to initiation of the rotor track and balance function the aircraft must be in the flight regime that is required for this analysis. Once rotor track and balance is initiated the HUMS will not perform vibration analysis until the rotor track and balance function is complete.

The tail rotor is monitored with two vibration sensors on the tail gearbox (axial and radial) and a photo tachometer on the tail rotor. Vibration and track data can be taken by manual initiation or automatically for eight regimes (idle, 100% rpm-flat pitch, 100% rpm-with pitch, hover, 60 kt climb, 120 kt cruise, 140 kt dive and 60 kt let down).

Vibration trending and exceedance monitoring is conducted by the HUMS along with calculations of main and tail rotor adjustments. Fault detection is done for known faults, such as defective lead-lag dampers, where characteristic signatures of vibration, track, or lead-lag are known. The rotor system monitoring parameters and sensors are shown in Figure 3.

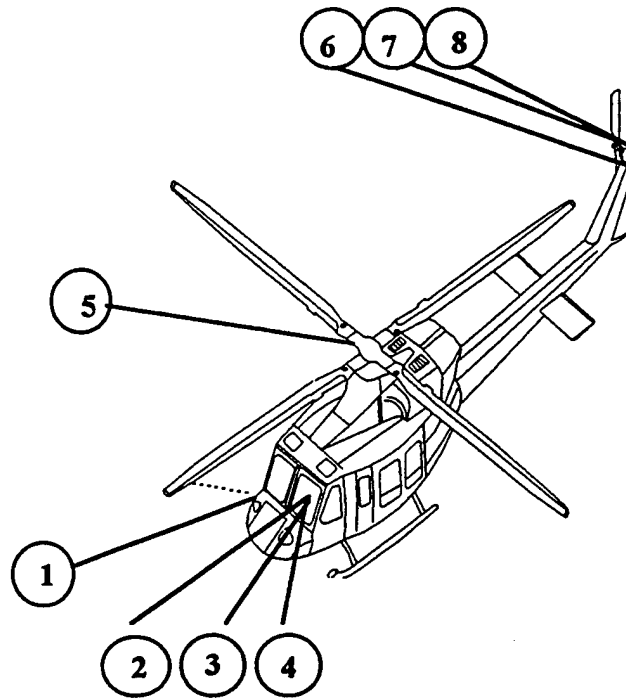

	<u>Parameter</u>	<u>Sensor</u>
<u>Main Rotor:</u>	1. Track-Lag	Optical Day/Night Tracker
	2. Cockpit Lateral Vibration	Accelerometer
	3. Cockpit Vertical Vibration	Accelerometer
	4. Cockpit Longitudinal Vibration	Accelerometer
	5. Main Rotor (Mast) Azimuth	Magnetic Tachometer
<u>Tail Rotor:</u>	6. Tailrotor Radial Vibration	Accelerometer
	7. Tailrotor Axial Vibration	Accelerometer
	8. Tailrotor Azimuth -	Optical Tachometer

Figure 3. Rotor System Monitoring Parameters and Sensors

2.2.2 Engine Monitoring

The MDAU is wired into the existing aircraft engine monitoring system, thus no additional sensors are installed for engine monitoring.

Engine monitoring functions include power assurance checks, monitoring of exceedances, performance trends, usage, and vibration. Exceedences in the speeds, pressures, temperatures, torque, and vibration are monitored. The vibration is measured on left-hand and right-hand sides of the combining gearbox and checked at flat-pitch-on-ground and 120 kt cruise and includes first and second harmonics of the gas generator and power turbines and broadband vibrations.

The power assurance check is initiated manually by the flight crew in hover using the cockpit panel and calculated automatically by the HUMS. Pass/fail indications are displayed in the cockpit and the calculated margins are downloaded through the DRU to the ground station. HUMS automates flight and maintenance manual procedures to help reduce flight crew and maintenance tasks.

The parameters that are monitored on the two engines and combining gearbox are listed in Figure 4.

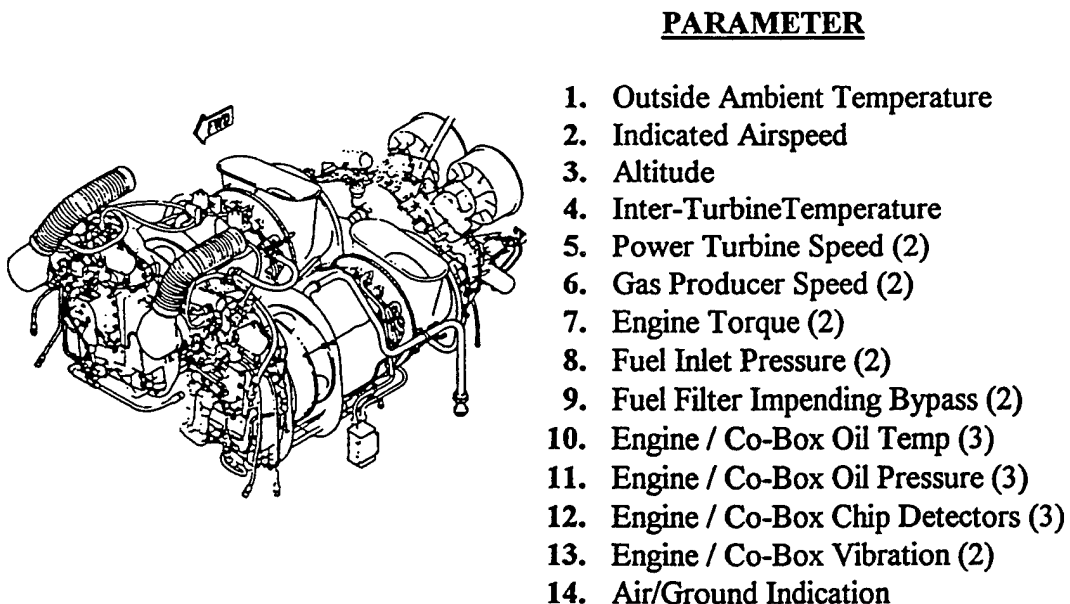

Figure 4. Engine Monitored Parameters

2.2.3 Drive Train Monitoring

The installed HUMS monitors the critical drive train components by monitoring vibration, chip detectors, torque and oil temperature and pressure. The monitored parameters for each component are summarized in Table 2. Drive train vibration sensor locations are shown in Figure 5. A magnetic azimuth marker, located on the main gearbox input, is used as the tachometer. Three accelerometers mounted on the main gearbox, one on the upper case, one on the main gearbox output, and one on the main gearbox input, monitor the main gearbox, main driveshaft and tail rotor output driveshaft. Located on the combiner gearbox are two accelerometers, one located top starboard side and one located port side, which monitor the combiner gearbox, engines and main driveshaft. One accelerometer is located on each hanger bearing and the intermediate gearbox. Two accelerometers are located on the ninety degree gearbox along with an optical azimuth marker, used as the tail rotor tachometer (these are used to monitor the ninety degree gearbox and the tail rotor track and balance).

Drive train monitoring involves a network of vibration sensors being located on the aircraft to monitor drive train components. The vibration signatures are analyzed and reduced to simple indicators that can be used to develop straight forward maintenance actions. A vibration diagnostic system called VMADS (Ref. 2) was developed by the manufacturer and is used for evaluation of the vibration monitoring algorithms used in the HUMS. The vibration data is recorded and analyzed using VMADS for comparison with the HUMS data. Also, blind fault data was analysed by the HUMS supplier to validate the fault detection capabilities of the algorithms.

The main transmission has existing torque-monitoring and oil debris/ pressure/ temperature monitoring that provides diagnostic coverage for certain faults. Vibration monitoring provides additional coverage of other faults such as gear tooth bending/cracking. Redundant coverage by two monitoring techniques can serve as a check on one another and improve reliability.

The combining gearbox has a single load path gear that drives the input drive shaft at 6600 rpm and is monitored with the two combining gearbox accelerometers. These sensors also monitor driveshaft balance.

The sensors on the main gearbox monitor the single load path input and output bevel gear sets and the offset gear set between them, as shown in Figure 6. The sensors on the intermediate and tail gearboxes monitor the single bevel gear sets in each box. The sensors on the tail driveshaft monitor the four grease-packed hanger bearings.

Drive train monitoring is performed only when the aircraft is within the specified regime for that intended analysis. The data acquisition is automatic as the HUMS will sense the regimes in which the aircraft is operated. The MDAU performs the onboard data analysis and the results are downloaded to the GSC using the DRU. The GSC stores and trends the data.

Table 2. Drive Train Monitoring Parameters

Component	Chip Det.	Vibration	Torque	Temp	Pressure
Main Gearbox	3	3	1	1	1
Intermediate Gearbox	1*	1			
Tail Rotor Gearbox	1*	2		1	
Hanger Bearing		4			
Engine Co-Box	1	2	2 (Eng. 1 & 2)	1	1

* Combined into one indicator

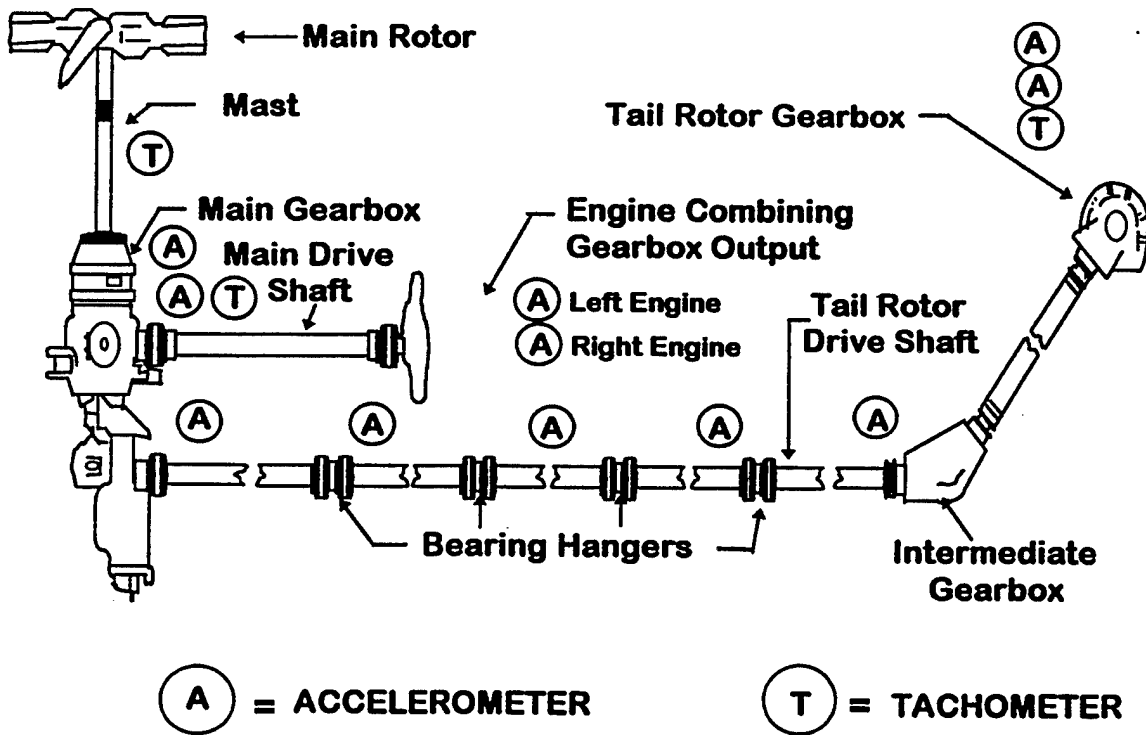

Figure 5. Drive Train Vibration Sensors

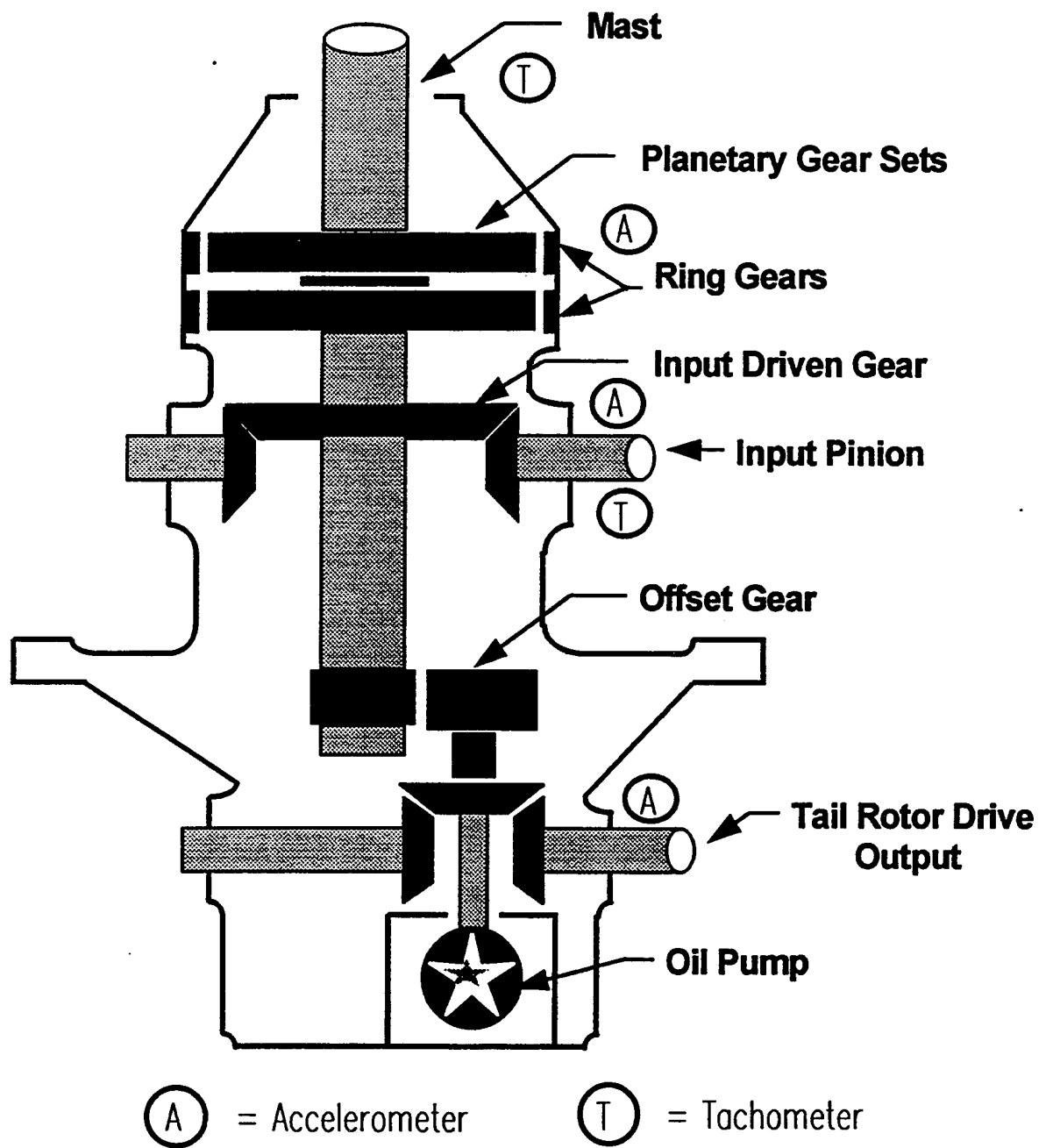

Figure 6. Transmission Gears and Shafts

2.2.4 Usage Monitoring

Usage monitoring involves automated tracking of life-limited parts and retirement of these parts based on actual aircraft usage rather than "worst case" conservative usage estimations used for certification. Since the certification method establishes part retirement lives based on a conservative usage spectrum, it is easy to see that if the actual spectrum were found to be less severe or specific flight conditions were performed for a lesser flight time, a part could be allowed to be used for a longer period of time.

The HUMS recognizes and records different flight conditions such as ground, in-ground-effect maneuvers, level flight, power on maneuvers, power transitions, autorotation, and slope take-off and landings at actual weight, altitude and airspeed and time spent in each of these conditions.

The HUMS monitors the parameters listed in Table 3 and determines actual recognized flight conditions flown by the aircraft and compares these to the flight spectrum used for certification to determine the effect on established part lives. For instance if the aircraft flew for 10:00 flight hours, without HUMS the part would be charged a full 10:00 hours. With HUMS the flight conditions and time in each condition will be determined and produce an adjusted percentage of flight hours used. For example, if the actual flight spectrum was only 50% as severe as the certification flight spectrum then the part may be charged only 5:00 hours or 50% of the 10:00 hours flown.

The calculation of helicopter dynamic component lives involves the use of three types of information: the endurance limit or fatigue allowable determined from component or coupon test data; the loads the component will be subjected to in operation, obtained from the contractor flight strain survey; and the duration and time distribution of the loads, normally defined by an FAA approved Frequency of Occurrence Spectrum.

The HUMS system is designed to automate the life calculation as well as provide a better spectrum of data to determine when the component should be retired, based on the many parameters monitored, time spent in each condition, aircraft weight, and altitude in each condition.

Implementation of usage monitoring is based on the helicopter manufacturer's validation of the system ensuring that the needed monitoring requirements are provided and that the diagnostic and usage information is accurate.

Table 3. HUMS Usage Parameters

PARAMETER
1. Calibrated Airspeed
2. Density Altitude
3. Magnetic Heading
4. Vertical CG Acceleration
5. Pitch Attitude
6. Roll Attitude
7. Altitude Rate of Climb or Descent
8. Main Rotor RPM
9. Engine Torque - Engine 1 or 2
10. Gross Weight - GW (Weight at Takeoff Using Strain Gaged Landing Gear Transducers Modified By Fuel Burned and Hook Load)
11. Collective Stick Position
12. Long. Cyclic Stick Position
13. Lat. Cyclic Stick Position
14. Pedal Position
15. LH Cyclic Boost Load
16. RH Cyclic Boost Load
17. Collective Boost Load
18. LH Forward Fin Spar Stress

2.2.5 Flight Data Recorder Integration with HUMS

The HUMS is integrated into a Flight Data Recorder (FDR) system to reduce cost and redundancy. The FDR Parameters are shown in Table 4. New aircraft released from the manufacturer have the FDR system installed. The aircraft used in this study, did not have a manufacturer installed FDR system.

To accomplish the FDR installation, a crash protected flight data recorder was installed, all single oil temperature probes were replaced with dual oil temperature probes, a multi-axial accelerometer was installed and the internal turbine temperature indicators were replaced with an indicator that has a buffered output. Also an air data sensor, and a control motion transducer to sense collective position and movement was installed.

Table 4. Table of FDR Parameters

FDR Parameters
1. Relative Time
2. Altitude
3. Airspeed
4. Magnetic Heading
5. Pitch Attitude
6. Roll Attitude
7. Power Turbine 1 Speed
8. Power Turbine 2 Speed
9. Engine 1 Torque
10. Engine 2 Torque
11. Main Rotor Speed
12. Collective Position
13. Long Cyclic Position
14. Lat. Cyclic Position
15. Pedal Position
16. Normal Accel
17. Longitudinal Accel
18. Outside Air Temp
19. Altitude Rate
20. Required Discrettes

2.3 Data Retrieval, Transfer and Analysis Procedures

Data is retrieved through the Data Retrieval Unit (DRU). This unit transfers data from the Modular Data Acquisition Unit (MDAU) to the Ground Station Computer (GSC) and uploads an analysis configuration to the MDAU as illustrated in Figure 7.

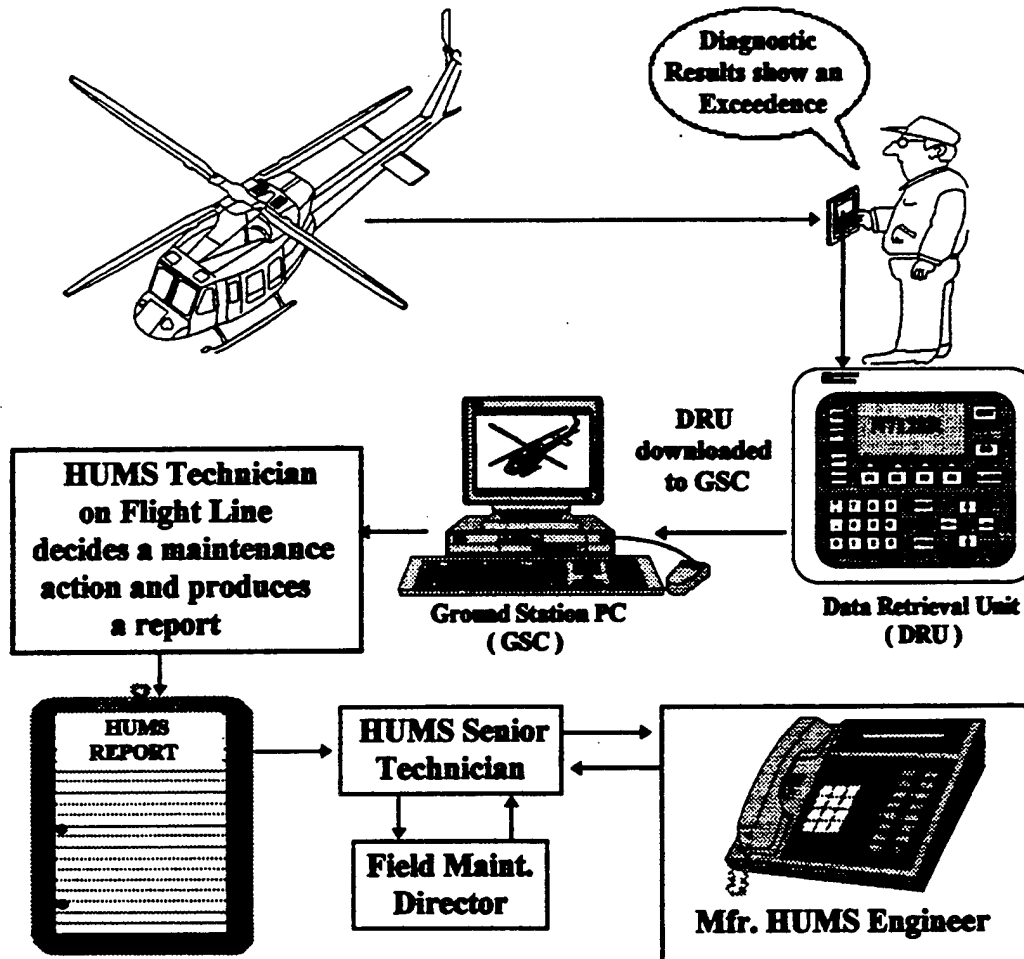

Figure 7. HUMS Data Transfer and Analysis Process

The GSC provides two primary functions, it stores all analytical results produced by the HUMS or manually entered by the operator, and defines the analyses to be performed by the airborne system. Configuration control for the aircraft is maintained within the GSC and uploaded to the DRU and onboard MDAU. The GSC provides for data storage, trending, and review of HUMS data when there is an alert.

Communication and data can be transferred to the manufacturer by the operator. For example, the operator delivers the following supportive data to the manufacturer on a weekly basis:

- 1) Seven (7) daily engineering sheets
- 2) One (1) optical disk from the QAR
- 3) One (1) GSC tape
- 4) Weekly HUMS operational report including maintenance reports and change in status of time life parts
- 5) Updated list of removed components requiring teardown reports
- 6) Received teardown reports

The time frame of data transmission from the operator to the manufacturer can be adjusted as necessary, taking into account aircraft major maintenance down time and fluctuation in flight hours accumulated due to different job requirements.

Alerts, if any occurred, are displayed by the DRU. Alerts can be an exceedence of any of the monitored systems or a discrete such as a chip detector. The first level of analysis is done by HUMS Flight Line Technician who analyzes the DRU diagnostic results and then decides a maintenance action or consults the HUMS Senior Technician for assistance. The second level of analysis occurs after the data in the DRU is transferred to the GSC. The HUMS Flight Line Technician performs the download from the DRU to the GSC. The HUMS Technician can then determine the severity and the time the alerts may have taken place. The HUMS technicians are able to view all data the airborne system has acquired, allowing maintenance planning against pending maintenance actions. The third level of analysis occurs after the operator request assistance from the manufacturer.

3. HUMS OPERATIONAL ASSESSMENT

Information for this section has been obtained through actual interviews with the operator's HUMS Technicians. The operational assessment of the HUMS used in this study is based on the actual experiences of the operator's HUMS Technicians. The following subjects are addressed:

- (1) Training
- (2) Daily Maintenance
- (3) Inspections
- (4) Accuracy
- (5) Timeliness of Data
- (6) Data Security

3.1 Training

The operator's HUMS Technicians emphasized the importance training has on obtaining the maximum benefits HUMS has to offer. Inadequate training on the HUM system may result in costly unjustified removals as well as incorrect fault diagnosis.

The Technicians felt they could have benefited by additional training relating to HUMS fault analysis and decision processes. The HUMS technicians were introduced to new terms of measurement, such as measuring in G's in which they were unfamiliar. Once G's were converted to a more familiar form of measurement such as inches per second (IPS), a better understanding of the thresholds used in the fault diagnosis process was received by the technicians.

Adequate training is considered inexpensive compared to the cost ignorance can generate. Technicians felt they are more adequately trained when training methods include video assisted instruction of real life HUMS applications as well as on the job training. Suggested elements of a HUMS training program are outlined in Figure 8. Continuous checking of the acquired knowledge helps to ensure the information is assimilated. A written examination is given and a passing grade required for the initial HUMS course as well as scheduled recurrent training at intervals not to exceed 12 months. Upon completion of the course mechanics are then issued a qualification card which is required to be in the Technician's possession. The Technician's qualifications are upgraded by on the job training or by completing operator or manufacturer schools.

3.2 Daily Maintenance

Daily maintenance consists of a daily down load of data to the DRU and analysis of the DRU's diagnostic results, a nightly down load of the DRU to the GSC and once a week tape backups of HUMS data and transfer of paper work to the helicopter manufacturer. Technicians felt an extra Technician would have helped ease the extra time needed to properly perform HUMS analysis on the ground station unit. If several aircraft in the fleet had HUMS installed, additional help would have been a requirement.

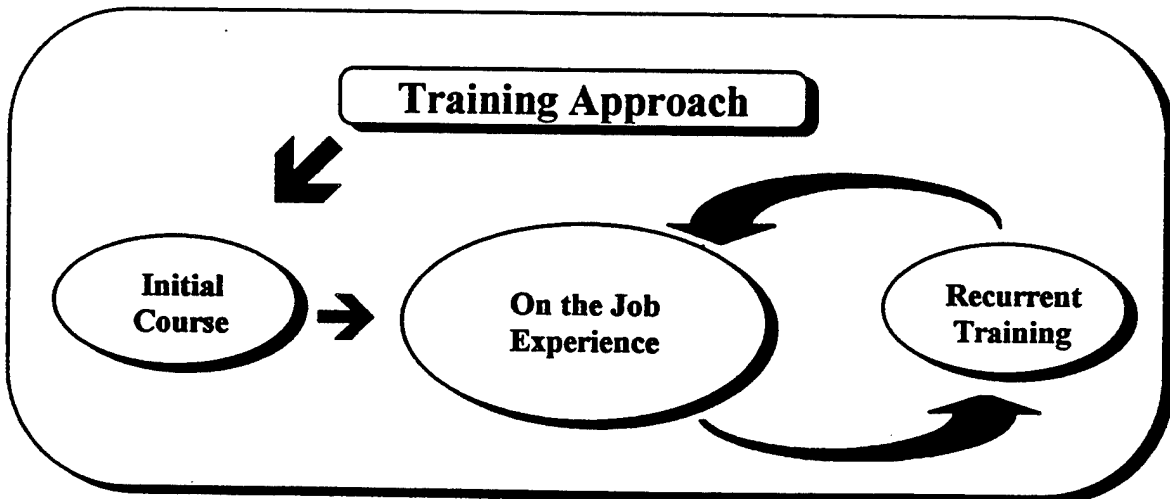
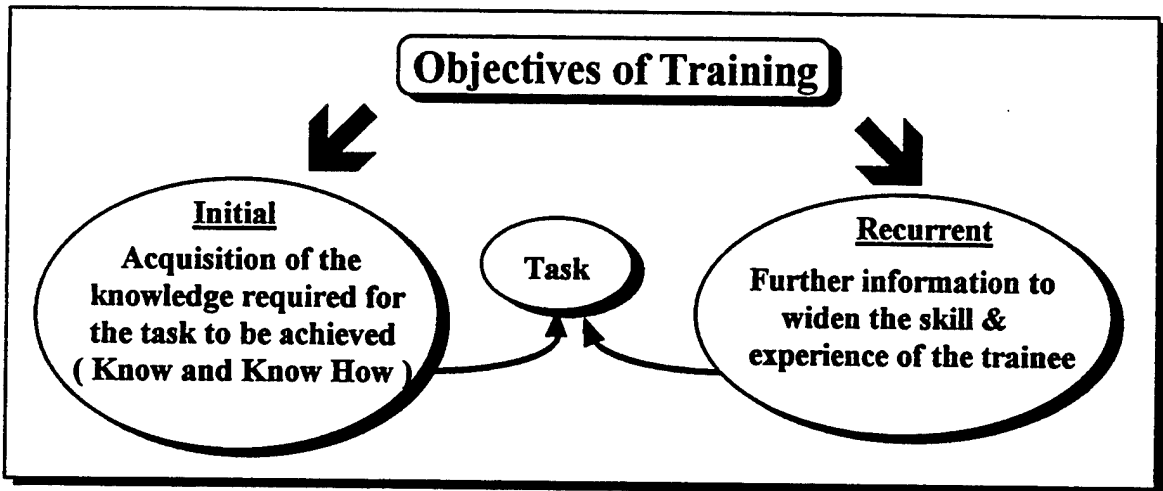
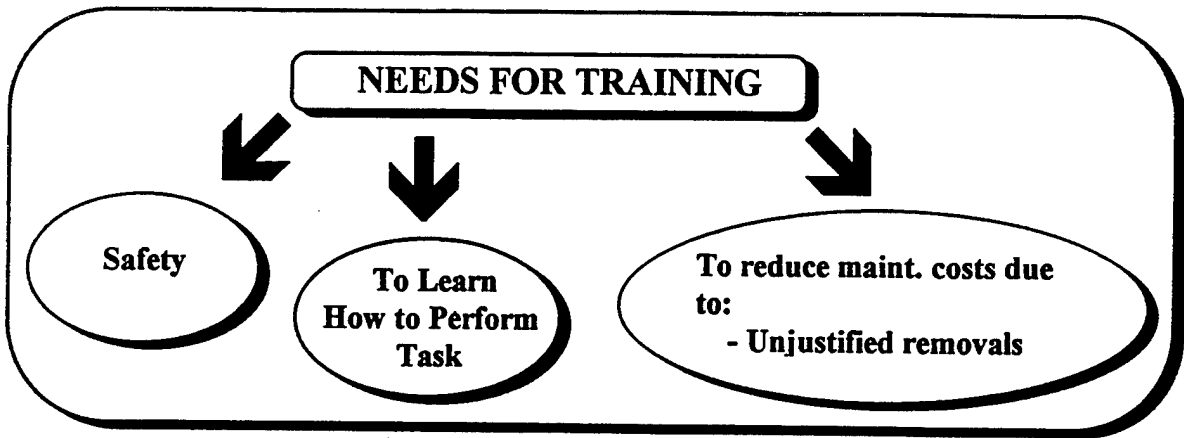

Figure 8. HUMS Training Program

3.3 Inspections

For the trial program only, the HUM system required a 25 hour visual inspection. This did not create any extra burden for the Technician in that it was incorporated as part of the airframe 25 hour/15 day manufacturer inspection requirements. No extra work was involved due to this required HUMS inspection.

3.4 Accuracy

A comparison of main rotor track and balance measurements with RADS revealed the accuracy of the sensors had to be improved. Replacement of the accelerometers with new, more accurate sensors at the main rotor, tail rotor and input driveshaft locations solved the sensor accuracy problem.

The HUMS discovery of a worn tail rotor pitch change link bearing sparked a reassuring glow of confidence in the accuracy of the system. The system proved its ability to detect vibration levels and trend it hours before the crew is able to detect it. Once the tail rotor pitch change link bearing was replaced the vibration measurement went from 2.0 IPS to .2 IPS.

Analytical assessments made from the data supplied by the GSC were also accurate. Using this ability, a maintenance crew can plan maintenance days in advance. Accurate data is essential for the HUM system to be effective.

3.5 Timeliness of Data

The entire process of taking the DRU out to the aircraft, connecting the cannon plug to the DRU and aircraft external connector port, performing the download and connecting the DRU to the GSC takes approximately 15 minutes. The downloading of data alone, from the aircraft to the DRU takes approximately 3 to 5 minutes. The upload of data from the DRU to the ground station computer takes approximately 15 to 20 minutes depending of the amount of aircraft time flown for that day.

The compiling of analytical data by the ground station computer takes approximately 1.5 hours. This delay has not been a problem for the HUMS technicians in that they schedule their maintenance around the compiling process or perform the process during their lunch period. Also the ground station computer can be used while the uploading or compiling process of data takes place. The tape backup of the ground station data takes approximately 40 to 45 minutes.

The timeliness in which data is downloaded, uploaded, compiled or the system backup is performed is relative to the type of computer used.

A personal computer with a 386 processor is currently used for the GSC. An upgraded computer with 486 or Pentium processor would significantly reduce the time required to download, upload and compile the data as well as the tape backups. Also, reducing the many key board commands required to initiate access to the ground station computer software would also reduce the technician's time on the GSC and provide quicker access to perform the required analytical assessments

3.6 Data Security

Data security is a very important issue and concern. Any corruption of data may have consequences in which flight safety could be adversely affected. Programming must be incorporated into the HUMS computer that performs data checks for possible corruption. The system should alert the user if and when a change to the data base has occurred.

The HUMS ground station computer should have the latest version of virus protection software installed. The reliability of the HUMS is dependent on the recording and transferring of accurate data. High priorities should be set on tamper proofing the system. Security in the form of regular backups of the data is also important. The revisions to the operations maintenance manual should cover all areas of security including backup requirements. HUMS Technicians will be properly trained in areas relating to security. Each HUMS Technician certified will be given a security code which will be required to access the HUMS computer.

4. INTEGRATION OF HUMS WITH CURRENT PROCEDURES

The Integration of HUMS with an operator's current procedures requires some change to the systematic way of doing things although these changes are thought to be minimal. Note that changes made must be done in accordance with current Federal Aviation Regulations.

In the future, electronic interface of the HUMS data with an operator's maintenance management system network would improve efficiency and eliminate manual transfer of data, as shown in Figure 9.

The following sub sections of this chapter include the proposed intergration of HUMS with an operator's currently approved procedures. References to the HUM system in this section are intended to be interpreted as proposed procedures and not procedures already approved for the operator.

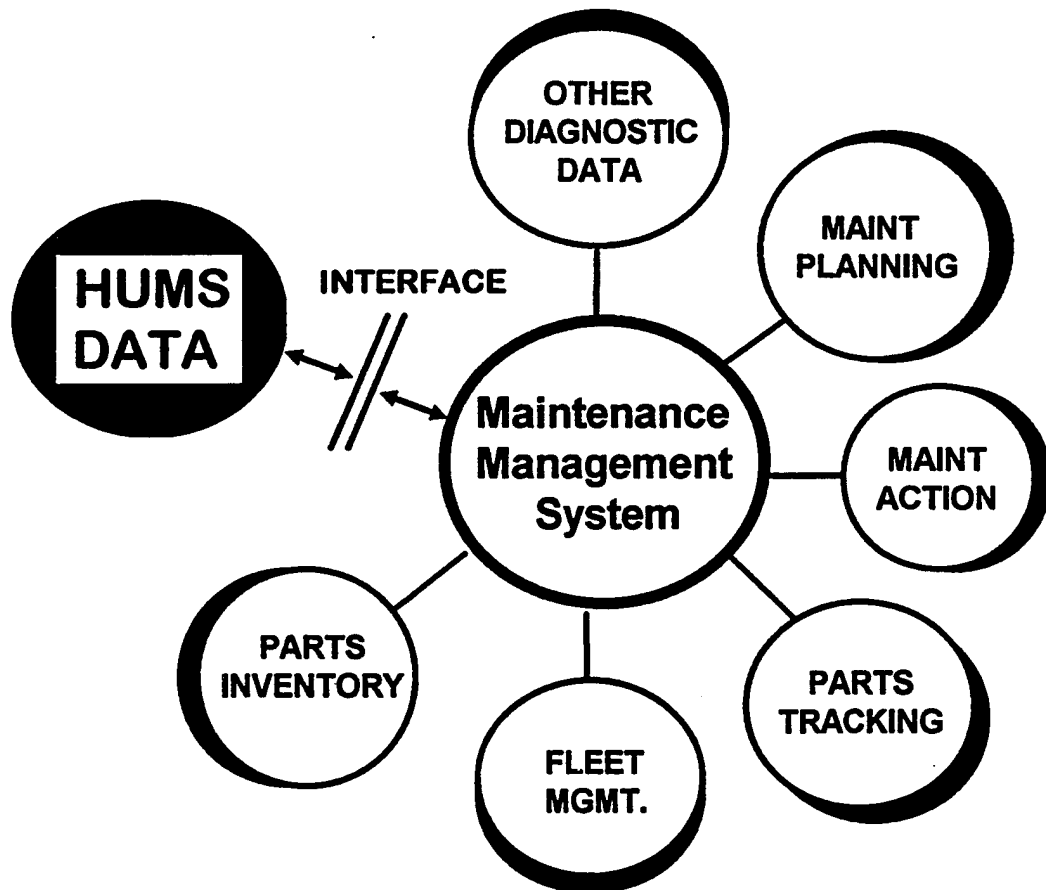

Figure 9. Integration of HUMS with Operator's Maintenance Management System

4.1 Revisions to the Operator's Maintenance Manual

The implementation of HUMS is expected to require minimal changes to the operator's operational maintenance procedures. Integration of HUMS into an operator's maintenance program would first require revisions to the Operator's Maintenance Manual.

Federal Aviation Regulation 135.21 sets forth the requirement for the certificate holder to prepare and keep current a manual setting forth the certificate holder's procedures and policies acceptable to the Administrator. The manual is referenced throughout the regulations as the operator's maintenance manual and several different regulations add requirements that make up the manual. Aircraft with ten seats or more, such as the aircraft used in this study, shall be maintained under a maintenance program in accordance with FAR 135.415, 135.417, and 135.423 through 135.443.

Each certificate holder shall have an inspection program and a program covering other maintenance, preventive maintenance, and alterations, that ensures that maintenance, preventive maintenance, and alterations performed by it, or by other persons, are performed under the certificate holder's manual as specified by FAR 135.425.

HUMS integration would require revisions to the following parts of the Operator's Maintenance Manual:

- Maintenance Organization in accordance with FAR Part 135.423
- Maintenance Training Program in accordance with FAR Part 135.433
- Maintenance Program in accordance with FAR Part 135.425
- Continuing Analysis and Surveillance Program (CASP) in accordance with FAR Part 135.431
- Maintenance Records Program in accordance with FAR Part 135.439.

The following Figure 10 illustrates further break down of the programs and the revisions required of each.

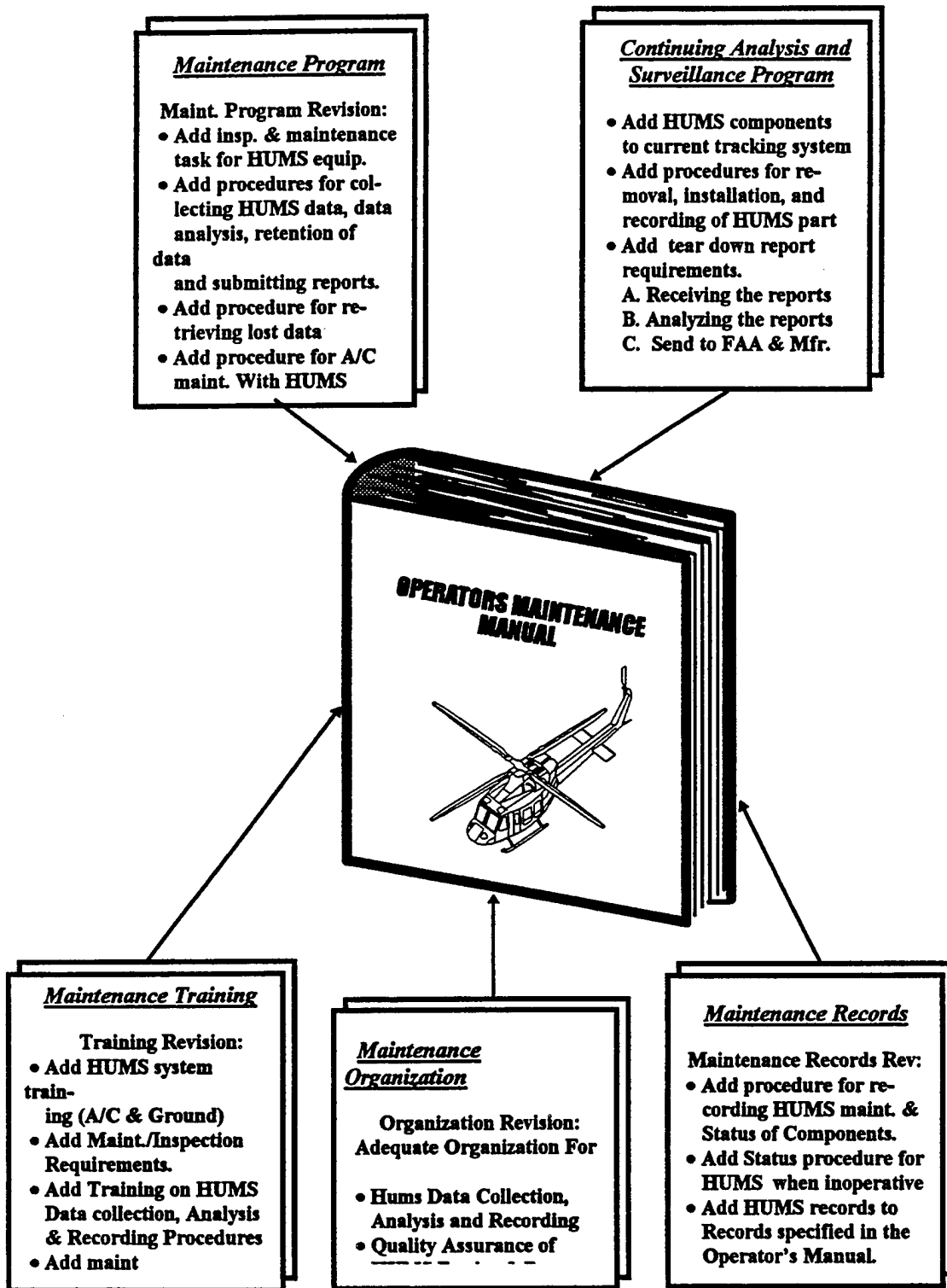

Figure 10.
Revisions to the Operator's
Maintenance Manual for
HUMS Integration

4.2 Changes to the Operator's Maintenance Program

An operator's maintenance program would require minor changes. Some of these changes would include the addition of scheduled inspections and maintenance task for HUMS equipment.

Procedures would be defined for collecting HUMS data, data analysis, retention of data and submitting reports. A maximum time frame limit would be established as to the maximum time span allowed before HUMS data must be down loaded to the Data Retrieval Unit (DRU) as well as the Ground Station Computer (GSC).

Procedures for backing up and retrieval of the computer data would be defined in the maintenance program as well as data retention requirements. Procedures and security requirements for prevention of HUMS data corruption would be established in the maintenance program.

This is an area of concern that can better be controlled in the programming of the HUMS computer. It is very important that the data base be designed to eliminate any possible data corruption and with an alert that could possibly indicate when data corruption has occurred.

Procedures for aircraft with HUMS inoperative would specify instructions to be accomplished which would return the aircraft to a non-HUMS Maintenance Program Status. Procedures for adding HUMS to the minimum equipment list (MEL) would also be defined.

The aircraft status program would continue tracking components as it did with the HUMS operative except maintenance credits for any inspections, overhauls or retirements would not be credited to the usage service life. Parts would again be penalized as before the HUMS installation. This simple transition would require no additional work load as far as record keeping is concerned.

The maintenance program may require the addition of an extra maintenance technician for the purpose of analyzing the data on the ground station computer. This extra position would be especially important if several aircraft at one location had the installed HUM system. With a larger fleet of aircraft with HUMS installed, data analyzing would become a full time position and would probably benefit by having one individual analyze the data of each aircraft so that a comparison of data from aircraft to aircraft could be made. This would enhance the accumulation of data for analysis.

5. ASSESSMENT OF BENEFITS / CREDITS ASSOCIATED WITH HUMS

5.1 Maintenance Benefits / Credits

Achieving maintenance benefits provided by application of HUMS technology are of great interest to the aircraft operators because of the potential to enhance aircraft safety, and for direct operating cost reductions that are needed today to operate profitably.

One maintenance benefit offering great potential is the automated rotor track and balance. It is common knowledge that vibrations can cause serious damage in the way of airframe deterioration and reduced avionics integrity. HUMS rotor track and balance technology is reducing the heavy maintenance and check flight burden from smoothing the rotor, in turn giving dynamic and avionic components an easier ride and increased reliability. These vibrations can be reduced offering increased life to main rotor head components as well as reduce structural damage to the airframe. Although not always felt in the cockpit, a high tail rotor imbalance can, if not corrected, lead to structural damage of the tail boom. Reducing vibrations also reduces pilot fatigue as well as gives the customer a quieter, smoother and overall safer flight. The benefits offered by automated rotor track and balance have great potential and can be achieved through HUMS user experience and through the assessment of data accumulated.

Other benefits include self-diagnostic malfunction identification (eliminates troubleshooting), prediction of planned maintenance and workforce requirements, exceedance monitoring which can eliminate unnecessary maintenance, increased aircraft availability as well as customer confidence, a better resale value and reduced insurance cost.

The monitoring of flight critical transmission elements (gears, shafts, etc.) conceivably offer the greatest potential benefit from a health monitoring system in enhancing safety. It has the capability for monitoring the multiple failure modes for which there are unlikely to be warning systems other than subtle changes in their normal vibration signatures. For example, failure modes propagating through pure fatigue may never or only at their final stages shed debris capable of detection by magnetic plugs. For other critical parts, such as driveshaft bearings, that are not oil wetted and therefore probably not monitored by other means, vibration analysis may offer the only available protection.

Given the necessary validated accumulation of reliable and effective data, maintenance credits may be sought in the way of:

- (a) relaxation of the extent or form of testing employed following the reconditioning and/or installation of replacement components.
- (b) Extension of component retirement life, for example from 5,000 hours to 10,000 hours may be achievable through changing the basis of retirement from elapsed time or flying hours to measured load exposure through usage monitoring.

As shown below in Figure 11, the service life could be extended if the actual usage severity was low compared to the predicted usage (basis for certification). On the other hand, usage monitoring would provide a safety benefit if actual usage was more severe than predicted.

- (c) Credit of component overhaul lives may be achievable through changing the basis of removal from elapsed time or flying hours to measured load exposure as described in (b).
- (d) Extension of component overhaul service lives.
- (e) Extension of scheduled servicing or inspection intervals may be achievable through component life usage monitoring and appropriate health monitoring indications where sufficient component damage tolerance can be demonstrated.
- (f) Relaxation of inspection or maintenance data recording procedures may be achieved by replacing manual recording or reporting procedures with automated ones.
- (g) Avoidance or delay of modification introductions may be achievable through usage monitoring in combination with health monitoring provisions where sufficient damage tolerance can be demonstrated.

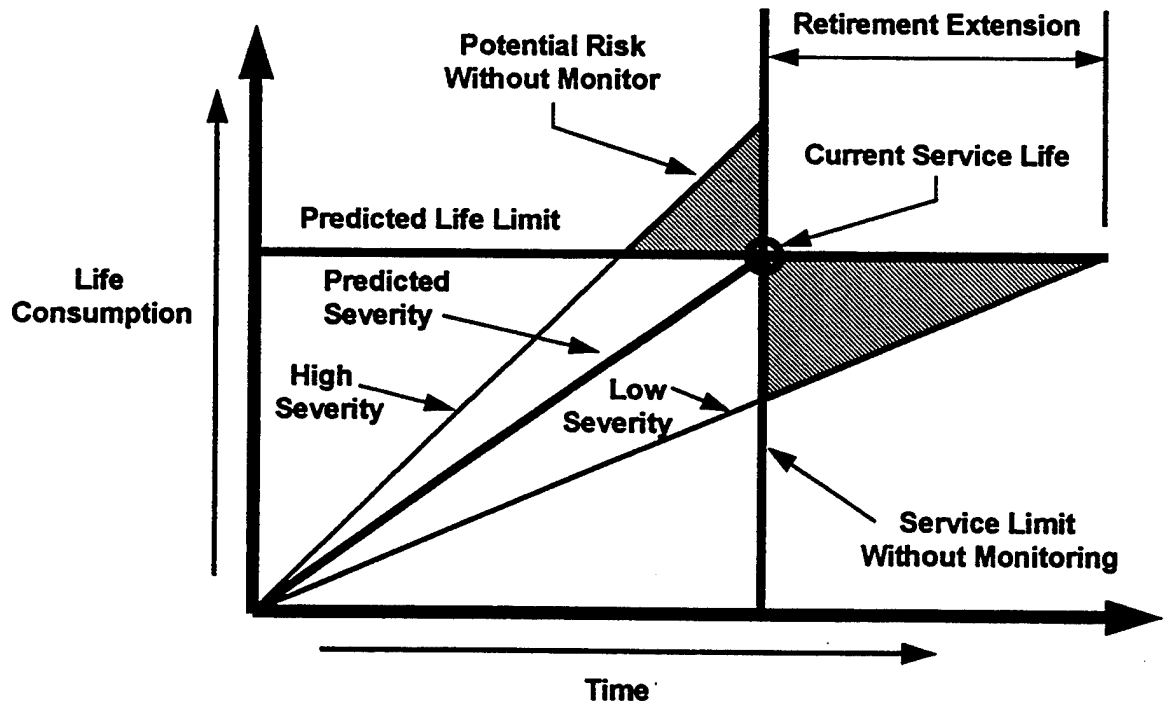

Figure 11. Potential Benefits Provided by Usage Monitoring with HUMS

5.2 Procedures for Implementation of Maintenance Benefits / Credits

Maintenance benefits are not implemented but are normally a positive result of the HUM system data acquisition and analysis such as, (1) automated rotor track and balance, (2) the ability to monitor exceedances and avoid unnecessary maintenance actions and (3) increased customer confidence. The benefits increase as the data base increases and data is analyzed and assessments are made. The experience gained is a benefit in itself.

Maintenance credits however, adjust or remove a maintenance action. Maintenance credits fall under two categories:

- (1) **Minor Maintenance Credits:** Minor maintenance credits adjust an inspection interval; or revise the content of a maintenance task and/or adjust a component overhaul interval; or revises the overhaul requirements.
- (2) **Major Maintenance Credits:** Major maintenance credits adjust a component life limit, in accordance with the appropriate regulations.

Implementation of maintenance credits would require obtaining FAA approval for HUMS by applying to the:

Aircraft Certification Office (ACO) for the following:

- (1) Supplemental Type Certificate (STC) or Type Design Change
- (2) Certification of HUMS Equipment by (TC), (STC) or Field Approval
- (3) Aircraft HUMS Installation
- (4) Approval of Major and Minor Maintenance Credits

Flight Standards District Office (FSDO) for the following:

- (1) Field Approval of Aircraft HUMS Installations
- (2) Approval of HUMS Maintenance Program Revisions
- (3) Approval of Maintenance and Operations Training
- (4) Approval of Maintenance Organization
- (5) Approval of Component Tracking and Reliability Procedures
- (6) Approval of HUMS Operations
- (7) Approval of Minor Maintenance Credits

Once approved, the minor and major maintenance credits are implemented as part of the HUMS maintenance program revisions.

5.3 Life Limited Parts Retirement - HUMS Usage Data verses Time Life

Life limited parts installed on a HUMS aircraft would be handled in the same manner as a part on an aircraft without a HUMS. The only difference would be that the actual part time on a HUMS installation aircraft will be adjusted up or down based on HUMS usage data. For this discussion, the value used to adjust time is called the "Usage Index" (UI). The UI is applied to establish the actual time credited or debited to the part. For instance a part with a retirement life of 10,000 hours has the same retirement life on a HUMS installed aircraft or on a non-HUMS installed aircraft, although the time charged to the part per flight hour may be different. The non-HUMS installed aircraft part will always be charged one hour for each hour the aircraft flies. The HUMS installed aircraft part will be charged a percentage of the actual time flown on the part if the part has been approved for HUMS credit. For example, the aircraft may have flown ten actual hours but the part is charged 50% or only five hours based on the actual flight spectrum being 50% of the severity of the certification flight spectrum as determined by the HUMS usage monitoring system.

By adjusting part usage time using this method the operator can treat parts on and off HUMS installed aircraft in the same manner. The historical record card for the individual part installed on a HUMS aircraft should indicate the part was installed on a HUMS aircraft to clarify time accumulation. On a non-HUMS installation, the part may be installed at aircraft total time new and removed at 1,000 hours which would calculate to time used on the part equals to 1,000 hours. On a HUMS installed aircraft, the time used on the part would not be calculated as on a non HUMS installation, therefore the historical record card must indicate that this part was a HUMS credited part.

Figure 22 illustrates the above HUMS retirement credit procedure. The HUMS status program is integrated into the operators existing status program for ease of transition from non HUMS installations to aircraft incorporating HUMS installation. In the event the HUMS becomes inoperative the transition back to the previous method becomes as simple as returning the penalty applied to the part to 100% .

The above described procedure is presented to illustrate the concept that part lives can be determined and tracked based on actual usage by using a HUM system.

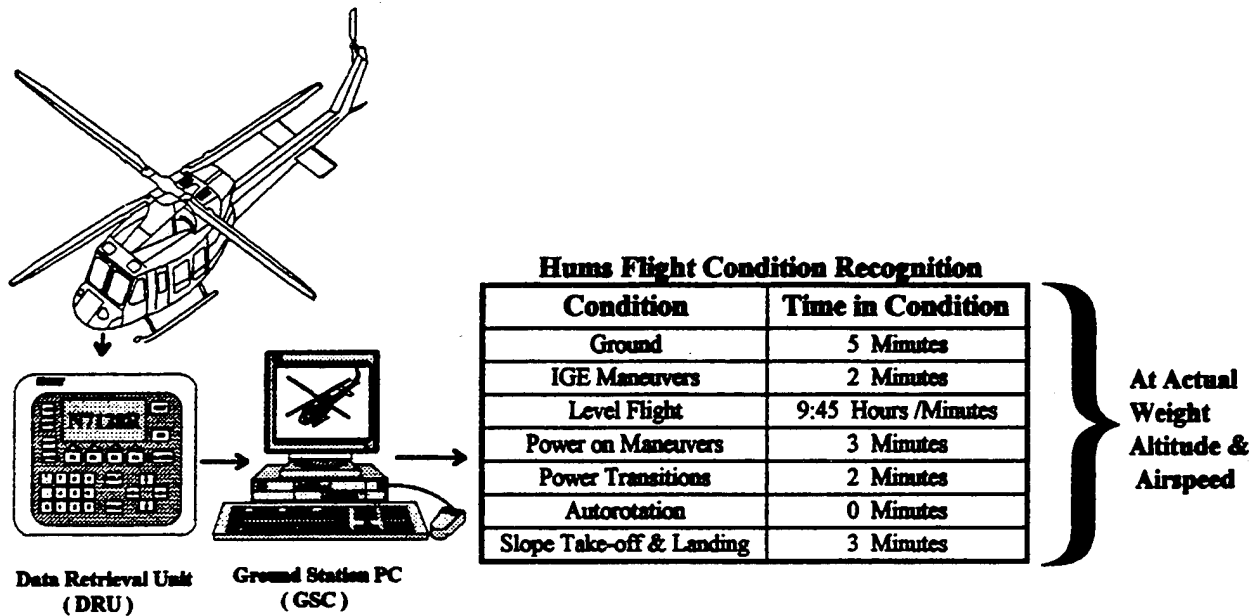

GSC Computer Calculates Time and Updates Main Frame Computer

Part Number Nomenclature	Usage Index	Multiplied by Actual A/C Hours Flown	= Time to Add to Part	= Part Total Time + Penalty	Service Life of Part	= Time Remaining
P/N 412-010-263-101 Arm Assembly	50 %	10:00 Hours	5:00 Hours	New + 5 Hrs	5,000 Hrs	4995 Hrs
P/N 412-010-186-103 Upper Cone Seat	25 %	10:00 Hours	2:50 Hours	New + 2:50 Hrs	10,000 Hrs	9997:10 Hrs
P/N 204-010-404-001 Gimbal Ring	60 %	10:00 Hours	6:00 Hours	New + 6 Hrs	9,000 Hrs	8994 Hrs
P/N 20-057-5-25D M/R Horn Bolts	75 %	10:00 Hours	7:50 Hours	New + 7:50 Hrs	2,500 Hrs	2492:10 Hrs
P/N 412-040-101-117 Main Rotor Mast	100 %	10:00 Hours	10:00 Hours	New + 10 Hrs	10,000 Hrs	9990 Hrs

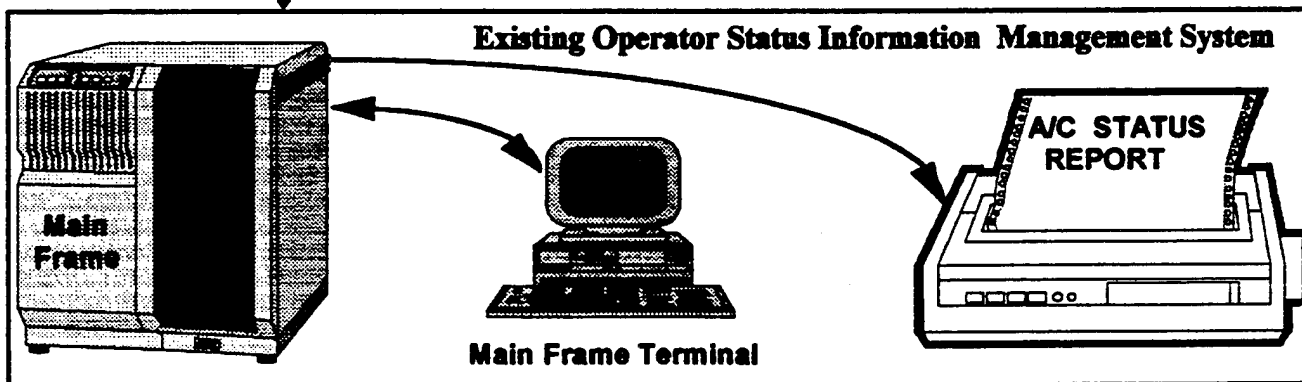

Figure 12. HUMS Retirement Credit Procedure

5.4 Impact on Parts Inventory/Tracking/Ordering

Spare components and parts for HUMS aircraft will require the same established procedures regarding inventory, tracking and ordering as non-HUMS aircraft. Due to the method used to credit part or component life, segregation of HUMS aircraft parts is not required. Parts will continue to come from the same pool when installed and go to the same pool when removed regardless if installed on a HUMS aircraft or not.

Spare backup equipment and parts for the HUMS system should be minimal due to procedural implementation reverting back to non HUMS installation requirements, in the event of HUM system failure. Until the necessary parts could be obtained to repair the HUM system, the aircraft is certified to operate without HUMS.

Although the aircraft would not be grounded due to HUMS spares not being available, it could be costly considering the sudden loss of maintenance credits as well as the temporary loss of benefits acquired through HUMS usage.

Spare parts and equipment holdings will have to be reviewed in the light of operational experience in determining which parts spares should be on hand, eliminating any long term system down time.

5.5 Cost Effectiveness of HUMS

To be cost effective, it is desirable that the benefits of HUMS outweigh the actual cost of purchasing, installing, and maintaining a HUMS. The benefits offered in the form of paybacks can quickly offset the actual cost of HUMS implementation providing the benefits are available and implemented by the operator.

Applying a HUMS to a maintenance program to monitor performance and actual aircraft usage requires consideration of both the pros and cons of such a system. Only then can an operator determine if such a system is cost effective and can satisfy their requirements as a maintenance aid, which enhances safety and reduces maintenance cost and not a maintenance burden. Areas that would have to be considered are the added work load, accuracy of the system, and the actual cost of purchasing, implementing and maintaining such a system.

Once a HUMS is installed, a short acceptance or adjustment period can be expected. The HUMS is able to monitor and store all engine indications, this may cause the flight crew to be apprehensive. Once a telltale monitoring system is introduced all parties concerned must realize that the intent of the system is to enhance safety and confidence in the maintenance program. The operator must consider:

- Will the benefits overcome the cost and weight impact?
- Will the convenience of on board analysis gear enhance the aircraft or burden the maintenance crew?
- Will the system be reliable and not cause aircraft down time?
- Will data analysis support be available?
- Will HUM system support be available in the form of HUM system part availability from the HUMS supplier and technical support in replacing faulty HUMS equipment?
- Are maintenance credits achievable?
- Ground Station ease of use.
- Impact of HUMS interfacing with operator's existing operational procedures.
- Training.
- Will HUMS be fully supported and approved by the Federal Aviation Administration?
- Will HUMS installations eventually become a mandatory safety requirement?

The cost effectiveness of HUMS can be determined by taking the cost of implementing and maintaining a HUM system in comparison to the pay back HUMS will generate in maintenance benefits and credits.

Current direct operating cost estimates (expendables and maintenance) for the helicopter used in this study are listed in Table 5.

Table 5. Direct Operating Cost Estimates

Fuel at \$1.50 a gal & Lubricants at 3% of fuel cost per hour	\$174.59
Airframe Direct Maintenance Labor at \$45.00 per hour	
Inspection	\$18.14
Overhaul	\$4.64
Unscheduled and On-condition	\$20.16
SUB TOTAL	\$42.94
Parts	
Inspections	\$15.66
Overhauls	\$25.30
Retirements	\$83.82
Unscheduled and On-condition	\$130.04
SUB TOTAL	\$254.82
Powerplant Direct Maintenance	
Module and Accessory Exchange	\$128.47
Line Maintenance	\$15.07
SUB TOTAL	\$143.54
Total Average Cost Per Flight Hour	\$615.89

More than half of the cost per flight hour consumed by the helicopter is spent on parts and labor. The cost effectiveness of HUMS is dependent on its ability to provide the needed credits and benefits which would result in reducing the direct operating cost of parts and labor. Insurance might be reduced due to the enhanced safety offered by HUMS which is a cost not reflected in the above table.

5.6 Components with Highest Cost Effectivity

A major assembly where the HUMS would be most cost effective is the main rotor head. The main rotor head alone cost \$101.65 per flight hour in component and labor cost to meet scheduled airworthiness limitations requirements. Of the \$101.65 per flight hour spent, \$74.13 per flight hour is spent on just the main rotor hub assembly portion of the main rotor head, which consumes approximately 73% of the entire main rotor head component cost per hour.

The main rotor hub assembly, which is part of the main rotor head, consist of 93 status line items which contain an airworthiness limitation such as an inspection or a retirement item. The main rotor hub assembly is inspected per the airworthiness limitations section of the maintenance manual each 2500 hours, costing an average of 70 labor hours plus parts. There are also 55 items that retire on the main rotor hub at the 5,000 hour interval and 30 items that retire at the 10,000 hour interval. The replacement cost for these parts are quite expensive. In addition there are cost for parts and labor for the main rotor mast assembly, swashplate and support assembly, drive hub and sleeve assembly and pitch link assemblies for retirements, inspections and overhauls.

The single most expensive part of the main rotor hub is the upper and lower main rotor yoke assembly, followed by the four main rotor spindle Assemblies. Replacing the yokes and spindles consumes 80% of the replacement parts cost of the main rotor hub at each 5000 hour interval.

5.7 Economic Impact of Extensions of Maintenance Activity & Retirements

Extensions in the form of credits could have a major economic impact for example, reducing the direct operating cost by only 10% could result in a savings of \$307,945.00 within a 5,000 hour period. This is a savings of \$61.58 per flight hour in direct operating cost.

A \$100,000.00 HUM System able to reduce operating cost by 10% would be able to pay for itself within 1624 hours of flying time. These types of savings can give the operator the competitive edge needed to operate profitably and enhance safety at the same time.

5.8 Other Benefits of HUMS

In addition to the maintenance benefits discussed in the previous sections, other potential benefits with HUMS include the following:

- **Weight & Balance - Operations management & Passenger Loading
(Gross weight CG Sensor)**
- **On Board Rotor Track and Balance**
- **On Board Diagnostics Malfunction Identification (Troubleshooting Benefit)
maintenance errors flagged by HUMS soon after action performed**
- **Prediction of Work Force Requirements**
- **Prediction of Planned maintenance**
- **Aid to flight management usage**
- **Reduced vibration - reduces pilot fatigue, gives customer quieter
smoother flight, gives dynamic and avionic
components an easier ride and increased reliability**
- **Exceedance Monitoring - (avoid unnecessary maintenance)**
- **Increased Aircraft Dispatch Reliability and Availability**
- **Automated Records**
- **Reduced Insurance Cost**
- **Better Resale Value**
- **Enhanced Aircraft Safety**
- **Reduced Operating Cost**
- **Increased Customer Confidence**

6. RECOMMENDED PROCEDURES FOR OBTAINING MAINTENANCE CREDITS

6.1 Operator - Manufacturer - FAA Interaction

It is of utmost importance that a dissemination of information and experience be transferred between the Operator, Manufacturer, HUMS equipment supplier and the Regulator (FAA). This continual circulation of information is vital to the HUMS program. It is important that each entity be included in the process of reviewing experience gained with the HUM system. This transfer of information will help improve the data assessment process.

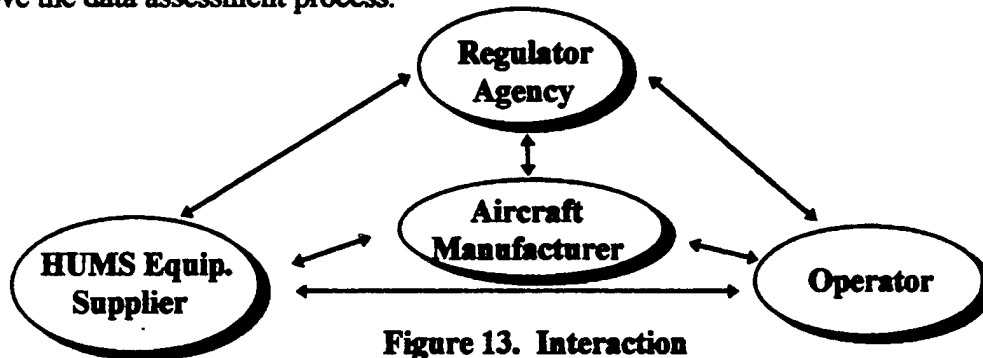

Figure 13. Interaction

6.2 Procedure for Obtaining Minor & Major Credits

Maintenance credits adjust or remove a maintenance action. Maintenance credits fall under two categories:

- (1) **Minor Maintenance Credits:** Minor maintenance credits adjust an inspection interval; or revise the content of a maintenance task and/or adjust a component overhaul interval; or revises the overhaul requirements.
- (2) **Major Maintenance Credits:** Major maintenance credits adjust a component life limit, in accordance with the appropriate regulations.

A procedural flow diagram for obtaining manufacturer and regulatory approval for each maintenance credit is shown in Figure 14. Obtaining maintenance credits requires the necessary data accumulation for substantiation of each credit. Once the necessary data is accumulated, it is sent to the rotorcraft manufacturer for review and recommendation for credit approval. Upon manufacturer approval, the data is sent to the FAA Rotorcraft Certification Office.

The FAA Rotorcraft Certification Office is petitioned for approval and if approved by the FAA Rotorcraft Certification Office the operator must then submit data and revision of the HUMS maintenance program to the FAA FSDO Principal Maintenance Inspector (PMI) for approval. If approved by the FAA Principal Maintenance Inspector (PMI) the credit is granted and revision to the operators maintenance program is implemented.

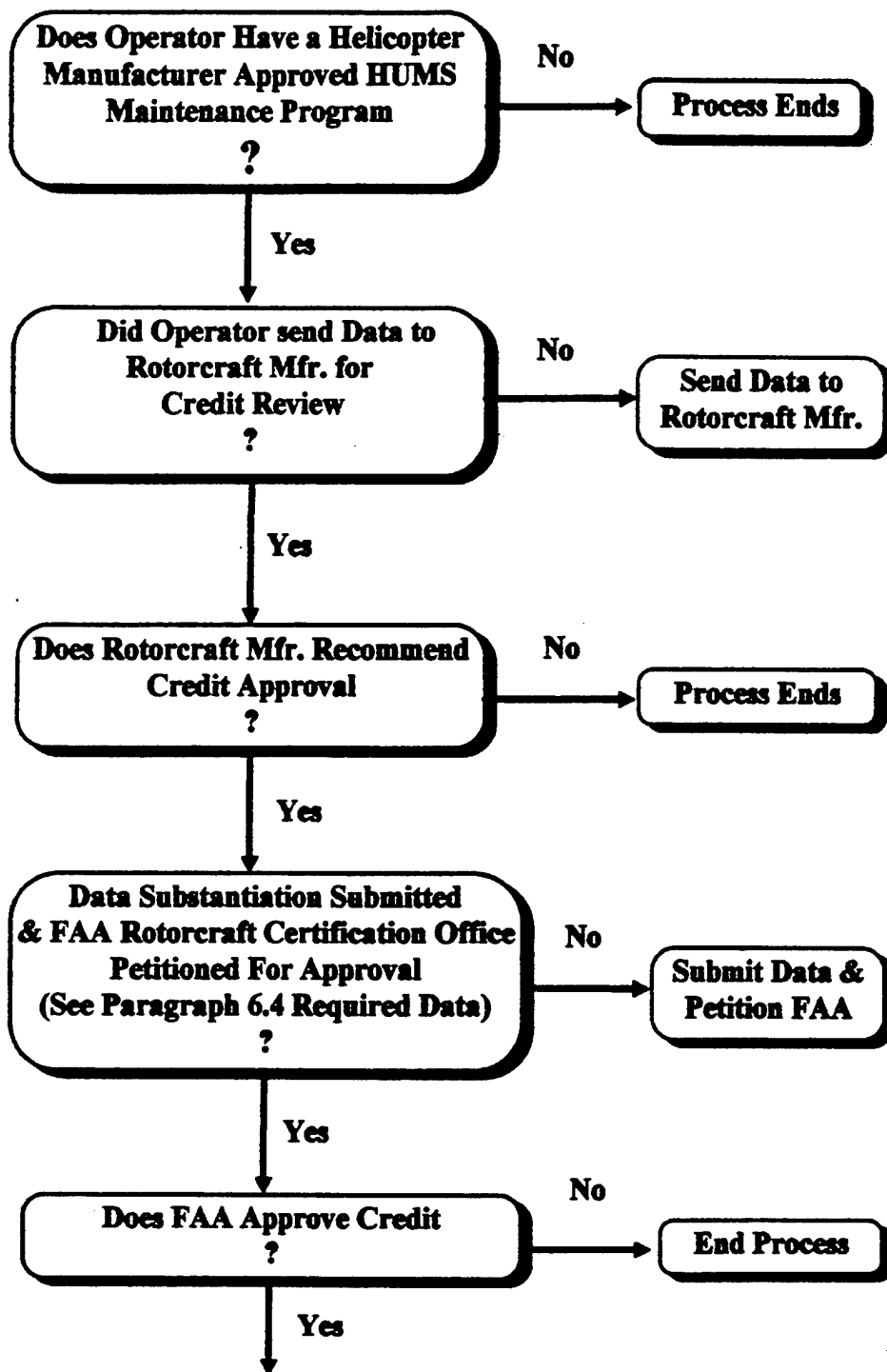
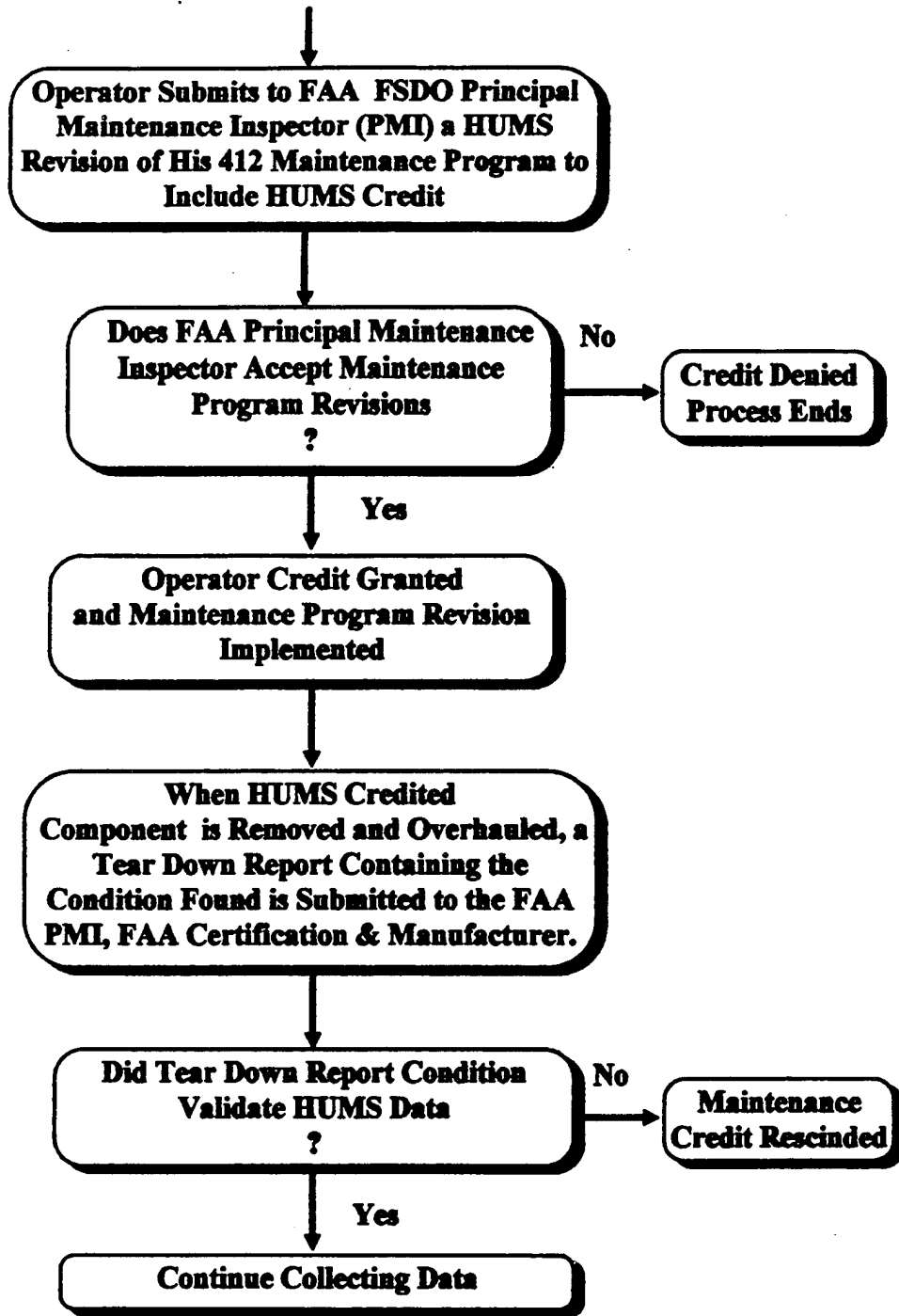

Figure 14.
Procedure to Obtain FAA & Manufacturer
Maintenance Credit Concurrence



**Figure 14. (Continued from previous page)
 Procedure to Obtain FAA & Manufacturer
 Maintenance Credit Concurrence**

6.3 Type and Quantity of Data Required

Airworthiness authority approval requires the collection, storage, and analysis of data. The analyzed data must be assembled into a form usable by the airworthiness authority to make the necessary decision to approve or disapprove a request for change.

The data required by the Federal Aviation Administration is normally supplied in duplicate unless otherwise specified. The amount of data required is normally the amount of data needed to justify the intent of the request and satisfy the administrator. This request could vary from one Flight Standards District Office Principal Maintenance Inspector (PMI) to the next and is at the sole discretion of the FAA.

The data required for obtaining airworthiness authority approval for maintenance credits would include supporting information such as but not limited to:

- 1) Identification of life limiting features**
- 2) Identification of maintenance/inspection requirements that will be imposed by application of the approved maintenance credit**
- 3) HUMS functions and techniques associated with preliminary hazard analysis of these functions**
- 4) Sampling intervals to include teardown reports**
- 5) Acceptance/rejection criteria**
- 6) Associated maintenance actions**
- 7) Evidence of reliability monitoring & effectivity of chosen techniques**
- 8) Flight load synthesis activity and original certification criteria**
- 9) HUMS recorded data to include all analysis and flight condition recognition information recorded on component**
- 10) Operator's proposed maintenance program revisions to include revisions to: Maintenance Organization
Maintenance Training Program
Maintenance Program
Continuing Analysis and Surveillance Program
Maintenance Records**

7. RECOMMENDED HUMS IMPROVEMENTS

Highly recommended is a secured data base for the HUMS and a means of self testing upon start up of the computer which would check for viruses as well as data corruption. The system should be able to alert the operator if a change in the data base has occurred. Each HUMS technician should be required to input his own security clearance code or pass word to access the ground station computer. It is also important that the HUMS computer requirement specifications given by the HUMS supplier be specific enough to eliminate any possibilities of any ground station hardware / software compatibility problems. Clear maintenance actions need to be implemented into the GSC, and false alarms need to be eliminated.

When considering the application of usage monitoring for individual parts, it is important to group as many like parts together as to allow them to retire at the same time to facilitate maintenance. For instance the main rotor head alone consist of 55 parts that retire at the 5,000 hour interval. It is important that the HUMS program does not penalize or credit each of the 55 parts with different penalties due to the fact that a different part would be due each week counteracting the HUMS paybacks. Some parts may be required to have a slightly higher penalty to facilitate replacement of parts as a group.

Again training must be emphasized. The HUM system needs to be sold with the necessary training to fully utilize the HUMS benefits. It should be noted that inadequate training on the HUM system can be very costly to the operator. The misinterpretation of data by the HUMS Technician may result in costly unjustified removals as well as incorrect fault diagnosis. During this study HUMS Technicians strongly emphasized the need for proper training on the HUM system.

8. SUMMARY AND CONCLUSIONS

The operators evaluation and operational assessment of the integrated FDR/HUM System installed on the study aircraft has demonstrated a high level of reliability. The system monitoring of: (1) Rotor Track and Balance, (2) Engines, (3) Drive Train, and (4) Life-Limited Structural Components, proved to be accurate.

The system's self-diagnostics and built-in test capabilities ensure that malfunctions can be identified and appropriate actions taken prior to failures occurring. HUMS can provide information on the source of a failure, e.g., sensor, processor, or monitored component. HUMS acts as a sentinel over the state of critical components and warns of impending failures, offering the latest in technology, contributing to a safer aviation environment.

HUMS offers the potential benefits to the operator of enhanced safety, reduced maintenance costs, and increased aircraft availability. In addition, when the benefits from HUMS are realized and confidence in the reliability of the HUMS equipped helicopter is proven, there should be a significant impact on insurance cost with HUMS. Note that as aircraft age, the depreciation cost become much smaller, and the maintenance and insurance costs become even more dominant contributors to total operating cost.

Other benefits the HUM System offers are in the way of on-board rotor track and balance, on-board diagnostics malfunction identification, weight and balance - Gross weight CG sensor, prediction of work force requirements, prediction of planned maintenance, aid to flight management usage, exceedance monitoring, automated records, a better resale value as well as increased customer confidence.

The reduction in vibrations offered by utilization of the HUMS, reduces pilot fatigue, gives customer a quieter smoother flight, gives dynamic and avionic components an easier ride as well as increases reliability.

The interfacing of HUMS with current operational procedures is considered to be minimal. The implementation of a HUMS requires revisions to the following parts of the operator's maintenance manual. (1) Maintenance Organization in accordance with FAR Part 135.423, (2) Maintenance Training Program in accordance with FAR Part 135.433, (3) Maintenance Program in accordance with FAR 135.425, (4) Continuing Analysis and Surveillance Program (CASP) in accordance with FAR Part 135.431 and (5) Maintenance Records Program in accordance with FAR Part 135.439.

The bottom line is if direct operating cost continue to increase, the helicopter commercial market will collapse. HUMS offers solutions in the form of paybacks that will take the commercial helicopter market to new heights. With the continued interaction between the operator, aircraft manufacturer, HUMS supplier and regulators (FAA), HUMS will continue to improve as the data base and experience with this new technology grows, offering new methodologies in system monitoring techniques which can enhance the safety of aviation as well as reduce direct operating cost.

9. REFERENCES

1. "Technical Manual for Test Set, Aviation Vibration Analyzer", Headquarters Dept. U.S. Army, Technical Manual TM 16625-724-13 & P, August 1994.
2. Dousis, D.A., " A Vibration Monitoring, Acquisition and Diagnostic System (VMADS) for Helicopter Drive Train Bench Tests", Presented at the 48th American Helicopter Society Annual Forum, Washington D.C., June 3-5, 1992.

REPORT DOCUMENTATION PAGE

Form Approved
OMB No. 0704-0188

Public reporting burden for this collection of information is estimated to average 1 hour per response, including the time for reviewing instructions, searching existing data sources, gathering and maintaining the data needed, and completing and reviewing the collection of information. Send comments regarding this burden estimate or any other aspect of this collection of information, including suggestions for reducing this burden, to Washington Headquarters Services, Directorate for Information Operations and Reports, 1215 Jefferson Davis Highway, Suite 1204, Arlington, VA 22202-4302, and to the Office of Management and Budget, Paperwork Reduction Project (0704-0188), Washington, DC 20503.

1. AGENCY USE ONLY (Leave blank)	2. REPORT DATE February 1996	3. REPORT TYPE AND DATES COVERED Final Contractor Report	
4. TITLE AND SUBTITLE Feasibility Study of a Rotorcraft Health and Usage Monitoring System (HUMS): Results of Operator's Evaluation		5. FUNDING NUMBERS WU-505-62-36 NAS3-25455 1L162211A47A	
6. AUTHOR(S) Raylund Romero, Harold Summers, and James Cronkhite		7. PERFORMING ORGANIZATION NAME(S) AND ADDRESS(ES) Petroleum Helicopters Inc. Lafayette, Louisiana	
8. PERFORMING ORGANIZATION REPORT NUMBER E-10092		9. SPONSORING/MONITORING AGENCY NAME(S) AND ADDRESS(ES) Vehicle Propulsion Directorate National Aeronautics and Space Administration U.S. Army Research Laboratory Lewis Research Center Cleveland, Ohio 44135-3191 Cleveland, Ohio 44135-3191 Federal Aviation Administration, Technical Center Atlantic City International Airport, New Jersey 08405	
10. SPONSORING/MONITORING AGENCY REPORT NUMBER NASA CR-198446 ARL-CR-289 DOT/FAA/AR-95/50		11. SUPPLEMENTARY NOTES Raylund Romero and Harold Summers, Petroleum Helicopters Inc., Lafayette, Louisiana (work performed under NASA Contract NAS3-25455); James Cronkhite, Bell Helicopter Textron Inc., Fort Worth, Texas. Work partially funded by Interagency Agreement No. DTFA03-89-A-00019. Project Manager, Robert F. Handschuh, Vehicle Propulsion Directorate, U.S. Army Research Laboratory, NASA Lewis Research Center, organization code 2730, (216) 433-3969.	
12a. DISTRIBUTION/AVAILABILITY STATEMENT Unclassified - Unlimited Subject Category 37 This publication is available from the NASA Center for Aerospace Information, (301) 621-0390.		12b. DISTRIBUTION CODE	
13. ABSTRACT (Maximum 200 words) The objective of this study was to evaluate the feasibility of a state-of-the-art health and usage monitoring system (HUMS) to provide monitoring of critical mechanical systems on the helicopter, including motors, drive train, engines and life-limited components. The implementation of HUMS and cost integration with current maintenance procedures was assessed from the operator's viewpoint in order to achieve expected benefits from these systems, such as enhanced safety, reduced maintenance cost and increased availability. An operational HUMS was used as a basis for this study that was installed and operated under an independent flight trial program. The HUMS equipment and software were commercially available. Based on the results of the feasibility study, the HUMS used in the flight trial program generally demonstrated a high level of reliability in monitoring the rotor system, engines, drive train and life-limited components. The system acted as a sentinel to warn of impending failures. A worn tail rotor pitch bearing was detected by HUMS, which had the capability for self testing to diagnose system and sensor faults. Examples of potential payback to the operator with HUMS were identified, including reduced insurance cost through enhanced safety, lower operating costs derived from maintenance credits, increased aircraft availability and improved operating efficiency. The interfacing of HUMS with current operational procedures, was assessed to require only minimal revisions to the operator's maintenance manuals. Finally the success in realizing the potential benefits from HUMS technology was found to depend on the operator, helicopter manufacturer, regulator (FAA), and HUMS supplier working together. A companion activity was also accomplished as a second phase of this project and is contained in NASA CR198447 (ARL-CR-290; DOT/FAA/AR-95/9). In that report two techniques are used to assess data gathered under an independent flight study as it related to rotorcraft health and usage monitoring.			
14. SUBJECT TERMS Gears; Gear drives; Diagnostics; Usage monitoring		15. NUMBER OF PAGES 52	
17. SECURITY CLASSIFICATION OF REPORT Unclassified		16. PRICE CODE A04	
18. SECURITY CLASSIFICATION OF THIS PAGE Unclassified		19. SECURITY CLASSIFICATION OF ABSTRACT	
20. LIMITATION OF ABSTRACT		20. LIMITATION OF ABSTRACT	