

PA 12, 132 R

NASA TECHNICAL NOTE

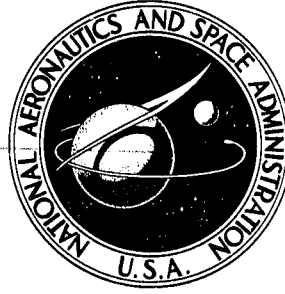

NASA TN D-2109

NASA TN D-2109

WEG
S-L/NCA

THE WORLD MAGNETIC SURVEY

by James P. Heppner

Goddard Space Flight Center

Greenbelt, Maryland

19960624 003

DISTRIBUTION STATEMENT A
Approved for public release;
Distribution Unlimited

12-8-64
Rec'd 12-7-64
BMI-CC

NATIONAL AERONAUTICS AND SPACE ADMINISTRATION • WASHINGTON, D. C. • JANUARY 1964

DTIC QUALITY INSPECTED 1

TOI

THE WORLD MAGNETIC SURVEY

By James P. Heppner

**Goddard Space Flight Center
Greenbelt, Maryland**

NATIONAL AERONAUTICS AND SPACE ADMINISTRATION

**For sale by the Office of Technical Services, Department of Commerce,
Washington, D.C. 20230 -- Price \$1.25**

THE WORLD MAGNETIC SURVEY

by

James P. Heppner
Goddard Space Flight Center

SUMMARY

The mathematical and graphical description of the earth's main field has been, and is, a "data limited" problem. The World Magnetic Survey (WMS) is an endeavor to minimize this limitation by rapidly and comprehensively blanketing the earth with magnetic field measurements. Satellite surveys, which will play a key role in the WMS, are the principal topic of this paper. Existing magnetic field descriptions, the expected results from new surveys, and the methods of obtaining these results with the POGO satellite are emphasized. It is anticipated on the basis of extrapolation from Vanguard III results and other considerations that a factor-of-10 improvement will be obtained. This means that the average errors of 1 to 3 percent now present in field charts and spherical harmonic descriptions should be reduced to 0.1 to 0.3 percent as a result of the survey.

NEXT

CONTENTS

Summary i

INTRODUCTION 1

LAND, SEA, AND AIR SURVEYS 3

 Observatories and Repeat Stations 3

 Ship Surveys 3

 Aerial Surveys 4

EXISTING MAGNETIC FIELD DESCRIPTIONS 6

 Spherical Harmonic Analysis of Surface Data 6

 Recent Analyses Using F and Space Data 11

 Questions Regarding Field Sources and
 the Number of Coefficients 14

WMS SATELLITES: GENERAL CONSIDERATIONS
AND THE POGO SYSTEM 17

 Orbit Selection 17

 Location Accuracy 19

 Scalar or Vector Measurement Question 20

 Magnetometers 22

 POGO Magnetic Field Instrumentation 25

WMS DATA REDUCTION AND ANALYSIS 28

 Handling of Raw Data 28

 Analysis Procedures 30

POGO MEASUREMENTS OF TEMPORAL VARIATIONS ... 33

SECULAR CHANGE AND FUTURE SURVEYS 34

SURVEYS OF THE OUTER MAGNETOSPHERE 36

WMS INTERNATIONAL COOPERATION 37

ACKNOWLEDGMENTS 37

References 38

END

THE WORLD MAGNETIC SURVEY*

by

James P. Heppner
Goddard Space Flight Center

INTRODUCTION

The World Magnetic Survey (WMS) denotes an international effort to obtain data for mathematical descriptions of the earth's magnetic field and its secular variations and for constructing charts of the field at the earth's surface. It is distinguished from previous survey efforts in the scope of the effort, which hopefully will lead to a truly worldwide coverage. In obtaining this coverage it is particularly important that: (1) emphasis be placed on the magnetically unmapped and poorly mapped regions of the globe, and (2) the survey be conducted within a time interval that is sufficiently short to not require major corrections for secular variations in describing the field at a particular date. The advantages of conducting the survey during years of minimum solar activity relate the WMS to the International Year of the Quiet Sun (IQSY). The context of the WMS is logically extended to include studies of temporal magnetic variations at least to the degree that these variations influence the survey measurements. The future determination and study of secular variations is obviously closely related to the primary objectives of the WMS.

The principal objective of the WMS, as first proposed at the International Union of Geodesy and Geophysics (IUGG) meeting in Toronto in 1957, was to obtain more accurate magnetic charts through expansion of existing surveys and creation of new programs for magnetic surveys by sea and air. The advantages of conducting surveys during years of sunspot minimum and the potential use of rockets and satellites in mapping the field were noted at the meeting of the ICSU Special Committee for the IGY (CSAGI) in Moscow in 1958 (Reference 1). Resolutions, recommendations, and discussions at these and subsequent international meetings (e.g., IUGG, Helsinki, 1960; COSPAR, Florence, 1961) gave the WMS an international foundation and established guidelines to promote compatibility of measurements from various sources. These have been described in detail in the IAGA[†]-IUGG Instruction Manual on the World Magnetic Survey, prepared by Vestine (Reference 2).

Since the proposal in Toronto in 1957 the advent of the satellite as a new vehicle for magnetic surveys has been paralleled by new reasons for needing a world magnetic survey. The need in 1957 came primarily from lack of adequate data for studying the origin of the magnetic field and its secular changes and for preparing more accurate magnetic charts for nautical and

*An invited review to be published in June 1963 in *Space Science Reviews* (Issue no. 6), D. Riedel Publishing Company, Dordrecht, Holland.

[†]International Association of Geomagnetism and Aeronomy.

aeronautical navigation. These reasons are still fundamental, but of equal importance now is the need for better descriptions of the earth's magnetic field in space. In space science, this need comes from the requirements for: (1) an accurate main field reference for satellite magnetic field experiments designed to determine the distribution of sources of magnetic disturbance; (2) describing the motions and distribution of trapped particles and the trajectories of solar particles and cosmic rays as they approach the earth; (3) determining the trapping lifetime for particles naturally or artificially injected into the magnetosphere; and (4) determining the detailed geometry of field lines for field-dependent radio transmissions, for locating conjugate points, etc. In space technology, this need arises from the use of the magnetic field in spacecraft orientation control and aspect systems.

A magnetic "chart" or "map," a two-dimensional representation of the field, would be of very limited use in space problems. A mathematical description, on the other hand, is directly useful. Thus, although we speak of "mapping" the field, it should be understood that the objective is first a three-dimensional (latitude, longitude, altitude) mathematical description of the field and, second, a four-dimensional description in which secular changes are adequately known to write the coefficients as a function of time. A related question, discussed later, is whether or not world magnetic charts at the earth's surface drawn from mathematical descriptions will be more or less representative than charts constructed by contouring measurements, as done in the past.

A world magnetic survey, in a strict sense, has never been made and has never been feasible by land, sea, and air if we accept a definition that such a survey ideally requires global coverage on a time scale short compared with the time in which secular variations invalidate the first measurements relative to the last. This does not mean that land, sea, and air methods have become obsolete, as this would be misleading in view of the complementary nature of surface and space measurements and the advantages of surface data in mapping crustal anomalies. It does, however, imply that satellites have made a truly world magnetic survey feasible; and, if successful, it may in the future be fitting to refer to this survey as *The First World Magnetic Survey*. Logically this survey will be followed by others to update the descriptions of the magnetic field and delineate the patterns of secular change.

Satellite magnetic surveys are the principal topic of this review. Land, sea, and air surveys are briefly discussed to give perspective on the surface data available for main field analyses and to illustrate the complementary features of the various surveys. Existing magnetic field analyses are discussed. Attention is then directed to: problems in satellite surveys, details of the magnetic survey to be conducted with the POGO satellite, analysis problems likely to be encountered in arriving at the best description of the earth's field and secular variations from the data obtained, some of the pre-flight thoughts on methods of handling and analyzing data from POGO, and the many possibilities for studies of temporal magnetic variations using simultaneous data from the survey vehicle and surface observatories. The satellite discussion will center on the POGO (Polar Orbiting Geophysical Observatory) survey largely because details on other satellite surveys are not available. The POGO survey should, however, be adequately illustrative.

No attempt is made to provide a comprehensive list of references. Recent papers are referenced in preference to many outstanding, older publications on geomagnetism on the grounds that these older

ones can be found by examination of the references in recent publications and in Chapman and Bartels' "Geomagnetism" (Reference 3).

LAND, SEA, AND AIR SURVEYS

Observatories and Repeat Stations

Measurements on land come primarily from two sources: magnetic observatories, and repeat stations. The quantity and distribution of data for the period 1905-1945 is illustrated in the Carnegie Institution Publication 578 (Reference 4). As of 1945 there were approximately 100 observatories and 2000 repeat stations, where a repeat station is defined as a location occupied more than once. Since 1945 the number of observatories has increased to about 150 (a recent listing is available in the Annals of the IGY, vol. VIII, 1959). The number of new repeat stations is not readily estimated accurately, but it appears unlikely that the number has greatly increased. The distribution of observatories and repeat stations is extremely spotty, not only as a consequence of the distribution of land masses but also because the locations within land areas tend to be grouped. The fact that the field at a single observatory or station may not be representative of a region, because of a local anomaly, does not permit assigning large weighting factors to observatory data relative to other observations for mapping purposes. Although these are serious disadvantages, observatories provide the most reliable data for studies of secular change and, in the past, the only data for studying secular change on a year-to-year basis. Observatories also provide the data for editing and correcting survey measurements for temporal variations when these corrections are applied.

Ship Surveys

The earliest magnetic charts, epoch 1700, were those of declination drawn from ship records of compass direction. Although magnetic measurements were made on various ocean expeditions in the 1800's (Reference 5), it was not until 1905 that a serious attempt was made to map the oceans. The most comprehensive surveys by ship were those made by the Carnegie, a nonmagnetic ship constructed as a part of the Carnegie Institution of Washington's program for magnetic mapping conducted from 1905 to 1929, when the ship was destroyed by fire. The extensive coverage achieved by the Carnegie Institution's 25-year survey has been illustrated by Fleming (Reference 5) and Vestine (Reference 6). Ship surveys were reactivated in 1956 by the USSR nonmagnetic ship, the Zarya, which in 1957 and 1958 covered 47,000 nautical miles in the Atlantic and Indian Oceans (References 7 and 8) and has since surveyed also in the Pacific. Using towed magnetometers measuring the scalar field, ship surveys also have been conducted on a regional scale by various groups engaged in oceanographic and submarine geologic studies; and magnetic traverses have been made on various expeditions.

The relative merits of ship and aerial surveys are often compared. Such comparisons are often confused by lack of distinction between what has been achieved and what it is possible to achieve. It is obvious that ship surveys take considerably more time, and global secular changes can be studied only in terms of a number of decades. There has, however, been a general belief that this

disadvantage is partially counterbalanced by greater system accuracy in ship surveys because they are less susceptible to navigational errors. This belief may be justified in given cases, but generalizations are not obviously justified.

Aerial Surveys

Magnetometers carried or towed by aircraft, measuring the scalar field, have been used for local and regional geologic studies by commercial firms and national geological surveys for about 15 years. The data from these efforts have in some cases been available for constructing magnetic charts. About 10 years ago groups in the United States and Canada redesigned the airborne systems to provide vector measurements, and later undertook magnetic surveys on a scale which would contribute more significantly to world magnetic charts. The Canadian Dominion Observatory survey subsequently covered Canada in a nearly uniform pattern and provided several traverses across the Pacific and North Atlantic (Reference 9). The U. S. Naval Hydrographic Office in 1959 initiated its plan for worldwide coverage of ocean areas under the name *Project Magnet*. The coverage achieved by Project Magnet through February 15, 1963, is illustrated by the heavy lines in Figure 1. The lighter lines indicate future survey tracks. The shaded area in the Atlantic Ocean was surveyed between 1953 and 1959.

An excellent review of airborne magnetic surveys for world charts, expressing both the capabilities and the limitations, has been written by Serson (Reference 9). A summary is hardly possible here, but it will be instructive to note some of the problems encountered in aircraft surveys for later reference in discussing similar satellite problems. Serson (Reference 9) has listed the sources of error in a vector aerial system as follows: (1) errors in measuring the magnetic field at the magnetometer with respect to the direction reference system, (2) errors in the direction reference system, (3) errors due to changes in the magnetic field of the aircraft, (4) errors due to transient changes in the magnetic field, and (5) errors in geographical position. Serson describes the approximate equivalence of the U. S. and Canadian systems. For Project Magnet, Byrnes (Reference 10) gives the following probable errors of observations under good survey conditions: total field magnitude, ± 15 gammas; angle accuracies equivalent to inclination and declination, ± 0.1 degree; geographical position, ± 5 km. Transformed to component errors, the angle errors give north-south and east-west errors varying from zero at the equator to 100 gammas at high latitudes and vertical errors ranging from 50 gammas at the equator to zero at the dip poles. Regarding the geographical position, or navigational, errors Serson (Reference 9) states that errors of the order of 100 to 150 gammas resulting from moderate errors of a few kilometers in navigation are responsible for the largest source of error in the results as plotted on charts. It should be noted, however, that errors of 100 to 150 gammas should not result from position inaccuracies of a few kilometers in the horizontal plane in the absence of crustal anomalies. Thus, in a spherical harmonic analysis limited to describing very deep sources, the effective field error due to position errors is reduced to values proportional to the regional gradient if the position errors are systematic. If the position errors are random, their principal effect is that of increasing the magnitude of the residuals, or noise level, already present in the analysis as a consequence of local anomalies. Returning now to field measurement errors of 50 to 100 gammas, these become slightly more important than a few kilometers

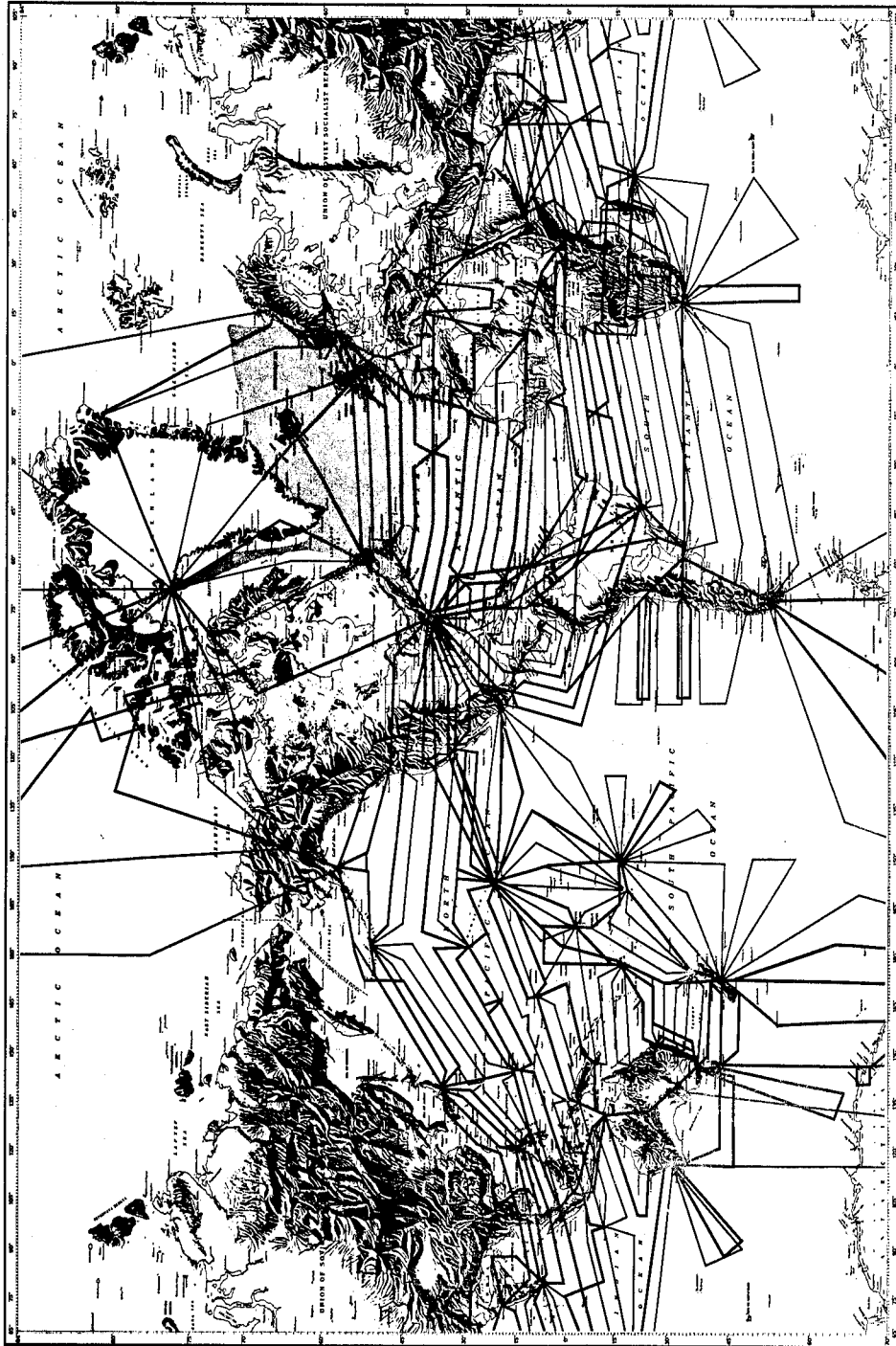

Figure 1—Project Magnet airborne geomagnetic survey tracks: 1959 to February 15, 1963 (heavy lines); future tracks (light lines); surveys between 1953 and 1959 (Atlantic Ocean shaded area). (Courtesy of U. S. Naval Oceanographic Office)

error in horizontal location for global harmonic analyses. The considerations of systematic versus random errors apply equally well for these errors. Thus, for mathematical descriptions of the field, world charts, and especially studies of secular variations it is desirable to reduce the errors in aerial surveys, but it is even more important that attention be directed toward avoiding systematic errors.

Another topic worthy of discussion, but not detailed here, is the relative merits of total field versus vector measurements in aircraft surveys. Noting that the errors quoted above are probable values under good survey conditions, we can expect the total range of operational errors to be considerably larger, and we can question whether the angle measurements are always of value. The answer at present, and at least until methods of analysis of worldwide scalar values are thoroughly demonstrated, is unquestionably "Yes." It follows, however, that there may be considerable merit in flying absolute scalar magnetometers in the same aircraft with the saturable core magnetometers for checking and reducing errors.

EXISTING MAGNETIC FIELD DESCRIPTIONS

Spherical Harmonic Analysis of Surface Data

The reader is referred to Chapman and Bartels (Reference 3) for a detailed discussion of the applicability of spherical harmonics to field analyses. The basic formulation is given here for later reference. In a source-free spherical shell ($a < r < R$) the magnetic potential V satisfies the Laplace equation $\nabla^2 V = 0$ and can be expressed in terms of spherical coordinates as follows:

$$V = a \sum_{n=0}^{\infty} \sum_{m=0}^n P_n^m(\cos \theta) \left\{ \left[c_n^m \left(\frac{r}{a} \right)^n + \left(1 - c_n^m \right) \left(\frac{a}{r} \right)^{n+1} \right] A_n^m \cos m\phi + \left[s_n^m \left(\frac{r}{a} \right)^n + \left(1 - s_n^m \right) \left(\frac{a}{r} \right)^{n+1} \right] B_n^m \sin m\phi \right\}, \quad (1)$$

where c_n^m and s_n^m are numbers between 0 and 1 representing the fractional contribution from sources external to R at $r = a$. The $P_n^m(\cos \theta)$ are the partly normalized associated Legendre functions which have been extensively used in geomagnetism since their introduction by Schmidt (see Reference 3). As the magnetic force rather than the potential is the measured quantity, harmonic expressions for $F = -\text{grad } V$ are used in analysis, where F is the total vector field intensity.

Until very recently all analyses were based on the coefficients of one or more of the components

$$Z = \frac{\partial V}{\partial r} \text{ (vertical) } , \quad (2)$$

$$X = \frac{\partial V}{r \partial \theta} \text{ (north) } , \quad (3)$$

$$Y = \frac{-\partial V}{r \sin \theta \partial \phi} \text{ (east) } , \quad (4)$$

and used only surface measurements. Thus, at $r = a$, where a is the earth radius, some condensation of the harmonic expressions comes from $r/a = 1$; and X , Y , and Z can be expressed as follows:

$$Z_{r=a} = \sum \sum (\alpha_n^m \cos m\phi + \beta_n^m \sin m\phi) P_n^m (\cos \theta) , \quad (5)$$

$$X_{r=a} = \sum \sum (A_n^m \cos m\phi + B_n^m \sin m\phi) \frac{dP_n^m (\cos \theta)}{d\theta} , \quad (6)$$

$$Y_{r=a} = \frac{1}{\sin \theta} \sum \sum (m A_n^m \sin m\phi - m B_n^m \cos m\phi) P_n^m (\cos \theta) , \quad (7)$$

where

$$\alpha_n^m = [n c_n^m - (n+1)(1 - c_n^m)] A_n^m , \quad (8)$$

$$\beta_n^m = [n s_n^m - (n+1)(1 - s_n^m)] B_n^m . \quad (9)$$

Most of the approaches for obtaining the coefficients have differed only in numerical technique and weighting factors, although there are exceptions noted later. The method used by Vestine et al. (Reference 11) is illustrative. In this analysis the functions $X_n^m = dP_n^m (\cos \theta)/n d\theta$ and $Y_n^m = m P_n^m (\cos \theta)/n \sin \theta$ tabulated by Schmidt (Reference 12) were used for convenience. World magnetic charts compiled separately for X , Y , and Z were used to obtain from X and Y two determinations of A_n^m and B_n^m and from Z the α_n^m and β_n^m coefficients. Data were taken at intervals of 10 degrees in colatitude and longitude. Fourier coefficients a_m , b_m were first determined for $m \leq 6$ along each 10 degree parallel of colatitude and then fitted by the functions X_n^m and Y_n^m to obtain two values for A_n^m and B_n^m (except for zonal harmonics, $m = 0$, given only by X). The Fourier coefficients a_m , b_m were weighted as a function of latitude from 10 for $\theta = 80, 90$, and 100 degrees to 1 for $\theta = 10$ and 170 degrees. To separate internal and external sources, the α_n^m , β_n^m from Z and averages for A_n^m , B_n^m from X and Y were used in Equations 8 and 9 to give c_n^m and s_n^m .

The above illustrates a number of features which individually have been common to a number of analyses, such as: the use of world magnetic charts for input data, the dependence on Z in separating internal and external sources, the weighting of data as a function of latitude, and the assumption that $r = \text{constant}$. For exceptions to several of these features and detailed differences between analyses the reader should examine the analyses reviewed by Chapman and Bartels (Reference 3) and the more recent analyses of Finch and Leaton (Reference 13), Fanselau and Kautzleben (Reference 14), and Jensen and Whitaker (Reference 15).

In using readings scaled from the world magnetic charts, the accuracy of the analysis is necessarily limited to the accuracy of the chart. This, in turn, is a function of the latitude-longitude distribution of observations, the year of the observations relative to the chart year, the measurement errors including temporal variations, and the subjective nature of contouring by hand. The latter point is not at all negligible, as illustrated by comparing magnetic charts drawn by different

organizations using essentially the same data. Thus, in the past it has been argued that a better description might be obtained by using only observatory values. This represents an extreme view which ignores the influence of local anomalies at observatory sites and the fact that the mutual dependence of the coefficients is such that large errors are likely to occur in regions lacking an observatory. Figure 2, by comparison with Figure 3,* illustrates the detail that appears on a world chart, after corrections and analysis, relative to the detail given by an $m = n = 6$, 48 coefficient, representation of the field. When expanded to greater dimensions and broken into smaller contour intervals, the detail in Figure 2 increases (see section maps of Vestine et al., Reference 4) whereas the detail in Figure 3 remains constant. If the small wiggles and bumps in the contours of Figure 2 are the consequence of local anomalies not being perfectly removed from the observations (which is very likely: see discussion on page 14; also note the prevalence of irregularities in poorly mapped regions), they will create errors in any spherical harmonic analysis based on chart scalings at regular grid intervals. The use of regular grid intervals is also subject to criticism on grounds that poorly mapped and unmapped regions receive the same weight as regions that are well mapped. The availability of high-speed digital computers is currently providing a compromise between the various extremes. An analysis program which utilizes directly all the data normally used in chart making can eliminate the subjectivity of the hand contouring without being influenced by local anomalies and data distribution to any greater degree than in the contouring process. Initial steps for achieving this compromise have been made in the methods of Jensen and Cain (Reference 16) and Fougere (Reference 17).

Efforts to determine c_n^m and s_n^m in Equations 8 and 9 have placed an upper limit of several percent on the fraction of the surface field caused by external sources. Various errors may contribute to give this large upper limit, but it is most probable that the accuracy is primarily limited by average errors of 1 to 3 percent in the charts used for input data. Another factor is that charts for Z are in general likely to be the least accurate of the three components. The sensitivity to the accuracy of the Z charts is illustrated by an example in Chapman and Bartels (Reference 3, p. 664) in which a 0.3 mm displacement of isoclines of inclination I is shown to be equivalent to a 3 percent external contribution found in an analysis by Bauer (Reference 18). In analyzing the vertical component of both U. S. and U. S. S. R. charts for 1955, Jensen and Whitaker (Reference 15) noted differences of up to 6 percent in some regions. Ivanov (Reference 8), in reporting on "Zarya" measurements, noted regions where the errors in the U. S. charts for Z exceeded 2000 gammas, approximately 8 percent. Ivanov (Reference 8) also states that the discrepancies between U. S. charts for the total scalar field F and the "Zarya" measurements amount to 1500 gammas in almost the entire Southern Hemisphere at latitudes less than 40 degrees and speculates that the errors are probably greater at higher latitudes. The "Zarya" in general showed better agreement with the British Admiralty charts in the Atlantic and Indian Oceans at latitudes less than 40 degrees. Errors in the British charts approached 1 degree in declination and 500 gammas in intensity in the Northern Hemisphere and 2 degrees and 1000 gammas in the Southern Hemisphere.

The data limitations also explain why the assumption of a constant radius, $r = a$, which neglects Δr 's of 1 part in 297 from earth oblateness as well as topographical differences, has had little, if any, influence on results.

*The Cain and Neilon data used in Figure 3 was taken from: "Automatic Mapping of the Geomagnetic Field," presented by J. C. Cain and J. R. Neilon at the 44th Annual Meeting, AGU, Washington, 1963.

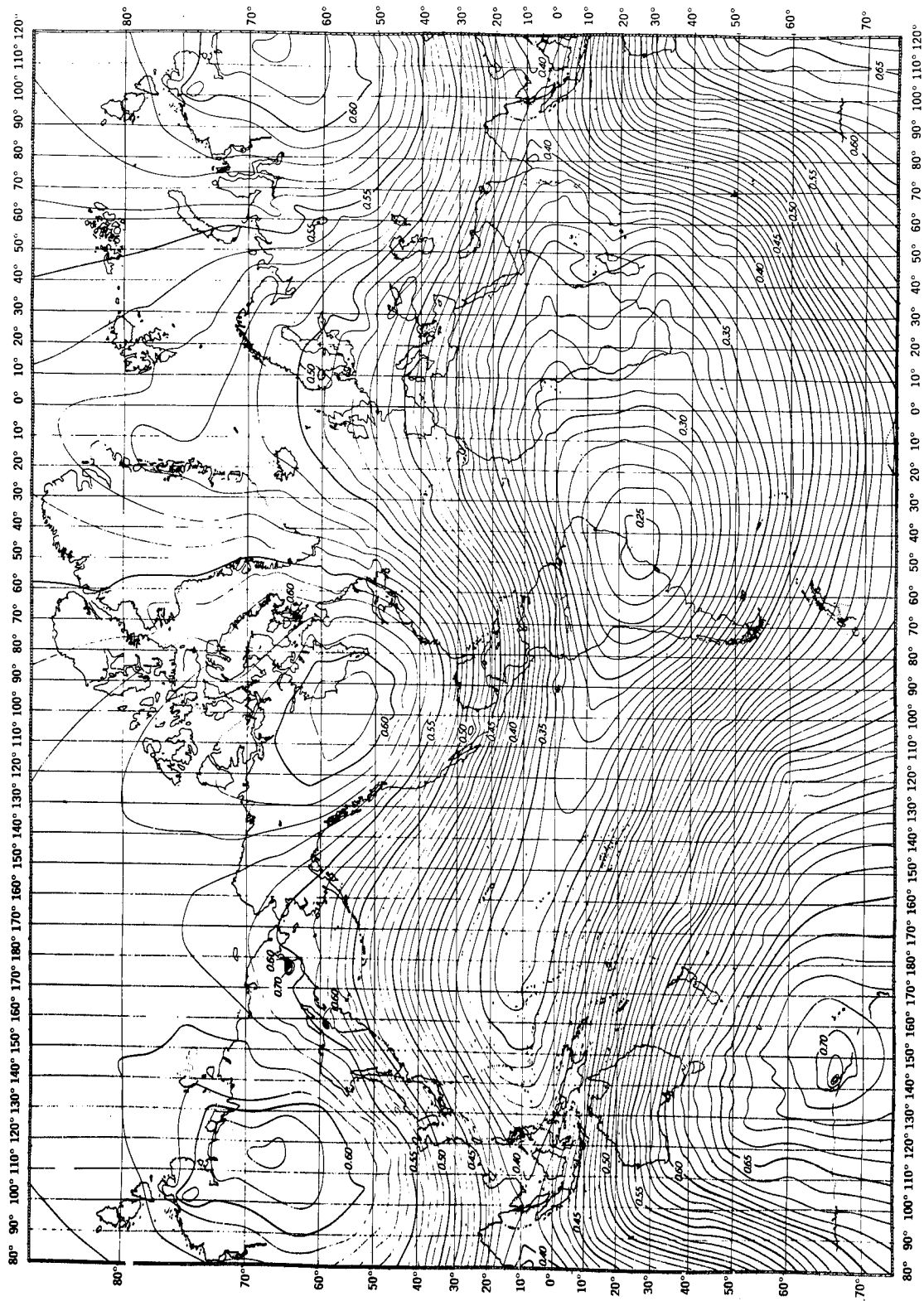

Figure 2—Chart of total magnetic field intensity for Epoch 1945 in units of Gauss (Reference 4).

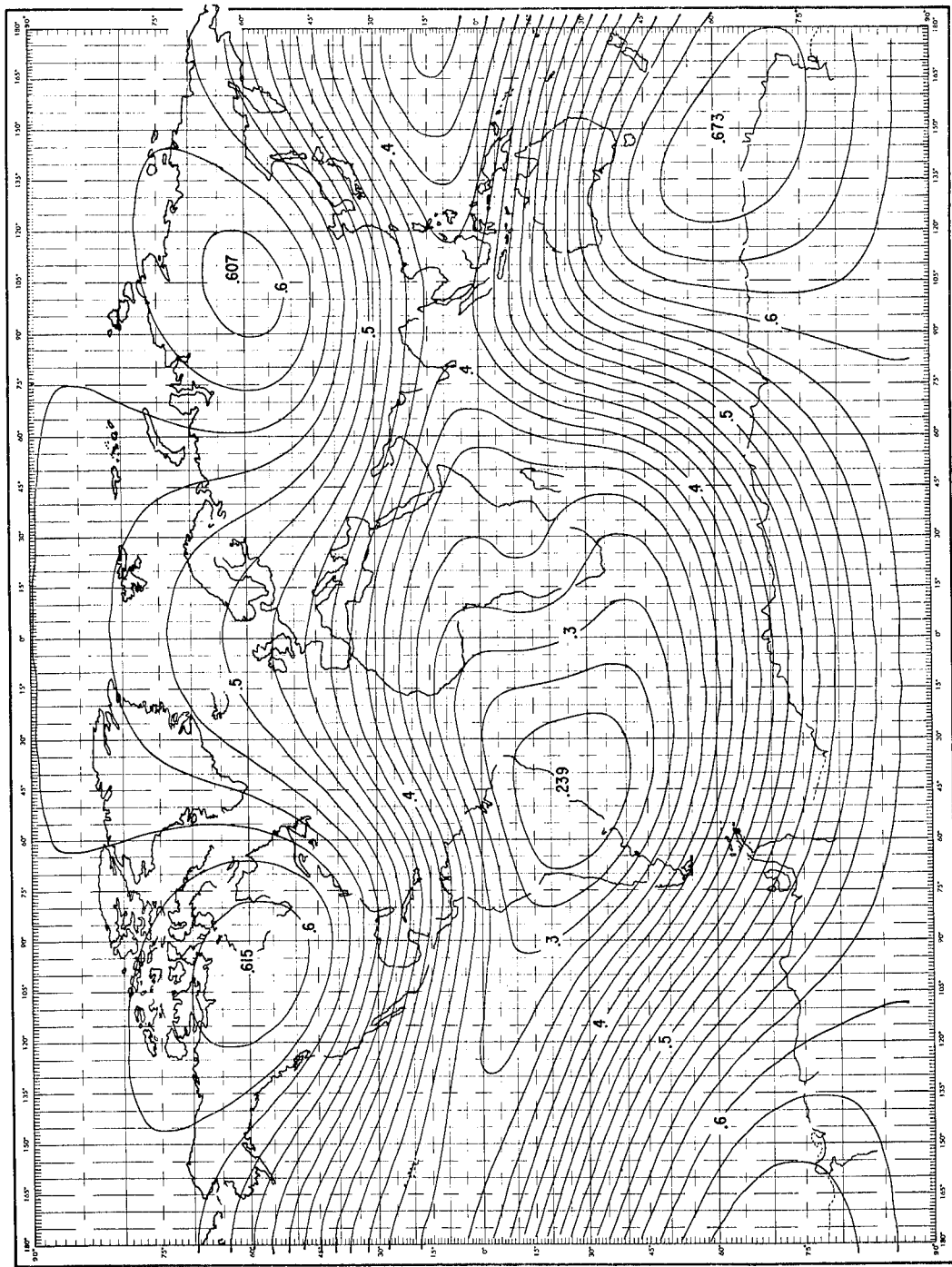

Figure 3—Machine plot (Cain and Neilson, 1963) of total magnetic field intensity for 1960 given by 48 coefficient expansion of Jensen and Cain (Reference 16).

Recent Analyses Using F and Space Data

The need for methods of analysis utilizing total scalar magnetic intensity F rather than component intensities appeared about 1957 when it became apparent that data from future satellites would be primarily scalar as a consequence of the instruments to be used and, even more important, the difficulties of achieving the accurate reference directions required for component measurements. Zmuda (Reference 19) first illustrated that the Gaussian coefficients g_n^m, h_n^m for internal sources appearing in

$$V = a \sum_{n=0}^{\infty} \sum_{m=0}^n \left(\frac{a}{r}\right)^{n+1} P_n^m(\cos \theta) (g_n^m \cos m\phi + h_n^m \sin m\phi) \quad (10)$$

were obtainable through analysis of F^2 by squaring the series for each component $X, Y,$ and Z and adding the terms, thus obtaining a series for

$$F^2 = X^2 + Y^2 + Z^2 \quad (11)$$

As illustrated for an eccentric dipole model the first eight harmonics, through $n = 2, m = 2,$ give 31 new coefficients representing combinations of the 8 desired. Although 31 coefficients is a considerable reduction from the 93 obtained without addition, it is apparent that the series becomes immense in higher degree representations, such as $n = 6.$ Zmuda (Reference 19) further treated the problem of separating internal and external sources but here made an error in assuming that a scalar subtraction of fields due to internal and external sources was a valid simplification.

Jensen and Cain (Reference 16), using Equations 10 and 11 and considering internal sources only—such that the coefficients of Equations 5, 6, and 7 become the Gaussian coefficients g_n^m, h_n^m —devised a method to determine the coefficients which avoids the nonlinear dependence of F^2 (or F) on g_n^m, h_n^m and permits the use of least squares fitting to the data. The method is one of improving on an existing set of coefficients without being dependent on the existing set being very accurate. The procedure is to expand F^2 into a Taylor series that includes only the linear term, giving

$$F^2 = F_0^2 + 2 \sum [u_n^m (\Delta g_n^m) + v_n^m (\Delta h_n^m)] \quad (12)$$

where

$$u_n^m = \left(\frac{a}{r}\right)^{n+2} \left[Z_0(n+1) (\cos m\phi) P_n^m(\cos \theta) - X_0 \cos m\phi \frac{dP_n^m(\cos \theta)}{d\theta} + Y_0 (m \sin m\phi) \frac{P_n^m(\cos \theta)}{\sin \theta} \right] \quad (13)$$

and

$$v_n^m = \left(\frac{a}{r}\right)^{n+2} \left[Z_0(n+1) (\sin m\phi) P_n^m(\cos \theta) - X_0 \sin m\phi \frac{dP_n^m(\cos \theta)}{d\theta} - Y_0 (m \cos m\phi) \frac{P_n^m(\cos \theta)}{\sin \theta} \right] \quad (14)$$

Values for F_0 , Z_0 , X_0 , and Y_0 are computed at the data locations using the best available set of coefficients g_n^m and h_n^m . The Δg_n^m and Δh_n^m are the corrections made to the initial g_n^m and h_n^m to obtain the best fit to the measurements. The summation term in Equation 12 given by

$$E = F^2 - F_0^2 \quad (15)$$

indicates the error, or residual between measured and computed values; and, as this term is linear with respect to the Δg_n^m , Δh_n^m , a least squares fitting can be used to find the corrections and thus generate an improved set of coefficients. In application the process is one of successively applying the corrections and repeating the procedure until significant improvements in accuracy are no longer obtained. The procedure also applies to the components and can be used to mix component and total field data (e.g., for the horizontal intensity H we have $E = H^2 - H_0^2$).

The method of minimizing $F^2 - F_0^2$ was first applied to approximately 3000 measurements of the scalar field taken by Vanguard III (1959 $\gamma 1$) between latitudes ± 33.5 degrees and altitudes 510 to 3753 km. Although this produces a good fit, it automatically weights the data using least squares by the factor $(F + F_0)^2$ as seen by rewriting the squares as

$$\sum (F^2 - F_0^2)^2 = \sum (F - F_0)^2 (F + F_0)^2 \quad (16)$$

which emphasizes the data at low altitudes and high latitudes relative to the high altitude and low latitude data. As the difference between $2F$ and $F + F_0$ is negligible in a weighting sense, the weighting factor can be removed by minimizing the error quantity

$$E = \frac{F^2 - F_0^2}{2F} = F - F_0 \quad (17)$$

in place of Equation 15. Another alternative is to minimize the fractional (or percentage) error given by

$$E = \frac{F - F_0}{F} \quad (18)$$

This has the effect of weighting the high altitude or low latitude data more heavily than the low altitude or high latitude data.

In subsequent analyses of Vanguard III data (Cain et al., Reference 20) all three Equations 15, 17, and 18 were used with comparable results. Average residuals versus altitudes, from use of Equations 15 and 18, are shown in Figure 4. The series involved 63 coefficients, g_n^m and h_n^m with n and m of 7, which, as an example taking Equation 18, fitted all data (disturbed as well as quiet days) with a root-mean-square (rms) residual of 21 gammas or 0.13 percent. Of this 12 gammas could be attributed to errors of measurement coming primarily from orbit position errors. The remaining 9 gammas was easily attributed to disturbance effects. In contrast, use of the initial Finch and Leaton (Reference 13) coefficients on the same data gave an rms residual of 255 gammas. Thus the method worked well for this limited case, which represents strictly a curve-fitting procedure not

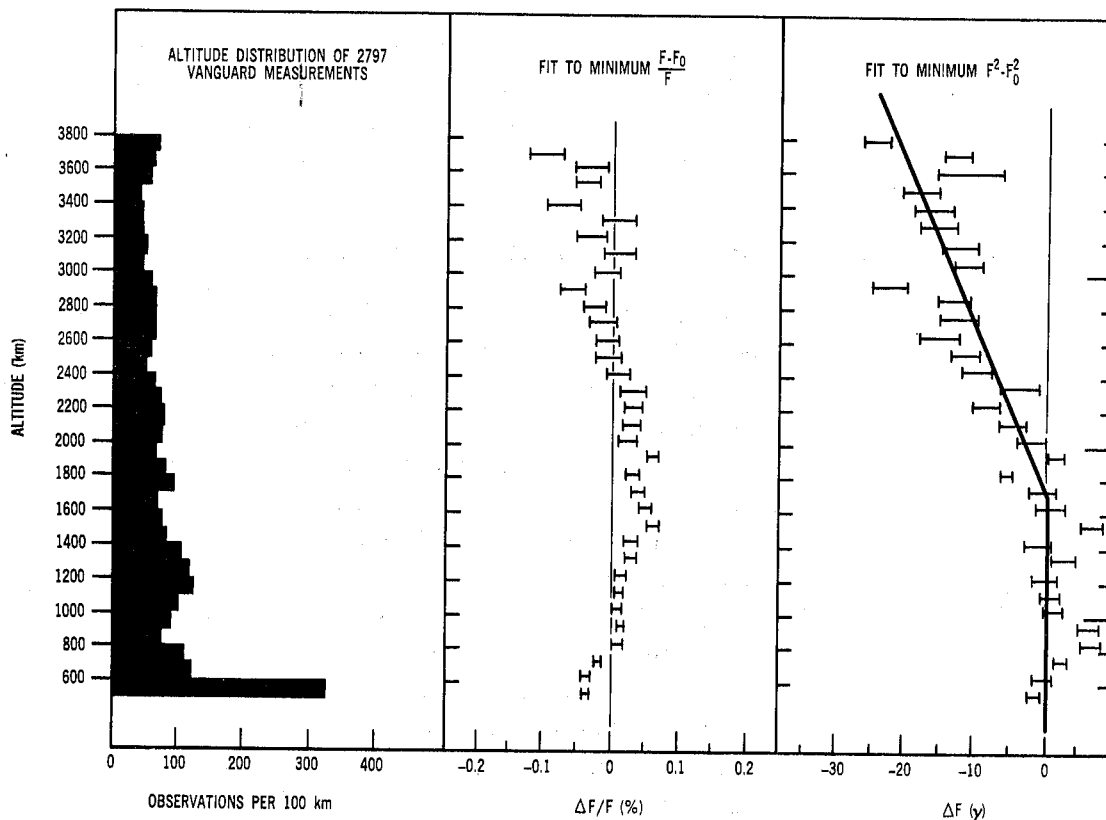

Figure 4— Average residuals of Vanguard III data relative to two different, $n = m = 7$, spherical harmonic reference fields as a function of altitude. Error bars show the standard errors of the mean residuals.

taking into account the existence of external sources and not attempting to fit data outside the regions of measurement. The coefficients for this special analysis of limited regions over North and South America, the Caribbean, Australia, and South Africa are given by Cain et al. (Reference 21).

The method was next applied by Jensen and Cain (Reference 16), using Equation 17 and the H equivalent, to a collection of 74,000 values of F and H taken since 1940—of which about 28,000 points were F measurements from aerial surveys, 3000 points were F measurements from Vanguard III, and the remainder were surface values for H. To shorten the time for each iteration, only every tenth point was used in the computation of coefficients. The fit was made to the year 1960 with the assumption that secular variations could be approximated by a linear time dependence. This was included by substituting coefficients $\Delta g_n^m + (t - 1960) \Delta (dg_n^m/dt)$ and $\Delta h_n^m + (t - 1960) \Delta (dh_n^m/dt)$ for Δg_n^m and Δh_n^m in Equation 12. The accuracy achieved, as indicated by the residuals, was closely related to the distribution of data, giving rms errors of: 135 gammas in regions of good coverage, about 600 gammas in regions of poor coverage, and 304 gammas for the total data. As a check on the method, computed values were compared with U. S. chart values along parallels of latitude; and in general closer agreement was achieved by using the new coefficients than by using the Finch and Leaton (Reference 13) coefficients used for the initial g_n^m , h_n^m . Although the Jensen and Cain method worked well, major improvements over past analyses could not be expected with the existing data.

Comparing also the relative magnitude of the residuals in fitting just Vanguard data and in fitting the more heterogeneous set of surface data gives some indication of the refinements in analysis than can be expected from future satellite data relative to handling data from the earth's surface where local anomalies have a major influence.

Questions Regarding Field Sources and the Number of Coefficients

It is commonly believed that sources of the field interior to the earth's surface are confined to two regions: a primary region located in the earth's core (depth > 2900 km), and a secondary region, the earth's crust. There is also considerable evidence (References 22, 23, and 24) that the sources in the crust most typically have linear dimensions of less than 50 km and that the number of occurrences of anomalies with greater dimensions decreases rapidly with increasing dimensions up to several hundred kilometers. Anomalies with dimensions greater than several hundred kilometers appear to be very rare. Thus any attempt to represent typical crustal sources in a global spherical harmonic description would be ridiculously cumbersome, and these "local" anomalies are more properly treated as noise. It should, however, be noted that strike-slip fault displacements of magnetic anomaly patterns of 1420 km have only recently been found by Vacquier et al. (Reference 25); and it is not inconceivable that major geologic features still unknown may contribute to future descriptions. Similarly the available data don't completely rule out the possibility that crustal differences between oceans and continents may have an influence in future analyses. If we ignore these latter possibilities for the time being, the question then is "How many coefficients are required to describe the interior field as observed at and above the earth's surface, exclusive of crustal anomalies?" The question has direct physical significance in understanding the hydromagnetic dynamics of the core. Although a unique determination of interior sources is not possible with surface measurements, it is partly on the basis that coefficients of higher degree and order than $n = m = 6$ have historically been unnecessary that the belief has evolved that sources of continental dimensions and sources in the mantle are essentially nonexistent. There are, of course, physical reasons as well for assuming an absence of primary sources in the mantle (e.g., Reference 26).

Strictly from an analysis standpoint there are grounds for questioning the ultimate adequacy of an $n = m = 6$, or 48 coefficient, representation. Jensen and Whitaker (Reference 15), for example, found that higher order terms were not insignificant in their analysis and permitted the computer to run through $n = 24$, $m = 17$, producing 512 coefficients, at which point 1 percent contributions were still being obtained. They concluded quite logically that the large number of coefficients merely reflected the chart errors as the analysis technique assumed a perfect chart. Similarly, Fanselau and Kautzleben (Reference 14) carried an analysis through $n = m = 15$ and reached the conclusion that beyond $n = m = 6$ the data were too inaccurate to obtain an improvement in the description. This point is simply seen in a rough way by noting the agreements and disagreements between the signs of the three sets of coefficients in Table 1, which were derived from three different data sources. Through $n = 4$, all signs agree; for $n = 5$, three sign disagreements are noted in the 11 coefficients; for $n = 6$, seven sign disagreements appear in the 13 coefficients. It appears logical to conclude that the $n = m = 6$ cutoff point in past global analysis is imposed by the data and is not necessarily determined by the real form of the field.

Table 1
 Values of g_n^m, h_n^m to $n = m = 6$ from Several Analyses.

n	m	Reference 15 (Jensen and Whitaker) Year 1955*		Reference 13 (Finch and Leaton) Year 1955		Reference 16 (Jensen and Cain) Year 1960	
		g	h	g	h	g	h
1	0	30396		30550		30411	
1	1	1955	-5677	2270	-5900	2147	-5799
2	0	2331		2280		2404	
2	1	-5007	3133	-5250	3290	-5125	3312
2	2	-1444	-398	-1370	-210	-1338	-158
3	0	-2946		-2950		-3152	
3	1	5672	1346	5860	1380	6213	1487
3	2	-2181	-407	-2440	-570	-2490	-408
3	3	-788	37	-720	80	-650	21
4	0	-3849		-4150		-4179	
4	1	-4292	-427	-4400	-820	-4530	-1183
4	2	-2307	876	-2270	1210	-2180	1001
4	3	770	296	800	80	701	43
4	4	-269	144	-230	120	-204	139
5	0	1402		2090		1626	
5	1	-3925	60	-3220	-170	-3441	-80
5	2	-990	-688	-1550	-750	-1945	-200
5	3	465	-82	170	230	-61	460
5	4	237	195	340	310	278	242
5	5	19	-39	50	-60	70	-122
6	0	-55		-1500		-1952	
6	1	-1515	695	-930	440	-485	-576
6	2	-1336	-1972	-250	-1660	321	-874
6	3	1833	346	2410	-40	2141	-341
6	4	208	262	160	60	105	-12
6	5	-34	-58	-10	60	23	-112
6	6	37	31	70	10	112	-33

*Continues to $n = 24, m = 17$.

Thus for clues to the answer regarding the number of significant coefficients, prior to analysis of WMS data, we have to look at analyses of measurements that are restricted in distribution but are at least homogeneous in quality and taken within a time span that does not involve large uncertainties caused by secular variations. Alldredge et al. (Reference 24) have attempted to do this by piecing together flight tracks from Project Magnet to simulate a single around-the-world, roughly great circle, magnetic profile. Using F rather than components for reasons of accuracy and completeness, harmonic coefficients in a Fourier series were computed up to the 2000th order. The amplitude of the coefficients dropped off rapidly up to order 7. Beyond the 6th order, the envelope of the coefficients slowly decreased in amplitude to a value of about 1 gamma for the 2000th harmonic. The break above the 6th order coefficient was attributed to the separation of core and crustal sources. The authors noted that roughly 4 million spherical harmonic coefficients would be required to similarly represent crustal anomalies over the entire earth and proceeded to estimate the number of

the negative effect above 1800 km to the influence of external sources in and above the region of measurement, and (2) attribute the negative shift below 800 km to inadequate description of the internal sources with an $n = m = 7$ approximation. In detail the negative behavior between 500 and 800 km comes primarily from effects near-perigee in the regions of southern Australia, noted above, and an area centered on the southwest corner of the U. S. If explanation (2) is correct, it suggests that the estimate made by Alldredge et al. (Reference 24), that $n = m = 10$ should be sufficient for internal sources, may be too low.

WMS SATELLITES: GENERAL CONSIDERATIONS AND THE POGO SYSTEM

Orbit Selection

Orbits will be discussed in terms of optimum orbits for meeting the basic WMS objectives. Thus, highly eccentric orbits and/or circular orbits at great distances primarily intended for magnetospheric studies will be ignored because they provide relatively little information on the detailed form of the field from interior sources. It should, however, be recognized that they have considerable importance in determining the distribution of external field sources. Similarly, considering coverage rather than altitude, orbits of low inclination are certainly not in the optimum category for the WMS.

The desirability of having a highly inclined orbit plane, preferably passing close to the poles, is obvious. The need for latitude coverage comes not only from considering the analysis of satellite data but also from the consideration that surface data are very sparse and difficult to obtain in the high latitude regions—especially in the Southern Hemisphere.

If all magnetic field sources were interior to the earth's surface, the orbit having the lowest possible altitude would be optimum for the WMS. "Lowest possible," however, still means an altitude that would provide adequate lifetime for achieving the desired global coverage. It also means an altitude at which variations in satellite drag are sufficiently small to not introduce significant errors in the determination of the instantaneous location of the satellite at the time of each field measurement.

The question "what is an adequate lifetime and/or coverage?" has two quite different answers, with the choice depending on the importance attached to removing possible effects of diurnal magnetic variations. The first answer either neglects diurnal effects and hopes that they are negligible, or assumes that they can be removed in analysis using independent surface observations in conjunction with a theoretical model for their cause. For this answer, for a polar orbit, we are concerned with the choice of the local time zone of the orbit plane but treat the lifetime solely in terms of the rate of measurement and longitude differences in equatorial crossings to arrive at a measurement grid with some minimum spacing between points. The IUGG manual (Reference 2), for example, suggests a minimum density of readings each 100 km along the orbit and equatorial crossings separated by a maximum of 400 km. Assuming that the orbit period does not have an integral multiple giving 24 hours, which would give equatorial crossings at the same longitudes on successive days, a grid of this density is easily achieved in several weeks. The exact lifetime depends of course on the orbit period and on what portion of the data is considered questionable for mapping because of magnetic

disturbance. The second answer comes closer to perfection by assuming that the diurnal magnetic variations are not negligible and, similarly, that corrections based on theoretical models for their cause may be grossly erroneous. In this case satellite passes through all local time zones are needed and this requires a lifetime of 6 months.

Next, to be optimum, the orbit should have characteristics which simplify the problem of separating internal and external sources. Here we are concerned, relative to existing knowledge, with external sources having worldwide effects such as those of magnetospheric compression by the solar wind and trapped particle drifts and diamagnetism. There is considerable evidence that these external sources contribute at least 20 to 50 gammas, and possibly more, to the average surface field. In global descriptions the external field effects have obviously been hidden in the limitations of past analysis (see page 6), but they will assume importance in future analysis anticipating a factor of 10 improvement. It is apparent that the resolution in separating the terms $(a/r)^{n+1}$ and $(r/a)^n$ in Equation 1 is improved considerably when satellite measurements are available at different altitudes. Thus, Kalinin (Reference 28) suggested that two satellites in circular orbits of different altitudes should be used for the WMS. As noted in the POGO discussion below, a range of altitudes also can be obtained at all latitudes using only one polar satellite, provided the orbit is eccentric. We are then faced with the question of an optimum apogee altitude, assuming that a choice of low perigee has been made in accord with the previous discussion. Ideally, to get maximum resolution in separating sources, we want the apogee altitude below, but approaching close to, the altitude of the lowest altitude external source of significance. Conversely, we do not want an apogee so high that sensitivity to the high order internal terms is lost—particularly if the operating lifetime is shortened by failures. Obviously compromises and assumptions become necessary in picking apogee. For example, from the discussion of Vanguard data in the last section we might assume a maximum apogee of less than 1800 km for staying below significant external sources and less than 800 km for maintaining sensitivity to interior sources of high order. Similarly we might assume that there was merit in staying below the intense regions of the inner radiation belt (i.e., < 1200 km). There is not an obvious select altitude; but there are good reasons for keeping apogee in the range of several hundred kilometers above perigee to altitudes less than 2000 km, and additional arguments for placing apogee below 800 km if the operating life is short compared with the time it takes for perigee and apogee to move roughly 180 degrees in latitude.

Without going into detail it is apparent that analogous problems are encountered in Kalinin's (Reference 28) suggestion of two circular orbits: for example, in picking the altitude of the highest orbit, and in considering the consequences of an early failure in either of the two satellites.

In summary, the above depicts the most favorable single orbit as an orbit with the following characteristics: polar inclination; a minimum lifetime of 6 months; perigee as low as possible subject to the lifetime requirement; and an apogee altitude, less critically defined, but located at least several hundred kilometers above perigee and less than 2000 kilometers altitude. There are various other orbits which could give more definitive results pertaining to isolated WMS objectives, but these could not individually meet the overall objectives as well as the orbit described above. Further improvements can, of course, be obtained by using two or more satellites in orbits selected to complement each other.

The POGO orbit parameters, as currently planned, are: inclination between 82 and 90 degrees, 250 km perigee, 925 km apogee, and an active life that will approach 1 year if there are not critical failures. The fact that these characteristics are favorably matched to the optimum single orbit described previously is partly circumstantial in that the initial selection of altitudes for POGO was primarily the result of other considerations, such as a favorable altitude range for a variety of aeronomy experiments.

Figure 6 illustrates the retrograde motion of perigee in days as a function of latitude and local time for two orbits roughly similar to the orbits planned for POGO. The assumption of satellite injection, or 0 day, at 06 hours is arbitrary. The equivalence to having a low altitude circular orbit, and a number of higher circular orbits, is evident by noting that, within 49 and 58 days respectively for 90 and 80 degree inclinations, perigee has moved over the entire range of north and south latitudes. An additional feature of a noncircular orbit, pertinent to the external source problem, is that measurements are obtained at two altitudes each day with the exceptions of polar regions and times when the apses are at maximum inclination.

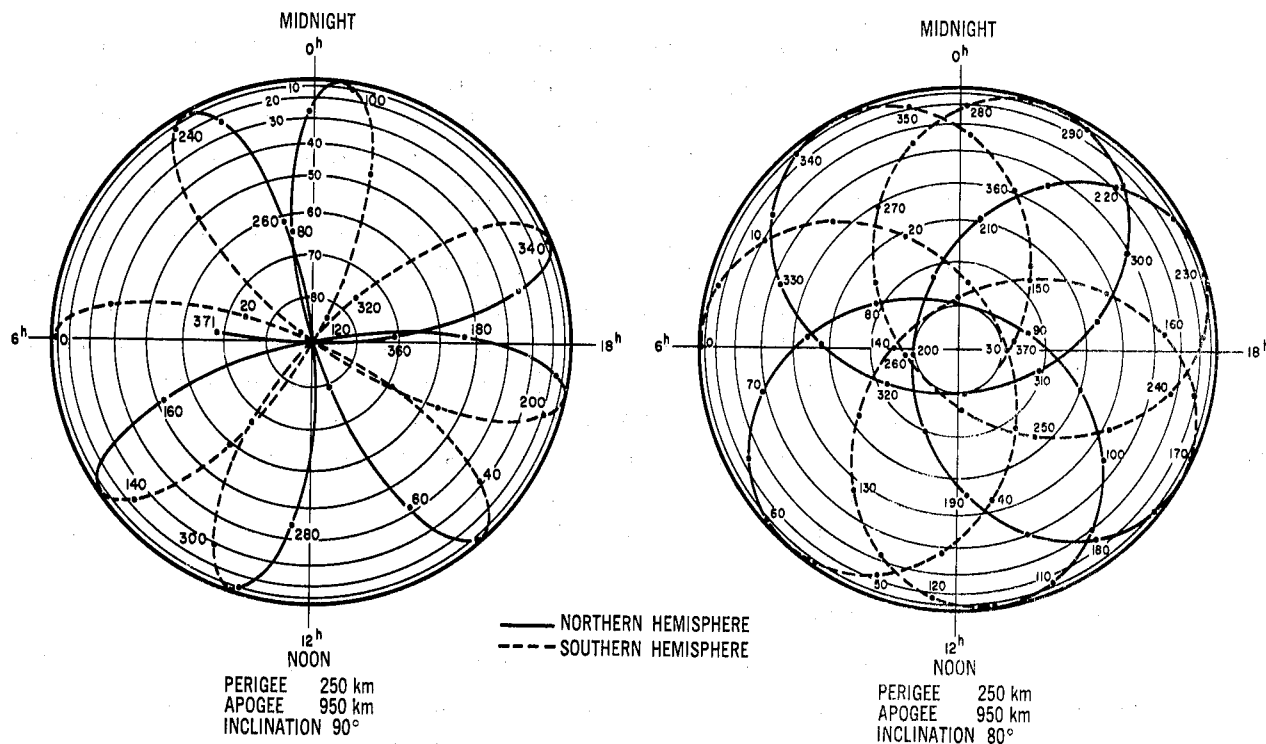

Figure 6—Latitude and local (solar) time of perigee point as a function of days after satellite injection for two orbits similar to the POGO orbit. Local time of injection is arbitrarily taken at 06 hours. Days following injection are noted at 10 or 20 day intervals.

Location Accuracy

Knowing the exact space location (latitude, longitude, and altitude) at the time of each field measurement is one of the most critical problems for the WMS. The instantaneous location of the satellite must be known with errors < 1.0 km horizontally and < 0.25 km vertically to be consistent with the

objective of maintaining maximum field errors from all sources below 10 gammas. This assumes that all other sources of error are small relative to the errors created by the displacement between the true location and the computed location.

Location errors have, in general, been difficult to estimate in an absolute sense because the estimates are usually based on relative agreement between independent determinations. Confidence is developed primarily by finding agreement between determinations employing different types of tracking data. When the satellite also is making absolute magnetic field measurements, there is an additional check on the daily, weekly, or monthly precision of the orbit analysis as illustrated by Heppner et al. (References 29 and 30) for Vanguard III. The critical evaluations of the Vanguard III orbit determinations (see References 20 and 21) illustrate the problem, as they are based on both optical tracking and Minitrack, radio-interferometer tracking and have the additional feature that they were checked against field measurements and subsequently reevaluated a number of times to remove obvious discrepancies. The results show that the WMS objective would not be met using tracking and analysis techniques similar to those of Vanguard III.

An important step toward solving this problem in POGO is the inclusion of a two-way Doppler, range and range rate tracking system to supplement the standard radio-interferometer, Minitrack tracking system. This combination of distance, velocity, and angle measurements is expected to provide the required accuracy. Early flight tests of the range and range rate system have, for example, shown precisions equivalent to maximum errors of several tens of meters. There are, however, other considerations in addition to tracking errors, such as: (1) relative time errors between stations; (2) errors in knowing the exact geodetic location of each station; (3) errors which will vary with satellite location and/or time—coming from inaccuracies in knowing or accounting for small differences in the gravitational acceleration, satellite drag, radiation pressure, and in some systems the propulsion effects of satellite orientation controls; and (4) errors in the methods of analyzing tracking data and computing instantaneous positions over the entire earth when tracking data are available from only a small number of stations. Cumulatively, these considerations cast doubt on any anticipation of maintaining maximum errors well below 10 gammas in a low altitude orbit. Thus, it is likely that location errors will be the limiting factor in the accuracy of the WMS satellite data.

Scalar or Vector Measurement Question

A question which has frequently appeared in discussions of the WMS is whether or not the satellite scalar total intensity measurements will be adequate for obtaining a vector description of the field. As the potential derived from scalar measurements in a source-free region is unique (see, e.g., proof by Jensen, Reference 16), the question is primarily directed toward the computational feasibility. What little experience there is to date does not suggest that the scalar analysis involves inherent difficulties. In fact, the analyses of Jensen and Cain (see page 11) suggest that the question of scalar or vector measurements is not particularly critical. This may, however, be partially a consequence, and perhaps a merit, of the method in that an initial field based on vector information is used as a starting point. Conversely an initial field based on a previous scalar analysis could also serve as a starting point, so this can hardly be considered an essential feature at present. It should, however, be recognized that the fields derived from scalar values have to date only considered internal

sources; and adequate attempts to compare analyses under conditions of external field sources have not been made. Such comparisons would also be relatively meaningless using existing data.

The question is also equivalent to asking whether or not the coefficients derived from the scalar field F will give convergence to a higher, equal, or lower noise level, or magnitude of residuals, than a set of coefficients derived from X , Y , Z , or equivalent angle and component measurements. Thus the question in a practical sense is related to the relative accuracy of scalar and component measurements from a low altitude satellite.

Absolute accuracies of a fraction of a gamma to several gammas, depending on the particular system, are readily achieved with nuclear and atomic resonance magnetometers measuring the scalar intensity. It is more difficult to estimate an accuracy for component measurements because a number of variables have to be considered, such as:

- (1) The accuracy of the magnetometer measuring components or angles,
- (2) The accuracy of knowing the orientation of a coordinate system at the magnetometer relative to the coordinates of the satellite system providing measurements of the satellite orientation, and
- (3) The accuracy of measuring the satellite orientation relative to earth coordinates.

A proper review of item (1), which would consider various possible magnetometer systems many of which are in turn dependent on the type of satellite motion, would be unduly long. The use of fluxgate, or second harmonic saturable core, magnetometers is well known for component airborne measurements (References 9 and 31), for scalar field rocket measurements (References 32 and 33), and for scalar field satellite measurements (References 34, 35, and 36). Although item (3) would not permit useful vector measurements in the rocket and satellite measurements noted above, the system descriptions (especially Reference 36) illustrate many of the problems in past systems. Recently Heppner and Boroson* demonstrated the feasibility of a new technique using fluxgates which is inherently simple in satellite application and is at least as accurate at near-earth field intensities as any fluxgate system known to the writer. Over the field range of the POGO orbit, magnetometer accuracies ranging from 20 to 60 gammas could nominally be expected. To reduce component measurement errors significantly below these figures, it would probably be necessary to use a system involving the application of bias fields to an atomic resonance, optical pumping magnetometer in a manner similar to the method described by Shapiro et al. (Reference 37) for a vector proton magnetometer. The accuracy in a low altitude satellite system would depend on the time interval between successive bias field reversals and on having negligible changes in satellite orientation within these time intervals. The system requirements are not simple, and further elaboration here is not justified in view of the likely errors from items (2) and (3) in satellite systems such as POGO.

Item (2), relating magnetometer coordinates to the coordinates of attitude sensors, is a matter of mechanical rigidity which might not appear to be a fundamental problem. Consider, however, that

*NASA patent disclosure (1962), unpublished.

a factor-of-10 improvement in describing the earth's field requires an angle accuracy of about 0.1 degree (roughly equivalent to component errors of 0 to 50 and 0 to 100 gammas, depending on the component and latitude as noted in the section "Aerial Surveys"). For this accuracy the mechanical rigidity requirement would not be severe in a highly specialized nonmagnetic satellite in which the magnetometer-to-satellite body separation was small. However, with separations requiring long booms, such as the 6 meter booms on POGO, the rigidity problem very definitely becomes fundamental; and making this source of error a fraction of the total 0.1 degree error requires either a mechanical assembly of large weight or an auxiliary orientation sensing system relating the two coordinate systems.

Item (3), measuring the satellite's orientation relative to earth coordinates, presents a major problem. There is not (to the writer's knowledge) any precedent in terms of satellites flown for measuring satellite orientation in all three coordinates with errors < 0.1 degree, especially under conditions that can be related to a polar orbiting satellite passing alternately in and out of the earth's shadow. For three axis data, reference to two bodies is required. Horizon and solar sensing combinations such as those in the OGO satellites (References 38 and 39) can provide measurements with errors less than 2 degrees when sensor error signals are analyzed, but are inherently limited to minimum errors of 0.5 degree by horizon variability. Looking beyond the existing art to future systems there are several possibilities, such as: (1) a satellite similar to the Orbiting Astronomical Observatory (OAO) with active, star-tracking pointing control but modified to include accurate optical measurements in the roll plane, and (2) spin stable satellites designed for negligible torque influences over several orbits and utilizing optical sensors having sharp resolution in recognizing the edge of the solar disk and a particular wavelength at the earth's horizon.

The additive nature of errors makes each of the problems noted above more severe than indicated. Solutions are in principle feasible in terms of known technological capabilities, but in practice the extensive effort required to achieve vector accuracy has to be weighed against what is more easily achieved with scalar measurements. Thus, when it is not obvious that vector measurements of 100 gamma accuracy possess advantages over scalar measurements accurate to several gammas, the extensive effort does not appear justified. There is not, however, an ideal substitute for direct vector measurement; and ultimately such measurements will be needed for confirmation and further refinements. Vector measurements in low orbits are also needed for studies of various field variations. Thus, efforts to obtain vector measurements of high accuracy can be expected in the future.

Magnetometers

The characteristics of optical pumping magnetometers make them particularly well suited for the WMS satellite requirements for accuracy and in-flight data storage between command readouts. To illustrate this preference for optical pumping magnetometers, it is instructive to note the principal limitations of other types. Saturable core, second-harmonic magnetometers cannot be expected to meet the accuracy requirements for scalar measurements, and their use for vector measurements would be very limited in satellites not having an appropriate direction reference system—as discussed in the previous section. Similarly, Hall generator and spinning coil magnetometers do not have sufficient accuracy. Proton precession, nuclear-resonance magnetometers of the free precession

type, $f_p(\text{cps}) = 4257.6(F)$, with F in gauss, used in Vanguard III have the necessary absolute accuracy; but difficult operational problems occur in data storage as a consequence of the low signal-to-noise ratio when a wide range of field intensities is to be measured. Solutions involve having either: (1) a high-Q selective filter that automatically adjusts to the precession frequency such that in-flight frequency measurements can be made relative to a higher frequency oscillator (see Reference 40 for an example) or (2) in-flight direct storage of the precession signal on magnetic tape for command playback. Technique (2) involves wasteful use of a high-speed tape recorder which also must record a standard frequency signal such as 10 or 100 kc to achieve accuracy independent of variations in tape speed. Other disadvantages include: low information content per unit of power, and susceptibility to audio noise frequencies from spacecraft sources and natural whistlers and VLF emissions.

The magnetometers noted above have known operational characteristics that permit evaluation. There are other types of magnetometers to consider that fall in the category of being potentially suitable for the WMS but whose state of development does not permit use in the earliest WMS satellites. One example is the nuclear resonance, "maser" magnetometer described by Abragam et al. (Reference 41), which utilizes the Overhauser effect between the magnetic moment of an electron carried by a free radical and the magnetic moment of a proton to produce a continuous signal at the Larmor frequency of the proton, $f_p = 4257.6(F)$. The advantages relative to proton free precession, of greater signal strength and lower power input, remove some of the operational difficulties in using proton magnetometers. A problem which has been critical, at least in the past, is obtaining samples in which the free radical lifetime permits operation for long periods of time. Another example, which shows promise as a result of observations of the electron gyrofrequency by the Topside Sounder satellite, is a magnetometer based on phase-locking a transmitter either to signals received at a harmonic of the electron gyrofrequency or to a transmitting antenna impedance characteristic occurring at a harmonic of the gyrofrequency. The locked transmitter frequency, $f(\text{cps}) = N(2.8 \times 10^6)F$, with F in gauss and N designating the harmonic, can potentially provide an extremely sensitive field measurement in regions of strong magnetic fields and high electron densities like those occurring along the POGO orbit.

Returning to the subject of optical pumping, atomic-resonance magnetometers there are two types to consider: metastable helium, and alkali vapor. Of the various alkalis (Li, Na, K, Rb, Cs), rubidium and cesium are the most favorable from the standpoint of the operating temperature and the resonant line width for all m levels. Within the United States developments have concentrated on rubidium. The Rb-vapor magnetometer to be flown on the first POGO satellite for the WMS is discussed in the next section. As metastable helium magnetometers may be used in future magnetic survey satellites, a brief discussion is appropriate.

Figure 7 is a photograph of a prototype metastable helium magnetometer developed for the Goddard Space Flight Center by Texas Instruments, Inc. Three absorption cells, each with a circular polarizer, infrared detector, sweep coil, and cell exciting winding, are located along three orthogonal axes extending radially from a helium lamp which is driven by a 50 Mc RF oscillator following ignition by a high voltage. A preamplifier, to drive signals over a long boom cable, is located at the base of the lamp-sensor assembly. The lamp-sensor assembly is designed to fit in the same spherical enclosure on the POGO boom as the Rb-vapor lamp-sensor assembly discussed in the next section.

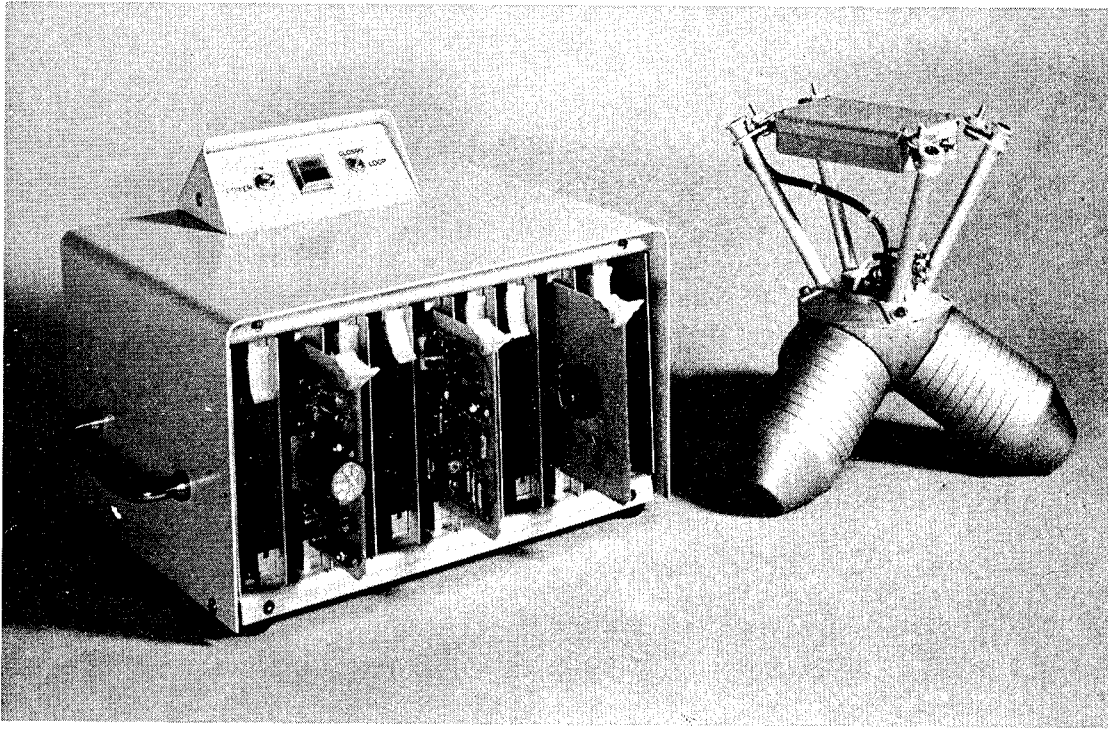

Figure 7—Prototype of a three axis, omnidirectional metastable helium magnetometer.

Electronic units consisting of the RF power oscillator, ignition circuits, amplifiers, servo sweep oscillator and phase lock circuits, and voltage controlled oscillator are located in the box shown. As demonstrated initially by Franken and Colegrove (Reference 42), the Zeeman splitting (Larmor frequency separation) of a helium metastable energy level is such that the absorption of helium light near 10,830A occurs at different rates in the various Zeeman, m , levels. Application of a weak magnetic field at the Larmor frequency, approximately 28 cps/gamma (2.8 Mc/gauss), produces a redistribution of electron populations in the Zeeman levels, and light is absorbed at this resonant frequency. Helium atoms in the metastable state are continually provided by maintaining a weak discharge in the absorption cell. In an operational magnetometer an electronic servo technique, employing a sweep oscillator and phase detection, is used such that the frequency of a voltage controlled oscillator is continuously locked to the Larmor frequency. The oscillator output frequency thus provides the measurement of scalar magnetic field intensity. Orientation effects on the field value are small, about 2 gammas with 180 degree field reversal, but require compensation for high accuracy. Signal amplitude varies approximately as $\cos^2 \theta$ where θ is the angle between the optical axis and the magnetic field. This necessitates the use of three optical axes, Figure 7, and signal mixing in an instrument that is to provide measurements in all orientations.

Assessment of the relative advantages and disadvantages of metastable helium and rubidium vapor magnetometers is not intended here. It is obvious that the servo systems currently required in helium magnetometers, because of the frequency limitations of available infrared detectors, lead to a more complex electronic system than self-oscillating Rb-vapor magnetometers. On the other

hand, the wider temperature range for operation of a helium magnetometer without thermal control is a distinct advantage of the helium magnetometer. Similar considerations applied to weight, power consumption, susceptibility to errors, signal-to-noise ratio, reliability, etc. appear with advantages and disadvantages in each type. The most important single factor in selecting a Rb-vapor magnetometer for the first POGO satellite was the state of knowledge regarding operating characteristics in a space environment within spacecraft restraints.

POGO Magnetic Field Instrumentation

Descriptions of the series of satellites designated Orbiting Geophysical Observatories (OGO), which include the Eccentric Orbiting Geophysical Observatory (EGO) and the Polar Orbiting Geophysical Observatory (POGO), have been published by Scull and Ludwig (Reference 39) and Ludwig (Reference 38). These descriptions should be consulted for details involving the spacecraft system.

Both the EGO and POGO satellites carry Rb-vapor magnetometers with the lamp-sensor assembly enclosed in a 33-cm sphere at the end of a boom extending 6.6 meters from the main body of the spacecraft. The external appearance of the EGO and POGO units is similar, with the exception that the EGO sphere includes bias field windings and also carries a three-axis fluxgate magnetometer located about 2 meters closer to the spacecraft. Figure 8, a photograph of the prototype of the EGO

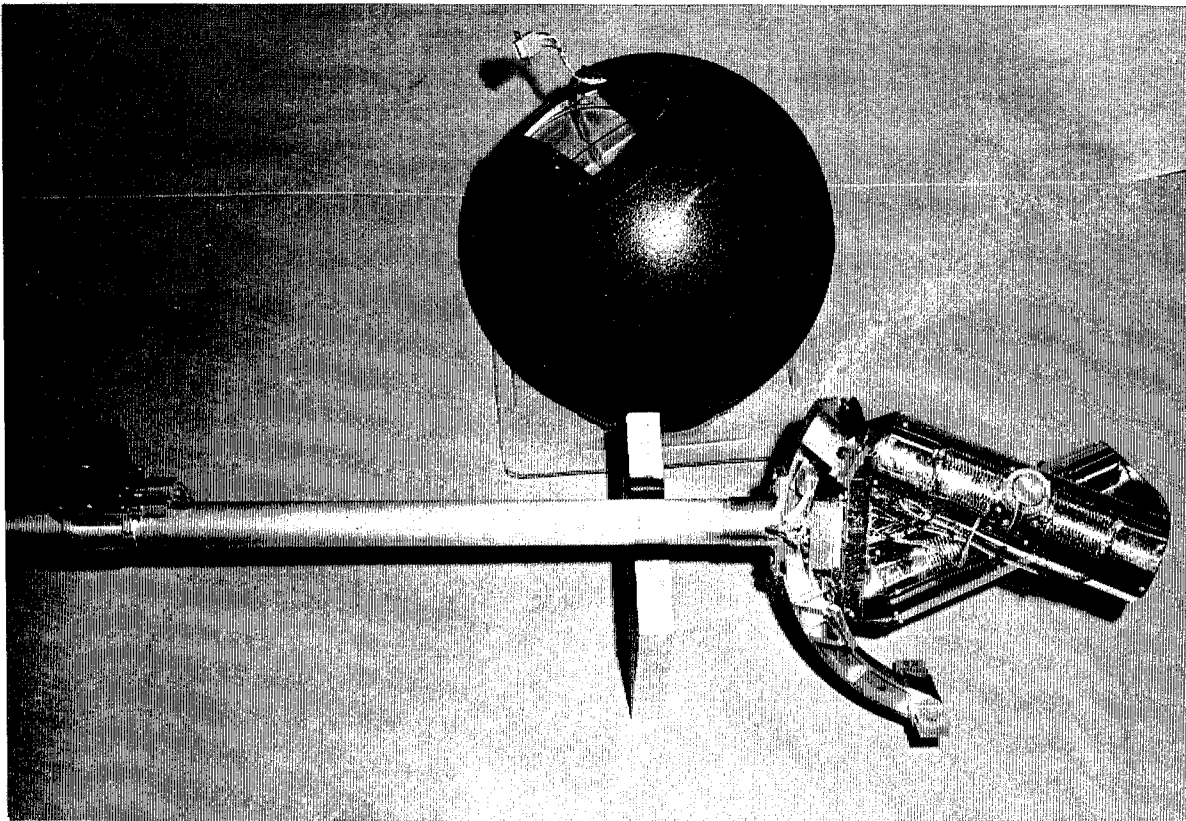

Figure 8—Prototype of an EGO boom-mounted rubidium-vapor magnetometer consisting of two double-gas-cell units. RF oscillators for lamp excitation are located at the boom to the left. The 33-cm enclosing sphere is shown removed.

unit, is thus also representative of the POGO unit. The block diagram in Figure 9 illustrates the principal electronic units of the POGO magnetic field instrumentation.

The Rb-vapor magnetometer consists of two, self-oscillating, double-gas-cell magnetometers individually similar to the type flown in Explorer X (1961 κ), References 43 and 44. The use of two units, placed in a crossed configuration as illustrated in Figures 8 and 9, greatly reduces the size of zones of field orientation where the signal-to-noise ratio is low. For each unit, signal amplitude is approximately proportional to $\sin 2\theta$, where θ is the angle between the field vector and the optical axis. This gives two regions of low amplitude: a conical region centered on the optical axis ($\theta = 0^\circ$), and a zone centered on a plane perpendicular to the optical axis ($\theta = 90^\circ$). Thus, using two such units in an "X" configuration eliminates all orientations of low amplitude except where the two $\theta = 90^\circ$ zones intersect to form two rhombic regions. The angle between the two optical axis is 55 degrees in the case of POGO. For nominal performance the size of these regions, determined by the signal-to-noise ratio for reliable frequency counting, is about 500 square degrees each, or in total about 2.5 percent of the total spherical solid angle. The 2.5-percent-loss region could, of course, be eliminated using a third optical axis; but the complexity is not merited using double-cell units. The use of three single cells, as described for helium in the previous section, is ruled out at the field intensities along the orbits of POGO for reasons of orientation errors, as noted below.

The Larmor frequencies for the rubidium-85 and -87 isotopes in a single-gas-cell, self-oscillating magnetometer are given by

$$f(\text{cps}) = 466744(F) \pm (K) 359 F^2 \text{ for RB-85}$$

and

$$f(\text{cps}) = 699585(F) \pm (K) 216 F^2 \text{ for RB-87}$$

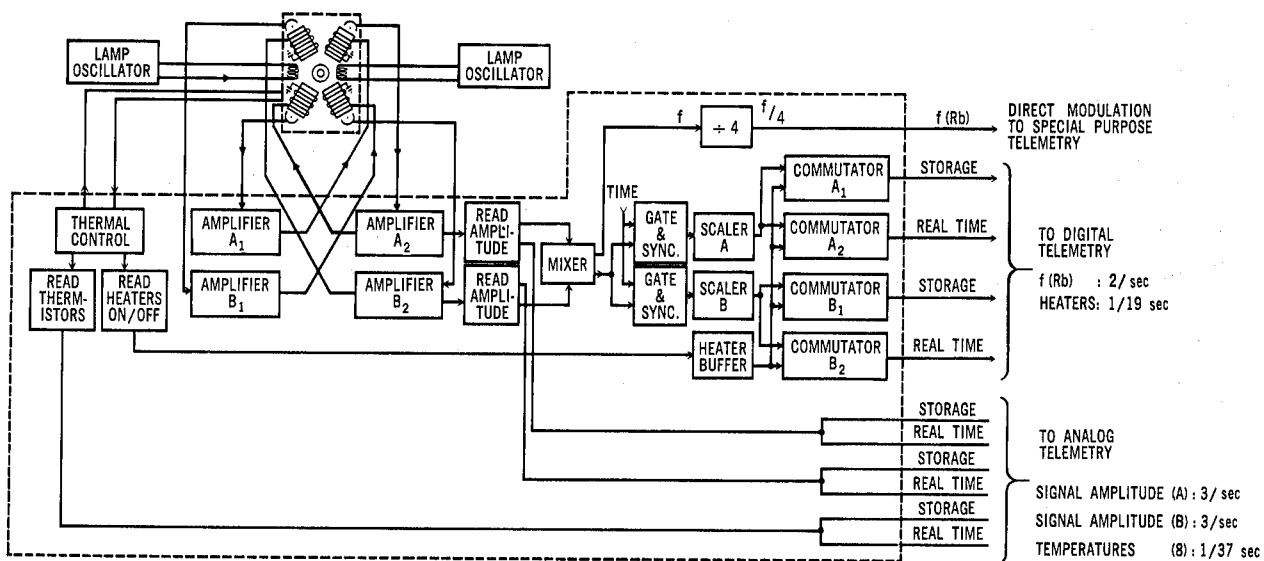

Figure 9—Functional block diagram of instrumentation for POGO magnetic field experiment.

where F is in gauss, and K , usually < 0.4 , indicates the fraction of the constant with the squared term that appears in a given instrument. As the F^2 dependence comes from the relative electron populations in the various m levels, which in turn depends on the field orientation relative to the optical axis, it is symmetrically + and - with respect to 180 degree field reversal. Thus by use of the double-gas-cell arrangement the F^2 dependence is eliminated and the field measurement is independent of orientation (see References 44 and 45 for further details). The choice of isotope, 85 or 87, is not critical. Rubidium-85 will probably be used on the first POGO for reasons of signal-to-noise as limited by the high frequency response of the silicon cell light detectors in fields approaching 0.65 gauss.

To decrease the probability of a single failure causing a total loss of data, the design is oriented toward achieving redundancy within the restrictions of weight and power. Thus (see Figure 9), a separate lamp is used in each unit rather than using one lamp for each optical axis; scaling circuits and the commutator circuits through which the count is shifted to the spacecraft data storage and telemetry system are paralleled such that the frequency is counted by alternate scalars each 1/2 second (this also serves as a check against any malfunction in the counting circuit that would give an incorrect reading); separate power converters, whose supplies can be individually turned on and off by ground command, are used for magnetometer units A and B and scaling lines A and B; thermal controls for A and B units are similarly separate and supplied power from the corresponding magnetometer power source. As shown in Figure 9, the outputs of units A and B are mixed before entering the scaling circuits; this choice, rather than treating the two outputs separately, is made primarily to reduce the amount of data editing that would result from one of the two units frequently being in an orientation of low signal amplitude. The redundant features noted above have two primary consequences: (1) A failure in one of the magnetometer units will still permit data coverage of the type available from a unit with one optical axis when the faulty unit is turned off, and (2) a failure in one of the scalar commutator units will reduce the number of measurements from 2 per second to 1 per second. There are, however, some types of single failures that can cause complete loss of data, both within the experiment and in the interface connections between the spacecraft and the experiment. Thus, the design is not completely redundant.

As indicated in Figure 9, temperatures in the lamp-sensor assembly, the duty cycle of heater controls, and signal amplitudes are also telemetered. These functions provide information that permits detection of a malfunction in either unit which may be correctable in some cases by turning power on and off by ground command.

Digital and analog outputs are stored for playback to ground stations and also readout in real time by the spacecraft system when in line of sight of ground stations (References 38 and 39). In addition, the Larmor frequency, $f = 466744(F)$, is divided by 4, to fall within a 100 kc modulation limit, and is fed directly to the Special Purpose Telemetry transmitter, where it is transmitted continuously along with four subcarrier signals from other experiments. The primary purpose of this signal is to permit studies of field fluctuations at frequencies > 1 cps over receiving station sites. It also serves as a check on the correctness of the digital system through all phases: experiment, spacecraft, and surface equipment.

The sphere enclosing the lamp-sensor assembly has a black surface over all areas exposed to the sun such that its radiation properties are predictable and not subject to change through surface contamination. Aluminum coatings are used on the surfaces of the lamp-sensor assembly to minimize radiation losses from the lamp and heater circuits. Active thermal control is achieved by having the passive, uncontrolled temperature on the low side of the nominal 30° to 55°C operating range for the gas cells and then adding heat. Heat is added using bifilar, nonmagnetic circuits controlled by thermistor readings to several degrees Centigrade at the center of the temperature range. Heater windings are inside the cylinders shown in Figure 8; the winding that appears on the outer surface of the cylinders is in series opposition to the Larmor frequency feedback coil and serves to keep the feedback field from one magnetometer from appearing in the other magnetometer.

Power required for the instrumentation, including conversion losses from the 28 ±5 volt spacecraft supply, is 6 watts with an additional 2 watts required for thermal control. The weight of the lamp-sensor assembly is 2.5 pounds. The instrumentation within the spacecraft body, including power converters and containers, weighs less than 10 pounds.

WMS DATA REDUCTION AND ANALYSIS

Handling of Raw Data

The POGO magnetic field survey is to yield two field measurements per second throughout the active life of the experiment and spacecraft instrumentation. This amounts to approximately 10⁶ measurements per week, or 3 × 10⁷ measurements in 6 months. The processing and transfer of this information from receiving station tape recordings to a computer tape suitable for analysis (See Figure 10) is a major undertaking. However, in terms of the complete POGO system this magnetic

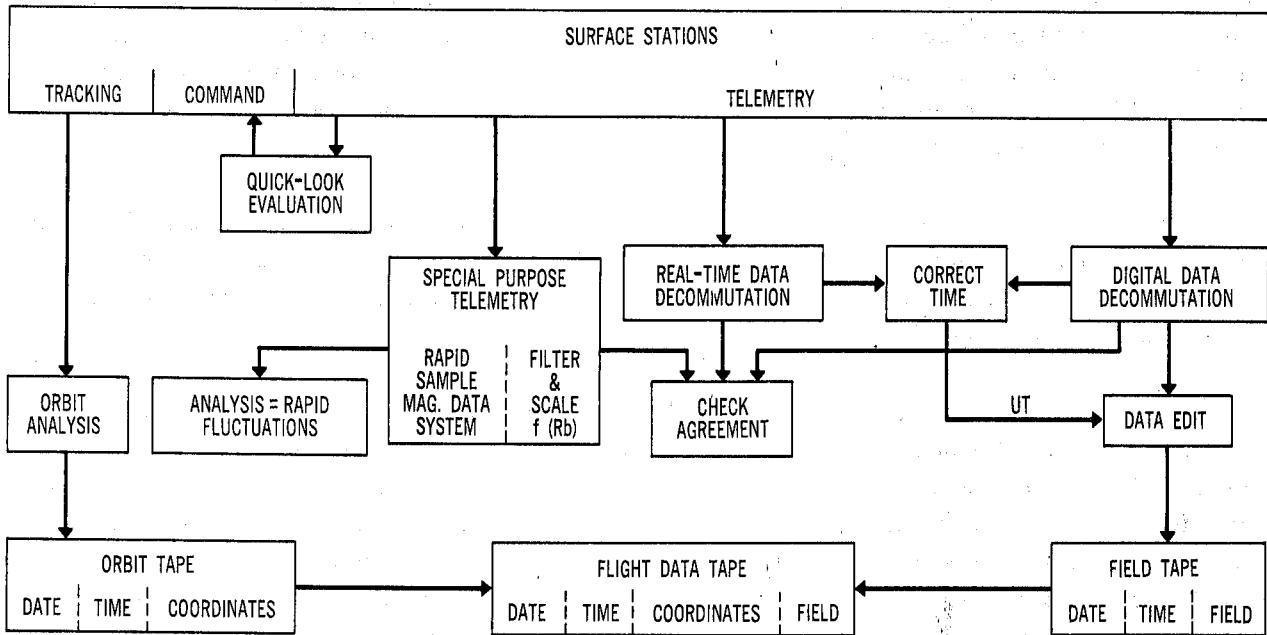

Figure 10—Reduction of POGO magnetic field data from telemetry tape.

field information constitutes less than 4 percent of the telemetered experimental data; and, with the auxiliary information (See Figure 9 and previous section) on signal amplitude, heater cycles, and temperatures included, the total for the experiment is less than 6 percent. With the exception of the signal transmitted via the Special Purpose Telemetry the information is digital and the processing is largely a tape-handling and computer operation problem. Signals received from Special Purpose Telemetry are processed in a system particularly designed for reducing data from optical pumping magnetometers. Unlike the spacecraft digital system, whose measurements are set at twice per second with a precision of ± 2 cps in 466744 (F) cps by the technique of direct frequency counting, sample periods in this system can be set in 0.001 second increments from 0.001 second to 10 seconds; and the technique of gating a 5 Mc reference frequency gives a theoretical precision of ± 1 part in 5×10^6 (Δt), where Δt is the set sample interval (e.g., ± 0.1 gamma in a 0.5 gauss field with $\Delta t = 0.1$ second). This provides a more than adequate check on the spacecraft digital system, but its principal use for POGO data is in studying rapid field fluctuations.

Inasmuch as analysis of the satellite data is dependent on knowing the temporal behavior of the field as recorded by surface magnetic observatories, the observatory records, which are generally in the form of 24-hour analog traces of D, H, and Z or X, Y, and Z, must also be processed to place the data in a form suitable for analysis with computers [See Figure 11(a)]. The task of converting the analog records to digital form is not particularly formidable using modern equipment, but the additional attention required in checking baselines, scale values, reproducing records, verifying scalings, etc. makes it desirable to use a selected set of observatories rather than all existing

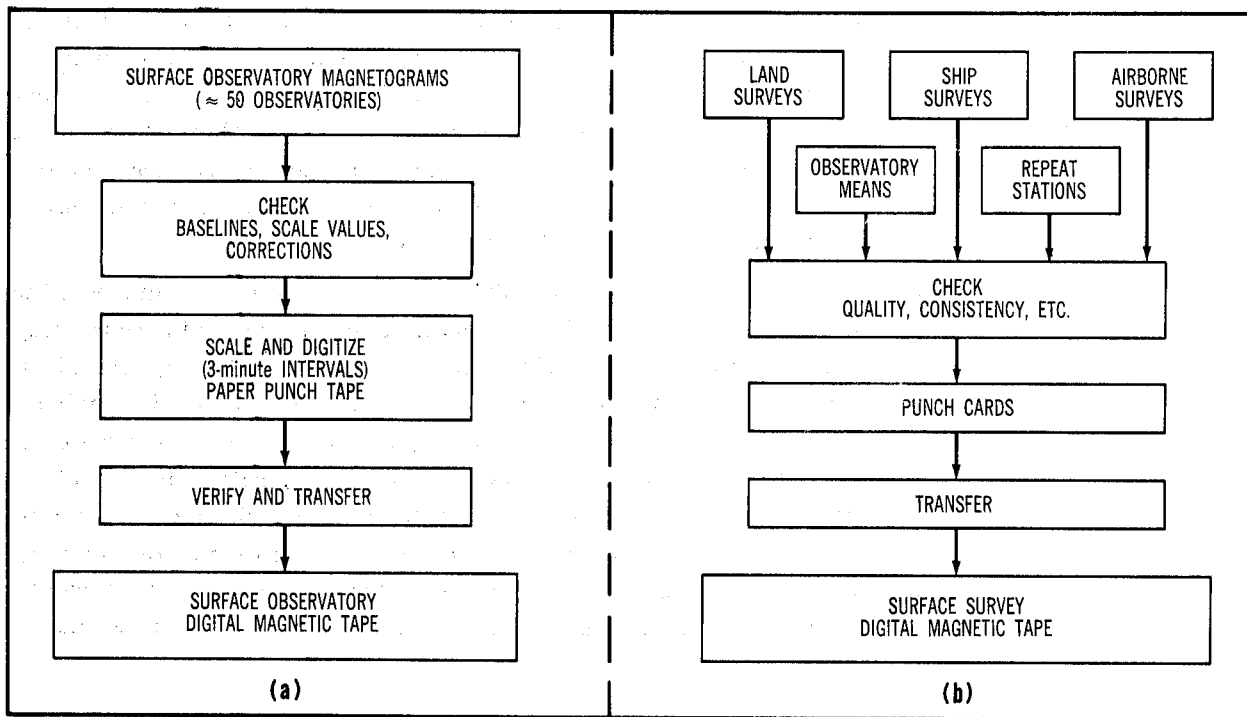

Figure 11—Processing of surface magnetic field recordings and tabulated data.

observatories. Factors such as the locations of observatories and the time-space scale of equatorial and high latitude magnetic phenomena do not, however, permit selection of an ideal minimum number of observatories. Preliminary planning suggests that approximately 50 existing observatories will provide a distribution that could not be greatly improved without establishing new observatories in the large regions of the globe currently not represented. Selecting a time interval between digital readings of observatory magnetograms presents additional questions for which there are not strict answers. The interval of 3 minutes, noted on Figure 11(a), has been tentatively selected on the basis that it is sufficiently short to reveal most of the level changes evident on magnetograms with recording speeds of 15 or 20 mm/hr.

Utilization of surface survey data as an integral part of the analysis is also dependent on having the data in computer input form. As originally recorded, most of the data from past and present surveys is in analog or tabulated form. In some cases the organization conducting the survey converts the recordings to a digital form such as punch cards. Efficient handling of the data from diverse sources is, however, dependent on having all the information in a common format. Within the United States a joint effort is being made by the Coast and Geodetic Survey and the Goddard Space Flight Center to compile all available survey data as illustrated in Figure 11(b). These organizations, with the cooperation of the U. S. National Science Foundation, are also planning the reduction of magnetograms illustrated in Figure 11(a).

Analysis Procedures

The direct application of techniques previously used in field fitting* to quantities of 10^6 to 10^8 measurements would not be practical even by making simplifying assumptions, such as neglecting external sources and diurnal effects. When external terms are included—as they must be to get a valid description—and/or coefficients of $m = n > 6$ or 10 appear probable (see page 14), the computation effort assumes enormous proportions in terms of computer time per coefficient. Solutions to this forthcoming problem are currently being sought along two general lines: examining how the quantity of data can be most effectively reduced with minimum loss of information, and examining alternative analysis techniques and the associated computation problems.

There are, of course, obvious ways of reducing the quantity of data, such as merely disregarding all but a small fraction of the measurements. This is hardly ideal, however, and the throwing away of data points is best done, if necessary, after first applying a selection technique having some physical basis. Various techniques of simple averaging or smoothing of data, such as applied to airborne data, are likely to increase rather than decrease errors, as a consequence of the 4 km separation of 1/2 second data points. One analytical approach that would serve the same function as smoothing, but is potentially more convenient in analysis, would be to represent the data along each orbit by means of a Fourier series and then reconstruct a data grid for the spherical analysis from the various Fourier series. In this and similar techniques it is essential that the time of measurement be preserved in the reduction technique such that diurnal and disturbance effects can be analyzed and removed.

*See section titled "Existing Magnetic Field Descriptions."

The most logical approach to reducing the quantity of data for main field analysis is, in the author's opinion, one in which the data are subdivided such that: (1) measurements significantly affected by magnetic disturbances do not appear in the main field analysis, and (2) measurements are grouped according to local (solar) time such that diurnal effects can be readily recognized. When measurements are taken over periods exceeding several months, a third grouping based on the dates of measurement becomes desirable for recognizing secular changes. Subdividing the data in this manner has additional advantages in facilitating studies directed toward understanding the source and cause of the field variations.

The flow diagram in Figure 12 illustrates one method of approaching the data that fits the above criteria and makes use of the motion of the orbit plane with time to reveal diurnal effects. The diagram is self-explanatory, but several steps require comment. The selection of "quiet periods" is based on surface observatory data as indicated in Figure 13. The selection, involving visual, range, and level criteria, is roughly analogous to using K_p indices along with a D_{st} (or D_0 as used here) analysis to avoid including storm recovery periods. A minimum quiet period (λ_i in Figure 12) of 24 consecutive hours is essential to obtain 360 degree longitude coverage in the two local time zones sampled each orbit. Long quiet periods (e.g., more than 2 days) improve the density with longitude

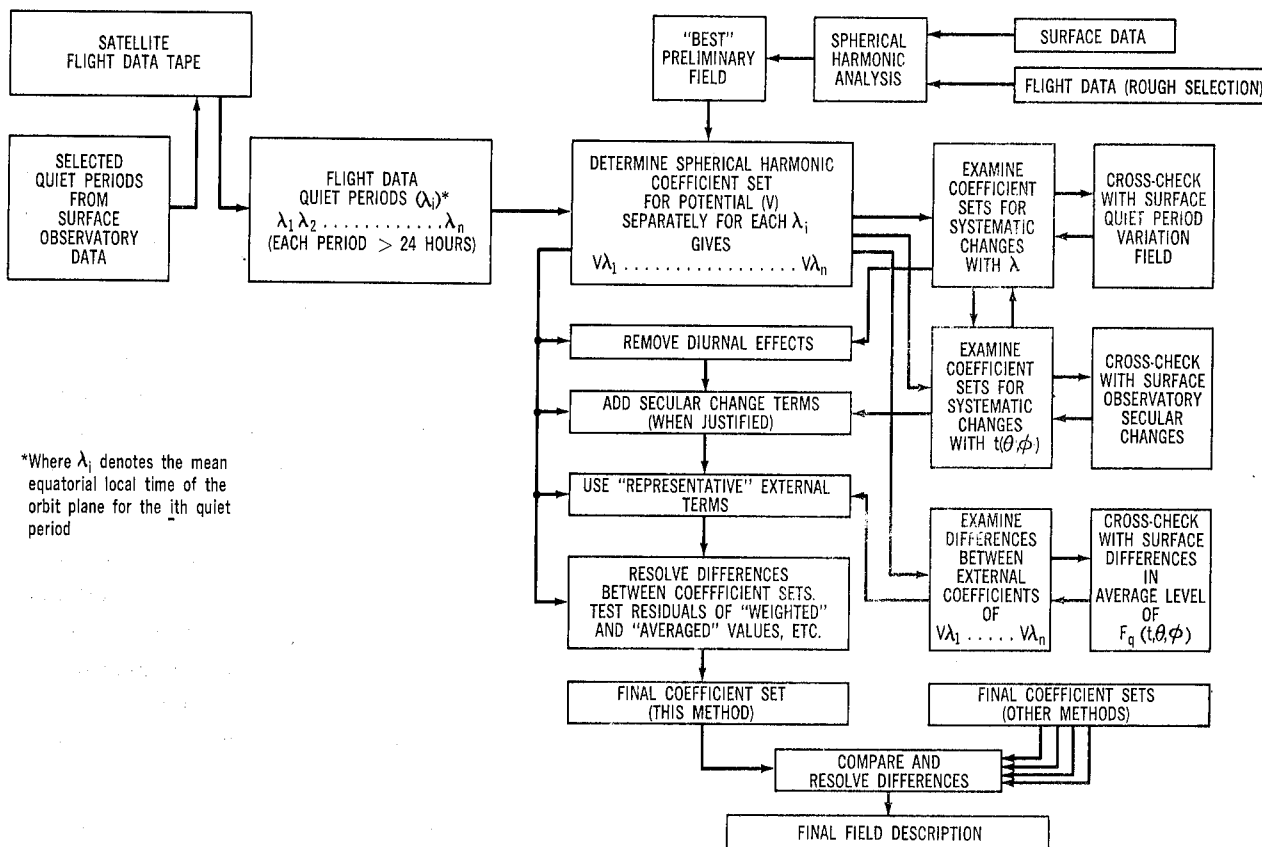

Figure 12—Functional diagram illustrating steps involved in one method of arriving at field coefficients not contaminated by diurnal, disturbance, and secular effects.

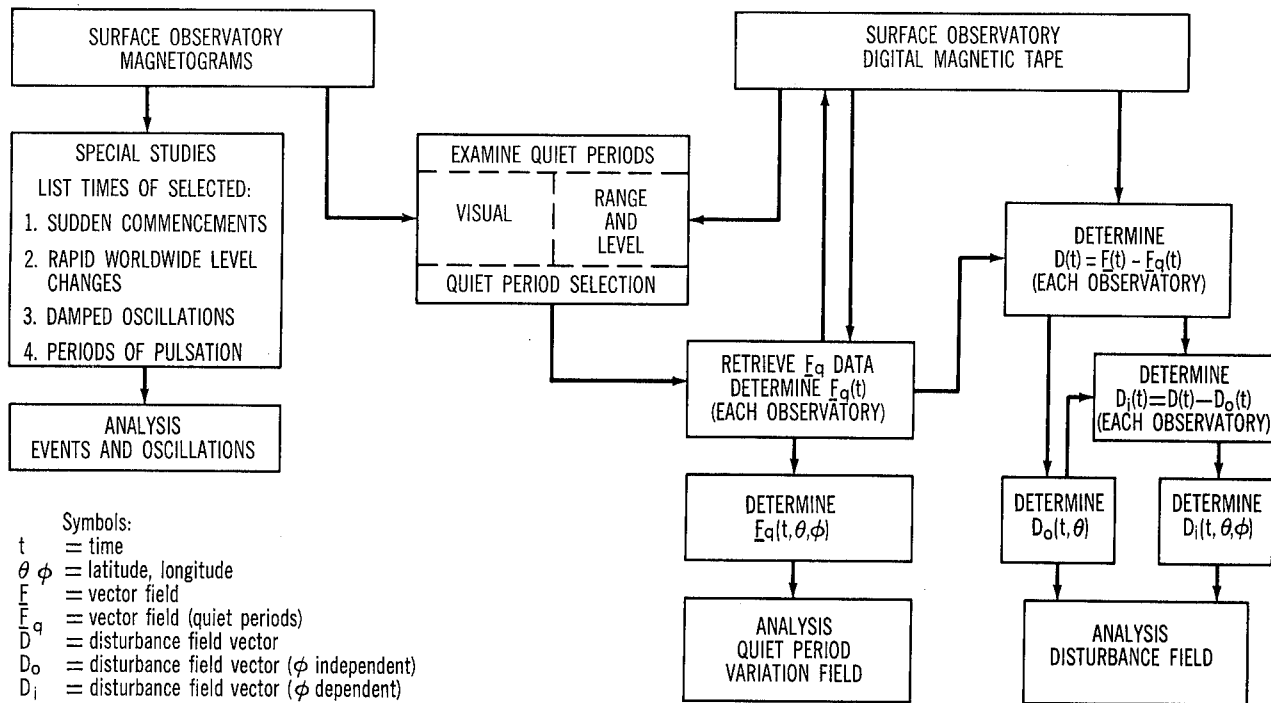

Figure 13—Routine steps in analysis of surface observatory data.

near the equator, where density is needed, but also present a greater computation problem. At this point it will be desirable to make a second selection of the data (not shown), in which measurements taken at high latitudes during polar and auroral zone disturbances are thrown out. This is the logical place to reduce the quantity of data from both the standpoint of density per unit area and disturbance effects. If the number of measurements after these steps is still too great for computation efficiency, successive selections based on eliminating successively smaller disturbance effects can be applied. A very rough estimate of the number of suitable quiet periods that might be expected is 2 to 6 such periods each month with durations ranging from 1 to 5 days. Thus, when analyzed separately (Figure 12), it can be anticipated that a spherical harmonic description would be obtained for approximately each hour of local (solar) time after 6 months as a consequence of the orbit plane (90° inclination) moving 1 degree/day in local time.

The motion of the orbit plane with time, which makes λ_1 equivalent to time, presents a dilemma in separating diurnal and secular effects. As the magnitude of secular change will over 6 months be equivalent to diurnal magnitudes in many regions of the earth, magnitude alone will not permit separation. Space will not permit full discussion here, but it should be apparent that this separation will be dependent on analysis of secular change patterns at the earth's surface unless assumptions regarding the source of the diurnal variations are inserted in the analysis. Ideally, we would prefer not to include such assumptions.

The difficulty and accuracy of resolving the differences between coefficient sets after removing the systematic changes depends on the magnitude of the nonsystematic changes. In the case of external terms the observatory data on small level changes provide additional criteria. For the

internal terms the differences may be extremely small, in which case weighting and averaging according to some criteria such as mean residuals may be adequate. If the differences between sets are large, the method has obviously failed.

Failure to achieve an accurate description is not likely if all the desired instrumental, spacecraft, and orbit criteria are met unless an invalid assumption is inherent in the method. The assumption of this type likely to cause the most trouble is the assumption that the region of measurement is free of field sources. Over the POGO altitude range, 250 to 925 km, this would appear to be a good assumption in terms of present knowledge; but this knowledge is very incomplete, especially with regard to diamagnetic contributions at magnetic latitudes > 45 degrees. If it is found that the assumption of no significant sources in the region of measurement during quiet periods is not valid, modifications in the analysis procedures will be necessary.

It has also been assumed that spherical harmonic analysis is the best method for achieving the field description. There are very few examples in past works involving the direct use of the equivalent multiple dipoles or surface integrals. McNish (Reference 46) and Lowes and Runcorn (Reference 47) have, for example, used graphical methods to locate a number of dipoles for fitting the main and secular change fields. Graphical methods are not applicable where large quantities of data are involved, but the direct use of multiple dipoles is not necessarily out of the question. If efficient computation techniques for analytically adjusting the dipole locations and moments are devised, there are possibly other computational advantages as noted by Jensen (Reference 16). The total problem, including external sources, apparently has not even been approached by these methods.

POGO MEASUREMENTS OF TEMPORAL VARIATIONS

Magnetic variations of diurnal and disturbance character have been treated as undesirable noise in their relation to the topic of this review. Their study is, however, an important part of the POGO experiment, which should not go unmentioned. A review of the variety of field variations to be encountered in a low altitude orbit of 90 degree inclination is too large a subject to tackle here. A list of topics would include studies of: (1) the latitude-longitude distribution of the equatorial electrojet, and related questions regarding the closure of the electrojet circuit and whether or not the non-equatorial S_q system is truly located in the E-region of the ionosphere; (2) the ionospheric or non-ionospheric source for the middle latitude field disturbances apparently associated with activity in the auroral zone, and usually referred to as the SD and DS fields in harmonic representations (see Sugiura and Chapman, Reference 48); (3) the distribution of disturbance effects in auroral and polar cap regions; (4) the magnitude of diamagnetic effects associated with particle influx in auroral regions, and questions regarding the existence of currents along field lines and the closure of auroral electrojet circuits; and (5) the ionospheric attenuation and induction effects on hydromagnetic waves and transients as revealed by surface and satellite comparisons, etc. The analysis of surface observatory records for comparison with the field deviations seen at the satellite is an essential part of these studies. Figure 13 outlines some of the routine steps in expediting the surface analysis.

The POGO measurements, because they are scalar and not vector, are not ideally suited for some of these problems. They will nevertheless give a vast amount of information on causes of

magnetic disturbance that is not otherwise available—particularly with regard to localized effects and ionospheric currents which cannot be studied with higher altitude satellites.*

SECULAR CHANGE AND FUTURE SURVEYS

The fact that the earth's magnetic field slowly changes in form and intensity has been recognized for several centuries, and in very recent years there has been general acceptance of the belief that these changes have a hydromagnetic origin in the earth's fluid core (References 26 and 49). The attempts of various hydromagnetic theories to explain the surface patterns of secular change have given additional impetus to obtaining more accurate descriptions of these patterns. The principal impetus has come from requirements for updating magnetic charts in regions where recent measurements do not exist. For this purpose and for illustrating the patterns of change, charts showing contours of equal annual change (called *isoporics charts*) are constructed for each of the field elements (X, Y, and Z or D, H, and Z) and the total field (See Reference 4 for a description of procedures).

The sparsity of observatories and repeat stations makes the construction of isoporics charts highly subjective over large areas of the earth's surface. Thus isoporics charts, such as Figure 14, should not be expected to be correct in detail. Although there is reason for skepticism in using isoporics charts in many regions of the earth, there has nevertheless been fair agreement in various analysis with regard to the major patterns and the movements of these patterns (especially the westward drift of the eccentric dipole) over the past 50 years (References 4, 50, 51, and 52).

Analyses are also consistent in finding that the dipole moment of the earth has in recent years been decreasing with time. The rates given by Nagata and Syono (Reference 51) for 1955 to 1960 based on a spherical harmonic analysis of dX/dt , dY/dt , and dZ/dt are typical. These are: (1) the eccentric dipole moment is decreasing by 4.4×10^{22} emu/yr (total moment 8.05×10^{25} emu); (2) the eccentric dipole is drifting westwards by 0.3 degree/yr, northward by 0.2 degree/yr, and outwards by 3.4×10^{-4} earth radii/yr; and (3) other harmonics are drifting mostly westward and also at rates of several tenths of a degree per year.

Nagata and Syono (Reference 51) and Nagata and Rikitake (Reference 53) also point out that very intense foci appear in the isopors in the region of Antarctica with changes reaching 200 gammas/year in dZ/dt . Mansurov (Reference 54) also has discussed the behavior in Antarctica, noted that change in the sign of dZ/dt at other locations as well is not rare, and states that superimposed periodicities of about 2 years were evident in Antarctica. The latter feature previously noted by Kalinin (Reference 55) in other regions was attributed to the influence of external sources. Orlov (Reference 56) has emphasized the need for examining solar activity effects in secular change studies.

From the magnitudes quoted above and inspection of isoporics charts such as Figure 14, it is apparent that the POGO satellite measurements over periods of 6 months to 1 year will be influenced by average values of secular change. In regions such as those south of S. America and S. Africa (Figure 14) and Antarctica the rates are such that they will not only be an influence but also should

*See section "Surveys of the Outer Magnetosphere."

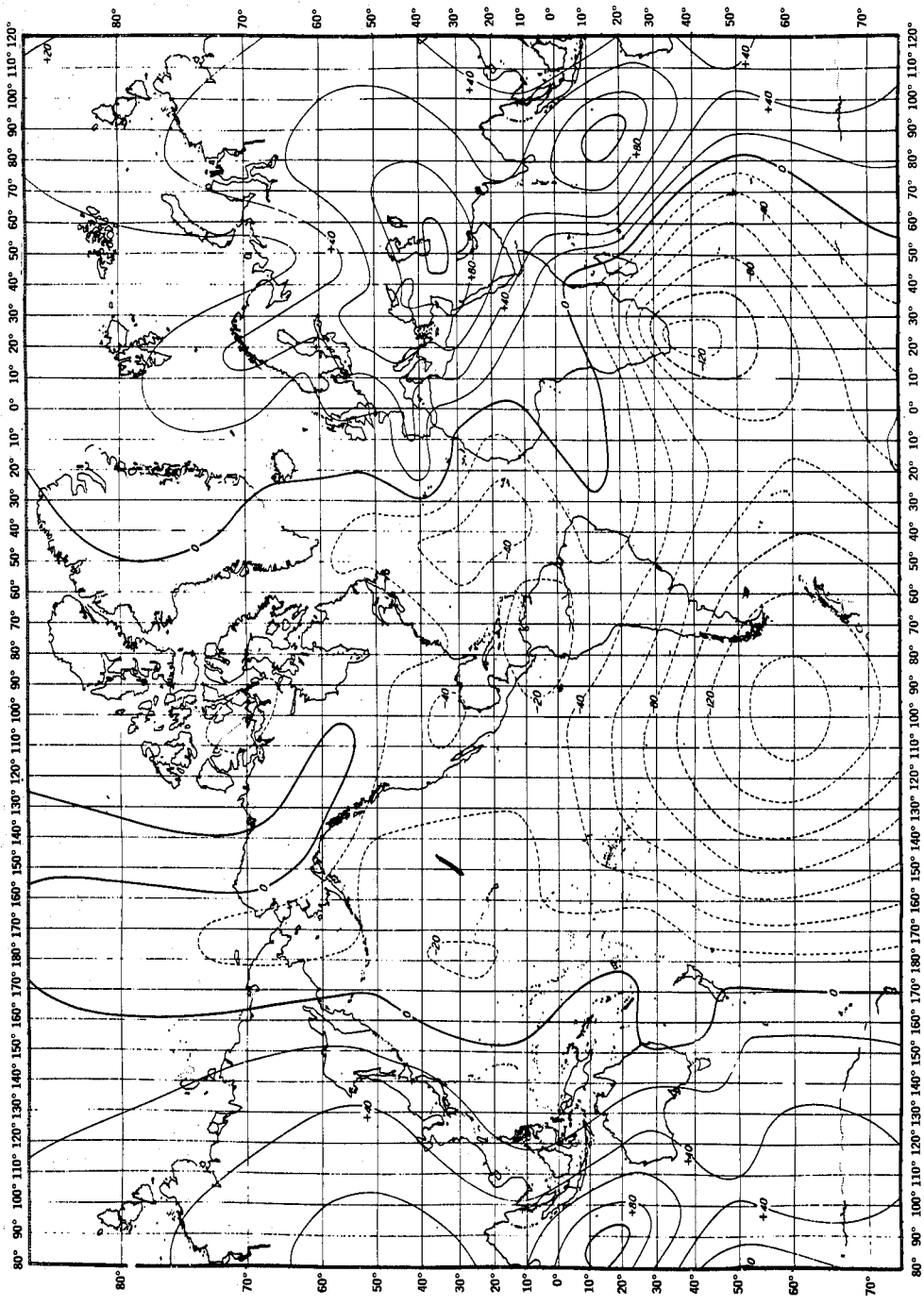

Figure 14—Secular change of total magnetic field intensity in gammas per year, Epoch 1942.5 (Reference 4).

be detectable such that limited analyses can be performed. The prospects for determining the detailed worldwide patterns of secular change with follow-on satellites to POGO at intervals of 3 to 4 years are particularly good. In the regions previously mapped by Vanguard III in 1959 (References 21 and 27) there is the opportunity to study secular changes relevant to the first of the POGO satellites. These time scales for secular change studies are currently feasible only at observatories, whose distribution leaves much to be desired. The satellites should also demonstrate whether or not the present agreements in the characteristics of secular change have general validity or whether the agreements are primarily a consequence of different investigations using the same or similar data from the same observatory distribution.

SURVEYS OF THE OUTER MAGNETOSPHERE

The WMS satellite (POGO) discussed is oriented toward obtaining the best description of the earth's main field at, and close to, the earth's surface. It should reveal the existence of external field contributions and the form of the vector summation within the volume swept out by the satellite. The description does not, however, give unique solutions for the locations of the external sources just as it does not uniquely determine the locations of the internal sources. Thus we cannot necessarily expect to trace accurately the geometrical path of a field line extending to a number of earth radii, even though its path up to some altitude (e.g., 1000 km if the POGO orbit is in a source-free region) is well known in both hemispheres. Geomagnetic coordinates such as the L parameter for trapped particles, defined by McIlwain (Reference 57), are similarly sensitive to external sources in weak field regions; and determining the limitations will in the future rest on knowledge of the external sources.

A complete description of the earth's field in space requires direct vector measurements throughout the volume enclosed by the magnetosphere cavity formed by the solar wind. This is an immense region, and any average or representative description would have to make allowance for large variations in $\Delta F/F$ with time. The existing vector measurements of Explorer X (Reference 43) and Explorers XII and XIV (respectively, References 58 and Cahill, 1963*), the two component measurements of Explorer VI and Pioneer V (Reference 59), and the scalar field measurements of the USSR Cosmic Rockets I and II (Reference 60) have provided important data for initiating this description. †

Scheduled satellites which will provide considerably more data and additional coverage within, at, and outside the magnetospheric boundary include the series of Eccentric Orbit Geophysical Observatories (EOGO) and the Interplanetary Monitor Probes (IMP). The first two satellites in each of these series are instrumented with both rubidium-vapor and fluxgate magnetometers. Initial flights in each of these series precede the POGO survey. This also means that there should be more

*Cahill, L. J., "Explorer Magnetometer," presentation at 44th Annual Meeting AGU, Washington, April 1963.

†Designations: Explorers VI, X, XII, XIV, respectively, 1959 δ 1, 1961 κ 1961 ν 1, 1962 γ 1; Pioneer V, 1960 α ; and Cosmos I and II, 1962 θ 1 and 1962 ϵ 1.

definitive knowledge regarding external sources prior to the POGO survey. This information will further facilitate the analysis of external terms in the POGO field description—a fact purposely neglected in the preceding survey discussions on grounds that the survey data should be independently complete for main field description.

A very significant gap in achieving a description of fields in the distant magnetosphere is evident in the fact that current satellite schedules do not include magnetic field measurements at large distances (e.g., 0.5 to 20 earth radii) in high latitude regions. Field mapping in these regions is of utmost importance in terms of determining the entry into the magnetosphere of solar particles and the geometry of polar cap field lines that form the anti-solar "geomagnetic tail" in response to solar wind pressures. Hopefully, this situation will be rectified in the near future to complete the outer magnetosphere survey.

WMS INTERNATIONAL COOPERATION

The need for an internationally coordinated program in mapping the earth's magnetic field has been the basis for World Magnetic Survey planning (see "Introduction"). The recommendations put forth by international committees such as the IUGG-IAGA Committee on World Magnetic Survey and Magnetic Charts (Reference 2) and the working groups for geomagnetism within COSPAR and IQSY-CIG committees are excellent guides for achieving coordination. They have in the past been lacking in one aspect which is particularly important to the satellite survey problem: the transmittal speed of magnetograms and survey data to the World Data Centers, which were established during the IGY and are continuing operations for the WMS and IQSY periods. From the discussions in the previous sections it should be evident that surface magnetograms and survey data play an important role in the satellite data analysis. This analysis also must be conducted rapidly and efficiently, and this becomes dependent on having the surface data available. In recognition of this factor the Working Group on Geomagnetism of the CIG-IQSY recently has recommended (2nd General Assembly, Rome, 1963) that observatories transmit copies of magnetograms to the World Data Centers for Geomagnetism within several weeks of the month of recording. This is a significant recommendation to groups feeling the responsibility of satellite surveys, and the cooperation that hopefully will follow this recommendation will significantly contribute to the success of the WMS satellite effort.

ACKNOWLEDGMENTS

The assistance of J. C. Cain, S. Hendricks, and W. H. Farthing, Goddard Space Flight Center, has been valuable in preparing this review. The author is grateful to W. Geddes of the U. S. Naval Oceanographic Office and to L. R. Alldredge of the U. S. Coast and Geodetic Survey for supplying charts and analysis results pertaining to Project Magnet.

REFERENCES

1. Chapman, S., "Closing Address to Final Plenary Session, CSAGI Meeting," in: *Annals of the IGY*, v. 10 (M. Nicolet, ed.): 57, London: Pergamon Press, 1960.
2. Vestine E. H., "Instruction Manual on World Magnetic Survey," IUGG, Monograph no. 11, August 1961.
3. Chapman, S., and Bartels, J., "Geomagnetism," Oxford: Clarendon Press, 1940.
4. Vestine, E. H., Laporte, L., Lange, I., Cooper, C., and Hendrix, W. C., "Description of the Earth's Main Magnetic Field and Its Secular Change, 1905-1945," Carnegie Institution, Washington, Publ. 578, 1947.
5. Fleming, J. A., "The Earth's Magnetism and Magnetic Surveys; Chapter 1, Terrestrial Magnetism and Electricity," McGraw Hill, 1939; Dover, 1949.
6. Vestine, E. H., "The Survey of the Geomagnetic Field in Space," *Trans. AGU* 41(1):4-21, March 1960.
7. Ivanov, M. M., "Results of Magnetic Observations in Oceans During the IGY. Presentation at IUGG, Helsinki, 1960," *Trans. AGU* 41(4):613, 1960 (abstract).
8. Ivanov, M. M., "The Accuracy of World Magnetic Charts for Ocean Areas," (translation), *J. Geomag. and Aeron.* 1:97, 1961.
9. Serson, P. H., "Airborne Magnetic Surveys for World Charts," paper presented at IUGG XIIth General Assembly, Helsinki, 1960.
10. Byrnes, B. C., "Project Magnet. Presentation at IUGG, Helsinki, 1960," *Trans. AGU* 41(4):613-614, December 1960 (abstract).
11. Vestine, E. H., Laporte, L., Lange, I., and Scott, W. E., "The Geomagnetic Field, Its Description and Analysis," Carnegie Institution, Washington, Publ. 580, 1947.
12. Schmidt, A., "Tafeln der Normierten Kugelfunktionen," Gotha: Engelhard-Reyher Verlag, 1935.
13. Finch, H. F., and Leaton, B. R., "The Earth's Main Magnetic Field-Epoch 1955," *Monthly Notices Royal Astronom. Soc., Geophys. Suppl.* 7(6):314-317, November 1957.
14. Fanselau, von G., and Kautzleben, H., "Die Analytische Darstellung des Geomagnetischen Feldes," Geomagnetischen Institut, Potsdam, Akademie-Verlag, Berlin, 1958.
15. Jensen, D. C., and Whitaker, W. A., "A Spherical Harmonic Analysis of the Geomagnetic Field," *J. Geophys. Res.* 65(8):2500, August 1960 (abstract of report, AFSWC, Kirtland AFB, New Mexico, 1960).

16. Jensen, D. C., and Cain, J. C., "An Interim Geomagnetic Field," *J. Geophys. Res.* 67(9):3568, August 1962 (abstract).
17. Fougere, P. F., "Spherical Harmonic Analysis. 1. A New Method and Its Verification," *J. Geophys. Res.* 68(4):1131-1140, February 15, 1963.
18. Bauer, L. A., "Analysis of the Earth's Magnetic Field for 1922. No. 1," *Terrest. Mag.* 28:1-28, March-June 1923.
19. Zmuda, A. J., "A Method for Analyzing Values of the Scalar Magnetic Intensity," *J. Geophys. Res.* 63(3):477-490, September 1958.
20. Cain, J. C., Shapiro, I. R., Stolarik, J. D., and Heppner, J. P., "Vanguard 3 Magnetic-Field Observations," *J. Geophys. Res.* 67(13):5055-5070, December 1962.
21. Cain, J. C., Stolarik, J. D., Shapiro, I. R., and Heppner, J. P., "Measurements of the Geomagnetic Field by the Vanguard III Satellite," NASA TN D-1418, September 1962.
22. Serson, P. H., and Hannaford, W. L. W., "Statistical Analysis of Magnetic Profiles," *J. Geophys. Res.* 62(1):1-18, March 1957.
23. Alldredge, L. R., and Van Voorhis, G. D., "Depth to Sources of Magnetic Anomalies," *J. Geophys. Res.* 66(11):3793-3800, November 1961.
24. Alldredge, L. R., Van Voorhis, G. D., and Davis, T. M., "A Magnetic Profile Around the World," *J. Geophys. Res.* 68; to be published, 1963.
25. Vacquier, V., Duff, A. D., and Warren, R. E., "Horizontal Displacements in the Floor of the Northeastern Pacific Ocean," *Geol. Soc. America Bull.* 72(8):1251-1258, 1961.
26. Elsasser, W. M., "The Earth's Interior and Geomagnetism," *Rev. Mod. Phys.* 22:1-35, January 1950.
27. Heppner, J. P., Skillman, T. L., and Cain, J. C., "Contributions of Rockets and Satellites to the World Magnetic Survey," *Space Research II, Proc. 2nd Intern. Space Sci. Sym.*, North-Holland Publ. Co., Amsterdam, 681, 1961.
28. Kalinin, J. D., "Magnetic Observations by Artificial Sputniks and Rockets in Connection with the World Magnetic Survey," *Space Research II, Proc. 2nd Intern. Space Science Symposium*, North-Holland Publ. Co., Amsterdam, 679, 1961.
29. Heppner, J. P., Stolarik, J. D., Shapiro, I. R., and Cain, J. C., "Project Vanguard Magnetic Field Instrumentation and Measurements," in: *Space Research, Proceedings of the First International Space Science Symposium*, Nice, 1960: 982-999, Amsterdam: North-Holland Publ. Co., 1960.
30. Heppner, J. P., Cain, J. C., Shapiro, I. R., and Stolarik, J. D., "Satellite Magnetic Field Mapping," NASA TN D-696, May 1961.

31. Schonstedt, E. O., and Irons, H. R., "NOL Vector Airborne Magnetometer Type 2A," *Trans. AGU* 36(1):25-41, February 1955.
32. Maple, E., Bowen, W. A., and Singer, S. F., "Measurement of the Earth's Magnetic Field at High Altitudes at White Sands, New Mexico," *J. Geophys. Res.* 55:115-126, June 1950.
33. Singer, S. F., Maple, E., and Bowen, W. A., Jr., "Evidence for Ionosphere Currents from Rocket Experiments near the Geomagnetic Equator," *J. Geophys. Res.* 56:265-281, June 1951.
34. Dolginov, S. Sh., Zhuzgov, L. N., and Pushkov, N. V., "Preliminary Report on Geomagnetic Measurements Carried Out from the Third Soviet Artificial Earth Satellite," in: *Artificial Earth Satellites*, v. 2 (L. V. Kurnosova, ed.): 63-67, New York: Plenum Press, 1960.
35. Dolginov, S. Sh., Zhuzgov, L. N., and Selyutin, V. A., "Magnetometers in the Third Soviet Earth Satellite," in: *Artificial Earth Satellites*, v. 4 (L. V. Kurnosova, ed.): 358-396, New York: Plenum Press, 1960.
36. Dolginov, S. Sh., Zhuzgov, L. N., Pushkov, N. V., Tyurmina, L. O., and Fryazinov, I. V., "Some Results of Measurements of the Constant Geomagnetic Field above the USSR from the Third Artificial Earth Satellite," (translation) *J. Geomag. and Aeron.* 2:1061, 1962.
37. Shapiro, I. R., Stolarik, J. D., Heppner, J. P., "The Vector Field Proton Magnetometer for I.G.Y. Satellite Ground Stations," *J. Geophys. Res.* 65(3):913-920, March 1960.
38. Ludwig, G. H., "The Orbiting Geophysical Observatories," *Space Sci. Rev.* 2(5), 1963.
39. Scull, W. E., and Ludwig, G. H., "The Orbiting Geophysical Observatories," *Proc. IRE* 50(11):2288-2296, November 1962.
40. Heppner, J. P., Stolarik, J. D., and Meredith, L. H., "The Earth's Magnetic Field Above WSPG, New Mexico, from Rocket Measurements," *J. Geophys. Res.* 63(2):277-288, June 1958.
41. Abragam, A., Combrisson, J., and Solomon, I., "Method and Device for the Measurement of Magnetic Fields by Magnetic Resonance," U. S. Patent Office, Patent no. 3,049,662; 1962.
42. Franken, P. A., and Colegrove, F. D., "Alignment of Metastable Helium Atoms by Unpolarized Resonance Radiation," *Phys. Rev. Letters* 1(9):316-318, November 1, 1958.
43. Heppner, J. P., Ness, N. F., Searce, C. S., and Skillman, T. L., "Explorer 10 Magnetic Field Measurements," *J. Geophys. Res.* 68(1):1-46, January 1963.
44. Ruddock, K. A., "Optically Pumped Rubidium Vapor Magnetometer for Space Experiments," Space Research II, Proc. 2nd Intern. Space Science Symposium, North-Holland Publ. Co., Amsterdam, 692, 1961.
45. Bloom, A. L., "Principles of Operation of the Rubidium Vapor Magnetometer," *Appl. Opt.* 1(1):61-68, January 1962.

46. McNish, A. G., "Physical Representations of the Geomagnetic Field," *Trans. AGU* 28(1), 1940.
47. Lowes, F. J., and Runcorn, S. K., "The Analysis of the Geomagnetic Secular Variation," *Phil. Trans. Roy. Soc. London A* 243(871):525-546, 1951.
48. Sugiura, M., and Chapman, S., "The Average Morphology of Geomagnetic Storms with Sudden Commencement," *Abh. Akad. Wiss. Göttingen, Math.-Phys. Klasse, Sonderheft Nr. 4*, Göttingen, 1960.
49. Bullard, E., and Gellman, H., "Homogeneous Dynamos and Terrestrial Magnetism," *Phil. Trans. Roy. Soc. London A* 247(928):213-278, 1955.
50. Bullard, E. C., Freedman, C., Gellman, H., and Nixon, J., "The Westward Drift of the Earth's Magnetic Field," *Phil. Trans. Roy. Soc. London A* 243:67-92, 1951.
51. Nagata, T., and Syono, Y., "Geomagnetic Secular Variation During the Period from 1955 to 1960," *J. Geomag. Geoelect.* 12(2):84-98, 1961.
52. Benkova, N. P., and Tyurmina, L. O., "Analytical Representation of the Geomagnetic Field over the Territory of the Soviet Union for the 1958 Epoch," (translation) *J. Geomag. and Aeron.* 1:81, 1961.
53. Nagata, T., and Rikitake, T., "Geomagnetic Secular Variation and Poloidal Magnetic Fields Produced by Convective Motions in the Earth's Core," *J. Geomag. and Geoelect.* 13:42, 1961.
54. Mansurov, S. M., "Geomagnetic Secular Variation in East Antarctica," *Acad. Sci. USSR, IGY Committee, Moscow*, pp. 48-52, 1960; Canadian DRB Translation T375R, by E. R. Hope, 1962.
55. Kalinin, Yu. D., "The Long Period Geomagnetic Variation," *Publ. of the Res. Inst. for Terr. Magn.*, Leningrad, 1954; Canadian DRB Translation T379R, by E. R. Hope, 1961.
56. Orlov, V. P., "Secular Variations of the Geomagnetic Field and Methods of Using it in Compiling Small-Scale Magnetic Charts," (translation) *J. Geomag. and Aeron.* 1:226, 1961.
57. McIlwain, C. E., "Coordinates for Mapping the Distribution of Magnetically Trapped Particles," *J. Geophys. Res.* 66(11):3681-3691, November 1961.
58. Cahill, L. J., and Amazeen, P. G., "The Boundary of the Geomagnetic Field," *J. Geophys. Res.* 68(7):1835-1844, April 1963.
59. Smith, E. J., Coleman, P. J., Judge, D. L., and Sonett, C. P., "Characteristics of the Extraterrestrial Current System: Explorer VI and Pioneer V," *J. Geophys. Res.* 65(6):1858-1861, June 1960.
60. Dolginov, S. Sh., and Pushkov, N. V., "Some Results of the Earth's Magnetic Field Investigations in Outer Space," COSPAR, Washington, 1962, Space Research III, North-Holland Publ. Co., 1962.

NASA TN D-2109

descriptions should be reduced to 0.1 to 0.3 percent as a result of the survey.

NASA

NASA

NASA TN D-2109

descriptions should be reduced to 0.1 to 0.3 percent as a result of the survey.

NASA TN D-2109

descriptions should be reduced to 0.1 to 0.3 percent as a result of the survey.

NASA

NASA

NASA TN D-2109

descriptions should be reduced to 0.1 to 0.3 percent as a result of the survey.

NASA TN D-2109

National Aeronautics and Space Administration.
THE WORLD MAGNETIC SURVEY. James P.
Heppner. January 1964. iii, 41p. OTS price,
\$1.25. (NASA TECHNICAL NOTE D-2109)

The mathematical and graphical description of the earth's main field has been, and is, a "data limited" problem. The World Magnetic Survey (WMS) is an endeavor to minimize this limitation by rapidly and comprehensively blanketing the earth with magnetic field measurements. Satellite surveys, which will play a key role in the WMS, are the principal topic of this paper. Existing magnetic field descriptions, the expected results from new surveys, and the methods of obtaining these results with the POGO satellite are emphasized. It is anticipated on the basis of extrapolation from Vanguard III results and other considerations that a factor-of-10 improvement will be obtained. This means that the average errors of 1 to 3 percent now present in field charts and spherical harmonic

(over)

NASA

- I. Heppner, James P.
- II. NASA TN D-2109

NASA TN D-2109

National Aeronautics and Space Administration.
THE WORLD MAGNETIC SURVEY. James P.
Heppner. January 1964. iii, 41p. OTS price,
\$1.25. (NASA TECHNICAL NOTE D-2109)

The mathematical and graphical description of the earth's main field has been, and is, a "data limited" problem. The World Magnetic Survey (WMS) is an endeavor to minimize this limitation by rapidly and comprehensively blanketing the earth with magnetic field measurements. Satellite surveys, which will play a key role in the WMS, are the principal topic of this paper. Existing magnetic field descriptions, the expected results from new surveys, and the methods of obtaining these results with the POGO satellite are emphasized. It is anticipated on the basis of extrapolation from Vanguard III results and other considerations that a factor-of-10 improvement will be obtained. This means that the average errors of 1 to 3 percent now present in field charts and spherical harmonic

(over)

NASA

- I. Heppner, James P.
- II. NASA TN D-2109

NASA TN D-2109

National Aeronautics and Space Administration.
THE WORLD MAGNETIC SURVEY. James P.
Heppner. January 1964. iii, 41p. OTS price,
\$1.25. (NASA TECHNICAL NOTE D-2109)

The mathematical and graphical description of the earth's main field has been, and is, a "data limited" problem. The World Magnetic Survey (WMS) is an endeavor to minimize this limitation by rapidly and comprehensively blanketing the earth with magnetic field measurements. Satellite surveys, which will play a key role in the WMS, are the principal topic of this paper. Existing magnetic field descriptions, the expected results from new surveys, and the methods of obtaining these results with the POGO satellite are emphasized. It is anticipated on the basis of extrapolation from Vanguard III results and other considerations that a factor-of-10 improvement will be obtained. This means that the average errors of 1 to 3 percent now present in field charts and spherical harmonic

(over)

NASA

- I. Heppner, James P.
- II. NASA TN D-2109

NASA TN D-2109

National Aeronautics and Space Administration.
THE WORLD MAGNETIC SURVEY. James P.
Heppner. January 1964. iii, 41p. OTS price,
\$1.25. (NASA TECHNICAL NOTE D-2109)

The mathematical and graphical description of the earth's main field has been, and is, a "data limited" problem. The World Magnetic Survey (WMS) is an endeavor to minimize this limitation by rapidly and comprehensively blanketing the earth with magnetic field measurements. Satellite surveys, which will play a key role in the WMS, are the principal topic of this paper. Existing magnetic field descriptions, the expected results from new surveys, and the methods of obtaining these results with the POGO satellite are emphasized. It is anticipated on the basis of extrapolation from Vanguard III results and other considerations that a factor-of-10 improvement will be obtained. This means that the average errors of 1 to 3 percent now present in field charts and spherical harmonic

(over)

NASA

- I. Heppner, James P.
- II. NASA TN D-2109