

LOAN DOCUMENT

PHOTOGRAPH THIS SHEET

①

INVENTORY

DTIC ACCESSION NUMBER

LEVEL

DoD Inf. Integration Strategy
Book 2 of 2 . . .

DOCUMENT IDENTIFICATION

Apr 96

DISTRIBUTION STATEMENT A

Approved for public release
Distribution Unlimited

DISTRIBUTION STATEMENT

DATE ACCESSIONED

DATE ACCESSIONED

DATE RETURNED

DATE RETURNED

REGISTERED OR CERTIFIED NUMBER

REGISTERED OR CERTIFIED NUMBER

ACCESSION FOR	
NTIS	GRA&I <input checked="" type="checkbox"/>
DTIC	TRAC <input type="checkbox"/>
UNANNOUNCED	<input type="checkbox"/>
JUSTIFICATION	<input type="checkbox"/>
BY	
DISTRIBUTION/	
AVAILABILITY CODES	
DISTRIBUTION	AVAILABILITY AND/OR SPECIAL
A-1	

DISTRIBUTION STAMP

19960805 005

DATE RECEIVED IN DTIC

PHOTOGRAPH THIS SHEET AND RETURN TO DTIC-FDAC

H
A
N
D
L
E

W
I
T
H

C
A
R
E



DoD Information Integration Strategy Migration Diagrams

Book Two of Two

**Department of Defense
Defense Information Systems Agency
Joint Requirements Analysis & Integration**

VERSION 9
APRIL 1996

**Office of the Assistant Secretary of Defense (C3I)
Office of the Deputy Assistant Secretary of Defense (C3)
6000 Defense Pentagon
Room 1C255
Washington, DC 20301-6000**

**PROVIDED BY: Defense Information Systems Agency
Joint Requirements Analysis and Integration Directorate
5201 Leesburg Pike, Suite 1501
Falls Church, VA 22041**

E
L
O
P
E
N
D
I
T
E

REPORT DOCUMENTATION PAGE			Form Approved OMB No. 0704-0188	
Public reporting burden for this collection of information is estimated to average 1 hour per response, including the time for reviewing instructions, searching existing data sources, gathering and maintaining the data needed, and completing and reviewing the collection of information. Send comments regarding this burden estimate or any other aspect of this collection of information, including suggestions for reducing this burden, to Washington Headquarters Services, Directorate for Information Operations and Reports, 1215 Jefferson Davis Highway, Suite 1204, Arlington, VA 22202-4302, and to the Office of Management and Budget, Paperwork Reduction Project (0704-0188), Washington, DC 20503.				
1. AGENCY USE ONLY (Leave blank)	2. REPORT DATE 15 April 1995	3. REPORT TYPE AND DATES COVERED Periodic (Each version represents a "slice in time")		
4. TITLE AND SUBTITLE DoD Information Integration Strategy Migration ("Tree") Diagrams, Book One of Two DoD Information Integration Strategy Migration ("Tree") Diagrams, Book Two of Two			5. FUNDING NUMBERS NA	
6. AUTHOR(S) NA				
7. PERFORMING ORGANIZATION NAME(S) AND ADDRESS(ES) 7. Department of Defense Defense Information Systems Agency, Joint Requirements/Analysis & Integration (D7) and C4I Modeling, Simulation & Assessment (D8), 5201 Leesburg Pike, Suite 1501, Falls Church, VA 22041			8. PERFORMING ORGANIZATION REPORT NUMBER NA	
9. SPONSORING/MONITORING AGENCY NAME(S) AND ADDRESS(ES) Office of the Assistant Secretary of Defense (C3I), Office of the Deputy Assistant Secretary of Defense (C3), 6000 Defense Pentagon, Room 1C255, Washington, DC 20301-6000			10. SPONSORING/MONITORING AGENCY REPORT NUMBER NA	
11. SUPPLEMENTARY NOTES "Field 25 should contain the identifier CIM (Collection), as detailed in A. Washington DTIC-OCS IOM, dated April 11, 1994." POC: Gross, Martin R. grossm@ncr.disa.mil 703-681-4740 x167				
12a. DISTRIBUTION AVAILABILITY STATEMENT Unrestricted			12b. DISTRIBUTION CODE NA	
13. ABSTRACT (Maximum 200 words) The present document provides information in fulfillment (except for cost data) of the reporting requirements to Congress as contained in the FY 1996 National Defense Authorization Act signed on 10 February 1996. Specifically, it provides the information requested in points (i), (ii), part of (iii), and (iv) of Part (C) of Section 366 of the Act. The DoD has thousands of existing (i.e., "legacy") information system applications that are being consolidated into a greatly reduced set of "migration" applications, with a goal of eventually migrating to a set of common applications in an open systems environment. The migration/tree diagrams represent a reported inventory of legacy and migration applications for each functional area and activity identified to date for the mission areas of Command and Control, Intelligence, and Mission Support. The development of these diagrams is evolutionary, reflecting the progress made by each DoD functional area. Functional areas included are: DoD Summary; Command & Control; Intelligence; Acquisition & Technology (Economic Security, Environmental Security, Logistics, Depot Maintenance, Material Management, Meteorology & Oceanography, NCB Defense Programs, Distribution, Procurement, Science & Technology, Systems Acquisition Management, Test & Evaluation); Communications, Finance, Health, Human Services (Military Personnel, Civilian Personnel), Information Management, Inspector General, Legal, Policy, and Reserve Components.				
14. SUBJECT TERMS Legacy Systems, Migration Systems, Enterprise Integration, OSD PSA Functional Areas (i.e., Command & Control, Intelligence, A&T, P&R, Comptroller, IG, etc.), Migration Schedules, Congressional Reporting Requirements. CIM (Collection)			15. NUMBER OF PAGES 761	
			16. PRICE CODE NA	
17. SECURITY CLASSIFICATION OF REPORT Unclassified	18. SECURITY CLASSIFICATION OF THIS PAGE Unclassified	19. SECURITY CLASSIFICATION OF ABSTRACT Unclassified	20. LIMITATION OF ABSTRACT UL	



EXECUTIVE SUMMARY

EXECUTIVE SUMMARY

The present document provides information in fulfillment (except for cost data) of the reporting requirements to Congress as contained in the FY 1996 National Defense Authorization Act signed on 10 February 1996.

Specifically, it provides the information requested in points (i), (ii), part of (iii), and (iv) of Part (C) of Section 366 of the Act, which part reads as follows:

(C) An assessment of the implementation of migration systems and applications, including –

(i) identification of the systems and applications by functional business area, specifying target dates for operation of the systems and applications;

(ii) identification of the legacy systems and applications that will be terminated;

(iii) the cost of and schedules for implementing the migration systems and applications;

and

(iv) termination schedules.

As explained in detail in the following section, "How To Read the Migration Diagrams," the migration diagrams, and their underlying tables, identify all systems and applications, by functional business area, that have been chosen as Migration systems and applications, and specify target dates for operation; identify legacy systems and applications to be terminated; and indicate the termination schedules for these legacy systems and applications.

The information is contained in the tables entitled "Migration Path Detail Report" for each Functional business area. There is a separate table or tables for every Functional Activity within each Functional Area, for which Legacy and/or Migration systems and applications have been identified, listing all Legacy and Migration systems and applications in alphabetical order. Each table shows, for each system and application listed, its acronym as stored in the Defense Information Support Tools (DIST) database, its name, its phase (Legacy, Migration or Interim), the start month and year of that system or application, where it migrates to, if known, and the month and year it both begins and ends its migration to that target system or application. This information fulfills the request contained in Part C of Section 366 of the FY 1996 National Defense Authorization Act.

Please note that in some Functional Activities, there is a further breakdown into Groups, and in a few instances, into Subgroups. The Migration Path Detail Report is provided only at the lowest applicable level, as explained in the following section.



**HOW TO READ MIGRATION
DIAGRAMS AND TABLES**

HOW TO READ MIGRATION DIAGRAMS AND TABLES

The numbered items below correspond to the numbers on the charts on the facing page. There are three sample charts: a Table, the Detail Diagram generated from that table, and a sample Summary Diagram.

1. On Summary Diagram, number of Migrations, Interims and Legacies existing as of 9/91. TBD means "to be determined."
2. The line extends from the left margin to the time that the last planned migration event is completed. The total count of those systems that are designated as Migration, Interim and Legacy as of FY 2010 are displayed in parentheses.
3. On Summary Diagram, arrowhead commences at date FY 2001 (see Fiscal Year line). Entries to right of this vertical line have dates between FY 2001 and FY 2010.
4. Total number of unique applications (bold number); and total of Migrations plus Interims, then Legacies (in parenthesis-Legacies follow "/"). Fiscal year at bottom applies to above two lines, and to entire diagram above.
5. The total number of Migrations, Interims and Legacies as of present date. Present date generally chosen to be date of last update, but can be modified by user to reflect future or past date. Corresponding dashed vertical line divides diagram into left-hand section, representing the past, and right-hand section, representing the future.
6. On the Summary Diagram, total number of unique Migration and Interims accounted for in the chart. On Detail Diagram, total number of Migrations and Interims displayed on the current chart.
7. Interim system as denoted in Table and Detail Diagram. Acronym appears in bold face type and in Detail Diagram is followed by "=I".
8. Month and year in which migration of listed application commences and completed. Shown in month/year format on Table. On Detail Diagram, line bends toward line of targeted migration system on migration begin date and terminates at migration end date. For non-migrating Interims, and all Migrations, default date of 01/2010 is shown in Table.
9. Legacy system for which migration planning has not yet been entered. By default, name appears in far right section of diagram, which signifies default termination date of FY 2010.
10. Migration system as denoted in Table and Detail Diagram. Acronym appears in bold face, italic, shaded type and in Detail Diagram is followed by "=M".

Migration Path Detail Report

Finance

April 1, 1996

Activity: Def. Bus. Operations Fund

DBO0200

Group: Supply Management, Navy

Subgroup: Operations

Acronym Alias (Migration / Legacy)	Application Title	Phase	Start Date		Migrates to	Mig Beg Date		Mig End Date	
			Month	Year		Month	Year	Month	Year
<i>UADPS-SPEF</i>	Uniform Automated Data Processing System - Stock Points E&F	M	12	1994		01	2010	01	2010
MFCS	Material Financial Control System (PX02, PX04, PX06)	I	12	1994	<i>UADPS-SPEF</i>	01	1998	01	1999
MFCS(L)	Material Financial Control System (PX02, PX04, PX06)	L	09	1991	MFCS	12	1994	06	1995
MICS	Medical Inventory Control System	L	09	1991	<i>UADPS-SPEF</i>	09	1995	09	1996
MUMMS	Marine Corps Unified Material Management System	L	09	1991		12	2010	12	2010
ROMS	Resale Operations Management System	L	09	1991	<i>UADPS-SPEF</i>	09	1995	09	1996
SAC 207	Shipboard Uniform ADP System, Special Accounting Class 207	L	09	1991	<i>UADPS-SPEF</i>	09	1995	09	1996
SUADPS-RT	Shipboard Uniform Automated Data Processing System - Real Tim	L	09	1991	<i>UADPS-SPEF</i>	09	1995	09	1996
UADPS-G03/G06	UADPS-ICP Integrated Disbursing and Accounting G03/G06	L	09	1991	MFCS	09	1995	09	1996
UADPS-LEVEL II SF	Uniform Automated Data Processing System - Level II Stock Fund	L	09	1991	<i>UADPS-SPEF</i>	09	1995	09	1996
UADPS-SPE&F(L)	Uniform Automated Data Processing System - Stock Points E&F	L	09	1991	<i>UADPS-SPEF</i>	12	1994	06	1995

Mission Support

Finance

Summary Diagram

LEGACY APPLICATIONS

- Civ Pay Foreign Nationals (L 24)
- Civ Pay Non-appropriated (L 2)
- Civilian Pay (L 25)
- Contract Payment (L 2)
- Debt Management (L 3)
- Def. Bus. Operations Fund (L 75)**
- Departmental Reporting (L 15)
- Disbursing (L 7)
- Foreign Military Sales (L 8)
- Gen. Funds/DBOF Accounting TBD
- General Fund Accounting (L 48)
- Mil. Retiree/Annuity Pay (L 6)
- Military Pay (L 24)
- Non-Approp. Fund Acct. (L 7)
- PEES TBD
- Transportation Payment (L 4)
- Travel Payment (L 3)
- Trust Fund Accounting (L 4)
- Undefined TBD
- Vendor Payment (L 6)

Summary

MIGRATION APPLICATIONS

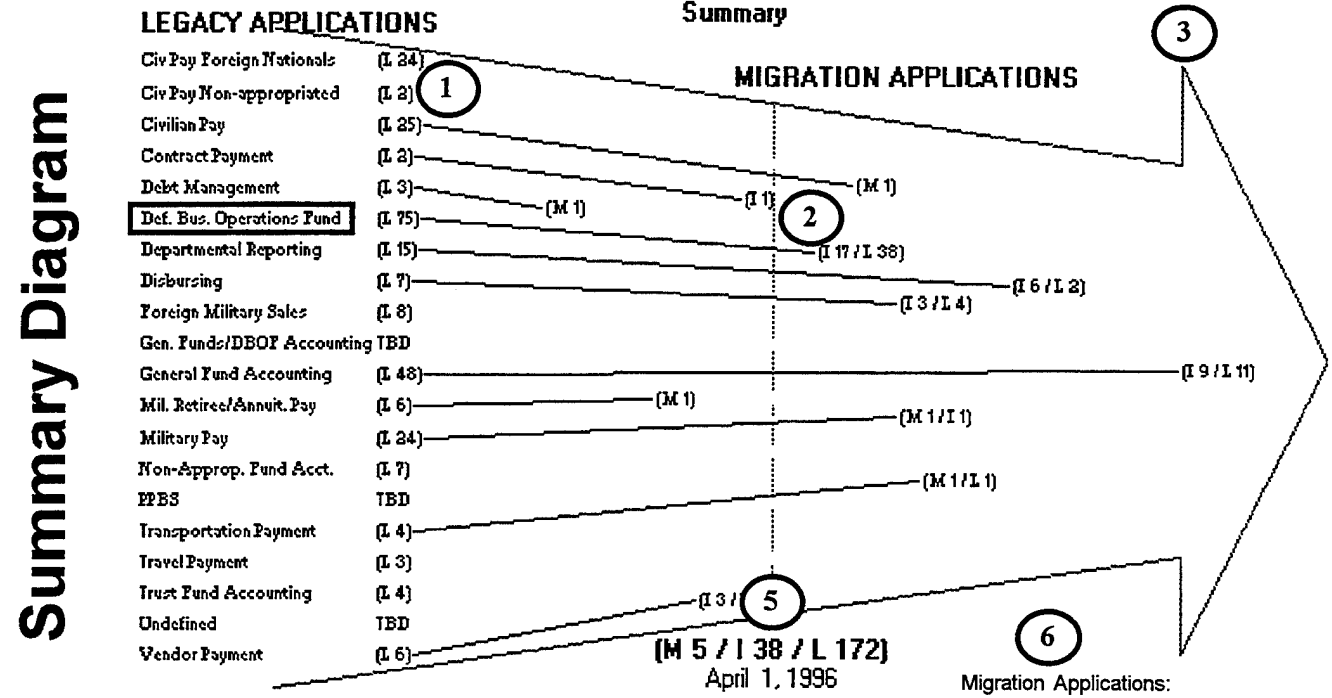

4

(Migration/Legacy)	(0/262)	(4/253)	(8/241)	(8/227)	(42/183)	(43/138)	(41/121)	(41/117)	(41/112)	(41/109)
Unique Apps.	262	257	249	235	225	181	162	158	153	150
Fiscal Year	91	92	93	94	95	96	97	98	99	00

(M 5 / I 38 / L 172)
April 1, 1996

6 Migration Applications:
6 Selected + 37 Interim

Mission Support

*Def. Bus. Operations Fund
Supply Management, Navy
Operations*

Current as of March 19, 1996

Finance

LEGACY APPLICATIONS

MIGRATION APPLICATIONS

Detail Diagram

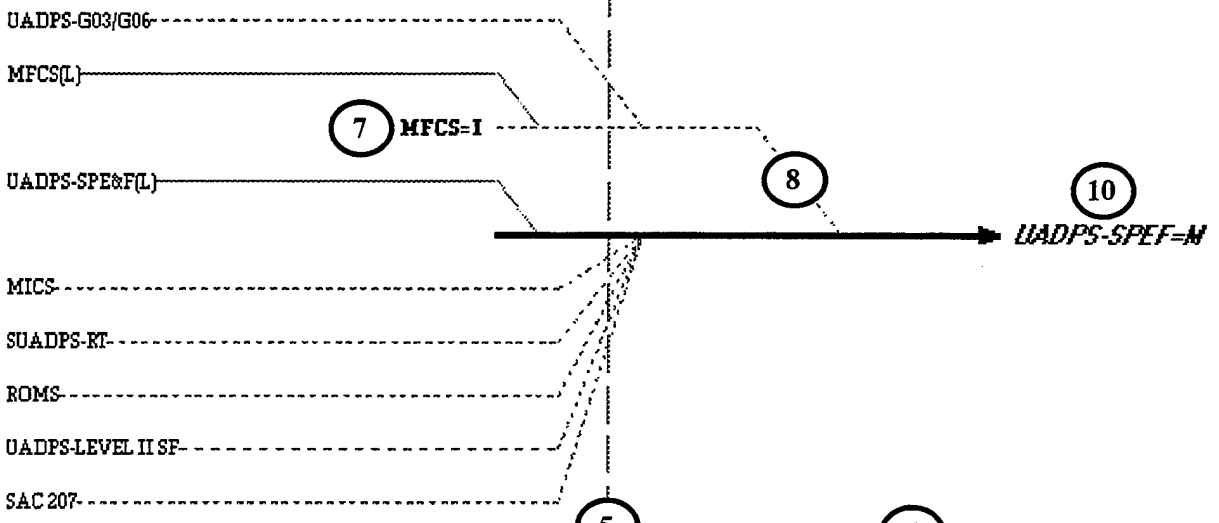

4

(Migration/Legacy)	(0/9)	(0/9)	(0/9)	(0/9)	(2/7)	(2/1)	(2/1)	(2/1)	(1/1)	(1/1)
# Applications	9	9	9	9	9	3	3	3	2	2
Fiscal Year	91	92	93	94	95	96	97	98	99	00

Migration Applications:
1 Selected + 1 Interim

Legend
Planned - - - -
Completed - - - -

THIS PAGE INTENTIONALLY LEFT BLANK

DEFINITIONS

All information contained in the migration diagrams and tables in this publication is stored in the Defense Integration Defense Tools (DIST) database.

The publication consists of tables (titled "Migration Path Detail Reports"), detail diagrams (known as "fishbone" diagrams, formerly known as "tree" diagrams), and summary diagrams. The tables and detail diagrams report migration information for all systems and applications (hereafter referred to simply as "systems") entered in the DIST database which have been identified as Legacy, Interim or Migration systems. (see "Definitions" section below for definitions of Legacy, Interim and Migration systems). The detail diagrams graphically display the migration paths of all identified Legacy systems, including the Interim and Migration systems to which they migrate, and the start and completion dates of each migration process. The data from which the detail diagrams are constructed is drawn from the tables associated with each detail-level diagram. The migration information is entered directly by authorized users into the tables, from which data the detail diagrams are generated.

Each completed line of a table contains a distinct system, identified by its acronym and name. Every system in the DIST has at least one Mission/Functional Area/Functional Activity designation, and this designation determines which table a given system appears in. Some Functional Activities are further subdivided into Groups, and some Groups are further subdivided into Subgroups. If an Activity is subdivided into Groups, each Group will have an associated table and detail diagram, and the Activity will be associated with a summary diagram, summarizing the migration planning at the Group level. If a Group is subdivided into Subgroups, each Subgroup will have an associated table and detail diagram, and the Group will be associated with a summary diagram, summarizing the migration planning at the Subgroup level. If an Activity has no Groups, then it will be associated with a table and detail diagram.

There is also a summary diagram for each Functional Activity, that summarizes the migration planning at the Activity level, and a summary diagram for each Mission that summarizes the migration planning at the Functional Area level. (Additionally, the "DoD Summary" diagram at the beginning of this publication shows migration planning for Command and Control and Intelligence at the Mission level, and at the Functional Area level for Mission Support.)

Summary diagrams do not have tables directly associated with them, and they do not list any systems or applications by name. They show summary totals for numbers of Legacies, Interims and Migrations, as of 1991, and as of 2010, for the Group, Activity, Area or Mission summarized. These tables therefore show quantitatively the progress of migrating Legacies to Interims and Migrations, and of terminating Legacies.

In all summary diagrams, the totals given are for unique systems. It is frequently the case that the same system may appear on more than one detail diagram within the same Activity, Group or Subgroup. The summary diagram(s) reporting on that Activity, Group or Subgroup will ignore this duplication, and total only unique systems in all the detail diagrams that the summary diagram subsumes.

TERMS

Migration Process The selection of Automated Information Systems (AIS's) to be phased out or terminated, and the identification of other AIS's that will not be terminated, and which will take over or replace the functionality of the AIS's designated to be terminated.

Phase The name that identifies whether a given AIS is to be terminated, or is to remain and take over the functionality of other AIS's that are being terminated. There are three phase designations:

Legacy Legacy systems are those AIS's slated to be phased out or terminated.

Migration Migration systems are those AIS's that have been selected by the Principal Staff Assistants and officially designated by ASD(C3I), to which Legacy AIS's performing the same or similar functionality are scheduled to migrate.

Interim AIS's that are at any stage of consideration for selection as a Migration system, or any other system that one or more Legacy systems are scheduled to migrate to before they migrate to an officially selected migration system.

System Hierarchy The designation of all AIS's as belonging to one or more categories that correspond to the functionality provided by that system. There are three obligatory levels of hierarchy required to define the functional categories, and two further, optional levels providing greater degrees of detail.

Mission DoD Major Missions. There are three approved Missions: Command and Control, Intelligence, and Mission Support.

Functional Area Each Mission is composed of two or more Functional Areas, which define sub-missions within each Mission. Within the Mission Support mission, there is at least one Principal Staff Assistant (PSA) responsible for each of the Functional Areas, with the exceptions of Human Resources, which has two PSAs, and Logistics, which has five PSAs, one for each Activity.

Functional Activity The Functional Area is the next level of the hierarchy, and is the last required one. It identifies specific functions within a Functional Area and groups AIS's that share that function. These three designations are obligatory at the time an AIS is initially entered into the DIST. They are sometimes summarily written as "Mission/Function/Area," or abbreviated as "M/F/A." The same hierarchy is utilized in the Migration section of the DIST. The following two categories are only utilized in the Migration section of the DIST, and are neither required, nor can they be input, into the general DIST database. They are strictly Migration categories as reflected in the tables and detail diagrams:

Group The next level of hierarchy further subdividing functional activity, under Functional Activity. Not all Functional Activities are broken down into Groups.

Subgroup The most detailed level in the hierarchy, further subdividing functional activity, under Group. Not all Groups are broken down into Subgroups.

EXPLANATION OF TABLE, DETAIL DIAGRAM AND SUMMARY DIAGRAM

The numbered items below correspond to the numbers on the charts on the facing page. There are three sample charts: a Table, the Detail Diagram generated from that table, and a sample Summary Diagram.

1. Mission
2. Functional Area
3. Functional Activity
4. Group
5. Subgroup
6. Application acronym (this column can include Legacies, Interims and/or Migrations)
7. Application title (name)
8. Phase: Legacy, Interim or Migration system or application (L, I, or M)
9. Interim system as denoted in Table and Detail Diagram. Acronym appears in bold face type and in Detail Diagram is followed by “=I”.
10. Migration system as denoted in Table and Detail Diagram. Acronym appears in bold face, italic, shaded type and in Detail Diagram is followed by “=M”.
11. Legacy system for which migration planning has not been entered yet. By default, name appears in far right section of diagram, which signifies default termination date of 2010.
12. For systems which began operations subsequent to 9/91, shows month and year system began operations. All other systems show default start date of 9/91.
13. Acronym of Migration or Interim to which the listed system migrates, if any. This is blank for all Migrations, and for Interims which don't migrate to a Migration system.
14. Month and year in which migration of listed application commences. Shown in month/year format on Table. On Detail Diagram, line bends toward line of targeted migration system on this date (see point 24, Fiscal Year, to read diagram dates). For non-migrating Interims, and all Migrations, default date of 09/2010 is shown in Table.
15. Month and year in which migration of listed application is completed. Shown in month/year format on Table. On Detail Diagram, line terminates at line of targeted migration system on this date (see point 24, Fiscal Year, to read diagram dates). If date is a past date, Legacy has already terminated. For non-migrating Interims, and all Migrations, default date of 09/2010 is shown in Table.
16. Alphanumeric ID of Detail Diagram. ID is composed of 3-letter acronym of Functional Activity that diagram belongs to, followed by 4-digit number chosen at time of creation of Table.
17. Date on which Table or Detail Diagram was last saved or modified. This date is provided by the DIST, and cannot be altered by user.
18. Dotted line signifies Legacy that has not yet completed its migration process.
19. Solid line signifies Legacy that has completed its migration, and has been terminated.
20. Solid bold line signifies Migration system.
21. The total number of Migrations, Interims and Legacies as of date in 22. below.
22. Present date. Generally chosen to be date of last update, but can be modified by user to reflect future or past date. Corresponding dashed vertical line divides diagram into left-hand section, representing the past, and right-hand section, representing the future.
23. Total number of Migrations and Interims in year 2010.
24. Total number of unique applications (bold number); and Legacies, and total of Migrations plus Interims (in parenthesis—Legacies follow “/”). Fiscal year at bottom applies to above two lines, and to entire diagram above.
25. On Summary Diagram, number of Legacies, Interims and Migrations existing as of 9/91. TBD means “to be determined.”
26. On Summary Diagram, number of Legacies, Interims and Migrations as of date that final Legacy scheduled to migrate, does so. Systems denoted by numbers in parenthesis continue by default until 2010 without change.
27. On Summary Diagram, arrowhead commences at date 01/2001 (see Fiscal Year line). Entries to right of this vertical line have dates between 01/2001 and 09/2010.

Migration Path Detail Report

2 Finance 3 Activity: Def. Bus. Operations Fund 4 8 Group: Supply Management, Navy 5 Subgroup: Operations 16 DBO0200 17 March 7, 1996

Acronym Alias (Migration / Legacy)	Application Title	Phase	Start Date		Migrates to	Mig Beg Date		Mig End Date	
			Month	Year		Month	Year	Month	Year
UADPS-RT	Interim Migration System (Supply Mgmt, Retail - NC1)	M	09	1994	UADPS-RT	01	2010	01	2010
MFCS-WH	Interim Migration System (Supply Mgmt, Wholesale - NC10)	I	09	1994	UADPS-RT	01	2010	01	2010
MFCS	Material Financial Control System (PX02, PX04, PX06)	L	09	1991	MFCS-WH	09	1995	09	1996
MICS	Medical Inventory Control System	L	09	1991	UADPS-RT	09	1994	09	1995
MUMMS	Marine Corps Unified Material Management System	L	09	1991	UADPS-RT	12	2010	12	2010
ROMS	Resale Operations Management System	L	09	1991	UADPS-RT	09	1995	09	1996
SAC 207	Shipboard Uniform ADP System, Special Accounting Class 207	L	09	1991	UADPS-RT	05	1995	04	1996
SUADPS-RT	Shipboard Uniform Automated Data Processing System - Real Tim	L	09	1991	UADPS-RT	09	1995	09	1996
UADPS-G03/G06	UADPS-ICP Integrated Disbursing and Accounting G03/G06	L	09	1991	MFCS-WH	09	1995	06	1996
UADPS-LEVEL II SF	Uniform Automated Data Processing System - Level II Stock Fund	L	09	1991	UADPS-RT	09	1993	09	1994
UADPS-SP-E&F	Uniform Automated Data Processing System - Stock Points E&F	L	09	1991	UADPS-RT	09	1996	09	1997

Table

MISSION SUPPORT 1 *Def. Bus. Operations Fund* 3 17 Current as of March 7, 1996
FINANCE 2 *Supply Management, Navy* 4
 LEGACY APPLICATIONS 5 Operations 5 → MIGRATION APPLICATIONS

Detail Diagram

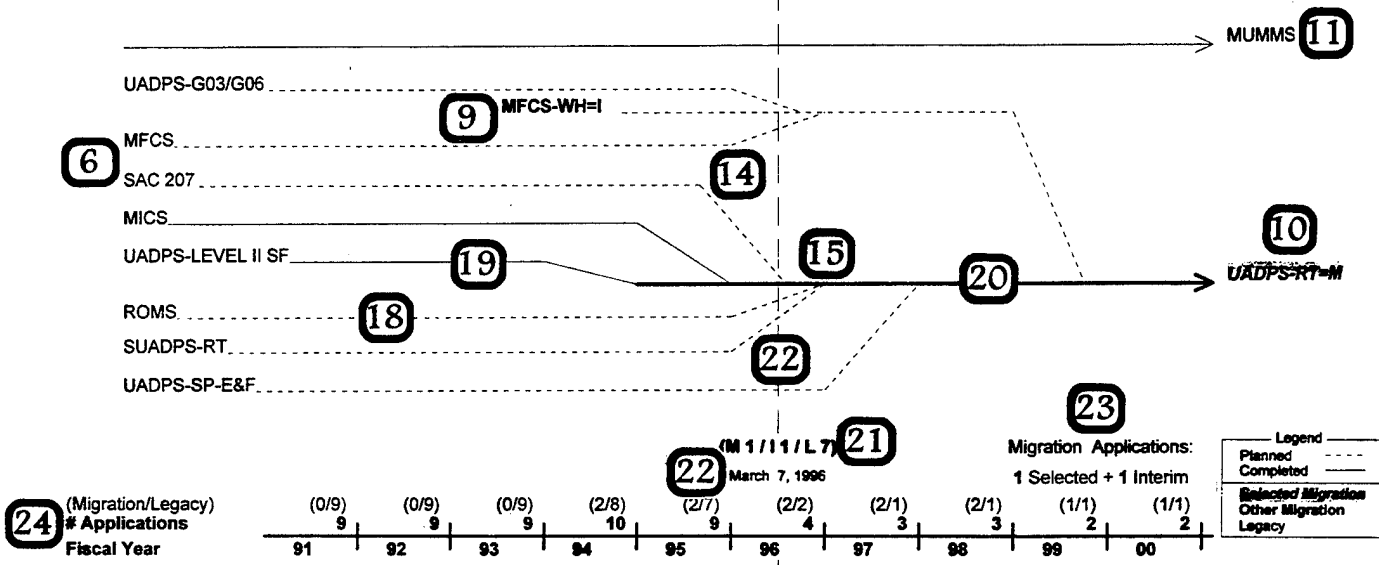

Summary Diagram

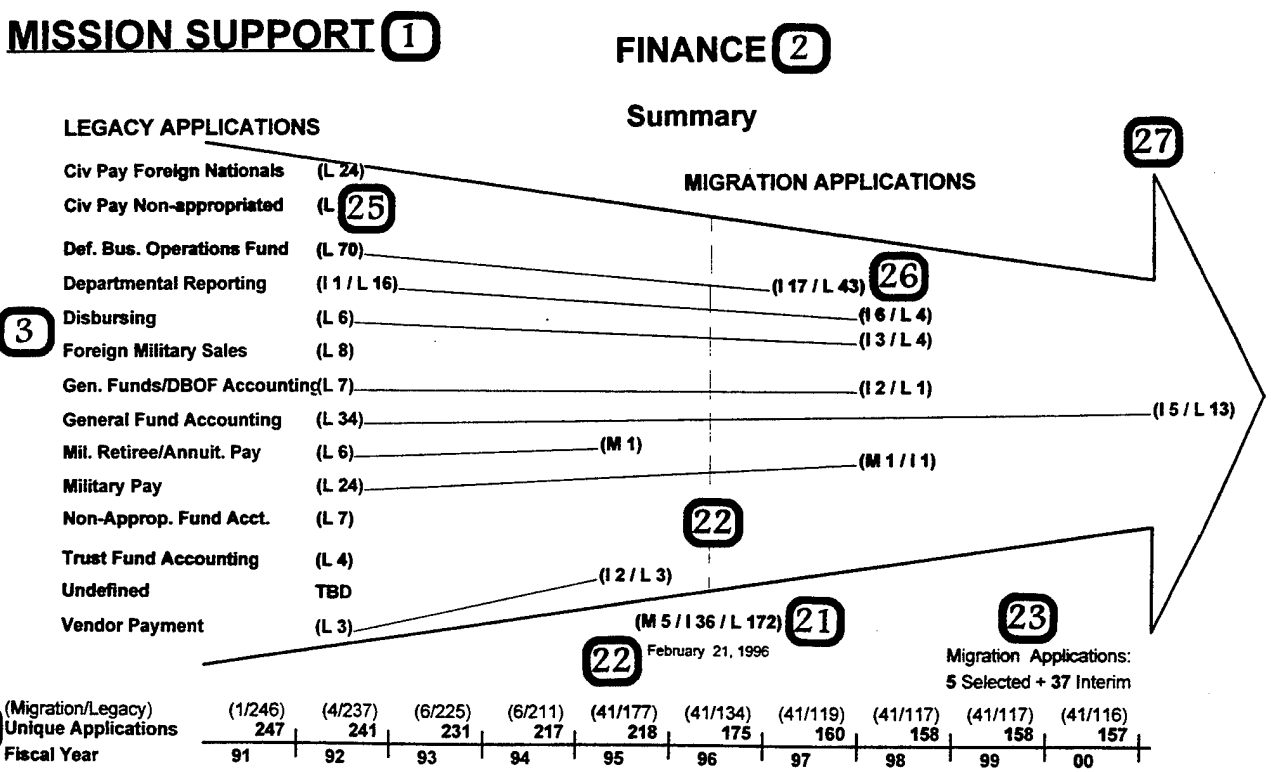



TABLE OF CONTENTS

**Table of Contents
Version 9**

Book One of Two (Mission Support)

Executive Summary
How to Read Migration Diagrams
Table of Contents
DoD Summary
Cross Functional Applications
Mission Support Migration Diagrams
 Acquisition & Technology Functional Areas
 Economic Security
 Environmental Security
 Logistics
 Meteorology & Oceanography
 NCB Defense Programs
 Procurement
 Science & Technology
 Systems Acquisition Management
 Test & Evaluation
 Other Mission Support Functional Areas
 Communications
 Finance
 Health
 Human Resources
 Information Management
 Inspector General
 Legal
 Policy
 Reserve Components

Book Two of Two (Other Missions)

Executive Summary
How to Read Migration Diagrams
Table of Contents
DoD Summary
Command and Control Migration Diagrams
Intelligence Migration Diagrams

DoD SUMMARY

DoD Migration Activity by Fiscal Year

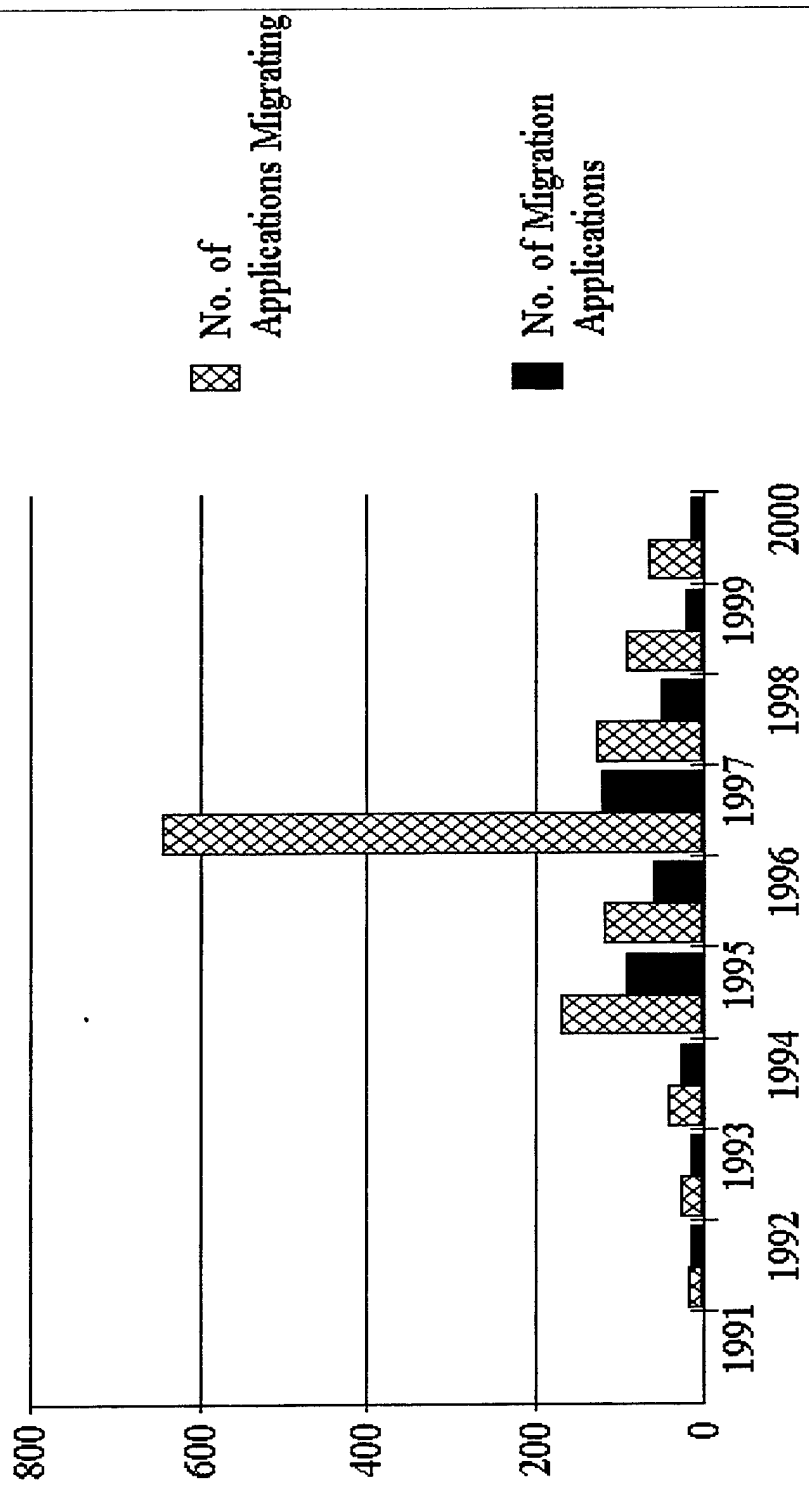

MISSION LEVEL

DOD SUMMARY

LEGACY APPLICATIONS

MIGRATION APPLICATIONS

Command and Control	(M 11 / L 62)	
Intelligence	(M 49 / I 3 / L 299)	
Communications	(M 1 / L 14)	(M 33)
Economic Security	TBD	
Environmental Security	(M 2 / I 2 / L 282)	(M 1 / I 1 / L 17)
Finance	(M 1 / I 2 / L 280)	(M 56 / L 15)
Health	(I 27 / L 54)	
Human Resources	(M 3 / I 5 / L 196)	(M 9 / I 3 / L 257) (M 7 / I 35 / L 110)
Information Management	(I 2 / L 21)	(M 4) (M 7 / I 6 / L 164)
Inspector General	(L 5)	(I 3 / L 11)
Legal	TBD	(M 2)
Logistics	(M 25 / I 4 / L 482)	(M 35 / I 2 / L 14)
Meteorology & Oceanography	(M 33 / L 34)	TBD
NCB Defense Programs	TBD	(M 7) (M 1)
Other	TBD	
Policy	(M 6 / L 3)	
Procurement	(L 71)	
Reserve Components	TBD	
Science & Technology	(L 102)	
Systems Acquisition Management	TBD	(M 180 / I 112 / L 1630)
Test & Evaluation	TBD	

April 1, 1996
Migration Applications:
225 Selected + 138 Interim

(Migration/Legacy)	(180/1876)	(192/1839)	(206/1824)	(219/1782)	(285/1677)	(301/1570)	(320/1002)	(314/896)	(278/843)	(269/791)
Unique Applications	2056	2031	2030	2001	1962	1871	1322	1210	1121	1060
Fiscal Year	91	92	93	94	95	96	97	98	99	00



COMMAND AND CONTROL

Command and Control Migration Activity by Fiscal Year

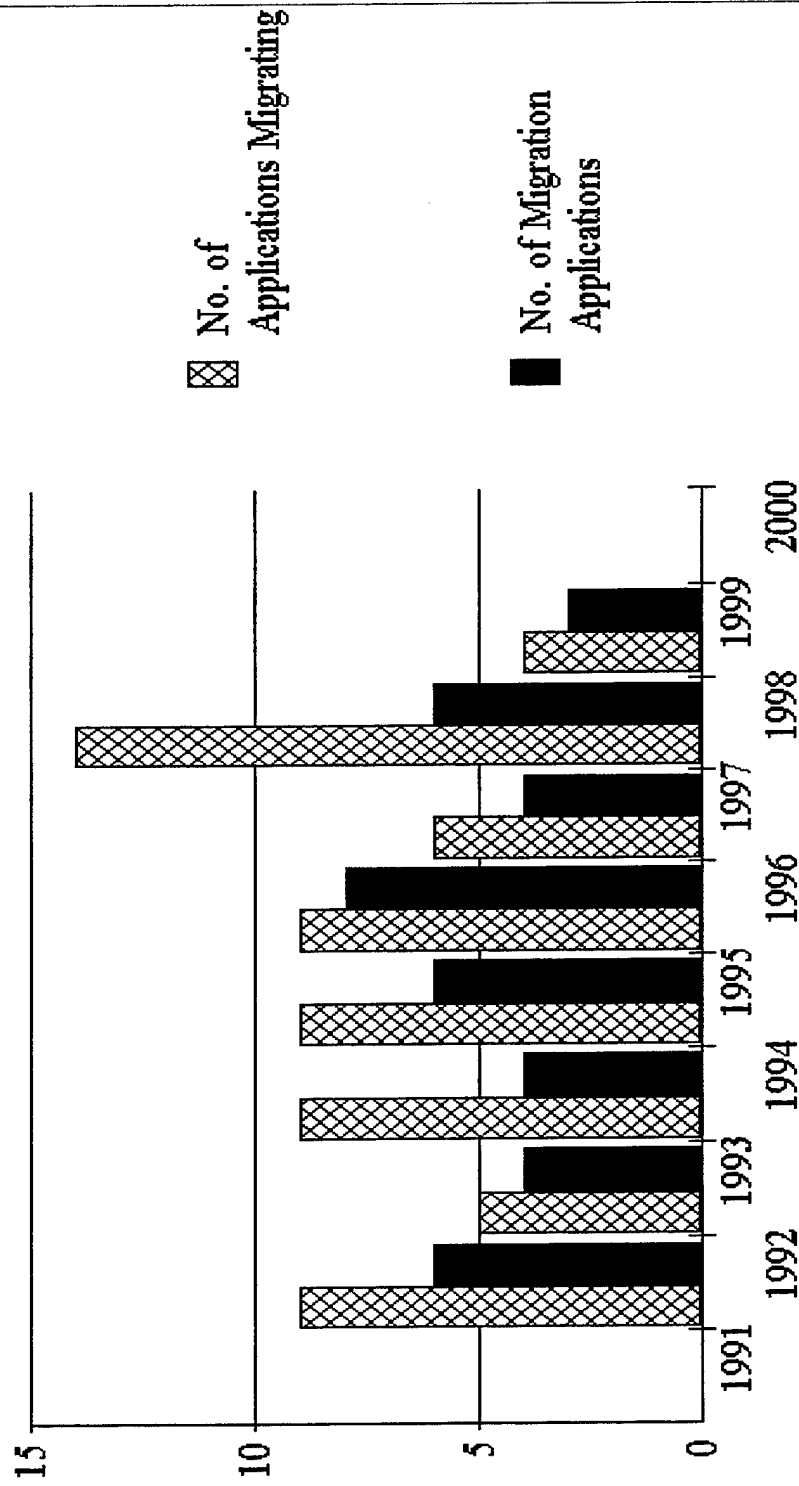

COMMAND AND CONTROL Summary

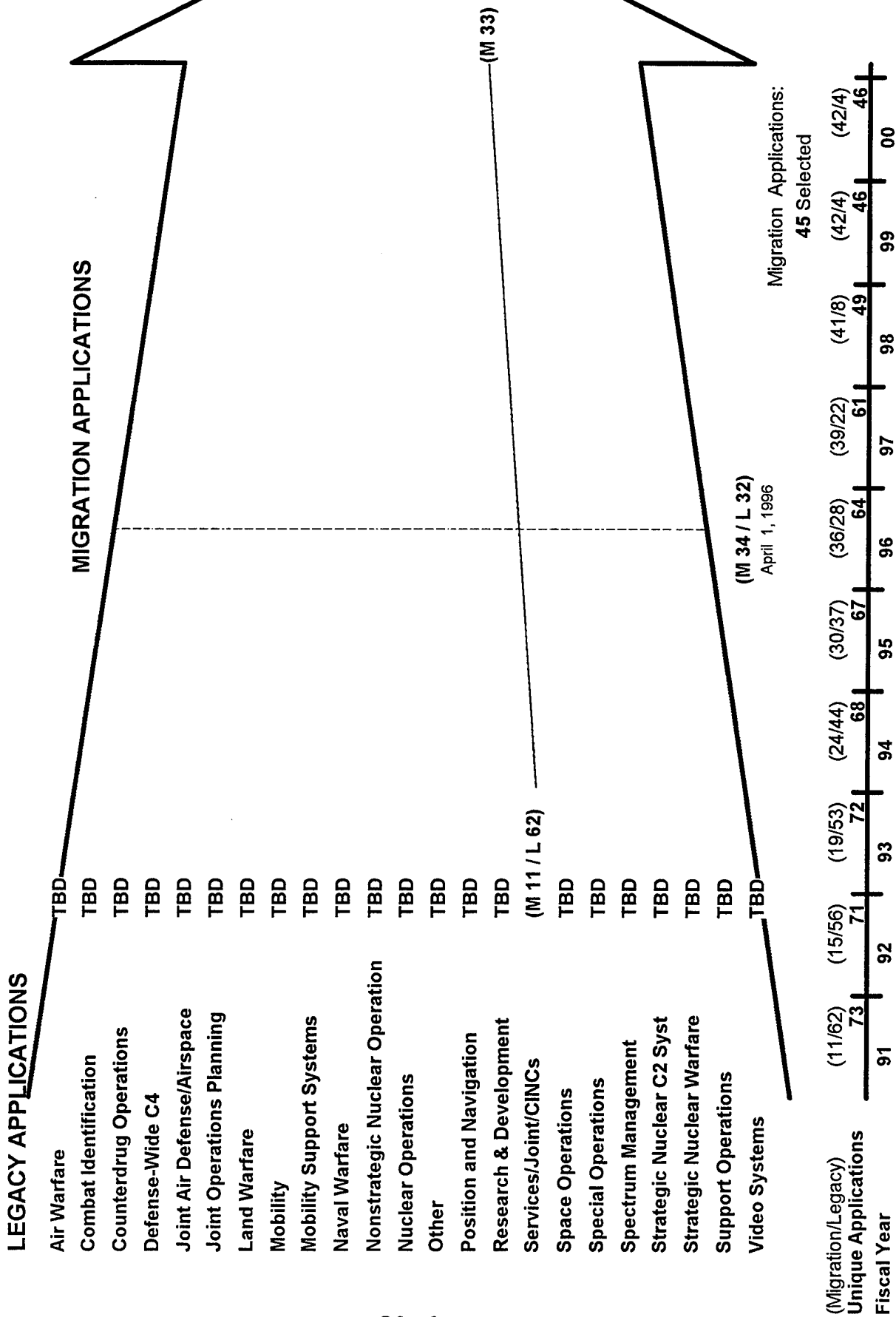

COMMAND AND CONTROL SERVICES/JOINT/CINCS

Summary

LEGACY APPLICATIONS

MIGRATION APPLICATIONS

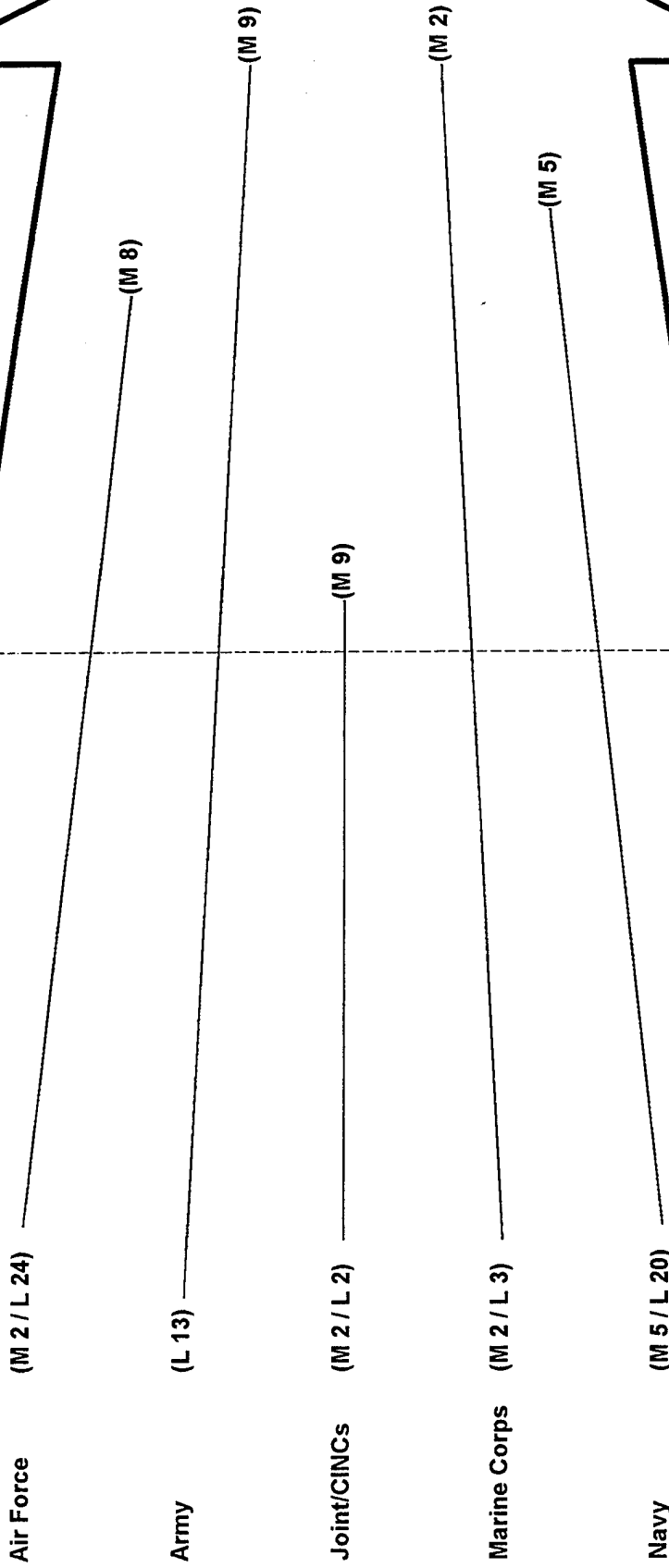

(M 34 / L 32)

April 1, 1996

Migration Applications:

45 Selected

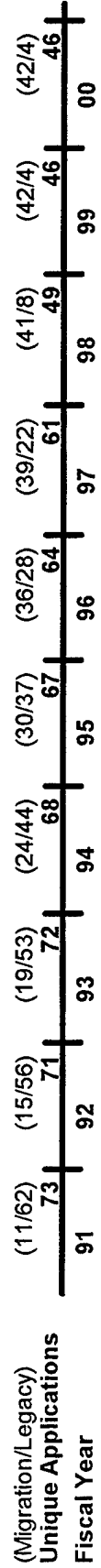

Services/Joint/CINCs
Activity: Air Force

Migration Path Detail Report

April 1, 1996
AIR1000

Acronym Alias (Migration / Legacy)	Application Title	Phase	Start Date		Migrates to		Mig Beg Date		Mig End Date	
			Month	Year	Month	Year	Month	Year	Month	Year
JMAPS	Joint Message Analysis and Processing System	M	09	1991			01	2010	01	2010
JMPS	Joint Message Preparation System	M	09	1991			01	2010	01	2010
C2IPS	Command and Control Information Processing System	M	06	1992			01	2010	01	2010
CTAPS	Contingency Theater Automated Planning System	M	10	1992			01	2010	01	2010
DCAPES	Deliberate Crisis Action Planning and Execution System	M	01	1994			01	2010	01	2010
WCCS	Wing Command and Control System	M	06	1994			01	2010	01	2010
AFMSS	Air Force Mission Support System	M	01	1995			01	2010	01	2010
ACFP	Advanced Computer Flight Plan System	M	08	1995			01	2010	01	2010
3DS	Digital Decision Display System	L	09	1991		CTAPS	12	1997	12	1997
AFC2S	Air Force Command and Control System	L	09	1991		DCAPES	01	1994	01	1994
ASDS	Air Situation Display System	L	09	1991		CTAPS	12	1997	12	1997
CADS	Combat Airspace Deconfliction	L	09	1991		CTAPS	12	1997	12	1997
CAFMS	Computer Assisted Force Management System	L	09	1991		CTAPS	12	1997	12	1997
CFMS	Combat Fuels Management System	L	09	1991		DCAPES	01	1994	01	1994
CMPPS	Conventional Munitions Planning and Preparation System	L	09	1991		AFMSS	10	1997	10	1997
COMPES	Contingency Operation/Mobility Planning and Execution System	L	09	1991		DCAPES	01	1997	01	1997
CSMS/D226	Combat Supplies Management System	L	09	1991		DCAPES	01	1994	01	1994
CTIS	Combat Terrain Information System	L	09	1991		WCCS	09	1995	09	1995
FAST	Force Augmentation Status and Tracking	L	09	1991		DCAPES	01	1994	01	1994
FPLAN	Flight Plan	L	09	1991		AFMSS	01	1995	01	1995
FSM	Flight Simulation Model	L	09	1991		ACFP	12	1997	12	1997
HAFCOMPES	HQ Air Force COMPES	L	09	1991		DCAPES	01	1994	01	1994
JAMPS	Joint Automated Message Preparation System	L	09	1991		CTAPS	10	1995	10	1995
MDPS	Mission Data Preparation System	L	09	1991		AFMSS	01	1998	01	1998
MSSII	Mission Support System II	L	09	1991		AFMSS	01	1999	01	1999
OMCFP	Unkown	L	09	1991		ACFP	12	1997	12	1997
SMDPS	Strategic Mission Data Preparation System	L	09	1991		AFMSS	01	1999	01	1999
SORTS-DIS	SORTS Designed Operational Capability (DOC) Inform	L	09	1991		DCAPES	01	1994	01	1994
STAMPS	Strategic Tactical Air Mission Planning System	L	09	1991		AFMSS	04	1996	04	1996
TTSD/JMI	Unkown	L	09	1991		CTAPS	12	1997	12	1997
WINGS	Wing Integration For Global Support	L	09	1991		C2IPS	07	1996	07	1996
WMP 3/5	War and Mobilization Planning System	L	09	1991		DCAPES	01	1997	01	1997

Migration Path Detail Report

Services/Joint/CINCs

Activity: Air Force (cont'd)

April 1, 1996

AIR1000

Acronym Alias (Migration / Legacy)	Application Title	Phase	Start Date		Migrates to		Mig Beg Date		Mig End Date	
			Month	Year			Month	Year	Month	Year
TAMS	Theater Airlift Management System	L	10	1991	C2IPS		07	1997	07	1997
CAASS (AMC)	Command Airlift Aircrew Scheduling System	L	10	1992	C2IPS		12	1998	12	1998

COMMAND AND CONTROL SERVICES/JOINT/CINCS

Air Force

Current as of April 3, 1996

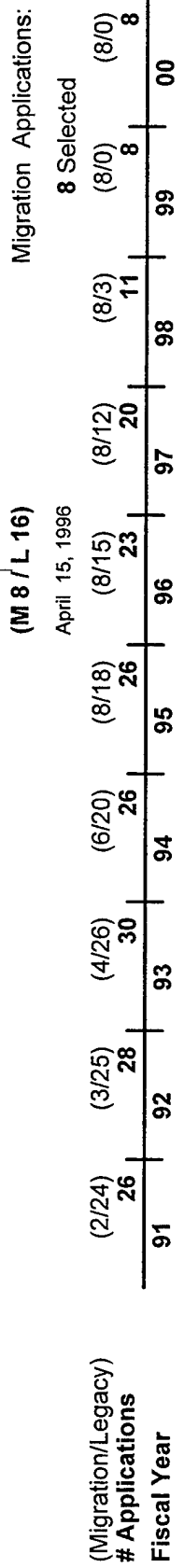
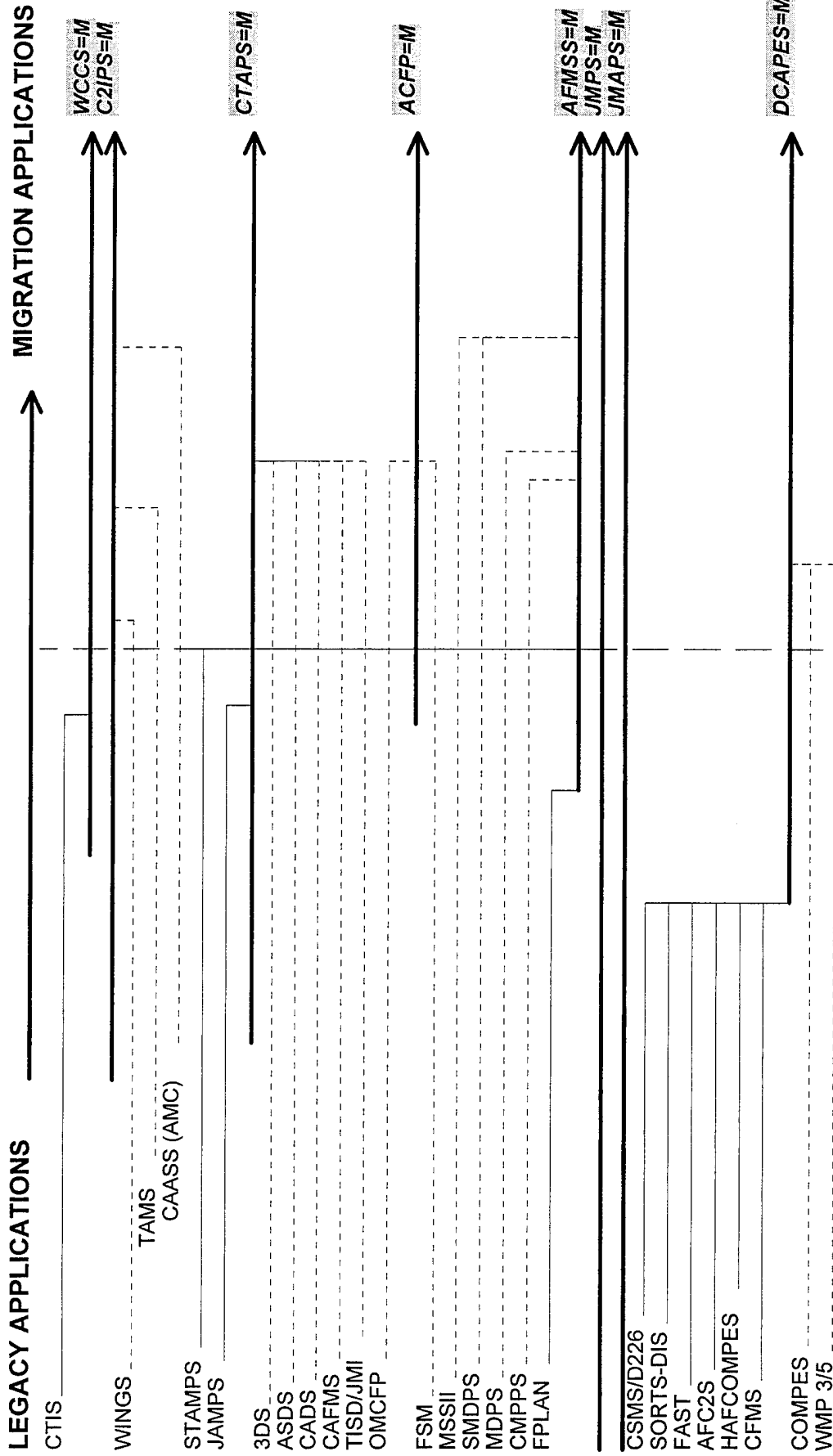

Legend
Planned
Completed
Selected Migration
Other Migration
Legacy

Migration Path Detail Report

Services/Joint/CINCS
Activity: Army

April 1, 1996
ARM1000

Acronym Alias (Migration / Legacy)	Application Title	Phase	Start Date		Migrates to	Mig Beg Date		Mig End Date	
			Month	Year		Month	Year	Month	Year
ASAS	All Source Analysis System	M	01	1992		01	2010	01	2010
CM/CMS	Counter Narcotics Command Management Control System	M	01	1992		01	2010	01	2010
FAADC2I	Forward Area Air Defense Command and Control Intelligence System	M	09	1993		01	2010	01	2010
ARCIS	Army Company Information System	M	12	1993		01	2010	01	2010
AFATDS	Advanced Field Artillery Tactical Data System	M	08	1995		01	2010	01	2010
AGCCS	Army Global Command and Control Systems	M	09	1995		01	2010	01	2010
CSSCS	Combat Service Support Control System	M	01	1997		01	2010	01	2010
MCS	Maneuver Control System	M	06	1998		01	2010	01	2010
DTSS	Digital Topographic Support System (USA)	M	09	1999		01	2010	01	2010
BCS	Battery Computer System	L	01	1979	AFATDS	01	2005	01	2005
TSS	Topographic Control System	L	06	1985	DTSS	10	2005	10	2005
AWIS	Army WWMCCS Information System	L	09	1991	AGCCS	09	1995	09	1995
CIS	Combat Identification System	L	09	1991	ARCIS	03	1996	03	1996
HAWKEYE	Hawkeye	L	09	1991	ASAS	01	1992	01	1992
LTACFIRE	Lightweight Tactical Fire Direction System	L	09	1991	AFATDS	01	2006	01	2006
STACCS	Standard Theater Army Command and Control System	L	09	1991	AGCCS	09	1995	09	1995
TACCIMS	Theater Automated Command and Control Information Management	L	09	1991	AGCCS	07	1997	07	1997
TACFIRE	Tactical Fire Direction System	L	09	1991	AFATDS	08	1995	02	1996
TCAC	Technical Control and Analysis Center System	L	09	1991	ASAS	09	1994	09	1994
UCCS	USEUCOM Command & Control System	L	09	1991	AGCCS	12	1995	12	1995
UTACCS	USAREUR Tactical Command and Control System	L	09	1991	STACCS	01	1992	01	1992
WARRIOR	Warrior	L	09	1991	ASAS	01	1996	01	1996
IFSAS	Interim Fire Support Automated System	L	08	1993	AFATDS	01	2007	01	2007

Migration Path Detail Report

Services/Joint/CINCS
Activity: Joint/CINCS

April 1, 1996
JC11000

Acronym Alias (Migration / Legacy)	Application Title	Phase	Start Date		Migrates to		Mig Beg Date		Mig End Date	
			Month	Year			Month	Year	Month	Year
ADNET	Anti-Drug Network	M	04	1988			01	2010	01	2010
CCSS	USSTRATCOM Command Center Support Systems	M	02	1989			01	2010	01	2010
SWPS	Strategic War Planning System	M	04	1993			01	2010	01	2010
TCCS	Theater Command & Control System	M	04	1993			01	2010	01	2010
GCCS	Global Command and Control System	M	01	1994			01	2010	01	2010
NCCS	NMCC Command And Control System	M	04	1995			01	2010	01	2010
ASOCNET	Army Special Operations Command Network	M	06	1995			01	2010	01	2010
NPES II	Nuclear Planning and Execution System II	M	10	1995			01	2010	01	2010
SOFPARS	SOF Operations Force Planning and Rehearsal System	M	07	1996			01	2010	01	2010
WWMCCS	World Wide Military Command and Control System	L	01	1970	GCCS		09	1996	09	1996
JOPEX	Joint Operation Planning and Execution System	L	09	1991	GCCS		09	1996	09	1996

COMMAND AND CONTROL SERVICES/JOINT/CINCS

Joint/CINCS

Current as of April 3, 1996

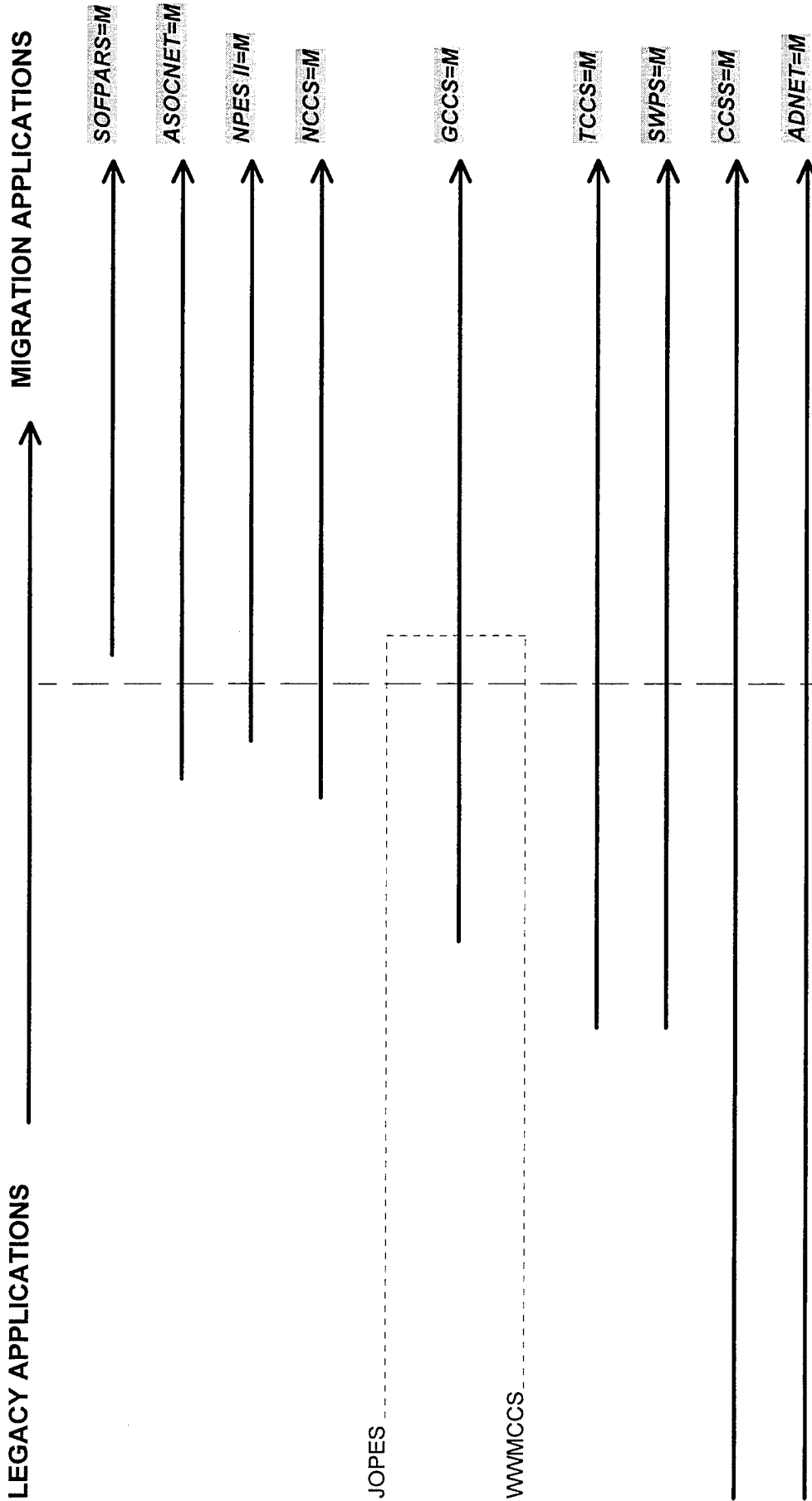

Migration Applications:

(M 8 / L 2)

April 15, 1996

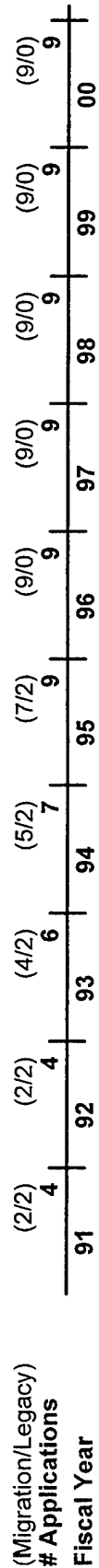

Legend
Planned
Completed
Selected Migration
Other Migration
Legacy

Migration Path Detail Report

Services/Joint/CINCs
Activity: Marine Corps

April 1, 1996
MAR1000

Acronym Alias (Migration / Legacy)	Application Title	Phase	Start Date		Migrates to		Mig Beg Date		Mig End Date	
			Month	Year			Month	Year	Month	Year
PLRS	Position Location Reporting System	M	10	1984			12	2000	12	2000
SPEED	Systems Planning, Engineering and Evaluation Device	M	04	1990			12	2000	12	2000
TAOM	Tactical Air Operations Module	M	10	1991			12	2000	12	2000
TOPO SET	Topographic Set	M	10	1991			01	2010	01	2010
TCO	Tactical Combat Operations System	M	10	1995			12	2000	12	2000
ATACC	Advanced Theater Air Command Center	M	04	1996			12	2000	12	2000
MTWS	Marine Air-Ground Task Force Tactical Warfare Simulation	M	04	1996			12	2000	12	2000
IAS	Intelligence Analysis System	M	06	1996			01	2010	01	2010
IDASC	Improved Direct Air Support Central	M	10	1996			12	2000	12	2000
ADCP	Air Defense Communications Platform	M	07	1997			12	2000	12	2000
AFATDS	Advanced Field Artillery Tactical Data System	M	01	1998			12	2000	12	2000
MCSSC2	Marine Combat Service Support Command and Control System	M	07	1998			12	2000	12	2000
TDCC	Tactical Data Communications Central	L	08	1980		ATACC	01	1997	01	1997
TACC	USMC Tactical Air Command and Control	L	09	1991		ATACC	01	1997	01	1997
TAOC	USMC Tactical Air Ops Center	L	09	1991		TAOM	01	1992	01	1992
MCFSS	Marine Corps Fire Support System	L	10	1994		AFATDS	01	1998	01	1998

COMMAND AND CONTROL SERVICES/JOINT/CINCS

Marine Corps

Current as of April 3, 1996

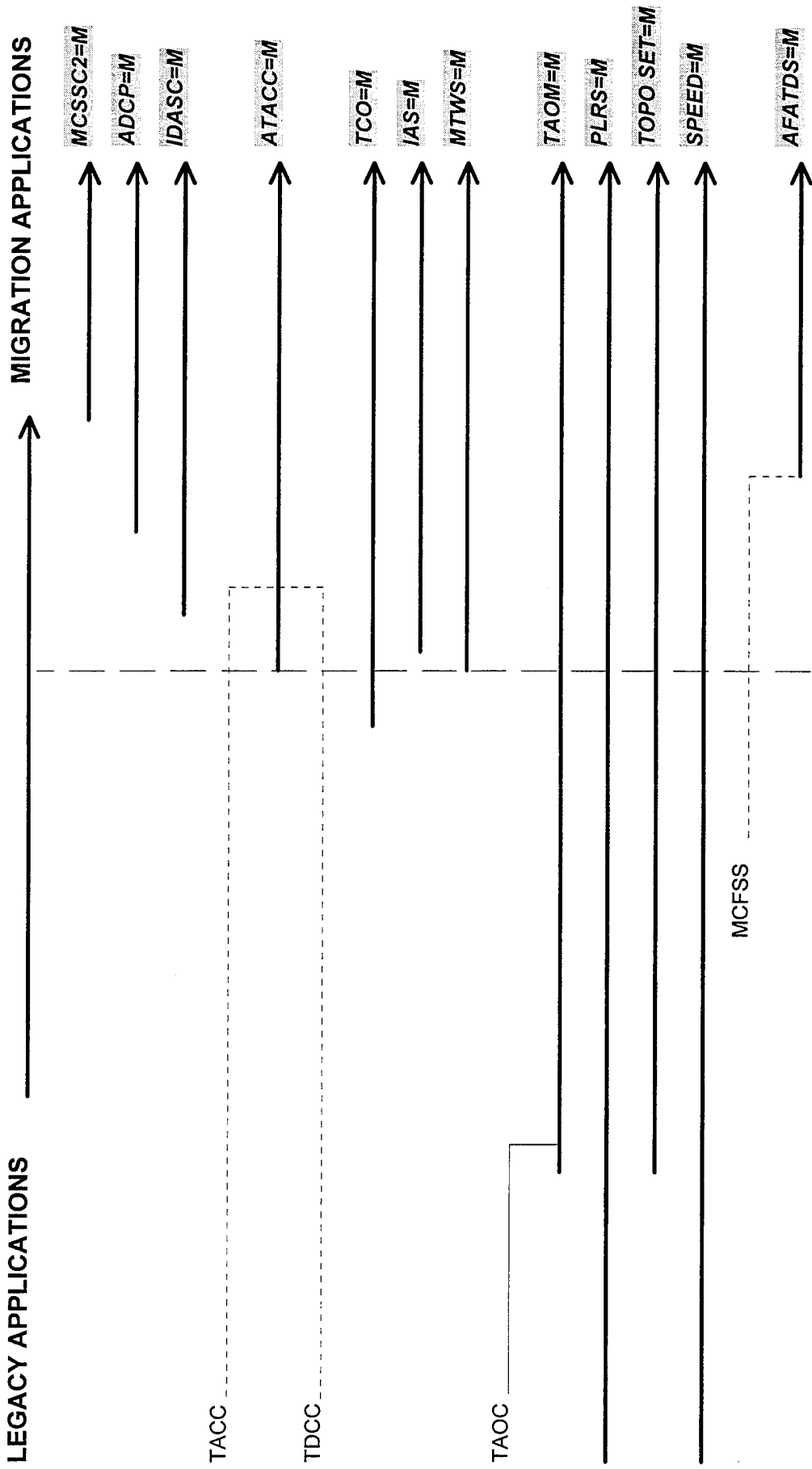

Migration Applications:

(Migration/Legacy) # Applications	91	92	93	94	95	96	97	98	99	00
12 Selected										
(2/3)	5	(4/2)	(4/2)	(4/2)	(4/3)	(8/3)	(10/1)	(12/0)	(12/0)	(12/0)
		6	6	6	7	11	11	12	12	12
Fiscal Year										

Legend	-----
Planned	-----
Completed	-----
Selected Migration	-----
Other Migration	-----
Legacy	-----

Migration Path Detail Report

Services/Joint/CINCS

Activity: Navy

April 1, 1996

NAV1000

Acronym Alias (Migration / Legacy)	Application Title	Phase	Start Date		Migrates to		Mig Beg Date		Mig End Date	
			Month	Year	Month	Year	Year	Month	Year	Month
OSS	Operations Support System	M	05	1987			01	2010	01	2010
MRMS	Maintenance Resource Management System	M	09	1991		NTCSS	09	1992	09	1992
NALCOMIS	Naval Aviation Logistics Command Management Information System	M	09	1991		NTCSS	07	1995	07	1995
NTCS-A/NIPS	Naval Tactical Command System - Afloat	M	09	1991			01	2010	01	2010
SNAP III	Shipboard Non-Tactical ADP Program III	M	09	1991		NTCSS	09	1992	09	1992
NTCSS	Naval Tactical Command Support System	M	09	1992			01	2010	01	2010
TAMPS	Tactical Aircraft Mission Planning System	M	09	1994			01	2010	01	2010
TSC	Tactical Support Center	M	03	1995			01	2010	01	2010
ACS	Afloat Correlation System	L	09	1991		NTCS-A/NIPS	12	1992	12	1992
ATP	Advanced Tracking Prototype	L	09	1991		NTCS-A/NIPS	12	1991	12	1991
CHAMPS	Common Helicopter Aircraft Mission Planning System	L	09	1991		TAMPS	12	1997	12	1997
CLI	Communication Line Interface	L	09	1991		OSS	09	1993	10	1994
EWCM	Electronic Warfare Coordination Module	L	09	1991		NTCS-A/NIPS	12	1992	12	1992
FDDS	Flag Display Distribution System	L	09	1991		NTCS-A/NIPS	12	1991	12	1991
FHLT	FHLT	L	09	1991		OSS	09	1993	09	1993
FIST	Fleet Imagery Support Terminal	L	09	1991		NTCS-A/NIPS	12	1991	12	1991
JOTS	Joint Operational Tactical System	L	09	1991		NTCS-A/NIPS	12	1993	12	1993
JTU	JINTACCS Translator Unit	L	09	1991		OSS	04	1995	04	1995
MOMS	AV8B Map Operator and Maintenance Station	L	09	1991		TAMPS	09	1999	09	1999
NWSS	Navy WMMCCS Software Standardization	L	09	1991		OSS	04	1995	04	1995
PC-NIPS	Personnel Computer Naval Intelligence Processing S	L	09	1991		NTCS-A/NIPS	03	1994	03	1994
POST	Prototype Ocean Surveillance Terminal (USN)	L	09	1991		NTCS-A/NIPS	06	1993	06	1993
SNAP III JTU	Shipboard Non-Tactical ADP Program III JTU	L	09	1991		SNAP III	09	1992	09	1992
STT	STT	L	09	1991		OSS	04	1995	04	1995
TEAMS	Tactical EA-6B Mission Support System	L	09	1991		TAMPS	12	1997	12	1997
TIMS	Tank Inventory Management System	L	09	1991		NTCS-A/NIPS	03	1993	03	1993
TSCM	Tomahawk Strike Coordination Module	L	09	1991		TAMPS	12	1997	12	1997
VIPER	VIPER	L	09	1991		TAMPS	12	1997	12	1997

COMMAND AND CONTROL SERVICES/JOINT/CINCS

Navy

Current as of April 3, 1996

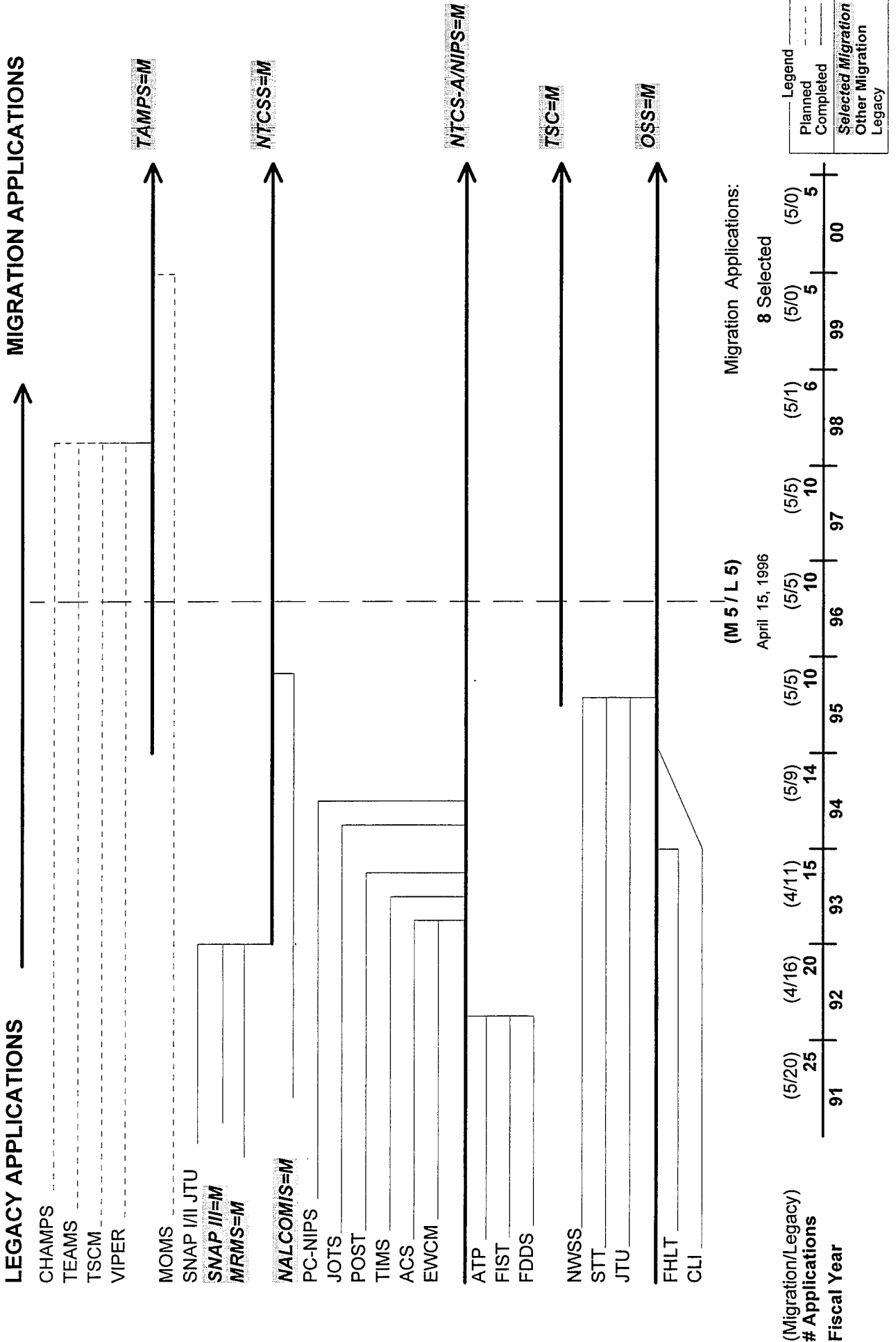

INTELLIGENCE

Intelligence Migration Activity by Fiscal Year

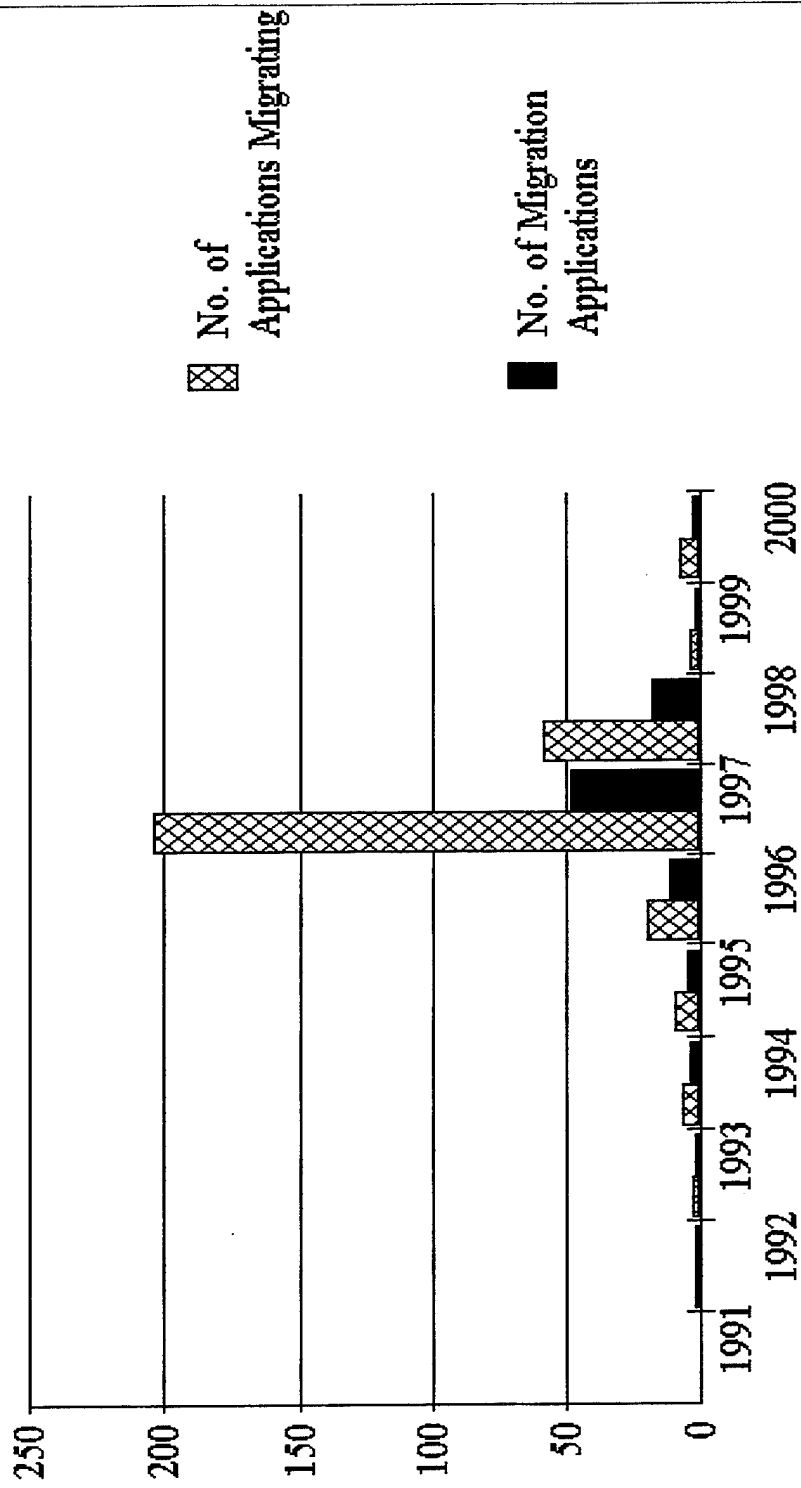

INTELLIGENCE Summary

LEGACY APPLICATIONS

MIGRATION APPLICATIONS

All Source Intel/Ops Interfac	(M 2 / L 24)	
Collection	(M 4 / L 13)	(M 7)
Counter Intelligence	(M 1 / L 28)	(M 3)
Dissemination	(L 55)	(M 1)
Other	TBD	(M 2 / L 2)
Planning and Direction	(M 2 / L 7)	(M 1)
Processing	(L 1)	(M 1)
Production	(M 38 / I 3 / L 164)	(M 3)
Support	(M 2 / L 14)	(M 38 / L 13)
		(M 57 / I 3 / L 265)

April 1, 1996

Migration Applications:
71 Selected + 4 Interim

(Migration/Legacy)	(52/299)	(55/298)	(55/297)	(55/290)	(61/281)	(63/262)	(60/79)	(57/28)	(58/24)	(57/17)
Unique Applications	351	353	352	345	342	325	139	85	82	74
Fiscal Year	91	92	93	94	95	96	97	98	99	00

THIS PAGE INTENTIONALLY LEFT BLANK

INTELLIGENCE

ALL SOURCE INTEL/OPS INTERFAC Summary

LEGACY APPLICATIONS

MIGRATION APPLICATIONS

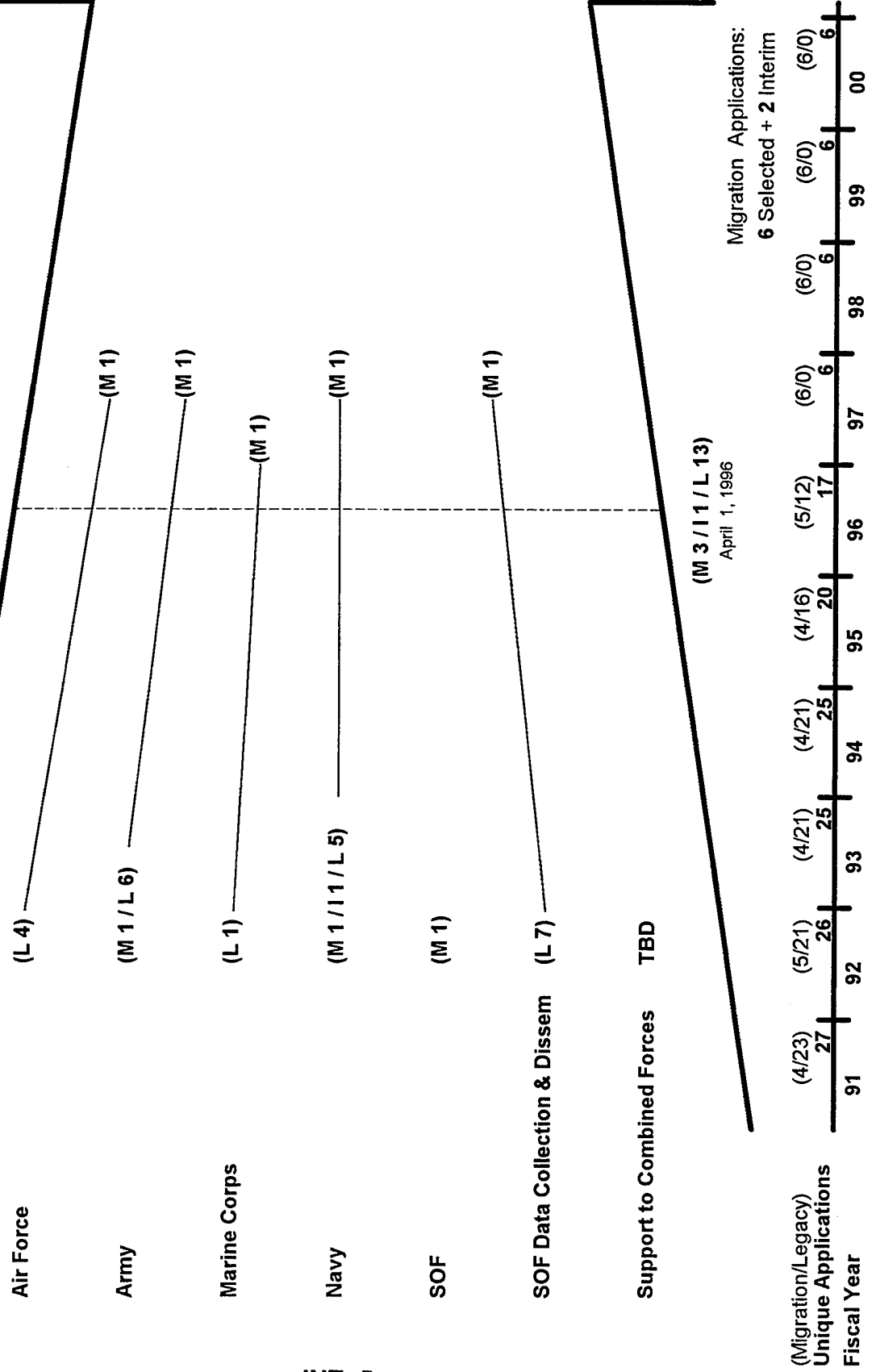

(M 3 / I 1 / L 13)
April 1, 1996

Migration Applications:
6 Selected + 2 Interim

Migration Path Detail Report

All Source Intel/Ops Interfac
Activity: Air Force

April 1, 1996

AFI0100

Acronym Alias (Migration / Legacy)	Application Title	Phase	Start Date		Migrates to	Mig Beg Date		Mig End Date	
			Month	Year		Month	Year	Month	Year
C/S	Combat Intelligence Systems	M	04	1997		01	2010	01	2010
CONSTANT SOURCE	Constant Source	L	09	1991	CIS	04	1996	04	1997
ICM	Intelligence Correlation Module	L	09	1991	CIS	04	1996	04	1997
RAAP	Rapid Application of Air Power	L	09	1991	CIS	04	1996	04	1997
SENTINEL BYTE	Sentinel Byte	L	09	1991	CIS	04	1996	04	1997

INTELLIGENCE

Air Force

Current as of January 1, 1989

ALL SOURCE INTEL/OPS INTERFAC

LEGACY APPLICATIONS

MIGRATION APPLICATIONS

CIS-M

CONSTANT SOURCE

ICM

RAAP

SENTINEL BYTE

Migration Applications:

1 Selected

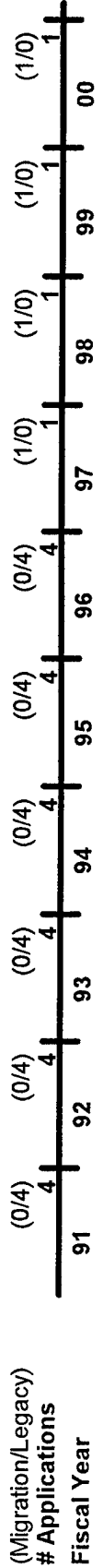

(L 4)

April 1, 1996

(Migration/Legacy)

Applications

Fiscal Year

Legend

Planned

Completed

Selected Migration

Other Migration

Legacy

Migration Path Detail Report

All Source Intel/Ops Interfac
Activity: Army

April 1, 1996

ARM0100

Acronym Alias (Migration / Legacy)	Application Title	Phase	Start Date		Migrates to		Mig Beg Date		Mig End Date	
			Month	Year			Month	Year	Month	Year
ASAS	All Source Analysis System	M	09	1991			01	2010	01	2010
ETUT	Enhanced Tactical User's Terminal	L	09	1991	ASAS		09	1994	09	1995
FAISS/e	FORSCOM Automated Intelligence Support System/extended	L	09	1991	ASAS		04	1996	04	1997
HAWKEYE	Hawkeye	L	09	1991	ASAS		09	1994	09	1995
MICROFIX	Microfix	L	09	1991	ASAS		09	1994	09	1995
TCAC	Technical Control and Analysis Center System	L	09	1991	ASAS		09	1994	09	1995
WARRIOR	Warrior	L	09	1991	ASAS		09	1994	09	1995

Migration Path Detail Report

All Source Intel/Ops Interfac
Activity: Marine Corps

April 1, 1996

MCI0100

Acronym Alias (Migration / Legacy)	Application Title	Phase	Start Date		Migrates to		Mig Beg Date		Mig End Date	
			Month	Year			Month	Year	Month	Year
IAS	Intelligence Analysis System	M	09	1996			01	2010	01	2010
IAS	Intelligence Analysis Center	L	09	1991	IAS		09	1995	09	1996

INTELLIGENCE

Marine Corps

Current as of January 1, 1989

ALL SOURCE INTEL/OPS INTERFAC

LEGACY APPLICATIONS

MIGRATION APPLICATIONS

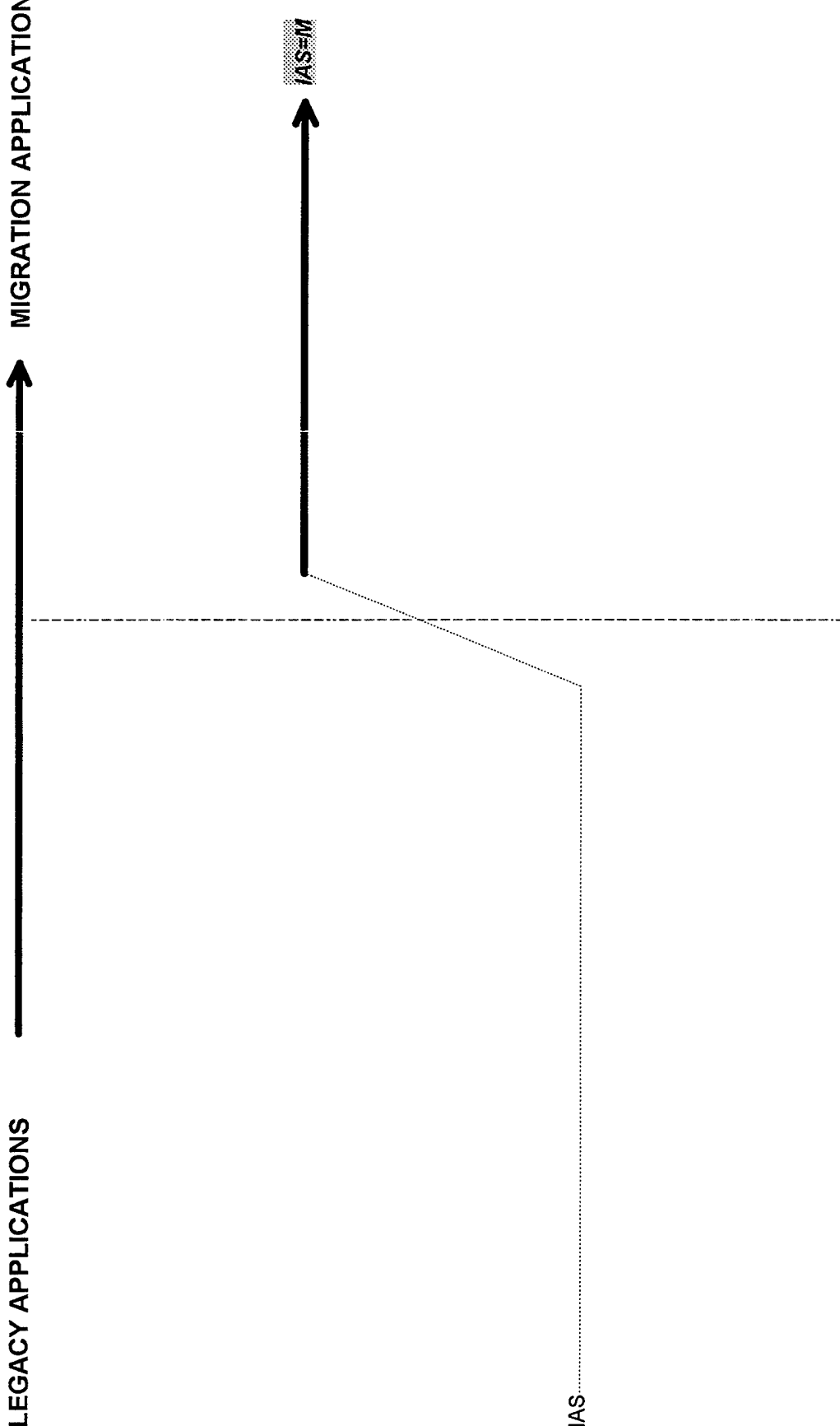

IAS

(Migration/Legacy)
Applications
Fiscal Year

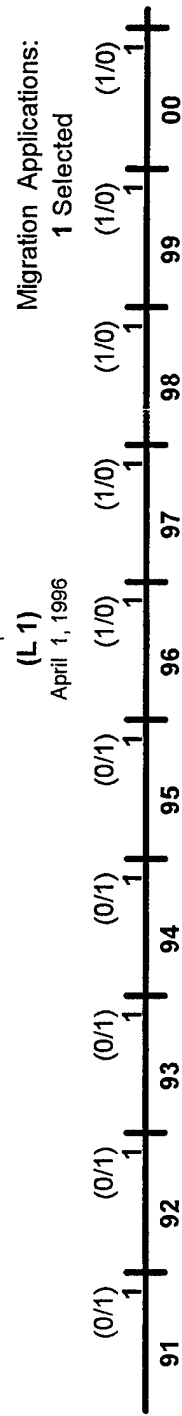

Legend	
Planned
Completed
Selected Migration
Other Migration
Legacy

Migration Path Detail Report

All Source Intel/Ops Interfac
Activity: Navy

April 1, 1996

NAV0100

Acronym Alias (Migration / Legacy) <i>JMCIS (Architecture)</i>	Application Title	Phase	Start Date		Migrates to		Mig Beg Date		Mig End Date	
			Month	Year			Month	Year	Month	Year
	Joint Maritime Comamnd Information System	M	09	1991	JMCIS (Architecture)		01	2010	01	2010
OBU	OSIS Baseline Upgrade (OBU)/OED	I	09	1991	JMCIS (Architecture)		04	1996	04	1997
NTCS-AFLOAT	Naval Tactical Command System - Afloat	I	01	1992	JMCIS (Architecture)		06	1992	06	1993
ACS	ACS	L	09	1991	JMCIS (Architecture)		10	1994	10	1995
ATP	Advanced Tracking Prototype	L	09	1991	JMCIS (Architecture)		10	1994	10	1995
EWCM	Electronic Warfare Coordination Module	L	09	1991	JMCIS (Architecture)		10	1994	10	1995
JOTS	JOTS	L	09	1991	NTCS-AFLOAT		10	1991	01	1992
NIPS	Naval Intelligence Processing System	L	09	1991	NTCS-AFLOAT		10	1991	01	1992

INTELLIGENCE

Navy

Current as of April 9, 1996

ALL SOURCE INTEL/OPS INTERFAC

LEGACY APPLICATIONS

MIGRATION APPLICATIONS

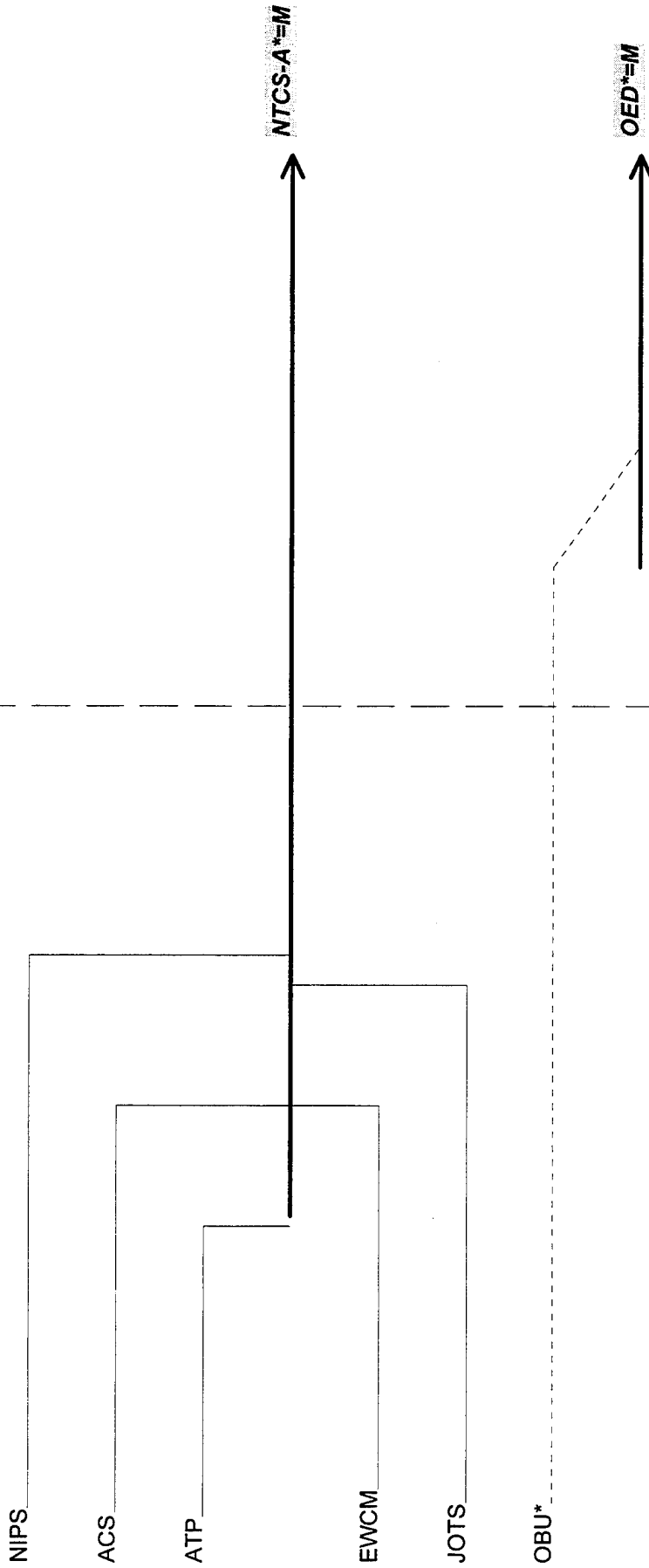

* These systems use JMCIS as a common operating environment.

(M 1 / L 1)
April 1, 1996

(Migration/Legacy) # Applications	91	92	93	94	95	96	97	98	99	00
Migration Applied	0/6	1/5	1/3	1/1	1/1	1/1	2/1	2/0	2/0	2/0
2 Selected	6	6	4	2	2	2	3	2	2	2

Legend
Planned
Completed
Selected Migration
Other Migration
Legacy

Migration Path Detail Report

All Source Intel/Ops Interfac
Activity: SOF

April 1, 1996

DCD0101

Acronym Alias (Migration / Legacy)	Application Title	Phase	Start Date		Migrates to		Mig Beg Date		Mig End Date	
			Month	Year	Month	Year	Month	Year	Month	Year
SOF-IV	Special Operations Forces Intelligence Vehicle	M	09	1991			01	2010	01	2010

SOF

INTELLIGENCE

ALL SOURCE INTEL/OPS INTERFAC

LEGACY APPLICATIONS

MIGRATION APPLICATIONS

SOF IV=M

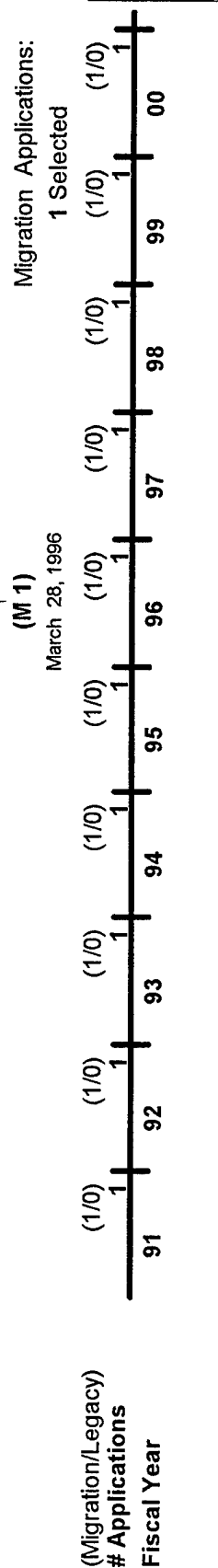

Migration Path Detail Report

All Source Intel/Ops Interfac
 Activity: SOF Data Collection & Dissem

April 1, 1996

SOF0200

ISP Acronym Alias (Migration / Legacy)	Application Title	Phase	Start Date		Migrates to	Mig Beg Date		Mig End Date		
			Month	Year		Month	Year	Month	Year	
	Integrated Survey Program	M	04	1997			01	2010	01	2010
CONSTANT LOOK	Constant Look	L	09	1991	ISP		04	1996	04	1997
DNA EASO ELEMENT	DNA EASO Element	L	09	1991	ISP		04	1996	04	1997
ESAT	EUCOM Survey and Assessment Team	L	09	1991	ISP		04	1996	04	1997
IST	Interagency Survey Team	L	09	1991	ISP		04	1996	04	1997
MOSP	Maritime Operational Support Program	L	09	1991	ISP		04	1996	04	1997
RST	Regional Survey Teams	L	09	1991	ISP		04	1996	04	1997
STP	Surrogate Travel Program	L	09	1991	ISP		04	1996	04	1997

THIS PAGE INTENTIONALLY LEFT BLANK

INTELLIGENCE

COLLECTION

Summary

LEGACY APPLICATIONS

MIGRATION APPLICATIONS

Collection Asset Management (L 1) --- TBD

Collection Management (M 1 / L 5) --- (M 1)

Collection Operations (M 3 / L 7) --- (M 2)

(M 4 / L 13)

April 1, 1996

Migration Applications:

5 Selected

(Migration/Legacy) Unique Applications	91	92	93	94	95	96	97	98	99	00				
	17	(4/13)	17	(4/13)	17	(4/13)	16	(4/12)	4	(4/0)	3	(3/0)	3	(3/0)
Fiscal Year														

Migration Path Detail Report

Collection

April 1, 1996

Activity: Collection Asset Management

CAM0200

Acronym Alias (Migration / Legacy)	Application Title	Phase	Start Date		Migrates to		Mig Beg Date		Mig End Date	
			Month	Year			Month	Year	Month	Year
RMS	Requirements Management System	M	06	1996			06	1996	06	1996
CAMS	COMIREX Automated Management System	L	06	1970			06	1996	06	1996

INTELLIGENCE COLLECTION

Collection Asset Management

Current as of March 14, 1996

LEGACY APPLICATIONS

MIGRATION APPLICATIONS

CAMS

RIMS-M

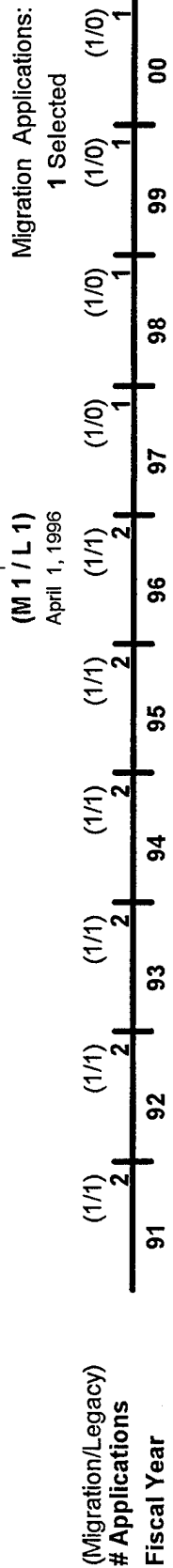

Legend
Planned
Completed
Selected Migration
Other Migration
Legacy

Migration Path Detail Report

Collection

Activity: Collection Management

April 1, 1996

CLM0100

Acronym Alias (Migration / Legacy)	Application Title	Phase	Start Date		Migrates to	Mig Beg Date		Mig End Date	
			Month	Year		Month	Year	Month	Year
JCMT	Joint Collection Management Tools(oid:Collection Management Suppo	M	09	1991		01	2010	01	2010
CMST	Cruise Missile Surveillance Technology	L	09	1991	JCMT	04	1996	04	1997
CRMA (C*)	Collection Requirements Management Applications	L	09	1991	JCMT	04	1996	04	1997
CRMS	Collection Requirements Management System	L	09	1991	JCMT	04	1996	04	1997
SEPP/IPST	SIGINT End Product Program/Intel Support Processing Tool	L	09	1991	JCMT	04	1996	04	1997
UNEST	UNEST	L	09	1991	JCMT	04	1996	04	1997

INTELLIGENCE

COLLECTION

Collection Management

Current as of March 12, 1996

LEGACY APPLICATIONS

MIGRATION APPLICATIONS

CMST

CRMA (C*)

JCMT=M

CRMS

SEPP/IPST

UNEST

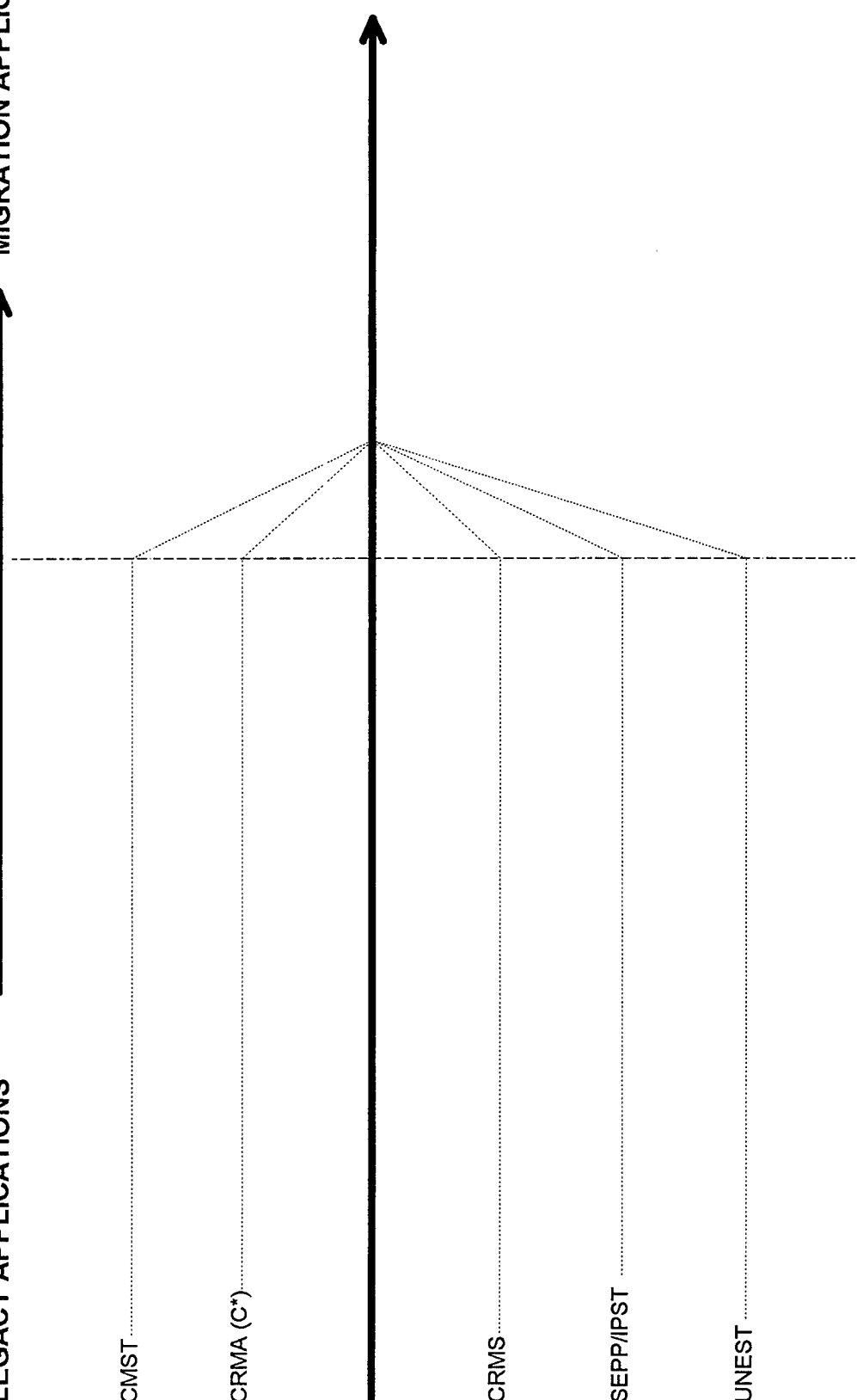

Migration Applications:

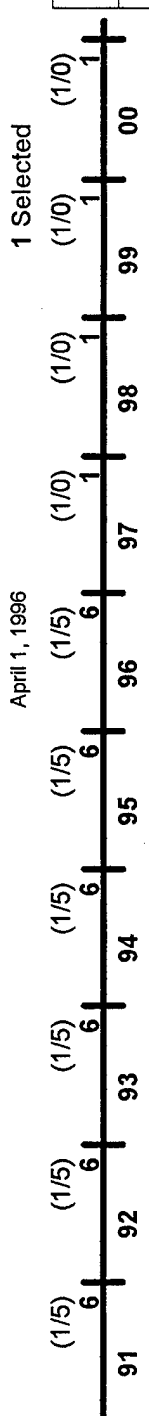

(Migration/Legacy)
Applications
Fiscal Year

Legend	
Planned
Completed	_____
Selected Migration	▨
Other Migration	▩
Legacy	_____

THIS PAGE INTENTIONALLY LEFT BLANK

INTELLIGENCE COLLECTION

Collection Operations Activity Summary

LEGACY APPLICATIONS

MIGRATION APPLICATIONS

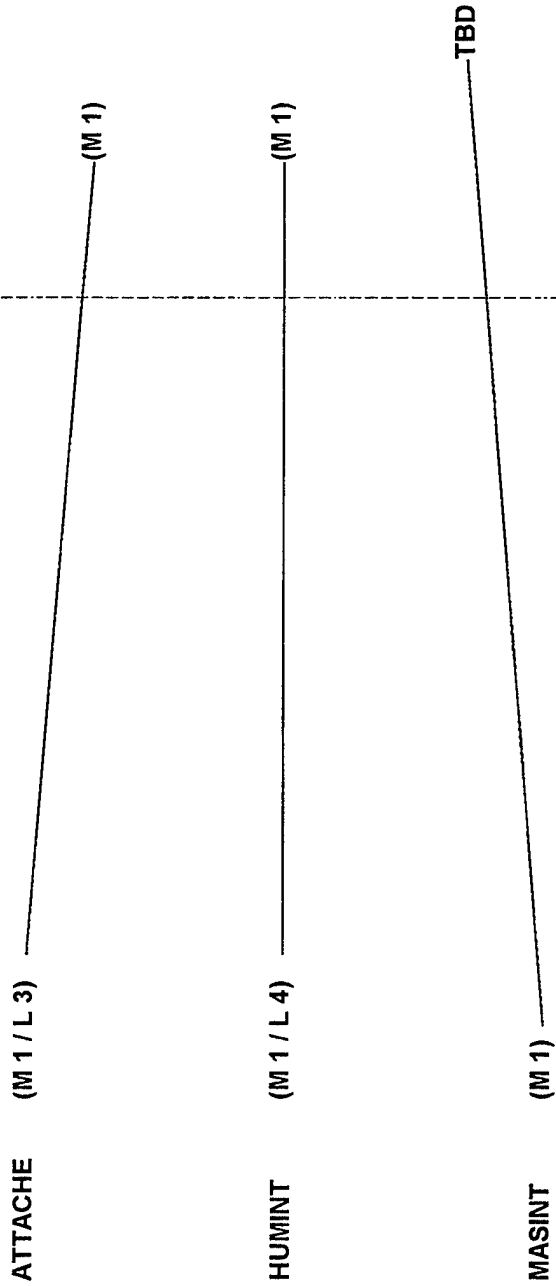

(M 3 / L 7)
April 1, 1996

Migration Applications:
3 Selected

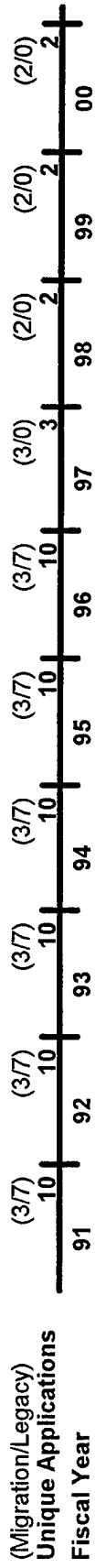

Migration Path Detail Report

Collection

April 1, 1996

Activity: Collection Operations

Group: ATTACHE

CLO0301

Acronym Alias (Migration / Legacy)	Application Title	Phase	Start Date		Migrates to		Mig Beg Date		Mig End Date	
			Month	Year			Month	Year	Month	Year
DAWN (C*)	Defense Attache Worldwide Network	M	09	1991			01	2010	01	2010
ASOC/ATP	Joint Military Attache School	L	09	1991	DAWN (C*)		04	1996	04	1997
DAS(FINANCIAL)	Defense Attache System (Financial) v 1.0	L	09	1991	DAWN (C*)		04	1996	04	1997
SAT	School of Attache Training (ASPC/ATP)	L	09	1991	DAWN (C*)		04	1996	04	1997

INTELLIGENCE COLLECTION

Collection Operations ATTACHE

Current as of January 1, 1989

LEGACY APPLICATIONS

MIGRATION APPLICATIONS

DAWN (C) = M

ASOC/ATP

DAS(FINANCIAL)

SAT

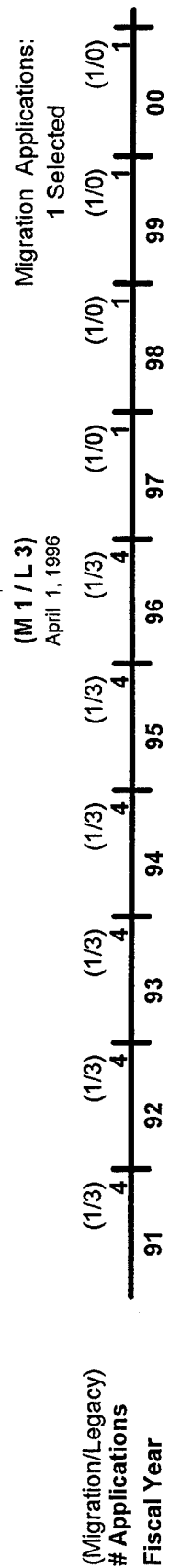

Migration Path Detail Report

Collection

April 1, 1996

Activity: Collection Operations

Group: HUMINT

CLO0302

Acronym Alias (Migration / Legacy)	Application Title	Phase	Start Date		Migrates to		Mig Beg Date		Mig End Date	
			Month	Year			Month	Year	Month	Year
HOCNET	HUMINT Operational Communications Network	M	09	1991			01	2010	01	2010
AFHMS	Air Force HUMINT Management System	L	09	1991	HOCNET		04	1996	04	1997
COMS (SAFE D.3:3/7)	Collections Operation Mgmt System	L	09	1991	HOCNET		02	1996	02	1997
DSR	Defense Source Registry	L	09	1991	HOCNET		04	1996	04	1997
EVAL	Evaluation v 3.3	L	09	1991	HOCNET		04	1996	04	1997

INTELLIGENCE
COLLECTION

Collection Operations
HUMINT

LEGACY APPLICATIONS

MIGRATION APPLICATIONS

HOCNET#M

COMS (SAFE D.3.3/7)

AFHMS

DSR

EVAL

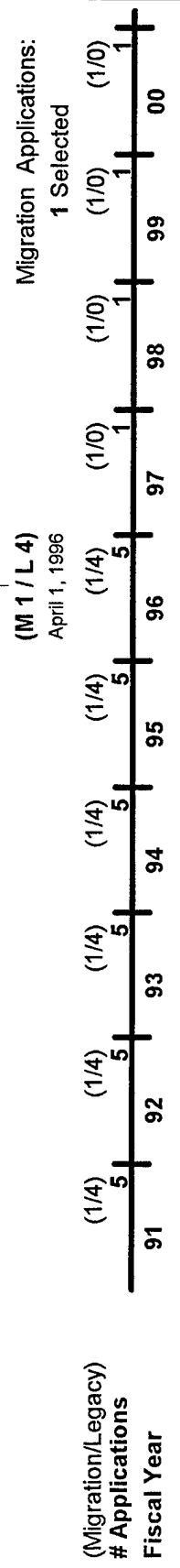

Legend

—	Planned
- - -	Completed
· · ·	Selected/Migration
▨	Other Migration/Legacy

Migration Path Detail Report

Collection

Activity: Collection Operations

April 1, 1996

Group: MASINT

CLO0303

Acronym Alias (Migration / Legacy)	Application Title	Phase	Start Date		Migrates to		Mig Beg Date		Mig End Date	
			Month	Year			Month	Year	Month	Year
MRDBS	MASINT Requirements Database System	M	09	1991			01	1997	01	1998

INTELLIGENCE
COLLECTION

Collection Operations
MASINT

Current as of January 1, 1989

LEGACY APPLICATIONS

MIGRATION APPLICATIONS

MRDBSE=M

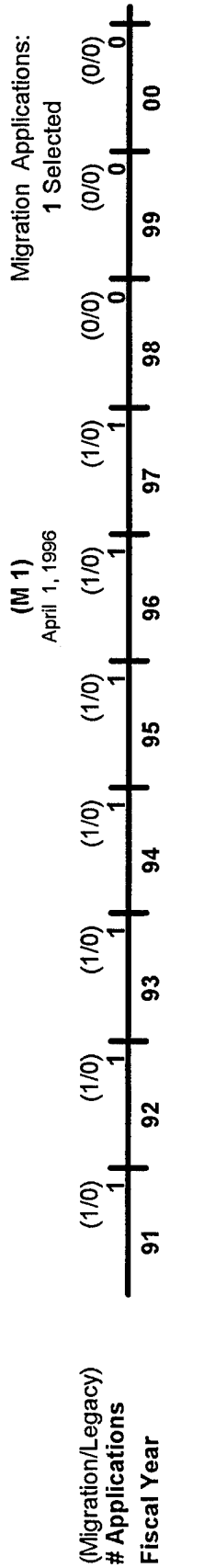

Legend
Planned
Completed
Selected Migration
Other Migration
Legacy

THIS PAGE INTENTIONALLY LEFT BLANK

INTELLIGENCE

COUNTER INTELLIGENCE Summary

LEGACY APPLICATIONS

MIGRATION APPLICATIONS

Production (M 1 / L 28)

(M 1)

(M 1 / L 31)
April 1, 1996

Migration Applications:
1 Selected

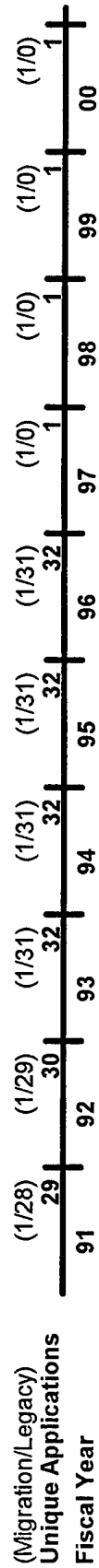

Migration Path Detail Report

Counter Intelligence
Activity: Production

April 1, 1996

PDT0100

Acronym Alias (Migration / Legacy)	Application Title	Phase	Start Date		Migrates to	Mig Beg Date		Mig End Date	
			Month	Year		Month	Year	Month	Year
MDITDS	Migration Defense Intelligence Threat Data System	M	09	1991		01	2010	01	2010
ADAPT	Automated Decision Making and Program Timeline Testbed/G-LAN	L	09	1991		04	1996	09	1997
AEIGS		L	09	1991		04	1996	10	1996
AIIRS	Automated Intelligence Information Retrieval System	L	09	1991		04	1996	10	1996
CANON LIGHT	CANON LIGHT (ARMY CI)	L	09	1991		04	1996	10	1996
COUNTRY CONT	Country Cont	L	09	1991		04	1996	04	1997
DAWS	Defense Automated Warning System MHS Module	L	09	1991		04	1996	10	1996
DITDS MHS MODULE	Defense Intelligence Threat Data System-MHS Module	L	09	1991		10	1994	10	1996
EINSTEIN	EINSTEIN	L	09	1991		04	1996	04	1997
ENVOY	ENVOY *	L	09	1991		04	1996	10	1996
FTDB	Foreign Technology Database	L	09	1991		04	1996	09	1997
GUARDIAN	GUARDIAN	L	09	1991		04	1996	10	1996
INTI	INTI	L	09	1991		04	1996	10	1996
KAWS	Korean Analyst Workstation	L	09	1991		04	1996	09	1997
KIVA	KIVA	L	09	1991		04	1996	09	1997
MATTHEW	MATTHEW	L	09	1991		04	1996	10	1996
MCS	Military Capabilities Studies	L	09	1991		04	1996	04	1997
MO	MO	L	09	1991		04	1996	10	1996
PATHFINDER	Pathfinder *	L	09	1991		04	1996	09	1997
PYRAMID	Pyramid	L	09	1991		04	1996	10	1996
SAFE AREA	Selected Areas for Evasion	L	09	1991		04	1996	04	1997
SARA	Systems Analysis and Resource Accounting	L	09	1991		04	1996	10	1996
SCARF	Sensitive Compartmented Automated Research Facility (Army CI)	L	09	1991		04	1996	10	1996
SOLOG	Special Operations Logistical System	L	09	1991		04	1996	10	1996
SPHINX	SPHINX	L	09	1991		04	1996	10	1996
TAS	Timeline Analysis System *	L	09	1991		04	1996	09	1997
THESEUS	THESEUS	L	09	1991		04	1996	09	1997
TRAP	Terrorism Research & Analysis Program	L	09	1991		04	1996	10	1996
WORLD TECH	World Tech	L	09	1991		04	1996	09	1997
MAS	MAS	L	09	1992		04	1996	10	1996
FOMA	Foreign Military Assistance	L	09	1993		04	1996	04	1997
MILPRO	Military Production	L	09	1993		04	1996	04	1997

INTELLIGENCE DISSEMINATION

Publish & Dissemination Activity Summary

LEGACY APPLICATIONS

MIGRATION APPLICATIONS

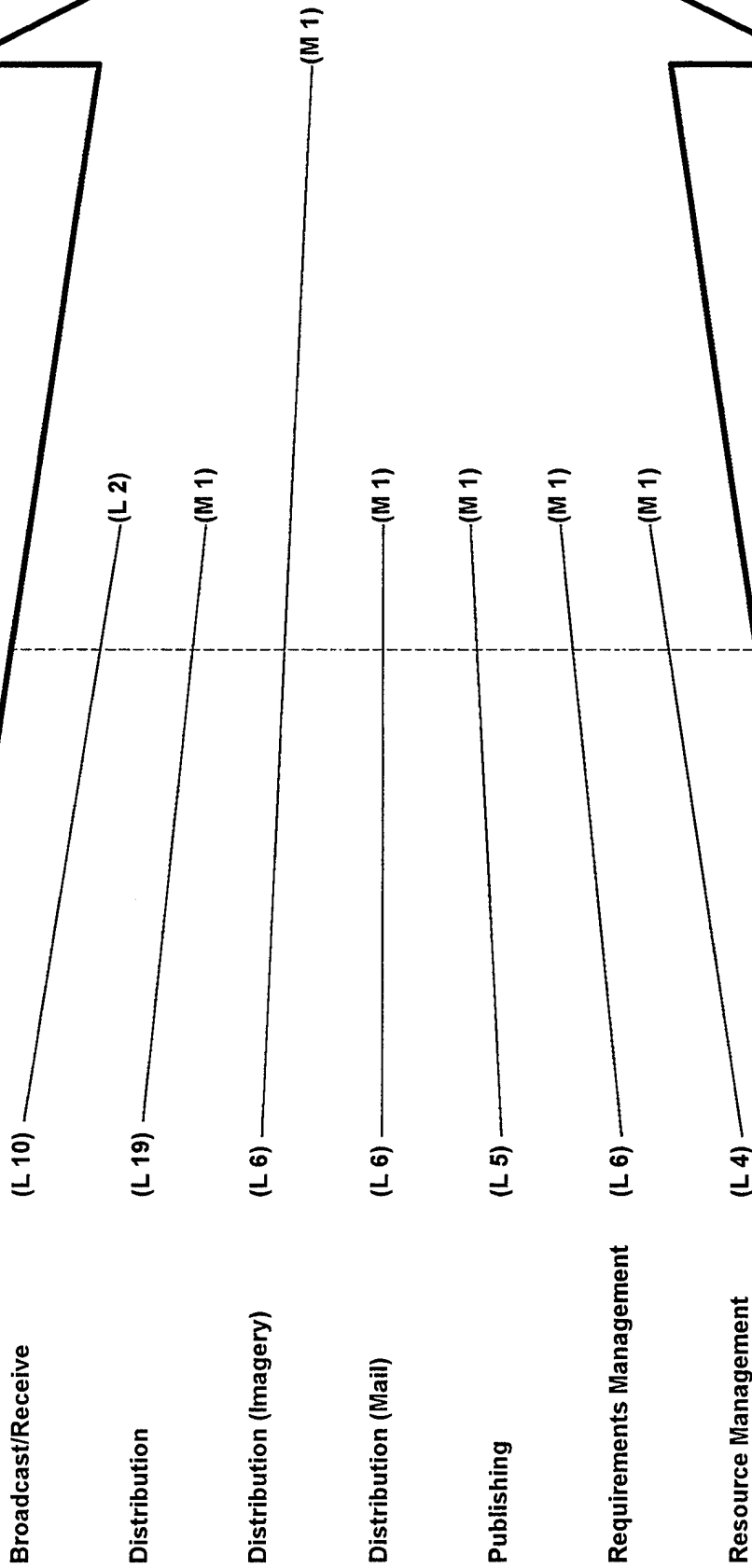

(L 55)
April 1, 1996

Migration Applications:
2 Selected

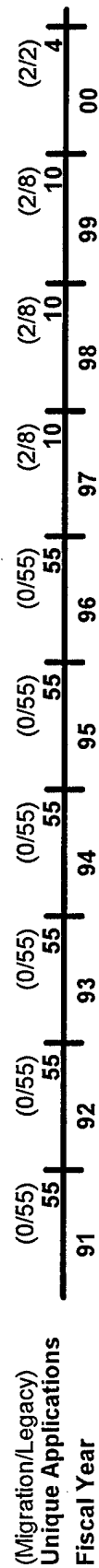

Migration Path Detail Report

Dissemination

Activity: Publish & Dissemination

Group: Broadcast/Receive

April 1, 1996

PND0107

Acronym Alias (Migration / Legacy)	Application Title	Phase	Start Date		Migrates to		Mig Beg Date		Mig End Date	
			Month	Year			Month	Year	Month	Year
BINOCULAR	BINOCULAR	L	09	1991	IBS		04	1996	04	1997
CONSTANT SOURCE	Constant Source	L	09	1991	JTT		04	1996	04	1997
CJT-H/R	Commanders Tactical Terminal - Hybrid Receive	L	09	1991	JTT		04	1996	04	1997
MATT	Multi-Mission Advanced Tactical Terminal	L	09	1991	JTT		04	1996	04	1997
STARS	Surveillance, Target Acquisition and Reporting System	L	09	1991	JTT		04	1996	04	1997
SUCCESS	SUCCESS Radio System	L	09	1991	JTT		04	1996	04	1997
TDDS (TRAP)	Tactical and Related Applications (TRAP) Data Dissemination System	L	09	1991	IBS		04	1996	04	1997
TIBS	Tactical Information Broadcast Service	L	09	1991	IBS		04	1996	04	1997
TRE	Tactical Receive Equipment	L	09	1991	JTT		04	1996	04	1997
TRIXS	Tactical Reconnaissance Intelligence Exchange System	L	09	1991	IBS		04	1996	04	1997
IBS	Integrated Broadcast System	L	04	1997			01	2010	01	2010
JTT	Joint Tactical Terminal	L	04	1997			01	2010	01	2010

INTELLIGENCE DISSEMINATION

Publish & Dissemination *Broadcast/Receive*

Current as of January 1, 1989

LEGACY APPLICATIONS

MIGRATION APPLICATIONS

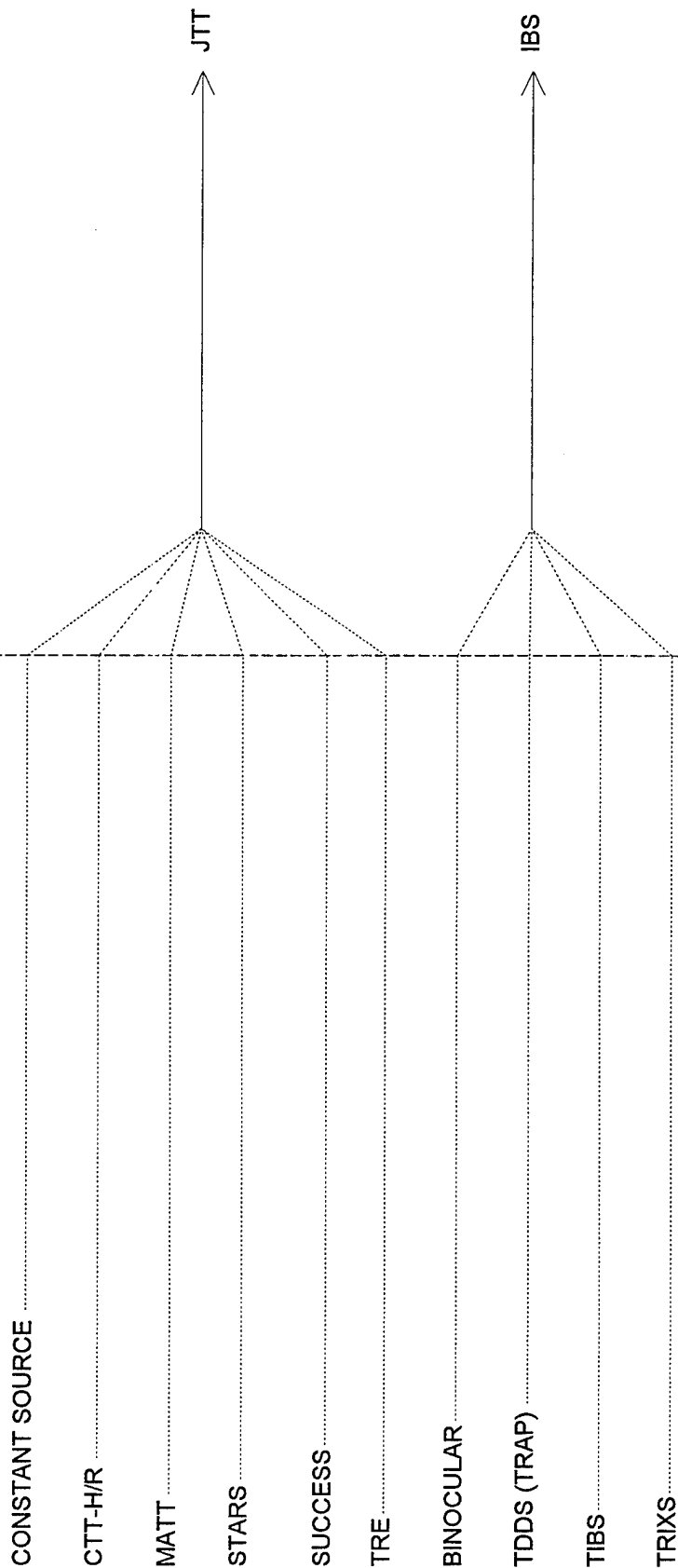

(L 10)
April 1, 1996

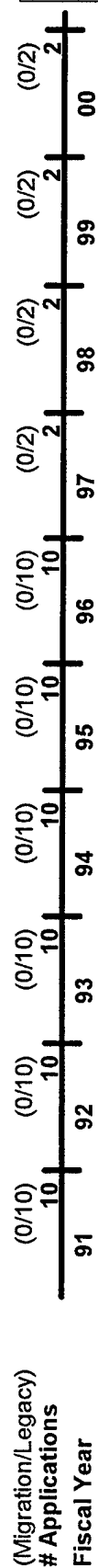

Legend	
.....	Planned
.....	Completed
.....	Selected Migration
.....	Other Migration
.....	Legacy

Migration Path Detail Report

Dissemination

Activity: Publish & Dissemination

Group: Distribution

April 1, 1996

PND0101

Acronym Alias (Migration / Legacy)	Application Title	Phase	Start Date		Migrates to		Mig Beg Date		Mig End Date	
			Month	Year			Month	Year	Month	Year
DODIIS/DISSEM	DODIIS DISSEM	M	04	1997			01	2010	01	2010
ASDIA	All Source Defense Collections Office Index File	L	09	1991		DODIIS DISSEM	04	1996	04	1997
CD-ROM	CD-ROM	L	09	1991		DODIIS DISSEM	04	1996	04	1997
CD-ROM DDS	CD-ROM Document Delivery System	L	09	1991		DODIIS DISSEM	04	1996	04	1997
CDHF	Customer Distribution History File	L	09	1991		DODIIS DISSEM	04	1996	04	1997
CDIT	Customer Defense Intelligence Thesaurus	L	09	1991		DODIIS DISSEM	04	1996	04	1997
CFRIF	Customer Finished Recurring Intel File	L	09	1991		DODIIS DISSEM	04	1996	04	1997
CFRIFZ	Customer Finished Recurring Intel File, Compartmented	L	09	1991		DODIIS DISSEM	04	1996	04	1997
CRRS/CRMS	Customer Requirements Registration/Management System	L	09	1991		DODIIS DISSEM	04	1996	04	1997
DDHF	Document Distribution History File	L	09	1991		DODIIS DISSEM	04	1996	04	1997
DIA MAIL	DIA MAIL (Current Manual Dissemination)	L	09	1991		DODIIS DISSEM	04	1996	04	1997
DIDS	Defense Intelligence Dissemination System	L	09	1991		DODIIS DISSEM	04	1996	04	1997
DIMAS	Defense Intel Mail Automation System	L	09	1991		DODIIS DISSEM	04	1996	04	1997
DRPS	Document Request Processing System	L	09	1991		DODIIS DISSEM	04	1996	04	1997
ENVOY	ENVOY *	L	09	1991		DODIIS DISSEM	04	1996	04	1997
IRISA	Intel Requirements Index Summary File	L	09	1991		DODIIS DISSEM	04	1996	04	1997
PINDEX	Publication Index	L	09	1991		DODIIS DISSEM	04	1996	04	1997
REDS	Request for Enclosure Dissemination System	L	09	1991		DODIIS DISSEM	04	1996	04	1997
SIPINDEX	Special Intel PubIndex	L	09	1991		DODIIS DISSEM	04	1996	04	1997
WAREHOUSE (S&T)	WAREHOUSE	L	09	1991		DODIIS DISSEM	04	1996	04	1997

INTELLIGENCE DISSEMINATION

Publish & Dissemination Distribution

Current as of January 1, 1989

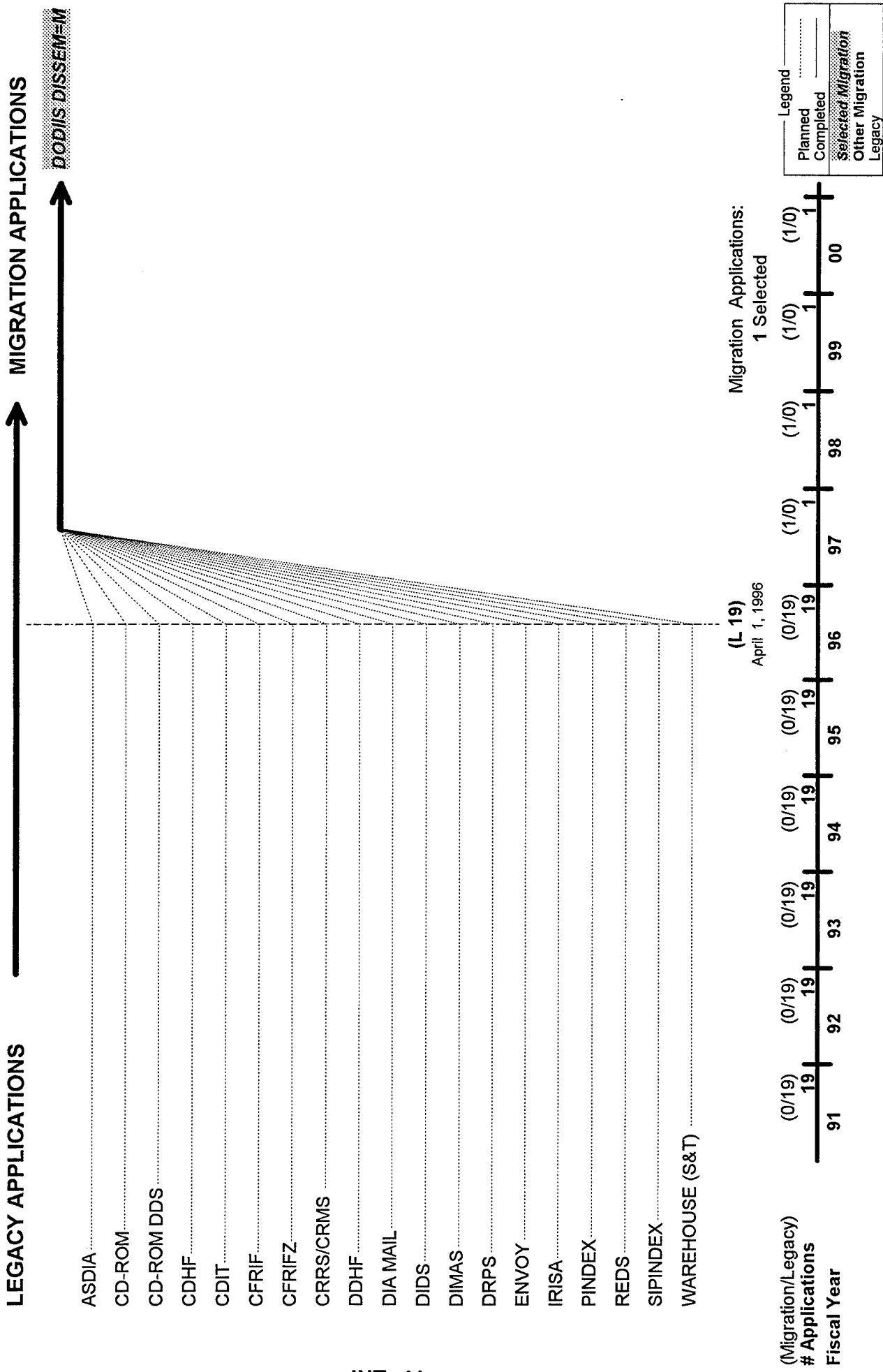

Migration Path Detail Report

Dissemination

April 1, 1996

Activity: Publish & Dissemination

Group: Distribution (Imagery)

PND0108

Acronym Alias (Migration / Legacy)	Application Title	Phase	Start Date		Migrates to		Mig Beg Date		Mig End Date	
			Month	Year	Month	Year	Month	Year	Month	Year
MDS	Modular Dissemination System	M	12	1996			01	2010	01	2010
DIEPS	Digital Imagery Exploitation and Production System	L	09	1991	MDS		04	1996	10	1999
IPDS	Imagery Processing and Dissemination System	L	09	1991	MDS		04	1996	10	1999
PINES	PACAF Interim National Exploitation System	L	09	1991	MDS		04	1996	10	1999
SIDS	Secondary Imagery Dissemination System	L	09	1991	MDS		04	1996	10	1999
SIDS SERVER	PAS DOS FTP Secondary Image Dissemination System Workstation	L	09	1991	MDS		04	1996	10	1999
SYSTEM III	System III	L	09	1991	MDS		04	1996	10	1999

***Publish & Dissemination
Distribution (Imagery)***

**INTELLIGENCE
DISSEMINATION**

LEGACY APPLICATIONS → MIGRATION APPLICATIONS

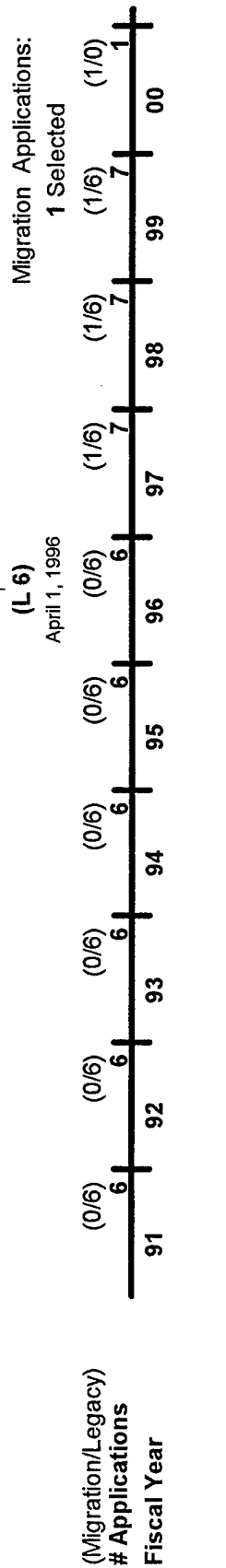
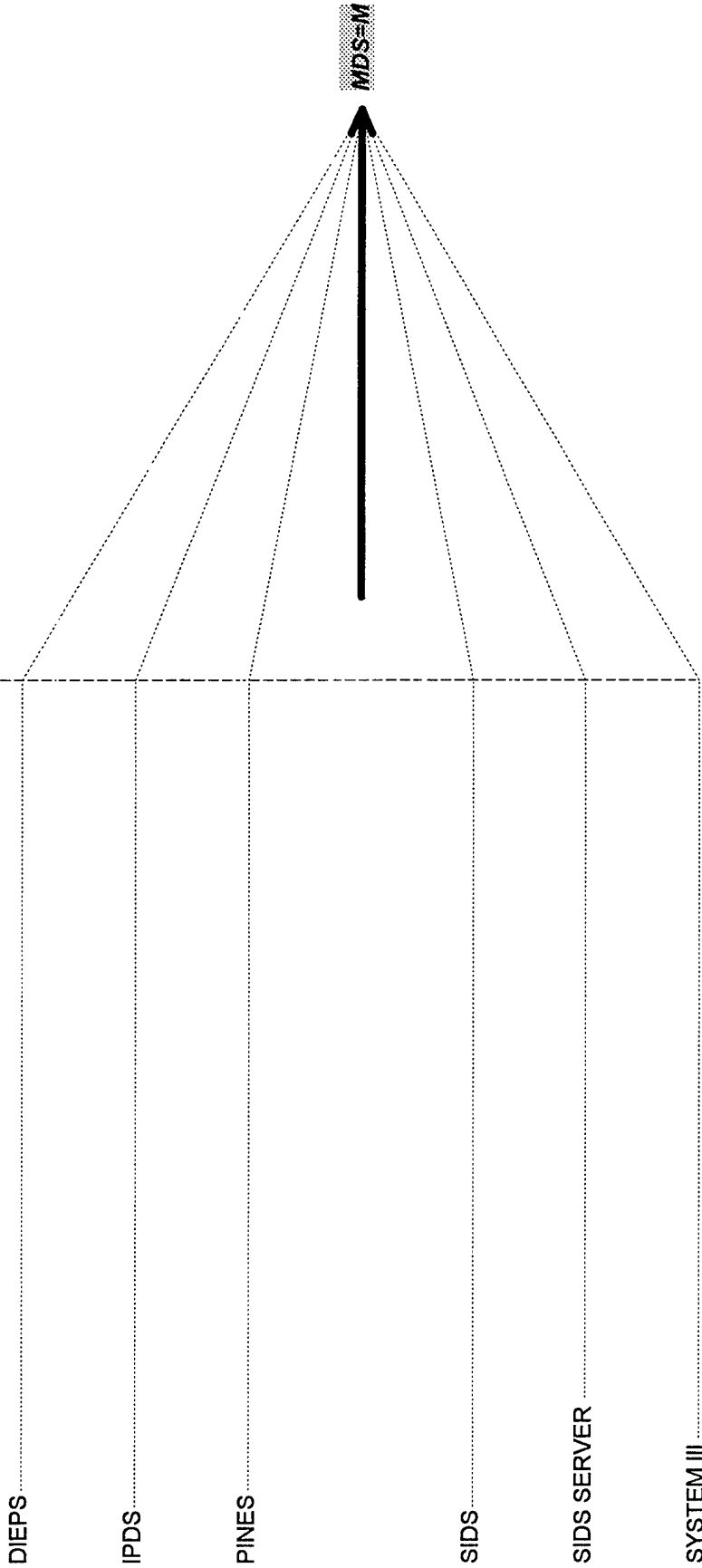

Legend
Planned
Completed
Selected Migration
Other Migration
Legacy

Migration Path Detail Report

April 1, 1996

Dissemination

Activity: Publish & Dissemination

Group: Distribution (Mail)

PND0106

Acronym Alias (Migration / Legacy)	Application Title	Phase	Start Date		Migrates to		Mig Beg Date		Mig End Date	
			Month	Year			Month	Year	Month	Year
DODIIS DISSEM	DoDIIS DISSEM	M	04	1997			01	2010	01	2010
ACCOUNTABLE MAIL	Accountable Mail	L	09	1991	DODIIS DISSEM		04	1996	04	1997
METERED MAIL	Metered Mail	L	09	1991	DODIIS DISSEM		04	1996	04	1997
MISCELLANEOUS REGIST	Miscellaneous Registry	L	09	1991	DODIIS DISSEM		04	1996	04	1997
REGISTERED MAIL	REGISTERED MAIL	L	09	1991	DODIIS DISSEM		04	1996	04	1997
SCI MAIL SYSTEM	SCI MAIL SYSTEM	L	09	1991	DODIIS DISSEM		04	1996	04	1997
TS NATO MAIL SYSTEM	TS NATO MAIL SYSTEM	L	09	1991	DODIIS DISSEM		04	1996	04	1997

INTELLIGENCE DISSEMINATION

Publish & Dissemination Distribution (Mail)

Current as of January 1, 1989

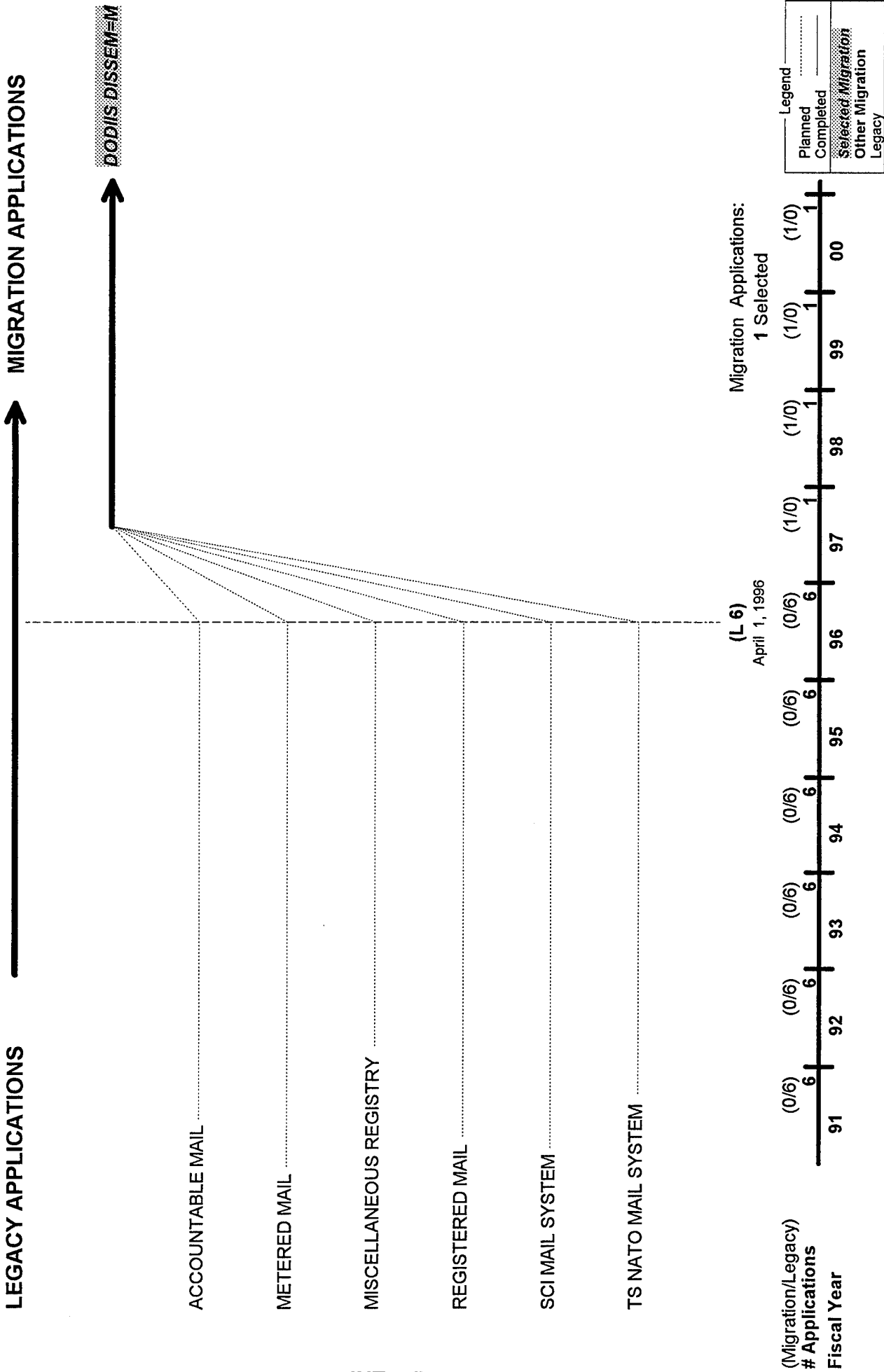

Migration Path Detail Report

Dissemination

April 1, 1996

Activity: Publish & Dissemination

Group: Publishing

PND0103

Acronym Alias (Migration / Legacy)	Application Title	Phase	Start Date		Migrates to		Mig Beg Date		Mig End Date	
			Month	Year			Month	Year	Month	Year
DODIIS DISSEM	DoDIIS DISSEM	M	04	1997			01	2010	01	2010
CHESAPEAKE(S&T)	Chesapeake (S & T)	L	09	1991	DODIIS DISSEM		04	1996	04	1997
EPS	Electronic Publishing System	L	09	1991	DODIIS DISSEM		04	1996	04	1997
IPSG PS	IPSG Publishing System	L	09	1991	DODIIS DISSEM		04	1996	04	1997
PRE/POST FILE TRANSFE	DoDIIS Pre/Post Processor Software	L	09	1991	DODIIS DISSEM		04	1996	04	1997
SASS SOFTWARE	Systems Acquisition and Services Support Software	L	09	1991	DODIIS DISSEM		04	1996	04	1997

INTELLIGENCE
DISSEMINATION

*Publish & Dissemination
Publishing*

LEGACY APPLICATIONS

MIGRATION APPLICATIONS

DODIIS DISSEM=M

CHESAPEAKE(S&T)

EPS

IPSG PS

PRE/POST FILE TRANSFER

SASS SOFTWARE

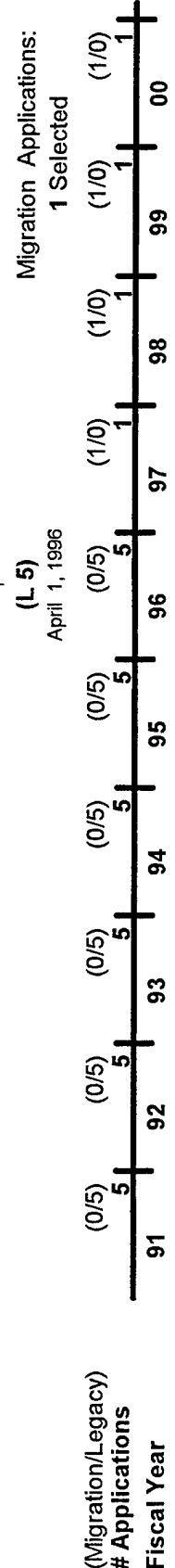

Migration Path Detail Report

Dissemination

Activity: Publish & Dissemination

April 1, 1996

PND0104

Group: Requirements Management

Acronym Alias (Migration / Legacy)	Application Title	Phase	Start Date		Migrates to		Mig Beg Date		Mig End Date	
			Month	Year	Month	Year	Month	Year	Month	Year
DODIIS DISSEM	DoDIIS DISSEM	M	04	1997			01	2010	01	2010
ADAPT TESTBED	ADAPT Testbed	L	09	1991			04	1996	04	1997
ADAPT/G-LAN	Automated Decision Making and Program Timeline Testbed/G-LAN	L	09	1991			04	1996	04	1997
DAMIS	Directorate for Attache Operations Management System	L	09	1991			04	1996	04	1997
DIAPF	DIAPF	L	09	1991			04	1996	04	1997
DISLEEP	DISLEEP	L	09	1991			04	1996	04	1997
PCS	Publication Control System	L	09	1991			04	1996	04	1997

INTELLIGENCE DISSEMINATION

Publish & Dissemination *Requirements Management*

Current as of January 1, 1989

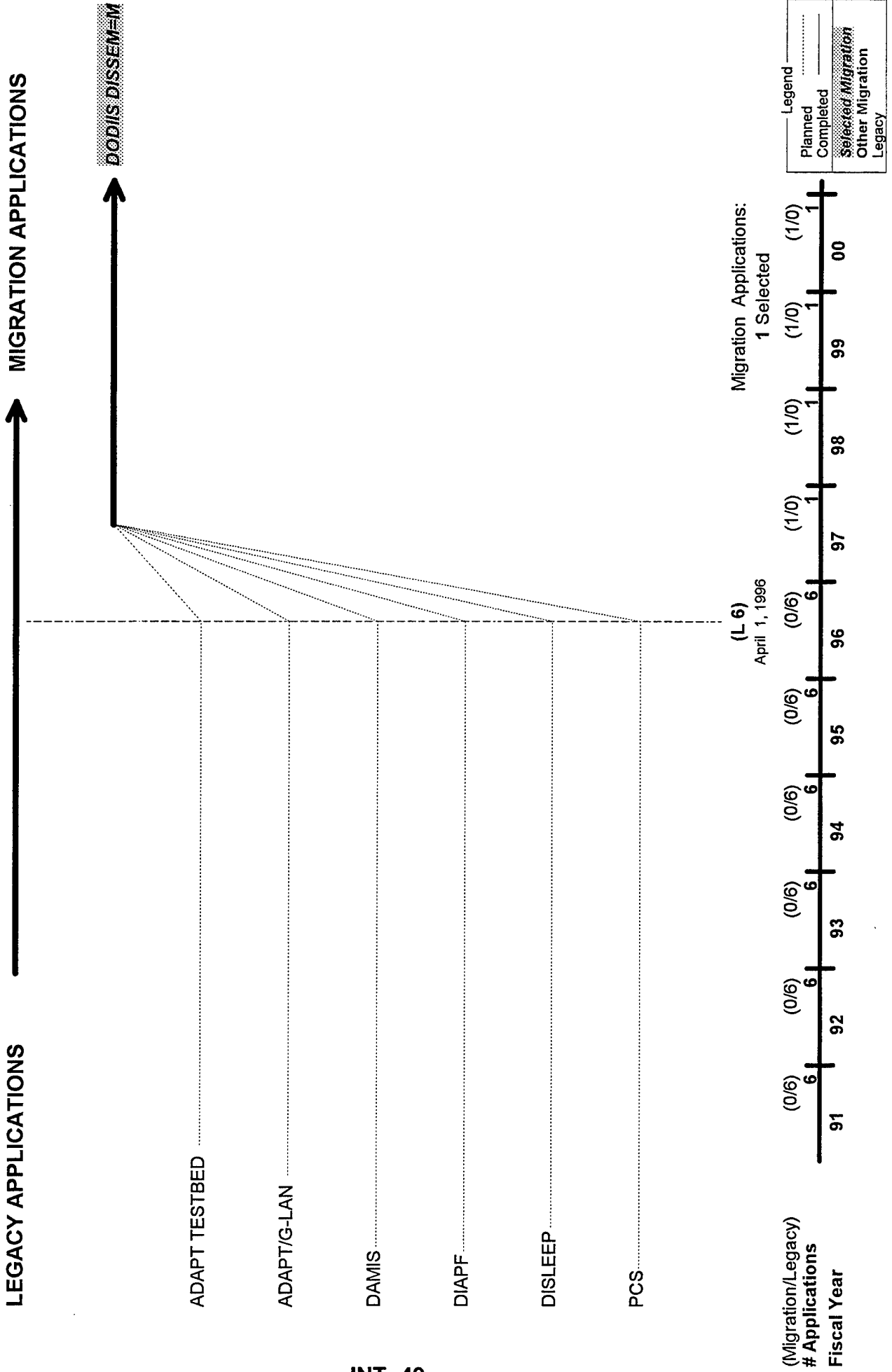

Migration Path Detail Report

Dissemination

Activity: Publish & Dissemination

April 1, 1996

Group: Resource Management

PND0105

Acronym Alias (Migration / Legacy)	Application Title	Phase	Start Date		Migrates to		Mig Beg Date		Mig End Date	
			Month	Year	Month	Year	Month	Year	Month	Year
DODIIS DISSEM	DoDIIS DISSEM	M	04	1997			01	2010	01	2010
ADP INVENTORY	SCI Mail Distribution File System	L	09	1991	DODIIS DISSEM		04	1996	04	1997
PCS	Publication Control System	L	09	1991	DODIIS DISSEM		04	1996	04	1997
PRIMACS	Production Information Mgmt Control System	L	09	1991	DODIIS DISSEM		04	1996	04	1997
TRANSHIPMENT DATABAS	TRANSHIPMENT DATABASE V 1.0	L	09	1991	DODIIS DISSEM		04	1996	04	1997

INTELLIGENCE DISSEMINATION

Publish & Dissemination Resource Management

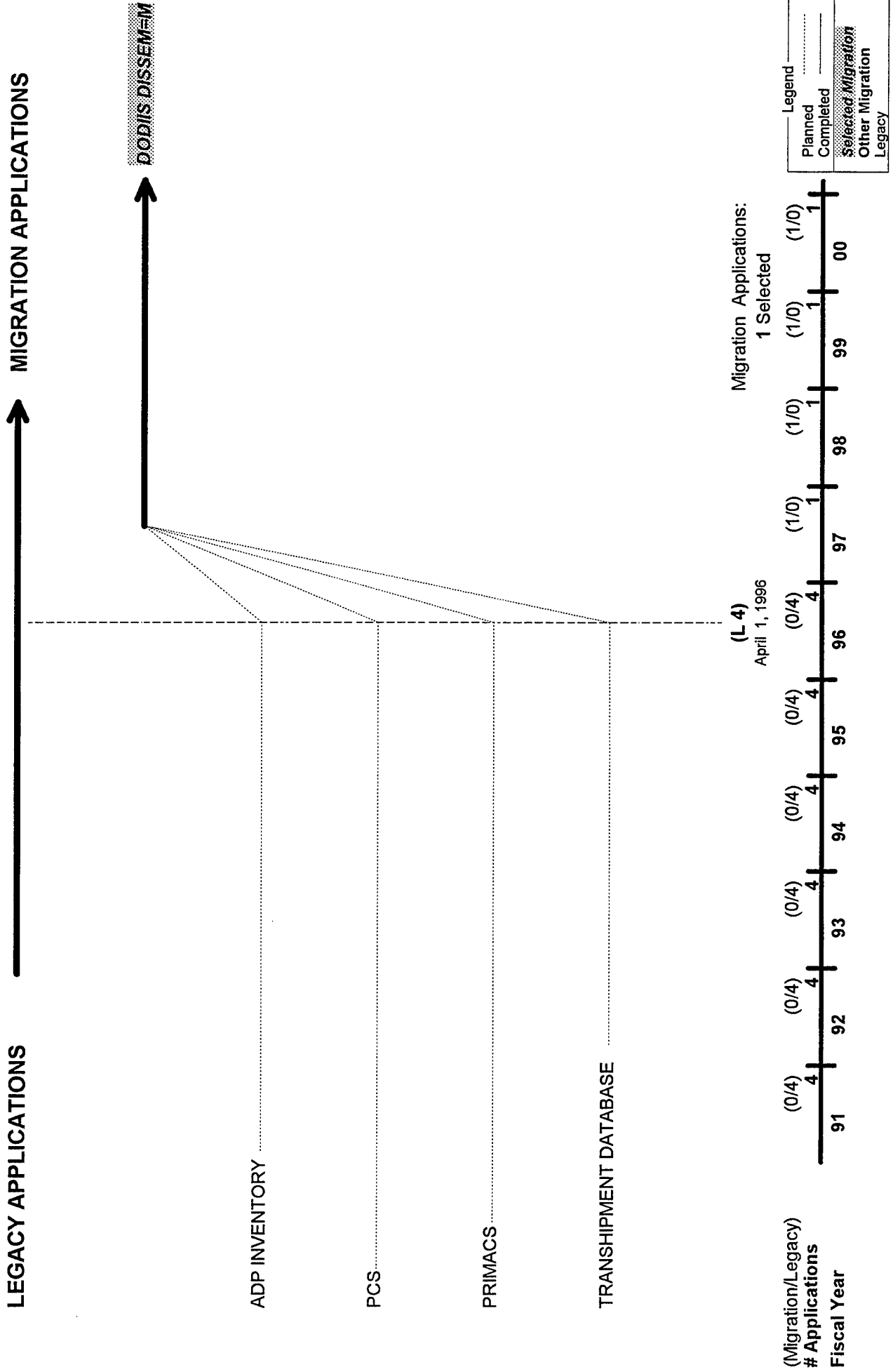

THIS PAGE INTENTIONALLY LEFT BLANK

INTELLIGENCE

PLANNING AND DIRECTION Summary

LEGACY APPLICATIONS

MIGRATION APPLICATIONS

Functional & System Architect

(M 1)

TBD

National Production Management

(M 1 / L 7)

(M 1)

(M 2 / L 7)
April 1, 1996

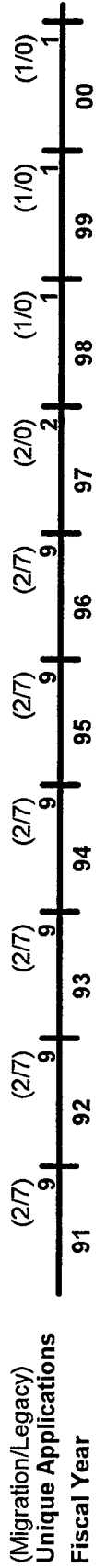

Migration Path Detail Report

Planning and Direction

April 1, 1996

Activity: Functional & System Architect

FSA0200

Acronym Alias (Migration / Legacy)	Application Title	Phase	Start Date		Migrates to		Mig Beg Date		Mig End Date	
			Month	Year			Month	Year	Month	Year
ICARIS	Intelligence Communications & Architectures Requirements Informatio	M	09	1991			01	1997	01	1998

INTELLIGENCE

PLANNING AND DIRECTION

Functional & System Architect

Current as of January 1, 1989

LEGACY APPLICATIONS



MIGRATION APPLICATIONS

INT- 55

ICARIS=M

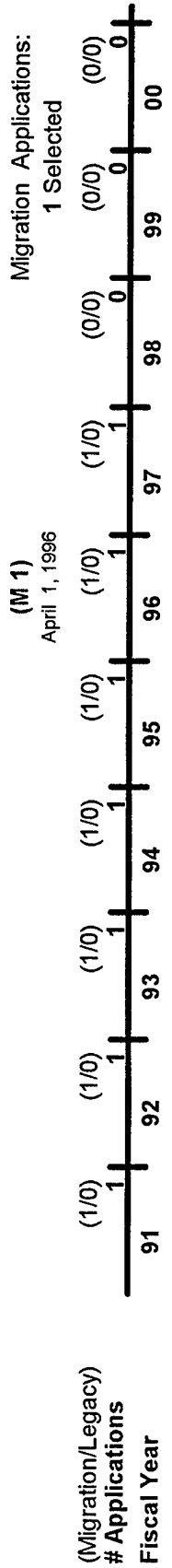

Migration Path Detail Report

Planning and Direction

April 1, 1996

Activity: National Production Management

NPM0600

Acronym Alias (Migration / Legacy)	Application Title	Phase	Start Date		Migrates to		Mig Beg Date		Mig End Date	
			Month	Year			Month	Year	Month	Year
COLISEUM	Community On-Line Intelligence System for End-Users and Managers	M	09	1991			01	2010	01	2010
ARMS	Automated Requirements Management System	L	09	1991	COLISEUM		04	1996	06	1997
CIPP	Current Intel Products Program	L	09	1991	COLISEUM		04	1996	06	1997
DIMIS	DIA Management Information System	L	09	1991	COLISEUM		04	1996	06	1997
ISPT	Intel Support Processing Tool	L	09	1991	COLISEUM		04	1996	06	1997
RIL	Requests for Intelligence Information	L	09	1991	COLISEUM		04	1996	06	1997
S&T MIS	S&T Management Information System	L	09	1991	COLISEUM		04	1996	06	1997
SEPP	SIGINT End Product Program	L	09	1991	COLISEUM		04	1996	06	1997

INTELLIGENCE

National Production Management

Current as of March 12, 1996

PLANNING AND DIRECTION

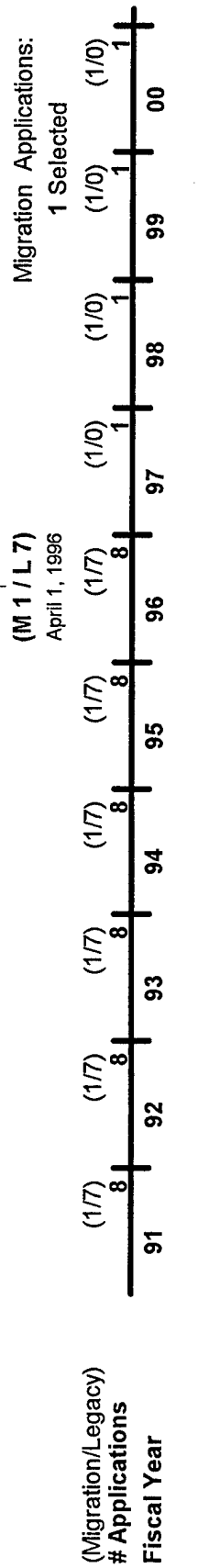
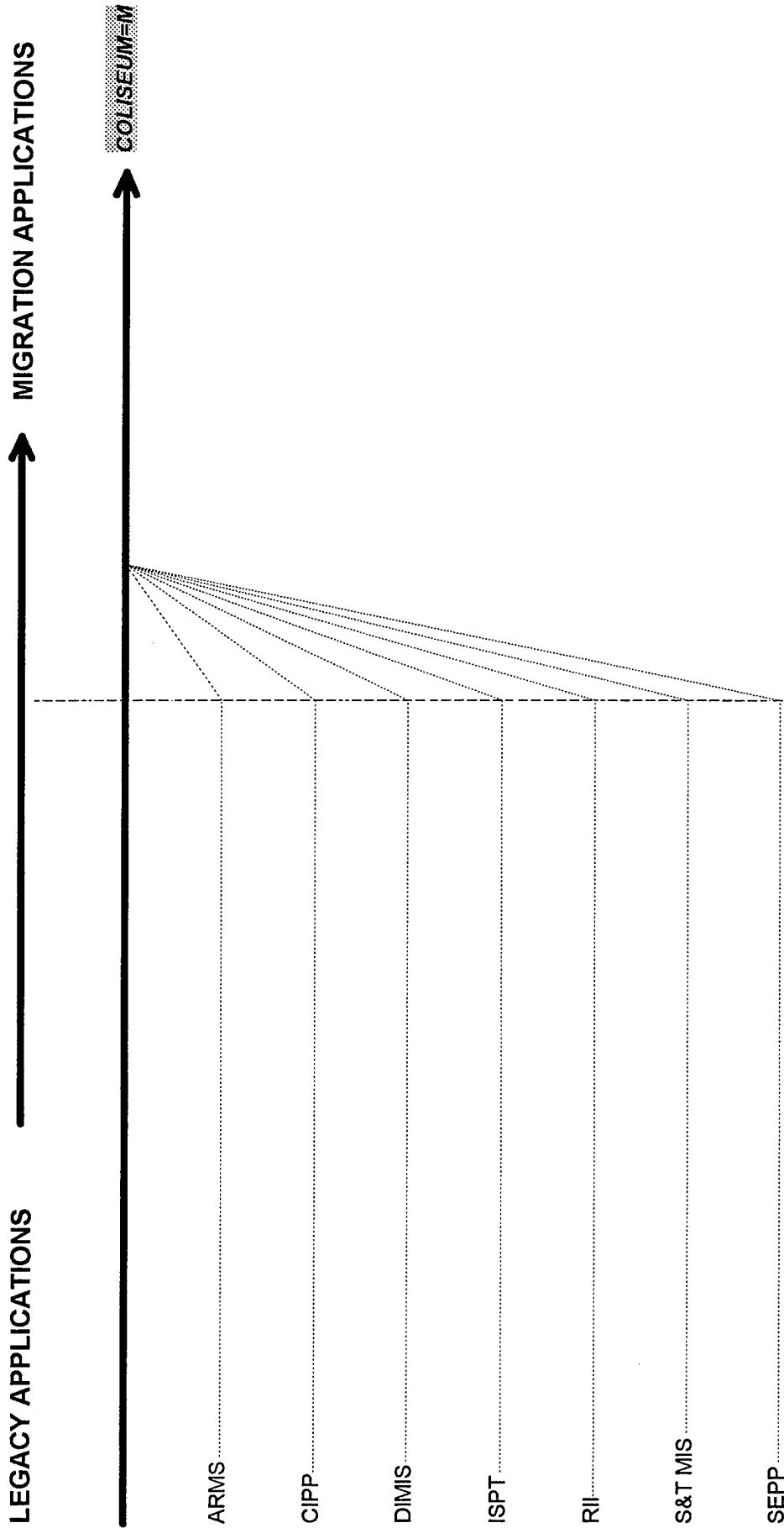

THIS PAGE INTENTIONALLY LEFT BLANK

INTELLIGENCE

PROCESSING Summary

LEGACY APPLICATIONS

MIGRATION APPLICATIONS

SIGINT

(L 1)

(M 1)

(L 1)
April 1, 1996

Migration Applications:
1 Selected

(Migration/Legacy) Unique Applications	91	92	93	94	95	96	97	98	99	00
Fiscal Year	(0/1) 1	(0/1) 1	(0/1) 1	(0/1) 1	(0/1) 1	(1/0) 1	(1/0) 1	(1/0) 1	(1/0) 1	(1/0) 1

Migration Path Detail Report

Processing Activity: **SIGINT**

April 1, 1996

SIG0100

Acronym Alias (Migration / Legacy)	Application Title	Phase	Start Date		Migrates to		Mig Beg Date		Mig End Date	
			Month	Year			Month	Year	Month	Year
TCAC-PIP	Technical Control and Analysis Center Product Improvement Plan	M	09	1996			01	2010	01	2010
TCAC	Technical Control and Analysis Center System	L	09	1991	TCAC PIP		09	1995	09	1996

INTELLIGENCE PROCESSING

SIGINT

Current as of January 1, 1989

LEGACY APPLICATIONS

MIGRATION APPLICATIONS

TCAC PIP=M

TCAC

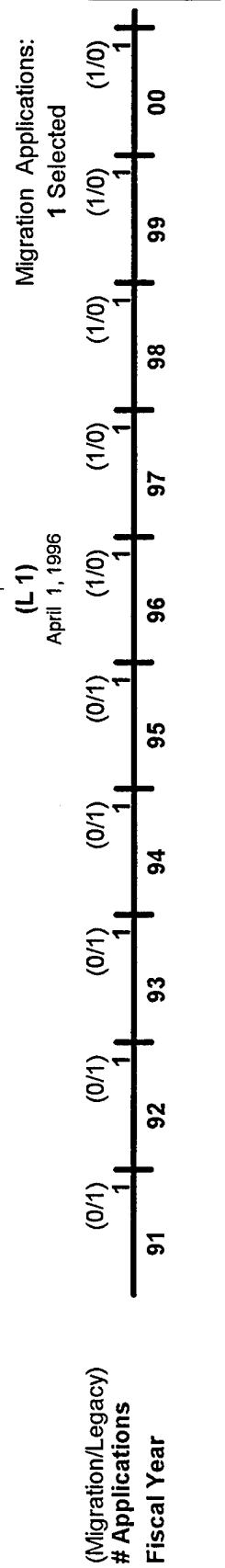

INTELLIGENCE

PRODUCTION Summary

LEGACY APPLICATIONS

MIGRATION APPLICATIONS

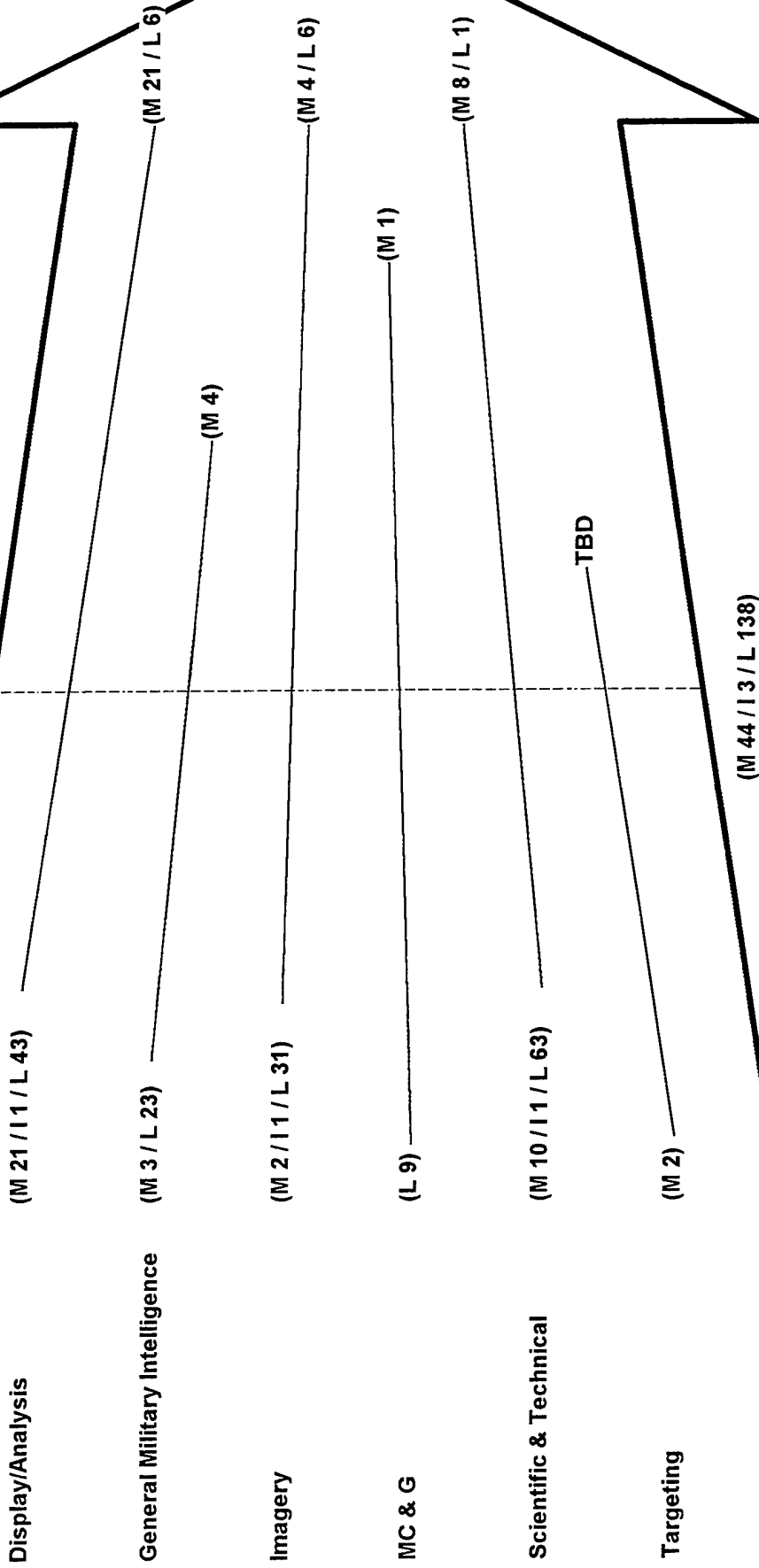

(M 44 / I 3 / L 138)

April 1, 1996

Migration Applications:
49 Selected + 4 Interim

Migration/Legacy Unique Applications	91	92	93	94	95	96	97	98	99	00
(41/164)	205	206	205	200	201	186	111	59	56	54
(42/164)			(42/163)	(42/158)	(47/154)	(48/138)	(40/71)	(39/20)	(40/16)	(39/15)
Fiscal Year										

INTELLIGENCE PRODUCTION

Display/Analysis Activity Summary

LEGACY APPLICATIONS

MIGRATION APPLICATIONS

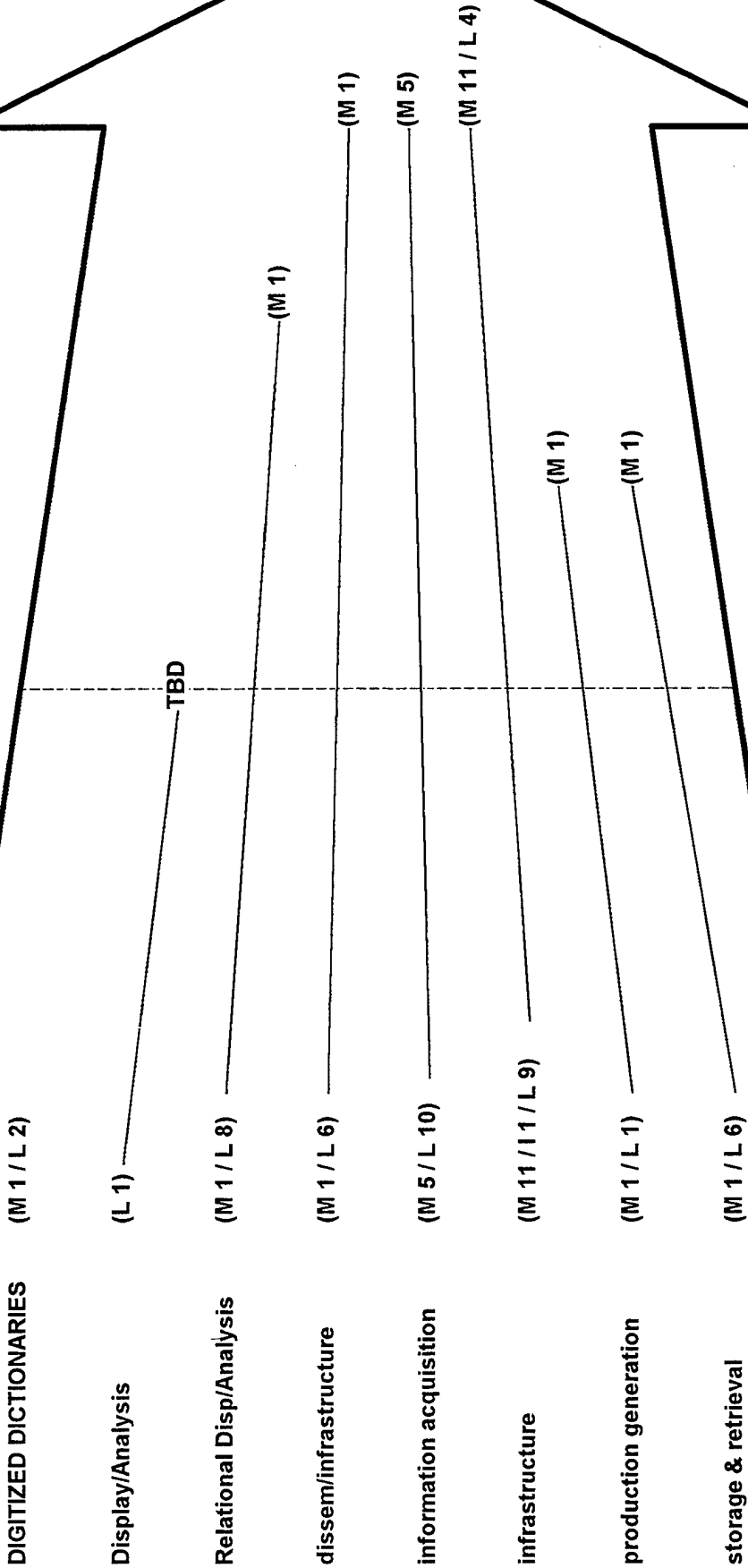

(M 21 / L 37)

April 1, 1996

Migration Applications:
22 Selected + 1 Interim

(Migration/Legacy) Unique Applications	91	92	93	94	95	96	97	98	99	00
	65	66	66	66	66	59	44	31	30	28
	(22/43)	(22/44)	(22/44)	(22/44)	(22/44)	(22/37)	(22/22)	(22/9)	(22/8)	(21/7)
Fiscal Year										

Migration Path Detail Report

Production
 Activity: Display/Analysis
 Group: Relational Disp/Analysis
 April 1, 1996
 DNA0201

Acronym Alias (Migration / Legacy)	Application Title	Phase	Start Date		Migrates to	Mig Beg Date		Mig End Date	
			Month	Year		Month	Year	Month	Year
GALE	Generic Area Limitation Environment	M	09	1991		01	2010	01	2010
ATP	Advanced Tactical Processor	L	09	1991	EOB SERVER	04	1996	04	1997
EAPSS	Emergency Action Procedures Support System	L	09	1991	EOB SERVER	04	1996	04	1997
JEAP/SUNSHINE	Joint Electronic Analysis Program/SUNSHINE	L	09	1991	GALE	04	1996	04	1997
MARS	Mapping, Analysis, Research System	L	09	1991	GALE	04	1996	04	1997
OSIS	Ocean Surveillance Information System	L	09	1991	EOB SERVER	04	1996	04	1997
RTAPS	Relocatable Target Adaptive Planning System	L	09	1991	GALE	04	1996	04	1997
SEAVIEW/MERWATCH	SEAVIEW/Merchant Watch	L	09	1991	GALE	04	1996	04	1997
WALLABA	WALLABA	L	09	1991	EOB SERVER	04	1996	04	1997
EOB SERVER	ELINT Order of Battle Server	L	06	1992	GALE	04	1998	04	1999

INTELLIGENCE PRODUCTION

Display/Analysis Relational Disp/Analysis

Current as of January 1, 1989

LEGACY APPLICATIONS

MIGRATION APPLICATIONS

GALE=M

JEAP/SUNSHINE

MARS

RTAPS

SEAVIEW/MERWATCH

EOB SERVER

ATP

EAPSS

OSIS

WALLABA

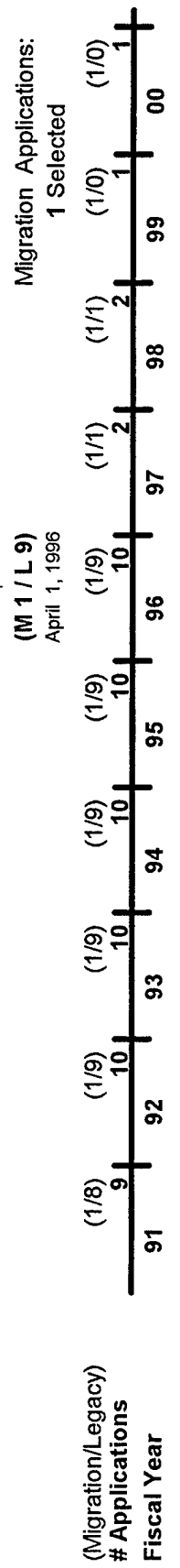

Legend
Planned
Completed
Selected/Migration
Other Migration
Legacy

Migration Path Detail Report

Production

Activity: Display/Analysis

April 1, 1996

Group: Display/Analysis

DNA0202

Acronym Alias (Migration / Legacy)	Application Title	Phase	Start Date		Migrates to		Mig End Date	
			Month	Year	Month	Year	Month	Year
STRED	Standard Tactical Receive Equipment Display	M	02	1996			02	1996
GIST	GIST	L	06	1988	STRED		12	1995

INTELLIGENCE PRODUCTION

Display/Analysis
Display/Analysis

Current as of January 1, 1989

LEGACY APPLICATIONS

MIGRATION APPLICATIONS



STREDFM



GIST

Migration Applications:
1 Selected

TBD
April 1, 1996

(Migration/Legacy)
Applications
Fiscal Year

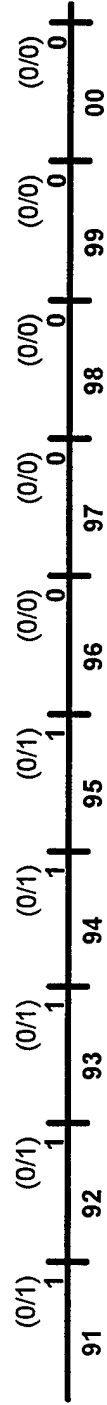

Legend	
Planned
Completed
Selected Migration
Other Migration
Legacy

Migration Path Detail Report

Production

Activity: Display/Analysis

April 1, 1996

DNA0802

Group: DIGITIZED DICTIONARIES

Acronym Alias (Migration / Legacy)	Application Title	Phase	Start Date		Migrates to		Mig Beg Date		Mig End Date	
			Month	Year	Month	Year	Month	Year	Month	Year
CUAD/KINSFOLK	CUAD/KINSFOLK	M	09	1991			01	1998	01	2010
FOREIGN LANGUAGE A DI	FOREIGN LANGUAGE A DICTIONARY	L	09	1991	CUAD/KINSFOLK		01	2000	01	2010
FOREIGN LANGUAGE B DI	FOREIGN LANGUAGE B DICTIONARY	L	09	1991	CUAD/KINSFOLK		01	2000	01	2010

INTELLIGENCE PRODUCTION

Display/Analysis DIGITIZED DICTIONARIES

Current as of March 15, 1996

LEGACY APPLICATIONS



MIGRATION APPLICATIONS

FOREIGN LANGUAGE
A DICTIONARY

CUAD/KINSFOLK=

FOREIGN LANGUAGE B DICTIONARY

Migration Applications:

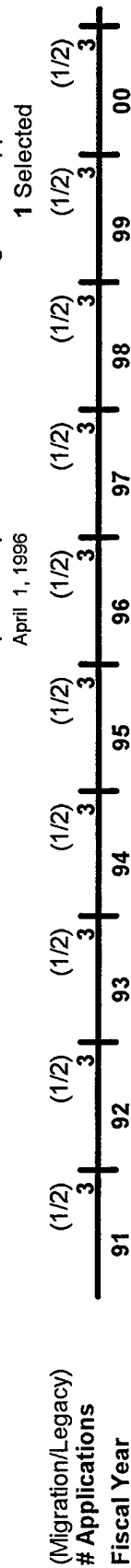

Legend
Planned
Completed
Selected/Migration
Other Migration
Legacy

Migration Path Detail Report

Production

Activity: Display/Analysis

April 1, 1996

Group: storage & retrieval

DNA0803

Acronym Alias (Migration / Legacy)	Application Title	Phase	Start Date		Migrates to		Mig Beg Date		Mig End Date	
			Month	Year	Month	Year	Month	Year	Month	Year
ENGRAFT	ENGRAFT	M	09	1991			01	1996	01	2010
ALTAIR	ARPA Long Range Tracking and Instrumentation Radar	L	09	1991	ENGRAFT		01	1997	12	1997
EYEBOLT	EYEBOLT	L	09	1991	ENGRAFT		01	1996	12	1996
FISPRO	FISPRO	L	09	1991	ENGRAFT		01	1996	12	1996
IVORYSNOW	IVORYSNOW	L	09	1991	ENGRAFT		01	1997	12	1997
STANZA	STANZA	L	09	1991	ENGRAFT		01	1996	12	1996
TRAMCAR	TRAMCAR	L	09	1991	ENGRAFT		01	1997	12	1997

INTELLIGENCE PRODUCTION

*Display/Analysis
storage & retrieval*

Current as of March 15, 1996

LEGACY APPLICATIONS

MIGRATION APPLICATIONS

EYEBOLT

FISPRO

STANZA

ALTAIR

IVORYSNOW

TRAMCAR

ENGRAFT-M

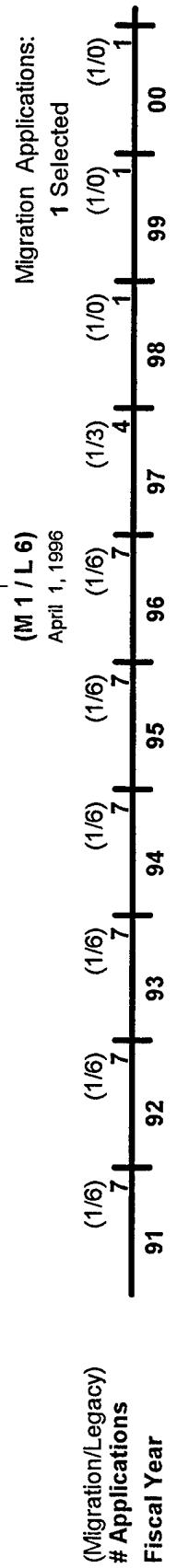

Migration Path Detail Report

Production

Activity: Display/Analysis

April 1, 1996

Group: infrastructure

DNA0804

Acronym Alias (Migration / Legacy)	Application Title	Phase	Start Date		Migrates to	Mig Beg Date		Mig End Date	
			Month	Year		Month	Year	Month	Year
GALIDIA		M	09	1991		01	1994	01	2010
GISTER		M	09	1991		01	1992	01	2010
GLADLY		M	09	1991		01	1996	01	2010
GOLDPOINT		M	09	1991		01	1994	01	2010
KLONDIKE		M	09	1991		01	1993	01	2010
KNOCKDOWN II		M	09	1991		01	1996	01	2010
ORCHESTRA		M	09	1991		01	1994	01	2010
QUICKSILVER		M	09	1991		01	1997	01	2010
TEAS		M	09	1991		01	1994	01	2010
ANALOG TAPE ARCHIVING	ANALOG TAPE ARCHIVING	L	09	1991	ORCHESTRA	01	1995	01	1996
MINSTREL	MINSTREL	L	09	1991	ORCHESTRA	01	1995	01	1996
STICKBALL	STICKBALL	L	09	1991	GLADLY	01	1996	12	1996
TANG	TANG	L	09	1991	QUICKSILVER	12	1997	01	2010

INTELLIGENCE PRODUCTION

Display/Analysis infrastructure

Current as of March 15, 1996

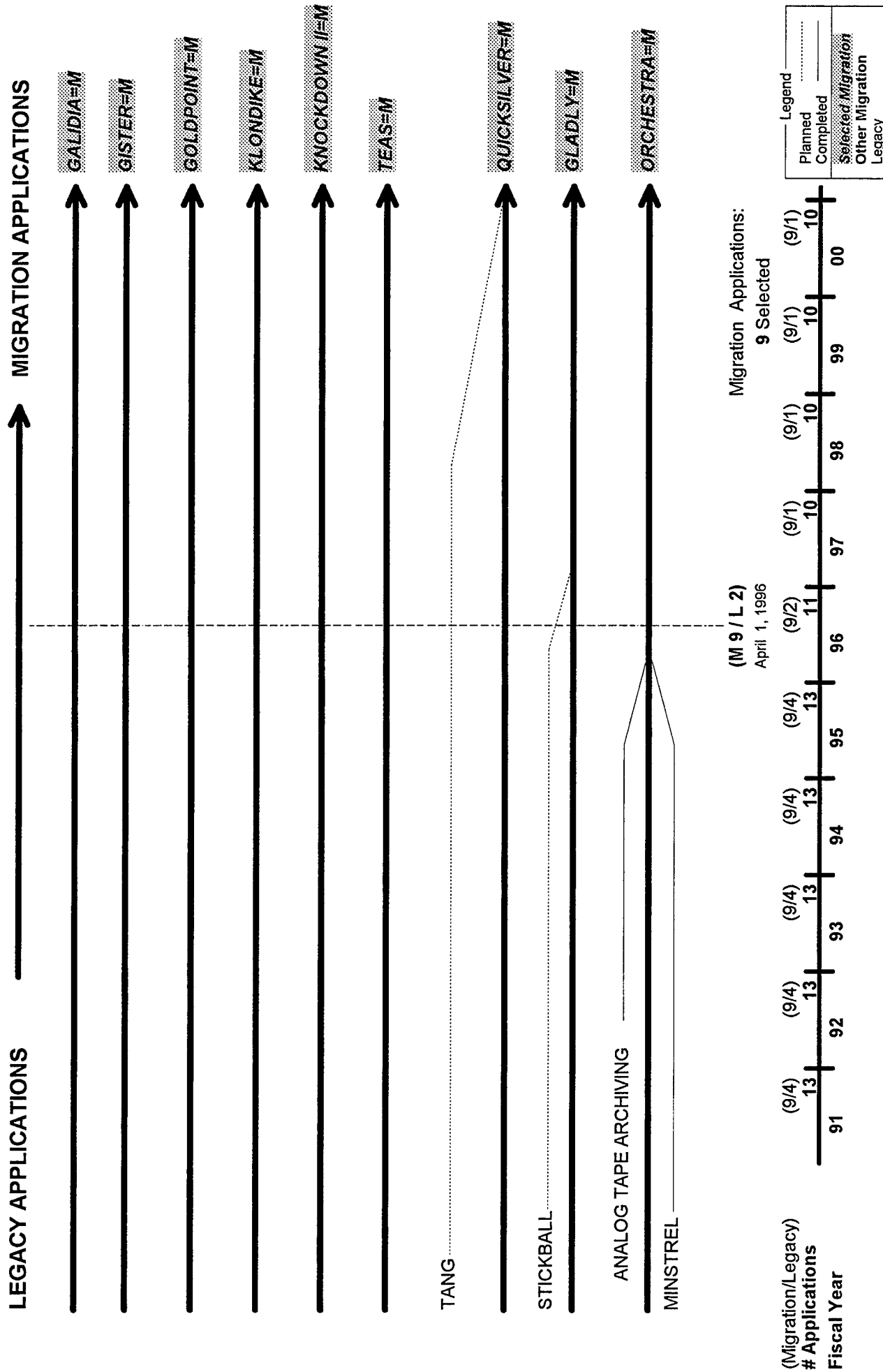

Migration Path Detail Report

Production

Activity: Display/Analysis

April 1, 1996

Group: information acquisition

DNA0805

Acronym Alias (Migration / Legacy)	Application Title	Phase	Start Date		Migrates to		Mig Beg Date		Mig End Date	
			Month	Year	Month	Year	Month	Year	Month	Year
INTEGRA	INTEGRA	M	09	1991			01	1997	01	2010
MARTES	MARTES	M	09	1991			01	1994	01	2010
PINWALE	PINWALE	M	09	1991			01	1994	01	2010
PROPELLER	PROPELLER	M	09	1991			01	1995	01	2010
SUNSHINE/JEAP	SUNSHINE/JEAP	M	09	1991			01	1992	01	2010
ACQUAINTANCE	ACQUAINTANCE	L	09	1991		PROPELLER	01	1997	12	1997
BODYSURF	BODYSURF	L	09	1991		PINWALE	01	1995	12	1995
MSAS	MSAS	L	09	1991		MARTES	01	1997	12	1997
PARENTAGE	PARENTAGE	L	09	1991		PROPELLER	01	1997	12	1997
PRELUDE	PRELUDE	L	09	1991		INTEGRA	01	2000	12	2000
PROPHET	PROPHET	L	09	1991		SUNSHINE/JEAP	01	1996	12	1996
TARTLETT	TARTLETT	L	09	1991		SUNSHINE/JEAP	01	1996	12	1996
THOROUGH/BRED	THOROUGH/BRED	L	09	1991		MARTES	01	1997	12	1997
WHEATSTALK	WHEATSTALK	L	09	1991		PINWALE	01	1995	12	1995
WHIPPOORWILL	WHIPPOORWILL	L	09	1991		MARTES	01	1996	12	1996

INTELLIGENCE PRODUCTION

*Display/Analysis
information acquisition*

Current as of March 15, 1996

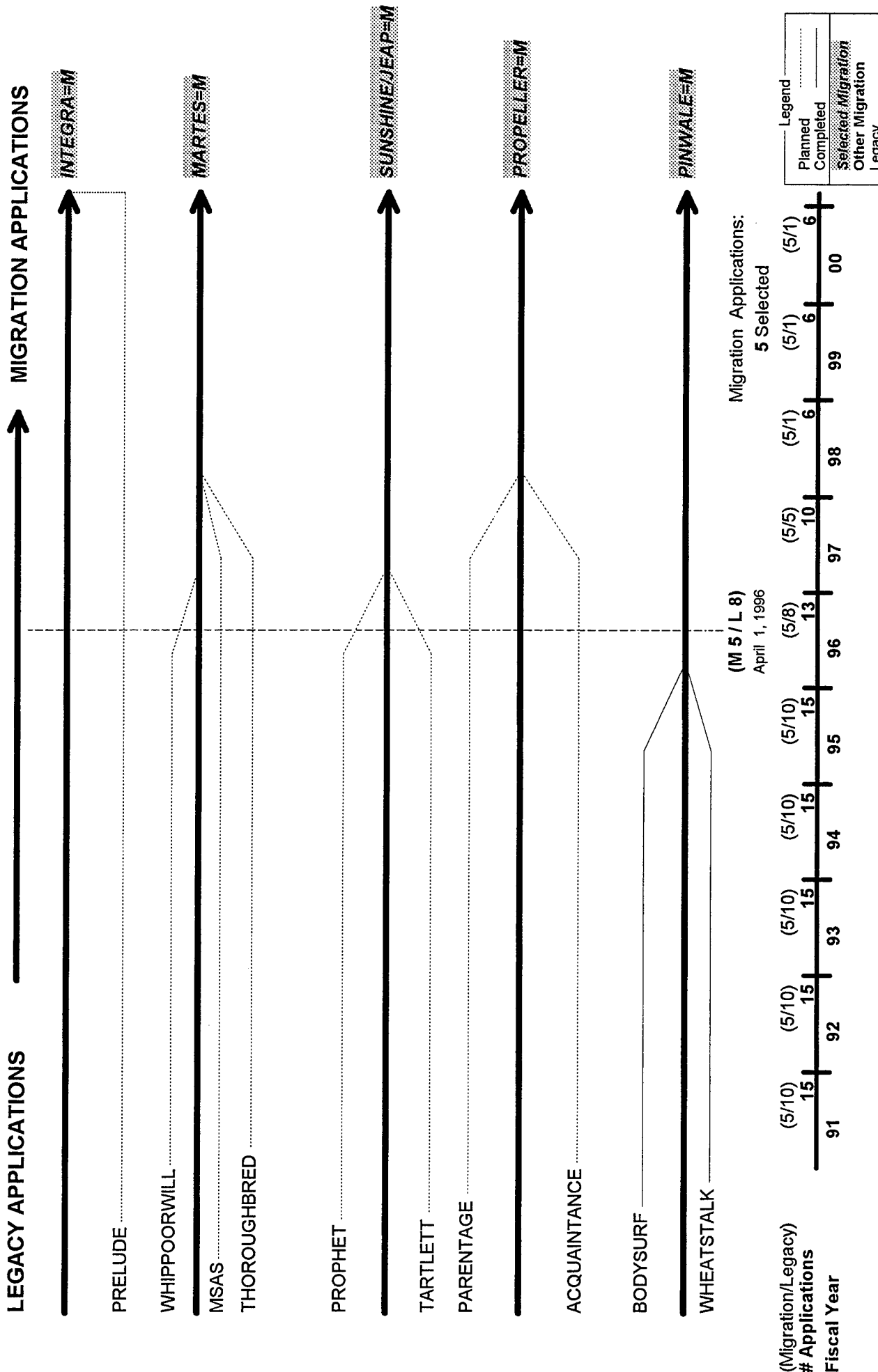

Migration Path Detail Report

Production

April 1, 1996

Activity: Display/Analysis

Group: production generation

DNA0806

Acronym Alias (Migration / Legacy)	Application Title	Phase	Start Date		Migrates to		Mig Beg Date		Mig End Date	
			Month	Year	Month	Year	Month	Year	Month	Year
PACESETTER	PACESETTER	M	09	1991			01	1995	01	2010
PINSETTER	PINSETTER	L	09	1991	PACESETTER		01	1997	12	1997

INTELLIGENCE PRODUCTION

*Display/Analysis
production generation*

Current as of March 15, 1996

LEGACY APPLICATIONS

MIGRATION APPLICATIONS

PACESETTER-M

INT- 77

PINSETTER

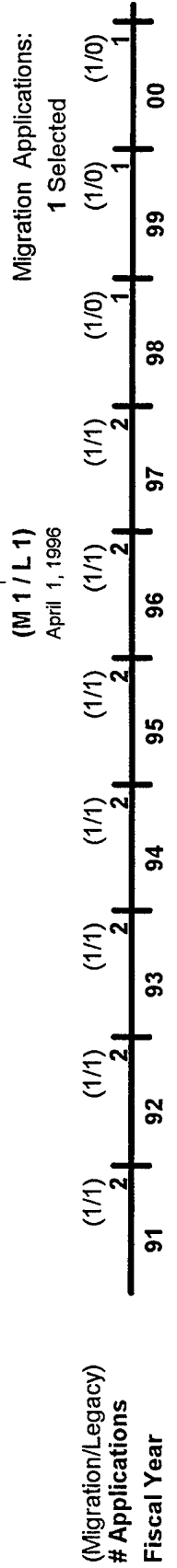

Migration Path Detail Report

Production

April 1, 1996

Activity: Display/Analysis

DNA0807

Group: infrastructure

Acronym Alias (Migration / Legacy)	Application Title	Phase	Start Date		Migrates to	Mig Beg Date		Mig End Date
			Month	Year		Month	Year	
JAGUAR	JAGUAR	M	09	1991		01	1994	01 2010
RUNBACK	RUNBACK	M	09	1991		01	1995	01 2010
GUNSHOT	GUNSHOT	I	09	1991	RUNBACK	01	1997	01 2000
GENDB	GENDB	L	09	1991	JAGUAR	01	2010	01 2010
NAVIGATOR	Navigator	L	09	1991	JAGUAR	01	2010	01 2010
RIGEL	RIGEL	L	09	1991	JAGUAR	01	1995	12 1995
SCANNER	SCANNER	L	09	1991	JAGUAR	01	2010	01 2010
WALDO	WALDO	L	09	1991	GUNSHOT	01	1995	12 1995

Migration Path Detail Report

Production

Activity: Display/Analysis

April 1, 1996

Group: dissem/infrastructure

DNA0808

Acronym Alias (Migration / Legacy)	Application Title	Phase	Start Date		Migrates to		Mig Beg Date		Mig End Date	
			Month	Year	Month	Year	Month	Year	Month	Year
SKYWRITER	SKYWRITER	M	09	1991			01	1997	01	2010
CIR REPORTING TOOL	CIR REPORTING TOOL	L	09	1991	SKYWRITER		06	1997	12	1997
PIPAR-RER-SPR	PIPAR-RER-SPR	L	09	1991	SKYWRITER		06	1997	12	1997
PPREP	PPREP	L	09	1991	SKYWRITER		06	1997	12	1997
RICOCHET	RICOCHET	L	09	1991	SKYWRITER		01	1999	12	1999
SANDLOT REPORTING SY	SANDLOT REPORTING SYSTEM	L	09	1991	SKYWRITER		06	1997	12	1997
SMACPROD	SMACPROD	L	09	1991	SKYWRITER		06	1997	12	1997

INTELLIGENCE PRODUCTION

*Display/Analysis
dissem/infrastructure*

Current as of March 15, 1996

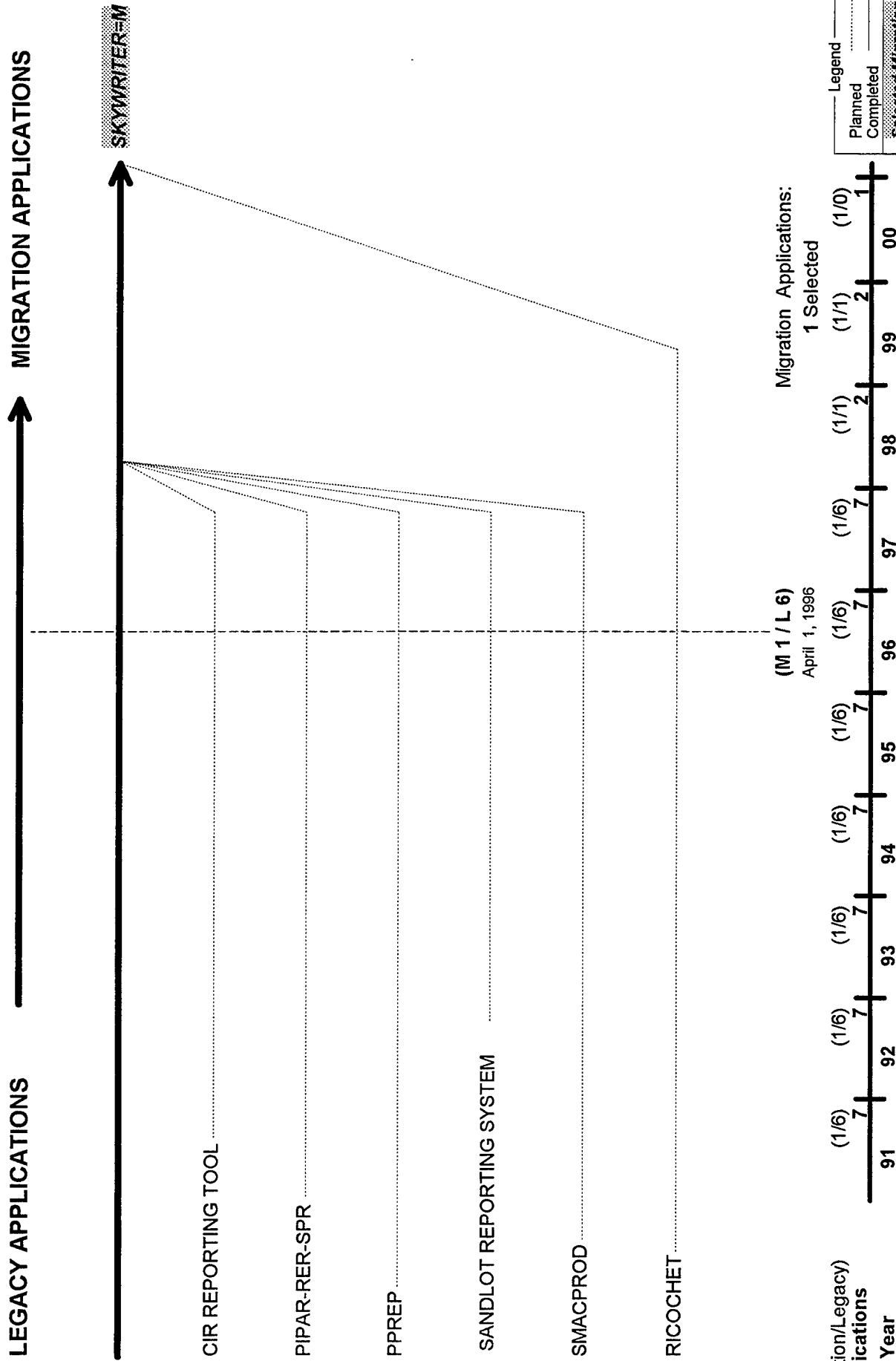

THIS PAGE INTENTIONALLY LEFT BLANK

INTELLIGENCE PRODUCTION

General Military Intelligence Activity Summary

LEGACY APPLICATIONS

MIGRATION APPLICATIONS

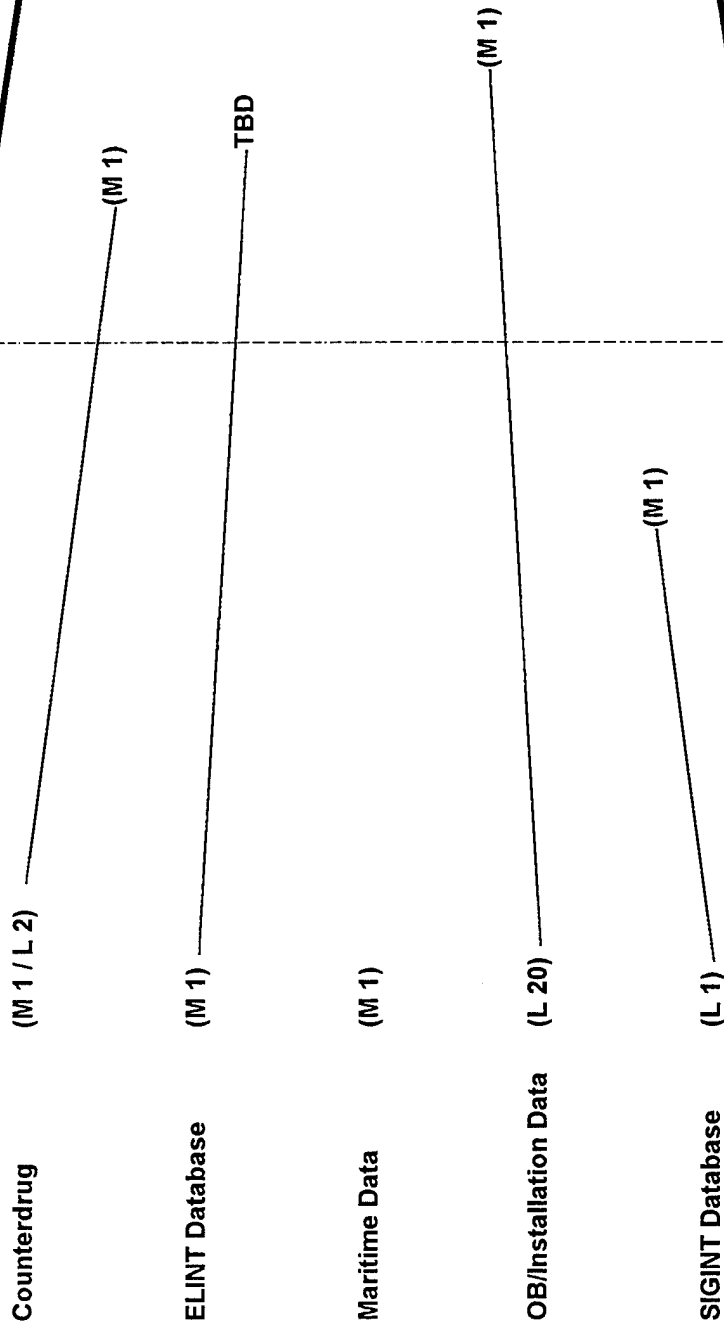

(M 7 / L 15)

April 1, 1996

Migration Applications:
8 Selected

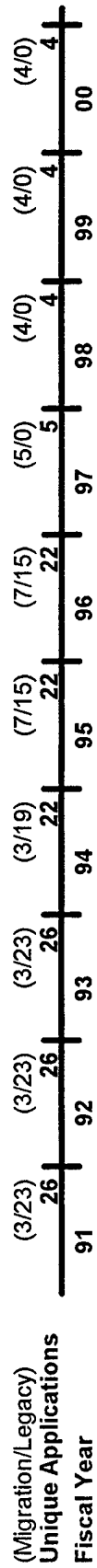

Migration Path Detail Report

Production

April 1, 1996

Activity: **General Military Intelligence**

Group: Counterdrug

GMI0301

Acronym Alias (Migration / Legacy)	Application Title	Phase	Start Date		Migrates to		Mig Beg Date		Mig End Date	
			Month	Year	Month	Year	Month	Year	Month	Year
CDIS	Counter Drug Intelligence System	M	09	1991			01	2010	01	2010
CRYSTAL	Joint National Intelligence Data Project 7	L	09	1991	CDIS		04	1996	04	1997
EMERALD - I	EMERALD - I	L	09	1991	CDIS		04	1996	04	1997

INTELLIGENCE PRODUCTION

General Military Intelligence Counterdrug

Current as of March 12, 1996

LEGACY APPLICATIONS

MIGRATION APPLICATIONS

CDIS=M

CRYSTAL

EMERALD - I

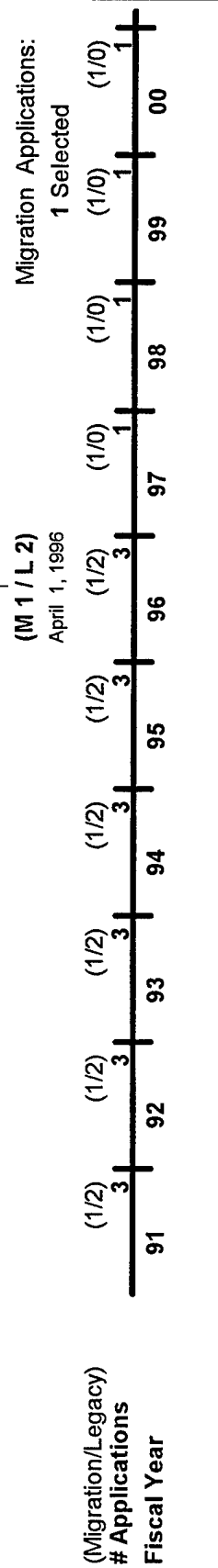

Legend	
.....	Planned
————	Completed
▨	Selected Migration
.....	Other Migration
.....	Legacy

Migration Path Detail Report

Production

April 1, 1996

Activity: General Military Intelligence

Group: OB/Installation Data

GMI0302

Acronym Alias (Migration / Legacy)	Application Title	Phase	Start Date		Migrates to	Mig Beg Date		Mig End Date	
			Month	Year		Month	Year	Month	Year
MIDB V1.0	MIDB Version 1.0	M	06	1995	MIDB V2.0	04	1996	11	1996
MIDB V2.0	MIDB Version 2.0	M	06	1995	MIDB V3.0	11	1996	11	1997
MIDB V3.0	MIDB Version 3.0	M	06	1995	MIDB	04	1997	04	1998
MIDB	Modernized Integrated Data Base	M	04	1998		01	2010	01	2010
ACOM ADB	ACOM Amphibious Database	L	09	1991	MIDB V2.0	12	1995	12	1996
ACOM TMM	ACOM Target Materials Management	L	09	1991	MIDB V2.0	12	1995	10	1996
C&P DATA SERVER	C&P DATA SERVER	L	09	1991	MIDB V2.0	09	1996	07	1997
COLLATERAL XIDB	Collateral Extended Integrated Database	L	09	1991	XIDB	04	1993	04	1994
CONSTANT WEB	CONSTANT WEB	L	09	1991	XIDB	04	1993	04	1994
CSIDS	CENTCOM/SOCOM Integrated Data System	L	09	1991	MIDB V3.0	06	1995	07	1997
EOB SERVER	ELINT Order of Battle Server	L	09	1991	MIDB V2.0	09	1996	07	1997
FORT/FORTRIS	Force Trends Database/Army Force Tracking Information System	L	09	1991	MIDB V3.0	12	1995	07	1997
IDB II	Integrated Database II	L	09	1991	MIDB V1.0	06	1995	10	1996
JMIS 1.0	Joint Military Integrated Intelligence System	L	09	1991	MIDB V1.0	06	1994	06	1995
MAINFRAME IDB	Mainframe Integrated Database	L	09	1991	MIDB V2.0	06	1996	06	1997
MARS	Mapping, Analysis, Research System	L	09	1991	MIDB V2.0	12	1995	07	1997
MIDB C&P P	MIDB C&P Capability	L	09	1991	MIDB V2.0	06	1994	06	1995
MIIPS	Military Intelligence Information Processing System	L	09	1991	MIDB V1.0	06	1994	06	1995
MILFAC	Military Facilitator	L	09	1991	MIDB V2.0	12	1995	07	1997
PORTS	DIA Ports File	L	09	1991	MIDB V2.0	12	1995	07	1997
RAILS	Relational Analysis of Internettet Linkages System	L	09	1991	XIDB	04	1993	04	1994
SDB	Space Database	L	09	1991	MIDB V3.0	03	1995	10	1996
STANS	Space Targeting, Analysis and Networking System	L	09	1991	XIDB	04	1993	04	1994
XIDB	eXtended Integrated DataBase	L	09	1991	MIDB V1.0	04	1996	10	1996

INTELLIGENCE PRODUCTION

General Military Intelligence OB/Installation Data

Current as of March 18, 1996

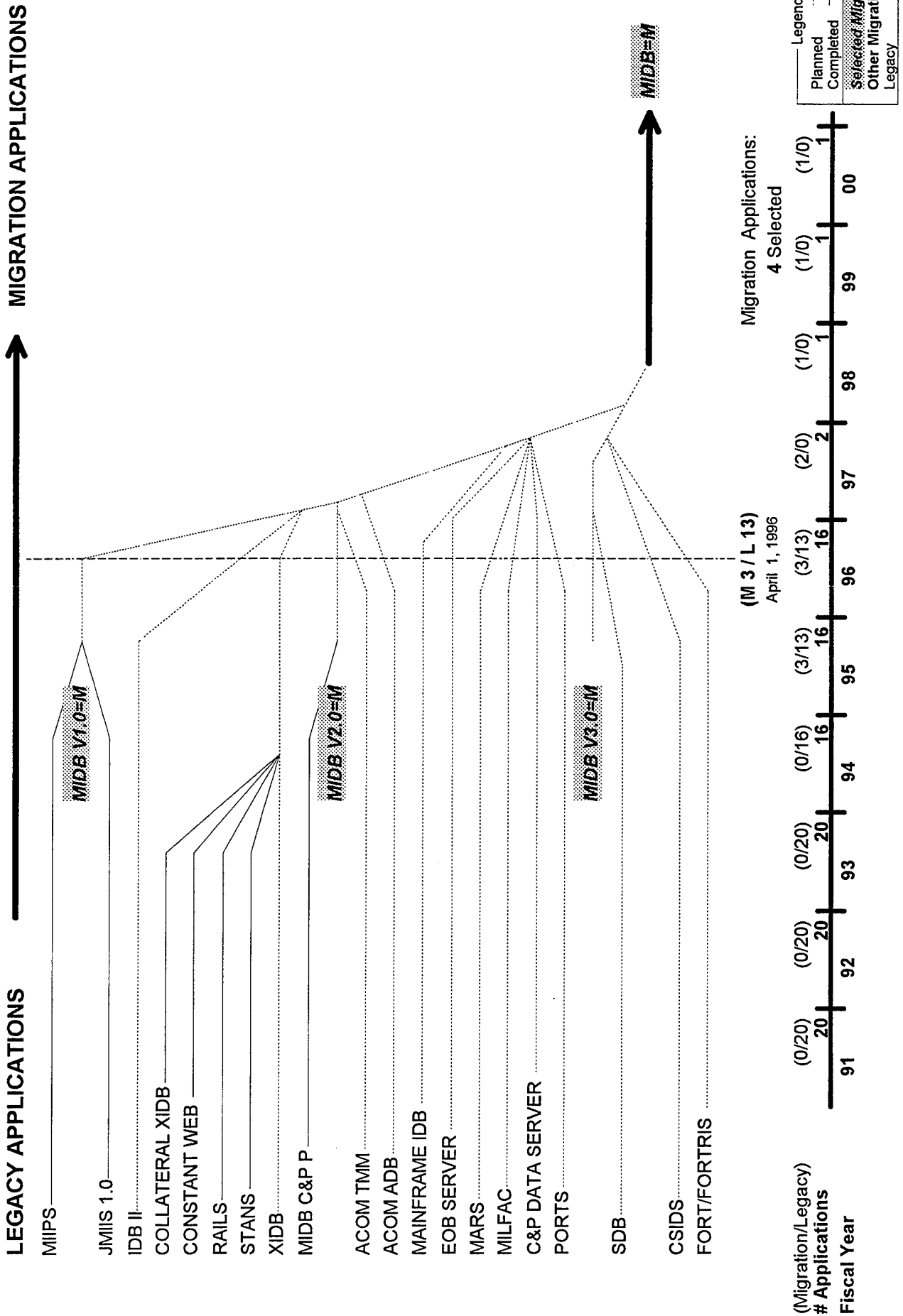

Migration Path Detail Report

Production

April 1, 1996

Activity: General Military Intelligence

Group: Maritime Data

GMI0303

Acronym Alias (Migration / Legacy)	Application Title	Phase	Start Date		Migrates to		Mig Beg Date		Mig End Date	
			Month	Year	Month	Year	Month	Year	Month	Year
JMIE/JEM	Joint Maritime Information Element Support System Enhancement & M	M	09	1991	JMIE/JEM		01	2010	01	2010

INTELLIGENCE PRODUCTION

General Military Intelligence Maritime Data

Current as of January 1, 1989

LEGACY APPLICATIONS

MIGRATION APPLICATIONS

INT-89

JMIE/JEM-M

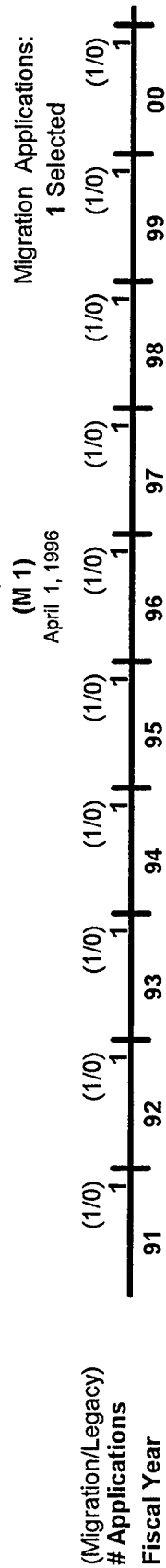

Legend
Planned
Completed
Selected Migration
Other Migration
Legacy

Migration Path Detail Report

Production

April 1, 1996

Activity: **General Military Intelligence**

Group: ELINT Database

GMI0304

Acronym Alias (Migration / Legacy)	Application Title	Phase	Start Date		Migrates to		Mig Beg Date		Mig End Date	
			Month	Year	Month	Year	Month	Year	Month	Year
WRANGLER	WRANGLER	M	09	1991			09	1996	09	1997

INTELLIGENCE PRODUCTION

LEGACY APPLICATIONS

General Military Intelligence ELINT Database

MIGRATION APPLICATIONS

Current as of January 1, 1989

INT- 91

WRANGLER=M

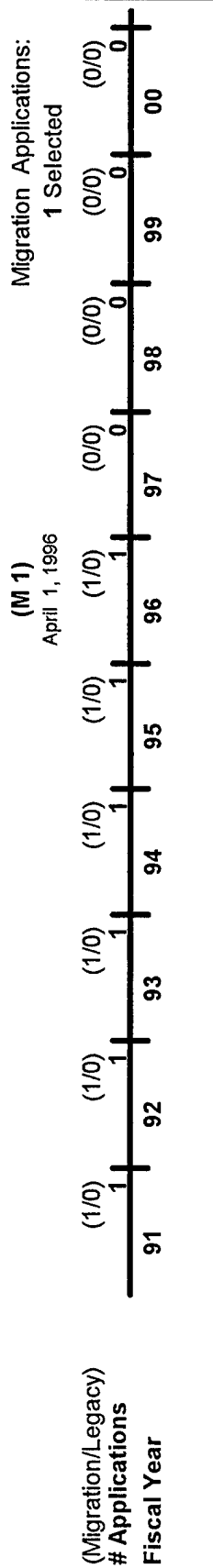

Migration Path Detail Report

Production

Activity: General Military Intelligence

Group: SIGINT Database

April 1, 1996

GMI0305

Acronym Alias (Migration / Legacy)	Application Title	Phase	Start Date		Migrates to		Mig Beg Date		Mig End Date	
			Month	Year			Month	Year	Month	Year
ANCHORY	ANCHORY	M	12	1994			01	2010	01	2010
SOLIS/BELLTOPPER	SIGINT On-Line Information System/BELLTOPPER	L	09	1991	ANCHORY		12	1993	12	1994

INTELLIGENCE PRODUCTION

General Military Intelligence SIGINT Database

Current as of January 1, 1989

LEGACY APPLICATIONS



MIGRATION APPLICATIONS

ANCHORY=IM

SOLIS/BELLTOPPER

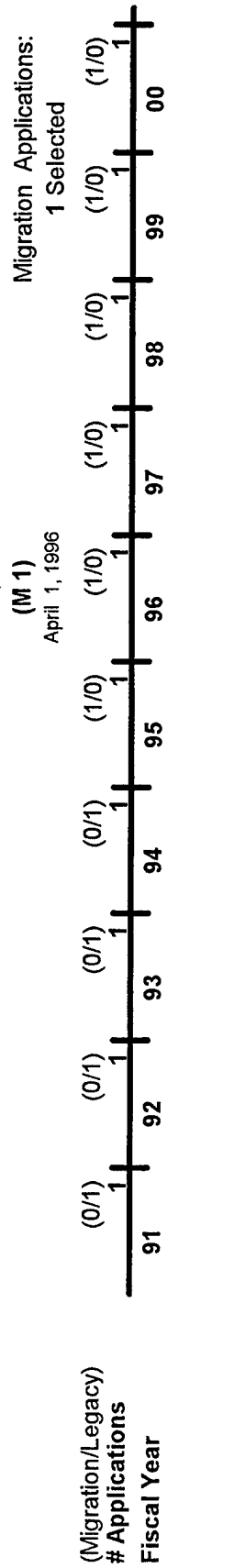

THIS PAGE INTENTIONALLY LEFT BLANK

INTELLIGENCE PRODUCTION

Imagery Activity Summary

LEGACY APPLICATIONS

MIGRATION APPLICATIONS

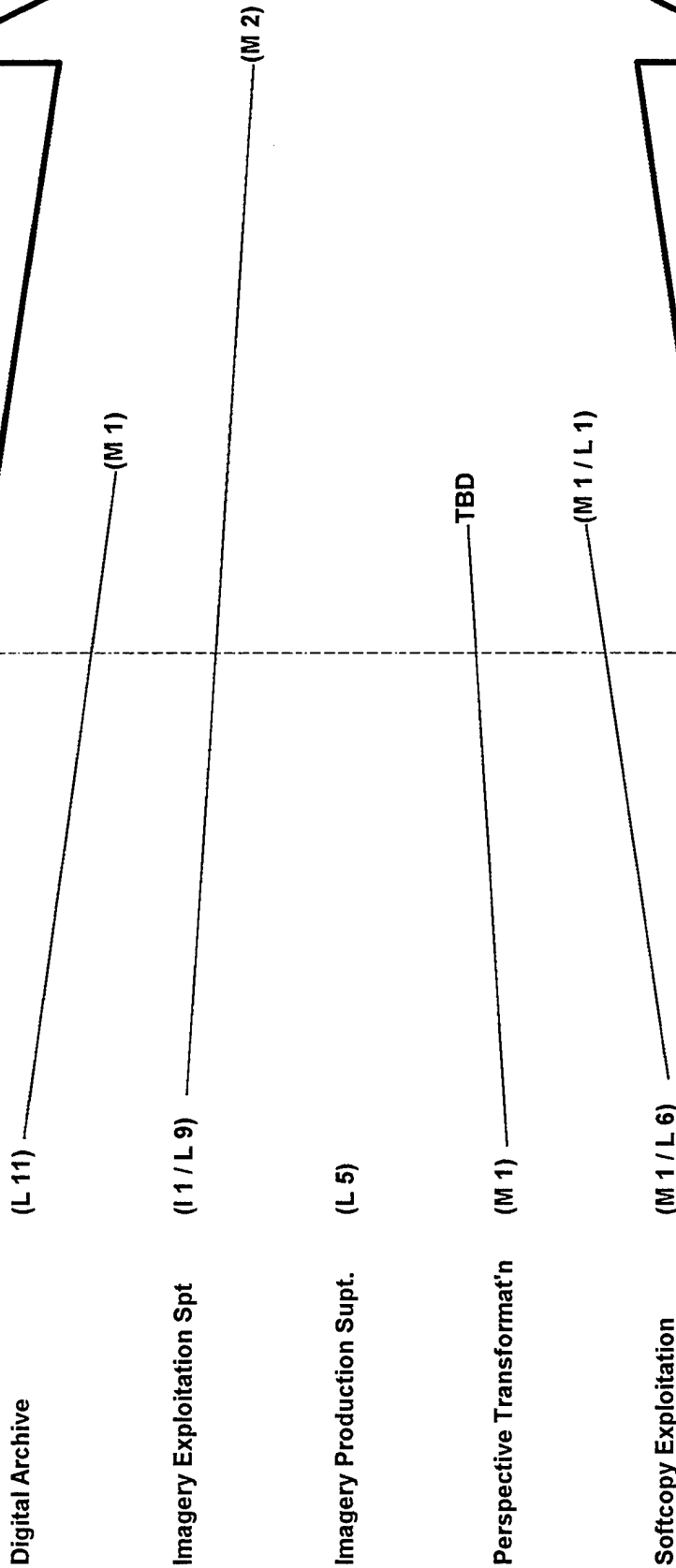

Migration Applications:
5 Selected + 2 Interim

(Migration/Legacy) Unique Applications	91	92	93	94	95	96	97	98	99	00
	34	34	34	34	34	26	18	10	11	11
	(3/31)	(3/31)	(3/31)	(3/31)	(3/31)	(4/22)	(3/15)	(4/6)	(5/6)	(5/6)
Fiscal Year										

Migration Path Detail Report

Production

Activity: Imagery

April 1, 1996

IGY0401

Group: Digital Archive

Acronym Alias (Migration / Legacy)	Application Title	Phase	Start Date		Migrates to		Mig Beg Date		Mig End Date	
			Month	Year			Month	Year	Month	Year
IPL	Image Product Library	M	09	1996			01	2010	01	2010
5-D	Demand Driven Direct Digital Dissemination	L	09	1991	IPL		09	1996	09	1997
DITS	Digital Imagery Transmission System	L	09	1991	5-D		01	1995	02	1996
DVITS	Digital Video Imaging Transmission System	L	09	1991	5-D		01	1995	02	1996
FIST	Fleet Imagery Support Terminal	L	09	1991	5-D		01	1995	02	1996
ICON	Imagery Communications and Operations Node	L	09	1991	5-D		01	1995	02	1996
IPA	Image Product Archive	L	09	1991	IPL		09	1996	09	1997
NEIT	NPIC Electronic Image Transfer	L	09	1991	IPA		09	1995	02	1996
PACS	Photo Analysis Comment Systems	L	09	1991	IPA		09	1995	02	1996
SIDS (ASSORTED)	Assorted lesser Secondary Imagery Dissemination Systems	L	09	1991	5-D		01	1995	02	1996
SIRADS	Shared Imagery Repository And Dissemination System	L	09	1991	IPA		09	1995	02	1996
SPORTS	Second generation Portable Remote Telecommunications System	L	09	1991	5-D		01	1995	02	1996

INTELLIGENCE PRODUCTION

Current as of March 14, 1996

Imagery Digital Archive

LEGACY APPLICATIONS → MIGRATION APPLICATIONS

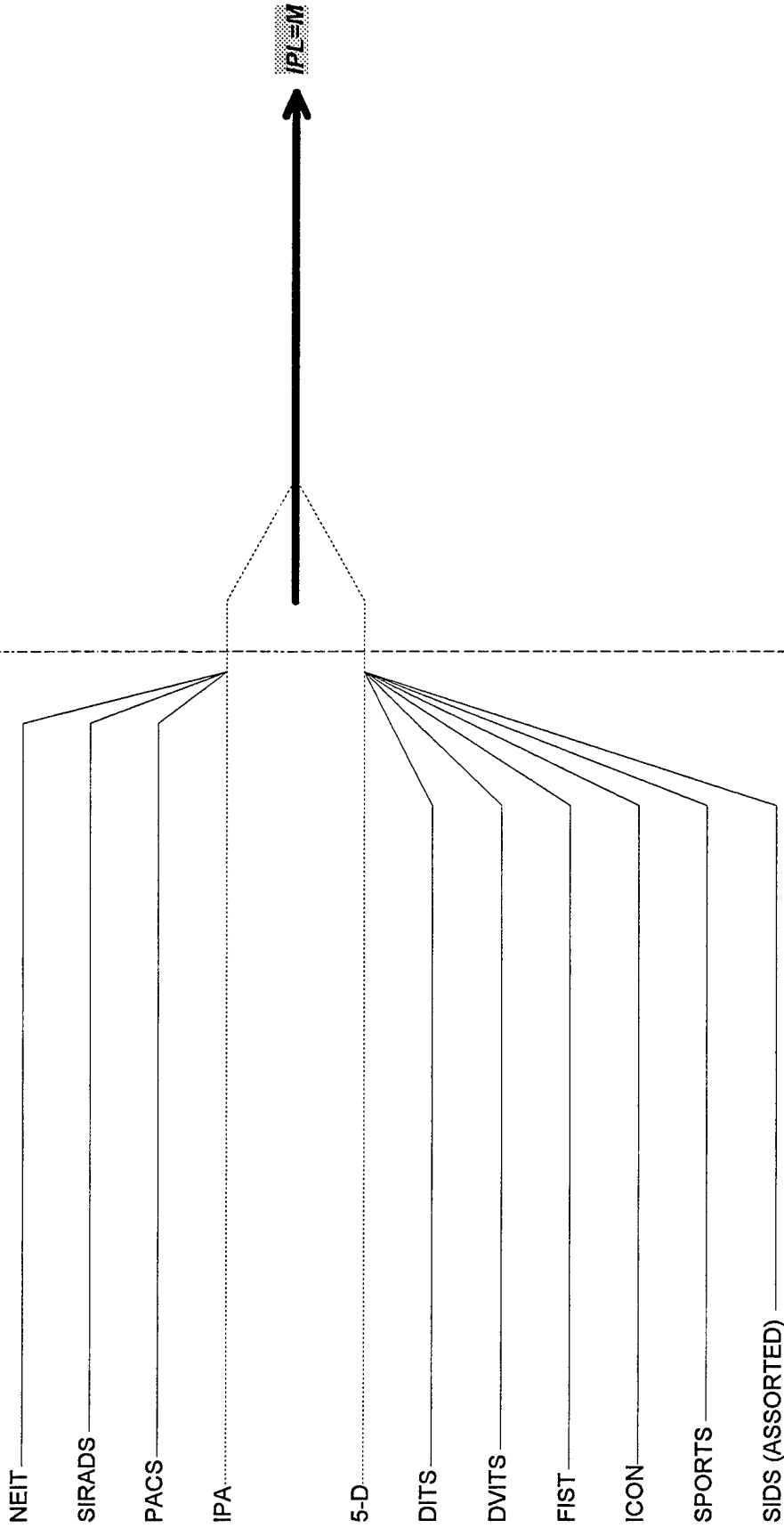

Migration Applications:

(Migration/Legacy) # Applications	91	92	93	94	95	96	97	98	99	00
1 Selected	(0/11)	(0/11)	(0/11)	(0/11)	(0/11)	(1/2)	(1/0)	(1/0)	(1/0)	(1/0)
1 Selected	11	11	11	11	11	3	1	1	1	1

April 1, 1996

(L-2)

Legend	Planned	Completed	Selected Migration	Other Migration	Legacy
Legend
Planned
Completed
Selected Migration
Other Migration
Legacy

Migration Path Detail Report

Production

Activity: Imagery

April 1, 1996

IGY0402

Group: Imagery Production Supt.

Acronym Alias (Migration / Legacy)	Application Title	Phase	Start Date		Migrates to		Mig Beg Date		Mig End Date	
			Month	Year	Month	Year	Month	Year	Month	Year
AIRES/ALE	Advanced Imagery Requirements and Exploitation System/Lifecycle Ex	L	09	1991			01	2010	01	2010
GSD	Graphical Situation Display	L	09	1991			01	2010	01	2010
IROS	Imagery Requirements and Objectives System	L	09	1991			01	2010	01	2010
PHOTOLS/HOST88	Photo On-line System/HOST88	L	09	1991			01	2010	01	2010
PLOTSHEET	PLOTSHEET	L	09	1991			01	2010	01	2010

INTELLIGENCE PRODUCTION

Imagery *Imagery Production Supt.*

Current as of January 1, 1989

LEGACY APPLICATIONS



MIGRATION APPLICATIONS

AIRES/ALE

GSD

IROS

PHOTOLS/HOST88

PLOTSHEET

INT - 99

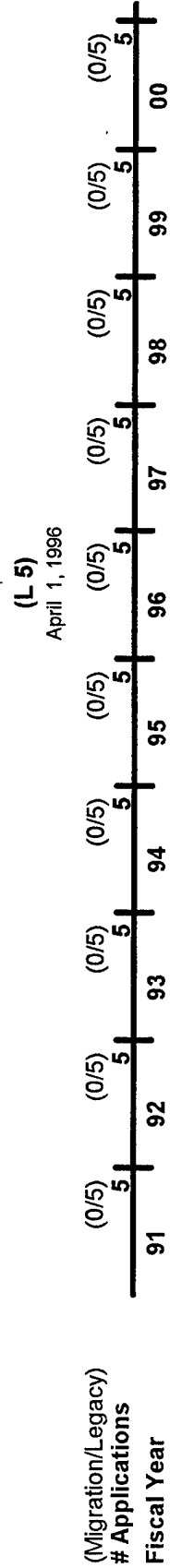

Legend
Planned
Completed
Selected Migration
Other Migration
Legacy

Migration Path Detail Report

Production

Activity: Imagery

April 1, 1996

IGY0404

Group: Perspective Transform'n

Acronym Alias (Migration / Legacy)	Application Title	Phase	Start Date		Migrates to		Mig Beg Date		Mig End Date	
			Month	Year	Month	Year	Month	Year	Month	Year
PERIGEE	Perspective Image Generation and Exploitation	M	09	1991			04	1996	04	1997

INTELLIGENCE PRODUCTION

*Imagery
Perspective Transformat'n*

Current as of January 1, 1989

LEGACY APPLICATIONS

MIGRATION APPLICATIONS

INT- 101

PERIGEE=M

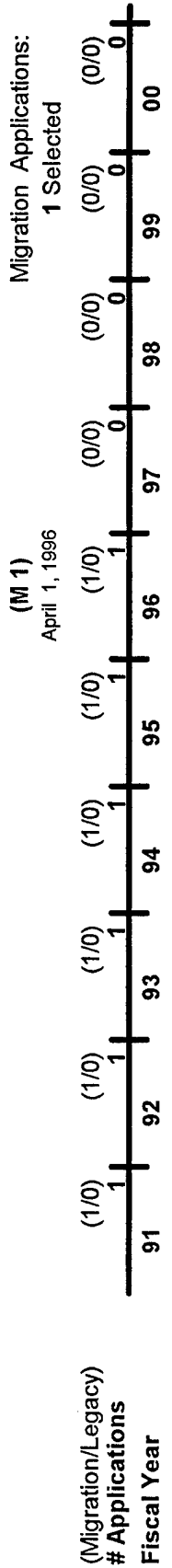

Legend	_____
Planned	_____
Completed	_____
Selected Migration	_____
Other Migration	_____
Legacy	_____

Migration Path Detail Report

Production

April 1, 1996

Activity: Imagery

IGY0405

Group: Softcopy Exploitation

Subgroup: High End

Acronym Alias (Migration / Legacy)	Application Title	Phase	Start Date		Migrates to		Mig Beg Date		Mig End Date	
			Month	Year	Month	Year	Month	Year	Month	Year
INDEX II	Image Data Exploitation System II	L	09	1991			01	2010	01	2010

INTELLIGENCE
PRODUCTION

Current as of January 1, 1989

LEGACY APPLICATIONS

Imagery
Softcopy Exploitation
High End

MIGRATION APPLICATIONS

INDEX II

Legend
Planned
Completed
Selected Migration
Other Migration
Legacy

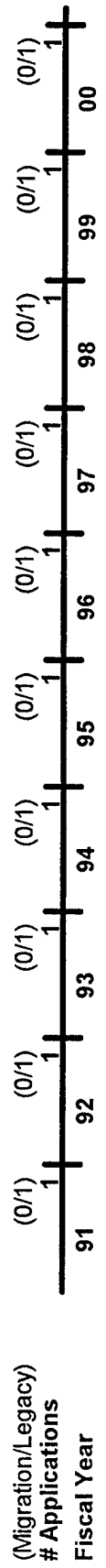

Migration Path Detail Report

Production

Activity: Imagery

April 1, 1996

IGY0406

Group: Softcopy Exploitation Subgroup: Low End

Acronym Alias (Migration / Legacy)	Application Title	Phase	Start Date		Migrates to		Mig Beg Date		Mig End Date	
			Month	Year	Month	Year	Month	Year	Month	Year
ISSES	Imagery Scientist Softcopy Exploitation System	M	09	1991			01	2010	01	2010
DIAS	Digital Imagery Analysis System	L	09	1991	ISSES		04	1996	04	1997
GIITS	General Imagery Interpretation Training System	L	09	1991	ISSES		04	1996	04	1997
GST/GSM	Ground Support Terminal/Ground Station Module	L	09	1991	ISSES		04	1996	04	1997
LTMS	Light Table Mensuration System	L	09	1991	ISSES		04	1996	04	1997
MATRIX	Multisource Automatic Target Recognition with Interactive Exploitation	L	09	1991	ISSES		04	1996	04	1997

INTELLIGENCE PRODUCTION

Current as of January 1, 1989

LEGACY APPLICATIONS

*Imagery
Softcopy Exploitation
Low End*

MIGRATION APPLICATIONS

ISSES=M

DIAS.....

GIITS.....

GST/GSM.....

LTMS.....

MATRIX.....

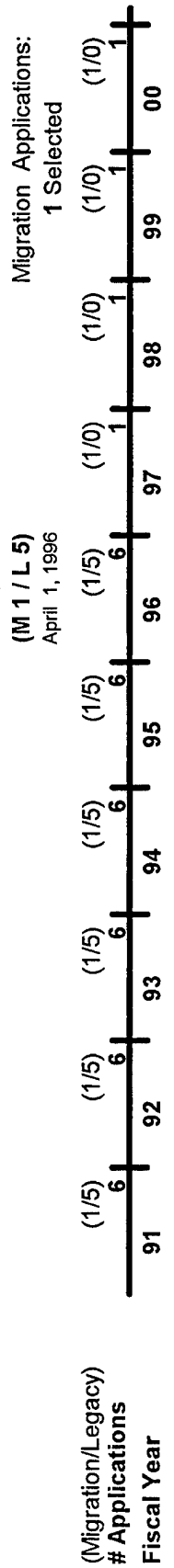

Migration Path Detail Report

Production
Activity: Imagery

April 1, 1996

IGY0407

Group: Imagery Exploitation Spt

Acronym Alias (Migration / Legacy)	Application Title	Phase	Start Date		Migrates to		Mig Beg Date		Mig End Date	
			Month	Year			Month	Year	Month	Year
ESS	Exploitation Support System	M	09	2001			01	2010	01	2010
IESS	Imagery Exploitation Support System	I	09	1991		ESS	10	1998	09	2001
NES	NIMA Exploitation System	I	07	1998		ESS	08	1998	09	2001
ALE	AIRES Life Extension	L	09	1991		NES	01	1996	07	1998
CARS	Contingency Airborne Reconnaissance System	L	09	1991		IESS	09	1997	09	1998
ETRAC	Enhanced Tactical Radar Correlator	L	09	1991		IESS	01	1996	09	1998
IDPS	Integrated Deployable Processing System	L	09	1991		IESS	01	1996	09	1998
JSIPS	Joint Svcs Imagery Processing System	L	09	1991		IESS	04	1996	09	1998
MIES	Modernized Imagery Exploitation System	L	09	1991		IESS	01	1996	09	1998
NES	NPIC Exploitation System	L	09	1991		NES	01	1996	07	1998
PHOTOLS	Photo On-line System	L	09	1991		IESS	01	1996	09	1998
PINES	PACAF Interim National Exploitation System	L	09	1991		IESS	01	1996	09	1998

INTELLIGENCE PRODUCTION

Imagery Imagery Exploitation Spt

Current as of March 14, 1996

LEGACY APPLICATIONS

MIGRATION APPLICATIONS

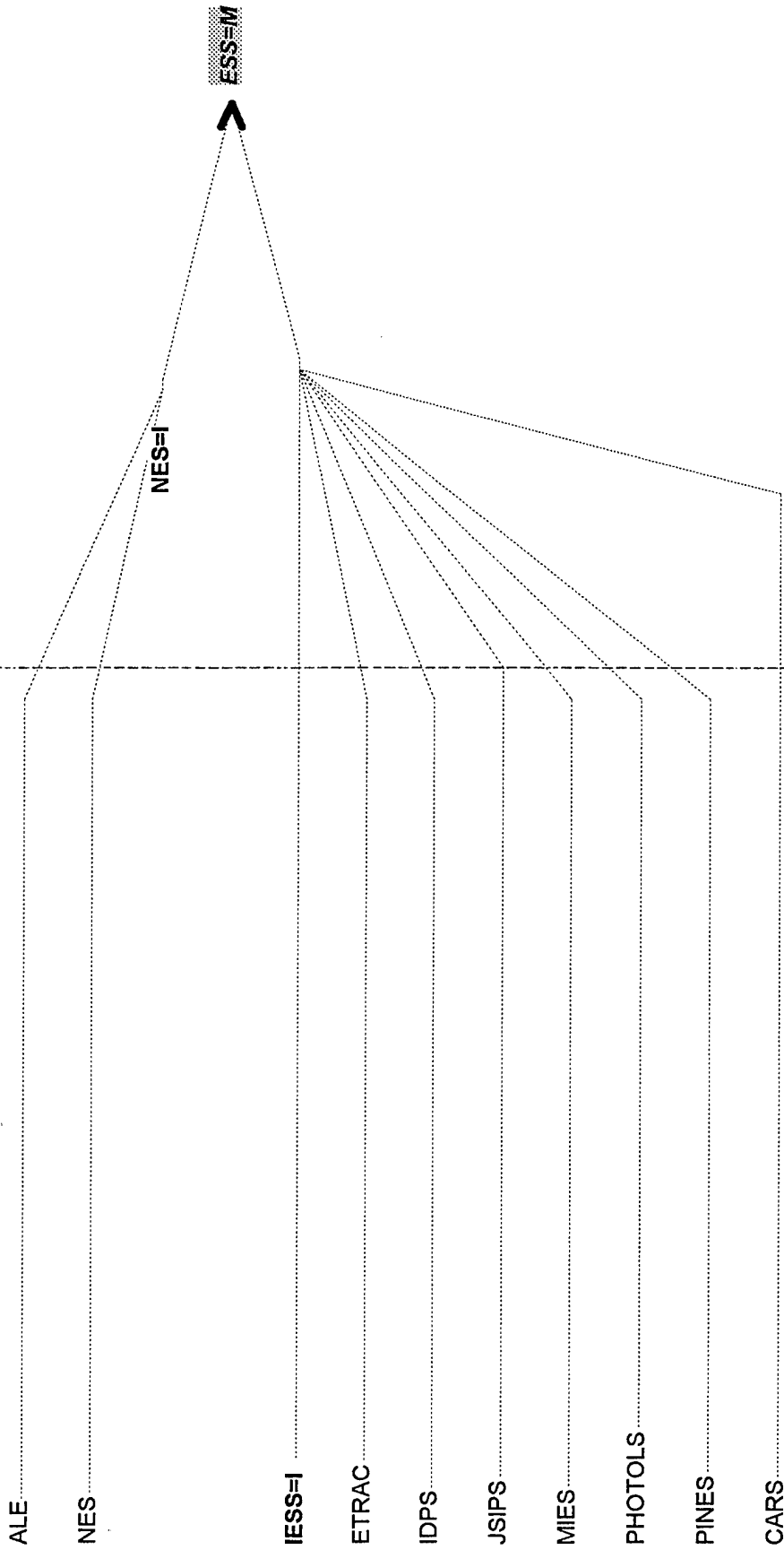

Migration Applications:

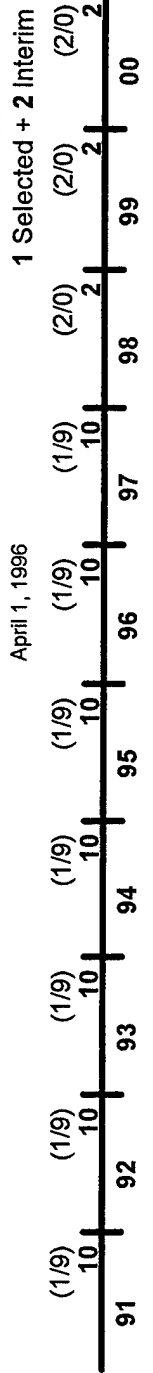

(Migration/Legacy)
Applications
Fiscal Year

(11 / L 9)

April 1, 1996

Legend
Planned
Completed
Selected Migration
Other Migration
Legacy

Migration Path Detail Report

Production

Activity: Imagery

April 1, 1996

IGY0408

Group: Imagery Exploitation Spt

Subgroup: Airborne Msn Tracking

Acronym Alias (Migration / Legacy)	Application Title	Phase	Start Date		Migrates to		Mig Beg Date		Mig End Date	
			Month	Year	Month	Year	Month	Year	Month	Year
AIRTAPS	Aerial Imagery Reconnaissance Tracking and Plotting System	M	12	1998			01	2010	01	2010

INTELLIGENCE PRODUCTION

LEGACY APPLICATIONS

Imagery
Imagery Exploitation Spt
Airborne Msn Tracking

MIGRATION APPLICATIONS

Current as of March 14, 1996

AIRTAPS=M

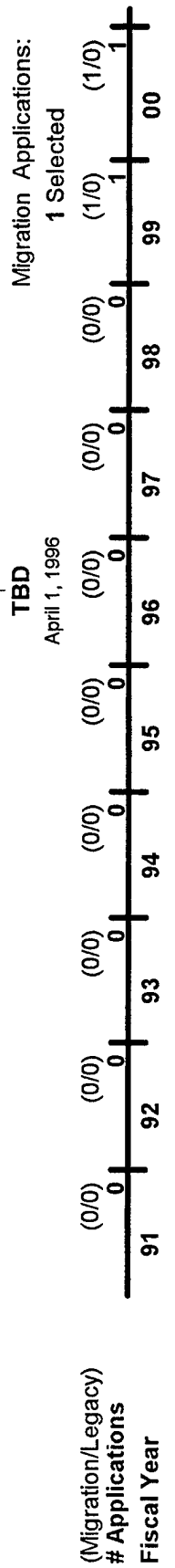

TBD
April 1, 1996

Legend	_____
Planned
Completed	_____
Selected Migration	▨
Other Migration	▩
Legacy	_____

THIS PAGE INTENTIONALLY LEFT BLANK

INTELLIGENCE
PRODUCTION

LEGACY APPLICATIONS

MC & G
Activity
Summary

MIGRATION APPLICATIONS

MC&G Data Development (L 9)

(M 1)

(M 1 / L 7)
 April 1, 1996

Migration Applications:
 1 Selected

(Migration/Legacy) Unique Applications	91	92	93	94	95	96	97	98	99	00
	9	9	10	9	8	8	8	4	4	1
	(0/9)	(1/8)	(1/9)	(1/8)	(1/7)	(1/7)	(1/3)	(1/3)	(1/0)	(1/0)
Fiscal Year										

Migration Path Detail Report

Production

Activity: MC & G

April 1, 1996

MCG0500

Group: MC&G Data Development

Acronym Alias (Migration / Legacy)	Application Title	Phase	Start Date		Migrates to		Mig Beg Date		Mig End Date	
			Month	Year			Month	Year	Month	Year
MC&GPS	MC&GPS Production System	M	06	1992			01	2010	01	2010
AGDS/CPS	Automated Graphics Digitizing System/Cluster Processing System	L	09	1991	MC&GPS		10	1994	09	1997
DADMS	Defense Mapping Agency Automated Distribution Management System	L	09	1991	MC&GPS		10	1996	09	1997
DC/S	Digital Comparator Segment	L	09	1991	MC&GPS		10	1995	09	1999
OLOPS	Off-line Orthophoto Printing System	L	09	1991	MC&GPS		10	1996	09	1997
PAMS	Pooled Analytical Mensuration System	L	09	1991	MC&GPS		10	1995	09	1999
PASS	Pooled Analytical Stereoplotter System	L	09	1991	MC&GPS		10	1995	09	1999
TES/EMPS	Terrain Edit System/Elevation Matrix Processing System	L	09	1991	MC&GPS		10	1993	09	1994
TFAS	Terrain/Feature Analysis System	L	09	1991	MC&GPS		10	1992	09	1993
UR/S	Universal Rectifier System	L	09	1991	MC&GPS		10	1996	09	1997

INTELLIGENCE PRODUCTION

MC & G MC&G Data Development

Current as of January 1, 1989

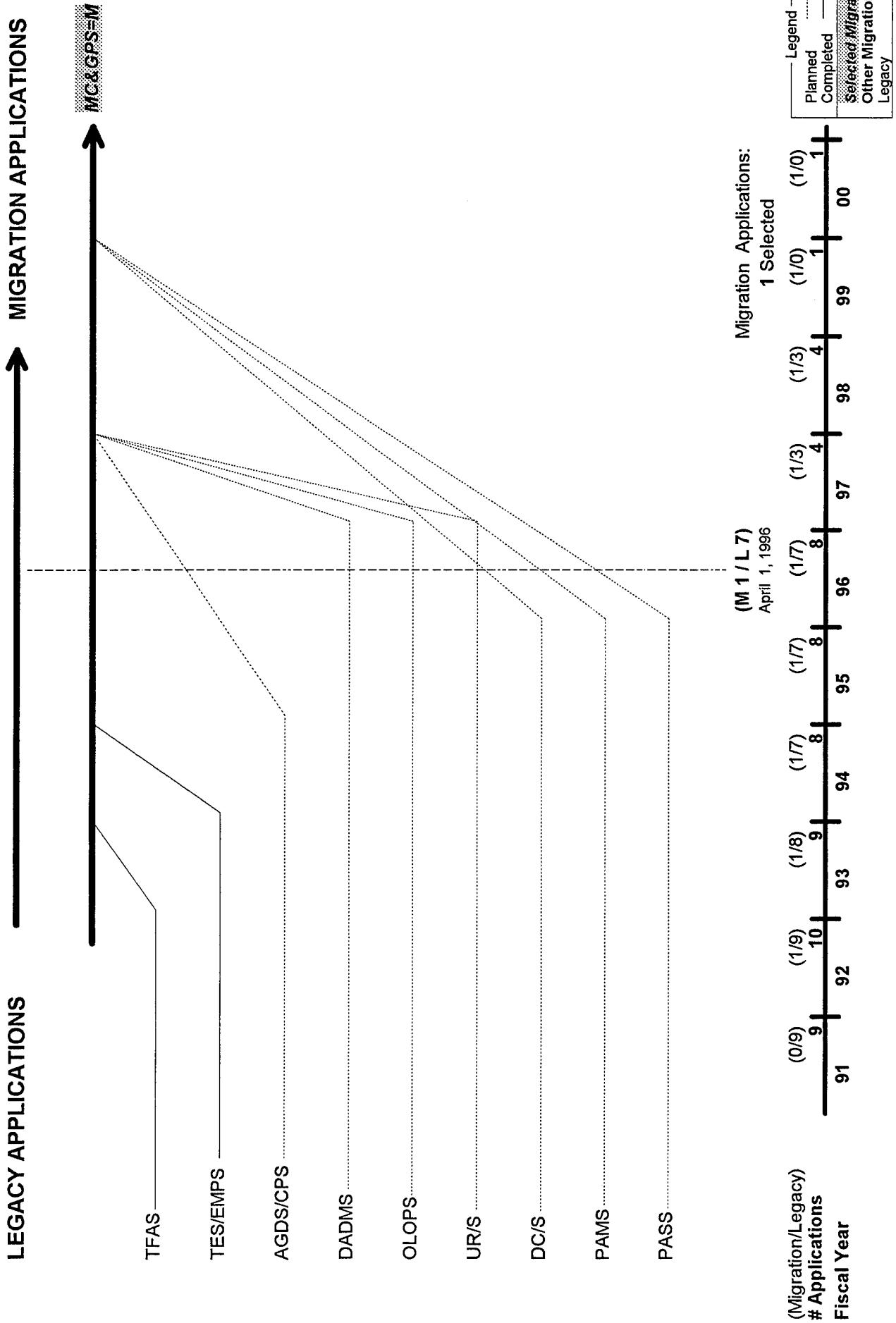

THIS PAGE INTENTIONALLY LEFT BLANK

INTELLIGENCE PRODUCTION

Scientific & Technical Activity Summary

LEGACY APPLICATIONS

MIGRATION APPLICATIONS

Charact. & Perform. Data	(M 1 / L 7)	
Data Notification	(M 1 / L 2)	(M 1)
For. Mat'l. Exploit.-Doc	(M 1 / L 5)	(M 1)
Foreign Mat'l. Exploit	(M 1 / L 4)	(M 1)
High Perform. Cmptg. Res.	(M 1)	(M 1)
Information Reference	(M 1)	TBD
MASINT Analysis	(M 1 / L 4)	TBD
Machine Translation	(M 1)	(M 1)
Scient. Imagery Analysis	(L 6)	(L 1)
Signals Analysis	(M 1 / L 25)	(M 1)
Signature Prediction	(L 6)	(M 1)
filtering	(M 1 / L 1 / L 5)	(M 11 / L 1 / L 63)

April 1, 1996

Migration Applications:
11 Selected + 1 Interim

(Migration/Legacy) Unique Applications	91	92	93	94	95	96	97	98	99	00
	74	74	74	74	75	75	40	10	10	10
	(11/63)	(11/63)	(11/63)	(11/63)	(12/63)	(12/63)	(9/31)	(8/2)	(8/2)	(8/2)

Migration Path Detail Report

Production

Activity: Scientific & Technical

April 1, 1996

Group: Charact. & Perform. Data

STI0701

Acronym Alias (Migration / Legacy)	Application Title	Phase	Start Date		Migrates to	Mig Beg Date		Mig End Date	
			Month	Year		Month	Year	Month	Year
DC&PDB	Distributed C&P Database	M	09	1991		01	2010	01	2010
CPDB	Combined Personnel DataBase	L	09	1991	DC&PDB	04	1996	01	1998
EWIRS	Electronic Warfare Integrated Reprogramming System	L	09	1991	DC&PDB	04	1996	01	1998
FIDB	Finished Intelligence Database	L	09	1991	DC&PDB	04	1996	01	1998
NID	Naval Intelligence Database	L	09	1991	DC&PDB	04	1996	01	1998
PAWS	Parametric Assessment of Weapons Systems	L	09	1991	DC&PDB	04	1996	01	1998
PCQT	PC Query Tools	L	09	1991	DC&PDB	04	1996	01	1998
STIDB	S&T Intel Database	L	09	1991	DC&PDB	04	1996	01	1998

INTELLIGENCE PRODUCTION

Scientific & Technical Charact. & Perform. Data

Current as of March 12, 1996

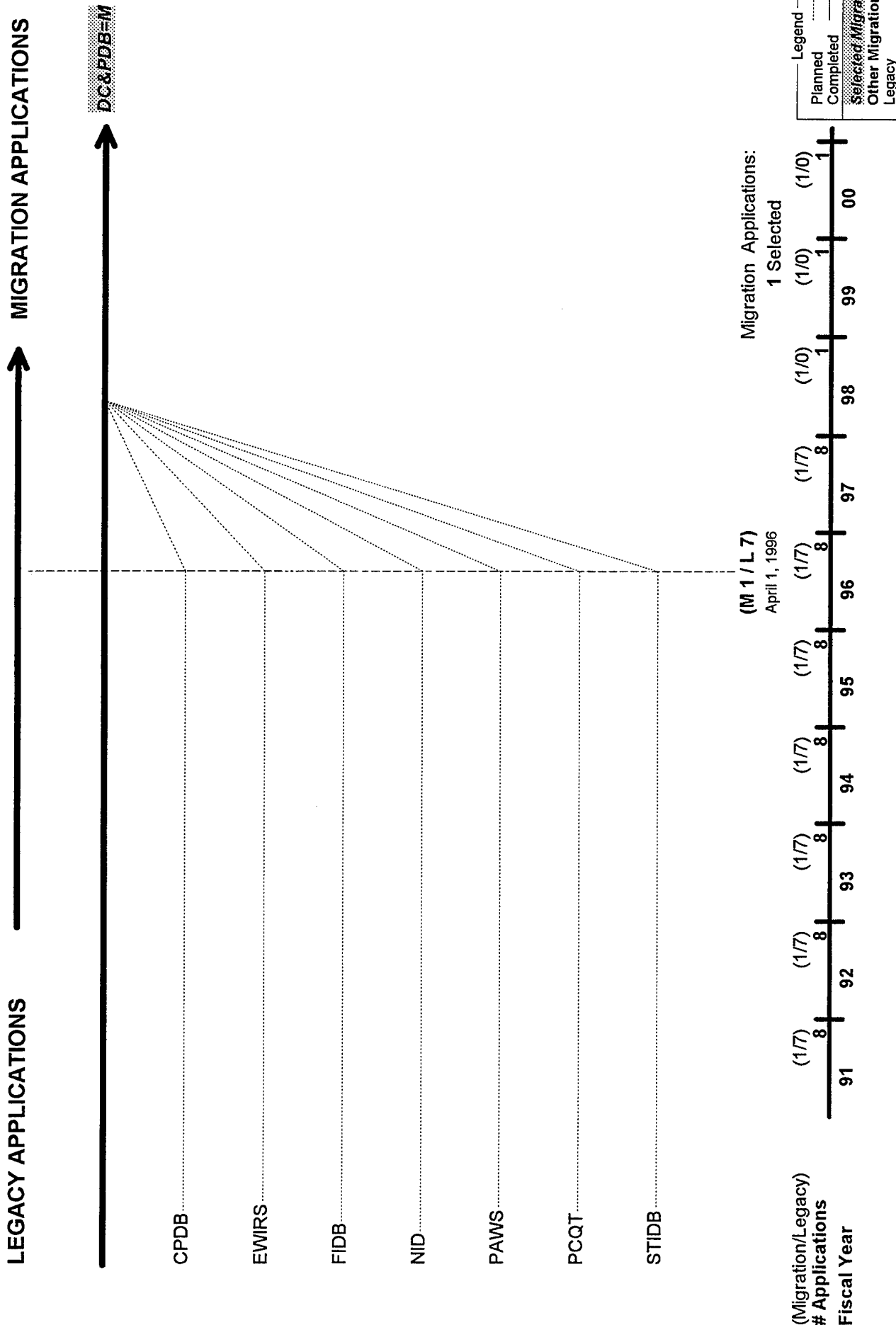

Migration Path Detail Report

Production

Activity: Scientific & Technical

April 1, 1996

Group: Data Notification

STI0702

Acronym Alias (Migration / Legacy)	Application Title	Phase	Start Date		Migrates to		Mig Beg Date		Mig End Date	
			Month	Year	Month	Year	Month	Year	Month	Year
MINS	Multisource Integrated Notification System	M	09	1991			01	2010	01	2010
CIRC	Central Information Reference and Control System Profiles	L	09	1991	MINS		04	1996	03	1998
EASI	Emergency Action System for Intelligence	L	09	1991	MINS		04	1996	03	1998

INTELLIGENCE PRODUCTION

Scientific & Technical Data Notification

Current as of March 12, 1996

LEGACY APPLICATIONS

MIGRATION APPLICATIONS

MINS=M

INT- 119

CIRC

EASI

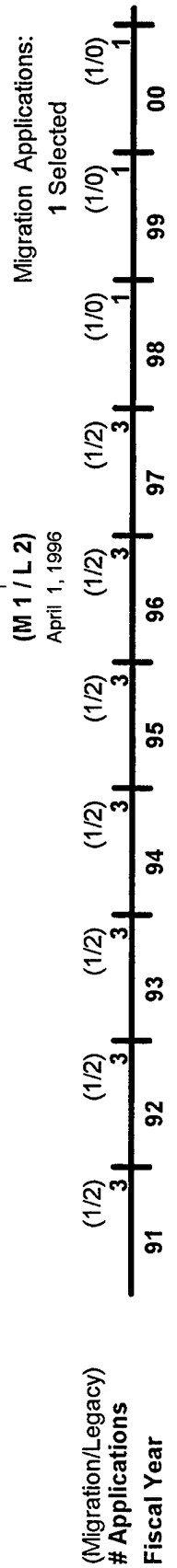

Legend
Planned
Completed
Selected Migration
Other Migration
Legacy

Migration Path Detail Report

Production

Activity: Scientific & Technical

April 1, 1996

STI0703

Group: For. Mat'l. Exploit.-Doc

Acronym Alias (Migration / Legacy)	Application Title	Phase	Start Date		Migrates to		Mig Beg Date		Mig End Date	
			Month	Year	Month	Year	Month	Year	Month	Year
HARMONY	HARMONY	M	09	1991			01	2010	01	2010
DOCEX	Document Exploitation	L	09	1991	HARMONY		04	1996	06	1998
FORDIMS	Foreign Document Information Management System	L	09	1991	HARMONY		04	1996	06	1998
FORMIDABLE	FORMIDABLE	L	09	1991	HARMONY		04	1996	06	1998
PCSTIMS	Personal Computer S&T Intelligence Management System	L	09	1991	HARMONY		04	1996	06	1998
TRANS	Translation System	L	09	1991	HARMONY		04	1996	06	1998

INTELLIGENCE PRODUCTION

Scientific & Technical For. Mat'l. Exploit.-Doc

Current as of March 12, 1996

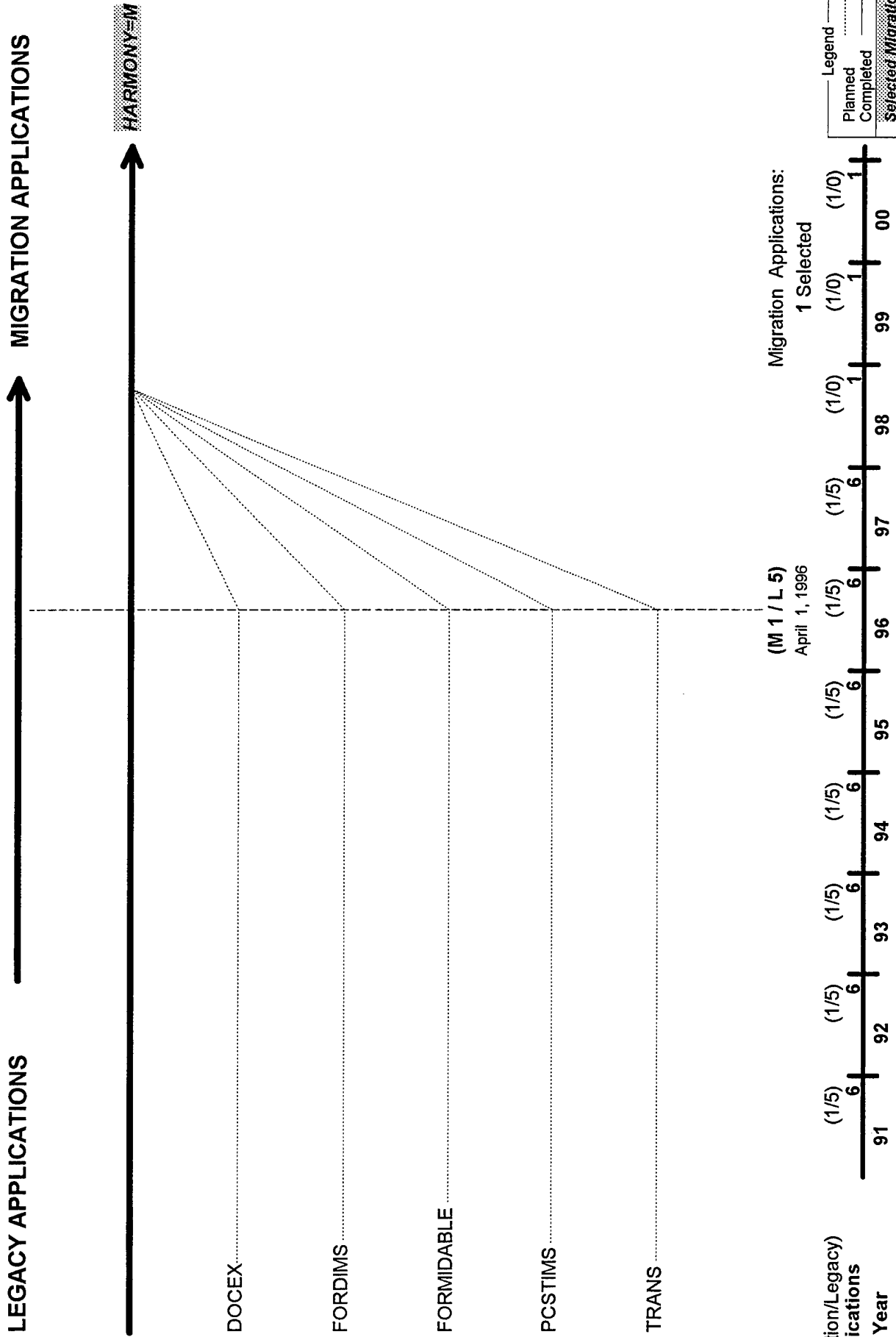

Migration Path Detail Report

Production

Activity: Scientific & Technical

April 1, 1996

Group: Foreign Mat'l. Exploit

STI0704

Acronym Alias (Migration / Legacy)	Application Title	Phase	Start Date		Migrates to	Mig Beg Date		Mig End Date	
			Month	Year		Month	Year	Month	Year
FORMMS	Foreign Materiel Management System	M	09	1991		01	2010	01	2010
FMEC	Foreign Material Exploitation Catalog	L	09	1991	FORMMS	04	1996	02	1998
FORMIDABLE	FORMIDABLE	L	09	1991	FORMMS	04	1996	02	1998
HTD	Hyperlinked Threat Description	L	09	1991	FORMMS	04	1996	02	1998
NAIC-FME	National Air Intelligence Center - Foreign Materials Exploitations	L	09	1991	FORMMS	04	1996	02	1998

INTELLIGENCE PRODUCTION

Scientific & Technical Foreign Mat'l. Exploit

Current as of March 12, 1996

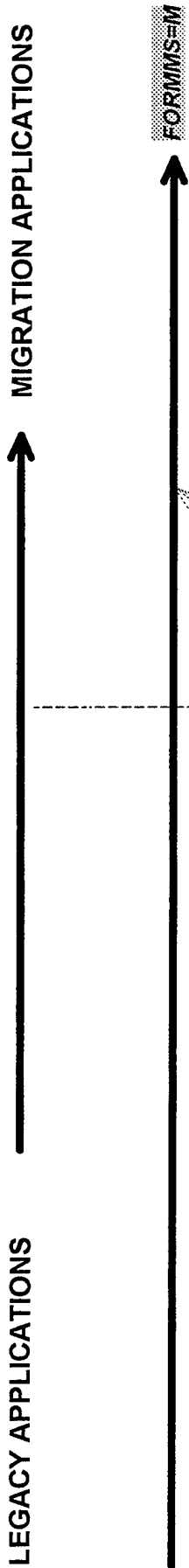

FMEC

FORMIDABLE

HTD

NAIC-FME

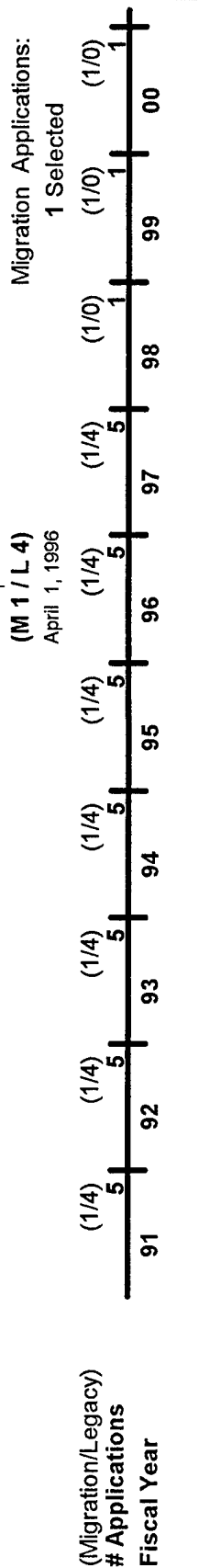

Migration Path Detail Report

Production

April 1, 1996

Activity: Scientific & Technical

STI0705

Group: High Perform. Cmpg. Res.

Acronym Alias (Migration / Legacy)	Application Title	Phase	Start Date		Migrates to		Mig Beg Date		Mig End Date	
			Month	Year	Month	Year	Month	Year	Month	Year
HPSC	High Performance Scientific Computing Research	M	09	1991			04	1996	04	1997

INTELLIGENCE
PRODUCTION

*Scientific & Technical
High Perform. Cmptg. Res.*

Current as of January 1, 1989

LEGACY APPLICATIONS

MIGRATION APPLICATIONS

HPSC=M

Migration Applications:
1 Selected

(M 1)
April 1, 1996

(Migration/Legacy)
Applications
Fiscal Year

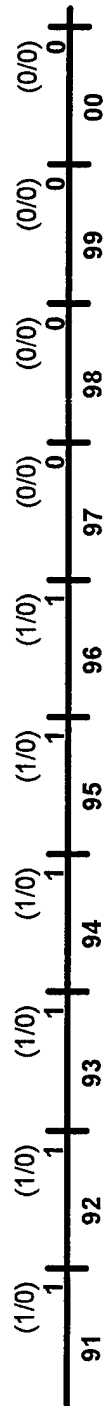

Legend	_____
Planned
Completed	_____
Selected Migration	▨
Other Migration	▩
Legacy	_____

Migration Path Detail Report

Production

Activity: Scientific & Technical

April 1, 1996

Group: Information Reference

STI0706

Acronym Alias (Migration / Legacy)	Application Title	Phase	Start Date		Migrates to		Mig Beg Date		Mig End Date	
			Month	Year	Month	Year	Month	Year	Month	Year
CIRC	Central Information Reference and Control System	M	09	1991			04	1996	04	1997

INTELLIGENCE
PRODUCTION

**Scientific & Technical
Information Reference**

Current as of January 1, 1989

LEGACY APPLICATIONS

MIGRATION APPLICATIONS

CIRC-M

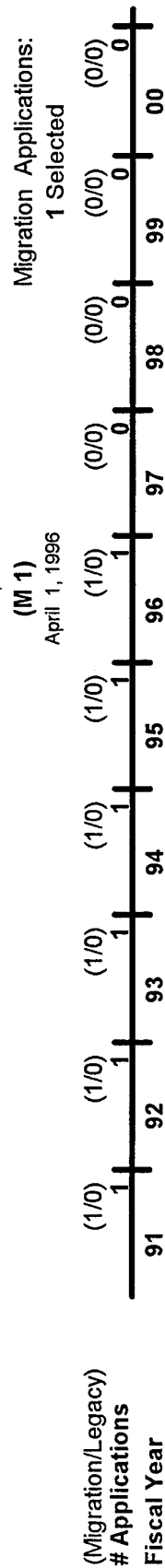

Legend
Planned
Completed
Selected Migration
Other Migration
Legacy

Migration Path Detail Report

Production

Activity: Scientific & Technical

April 1, 1996

Group: Machine Translation

STI0707

Acronym Alias (Migration / Legacy)	Application Title	Phase	Start Date		Migrates to		Mig Beg Date		Mig End Date	
			Month	Year	Month	Year	Month	Year	Month	Year
MT Machine Translation		M	09	1991			04	1996	04	1997

INTELLIGENCE
PRODUCTION

**Scientific & Technical
Machine Translation**

Current as of January 1, 1989

LEGACY APPLICATIONS

MIGRATION APPLICATIONS



INT- 129

MT=M

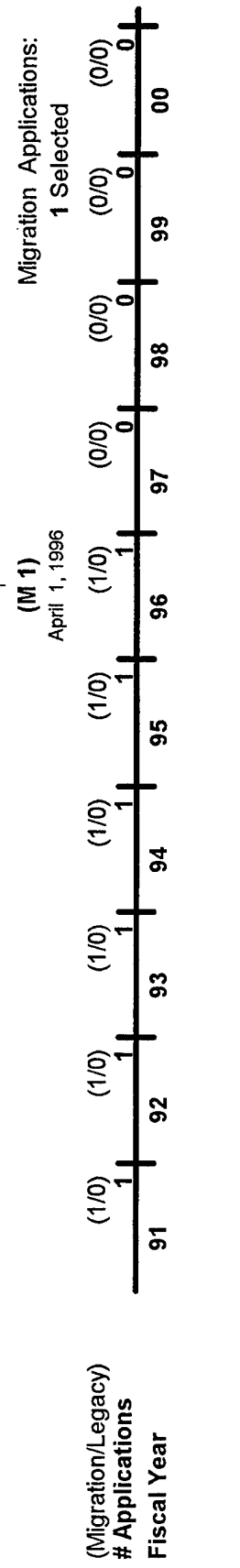

(M 1)
April 1, 1996

Migration Path Detail Report

Production

Activity: Scientific & Technical

April 1, 1996

Group: MASINT Analysis

STI0708

Acronym Alias (Migration / Legacy)	Application Title	Phase	Start Date		Migrates to	Mig Beg Date		Mig End Date	
			Month	Year		Month	Year	Month	Year
MPAS	MASINT Processing & Analysis System	M	09	1991		01	2010	01	2010
CDPS	Complex Data Processing	L	09	1991	MPAS	04	1996	04	1997
DES	Data Exploitation System	L	09	1991	MPAS	04	1996	04	1997
MASINT INTEGRATION	MASINT INTEGRATION	L	09	1991	MPAS	04	1996	04	1997
RTOS	Real Time Optical System	L	09	1991	MPAS	04	1996	04	1997

INTELLIGENCE PRODUCTION

Scientific & Technical MASINT Analysis

Current as of January 1, 1989

LEGACY APPLICATIONS

MIGRATION APPLICATIONS



CDPS

DES

MASINT INTEGRATION

RTOS

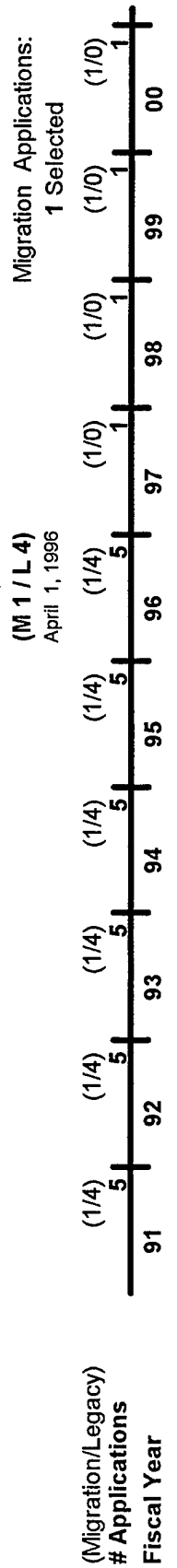

Legend	
Planned
Completed	————
Selected/Migration	▨
Other Migration	▩
Legacy	□

Migration Path Detail Report

Production

Activity: Scientific & Technical

April 1, 1996

Group: Scient. Imagery Analysis

STI0710

Acronym Alias (Migration / Legacy)	Application Title	Phase	Start Date		Migrates to		Mig Beg Date		Mig End Date	
			Month	Year			Month	Year	Month	Year
DIAF (S&T)	Digital Imagery Analysis Facility (S&T)	L	09	1991	VISION/VISTA	04	1996	04	1997	
DIPS (S&T)	Digital Imagery Processing System (S&T)	L	09	1991	VISION/VISTA	04	1996	04	1997	
MISC DESK (S&T)	MISC Desk (S&T)	L	09	1991	VISION/VISTA	04	1996	04	1997	
NAIC IMAGES (S&T)	NAIC Images (S&T)	L	09	1991	VISION/VISTA	04	1996	04	1997	
SYSTEM III	System III	L	09	1991	VISION/VISTA	04	1996	04	1997	
VISION/VISTA	VISION/Very Intelligence Surveillance and Target Acquisition	L	09	1991		01	2010	01	2010	

INTELLIGENCE PRODUCTION

Scientific & Technical Scient. Imagery Analysis

Current as of January 1, 1989

LEGACY APPLICATIONS

MIGRATION APPLICATIONS

VISION/MISTA

DIAF (S&T)

DIPS (S&T)

MISC DESK (S&T)

NAIC IMAGES (S&T)

SYSTEM III

(L 6)
April 1, 1986

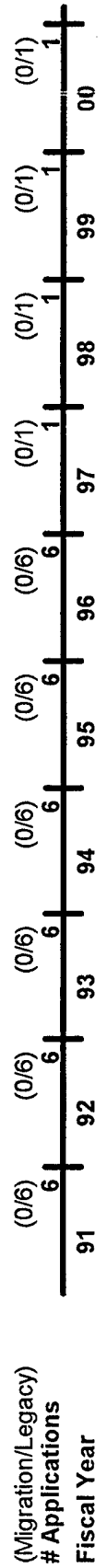

Legend	
Planned
Completed
Selected Migration
Other Migration
Legacy

Migration Path Detail Report

Production

Activity: Scientific & Technical

Group: Signals Analysis

April 1, 1996

STI0711

Acronym Alias (Migration / Legacy)	Application Title	Phase	Start Date		Migrates to		Mig Beg Date		Mig End Date	
			Month	Year	Month	Year	Month	Year	Month	Year
NSES	Noncommunications Signals Exploitation System	M	09	1991			01	2010	01	2010
ASSET	All Source Satellite Evaluation Tool	L	09	1991		NSES	04	1997	04	1998
BLACK ONYX		L	09	1991		NSES	04	1997	04	1998
DSAS	Digital Signal Analysis System	L	09	1991		NSES	04	1996	04	1997
HUMMINGBIRD	Hummingbird	L	09	1991		NSES	04	1996	04	1997
HYSAS	Hybrid Signal Analysis System	L	09	1991		NSES	04	1996	04	1997
KHOROS		L	09	1991		NSES	04	1997	04	1998
MOCKINGBIRD	Mockingbird	L	09	1991		NSES	04	1997	04	1998
OILSTOCK	OILSTOCK	L	09	1991		NSES	04	1997	04	1998
OS MARINARA	OS Marinara	L	09	1991		NSES	04	1997	04	1998
REVEAL	REVEAL	L	09	1991		NSES	04	1997	04	1998
S&T PLOT	S & T Plot	L	09	1991		NSES	04	1996	04	1997
SAS	Signal Analysis System	L	09	1991		NSES	04	1996	04	1997
SCMP	Space Craft Modeling Program	L	09	1991		NSES	04	1996	04	1997
SIGINT TUTOR	SIGINT TUTOR	L	09	1991		NSES	04	1997	04	1998
SIGIPS	Signals Intelligence Processing System	L	09	1991		NSES	04	1996	04	1997
SIGNAL TUTOR	SIGNAL TUTOR	L	09	1991		NSES	04	1996	04	1997
STANZA	STANZA	L	09	1991		NSES	04	1996	04	1997
SUNSHINE	SUNSHINE	L	09	1991		NSES	04	1997	04	1998
TARTLETT	TARTLETT	L	09	1991		NSES	04	1997	04	1998
TEXAS	Telemetry External analysis System	L	09	1991		NSES	04	1996	04	1997
TPAS I	Telemetry Pulse Analysis System I	L	09	1991		NSES	04	1996	04	1997
TPAS II	Telemetry Pulse Analysis System II	L	09	1991		NSES	04	1996	04	1997
VISUALIZE	Visualize	L	09	1991		NSES	04	1997	04	1998
WHIPPOORWILL	WHIPPOORWILL	L	09	1991		NSES	04	1996	04	1997
X-MIDAS	Extended MAXI Intelligence Desktop Application Software	L	09	1991		NSES	04	1997	04	1998

INTELLIGENCE PRODUCTION

Scientific & Technical Signals Analysis

Current as of January 1, 1989

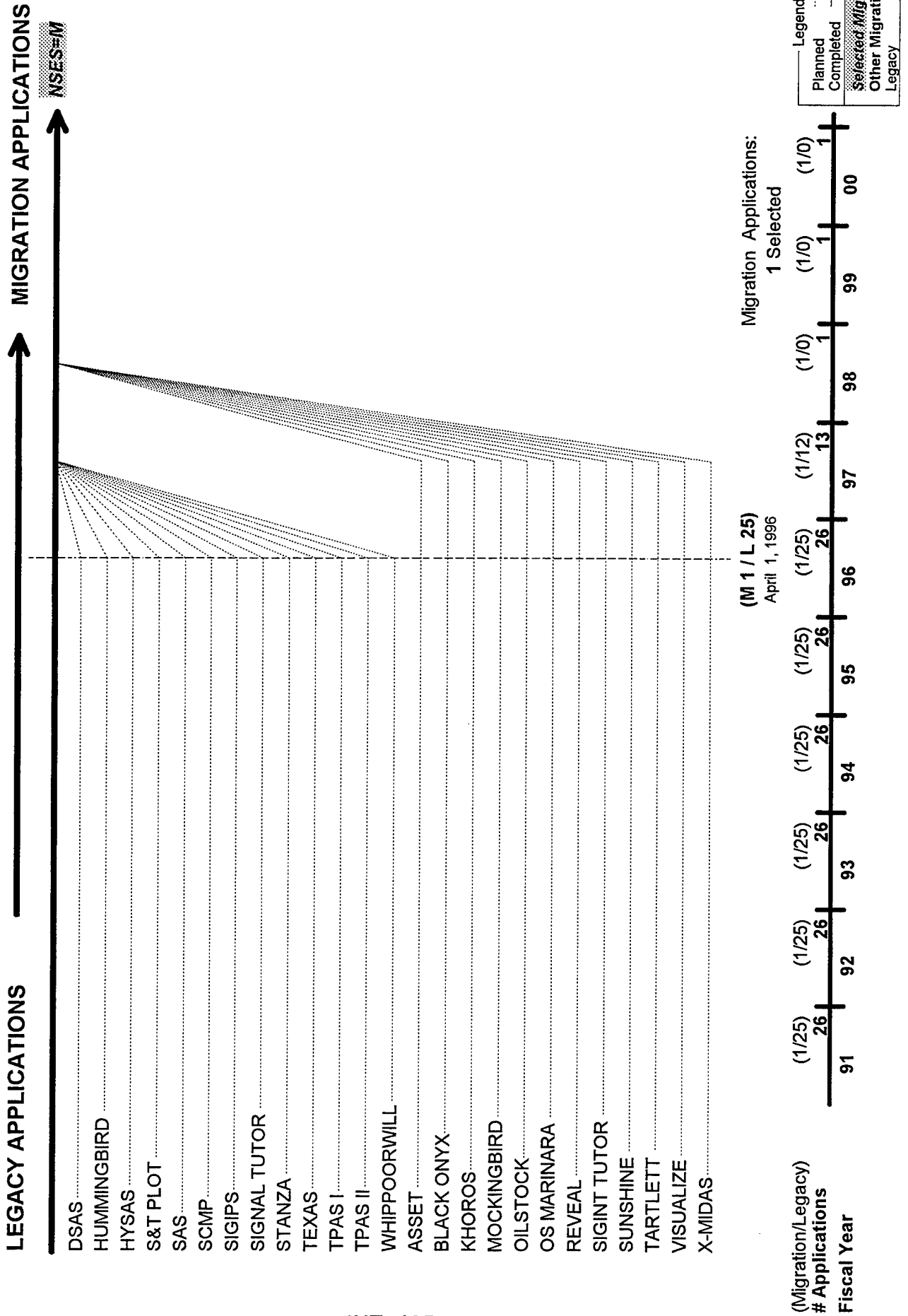

Migration Path Detail Report

Production

April 1, 1996

Activity: Scientific & Technical

Group: Signature Prediction

STI0713

Acronym Alias (Migration / Legacy)	Application Title	Phase	Start Date		Migrates to	Mig Beg Date		Mig End Date	
			Month	Year		Month	Year	Month	Year
NTSDS	National Target/Threat Signatures Data System	M	09	1995		01	2010	01	2010
ARGUS	ARGUS	L	09	1991	NTSDS	04	1996	01	1997
BATS	BATS	L	09	1991	NTSDS	04	1996	01	1997
DARTS	Design & Analysis of Reference Threat Signatures	L	09	1991	NTSDS	04	1996	01	1997
FATS	FATS	L	09	1991	NTSDS	04	1996	01	1997
JESEBEL	JESEBEL	L	09	1991	NTSDS	04	1996	01	1997
TABLS	TABLS	L	09	1991	NTSDS	04	1996	01	1997

INTELLIGENCE PRODUCTION

Scientific & Technical Signature Prediction

Current as of March 12, 1996

LEGACY APPLICATIONS

MIGRATION APPLICATIONS

NTSDS=M

ARGUS

BATS

DARTS

FATS

JESEBEL

TABILS

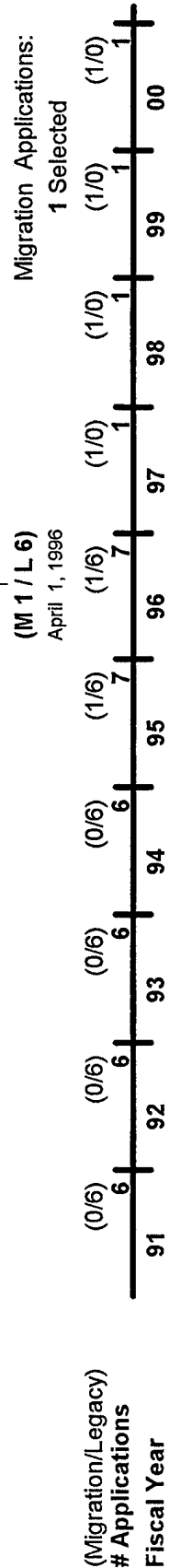

Migration Path Detail Report

Production

April 1, 1996

Activity: Scientific & Technical

Group: filtering

STI0801

Acronym Alias (Migration / Legacy)	Application Title	Phase	Start Date		Migrates to		Mig Beg Date		Mig End Date	
			Month	Year	Month	Year	Month	Year	Month	Year
COALESCE	Coalesce	M	09	1991			01	2010	01	2010
HYBRID	HYBRID	I	09	1991		COALESCE	01	1997	12	1997
HALLOCK	HALLOCK	L	09	1991		HYBRID	01	1996	12	1996
ORCHESTRA	ORCHESTRA	L	09	1991		COALESCE	01	1996	12	1996
ROSECROSS	ROSECROSS	L	09	1991		COALESCE	01	1996	12	1996
TNH-21	TNH-21	L	09	1991		COALESCE	01	1996	12	1996
VOICECAST	VOICECAST	L	09	1991		COALESCE	01	2000	12	2000

INTELLIGENCE PRODUCTION

Scientific & Technical filtering

Current as of January 1, 1989

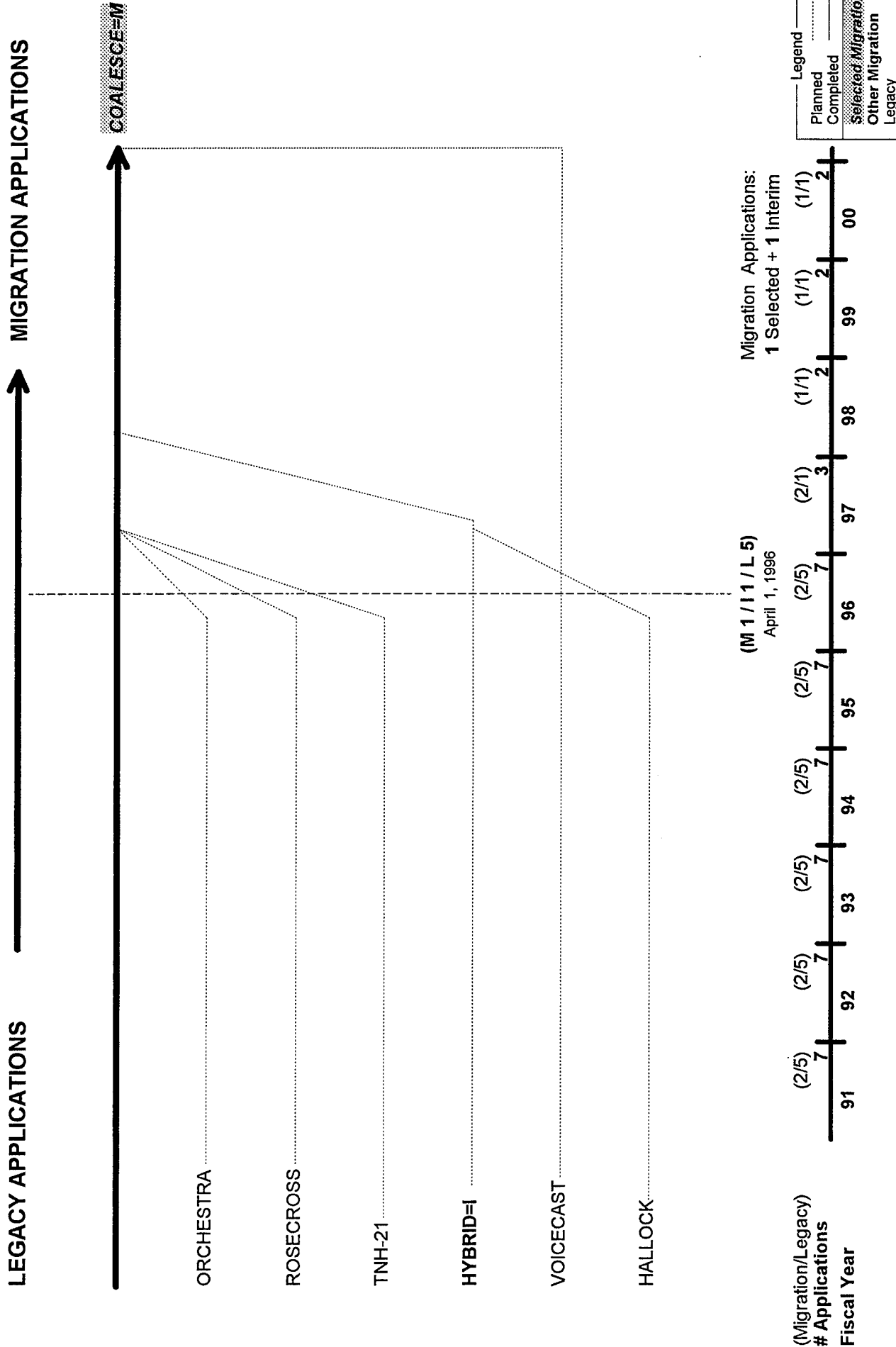

THIS PAGE INTENTIONALLY LEFT BLANK

INTELLIGENCE PRODUCTION

LEGACY APPLICATIONS

Targeting
Activity
Summary

MIGRATION APPLICATIONS

Air EC Analysis (M 1)

TBD

Target Materials (M 1)

TBD

(M 2)
April 1, 1996

Migration Applications:
2 Selected

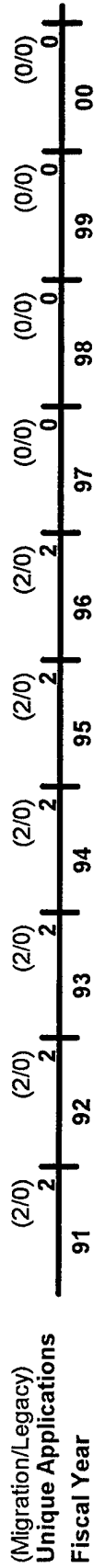

Migration Path Detail Report

Production

Activity: Targeting

April 1, 1996

TGT0801

Group: Air EC Analysis

Acronym Alias (Migration / Legacy)	Application Title	Phase	Start Date		Migrates to		Mig Beg Date		Mig End Date	
			Month	Year	Month	Year	Month	Year	Month	Year
IMOM	Improved Many on Many	M	09	1991			04	1996	04	1997

INTELLIGENCE PRODUCTION

Targeting Air EC Analysis

Current as of January 1, 1989

LEGACY APPLICATIONS

MIGRATION APPLICATIONS

INT- 143

IMOMIM

Migration Applications:

1 Selected

(Migration/Legacy)
Applications
Fiscal Year

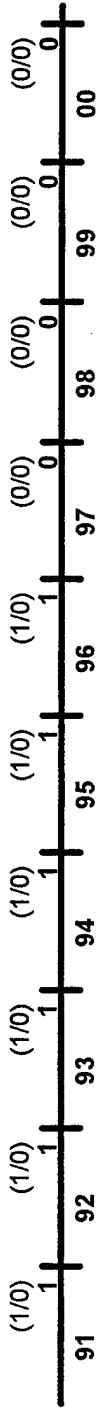

Legend	
Planned
Completed	————
Selected Migration	▨
Other Migration	▩
Legacy	▧

Migration Path Detail Report

Production

Activity: Targeting

April 1, 1996

Group: Target Materials

TGT0802

Acronym Alias (Migration / Legacy)	Application Title	Phase	Start Date		Migrates to		Mig Beg Date		Mig End Date	
			Month	Year			Month	Year	Month	Year
TMWS	Target Materials Work Station	M	09	1991			04	1996	04	1997

INTELLIGENCE PRODUCTION

Targeting
Target Materials

Current as of January 1, 1989

LEGACY APPLICATIONS

MIGRATION APPLICATIONS



TIMWS-M



Migration Applications:
1 Selected

(M 1)
April 1, 1996

(Migration/Legacy)
Applications
Fiscal Year

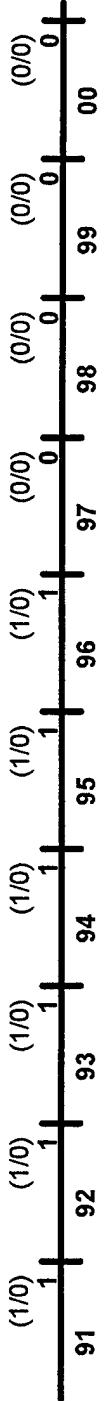

Legend	
Planned
Completed	_____
Selected Migration	▨
Other Migration	▩
Legacy	_____

INTELLIGENCE

SUPPORT Summary

LEGACY APPLICATIONS

MIGRATION APPLICATIONS

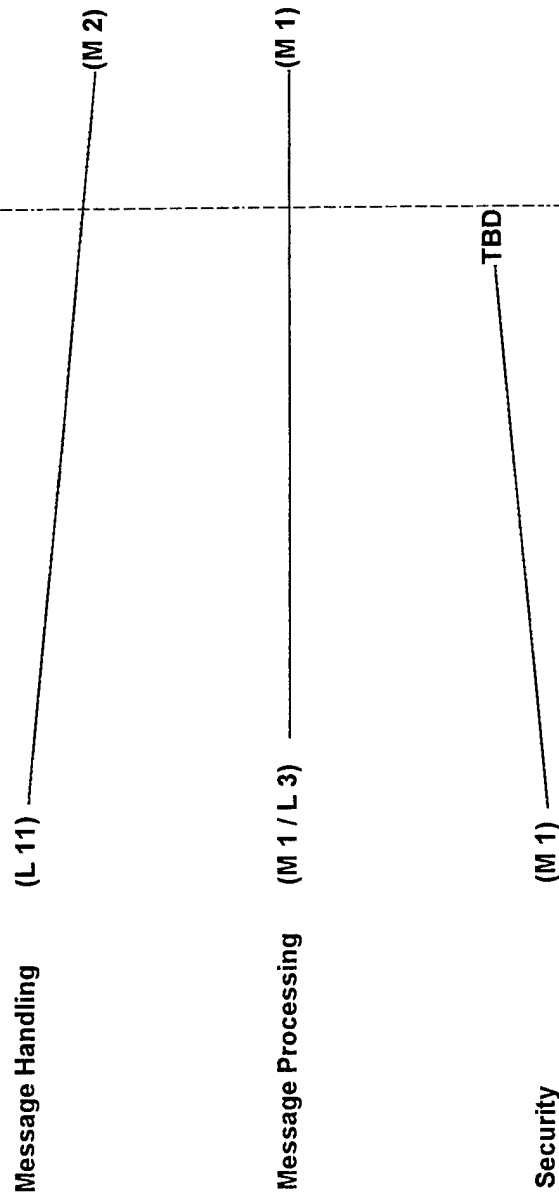

(M 3 / L 12)
April 1, 1996

Migration Applications:
4 Selected

(Migration/Legacy) Unique Applications	91	92	93	94	95	96	97	98	99	00
	16	(2/14)	(3/13)	(3/13)	(4/12)	(3/12)	(3/0)	(3/0)	(3/0)	(3/0)
Fiscal Year			16	16	16	15	3	3	3	3

INTELLIGENCE SUPPORT

LEGACY APPLICATIONS

Message Handling Activity Summary

MIGRATION APPLICATIONS

Autodin Interface

(L 1)

(M 1)

Automated Msg Handling

(L 10)

(M 1)

(M 2 / L 11)
April 1, 1996

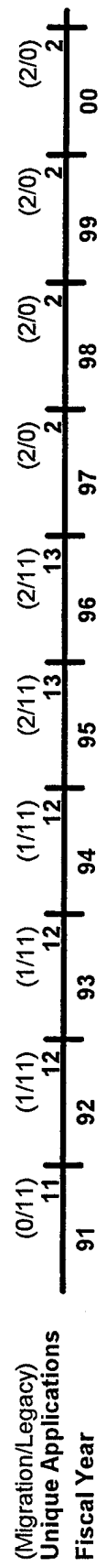

Migration Path Detail Report

April 1, 1996

Support
Activity: Message Handling

MSH0101

Group: Autodin Interface

Acronym Alias (Migration / Legacy)	Application Title	Phase	Start Date		Migrates to		Mig Beg Date		Mig End Date	
			Month	Year	Month	Year	Month	Year	Month	Year
CSP-HOL	Communication Support Processor - High Order Language	M	04	1995			01	2010	01	2010
CSP	Communications Support Processor V.3.2.1	L	09	1991	CSP-HOL		04	1996	04	1997

INTELLIGENCE SUPPORT

Message Handling Autodin Interface

Current as of March 12, 1996

LEGACY APPLICATIONS

MIGRATION APPLICATIONS

CSP-HOL-M

CSP

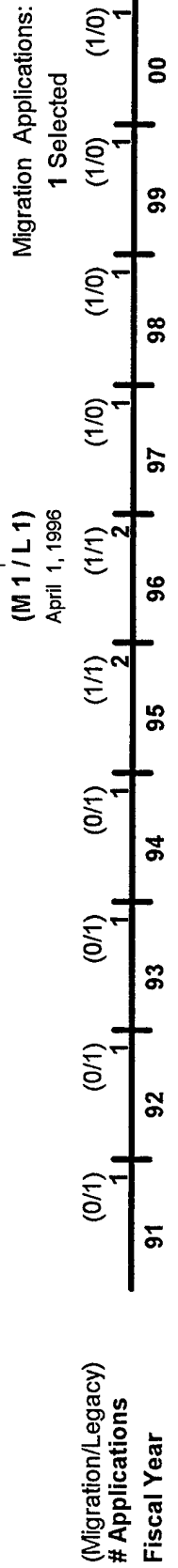

Legend	
Planned	_____
Completed
Selected Migration	▨
Other Migration	▩
Legacy	□

Migration Path Detail Report

Support

Activity: Message Handling

April 1, 1996

MSH0102

Group: Automated Msg Handling

Subgroup: 1 of 2

Acronym Alias (Migration / Legacy)	Application Title	Phase	Start Date		Migrates to		Mig Beg Date		Mig End Date	
			Month	Year	Month	Year	Month	Year	Month	Year
DODIIS AMHS	DODIIS Automated Message Handling	M	06	1992			01	2010	01	2010
CAMP	Communications and Message Profiler	L	09	1991	DODIIS AMHS		04	1996	04	1997
CDF	Central Document File	L	09	1991	DODIIS AMHS		04	1996	04	1997
CRSPRAC MHS MODULE	CRSPRAC MHS Module	L	09	1991	DODIIS AMHS		04	1996	04	1997
DAWS MHS MODULE	Defense Automated Warning System MHS Module	L	09	1991	DODIIS AMHS		04	1996	04	1997
EMHS MHS MODULE	EUCOM MHS Module	L	09	1991	DODIIS AMHS		04	1996	04	1997
LAMPS MHS MODULE	LANTCOM Automated Msg Processing Sys MHS Module	L	09	1991	DODIIS AMHS		04	1996	04	1997
MAXI	Modular Architecture for Exchange of Intelligence	L	09	1991	DODIIS AMHS		04	1996	04	1997
SAFE AMHS	Support for the Analysis' File Environment Msg handling	L	09	1991	DODIIS AMHS		04	1996	04	1997

INTELLIGENCE SUPPORT

Message Handling Automated Msg Handling

1 of 2

Current as of March 15, 1996

LEGACY APPLICATIONS

MIGRATION APPLICATIONS

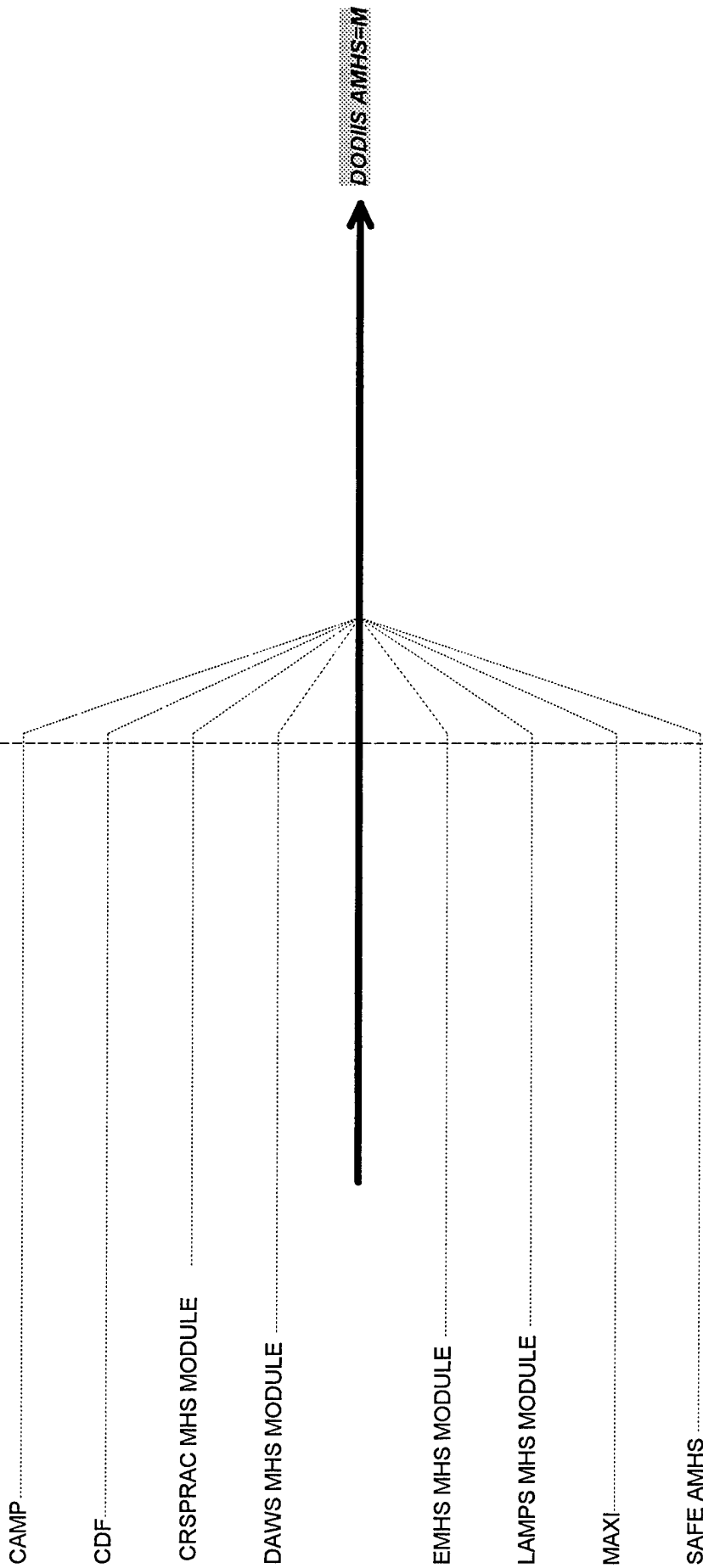

INT- 151

Migration Applications:

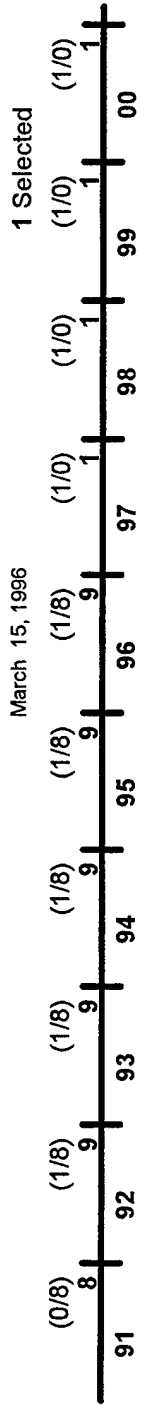

(Migration/Legacy)
Applications
Fiscal Year

(M 1 / L 8)
March 15, 1996

Legend
Planned
Completed
Selected Migration
Other Migration
Legacy

Migration Path Detail Report

Support

April 1, 1996

Activity: Message Handling

MSH0103

Group: Automated Msg Handling Subgroup: 2 of 2

Acronym Alias (Migration / Legacy)	Application Title	Phase	Start Date		Migrates to		Mig Beg Date		Mig End Date	
			Month	Year	Month	Year	Month	Year	Month	Year
DODIIS AMHS	DODIIS Automated Message Handling	M	06	1992			01	2010	01	2010
JMIS MHS MODULE	Joint Military Intelligence System MHS Module	L	09	1991			04	1996	04	1997
KCSS MHS MODULE	Korean Combat Support System MHS Module	L	09	1991			04	1996	04	1997

INTELLIGENCE SUPPORT

LEGACY APPLICATIONS

*Message Handling
Automated Msg Handling*
2 of 2

MIGRATION APPLICATIONS

DODIS AMHS=M

JMIS MHS MODULE

KCSS MHS MODULE

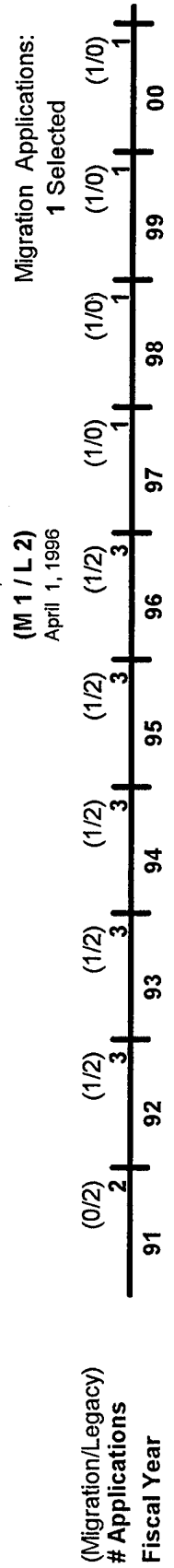

Legend
Planned
Completed
Selected Migration
Other Migration
Legacy

Migration Path Detail Report

Support

Activity: Message Handling

April 1, 1996

MSH0104

Group: Automated Msg Handling

Acronym Alias (Migration / Legacy)	Application Title	Phase	Start Date		Migrates to	Mig Beg Date		Mig End Date	
			Month	Year		Month	Year	Month	Year
DODIIS AMHS	DODIIS Automated Message Handling	M	06	1992		01	2010	01	2010
CAMP	Communications and Message Profiler	L	09	1991	DODIIS AMHS	04	1996	04	1997
CDF	Central Document File	L	09	1991	DODIIS AMHS	04	1996	04	1997
DAWS MHS MODULE	Defense Automated Warning System MHS Module	L	09	1991	DODIIS AMHS	04	1996	04	1997
MAXI	Modular Architecture for Exchange of Intelligence	L	09	1991	DODIIS AMHS	04	1996	04	1997
SAFE AMHS	Support for the Analysts' File Environment Msg handling	L	09	1991	DODIIS AMHS	04	1996	04	1997

INTELLIGENCE SUPPORT

Message Handling Automated Msg Handling

Current as of March 15, 1996

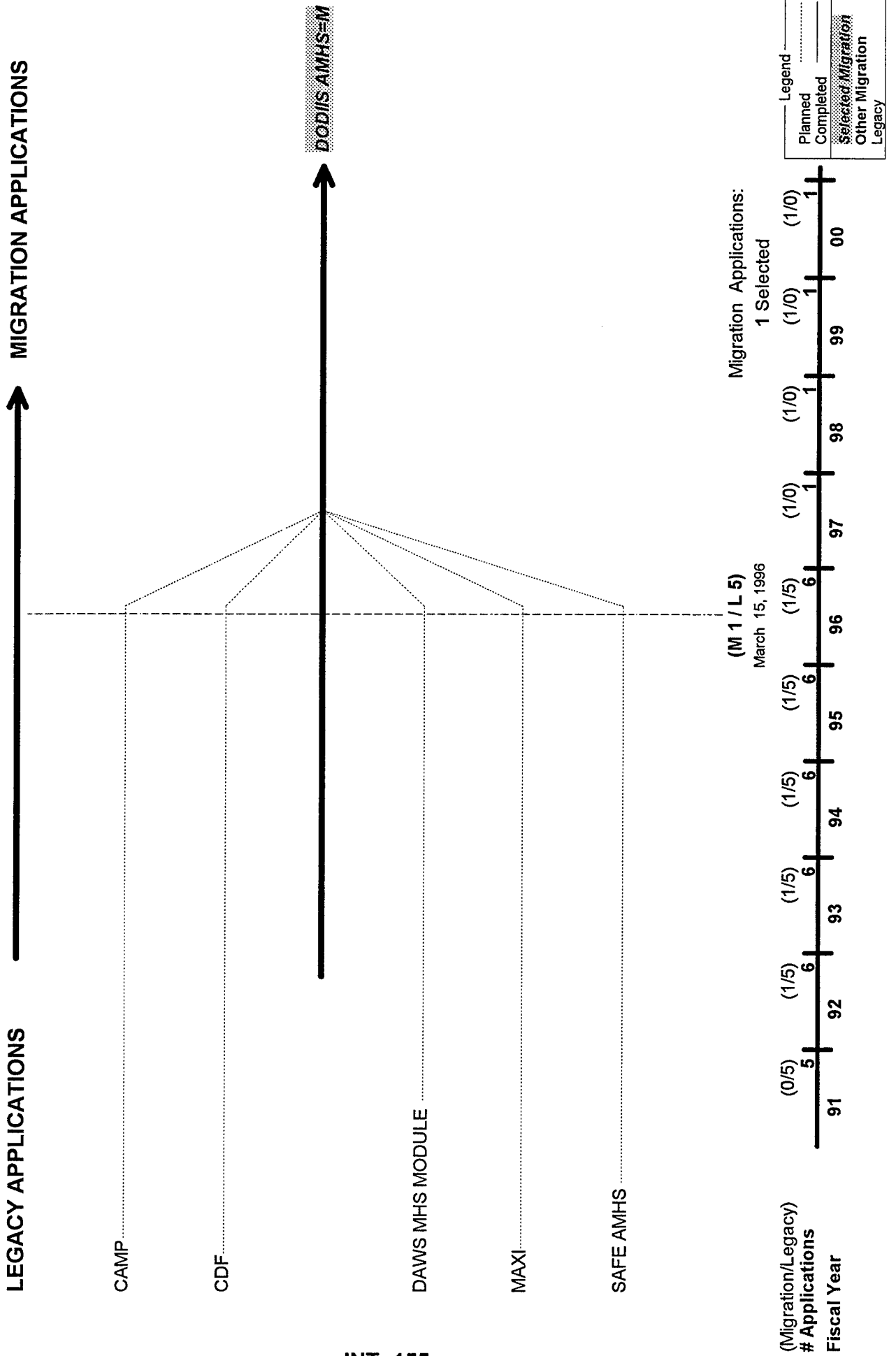

Migration Path Detail Report

Support

April 1, 1996

Activity: Message Processing

MSP0200

Acronym Alias (Migration / Legacy)	Application Title	Phase	Start Date		Migrates to		Mig Beg Date		Mig End Date	
			Month	Year	Month	Year	Month	Year	Month	Year
NEWSDEALER/NEWSTAN	NEWSDEALER/NEWSTAND	M	09	1991			01	2010	01	2010
ABOVEBOARD/ABOVEGRC	Aboveboard/Aboveground	L	09	1991			04	1996	04	1997
IDDF	Internal Data Distribution Facility	L	09	1991			06	1992	06	1992
STREAMLINER	STREAMLINER	L	09	1991			05	1994	05	1995

INTELLIGENCE SUPPORT

Message Processing

Current as of January 1, 1989

LEGACY APPLICATIONS

MIGRATION APPLICATIONS

NEWSDEALER

/NEWSTAND=M

IDDF

STREAMLINER

ABOVEBOARD/ABOVEGROUND

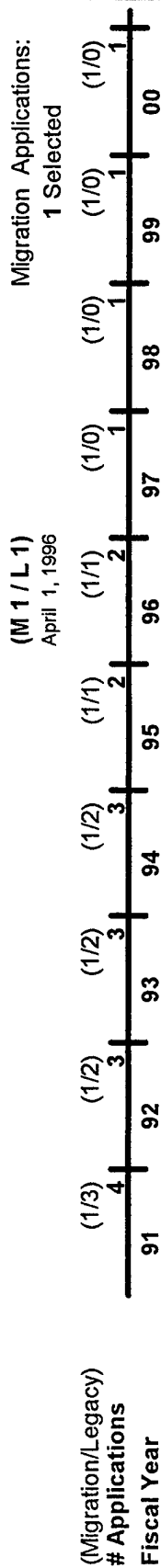

Legend	
Planned
Completed
Selected Migration
Other Migration
Legacy

Migration Path Detail Report

Support

Activity: Security

April 1, 1996

SCY0300

Acronym Alias (Migration / Legacy)	Application Title	Phase	Start Date		Migrates to		Mig Beg Date		Mig End Date	
			Month	Year			Month	Year	Month	Year
RADIANT MERCURY	Radiant Mercury	M	06	1986			04	1993	11	1995

INTELLIGENCE SUPPORT

Security

Current as of January 1, 1989

LEGACY APPLICATIONS

MIGRATION APPLICATIONS

RADIANT MERCURY=M

