

ESL-TR-91-53

**FIBROUS SHOTCRETE FOR EXPEDIENT
REPAIR OF STRUCTURES**

L.C. MUSZYNSKI, M.A. ROCHEFORT

**APPLIED RESEARCH ASSOCIATES, INC.
P. O. BOX 40128
TYNDALL AFB FL 32403**

SEPTEMBER 1994

FINAL REPORT

MAY 1990 - DECEMBER 1990

**APPROVED FOR PUBLIC RELEASE:
DISTRIBUTION UNLIMITED**

19960802 024



**ENGINEERING RESEARCH DIVISION
Air Force Civil Engineering Support Agency
Civil Engineering Laboratory
Tyndall Air Force Base, Florida 32403**



THIS REPORT IS UNCLASSIFIED

NOTICE

PLEASE DO NOT REQUEST COPIES OF THIS REPORT FROM HQ AFCESA/RA (AIR FORCE CIVIL ENGINEERING SUPPORT AGENCY). ADDITIONAL COPIES MAY BE PURCHASED FROM:

**NATIONAL TECHNICAL INFORMATION SERVICE
5285 PORT ROYAL ROAD
SPRINGFIELD, VIRGINIA 22161**

FEDERAL GOVERNMENT AGENCIES AND THEIR CONTRACTORS REGISTERED WITH DEFENSE TECHNICAL INFORMATION CENTER SHOULD DIRECT REQUESTS FOR COPIES OF THIS REPORT TO:

**DEFENSE TECHNICAL INFORMATION CENTER
CAMERON STATION
ALEXANDRIA, VIRGINIA 22314**

REPORT DOCUMENTATION PAGE

Form Approved
OMB No. 0704-0188

Public reporting burden for this collection of information is estimated to average 1 hour per response, including the time for reviewing instructions, searching existing data sources, gathering and maintaining the data needed, and completing and reviewing the collection of information. Send comments regarding this burden estimate or any other aspect of this collection of information, including suggestions for reducing this burden, to Washington Headquarters Services, Directorate for Information Operations and Reports, 1215 Jefferson Davis Highway, Suite 1204, Arlington, VA 22202-4302, and to the Office of Management and Budget, Paperwork Reduction Project (0704-0188), Washington, DC 20503.

1. AGENCY USE ONLY (Leave blank)	2. REPORT DATE September 1994	3. REPORT TYPE AND DATES COVERED Final, 1 May 1990-31 December 1990
----------------------------------	----------------------------------	--

4. TITLE AND SUBTITLE Fibrous Shotcrete for Expedient Repair of Structures	5. FUNDING NUMBERS C: F08635-88-C-0067
---	---

6. AUTHOR(S) Muszynski, L.C. and Rochefort, M.A.	
---	--

7. PERFORMING ORGANIZATION NAME(S) AND ADDRESS(ES) APPLIED RESEARCH ASSOCIATES, INC. P.O. BOX 40128 TYNDALL AFB, FL 32403	8. PERFORMING ORGANIZATION REPORT NUMBER
--	--

9. SPONSORING/MONITORING AGENCY NAME(S) AND ADDRESS(ES) AIR FORCE CIVIL ENGINEERING SUPPORT AGENCY CIVIL ENGINEERING LABORATORY ENGINEERING RESEARCH DIVISION TYNDALL AFB, FL 32403	10. SPONSORING/MONITORING AGENCY REPORT NUMBER ESL-TR-91-53
---	--

11. SUPPLEMENTARY NOTES

12a. DISTRIBUTION/AVAILABILITY STATEMENT Approved for public release. Distribution unlimited.	12b. DISTRIBUTION CODE
---	------------------------

13. ABSTRACT (Maximum 200 words)

The objectives of this effort were to develop fast-set, high-early strength concrete that can be pneumatically conveyed. The dry process shotcrete system was utilized to the advantage of the fast-set, high-early strength concrete system developed. Steel fibers were included to increase the toughness of the material system.

14. SUBJECT TERMS Shotcrete Accelerating Admixtures High Early Strength Cements Steel Fibers	15. NUMBER OF PAGES 51
	16. PRICE CODE

17. SECURITY CLASSIFICATION OF REPORT UNCLASSIFIED	18. SECURITY CLASSIFICATION OF THIS PAGE UNCLASSIFIED	19. SECURITY CLASSIFICATION OF ABSTRACT UNCLASSIFIED	20. LIMITATION OF ABSTRACT UL.
---	--	---	-----------------------------------

EXECUTIVE SUMMARY

A. OBJECTIVE

The objective of this research effort was to develop an expedient repair system to repair conventional weapon damage to mission-critical facilities at United States Air Force Bases in Europe (USAFE) and Pacific Air Force Bases (PACAF) in a postattack environment. The expedient repair system would consist of a high early-strength repair material and method of application.

B. BACKGROUND

As a result of the SALT DEMO air base survivability exercise in 1985, it became apparent that the Air Force did not have in-place systems to expediently repair mission-critical facilities that were damaged by conventional weapons. Therefore, an Expedient Repair of Structural Facilities (ERSF) development effort was undertaken by the Air Force Civil Engineering Support Agency (AFCESA) Airbase Survivability Branch (RACS).

C. SCOPE

The scope of this study was to identify, test, evaluate, and recommend construction materials, equipment and techniques for the expedient repair of conventional weapon damage to mission-critical structures for PACAF and USAFE.

D. EVALUATION METHODOLOGY

The expedient repair material and method of application would have to be flexible enough to be applied under a variety of environmental conditions and develop a minimum of 2000 psi compressive strength in 1 hour. High early-strength materials were screened by conventional laboratory methods and the most viable candidate material and method of application was field tested. Field testing included evaluating dry-process shotcrete nozzle types and operating conditions, a shotcrete wall-breach repair and replacement at the Tyndall AFB,

SKY TEN explosive test range, and explosive testing of the wall-breach replacement using a 1000-pound conventional weapon.

E. RESULTS

The expedient repair system developed consisted of a high early strength concrete which was pneumatically conveyed using dry-process shotcrete equipment. This material system produced a 1-hour compressive strength of 5000 psi in the laboratory. Operating conditions for the shotcrete equipment were evaluated and shotcrete produced in the field attained compressive strengths of up to 4000 psi in 1 hour.

F. CONCLUSIONS

An ERSF system was developed and field tested. The developed ERSF system meets the requirements for structural strength, durability, blast resistance, fragment penetration resistance and air tightness of the resulting repair.

G. RECOMMENDATIONS

Full-scale development of the ERSF dry-process shotcrete system should be undertaken. Development should include robotic controlled operating equipment, training, and material storage requirements.

PREFACE

This report was prepared by Applied Research Associates, Inc. (ARA), P.O. Box 41028, Tyndall AFB, FL 32403, under Contract F08635-88-C-0067, for the Air Force Civil Engineering Laboratory, Tyndall Air Force Base, Florida.

This report summarizes work done between 1 May 1990 to 31 December 1990. Mr Walter Buchholtz was the AFCESA/RACS Project Officer for the subtask under which this work was accomplished.

This report has been reviewed by the Public Affairs Office and is releasable to the National Technical Information Service (NTIS). At NTIS, it will be available to the public, including foreign nations.

This technical report has been reviewed and is approved for publication.

WALTER C. BUCHHOLTZ
Project Officer

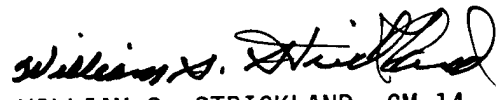
WILLIAM S. STRICKLAND, GM-14
Chief, Airbase Survivability Branch

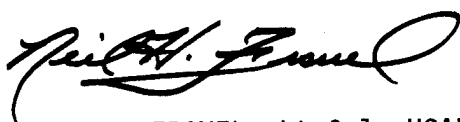
NEIL H. FRAVEL, Lt Col, USAF
Chief, Engineering Research Division



FRANK P. GALLAGHER, Col, USAF
Director, Civil Engineering Laboratory

TABLE OF CONTENTS

Section	Title	Page
I	INTRODUCTION	1
	A. OBJECTIVE	1
	B. BACKGROUND	1
	C. TEST PROGRAM	1
II	PRELIMINARY TESTING	3
	A. OVERVIEW	3
	B. MATERIALS	3
	1. Ocean Fiber Microsil [®] Shotcrete	3
	2. Pyrament [®] 505 Mortar	4
	C. EQUIPMENT	5
	1. Dry-Process Equipment	5
	2. Nozzle Body and Tip	6
	D. RESULTS	7
	1. Ocean Fiber-Reinforced Microsil [®] Shotcrete	7
	2. Pyrament [®] 505 Mortar	9
III	LABORATORY TESTING	10
	A. OVERVIEW	10
	B. MATERIALS	10
	1. Cements	10
	2. Coarse Aggregate	11
	3. Force 10,000 [®] D Microsilica	11
	4. Fibercon [®] Steel Fibers	12
	5. Accelerator	12
	C. EQUIPMENT	12
	1. Mixer	12
	2. Placement	13
	3. Testing Machine	13
	D. RESULTS	14
IV	FIELD TESTING	17
	A. OVERVIEW	17
	B. MATERIALS	17

TABLE OF CONTENTS
(CONCLUDED)

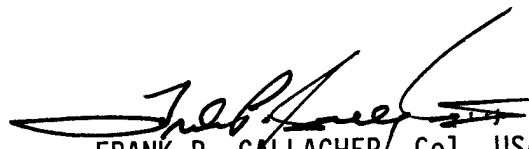
Section	Title	Page
C.	EQUIPMENT	18
	1. Dry-Process Shotcrete Equipment . . .	18
	2. Nozzle Bodies and Tips	20
D.	RESULTS	23
	1. Material Properties	23
	2. Operating Parameters	27
	3. Particle Velocities	32
V	ENVIRONMENTAL TESTING	35
	A. HOT WEATHER	35
	B. COLD WEATHER	35
VI	ECONOMICS AND FIELD DEMONSTRATION	39
	A. ECONOMICS	39
	B. DEVELOPMENT OF FIELD DEMONSTRATION	39
VII	CONCLUSIONS	46
	A. CONCLUSIONS	46
	REFERENCES	47
APPENDIX		
A	RAW DATA OF SHOTCRETE PARTICLE VELOCITY MEASUREMENTS	48

LIST OF FIGURES

Figure	Title	Page
1	Standard Reed Gunite Equipment	5
2	Standard Nozzle Body and Tip for Dry-Mix Process .	6
3	Ocean Fiber-Reinforced Microsilica Shotcrete Material	7
4	Non Destructive Testing Using the Windsor Probe .	8
5	Pyrament 505 Shotcrete Material	9
6	Omni OM-10 Mixer	13
7	Compressive Strength Testing Equipment for Cylindrical Concrete Specimens	15
8	MEYCO 020 Shotcrete Equipment	19
9	Standard Hamm Style Shotcrete Nozzle	20
10	Spirolet Shotcrete Nozzle	21
11	"Double Bubble" Shotcrete Nozzle	21
12	Hydro-Mix Prewetting Nozzle Assembly	22
13	Dry-Mix Shotcrete Placement Hose Construction . .	23
14	Shotcreting Field Sample Boxes	24
15	Coring Test Cylinders from Field Sample Boxes . .	25
16	Equipment Operating Principle for Dry-Mix Process	28
17	Shotcrete Output yd ³ /hr vs. Rotor RPM Dry-Blended Material	29
18	Shotcrete Output lbs/min vs. Rotor RPM Dry-Blended Material	30
19	Controlled Constant Flow Rate with Temperature Control	31
20	Test Set Up for Determining Particle Velocities Using High-Speed Photography	32

LIST OF FIGURES (CONTINUED)

Figure	Title	Page
21	High-Speed Photography of Particles Ejected from Standard Hamm Nozzle	33
22	High-Speed Photography of Particles Ejected from the Spirolet Nozzle	33
23	High-Speed Photo of Particles Ejected from "Double Bubble" Nozzle	34
24	Compressive Strength vs. Time for Expedient Repair Material	38
25	Door Opening in NATO Structure Used for Wall Breach	40
26	Rebar Welded Along the Top Bottom, and Sides of the Door Opening	41
27	Plywood Backing in the Door Opening	43
28	Depth Indicator Conduits in the Plywood Backing	44
29	Shotcreting Wall Replacement	45

LIST OF TABLES

Table	Title	Page
1	ACI 506 R-85 GRADATION LIMITS FOR COMBINED AGGREGATES	4
2	STRENGTH-OF-STEEL FIBER MICROSIL [®] SHOTCRETE MATERIAL PURCHASED FROM OCEAN CONSTRUCTION, LTD	8
3	INITIAL SET TIMES OF POTENTIAL CEMENT SYSTEMS . .	16
4	LABORATORY SCREENING RESULTS	16
5	INGREDIENTS USED IN THE DRY-BLENDED PRE PACKAGED XPR SYSTEM PER 50-POUND BAG	18
6	MEYCO 020 SHOTCRETE EQUIPMENT SPECIFICATIONS . . .	20
7	RESULTS OF SHOTCRETE FIELD TESTING	26
8	STRENGTH VS. WATER CONTENT	31
9	PARTICLE VELOCITIES VS. NOZZLE TYPE USING HIGH-SPEED PHOTOGRAPHY	32
10	HOT-WEATHER SHOTCRETE TEST RESULTS	36
11	COLD-WEATHER TEST RESULTS (LABORATORY)	36
12	COMPRESSIVE STRENGTH VS. TIME FOR EXPEDIENT REPAIR MATERIAL	37
13	ECONOMIC ANALYSIS OF THE XPR EXPEDIENT REPAIR SHOTCRETE SYSTEM	39
A-1	SHOTCRETE TEST #1 USING A SPIROLET NOZZLE	49
A-2	SHOTCRETE TEST #2 USING A HAMM NOZZLE DISTANCE (IN)	50
A-3	SHOTCRETE TEST #3 USING A DOUBLE BUBBLE NOZZLE DISTANCE (IN)	51

SECTION I

INTRODUCTION

A. OBJECTIVE

The Air Force Civil Engineering Support Agency/Airbase Survivability Branch (AFCESA/RACS) is investigating materials and methods for ERSF at air bases after an attack. The purpose of ERSF is to: (1) make damaged structures, which are mission-critical to an airbase, safe for use, or allow entry into the structure so critical equipment and resources can be removed; (2) make damaged structures more resistant to subsequent attack; (3) minimize entry of chemical and biological agents into the structure; and (4) minimize environmental effects, such as rain, snow, wind, or fire from entering the structure.

The developed repair system must meet environmental operating requirements; environmental material storage requirements, material performance requirements and reliability requirements. To meet these requirements, the material must be functional under the following conditions: an (1) ambient thermal environment of -15 to 120° F; (2) a rainstorm of 1-inch per hour or equivalent snowfall, day or night placement; and (3) the presence of chemical and biological agents. The materials must have a storage life of 3 years at temperatures between 30 and 90° F with no humidity control, must provide structural integrity to the facility, and must attain the design compressive strength of the structure in 1 hour after placement (Reference 1).

B. BACKGROUND

An extensive literature review was performed by Dr. Mark Anderson prior to initiating the Expedient Repair of Structural Facilities program (Reference 2).

C. TEST PROGRAM

A testing program was initiated to develop, test, evaluate and recommend an expedient repair material system and method of application. The type of structures in need of repair are damaged, mission-critical, air base structures

produced from reinforced concrete. Therefore, rapid strength development, easily deployable repair systems that can be applied under a variety of environmental conditions and having a certain degree of "forgiveness" were investigated.

One method of placement of these rapid repair systems is pneumatically applied concrete, that is shotcrete. Shotcreting is an adaptable, flexible construction method that allows concrete to be produced in any desired thickness, shape, or form.

SECTION II PRELIMINARY TESTING

A. OVERVIEW

Ocean Construction Supplies Ltd., Vancouver, B. C., has developed a preblended, dry shotcrete material that has greatly improved the adhesion and cohesion characteristics of Shotcrete. Some other advantages include: thick layers, in excess of 12 inches, can be applied in a single pass in both vertical and overhead orientations; sagging and sloughing are eliminated; and rebound is significantly reduced. This material has been applied successfully in both Alaska and Arizona on concrete repair and restoration projects.

B. MATERIALS

Fifty preblended, 66-pound bags of Ocean fiber reinforced Microsil[®] shotcrete material were purchased to evaluate its effectiveness for application. Pyrament[®] Mortar 505, an alternative material for this application, was also evaluated. Pyrament[®] is a rapid-strength development cement that has been previously evaluated by Hardy BBT Ltd. (Reference 3) as a dry-process shotcrete material.

1. Ocean Fiber Microsil[®] Shotcrete

The material is composed of the following: portland cement, silica sand, pea gravel, steel fibers, microsilica, and a shotcrete accelerator. The portland cement-microsilica blended system meets the requirements of ASTM standard C-595, "Standard Specification for Blended Hydraulic Cements."

The aggregate gradation corresponds to ACI 506 R-85 Gradation number 2, "Specifications for Materials, Proportioning, and Application of Shotcrete," given in Table 1.

The high strength, carbon steel wire fiber is indented with minute deformations along its length to provide micromechanical anchorage in shotcrete applications.

TABLE 1. ACI 506 R-85 GRADATION LIMITS FOR COMBINED AGGREGATES.

SIEVE SIZE, U.S. STANDARD SQUARE MESH	PERCENT NY WEIGHT PASSING INDIVIDUAL SIEVES		
	GRADATION NO.1	GRADATION NO. 2	GRADATION NO. 3
3/4 in. (19mm)	---	---	100
1/2 in. (12mm)	---	100	80-95
3/8 in. (10mm)	100	90-100	70-90
No. 4 (4.75mm)	95-100	70-85	50-70
No. 8 (2.40mm)	80-100	50-70	35-55
No. 16 (1.2mm)	50-85	35-55	20-40
No. 30 (600 μ)	25-60	20-35	10-30
No. 50 (300 μ)	10-30	8-20	5-17
No. 100 (150 μ)	2-10	2-10	2-10

Scamper 16[®] is a non caustic set accelerator used in shotcrete applications. It is supplied in a dry powder form and enables the Mircrosil[®] system to have an initial set time of 10 minutes and a final set time of 15 minutes in accordance with ASTM C-403, "Test Method for Time of Setting of Concrete Mixtures by Penetration Resistance." The material is designed to have an 8-hour strength of approximately 1000 psi. More information concerning the properties of Microsil[®] shotcrete can be obtained from Ocean Construction Supplies LTD (Reference 4).

2. Pyrament[®] 505 Mortar

The material is a patented, proprietary formulation consisting of portland cement, mineral additions, and chemical admixtures, that conforms to ASTM C-595, "Standard Specification for Blended Hydraulic Cements." The Pyrament[®] cement is blended with a fine aggregate to produce the 505 mortar. The Pyrament[®] 505 mortar has a set time of 30 minutes and a two-hour compressive

strength of 2500 psi. More information concerning this material can be obtained by contacting Lone Star Industries (Reference 5).

C. EQUIPMENT

1. Dry-Process Equipment

The dry-process shotcrete equipment used in this preliminary demonstration was rented from a swimming pool contractor. The equipment used was a standard Reed gunite machine with an eight-chamber, rotary vane air motor. An air compressor provided 650 cfm of air flow at 120 psi. The capacity of the shotcrete equipment was approximately 2 yd³ of shotcrete per hour. See Figure 1.

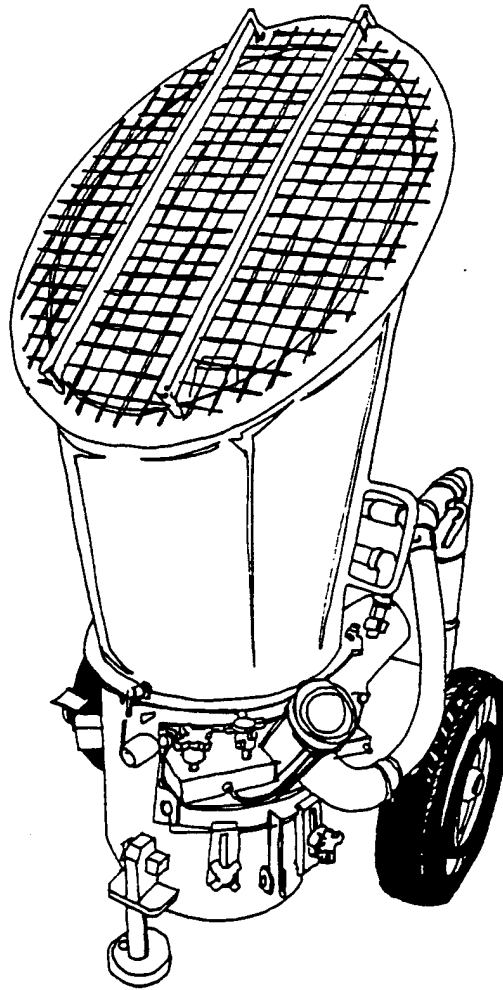

Figure 1. Standard Reed Gunite Equipment

2. Nozzle Body and Tip

The nozzle body and tip used in the dry-mix process are illustrated in Figure 2. The dry material is pneumatically conveyed through the larger diameter hose, and mixed with water from the smaller diameter hose.

The water feed rate is adjusted by the operator at the nozzle, using the water valve, and the mixing takes place in the water ring, which is a perforated metal ring. The nozzle is lined with a thin elastomeric membrane to prevent erosion of the metallic nozzle tip.

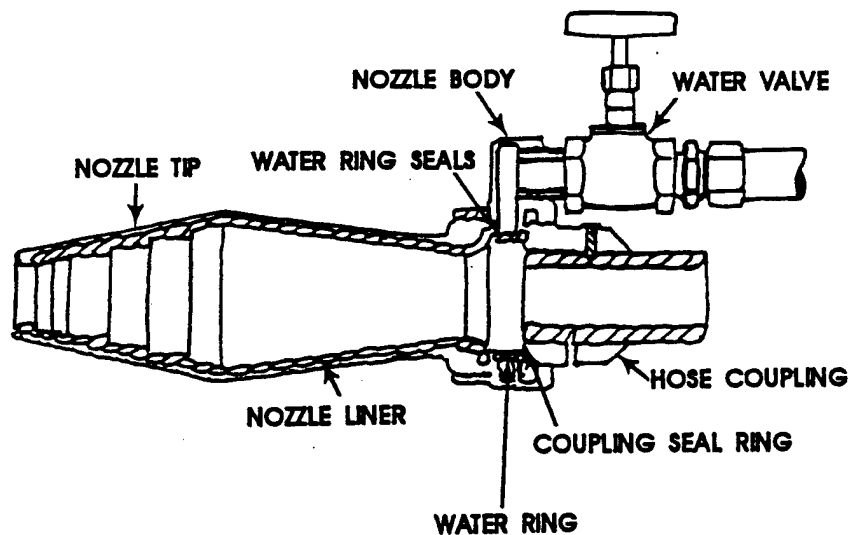

Figure 2. Standard Nozzle Body and Tip for Dry-Mix Process.

D. RESULTS

The results of the preliminary investigation included the following:

1. Ocean Fiber-Reinforced Microsil[®] Shotcrete

The ocean material was sprayed onto several 4 foot by 4 foot plywood panels backed with a wire mesh. The shotcrete operator was subcontracted from a local swimming pool gunite company. The material was applied in layers that built up rather quickly, giving a total thickness of up to 12 inches, as shown in Figure 3.



Figure 3. Ocean Fiber-Reinforced Microsilica Shotcrete Material

Cores were taken after 1 day and after 7 days for strength analysis. A Windsor probe was used to determine the strength of the shotcrete material non-destructively, as shown in Figure 4.

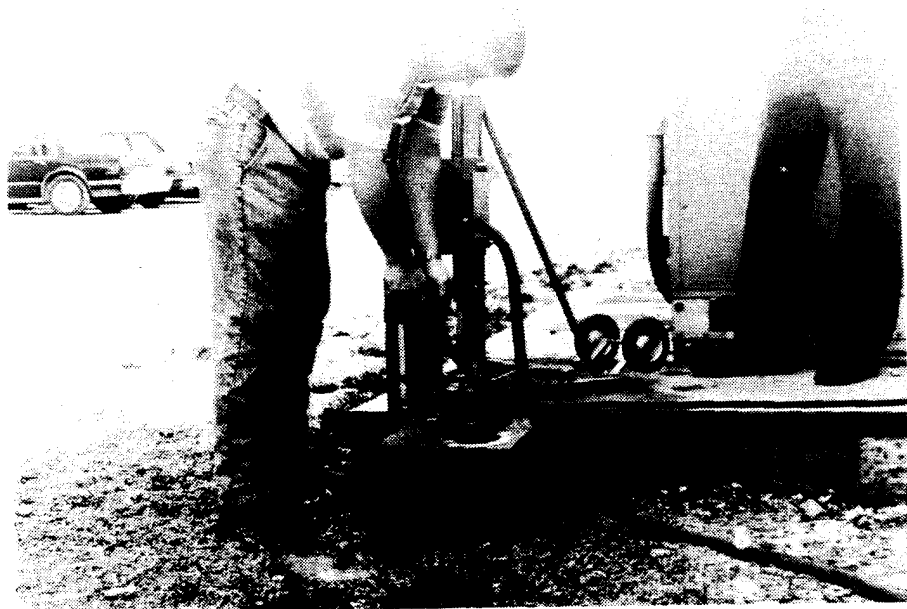

Figure 4. Non Destructive Testing Using the Windsor Probe

A comparison of the strengths obtained destructively and non destructively can be found in Table 2.

TABLE 2. STRENGTH-OF-STEEL FIBER MICROSIL® SHOTCRETE MATERIAL PURCHASED FROM OCEAN CONSTRUCTION, LTD.

TIME, DAYS	COMPRESSIVE STRENGTH PSI, CORED CYLINDERS (1)	COMPRESSIVE STRENGTH PSI, WINDSOR PROBE
1 DAY	2825	2800
4 DAYS	3555	3400
7 DAYS	3370 (2)	3625

(1) Three 2-inch cylinders were cored from the shotcreted slabs. The cores were broken according to ASTM C-39, and the strength values corrected for the difference in size between a 2-inch core and a 6-inch core, ASTM C-42.

(2) The cores taken from the slab at Day 7 contained several honeycombed areas visible from the core exterior.

2. Pyrament[®] 505 Mortar

The gunite operator also shot the Pyrament[®] 505 material. It was extremely difficult to build up layers greater than 3 inches, as shown in Figure 5.



Figure 5. Pyrament[®] 505 Shotcrete Material.

The material is highly water sensitive, and also sensitive to flow. Hardy BBT Ltd. (Reference 5) experienced the same result with the Pyrament[®] material they tested. They had to add about 12 percent microsilica, by weight of cement, to build thicker layers than 3 inches.

SECTION III

LABORATORY TESTING

A. OVERVIEW

Product development and evaluation were initiated based on the results of the preliminary investigation, using the Ocean fiber reinforced Microsil[®] Shotcrete product. The initial goal was to develop a repair system similar to the Ocean fiber reinforced Microsil[®] system, with its enhanced shooting characteristics and physical properties, and having a minimum compressive strength of 2000 psi in one hour. The Microsil[®] blended cement system was not considered in the laboratory testing-phase since its strength gain of 1000 psi at 8 hours did not meet the minimum performance requirements.

B. MATERIALS

1. Cements

(a) Pyrament[®] 505

Pyrament[®] is a blended cement that meets ASTM C-595, "Standard Specification for Blended Hydraulic Cements." Pyrament[®] 505 is a grout to which fine sand has been added. It contains a high early-strength blended cement which is relatively fast-setting and extremely durable to freeze/thaw attack, sulfate attack and chloride-ion intrusion. This cement is manufactured by the Pyrament[®] Division of Lone Star Industries (Reference 5).

(b) Rapid-Set[®] Grout

Rapid-Set[®] grout consists of a unique, dry-blended, hydraulic cement and fine aggregate. The cement is based on calcium sulfoaluminate. Rapid-Set[®] cement sets quickly, and exhibits high early strength even at low temperatures. This cement is manufactured by Rapid-Set[®] Products, Inc. (Reference 6).

(c) Regulated-Set[®] Cement

Regulated-Set[®] cement is based on calcium fluoroaluminate, and exhibits rapid set and high early strength. Its principal drawbacks are that at temperatures less than 50° F., it fails to gain strength, and it exhibits very large and disruptive volume expansion. This cement is manufactured by Holnam, Inc. (Reference 7).

(d) Set-45[®]

Set-45[®] is a patented, one-component, magnesium phosphate cement that is fast-setting and produces very high early strength. This cement is produced by Master Builders, Inc. (Reference 8).

(e) Duracal[®]

Duracal[®] cement is a fast-setting, high early strength blend of portland cement and gypsum. This cement is manufactured by U.S. Gypsum, Inc. (Reference 9).

2. Coarse Aggregate

The coarse aggregate used in this study is a standard river gravel, distributed by Florida Mining and Minerals. The maximum size of the gravel is 3/8 inches, whereby 100 percent of the material passes the 1/2 inch sieve (12.5mm) and is retained on the number 16 sieve (1.18mm). The composition of the rock is primarily siliceous, very smooth in texture, and rounded in shape.

3. Force 10,000[®] D Microsilica

The microsilica, Force 10,000R D (silica fume) used in this study was purchased from W. R. Grace (Reference 10). It is a dry, densified powder, which increases strength, durability, adhesion, and cohesion. It also reduces permeability and rebound.

4. Fibercon® Steel Fibers

The carbon steel fibers, Fibercon®, used in this study were produced by Mitchell Fibercon, Inc. (Reference 11). These fibers are deformed at the ends and have dimensions of 0.01 inch by 0.047 inch by 1 inch in length, with an aspect ratio of 41. There are 9,000 individual fibers per pound. These fibers increase flexural, tensile, fatigue, and impact strength, as well as spall resistance.

5. Accelerator

The accelerator used in this study is Scamper 16®, a non-caustic set accelerator for shotcrete applications, and is sold by Surecrete Inc. (Reference 12). Scamper 16® is a patented formulation that can provide fast set times (2 - 4 minutes) which can result in very high early strength. The active ingredients of Scamper 16® include triethanolamine, sodium carbonate, and potassium carbonate.

C. EQUIPMENT

1. Mixer

A very fast, efficient mixer was used in this study, to simulate the rapid mixing of a fast-setting, dry-process shotcrete mix. The mixer, shown in Figure 6, is an Omni OM-10 mixer, manufactured by Chiyoda, Japan. The Omni Mixer is a unique machine, which disperses the material particles in random directions inside a wobbling flexible rubber bowl, instead of using forced mixing by agitators. A homogeneous mixture can be produced in a very short time span (30 seconds).

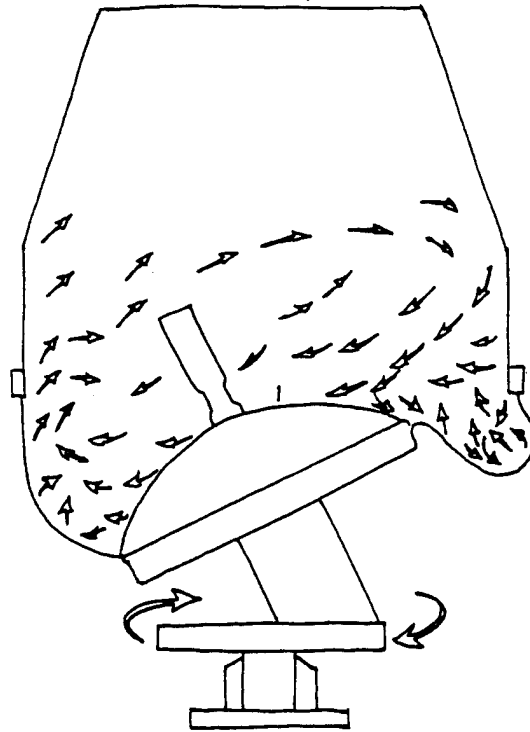

Figure 6. Omni OM-10 Mixer

2. Placement

The mix was placed into a 6 inch by 12 inch polyethylene cylindrical mold, and vibrated on a standard laboratory vibrating table having a high speed, 3600 Hz electromagnetic vibrator. The vibration time was approximately 30 seconds.

3. Testing Machine

A Soiltest 250,000 pound compression testing machine, shown in Figure 7, was used to test the 6 inch by 12 inch concrete cylinders at 1 hour after mixing in accordance with ASTM C-39, "Compressive Strength of Cylindrical Concrete Specimens". The machine is equipped with a 1-horsepower electro-hydraulic pump. Concrete capping pads and retainers were used instead of capping compound for environmental reasons. The pads are made of a tough, elastomeric material of 60 durometer hardness, and the retainers are machined, high-alloy steel.

D. RESULTS

The cements described above were evaluated initially for their appropriateness as an expedient repair material. This was accomplished by evaluating product literature, conversations with technical product representatives, and some minor laboratory experiments.

Regulated-Set[®] cement was eliminated due to its inability to gain strength below 50° F.

Pyrament[®] cement can be altered by adding 12 percent silica fume, to produce thick layers of dry-process shotcrete. Unfortunately, Pyrament[®] could not be accelerated by the Scamper 16[®] accelerator, so that further work on this system was abandoned.

Rapid-Set[®] cement not only developed high early strength but the set time was accelerated using the Scamper 16[®] admixture. Therefore, this cement was used as a basis for developing an expedient repair material.

Historically, Set-45[®] and Duracal[®] have been efficient rapid repair materials but, in this case, they were not recommended by their manufacturers as a dry-process shotcrete material. The reasons include their water sensitivity and flow characteristics, that is rheology.

The Rapid-Set[®] cement system that was investigated was "blue grout," which is a dry blend of Rapid-Set[®] cement and clean well-graded fine sand. The product contains no chlorides, and, when mixed with water, produces a uniform, nonshrinking mortar.

Initial set times of potential cement systems incorporating the shotcrete accelerator, Scamper 16[®], are given in Table 3. The results indicate that Pyrament[®] cements are not responsive to Scamper 16[®], and Rapid-Set[®] cement, both with and without silica fume is very responsive to the dry powdered accelerator. The laboratory screening results in Table 4 were developed by varying the aggregate content, silica fume content, fiber content, and accelerator dosage.

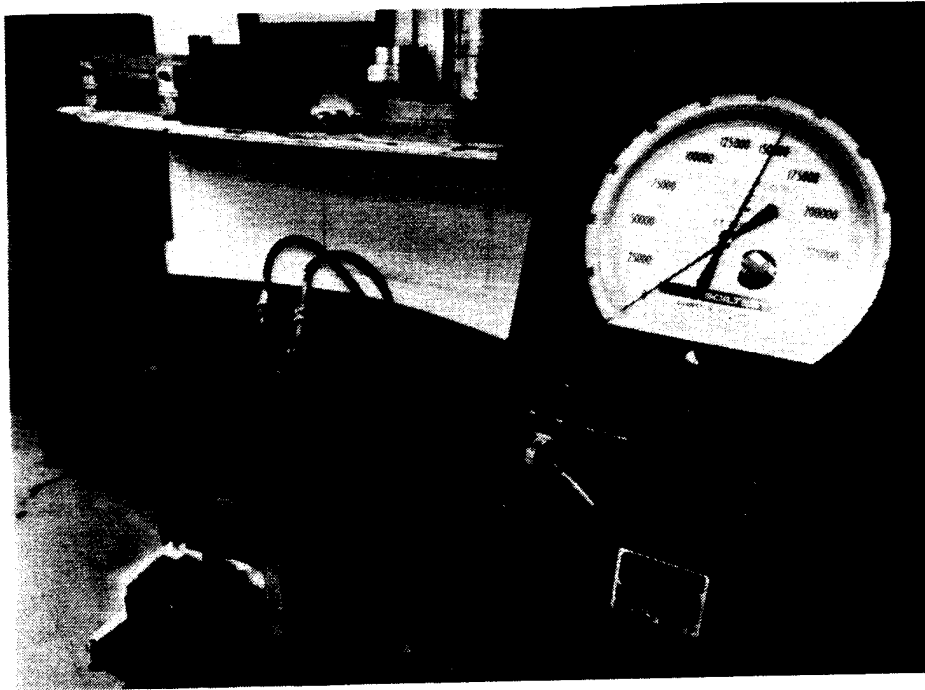

Figure 7. Compressive Strength Testing of Cylindrical Concrete Specimens

TABLE 3. INITIAL SET TIMES OF POTENTIAL CEMENT SYSTEMS.

TYPE OF CEMENT	PERCENT (1) ACCELERATOR	PERCENT (2) MICROSILICA	INITIAL SET TIME, MIN. (3)
Pyrament 505 (4)	0	0	22
Pyrament 505	2	0	20
Rapid-Set (5)	0	0	25
Rapid-Set	2	0	4.0
Rapid-Set	2	6	7.0
Rapid-Set	2	12	4.0
Rapid-Set	2	18	3.5

- (1) Percent by weight of cement
- (2) Percent by weight of cement
- (3) ASTM C-403 at 77° F.
- (4) Based on a water/cement ratio of 0.27.
- (5) Based on a water/cement ratio of 0.41.

TABLE 4. LABORATORY SCREENING RESULTS

Mix No.	QUANTITIES IN POUNDS					
	1	2	3	4	5	6
Rapid-Set Cement	7.2	9.6	7.2	7.2	7.2	7.2
Coarse Aggregate	15	10	15	15	15	15
Fine Aggregate	7.8	10.4	7.8	7.8	7.8	7.8
Accelerator	0.14	0.19	0.14	0.14	---	0.14
Microsilica	---	---	0.43	0.86	0.86	0.86
Steel Fibers	---	---	---	---	0.98	1.96
Water	2.46	3.32	2.46	2.76	2.76	2.76
Water/C+MS(1)	0.35	0.35	0.32	0.35	0.35	0.35
Set time, min.	4.5	4.0	7.5	4.5	25.0	4.5
1 hour Compressive Strength, ksi	5.09	5.09	(2)	4.53	(3)	5.09

- (1) Water/(cement + microsilica) ratio
- (2) Mix design optimized microsilica content at 12% by weight of cement.
- (3) Mix design optimized steel fiber content at 2% by volume of the hardened concrete.

SECTION IV

FIELD TESTING

A. OVERVIEW

The objective of the field testing part of this study was to develop shotcrete equipment, operating parameters that would allow successful build-up of shotcrete layers, strength gain, and material uniformity. These parameters include dry material flow rate, water flow rate, and rotor speed, which determine the equipment output capacity.

Another area of interest is the effect of different nozzle/tip assemblies on the physical properties of the shotcrete repair material.

Eleven shotcrete tests were performed to develop information regarding the relationship between material strength development and shotcrete operating conditions. The sensitivity of this formulation to variation in the water/cement ratio was also investigated.

High speed photography was used to measure particle velocities of the material exiting through three different nozzles.

Shotcrete tests simulating hot-weather and cold-weather environments were also performed with the expedient repair material formulation.

B. MATERIALS

1. USAF Expedient Repair Material System

The expedient repair material system, developed in the laboratory, is a dry-blended, prepackaged system, the composition of which is given in Table 5. The formulation is equivalent to 8 sack of cement per cubic yard of shotcreted material. The silica fume content is 12 percent by weight of cement, and the steel fiber content is 1.4 percent by volume of the concrete composite.

TABLE 5. INGREDIENTS USED IN DRY-BLENDED PREPACKAGED XPR SYSTEM
PER 50-POUND BAG

MATERIAL IN BAG	WEIGHT, LBS	PERCENT BY WEIGHT
Rapid-Set Cement	11.5	22%
Fine Aggregate	12.5	23.6%
Coarse Aggregate	24	45.6%
Dry densified silica fume	1.4	2.7%
Steel fibers (1 in. long)	3.0	5.7%
Scamper 16 accelerator	0.25	0.5%
Total weight per bag	52.65	

Physical Properties

Unit weight of dry material	121 lbs/ft ³
Equivalent cement sack content	8 sacks/yd ³
Water Required	4.5 lbs
Water/cement + silica fume) ratio	0.35

The water/cement ratio is based on the total water required per total combined unit weight of cement and dry densified silica fume.

C. EQUIPMENT

I. Dry-Process Shotcrete Equipment

The dry-process shotcrete equipment investigated in this study was leased from the Shotcrete Division of Master Builders Technologies. The machine shown in Figure 8, was a MEYCO Piccola 020, an air-motor-operated machine with a capacity of 3.5 yd³/hr.

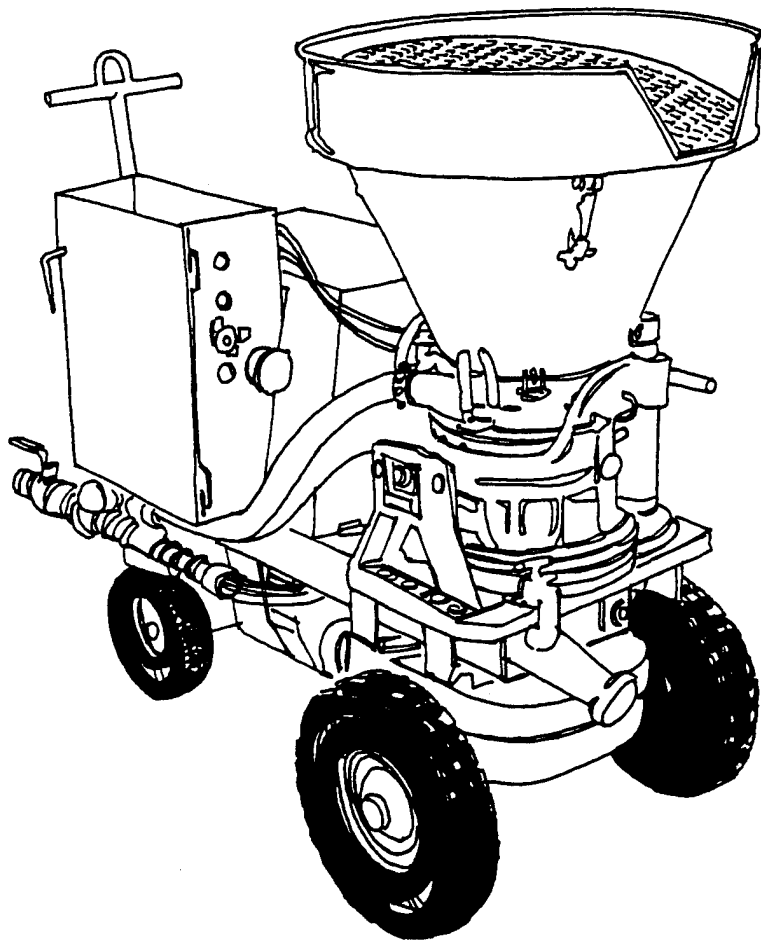

Figure 8. MEYCO 020 Shotcrete Equipment

The specifications for the MEYCO 020 are given in Table 6.

TABLE 6. MEYCO 020 SHOTCRETE EQUIPMENT SPECIFICATION

SPECIFICATIONS:

Overall width	700 mm
Overall length	1500 mm
Height without hopper	900 mm
Overall height with hopper	1370 mm
Hopper capacity	70 liters
Total weight	470 kg
Pneumatic motor	4.5 kW at 1500 rpm, air consumption 5 cu.m. per minute at 6 bar.

2. Nozzle Bodies and Tips

The nozzle bodies and tips evaluated in this study were the standard Hamm style, the Spirolet, the Double Bubble, and the Hydro-Mix Nozzle, shown in Figures 9, 10, 11, and 12, respectively.

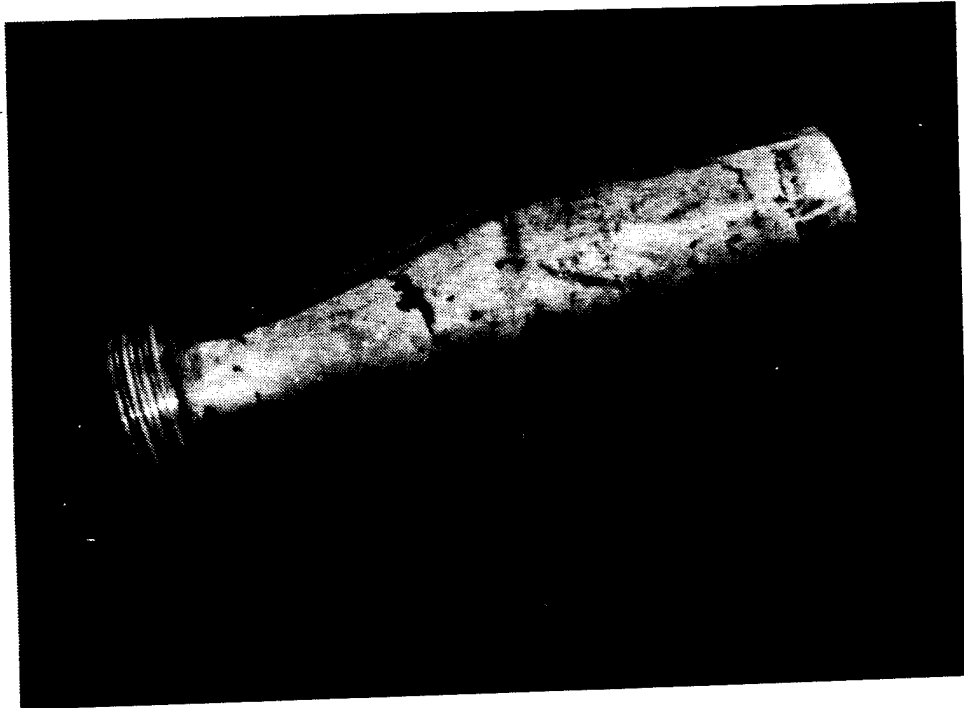

Figure 9. Standard Hamm Style Shotcrete Nozzle.

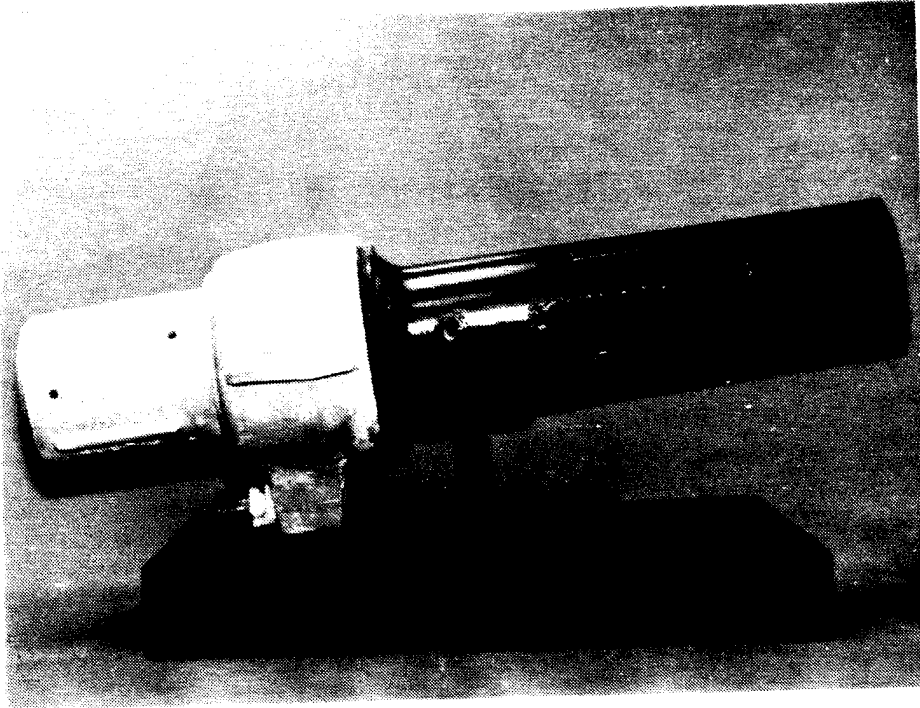

Figure 10. Spirolet Shotcrete Nozzle.

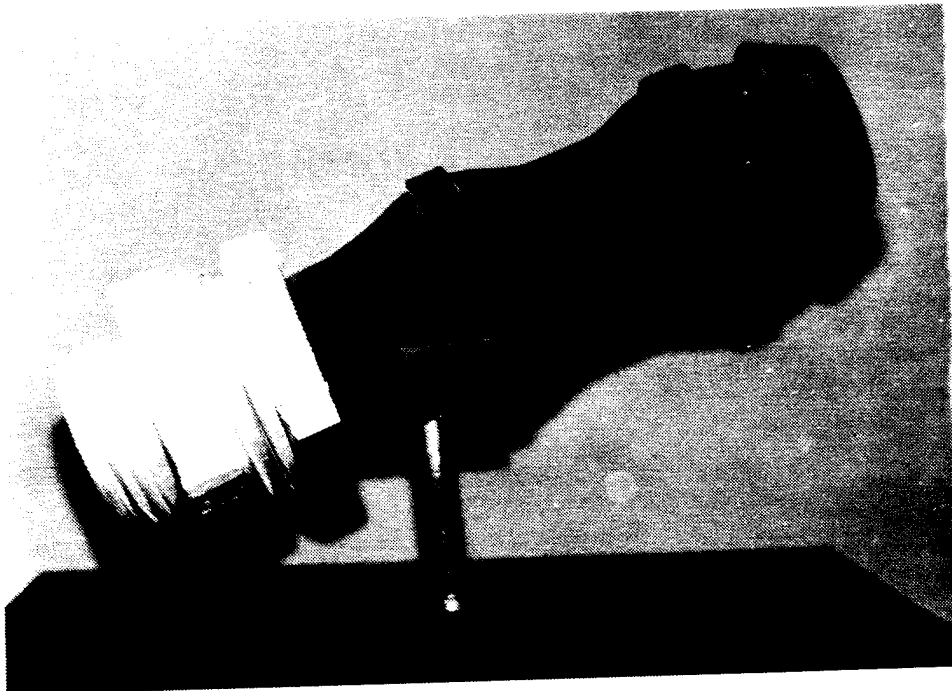

Figure 11. "Double Bubble" Flexible Shotcrete Nozzle.

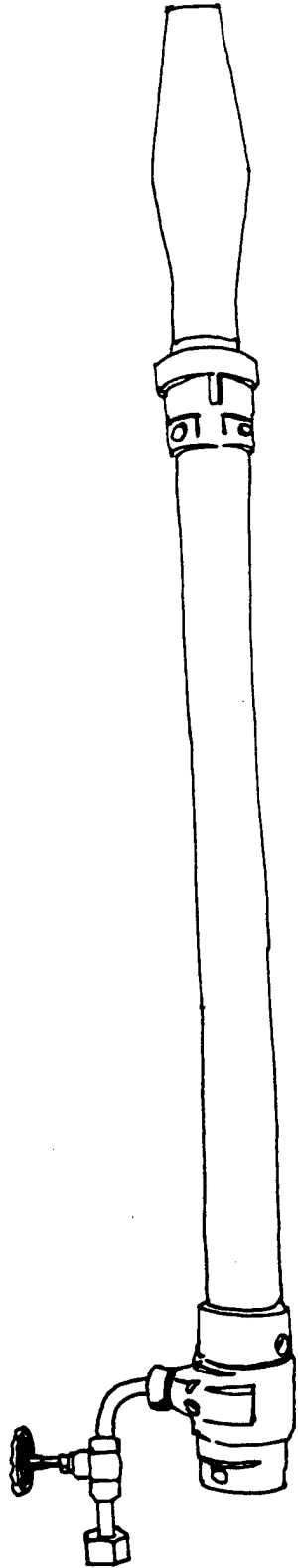

Figure 12. Hydro-Mix Prewetting Nozzle Assembly.

The Hamm nozzle body is made of a metal and is considered by most as the standard in the shotcrete industry. The Spirolet nozzle is made of polyurethane with rifling in the barrel. This provides higher particle velocity and a tighter shot pattern. The "double bubble" nozzle is made with a flexible elastomer, and is shaped like an old-fashioned coke bottle. It can be manually bent to direct the exiting material into tight places. The hydro-mix nozzle is actually a predampening device, attached about two feet upstream of the nozzle and tip. The operator controls the both the amount of "prewet" the dry material receives, and the amount of mix water injected at the dry-process nozzle. This predampening nozzle reduces the dust associated with dry-process shotcrete operations, and assures better mixing of the predampened material at the nozzle.

The hose diameter used in this study was 1.5 inches. Its construction for the dry-mix process is illustrated in Figure 13. One standard 50 foot length of hose used in these tests.

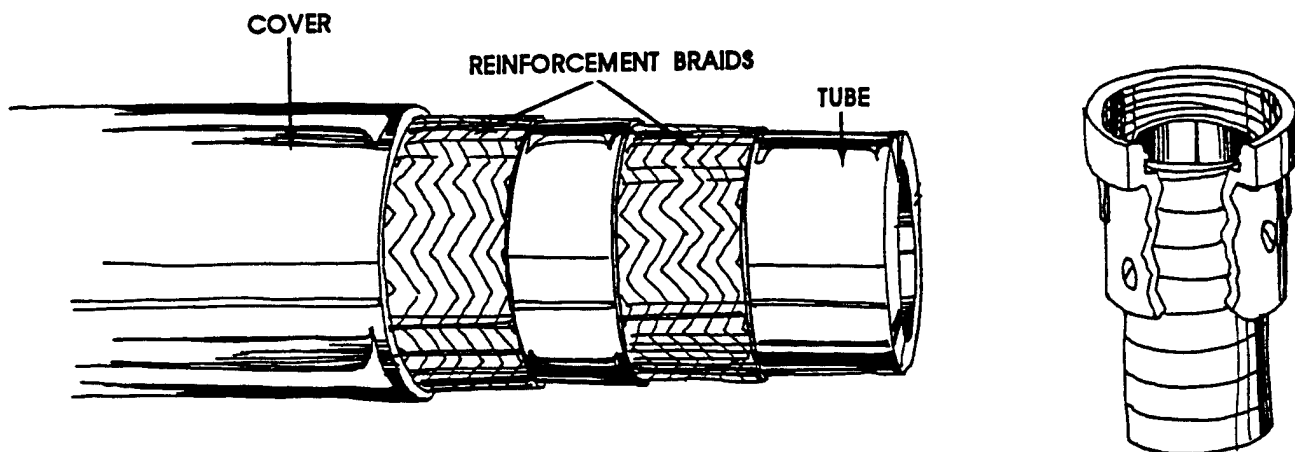

Figure 13. Dry-Mix Shotcrete Placement Hose Construction.

D. RESULTS

1. Material Properties

One-foot square boxes 10 inches deep and two-foot square boxes 10 inches deep were shotcreted in the field, as shown in Figure 14. Cores were taken approximately 30 minutes after shotcreting and tested at 1 hour, as shown in Figure 15.



Figure 14. Shotcreting Field Sample Boxes



Figure 15. Coring Test Cylinders from Field Sample Boxes

The results of the eleven shotcrete tests are summarized in Table 7.

TABLE 7. RESULTS OF SHOTCRETE FIELD TESTING

Test No.	Operating Conditions			Unit Weight pcf	C.S. cores psi	C.S. NDT psi
	MLP psi	Rotor rpm	Water flow gpm			
1H	60	9	1.1	139	3400	3600
	60	9	1.6	132	2700	2900
2S	60	9	1.0	142	3600	3800
	60	9	0.7	141	2900	3100
3D	60	9	1.3	136	2750	2900
	60	9	1.5	134	2400	2600
4S	50	8	1.1	143	3400	3700
5HM	60	8	0.7 0.4*	134	2700	2800
6S	60	8	1.3	140	2120	2300
7S	60	8	0.9	142	3050	3400
8S	60	8	1.1**	141	4070	4200

* Extra water supplied to the Hydro-Mix Assembly
 ** Hot water used (135° F)

Notes:

Test No.:

H = Hamm nozzle and tip
 S = Spirolet nozzle and tip
 D = Double bubble nozzle and tip
 HM = Hydro-Mix assembly with Hamm tip

Operating Conditions:

MLP = Main line pressure in psi
 Rotor = Rotor speed in rpm (see Figures 17 and 18)
 Water Flow = Water flow rate in gal/min

Unit weight = Dry unit weight of cored specimens, in lbs/ft²

C.S. cores = Compressive strength of cored cylinders, in psi

C.S. NDT = Compressive strength of shotcrete sample cores, measured using the Windsor Probe method

Highlights include one-hour compressive strengths of 3600 psi using ambient temperature water, and over 4000 psi using 135° F water, and 1-hour compressive strengths of 3800 psi measured using the Windsor Probe non-destructive test method.

2. Operating Principles

Shotcrete equipment operating principles are described in Figure 16. The dry mix is fed into the hopper (1). Between the hopper clamping plate and the gear box cover plate (2), a cylindrical rotor (3) is rotates between two hermetically sealed rubber disks. An air, diesel or hydraulic motor can be the power source. From the hopper (1), the mix flows freely into the rotor chambers (4) passing underneath. Once they are filled, the mix reaches the opposite outlet opening (5), from which it is carried away by the stream of compressed air (P).

The information given in Figure 17 was provided by the manufacturer of the Meyco 020 shotcrete equipment. Figure 18 illustrates the weight of material produced per minute as a function of rotor speed in RPMs, based on the unit weight of dry shotcrete material measured in the laboratory. The operating conditions were optimized to properly match the dry material flow rate to the corresponding water flow rate i.e. water/cement ratio, both of which depend on air flow through the discharge chamber.

Figure 19 illustrates the method of controlling the water flow rate to the nozzle by using a digital flow-meter in series with a drum pump. A drum heater was used to control the water temperature. The sensitivity of this formulation to water flow rate is shown in Table 8. The flow rate was increased by approximately 40 percent and decreased by approximately 20 percent of the optimum flow rate.

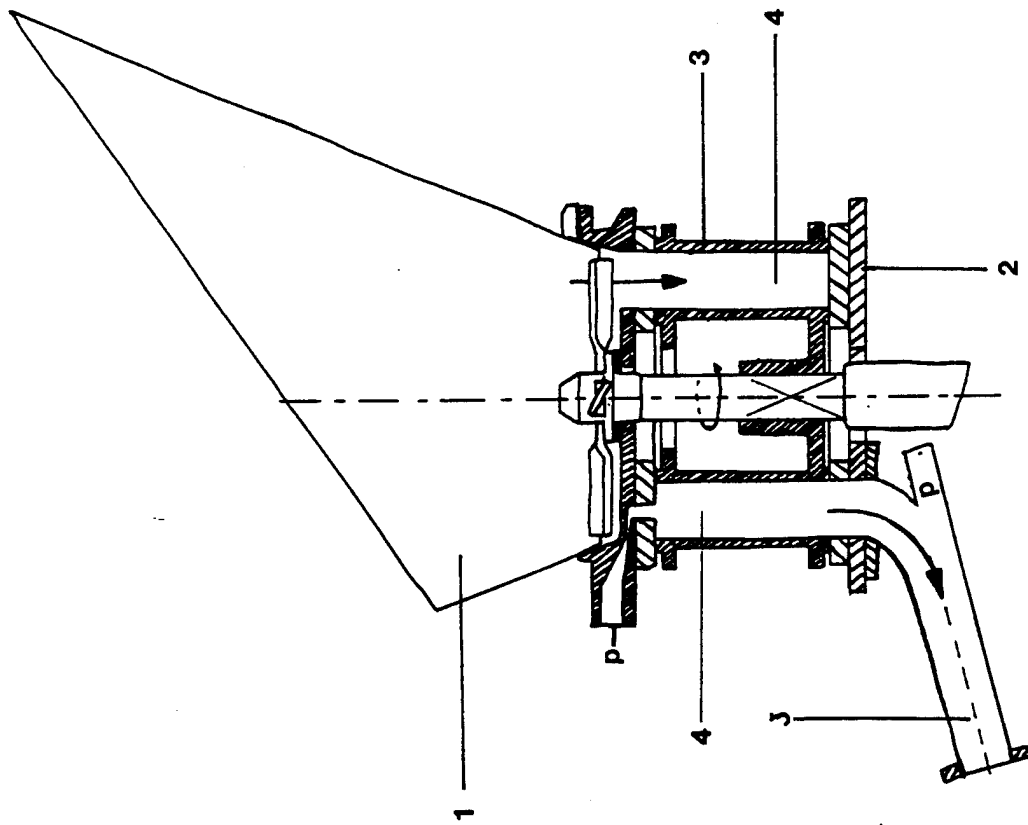

Figure 16. Equipment Operating Principle for Dry-Mix Process

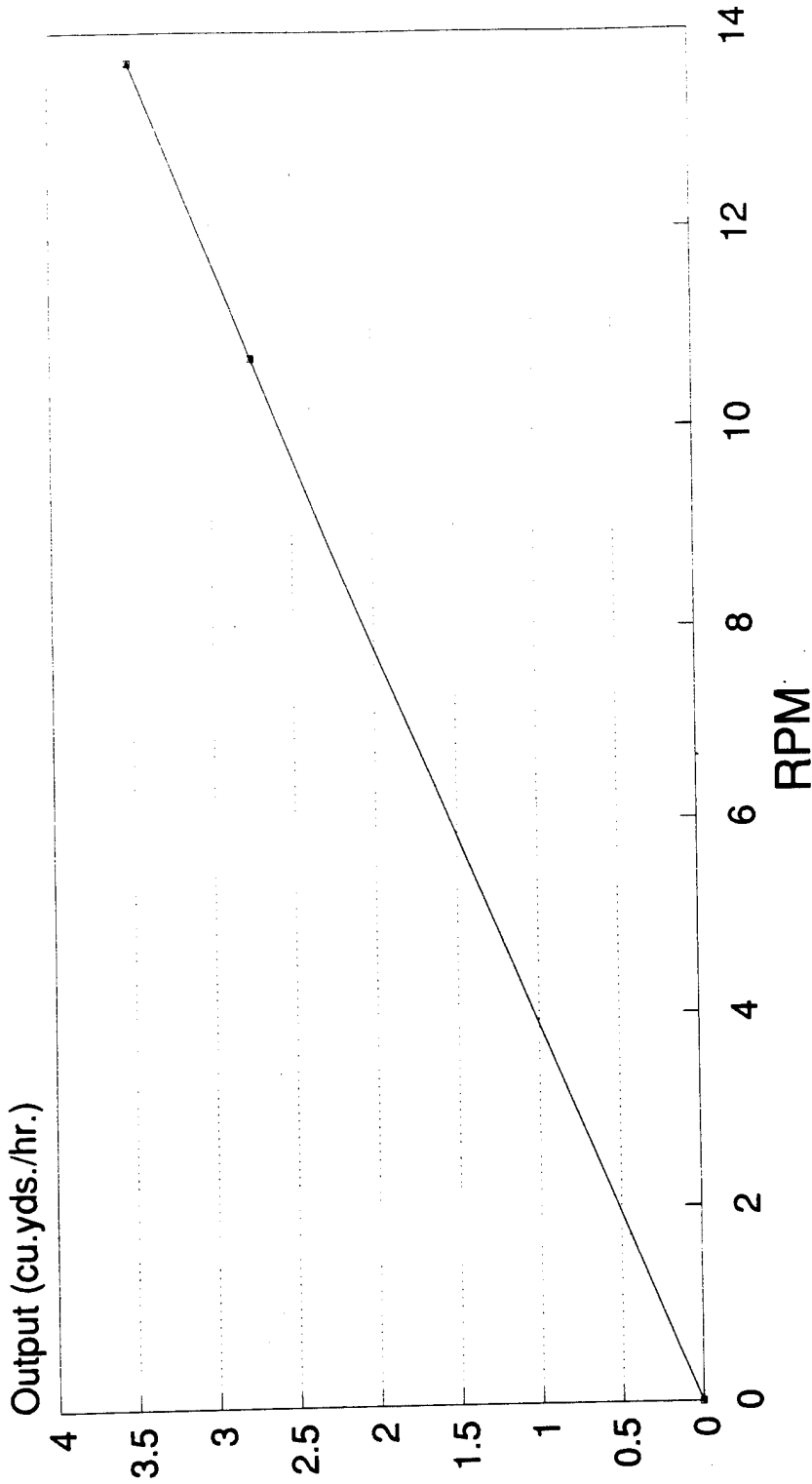

Figure 17. Shotcrete Volume Output vs. Rotor RPM for Dry-Blended Material

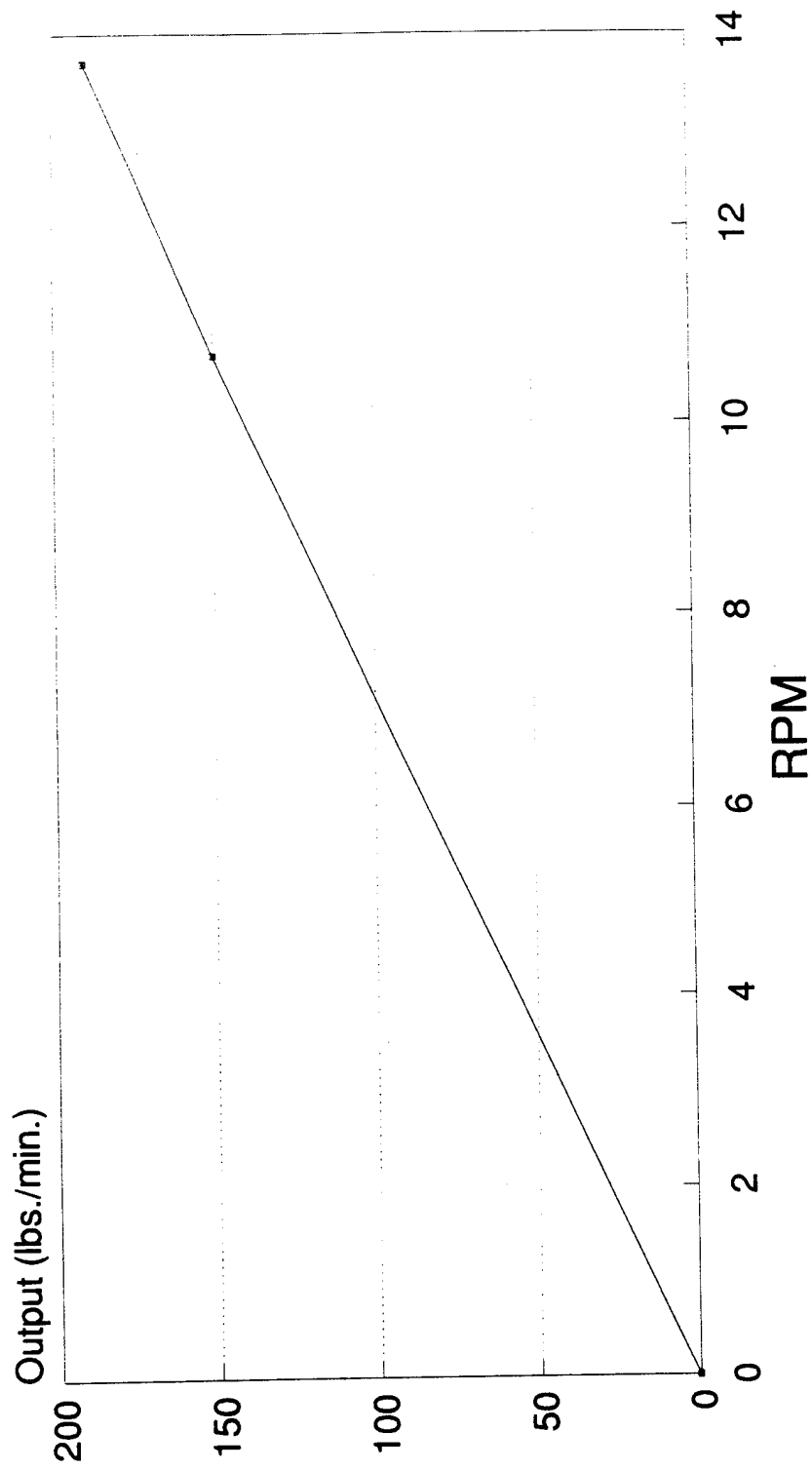

Figure 18. Shotcrete Weight Output vs. Rotor RPM for Dry-Blended Material

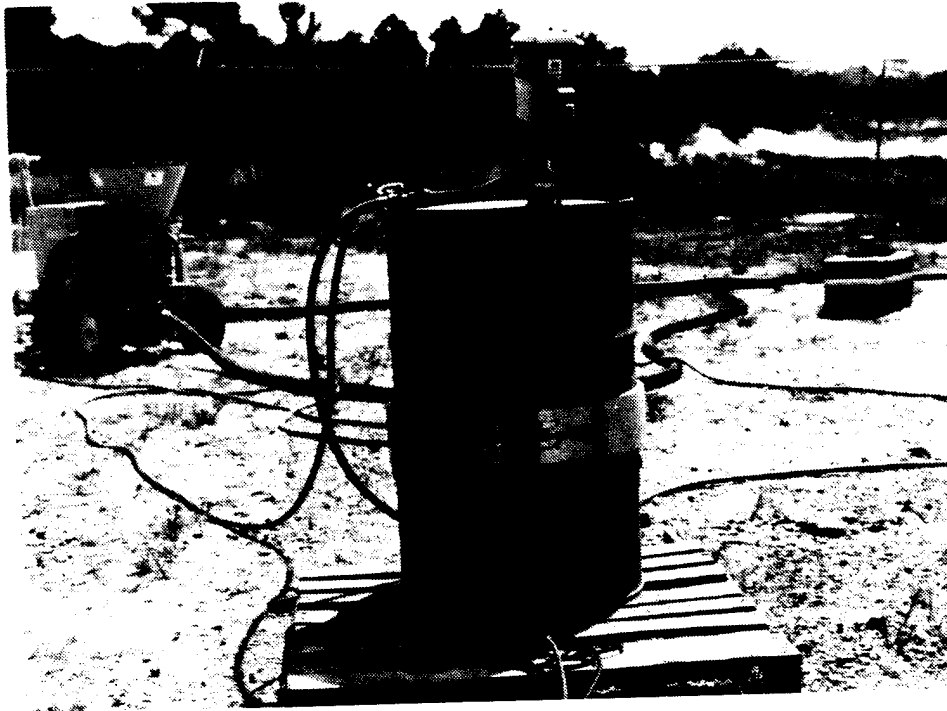

Figure 19. Controlled Constant Flow Rate Water Supply with Temperature Control

TABLE 8. STRENGTH VS. WATER CONTENT

Water Flow Rate gal/min	Dry Material Flow Rate ¹ lbs/min	W/C	1 Hour Compressive Strength, psi
1.5	109	0.47	2120
1.1	109	0.35	3550
0.9	109	0.28	3050

Shotcrete Operating Parameters:

Main line pressure = 60 psi

Rotor rpm = 8 rpm

¹ Amount of cement + silica fume in dry material = 24.4% by weight Nozzle type = Spirolet.

3. Particle Velocities

The particle velocities obtained with the three basic nozzle types are given in Table 9.

TABLE 9. PARTICLE VELOCITIES VS. NOZZLE TYPE USING HIGH-SPEED PHOTOGRAPHY

Nozzle Type	Average Particle Velocity ft/sec	Standard Deviation	Film Speed frames/sec
Hamm	231.13	2.74	5300
Double Bubble	172.04	4.83	7000
Spirolet	265.35	3.52	8000

Shotcrete Operating Conditions:

Main Line Pressure = 60 psi

Rotor rpm = 8

Dry material flow rate (from Figure 18) = 109 lbs/min

Water flow rate = 1.1 gal/min

They correspond with the literature values for velocities determined by high speed photography (Reference 13). Figure 20 illustrates the test setup.



Figure 20. Test Set Up for Determining Particle Velocities Using High-Speed Photography

Figures 21, 22, and 23, show the particle velocities obtained using the Hamm, Spirolet, and double bubble nozzle tips respectively. The raw particle velocity data and its statistical analysis are given in Appendix A.

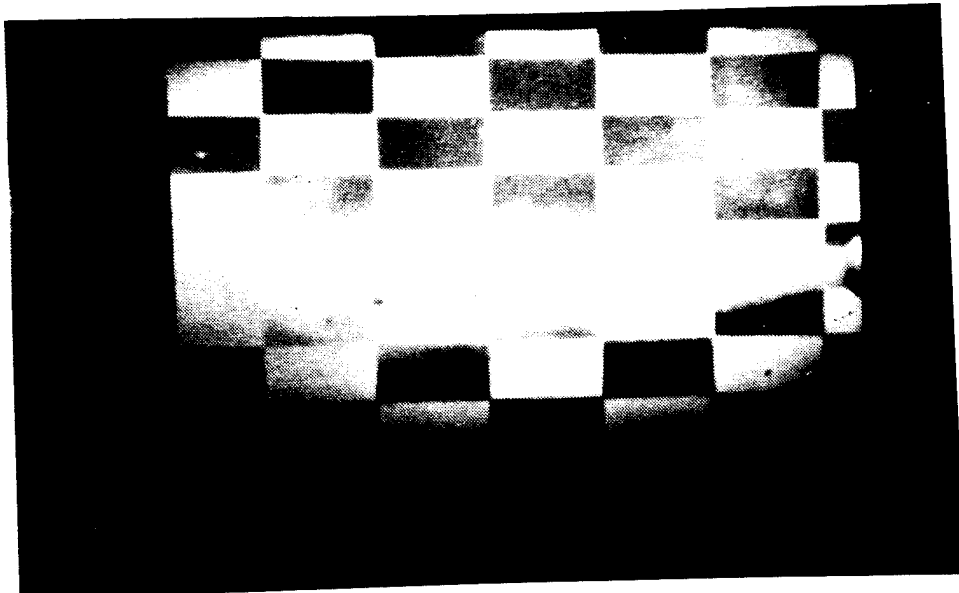

Figure 21. High-Speed Photography of Particles Ejected from Standard Hamm Nozzle.

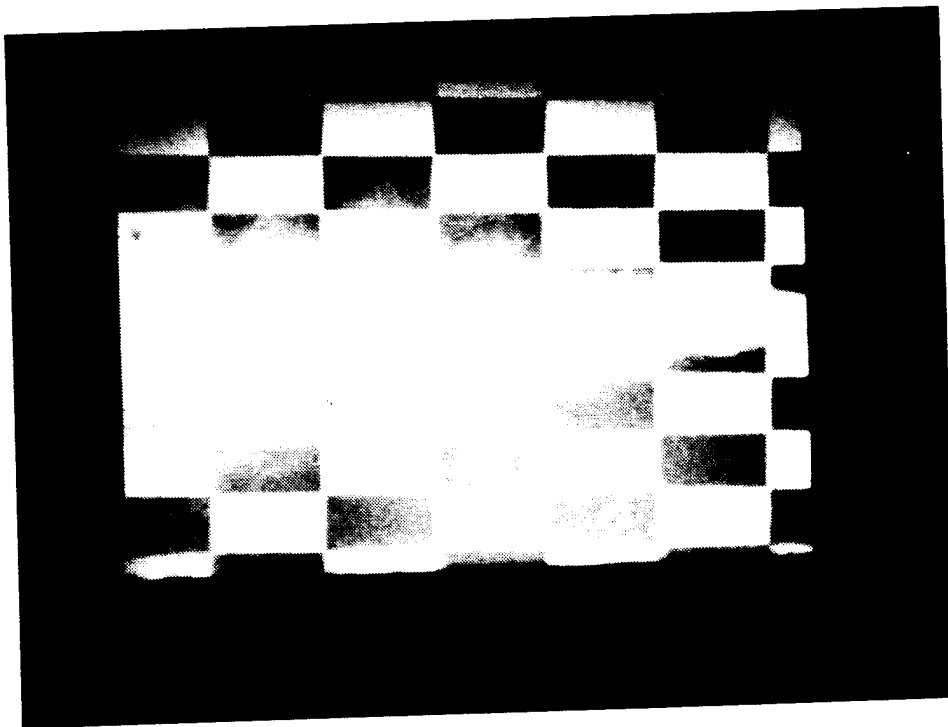

Figure 22. High-Speed Photography of Particles Ejected from the Spirolet Nozzle

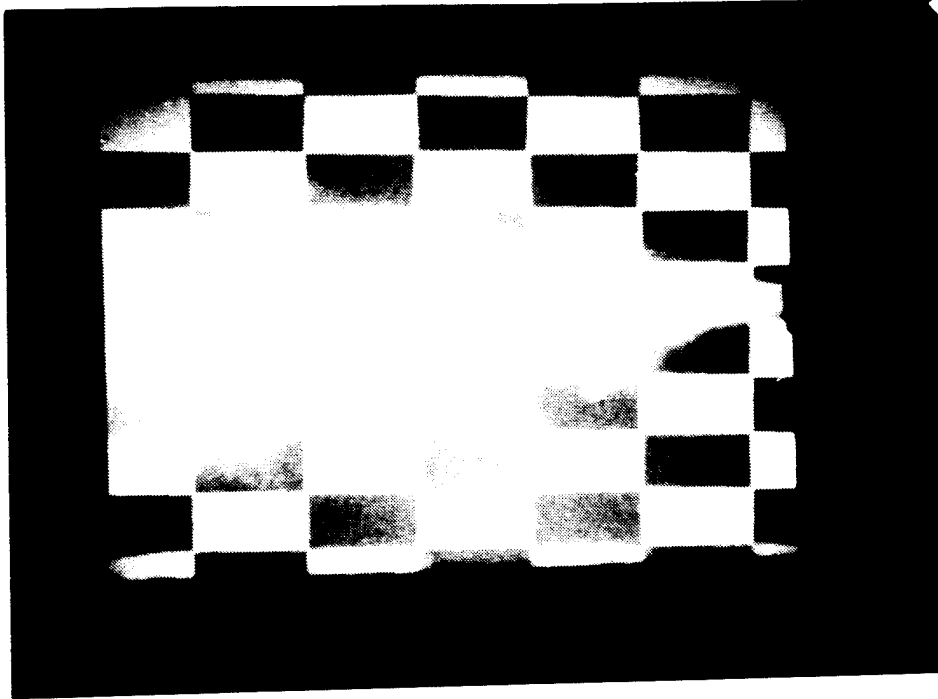

Figure 23. High-Speed Photography of Particles Ejected from the "Double Bubble" Flexible Nozzle.

SECTION V

ENVIRONMENTAL TESTING

A. HOT WEATHER

Shotcreting in Florida during the months of June and July is considered as "hot-weather concreting." The hot weather conditions were exacerbated by exposing the dry materials to hot ambient conditions for several hours prior to testing, and heating the mix water to 135° F. The results are summarized in Table 10. The average 1-hour compressive strength was 3800 psi, and the Windsor Probe gave an average compressive strength value of 3450 psi.

B. COLD WEATHER

Since a large "cold room" environmental chamber was not available for a full scale field test for "cold-weather shotcreting," the cold weather effectiveness of material system was evaluated in the laboratory. The test results are given in Table 11.

The dry materials were refrigerated until they reached an equilibrium temperature of 34° F. The dry material was then mixed with water at varying temperatures, and cured at 33° F prior to testing. At a water temperature of 35° F, no strength was developed in 1 hour. The water temperature was then raised to 120° F, which yielded a 1-hour compressive strength of 4810 psi. Variation of compressive strength with time, up to 7 days in a cold-weather environment, are given in Table 12 and illustrated in Figure 24. The dry material was mixed with water at varying temperatures, and cured at 33° F. prior to testing at 1 hour, 1 day, and 7 days.

TABLE 10. HOT-WEATHER SHOTCRETE TEST RESULTS

Dry Material Temperature	Water Temperature	1 Hour Compressive Strength, Cores	1 Hour Compressive Strength, NDT(1)
95° F	135° F	3560 psi 4070 psi	3250 psi 3650 psi

(1) NDT method = Windsor Probe

Shotcrete Operating Conditions:

Main Line Pressure = 60 psi

Rotor rpm = 8

Dry Material Flow Rate (from figure 18) = 109 lbs/min

Water Flow Rate = 1.1 gal/min

Nozzle Type = Spirolet

TABLE 11. COLD-WEATHER TEST RESULTS (LABORATORY)

Dry Material Temperature	Water Temperature	1 Hour Compressive Strength, psi
35° F	35° F	<500
35° F	120° F	4800

Notes:

Dry material was stored in a refrigerator for two days in order to reach equilibrium temperature.

Dry material was mixed with water for 30 seconds, then vibrated into a mold for another 30 seconds.

Mold and contents were placed in a refrigerator at an air temperature of 33° F for 1 hour prior to testing.

TABLE 12. COMPRESSIVE STRENGTH VS. TIME FOR COLD-WEATHER CONDITIONS

Dry Material Temperature	Water Temperature	Compressive Strength, psi		
		1 Hour	1 Day	7 Days
35° F	67° F	2980	5900	5900
35° F	90° F	3200	5300	6050
35° F	110° F	3820	5100	6250

Notes:

Materials were mixed in the high-speed Omni mixer for 30 seconds, then placed into molds in another 30 seconds. The molds and contents were cured for 1 hour, 1 day, and 7 days in a refrigerator having an air temperature of 33° F prior to testing.

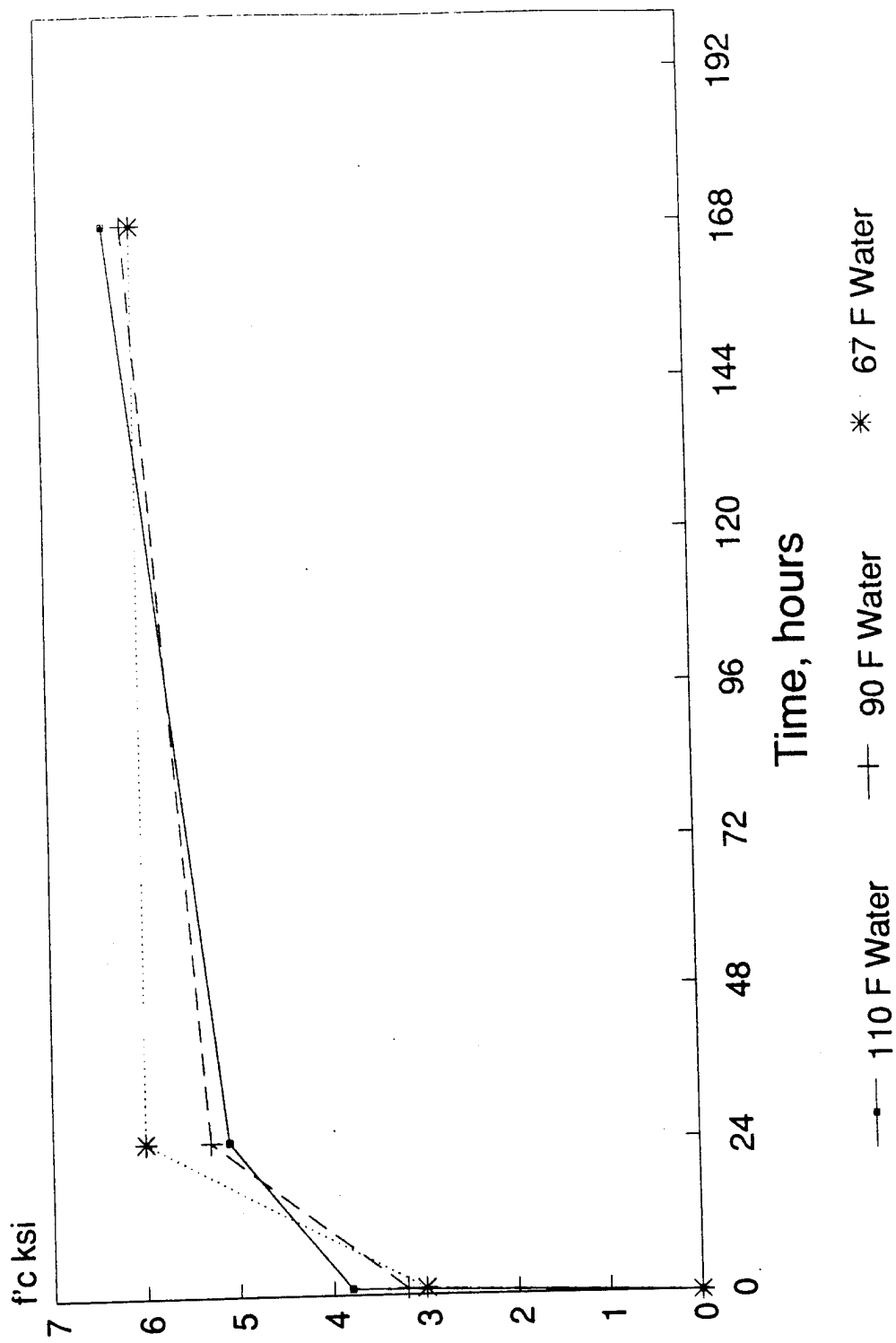

Figure 24. Compressive Strength Vs. Time for Expedient Repair Material

SECTION VI

ECONOMICS AND FIELD DEMONSTRATION

A. ECONOMICS

An economic analysis of the very high early strength expedient repair shotcrete system is given in Table 13.

TABLE 13. ECONOMIC ANALYSIS OF THE XPR EXPEDIENT REPAIR SHOTCRETE SYSTEM

Materials	Amount/Bag	Cost/Lb.	Cost/Bag
Rapid-Set Cement	11.5	\$0.1225	\$1.41
Fine Aggregate	12.5	\$0.003	\$0.04
3/8 in. gravel	24	\$0.006	\$0.14
Microsilica	1.4	\$0.38	\$0.53
1 in. Steel Fibers	3.0	\$0.36	\$1.08
Scamper 16	0.22	\$0.75	\$0.17
Total Weight/bag	52.6		
Material Cost/bag (FOB plant)			\$3.37
Packaging Cost			\$2.10
Total Cost/bag			\$5.47

These number do not reflect the costs associated with purchasing the individual materials in bulk, or bulk packaging such as "super-sacks."

B. DEVELOPMENT OF FIELD DEMONSTRATION

A field demonstration which involved repairing specific areas of a damaged NATO structure at Tyndall AFB was conducted on 19 October 1990. This demonstration involved packaging 300 bags of dry-blended material by a commercial concrete bagging company.

A door opening in the NATO hardened structure at Sky-10, Tyndall AFB, Florida, was used to simulate a wall breach (Reference 1). The door area measured approximately 7 feet high by 4 1/2-feet wide, as shown in Figure 25. Number 4 steel-reinforcing rod stubs were welded at 1-foot intervals around the door to simulate fractured reinforcing bars, and to provide shear transfer, as shown in Figure 26. Plywood backing was placed behind the repair area, and

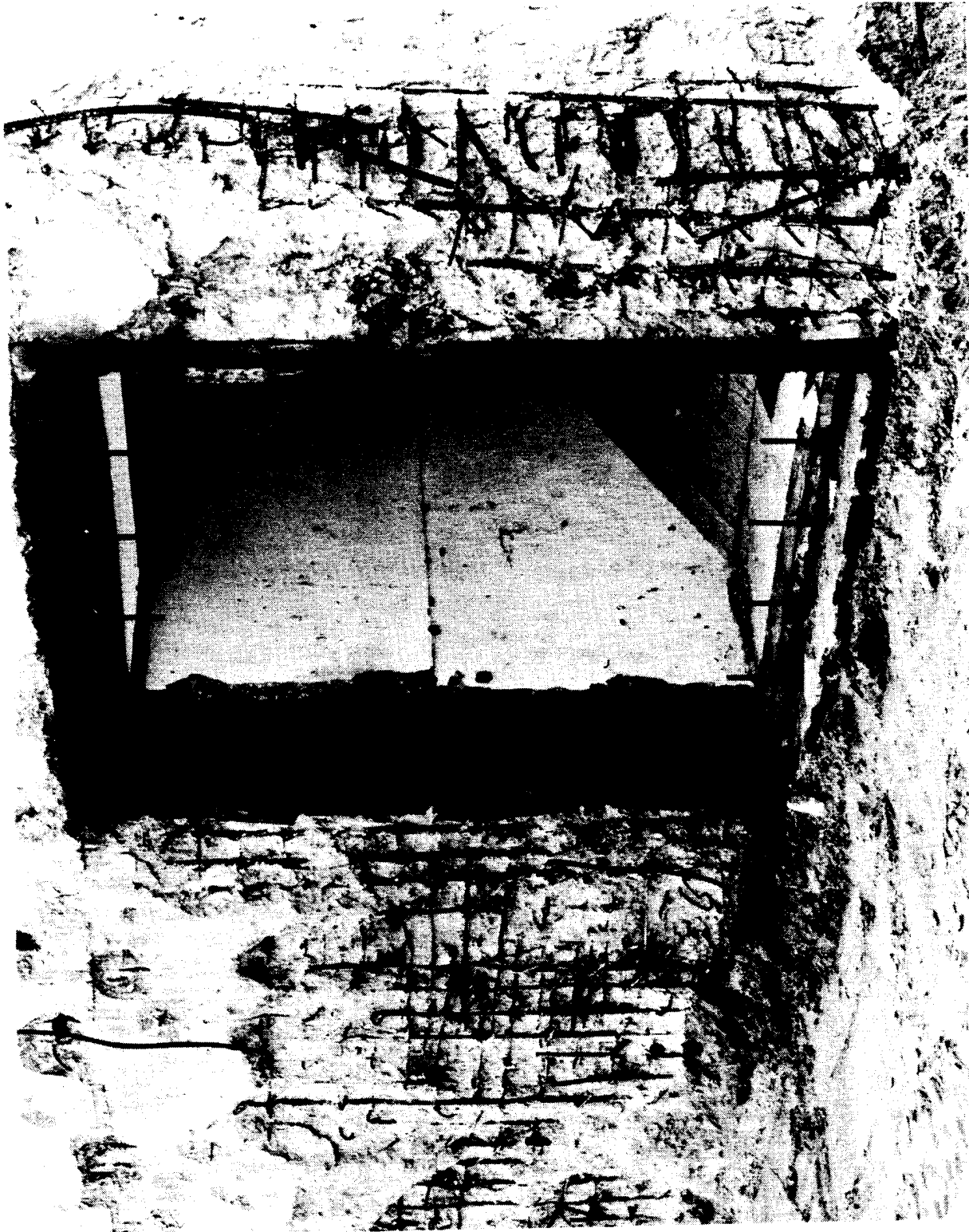

Figure 25. Door Opening in NATO Structure Used for wall Breach



Figure 26. Rebar Welded Along the Top Bottom, and Sides of the Door Opening

braced with 2 x 4's and sand bags, as shown in Figures 27. Eight-inch long repair depth indicator rods protruded from the plywood backing toward the door front, as shown in Figure 28. Six pieces of shotcrete equipment were required for this demonstration: (1) an air compressor, (2) the shotcrete unit, (3) the Hydromix nozzle assembly and Spirolet tip, (4) a 55-gallon water drum, fitted with a drum pump, (5) a portable electric generator to power the drum pump, and (6) a concrete bucket attached to an all-terrain forklift. The shotcrete material was continuously fed from the concrete bucket to the nozzle by compressed air, and the water was metered to the nozzle by a drum pump/flowmeter arrangement. The shotcrete material is then pneumatically conveyed at high velocities toward the repair area, Figure 29.

Details of the explosive tests against the very high early strength shotcrete repair are indicated in ESL-TR-91-13, "Expedient Repair of Structural Facilities", Section VI, Paragraph E, pages 126 through 158.

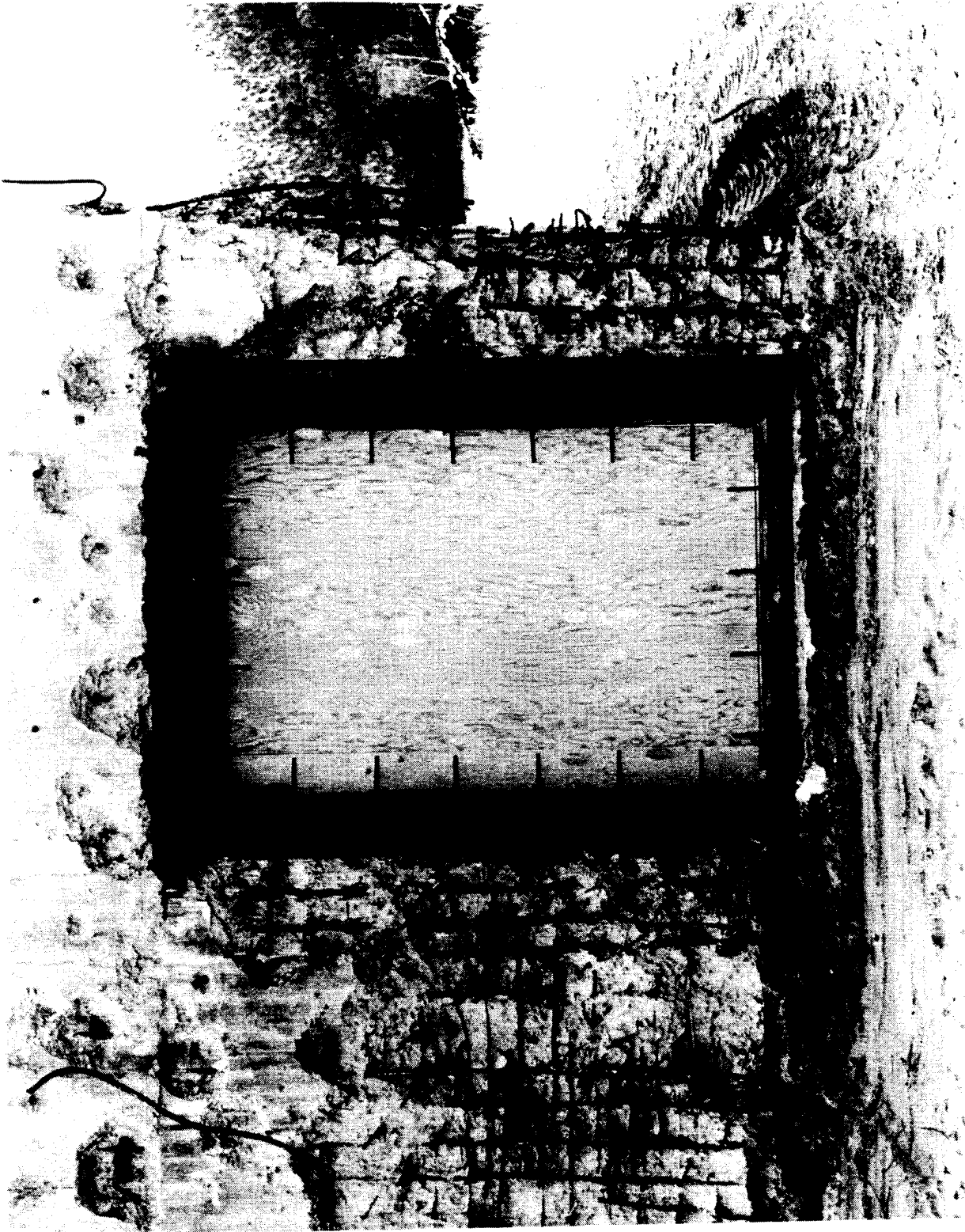

Figure 27. Plywood Backing in the Door Opening



Figure 28. Depth Indicator Conduits in the Plywood Backing



Figure 29. Shotcreting Wall Replacement

SECTION VII

CONCLUSIONS

A. CONCLUSIONS

A very high-early-strength, dry-process shotcrete material was developed for expedient repair of mission-critical airbase structural facilities damaged by conventional attack (Reference 14). The dry-mix shotcrete process was selected because (1) it allows the use of a very fast setting system and (2) it reduces the amount of equipment and material waste required for such an operation. In the dry-mix process, the dry material is passed pneumatically through a hose to a nozzle. Water is pumped directly to the nozzle, and the metering and mixing takes place in the nozzle body. The wet mixture is then immediately ejected through the nozzle onto the repair target. The pneumatically placed material sets in less than 2 minutes, and attains a compressive strength of about 4000 psi in 1 hour. Cylindrical samples were cored and tested, both destructively, and non-destructively using a Windsor Probe.

1. A Rapid-Set[®] cement-based formulation, incorporating microsilica, steel fibers, and a dry shotcrete accelerator produces high-early strength shotcrete and functions as an expedient repair material. This material system meets most of the operating conditions recommended by AFCESA/RACS Airbase Survivability Branch.

2. Dry-process shotcrete equipment with high output capacity, (e.g., 10 yd³/hour or more), is a very efficient method of applying an expedient repair material, as described above. This equipment should be mobile, having self-contained utilities, and may even be equipped to operate the shotcrete nozzle using a robotic arm assembly.

3. The nozzle of choice in this work was the spirolet type, but other nozzles produced by other manufacturers might perform as efficiently. The nozzle of choice will depend upon the complete fielded shotcrete system.

REFERENCES

1. Read, D.L., Merkle, D.H., et. al., Expedient Repair of Structural Facilities (ERSF), Vol 1, ERSF System Development, Applied Research Associates, Inc., Final Report to The Engineering Services Laboratory, Air Force Engineering and Services Center, Tyndall Air Force Base, Florida, ESL-TR-91-13, 1991.
2. Anderson, M., Shotcrete for Expedient Structural Repair, Applied Research Associates Final Report to The Engineering and Services Laboratory, AFESC, Tyndall Air Force Base, Florida, ESL-TR-90-14, 1990.
3. Hardy BBT Ltd., Evaluation of Pyrament Dry-Mix Shotcrete, 23 October 1989.
4. Ocean Construction Supplies Ltd., P. O. Box 2300, Vancouver, B.C., V6B 3W6.
5. Pyrament-A Division of Lone Star Industries, Inc., P. O. Box 2148, Houston, Texas, 77252.
6. Rapid Set Products, 2077 Linda Flora Drive, Los Angeles, California 90077.
7. Holnam Inc., P. O. Box 99, Saratoga, Arkansas 71859.
8. Master Builders Inc., 23700 Chagrin Blvd., Cleveland, Ohio 44122.
9. U. S. Gypsum Co., 101 S. Wacker Dr., Chicago, Illinois 60606.
10. Grace Construction Products, 1200 NW 15th Avenue, Pompano Beach, Florida 33069.
11. Mitchell-Fibercon, 100 South Third Street, Evans City, Pennsylvania 16033.
12. Surecrete, Inc., 155 NE 100th, Seattle, Washington 98125.
13. Glassgold, I.L., "Shotcrete Durability: An Evaluation", Concrete International, ACI, August 1989, pp. 78-85.
14. Muszynski, L.C., and Rochefort, M.A., "Fibrous Concrete for Expedient Repairs of Structures", 5th International Symposium on Interaction of Conventional Munitions with Protective Structures, Mannheim, FRG, April 1991.

APPENDIX A

RAW DATA OF SHOTCRETE PARTICLE VELOCITY MEASUREMENTS.

TABLE A-1. SHOTCRETE TEST #1 USING A SPIROLET NOZZLE

AGGREGATE TIME (ms)	DISTANCE (IN)	VELOCITY (FT/SEC)
15	36	200.00
13	36	230.77
12	36	250.00
15	36	200.00
12	36	250.00
13	36	230.77
20	36	150.00
8	36	375.00
9	36	333.33
12	36	250.00
9	36	333.33
11	36	272.73
11	36	272.73
10	36	300.00
13	36	230.77
20	36	150.00
12	36	250.00
14	36	214.29
12	36	250.00
15	36	200.00
10	36	300.00
13	36	230.77
15	36	200.00
12	36	250.00
9	36	333.33
6	36	500.00
7	36	428.57
7	36	428.57
16	36	187.50
19	36	157.89

AVE TIME: 12.33 (Time for aggregate to travel 36" in ms)
 STD DEV: 3.52 (Standard Deviation of aggregate travel)
 AVE VEL: 265.35 (Feet per second)

TABLE A-2. SHOTCRETE TEST #2 USING A HAMM NOZZLE

AGGREGATE TIME (ms)	DISTANCE (IN)	VELOCITY (FT/SEC)
12	36	250.00
11	36	272.73
15	36	200.00
12	36	250.00
12	36	250.00
12	36	250.00
10	36	300.00
12	36	250.00
12	36	250.00
8	36	375.00
16	36	187.50
13	36	230.77
14	36	214.29
20	36	150.00
10	36	300.00
20	36	150.00
14	36	214.29
15	36	200.00
10	36	300.00
14	36	214.29
14	36	214.29
14	36	214.29
16	36	187.50
13	36	230.77
15	36	200.00
10	36	300.00
16	36	187.50
17	36	176.47
14	36	214.29
15	36	200.00

AVE TIME: 13.53 (Time for aggregate to travel 36" in ms)
 STD DEV: 2.74 (Standard Deviation of aggregate travel)
 AVE VEL: 231.13 (Feet per second)

TABLE A-3. SHOTCRETE TEST #3 USING A DOUBLE BUBBLE NOZZLE

AGGREGATE TIME (ms)	DISTANCE (IN)	VELOCITY (FT/SEC)
18	36	166.67
15	36	200.00
20	36	150.00
26	36	115.38
17	36	176.47
17	36	176.47
15	36	200.00
19	36	157.89
21	36	142.86
24	36	125.00
17	36	176.47
14	36	214.29
13	36	230.77
18	36	166.67
16	36	187.50
14	36	214.29
25	36	120.00
30	36	100.00
12	36	250.00
21	36	142.86
14	36	214.29
19	36	157.89
13	36	230.77
16	36	187.50
12	36	250.00
18	36	166.67
28	36	107.14
26	36	115.38
16	36	187.50
23	36	130.43

AVE TIME: 18.57 (Time for aggregate to travel 36" in ms)
 STD DEV: 4.83 (Standard Deviation of aggregate travel)
 AVE VEL: 172.04 (feet per second)