

1 April 1996

To all holders of NSWCCD/MP-93/85 (AEGIS Document-93/1)

Subject: Change 4 dated 1 April 1996

Title: AEGIS SOFTWARE ENGINEERING PROCESS DOCUMENT,
dated August 1993

Change 4 adds a detailed description of the Build Implementation Phase and its activities. The Element Definition Phase is modified only to the extent that one new activity, 1.3.1.3, Assess Design Impact, is included to be compatible with the Build Implementation Phase.

Remove pages and replace with new pages in accordance with the following instructions. File this letter in the front of the document.

Address questions and requests for additional copies to NSWCCD, Code N20P.

INSTRUCTIONS FOR REMOVAL AND INSERTION OF PAGES

Remove

Title Page/A
B/C and D/E
v/vi
II-3-1/II-3-2
II-3-5 through II-3-8
--
II-3-9/II-3-10
II-5-1/II-5-2
(1)/(2)

Insert

Title Page/A
B/C and D/E
v/vi
II-3-1/II-3-2
II-3-5 through II-3-8
II-3-8A/II-3-8B
II-3-9/II-3-10
II-5-1 through II-5-52
(1)/(2)

19960821 121

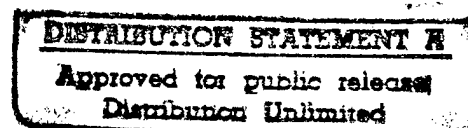

DTIC QUALITY INSPECTED 1

DISCLAIMER NOTICE



THIS DOCUMENT IS BEST QUALITY AVAILABLE. THE COPY FURNISHED TO DTIC CONTAINED A SIGNIFICANT NUMBER OF PAGES WHICH DO NOT REPRODUCE LEGIBLY.

**NSWCDD/MP-93/85
AEGIS DOCUMENT-93/1**

**AEGIS SOFTWARE ENGINEERING
PROCESS DOCUMENT**

**BY SOFTWARE ENGINEERING PROCESS
GROUP
AEGIS PROGRAM OFFICE
COMBAT SYSTEMS DEPARTMENT**

AUGUST 1993

CHANGE 4 - 1 APRIL 1996

Approved for public release; distribution is unlimited.

**NAVAL SURFACE WARFARE CENTER
DAHLGREN DIVISION
Dahlgren, Virginia 22448-5000**

LIST OF EFFECTIVE PAGES

Insert latest change pages in accordance with the cover letter instructions..

Original (Change 0) August 1993	Page	Change
Change 1 18 November 1993		
Change 2 29 July 1994	II-1-15 through II-1-17	2
Change 3 27 March 1995	II-1-18	0
Change 4 1 April 1996	II-1-18A/II-1-18B	3
	II-1-19/II-1-20	0
	II-1-21/II-1-22	3
	II-1-23/II-1-24	2
	II-1-25/II-1-26	0
	II-1-27 through II-1-32	2
	II-1-33/II-1-34	0
	II-1-35/II-1-36	2
	II-1-37/II-1-38	0
	II-1-39/II-3-40	2
	Tab System Def	0
	II-2-1/II-2-2	0
	II-2-3 through II-2-16	2
	II-2-17/II-2-18	0
	II-2-19	2
	II-2-20	0
	II-2-21/II-2-22	2
	II-2-23	0
	II-2-24 through II-2-28	2
	II-2-29 through II-2-31	0
	II-2-32 through II-2-35	2
	II-2-36	0
	II-2-37 through II-2-40	2
	II-2-41/II-2-42	0
	II-2-43/II-2-44	2
	Tab Element Definition	0
	II-3-1	4
	II-3-2	1
	II-3-3 through II-3-5	2
	II-3-6 through II-3-8	4
	II-3-8A/B	4
	II-3-9/II-3-10	4
	II-3-11	3
	II-3-12 through II-3-14	1
	II-3-15/II-3-16	2
	II-3-17	3
	II-3-18 through II-3-20	2
	II-3-21	3

<u>Page</u>	<u>Change</u>
Cover	0
Title Page/A	4
B/C and D/E	4
i/ii	0
iii/ iv	3
v/vi	4
Tab Part I	0
I-1/I-2	0
Tab Model	0
I-3	3
I-4	0
I-5/I-6	3
Tab AEGIS Orgs	0
I-7	0
I-8	3
I-8A/I-8B	3
Tab Abbreviations	0
I-9	2
I-10	0
I-11/I-12	3
I-13 through I-20	0
Tab Terms	0
I-21 through I-28	2
I-29 through I-32	3
Tab Part II	0
II-1/II-2	0
II-3/II-4	3
Tab Project Def	0
II-1-1/II-1-2	0
II-1-3/II-1-4	3
II-1-5/II-1-6	2
II-1-7 through II-1-10	0
II-1-11/II-1-12	2
II-1-13/II-1-14	0

LIST OF EFFECTIVE PAGES (Continued)

<u>Page</u>	<u>Change</u>
II-3-22 through II-3-24	2
II-3-25/II-3-26	3
II-3-27 through II-3-29	1
II-3-30 through II-3-32	2
II-3-33 through II-3-36	1
II-3-37/II-3-38	2
II-3-39 through II-3-42	1
II-3-43/II-3-44	2
Tab High-Level Design	0
II-4-1 through II-4-40	3
Tab Build Implementation	3
II-5-1 through II-5-2	4
Tab Element Test	0
II-6-1	3
II-6-2	0
Tab System Test	0
II-7-1	3
II-7-2	0
Tab Operation	0
II-8-1	3
II-8-2	0
Tab Part III	0
III-1/III-2	0
Tab Part IV	0
IV-1/IV/2	0
(1)	4
Cover	0

Blank

FOREWORD TO CHANGE 4

Change 4 was prepared by David E. McConnell and Charles H. Sperry. It was reviewed by representatives from the NSWCDD AEGIS Organizations.

Approved by:

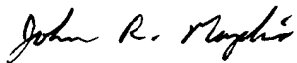

JOHN R. MAPHIS
Chairperson, Software Engineering
Process Group



JAMES D. ROBINSON
Assistant Program Manager
for Computer Program
Engineering

Authorized by:



REUBEN S. PITTS III
Head, AEGIS Program Office

Blank

ILLUSTRATIONS (Continued)

	<u>Page</u>
Diagram 1.5 Build Implementation Phase	II-5-5
Diagram 1.5.1 Update Development Plan Process	II-5-9
Diagram 1.5.2 Plan Unit Test Activities Process	II-5-13
Diagram 1.5.3 Develop Unit Detailed Design (For Each Unit) Process	II-5-19
Diagram 1.5.4 Develop Unit Test Procedures (For Each Unit) Process	II-5-25
Diagram 1.5.5 Product Code/Perform Unit Testing Process	II-5-31
Diagram 1.5.6 Perform Build Integration and Testing Process	II-5-37
Diagram 1.5.7 Conduct Build Implementation Review (BIR) Process	II-5-41
Diagram 1.5.8 Perform Supporting Activities Process	II-5-47
Diagram 1.5.9 Produce System Test Plan Process	II-5-51

TABLES

	<u>Page</u>
Table II-1 Matrix of Processes in the Project Definition Phase and Their Constituent Activities	II-1-3
Table II-2 Matrix of Processes in the System Definition Phase and Their Constituent Activities	II-2-3
Table II-3 Matrix of Processes in the Element Definition Phase and Their Constituent Activities	II-3-6
Table II-4 Matrix of Processes in the High-Level Design Phase and Their Constituent Activities	II-4-3
Table II-5 Matrix of Processes in the Build Implementation Phase and Their Constituent Activities	II-5-3

Blank

3. ELEMENT DEFINITION PHASE

In the Element Definition Phase each Element performs the engineering analysis necessary to implement the allocated system requirements and specify the functional design. This effort leads to the development of Element computer program performance requirements, detailed interface requirements, associated design-level disclosure, and rationale.

The Elements develop the required PPS SCs and ICRs to implement the system requirements. They perform the design requirements analysis and identify any necessary changes to the PIDS SCs. They modify program design documentation to reflect program design approach and the computing system components and architecture. Data and control flows and analysis requirements are documented in the Element functional development folders (FDFs).

Each Element prepares preliminary ICRs¹ and routes them for approval by the Element Change Control Board (ECCB), System Engineering, AWS CRB, and the NSWCDD Mk 7 Interface Control Working Group (ICWG) or the PMS400 non-Mk 7 ICWG. The Element also prepares preliminary PPS SCs and the associated film label change requests (FLCRs) and CPCR and routes them for approval by the ECCB and the AWS CRB.

Each Element evaluates the PPS SCs and the ICRs and updates its Element development plan, which includes a functional build definition, a description of resource impacts, an element development schedule, preliminary ACC and ACSC site requirements, and a risk management plan. The Elements, System Engineering, ST&E,² and ATC conduct an analysis of requirements and update the specific simulator and simulation performance requirements. ST&E performs engineering analysis based on system changes and Element test concepts and initiates system test planning. Systems Simulation, in consultation with System Engineering, Elements, and ATC, identifies crew training requirements and changes to AEGIS Combat Training System (ACTS) and Computer-Aided Submode Training (CAST) lessons. Baseline Management conducts a review of the test planning and training requirements and updates the baseline management plan.

Preliminary Design Review (PDR) packages are developed and reviewed by the Elements. The PDR packages are presented to the AWS CRB for approval and then distributed to NSWCDD Organizations for review and preparation of technical comments. ERTs and an SRT are formed to direct and coordinate the review of the PDR package. ERTs review, categorize, and adjudicate all comments. The SRT reviews the categorized comments, preliminary system test planning, and crew training requirements and adjudicates all problems.

¹ICRs are considered preliminary until they are formally approved and distributed.

²Combat Systems Test & Evaluation; formerly System Test & Integration (ST&I).

The PDR presentation is prepared and reviewed by the Elements. The technical results of their reviews are presented to Baseline Management. Baseline Management then conducts a review of the Element PDR presentations and adds the programmatic scope, schedule, and resource requirements and approves the presentation.

The formal PDR is chaired by PMS400B. Acceptance of the PDR results by PMS400B and a formal letter authorizing NSWCDD to proceed to the High-Level Design Phase represent completion of the Element Definition Phase.

PPS and PIDS SCs and ICRs are updated in accordance with PDR direction. Baseline Management updates the baseline management plan, and the Elements update the functional development folders. Documentation Management prepares SCNs or new specifications for PPSs, PIDS, and IDSs; obtains required approvals; and arranges for distribution of SCNs and new specifications.

There are seven processes in the Element Definition Phase:

- Conduct Element Analysis and Define PPS SCs and ICRs (1.3.1)
- Prepare and Review Preliminary ICRs (1.3.2)
- Prepare and Review Preliminary PPS SCs (1.3.3)
- Update Element Development Plans and Support Program Requirements (1.3.4)
- Develop and Review PDR Data Package (1.3.5)
- Prepare PDR Presentation and Conduct PDR (1.3.6)
- Approve and Distribute SCNs and New Specifications (1.3.7)

Diagram 1.3 is a depiction of the Element Definition Phase, including its seven processes.

Activities, Products, and Control Event

Each of these processes consists of a number of activities. Table 1-3 is a matrix of the processes and their constituent activities.

The key products of this phase, as shown in the process model in Part I, are

PIDS SCs

Preliminary ICRs

Preliminary PPS SCs

Updated Element Development Plan

Simulator Requirements

PDR Presentation

Other products expected to result from conduct of the activities are listed below:¹

Schedules

Resource Allocation

Patch Conversion Plan

Element Performance Disclosure

Development Tools Definition

Analysis Tools

Element Support Tools

CASE Tools

Element Test Concept Definition

Identified List of ACTS and CAST Lessons

Allocated CPR List

Man/Machine Interface Requirements Definition

Data Analysis Requirements Definition

User Documentation Plan

Crew Training Impact Report

Baseline Development Folders

The single control event for this phase is the Preliminary Design Review, whose purposes are to review validity and completeness of the allocated requirements as defined in the PIDSs, PPSs, and IDSs; apprise PMS400 of progress and plans; and obtain PMS400 authorization to proceed.

¹In the event of a discrepancy between this list and the details shown in the process flows and activities that follow, the activities and flows should be followed.

**TABLE 1-3. MATRIX OF PROCESSES IN THE ELEMENT DEFINITION PHASE
AND THEIR CONSTITUENT ACTIVITIES**

<u>PROCESS</u>	<u>NUMBER</u>	<u>TITLE</u>	<u>ACTIVITY</u>	<u>DATE</u>
Conduct Element Analysis and Define PPS SCs and ICRs	1.3.1.1	Define Required PPS SCs/ICRs		29 Jul 94
	1.3.1.2	Perform Requirements Analysis		29 Jul 94
	1.3.1.3	Assess Design Impact		1 Apr 96
Prepare and Review Preliminary ICRs	1.3.2.1	Prepare Preliminary ICRs		18 Nov 93
	1.3.2.2	Conduct Side A ECCB Review and Approval of Preliminary ICRs		18 Nov 93
	1.3.2.3	Conduct Side B ECCB Review and Approval of Preliminary ICRs		18 Nov 93
	1.3.2.4	Conduct NSWCDD MK7 ICWG Evaluation of Preliminary ICRs		18 Nov 93
	1.3.2.5	Conduct AWS CRB Preliminary ICR Processing Present		18 Nov 93
	1.3.2.6	Non MK7 Preliminary ICRs for Non MK7 ICWG Review and Approval		18 Nov 93
Prepare and Review Preliminary PPS SCs	1.3.3.1	Prepare Preliminary PPS SCs		29 Jul 94
	1.3.3.1A	Inspect Preliminary PPS SCs		29 Jul 94
	1.3.3.2	Conduct ECCB Review and Approval of Preliminary PPS SCs		18 Nov 93
	1.3.3.3	Conduct AWS CRB Preliminary PPS SC Processing		18 Nov 93
Update Element Development Plans and Support Program Requirements	1.3.4.1	Update Element Development Plans		18 Nov 93
	1.3.4.1A	Review Element Development Plans		27 Mar 95
	1.3.4.2	Update Simulator Requirements		18 Nov 93
	1.3.4.3	Develop Element Test Concept		18 Nov 93
	1.3.4.4	Initiate System Test Planning		18 Nov 93
Develop and Review PDR Data Package	1.3.4.5	Update Baseline Contents		18 Nov 93
	1.3.5.1	Prepare PDR Data Package		18 Nov 93
	1.3.5.2	Distribute PDR Data Package for Review		18 Nov 93
	1.3.5.3	Conduct PDR Data Package Review		18 Nov 93
	1.3.5.4	Support ERT Review of PDR Data Package Comments		18 Nov 93
Prepare PDR Presentation and Conduct PDR	1.3.5.5	Support SRT Review of ERT Comments on PDR Data Package		29 Jul 94
	1.3.6.1	Prepare Element Portion of PDR Presentation		18 Nov 93
	1.3.6.2	Prepare System Engineering Portion of PDR Presentation		18 Nov 93
	1.3.6.3	Prepare Baseline Management Portion of PDR Presentation		18 Nov 93
	1.3.6.4	Conduct Management Review of PDR Presentation		18 Nov 93
Approve and Distribute SCNs and New Specifications	1.3.6.5	Conduct PDR		18 Nov 93
	1.3.6.6	Update PDR Data Package Per PMS400B Direction		18 Nov 93
	1.3.7.1	Process and Distribute IDS SCNs and New IDSs		18 Nov 93
	1.3.7.2	Obtain Element Approval of IDS SCNs		18 Nov 93
	1.3.7.3	Obtain System Engineering Approval of IDS SCNs		18 Nov 93
	1.3.7.4	Prepare PPS SCNs		18 Nov 93
1.3.7.5	Obtain Approval of PPS SCNs		18 Nov 93	
1.3.7.6	Distribute PPS and MK7 IDS SCNs		18 Nov 93	

The Conduct Element Analysis and Define PPS SCs and ICRs Process is comprised of three activities as described below. Diagram 1.3.1 (Page II-3-9) is a data flow diagram of the process and its constituent activities.

Activity: ED-1.3.1.1

DEFINE REQUIRED PPS SCs and ICRs

The Element leader and engineers consider the AWS and ACS SCs, the preliminary ICRs and IDSs developed in the System Definition Phase, the PIDS SCs, fleet requests, lessons learned, known design shortcomings, non-Mk 7 modifications, and the baseline management plan; they begin to specify the functional design and compile a definition of the required PPS SCs and ICRs. Finally, the engineers make a determination about the patches to be converted to source code and allocate them to the builds. They document these components in the Element development plans. An example of the data considered for establishing the baseline definition is the Government Electronic Systems-approved forward-fit PPS SCs and the PMS400B-approved ICRs. Element leaders then update the baseline definition list that contains the SCs, ICRs, and CPCR's planned for incorporation and the Element development schedule. They coordinate the schedule with Baseline Management.

PERFORMER:	Elements
SUPPORTING ORGANIZATION:	Baseline Management AWS CRB CM System Engineering Fleet Support
APPROVAL REQUIRED:	None
APPLICABLE INSTRUCTION:	Element Development Plan Standard

Activity: ED-1.3.1.2

PERFORM REQUIREMENTS ANALYSIS

Element engineers perform the required analysis to document the requirements in preliminary SCs at the PPS level and identify the ICRs that are required at the IDS level. System changes that affect multiple Elements are specified in multi-element working groups initiated and coordinated by System Engineering. If changes are required to the PIDS SCs due to the preliminary PPS SCs and ICRs, the changes are made and the previous change control cycle is repeated. The analysis includes an evaluation of the proposed changes and identification of data analysis requirements.

For new requirements that cross several Elements and require modeling and computer simulation, System Engineering coordinates the analysis/modeling/simulation efforts between the impacted elements.

The requirements analysis data includes evidence that the problem impacts are well understood. Typical analysis products may include:

- (1) Models of algorithms
- (2) Models of data or user interface design
- (3) Control flow model of change
- (4) Evaluation of model performance
- (5) Preliminary impact assessment - schedule, cost, time, core, etc.
- (6) An understanding of the domain of change (The parts of the system that change should be documented within a boundary of system components that do not change. This should adequately address logical structure, data flow, and control flow at the PPS level.)
- (7) Presentation of results documented in reports, graphs, white papers, etc.

These inputs are compiled in the Element functional development folders. The Element leader uses the results of the requirements analysis to refine the preliminary SC list for input to Baseline Management.

PERFORMER:	Elements
SUPPORTING ORGANIZATION:	Baseline Management System Engineering AEGIS Ships
APPROVAL REQUIRED:	None
APPLICABLE INSTRUCTION:	None

Activity: ED-1.3.1.3**ASSESS DESIGN IMPACT**

Element engineers review the planned requirements that pertain to their element, including interface changes. Changes that impact the architecture of the computer programs or the computer program environment are determined, documented, and filed in the baseline development folder for subsequent use in developing or updating the element development plan.

The Elements develop and document design goals that form the basic guidance for computer program designers to make appropriate choices in deciding among alternatives as they implement allocated requirements. Such goals should include one or more of the following (including specified priorities when multiple goals are specified):

- Resource conservation (minimizing impact on core, time utilization, or interface impact)
- Efficiency (i.e., the resources required by a program; each of the following resources must be considered: cpu, memory, online storage, I/O and human development effort)
- Maintainability (i.e., the effort required to locate and correct an error)
- Flexibility (i.e., the effort required to modify an operational program)
- Reusability (i.e., the extent to which parts of a program can be reused in other applications)

PERFORMER:	Elements
SUPPORTING ORGANIZATION:	None
APPROVAL REQUIRED:	None
APPLICABLE INSTRUCTION:	Program Design Document Standard

Blank

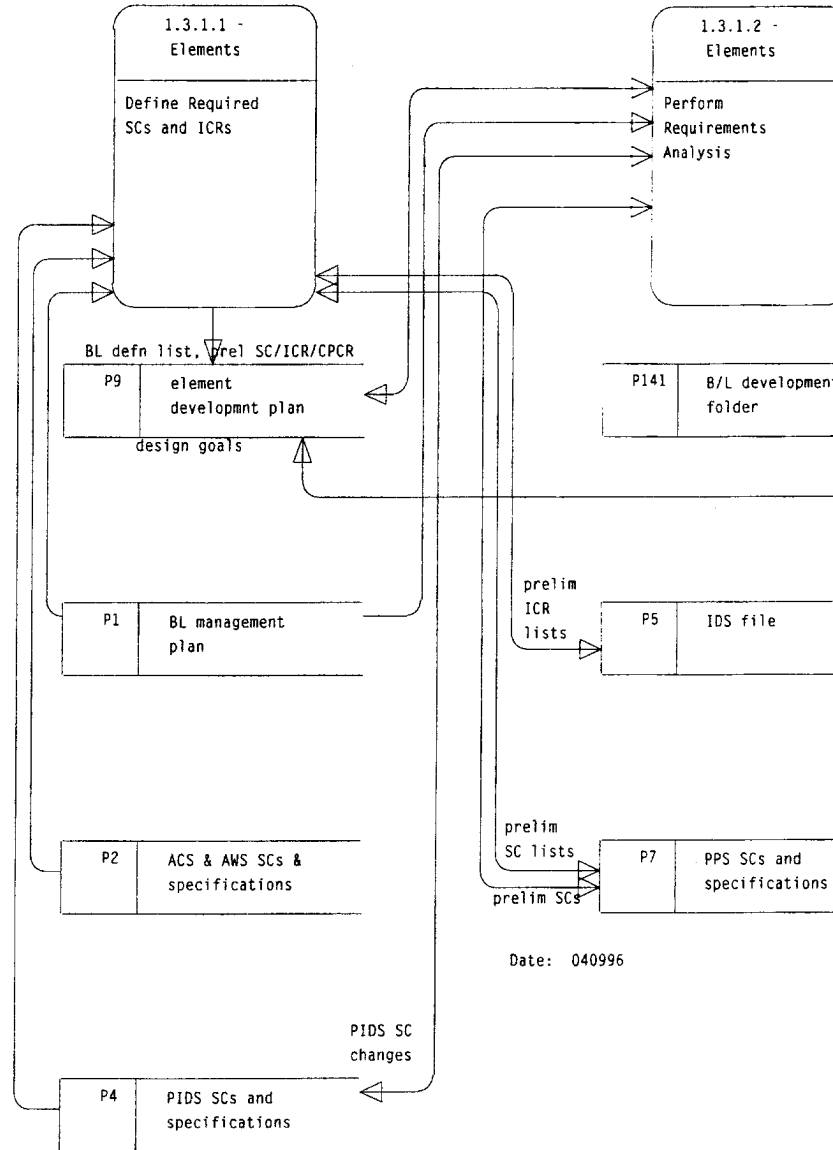

DIAGRAM 1.3.1 - CONDUCT ELEMENT ANALYSIS AND ICRs PROCESS

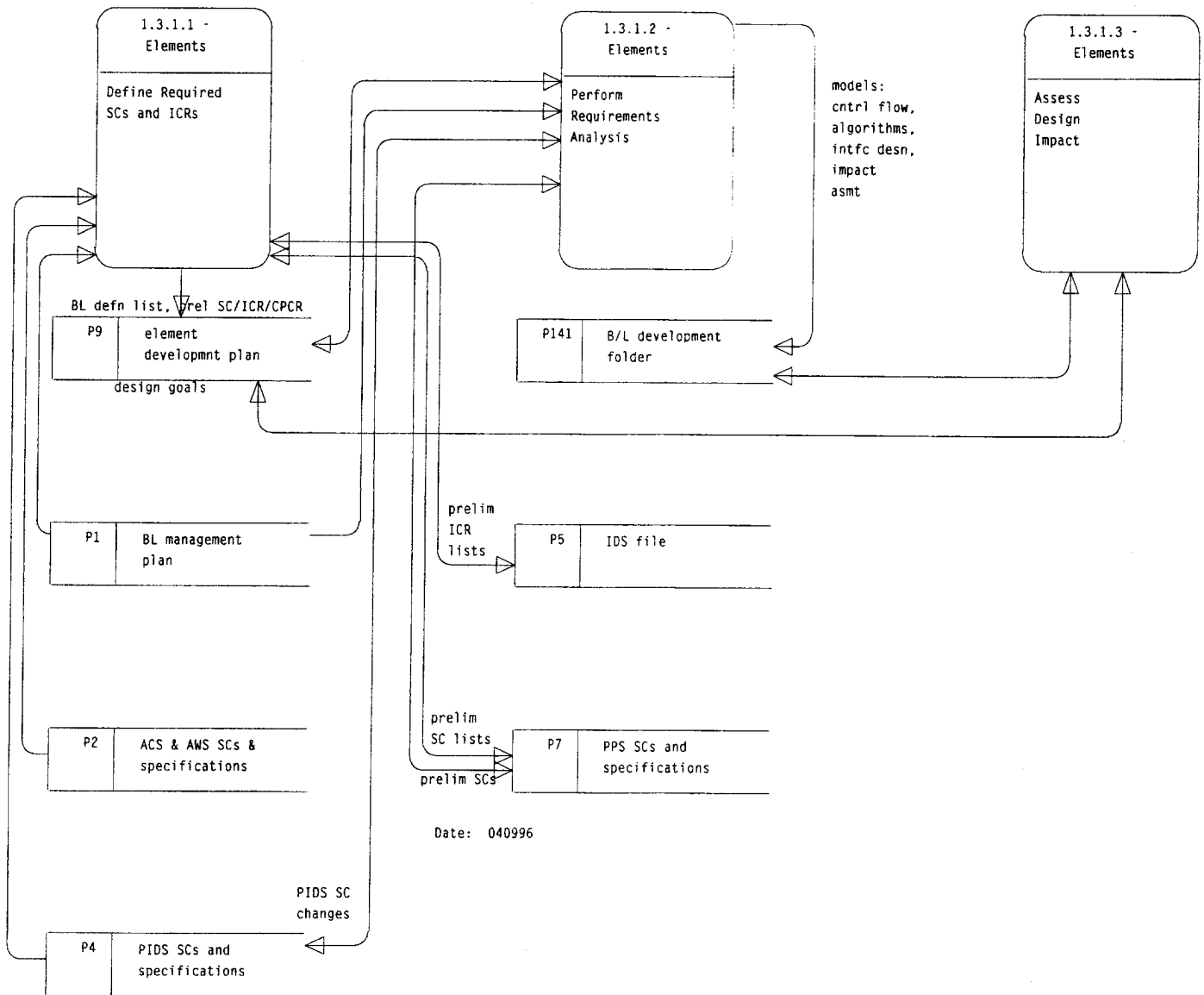

DIAGRAM 1.3.1 - CONDUCT ELEMENT ANALYSIS AND DEFINE PPS SCs AND ICRs PROCESS

Blank

5. BUILD IMPLEMENTATION PHASE

The Build Implementation Phase consists of a sequence of one or more builds during which each computer program unit identified during the High-Level Design Phase is developed and checked out. Independent of these builds, support tools and the system test plan are created or updated, as appropriate.

Existing plans are reviewed to determine updates that must be made to reflect changes. The plans are further refined as required to implement the Build Implementation Phase activities. This includes scheduling of the detailed design, code, and unit test of each unit that is to be a part of the build. Because individual units are of varying size and complexity, different units may be at different steps in the build process at the same time. For example, while a relatively small unit may have progressed to the unit test step, a much larger unit may still be in the detailed design step.

As units complete unit testing, they are executed in a load file with previously completed units and the rest of the Element and other Elements or simulators to ensure that no recently integrated unit has an adverse effect on previously tested code. This results in a gradual integration of all units planned for development.

At the conclusion of each build, a Build Implementation Review (BIR) is conducted to discuss the results of all build activities. Special emphasis is placed on any facts or plans disclosed at prior reviews which might be invalidated by the recently completed build. The BIR for the final build summarizes the disclosures of the previous BIRs and serves as the control event that signals the completion of the Build Implementation Phase. The BIR is documented, action items are assigned, and the action items are tracked to closure. The final BIR is the control event that ensures completeness of all code and unit testing activities for all builds and serves as a status report to Baseline Management. There are nine processes in the Build Implementation Phase:

1. Update Development Plan
2. Plan Unit Test Activities
3. Develop Unit Detailed Design
4. Develop Unit Test Procedures
5. Produce Code/Perform Unit Testing
6. Perform Build Integration and Testing
7. Conduct Build Implementation Review (BIR)
8. Perform Supporting Activities
9. Produce System-Level Test Plan

For developments involving multiple builds, processes 1 through 7, referred to collectively as "the build process," are repeated for each build identified in the element development plan.

Diagram 1.5 (Page II-5-5) is a depiction of the Build Implementation Phase, including its nine processes.

Activities, Products, and Control Event

Most of the nine processes consist of a number of activities. Table II-5-1 is a matrix of the processes and their constituent activities.

The key products of this phase are

- Program Design Document
- Database Design Documents
- Element QA Reports
- Unit Test Procedures
- System-Level Test Plan
- Element Test Procedures
- Source Code
- Unit Test Reports
- Executable Computer Programs
- Build Implementation Review (BIR) Presentation
- Element Test Disclosure Review Presentation

The control events for this phase are the BIRs, held at the completion of each build. The purpose of a BIR is to discuss the results of all build activities. Process 1.5.7 is representative of BIRs iterative throughout this phase. The final BIR, at the conclusion of the final build, marks the end of the phase.

**TABLE II-5. MATRIX OF PROCESSES IN THE BUILD IMPLEMENTATION PHASE
AND THEIR CONSTITUENT ACTIVITIES**

<u>PROCESS</u>	<u>ACTIVITY</u>		
PROCESS	NUMBER	TITLE	DATE
Update Development Plan	1.5.1.1	Review Commitments	1 Apr 96
	1.5.1.2	Plan Current Build	1 Apr 96
Plan Unit Test Activities	1.5.2.1	Define Approach for Verifying Each Impacted Unit	1 Apr 96
	1.5.2.2	Update Element Development Plan	1 Apr 96
Develop Unit Detailed Design (For Each Unit)	1.5.3.1	Perform Predesign Analysis	1 Apr 96
	1.5.3.2	Develop Unit Design	1 Apr 96
	1.5.3.3	Update and Verify Interface Changes	1 Apr 96
	1.5.3.4	Update Design Document	1 Apr 96
	1.5.3.5	Review Detailed Design	1 Apr 96
Develop Unit Test Procedures (For Each Unit)	1.5.4.1	Analyze Unit Test Factors	1 Apr 96
	1.5.4.2	Develop Unit Test Procedures	1 Apr 96
	1.5.4.3	Review Unit Test Procedures	1 Apr 96
Produce Code/Perform Unit Testing	1.5.5.1	Implement Changes to Code	1 Apr 96
	1.5.5.2	Perform Code Inspection	1 Apr 96
	1.5.5.3	Assemble Test Unit	1 Apr 96
	1.5.5.4	Perform Unit Testing	1 Apr 96
	1.5.5.5	Analyze Test Results	1 Apr 96
Perform Build Integration and Testing	1.5.6.1	Assemble Load File	1 Apr 96
	1.5.6.2	Perform Build Integration and Test	1 Apr 96
	1.5.6.3	Analyze Test Results	1 Apr 96
	1.5.6.4	Prepare Element QA Report	1 Apr 96
Conduct Build Implementation Review (BIR)	1.5.7.1	Prepare Documentation for BIR	1 Apr 96
	1.5.7.2	Conduct BIR Meeting	1 Apr 96
	1.5.7.3	Perform BIR Corrective Actions	1 Apr 96
Perform Supporting Activities	1.5.8.1	Upgrade Analysis Tools and Documentation	1 Apr 96
	1.5.8.2	Prepare Element Test Documentation	1 Apr 96
	1.5.8.3	Inspect Element Test Procedures	1 Apr 96
	1.5.8.4	Build System QA/Element-Controlled Load Files	1 Apr 96
	1.5.8.5	Update Element Test Disk Packs	1 Apr 96
	1.5.8.6	Develop Special Element Engineering Tests	1 Apr 96
Produce System-Level Test Plan	1.5.9.1	Write System-Level Test Plan	1 Apr 96

Blank

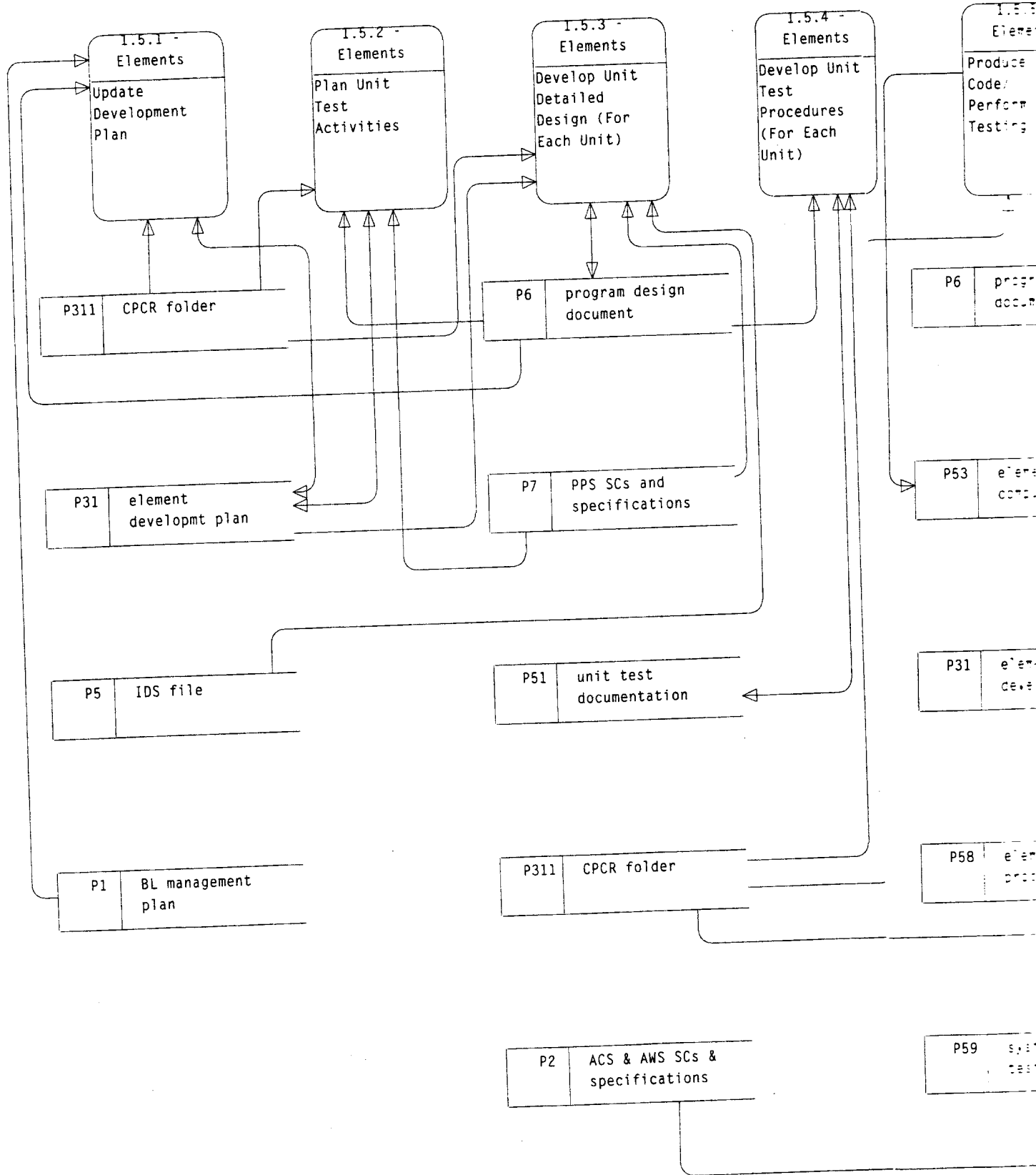

DIAGRAM 1.5 BUILD IMP

NSWCDD/MP-93/85

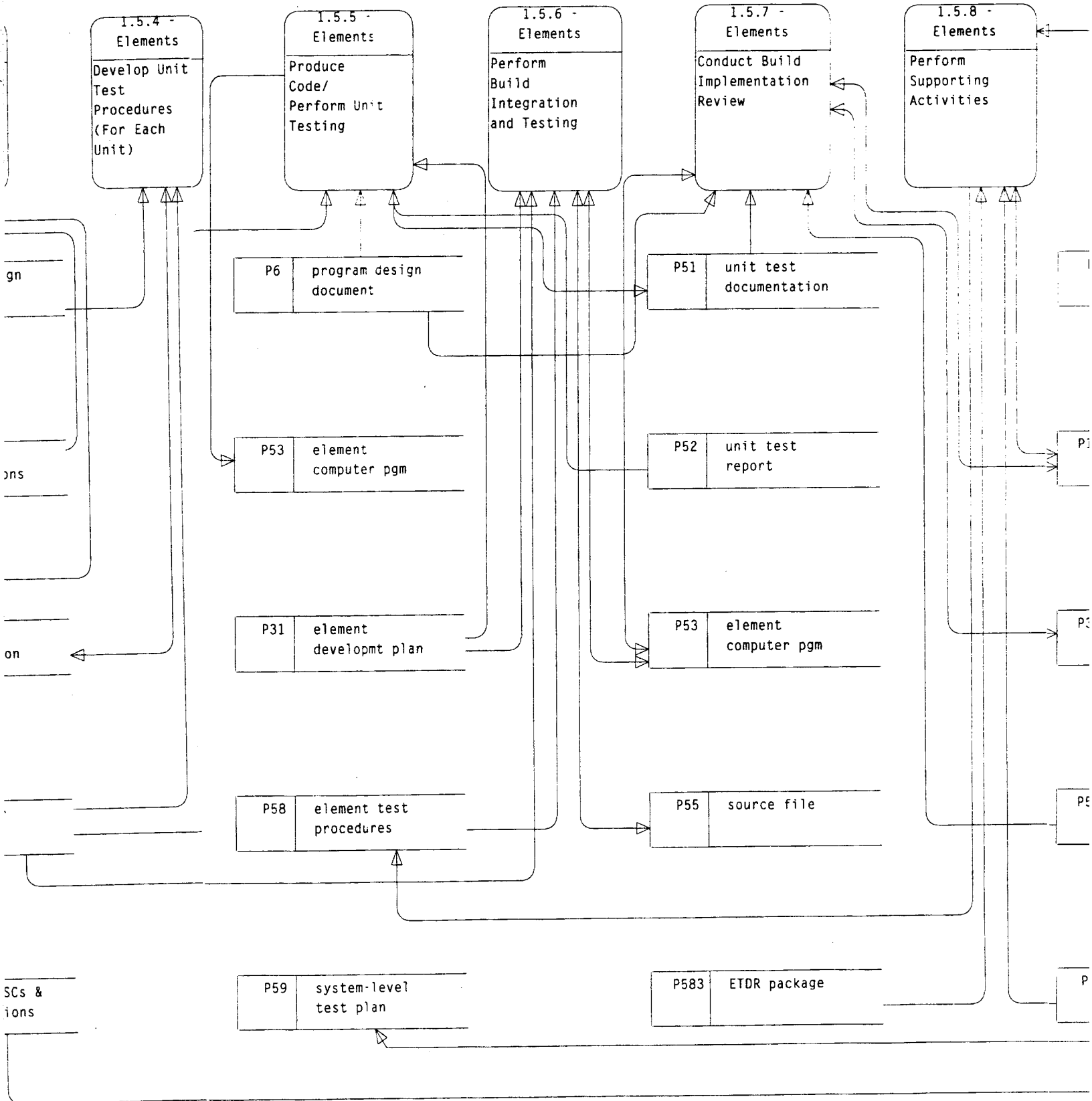
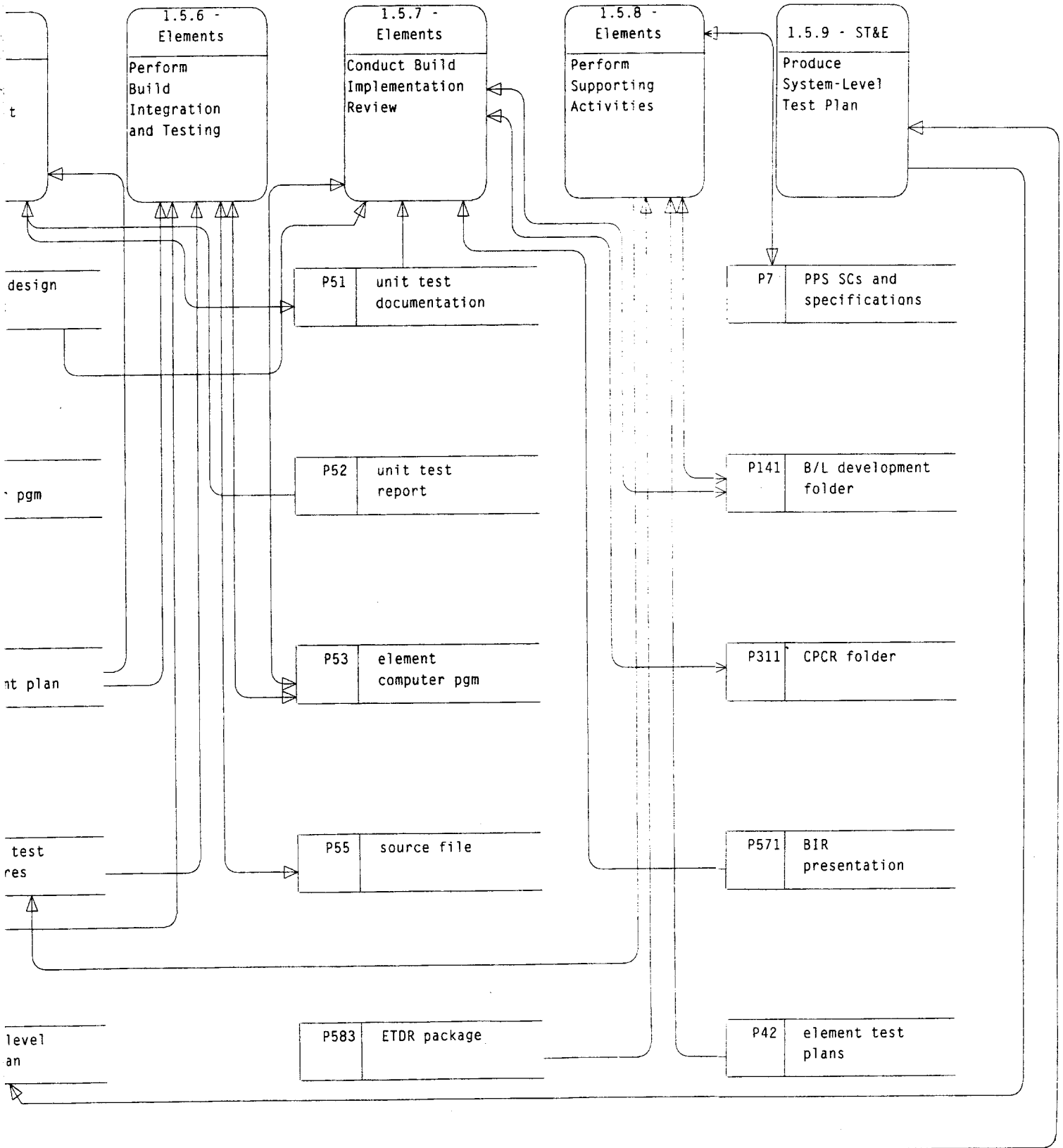

DIAGRAM 1.5 BUILD IMPLEMENTATION PHASE



MENTATION PHASE

1.5.1 UPDATE DEVELOPMENT PLAN PROCESS

The Update Development Plan Process is comprised of two activities as described below. Diagram 1.5.1 (Page II-5-9) is a data flow diagram of the process and its two constituent activities.

Activity: BI-1.5.1.1

REVIEW COMMITMENTS

The Elements review the baseline management plan and the element development plan along with any emergent non-SC CPRs that are to be included in the current build. They review the component description, design approach, element computer program breakdown, and module design descriptions of the program design document to identify the modules and common data that will be impacted. Based on this review, they assess the allocation of CPRs to builds and determine the final CPR to build allocation. The element development plan is updated to reflect any changes. They process CPRs that have high-level design impact in accordance with the defined high-level design process, prior to reaching build integration.

The Elements ensure that Baseline Management is aware of any changes which impact inter-Element interfaces. They coordinate those changes with both Baseline Management and the affected elements in terms of both functionality and schedule.

PERFORMER:	Elements
SUPPORTING ORGANIZATION:	Baseline Management
APPROVAL REQUIRED:	None
APPLICABLE INSTRUCTION:	Baseline Management Plan Standard Element Development Plan Standard AWS CRB Procedures (AEGIS Document-94/5)

Activity: BI-1.5.1.2

PLAN CURRENT BUILD

The Elements first identify and define all interim and final products required for the build. They then identify each task required to prepare each of those products and estimate the resources required for their performance. Required resources are compared with those available and the sequence of tasks is altered, as necessary, to balance available and required resources.

The Element then updates the risk management section of the element development plan, including the following, as appropriate:

Risk factors

Risk probabilities and effects on the project

Strategies to mitigate identified risks (e.g., action plans, contingency plans)

Methods to monitor the risk factors

A contingency plan (when a quantitative risk indicator crosses a predetermined threshold),

Risk management plan (how to manage the crisis through reallocation of resources and reevaluation), and

Description of how to recover from the crisis.

Considering the risk mitigation and reduction activities, the Elements may reallocate the resources and modify, add, or resequence steps. When all risk-motivated issues are worked into the plan, the Elements assign specific responsibilities for each identified task. Finally, they update the element development plan to reflect the revised build plan and schedule.

PERFORMER:	Elements
SUPPORTING ORGANIZATION:	None
APPROVAL REQUIRED:	None
APPLICABLE INSTRUCTION:	Element Development Plan Standard

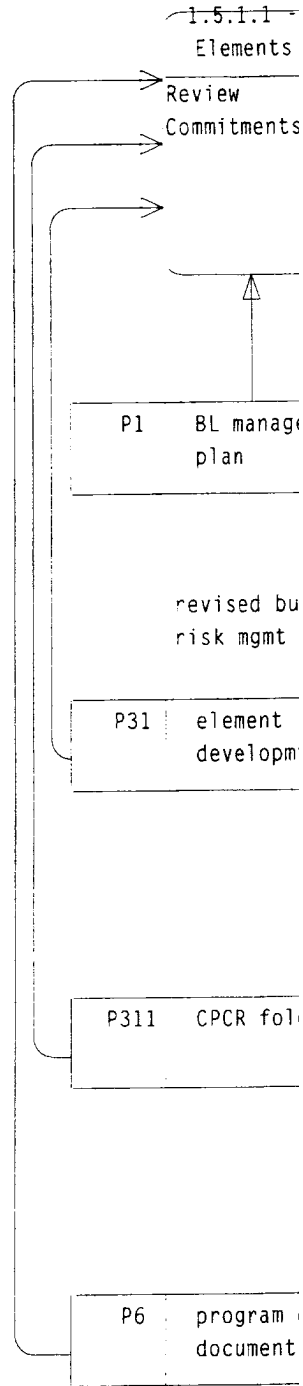

DIAGRAM 1.5.1 UPDATE

Build Implementation

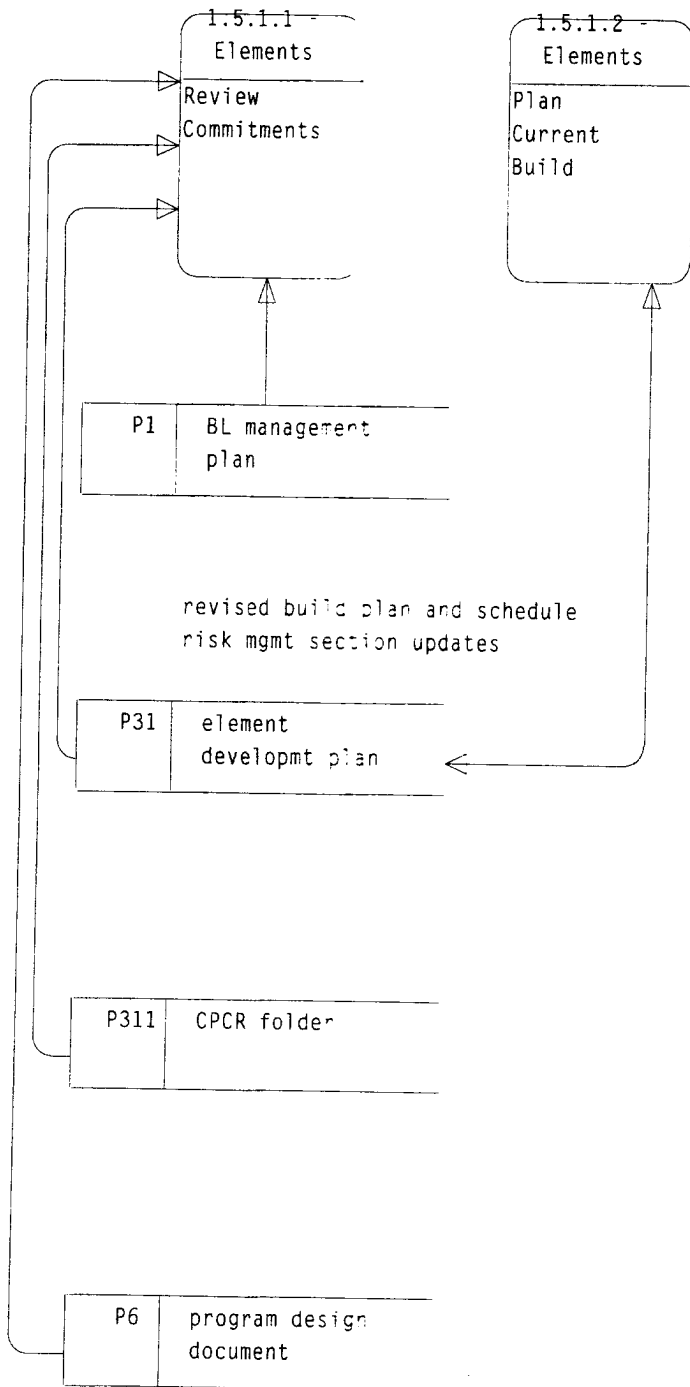

DIAGRAM 1.5.1 UPDATE DEVELOPMENT PLAN PROCESS

Build Implementation

NSWCDD/MP-93/85

Blank

1.5.2 PLAN UNIT TEST ACTIVITIES PROCESS

The Plan Unit Test Activities Process is comprised of two activities as described below. Diagram 1.5.2 (Page II-5-13) is a data flow diagram of the process and its two constituent activities.

Activity: BI-1.5.2.1

DEFINE APPROACH FOR VERIFYING EACH IMPACTED UNIT

The Elements review each unit impacted by changes in the build in terms of both requirements and design to determine the best approach for verifying the unit upon modification. They identify the required test environment, including tactical environment and load file, where appropriate, and identify simulators required to support the environment. They also specify other Elements, computer programs, units, or drivers required to support the environment. The Elements determine any dependent, concurrent changes and identify the data that must be analyzed. Next, they identify all required physical resources. And finally, the Elements verify the availability of required resources.

PERFORMER: Elements

SUPPORTING ORGANIZATION: None

APPROVAL REQUIRED: None

APPLICABLE INSTRUCTION: None

Activity: BI-1.5.2.2

UPDATE ELEMENT DEVELOPMENT PLAN

The Elements update the element development plan schedule to reflect the defined verification approach. They make any required adjustments to accommodate resource availability, and negotiate concurrence among all participants. The Element group leader verifies that the plan is viable and adequately addresses risks.

PERFORMER: Elements

SUPPORTING ORGANIZATION: None

APPROVAL REQUIRED: None

APPLICABLE INSTRUCTION: Element Development Plan Standard

Build Implementation

NSWCDD/MP-93/85

Blank

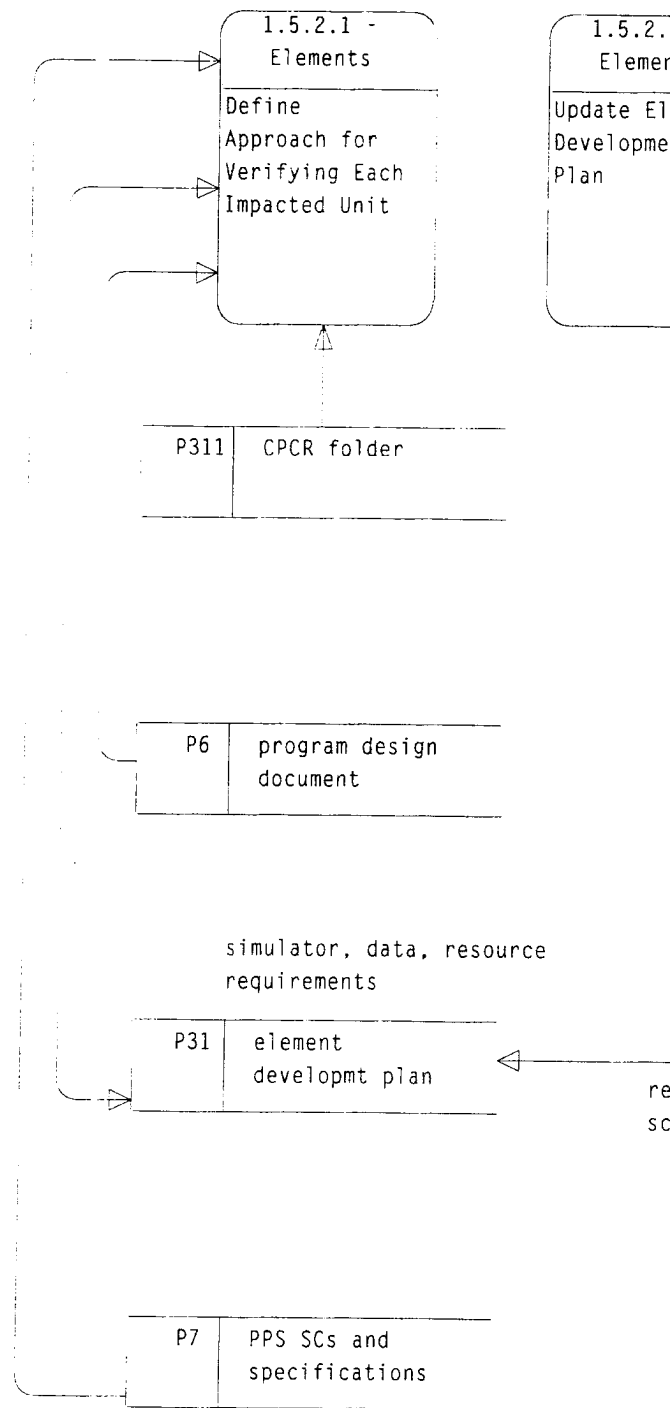

DIAGRAM 1.5.2 PLAN UNIT TEST ACTIVITIES

Build Implementation

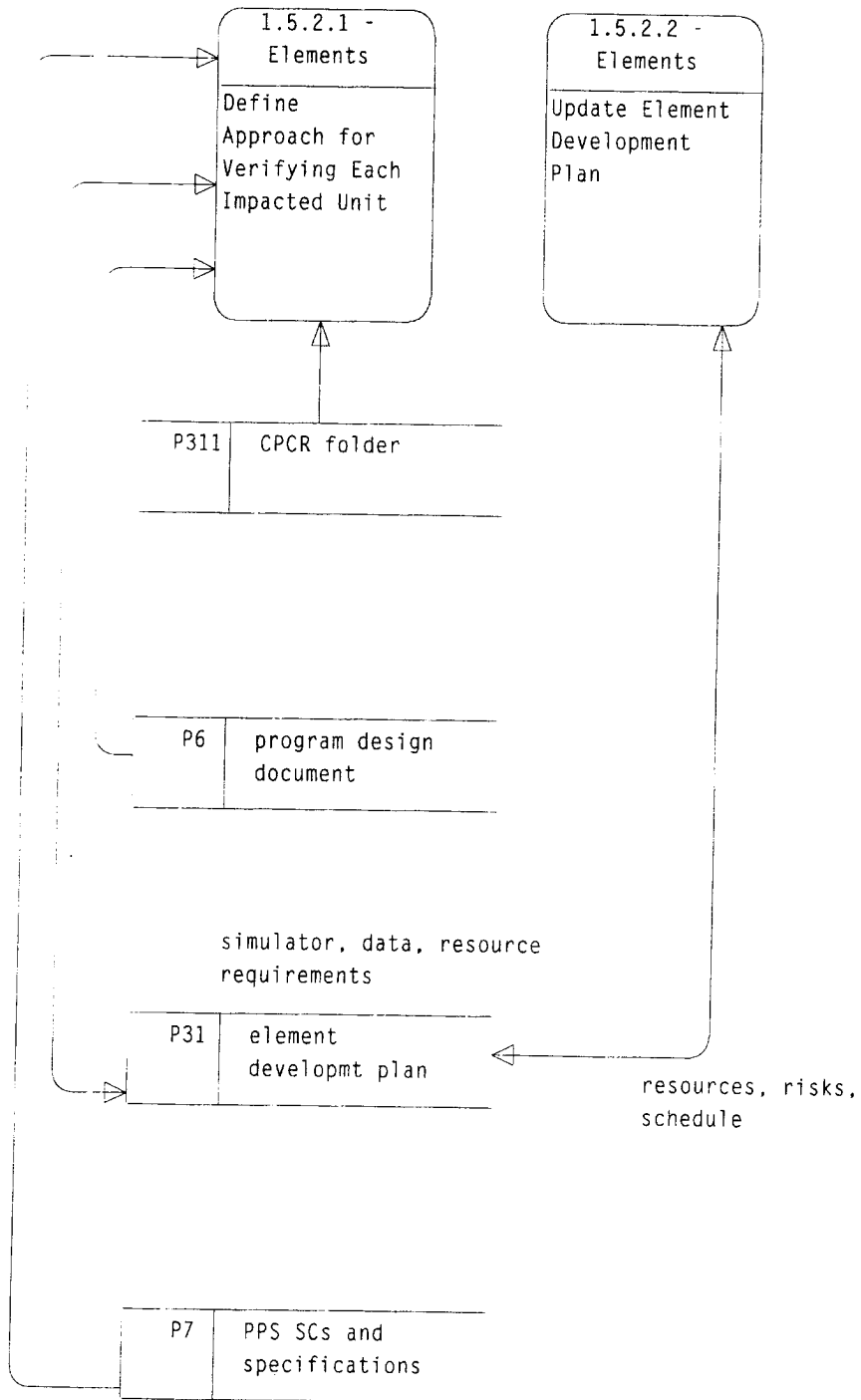

DIAGRAM 1.5.2 PLAN UNIT TEST ACTIVITIES PROCESS

Blank

1.5.3 DEVELOP UNIT DETAILED DESIGN (FOR EACH UNIT) PROCESS

The Develop Unit Detailed Design (For Each Unit) Process is comprised of five activities as described below. Diagram 1.5.3 (Page II-5-19) is a data flow diagram of the process and its five constituent activities.

Activity: BI-1.5.3.1

PERFORM PREDESIGN ANALYSIS

The Elements identify each impacted unit in the element development plan. For each unit, they review relevant SCs and the PPS to ensure a thorough understanding of each new or changed requirement (or existing requirement in the case of non-SC CPCR's). The Elements also review existing design documentation (when practical) and existing code to ensure an understanding of the detailed design of both the impacted unit and those units with which it directly interfaces.

PERFORMER:	Elements
SUPPORTING ORGANIZATION:	None
APPROVAL REQUIRED:	None
APPLICABLE INSTRUCTION:	Element Development Plan Standard Program Design Document Standard

Activity: BI-1.5.3.2

DEVELOP UNIT DESIGN

After all requirements and the surrounding detailed design are understood by the Elements, they develop and document algorithms to satisfy the new or changed requirements (normally via flow charts or Program Design Language (PDL)). During algorithm development, the Elements identify new and existing data structures required to support the algorithms. As the trial unit design evolves, the Elements review it to determine if additional legality checks, error processing, or exception handling is required. They analyze the possible content of all data items used by the unit to determine if special initialization processing is needed. As the trial unit design is finalized, the Elements define new or modified data structures to ensure required accuracy. After the design has been completed and reviewed for accuracy, the Elements develop or update core and timing estimates for the unit.

Build Implementation

NSWCDD/MP-93/85

PERFORMER: Elements
SUPPORTING ORGANIZATION: None
APPROVAL REQUIRED: None
APPLICABLE INSTRUCTION: None

Activity: BI-1.5.3.3

UPDATE AND VERIFY INTERFACE CHANGES

The Elements contrast the trial unit design with all sections of the program design document to ensure that unit design activities do not violate or negate any facet of the high-level design. They adjust the high-level or detailed design, as appropriate. The Elements also review the design of interfacing units for efficiency and accuracy in view of the unit being modified. If the unit interfaces with another Element, the Element reviews the design of both units comprising the interface with their counterparts in the other affected Element. They consider and note improvements in a verified unit design.

PERFORMER: Elements
SUPPORTING ORGANIZATION: None
APPROVAL REQUIRED: None
APPLICABLE INSTRUCTION: Program Design Document Standard

Activity: BI-1.5.3.4

UPDATE DESIGN DOCUMENT

The Elements update the shared data and unit (or subprogram) processing sections of the program design document to reflect all changes as documented in the verified unit design. Sections of the program design document produced in earlier phases are reviewed for consistency with the updated sections. All discrepancies are reconciled and appropriate changes are made.

PERFORMER: Elements
SUPPORTING ORGANIZATION: None
APPROVAL REQUIRED: None
APPLICABLE INSTRUCTION: Program Design Document Standard

Activity: BI-1.5.3.5**REVIEW DETAILED DESIGN**

The detailed design of each unit undergoing change is reviewed during a formal design review. This activity begins by identifying the areas to be reviewed and often includes interfacing units as well as the units which were the primary focus of the change.

Elements choose review participants based on their knowledge of the affected area and their ability to detect errors in the detailed design. In units with complex interfaces, some participants may be chosen based on their knowledge of the interfacing units rather than the one actually being reviewed. The Elements collect materials to be reviewed from information contained in the program design document, CPCR folders, and working papers of the element engineers who performed the actual design. They conduct each review in accordance with documented element procedures. System and Element QA verify compliance with those procedures, and document the results.

The Elements correct all defects identified during the review, and update all appropriate documents accordingly. In addition, the Elements and System QA update the Element and system metric files with pertinent data about the review.

PERFORMER:	Elements
SUPPORTING ORGANIZATION:	System QA
APPROVAL REQUIRED:	None
APPLICABLE INSTRUCTION:	Element Design Review Procedure

Blank

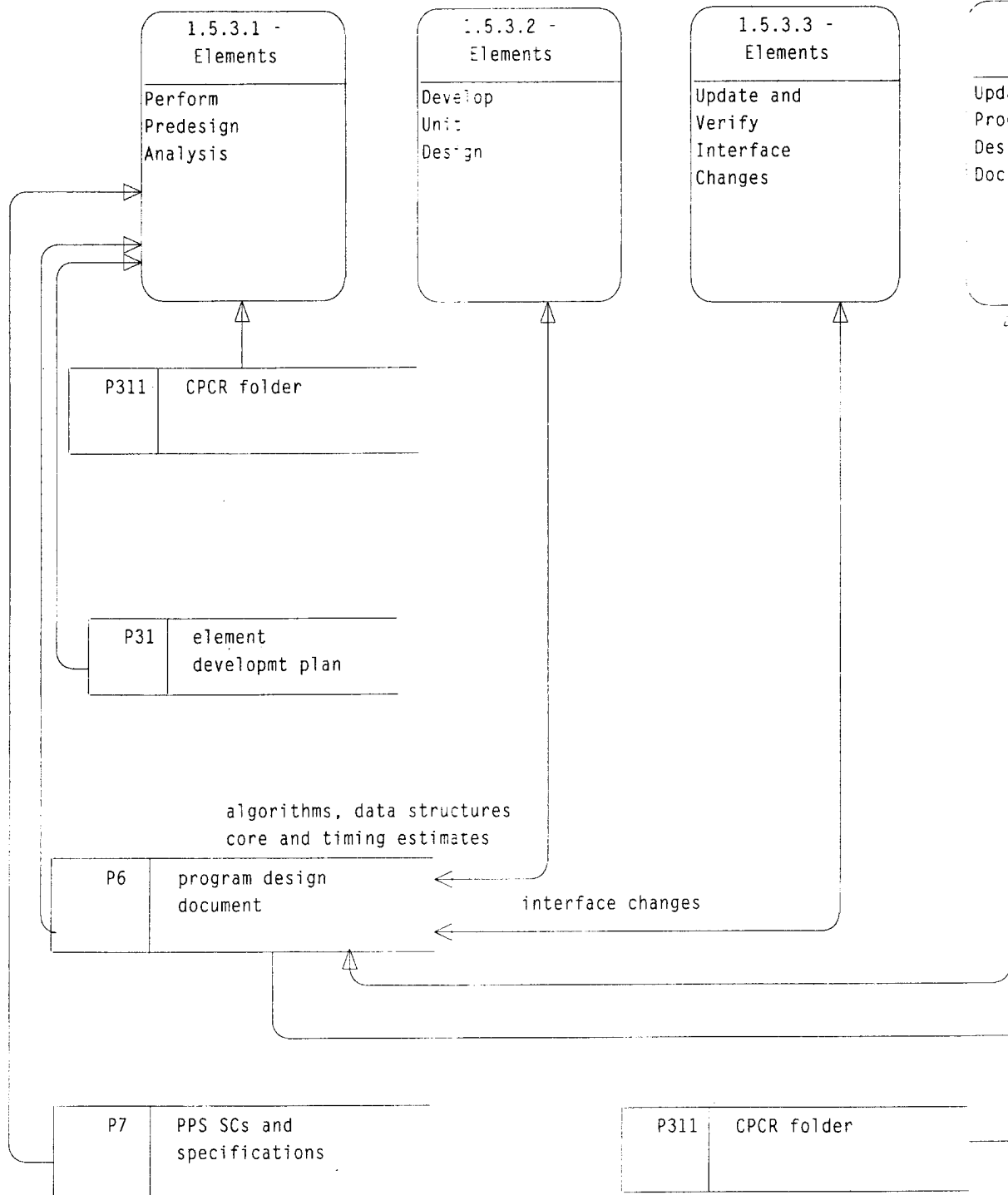
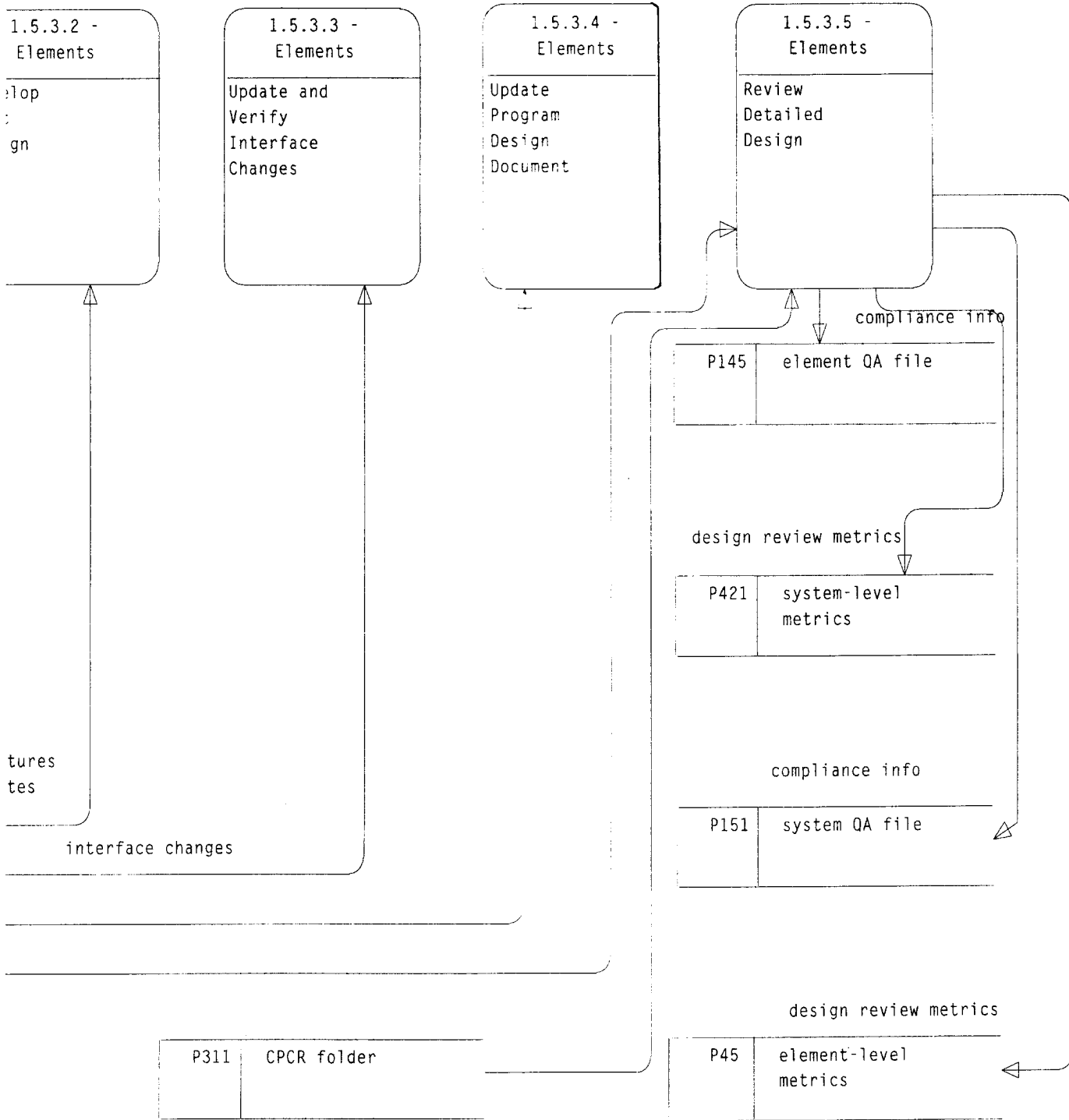

DIAGRAM 1.5.3 DEVELOP UNIT DETAILED DESIGN (FOR



1.5.3 DEVELOP UNIT DETAILED DESIGN (FOR EACH UNIT) PROCESS

Build Implementation

NSWCDD/MP-93/85

Blank

1.5.4 DEVELOP UNIT TEST PROCEDURES (FOR EACH UNIT) PROCESS

The Develop Unit Test Procedures Process is comprised of three activities as described below. Diagram 1.5.4 (Page II-5-25) is a data flow diagram of the process and its three constituent activities.

Activity: BI-1.5.4.1

ANALYZE UNIT TEST FACTORS

The Elements analyze factors affecting unit test of the code to be developed from the modified design to determine the optimum environment (e.g., ACC, Vax) and method for testing each unit. In addition, they consider and identify the various conditions under which the unit must be tested. The Elements study both the high-level and detailed design of the affected unit to determine the best approach for

Executing the unit
 Providing necessary data to the unit
 Observing the expected outputs from the unit

The Elements also explicitly define the test criteria, consisting of specific data inputs and the expected results, methods for scheduling the unit, and the method for recording the output values.

PERFORMER:	Elements
SUPPORTING ORGANIZATION:	None
APPROVAL REQUIRED:	None
APPLICABLE INSTRUCTION:	None

Activity: BI-1.5.4.2

DEVELOP UNIT TEST PROCEDURES

The Elements use test criteria for preparing a written unit test procedure, written with sufficient detail to be repeatable by Element personnel, that documents each of the following:

1. The hardware, firmware, and software including tactical and simulation load files, applicable patch files, etc., to be used during the testing of each unit.

2. The steps required to prepare the test environment. This documents which files are loaded in which computers, initialization procedures, assignment of operators to consoles, etc.
3. The sequence of steps (e.g., VAB actions or console commands), to be used during the actual test and the expected results.
4. The steps to be taken to collect data for analysis or observations to be made and recorded in order to assess the outcome of the test.
5. The steps to be performed in analyzing output data or observations, including explicit pass/fail criteria for each data/observation set.

PERFORMER:	Elements
SUPPORTING ORGANIZATION:	None
APPROVAL REQUIRED:	None
APPLICABLE INSTRUCTION:	None

Activity: BI-1.5.4.3

REVIEW UNIT TEST PROCEDURES

The Elements review unit test procedures. One or more procedures are chosen for each individual review based on their size, complexity, and the expected length of the actual review. This process is repeated until all procedures have been reviewed.

Review participants are chosen based on their knowledge of the areas to be tested and their ability to detect errors in the procedure. In units with complex interfaces, some participants may be chosen based on their knowledge of the interfacing units rather than the one actually being inspected. In addition to the test procedure itself, other materials useful to the reviewers are collected from information contained in the program design document, CPCR folders, and working papers of the Element engineers who designed the unit or wrote the test procedure. Each review is conducted in accordance with standard procedures. Element and System QA verify compliance with those procedures and document the results.

All defects identified during the review are corrected and all appropriate documents are updated accordingly. In addition, Element and System metric files are updated with pertinent data about the review.

PERFORMER:	Elements
SUPPORTING ORGANIZATION:	System QA
APPROVAL REQUIRED:	None
APPLICABLE INSTRUCTION:	None

Blank

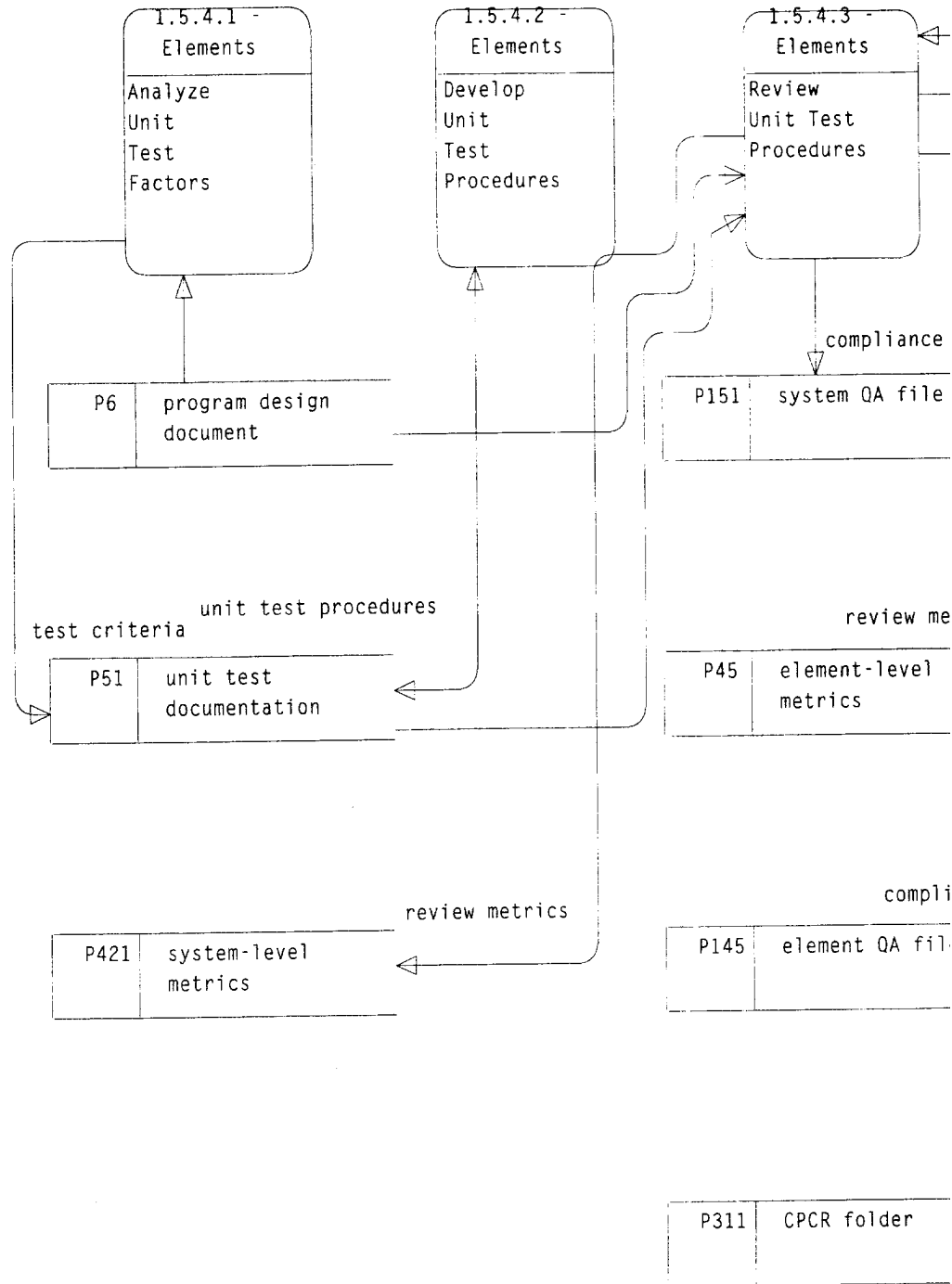
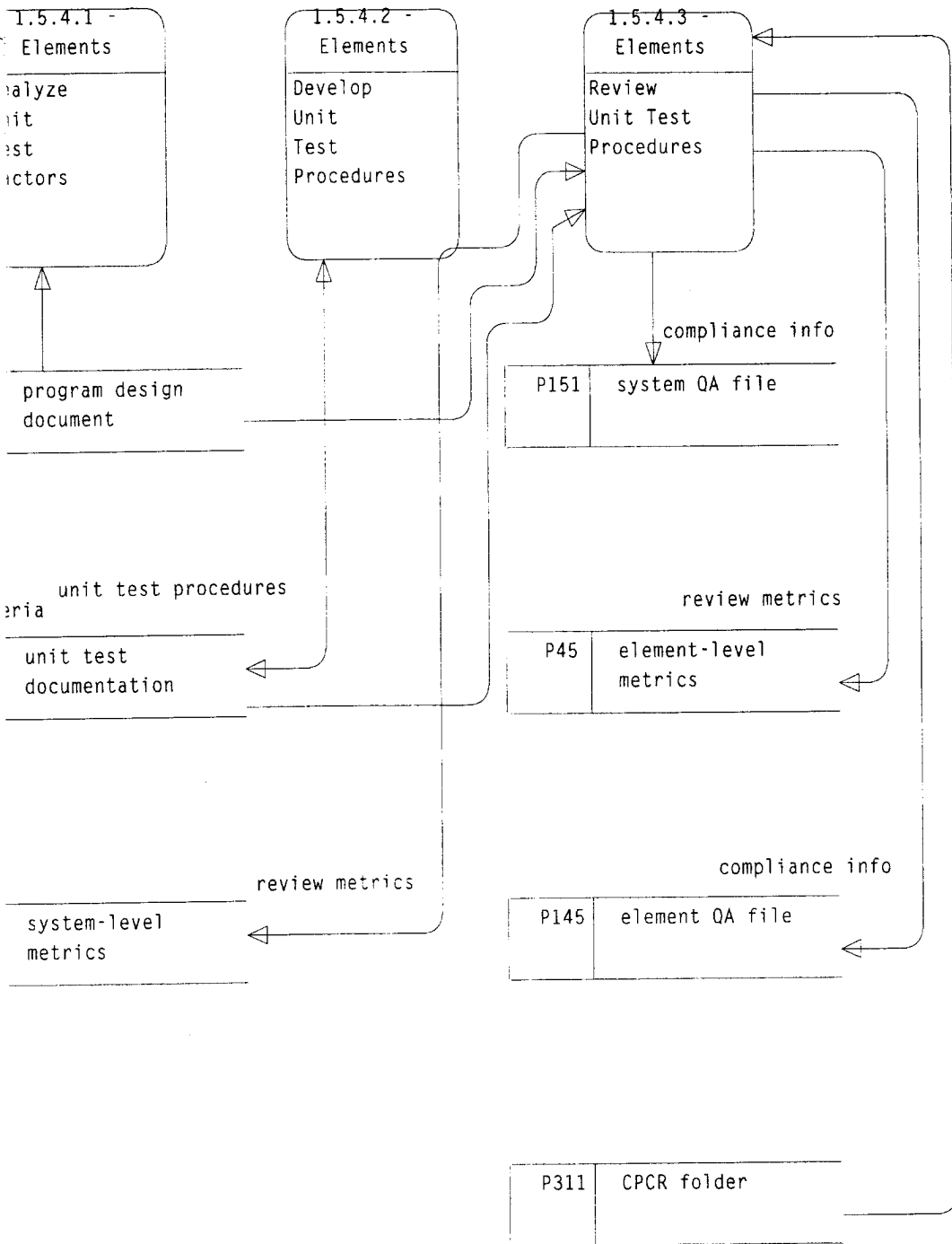

DIAGRAM 1.5.4 DEVELOP UNIT TEST PROCEDURES (FOR EACH PROCESS)

Buld Implementation



GRAM 1.5.4 DEVELOP UNIT TEST PROCEDURES (FOR EACH UNIT) PROCESS

1 April 1996

Build Implementation

NSWCDD/MP-93/85

Blank

1 April 1996

II-5-26

1.5.5 PRODUCE CODE/PERFORM UNIT TESTING PROCESS

The Produce Code/Perform Unit Testing Process is comprised of four activities as described below. Diagram 1.5.5 (Page II-5-31) is a data flow diagram of the process and its four constituent activities.

Activity: BI-1.5.5.1

IMPLEMENT CHANGES TO CODE

Element engineers are assigned units for coding based on the schedule in the element development plan. Element engineers must become familiar with the detailed design, the code surrounding the area to be changed, and the code in interfacing units before coding actually begins. In addition, they examine all data to be used by the new code.

When the engineers are satisfied with their understanding of the indicated areas, they write the actual code in accordance with AEGIS coding standards and upon completion, desk-check and compile the code. The engineers repeat this process until all compilation errors are eliminated.

PERFORMER:	Elements
SUPPORTING ORGANIZATION:	None
APPROVAL REQUIRED:	None
APPLICABLE INSTRUCTION:	Applicable Coding Standards

Activity: BI-1.5.5.2

PERFORM CODE INSPECTION

During a formal code inspection, the Elements review the code. They choose one or more units for an individual inspection based on their size and complexity and the expected length of the actual inspection.

Elements choose inspection participants based on their knowledge of the code to be inspected and their ability to detect code errors. In units with complex interfaces, some participants may be chosen based on their knowledge of the interfacing units rather than the one actually being inspected. In addition to the code itself, the Elements collect other materials useful to the inspectors from information contained in the program design document, CPR folders, or working papers of the Element engineers who developed the

design or wrote the code. Elements conduct each inspection in accordance with standard procedures. Element and System QA verify compliance with those procedures and document the results.

PERFORMER: Elements

SUPPORTING ORGANIZATION: None

APPROVAL REQUIRED: None

APPLICABLE INSTRUCTION: Applicable Computer Program Coding Standards Inspection Standard

Activity: BI-1.5.5.3**ASSEMBLE TEST UNIT**

Element engineers release their testable unit to their Element QA representative. The Element QA representative places the testable unit into an Element-controlled area. Then the Element QA representative ensures that the testable unit complies with all Element guidelines and QAIs. If necessary, the Element QA representative compiles the appropriate files and creates a load file.

PERFORMER: Elements

SUPPORTING ORGANIZATION: None

APPROVAL REQUIRED: None

APPLICABLE INSTRUCTION: Program Maintenance and Software Quality Assurance in the VAX Environment, QAI 202

Activity: BI-1.5.5.4**PERFORM UNIT TESTING**

The Elements prepare the test environment, including the construction of any required load files, and set it up in accordance with the documented test procedure. They execute each step in the test sequence, as written. The Elements also collect data and record observations, as specified in the test procedure. Element engineers note discrepancies in the test procedure and reexecute the test at the direction of the unit test personnel. The Elements update the test procedure to reflect each noted change.

PERFORMER: Elements
SUPPORTING ORGANIZATION: None
APPROVAL REQUIRED: None
APPLICABLE INSTRUCTION: Element Development Plan Standard

Activity: BI-1.5.5.5**ANALYZE TEST RESULTS**

The Elements compare relevant recorded observations and collected data with their expected values and pass/fail criteria as documented in the unit test procedures. They analyze data that fails to meet pass criteria to determine the cause and the appropriate correction. The Elements then document results, including all corrective action, in the unit test report.

PERFORMER: Elements
SUPPORTING ORGANIZATION: None
APPROVAL REQUIRED: None
APPLICABLE INSTRUCTION: None

Blank

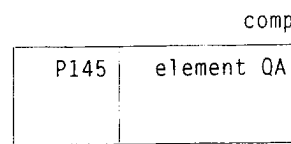
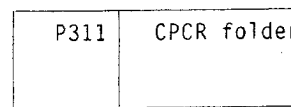
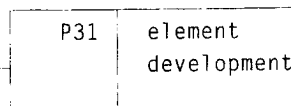
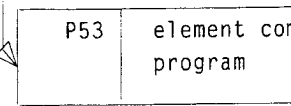
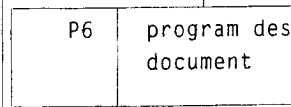
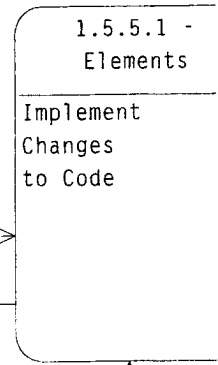

**DIAGRAM 1.5.5 PRODUCE CODE/
PERFORM UNIT TESTING PROCESS**

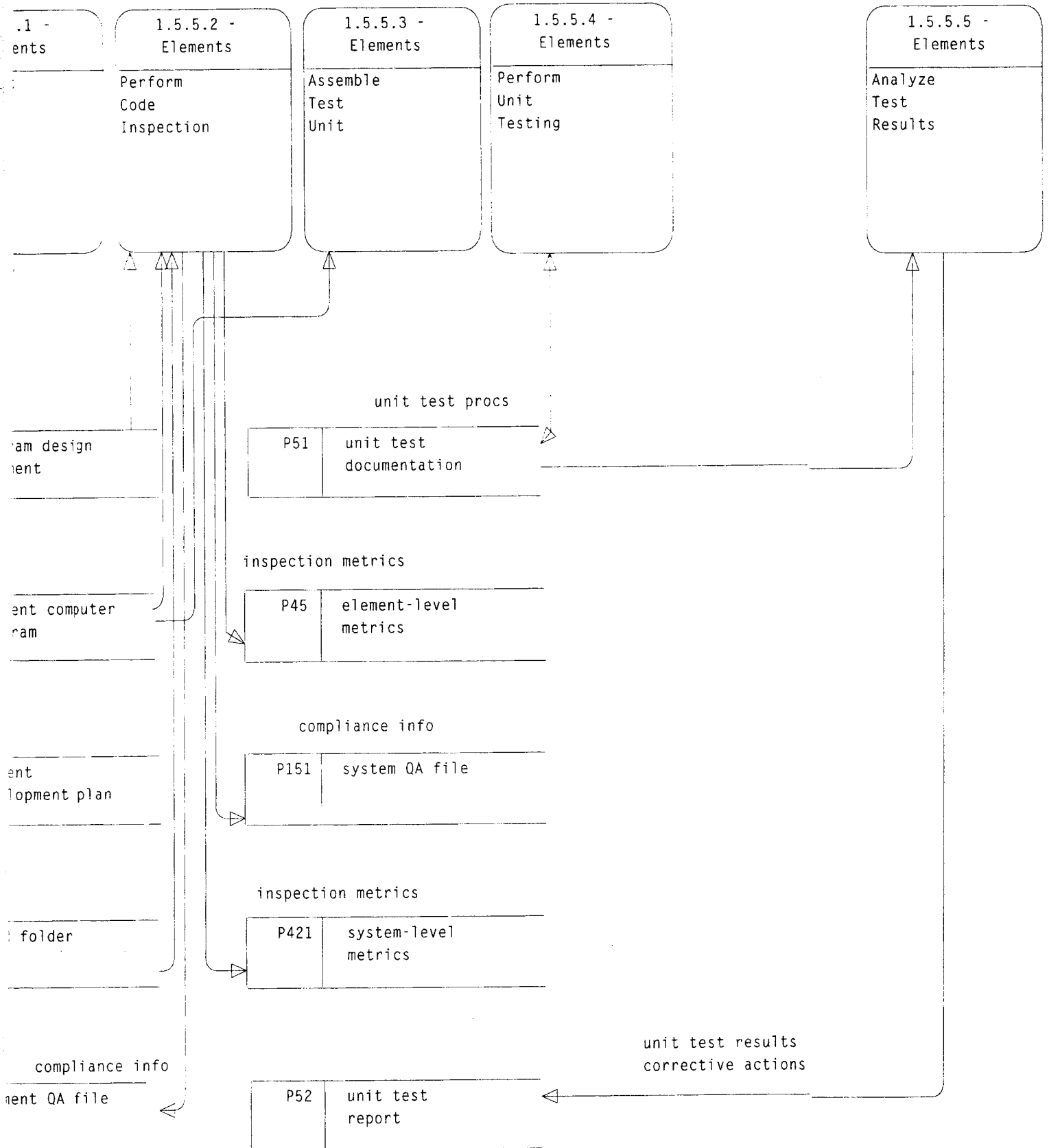

Blank

1.5.6 PERFORM BUILD INTEGRATION AND TESTING PROCESS

The Perform Build Integration and Testing Process is comprised of four activities as described below. Diagram 1.5.6 (Page II-6-37) is a data flow diagram of the process and its four constituent activities.

Activity: BI-1.5.6.1

ASSEMBLE LOAD FILE

The Elements select a set of compatible units for the initial build integration load file. Based on that set of units, they compile appropriate files and create a load file. Element QA scans the files collecting the embedded CPR numbers, which are verified against the closure memo and ACCESS records. The Elements test this load as described in the following two activities. Upon completion of activity BI-1.5.6.3, the Elements add additional units to the next load file and perform additional testing. They repeat this process until all units scheduled for the current build are included and demonstrated to be working.

PERFORMER:	Elements
SUPPORTING ORGANIZATION:	None
APPROVAL REQUIRED:	None
APPLICABLE INSTRUCTION:	CRB Procedures

Activity: BI-1.5.6.2

PERFORM BUILD INTEGRATION AND TEST

The Elements define an appropriate test environment based on the Element and the functional capabilities to be exercised, as defined in the element development plan. They identify the specific hardware, simulators, and particular MEIT load files for other AEGIS Elements to be used during the integration effort.

The Elements prepare informal test procedures with pass/fail criteria. These procedures focus on four different types of testing:

1. Functional tests which demonstrate that the new or modified units satisfy their functional requirements. These tests must demonstrate that the full range of inputs produce the expected outputs within the allowable fidelity of the test environment.

2. Regression tests to ensure that the new or modified units do not have an adverse effect on previously tested capabilities. During build integration, regression testing focuses on existing capabilities supported by the modified units or by units that directly interface with new or modified units.
3. Performance tests that focus on critical or planned timing characteristics of the system. This testing can occur in either of two different situations. One ensures that critical performance characteristics have not been adversely affected (e.g., minimum response time can still be met). The other focuses on overall system throughput (e.g., Is the new build consuming so much additional CPU time that subsequent builds will not be able to work?).
4. Operational tests that ensure that all system capabilities function collectively.

In many cases, the Elements correct problems as they are discovered during integration testing. In other cases, they may choose to collect data and analyze it at a later time.

PERFORMER:	Elements
SUPPORTING ORGANIZATION:	None
APPROVAL REQUIRED:	None
APPLICABLE INSTRUCTION:	Element Development Plan Standard

Activity: BI-1.5.6.3**ANALYZE TEST RESULTS**

The Elements collect all recorded observations and compare the data with their expected values and pass/fail criteria as documented in the informal procedures documented in the previous activity. They analyze data that fails to meet pass criteria to determine the cause and make corrections. In addition, the Elements assess the overall effectiveness of the integration effort for the current build. If required, the Elements may prescribe additional testing.

PERFORMER:	Elements
SUPPORTING ORGANIZATION:	None
APPROVAL REQUIRED:	None
APPLICABLE INSTRUCTION:	None

Activity: BI-1.5.6.4**PREPARE ELEMENT QA REPORT**

Element QA reviews the overall conduct of the build by comparing results with the element development plan and any applicable element standards and procedures. They document specific deviations in the Element QA report. The Elements collect and document the required metrics.

PERFORMER:	Elements
SUPPORTING ORGANIZATION:	None
APPROVAL REQUIRED:	None
APPLICABLE INSTRUCTION:	Element QA Report Standard (TBD)

Blank

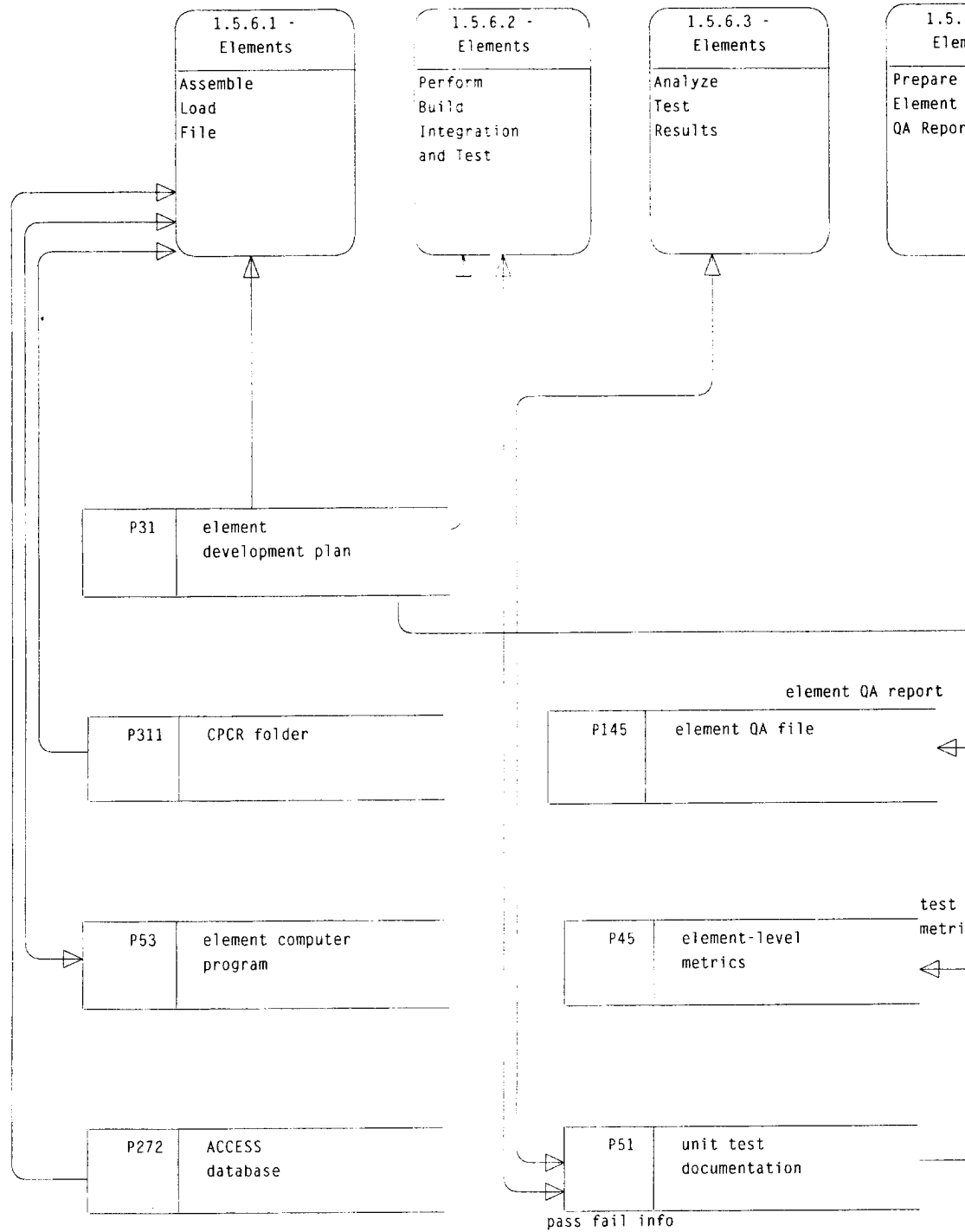

DIAGRAM 1.5.6. PERFORM BUILD INTEGRATION AND TESTING PROC

Build Implementation

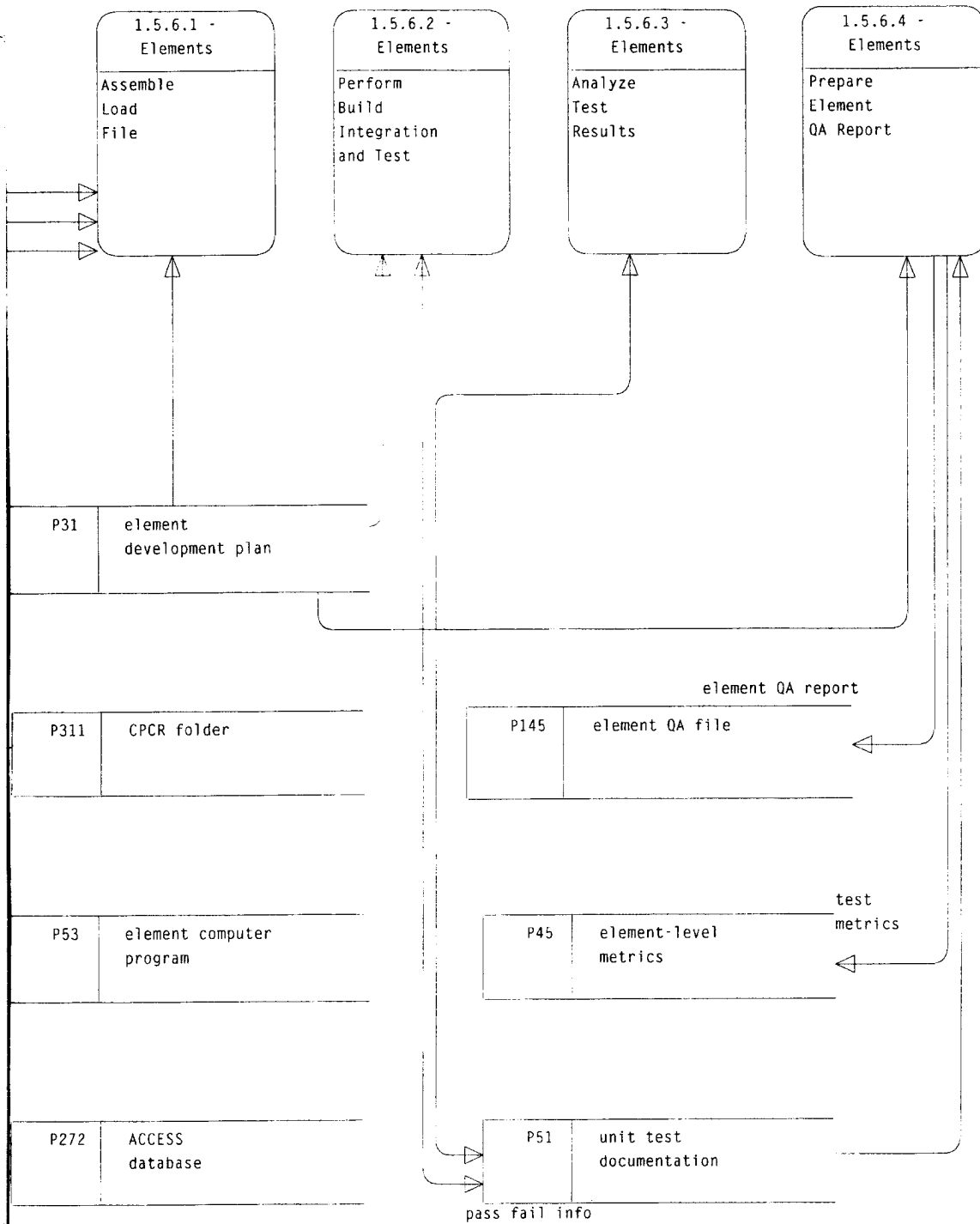

DIAGRAM 1.5.6. PERFORM BUILD INTEGRATION AND TESTING PROCESS

Build Implementation

NSWCDD/MP-93/85

Blank

1.5.7 CONDUCT BUILD IMPLEMENTATION REVIEW (BIR) PROCESS

The Conduct Build Implementation Review (BIR) Process is comprised of three activities as described below. Diagram 1.5.7 (Page II-5-41) is a data flow diagram of the process and its three constituent activities.

Activity: BI-1.5.7.1

PREPARE DOCUMENTATION FOR BIR

Upon completion of all unit developments and the integration of all units in the build, the Elements prepare for the BIR. Prior to the BIR, the Elements update the CPCR folders and baseline development folders. The Elements assemble information to define and describe the status of unit development and unit integration activities. The Elements then perform impact assessments of the present build upon previous and subsequent builds. They assess and document any impact on high-level design or requirements. And they assemble the information into a presentation for review by the branch head.

PERFORMER:	Elements
SUPPORTING ORGANIZATION:	None
APPROVAL REQUIRED:	None
APPLICABLE INSTRUCTION:	Standard for Review Process

Activity: BI-1.5.7.2

CONDUCT BIR MEETING

At the end of each build the Element conducts an internal, Element-level BIR for the Element group leader and selected Element personnel. The reviewers verify the adequacy of build implementation, ensuring that activities include adequate inter-unit and inter-build coordination as well as quality verification activities. They determine the status of unit documentation and identify corrective actions, which are assigned to individuals and tracked to closure.

For the final build and for any build which resulted in unexpected high-level design changes or significant changes to other Elements, additional procedures are required. First, the list of reviewers must include Baseline Management and all affected branch heads. Second, the review must be expanded to include each of the following:

1. All areas of high-level design which were impacted as well as the detailed design which supports those areas.

- 2. All areas that caused changes to other Elements with emphasis on the inter-Element coordination and verification activities.

Responsibilities:

Preparer--Element Build Personnel

Reviewer (Normal)--Element Group Leader; Element Branch Head

Reviewer (Final/Expanded)--Element Group Leader, all Affected Branch Heads, Baseline Management

Coordinator--Element Build Leader

Authorizing Agent--Element Branch Head

PERFORMER: Elements
SUPPORTING ORGANIZATION: Baseline Management
APPROVAL REQUIRED: None
APPLICABLE INSTRUCTION: Standard for Review Process

Activity: BI-1.5.7.3

PERFORM BIR CORRECTIVE ACTIONS

The Elements perform the assigned corrective actions from the Element-level BIR. The corrective actions may involve making design changes, performing additional verification activities, preparing or updating documentation, or providing additional information regarding status or design impact. Upon completion of all action items and upon obtaining authorization to proceed to the next phase, the Elements request that MEIT update the MEIT jump load.

PERFORMER: Elements
SUPPORTING ORGANIZATION: MEIT (Pack Management)
APPROVAL REQUIRED: None
APPLICABLE INSTRUCTION: None

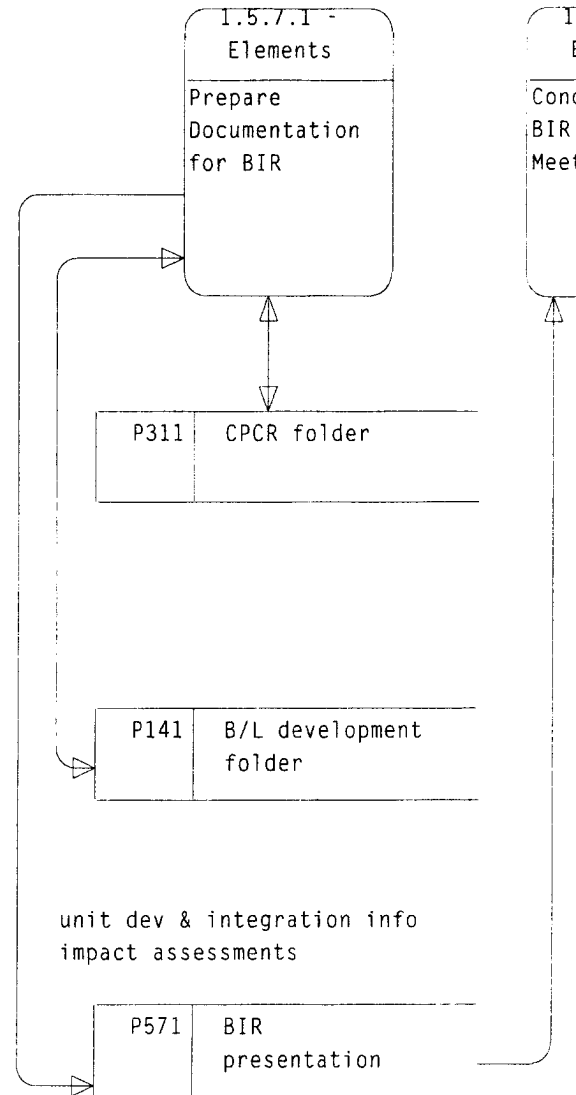
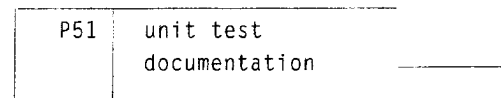
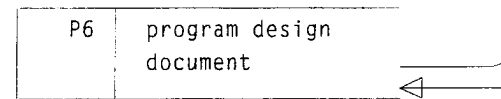
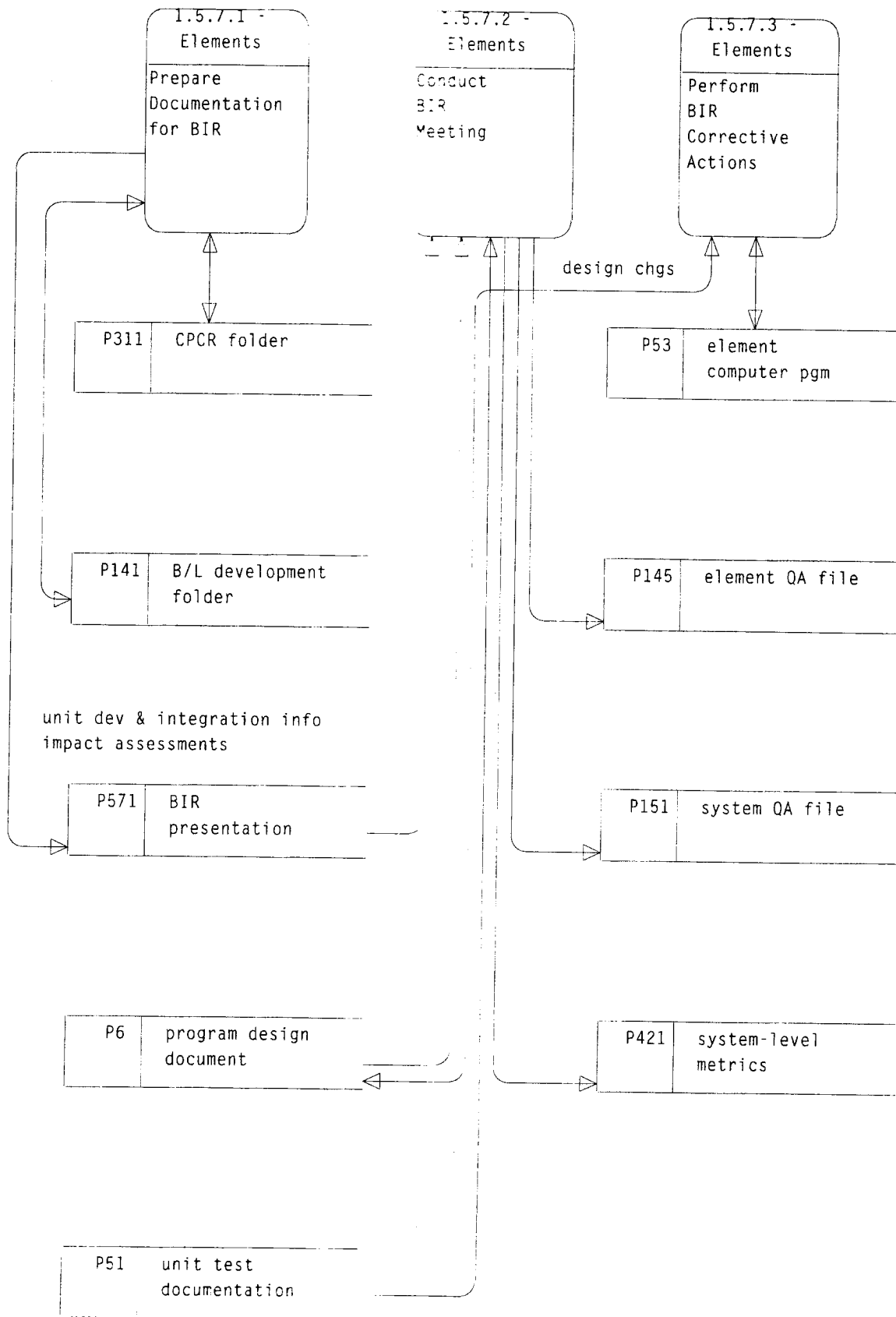

DIAGRAM 1.5.7. CONDUCT BUILD IMPLEMENTATION

REVIEW (BIR) PROCESS





Blank

1.5.8 PERFORM SUPPORTING ACTIVITIES PROCESS

The Perform Supporting Activities Process is comprised of six activities as described below. Diagram 1.5.8 (Page II-5-47) is a data flow diagram of the process and its six constituent activities.

Activity: BI-1.5.8.1

UPGRADE ANALYSIS TOOLS AND DOCUMENTATION

For each build affecting the data dictionary, the Elements transfer the data dictionary to the analysis facility. With support from SCP, they use the extraction point attribute collector (EPAC) text file generated by SYSBLD and the dump of the data recording item selection table (DRIST) to generate data dictionary files each time a new load is built. They generate the files and install them on the AEGIS data reduction (ADAR) system where the files can be accessed by the Elements for reducing tactical data.

For each build, the Elements update the analysis computer programs. This involves updating analysis and special-purpose programs that are affected by changes in the data dictionary. At the end of the last build, the Elements update the extraction and reduction inputs as follows:

- Determine data recording extraction points (EP) sets
- Generate data reduction templates and/or update, test, and verify
- Prepare message direction inputs for EPs for intercomputer messages
- Determine the periodicity of EPs where required

Finally, at the end of the last build, the Elements, supported by Baseline Control, update the computer room error code guide and data recording/data extraction (DX/DR) guidelines inputs.

PERFORMER:	Elements
SUPPORTING ORGANIZATION:	SCP Baseline Control
APPROVAL REQUIRED:	None
APPLICABLE INSTRUCTION:	None

Activity: BI-1.5.8.2

PREPARE ELEMENT TEST DOCUMENTATION

The Elements complete all documentation and preparations necessary for conducting the Element Test Disclosure Review (ETDR). As required, the Elements review the Element test requirements (documented in section 4 of the PPS), and review and update the Element test plans that were developed during the high-level design phase. The Elements develop required test cases in accordance with the updated Element test plan. They prepare test procedures for each test identified in the Element test plan. The Elements then review the Element test procedures. The Elements reconcile procedure errors, and the manager determines if there is a need for a follow-on review before they are inspected. Upon resolution of all deficiencies, the Elements place a copy of the Element test procedures in the baseline development folder. The Elements prepare an ETDR presentation package that provides indication that all preparations necessary for conducting Element testing are completed or the reasons why they are not completed. The package also identifies any risks and concerns.

PERFORMER: Elements
SUPPORTING ORGANIZATION: None
APPROVAL REQUIRED: None
APPLICABLE INSTRUCTION: ETDR Standard

Activity: BI-1.5.8.3

INSPECT ELEMENT TEST PROCEDURES

Element test procedures are inspected to verify that they will adequately support the element test plans and that they are consistent with other documentation. Elements choose inspection participants based on their knowledge of the Element test requirements and their experience in writing and evaluating similar test plans. The inspection is conducted in accordance with the AEGIS Software Standard for Inspections, including the collection of metrics. Element and System QA document the results. Following the inspection, the baseline development folder is updated, if necessary.

RESPONSIBLE ORGANIZATION: Elements
SUPPORTING ORGANIZATION: System QA
APPROVAL REQUIRED: None

APPLICABLE INSTRUCTION: Standard for Software
Engineering Inspections

Activity: BI-1.5.8.4

BUILD SYSTEM QA/ELEMENT-CONTROLLED LOAD FILES

This activity begins with an Element's notice to System QA that the Element is ready to build a System QA/Element-controlled load file. The Element provides System QA with a CPCR closure memo. The files are migrated from the Element's development area into the System QA and Element-controlled directory. System QA scans the files collecting the embedded CPCR numbers, which are verified against the closure memo and ACCESS records. System QA runs VMS Differences and verifies that all changes from the starting point are documented by a valid CPCR number. Upon completion of these steps, the Element and System QA build the controlled load files. Next, System QA checks patch file records against the approved CPCR lists and ACCESS reports. When all checks prove to be satisfactory, the controlled load file is migrated to the MEIT jump load.

PERFORMER: Elements

SUPPORTING ORGANIZATION: System QA

APPROVAL REQUIRED: None

APPLICABLE INSTRUCTION: Program Development and Software Quality Assurance in the VAX Environment, QAI-200; QAI-202; Requirements for Producing Trial QA Load Files via SYSBLD/43 or SYSBLD/7 in the VAX Environment, QAI-205; Preparation of Changes to Controlled Source Code in the VAX Environment, QAI-212; Patch File Coding Standards for UYK-7 Computer Programs, QAI-016; UYK-43, Naming and Formatting Conventions, QAI-300
CRB Procedures

Activity: BI-1.5.8.5

UPDATE ELEMENT TEST DISK PACKS

After an Element's controlled load file and patch file changes have been approved by System QA and Baseline Management, the Element instructs MEIT, via a migration form, to update the jump load. The migration form contains the name of the controlled load file, the patch file PFP order, CPCR numbers incorporated, a short description of the change, and any program limitations. Upon receipt of the migration form, the controlled load file is migrated to the jump load on the MEIT disk packs at the ACC and the ACSC. MEIT provides System QA, Baseline Management, and each Element point of contact with copies

of the migration form and the PFP order. MEIT also updates the MEIT logbooks found in the ACC and ACSC libraries with the descriptions of any changes made to the MEIT disk packs (e.g., listings, PFP order, and log sheets).

PERFORMER: MEIT (Baseline Control)

SUPPORTING ORGANIZATION: None

APPROVAL REQUIRED: None

APPLICABLE INSTRUCTION: Maintaining Jump Load on MEIT Disk Packs, MEIT SOP-002; Maintaining Disk Pack Documentation, MEIT-SOP-005

Activity: BI-1.5.8.6**DEVELOP SPECIAL ELEMENT ENGINEERING TESTS**

Occasionally, Elements may be required to support testing that is not associated with baseline deliveries. These tests may arise from the need to support operational evaluations, engineering evaluations, equipment development, or fleet exercises. As the test requirements arise, the Elements prepare necessary test plans and test procedures as well as additional data collection and analysis materials as required. They adapt the plans, procedures, and materials from existing data, where feasible.

PERFORMER: Elements

SUPPORTING ORGANIZATION: None

APPROVAL REQUIRED: None

APPLICABLE INSTRUCTION: None

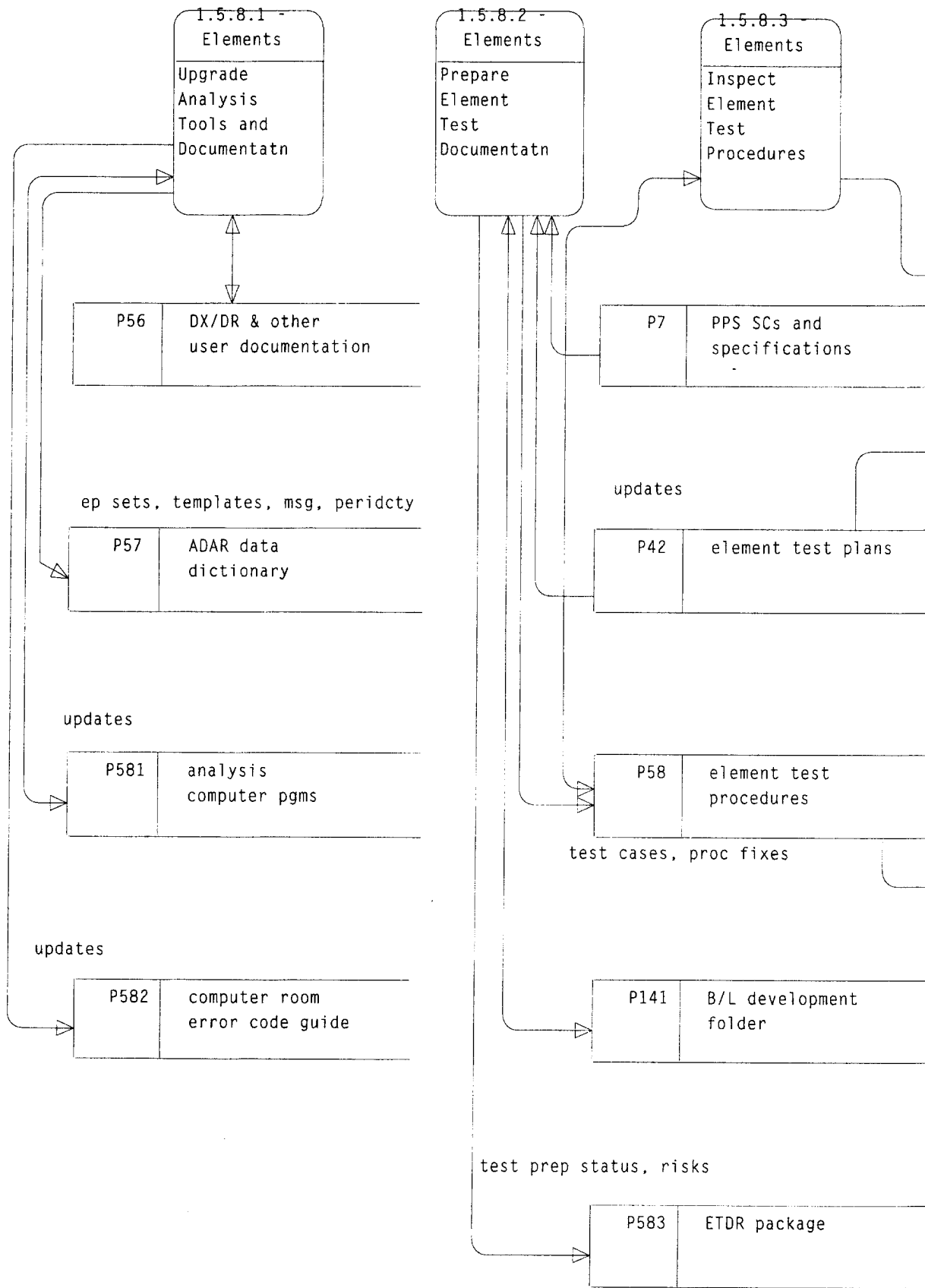

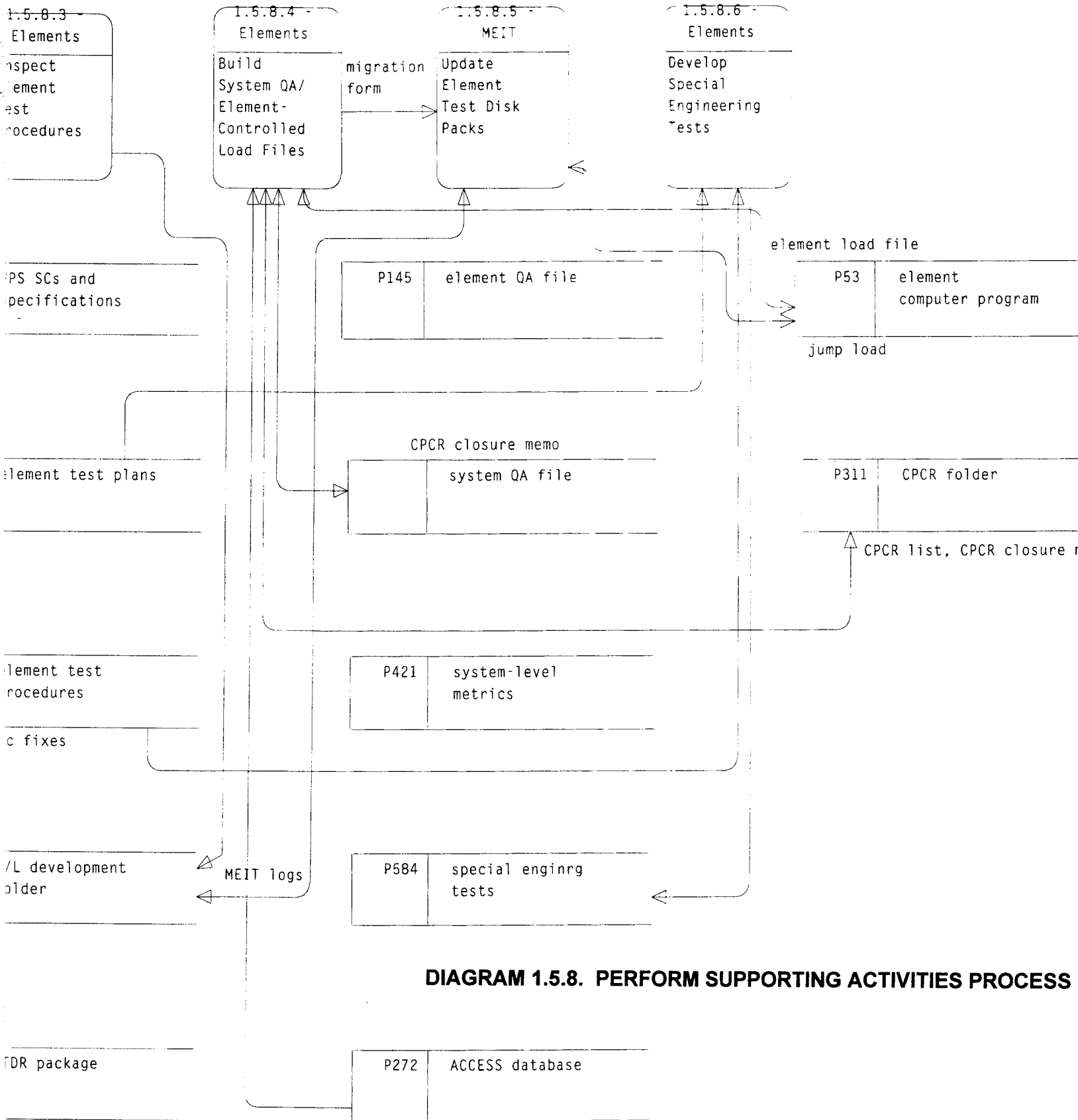

DIAGRAM 1.5.8. PERFORM SUPPORTING ACTIVITIES PROCESS

Build Implementation

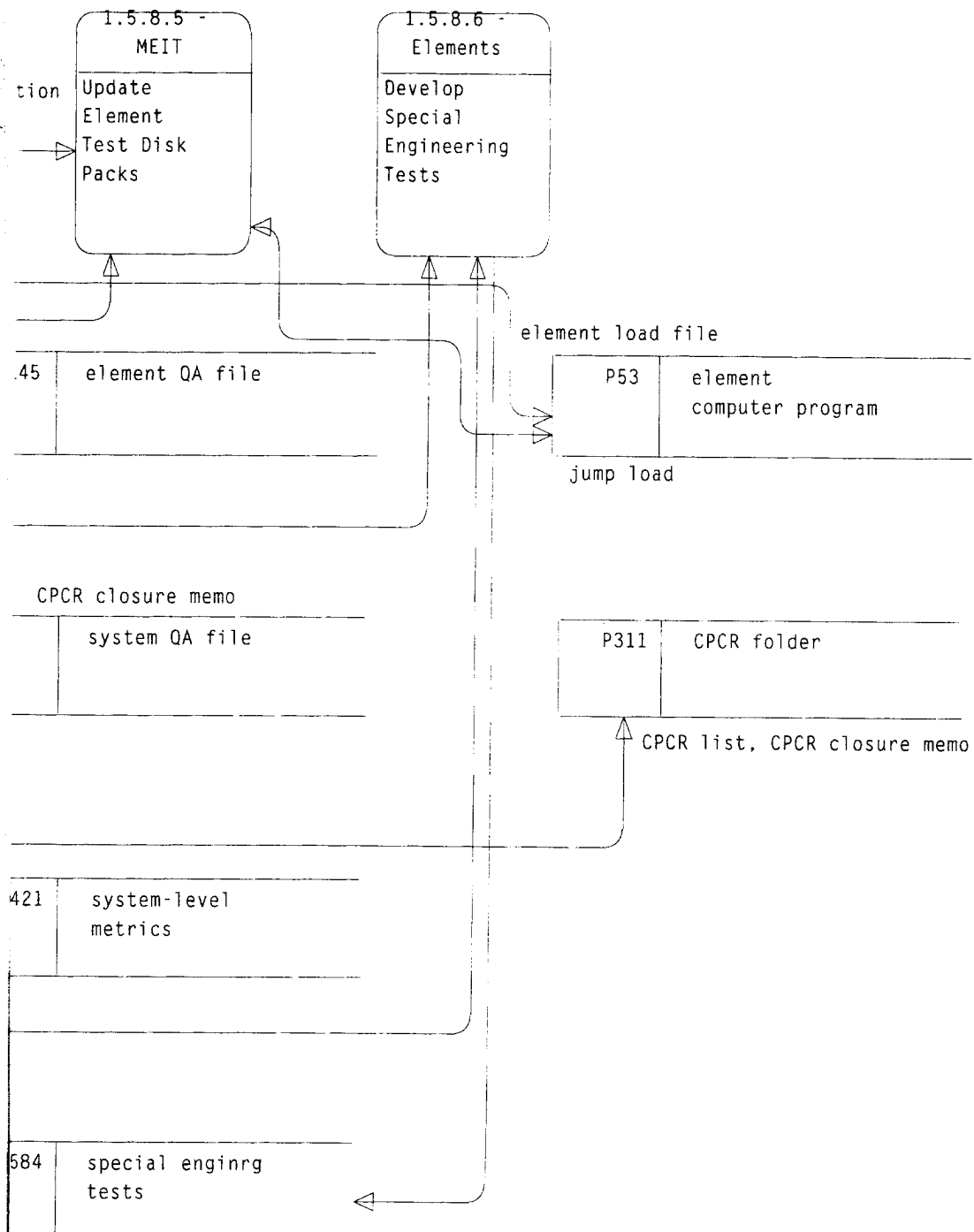

DIAGRAM 1.5.8. PERFORM SUPPORTING ACTIVITIES PROCESS

Blank

1.5.9 PRODUCE SYSTEM-LEVEL TEST PLAN PROCESS

The Produce System-Level Test Plan Process is comprised of one activity as described below. Diagram 1.5.9 (Page II-5-51) is a data flow diagram of the process and its constituent activity.

Activity: BI-1.5.9.1

WRITE SYSTEM-LEVEL TEST PLAN

ST&E evaluates the defined combat system baseline in order to determine specific test requirements. Test requirements are derived from AEGIS system-level specifications using applicable Element specifications to supplement and amplify the requirements, new capabilities, and functional upgrades as defined during the System Definition Phase, and from other computer program changes resulting from the Element Definition Phase. Non-Mk 7 upgrades are also evaluated to ensure adequate combat system integration. The result of the test requirements identification process is documented by ST&E in the Test Requirements List and Test Requirements Definition, documents that constitute the Test Requirements and Acceptance Criteria of the system-level test plan.

Once the test requirements are defined, analysis is performed to identify test procedure development requirements. Test site and resource requirements are evaluated, as well as test program implementation and quality assurance and configuration management requirements. ST&E writes the system-level test plan based on analyses, test requirements, and evaluations.

PERFORMER:	ST&E
SUPPORTING ORGANIZATION:	None
APPROVAL REQUIRED:	None
APPLICABLE INSTRUCTION:	System-Level Test Plan Standard

Blank

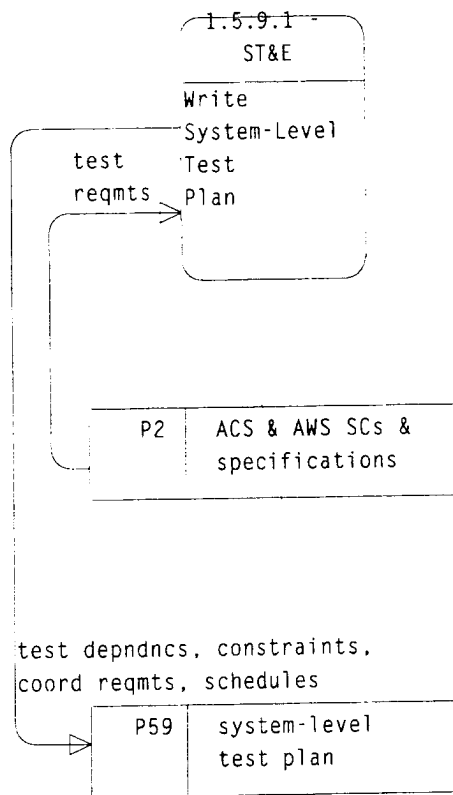

DIAGRAM 1.5.9 PRODUCE SYSTEM-LEVEL TEST PLAN PROCESS

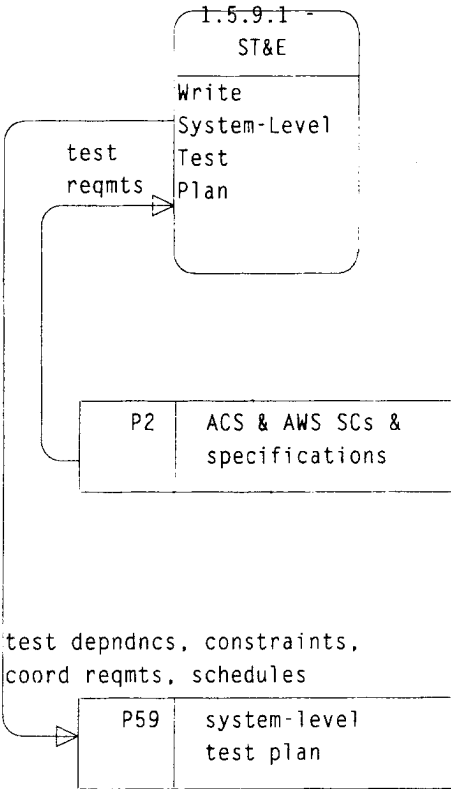

DIAGRAM 1.5.9 PRODUCE SYSTEM-LEVEL TEST PLAN PROCESS

Build Implementation

NSWCDD/MP-93/85

Blank

DISTRIBUTION

	<u>Copies</u>		<u>Copies</u>
DEFENSE TECHNICAL INFORMATION CENTER	1	N05	1
8725 JOHN J KINGMAN RD SUITE 0944		N054	1
FORT BELVOIR VA 22060-6218		N055	1
		N20	1
		N20A	1
ATTN CHARLES GRAHAM	1	N20B	1
COMPUTER SCIENCES CORPORATION		N20B (Stone)	1
304 W RT 38		N20C	1
MOORESTOWN NJ 08057		N20P	5
		N20P (Maphis)	1
ATTN CHARLES SPERRY	20	N20QA	1
COMPUTER SCIENCES CORPORATION		N21	4
5166 POTOMAC DRIVE SUITE 201		N21 (Blackwell)	1
KING GEORGE VA 22485		N21 (Carlson)	1
		N24	5
ATTN R M BLASEWITZ	2	N25	4
MAIL STOP 127-310		N25 (Buckler)	1
LOCKHEED MARTIN		N25 (Clark)	1
GOVERNMENT ELECTRONIC SYSTEMS		N80	
199 BORTON LANDING ROAD		N80P	1
MOORESTOWN NJ 08057-0927		N81	5
		N81 (George)	1
ATTN M MEARS	45	N85	8
LOGICON SYSCON CORPORATION		N86	7
PO BOX 1480		N86 (Martinezl)	3
DAHLGREN VA 22448		N87	2
		N90	1
ATTN JAMES STECKEL	2	N91	8
KPMG PEAT MARWICK		N91 (Irwin)	1
17010 DAHLGREN ROAD SUITE 11		N92	4
KING GEORGE VA 22485		N92 (Bucholdt)	1
		N92 (Hart)	1
ATTN DAVE WILLIAMS	1		
SYNETICS			
4485 DANUBE DRIVE			
SUITE 24			
KING GEORGE VA 22485-9302			
<u>Internal Distribution</u>			
A51 (Cardiel)	1		
E231	3		
E231C	1		
F40	1		
F42	3		
F42 (Pillis)	1		
F42 (Strock)	1		
F42 (Knecht)	1		
L10 (Blackwelder)	1		



UNITED STATES MARINE CORPS
MARINE CORPS COMBAT DEVELOPMENT COMMAND
QUANTICO, VIRGINIA 22134-5001

IN REPLY REFER TO

3900
C 44

19 JUL 1994

From: Commanding General, Marine Corps Combat Development
Command, 3300 Russell Road, Quantico, Virginia
22134-5021 (C 44)

Subj: JOINT OPERATIONAL REQUIREMENT (JOR) FOR TACTICAL UNIT
LEVEL SWITCHES (NO. CCC 11.5); CHANGE 2

Ref: (a) CG MCCDC ltr 3900 C 441 of 15 Mar 94

1. Purpose. To transmit pen changes to the basic Joint Operational Requirement (JOR) for Tactical Unit Level Switches (NO. CCC 11.5). Per the reference, the following changes to the basic JOR are approved.
2. Action
 - a. Delete paragraph 3.4.4.2(3).
 - b. Renumber paragraphs 3.4.4.2(4) and 3.4.4.2(5) as 3.4.4.2(3) and 3.4.4.2(4).
3. Rational. The requirement for improved network timing synchronization will be satisfied by a Global Positioning System sourced clock at the Digital Technical Control vice a Rubidium Time Standard Circuit Card Assembly in the Unit level Circuit Switch.
4. Filing Instructions. This change transmittal will be filed immediately following the signature page of the basic JOR.
5. The Marine Corps point of contact for this requirement is the Command, Control, Communications, and Computers Branch, Requirements Division, MCCDC, DSN 278-6185, commercial 703-784-6185.

R. J. ANTONICH
By direction

Distribution:
See attached

DISTRIBUTION LIST
APPROVED REQUIREMENT DOCUMENTS

<u>Marine Corps</u>	<u>Copies</u>
COMMARFORLANT (Attn: G-3), PSC Box 20115, Camp Lejeune, NC 28542-0115	(1)
COMMARFORPAC (Attn: G-3), Camp Smith, HI 96861-5001	(1)
COMMARCORSSYSCOM (PAE), Quantico, VA 22134-5080	(1)
COMMARFORRES (Attn: G-3), 4400 Dauphine Street, New Orleans, LA 70146-5500	(1)
CG I MEF, (Attn: G-3), Camp Pendleton, CA 92055-5402	(1)
CG II MEF, (Attn: G-3), PSC Box 20080, Camp Lejeune, NC 28542-0080	(1)
CG III MEF, (Attn: G-3), FPO AP 96606-8401	(1)
COMMARCORLOGBASES, (Code 831; 841), Albany, GA 31704-1128	(1)
CO EWTGPac, (Attn: S-3), 3423 Guadalcanal Road, San Diego, CA 92155-5099	(1)
CO MAWTS-1, (ADT&E) Box 99200, Yuma, AZ 85369-9200	(1)
MCLNO, NTSC, 12350 Research Parkway, (PDM-1) Orlando, FL 32826-3224	(1)
MCLNO, ARDEC, Bldg 1 (MCLO), Picatinny Arsenal, NJ 07806-5000	(1)
MCRep, USA Armor Center (ATZK-USMC-105), Bldg 2369, Fort Knox, KY 40121-5200	(1)
CO USMC Artillery Det. USAFAS, Bldg 759 McNair Avenue, Fort Sill Ok 73503-5600	(1)
Dir, MCOTEA, 3035 Barnett Avenue, Quantico, VA 22134-5014	(1)
 <u>Army</u>	
DC/S for OPS & Plans; Req't, Prog, & Priority Div (DAMO-FDR), DA, Washington, DC 20310	(1)
Comdr, USA TRADOC (ATCD-RM), Fort Monroe, VA 23651	(1)
Comdr, USA TSC (Attn: ATIC-DMD), Fort Eustis, VA 23604-5166	(1)
 <u>Navy</u>	
CNO (N810), RM 4A530, 2000 Navy Pentagon, Washington, DC 20350-2000	(1)
MGR, NARDIC, 2211 Jefferson Davis Hwy (Crystal Plaza 5, Room 802) Arlington, VA 22244-5114	(1)
 <u>Air Force</u>	
HQ USAF (XORD), The Pentagon, Washington, DC 20330-1480	(1)
Dir, Air Univ Library (AUL/LSE), Bldg 1405-600 Chennault Circle Maxwell AFB, AL 36112-6424	(1)
 <u>Department of Defense</u>	
Administrator, DTIC, Cameron Station, Alexandria, VA 22314 (Distribution Statement E)	(2)
 <u>HQMC Codes:</u>	
A; M&RA; PP&O; C4I	(1)
P&R (RPD & RPA)	(2)
 <u>CG MCCDC:</u> T&E Division (C 463); S&A Division (C 45); TFS Division (C 53)	(1) (1)