

Naval Research Reviews

Office of Naval Research
Four/1995
Vol XLVII

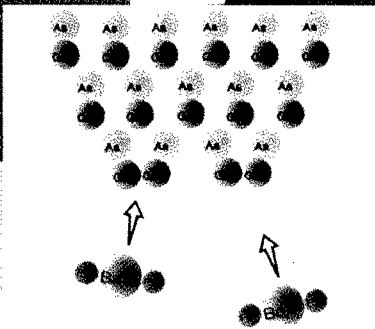
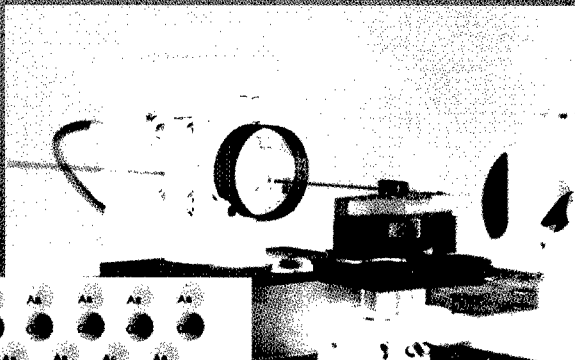

SELECTED

ACCOMPLISHMENTS

FOUNDATIONS
FOR THE NAVY AFTER NEXT

DISTRIBUTION STATEMENT A

Approved for public release;
Distribution Unlimited

19960820 071

DISCLAIMER NOTICE

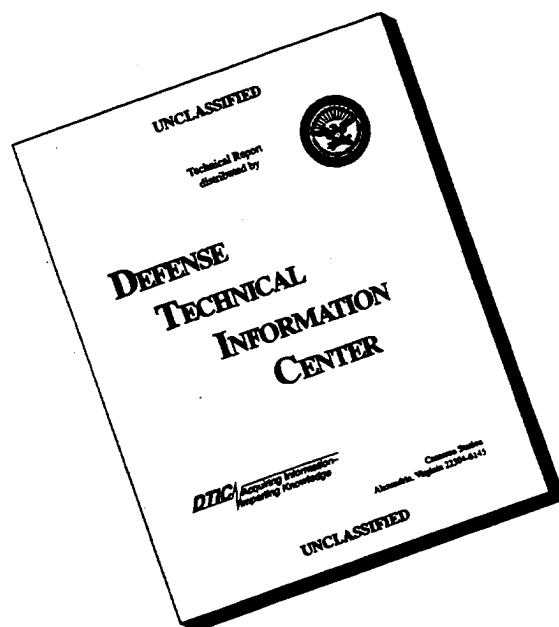

THIS DOCUMENT IS BEST QUALITY AVAILABLE. THE COPY FURNISHED TO DTIC CONTAINED A SIGNIFICANT NUMBER OF PAGES WHICH DO NOT REPRODUCE LEGIBLY.

Table of Contents

C4I, SURVEILLANCE AND SPACE

- Voice/Data Integration ATD 1
- Low Probability of Intercept Sensors 1
- Dual Band Infrared Detectors 2
- Ship Tracks 2
- Signal Compression (Wavelets) 3
- Advanced Technology Tactical Acoustic Communications 3
- Long-Baseline Interferometry 4
- Nanoscale Cermets 4
- Advanced Enclosed Mast/Sensor System Advanced Technology Demonstration 5
- Chaos Theory Aids Secure Communications 5
- Molecular Biosensors 5
- Precision SIGINT Targeting System (PSTS) 6
- Molecular Beam Epitaxy of Semiconductors and Insulators 6

MINE WARFARE

- Mine Countermeasures 7
- Laser Diode Pumped Dye Laser 8
- Benchmark Scattering Models for Proud & Buried Underwater Objects 8

UNDERSEA WARFARE

- Acoustic Daylight Imaging 9
- Antisubmarine Warfare (ASW) Advances 9
- Odyssey II 10
- Advanced Antisubmarine Warfare (ASW) Receiver 10
- Neural Nets for Submarine Maneuvering 10
- Intermediate Scale Measurement System Supports Submarine Detection and Stealth 11
- Nearfield Acoustical Holography 11

SURFACE SHIPS

- Multifunction Electromagnetic Radiating System 12
- Superconducting Antenna 12
- Thermoacoustic Refrigeration 12
- Laser-Welded Corrugated Core Sandwich Panel (LASCOR) 13
- Computational Ship Hydrodynamics 13
- Unidirectional Double Hull 13
- In Situ Bio-Emulsifier Cleaning of Oil/Water Separators 14
- Antibiofouling Technology—Biocorrosion 14
- High Pressure Water Jet Demonstration 15
- Superconducting Coil Development and Motor Demonstration 15

MANPOWER, READINESS AND SUPPORT

- Components Demonstrated in Advanced Self-Defense Combat System Advanced Technology Demonstration 16
- All-Organic Flexible Liquid Crystal Displays (LCD) 16
- Materials Discovery Through Biomimetic Principles 17
- Freeze-Dried Blood Advance Technology Demonstration 17
- Helmet Mounted Mission Rehearsal Simulation System 18
- Immunoprotection in Trauma by the Steroid DHEA 18

ELECTRONIC WARFARE

- Multiband Antiship Cruise Missile Tactical EW System (MATES) 19
- Passive Radio Frequency Targeting 19
- Multiscale Image Processing 20
- Improved Phased-Array Communications and Radar 20
- Infrared Search and Track (IRST) System 21

AIR WARFARE

- Air Vehicle Diagnostic System (AVDS) 22
- AirMet 100 Ultra-High Strength Steel 23
- UNICOAT: Pollution Prevention Coating 23
- Integrated High Performance Turbine Engine Technology (IHPTET) 24
- Aircraft Composite Components 24

MISSILES, TORPEDOES AND WEAPONRY

- CL20 Decreased Sensitivity, Increased Density Explosive 25
- Hydrox Propulsion 26
- Shallow Water Torpedo Guidance and Control Advanced Technology Demonstration 27
- Insensitive Matrix Component for Use of Missile Propellants 28
- Electromechanical Actuator (EMA) Technology 28
- Advanced Missile Airframe Advanced Technology Demonstration (ATD) 29
- Weapons Technology Concentric Canister Launcher Advanced Technology Demonstration 30
- H-Infinity Methods Transition to Highly Responsive Missile Control Systems 30
- Terminal Placement Advanced Technology Demonstration 31
- Anti-torpedo Torpedo 32

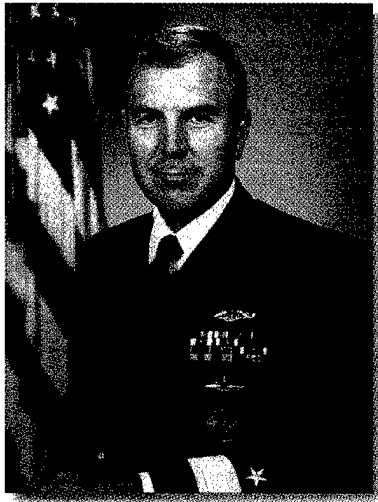

*Rear Admiral Marc Y.E. Pelaez
Chief of Naval Research*

Preface

ii

The naval research and development community is charged with ensuring that the Fleet of Sailors and Marines have the crucial force-multiplying weaponry and the supporting state-of-the-art systems needed to win in combat and capably defend American interests and policies. The science and technology (S&T) investments we make today will determine the technological superiority of the future Navy and Marine Corps, so it is imperative that we lay that foundation with informed vision.

All ONR science and technology initiatives work to anticipate what is possible in naval warfare and provide technology to future missions. Fleet operational requirements drive the need for S&T integration. We work closely with the developers to put improved products in the Fleet. Affordability, jointness, and transition—to the Fleet and to industry—

are fundamental to our plan's success. The S&T investment program maintains our strong commitment to work with other Services, with other government agencies to leverage our resources, with academia and industry, and as appropriate, with our foreign allies to support U.S. naval S&T needs.

Today, at the Office of Naval Research (ONR), we are investing in a broad spectrum of integrated science and technology programs from basic research through advanced technology development and manufacturing by U.S. industry. We are seeking order-of-magnitude changes in future naval mission capabilities and stand ready to create or exploit scientific breakthroughs to meet critical requirements and needs.

Navy S&T accomplishments enhance Navy warfighting capabilities by improving the affordability of these



*Dr. Fred E. Saalfeld
Deputy Chief of Naval Research
and Technical Director, ONR*

systems and reducing the life-cycle costs of maintenance and support. Navy programs are benefiting from our increased attention to Manufacturing Science and Technology. The affordability of major acquisition programs is being enhanced through our focused attention in areas such as advanced composite structures for integrated hull and systems designs, advanced packaging and production of multi-functional integrated systems, agile ship construction integrated into advanced design procedures, metal matrix composites and simulations capabilities for systems performance and production.

Because of ONR efforts, "The Navy After Next" will consume less fuel per hour, require fewer operating personnel, and spend less time in drydock for maintenance than any fleet before it. We expect that procedures undertaken by personnel to check-out systems will be increasingly replaced by "condition-based maintenance" systems in which sensors will report on the integrity of machines and materials and provide sufficient data for maintenance and repair.

This publication reports on selected research accomplishments recently achieved under ONR sponsorship at universities and Navy laboratories and in industry. These selected accomplishments represent a "snapshot" of the hundreds of achievements that annually advance our fundamental knowledge of science and ensure our national security.

It is exciting and rewarding to implement the Navy's support of our nation's vigorous scientific research effort. The results of that research are manifested in a strong Navy and in the continuing leadership of the United States in the advancement of science and technology for the benefit of all people.

Science and Technology Leadership

RADM Marc Y.E. Pelaez

Chief of Naval Research
O: 703/696-4767
F: 703/696-6065

Dr. Fred E. Saalfeld

Deputy Chief of Naval Research
Technical Director
O: 703/696-4517
F: 703/696-4065

Dr. Arthur D. Bisson

Director
Science and Technology Directorate
O: 703/696-8581
F: 703/696-4065

Dr. Bruce B. Robinson

Deputy Director
Science and Technology Directorate
O: 703/696-4101
F: 703/696-4065

CAPT R. T. Scott, Jr.

Assistance Chief of Naval Research
O: 703/696-4261
F: 703/696-4065

Dr. Bobby R. Junker

Department Head
Information, Electronics,
and Surveillance
O: 703/696-4212
F: 703/696-2611

Dr. James J. DeCorpo

Department head
Ocean, Atmosphere, and Space
O: 703/696-1300
F: 703/696-2007

Dr. Eugene A. Silva

Department Head
Engineering, Materials,
and Physical
O: 703/696-4408
F: 703/696-0308

Dr. Steven F. Zornetzer

Department Head
Personnel Optimization
and Biomolecular
O: 703/696-4501
F: 703/696-1212

Dr. Eli Zimet

Department Head
Special Programs
O: 703/696-4771
F: 703/696-4274

Mr. David Rossi

Department Head
Industrial Programs
O: 703/696-4448
F: 703/696-4884

Mr. T. H. Payne

Comptroller
Comptroller Department
O: 703/696-4277
F: 703/696-4529

CAPT F. J. Miller

Director
Acquisition Department
O: 703/696-4484
F: 703/696-0993

C4I, SURVEILLANCE AND SPACE

Voice/Data Integration ATD

- The Voice/Data Integration Advanced Technology Demonstration successfully displayed the ability to communicate both voice and data simultaneously on existing narrowband naval networks.

- The demonstration consisted of voice transmissions at 600, 800, and 1200 bits per second (bps) concurrent with data transmission in the form of video images, tactical displays and interactive whiteboards.

- The success of the demonstration opens the door to providing voice/data capability over two different communications media.

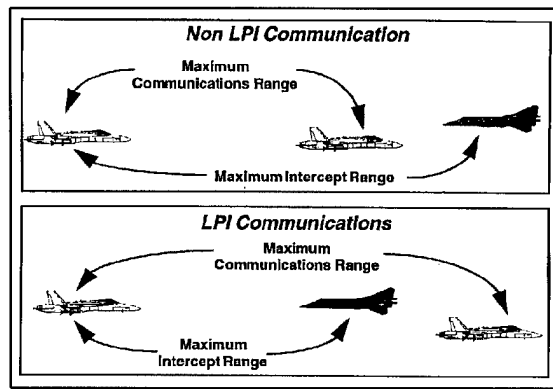

Low Probability of Intercept Sensors

- A system for **non-cooperative identification** of aircraft, ships and ground targets from airborne and surface platforms has been developed.
- The system **integrates various radar techniques and visible-band cameras** and provides the following sensing modes: LADAR imaging, passive IR imaging, visible imaging, range profile and MicroDoppler vibration measurement.
- A downsized shipboard system, Radiant Mist, has been delivered for data collection and at-sea testing.

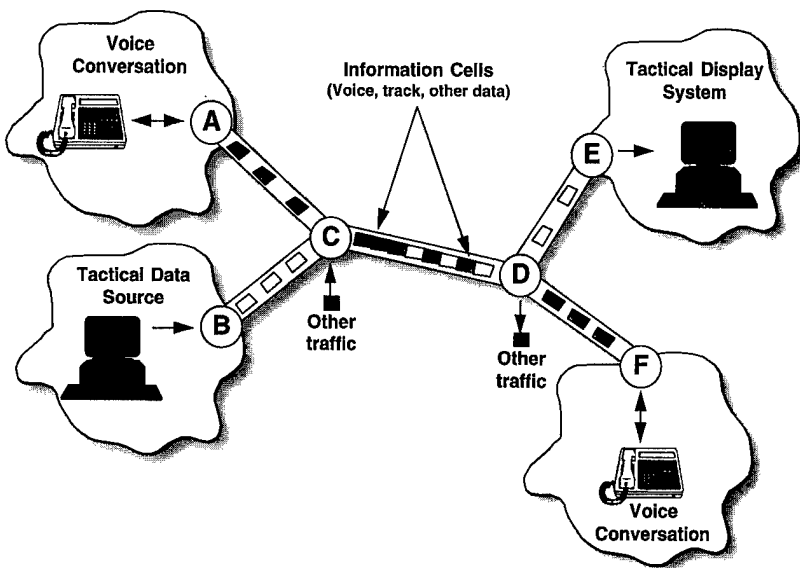

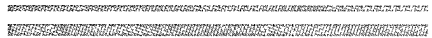

2

Dual Band Infrared Detectors

- A dual-band Infrared Focal Plane Array (IRFPA) has been designed, fabricated, and tested. Newly designed circuitry allows the **read-out of separate signals simultaneously in both bands.**
- Many Navy and Marine Corps systems require the use of IRFPA technology: surveillance, targeting, anti-ship, and anti-air warfare missions. The new dual-band IRFPA provides **enhanced capability in all-weather, day-night operations.**

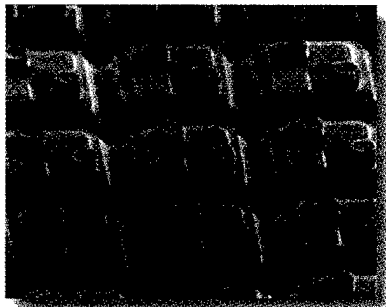

Infrared detectors



Ship Tracks

- Exhaust-generated aerosols from ships are drawn into clouds through convective processes which increase the droplet number while decreasing droplet size and provide a reflective surface when observed through infrared images—ship tracks.
- Using this new tool for Navy reconnaissance allows aircraft to **detect, identify, and track ships** while the aircraft remain hidden above the cover of clouds.



Signal Compression (Wavelets)

- A new signal processing technology which compresses images based on “wavelets” can **reduce still image storage and transmission requirements** by a ratio of **200 to 1**, thereby eliminating 95.5 percent of an image’s original digital data content while largely preserving image fidelity.
- Using the same technique, **video compression ratios of 2,000 to 1** have been achieved.
- This novel technology has been incorporated into the fleet’s SLAM Extended Range missile, making the video image transmitted back to the guiding pilot hard for the enemy to find and jam.

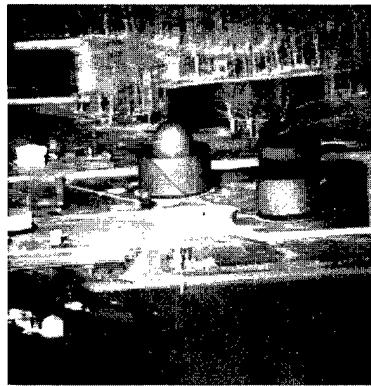

Original infrared image Compressed infrared image (400:1)
(Wavelets)

Advanced Technology Tactical Acoustic Communications

- Advances in signal processing techniques and concurrent improvements in electronic hardware have demonstrated **gains of more than 300 to 1 in data rate throughput** over traditional signal methods.

Signal processing improvements have been achieved by adaptive channel characterization techniques that permit multipath compensation in both deep and shallow water environments.

- Investigators now expect to effectively transmit data at 3 kilobars per second (kbps) at 30 nautical miles (nmi) and at least 1 kbps at all ranges to the power limits of the existing shipboard system; this will **advance capabilities in command, control, and communications.**

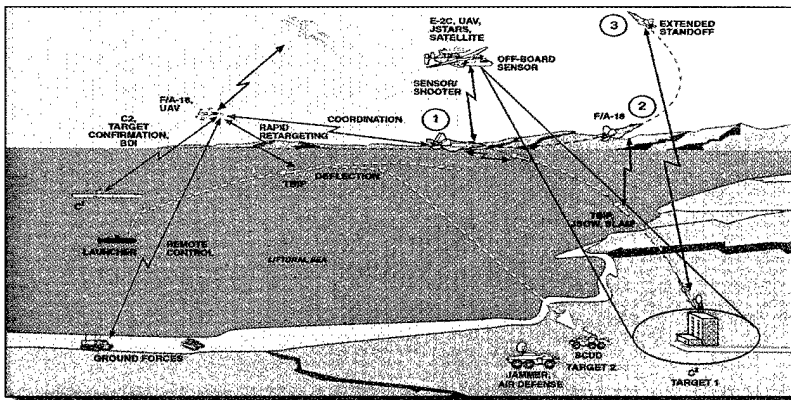

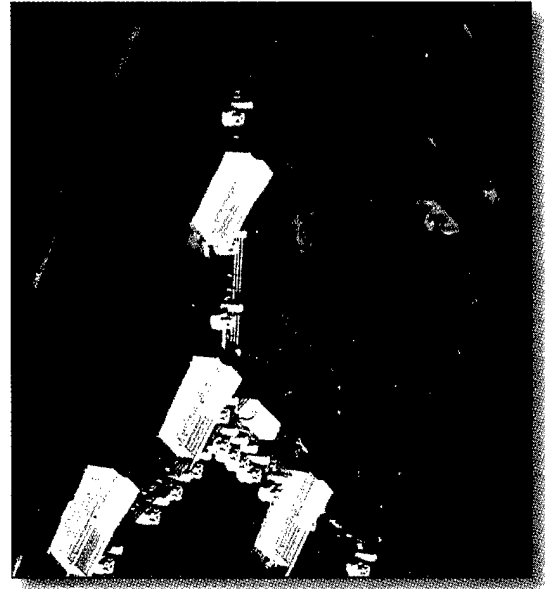

Long-Baseline Interferometry

- A new prototype interferometer images stars with 100 times the resolution of the Hubble space craft telescope, greatly **increasing surveillance and space capabilities**.
- The Navy Prototype Interferometer greatly decreases the limitation on the size of a telescope's primary light collecting mirror while correcting for atmospheric distortions.
- The prototype interferometer will be used for star mapping to provide reference for future space navigation, improve precise earth navigation, and enable the accurate prediction of earth orbital variations, which contribute to precision Coordinated Universal Time.

Nanoscale Cermets

- A new class of **versatile, tough materials**—nanoscale cermets—has been developed.
- The improved, wear resistance provided by nanoscale cermets has been made a part of the fabrication of twist drills with diameters as fine as 100nm for repetitive drilling in the most advanced printed circuit boards.
- A nickel/chrome carbide form of the material is under development. When used in component parts exposed to hot corrosive environments, this new material will extend material life and reduce associated repair and replacement costs.

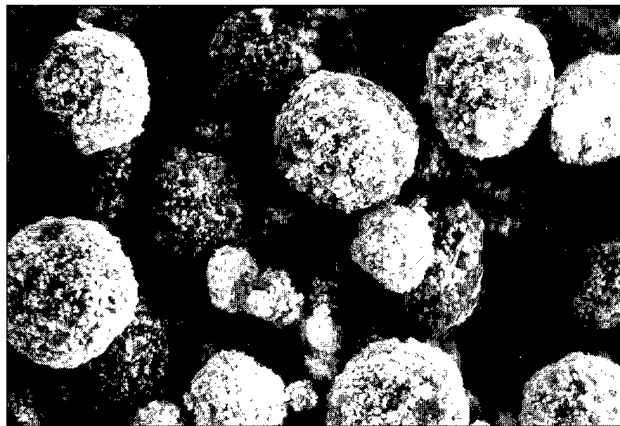

Cermets



Artist Concept of AEM/S System
Installed on USS RADFORD

Advanced Enclosed Mast/Sensor System Advanced Technology Demonstration

- A radical new concept for ship masts which fully encloses sensors in a hexagonal composite frequency selective structure has been demonstrated to **reduce radar signature**, greatly **improve sensor performance**, **increase sensor reliability**, and enable a new generation of embedded or enclosed sensors to be developed and deployed.
- The use of frequency selective structures reduces the RF signature of the mast and increases sensor performance by virtually eliminating the interference and blockage problems of current metallic masts.

Chaos Theory Aids Secure Communications

- Chaos theory research has produced a technology that will enable development of **easy-to-use secure communications devices**.
- The technology produces a noise mask of matched static-sounding signals that operate simultaneously in send- and receive-sites. When the matched elements are subtracted, the valuable message-carrying parts of the signal become discernible.

- This new technology, when integrated with available devices, is expected to provide greater convenience in secure communications and prove **difficult for enemies to break**.

Molecular Biosensors

- A breakthrough proof-of-principle for a molecular biosensor technology involves the design and construction of molecular channels and chemical binding sites.
- The technology provides the foundation for the development of solid-state devices used in **detecting chemical warfare agents**, **improving atmospheric monitoring in submarines and other closed systems**, and **environmental monitoring of the ocean and atmosphere**.

Precision SIGINT Targeting System (PSTS)

- A near real-time, precision location, sensor-to-shooter capability that uses existing national and tactical SIGINT assets has been successfully demonstrated.
- PSTS provides information that can be used for **precision targeting, specific target identification, order-of-battle analysis, and battle damage assessment information.**
- Continuing efforts will expand the **range of signal frequency and complexity** against which PSTS can accurately target.

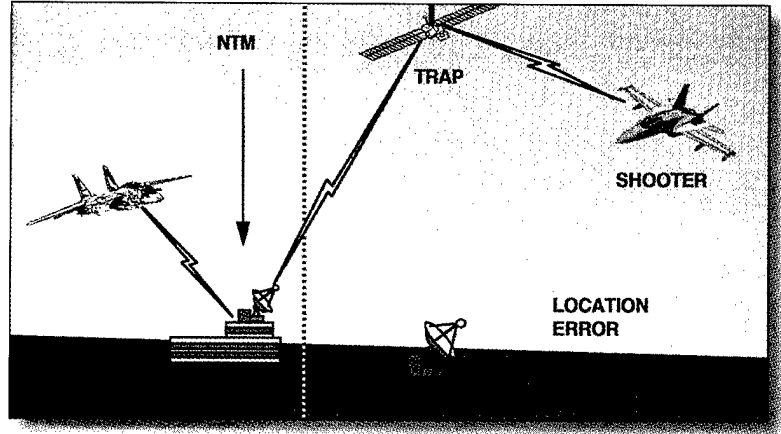

Molecular Beam Epitaxy of Semiconductors and Insulators

- A novel "molecular beam epitaxy process" has allowed researchers to build templates that bridge the mismatch between lattice structures of semiconductor and insulator materials.
- This technology breakthrough impacts civilian and military electronics by enabling the development of higher-speed field effect transistors, which will operate with **less power at speeds 10 times faster** than present units.
- This process can also provide a substrate for the next generation of wide bandgap semiconductors including gallium nitride, which is being pursued for high-temperature and high-frequency electronics.

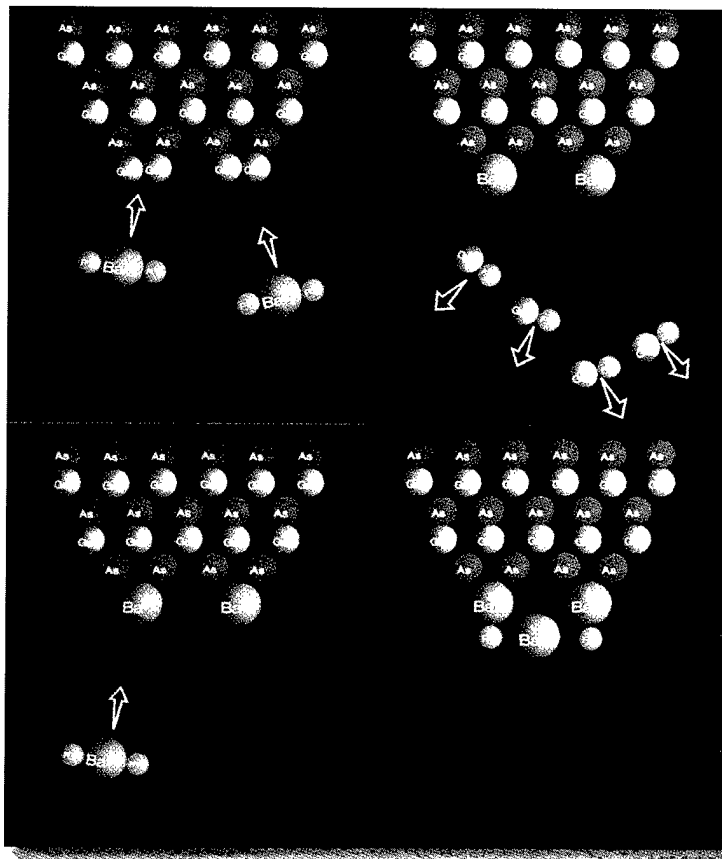

MINE WARFARE

Mine Countermeasures

- Researchers have recently completed the development and testing of a novel underwater acoustic sensor designed to **rapidly survey marine minefields**.
- Known as the Toroidal Volume Search Sonar, the new device uses a cylindrical transducer to **simultaneously form 120 beams covering an entire water column**. As such, it is the first acoustic mine countermeasure system to **simultaneously detect floating and bottom mines at rates up to 8 knots**.
- The sensor, designed to **fit inside a 21 inch diameter underwater vehicle**, will transition to the remote mine hunting system to provide information relevant to planning and engaging in warfare.

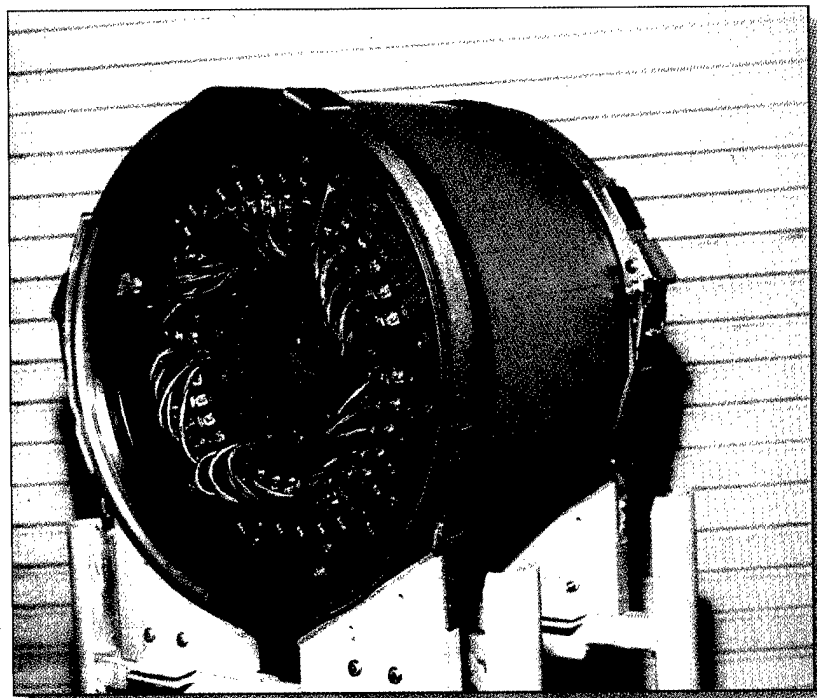

*ARL/PSU Polymer receiver
with outer boot.*

Laser Diode Pumped Dye Laser

- Using power supplied by four AAA commercial batteries, this novel, tunable, solid-state dye laser **improves the image acquisition process for shallow water, anti-personnel mine countermeasures.**
- Demonstration of the laser resonator, which **weighs less than three ounces**, represents a breakthrough in the development of high-resolution line scan imaging systems.
- The new technology enables operations from platforms above the water, a critical consideration in assault planning.

Laser

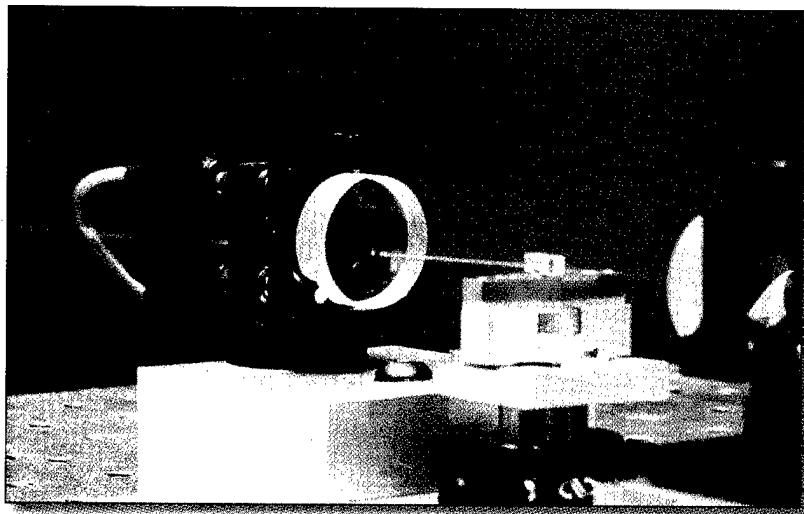

Benchmark Scattering Models for Proud & Buried Underwater Objects

- Researchers recently improved the odds of locating shallow water mine beds by formulating a benchmark scattering model using spherical elastic shells buried in the ocean bottom.
- The benchmark, which provides **scattering characteristics associated with buried mines**, effectively opened the possibility of designing sonars capable of enabling the long-range detection and classification of buried objects.

UNDERSEA WARFARE

Acoustic Daylight Imaging

- A sophisticated acoustic lens known as Acoustic Daylight Ocean Noise Imaging System or ADONIS, was recently designed and constructed with the capability of producing 126 pixels in an elliptical configuration on the screen of a desktop computer. This new system relies on ambient noise in the ocean as the source of acoustic illumination.
- ADONIS, deployed in the ocean for the first time off Point Loma, California, provided **real-time, moving color images** in which the target was not only visible but was shown with **sufficient resolution to be recognizable through its rectangular shape**.

Real-time acoustic daylight image of rectangular target (top) and the same image after applying bilinear interpolation (bottom).

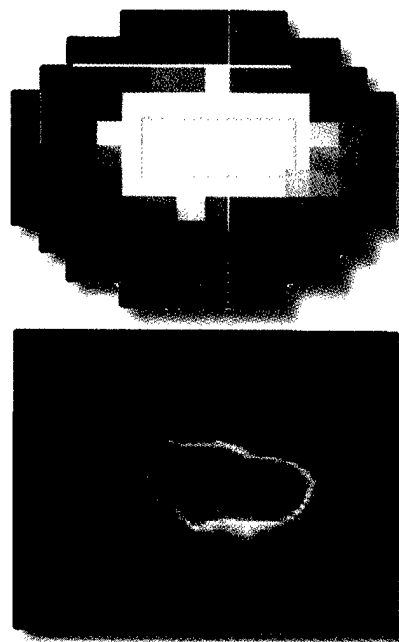

- This new technique for providing vision in the ocean shows potential in connection with several naval applications including: mine detection, harbor entrance monitoring and underwater vehicle navigation.

Antisubmarine Warfare (ASW) Advances

- A new lightweight micro-machined directional hydrophone provides acoustic sensing in a package **one-fortieth the size of the conventional sensor**.

- *Size and weight are particularly important to devices which must be deployed in large numbers from aircraft.*
- A new "multi-line" towed sonar array brings together multi-line capability with very thin and affordable fiber optic sensor technology.
- *The arrays will **boost detection ranges, overcome left-right ambiguity, and dramatically improve performance at end fire** (detection of submarines directly behind or in front of the array).*



Odyssey II

- The modular design of this new autonomous underwater vehicle provides a **low-cost, highly reliable vehicle**.
- Used for synoptic sampling, the Odyssey II has actuators, sensors, and on-board intelligence designed to complete sampling tasks autonomously. It is 2.1 meters long, has a maximum diameter of 0.6 meters, and is rated at a depth of 6,700 meters.
- Odyssey II's capabilities were demonstrated beneath the Arctic ice of Alaska and later at an underwater eruption off the coast of Washington.

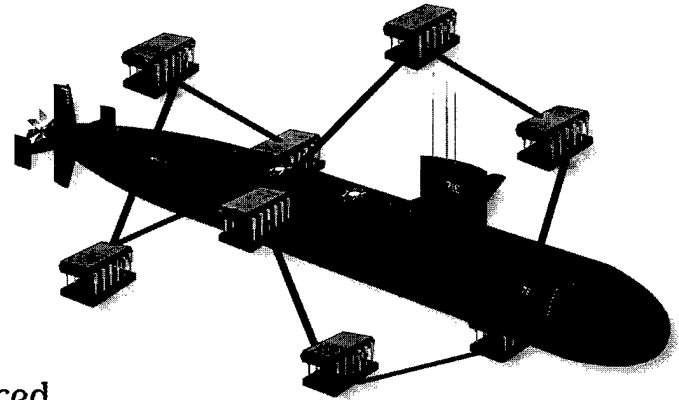

Advanced Antisubmarine Warfare (ASW) Receiver

- The Advanced Antisubmarine Warfare (ASW) Receiver project is a follow-on receiver to the current P3 aircraft sonobuoy receiver.
- The new receiver has an anti-jam communication mode and **doubles the number of sonobuoys an aircraft can monitor**. The system has also been designed with a digital uplink capability to accommodate future sonobuoy sensor development.
- The uninterrupted data flow from ASW sonobuoys in littoral regions, which are typically high radio frequency interference zones, will drastically improve underwater warfare techniques.

Neural Nets for Submarine Maneuvering

- Using a concept known as "neural nets," in which many variables are tracked by computer, integrated, and programmed to provide a cyber version of experience for improving continuing operations, investigators recently obtained data from a radio-controlled submarine (1:20 scale) and reproduced an extended range of maneuvers.
- This breakthrough accomplishment established neural nets as predictive tools for submarine maneuvering and provided a **reliable method to develop automatic control systems for full-scale submarines**.

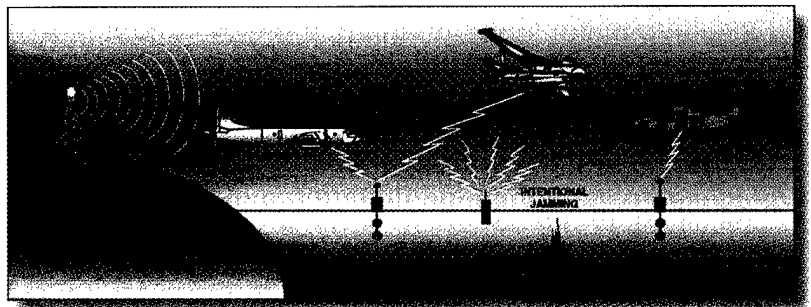

Intermediate Scale Measurement System Supports Submarine Detection and Stealth

- The Intermediate Scale Measurement System is a superbowl-sized web of branched cable and sensors below the surface of Idaho's Lake Pend Oreille.
- The system, which provides the **first three-dimensional acoustic picture of submarines**, has important new capabilities for analyzing the acoustic response of complex structures.
- Understanding the specific sources of radiated and reflected sound will allow **quieter, more cost-effective submarine designs in the future**. It will also **improve the sensitivity of fleet sonar to target emissions** encountered in operations.



- Knowledge of the locations on the hull of acoustic hot spots will provide critical information for the effective application of **cost-efficient**

quieting techniques and decreasing the vulnerability of the submarine fleet to passive and active detection.

11

Nearfield Acoustical Holography

- Nearfield acoustical holography technology will **identify acoustic hot spots on submarine hulls**.
- Source localization and quantification techniques have been developed theoretically and applied experimentally to realistic submarine models.

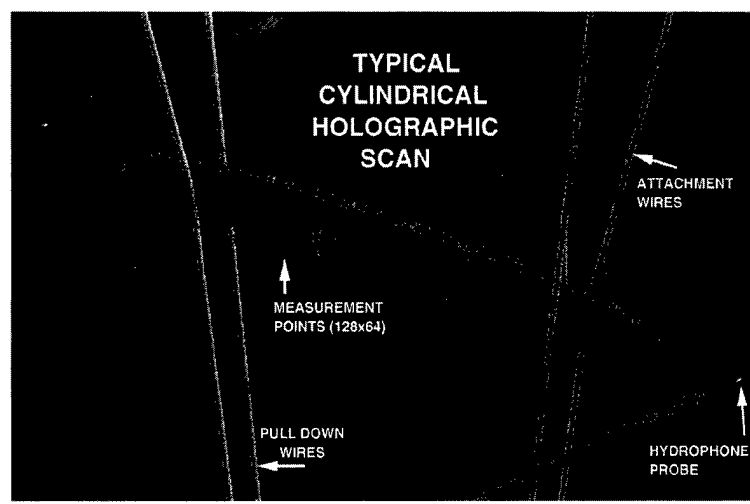

SURFACE SHIPS

Multifunction Electromagnetic Radiating System

- By merging four different antenna systems into a single system, the Multifunction Electromagnetic Radiating System (MERS) provides a low-cost antenna system with reduced signature, weight, and volume that meets the demands of a shipboard environment.
- The ultimate goal of MERS is to meet the antenna requirements of each ship class (up to 10 or more systems for some classes) in a single structure.

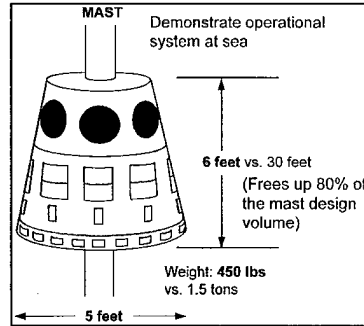

and frequency coverage while reducing the size, weight, and observability of the antenna system.

- The low-loss characteristic of HTS material benefited the spiral type of antenna by eliminating radar frequency (RF) losses and improving efficiency and performance. This enabled the design of innovative spiral antennas with meander-line slow-wave geometries for compact low-frequency spiral antennas.



Thermoacoustic Refrigeration

- The simplicity and reliability of a thermoacoustic refrigeration system was recently demonstrated aboard the USS DEYO (DD989). The refrigerator, capable of cooling 420 watts of heat load, was used to successfully cool a rack of electronics.
- Because the working medium is a mixture of inert gases, no environment-threatening chemicals are needed for cooling.

Superconducting Antenna

- Recent research efforts have shown that a superdirective array of half-loop antennas made from three-element high-temperature superconductive (HTS) materials had an 11-decibel improvement in efficiency over an identical gold array.
- Use of HTS materials in antennas also improves the efficiency, directive gain,

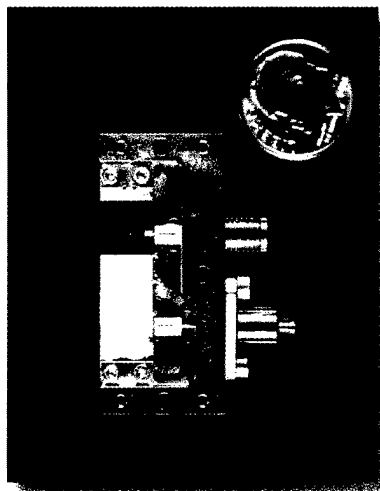

Laser-Welded Corrugated Core Sandwich Panel (LASCOR)

- Lightweight, strong steel ship structures are achieved by laser-welding thin steel into corrugated core panels (LASCOR), much like a cardboard box.
- LASCOR achieved a **weight savings of 50 percent** (20,000 lbs vs. 40,000 lbs) on a new antenna platform aboard the USS MOUNT WHITNEY, **while maintaining structural strength.**

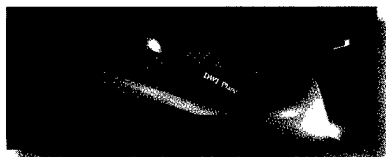

Hydrodynamics

- This technology results in **time and cost savings** by eliminating much of the trial and error methods previously used to study the geometries of ship design or the results of small changes to hull configuration.

Unidirectional Double Hull

- Use of the unidirectional double hull concept in ship construction **saves money** and produces a hull **better able to resist damage from underwater explosions.**
- This new hull design eliminates the transverse frames of conventional hull construction and connects inner and outer hull by longitudinal members. **The cost to fabricate the hull and outfit the**

Computational Ship Hydrodynamics

- New computational ship hydrodynamics technology allows ship designers to simulate the fluid dynamics and various ocean forces affecting the performance of a ship.

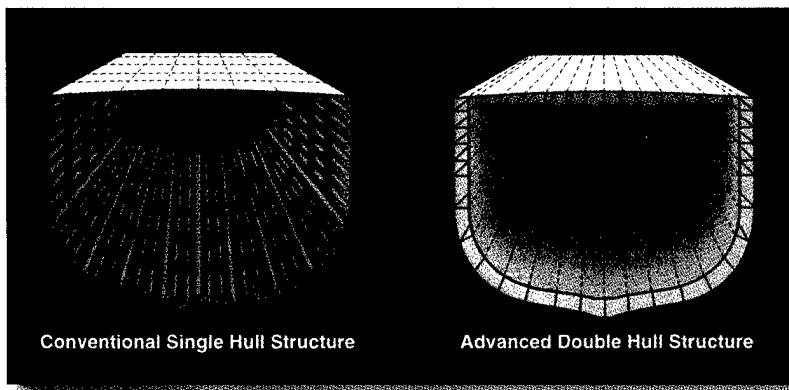

Conventional Single Hull Structure

Advanced Double Hull Structure

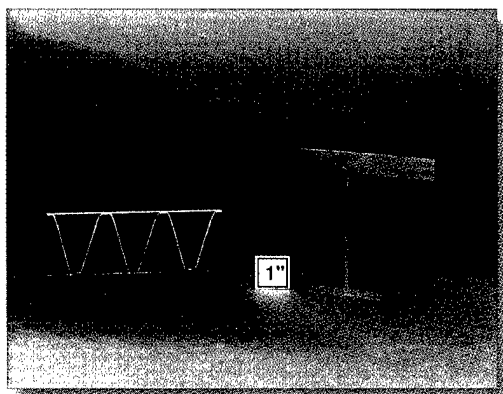

New LASCOR material on left, old heavy material on right. Note scale indicating one square inch.

- Tests, which represent the effects of a ship under attack by a mine under the keel or in contact with the hull, indicate that the hull has increased resistance to underwater explosion whipping and holing damage.

In Situ Bio-Emulsifier Cleaning of Oil/Water Separators

- A strain of bacteria recently produced through research, has proven to be a natural oil emulsifier for and has demonstrated its effectiveness in cleaning the oily sludge that builds up on oil/water separator plates onboard Navy ships.
- This new bacteria provides an ecologically sound method of cleaning that does not expose personnel to toxic sludge. It also reduces cleaning time and costs.



Antibiofouling Technology—Biocorrosion

- Investigators recently demonstrated the role of bacteria in the corrosion of copper and stainless steel. Results

showed that certain marine bacterium have a high binding capacity for copper and probably drive the metal leaving rates which facilitate corrosion.

- The studies defined the relationship between bacterial and pit corrosion.
- The findings will be used to provide effective methods for preventing fouling instead of costly removal.

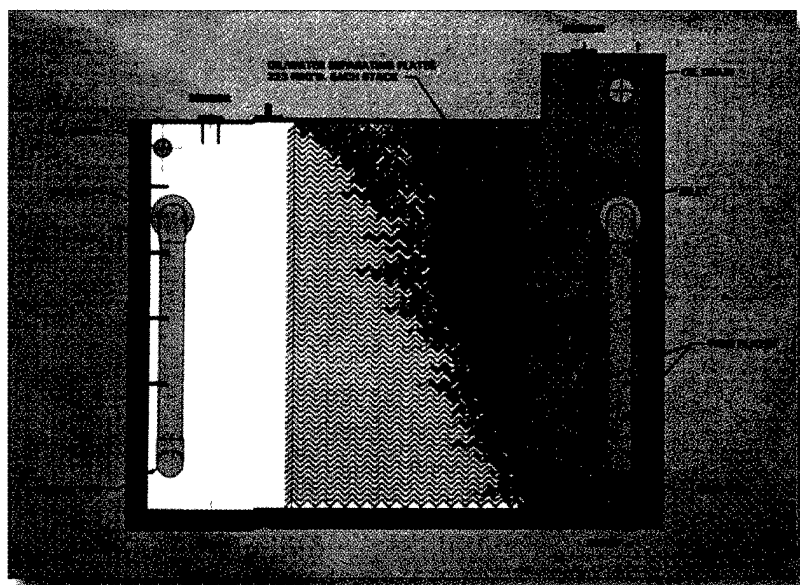

High Pressure Water Jet Demonstration

- A water-blasting, capturing and recycling system has been successfully demonstrated to remove hull and freeboard paint, non-skid coatings from a carrier deck, and the paint and residue left following the removal of hull tiles from a submarine.
- This new system **reduces the volume of environmental waste produced from paint removal by over 5,000 percent**, eliminates airborne dust and meets new, stricter environmental laws.
- Naval shipyards **will save millions of dollars** removing hull paint and containing the associated environmental waste.

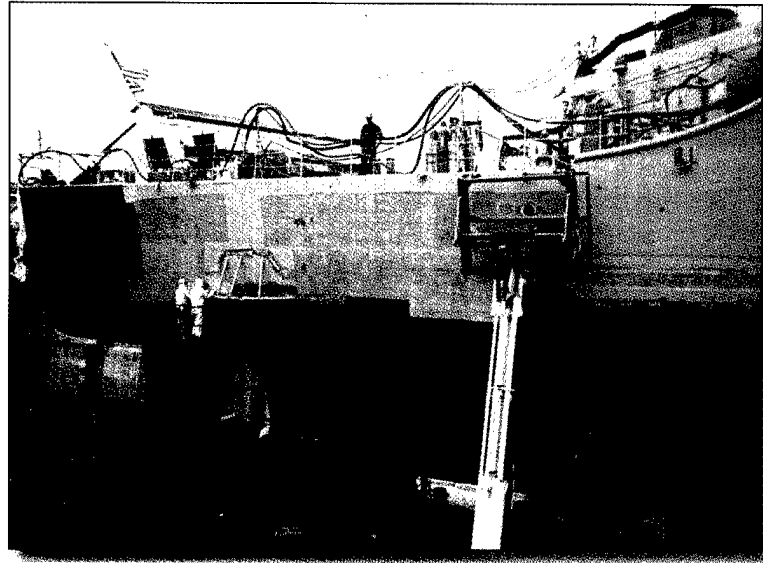

Superconducting Coil Development and Motor Demonstration

- A motor demonstration using new high-temperature superconducting (HTS) magnets indicates continuous **improvement in conductors** with wire lengths now over one kilometer, current ratings over 10,000 amperes/cm², and large coils carrying over 100 amperes. The first sets of "motor magnets" have been delivered and have successfully undergone preliminary tests. These magnets represent the largest, in terms of stored energy, of any HTS magnet to date.
- Several important areas where superconducting technology impacts requirements include mine sweeping and ship propulsion, where lighter weight, more efficient **superconducting motors could revolutionize ship design and operation.**

MANPOWER, READINESS AND SUPPORT

Components Demonstrated in Advanced Self-Defense Combat System Advanced Technology Demonstration

- Two critical efforts to **maintain and improve the performance of tactical action officers** have recently been demonstrated.
 - *The first effort provides situational awareness and scenario prediction, programmed to include "estimation of intent" data in its calculations.*
 - *The second effort, a goal-driven tactical response planner which employs a real-time multiple weapons scheduler, was demonstrated to produce **four plans per second on more than 90 tracks**. Additionally, requirements for the equipment that would present a multisource, composite tactical picture were completed.*

- These new technologies optimize the effective use of combat system resources.

All-Organic Flexible Liquid Crystal Displays

- New, flexible conducting substrates for the fabrication of liquid crystal displays offers a radical new approach to flexible, rugged displays.
- Use of the All-Organic Flexible Liquid Crystal Displays **will save money**, replacing current technology which has been susceptible to cracking at high degrees of curvature and is expensive to process.



Liquid Crystal Displays

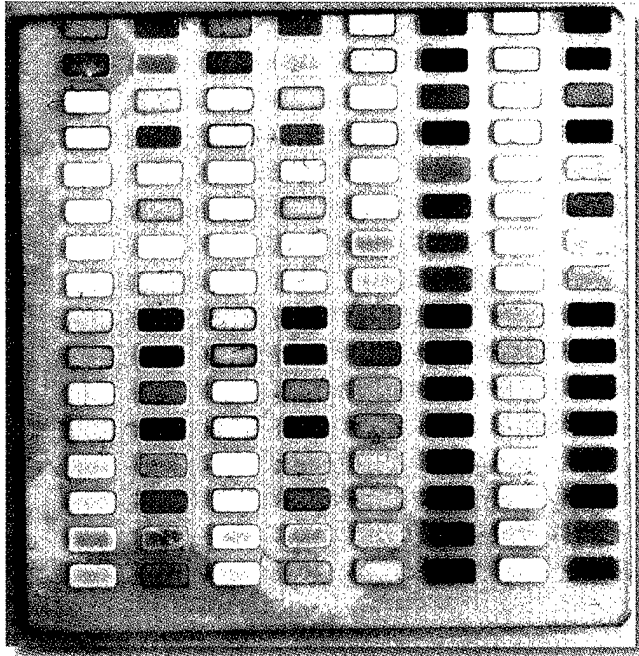

A 128 member solid state library containing superconducting copper oxide thin films with all combinations and different stoichiometrics of the oxides of bismuth, calcium and strontium.

Materials Discovery Through Biomimetic Principles

- A new materials discovery system facilitates the synthesis and testing of whole libraries of novel materials at a rate **10,000 times faster** than previously established methods.
- This new system, has already led to the discovery of cobalt-containing giant magnetoresistive oxides that are expected to prove useful as memory materials.

Freeze-Dried Blood Advance Technology Demonstration

- As part of the Freeze-Dried Blood Advanced Technology

Demonstration, freeze-dried platelets were recently shown to stop bleeding in animal models, a proof of principle for the concept.

- Freeze-dried human blood **will greatly simplify the logistics of collection,**

transport, and storage during times of war.

- The new processing method also appears to **eliminate life-threatening bacteria and viruses** as possible contaminants of the blood products.



Helmet Mounted Mission Rehearsal Simulation System

- A perspective scene generation software called PowerScene has demonstrated its ability to receive digital imagery from a satellite transmission and to display dynamic imagery in real-time.
- PowerScene has been integrated into a helmet mounted display system that is being used for intelligence and for mission preview, rehearsal and planning.

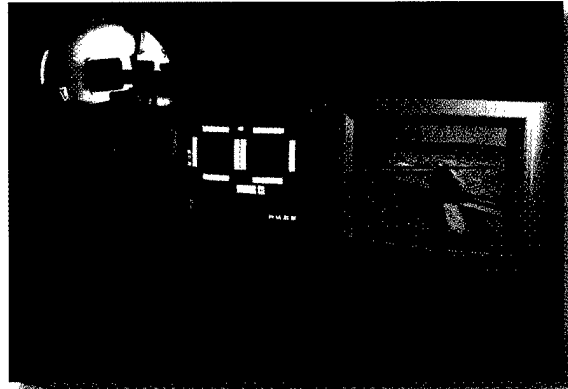

- Dehydroepiandrosterone (DHEA), a natural steroid, administered under the skin within an hour of trauma was shown to preserve the normal function of the immune system and to increase resistance to bacterial challenges in animal models.

Immunoprotection in Trauma by the Steroid DHEA

- Combat casualties that survive the acute consequences of trauma are highly susceptible to secondary infections and sepsis thought to be a consequence of immune system compromise by trauma-associated stress.



ELECTRONIC WARFARE

Multiband Antiship Cruise Missile Tactical EW System (MATES)

- A new laser-based counter-measures system which employs infrared seeker technology for **defense against antiship cruise missiles** has been successfully demonstrated.
- In action, MATES is first cued to an incoming missile by a surveillance sensor, it then determines the range and type of the threat. Next, it transmits a modulated infrared waveform which causes the threat missile seeker to breaklock and either fly in the water, lock onto a deployed decoy or enter the search phase again.

Passive Radio Frequency Targeting

- A compact (1 cubic foot, 35 pound) **pylon-mounted precision passive radio frequency targeting system** for the suppression of enemy air defenses has been developed.
- Successfully tested aboard F/A-18 aircraft against ground-based emitters, the system provides bearing and range data, enabling pilots to **detect enemy radar and target their HARM defenses well before becoming targets themselves.**
- Coupled with other radar-related electronic warfare techniques in battlespace tactics, this targeting system may also confirm the identification of specific emitters and their known air defense characteristics.

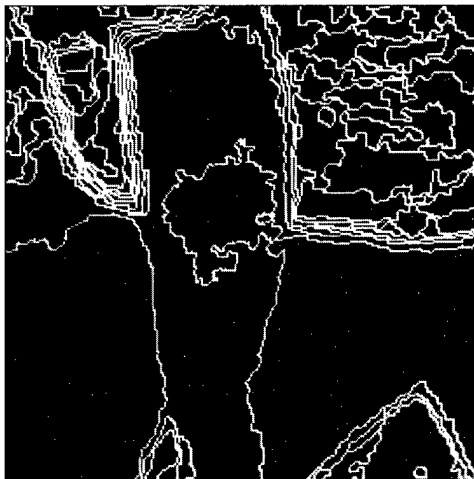

Segmentation of arm, showing region of suspected tattoo.

Multiscale Image Processing

- Multiscale image processing provides details of visual information from images, not perceivable by the human eye, that can be targeted, enhanced, and extracted from a background of "clutter."
- The technique was used during the Los Angeles riots when an assaulter was captured on film and convicted after multiscale processing produced the outline of a rose tattoo on his arm that was sufficiently accurate to provide convincing evidence in the case. This year, the technique assisted the Navy in enhancing images of an unsuccessful takeoff of an F/A-18 from the USS ABRAHAM LINCOLN (CVN 72). It was determined

by using multiscale imaging that the fault lay in stabilator failure associated with the flight control computer, not the plane's angle of attack.

- Other applications for the new image processing technique include **detection of targets, guidance, battle damage assessment, prospecting, security, and general photo enhancement.**

Improved Phased-Array Communications and Radar

- Improved gallium arsenide chip manufacturing techniques allow **affordable production** of advanced communication and radar systems.
- Fabrication of transmit/receive modules has been **reduced from \$6,000 per unit to under \$1,500**, a 75 percent reduction.

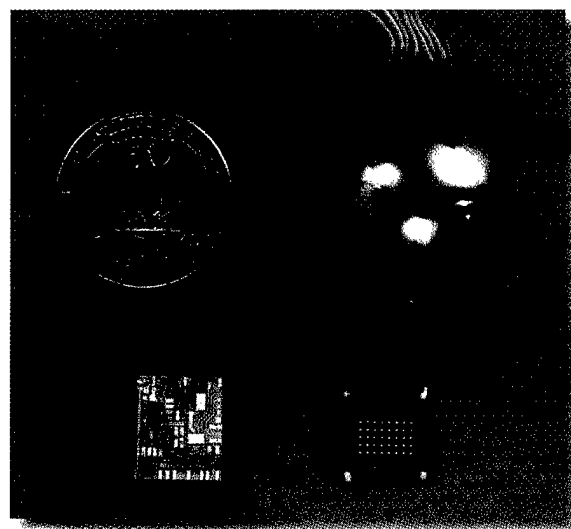

Infrared Search and Track (IRST) System

- Enabling tactical fighter pilots to detect and track closely spaced aircraft at long ranges has been a fleet objective for more than 15 years.
- The AN/AAS-42, Infrared Search and Track (IRST) system recently reached initial operational capability (IOC) on the Navy's F-14D fighter aircraft. The AN/AAS-42 is the first tactical airborne IRST to reach operational status.
- The AN/AAS-42 is a long wavelength infrared sensor that provides **passive day**

and night autonomous air surveillance and precision tracking of potential adversaries at tactically significant ranges. Long-range passive IR surveillance is now in the fleet and significantly increases Navy air superiority mission effectiveness.

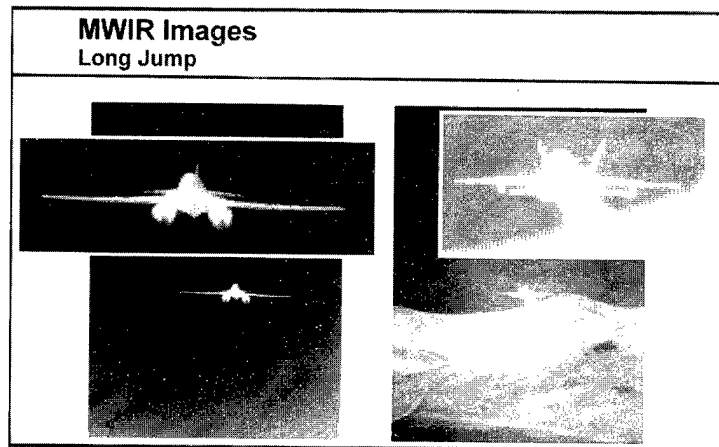

AIR WARFARE

Air Vehicle Diagnostic System (AVDS)

- Recent accomplishments of the Air Vehicle Diagnostic System Advanced Technology Demonstration include:
 - *an AVDS gearbox diagnostic algorithm identified severely damaged CH-46 helicopter aft gearbox spiral bevel pinion and ring gears presumed to be in good condition.*
 - *a rotor acoustics monitoring system detected and isolated a 0.029" fatigue crack in a CH-46 pitch shaft some 10,000 fatigue cycles prior to its visual detection. Because such fatigue cracks have resulted in several Class A mishaps and numerous fatalities, this accomplish-*

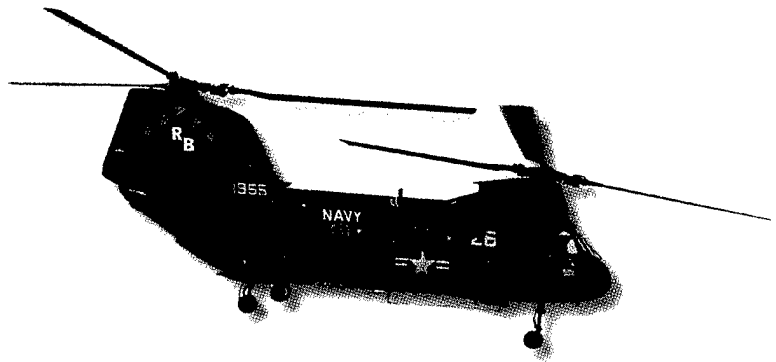

ment represents an especially significant leap forward for crew safety.

- Machine-based diagnostics from the AVDS program (for real-time in-flight rotor health monitoring; optical oil debris monitoring; in-cockpit monitoring; structural flight envelope cueing; etc.) **reduces maintenance and inspection costs** while improving safety and ensuring that conditions for safe flights are met.

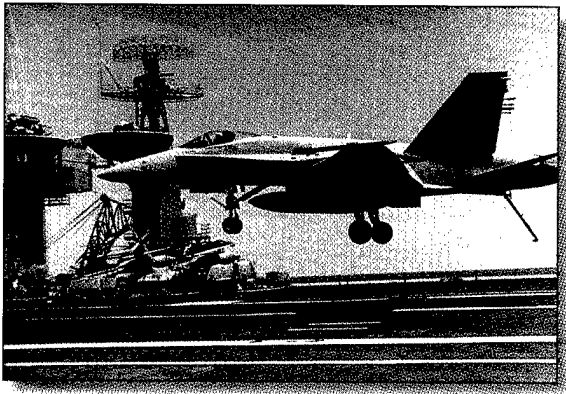

AirMet 100 Ultra-High Strength Steel

- Use of this durable, ultra-high strength, corrosion-resistant steel results in significant **weight and life-cycle cost savings**, as well as **improved fatigue, fracture, and environmental resistance**.
- The AirMet steel is now being used for the Navy's F/A 18E/F aircraft landing and arresting gear.
- Future applications include the F/A-18E/F horizontal stabilator (tail) spindle, V-22 swashplate actuator component, F-14 wing pivot pins, helicopter components and armor.

UNICOAT: Pollution Prevention Coating

- This "self-priming," single-layer topcoat eliminates the need for a primer when painting aircraft, **saving time and money**.
- Emissions from the hazardous, volatile organic compounds associated with painting are greatly reduced.
- UNICOAT contains no harmful lead, chromium, or strontium chromate, and **meets environmental requirements**.



Integrated High Performance Turbine Engine Technology (IHPTET)

- This Tri-Service program represents a coordinated effort to double propulsion system capability by the 21st Century. Recent achievements include:
 - a 30 percent increase over the 1987 baseline in thrust-to-weight ratio,
 - attainment of a target turbine inlet temperature of 600 degrees Fahrenheit,
 - a 20-30 percent decrease in fuel consumption and other engine-related costs, and
 - improved manufacturing processes, such as "castcool"

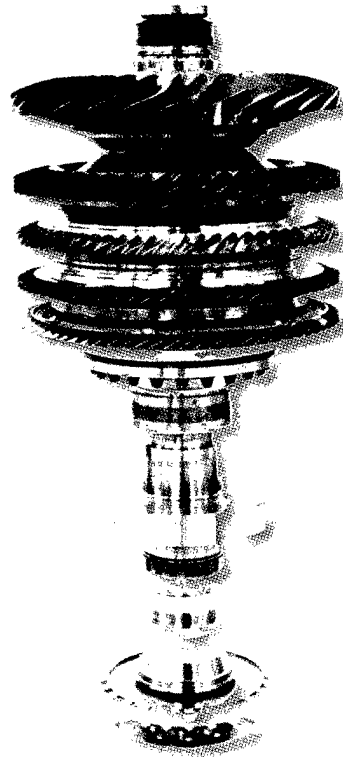

casting that produces single piece complex aerodynamic shapes and cooling passages.

- Advances in design and manufacturing **boost power density levels while reducing costs.**

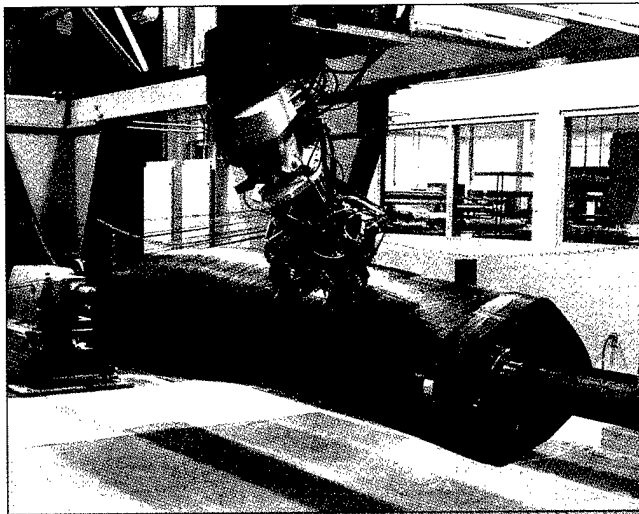

Aircraft Composite Components

- A new automated system has been developed for assembling of composite components, such as air inlet ducts, the stabilator and horizontal surfaces, in the F/A-18 aircraft. This new system replaces the time-consuming and costly hand assembling method.
- Automated composite fiber lay-up techniques for complex shapes **reduce production time and increase the quality of aircraft skin and control surfaces components** due to the conformity and repetition of the process.
- Lightweight skin and control surfaces in high-performance aircraft allow **greater weapons and sensor loadout.**

MISSILES, TORPEDOES AND WEAPONRY

CL20 Decreased Sensitivity, Increased Density Explosive

- A new high-energy CL-20 formulation provides **energy density level increases of 10 percent or more** and provides reduced sensitivities when mixed with other chemicals for specific applications.
- Efforts to bring CL20 into production for commercial and military use have **reduced the manufacturing costs from \$50K to \$600 per pound.**
- When used as a propellant, CL20 will significantly extend the range of a missile.

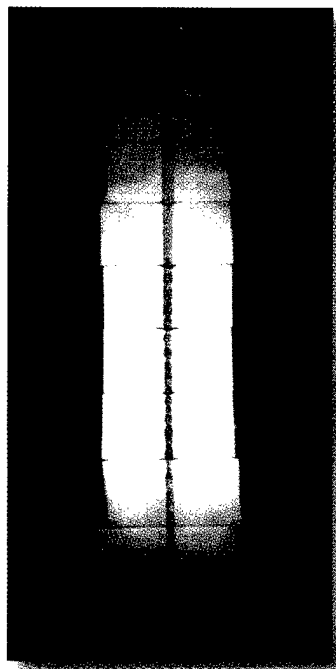

Demonstrated depth of penetration approximately 20% greater than equivalent HMX explosives.

Hydrox Propulsion

- New HYDROX-based engines achieve **high-energy efficiency in closed-cycle systems** by driving turbines with steam produced by burning hydrogen and oxygen.
- This new technology paves the way for wakeless torpedo deployment and a variety of novel unmanned underwater vehicles as well as **increased power, range, and stealth.**

Foot-high core of HYDROX engine technology. Chamber burns hydrogen and oxygen at extremely high temperatures to produce turbine-driving steam, which will provide propulsion for far ranging Unmanned Underwater and Unmanned Air Vehicle missions.

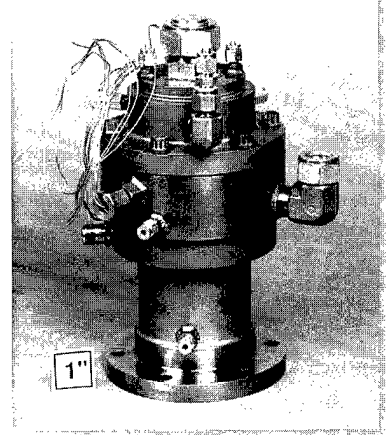

Lithium-based storage medium provides HYDROX fuel for small closed-system engine for long-distance UUV/UAV propulsion.

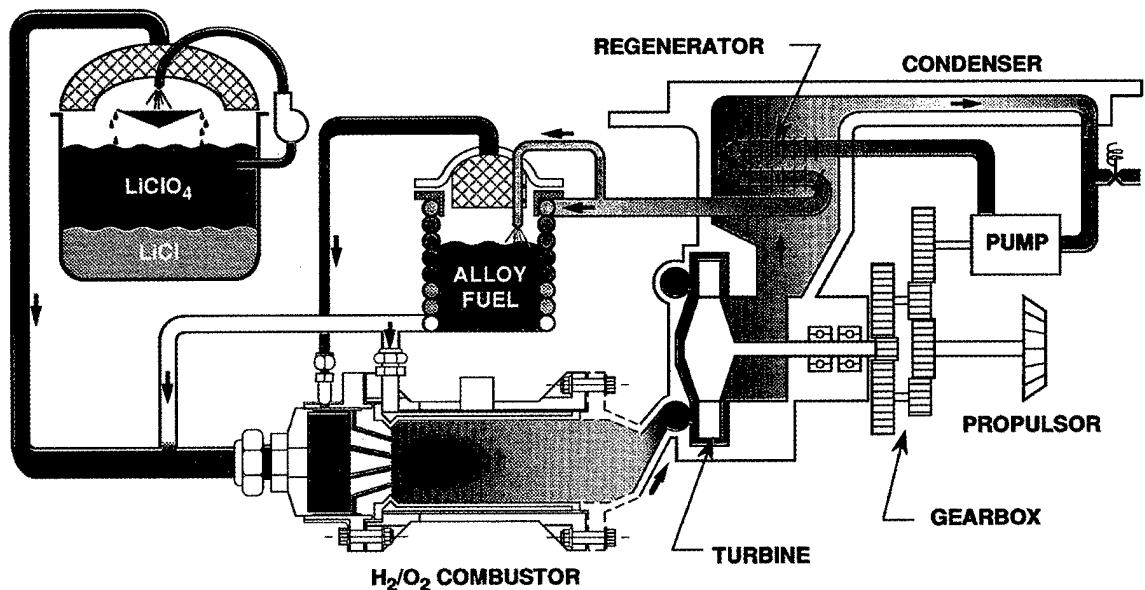

Shallow Water Torpedo Guidance and Control Advanced Technology Demonstration

- An “intelligent controller” has been demonstrated which is capable of **facilitating detection, classification, and homing** of small, low-signature, and lethally armed diesel-electric submarines in shallow littoral waters.
- In addition to its general antisubmarine capabilities, the controller offers an “adaptable tactic” ability and can adjust to varying target, countermeasure, and acoustic characteristics. In-water tests of the device have demonstrated a **10db improvement** in detection functions and the ability to adapt and generate new tactics in real-time.
- The detection, classification and homing improvements will go directly into planned upgrades of the Mk50, Mk48, ADCAP, and Lightweight Hybrid Torpedo.



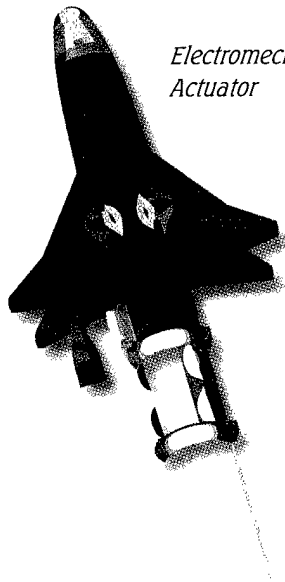

Electromechanical Actuator

Electromechanical Actuator (EMA) Technology

- A novel electromechanical actuator (EMA) produces a frequency response **27 times faster** than that of the existing pneumatic actuator. This new capability enables a reduced **time constant without increased costs.**
- The new technology has been delivered to the AIM-9X

program for flight tests and is expected to speed the air-to-air missile's sudden direction-changing reaction time, increase control at high angles of attack, and save space inside its 5 inch diameter fuselage.

Insensitive Matrix Component for Use of Missile Propellants

- A new family of energetic polymers has been developed which **suspends the main fuel ingredient, resists unintended ignition (e.g., by bullet shock), provides even burning fuel, combusts itself, reduces fuel weight, and proves environmentally sound** in storage and following combustion.
- The novel, safe matrix formulations will be used to improve missile performance.

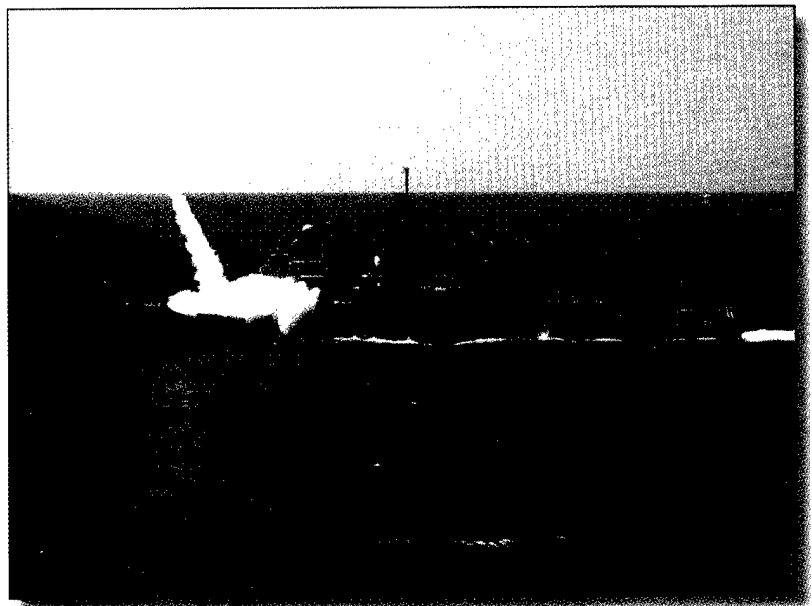

Advanced Missile Airframe Advanced Technology Demonstration (ATD)

- Developments to date include: Insensitive Energetic Reduced Smoke (IERS) propellants, a high-frequency response electromechanical actuator, and high-angle of attack aerodynamic prediction tools.
- The propellant **boosts energy density by more than five percent** over state-of-the-art Sidewinder propellant; the actuator provides sufficient bandwidth and torque required for the control of emerging rapidly-responding airframe concepts and the high angle of attack tools are expected to contribute

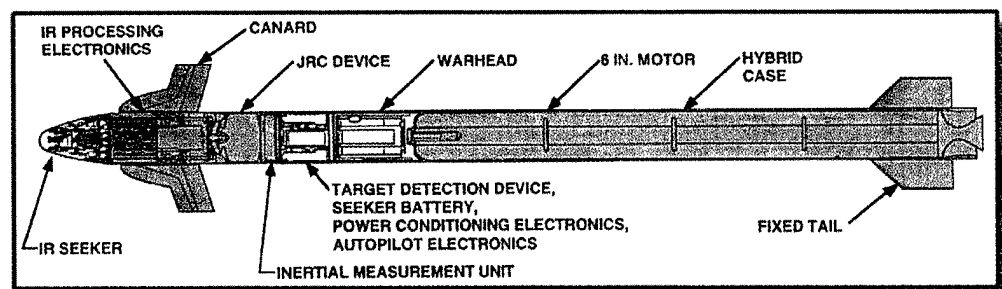

sufficient aerodynamic data for the ATD.

- As part of the ongoing program, the Advanced Missile Airframe Advanced Technology Demonstration should demonstrate a **factor of 8 reduction** turn radius capability for future missile systems.

Weapons Technology Concentric Canister Launcher Advanced Technology Demonstration (ATD)

- Successfully demonstrated “canister tubes”—the result of new computational fluid dynamic and thermal models and experimentation with subscale canister tube materials—will lead to an **affordable, versatile, and reloadable multiweapon launcher system** for missiles, torpedoes, sensors and countermeasures.
- Titanium and steel canister launchers as thin as .09 inches were successfully demonstrated.
- One-quarter to one-half scale fly-out testing of missiles (Tomahawk, Evolved Sea Sparrow, and Standard Missile 2 Block IV) proved successful. The data from these demonstrations enables an early start on a full scale demonstration.

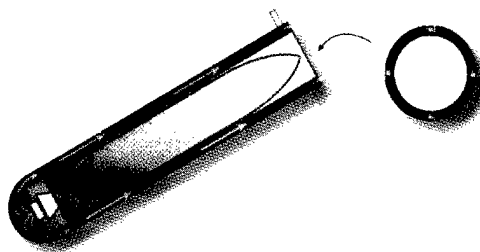

H-Infinity Methods Transition to Highly Responsive Missile Control Systems

- New intercept missile autopilot technology allows adjustment to target behavior with optimal efficiency and lethal effect. This new system should substantially **improve ship defenses against threats posed by anti-ship cruise and theater ballistic missiles.**
- This new technology uses algorithms based on “H-infinity” control principals which take into account high levels of uncertainty across

relevant guidance, targeting, and flight-maintenance variables-enabling exceptionally rapid decisions within the autopilot. **Reductions in autopilot time constants by a factor of three may be realized.**

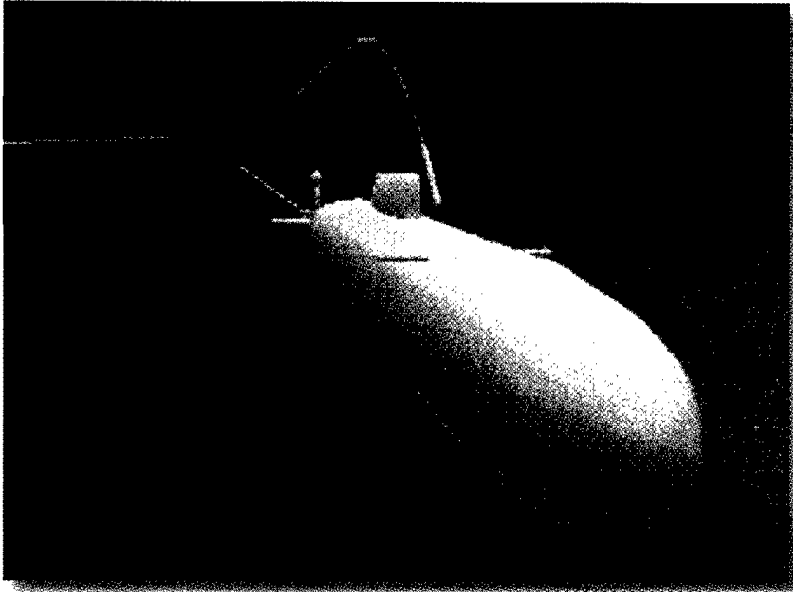

Terminal Placement Advanced Technology Demonstration

- ONR's Terminal Placement Advanced Technology Demonstration is an effort to maximize the effectiveness of the bulk charge and directed energy warheads used in antisubmarine warfare.
- Demonstrations were performed in-water against a real target, which studied variables including water depth and target depth and speed.
- In addition to demonstrating new capabilities, in-water test results produced excellent agreement with simulations, strengthening the role simulations may plan in the further development of antisubmarine guidance and weapons systems.

Anti-torpedo Torpedo

- A new warfighting weapon technology to defend surface ships and submarines against attacking torpedoes.
- Capable of high speeds and extreme accuracies, the Anti-torpedo Torpedo will provide for precision kills of attacking torpedoes which penetrate other defenses. Recent testing resulted in the technology exceeding stringent design specifications for weight and space and surpassing goals for guidance and control systems for close approach capabilities.
- Technology development to meet full operational requirements is continuing. Initial capability will transition into an Advanced Technology Demonstration in FY 97.

32

