



**AFCTN Test Report
94-029**

**AFTB-ID
93-015**



Technical Publication Transfer

Using:



Cubic Defense Systems' Data



**MIL-M-28001A (SGML)
MIL-D-28003 (CGM)**



Quick Short Test Report



02 March 1993

DEFINITION STATEMENT E
Approved for public release
Distribution Unlimited

19960822 156



Prepared for
Electronic Systems Center

DIGC QUALITY INSPECTED 3

DISCLAIMER NOTICE

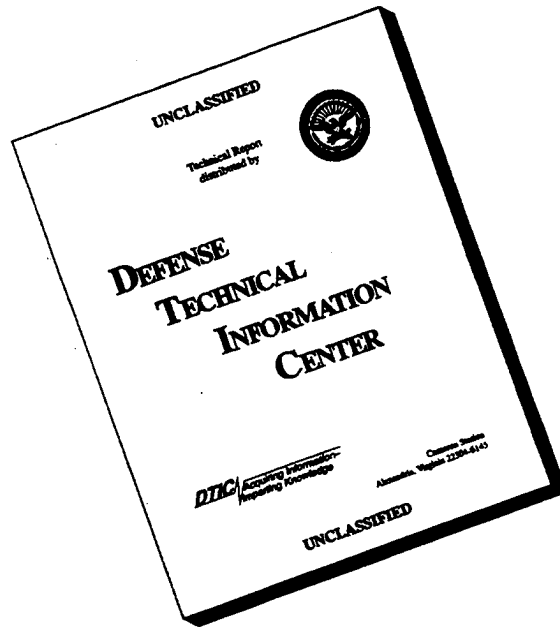

THIS DOCUMENT IS BEST QUALITY AVAILABLE. THE COPY FURNISHED TO DTIC CONTAINED A SIGNIFICANT NUMBER OF PAGES WHICH DO NOT REPRODUCE LEGIBLY.

AFCTN Test Report
94-029

AFCTB-ID
93-015

Technical Publication Transfer
Using:
Cubic Defense Systems' Data

MIL-M-28001A (SGML)
MIL-D-28003 (CGM)

Quick Short Test Report

02 March 1993

Prepared By

Air Force CALS Test Bed
Wright-Patterson AFB, OH 45433

AFCTB Contact

Gary Lammers
(513) 427-2295

AFCTN Contact

Mel Lammers
(513) 427-2295

DTIC QUALITY INSPECTED 3

DISCLAIMER

This document was prepared as an account of the work sponsored by the Air Force. Neither the United States Government, the Air Force, nor any of their employees, makes any warranty, express or implied, or assumes any legal liability or responsibility for the accuracy, completeness, or usefulness of any information, apparatus, product, or process disclosed, nor represents that its use would not infringe on privately owned rights. Reference herein to any specific commercial products, process, or service by trade name, trademark, manufacturer, or otherwise, does not necessarily constitute or imply its endorsement, recommendation, or favoring by the United States Government or the Air Force. The views and opinions of authors expressed herein do not necessarily state or reflect those of the United States Government or the Air Force, and shall not be used for advertising or product endorsement purposes.

Available to the public from the
National Technical Information Service
U.S. Department of Commerce
5285 Port Royal Road
Springfield, VA 22161

This report and those involved in its preparation do not endorse any product, process, or company stated herein. Use of these means by anyone does not imply certification by the Air Force CALS Test Network (AFCTN).

Contents

1.	Introduction.....	1
1.1.	Background.....	1
1.2.	Purpose.....	2
2.	Test Parameters.....	3
3.	1840A Analysis.....	5
3.1.	External Packaging.....	5
3.2.	Transmission Envelope.....	5
3.2.1.	Tape Formats.....	5
3.2.2.	Declaration and Header Fields.....	5
4.	IGES Analysis.....	6
5.	SGML Analysis.....	6
6.	Raster Analysis.....	7
7.	CGM Analysis.....	7
8.	Conclusions and Recommendations.....	10
9.	Appendix A - Tapetool Report Logs.....	11
9.1.	Tape Catalog.....	11
9.2.	Tape Evaluation Log.....	12
9.3.	Tape File Set Validation Log.....	18
9.4.	Other Tape Reading Logs.....	20
10.	Appendix B - Detailed SGML Analysis.....	21
10.1.	Parser Log.....	21
10.1.1.	First Attempt DTD.....	21

10.1.2.	Third Pass - DTD.....	22
10.1.3.	Text File Log.....	23
10.2.	Exoterica Parser.....	24
11.	Appendix C - Detailed CGM Analysis.....	25
11.1.	File D001C001.....	25
11.1.1.	Parser Log MetaCheck.....	25
11.1.2.	validcgm Log.....	27
11.1.3.	MetaView Log.....	28
11.1.4.	Output Harvard Graphics 3.05.....	29
11.1.5.	Output cgm2draw/IslandDraw.....	30
11.1.6.	Output IslandDraw.....	31
11.1.7.	Output HiJaak Windows.....	32
11.1.8.	Output Designer.....	33
11.1.9.	Output Ventura Publisher.....	34
11.2.	File D001C002.....	35
11.2.1.	Parser Log MetaCheck.....	35
11.2.2.	validcgm Log.....	37
11.2.3.	MetaView Log.....	38
11.2.4.	Output Harvard Graphics 3.05.....	39
11.2.5.	Output cgm2draw/IslandDraw.....	40
11.2.6.	Output IslandDraw.....	41
11.2.7.	Output HiJaak Windows.....	42
11.2.8.	Output Designer.....	43
11.2.9.	Output Ventura Publisher.....	44

11.3.	File D001C003.....	45
11.3.1.	Parser Log MetaCheck.....	45
11.3.2.	validcgm Log.....	47
11.3.3.	Metview Log.....	48
11.3.4.	Output Harvard Graphics 3.05.....	49
11.3.5.	Output cgm2draw/IslandDraw.....	50
11.3.6.	Output IslandDraw.....	51
11.3.7.	Output HiJaak Windows.....	52
11.3.8.	Output Designer.....	53
11.3.9.	Output Ventura Publisher.....	54
11.4.	File D001C004.....	55
11.4.1.	Parser Log MetaCheck.....	55
11.4.2.	validcgm Log.....	57
11.4.3.	MetaView Log.....	58
11.4.4.	Output Harvard Graphics 3.05.....	59
11.4.5.	Output cgm2draw/IslandDraw.....	60
11.4.6.	Output IslandDraw.....	61
11.4.7.	Output HiJaak Windows.....	62
11.4.8.	Output Designer.....	63
11.4.9.	Output Ventura Publisher.....	64
11.5.	File D001C005.....	65
11.5.1.	Parser Log MetaCheck.....	65
11.5.2.	validcgm Log.....	68
11.5.3.	MetaView Log.....	68

11.5.4.	Output cgm2draw/IslandDraw.....	69
11.5.5.	Output IslandDraw.....	70
11.5.6.	Output HiJaak Windows.....	71
11.5.7.	Output Ventura Publisher.....	72
11.6.	File D001C006.....	73
11.6.1.	Parser Log MetaCheck.....	73
11.6.2.	validcgm Log.....	75
11.6.3.	MetaView Log.....	76
11.6.4.	Output Harvard Graphics 3.05.....	77
11.6.5.	Output cgm2draw/IslandDraw.....	78
11.6.6.	Output IslandDraw.....	79
11.6.7.	Output HiJaak Windows.....	80
11.6.8.	Output Designer.....	81
11.6.9.	Output Ventura Publisher.....	82
11.7.	File D001C007.....	83
11.7.1.	Parser Log MetaCheck.....	83
11.7.2.	validcgm Log.....	86
11.7.3.	MetaView Log.....	89
11.7.4.	Output Harvard Graphics 3.05.....	90
11.7.5.	Output cgm2draw/IslandDraw.....	91
11.7.6.	Output IslandDraw.....	92
11.7.7.	Output HiJaak Windows.....	93
11.7.8.	Output Designer.....	94
11.7.9.	Output Ventura Publisher.....	95

1. Introduction

1.1 Background

The Department of Defense (DoD) Air Force Continuous Acquisition and Life-Cycle Support (CALs) Test Network (AFCTN) is conducting tests of the military standard for the Automated Interchange of Technical Information, MIL-STD-1840A, and its companion suite of military specifications. The AFCTN is a DoD sponsored confederation of voluntary participants from industry and government managed by the Electronic Systems Center (ESC).

The primary objective of the AFCTN is to evaluate the effectiveness of the CALs standards for technical data interchange and to demonstrate the technical capabilities and operational suitability of those standards. Two general categories of tests are performed to evaluate the standards; formal and informal.

Formal tests are large and comprehensive, which follow a written test plan, require specific authorization from the DoD, and may take months to prepare, execute, and report.

Informal tests are quick and short, used by the AFCTN technical staff, to broaden the testing base. They include representative samples of the many systems and applications used by AFCTN participants. They also allow the AFCTN staff to gain feedback from many industry and government interpretations of the standards, to increase the base of participation in the CALs initiative, and respond to the many requests for help that come from participants. Participants take part voluntarily, benefit by receiving an evaluation of their latest implementation (interpretation) of the standards, interact with the AFCTN technical staff, gain experience using the standards, and develop increased confidence in them. The results of informal tests are reported in Quick Short Test Reports (QSTRs) that briefly summarize the standard(s) tested, the hardware and software used, the nature of the test, and the results.

1.2 Purpose

The purpose of the informal test, reported in this QSTR, was to analyze Cubic Defense Systems's interpretation and use of the CALS standards in transferring technical publication data. Cubic used its CALS Technical Data Interchange System to produce data, in accordance with the standards, and delivered it to the AFCTN technical staff on a 9-track magnetic tape.

2. Test Parameters

Test Plan: AFCTB 93-015

Date of Evaluation: 02 March 1993

Evaluators: George Elwood
Air Force CALS Test Bed
DET 2 HQ ESC/AV-2P
Suite 300
4027 Colonel Glenn Hwy
Dayton OH 45431-1672

Data Originator: Cathy Kothawala
Cubic Defense Systems
9333 Balboa Avenue
San Diego CA 92123
(619) 277-6780 X2883

Data Description: Technical Manual Test
1 Document Declaration file
1 Document Type Definitions (DTD)
1 Text/Standard Generalized Markup Language (SGML) File
7 Computer Graphics Metafile (CGM) files

Data Source System:

Text/SGML
 HARDWARE Unknown
 SOFTWARE Unknown

CGM
 HARDWARE Unknown
 SOFTWARE Inset Systems *HiJaak* v2.1

Evaluation Tools Used:

MIL-STD-1840A (TAPE)

SUN 3/280

AFCTN Tapetool v1.2.8 UNIX

XSoft CAPS/CALS v40.4

Texas Instruments (TI) Tapetool v1.0.1

MIL-M-28001 (SGML)

Cheetah Gold 486

Exoterica XGMLNormalizer v1.2e3.2

McAfee & McAdam Sema Mark-it v2.2.2

Public Domain sgmls

MIL-D-28003 (CGM)

SUN SparcStation 2

ArborText cgm2draw

Island Graphics IslandDraw v3.0

Cheetah Gold 486

Advance Technology Center

(ATC) MetaView R 1.12

ATC MetaCheck R 2.05

Software Publishing Corporation

(SPC) Harvard Graphics v3.05

Inset Systems HiJaak v2.1

Inset Systems HiJaak v1.0 Windows

Micrografx Designer v3.1

Corel Ventura Publisher

Standards

Tested:

MIL-STD-1840A

MIL-M-28001A

MIL-D-28003

3. 1840A Analysis

3.1 External Packaging

The tape arrived at the Air Force CALS Test Bed (AFCTB) enclosed in an overnight shipping bag. The exterior of the bag was marked with the magnetic tape warning label, as required by MIL-STD-1840A, para. 5.3.1.3. The tape was protected against physical damage.

The tape was enclosed in a barrier bag as required by MIL-STD-1840A, para. 5.3.1.2. Inspection of the tape reel showed the label indicating the recording density, as required by MIL-STD-1840A, para. 5.3.1. Enclosed in the box was a packing list showing all files recorded on the tape.

3.2 Transmission Envelope

The 9-track tape received by the AFCTB contained MIL-STD-1840A files. The files were named per the standard conventions.

3.2.1 Tape Formats

The tape was run through the AFCTB *Tapetool v1.2.8* utility. No errors were encountered while evaluating the contents of the tape labels.

The tape was evaluated using TI's version of *Tapetool* with no reported errors.

The tape was read using XSoft's *CAPS read1840A* with no reported errors.

3.2.2 Declaration and Header Fields

No errors were reported in the Document Declaration file or data file header by either the AFCTN *Tapetool* or the TI version of *Tapetool*.

The physical structure of the tape meets the CALS MIL-STD-1840A requirements.

4. IGES Analysis

No Initial Graphics Exchange Specification (IGES) files were included on this tape.

5. SGML Analysis

The DTD and text files from this document were tested using Exoterica's *XGMLNormalizer* parser. The first attempt generated messages about unknown entity elements. While these are legal entities they were not available to the AFCTB. Shown below is one of eight entity sets (ISO GK4) which had to be commented out. As reported, this entity set is not available in the AFCTB.

```
<!-- STANDARD TEXT ENTITIES -->
<!--
<!ENTITY % efddate PUBLIC "-//USA-DOD//ENTITIES EFFECTIVE DATE NOTICE
900102//EN" "entities/efdate.ent">
```

After these missing entities were commented out, the DTD parsed without a reported error. When the text file was parsed using the corrected DTD three errors were reported. The error log is included in the Appendix to this report. The DTD used the branch entity while the text file used service. The text file was also missing the end doc tag. When these errors were corrected the text file parsed without a reported error.

```
<!ENTITY % branch " af | navy | army | mc | dla | cg" >
```

The basic DTD was parsed using another parser available within the AFCTB with reported errors. This program also stopped at the entities not available in the AFCTB. The next reported error was a duplicate entity in two of the ISO

sets. After the above errors were corrected the DTD parsed without a reported error. The corrected text file was parsed without a reported error.

The corrected DTD was parsed using the Public Domain *sgmls* parser. The initial pass through the parser, with the basic DTD, generated the same errors as noted above. When corrected no errors were reported. The basic text file was parsed with the corrected DTD and the same errors reported by the Exoterica parser were reported with this parser. When a corrected text file was used, no errors were reported.

The DTD and text files have some basic errors which had to be corrected before they would parse, and therefore they do not meet the CALS MIL-M-28001A specification.

6. Raster Analysis

No Raster files were included on this tape.

7. CGM Analysis

This tape contained seven CGM files. The files were all converted to CGM using Inset Systems' *HiJaak*.

The seven files were evaluated using ATC's *MetaCheck* software with CALS options. Note: This is not the most current version of this software! This software reported that files C001, C005 and C006 did not meet the CGM or CALS CGM specification. The most common error was too many points for a polyline.

Error 8502: Element Class/ID: 4/1 Offset: 6846 octets Element No. 304
Invalid POLYLINE; the number of points may not exceed 1024.

The files were also evaluated using the AFCTN beta *validcgm* utility. This utility also reported the same errors. In addition, it reported an illegal cross hatch in files C004 and C007.

The AFCTB has several tools for viewing CGM files. These tools are not used to generate a pass/fail but to report how commercially available software can handle the files. Many of these products are used in the development of technical publications and are good indicators of usability. The use of these products is not an endorsement nor an indication of CALS conformance. All operations were Performed using the default settings.

The files were converted using ArborText's *cgm2draw* utility with reported errors. Files C001 and C005 had reported errors during the conversion process. The resulting files were read into Island Graphics' *IslandDraw*. Errors were noted on files C003 - C007. The most notable error was the displacement of circle or text entities. The circle entities appear to be flipped up, top to bottom. The text on the keyboards in file C004 was shifted to the right. Some of the lines are missing on file C005.

The files were imported into the Micrografx *Designer*. File C005 would not import while displaying in the import window. The remainder of the files appeared to be correct.

According to Michael Harrison of Micrografx, "Micrografx is aware of the problems associated with reading these files and is working on a solution to be implemented in a future release of our products."

The files were imported into SPC's *Harvard Graphics v3.05* with reported errors. Files C001 and C007 were reported as being too large. Files C004 and C006 reported clipped objects and adjusted points. File C005 was reported as a bad file. The color in the files caused problems during the printing of the hard copies. The text in the blocks of file C002 appeared on the screen, but did not come through on the printed copy. The right shift of the keyboard letter, noted above, was also noted in the *Harvard Graphics v3.05* output.

The files were imported directly into Inset Systems' *HiJaak for Windows* with no reported problems. No effort was made to increase the size of the images during printing, which resulted in very small images. The right shift of the letters on the keyboard of file C004 was also noted. File C005 was missing lines.

The files were all converted using Inset Systems' *HiJaak for DOS* into an IMG format without a reported problem.

The files were imported directly into Island Graphics' *IslandDraw* without a reported error. Files C004 and C005 reported the same errors as described above.

The files were read into ATC's *MetaView*. Because of the black background, little of the files displayed on the screen. All seven files had reported errors during this procedure. These errors are located in the Appendix to this report.

The files were imported directly into Corel's *Ventura Publisher* without a reported error. The keyboard letter shift and missing lines in files C004 and C005 were also noted.

The CGM files do not meet the CALS MIL-D-28003 specification, due to reported CALS errors in files C001, C005, and C007.

8. Conclusions and Recommendations

In summary, the tape from Cubic Defense Systems was correct. The tape could be read properly using three different tape utilities without any reported errors. The physical structure of the tape meets the CALS MIL-STD-1840A requirements.

The SGML and DTD both had errors which had to be corrected. The DTD and SGML files do not meet the CALS MIL-M-28001A specification.

The CGM files were both bad and good. Three of the seven files do not meet the specification. The outputs from several CGM utilities had noted errors. The CGM files do not meet the CALS MIL-D-28003 specification.

Due to the errors in the SGML and CGM files, the tape does not meet the CALS MIL-STD-1840A requirements.

9. Appendix A - Tapetool Report Logs

9.1 Tape Catalog

Air Force CALS Test Network Catalog Evaluation - Version 1.2; Release Number 8

Standards referenced:

- MIL-STD-1840A (1987) - Automated Interchange of Technical Information
- MIL-R-28003 (1988) - Digital Representation For Communication Of
Illustration Data; CGM Application Profile
- ANSI X3.27 (1987) - File Structure and labeling of Magnetic Tapes
for Information Interchange
- ANSI X3.4 (1986) - Coded Character Sets - 7 Bit ASCII

Tue Mar 2 13:25:53 1993

MIL-STD-1840A File Catalog

File Set Directory: /cals/tapetool8/Set075

Page: 1

File Name	File Type	Record Format/ Length	Block Length/Total	Selected/ Extracted
D001	Document Declaration	D/00260	02048/000001	Extracted
D001C001	CGM	F/00080	00800/000113	Extracted
D001C002	CGM	F/00080	00800/000012	Extracted
D001C003	CGM	F/00080	00800/000048	Extracted
D001C004	CGM	F/00080	00800/000082	Extracted
D001C005	CGM	F/00080	00800/000022	Extracted
D001C006	CGM	F/00080	00800/000013	Extracted
D001C007	CGM	F/00080	00800/000167	Extracted
D001G008	DTD	D/00260	02048/000018	Extracted
D001T009	Text	D/00260	02048/000059	Extracted

Catalog Process terminated normally.

9.2 Tape Evaluation Log

Air Force CALS Test Network Tape Evaluation - Version 1.2; Release Number 8
Standards referenced:

ANSI X3.27 (1987) - File Structure and labeling of Magnetic Tapes
for Information Interchange

ANSI X3.4 (1986) - Coded Character Sets - 7 Bit ASCII

Tue Mar 2 13:25:29 1993

ANSI Tape Import Log

Allocating tape drive /dev/rmt0...

/dev/rmt0 allocated.

VOL1CAL501

4

Label Identifier: VOL1
Volume Identifier: CAL501
Volume Accessibility:
Owner Identifier:
Label Standard Version: 4

HDR1D001 CAL50100010001000000 93060 00000 000000

Label Identifier: HDR1
File Identifier: D001
File Set Identifier: CAL501
File Section Number: 0001
File Sequence Number: 0001
Generation Number: 0000
Generation Version Number: 00
Creation Date: 93060
Expiration Date: 00000
File Accessibility:
Block Count: 000000
Implementation Identifier:

HDR2D0204800260

00

Label Identifier: HDR2
Recording Format: D
Block Length: 02048
Record Length: 00260
Offset Length: 00

Implementation Identifier:

HDR2F0080000080 00

Label Identifier: HDR2
Recording Format: F
Block Length: 00800
Record Length: 00080
Offset Length: 00

***** Tape Mark *****

Actual Block Size Found = 800 Bytes.

Number of data blocks read = 113.

***** Tape Mark *****

EOF1D001C001 CALS0100010002000000 93060 00000 000113

Label Identifier: EOF1
File Identifier: D001C001
File Set Identifier: CALS01
File Section Number: 0001
File Sequence Number: 0002
Generation Number: 0000
Generation Version Number: 00
Creation Date: 93060
Expiration Date: 00000
File Accessibility:
Block Count: 000113
Implementation Identifier:

EOF2F0080000080 00

Label Identifier: EOF2
Recording Format: F
Block Length: 00800
Record Length: 00080
Offset Length: 00

***** Tape Mark *****

<<<< PART OF LOG REMOVED HERE >>>>

***** Tape Mark *****

Generation Number: 0000
Generation Version Number: 00
Creation Date: 93060
Expiration Date: 00000
File Accessibility:
Block Count: 000059
Implementation Identifier:

EOF2D0204800260

00

Label Identifier: EOF2
Recording Format: D
Block Length: 02048
Record Length: 00260
Offset Length: 00

***** Tape Mark *****

***** Tape Mark *****

End of Volume CALS01

End Of Tape File Set

Deallocating /dev/rmt0...

Tape Import Process terminated normally.

9.3 Tape File Set Validation Log

Air Force CALS Test Network File Set Evaluation - Version 1.2; Release Number 8
Standards referenced:

MIL-STD-1840A (1987) - Automated Interchange of Technical Information

Tue Mar 2 13:25:53 1993

MIL-STD-1840A File Set Evaluation Log

File Set: Set075

Found file: D001

Extracting Document Declaration Header Records...

Evaluating Document Declaration Header Records...

srcsys: cubic defense systems inc 9333 Balboa Ave San Diego Ca 92123 CAGE 94987
srcdocid: T001DME
srcrelid: NONE
chglvl: ORIGINAL
dteisu: 19930301
dstsys: OO-ALC, AD/YIC
dstdocid: T001DME
dstrelid: NONE
dtetm: 19930301
dlvacc: NONE
filcnt: C7,G1,T1
ttlcls: UNCLASSIFIED
doccls: UNCLASSIFIED
doctyp: Technical Publication
docttl: NONE

Found file: D001C001

Extracting CGM Header Records...

Evaluating CGM Header Records...

srcdocid: T001DME
dstdocid: T001DME
txtfilid: W
figid: NONE
srcgph: boardno 15240002
doccls: UNCLASSIFIED
notes: NONE

Saving CGM Header File: D001C001_HDR

Saving CGM Data File: D001C001_CGM

<<<< PART OF LOG REMOVED HERE >>>>

Found file: D001C007
Extracting CGM Header Records...
Evaluating CGM Header Records...

srcdocid: T001DME
dstdocid: T001DME
txtfilid: W
figid: NONE
srcgph: boardno 15240233
doccls: UNCLASSIFIED
notes: NONE

Saving CGM Header File: D001C007_HDR
Saving CGM Data File: D001C007_CGM

Found file: D001G008
Extracting DTD Header Records...
Evaluating DTD Header Records...

srcdocid: T001DME
dstdocid: T001DME
notes: NONE

Saving DTD Header File: D001G008_HDR
Saving DTD Data File: D001G008_DTD

Found file: D001T009
Extracting Text Header Records...
Evaluating Text Header Records...

srcdocid: T001DME
dstdocid: T001DME
txtfilid: W
doccls: UNCLASSIFIED
notes: NONE

Saving Text Header File: D001T009_HDR
Saving Text Data File: D001T009_TXT

Evaluating numbering scheme...
No errors were encountered during numbering scheme evaluation.
Numbering scheme evaluation complete.

Checking file count...

No errors were encountered during file count verification.
File Count verification complete.

No errors were encountered in Document D001.

No errors were encountered in this File Set.

MIL-STD-1840A File Set Evaluation Complete.

9.4 Other Tape Reading Logs

No errors were reported from the other tape reading utilities.

10. Appendix B - Detailed SGML Analysis

10.1 Parser Log

10.1.1 First Attempt DTD

SGML Document Type Definition Parser
An SGML System Conforming to
International Standard ISO 8879
Standard Generalized Markup Language

```
Log file: '9315.LOG'  
SDO File: 'ctnddecl.sdo'  
Namecase General is yes.  
Namecase Entity is no.  
Parsing DTD file: '9315.dtd'  
<!--DOCTYPE doc PUBLIC "-//USA;DOD//DTD MIL-M-38784B 900102//EN"-- >  
<!DOCTYPE doc Parsing DOCTYPE DOC  
  
<!-- STANDARD TEXT ENTITIES -->  
  
<!ENTITY % efdate PUBLIC "-//USA-DOD//ENTITIES EFFECTIVE DATE NOTICE  
900102//EN" "entities/efdate.ent">  
<!ENTITY % dsclos PUBLIC "-//USA-DOD//ENTITIES DISCLOSURE NOTICE  
900102//EN" "entities/dsclos.ent">  
<!ENTITY % pgclas PUBLIC "-//USA-DOD//ENTITIES CLASSIFIED PAGES NOTICE  
900102//EN" "entities/pgclas.ent">  
<!ENTITY % copynum PUBLIC "-//USA-DOD//ENTITIES NUMBER OF COPIES NOTICE  
900102//EN" "entities/copynum.ent">  
<!ENTITY % usage PUBLIC "-//USA-DOD//ENTITIES USAGE NOTICE 900102//EN"  
"entities/usage.ent">  
<!ENTITY % distrb PUBLIC "-//USA-DOD//ENTITIES DISTRIBUTION NOTICE  
900102//EN" "entities/distrb.ent">  
<!ENTITY % super PUBLIC "-//USA-DOD//ENTITIES SUPERSEDURE NOTICE  
900102//EN" "entities/super.ent">  
<!ENTITY % prsuper PUBLIC "-//USA-DOD//ENTITIES PRELIMINARY SUPERSEDURE  
NOTICE 900102//EN" "entities/prsuper.ent">  
  
%efdate;DTD0157: External entity file 'entities/efdate.ent' cannot be  
opened. Reference ignored.  
In declaration: '<!DOCTYPE'.  
  
in line 38 in file '9315.dtd'  
DTD0153: Unknown parameter entity: 'efdate'. Reference ignored.
```

```
In declaration: '<!DOCTYPE'.
in line 38 in file '9315.dtd'
DTD0137: Incorrect token '%.'. Parser Ignoring Input Up To Next MDO.
In declaration: '<!DOCTYPE'.
in line 38 in file '9315.dtd'
DTD0021: Expected last block of type DOCTYPE or LINKTYPE.
In declaration: '<!DOCTYPE'.
in line 38 in file '9315.dtd'
.DTO file not created due to parsing errors.

<!ENTITY inodot DTD0143: Attempt to declare general entity name 'inodot'
more than once denied.
In declaration: '<!ENTITY'.
In declaration: '<!['.
In declaration: '<!['.
In declaration: '<!['.
In declaration: '<!['.
In declaration: '<!['.
In declaration: '<!DOCTYPE'.
in line 54 in file '\public\iso$lat2.ent'
in line 353 in file '9315.dtd'
SDATA "[inodot]"--=small i without dot-->
<!ENTITY radic SDATA "[radic ]"
```

10.1.2 Third Pass - DTD

SGML Document Type Definition Parser
An SGML System Conforming to
International Standard ISO 8879
Standard Generalized Markup Language

Log file: '9315.LOG'
SDO File: 'ctnddecl.sdo'
Namecase General is yes.
Namecase Entity is no.
Parsing DTD file: '9315.dtd'

DTD0096: The generic ID SHORTTITLE has not been used in any content
model, inclusion, or as a doctype element.

This DTD conforms to the ISO 8879 standard

DTO file '9315.DTO' created

closing statistics:

Capacity points: 63072
Bytes of DTO file string space: 14011

SGML descriptor blocks: 6331

Document Type Definition is compliant and parsed normally.
Program status code: 0.

10.1.3 Text File Log

IPA0108: *** SGML Instance Parser Log File ***
Source Document File: '9315.txt'.
Job File: '9315.jbf'.
DTD File: ''.
SGML Declaration File: ''.

Reading File '9315.jbf', File Type 'JOB FILE'.

Concrete Syntax Settings In Effect For This Parse:

NAMECASE GENERAL: YES.
NAMECASE ENTITY: NO.;
NAMELEN: 32.
SHORTTAG: YES.

Closed '9315.jbf', File Type 'JOB FILE'.

Reading File '9315.txt', File Type 'DIRECT INPUT FILE'.

--> Scanned Up To Line 100 In 9315.txt.
--> Scanned Up To Line 200 In 9315.txt.
--> Scanned Up To Line 300 In 9315.txt.
--> Scanned Up To Line 400 In 9315.txt.
--> Scanned Up To Line 500 In 9315.txt.
--> Scanned Up To Line 600 In 9315.txt.
--> Scanned Up To Line 700 In 9315.txt.
--> Scanned Up To Line 800 In 9315.txt.
--> Scanned Up To Line 900 In 9315.txt.
--> Scanned Up To Line 1000 In 9315.txt.
--> Scanned Up To Line 1100 In 9315.txt.
--> Scanned Up To Line 1200 In 9315.txt.
--> Scanned Up To Line 1300 In 9315.txt.
--> Scanned Up To Line 1400 In 9315.txt.
--> Scanned Up To Line 1500 In 9315.txt.
--> Scanned Up To Line 1600 In 9315.txt.
--> Scanned Up To Line 1700 In 9315.txt.
--> Scanned Up To Line 1800 In 9315.txt.
--> Scanned Up To Line 1900 In 9315.txt.
--> Scanned Up To Line 2000 In 9315.txt.
--> Scanned Up To Line 2100 In 9315.txt.

Closed '9315.txt', File Type 'DIRECT INPUT FILE'.

Document Parsed Successfully, No Errors or Warnings.

10.2 Exoterica Parser

```
C:\XGML\XGMLNORM.EXE --  
Error on line 3 in file \ws\9315.txt:  
A REQUIRED attribute is missing.  
For start tag 'DOC': For REQUIRED name-group attribute 'BRANCH'.  
Valid values are: "AF", "NAVY", "ARMY", "MC", "DLA" and "CG".
```

```
C:\XGML\XGMLNORM.EXE --  
Error on line 3 in file \ws\9315.txt:  
Undeclared attribute specification.  
For start tag 'DOC': Unknown attribute is 'SERVICE'.  
Allowed attributes for the element 'DOC' are: 'BRANCH', 'DOCID',  
'DOCSTAT', 'MANTYPE', 'SECURITY', 'RESTRICT', 'RELEASE', 'CODEWORD',  
'SCILEVEL' and 'DIGLYPH'.
```

```
C:\XGML\XGMLNORM.EXE --  
Error on line 2150 in file \ws\9315.txt:  
An end tag is missing that must not be omitted.  
The element is 'DOC'.
```

11. Appendix C - Detailed CGM Analysis

11.1 File D001C001

11.1.1 Parser Log MetaCheck

MetaCheck Version 2.05 -- CGM/MIL-D-28003 Conformance Analyzer
Copyright 1988-91 CGM Technology Software
Execution Date: 03/02/93 Time: 14:20:09

Metafile Examined : i:\9315\c001.cgm

Pictures Examined : All

Elements Examined : All

Bytes Examined : All

=====
Trace Report
=====

Tracing not selected.

=====
CGM Conformance Violation Report
=====

Bulletin 20027: Element Class/ID: 4/4 Offset: 652 octets Element No. 61
Warning; a foreground color has been defined and referenced by a primitive,
while the background color has not been defined.

=====
CALC CGM Profile (MIL-D-28003) Report
=====

Error 8505: Element Class/ID: 4/7 Offset: 53110 octets Element No. 1064
Invalid POLYGON; the number of points may not exceed 1024.

Error 8505: Element Class/ID: 4/7 Offset: 57534 octets Element No. 1065
Invalid POLYGON; the number of points may not exceed 1024.

Error 8505: Element Class/ID: 4/7 Offset: 64076 octets Element No. 1071
Invalid POLYGON; the number of points may not exceed 1024.

=====
Conformance Summary Report
=====

MetaCheck Version 2.05 -- CGM/MIL-D-28003 Conformance Analyzer
Copyright 1988-91 CGM Technology Software
Execution Date: 03/02/93 Time: 14:20:22

Name of CGM under test: i:\9315\c001.cgm

Encoding : Binary

Pictures Examined : All
Elements Examined : All
Bytes Examined : All

BEGIN METAFILE string : "HiJaak 2"
METAFILE DESCRIPTION : "HiJaak 2 MIL-D-28003/BASIC-1"

Picture 1 starts at octet offset 336; string contains: "Awesome!"

Conformance Summary : This file conforms to the CGM specification.

However, this file does not satisfy
the CALS CGM Profile (MIL-D-28003).

Summary of Testing Performed and Errors Found:

1 Pictures Tested
1619 Elements Tested
89710 Octets Tested

0 Illegal CGM Elements	1000 -	1999
0 Incorrect CGM Element Lengths	2000 -	2999
0 CGM State Errors	3000 -	3499
0 Required CGM Elements Missing or Wrong	4000 -	4499
0 CGM Parameter Values Out of Range	6000 -	6499
0 CGM Structure Errors	7000 -	7499
0 *** CGM Errors Found (total) ***		

0 Profile State Errors	3500 -	3999
0 Illegal Profile Elements	4500 -	4999
0 Profile Parameter Values Out of Range	6500 -	6999
3 Profile Data Limits Exceeded	8500 -	8999
0 Other Profile Constraints Violated	9500 -	9999
3 *** Profile Violations Found (total) ***		

1 Warnings (Advisory Remarks)	20000 -	20999
-------------------------------	---------	-------

2 distinct errors and warnings were reported.

=====
===== End of Conformance Report =====

11.1.2 validegmm Log

Analysis for file c001.cgm using table table

MILSPEC 28003 error: too many points

(1064, 53110) (4, 7, 4420) Polygon 1105 points
(2889,15752) (15752,2889) (2889,15752)
(2889,15752) (15752,2890) (2890,15751)
(2890,15751) (15751,2891) (2891,15749)

<<<< PART OF LOG REMOVED HERE >>>>

MILSPEC 28003 error: too many points

(1065, 57534) (4, 7, 6500) Polygon 1625 points
(7065,15093) (15093,7064) (7064,15093)
(7057,15093) (15093,7051) (7051,15093)
(7033,15093) (15093,7021) (7021,15093)

<<<< PART OF LOG REMOVED HERE >>>>

MILSPEC 28003 error: too many points

(1071, 64076) (4, 7, 4160) Polygon 1040 points
(4712,15716) (15716,4713) (4713,15716)
(4714,15716) (15716,4715) (4715,15716)
(4716,15716) (15716,4717) (4717,15716)

<<<< PART OF LOG REMOVED HERE >>>>

(4712,15716) (15716,4712) (4712,15716)
(4712,15716) (15716,4712)

(0, 1) occurred 1 time
(0, 2) occurred 1 time
(0, 3) occurred 1 time
(0, 4) occurred 1 time
(0, 5) occurred 1 time
(1, 1) occurred 1 time
(1, 2) occurred 1 time
(1, 3) occurred 1 time
(1, 4) occurred 1 time
(1, 7) occurred 1 time
(1, 8) occurred 1 time
(1, 10) occurred 1 time
(1, 11) occurred 1 time
(2, 1) occurred 1 time
(2, 2) occurred 1 time
(2, 3) occurred 1 time
(2, 4) occurred 1 time .

(2, 5) occurred 1 time
(2, 6) occurred 1 time
(2, 7) never occurred, required by standard B
(3, 1) occurred 1 time
(4, 1) occurred 214 times
(4, 4) occurred 28 times
(4, 7) occurred 138 times
(5, 2) occurred 92 times
(5, 3) occurred 171 times
(5, 4) occurred 152 times
(5, 8) occurred 152 times
(5, 14) occurred 152 times
(5, 15) occurred 3 times
(5, 16) occurred 6 times
(5, 22) occurred 29 times
(5, 23) occurred 45 times
(5, 27) occurred 92 times
(5, 28) occurred 171 times
(5, 29) occurred 152 times
(5, 30) occurred 2 times

11.1.3 MetaView Log

System Error: Error -1018 in function 14.
 cl/id: 4/4, offs: 652, esqn: 61
Interpreter limit exceeded: Data buffer overflow.
 element: 4/7, offset: 53110, sequence number: 1064
Interpreter limit exceeded: Data buffer overflow.
 element: 4/7, offset: 57534, sequence number: 1065
Interpreter limit exceeded: Data buffer overflow.
 element: 4/7, offset: 64076, sequence number: 1071
Error detected in file i:\9315\C001.CGM

11.1.4 Output Harvard Graphics 3.05

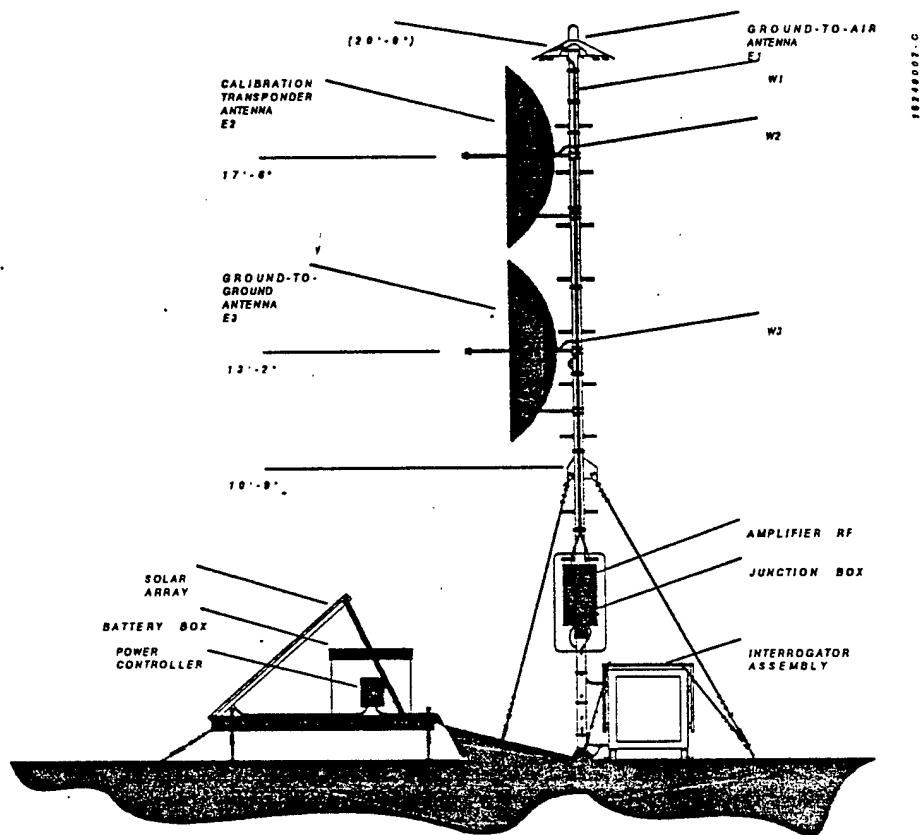

HG305 - D001C001

11.1.5 Output cgm2draw/IslandDraw

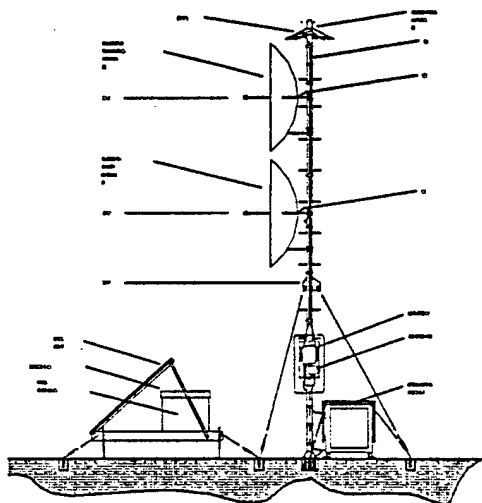

11.1.6 Output IslandDraw

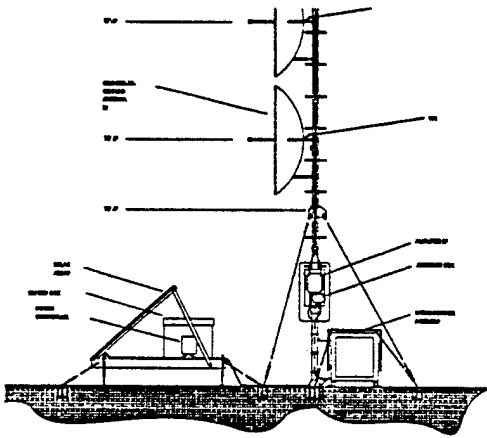

11.1.7 Output HiJaak Windows

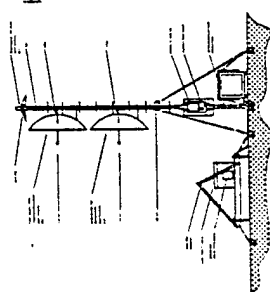

11.1.9 Output Ventura Publisher

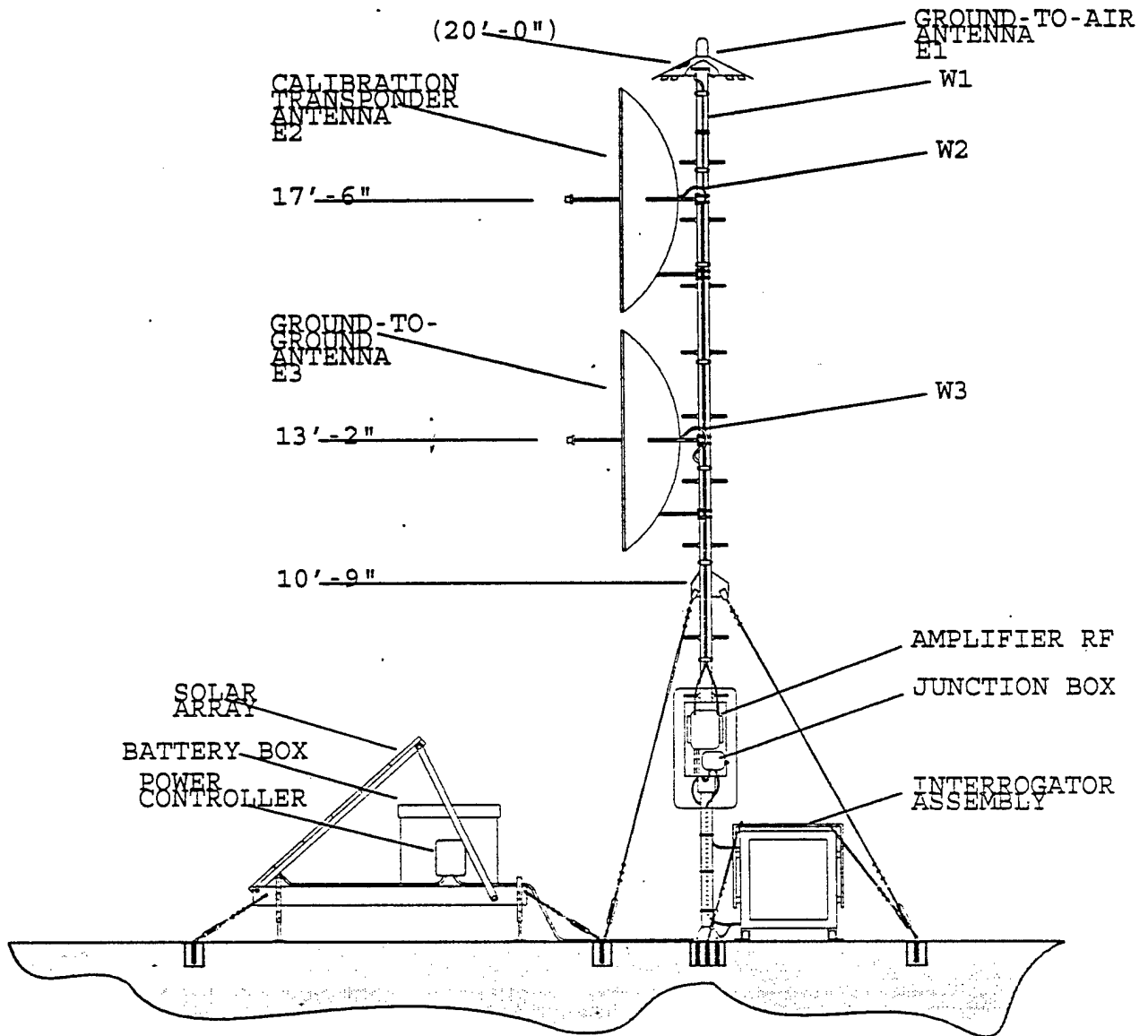

11.2 File D001C002

11.2.1 Parser Log MetaCheck

MetaCheck Version 2.05 -- CGM/MIL-D-28003 Conformance Analyzer
Copyright 1988-91 CGM Technology Software
Execution Date: 03/02/93 Time: 14:20:30

Metafile Examined : i:\9315\c002.cgm

Pictures Examined : All
Elements Examined : All
Bytes Examined : All

=====
Trace Report
=====

Tracing not selected.

=====
CGM Conformance Violation Report
=====

Bulletin 20027: Element Class/ID: 4/1 Offset: 660 octets Element No. 62
Warning; a foreground color has been defined and referenced by a primitive,
while the background color has not been defined.

=====
CALC CGM Profile (MIL-D-28003) Report
=====

No profile discrepancies detected.

=====
Conformance Summary Report
=====

MetaCheck Version 2.05 -- CGM/MIL-D-28003 Conformance Analyzer
Copyright 1988-91 CGM Technology Software
Execution Date: 03/02/93 Time: 14:20:33

Name of CGM under test: i:\9315\c002.cgm
Encoding : Binary

Pictures Examined : All
Elements Examined : All
Bytes Examined : All

BEGIN METAFILE string : "HiJaak 2"
METAFILE DESCRIPTION : "HiJaak 2 MIL-D-28003/BASIC-1"

Picture 1 starts at octet offset 336; string contains: "Awesome!"

Conformance Summary : This file conforms to the CGM specification.

This file meets the CALS CGM Profile (MIL-D-28003).

Summary of Testing Performed and Errors Found:

1 Pictures Tested
976 Elements Tested
8438 Octets Tested

0 Illegal CGM Elements	1000 -	1999
0 Incorrect CGM Element Lengths	2000 -	2999
0 CGM State Errors	3000 -	3499
0 Required CGM Elements Missing or Wrong	4000 -	4499
0 CGM Parameter Values Out of Range	6000 -	6499
0 CGM Structure Errors	7000 -	7499
0 *** CGM Errors Found (total)	***	

0 Profile State Errors,	3500 -	3999
0 Illegal Profile Elements	4500 -	4999
0 Profile Parameter Values Out of Range	6500 -	6999
0 Profile Data Limits Exceeded	8500 -	8999
0 Other Profile Constraints Violated	9500 -	9999
0 *** Profile Violations Found (total)	***	

1 Warnings (Advisory Remarks)	20000 -	20999
-------------------------------	---------	-------

1 distinct errors and warnings were reported.

===== End of Conformance Report =====

11.2.2 validcgm Log

Analysis for file c002.cgm using table table

(0, 1) occurred 1 time
(0, 2) occurred 1 time
(0, 3) occurred 1 time
(0, 4) occurred 1 time
(0, 5) occurred 1 time
(1, 1) occurred 1 time
(1, 2) occurred 1 time
(1, 3) occurred 1 time
(1, 4) occurred 1 time
(1, 7) occurred 1 time
(1, 8) occurred 1 time
(1, 10) occurred 1 time
(1, 11) occurred 1 time
(2, 1) occurred 1 time
(2, 2) occurred 1 time
(2, 3) occurred 1 time
(2, 4) occurred 1 time
(2, 5) occurred 1 time
(2, 6) occurred 1 time
(2, 7) never occurred, required by standard B
(3, 1) occurred 1 time
(4, 1) occurred 67 times
(4, 4) occurred 73 times
(4, 7) occurred 34 times
(5, 2) occurred 88 times
(5, 3) occurred 94 times
(5, 4) occurred 92 times
(5, 8) occurred 92 times
(5, 14) occurred 92 times
(5, 15) occurred 4 times
(5, 16) occurred 2 times
(5, 22) occurred 17 times
(5, 23) occurred 25 times
(5, 27) occurred 88 times
(5, 28) occurred 94 times
(5, 29) occurred 92 times
(5, 30) occurred 2 times

11.2.3 MetaView Log

System Error: Error -1018 in function 14.
 cl/id: 4/4, offs: 2156, esqn: 258
Error detected in file i:\9315\C002.CGM

11.2.4 Output Harvard Graphics 3.05

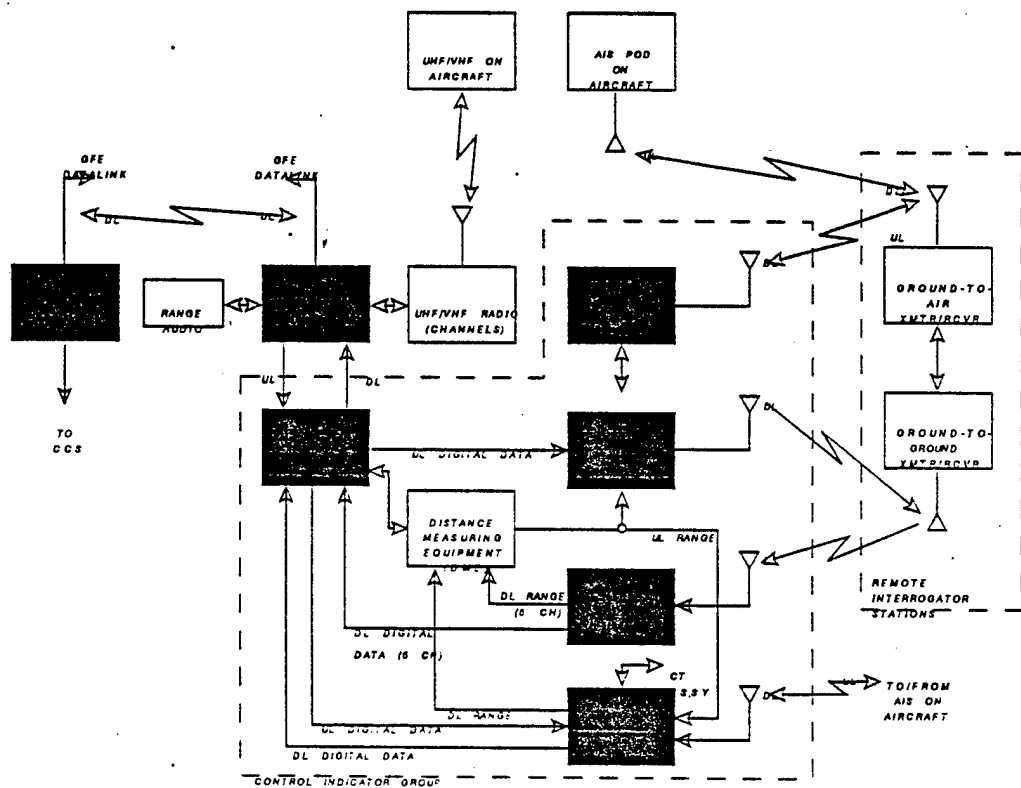

HG305 - D001C002

11.2.5 Output cgm2draw/IslandDraw

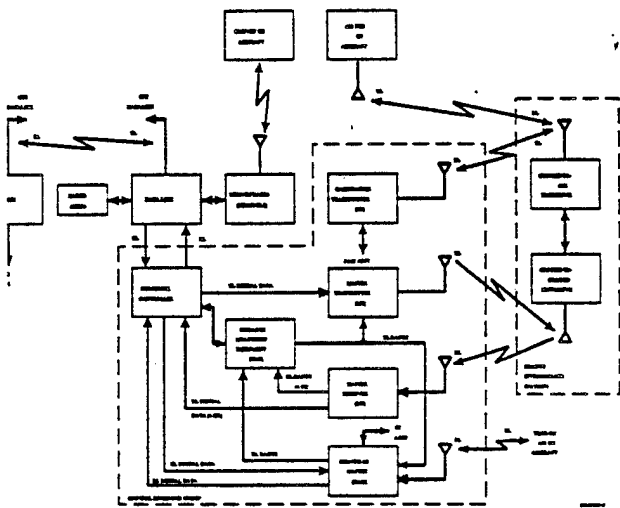

11.2.6 Output IslandDraw

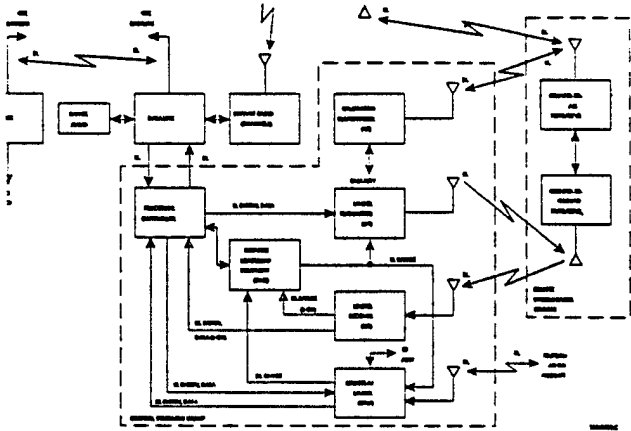

11.2.7 Output HiJaak Windows

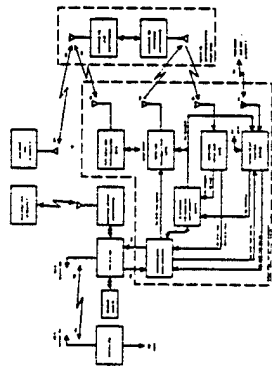

11.2.8 Output Designer

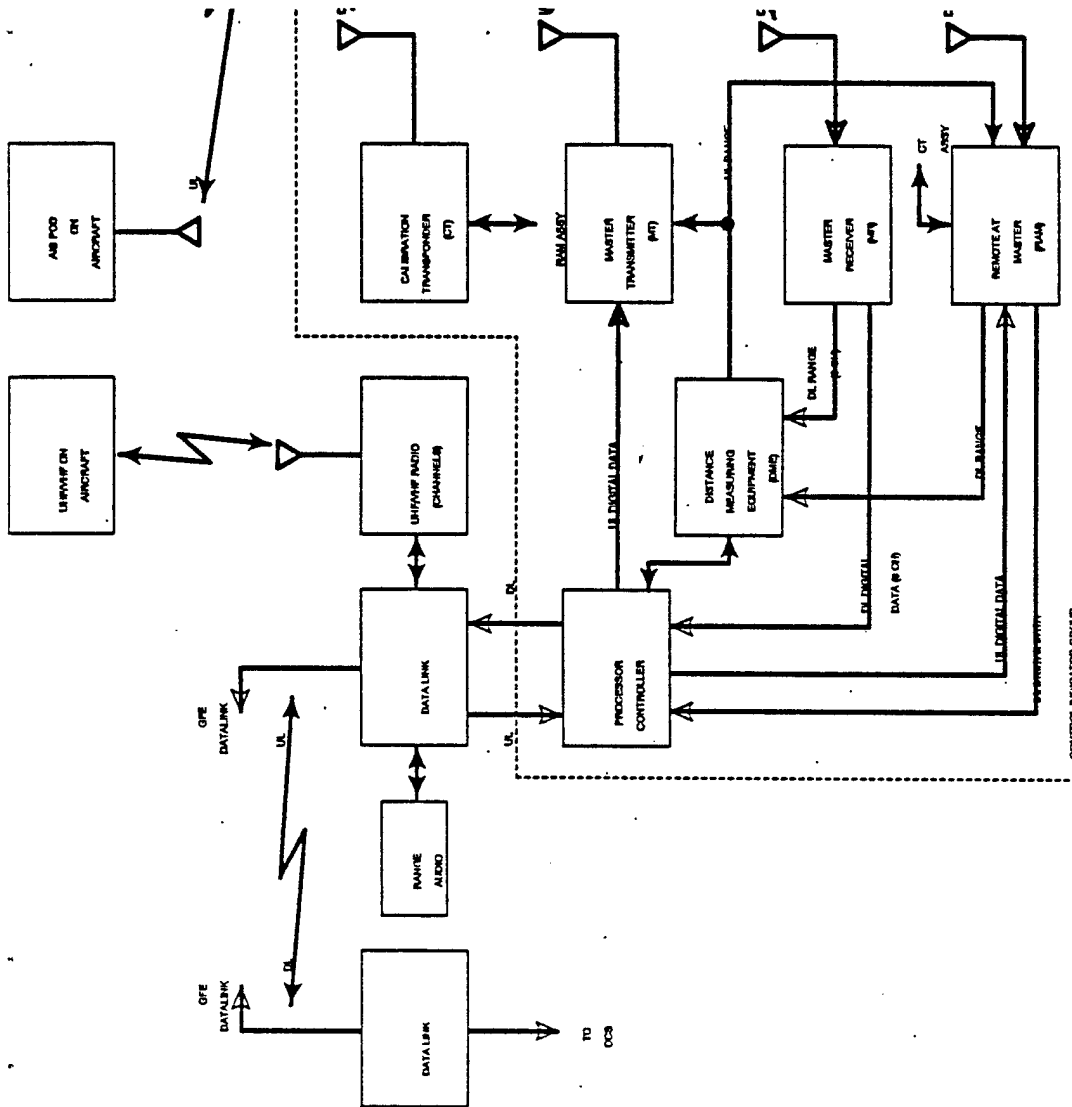

11.2.9 Output Ventura Publisher

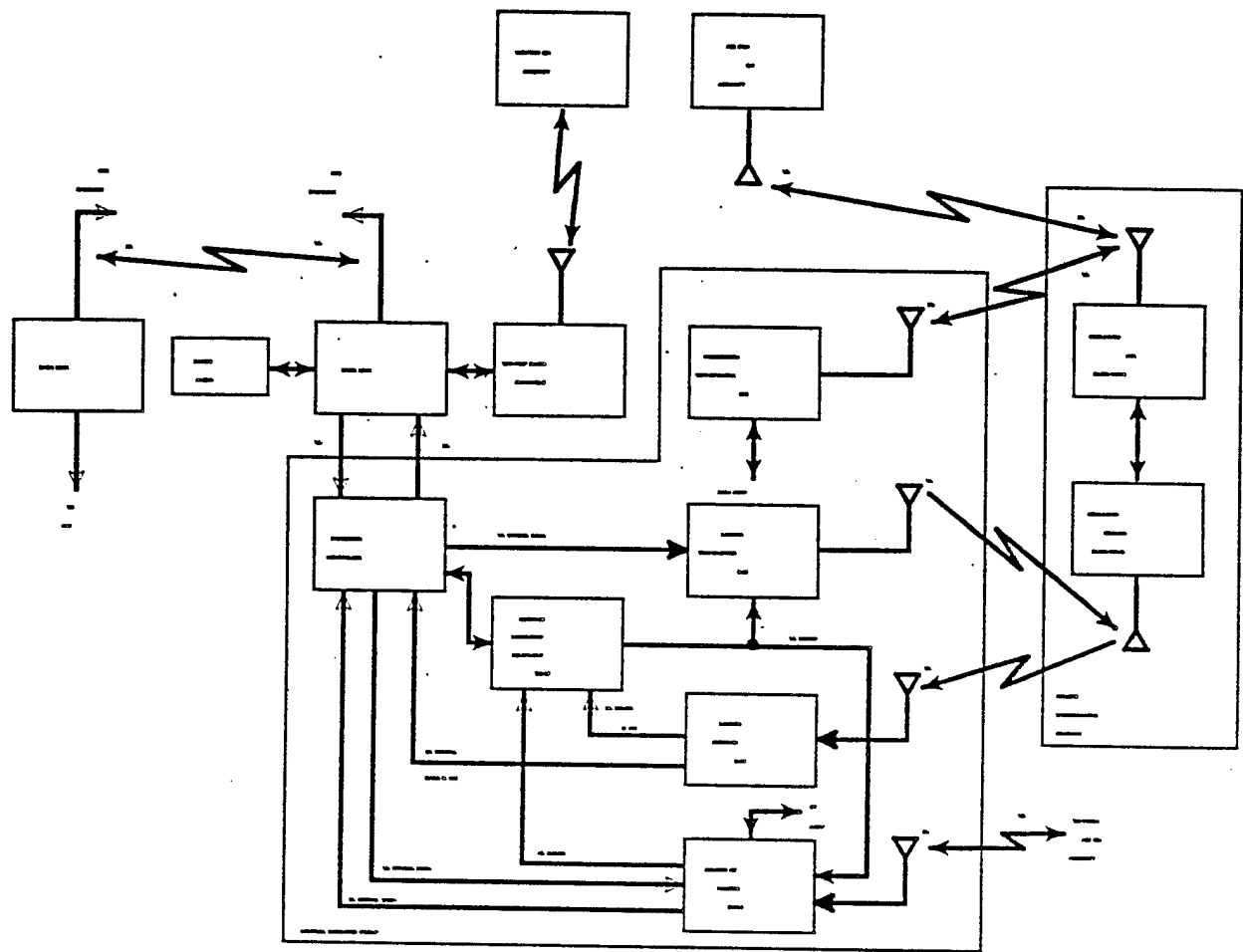

11.3 File D001C003

11.3.1 Parser Log MetaCheck

MetaCheck Version 2.05 -- CGM/MIL-D-28003 Conformance Analyzer
Copyright 1988-91 CGM Technology Software
Execution Date: 03/02/93 Time: 14:20:43

Metafile Examined : i:\9315\c003.cgm

Pictures Examined : All
Elements Examined : All
Bytes Examined : All

=====
Trace Report
=====

Tracing not selected.

=====
CGM Conformance Violation Report
=====

Bulletin 20027: Element Class/ID: 4/7 Offset: 664 octets Element No. 61
Warning; a foreground color has been defined and referenced by a primitive,
while the background color has not been defined.

=====
CAL S CGM Profile (MIL-D-28003) Report
=====

No profile discrepancies detected.

=====
Conformance Summary Report
=====

MetaCheck Version 2.05 -- CGM/MIL-D-28003 Conformance Analyzer
Copyright 1988-91 CGM Technology Software
Execution Date: 03/02/93 Time: 14:20:49

Name of CGM under test: i:\9315\c003.cgm
Encoding : Binary

Pictures Examined : All
Elements Examined : All
Bytes Examined : All

BEGIN METAFILE string : "HiJaak 2"
METAFILE DESCRIPTION : "HiJaak 2 MIL-D-28003/BASIC-1"

Picture 1 starts at octet offset 336; string contains: "Awesome!"

Conformance Summary : This file conforms to the CGM specification.

This file meets the CALS CGM Profile (MIL-D-28003).

Summary of Testing Performed and Errors Found:

1 Pictures Tested
1292 Elements Tested
37832 Octets Tested

0 Illegal CGM Elements	1000 -	1999
0 Incorrect CGM Element Lengths	2000 -	2999
0 CGM State Errors	3000 -	3499
0 Required CGM Elements Missing or Wrong	4000 -	4499
0 CGM Parameter Values Out of Range	6000 -	6499
0 CGM Structure Errors	7000 -	7499
0 *** CGM Errors Found (total) ***		
0 Profile State Errors	3500 -	3999
0 Illegal Profile Elements	4500 -	4999
0 Profile Parameter Values Out of Range	6500 -	6999
0 Profile Data Limits Exceeded	8500 -	8999
0 Other Profile Constraints Violated	9500 -	9999
0 *** Profile Violations Found (total) ***		
1 Warnings (Advisory Remarks)	20000 -	20999

1 distinct errors and warnings were reported.

===== End of Conformance Report =====

11.3.2 validcgm Log

Analysis for file c003.cgm using table table

(0, 1) occurred 1 time
(0, 2) occurred 1 time
(0, 3) occurred 1 time
(0, 4) occurred 1 time
(0, 5) occurred 1 time
(1, 1) occurred 1 time
(1, 2) occurred 1 time
(1, 3) occurred 1 time
(1, 4) occurred 1 time
(1, 7) occurred 1 time
(1, 8) occurred 1 time
(1, 10) occurred 1 time
(1, 11) occurred 1 time
(2, 1) occurred 1 time
(2, 2) occurred 1 time
(2, 3) occurred 1 time
(2, 4) occurred 1 time
(2, 5) occurred 1 time
(2, 6) occurred 1 time
(2, 7) never occurred, required by standard B
(3, 1) occurred 1 time
(4, 1) occurred 108 times
(4, 4) occurred 20 times
(4, 7) occurred 128 times
(5, 2) occurred 118 times
(5, 3) occurred 85 times
(5, 4) occurred 105 times
(5, 8) occurred 105 times
(5, 14) occurred 105 times
(5, 15) occurred 3 times
(5, 16) occurred 2 times
(5, 22) occurred 53 times
(5, 23) occurred 82 times
(5, 27) occurred 118 times
(5, 28) occurred 85 times
(5, 29) occurred 105 times
(5, 30) occurred 50 times

11.3.3 Metview Log

System Error: Error -1018 in function 14. cl/id: 4/4, offs: 1376, esqn: 155 Error dete
in file i:\9315\C003.CGM

11.3.4 Output Harvard Graphics 3.05

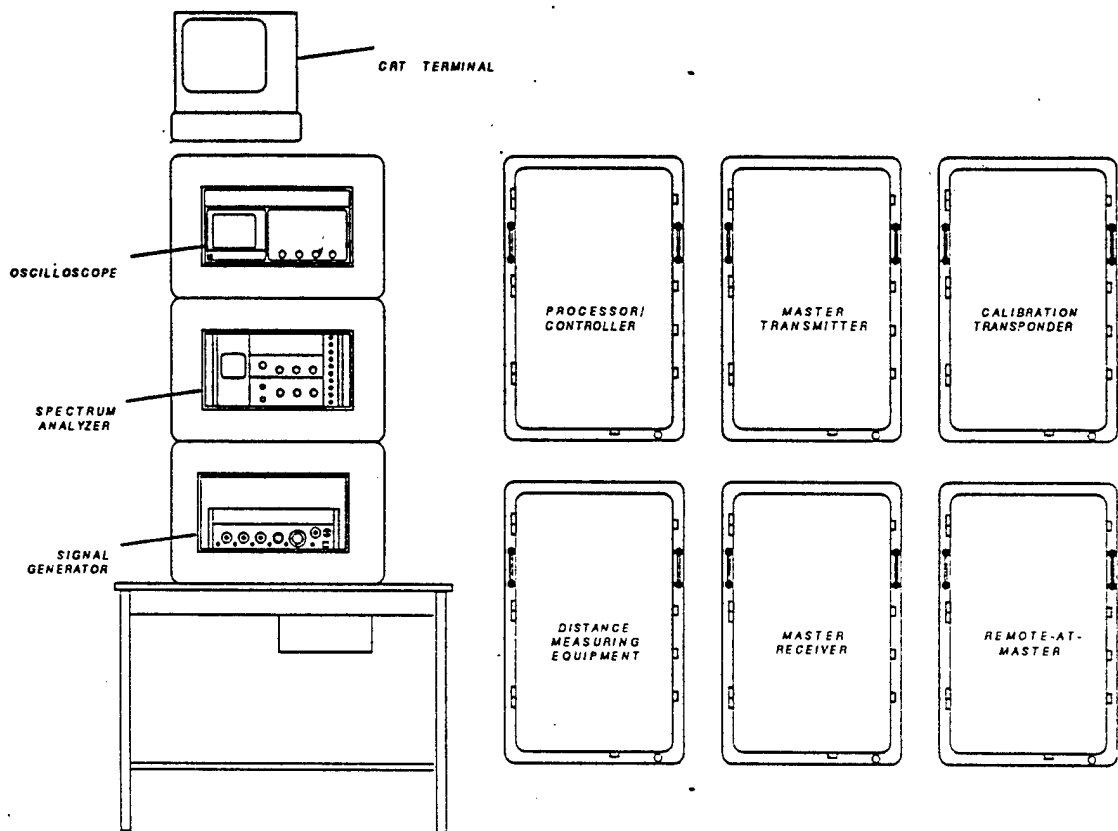

152400 16-C

11.3.5 Output cgm2draw/IslandDraw

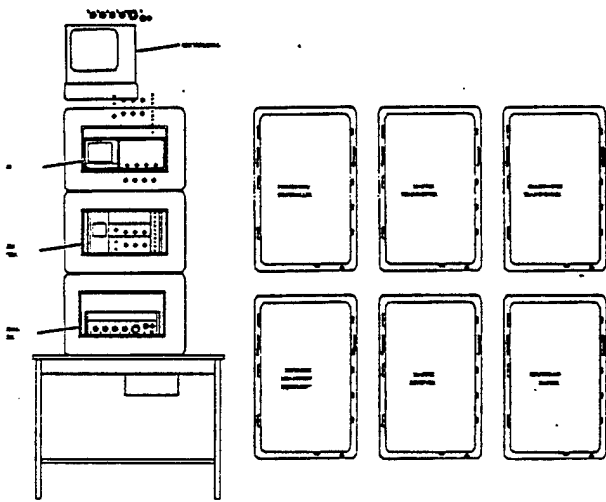

11.3.6 Output IslandDraw

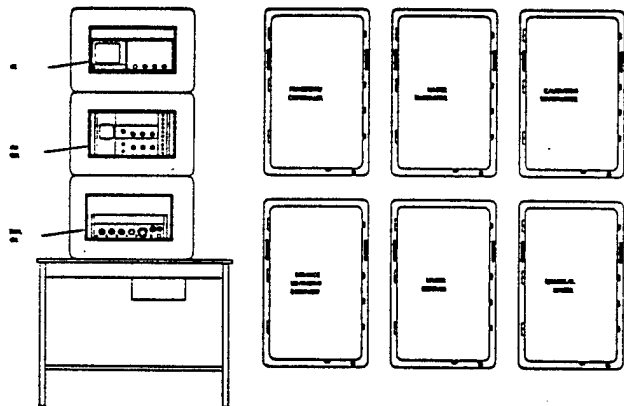

11.3.7 Output HiJaak Windows

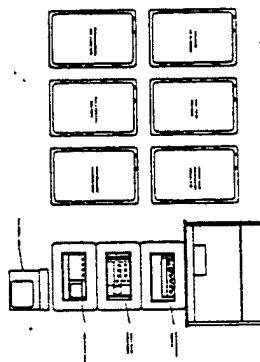

11.3.8 Output Designer

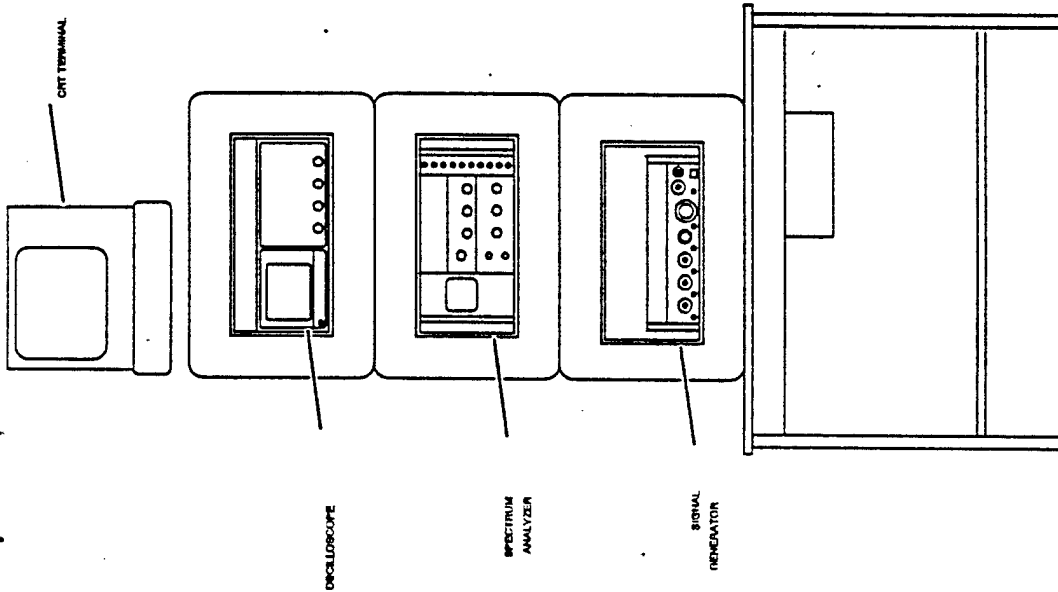
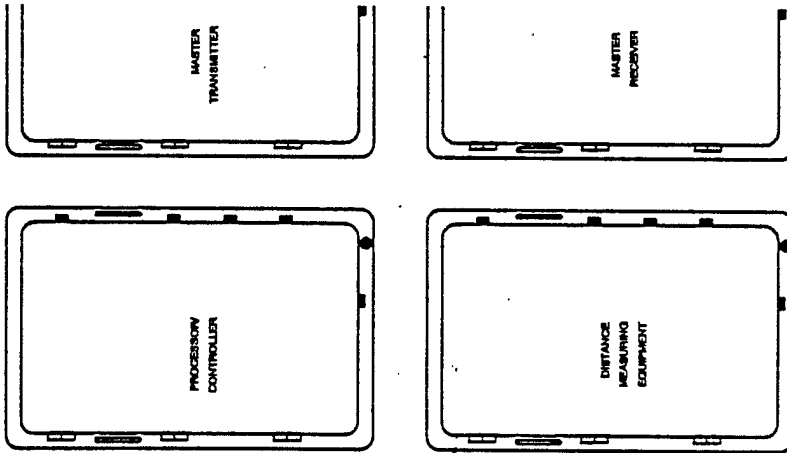

11.3.9 Output Ventura Publisher

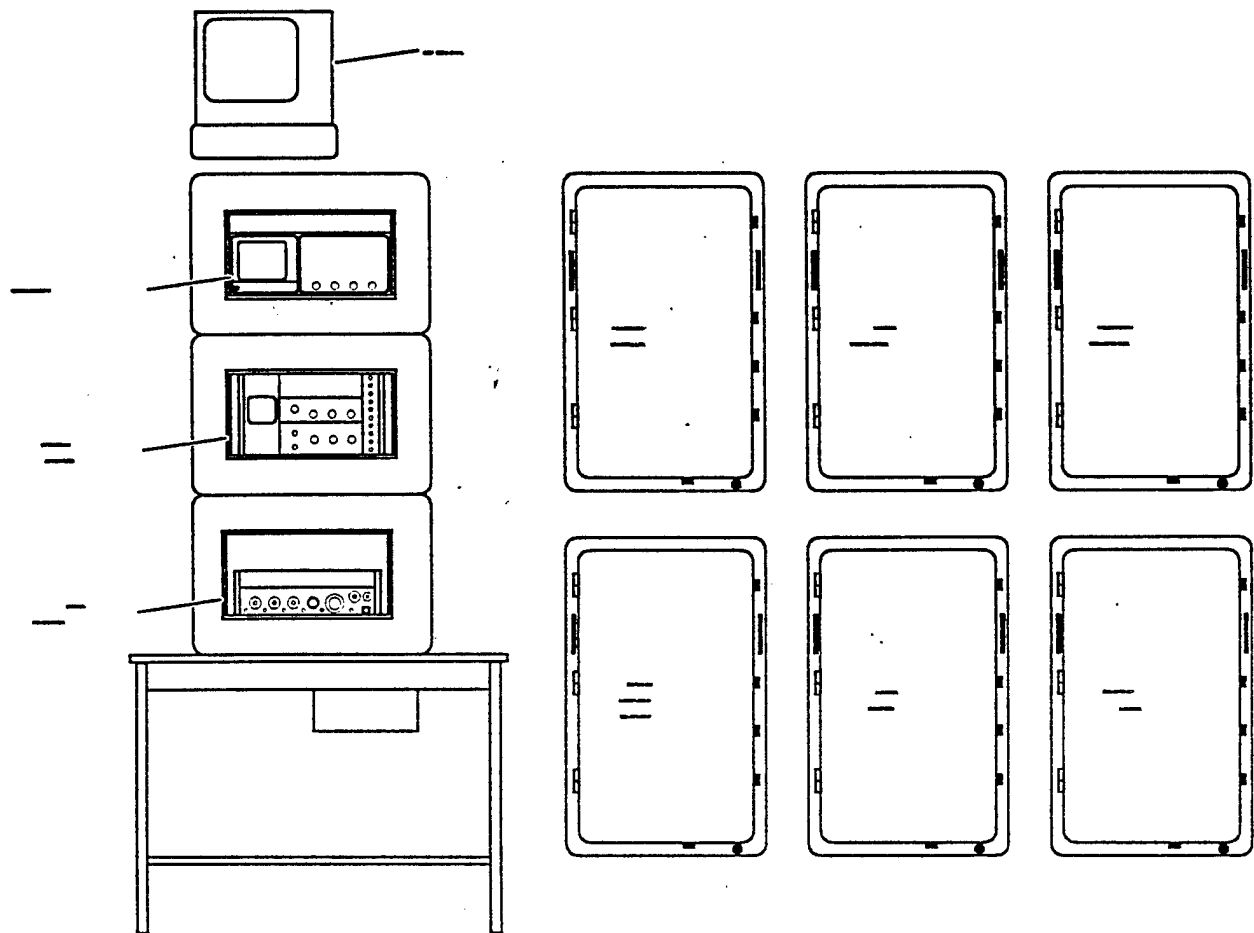

11.4 File D001C004

11.4.1 Parser Log MetaCheck

MetaCheck Version 2.05 -- CGM/MIL-D-28003 Conformance Analyzer
Copyright 1988-91 CGM Technology Software
Execution Date: 03/02/93 Time: 14:20:58

Metafile Examined : i:\9315\c004.cgm

Pictures Examined : All

Elements Examined : All

Bytes Examined : All

=====
Trace Report
=====

Tracing not selected.

=====
CGM Conformance Violation Report
=====

Bulletin 20027: Element Class/ID: 4/1 Offset: 672 octets Element No. 64
Warning; a foreground color has been defined and referenced by a primitive,
while the background color has not been defined.

=====
CALs CGM Profile (MIL-D-28003) Report
=====

No profile discrepancies detected.

=====
Conformance Summary Report
=====

MetaCheck Version 2.05 -- CGM/MIL-D-28003 Conformance Analyzer
Copyright 1988-91 CGM Technology Software
Execution Date: 03/02/93 Time: 14:21:10

Name of CGM under test: i:\9315\c004.cgm

Encoding : Binary

Pictures Examined : All

Elements Examined : All

Bytes Examined : All

BEGIN METAFILE string : "HiJaak 2"

METAFILE DESCRIPTION : "HiJaak 2 MIL-D-28003/BASIC-1"

Picture 1 starts at octet offset 336; string contains: "Awesome!"

Conformance Summary : This file conforms to the CGM specification.

This file meets the CALS CGM Profile (MIL-D-28003).

Summary of Testing Performed and Errors Found:

1 Pictures Tested
9507 Elements Tested
64838 Octets Tested

0 Illegal CGM Elements	1000 -	1999
0 Incorrect CGM Element Lengths	2000 -	2999
0 CGM State Errors	3000 -	3499
0 Required CGM Elements Missing or Wrong	4000 -	4499
0 CGM Parameter Values Out of Range	6000 -	6499
0 CGM Structure Errors	7000 -	7499
0 *** CGM Errors Found (total) ***		
0 Profile State Errors,	3500 -	3999
0 Illegal Profile Elements	4500 -	4999
0 Profile Parameter Values Out of Range	6500 -	6999
0 Profile Data Limits Exceeded	8500 -	8999
0 Other Profile Constraints Violated	9500 -	9999
0 *** Profile Violations Found (total) ***		
1 Warnings (Advisory Remarks)	20000 -	20999

1 distinct errors and warnings were reported.

=====
===== End of Conformance Report =====

11.4.2 validcgm Log

Analysis for file c004.cgm using table table
MILSPEC 28003 error: illegal hatch index
(2133, 17602) (5, 24, 2) Hatch Index 6

- (0, 1) occurred 1 time
- (0, 2) occurred 1 time
- (0, 3) occurred 1 time
- (0, 4) occurred 1 time
- (0, 5) occurred 1 time
- (1, 1) occurred 1 time
- (1, 2) occurred 1 time
- (1, 3) occurred 1 time
- (1, 4) occurred 1 time
- (1, 7) occurred 1 time
- (1, 8) occurred 1 time
- (1, 10) occurred 1 time
- (1, 11) occurred 1 time
- (2, 1) occurred 1 time
- (2, 2) occurred 1 time
- (2, 3) occurred 1 time
- (2, 4) occurred 1 time
- (2, 5) occurred 1 time
- (2, 6) occurred 1 time
- (2, 7) never occurred, required by standard B
- (3, 1) occurred 1 time
- (4, 1) occurred 418 times
- (4, 4) occurred 142 times
- (4, 7) occurred 122 times
- (5, 2) occurred 364 times
- (5, 3) occurred 2271 times
- (5, 4) occurred 409 times
- (5, 8) occurred 409 times
- (5, 14) occurred 409 times
- (5, 15) occurred 87 times
- (5, 16) occurred 228 times
- (5, 22) occurred 248 times
- (5, 23) occurred 877 times
- (5, 24) occurred 2 times
- (5, 27) occurred 364 times
- (5, 28) occurred 2271 times
- (5, 29) occurred 409 times
- (5, 30) occurred 457 times

11.4.3 MetaView Log

System Error: Error -1018 in function 14.
 cl/id: 4/4, offs: 934, esqn: 108
Error detected in file i:\9315\C004.CGM

11.4.4 Output Harvard Graphics 3.05

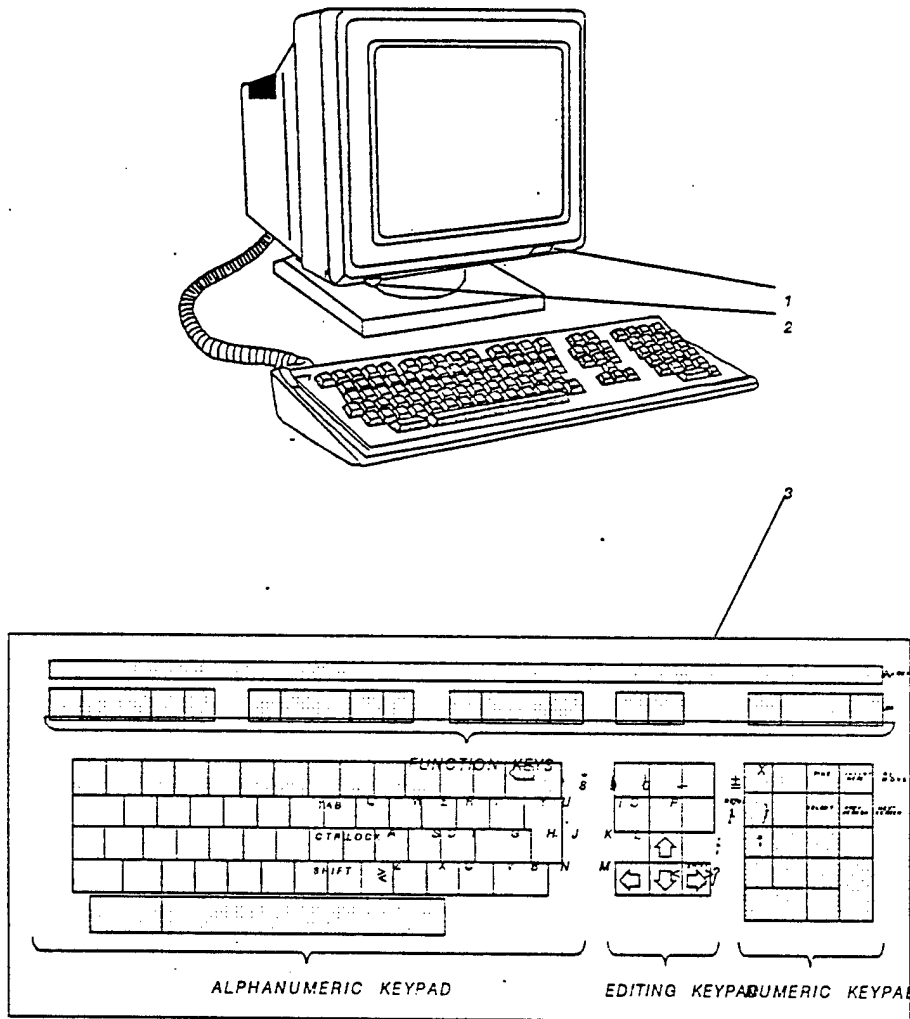

11.4.5 Output cgm2draw/IslandDraw

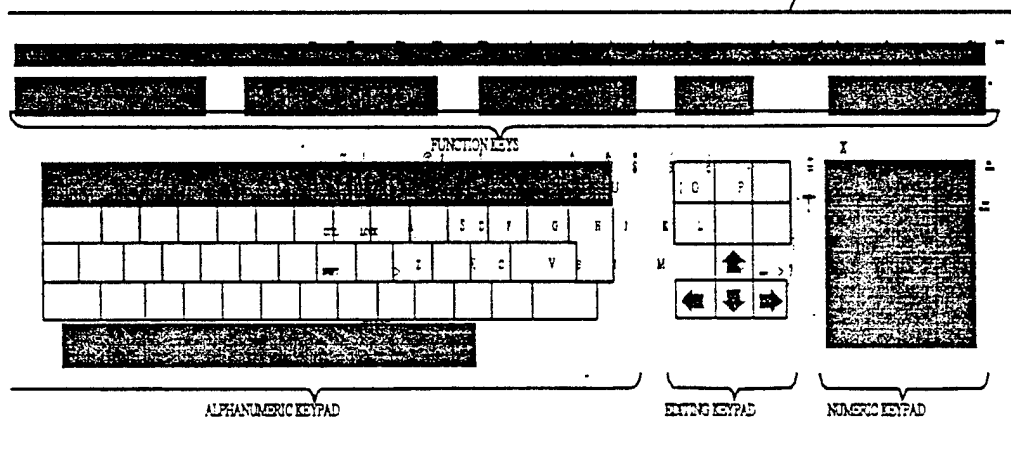
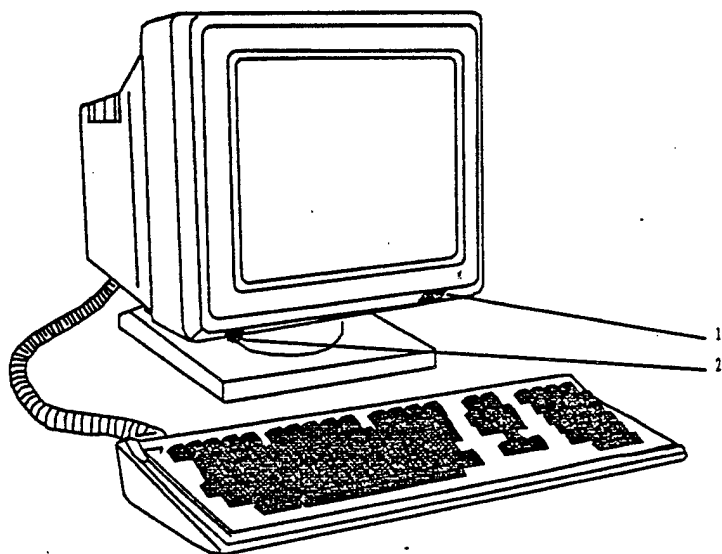

11.4.6 Output IslandDraw

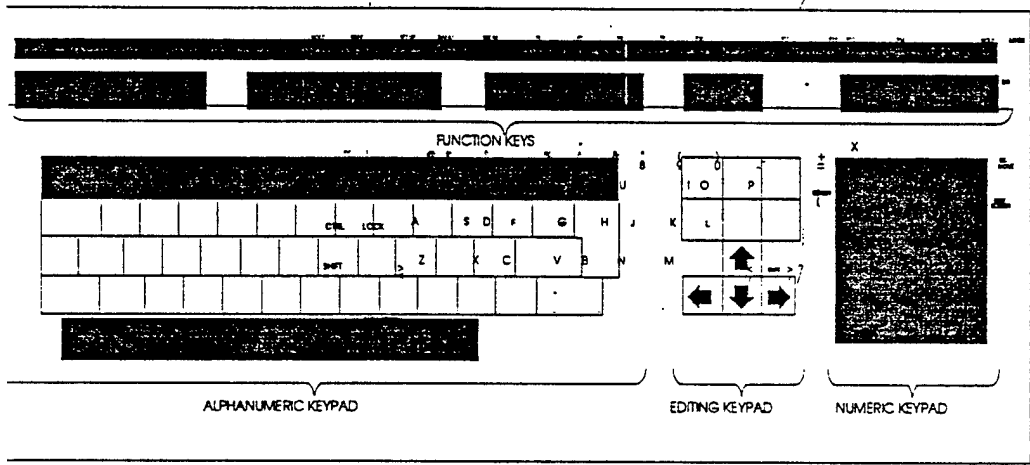
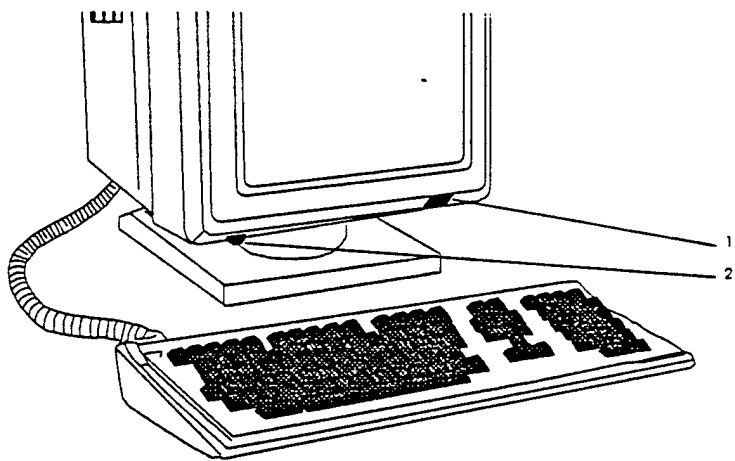

15240076-D

11.4.7 Output HiJaak Windows

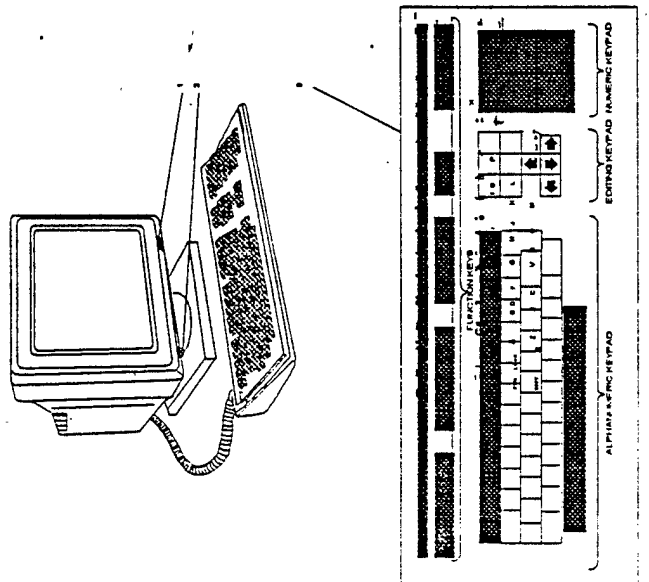

11.4.8 Output Designer

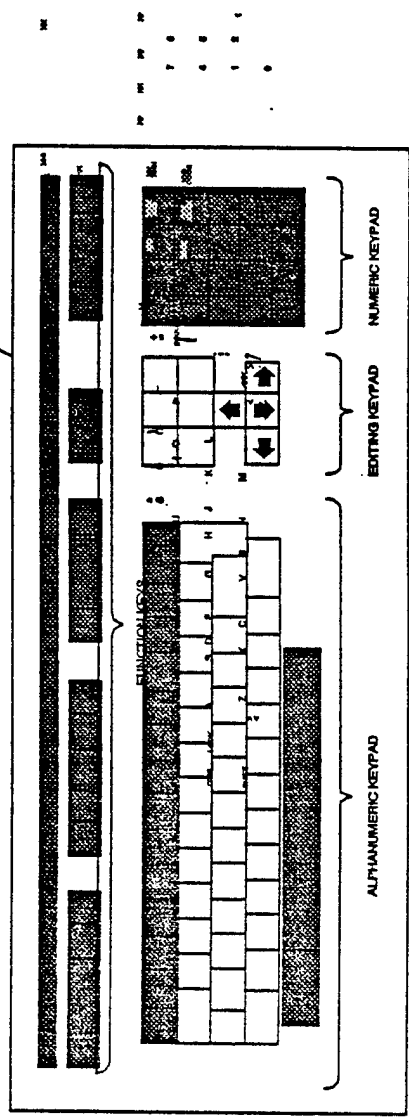
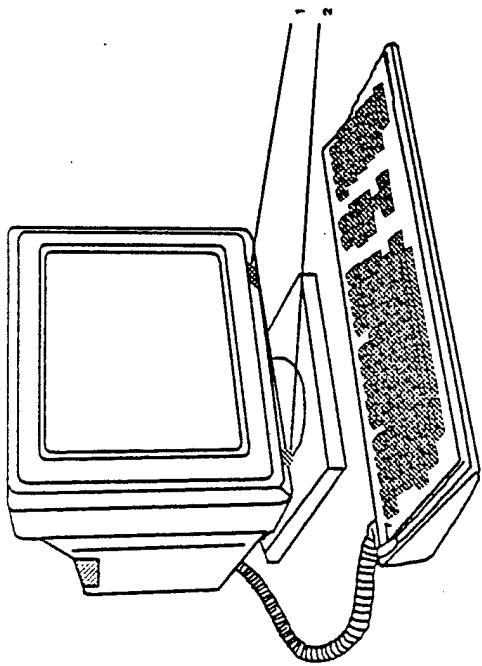

112-0078-D

11.4.9 Output Ventura Publisher

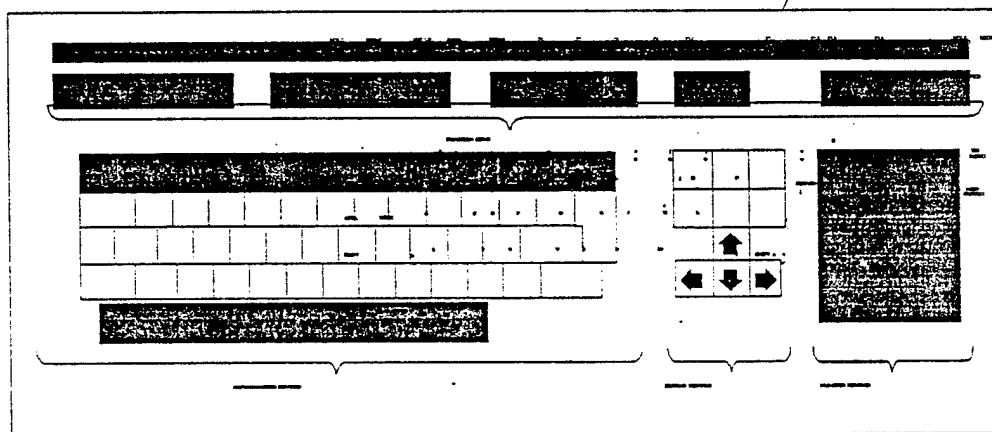
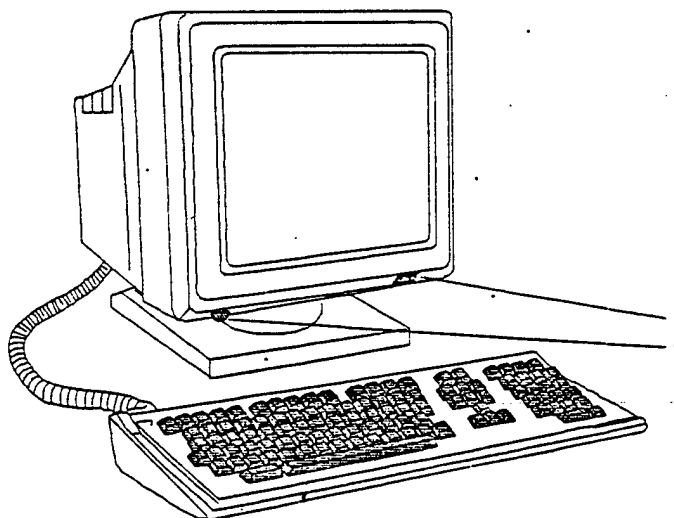

11.5 File D001C005

11.5.1 Parser Log MetaCheck

MetaCheck Version 2.05 -- CGM/MIL-D-28003 Conformance Analyzer
Copyright 1988-91 CGM Technology Software
Execution Date: 03/02/93 Time: 14:21:19

Metafile Examined : i:\9315\c005.cgm

Pictures Examined : All
Elements Examined : All
Bytes Examined : All

=====
===== Trace Report =====

Tracing not selected.

=====
===== CGM Conformance Violation Report =====

Bulletin 20027: Element Class/ID: 4/4 Offset: 652 octets Element No. 57
Warning; a foreground color has been defined and referenced by a primitive,
while the background color has not been defined.

Error 3022: Element Class/ID: 0/3 Offset: 16384 octets Element No. 2059
This element is not allowed in the Picture Body.

Bulletin 2002: Element Class/ID: 0/3 Offset: 16384 octets Element No. 2059
Too much data with element.

Bulletin 2001: Element Class/ID: 5/28 Offset: 16388 octets Element No. 2060
Insufficient parameter data for this element.

Error 2003: Element Class/ID: 5/28 Offset: 16388 octets Element No. 2060
Element parameter data ends with an incomplete operand.

Error 3011: Element Class/ID: 5/28 Offset: 16388 octets Element No. 2060
This element is not allowed in the Picture Descriptor.

Bulletin 2001: Element Class/ID: 5/3 Offset: 16392 octets Element No. 2061
Insufficient parameter data for this element.

Error 2003: Element Class/ID: 5/3 Offset: 16392 octets Element No. 2061
Element parameter data ends with an incomplete operand.

Error 3011: Element Class/ID: 5/3 Offset: 16392 octets Element No. 2061
This element is not allowed in the Picture Descriptor.

Bulletin 2001: Element Class/ID: 5/28 Offset: 16396 octets Element No. 2062
Insufficient parameter data for this element.

Error 2003: Element Class/ID: 5/28 Offset: 16396 octets Element No. 2062
Element parameter data ends with an incomplete operand.

Error 3011: Element Class/ID: 5/28 Offset: 16396 octets Element No. 2062
This element is not allowed in the Picture Descriptor.

Bulletin 7001: Element Class/ID: 5/28 Offset: 16400 octets Element No. 2063
END METAFILE element missing: end-of-file encountered.

===== CALS CGM Profile (MIL-D-28003) Report =====

No profile discrepancies detected.

===== Conformance Summary Report =====

MetaCheck Version 2.05 -- CGM/MIL-D-28003 Conformance Analyzer
Copyright 1988-91 CGM Technology Software
Execution Date: 03/02/93 Time: 14:21:23

Name of CGM under test: i:\9315\c005.cgm
Encoding : Binary

Pictures Examined : All
Elements Examined : All
Bytes Examined : All

BEGIN METAFILE string : "HiJaak 2"
METAFILE DESCRIPTION : "HiJaak 2 MIL-D-28003/BASIC-1"

Picture 1 starts at octet offset 336; string contains: "Awesome!"

Conformance Summary : This file is not a conforming CGM.

Consequently, it does not meet the
CALS CGM Profile (MIL-D-28003).

Summary of Testing Performed and Errors Found:

2 Pictures Tested
2062 Elements Tested
16400 Octets Tested

0	Illegal CGM Elements	1000	-	1999
7	Incorrect CGM Element Lengths	2000	-	2999
4	CGM State Errors	3000	-	3499
0	Required CGM Elements Missing or Wrong	4000	-	4499
0	CGM Parameter Values Out of Range	6000	-	6499
1	CGM Structure Errors	7000	-	7499
12	*** CGM Errors Found (total)	***		
0	Profile State Errors	3500	-	3999
0	Illegal Profile Elements	4500	-	4999
0	Profile Parameter Values Out of Range	6500	-	6999
0	Profile Data Limits Exceeded	8500	-	8999
0	Other Profile Constraints Violated	9500	-	9999
0	*** Profile Violations Found (total)	***		
1	Warnings (Advisory Remarks)	20000	-	20999

7 distinct errors and warnings were reported.

=====
===== End of Conformance Report =====

11.5.2 validcgm Log

Analysis for file c005.cgm using table table
MILSPEC 28003 error: illegal hatch index
(687, 6932) (5, 24, 2) Hatch Index 6
ERROR: illegal in this state (4), std B
ERROR: invalid times used per CGM (2), std B
(2059, 16384) (0, 3, 2) Begin Picture ""
ERROR: illegal in this state (3), std B
(2060, 16388) (5, 28, 2) Edge Width 7.001297 scaled
ERROR: illegal in this state (3), std B
(2061, 16392) (5, 3, 2) Line Width 7.001297 scaled
ERROR: illegal in this state (3), std B
(2062, 16396) (5, 28, 2) Edge Width 7.001297 scaled

11.5.3 MetaView Log

System Error: Error -1018 in function 14.
cl/id: 4/4, offs: 652, esqm: 57
Error in CGM: Element illegal in current metafile state.
element: 0/3, offset: 16384, sequence number: 2059
Error in CGM: Premature end of file.
element: 5/28, offset: 16400, sequence number: 2063
Error in CGM: Premature end of file.
element: 5/28, offset: 16480, sequence number: 2064
Error detected in file i:\9315\C005.CGM

11.5.4 Output cgm2draw/IslandDraw

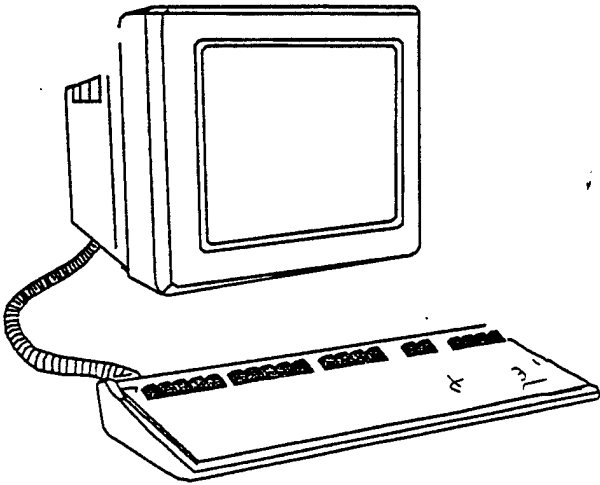

A2011200G
A0111200G

F1111

11.5.5 Output IslandDraw

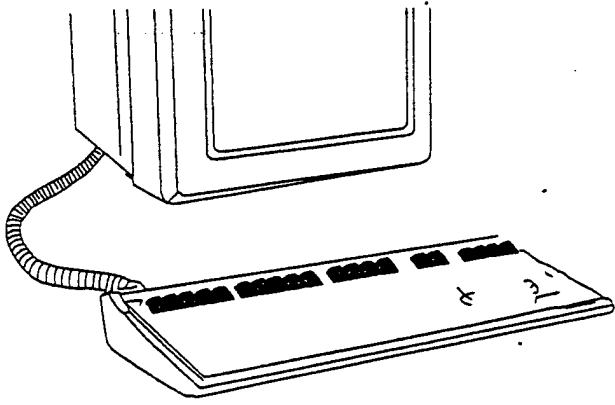

_____ AUDIO BRIDGING
AND SWITCHING

_____ R.ER

11.5.6 Output HiJaak Windows

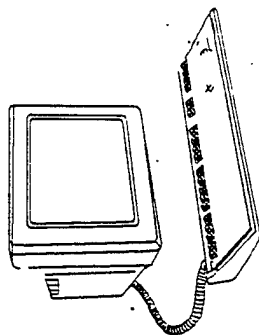

11.5.7 Output Ventura Publisher

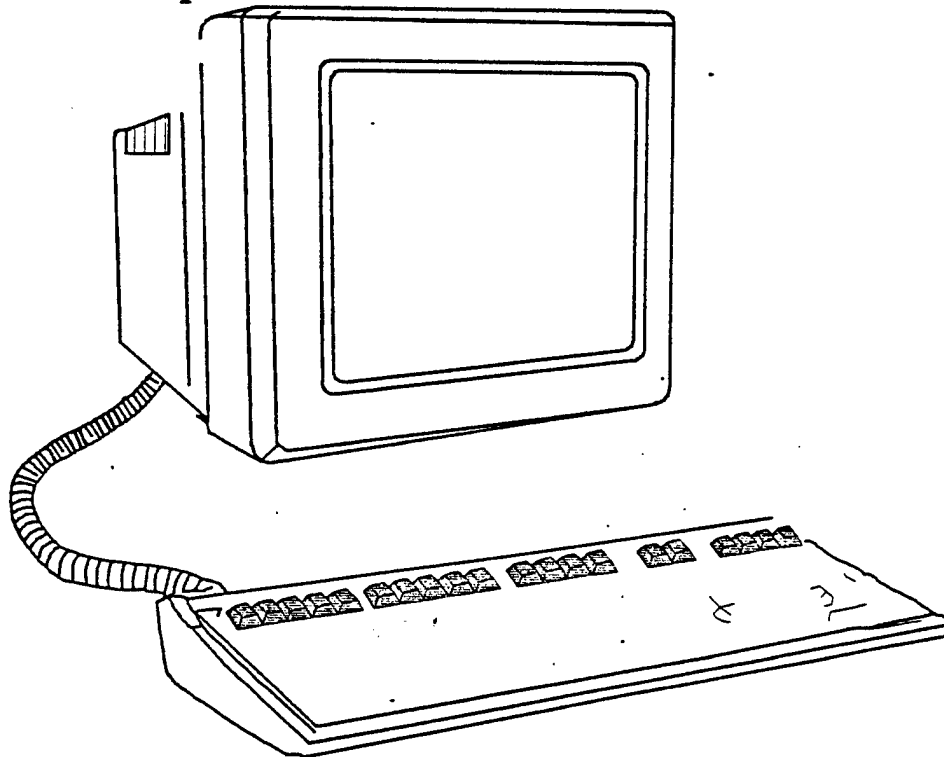

AUDIO BRIDGING
AND SWITCHING

FILTER

11.6 File D001C006

11.6.1 Parser Log MetaCheck

MetaCheck Version 2.05 -- CGM/MIL-D-28003 Conformance Analyzer
Copyright 1988-91 CGM Technology Software
Execution Date: 03/02/93 Time: 14:21:32

Metafile Examined : i:\9315\c006.cgm

Pictures Examined : All
Elements Examined : All
Bytes Examined : All

=====
Trace Report
=====

Tracing not selected.

=====
CGM Conformance Violation Report
=====

Bulletin 20027: Element Class/ID: 4/7 Offset: 724 octets Element No. 74
Warning; a foreground color has been defined and referenced by a primitive,
while the background color has not been defined.

=====
CAL S CGM Profile (MIL-D-28003) Report
=====

No profile discrepancies detected.

=====
Conformance Summary Report
=====

MetaCheck Version 2.05 -- CGM/MIL-D-28003 Conformance Analyzer
Copyright 1988-91 CGM Technology Software
Execution Date: 03/02/93 Time: 14:21:35

Name of CGM under test: i:\9315\c006.cgm
Encoding : Binary

Pictures Examined : All
Elements Examined : All
Bytes Examined : All

BEGIN METAFILE string : "HiJaak 2"
METAFILE DESCRIPTION : "HiJaak 2 MIL-D-28003/BASIC-1"

Picture 1 starts at octet offset 336; string contains: "Awesome!"

11.6.2 validegms Log

Analysis for file c006.cgm using table table

(0, 1) occurred 1 time
(0, 2) occurred 1 time
(0, 3) occurred 1 time
(0, 4) occurred 1 time
(0, 5) occurred 1 time
(1, 1) occurred 1 time
(1, 2) occurred 1 time
(1, 3) occurred 1 time
(1, 4) occurred 1 time
(1, 7) occurred 1 time
(1, 8) occurred 1 time
(1, 10) occurred 1 time
(1, 11) occurred 1 time
(2, 1) occurred 1 time
(2, 2) occurred 1 time
(2, 3) occurred 1 time
(2, 4) occurred 1 time
(2, 5) occurred 1 time
(2, 6) occurred 1 time
(2, 7) never occurred, required by standard B
(3, 1) occurred 1 time
(4, 1) occurred 42 times
(4, 4) occurred 40 times
(4, 7) occurred 19 times
(5, 2) occurred 56 times
(5, 3) occurred 227 times
(5, 4) occurred 73 times
(5, 8) occurred 73 times
(5, 14) occurred 73 times
(5, 15) occurred 14 times
(5, 16) occurred 66 times
(5, 22) occurred 15 times
(5, 23) occurred 60 times
(5, 27) occurred 56 times
(5, 28) occurred 227 times
(5, 29) occurred 73 times
(5, 30) occurred 15 times

11.6.3 MetaView Log

System Error: Error -1018 in function 14.
 cl/id: 4/4, offs: 2158, esqn: 220
Error detected in file i:\9315\C006.CGM

11.6.4 Output Harvard Graphics 3.05

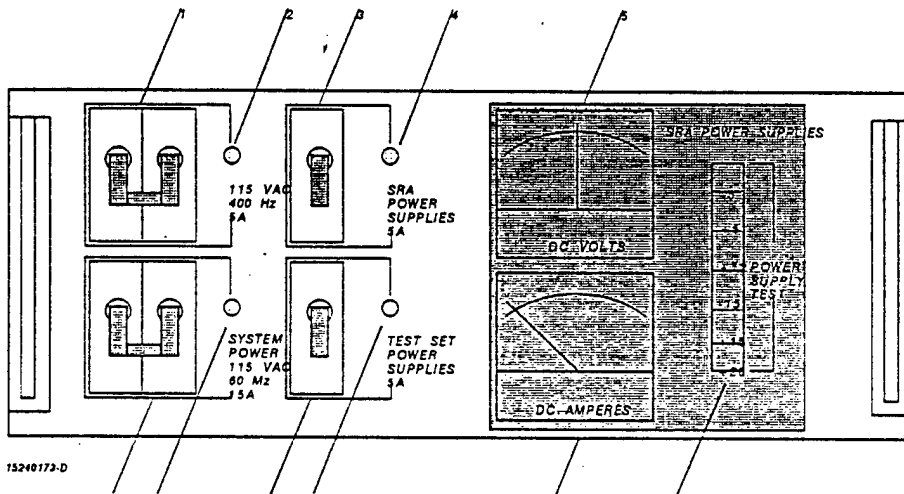

HG305 - D001C006

11.6.5 Output cgm2draw/IslandDraw

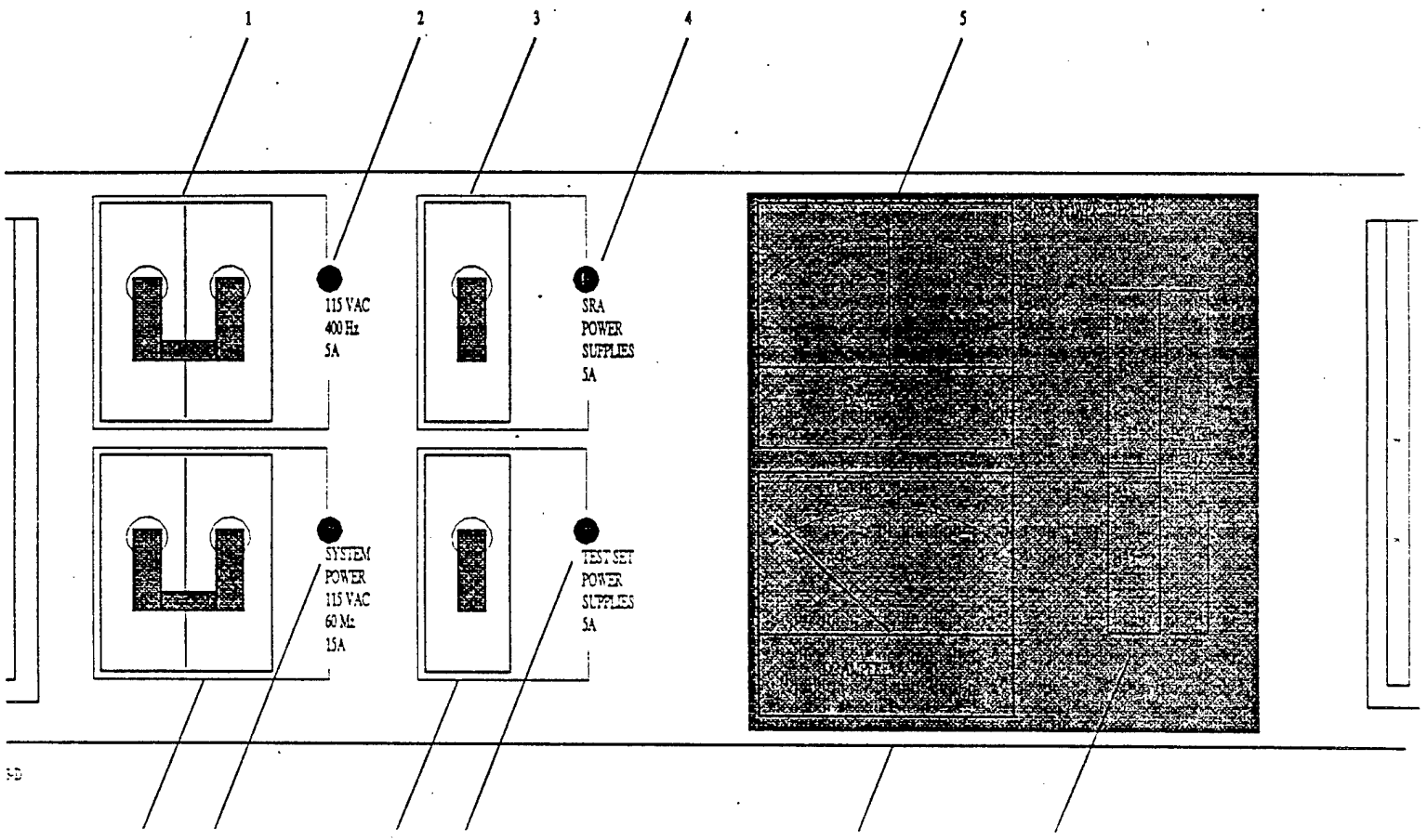

11.6.6 Output IslandDraw

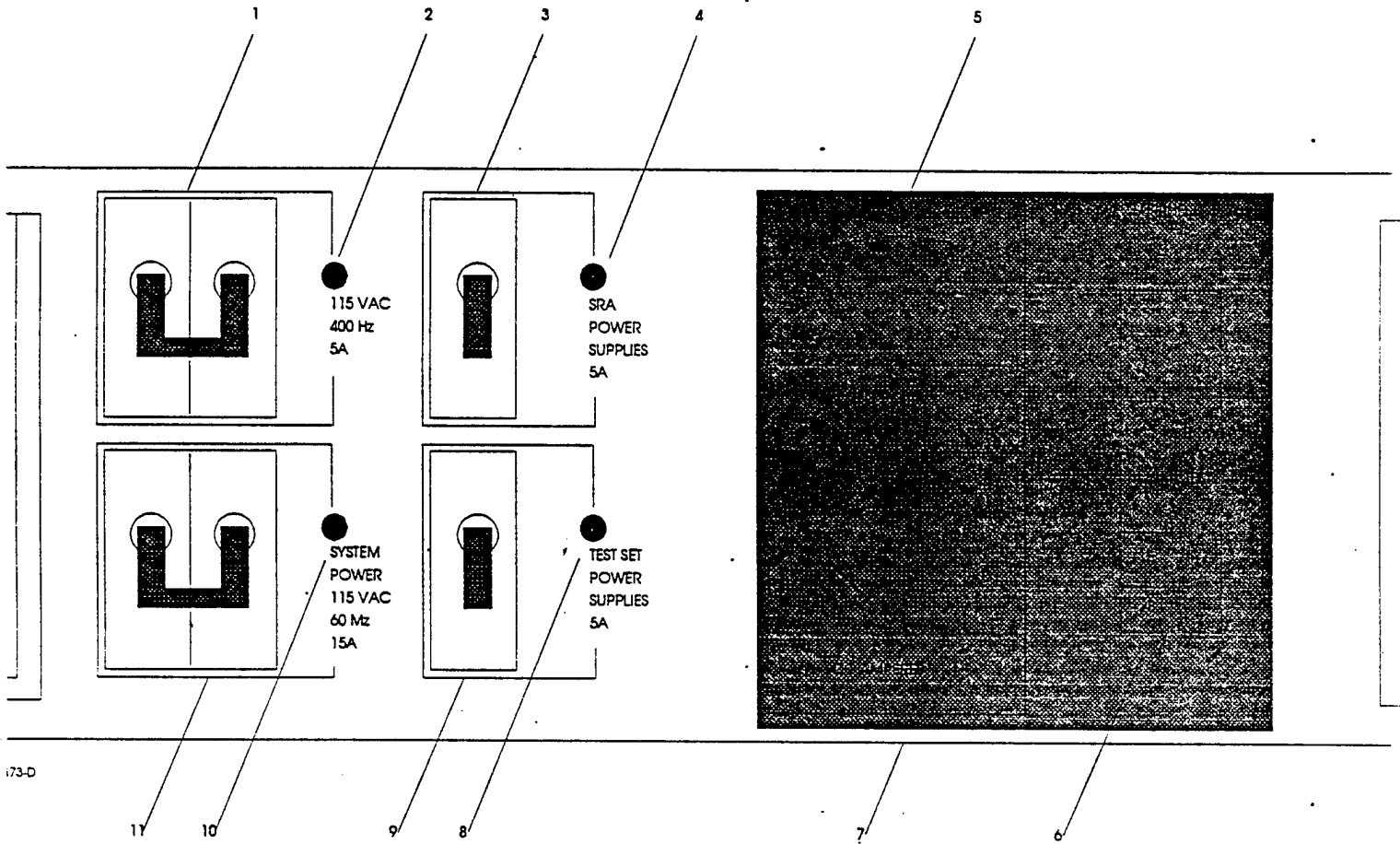

11.6.7 Output HiJaak Windows

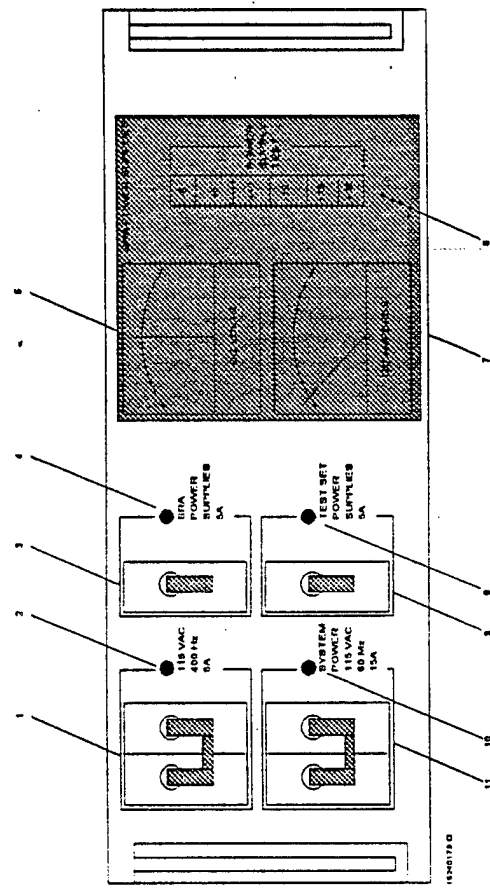

11.6.8 Output Designer

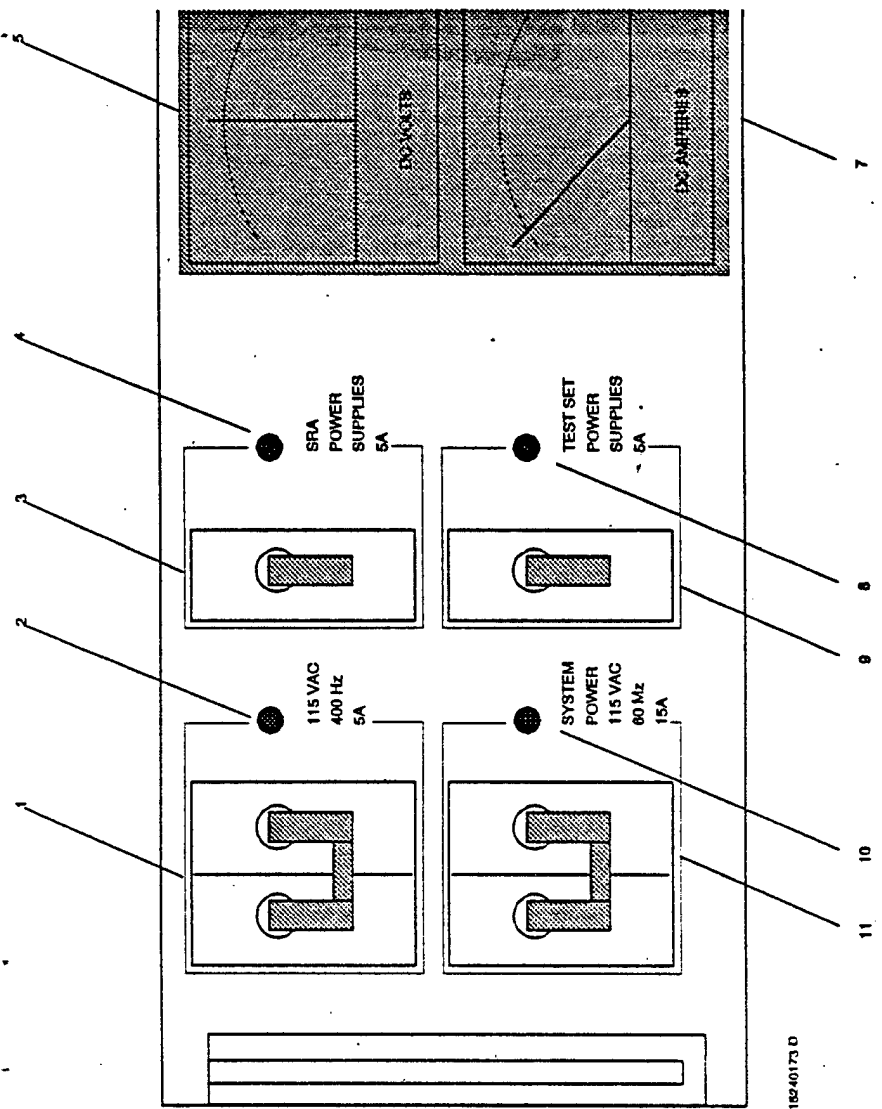

11.6.9 Output Ventura Publisher

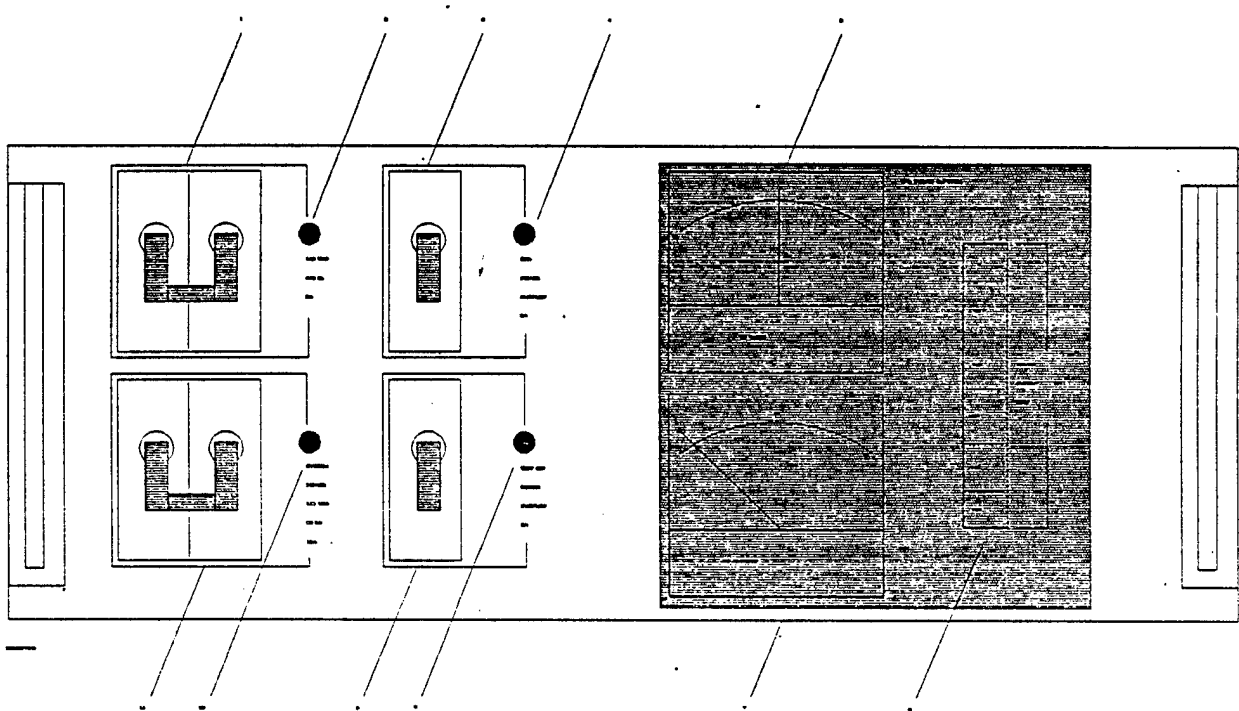

11.7 File D001C007

11.7.1 Parser Log MetaCheck

MetaCheck Version 2.05 -- CGM/MIL-D-28003 Conformance Analyzer
Copyright 1988-91 CGM Technology Software
Execution Date: 03/02/93 Time: 14:21:44

Metafile Examined : i:\9315\c007.cgm

Pictures Examined : All

Elements Examined : All

Bytes Examined : All

=====
===== Trace Report =====

Tracing not selected.

=====
===== CGM Conformance Violation Report =====

Bulletin 20027: Element Class/ID: 4/1 Offset: 664 octets Element No. 62
Warning; a foreground color has been defined and referenced by a primitive,
while the background color has not been defined.

=====
===== CALS CGM Profile (MIL-D-28003) Report =====

Error 8502: Element Class/ID: 4/1 Offset: 6846 octets Element No. 304
Invalid POLYLINE; the number of points may not exceed 1024.

Error 8502: Element Class/ID: 4/1 Offset: 12330 octets Element No. 398
Invalid POLYLINE; the number of points may not exceed 1024.

Error 8502: Element Class/ID: 4/1 Offset: 17814 octets Element No. 492
Invalid POLYLINE; the number of points may not exceed 1024.

Error 8502: Element Class/ID: 4/1 Offset: 23298 octets Element No. 586
Invalid POLYLINE; the number of points may not exceed 1024.

Error 8502: Element Class/ID: 4/1 Offset: 28782 octets Element No. 680
Invalid POLYLINE; the number of points may not exceed 1024.

Error 8502: Element Class/ID: 4/1 Offset: 34266 octets Element No. 774
Invalid POLYLINE; the number of points may not exceed 1024.

Error 8502: Element Class/ID: 4/1 Offset: 39750 octets Element No. 868

Invalid POLYLINE; the number of points may not exceed 1024.

Error 8502: Element Class/ID: 4/1 Offset: 81542 octets Element No. 1745
Invalid POLYLINE; the number of points may not exceed 1024.

Error 8502: Element Class/ID: 4/1 Offset: 87026 octets Element No. 1839
Invalid POLYLINE; the number of points may not exceed 1024.

Error 8502: Element Class/ID: 4/1 Offset: 92510 octets Element No. 1933
Invalid POLYLINE; the number of points may not exceed 1024.

Error 8502: Element Class/ID: 4/1 Offset: 97994 octets Element No. 2027
Invalid POLYLINE; the number of points may not exceed 1024.

Error 8502: Element Class/ID: 4/1 Offset: 103478 octets Element No. 2121
Invalid POLYLINE; the number of points may not exceed 1024.

===== Conformance Summary Report =====

MetaCheck Version 2.05 -- CGM/MIL-D-28003 Conformance Analyzer
Copyright 1988-91 CGM Technology Software
Execution Date: 03/02/93 Time: 14:22:02

Name of CGM under test: i:\9315\c007.cgm
Encoding : Binary

Pictures Examined : All
Elements Examined : All
Bytes Examined : All

BEGIN METAFILE string : "HiJaak 2"
METAFILE DESCRIPTION : "HiJaak 2 MIL-D-28003/BASIC-1"

Picture 1 starts at octet offset 336; string contains: "Awesome!"

Conformance Summary : This file conforms to the CGM specification.

However, this file does not satisfy
the CALS CGM Profile (MIL-D-28003).

Summary of Testing Performed and Errors Found:

1 Pictures Tested
2917 Elements Tested
132824 Octets Tested

0 Illegal CGM Elements

1000 - 1999

0	Incorrect CGM Element Lengths	2000	-	2999
0	CGM State Errors	3000	-	3499
0	Required CGM Elements Missing or Wrong	4000	-	4499
0	CGM Parameter Values Out of Range	6000	-	6499
0	CGM Structure Errors	7000	-	7499
0	*** CGM Errors Found (total)	***		
0	Profile State Errors	3500	-	3999
0	Illegal Profile Elements	4500	-	4999
0	Profile Parameter Values Out of Range	6500	-	6999
12	Profile Data Limits Exceeded	8500	-	8999
0	Other Profile Constraints Violated	9500	-	9999
12	*** Profile Violations Found (total)	***		
1	Warnings (Advisory Remarks)	20000	-	20999

2 distinct errors and warnings were reported.

===== End of Conformance Report =====

11.7.2 validcgm Log

Analysis for file c007.cgm using table table

MILSPEC 28003 error: too many points

(304, 6846) (4, 1, 4164) Polyline 1041 points
(6378,20341) (20341,6378) (6378,20341)
(6378,20343) (20343,6378) (6378,20344)

<<<< PART OF LOG REMOVED HERE >>>>

MILSPEC 28003 error: too many points

(398, 12330) (4, 1, 4164) Polyline 1041 points
(6653,20341) (20341,6653) (6653,20341)
(6653,20343) (20343,6653) (6653,20344)

<<<< PART OF LOG FILE REMOVED HERE >>>>

MILSPEC 28003 error: too many points

(492, 17814) (4, 1, 4164) Polyline 1041 points
(6927,20341) (20341,6927) (6927,20341)
(6927,20343) (20343,6927) (6927,20344)

<<<< PART OF LOG FILE REMOVED HERE >>>>

MILSPEC 28003 error: too many points

(586, 23298) (4, 1, 4164) Polyline 1041 points
(7202,20341) (20341,7202) (7202,20341)
(7202,20343) (20343,7202) (7202,20344)

<<<< PART OF LOG FILE REMOVED HERE >>>>

MILSPEC 28003 error: too many points

(680, 28782) (4, 1, 4164) Polyline 1041 points
(7477,20341) (20341,7477) (7477,20341)
(7477,20343) (20343,7477) (7477,20344)

<<<< PART OF LOG FILE REMOVED HERE >>>>

MILSPEC 28003 error: too many points

(774, 34266) (4, 1, 4164) Polyline 1041 points
(7757,20341) (20341,7757) (7757,20341)
(7757,20343) (20343,7757) (7757,20344)

<<<< PART OF LOG FILE REMOVED HERE >>>>

MILSPEC 28003 error: too many points

(868, 39750) (4, 1, 4164) Polyline 1041 points
(8033,20341) (20341,8033) (8033,20341)
(8033,20343) (20343,8033) (8033,20344)

<<<< PART OF LOG FILE REMOVED HERE >>>>

MILSPEC 28003 error: too many points
(1745, 81542) (4, 1, 4164) Polyline 1041 points
(6378,22792) (22792,6378) (6378,22792)
(6378,22794) (22794,6378) (6378,22795)

<<<< PART OF LOG FILE REMOVED HERE >>>>

MILSPEC 28003 error: too many points
(1839, 87026) (4, 1, 4164) Polyline 1041 points
(6653,22792) (22792,6653) (6653,22792)
(6653,22794) (22794,6653) (6653,22795)

<<<< PART OF LOG FILE REMOVED HERE >>>>

MILSPEC 28003 error: too many points
(1933, 92510) (4, 1, 4164) Polyline 1041 points
(6927,22792) (22792,6927) (6927,22792)
(6927,22794) (22794,6927) (6927,22795)

<<<< PART OF LOG FILE REMOVED HERE >>>>

MILSPEC 28003 error: too many points
(2027, 97994) (4, 1, 4164) Polyline 1041 points
(7202,22792) (22792,7202) (7202,22792)
(7202,22794) (22794,7202) (7202,22795)

<<<< PART OF LOG FILE REMOVED HERE >>>>

MILSPEC 28003 error: too many points
(2121, 103478) (4, 1, 4164) Polyline 1041 points
(7477,22792) (22792,7477) (7477,22792)
(7477,22794) (22794,7477) (7477,22795)

<<<< PART OF LOG FILE REMOVED HERE >>>>

(0, 1) occurred 1 time
(0, 2) occurred 1 time
(0, 3) occurred 1 time
(0, 4) occurred 1 time
(0, 5) occurred 1 time
(1, 1) occurred 1 time

(1, 2) occurred 1 time
(1, 3) occurred 1 time
(1, 4) occurred 1 time
(1, 7) occurred 1 time
(1, 8) occurred 1 time
(1, 10) occurred 1 time
(1, 11) occurred 1 time
(2, 1) occurred 1 time
(2, 2) occurred 1 time
(2, 3) occurred 1 time
(2, 4) occurred 1 time
(2, 5) occurred 1 time
(2, 6) occurred 1 time
(2, 7) never occurred, required by standard B
(3, 1) occurred 1 time
(4, 1) occurred 324 times
(4, 4) occurred 74 times
(4, 7) occurred 171 times
(5, 2) occurred 203 times
(5, 3) occurred 313 times
(5, 4) occurred 280 times
(5, 8) occurred 280 times
(5, 14) occurred 280 times
(5, 15) occurred 16 times
(5, 16) occurred 2 times
(5, 22) occurred 63 times
(5, 23) occurred 93 times
(5, 27) occurred 203 times
(5, 28) occurred 313 times
(5, 29) occurred 280 times
(5, 30) occurred 2 times

11.7.3 MetaView Log

System Error: Error -1018 in function 14.
 cl/id: 4/4, offs: 1024, esqn: 110
Error detected in file i:\9315\C007.CGM

11.7.4 Output Harvard Graphics 3.05 HG305 - D001C007

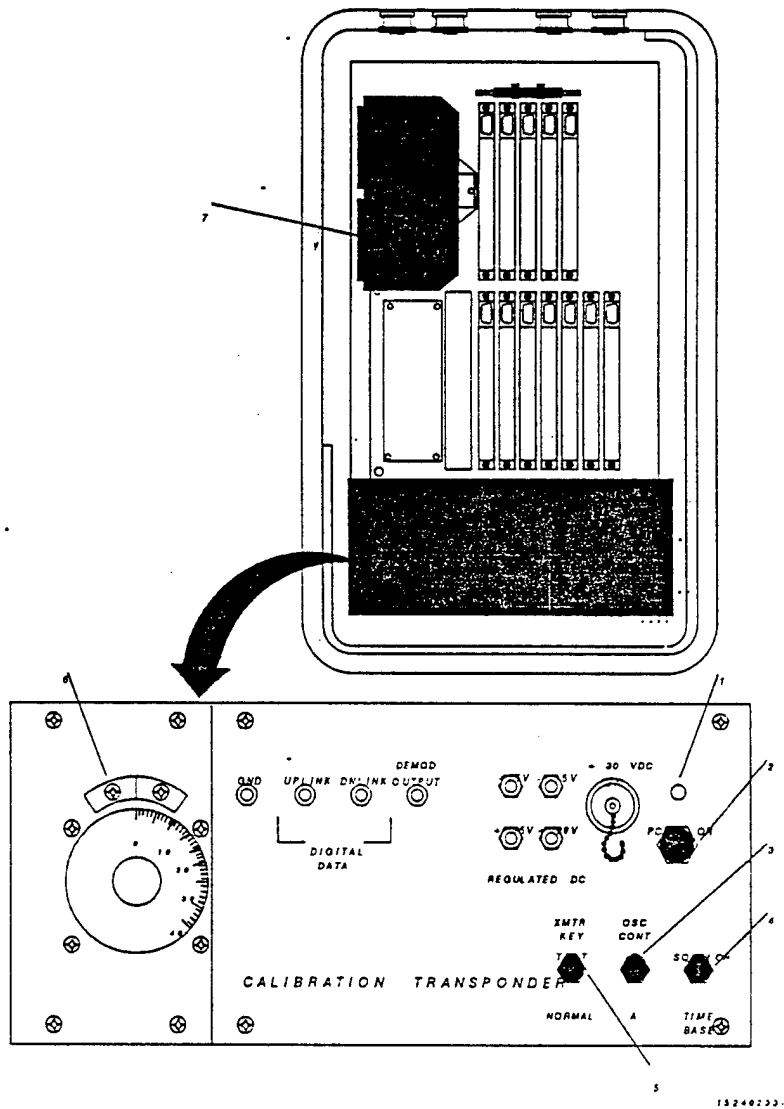

13240233.C

11.7.5 Output cgm2draw/IslandDraw

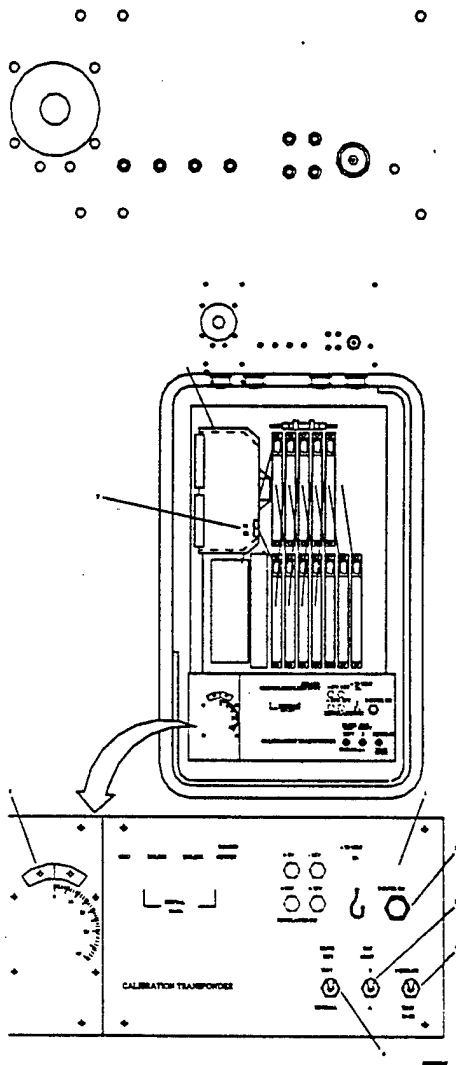

11.7.6 Output IslandDraw

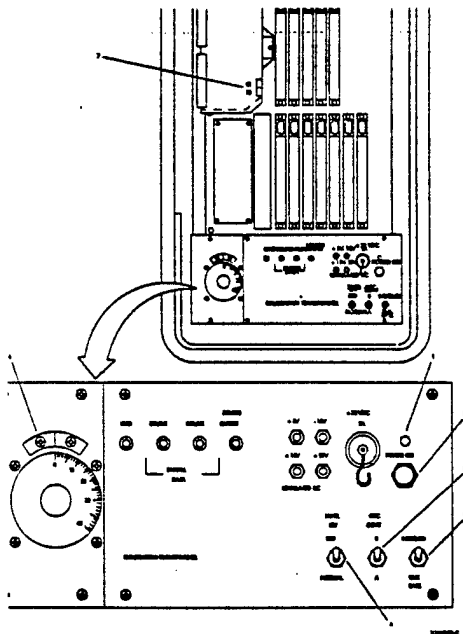

11.7.7 Output HiJaak Windows

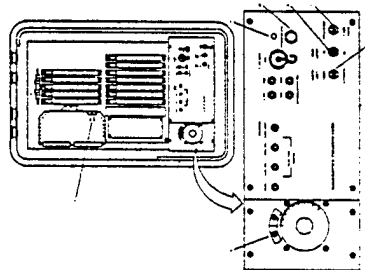

11.7.8 Output Designer

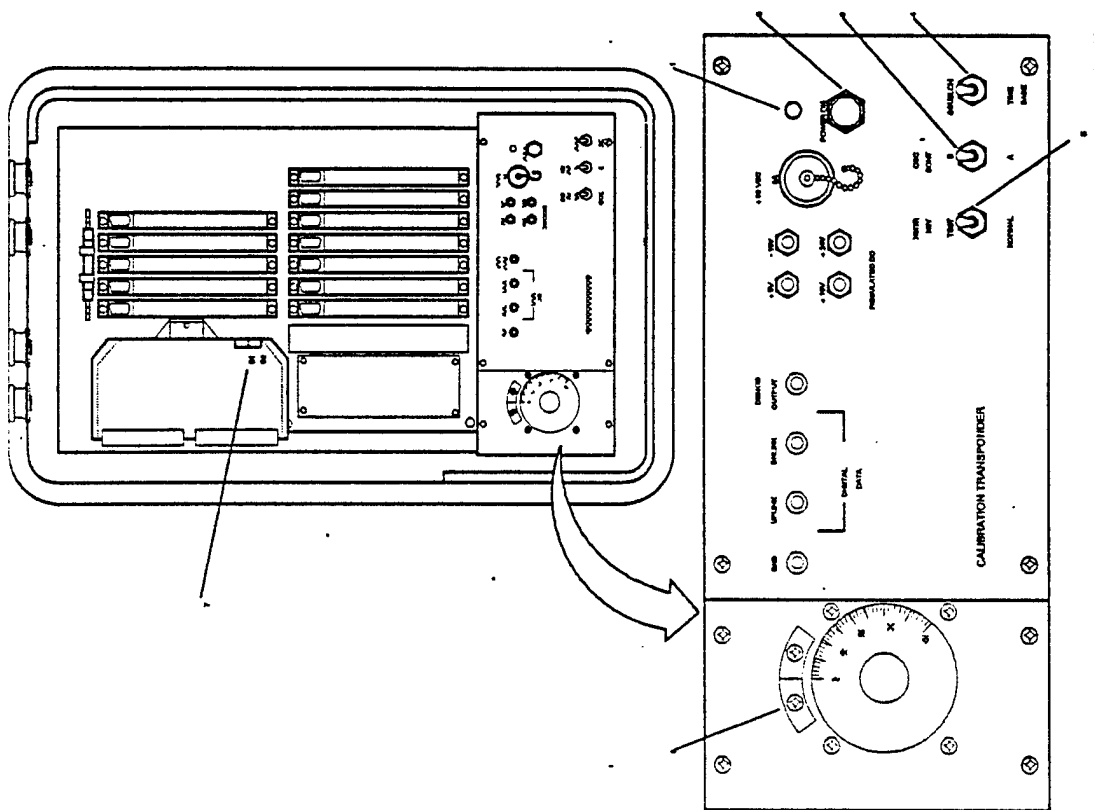

11.7.9 Output Ventura Publisher

