

---

**DEVELOPMENT AND DEMONSTRATION OF STSim, A  
SIMULATION ENVIRONMENT FOR SPACE  
TECHNOLOGY SYSTEMS**

**Craig Baer et al.**

**BCSi, Inc.  
102 South Tejon, Suite 400  
Colorado Springs, CO 80903**

**August 1995**

**Final Report**

19960828 036

---

**APPROVED FOR PUBLIC RELEASE; DISTRIBUTION IS UNLIMITED.**

---



**PHILLIPS LABORATORY  
Space Experiments Directorate  
AIR FORCE MATERIEL COMMAND  
KIRTLAND AIR FORCE BASE, NM 87117-5776**

---

# DISCLAIMER NOTICE



**THIS DOCUMENT IS BEST QUALITY AVAILABLE. THE COPY FURNISHED TO DTIC CONTAINED A SIGNIFICANT NUMBER OF PAGES WHICH DO NOT REPRODUCE LEGIBLY.**

Using Government drawings, specifications, or other data included in this document for any purpose other than Government procurement does not in any way obligate the U.S. Government. The fact that the Government formulated or supplied the drawings, specifications, or other data, does not license the holder or any other person or corporation; or convey any rights or permission to manufacture, use, or sell any patented invention that may relate to them.

This report has been reviewed by the Public Affairs Office and is releasable to the National Technical Information Service (NTIS). At NTIS, it will be available to the general public, including foreign nationals.

If you change your address, wish to be removed from this mailing list, or your organization no longer employs the addressee, please notify PL/SXEA, 3550 Aberdeen Ave SE, Kirtland AFB, NM 87117-5776.

Do not return copies of this report unless contractual obligations or notice on a specific document requires its return.

This report has been approved for publication.



JESSE A. LEITNER, PhD, GS-12  
Project Officer

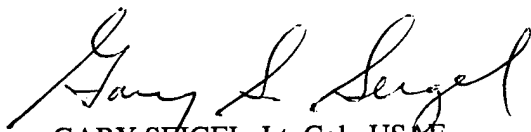

GARY SEIGEL, Lt. Col., USAF  
Chief, Mission Area Demonstrations Branch

FOR THE COMMANDER



MICHAEL HAVEY, Col., USAF  
Director, Space Experiments Directorate

# DRAFT SF 298

<b>1. Report Date (dd-mm-yy)</b> 15-08-95		<b>2. Report Type</b> Final		<b>3. Dates covered (from... to )</b> March 95 - August 95	
<b>4. Title &amp; subtitle</b> DEVELOPMENT AND DEMONSTRATION OF STSim, A SIMULATION ENVIRONMENT FOR SPACE TECHNOLOGY SYSTEMS				<b>5a. Contract or Grant #</b> F29601-95-C-0103	
				<b>5b. Program Element #</b> 65502F	
<b>6. Author(s)</b> Craig Baer et al				<b>5c. Project #</b> 3005	
				<b>5d. Task #</b> CO	
				<b>5e. Work Unit #</b> LY	
<b>7. Performing Organization Name &amp; Address</b> BCSi, Inc. 102 South Tejon, Suite 400 Colorado Springs, CO 80903				<b>8. Performing Organization Report #</b>	
<b>9. Sponsoring/Monitoring Agency Name &amp; Address</b> Phillips Laboratory 3550 Aberdeen Avenue, SE Kirtland AFB, NM 87117-5776				<b>10. Monitor Acronym</b> PL/SXD	
				<b>11. Monitor Report #</b> PL-TR-95-1137	
<b>12. Distribution/Availability Statement</b> Approved for public release; distribution is unlimited.					
<b>13. Supplementary Notes</b>					
<b>14. Abstract</b> This report documents the development of Space Technologies Simulation (STSim), a simulation environment which incorporates on-orbit space experiment assets, such as sensors, satellites, communications networks, and command centers in support of definition, acquisition, and operations phases for the Space Experiments Directorate (PL/SX). The design methodology involves utilizing consistent software procedures, tools, and infrastructure in an object-oriented software environment with a flexible scope and level of fidelity to adapt individual project needs. The simulation supports both analysis and operator-in-the-loop modes of operation to allow applicability from initial concept assessment through operational phases of a program. The modular, open architecture can be extended to perform end-to-end spacecraft hardware in the loop simulation and to interface with external facilities such as in wargaming simulations using standard protocols.					
<b>15. Subject Terms</b> modeling, simulation, object-oriented software, space experiments, GPS, mission design, modular simulation, satellite design, satellite communications, telemetry					
<b>Security Classification of</b>			<b>19. Limitation of Abstract</b>	<b>20. # of Pages</b>	<b>21. Responsible Person (Name and Telephone #)</b>
<b>16. Report</b> Unclassified	<b>17. Abstract</b> Unclassified	<b>18. This Page</b> Unclassified	Unlimited	150	Jesse Leitner 505-846-6071

## TABLE OF CONTENTS

<u>Section</u>		<u>Page</u>
	LIST OF FIGURES	v
1.0	PURPOSE/SCOPE	1
2.0	STSim REQUIREMENTS	2
2.1	INCORPORATE ON-ORBIT SPACE EXPERIMENT ASSETS	2
2.2	SUPPORT ALL THREE PL/SX SYSTEM PHASES	3
	2.2.1 Definition Phase	3
	2.2.2 Acquisition Phase	4
	2.2.3 Operations Phase	5
2.3	CONSISTENT SOFTWARE PROCEDURES, TOOLS, AND INFRASTRUCTURE	5
2.4	FLEXIBLE SCOPE AND LEVEL OF FIDELITY	6
2.5	SUPPORT BOTH ANALYSIS AND OPERATOR-IN- THE-LOOP MODES OF OPERATION	7
2.6	UTILIZE OBJECT-ORIENTED TECHNIQUES	7
3.0	STSim DEVELOPMENT APPROACH	8
3.1	OBJECT DESIGN PHASE	8
3.2	OBJECT DEVELOPMENT PHASE	9
3.3	INTEGRATED SYSTEM PHASE	9
4.0	STSim RESULTS	10
4.1	STSim SATELLITE	10
	4.1.1 Satellite Highlights	10
	4.1.2 Satellite Design	11
	4.1.3 Satellite Structures	12
	4.1.4 Satellite Electrical Power Subsystem (EPS)	14
	4.1.5 Satellite Tracking Telemetry and Control (TT&C)	19
	4.1.6 Satellite Attitude Control Subsystem (ACS)	23
	4.1.7 Satellite Propulsion Subsystem	28
	4.1.8 Satellite Optical Sensor Payload	31

DTIC QUALITY INSPECTED 3

TABLE OF CONTENTS  
(Concluded)

<u>Section</u>	<u>Page</u>
4.2 STSim COMMUNICATIONS NETWORK	32
4.2.1 Communications Network Highlights	32
4.2.2 Communications Network Design	33
4.2.3 Communications Results	33
4.3 STSim COMMAND CENTER	38
4.3.1 Command Center Highlights	38
4.3.2 Command Center Design	39
4.3.3 Command Center Results	40
4.4 STSim OPTIONAL CAPABILITIES	43
4.4.1 Threat/Launch Vehicle Option	43
4.4.2 Transmission Medium Option	44
4.4.3 Proctor Option	44
5.0 SUMMARY	45
6.0 RECOMMENDATIONS	46
REFERENCES	47
APPENDICES	
A. GPS IIR Discrete Command by Command Number Table	A-1
B. GPS IIR Message Command by Command Number Table	B-1
C. GPS IIR Telemetry By Word Table	C-1

## LIST OF FIGURES

<u>Figure</u>		<u>Page</u>
1.	BCSi simulation environment.	2
2.	Top-level STSim software segments.	10
3.	STSim satellite design.	11
4.	Satellite structures hierarchy.	13
5.	Satellite EPS subsystem.	14
6.	Satellite EPS hierarchy.	15
7.	EPS panel power and bus voltage.	16
8.	EPS battery voltage, battery current, and boost current.	17
9.	EPS shunt boom assembly output voltage and current.	18
10.	Satellite TT&C architecture.	20
11.	Satellite TT&C commands log file.	22
12.	Satellite ACS control law architecture.	24
13.	Satellite attitude - initial capture.	25
14.	Satellite control commands - initial capture.	26
15.	Satellite thruster commands - initial capture.	27
16.	Satellite propulsion subsystem model.	29
17.	Satellite thruster output - initial capture.	30
18.	Satellite payload class/object hierarchy.	32
19.	Communications network message generation.	35
20.	Communications network average transmission times.	36
21.	Communications network time history file.	37
22.	STSim command center design.	39
23.	Command center main window.	40
24.	Command center discrete command view.	41
25.	Command center serial message command view.	41
26.	Command center telemetry frame view.	41
27.	STSim forward user sensor viewpoint.	43

## 1.0 PURPOSE/SCOPE

The purpose of this Phase I Small Business Innovative Research (SBIR) contract was to develop and demonstrate the Space Technologies Simulation (STSim), a simulation environment which has the following features:

- Incorporates on-orbit space experiment assets, i.e., sensors, satellites, communications networks, and command centers
- Supports all three Phillips Lab/SX (PL/SX) system phases, i.e., Definition, Acquisition, and Operations Phases
- Utilizes consistent software procedures, tools, and infrastructure
- Addresses issues at appropriate scope and level of fidelity
- Supports both analysis and operator-in-the-loop modes of operation
- Utilizes object-oriented software techniques

The specific STSim application chosen to demonstrate these features was a space-based optical sensor controlled by the forward user. The emphasis of STSim was on space experiment type assets, i.e., satellites (both bus and payload systems), communications networks, and command centers. More specifically, the satellite bus is a combination of Global Positioning System (GPS) Block IIA and Block IIR systems. The payload is an optical sensor which is controlled by commands from the ground, e.g., azimuth and elevation commands. The communications network is a three node system consisting of satellite, Falcon Air Force Base (FAFB), and PL nodes where FAFB serves as a relay node. The command center allows the user to send/receive both bus and payload commands/telemetry.

The following sections discuss the above STSim requirements (Section 2.0), the STSim development approach (Section 3.0), and STSim results (Section 4.0). Since the emphasis of the STSim program was on the final demonstration, only a summary of the results is presented in Section 4.0.

## 2.0 STSim REQUIREMENTS

The STSim requirements listed above are designed to support definition, acquisition, and operation of PL space experiments. In general, these phases are technically challenging as well as technically fluid. STSim is responsive to both of these aspects of space experiments.

### 2.1 INCORPORATE ON-ORBIT SPACE EXPERIMENT ASSETS

STSim is a specific application of the BCSi simulation environment (Fig. 1). All models of space experiment assets fall into command center (BCCmdCtr), communications network (BCCom), or physics-based environment (BCSim) simulation segments. The proctor and network manager segments of the BCSi simulation environment are not included in the current version of STSim, although they are options which may be added.

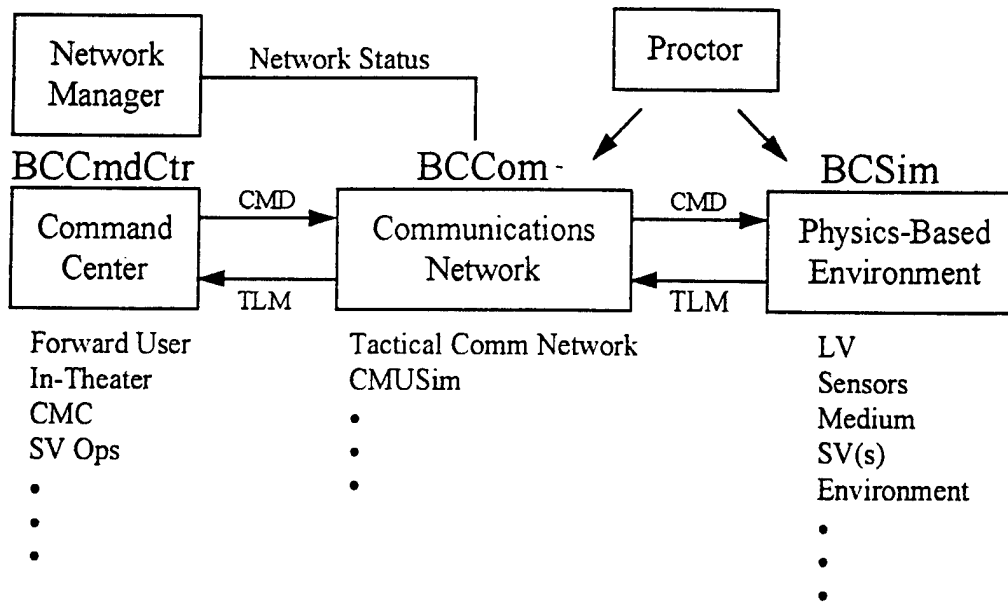

Figure 1. BCSi simulation environment.

BCCmdCtr software supports development of operator-in-the-loop Human Computer Interfaces (HCIs). These HCIs replicate operator interfaces such as telemetry screens and command

generation screens. The STSim HCI allows the user to send/receive both bus and payload commands/telemetry.”

BCCom is a high-fidelity message-based communications modeling tool which includes features such as routing algorithms, buffer management, protocols, message priority, and node dynamics. BCCom supports both detailed analysis and operator-in-the-loop operations. BCCom is used in STSim to model the strawman three node space experiment communications network.

BCSim supports object-oriented development of physics-based models. Models may be continuous, multi-rate, and/or input/output-driven. BCSim also supports both analysis and operator-in-the-loop operations. STSim uses BCSim to model the satellite bus and payload systems.

## 2.2 SUPPORT ALL THREE PL/SX SYSTEM PHASES

STSim has the flexibility required to support all three PL/SX system phases, i.e., Definition, Acquisition, and Operations Phases.

### 2.2.1 Definition Phase

During the Definition Phase, the STSim environment can be used to derive detailed technical specifications. For example, the communications network segment of STSim (BCCom) can be used to define all system nodes and links. Nodes can be further defined to include buffer size and management algorithms, message processing rates, protocols, message routing, and message formats. Links can be further defined to include data rates and Bit Error Rates (BERs). The effects of each of these design parameters upon overall network performance can be assessed.

In a similar manner, detailed technical requirements of physics-based systems can also be derived using BCSim. For example, satellite subsystems and subsystem interfaces can be designed and analyzed, e.g., satellite attitude control laws, power system sizing, etc.

Finally, since both BCCom and BCSim support analysis and operator-in-the-loop modes of operation, STSim can be used to demonstrate prototype system operations to include operator HCIs. At the conclusion of the Definition Phase, then, the customer can clearly define the detailed technical requirements for communications networks, physics-based systems (e.g., satellites, sensors, etc.), and operator HCIs. These detailed technical requirements can serve as the basis for technical support of the Acquisition Phase.

### 2.2.2 Acquisition Phase

STSim can be used to support a number of aspects of the Acquisition Phase. First, the detailed technical requirements and models developed from the Definition Phase can provide both 'performance audit' and 'technical roadmap' information during system acquisition. For example, test results of system components can be integrated into STSim as they become available. Subsequent analysis can be used to provide both an ongoing audit of system performance and an assessment of the effects of component anomalies such as underperforming communications processors, higher BERs, etc.

Second, STSim can be used to exploit potential system upgrades. For example, technically sophisticated systems often require extended periods for system acquisition and test. During this time, new and/or improved technologies inevitably become available; technologies such as increased processor speeds, different network protocols, etc. STSim can be used to assess the utility of integrating these new/improved technologies.

And finally, STSim can be used to support actual component/subsystem testing by wrapping parts of STSim around the component of interest. For example, the STSim GPS satellite model can be used to drive ground control software or the command center software can be used to drive actual on-board satellite software. (Other BCSi software similar to STSim is currently being used in these capacities to support development of a commercial satellite program currently under development.)

### 2.2.3 Operations Phase

STSim can be used to support three aspects of the systems Operations Phase. First, it can be used to determine the performance of the current system under various loads and stresses. For example, the BCCom portion of STSim can be used to determine operational performance of the communications network under a variety of experiment message loadings and/or stress events such as link/node outage or degradation.

Second, various aspects of system anomalies can be analyzed using STSim. Again, with regard to the communications network, the high-fidelity, message-based features of BCCom can be used to identify specific nodes and specific effects of network anomalies. The effects can be determined via analysis and operator-in-the-loop modes of simulation. Once the problem has been identified, the solution or parameters of the solution can be determined. If the problem is a result of network issues such as buffer size, message processing rates, link BERs, etc., BCCom can be used to confirm potential solutions. If, on the other hand, the problem is embedded in the operational software, BCCom can support analysis of the parameters of the solution. Even though one would not use BCCom to debug operational software, it can be used to parameterize the solution, i.e., message processing rates, message formats, etc.

And third, various portions of STSim can support operator training for both satellite bus and payload subsystems.

## 2.3 CONSISTENT SOFTWARE PROCEDURES, TOOLS, AND INFRASTRUCTURE

STSim has been developed using a consistent set of BCSi procedures, tools, and infrastructure classes. The procedures are outlined in Section 3.0 and are grouped in object design, object development, and integrated system phases. Each phase supports the object-oriented approach and has specific tasks and reviews. Development of other applications will follow these same phases.

The major BCSi software segments used in STSim are consistent with the object-oriented approach. BCCmdCtr and BCSim are BCSi tools which support full object-oriented software development of HCIs and physics-based models, respectively. BCCom, the high-fidelity message-based network modeling tool, is not currently object-oriented. When used in operator-in-the-loop simulation environments, however, the network model is a separate process operating as an independent communications object.

Along with each of the STSim segments, there is an existing infrastructure developed during other internal/external projects. BCCmdCtr has been used to command and control several satellite systems as well as support missile warning. BCCom has been used to model a wide variety of communications networks, some for analysis and others for operator-in-the-loop operations. Network model applications have included both satellite command and control as well as missile warning. BCSim has been used to model satellites, launch vehicles, and sensors. A rich set of supporting classes such as FreeBody, SpaceVehicle, and LaunchVehicle has been developed which support a variety of other applications. Section 4.1.3 gives a brief overview of these classes.

The combination of procedures, tools, and infrastructure classes allows STSim to be tailored to the appropriate scope and level of fidelity during Definition, Acquisition, and Operations Phases of space experiments.

#### 2.4 FLEXIBLE SCOPE AND LEVEL OF FIDELITY

As shown during the final demonstration, STSim is extremely flexible with regard to both scope and level of fidelity. With regard to STSim scope, depending upon the particular STSim configuration, various segments can be run standalone or integrated in an end-to-end simulation. For example, the communications network model and satellite operations can be run standalone for individual segment analysis. They may also be integrated with command center software to provide a simulation environment which extends from the satellite bus and payload systems through the communications network and to the forward user at PL.

Flexibility with regard to level of fidelity is also an integral part of STSim. For example, communications network models may be easily enhanced through the BCom menu-driven interface and integrated with STSim. Subsystem models of satellites other than GPS Block IIA and IIR have been developed in support of numerous other simulation efforts and can be easily integrated. Such flexibility allows the user to tailor the simulation environment segments to the appropriate scope and level of fidelity.

## 2.5 SUPPORT BOTH ANALYSIS AND OPERATOR-IN-THE-LOOP MODES OF OPERATION

It is important that a simulation environment to be used in the definition, acquisition, and operation of space-based experiments support both analysis and operator-in-the-loop modes of operation. Oftentimes, considerable insight is provided by an 'operator's eye' view of a detailed technical issue. Conversely, it is also important to be able to define the technical details of operational requirements. Obviously, both analysis and operator-in-the-loop modes must use consistent models.

As demonstrated in the Final Briefing, STSim supports both analysis and operator-in-the-loop modes of operation. The models used in both cases are the same; only the segment interfaces are modified.

## 2.6 UTILIZE OBJECT-ORIENTED TECHNIQUES

The fundamental feature of STSim which provides the capabilities mentioned above is the implementation of object-oriented design and development. Satellite subsystem models of one fidelity can be easily replaced with other models which have been tuned to the particular application. Software segments can be easily integrated to expand or restrict the scope of the simulation. As a result, the flexibility provided by the object-oriented approach makes STSim responsive to space experiment Definition, Acquisition, and Operations phases.

### 3.0 STSim DEVELOPMENT APPROACH

The approach used to develop STSim was to tailor the existing BCSi simulation environment to the space experiment application. Typically, development is conducted in three phases, each phase consisting of specific tasks and culminating with the following respective design reviews.

- Object Design Review - BCSi reviews overall STSim architecture and the scope and level of fidelity of all STSim objects. BCSi demonstrates object motion and an initial version of the user interface. Customer reviews object definition and user interface.
- Object Development Review - BCSi describes and demonstrates results of object development and upgrades to the user interface. Customer reviews object development with respect to scope and level of fidelity as well as the user interface with respect to preprocessing, runtime, and postprocessing data accessibility.
- Integrated System Review - BCSi presents results of the integrated operations.

Due to the size of this project, only a final demonstration of the Integrated System Review was conducted. The status of object design and development was documented via monthly status reports. The following sections give a brief description of the tasks performed during all three software phases.

#### 3.1 OBJECT DESIGN PHASE

The purpose of the Object Design Phase was to define simulation objects and demonstrate the STSim object dynamics and HCI. Specific tasks performed include:

- Identify simulation requirements
- Specify relevant simulation scenario
- Define simulation architecture, i.e., define top-level objects and interrelationships
- Design and implement the dynamic motion of top-level objects (full object functionality is added during the Object Development Phase)

- Design minor objects within each top-level object to appropriate scope and level of fidelity
- Conduct Object Design Review

### 3.2 OBJECT DEVELOPMENT PHASE

The purpose of the Object Development Phase was to develop those objects defined during the previous phase and perform the first iteration of the HCI. Specific tasks include:

- Prototype all objects to prescribed scope and level of fidelity
- Verify object design with available test or analytical results
- Integrate minor objects within appropriate top-level objects
- Conduct Object Development Review

### 3.3 INTEGRATED SYSTEM PHASE

The purpose of the Integrated System Phase was to integrate all major and minor objects to form the STSim simulation environment. Specific tasks include:

- Integrate all STSim objects
- Begin testing end-to-end STSim
- Begin final report
- Conduct Integrated Systems Review

## 4.0 STSim RESULTS

The major segments of STSim correspond to the scope described previously (Fig. 2). The satellite operations command center was developed using BCCmdCtr and included bus and payload operations. The communications network was developed using BCCom and included nodes for PL, FAFB, and satellite communications. The space-based platform was developed using BCSim and included subsystem models for both the payload experiment and satellite bus operations.

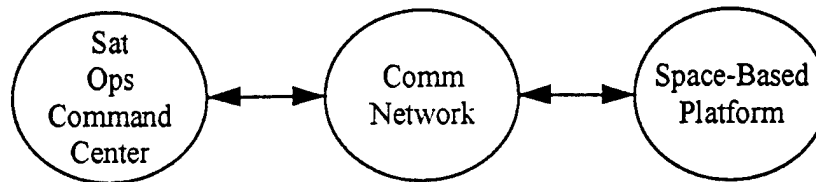

Figure 2. Top-level STSim software segments.

Sections 4.1 through 4.3 discuss each of these segments as they were presented in the final briefing, i.e., satellites, comm networks, and command centers. Each subsection discusses segment highlights, top-level design, and results. Section 4.4 gives a brief description other related options available, i.e., threat/launch vehicles, medium, and proctor functions.

### 4.1 STSim SATELLITE

#### 4.1.1 Satellite Highlights

The satellite segment has the following features:

- Variable fidelity satellite bus and payload modeling capability
- Six degree of freedom orientation
- Kepler propagator or simple geosynchronous propagator models

- Fully object-oriented design for easy interchangeability of components and instantiation of multiple occurrences
- Bus subsystems are hybrids of GPS IIA/IIR and include TT&C, Propulsion, Thermal, Attitude Controls, Structures, Power
- Payload model is a ground-controlled optical sensor

#### 4.1.2 Satellite Design

The satellite class and object hierarchies are depicted in Figure 3. The class hierarchy denotes that the STSim satellite inherits from the SpaceVehicle class which, in turn, inherits from the FreeBody class. Stated another way, the STSim satellite is a SpaceVehicle which is a FreeBody. The SpaceVehicle and FreeBody classes are part of the BCSi software infrastructure as implemented within BCSim. Together, these two classes support the physical integration of dynamic components. More specifically, the FreeBody class supports determination of forces/torques, orientation, and graphical realizations. The SpaceVehicle class supports six degree of freedom space vehicle dynamics. Detailed descriptions of the architecture and use of these classes are provided in other documents (Ref. 1).

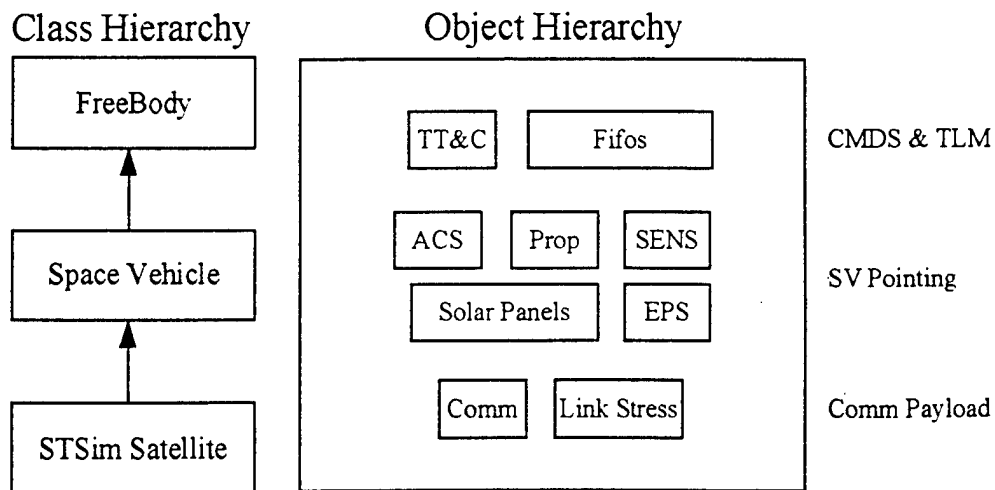

Figure 3. STSim satellite design.

The object hierarchy depicts the top-level subsystems of the STSim satellite. As indicated, these subsystems fall into the commands/telemetry, satellite pointing, and communications payload categories. In addition, the structure subsystem is modeled via the SpaceVehicle and FreeBody classes and does not appear explicitly within the object hierarchy. Features, design, and typical results of the major objects within the satellite hierarchy (i.e., structures, Electric Power Subsystem (EPS), Attitude Control System (ACS), propulsion, and payload) are discussed in the following subsections. The File In File Out (FIFO) and Link Stress objects support STSim satellite connectivity with other STSim segments such as the communications network model and command center and will not be discussed in detail.

### 4.1.3 Satellite Structures

4.1.3.1 Satellite Structures Highlights. The satellite structure model has the following features:

- Fully object-oriented architecture
- Automatically duplicates architecture of actual physical system via FreeBody/SpaceVehicle Classes
  - Attach components to base structure
  - Component defined by mass, moments of inertia, position/orientation, etc.
  - Virtual transmission of torque/forces and relative position/orientation
  - Supports 3-D graphical animation
  - Performs translation/rotation dynamics

4.1.3.2 Satellite Structures Design. The structures design hierarchy reflects the SpaceVehicle and FreeBody classes as well as the BCBlock class (Fig. 4). The BCBlock class supports object connectivity and controls object execution while the SpaceVehicle and FreeBody classes support functions described previously.

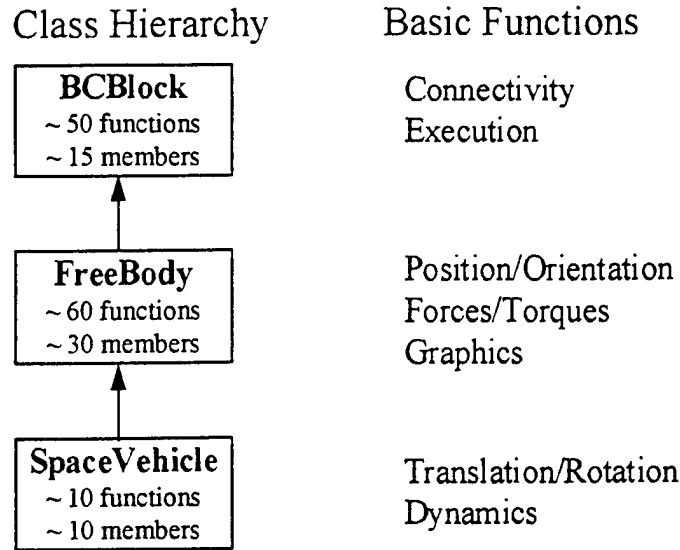

Figure 4. Satellite structures hierarchy.

When used together, these classes allow the developer to create a BCSim simulation of the satellite in software in a manner analogous to building the actual satellite in hardware. For example, attaching a sensor to the actual satellite structure establishes the orientation of the sensor vis-a-vis the satellite; and attaching a thruster establishes force/torque effects on the satellite. Similarly, the developer may "attach" a sensor or thruster to the satellite structure by specifying SpaceVehicle/FreeBody data members such as position and orientation values. After attaching the component, the developer may use any of the various member functions which determine orientations, forces, torques, dynamics, etc. Again, details of BCSim and existing infrastructure classes are contained in other documents (Ref. 1).

4.1.3.3 Satellite Structures Results. The results of the structure model were demonstrated during the final briefing and included 3-D articulated graphics, runtime control interfaces, and the dynamics effects of ACS and propulsion subsystems. Sun and earth motion were also included in the environment model. Plots depicting satellite dynamics, attitude control commands, and thruster forces for an initial capture scenario are presented in Section 4.1.5, Satellite Attitude Control Subsystem.

#### 4.1.4 Satellite Electrical Power Subsystem

4.1.4.1 Satellite EPS Highlights. The satellite EPS model has the following features:

- Hybrid of GPS Block IIA/IIR configurations
- Models all power management functions, e.g., batteries, power regulation unit, and shunt dissipators
- GPS Block IIA solar array drive digital logic controller
- Supported by PowerLoad and PowerBus classes

4.1.4.2 Satellite EPS Design. The STSim satellite EPS model is a hybrid of an existing BCSi simulation of the GPS Block IIA EPS and the GPS Block IIR EPS. The Block IIR EPS, as described in the IIR Orbital Operations Handbook (OOH), is depicted in Figure 5. The class and object hierarchy as modeled in BCSim has an architecture consistent with IIR (Fig. 6). Solar array drive and battery models are IIA models. The Power Regulation Unit (PRU) and the EPS bus and power loading architecture are IIR designs.

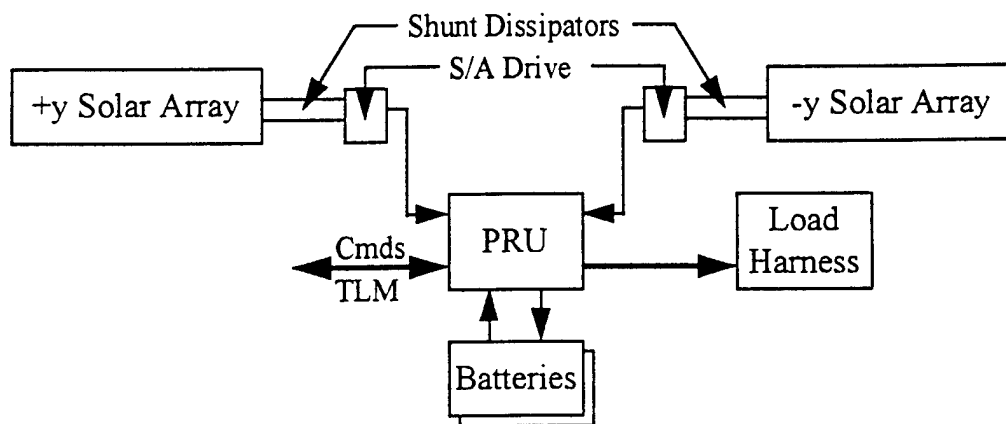
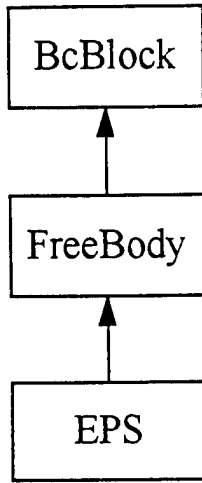

Figure 5. Satellite EPS subsystem.

## Class Hierarchy



## Object Hierarchy

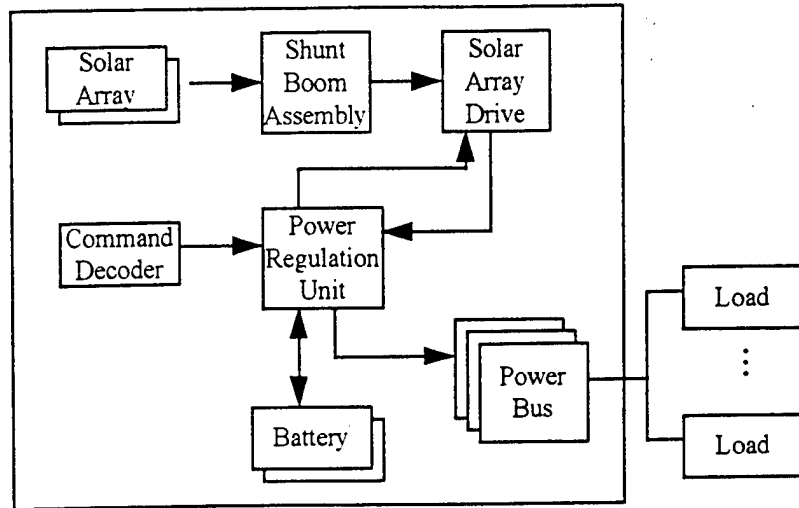
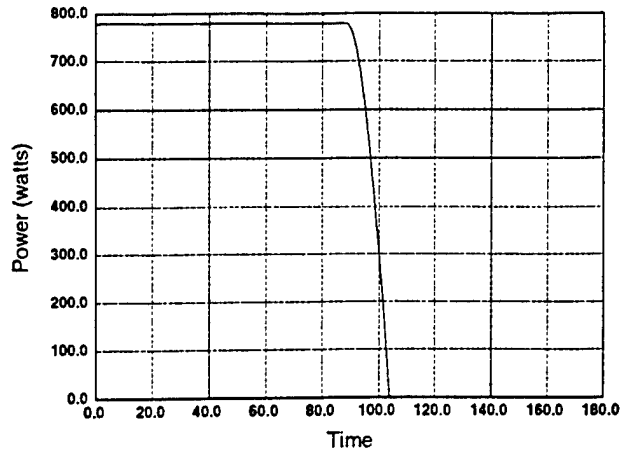

Figure 6. Satellite EPS hierarchy.

The EPS model has multiple power buses. Each bus can have multiple power loads attached to it via specifying individual impedances. By summing the bus impedance, the effects of component power loads on bus voltage can be modeled.

4.1.4.3 Satellite EPS Results. Figures 7 through 9 depict the results for a scenario wherein the solar panels are initially oriented to the sun and then are individually rotated via ground commands. Initially, both panels provide nearly 800 watts (Figs. 7a,b). Since this is considerably more than the power load required for this scenario (arbitrarily set to 600 watts), the power is directed to charging of the batteries as indicated by the increase in the battery voltage and the relatively small value of positive battery current (Figs. 8a,b). Since the power generated by the solar panels is still more than required, power is shunted as indicated by the drop in the net current coming out of the shunt boom assembly (Fig. 9b). After the initial transients settle, the bus voltage goes to 28.5 volts (Fig. 7c), the battery voltage and current go to their respective steady state charge values, and the boost current is not needed (Fig. 8c).



(a) +y panel power generated.

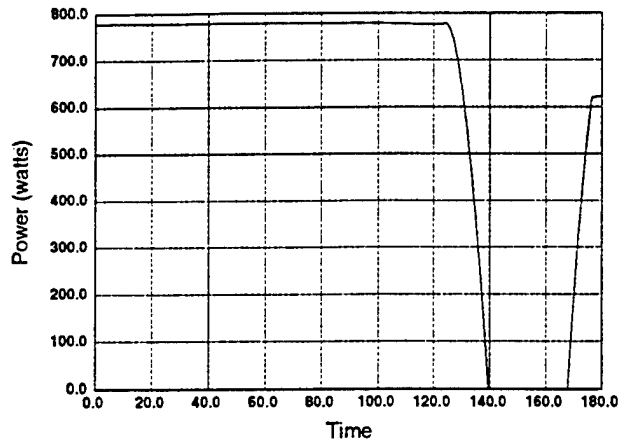

(b) -y panel power generated.

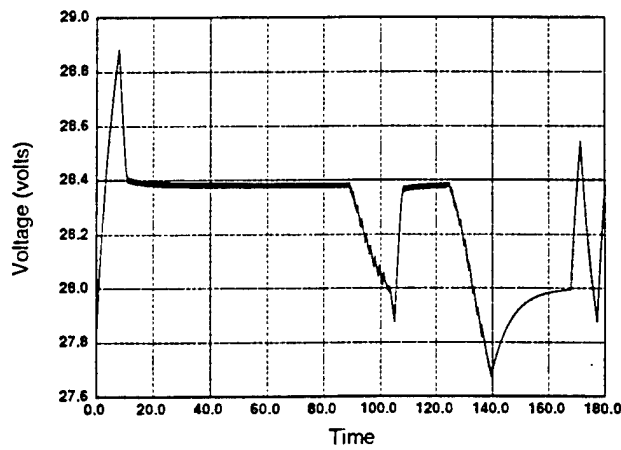

(c) Main bus voltage.

Figure 7. EPS panel power and bus voltage.

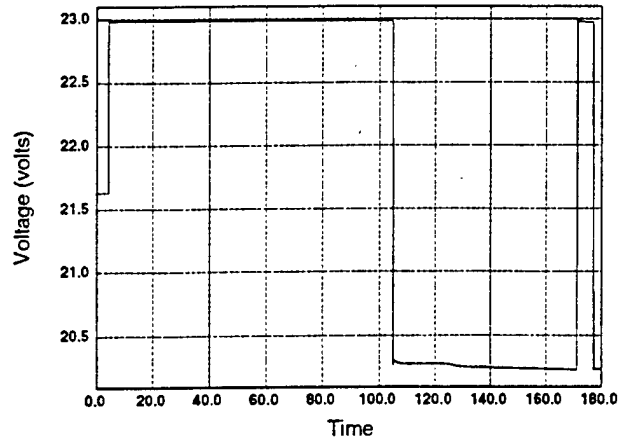

(a) Battery 1 voltage.

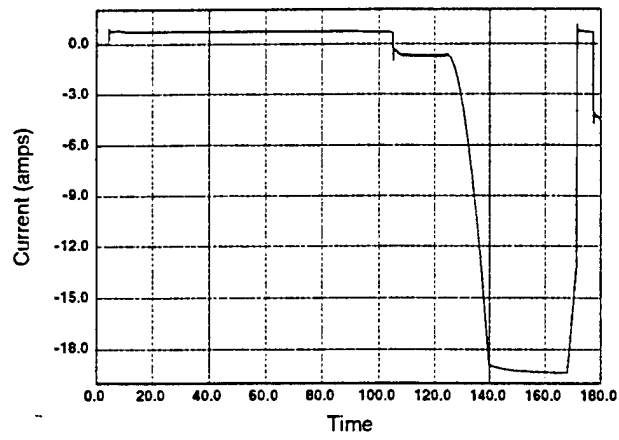

(b) Battery 1 current.

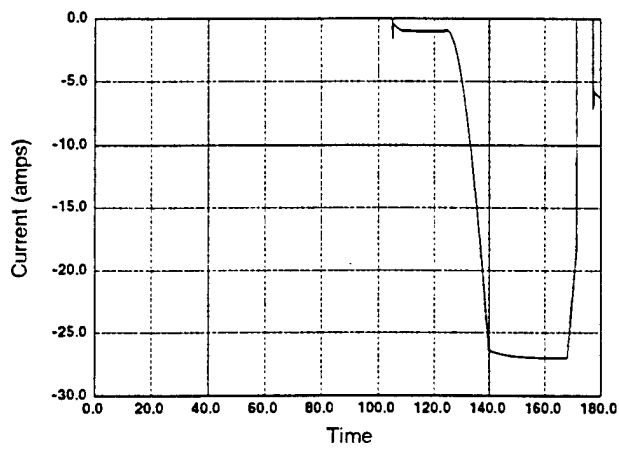

(c) Battery boost current.

Figure 8. EPS battery voltage, battery current, and boost current.

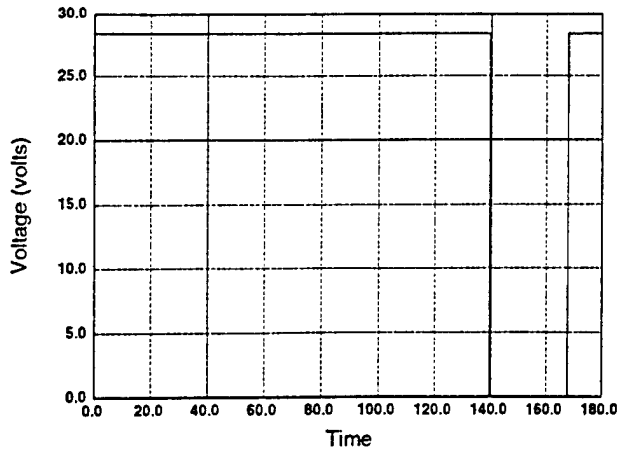

(a) Regulated voltage out of shunt boom assembly.

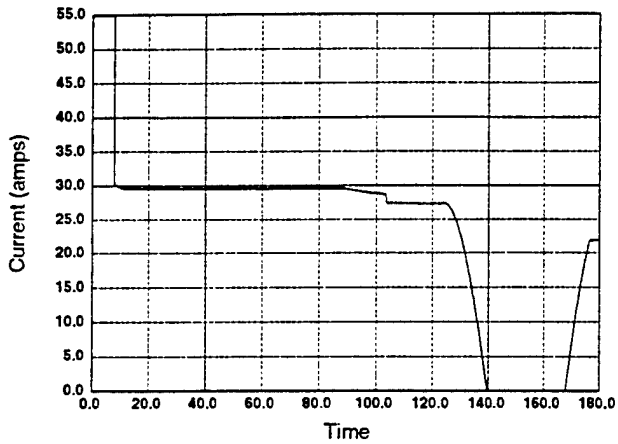

(b) Regulated current out of shunt boom assembly.

Figure 9. EPS shunt boom assembly output voltage and current.

The +y solar panel is rotated away from the sun starting at approximately 90 seconds into the scenario and faces completely away from the sun approximately 15 seconds later (Fig. 7a). As the +y panel is rotated, the bus voltage goes down a fraction of a volt (Fig. 7c), the batteries stop charging and are required to supply a small amount of boost current (Fig. 8). The battery boost voltage is fixed at approximately 20.2 volts (Fig. 8a). And finally, the net current out of the shunt boom is slightly reduced (Fig. 9c).

When the -y panel is rotated at approximately 125 seconds (Fig. 7b), the bus voltage again drops, the boost current from the batteries is increased considerably, and the power out of the shunt boom assembly drops to zero (i.e., the panels are supplying no power). Unlike the +y panel which stopped rotating when it faced away from the sun, the -y panel continued to rotate until it reached a fixed offset near the end of the scenario. The transients as the PRU adjusts between battery charging and batteries providing boost current are evident during the last ten seconds of the simulation run.

#### 4.1.5 Satellite Tracking Telemetry and Control (TT&C)

4.1.5.1 Satellite TT&C Highlights. The satellite TT&C model has the following features:

- Receives GPS Block IIR commands
- Generates GPS Block IIR telemetry stream
- Records all commands received as a function of time
- Uses actual bit format for both commands and telemetry (excluding encryption)
- Decodes all seven types of commands (discrete, message, and configuration)
- Routes commands to appropriate subsystem
- Uses command database for decoding (343 discrete commands and 181 serial message commands)
- Transmits entire telemetry master frame (8 major frames, 64 minor frames, 4096 words)
- Uses telemetry master frame database (5968 items)
- Encodes actual sensed/measured values from subsystems
- Handles all types of telemetry (serial, analog, discrete logic)
- Uses the normal telemetry mode (but not Dwell or Dump modes)

4.1.5.2 Satellite TT&C Design. The satellite TT&C subsystem has been upgraded to reflect the GPS Block IIR architecture (Fig. 10). Starting with the commands received on-board the satellite, the Command Receiver class accepts the command and strips off any communications

network message headers. The resulting 20 bit command is then passed to the Command Decoder Unit (CDU). The CDU determines which of the seven the message types has been received, e.g., CDU configuration, CDU discrete, Payload Control Electronics (PCE) discrete, precursor, serial message, abort, and no operation commands.

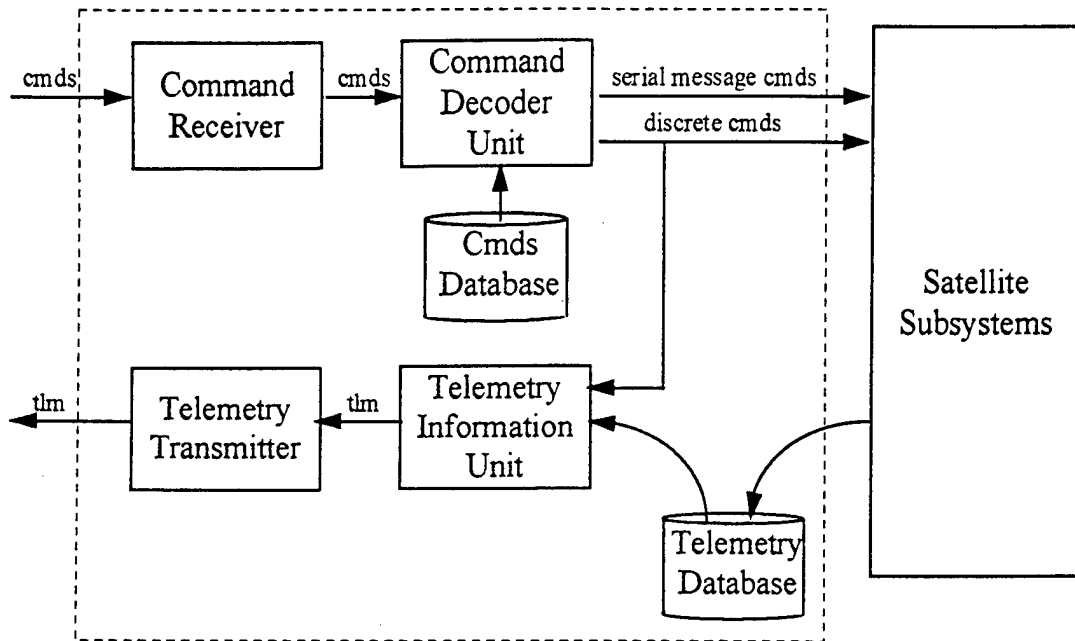

Figure 10. Satellite TT&C architecture.

Command processing depends upon the command type. CDU configuration commands apply to the CDU only and are not passed to any other subsystem. These commands turn on and/or swap CDUs.

The PCE and CDU discrete commands affect the payload and CDU subsystems, respectively. A 20-bit discrete command contains a 10-bit command code which is passed on to the appropriate subsystem for subsequent processing. The discrete commands database (Appendix A) is used to translate the 10-bit discrete command code into a command integer before it is passed to the corresponding subsystem.

Message commands are serial commands which start with a precursor command. The precursor puts the CDU into the message mode, setting the counter to the number of messages to follow. When in the message mode, only configuration commands or the abort command are accepted. Configuration commands are decoded and validated and then routed to other subsystems. Three types of configuration commands are processed: command words, data parameters, and checksums. The message command database is used to determine the command format (Appendix B). The abort message will immediately abort the message mode by returning the CDU to the non message mode.

When the message counter reaches zero, all messages have been received and the CDU exits the message mode. The CDU may also exit the message mode via the timeout feature (set to 42 seconds). If the entire message has not been received by the CDU timeout, the CDU will abort the message mode.

The no operations command is used for command verification and validation and ensures that the satellite is receiving commands. The command counter is incremented and will be evident in the telemetry stream.

The telemetry stream is constructed by the Telemetry Information Unit (TIU) on-board the satellite. The stream is constructed of one master frame per data cycle; each master frame consisting of 8 major frames; each major frame consists of 8 minor frames; and each minor frame consists of 64 words laid out in an 8x8 matrix. The size of one complete data cycle is 32,768 bits and can be transmitted at either 500 bps or 4000 bps.

The telemetry database has been created from the telemetry listing contained in the GPS Block IIR OOH (Appendix C). This database contains information about the telemetry measurands and the mapping of these measurands into the telemetry stream. Upon program initiation and reading of the telemetry database, measurand and telemetry stream mapping structures are created. Values in the measurand data structure may be updated by the appropriate satellite subsystems.

The mapping structure creates the telemetry stream using the current values in the measurand data structure.

In creating the telemetry stream, the TIU operates in one of three modes: Normal, Dump and Dwell. The Normal mode creates the stream from the nominal mapping information. In the Dump and Dwell modes, minor frame words 4 through 7, 12 through 15, etc. are replaced with the data requested by the Dump or Dwell modes. The STSim TT&C only operates in the Normal mode.

Finally, there are four measurand formats: Serial, Analog High, Analog Passive, and Discrete Logic. Information contained in the OOH specifies which format applies to each measurand.

4.1.5.3 Satellite TT&C Results. All commands are recorded to a log file during a specific run. These log files can be used for operator review and/or for script inputs. A small portion of the log file of a particular run is depicted in Figure 11.

```
DISCRETE Cmd 1 issued at 29.900000
DISCRETE Cmd 201 issued at 144.900000
DISCRETE Cmd 209 issued at 151.900000
DISCRETE Cmd 211 issued at 152.900000
DISCRETE Cmd 221 issued at 156.400000
DISCRETE Cmd 221 issued at 163.400000
DISCRETE Cmd 223 issued at 166.400000
Message Mode ENABLED for 3 msgs at 209.400000
Received MESSAGE 3000001 at 210.400000
Received MESSAGE 2000621 at 210.900000
Received MESSAGE 2000454 at 211.150000
MESSAGE issued and Mode terminated at 211.150000
Message Mode ENABLED for 3 msgs at 219.025000
Received MESSAGE 3000001 at 220.025000
Received MESSAGE 2000145 at 220.525000
Received MESSAGE 2000454 at 220.775000
```

Figure 11. Satellite TT&C commands log file.

The log file indicates several discrete commands were received. At approximately 209 seconds into the simulation, the message mode was enabled and a message command was received on-board the satellite. The message mode was terminated at approximately 211 seconds. Another message command was sent at approximately 220 seconds.

STSim telemetry is not logged, although this feature is available and has been incorporated in other BCSi simulation environments. Generation of telemetry on the satellite transmission through the communications network, and display at the PL/Command Center was demonstrated during the final briefing.

#### 4.1.6 Satellite Attitude Control Subsystem (ACS)

4.1.6.1 Satellite ACS Highlights. The satellite ACS model has the following features:

- High-fidelity GPS IIA jet controller
- Jet select modified for GPS IIR
- Mass properties updated for GPS IIR
- Sensor architecture updated to use FreeBody class
- Solar panel controller is GPS IIA
- High-fidelity wheel control and thruster momentum dumping available

4.1.6.2 Satellite ACS Design. The STSim satellite ACS replicates the thruster control system on-board the GPS Block IIA, i.e., the STSim controller has the same architecture, controller gains, difference equations, and sample rates. A top-level block diagram of the control law architecture as implemented in the Jet Control Logic module is depicted in Figure 12.

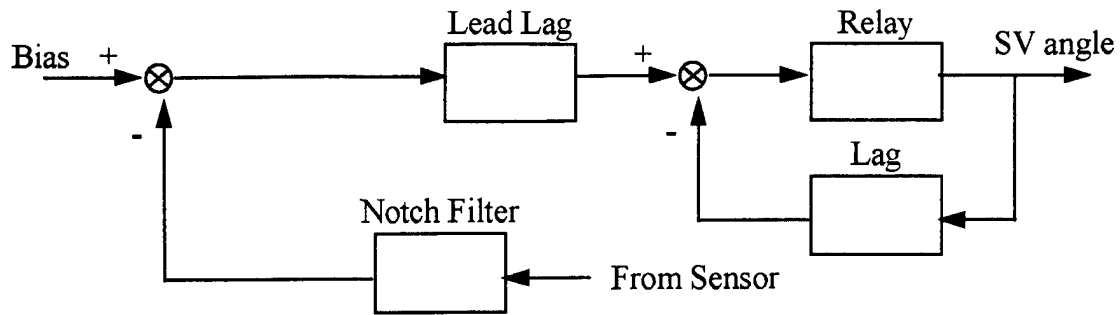
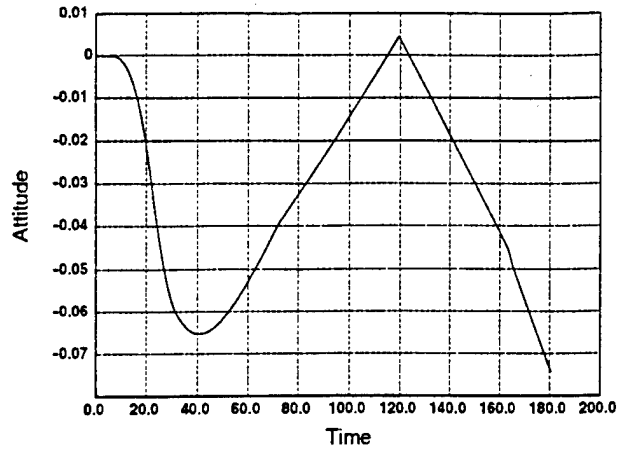

Figure 12. Satellite ACS control law architecture.

The outputs of the thruster controller are on/off commands for each satellite axis. These logical commands are converted to specific thruster commands in the Jet Select Logic module.

4.1.6.3 Satellite ACS Results. Results of a typical initial capture of the satellite are depicted in Figures 13 through 15. The initial roll and pitch angles of the satellite are zero and required no correction. The initial yaw angle of -23.5 degrees required controller action (Fig. 13). The yaw command was set to one to cause the satellite to rotate in the +yaw direction (i.e., about the +z axis). At approximately 20 seconds, a series of -yaw commands were issued to slow and eventually null the yaw rotation (Fig. 14). Selected thruster commands are depicted in Figure 15.



(a) Satellite attitude - roll.

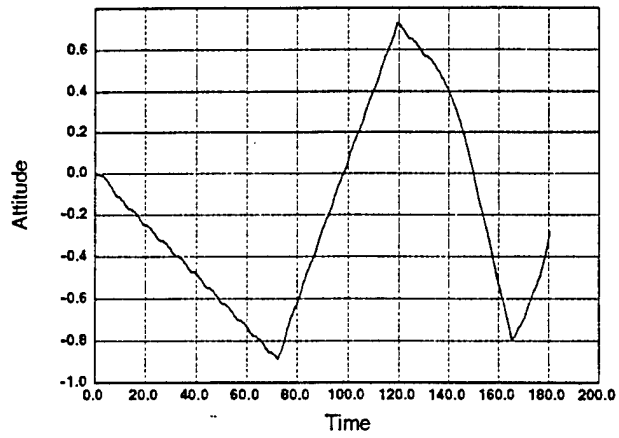

(b) Satellite attitude - pitch.

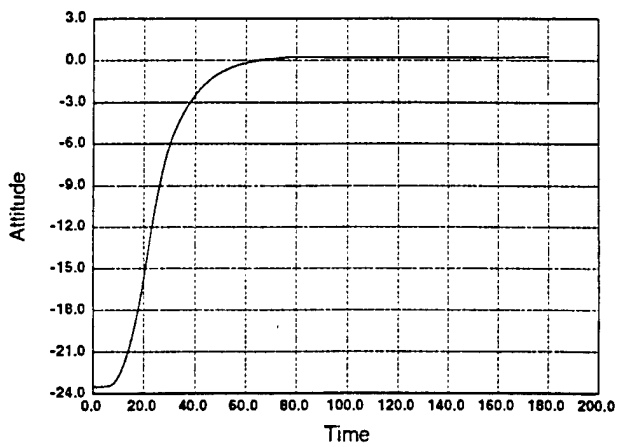

(c) Satellite attitude - yaw.

Figure 13. Satellite attitude - initial capture.

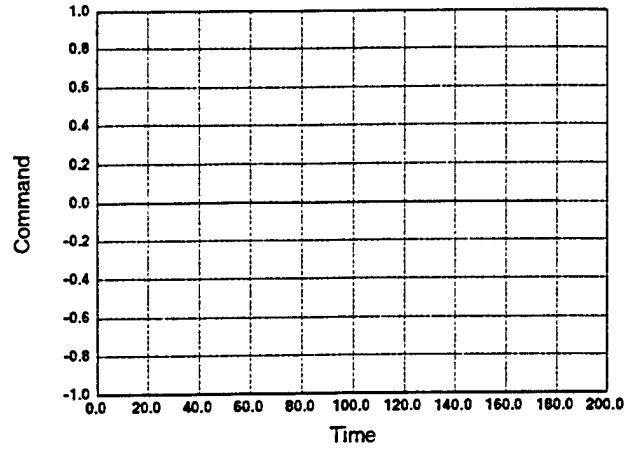

(a) Roll command.

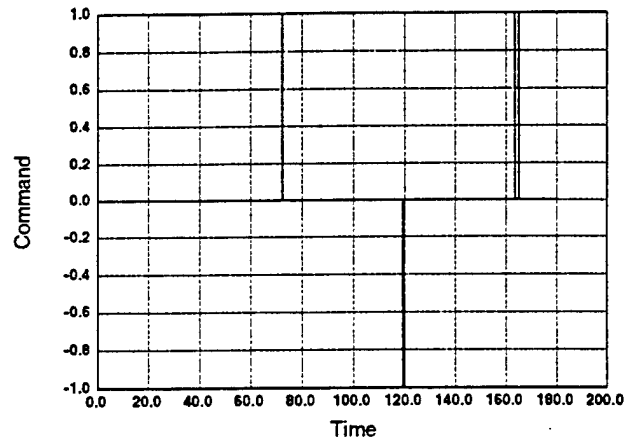

(b) Pitch command.

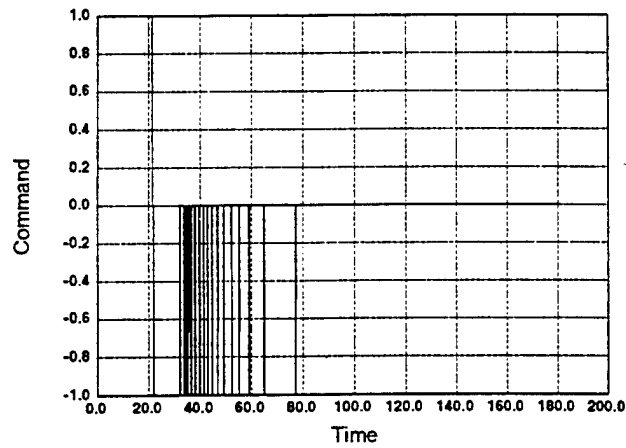

(c) Yaw command.

Figure 14. Satellite control commands - initial capture.

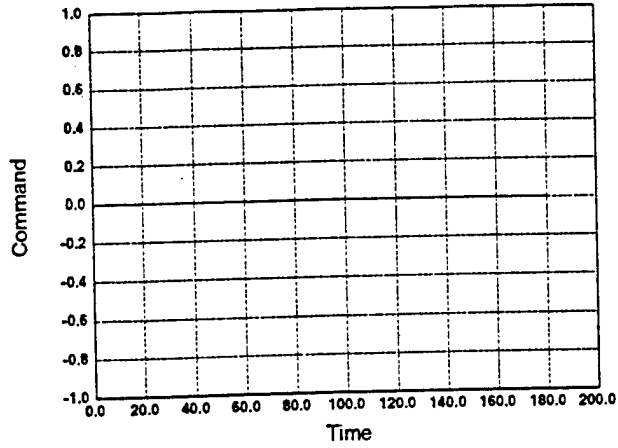

(a) Thruster #1 command.

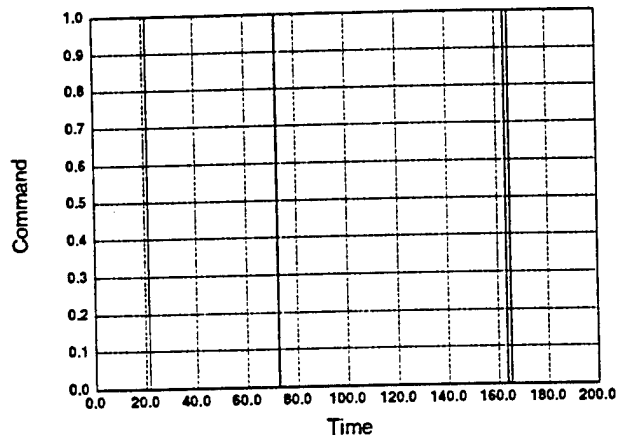

(b) Thruster #6 command.

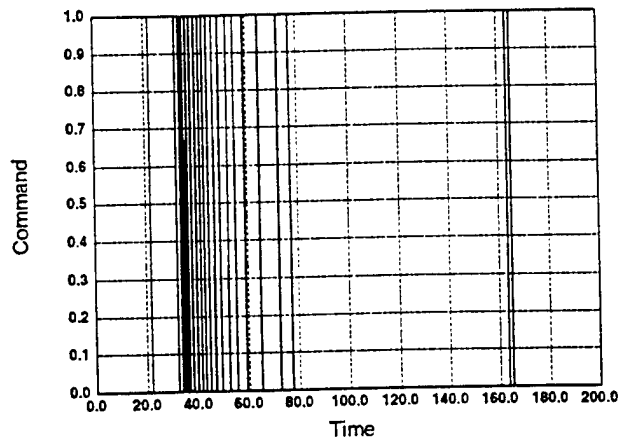

(c) Thruster #5 command.

Figure 15. Satellite thruster commands - initial capture.

The satellite pitch angle slowly drifts off null as the satellite propagates in its orbit. At approximately 70 seconds, the pitch angle exceeds the deadband value of .8 degrees and the satellite continues in a limit cycle as indicated by the attitude and thruster commands (Figs. 13b, 14b, 15b). The roll angle never exceeded the deadband value and therefore required no control action (Figs. 13a, 14a, 15a).

#### 4.1.7 Satellite Propulsion Subsystem

4.1.7.1 Satellite Propulsion Subsystem Highlights. The satellite propulsion subsystem has the following features:

- Responds to changes in pressure, temperature, and mass of each propellant tank
- Responds to all latch valve commands and connectivity
- Determines thruster force as a function of propellant tank pressure and temperature

4.1.7.2 Satellite Propulsion Subsystem Design. The satellite propulsion subsystem model duplicates the architecture of the actual Block IIR system (Fig. 16). In particular, two tanks, four latch valves, and 16 thrusters are modeled. The characteristics of each of these components is described in the propulsion subsystem highlights listed above. The location and orientation of each thruster corresponds to Block IIR. All thrusters models inherited the FreeBody class, thereby making determination of thruster orientation and the effects of thruster forces and torques straightforward.

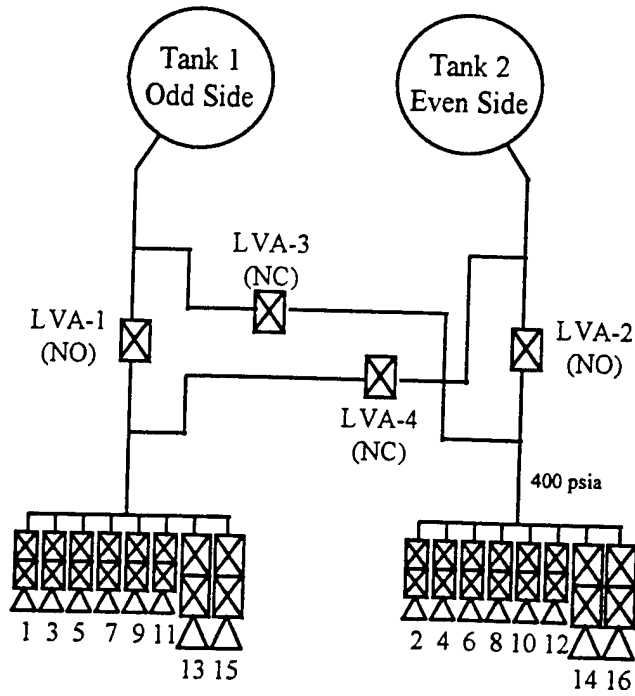
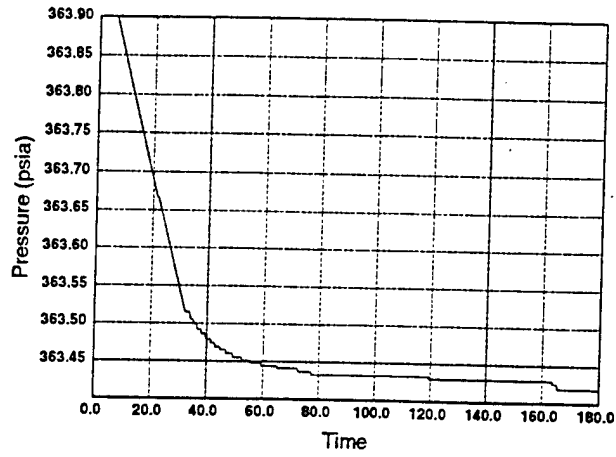
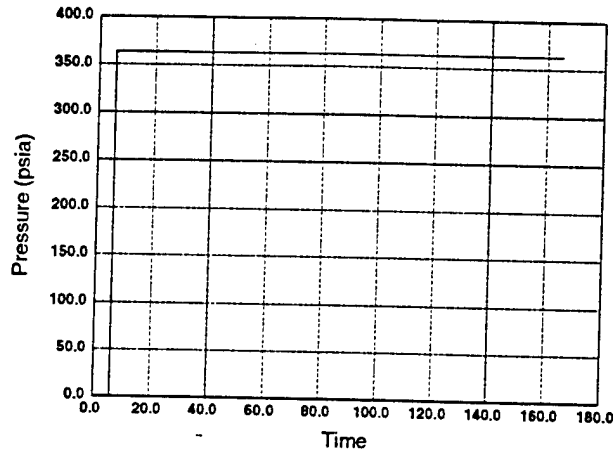

Figure 16. Satellite propulsion subsystem model.

4.1.7.3 Satellite Propulsion Subsystem Results. The thruster results of the initial capture scenario portrayed in the ACS section (Section 4.1.6) are depicted in Figure 17. As the thruster pulses, the tank pressure is drawn down a small amount (note the scale of the axis). The pressure variation is not noticeable from the latch valve pressure scale. The actual thrust is approximately .22 lbf and corresponds the propellant tank pressure.



(a) Tank 1 pressure.



(b) Latch valve 1 pressure.

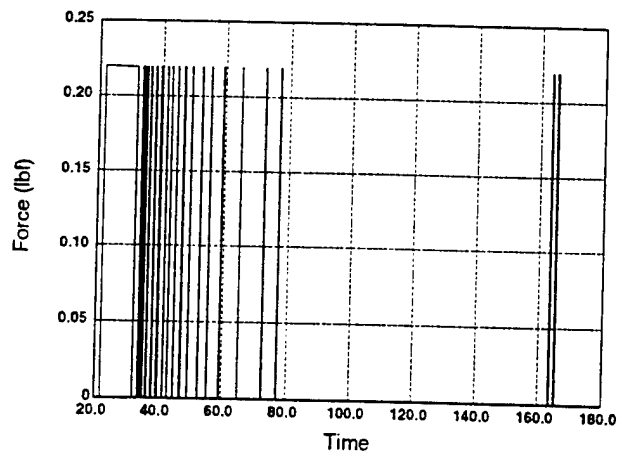

(c) Thruster #2 force.

Figure 17. Satellite thruster output - initial capture.

#### 4.1.8 Satellite Optical Sensor Payload

4.1.8.1 Satellite Optical Sensor Payload Highlights. The satellite optical sensor payload model has the following features:

- Generates sensor field of view image information
- Commandable horizontal and vertical offset
- Optical characteristics are configurable (i.e., beam diameter at earth)
- Graphical representation of field of view

4.1.8.2 Satellite Optical Sensor Payload Design. The purpose of the payload on-board the STSim satellite was to demonstrate an architecture which could support an experiment which required a ground controlled optical sensor experiment. As such, the STSim satellite sensor model is not high-fidelity. Sensor position and orientation resulting from commands from the ground are transmitted to the command center; focal plane data is not transmitted. Higher fidelity sensor models can be quickly substituted for other applications due to the object-oriented nature of the STSim satellite model.

The class and object hierarchy of the optical sensor payload is depicted in Figure 18. As with other objects which require position and orientation information, the sensor inherits from the FreeBody class.

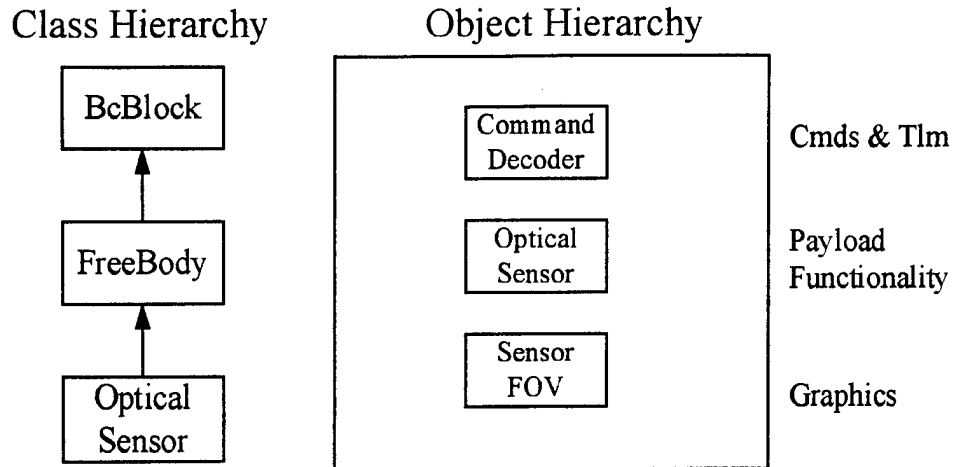

Figure 18. Satellite payload class/object hierarchy.

4.1.8.3 Satellite Optical Sensor Payload Results. The results of the optical sensor payload were demonstrated at the final briefing. Based on azimuth and elevation commands from the ground, the sensor reoriented and the corresponding sensor field of view was portrayed in the command center on the ground. Due to the visual and dynamic nature of the demonstration, no effort is made to portray the results in this report.

## 4.2 STSim COMMUNICATIONS NETWORK

### 4.2.1 Communications Network Highlights

The STSim communications network model has the following features:

- Based on BCCom, high-fidelity message-based modeling tool
- Contains satellite, FAFB relay, and PL nodes
- Processes commands, telemetry, and payload messages
- Includes message-based features, e.g., protocols, routing, buffers, etc.
- Menu-driven and postprocessing graphics

#### 4.2.2 Communications Network Design

Since the fundamental purpose of this program was to demonstrate a capability, the communications network model was kept as simple as possible. The network model was developed using BCCom and supported both analysis and realtime operator-in-the-loop modes of operation. The three nodes in the system modeled message processing at the PL command center, the FAFB relay node, and the STSim satellite. Both bus and payload commands were transmitted from the command center to the satellite; bus and payload telemetry were transmitted from the satellite to the command center. More sophisticated communications networks can be, and have been, developed by adding nodes and/or processes at the nodes.

#### 4.2.3 Communications Network Results

BCCom has a rich set of postprocessing graphics which are available for both the analysis and operator-in-the-loop operations. A brief summary of a short simulation run of the STSim communications network model is depicted in Table 1 and Figures 19 through 21. For this particular scenario, 11 bus commands were generated at the PL command center and transmitted through FAFB to the satellite. Eleven telemetry messages were also generated at the satellite payload and bus subsystems. Bus telemetry was transmitted through FAFB to PL while payload telemetry was sent directly to PL. All messages were generated at constant intervals.

The summary of the message flow indicates the number of messages generated, the nodes these messages were transmitted to, and the average transmission times (Table 1). Note that the SV node corresponds to the satellite bus node and the S node corresponds to the satellite payload node. The message generation profile shows the message generation intervals and the cumulative number of messages generated for each node (Fig. 19). The average transmission times for each message indicates that the messages were quickly transmitted and that there was no noticeable message backup (Fig. 20). Finally, the time history file traces each message as it is processed through each layer within each node (Fig. 21). The time history file provides valuable information for the purpose of network model verification.

Table 1. Communications Network Message Flow Summary.

Source Node	Number of Messages Generated	Destination Node	Number of Messages Received	Average Time
PL	11	FAL	11	0.1333E-01
		SV	11	0.1165
SV	11	FALCON	11	0.1941
		PL	11	0.2529
S	11	PL	11	0.8423E-01

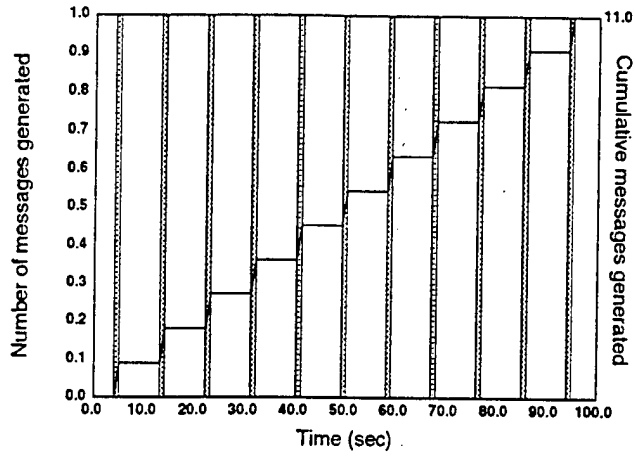

(a) Messages generated at node SV.

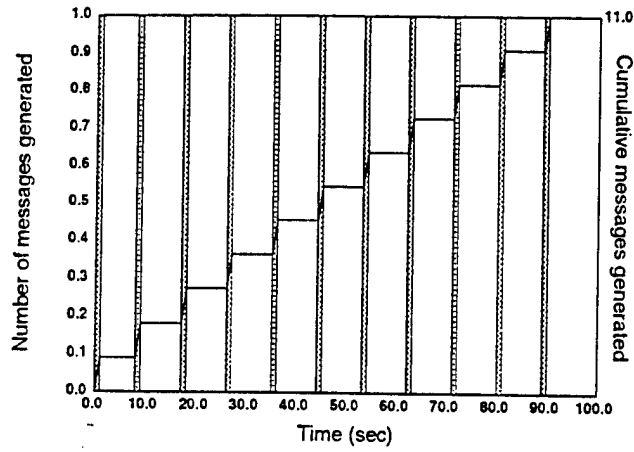

(b) Messages generated at node S.

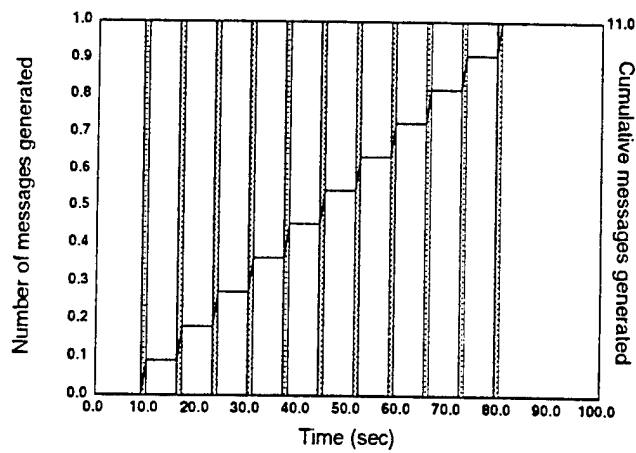

(c) Messages generated at node PL.

Figure 19. Communications network message generation.

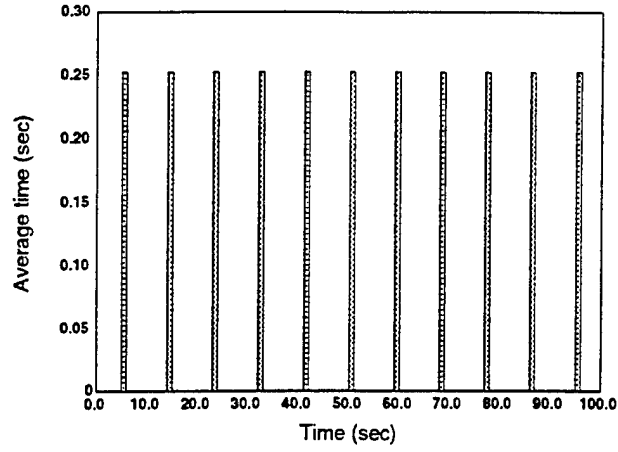

(a) Average transmission time from SV to PL.

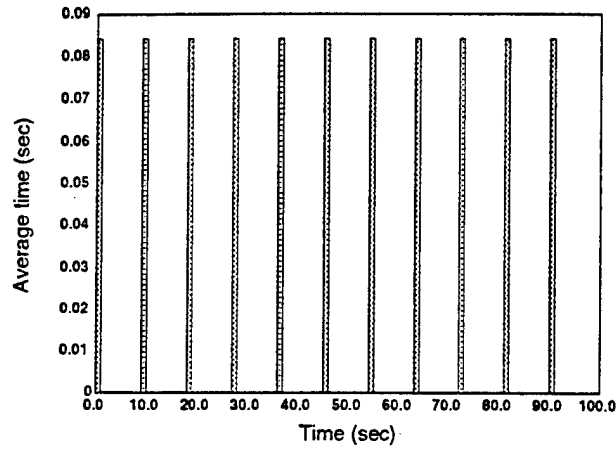

(b) Average transmission time from S to PL.

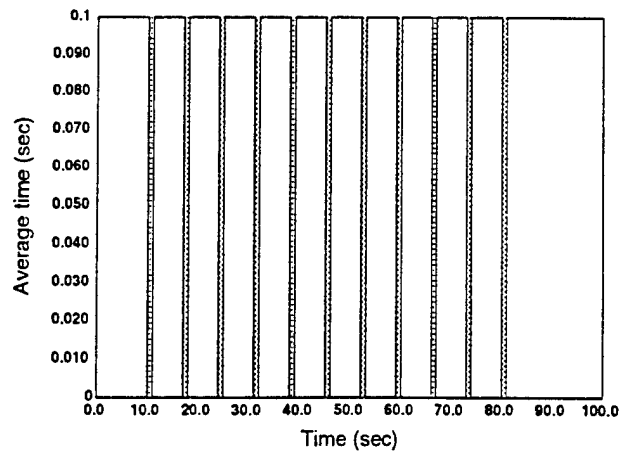

(c) Average transmission time from PL to SV.

Figure 20. Communications network average transmission times.

Time	Id	Node/Link	Process	Event
0.00000	0	S	NET	Generated PAYLOAD
0.00000	0	S	NET	Inserted msg in buffer
0.00000	0	S	NET	Message left buffer
0.00300	0	S	DATAPL	Inserted msg in buffer
0.00300	0	S	DATAPL	Transmitted message
0.00300	0	S	DATAPL	Message left buffer
0.00300	0	S	NET	Deleted msg from buffer
0.00600	0	S_PL		Successful transmission
0.00600	0	S	DATAPL	Deleted msg from buffer
0.08426	0	PL	PHYSFMSV	Received msg at node0
0.08426	0	PL	PHYSFMSV	Received msg at sink
5.00000	1	SV	NET	Generated TELEMETRY
5.00000	1	SV	NET	Inserted msg in buffer
5.00000	1	SV	NET	Message left buffer
5.05729	1	SV	DATA2FAL	Inserted msg in buffer
5.05729	1	SV	DATA2FAL	Transmitted message
5.05729	1	SV	DATA2FAL	Message left buffer
5.05729	1	SV	NET	Deleted msg from buffer
5.11458	1	SV_FALCON		Successful transmission
5.11458	1	SV	DATA2FAL	Deleted msg from buffer
5.19408	1	FALCON	PHYS2SV	Received msg at node
5.19408	1	FALCON	PHYS2SV	Received msg at sink
5.19408	1	FALCON	NET	Inserted msg in buffer
5.19408	1	FALCON	NET	Message left buffer
5.25138	1	FALCON	DATA2PL	Inserted msg in buffer
5.25138	1	FALCON	DATA2PL	Transmitted message
5.25138	1	FALCON	DATA2PL	Message left buffer
5.25138	1	FALCON	NET	Deleted msg from buffer
5.25293	1	PL_FALCON		Successful transmission
5.25293	1	PL	PHYSFMFA	Received msg at node
5.25293	1	PL	PHYSFMFA	Received msg at sink1
5.25293	1	FALCON	DATA2PL	Deleted msg from buffer

Figure 21. Communications network time history file.

### 4.3 STSim COMMAND CENTER

#### 4.3.1 Command Center Highlights

The STSim command center manages both satellite bus and payload commands/telemetry. The STSim command center bus model has the following features:

- Generates GPS Block IIR command stream for SV
- Decodes and displays GPS Block IIR telemetry stream
- Includes command database (343 discrete and 181 serial message commands)
- Sends/receives actual bit formats (excluding encryption)
- User friendly displays for entering commands (by mnemonic or cmd ID) or viewing telemetry
- Includes telemetry master frame database (5968 items)
- Displays telemetry frames major/minor frame number and the contents on hexadecimal byte format
- Displays a sample telemetry view (i.e., roll, pitch, yaw)
- Records commands sent and view telemetry received to log files and telemetry screens

The STSim command center payload model has the following features:

- Supports operator-in-the-loop
- Processes focal plane position and orientation data for SV
- Other BCSi simulation applications have processed actual focal plane pixel data
- Forward user HCI uses BCSi command center software (i.e., readily changeable formats and data processing)
- Supports 2-D and 3-D graphics

### 4.3.2 Command Center Design

The design of the PL command center is a near mirror image of the satellite TT&C subsystem described in Section 4.1.5 (Fig. 22). The user generates the desired command via the command center HCI. The HCI uses the command database (the same one used on-board the satellite) to convert the command integer to the appropriate 20-bit command. The command transmitter sends the command to the satellite via the STSim communications network model.

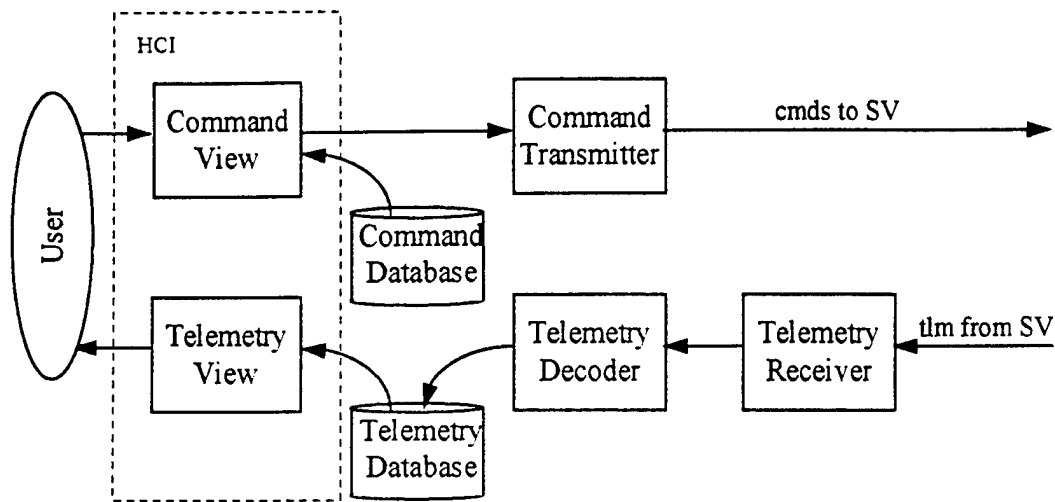

Figure 22. STSim command center design.

Telemetry from the satellite arrives at the telemetry receiver and is decoded using the telemetry database (again, the same database as used on-board the satellite). The telemetry database is also used to drive the telemetry screens at the command center.

The satellite payload telemetry is interpreted on the ground and the corresponding sensor viewpoint is displayed on the forward user console along with time, satellite position, and viewpoint information.

### 4.3.3 Command Center Results

Command center screens display the main window, command views, satellite bus telemetry, and forward-user payload telemetry. The command center main window consists of four pull-down menus across the top, simulation scenario status information, write message buttons, and a text window (Fig. 23). Command and telemetry screens are accessed from the pull-down menus. The scenario status information is self-explanatory. The write message buttons allow the operator to monitor message generation either by viewing information in the text window or in the log files.

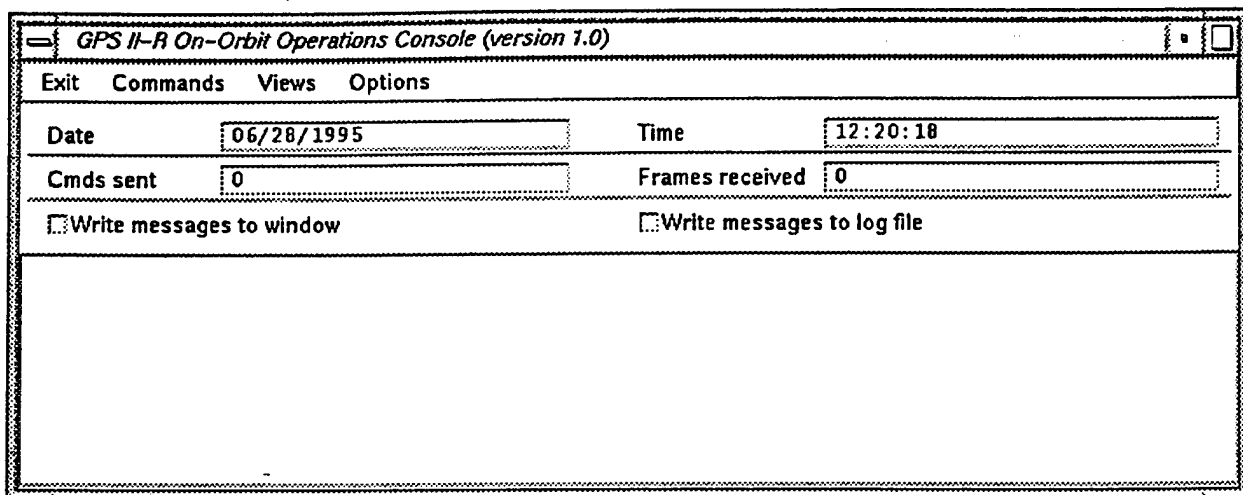

Figure 23. Command center main window.

Command views exist for both discrete and serial message commands (Figs 24 and 25). Both screens are supported by the commands database, i.e., when either the command mnemonic or command integer is entered, information such as command description, octal code, and parameter description is automatically filled in. Buttons are included for transmitting the command and closing the window.

Discrete Commands	
Command mnemonic	Command ID
IS12ARM	201
Description:	ISOLATION LATCH VALVE 1 & 2 ARM
Octal Code:	0430000
Transmit	Close

Figure 24. Command center discrete command view.

Message Commands	
Command mnemonic	Command ID
PCHFTSR	1B004
Description:	PATCH IFTEST/SELTS
Octal Code:	2600011
# Parameters:	8
Parameter	Value
CMX IFTEST ADDRESS	
CMX SELTS ADDRESS	
RECEIVE CONTROL CONNECTION ADDRESS	
RECEIVE CONTROL SIZE	
SEND CONTROL CONNECTION ADDRESS	
SEND CONTROL SIZE	
RECEIVE CONTROL CONNECTION CODE	
SEND CONTROL CONNECTION CODE	
Subsystem:	TT&C SPU
Transmit	Close

Figure 25. Command center serial message command view.

The telemetry frame view allows the operator to view the bytes of each telemetry frame as they are received (Fig. 26). Another telemetry screen allows the operator to view the values of a few selected telemetry measurands. Additional telemetry screens with various screen formats can be easily created with the BCCmdCtr software.

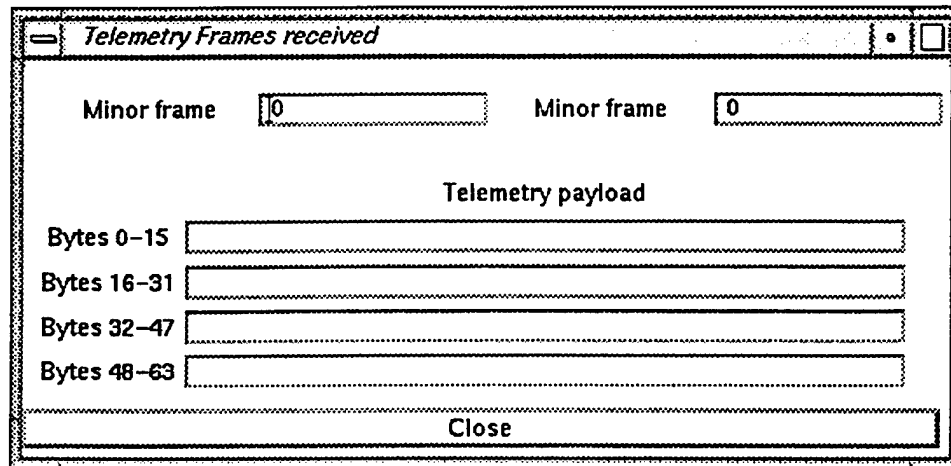

Figure 26. Command center telemetry frame view.

The command center forward user main view portrays the on-board sensor view (Fig. 27). This view is derived from the sensor and satellite position/orientation telemetry. Actual focal plane data has been transmitted in support of other projects, such a capability can be easily added to STSim.

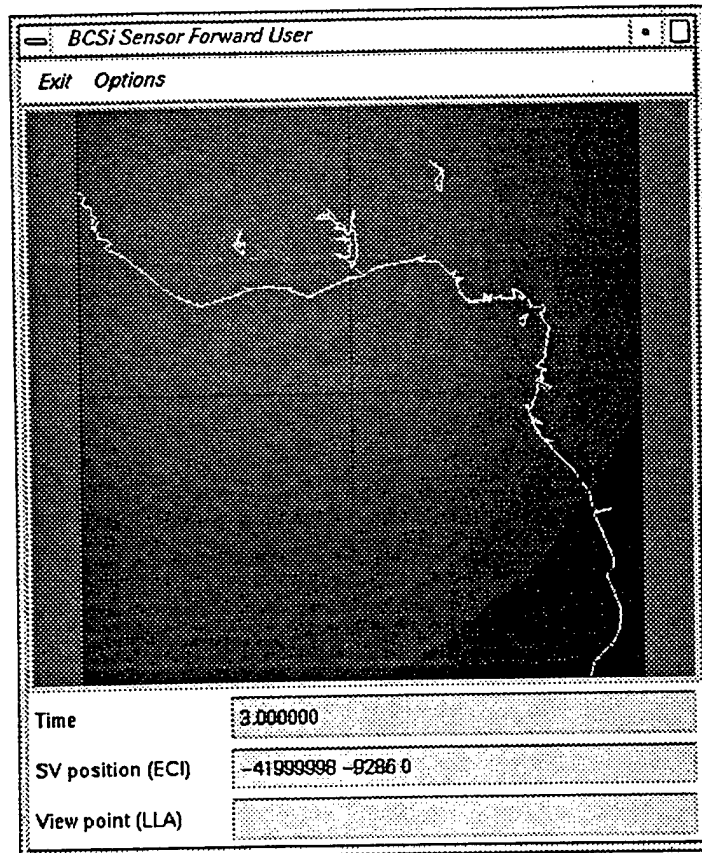

Figure 27. STSim forward user sensor viewpoint.

#### 4.4 STSim OPTIONAL CAPABILITIES

Several BCSi simulation environment capabilities, in addition to those in the current version of STSim, have been developed as part of other simulation projects (Refs. 2,3,4). A brief listing of the highlights of threat/launch vehicle, transmission medium, and proctor options follows.

##### 4.4.1 Threat/Launch Vehicle Option

The threat/launch vehicle segment of the BCSi simulation environment has the following features:

- Simulates a salvo of missiles
- Displays scenario in color 3-D graphics

- Loads different missile scenarios from threat input file
- Threat file is created using a dedicated off-line 3-D graphical environment
- Individual multiple-stage missiles are defined by user (e.g., mass, exit velocity, ...)
- Each missile can carry multiple re-entry vehicles
- Missiles are targeted by setting launch coordinates, pitch maneuver, and stage burn times
- Missiles may be used as satellite launch vehicles

#### 4.4.2 Transmission Medium Option

The transmission medium segment of the BCSi simulation environment has the following features:

- Supports connectivity between “emitters” and “receivers”
- Supplies array of course filtered emitters which are within the line of sight of the requesting receiver
- Architecture supports bi-directional calculations of power from a specific emitter to receiver

#### 4.4.3 Proctor Option

The proctor segment of the BCSi simulation environment has the following features:

- Realtime anomaly inputs to satellite and/or communications network
- Provides realtime contingency planning
- May be initiated/terminated any time during scenario
- Monitors operator actions
- Stores inputs for later playback

## 5.0 SUMMARY

As demonstrated during the Final Briefing, the STSim simulation environment achieved the specified requirements. In particular, the STSim environment:

- Supports PL assets
- Supports software development phases
- Uses BCSi software tools, procedures, and infrastructure
- Supports analysis and realtime operations
- Has flexible scope and level of fidelity
- Utilizes object-oriented techniques

In short, STSim can be a valuable tool in the support of definition, acquisition, and operation of PL space experiments.

## 6.0 RECOMMENDATIONS

Recommendations regarding STSim future work follow:

- Expand the utility of the software to the mission and campaign level by using an open architecture which will allow integration with standard protocols such as DIS (Distributed Interactive Simulation) and ADS (Advanced Distributed Simulation).
- Provide a user friendly interface and detailed user documentation to allow third party module C++ software development by engineers.
- Expand the modularity of the software to allow the exchange of software modules with associated hardware modules, thereby providing a framework for building a Hardware in the Loop (HIL) capability.
- Develop a strategy for validating the simulation model against real flight data, e.g., payload, bus subsystems, and /or mission operations.
- Use STSim to provide support to a PL space experiment. The specific nature of the support would depend on the space experiment phase of development, i.e., definition, acquisition, or operations.

## REFERENCES

1. Baer, C.A., et al, BCSim User's Manual, BCSi-95-751071-002, BCSi, Inc., Colorado Springs, CO., July 1995.
2. Baer, C.A., et al, Space Systems Technology Simulation (SSTSim) Final Report (draft), BCSi-95-410014-001, BCSi, Inc., Colorado Springs, CO., June 1995.
3. Baer, C.A., et al, Global Positioning System Simulation (GPSSim) Executive Summary, BCSi-93-751071-001, BCSi, Inc., Colorado Springs, CO., June 1993.
4. Baer, C.A., et al, Defense Satellite Communications System (DSCS) Simulation, RDA-TR-18-0307-0001-001, RDA Logicon, Colorado Springs, CO., February 1993.

APPENDIX A

GPS IIR DISCRETE COMMAND BY COMMAND NUMBER TABLE

Cmd No.	Mnemonic	S/S	Comp	Command Description	Command Bit Definitions				Telemetry Verification (MAF/MIF/WVRD/BIT)	
					CMD Type	CMD Class	20 Bit OCTAL	10 Bit HEX	TLM 0	TLM 1
101	ESA1OFFR	ADS	ESA	ESA-1 OFF	D		0416100	071		A/4/10/0
102	ES1ONR	ADS	ESA	ESA-1 ON/HCI-1 OFF	D		0412500	055	A/4/10/1	
103	HC1ONHIR	ADS	ESA	HCI-1 ON HIGH SPIN RATE	D		0410700	047	A/4/10/2	
104	HC1ONLOR	ADS	ESA	HCI-1 ON LOW SPIN RATE	D		0414300	063		A/4/10/2
105	ESA2OFFR	ADS	ESA	ESA-2 OFF	D		0417000	078		A/4/11/0
106	ES2ONR	ADS	ESA	ESA-2 ON/HCI-2 OFF	D		0413400	05C	A/4/11/1	
107	HC2ONHIR	ADS	ESA	HCI-2 ON HIGH SPIN RATE	D		0411600	04E	A/4/11/2	
108	HC2ONLOR	ADS	ESA	HCI-1 ON LOW SPIN RATE	D		0415200	06A		A/4/11/2
109	FSSOFFR	ADS	FSS	FSS-1 AND 2 OFF	DR		0432501	0D5	A/3/16/6	
110	FSS2ONR	ADS	FSS	FSS-2 ON/FSS-1 OFF	DR		0431601	0CE	A/3/16/6	A/4/16/6
111	FSS1ONR	ADS	FSS	FSS-1 ON/FSS-2 OFF	DR		0430701	0C7	A/4/16/6	A/3/16/6
112	RWA1OFFR	ADS	RWA	RWA 1 (ROLL-YAW) OFF	D		0412600	056		
113	RWA1ONR	ADS	RWA	RWA 1 (ROLL-YAW) ON	D		0413501	05D		
114	RWA2OFFR	ADS	RWA	RWA 2 (PITCH-YAW) OFF	D		0414401	064		
115	RWA2ONR	ADS	RWA	RWA 2 (PITCH-YAW) ON	D		0415301	06B		
116	RWA3OFFR	ADS	RWA	RWA 3 (ROLL-YAW) OFF	D		0416200	072		
117	RWA3ONR	ADS	RWA	RWA 3 (ROLL-YAW) ON	D		0417101	079		
118	RWA4OFFR	ADS	RWA	RWA 4 (PITCH-YAW) OFF	D		0410501	045		
119	RWA4ONR	ADS	RWA	RWA 4 (PITCH-YAW) ON	D		0411701	04F		
120	RMAPOFFR	ADS	RMA	RMA PITCH GYRO 1 & 2 OFF	DR		0432400	0D4		
121	RMAP2ONR	ADS	RMA	RMA PITCH GYRO 2 ON/1 OFF	DR		0431501	0CD	A/1/16/0	A/2/16/0
122	RMAP1ONR	ADS	RMA	RMA PITCH GYRO 1 ON/2 OFF	DR		0430600	0C6	A/2/16/0	A/1/16/0
123	RMAROFFR	ADS	RMA	RMA ROLL GYRO 1 & 2 OFF	DR		0432601	0D6		
124	RMAR2ONR	ADS	RMA	RMA ROLL GYRO 2 ON/1 OFF	DR		0431700	0CF	A/1/16/4	A/2/16/4
125	RMAR1ONR	ADS	RMA	RMA ROLL GYRO 1 ON/2 OFF	DR		0430500	0C5	A/2/16/4	A/1/16/4
126	RMAYOFFR	ADS	RMA	RMA YAW GYRO 1 & 2 OFF	DR		0434001	0E0		
127	RMAY2ONR	ADS	RMA	RMA YAW GYRO 2 ON/1 OFF	DR		0433101	0D9	A/3/16/2	A/4/16/2
128	RMAY1ONR	ADS	RMA	RMA YAW GYRO 1 ON/2 OFF	DR		0432200	0D2	A/4/16/2	A/3/16/2
129	RMA1LOR	ADS	RMA	RMA PRIMARY LOW RATE ON	D		0427701	0BF	A/7/16/4/5	
130	RMA1HIR	ADS	RMA	RMA PRIMARY HIGH RATE ON	D		0427600	0BE		A/7/16/4/5
131	RMA2LOR	ADS	RMA	RMA REDUNDANT LOW RATE ON	D		0447701	13F	A/8/16/4/5	
132	RMA2HIR	ADS	RMA	RMA REDUNDANT HIGH RATE ON	D		0447600	13E		A/8/16/4/5
133	PCFDIRS	ADS	MTC	PTC FWD DISABLE	DR		0434100	0E1	A/1/16/5	
134	PCFENAR	ADS	MTC	PTC FWD ENABLE	DR		0433000	0D8		A/1/16/5
135	PCRDISR	ADS	MTC	PTC REV DISABLE	DR		0435201	0EA	A+J66/2/16/5	
136	PCRENAR	ADS	MTC	PTC REV ENABLE	DR		0433300	0DB		A/2/16/5
137	PCSDISR	ADS	MTC	PTC SPARE DISABLE	DR		0435600	0EE	A/3/16/5	
138	PCSEENAR	ADS	MTC	PTC SPARE ENABLE	DR		0436101	0F1		A/3/16/5
139	PCSFWRDR	ADS	MTC	PTC SPARE COIL TO FORWARD MODE	DR		0433500	0DD		A/4/16/4/6

140	PCSREVR	ADS	MTC	PTC SPARE COIL TO REVERSE MODE	DR	0434400	0E4	A/4/64/6	
141	RYCFDISR	ADS	MTC	RYC FWD DISABLE	DR	0433600	0DE	A/1/16/1	
142	RYCFENAR	ADS	MTC	RYC FWD ENABLE	DR	0432700	0D7		A/1/16/1
143	RYGRDISR	ADS	MTC	RYC REV DISABLE	DR	0434501	0E5	A/2/16/1	
144	RYCENAR	ADS	MTC	RYC REV ENABLE	DR	0435401	0EC		A/2/16/1
145	RYCSDISR	ADS	MTC	RYC SPARE DISABLE	DR	0436300	0F3	A/3/16/1	
146	RYCSENAR	ADS	MTC	RYC SPARE ENABLE	DR	0432301	0D3		A/3/16/1
147	RYCSFWDR	ADS	MTC	RYC SPARE COIL TO FORWARD MODE	DR	0433401	0DC		A/4/64/7
148	RYCSREVR	ADS	MTC	RYC SPARE COIL TO REVERSE MODE	DR	0434301	0E3	A/4/64/7	
201	IS12ARR	RCS	LV	ISOLATION LATCH VALVE 1 & 2 DISARM	DR	0430000	0C0		A/6/16/0
202	IS12DARR	RCS	LV	ISOLATION LATCH VALVE 1 & 2 DISARM	DR	0435300	0EB	A/6/16/0	
203	XS34ARRM	RCS	LV	XSTRAP LATCH VALVE 3 & 4 ARM	DR	0431400	0CC		A/6/16/4
204	XS34DARR	RCS	LV	XSTRAP LATCH VALVE 3 & 4 DISARM	DR	0433701	0DF	A/6/16/4	
205	IS12ENAR	RCS	LV	ISOLATION LATCH VALVE 1 & 2 ENABLE	DR	0437100	0F9		A/5/16/0
206	IS12DISR	RCS	LV	ISOLATION LATCH VALVE 1 & 2 DISABLE	DR	0436201	0F2	A/5/16/0	
207	XS34ENAR	RCS	LV	XSTRAP LATCH VALVE 3 & 4 ENABLE	DR	0436401	0F4		A/5/16/4
208	XS34DISR	RCS	LV	XSTRAP LATCH VALVE 3 & 4 DISABLE	DR	0437301	0FB	A/5/16/4	
209	ISO1OPNR	RCS	LV	ISOLATION LATCH VALVE 1 OPEN	DR	0436600	0F6	A/5/64/0	
210	ISO1CLSR	RCS	LV	ISOLATION LATCH VALVE 1 CLOSE	DR	0435701	0EF	A/5/64/0	
211	ISO2OPNR	RCS	LV	ISOLATION LATCH VALVE 2 OPEN	DR	0436500	0F5	A/5/64/0	
212	ISO2CLSR	RCS	LV	ISOLATION LATCH VALVE 2 CLOSE	DR	0437601	0FE	A/5/64/1	
213	XST3OPNR	RCS	LV	XSTRAP LATCH VALVE 3 OPEN	DR	0435000	0E8	A/5/64/2	
214	XST3CLSR	RCS	LV	XSTRAP LATCH VALVE 3 CLOSE	DR	0434700	0E7	A/5/64/2	
215	XST4OPNR	RCS	LV	XSTRAP LATCH VALVE 4 OPEN	DR	0437200	0FA	A/5/64/3	
216	XST4CLSR	RCS	LV	XSTRAP LATCH VALVE 4 CLOSE	DR	0436000	0F0	A/5/64/3	
217	EVENENAR	RCS	REA	REA EVEN SYS PWR ENABLE	D	0441000	108	A/6/10/4	
218	EVENDISR	RCS	REA	REA EVEN SYS PWR DIS	D	0425601	0AE		A/6/10/4
219	EVCBHONR	RCS	REA	REA EVEN SYS C-B HEATERS ON	D	0421500	08D	A/6/10/3	
220	EVCBHOFR	RCS	REA	REA EVEN SYS C-B HEATER OFF	D	0424500	0A5		A/6/10/3
221	EV2XARMR	RCS	REA	REA EVEN 0.2LB X ARM	D	0421101	089	A/6/10/0	
222	EV2XDISR	RCS	REA	REA EVEN 0.2LB X DISARM	D	0424401	0A4		A/6/10/0
223	EV2YARMR	RCS	REA	REA EVEN SYS 0.2LB Y ARM	D	0610000	040	A/6/10/1	
224	EV2YDISR	RCS	REA	REA EVEN SYS 0.2LB Y DISARM	D	0425501	0AD		A/6/10/1
225	EV5ZARMR	RCS	REA	REA EVEN SYS 5LB Z ARM	D	0440400	104	A/6/10/2	
226	EV5ZDISR	RCS	REA	REA EVEN SYS 5LB Z DISARM	D	0422600	096		A/6/10/2
227	ODDENAR	RCS	REA	REA ODD SYS PWR ENABLE	D	0430401	0C4	A/6/11/4	
228	ODDDISR	RCS	REA	REA ODD SYS PWR DISABLE	D	0431301	0CB		A/6/11/4
229	ODCBHONR	RCS	REA	REA ODD SYS C-B HEATERS ON	D	0432100	0D1	A/6/11/3	
230	ODCBHOFR	RCS	REA	REA ODD SYS C-B HEATERS OFF	D	0431100	0C9		A/6/11/3
231	OD2XARMR	RCS	REA	REA ODD SYS 0.2LB X ARM	D	0437400	0FC	A/6/11/0	
232	OD2XDISR	RCS	REA	REA ODD SYS 0.2LB X DISARM	D	0437700	0FF		A/6/11/0
233	OD2YARMR	RCS	REA	REA ODD SYS 0.2LB Y ARM	D	0612700	057	A/6/11/1	
234	OD2YDISR	RCS	REA	REA ODD SYS 0.2LB Y DISARM	D	0431200	0CA		A/6/11/1

235	OD5ZARMR	RCS	REA	REA ODD SYS 5LB Z ARM	D	CC	0431001	0C8	A/6/11/2	A/6/11/2
236	OD5ZDISR	RCS	REA	REA ODD SYS 5 LB Z DISARM	D		0432001	0D0		A/6/11/2
301	SPUABONR	TT&C	SPU	SPU A & B PWR ON	D		0423301	09B		
302	SPUAONR	TT&C	SPU	SPU A PWR ON/SPU B PWR OFF	D		0427201	0BA		
303	SPUBONR	TT&C	SPU	SPU A PWR OFF/SPU B PWR ON	D		0426100	0B1		
304	SPUACNTR	TT&C	SPU	SPU A IN CONTROL OF I/O	D		0425700	0AF	A/7/10/4	A/7/11/4
305	SPUBCNTR	TT&C	SPU	SPU B IN CONTROL OF I/O	D		0426601	0B6	A/7/11/4	A/7/10/4
306	SPUARSTR	TT&C	SPU	SPU A CPU RESET, REBOOT	D		0426700	0B7		
307	SPUBRSTR	TT&C	SPU	SPU B CPU RESET, REBOOT	D		0427500	0B8		
308	SPAMNMR	TT&C	SPU	SPU A MEMORY LO/HI NORM	D		0446001	130		A/7/10/2
309	SPAMSWPR	TT&C	SPU	SPU A MEMORY HI/LO SWAP	D		0447201	13A	A/7/10/2	
310	SPBMNMR	TT&C	SPU	SPU B MEMORY LO/HI NORM	D		0447101	139		A/7/11/2
311	SPBMSWPR	TT&C	SPU	SPU B MEMORY HI/LO SWAP	D		0446501	135	A/7/11/2	
312	SPABONR	TT&C	SPU	SPU A I/O ON & SPU B I/O ON	D		0447300	13B	A/7/10/6	
313	SPUAIONR	TT&C	SPU	SPU A I/O ON/SPU B I/O OFF	D		0445501	12D	A/7/10/6	A/7/11/6
314	SPUBIONR	TT&C	SPU	SPU A I/O OFF/SPU B I/O ON	D		0446400	134	A/7/11/6	A/7/10/6
315	SCPUNRMR	TT&C	SPU	SPU CPU I/O NORM	D		0423400	09C		A/7/10/3
316	SCPUXSTR	TT&C	SPU	SPU CPU I/O CROSS-STRAP	D		0427000	0B8	A/7/10/3	
317	SADAONR	TT&C	SPU	SPU A ADE PWR ON, SPU B ADE OFF	D		0424600	0A6	A/7/10/3	A/7/11/3
318	SADBONR	TT&C	SPU	SPU A ADE PWR OFF, SPU B ADE PWR ON	D		0426400	0B4	A/7/11/3	A/7/10/3
319	SADOFFR	TT&C	SPU	SPU ADE A AND B OFF	D		0423700	09F		A/3/10/3
320	TIUAONR	TT&C	TIU	TIU A PWR ON/TIU B PWR OFF	D		0436701	0F7		
321	TIUBONR	TT&C	TIU	TIU A PWR OFF/TIU B PWR ON	D		0437501	0FD		
322	GEDAONR	TT&C	GED	GED A ON	D		0420601	086	A/7/64/0	
323	GEDAOFR	TT&C	GED	GED A OFF	D		0421701	08F		A/7/64/0
324	GEDBONR	TT&C	GED	GED B ON	D		0423100	099	A/8/64/1	
325	GEDBOFR	TT&C	GED	GED B OFF	D		0425001	0A8		A/8/64/1
326	LLEDAONR	TT&C	LLED	LLED A ON	D		0424000	0A0	A/6/64/7	
327	LLEDAOFR	TT&C	LLED	LLED A OFF	D		0425100	0A9		A/6/64/7
328	LLEDBONR	TT&C	LLED	LLED B ON	D		0422201	092	A/8/64/4	
329	LLEDBOFR	TT&C	LLED	LLED B OFF	D		0421201	08A		A/8/64/4
330	PCEAONR	TT&C	PCE	PCE-A ON/PCE-B OFF	D		0447401	13C		
331	PCEBONR	TT&C	PCE	PCE-A OFF/PCE-B ON	D		0446301	133		
332	PCEOFFR	TT&C	PCE	PCE A & B OFF	D		0445200	12A		
333	KG1ONR	TT&C	KG	KG-46 1 ON/KG-46 2 OFF	DR		0440601	106	A/8/16/5	A/8/16/1
334	KG2ONR	TT&C	KG	KG-46 2 ON/KG-46 1 OFF	DR		0441500	10D	A/8/16/1	A/8/16/5
335	KGOFFR	TT&C	KG	KG-46 1 OFF/KG-46 2 OFF	DR		0442300	113	A/8/16/1	
336	COM1ONR	TT&C	SBT	S-BAND DOWNLINK 1 ON	DR		0440501	105		A/7/16/2
337	ATO1ONR	TT&C	SBT	S-BAND DOWNLINK 1 ATO MODE	DR		0441701	10F	A/7/16/2	
338	COM2ONR	TT&C	SBT	S-BAND DOWNLINK 2 ON	DR		0441101	109		A/7/16/6
339	ATO2ONR	TT&C	SBT	S-BAND DOWNLINK 2 ATO MODE	DR		0442000	110	A/7/16/6	
340	PRN1ENAR	TT&C	SBT	S-BAND RCVR-1 PRN INHIBIT OFF	DR		0440100	101	A/6/16/3	
341	PRN1DISR	TT&C	SBT	S-BAND RCVR-1 PRN INHIBIT ON	DR		0442600	116		A/6/16/3

342	PRN2ENAR	TT&C	SBT	S-BAND RCVR-2 PRN INHIBIT OFF	DR		0442701	117	A/6/16/3	
343	PRN2DISR	TT&C	SBT	S-BAND RCVR-2 PRN INHIBIT ON	DR		0443400	11C		A/6/16/3
344	SQL1OFR	TT&C	SBT	S-BAND RCVR-2 STBY INHIBIT OFF	DR		0442201	112	A/7/16/3	
345	SQL1ONR	TT&C	SBT	S-BAND RCVR-2 STBY INHIBIT ON	DR		0443100	119		A/7/16/3
346	SQL2OFR	TT&C	SBT	S-BAND RCVR-2 STBY INHIBIT OFF	DR		0443700	11F	A/7/16/7	
347	SQL2ONR	TT&C	SBT	S-BAND RCVR-2 STBY INHIBIT ON	DR		0444600	126		A/7/16/7
348	UPLKNRMR	TT&C	SBT	S-BAND UPLINK RCVR/DECRYPTOR NORM	DR		0410100	041		
349	UPLKXSTR	TT&C	SBT	S-BAND UPLINK RCVR/DECRYPTOR XSTRAP	DR		0410200	042		
350	XMT1SELR	TT&C	SBT	S-BAND SW XMTR OUTPUT FROM XMTR 1	D		0446700	137	Z/7/16/4	
351	XMT2SELR	TT&C	SBT	S-BAND SW XMTR OUTPUT FROM XMTR 2	D		0446200	132		A/7/16/4
352	ANTA1R	TT&C	SBT	S-BAND ANT SW A (PRI) TO POS 2 (COVERAGE)	D		0444500	125		A/7/16/3
353	ANTA2R	TT&C	SBT	S-BAND ANT SW A (PRI) TO POS 1 (COVERAGE)	D		0445601	12E	A/7/16/3	
354	ANTB1R	TT&C	SBT	S-BAND ANT SW B (RED) TO POS 1 (COVERAGE)	D		0422000	090		A/8/16/3
355	ANTB2R	TT&C	SBT	S-BAND ANT SW B (RED) TO POS 2 (COVERAGE)	D		0424701	0A7	A/8/16/3	
356	ATOENAR	TT&C	CDU	S-BAND DOWNLINK ATO ENABLE	DR		0430101	0C1	A/4/16/3	
357	ATODISR	TT&C	CDU	S-BAND DOWNLINK ATO ENABLE	DR		0430201	0C2		A/4/16/3
358	XMTR1ONR	TT&C	SBT	S-BAND XMTR1 28VDC DISABLE	DR		0440700	107	1/8/16/6	A/8/16/2
359	XMTR2ONR	TT&C	SBT	BCN XMTR 2 ON/1 OFF	DR		0441600	10E	A/8/16/2	A/8/16/6
360	XMTROFFR	TT&C	SBT	BCN XMTR 1 & 2 OFF	DR		0442500	115	A/8/16/2	
361	TLM1ONR	TT&C	SBT	S-BAND XMTR 1 SUBCARRIER INHIBIT OFF	DR		0443200	11A	A/5/16/3	
362	TLM1OFFR	TT&C	SBT	S-BAND XMTR 1 SUBCARRIER INHIBIT ON	DR		0444101	121		A/5/16/3
363	TLM2ONR	TT&C	SBT	S-BAND XMTR 2 SUBCARRIER INHIBIT OFF	DR		0444401	124	A/5/16/7	
364	TLM2OFFR	TT&C	SBT	S-BAND XMTR 2 SUBCARRIER INHIBIT ON	DR		0443301	11B		A/5/16/7
365	MCLKENAR	TT&C	CDU	KIR-23 BYPASS MODE FOR SMC ENABLE TO MDU	DR		0410301	043		A/5/16/7
366	CDUAARMR	TT&C	CDU	CONFIGURATION A ARM CDU	D		0000001	NA		A/8/16/3
367	CDUBARMR	TT&C	CDU	CONFIGURATION B ARM CDU	D		0040000	NA		
368	CDUAEXGR	TT&C	CDU	CONFIGURATION A EXEC CDU	D		0140001	NA		
369	CDUBEXGR	TT&C	CDU	CONFIGURATION B EXEC CDU	D		0100000	NA		
370	CDUABTR	TT&C	CDU	ABORT & RECONFIGURE CDU	D		1400001	NA		
371	CDUNOOPR	TT&C	CDU	CDU NO OPERATIONS (NOOP) CMD	D		1000000	NA		
401	CHRG1HIR	EPS	PRU	BCC 1 CHARGE ON/HIGH RATE V/T; RED BCC OFF	D		0416601	076		A/2/10/2
402	CHRG1LOR	EPS	PRU	BCC 1 TRICKLE CHARGE RATE DISABLE V/T	D		0415001	068		A/2/10/3
403	BC1RSETR	EPS	PRU	BCC 1 V/T BITS/SHFT/DISA RST	D		0415100	069	A/2/10/4	A/2/10/1
404	VT1SHFTR	EPS	PRU	BCC 1 V/T BIT SHIFT TO 16 CELL OPS	D		0415400	06C	A/2/10/6	
405	VT1DISR	EPS	PRU	BCC 1 V/T DISABLE CONTROL	D		0414500	065	A/2/10/1	
406	BC1BIT1R	EPS	PRU	BCC 1 V/T BIT 1 SET SHIFT	D		0416301	073		A/2/10/4
407	BC1BIT2R	EPS	PRU	BCC 1 V/T BIT 2 SET SHIFT	D		0417500	07D		A/2/10/5
408	CHRG2HIR	EPS	PRU	BCC 2 CHARGER ON/HIGH RATE V/T; RED BCC OFF	D		0412101	051		A/2/11/2
409	CHRG2LOR	EPS	PRU	BCC 2 TRICKLE CHARGE RATE; DISABLE V/T	D		0411500	04D		A/2/11/3
410	BC2RSETR	EPS	PRU	BCC 2 V/T BITS/SHFT/DISA RST	D		0411300	04B	A/2/11/4	A/2/11/1
411	VT2SHFTR	EPS	PRU	BCC 2 V/T BIT SHIFT TO 16 CELL OPS	D		0416001	070	A/2/11/6	
412	VT2DISR	EPS	PRU	BCC 2 V/T DISABLE CONTROL	D		0410601	046	A/2/11/1	
413	BC2BIT1R	EPS	PRU	BCC 2 V/T BIT 1 SET SHIFT	D		0411101	049		A/2/11/4

414	BC2BIT2R	EPS	PRU	BCC 2 VIT BIT 2 SET SHIFT	D		0417201	07A	A/2/11/5
415	BCC1OFFR	EPS	PRU	BCC 1 OFF/BCC B/U ON	D		0415700	06F	A/2/64/5
416	BCC2OFFR	EPS	PRU	BCC 2 OFF/BCC B/U ON	D		0411201	04A	A/2/64/6
417	CHRGBHIR	EPS	PRU	BCC B/U HIGH RATE ENABLE VT	D		0412701	057	A/2/64/1
418	CHRGBLOR	EPS	PRU	BCC B/U TRICKLE CHARGE RATE; DISABLE VT	D		0412000	050	A/2/64/1
419	BURSETR	EPS	PRU	BCC B/U VIT BITS/SHFT/DISA RST	D		0426200	0B2	A/2/62/2
420	VTBSHFTR	EPS	PRU	BCC B/U VIT SHIFT TO 16 CELL OPS	D		0420700	087	A/2/64/4
421	VTBDISR	EPS	PRU	BCC B/U VIT DISABLE CONTROL	D		0417600	07E	A/2/64/0
422	BUBIT1R	EPS	PRU	BCC B/U VIT BIT 1 SET SHIFT	D		0421600	08E	A/2/64/2
423	BUBIT2R	EPS	PRU	BCC B/U VIT BIT 2 SET SHIFT	D		0422500	095	A/2/64/3
424	OCUAENAR	EPS	OCU	OCU ENABLE SIDE A	D	CC	0420001	080	A/4/10/4
425	OCUADISR	EPS	OCU	OCU DISABLE SIDE A	D		0412401	054	A/4/10/4
426	OCUBENAR	EPS	OCU	OCU ENABLE SIDE B	D	CC	0421401	08C	A/4/11/4
427	OCUBDISR	EPS	OCU	OCU DISABLE SIDE B	D		0420100	081	A/4/11/4
428	AKMAARMR	EPS	OCU	PRIMARY AKM ARM	D	CC	0411000	048	A/4/10/7
429	AKMADISR	EPS	OCU	DISARM AKM SIDE A	D		0413001	058	A/4/10/7
430	AKMFIRAR	EPS	OCU	FIRE AKM SIDE A	D		0413700	05F	
431	AKMBARMR	EPS	OCU	REDUNDANT AKM ARM	D	CC	0410400	044	A/4/11/7
432	AKMBDISR	EPS	OCU	DISARM AKM EED SIDE B	D		0420501	085	A/4/11/7
433	AKMFIRBR	EPS	OCU	FIRE AKM SIDE B	D		0426501	0B5	
434	SAARMR	EPS	S/A	ARM S/A PYROS SIDE-A	D	CC	0420400	084	A/4/10/5
435	SABARMR	EPS	S/A	ARM S/A PYROS SIDE-B	D	CC	0421000	088	A/4/11/5
436	SAADISR	EPS	S/A	DISARM S/A PYROS SIDE-A	D		0414000	060	A/4/10/5
437	SABDISR	EPS	S/A	DISARM S/A PYROS SIDE-B	D		0423001	098	A/4/11/5
438	SH1ABFAR	EPS	S/A	FIRE S/A SHEAR 1 +/- PYROS SIDE-A	D		0413200	05A	
439	SH1ABFBR	EPS	S/A	FIRE S/A SHEAR 1 +/- PYROS SIDE-B	D		0424101	0A1	
440	SH2ABFAR	EPS	S/A	FIRE S/A SHEAR 2 +/- PYROS SIDE-A	D		0412300	053	
441	SH2ABFBR	EPS	S/A	FIRE S/A SHEAR 2 +/- PYROS SIDE-B	D		0420200	082	
442	SN1ABFAR	EPS	S/A	FIRE S/A SNUBBER 1 +/- PYROS SIDE-A	D		0417401	07C	
443	SN1ABFBR	EPS	S/A	FIRE S/A SNUBBER 1 +/- PYROS SIDE-B	D		0426301	0B3	
444	SN2ABFAR	EPS	S/A	FIRE S/A SNUBBER 2 +/- PYROS SIDE-A	D		0416501	075	
445	SN2ABFBR	EPS	S/A	FIRE S/A SNUBBER 2 +/- PYROS SIDE-B	D		0425400	0AC	
446	SN3ABFAR	EPS	S/A	FIRE S/A SNUBBER 3 +/- PYROS SIDE-A	D		0415601	06E	
447	SN3ABFBR	EPS	S/A	FIRE S/A SNUBBER 3 +/- PYROS SIDE-B	D		0423501	09D	
448	SN4ABFAR	EPS	S/A	FIRE S/A SNUBBER 4 +/- PYROS SIDE-A	D		0414701	067	
449	SN4ABFBR	EPS	S/A	FIRE S/A SNUBBER 4 +/- PYROS SIDE-B	D		0422701	097	
450	WAAARMR	EPS	OCU	ARM W-SENSOR PYROS SIDE-A	D	CC	0411401	04C	A/4/10/6
451	WABARMR	EPS	OCU	ARM W-SENSOR PYROS SIDE-B	D	CC	0410001	040	A/4/11/6
452	WAADISR	EPS	OCU	DISARM W-SENSOR PYROS SIDE-A	D		0612400	054	A/4/10/6
453	WABDISR	EPS	OCU	DISARM W-SENSOR PYROS SIDE-B	D		0612020	050	A/4/11/6
454	WABTFAR	EPS	OCU	FIRE W-SENSOR LOWER-TIE PYROS SIDE-A	D		0610300	043	
455	WABTFBR	EPS	OCU	FIRE W-SENSOR UPPER-TIE PYROS SIDE-B	D		0614620	066	
456	WAETFAR	EPS	OCU	FIRE W-SENSOR LOWER-TIE PYROS SIDE-A	D		0616220	072	

457	WAETFBR	EPS	OCU	FIRE W-SENSOR LOWER-TIE PYROS SIDE-B	D	0613500	05D	
458	WAIBFAR	EPS	OCU	FIRE W-SENSOR INTERBOOM PYROS SIDE-A	D	0612100	051	
459	WAIBFBR	EPS	OCU	FIRE W-SENSOR INTERBOOM PYROS SIDE-B	D	0611400	04C	
460	WASPFAR	EPS	OCU	FIRE W-SENSOR SPOOL PYROS SIDE-A	DR	0617020	078	
461	WASPFBR	EPS	OCU	FIRE W-SENSOR SPOOL PYROS SIDE-B	DR	0615720	06F	
462	B2C17ONR	EPS	BATT	+X PNL BATT-2 CELL 17 INLINE RESET	D	0426001	0B0	A/2/10/7
463	B2C17OFR	EPS	BATT	+X PNL BATT-2 CELL 17 BYPASS MODE	D	0416700	077	A/2/10/7
464	B2BYPASR	EPS	BATT	+X PNL BATT-2 BYPASS MODE TO CELL SHORT	D	0412201	052	A/2/10/0
465	B1C17ONR	EPS	BATT	+X PNL BATT-1 CELL 17 INLINE RESET	D	0427101	0B9	A/2/11/7
466	B1C17OFR	EPS	BATT	+X PNL BATT-1 CELL BYPASS	D	0417701	07F	A/2/11/7
467	B1BYPASR	EPS	BATT	+X PNL BATT-1 BYPASS MODE TO CELL SHORT	D	0413100	059	A/2/11/0
468	BPRSCALR	EPS	BATT	BATT PRES MON TO CALIBRATE MODE	D	0413601	05E	
469	BPRSNUMR	EPS	BATT	BATT PRES MON TO NORM MODE	D	0414201	062	
601	AKMHONR	PSS	AKM	AKM HEATERS HIGH PWR ON	DR	0443001	118	A/2/16/2
602	AKMHONR	PSS	AKM	AKM HEATERS LOW PWR ON	DR	0441201	10A	A/2/16/6
603	AKMHOFR	PSS	AKM	AKM HEATERS HIGH PWR OFF	DR	0442101	111	A/2/16/2
604	AKMHLOFR	PSS	AKM	AKM HEATERS LOW PWR OFF	DR	0440301	103	A/2/16/6
605	DMPHAONR	MSS	DMP	DAMPERS HEATERS SIDE-A ON	DR	0443501	11D	A/1/16/2
606	DMPHONR	MSS	DMP	DAMPERS HEATERS SIDE-B ON	DR	0441300	10B	A/1/16/6
607	DMPHAOFR	MSS	DMP	DAMPERS HEATERS SIDE-A OFF	DR	0442401	114	A/1/16/2
608	DMPHBOFR	MSS	DMP	DAMPERS HEATERS SIDE-B OFF	DR	0440200	102	A/1/16/6
609	RWAHAONR	MSS	RWA	RWA HEATERS SIDE-A ON	D	0424201	0A2	A/5/16/2
610	RWAHBONR	MSS	RWA	RWA HEATERS SIDE-B ON	D	0446100	131	A/5/16/6
611	RWAHAOFR	MSS	RWA	RWA HEATERS SIDE-A OFF	D	0422300	093	A/5/16/2
612	RWAHBOFR	MSS	RWA	RWA HEATERS SIDE-B OFF	D	0447000	138	A/5/16/6
700	FREQ3ONR	NAV	AFS	CAFS 28 VDC ON	DR	0613000	058	A/7/14/10
701	FREQ3OFR	NAV	AFS	CAFS 28 VDC OFF	DR	0614100	061	A/7/14/10
702	FREQ1ONR	NAV	AFS	RAFS 1 28 VDC ON	DR	0614200	062	A/7/14/11
703	FREQ1OFR	NAV	AFS	RAFS 1 28 VDC OFF	DR	0613120	059	A/7/14/11
704	FREQ2ONR	NAV	AFS	RAFS 2 28 VDC ON	DR	0613420	05C	A/7/14/2/1
705	FREQ2OFR	NAV	AFS	RAFS 2 28 VDC OFF	DR	0614520	065	A/7/14/2/1
706	L1XBENAR	LBS	L1	L1 XMIT B ENABLE	D	0622200	092	A/6/14/10
707	L1XBDISR	LBS	L1	L1 XMIT B DISABLE	D	0623300	09B	A/6/14/10
708	L2XBENAR	LBS	L2	L2 XMIT B ENABLE	D	0624400	0A4	A/6/14/2/0
709	L2XBDISR	LBS	L2	L2 XMIT B DISABLE	D	0625500	0AD	A/6/14/2/0
710	FS3HTONR	NAV	CAFS	CAFS HEATER 28VDC ON	DR	0614400	064	A/7/14/2/0
711	FS3HTOFR	NAV	CAFS	CAFS HEATER 28VDC OFF	DR	0613300	05B	A/7/14/2/0
712	IXMTAONR	ITS	CTDU	CTDU XMTR A 28V ON B OFF	DR	0617400	07C	A/7/14/1/5
713	IXMTBONR	ITS	CTDU	CTDU XMTR A 28V OFF B ON	DR	0616300	073	A/7/14/1/5
714	IXMTOFFR	ITS	CTDU	CTDU XMTR A 28V OFF B OFF	DR	0615220	06A	A/7/14/1/5
715	IRCVANR	ITS	CTDU	CTDU RCVR A 28V ON B OFF	DR	0615000	068	A/7/14/1/3
716	IRCVBONR	ITS	CTDU	CTDU RCVR A 28V OFF B ON	DR	0617200	07A	A/7/14/1/3
717	IRCVOFFR	ITS	CTDU	CTDU RCVR A 28V OFF B OFF	DR	0616120	071	A/7/14/1/3

718	L12AONR	LBS	L1L2	L1/L2 DC CONV A ON	D	0620220	082		A/4/41/0
719	L12ASTBR	LBS	L1L2	L1/L2 DC CONV A STBY	D	0621320	08B	A/4/41/0	
720	L1XAENAR	LBS	L1	L1 XMIT A ENABLE	D	0622400	094	A/4/41/1	
721	L1XADISR	LBS	L1	L1 XMIT A DISABLE	D	0623500	09D		A/4/41/1
722	L2XAENAR	LBS	L2	L2 XMIT A ENABLE	D	0624620	0A6	A/4/42/1	
723	L2XADISR	LBS	L2	L2 XMIT A DISABLE	D	0625720	0AF		A/4/42/1
724	L12BONR	LBS	L1L2	L1/L2 DC CONV B ON	D	0622020	090		A/4/42/0
725	L12BSTBR	LBS	L1L2	L1/L2 DC CONV B STBY	D	0623120	099	A/4/42/0	
726	L1HPNMR	LBS	L1L2	L1/L2 CONV TO L1 HPA NORM	D	0624200	0A2	A/4/42/2	A/4/41/2
727	L1HPXSTR	LBS	L1L2	L1/L2 CONV TO L1 HPA XSTRAP	D	0625300	0AB	A/4/41/2	A/4/42/2
728	L2HPNMR	LBS	L1L2	L1/L2 CONV TO L2 HPA NORM	D	0626420	0B4	A/4/42/3	A/4/41/3
729	L2HPXSTR	LBS	L1L2	L1/L2 CONV TO L2 HPA XSTRAP	D	0627520	0BD	A/4/41/3	A/4/42/3
730	L1IPNMR	LBS	L1L2	L1/L2 CONV TO L1 MOD IPA NORM	D	0620120	081	A/4/42/4	A/4/41/4
731	L1IPXSTR	LBS	L1L2	L1/L2 CONV TO L1 MOD IPA XSTRAP	D	0621200	08A	A/4/41/4	A/4/42/4
732	L2IPNMR	LBS	L1L1	L1/L2 CONV TO L2 MOD IPA NORM	D	0622320	093	A/4/42/5	A/4/41/5
733	L2IPXSTR	LBS	L1L2	L1/L2 CONV TO L2 MOD IPA XSTRAP	D	0623420	09C	A/4/41/5	A/4/42/5
734	L1SYNMR	LBS	L1L2	L1/L2 CONV TO L1 SYNTH NORM	D	0621020	088	A/4/42/6	A/4/41/6
735	L1SYXSTR	LBS	L1L2	L1/L2 CONV TO L1 SYNTH XSTRAP	D	0622100	091	A/4/41/6	A/4/42/6
736	L2SYNMR	LBS	L1L2	L1/L2 CONV TO L2 SYNTH NORM	D	0623220	09A	A/4/42/7	A/4/41/7
737	L2SYXSTR	LBS	L1L2	L1/L2 CONV TO L2 SYNTH XSTRAP	D	0624320	0A3	A/4/41/7	A/4/42/7
738	L3CAONR	LBS	L3	L3 CONV A ON	D	0625420	0AC	A/5/41/0	
739	L3CASTBR	LBS	L3	L3 CONV A STBY	D	0626500	0B5		A/5/41/0
740	L3CBONR	LBS	L3	L3 CONV B ON	D	0624520	0A5	A/5/42/0	
741	L3CBSTBR	LBS	L3	L3 CONV B STBY	D	0625600	0AE		A/5/42/0
742	L3HPNMR	LBS	L3	L3 CONV TO L3 HPA NORM	D	0626720	0B7	A/5/42/2	A/5/41/2
743	L3HPXSTR	LBS	L3	L3 CONV TO L3 HPA XSTRAP	D	0627620	0BE	A/5/41/2	A/5/42/2
744	L3IPNMR	LBS	L3	L3 CONV TO L3 MOD IPA NORM	D	0620300	083	A/5/42/3	A/5/41/3
745	L3IPXSTR	LBS	L3	L3 CONV TO L3 MOD IPA XSTRAP	D	0621400	08C	A/5/41/3	A/5/42/3
746	L3SYNMR	LBS	L3	L3 CONV TO L3 SYNTH NORM	D	0622520	095	A/5/42/4	A/5/41/4
747	L3SYXSTR	LBS	L3	L3 CONV TO L3 SYNTH XSTRAP	D	0623600	09E	A/5/41/4	A/5/42/4
748	L3XAENAR	LBS	L3	L3 XMITR A ENABLE	D	0623000	098		A/5/41/1
749	L3AXDISR	LBS	L3	L3 XMITR A DISABLE	D	0624100	0A1	A/5/41/1	
750	L12CAPWR	LBS	L1L2	L1/L2 CONV A 28 V ON B OFF	DR	0614020	060	A/7/42/3	A/7/41/4
751	L12CBPWR	LBS	L1L2	L1/L2 CONV B 28 V ON A OFF	DR	0613720	05F	A/7/41/4	A/7/42/3
752	L12CVOFR	LBS	L1L2	L1/L2 CONV A AND B OFF	DR	0617320	07B	A/7/41/4	A/7/42/3
753	L3CVAPWR	LBS	L3	L3 CONV A 28 V ON B OFF	DR	0615300	06B	A/7/42/5	A/7/41/6
754	L3CVBPWR	LBS	L3	L3 CONV B 28 V ON A OFF	DR	0616420	074	A/7/41/6	A/7/42/5
755	L3CVOFFR	LBS	L3	L3 CONV A AND B OFF	DR	0617520	07D	A/7/41/6	A/7/42/5
756	BMINMR	NAV	MDU	MDU DC CONV BMI NORM	D	0625220	0AA	A/1/42/1	A/1/41/1
757	BMIWSTR	NAV	MDU	MDU DC CONV B TO BMI A XSTRAP	D	0626300	0B3	A/1/41/1	A/1/42/1
758	MCPUNMR	NAV	MDU	MDU DC CONV CPU MEM NORM	D	0620420	084	A/1/42/2	A/1/41/2
759	MCPUXSTR	NAV	MDU	MDU DC CONV CPU MEM XSTRAP	D	0621520	08D	A/1/41/2	A/1/42/2
760	L3XBENAR	LBS	L3	L3 XMITR B ENABLE	D	0622620	096		A/5/42/1

761	L3XBDISR	LBS	L3	L3 XMTR B DISABLE	D	0623720	09F	A/5/42/1	
762	MDUCVANR	NAV	MDU	MDU DC CONV A ON	D	0624020	0A0		A/1/4/1/0
763	MDUCVASR	NAV	MDU	MDU DC CONV A STBY	D	0625120	0A9	A/1/4/1/0	
764	MDUCVBNR	NAV	MDU	MDU DC CONV B ON	D	0626220	0B2		A/1/4/2/0
765	MDUCVBSR	NAV	MDU	MDU DC CONV B STBY	D	0627320	0BB	A/1/4/2/0	
766	FSUNRMR	NAV	MDU	CONV A TO FSU A VCXO NORM	D	0620500	085	A/1/4/2/4	A/1/4/1/4
767	FSUXSTR	NAV	MDU	MDU DC CONV FSU VCXO XSTRAP	D	0621620	08E	A/1/4/1/4	A/1/4/2/4
768	MDUCAONR	NAV	MDU	MDU A 28 VDC ON B OFF	DR	0615420	06C	A/7/4/2/6	A/7/4/1/7
769	MDUCBONR	NAV	MDU	MDU B 28 VDC ON A OFF	DR	0617620	07E	A/7/4/1/7	A/7/4/2/6
770	MDUCOFFR	NAV	MDU	MDU A AND B OFF	DR	0616500	075	A/7/4/1/7	A/7/4/2/6
801	BDPAONR	NDS	BDP	BDP 28 VDC A ON, B OFF	DR	0435500	0ED	A/4/16/0	A/3/16/0
802	BDPOFFR	NDS	BDP	BDP 28 VDC A & B OFF	DR	0437001	0F8	A/3/16/0	A/4/16/0
803	BDPBONR	NDS	BDP	BDP 28 VDC A OFF, B ON	DR	0434601	0E6	A/3/16/0	A/4/16/0
804	WAPWRONR	NDS	BDP	BDW 28 VDC A ON, B OFF	DR	0434200	0E2	A/4/16/4	A/3/16/4
805	WPWROFFR	NDS	BDP	BDW 28 VDC A & B OFF	DR	0433201	0DA	A/3/16/4	A/4/16/4
806	WBPWRONR	NDS	BDP	BDW 28 VDC A OFF, B ON	DR	0435101	0E9	A/3/16/4	A/4/16/4
807	BDPIN1R	NDS	BDP	BDP INITIALIZE 1	D	0443601	11E		
808	BDPIN2R	NDS	BDP	BDP INITIALIZE 2 (ALT)	D	0444701	127		
809	BDWAONR	NDS	BDP	BDW LOWBAND ON A CONVERTER	D	0444201	122		
810	BDWBONR	NDS	BDP	BDW LOWBAND ON B CONVERTER	D	0445301	12B		
811	BDWXSTPR	NDS	BDP	BDW CONVELEC B-A, A-B	D	0445400	12C		
812	BDWNRMR	NDS	BDP	BDW CONVELEC A-A, B-B	D	0444300	123		
813	BDYAONR	NDS	BDP	BDY A ON, BDY B OFF	D	0444000	120		
814	BDYBONR	NDS	BDP	BDY A OFF, BDY B ON	D	0445100	129		
815	RAPOFFR	RAP	RAP	RAP 28VDC OFF	DR	0614320	063	A/7/4/1/2	
816	RAPONR	RAP	RAP	RAP 28VDC ON	DR	0613220	05A		A/7/4/1/2

## REFERENCE

- A-1. GPS IIR Orbital Operations Handbook (OOH), Volume III - Command and Control, G73-OOH-0033B, Martin Marietta Corp. Philadelphia, PA., 13 February 1995.

APPENDIX B  
GPS IIR MESSAGE COMMAND BY COMMAND NUMBER TABLE

CMD No.	Mnemonic	S/S & Comp	Command/Parameter Description	CMD Bit Definition		16 Bit Hex	Command Parameter Definition No of Parameter Bit Field Bit Words	Comments
				Process	OC/TAL			
04000	GBDCMDLR	NDS GBD	GBD COMMAND DATA		2D		D=10AAAAAAAABBBB	
04001	GBDLOADR	NDS GBD	GBD MEMORY LOAD		3D		D=ABBBBBBBBBBB	
07000		TNP MDU	MDU SERIAL CMD DATA					
07100	FINPGCHR	TNP MDU	MDU PULSE TYPE SMCs					
07101	CLEARUPR	TNP MDU	FINALIZE PROGRAM CHANGE	MDU PULSE	2304067	C41B		
07102	PFALLBKR	TNP MDU	CLEAR UPLOAD	MDU PULSE	2310045	C812		
07103	PRQRSTR	TNP MDU	PROGRAM FALLBACK COMMAND	MDU PULSE	2314053	CC15		
07104	BRRESETR	TNP MDU	PROCESSOR RESET	MDU PULSE	2320046	D013		
07105	HPWULSTR	TNP MDU	BASEBAND RESET	MDU PULSE	2324050	D414		
07107	NEDTESTR	TNP MDU	SPARE HW PULSE 1	MDU PULSE	2330072	D81D		
07108		TNP MDU	NED TEST	MDU PULSE	2334064	DC1A		
07300	B2HSGMR	TNP MDU	MDU STORED TYPE SMCs	MDU STORED				
07301	B2RHSGMR	TNP MDU	HSG MODE SEL BLOCK II-SW 1	MDU STORED	2300123	C029		DEFAULT
07302	COLDSONR	TNP MDU	HSG MODE SEL BLOCK IIR-SW 1	MDU STORED	2304135	C42E		DEFAULT
07303	COLDSONR	TNP MDU	COLD START ON-SW 2	MDU STORED	2300207	C043		DEFAULT
07304	COLDSONR	TNP MDU	COLD START OFF (WARM START)-SW 2	MDU STORED	2304211	C444		
07305	CLTXENAR	TNP MDU	CLTX ENABLE-SW 3	MDU STORED	2300410	C084		
07306	CLTXDISR	TNP MDU	CLTX DISABLE-SW 3	MDU STORED	2304406	C483		DEFAULT
07307	L3DATONR	TNP MDU	L3 C/A + DATA ON-HW 4	MDU STORED	2301025	C10A		DEFAULT
07308	L3CAR	TNP MDU	L3 C/A ONLY-HW 4	MDU STORED	2305033	C50D		DEFAULT
07309	AAFSEMAR	TNP MDU	AUTONOMOUS AFS SW ENABLE-SW 5	MDU STORED	2302013	C205		DEFAULT
07310	AAFSDISR	TNP MDU	AUTONOMOUS AFS SW DISABLE-SW 5	MDU STORED	2306005	C602		DEFAULT
07311	SQENAOFR	TNP MDU	STATUS QUEUE ENABLE ON-SW 6	MDU STORED	2300324	C065		DEFAULT
07312	SQENAOFR	TNP MDU	STATUS QUEUE OFF-SW 6	MDU STORED	2304304	C462		DEFAULT
07313	SWSP9ONR	TNP MDU	SOFTWARE SPARE 9 ON-SW 7	MDU STORED	2320114	D026		DEFAULT
07314	SWSP9OFR	TNP MDU	SOFTWARE SPARE 9 OFF-SW 7	MDU STORED	2324102	D421		DEFAULT
07315	ASOFR	TNP MDU	A-S ON-SW 8	MDU STORED	2320230	D04C		DEFAULT
07316	ASOFR	TNP MDU	A-S OFF-SW 8	MDU STORED	2324226	D44B		DEFAULT
07317	DUMPFONR	TNP MDU	MEMORY DUMP ON-SW 9	MDU STORED	2320427	D08B		DEFAULT
07318	DUMPOFFR	TNP MDU	MEMORY DUMP OFF-SW 9	MDU STORED	2324431	D48C		DEFAULT
07319	MRSTENAR	TNP MDU	MDU RESTART ENABLE-SW 10	MDU STORED	2321012	D105		DEFAULT
07320	MINIENAR	TNP MDU	MDU INITIALIZATION ENABLE-SW 10	MDU STORED	2325004	D502		DEFAULT
07321	IDBYPASR	TNP MDU	IDD BYPASS ON-SW 11	MDU STORED	2322024	D20A		DEFAULT
07322	IDDOFR	TNP MDU	IDD BYPASS OFF-SW 11	MDU STORED	2328032	D80D		DEFAULT
07323	SWS10ONR	TNP MDU	SOFTWARE SPARE 10 ON-SW 12	MDU STORED	2320325	D06A		DEFAULT
07324	SWS10OFR	TNP MDU	SOFTWARE SPARE 10 OFF-SW 12	MDU STORED	2324333	D46D		DEFAULT
07325	WDMONENR	TNP MDU	WATCHDOG MON ENABLE ON-HW 13	MDU STORED	2330120	D828		DEFAULT
07326	WDMONDIFR	TNP MDU	WATCHDOG MON DISABLE OFF-HW 13	MDU STORED	2334136	DC2F		DEFAULT
07327	HWSP2ONR	TNP MDU	HARDWARE SPARE 2 ON-HW 14	MDU STORED	2330204	D842		DEFAULT
07328	HWSP2OFR	TNP MDU	HARDWARE SPARE 2 OFF-HW 14	MDU STORED	2334212	DC45		DEFAULT
07329	HWSP1ONR	TNP MDU	HARDWARE SPARE 1 ON-HW 15	MDU STORED	2330413	D885		DEFAULT
07330	HWSP1OFR	TNP MDU	HARDWARE SPARE 1 OFF-HW 15	MDU STORED	2334405	DC82		DEFAULT
07331	L2BONR	TNP MDU	L2 SEL B ON-HW 16	MDU STORED	2331026	D90B		DEFAULT
07332	L2BOFR	TNP MDU	L2 SEL B OFF-HW 16	MDU STORED	2335030	DD0C		DEFAULT
07333	L2AONR	TNP MDU	L2 SEL A ON-HW 17	MDU STORED	2332010	DA04		DEFAULT
07334	L2AOFR	TNP MDU	L2 SEL A OFF-HW 17	MDU STORED	2336006	DE03		DEFAULT
07335	PORTEONR	TNP MDU	PORT ERROR RESET ENABLE-HW 18	MDU STORED	2330311	D864		DEFAULT
07336	PORTEOFR	TNP MDU	PORT ERROR RESET INHIBITED-HW 18	MDU STORED	2334907	DC63		DEFAULT
07337	SWS3ONR	TNP MDU	SOFTWARE SPARE 3 ON-SW 19	MDU STORED	2310117	C827		DEFAULT
07338	SWS3OFR	TNP MDU	SOFTWARE SPARE 3 OFF-SW 19	MDU STORED	2314101	CC20		DEFAULT

07339	SWS40NR	TNP MDU	SOFTWARE SPARE 4 ON-SW 20	MDU STORED	2310233	C84D		
07340	SWS40FFR	TNP MDU	SOFTWARE SPARE 4 OFF-SW 20	MDU STORED	2314225	CC4A		DEFAULT
07341	SWS50NR	TNP MDU	SOFTWARE SPARE 5 ON-SW 21	MDU STORED	2310424	C88A		
07342	SWS50FFR	TNP MDU	SOFTWARE SPARE 5 OFF-SW 21	MDU STORED	2314432	CC8D		DEFAULT
07343	SWS60NR	TNP MDU	SOFTWARE SPARE 6 ON-SW 22	MDU STORED	2311011	C904		
07344	SWS60FFR	TNP MDU	SOFTWARE SPARE 6 OFF-SW 22	MDU STORED	2315007	CD03		DEFAULT
07345	SWS70NR	TNP MDU	SOFTWARE SPARE 7 ON-SW 23	MDU STORED	2312027	CA0B		
07346	SWS70FFR	TNP MDU	SOFTWARE SPARE 7 OFF-SW 23	MDU STORED	2316031	CE0C		DEFAULT
07347	SWS80NR	TNP MDU	SOFTWARE SPARE 8 ON-SW 24	MDU STORED	2310326	C86B		
07348	SWS80FFR	TNP MDU	SOFTWARE SPARE 8 OFF-SW 24	MDU STORED	2314330	CC6C		DEFAULT
07500		TNP MDU	MDU SVID STORED TYPE SMCs	MDU SVID STORED				
07501	SVID01R	TNP MDU	SVID 01	MDU SVID STORED	2340043	E011		
07502	SVID02R	TNP MDU	SVID 02	MDU SVID STORED	2340111	E024		
07503	SVID03R	TNP MDU	SVID 03	MDU SVID STORED	2340156	E037		
07504	SVID04R	TNP MDU	SVID 04	MDU SVID STORED	2340235	E04E		
07505	SVID05R	TNP MDU	SVID 05	MDU SVID STORED	2340272	E06D		
07506	SVID06R	TNP MDU	SVID 06	MDU SVID STORED	2340320	E068		
07507	SVID07R	TNP MDU	SVID 07	MDU SVID STORED	2340367	E07B		
07508	SVID08R	TNP MDU	SVID 08	MDU SVID STORED	2340422	E089		
07509	SVID09R	TNP MDU	SVID 09	MDU SVID STORED	2340465	E09A		
07510	SVID10R	TNP MDU	SVID 10	MDU SVID STORED	2340537	E0AF		
07511	SVID11R	TNP MDU	SVID 11	MDU SVID STORED	2340670	E0BC		
07512	SVID12R	TNP MDU	SVID 12	MDU SVID STORED	2340613	E0C5		
07513	SVID13E	TNP MDU	SVID 13	MDU SVID STORED	2340654	E0D6		
07514	SVID14R	TNP MDU	SVID 14	MDU SVID STORED	2340706	E0E3		
07515	SVID15R	TNP MDU	SVID 15	MDU SVID STORED	2340741	E0F0		
07516	SVID16R	TNP MDU	SVID 16	MDU SVID STORED	2341017	E107		
07517	SVID17R	TNP MDU	SVID 17	MDU SVID STORED	2341050	E114		
07518	SVID18R	TNP MDU	SVID 18	MDU SVID STORED	2341102	E121		
07519	SVID19R	TNP MDU	SVID 19	MDU SVID STORED	2341145	E132		
07520	SVID20R	TNP MDU	SVID 20	MDU SVID STORED	2341226	E14B		
07521	SVID21R	TNP MDU	SVID 21	MDU SVID STORED	2341261	E158		
07522	SVID22R	TNP MDU	SVID 22	MDU SVID STORED	2341333	E16D		
07523	SVID23R	TNP MDU	SVID 23	MDU SVID STORED	2341374	E17E		
07524	SVID24R	TNP MDU	SVID 24	MDU SVID STORED	2341431	E18C		
07525	SVID25R	TNP MDU	SVID 25	MDU SVID STORED	2341476	E19F		
07526	SVID26R	TNP MDU	SVID 26	MDU SVID STORED	2341524	E1AA		
07527	SVID27R	TNP MDU	SVID 27	MDU SVID STORED	2341563	E1B9		
07528	SVID28R	TNP MDU	SVID 28	MDU SVID STORED	2341600	E1C0		
07529	SVID29R	TNP MDU	SVID 29	MDU SVID STORED	2341647	E1D3		
07530	SVID30R	TNP MDU	SVID 30	MDU SVID STORED	2341715	E1E6		
07531	SVID31R	TNP MDU	SVID 31	MDU SVID STORED	2341752	E1F5		
07532	SVID32R	TNP MDU	SVID 32	MDU SVID STORED	2342021	E208		
07533	SVID33R	TNP MDU	SVID 33	MDU SVID STORED	2342066	E21B		
07534	SVID34R	TNP MDU	SVID 34	MDU SVID STORED	2342134	E22E		
07535	SVID35R	TNP MDU	SVID 35	MDU SVID STORED	2342173	E23D		
07536	SVID36R	TNP MDU	SVID 36	MDU SVID STORED	2342210	E244		
07537	SVID37R	TNP MDU	SVID 37	MDU SVID STORED	2342257	E257		DEFAULT
07700		TNP MDU	MDU SW AND CTIDU TYPE SMCs	MDU SW & CTIDU				
07701	SWCMDSPR	TNP MDU	SPARE COMMAND	MDU SW & CTIDU	270000D		D=0pP	
07702	L3XMITMDR	TNP MDU	SEL L3 XMIT MODE	MDU SW & CTIDU	207020D		D=00XXpP	XX=00 OFF DEFAULT XXXX=00000 DEFAULT (ALL OFF)
07703	ITXSMITR	TNP MDU	SEL XMIT SLOT	MDU SW & CTIDU	2704D		D=00XXXXXpP	



09911	TDWL1HR	TT&C TIU	TIU DWELL MODE-FORMAT 1-HIGH RATE	22D		D-XXXXXXXXXXXXXP	SEE TABLE 20-2 FOR 12 BIT DWELL ADDRESSES
09912	TDWL2HR	TT&C TIU	TIU DWELL MODE-FORMAT 2-HIGH RATE	26D		D-XXXXXXXXXXXXXP	SEE TABLE 20-2 FOR 12 BIT DWELL ADDRESSES
10000	CDUCMDOR	TT&C SPU	CDU COMMAND OPCODE	2400001	0		
10000A		TT&C SPU	16 BIT CDU COMMAND				
10100	XFERADRR	TT&C SPU	TRANSFER (RAM ADDRESS)	2401000	0100		
10100A		TT&C SPU	LOGICAL ADDRESS				
10101	EXECCMDR	TT&C SPU	GO (EXECUTE CMDS)	2401003	0101		
10102	READIOPR	TT&C SPU	READ I/O PORT	2401005	0102		
10102A		TT&C SPU	I/O PORT (ID OF PORT TO READ)				
10103	WRITIOPR	TT&C SPU	WRITE I/O PORT	2401006	0103		
10103A		TT&C SPU	I/O PORT (ID OF PORT TO WRITE)				
10103B		TT&C SPU	INFORMATION (DATA TO I/O PORT)				
10104	RAMCHKSR	TT&C SPU	CHECKSUM OF RAM	2401011	0104		
10104A		TT&C SPU	UPPER RAM ADDRESS (16 BITS)				
10104B		TT&C SPU	LOWER RAM ADDRESS (16 BITS)				
10104C		TT&C SPU	UPPER RAM RANGE (16 BITS)				
10104D		TT&C SPU	LOWER RAM RANGE (16 BITS)				
10105	ROMCHKSR	TT&C SPU	CHECKSUM OF ROM	2401012	0105		
10105A		TT&C SPU	ROM ADDRESS				
10105B		TT&C SPU	UPPER ROM RANGE (16 BITS)				
10105C		TT&C SPU	LOWER ROM RANGE (16 BITS)				
10106	NOOPCMDR	TT&C SPU	NOOP (NO OPERATION)	2401014	0106		
10200	LDMEMBR	TT&C SPU	UNLINKED MEMORY LOAD	2402000	0200		
10200A		TT&C SPU	UPPER RAM ADDRESS (16 BITS)				
10200B		TT&C SPU	LOWER RAM ADDRESS (16 BITS)				
10200C		TT&C SPU	RAM RANGE				
10200D		TT&C SPU	DATA				
10201	ROMRAMLR	TT&C SPU	LOAD ROM TO RAM	2402003	0201		0-123 16-BIT DATA WORDS
10201A		TT&C SPU	ROM ADDRESS				
10201B		TT&C SPU	UPPER ROM RANGE (16 BITS)				
10201C		TT&C SPU	LOWER ROM RANGE (16 BITS)				
10201D		TT&C SPU	UPPER RAM ADDRESS (16 BITS)				
10201E		TT&C SPU	LOWER RAM ADDRESS (16 BITS)				
10202	RAMRAMLR	TT&C SPU	LOAD RAM TO RAM	2402005	0202		
10202A		TT&C SPU	UPPER RAM START (16 BITS)				
10202B		TT&C SPU	LOWER RAM START (16 BITS)				
10202C		TT&C SPU	UPPER RAM RANGE (16 BITS)				
10202D		TT&C SPU	LOWER RAM RANGE (16 BITS)				
10202E		TT&C SPU	UPPER RAM DEST. (16 BITS)				
10202F		TT&C SPU	LOWER RAM DEST. (16 BITS)				
10203	ZEROMEMR	TT&C SPU	ZERO UPPER MEMORY	2402006	0203		
10300	RAMDUMPR	TT&C SPU	DUMP RAM DATA	2403001	0300		
10300A		TT&C SPU	UPPER RAM ADDRESS (16 BITS)				
10300B		TT&C SPU	LOWER RAM ADDRESS (16 BITS)				
10300C		TT&C SPU	UPPER RAM RANGE (16 BITS)				
10300D		TT&C SPU	LOWER RAM RANGE (16 BITS)				
10301	ROMDUMPR	TT&C SPU	DUMP ROM DATA	2403002	0301		
10301A		TT&C SPU	ROM ADDRESS				
10301B		TT&C SPU	UPPER ROM RANGE (16 BITS)				
10301C		TT&C SPU	LOWER ROM RANGE (16 BITS)				
10302	SEBFDMPR	TT&C SPU	DUMP SPU ERROR BUFFER	2403004	0302		

MODESWTR	TT&C SPU	SELECT MODE	MODES	2405001	0500	1
10500	TT&C SPU	MODE	MODES			
10500A	TT&C SPU	MODE	MODES			
10501	TT&C SPU	SET GRND MODE SW FLAG TRUE	MODES	2405002	0501	
10502	TT&C SPU	SET GRND MODE SW FLAG FALSE	MODES	2405004	0502	
10503	TT&C SPU	SET AUTON MODE SW FLAG TRUE	MODES	2405007	0503	
10504	TT&C SPU	SET AUTON MODE SW FLAG FALSE	MODES	2405010	0504	
10505	TT&C SPU	ENABLE MOMENTUM MANAGEMENT	MODES	2405013	0505	
10506	TT&C SPU	DISABLE MOMENTUM MANAGEMENT	MODES	2405015	0506	
10507	TT&C SPU	COMMAND RMA ON/OFF	MODES	2405016	0507	2
10507A	TT&C SPU	PARAMETER 1	MODES			
10507B	TT&C SPU	PARAMETER 2	MODES			
10508	TT&C SPU	ALL RMA OFF	MODES	2405020	0508	
10600	TT&C SPU	DUMP ADA ERROR BUFFER	ERRORS	2406001	0600	
10601	TT&C SPU	DUMP INTERRUPT ERROR BUFFER	ERRORS	2406002	0601	
10602	TT&C SPU	DUMP SINGLE BIT ERROR BUFFER	ERRORS	2406004	0602	
10700	TT&C SPU	ENABLE MEMORY CHECKING	MEMCHK	2407000	0700	
10701	TT&C SPU	DISABLE MEMORY CHECKING	MEMCHK	2407003	0701	
11000	TT&C SPU	MEMORY LOAD	UPLINK	2420000	1000	4
11000A	TT&C SPU	UPPER START ADDRESS (16 BITS)	UPLINK			
11000B	TT&C SPU	LOWER START ADDRESS (16 BITS)	UPLINK			
11000C	TT&C SPU	RANGE	UPLINK			
11000D	TT&C SPU	DATA	UPLINK			
11100	TT&C SPU	SPU TLM TABLE LOAD	SPUTLM	2421001	1100	3
11100A	TT&C SPU	TABLE NUMBER	SPUTLM			
11100B	TT&C SPU	TABLE RANGE	SPUTLM			
11100C	TT&C SPU	ELEMENTS TO LOAD	SPUTLM			
11101	TT&C SPU	INITIALIZE MEMORY DUMP	SPUTLM	2421002	1101	4
11101A	TT&C SPU	UPPER DUMP ADDRESS (16 BITS)	SPUTLM			
11101B	TT&C SPU	LOWER DUMP ADDRESS (16 BITS)	SPUTLM			
11101C	TT&C SPU	UPPER DUMP RANGE (16 BITS)	SPUTLM			
11101D	TT&C SPU	LOWER DUMP RANGE (16 BITS)	SPUTLM			
11102	TT&C SPU	INITIALIZE DUMP PREV MEM LOAD	SPUTLM	2421004	1102	
11103	TT&C SPU	PERFORM CHECKSUM PREV MEM LOAD	SPUTLM	2421007	1103	
11104	TT&C SPU	INITIALIZE CHECKSUM	SPUTLM	2421010	1104	4
11104A	TT&C SPU	UPPER HALF ADDRESS (16 BITS)	SPUTLM			
11104B	TT&C SPU	LOWER HALF ADDRESS (16 BITS)	SPUTLM			
11104C	TT&C SPU	UPPER HALF RANGE (16 BITS)	SPUTLM			
11104D	TT&C SPU	LOWER HALF RANGE (16 BITS)	SPUTLM			
11105	TT&C SPU	SWITCH TABLES	SPUTLM	2421013	1105	1
11105A	TT&C SPU	TLM MODE	SPUTLM			
11300	TT&C SPU	UPLOAD A MACRO	STCMD	2423000	1300	3
11300A	TT&C SPU	MACRO ID	STCMD			
11300B	TT&C SPU	MACRO SIZE	STCMD			
11300C	TT&C SPU	MACRO WORDS	STCMD			
11301	TT&C SPU	DELETE A MACRO	STCMD	2423003	1301	1
11301A	TT&C SPU	MACRO ID	STCMD			
11302	TT&C SPU	DUMP RANGE OF MACROS	STCMD	2423005	1302	1
11302A	TT&C SPU	MACRO ID AND NUMBER	STCMD			
11303	TT&C SPU	ABORT ALL MACROS	STCMD	2423006	1303	
11304	TT&C SPU	START A MACRO	STCMD	2423011	1304	3
11304A	TT&C SPU	MACRO ID	STCMD			
11304B	TT&C SPU	UPPER START TIME	STCMD			
11304C	TT&C SPU	LOWER START TIME	STCMD			

0-123 16-BIT DATA WORDS

3-30 MACR WORDS

11305	ABT-MACR	TT&C SPU	ABORT A MACRO	STCMD	2423012	1305	1
11305A	MACRO ID	TT&C SPU	MACRO ID	STCMD			
11500	DMPCVFOR	TT&C SPU	DUMP CVF QUEUE	CVSTORE	2425000	1500	
11501	DMPCVFER	TT&C SPU	DUMP CVF ERROR QUEUE	CVSTORE	2425003	1501	
11600	STRTAMR	TT&C SPU	ATTMON ON	ATTMON	2426000	1600	
11601	STOPATMR	TT&C SPU	ATTMON OFF	ATTMON	2426003	1601	
11700	AVGSPNPR	TT&C SPU	SET AVG SPIN PERIOD	SPM	2427001	1700	2
11700A		TT&C SPU	SPIN PERIOD UPPER HALF	SPM			
11700B		TT&C SPU	SPIN PERIOD LOWER HALF	SPM			
11701	NBRPPRSR	TT&C SPU	SET NUMBER OF REMAINING PULSE PAIRS	SPM	2427002	1701	1
11701A		TT&C SPU	PULSE PAIRS	SPM			
11702	SSPMPPR	TT&C SPU	SET SPM THRUSTER SELECTION	SPM	2427004	1702	1
11702A		TT&C SPU	THRUSTER SELECTION	SPM			
11703	FCTSPNPR	TT&C SPU	SET SPM FRAC OF SPIN PERIOD	SPM	2427007	1703	2
11703A		TT&C SPU	SPIN PER FRAC UPPER HALF	SPM			
11703B		TT&C SPU	SPIN PER FRAC LOWER HALF	SPM			
11704	CEP1DELR	TT&C SPU	SET CEP FIRST PULSE DELAY	SPM	2427010	1704	2
11704A		TT&C SPU	PULSE DELAY UPPER HALF	SPM			
11704B		TT&C SPU	PULSE DELAY LOWER HALF	SPM			
11705	SPMSTCGR	TT&C SPU	SPM STATE CHANGE	SPM	2427013	1705	1
11705A		TT&C SPU	SPM STATE	SPM			
12400	INCZTIMR	TT&C SPU	INCREMENT Z-TIME	EPHSUP	2444001	2400	2
12400A		TT&C SPU	UPPER HALF Z-TIME (16 BITS)	EPHSUP			
12400B		TT&C SPU	LOWER HALF Z-TIME (16 BITS)	EPHSUP			
12401	NEWZTIMR	TT&C SPU	NEW Z-TIME	EPHSUP	2444002	2401	2
12401A		TT&C SPU	UPPER HALF Z-TIME (16 BITS)	EPHSUP			
12401B		TT&C SPU	LOWER HALF Z-TIME (16 BITS)	EPHSUP			
12402	LDBUEPHR	TT&C SPU	LOAD BACKUP EPHEMERIS	EPHSUP	2444004	2402	38
12402P		TT&C SPU	COEFFICIENT REFERENCE TIME UPPER (16 BITS)	EPHSUP			
12402P		TT&C SPU	COEFFICIENT REFERENCE TIME LOWER (16 BITS)	EPHSUP			
12402P		TT&C SPU	BU EPHEM INCLINATION 1 UPPER	EPHSUP			
12402P		TT&C SPU	BU EPHEM INCLINATION 1 MIDDLE	EPHSUP			
12402P		TT&C SPU	BU EPHEM INCLINATION 1 LOWER	EPHSUP			
12402P		TT&C SPU	BU EPHEM INCLINATION 2 UPPER	EPHSUP			
12402P		TT&C SPU	BU EPHEM INCLINATION 2 MIDDLE	EPHSUP			
12402P		TT&C SPU	BU EPHEM INCLINATION 2 LOWER	EPHSUP			
12402P		TT&C SPU	BU EPHEM INCLINATION 3 UPPER	EPHSUP			
12402P		TT&C SPU	BU EPHEM INCLINATION 3 MIDDLE	EPHSUP			
12402P		TT&C SPU	BU EPHEM INCLINATION 3 LOWER	EPHSUP			
12402P		TT&C SPU	BU EPHEM INCLINATION 4 UPPER	EPHSUP			

12402P 13		TT&C SPU	BU EPHEM INCLINATION 4 MIDDLE	EPHSUP					
12402P 14		TT&C SPU	BU EPHEM INCLINATION 4 LOWER	EPHSUP					
12402P 15		TT&C SPU	BU EPHEM INCLINATION 5 UPPER	EPHSUP					
12402P 16		TT&C SPU	BU EPHEM INCLINATION 5 MIDDLE	EPHSUP					
12402P 17		TT&C SPU	BU EPHEM INCLINATION 5 LOWER	EPHSUP					
12402P 18		TT&C SPU	BU EPHEM INCLINATION 6 UPPER	EPHSUP					
12402P 19		TT&C SPU	BU EPHEM INCLINATION 6 MIDDLE	EPHSUP					
12402P 20		TT&C SPU	BU EPHEM INCLINATION 6 LOWER	EPHSUP					
12402P 21		TT&C SPU	BU EPHEM RIGHT ASCENSION 1 UPPER	EPHSUP					
12402P 22		TT&C SPU	BU EPHEM RIGHT ASCENSION 1 MIDDLE	EPHSUP					
12402P 23		TT&C SPU	BU EPHEM RIGHT ASCENSION 1 LOWER	EPHSUP					
12402P 24		TT&C SPU	BU EPHEM RIGHT ASCENSION 2 UPPER	EPHSUP					
12402P 25		TT&C SPU	BU EPHEM RIGHT ASCENSION 2 MIDDLE	EPHSUP					
12402P 26		TT&C SPU	BU EPHEM RIGHT ASCENSION 2 LOWER	EPHSUP					
12402P 27		TT&C SPU	BU EPHEM RIGHT ASCENSION 3 UPPER	EPHSUP					
12402P 28		TT&C SPU	BU EPHEM RIGHT ASCENSION 3 MIDDLE	EPHSUP					
12402P 29		TT&C SPU	BU EPHEM RIGHT ASCENSION 3 LOWER	EPHSUP					
12402P 30		TT&C SPU	BU EPHEM RIGHT ASCENSION 4 UPPER	EPHSUP					
12402P 31		TT&C SPU	BU EPHEM RIGHT ASCENSION 4 MIDDLE	EPHSUP					
12402P 32		TT&C SPU	BU EPHEM RIGHT ASCENSION 4 LOWER	EPHSUP					
12402P 33		TT&C SPU	BU EPHEM RIGHT ASCENSION 5 UPPER	EPHSUP					
12402P 35		TT&C SPU	BU EPHEM RIGHT ASCENSION 5 MIDDLE	EPHSUP					
12402P 36		TT&C SPU	BU EPHEM RIGHT ASCENSION 5 LOWER	EPHSUP					
12402P 37		TT&C SPU	BU EPHEM RIGHT ASCENSION 6 UPPER	EPHSUP					
12402P 38		TT&C SPU	BU EPHEM RIGHT ASCENSION 6 MIDDLE	EPHSUP					
12402P 39		TT&C SPU	BU EPHEM RIGHT ASCENSION 6 LOWER	EPHSUP					
12403	DMPBEPHR	TT&C SPU	DUMP BACKUP EPHEMERIS	EPHSUP	2444007	2403			

12404	BEPHENAR	TT&C SPU	CHANGE TO BACKUP EPIHEMERIS	EPHSUP	2444010	2404		
12405	BEPHDIR	TT&C SPU	CHANGE FROM BACKUP EPIHEMERIS	EPHSUP	2444013	2405		
12900	ESARBENR	TT&C SPU	ENABLE ESA RAD BIAS	ESAPR	2451000	2900		
12901	ESARBDJR	TT&C SPU	DISABLE ESA RAD BIAS	ESAPR	2451003	2901		
13201	SNPFENAR	TT&C SPU	ENABLE SK SNP ARRAY SLEW FLAG	THRSEL	2462003	3201		
13202	SNPFDIR	TT&C SPU	DISABLE SK SNP ARRAY SLEW FLAG	THRSEL	2462005	3202		
13203	THRTCNFR	TT&C SPU	THRUSTER CONFIGURATION	THRSEL	2462006	3203	2	
13203A		TT&C SPU	THRUSTER FACE	THRSEL				
13203B		TT&C SPU	THRUSTER SELECTION	THRSEL				
13300	TCMDPWDR	TT&C SPU	SET CMDED PW FOR EACH THRUSTER	TPF	2463001	3300	3	
13300A		TT&C SPU	THRUSTER SELECTION	TPF				
13300B		TT&C SPU	BURN TIME UPPER HALF	TPF				
13300C		TT&C SPU	BURN TIME LOWER HALF	TPF				
13301	STRTPFR	TT&C SPU	START TPF	TPF	2463002	3301		
13302	STOPTFR	TT&C SPU	STOP TPF	TPF	2463004	3302		
13500	SELACTR	TT&C SPU	SEL ACTUATOR	PID	2465001	3500	1	
13500A		TT&C SPU	ACTUATOR	PID				
13501	SELUNLDR	TT&C SPU	SEL MOMENTUM UNLOADING ACTUATOR	PID	2465001	3501	1	
13501A		TT&C SPU	UNLOAD ACTUATOR	PID				
13700	PSMONCFR	TT&C SPU	ENABLE/DISABLE SPECIFIED CAPABILITY	PSMON	2467000	3700	2	
13700A		TT&C SPU	CAPABILITY	PSMON				
13700B		TT&C SPU	CAPABILITY STATUS	PSMON				
13701	SELAHDR	TT&C SPU	AMP HOUR DISCHARGE (AHD) SELECTION	PSMON	2467003	3701	1	
13701A		TT&C SPU	AHD SELECTION	PSMON				
13800	LDSDENR	TT&C SPU	ENABLE LOAD SHEDDING	PSLS	2470000	3800		
13801	LDSHDIR	TT&C SPU	DISABLE LOAD SHEDDING	PSLS	2470003	3801		
14100	RDMNENR	TT&C SPU	ENABLE REDMAN	RDMGT	2501001	4100		
14101	RDMNISR	TT&C SPU	DISABLE REDMAN	RDMGT	2501002	4101		
14102	SRMCMATR	TT&C SPU	SET REDMAN HEALTH STATUS MATRIX	RDMGT	2501004	4102	2	
14102A		TT&C SPU	COMPONENT	RDMGT				
14102B		TT&C SPU	SET DESIRED COMPONENT STATE	RDMGT				
14103	UPRMSWFR	TT&C SPU	UPDATE REDMAN SWITCHING FLAGS	RDMGT	2501007	4103	2	
14103A		TT&C SPU	DEVICE	RDMGT				
14103B		TT&C SPU	DEVICE STATUS	RDMGT				
14104	UPRMTSFR	TT&C SPU	UPDATE TESTING FLAGS	RDMGT	2501010	4104	2	
14104A		TT&C SPU	TEST FLAGS	RDMGT				
14104B		TT&C SPU	TEST FLAG STATUS	RDMGT				
14105	DMPRMHMR	TT&C SPU	DUMP HEALTH MATRIX	RDMGT	2501013	4105		
14106	DMPRMDFR	TT&C SPU	DUMP DEVICE FAILURE LOG	RDMGT	2501015	4106		
14107	DMPRMDSR	TT&C SPU	DUMP DEVICE SWITCHING LOG	RDMGT	2501016	4107		
15000	SPUNOOPR	TT&C SPU	SPU NO OPERATION	CMDX	2520001	5000		
18000	SPCHCONR	TT&C SPU	SETUP PATCH CONNECTION	PATCHMAN	2600000	8000	3	
18000A		TT&C SPU	STARTING ADDRESS OF PATCH CONNECTION	PATCHMAN				
18000B		TT&C SPU	SIZE OF PATCH CONNECTION	PATCHMAN				
18000C		TT&C SPU	PATCH CONNECTION CODE	PATCHMAN				
18001	PCHDISCR	TT&C SPU	DISCONNECT PATCH	PATCHMAN	2600003	8001		
18002	PCHPGADR	TT&C SPU	READJUST PAGE REGISTERS	PATCHMAN	2600005	8002		
18003	CHGPAGER	TT&C SPU	CHANGE PAGE REGISTERS	PATCHMAN	2600006	8003	4	
18003A		TT&C SPU	ADDRESS STATE	PATCHMAN				ONLY ADDRESS STATE 0 IS CURRENTLY VALID
18003B		TT&C SPU	TYPE OF PAGE REGISTER	PATCHMAN				
18003C		TT&C SPU	PAGE CONTENTS	PATCHMAN				

18003D		TT&C SPU	PAGE NUMBER	PATCH MAN	2600011	8004	8	
18004	PCHIFTSR	TT&C SPU	PATCH IFTTEST/SELTS	PATCH MAN				
18004A		TT&C SPU	CMX IFTTEST ADDRESS	PATCH MAN				
18004B		TT&C SPU	CMX SELTS ADDRESS	PATCH MAN				
18004C		TT&C SPU	RECEIVE CONTROL CONNECTION ADDRESS	PATCH MAN				
18004D		TT&C SPU	RECEIVE CONTROL SIZE	PATCH MAN				
18004E		TT&C SPU	SEND CONTROL CONNECTION ADDRESS	PATCH MAN				
18004F		TT&C SPU	SEND CONTROL SIZE	PATCH MAN				
18004G		TT&C SPU	RECEIVE CONTROL CONNECTION CODE	PATCH MAN				
18004H		TT&C SPU	SEND CONTROL CONNECTION CODE	PATCH MAN				
18005	PCHIFDCR	TT&C SPU	DISCONNECT IFTTEST/SELTS PATCH	PATCH MAN	2600012	8005		

## REFERENCE

- B-1. GPS IIR Orbital Operations Handbook (OOH), Volume III - Command and Control, G73-OOH-0033B, Martin Marietta Corp. Philadelphia, PA., 13 February 1995.

APPENDIX C  
GPS IIR TELEMETRY BY WORD TABLE

Mnemonic	Bits		T	S	Mnemonic	LTOC	TLM Description	S/S	Comp	Type	Mode	Units	Conversion Data	Comments
	W	R												
AF5	5	58	8	0	7	8	+X+YACCT	PXYACCT	+X+Y ACCESS PNL TEMP	TCS	AP	Celsius		
AF5	5	58	8	0	7	8	+X+YACCT	PXYACCT	+X+Y ACCESS PNL TEMP	TCS	AP	Celsius		
AF6	6	158	8	0	7	8	+X+YCYLT	PXMYCYLT	+X+Y CENTER CYL TEMP	TCS	AP	Celsius		
AA3	3	10	1	4	4	1	+YSADAST	PYSADAST	SPU A +Y SAD STEPPED	SAD	DL		0=Step	
AA3	3	11	1	4	4	1	+YSADBST	PYSADBST	SPU B +Y SAD STEPPED	SAD	DL		0=Step	
AA6	6	855	1	4	4	1	+YSADDDAA	PYSADDDAA	+Y SADPOT A DEADBAND INDICATOR	SPU A	S		0=Not in Deadband 1=In Deadband	Power Flag Word
AA6	6	863	1	4	4	1	+YSADDDAB	PYSADDDAB	+Y SADPOT A DEADBAND INDICATOR	SPU B	S		0=Not in Deadband 1=In Deadband	Power Flag Word
AA6	6	855	1	5	5	1	+YSADDDBA	PYSADDDBA	+Y SADPOT B DEADBAND INDICATOR	SPU A	S		0=Not in Deadband 1=In Deadband	Power Flag Word
AA6	6	863	1	5	5	1	+YSADDDBB	PYSADDDBB	+Y SADPOT B DEADBAND INDICATOR	SPU B	S		0=Not in Deadband 1=In Deadband	Power Flag Word
AA8	8	554	8	0	7	16	+YSADPAA	PYSADPAA	+Y ACTUAL SADPOT (1 OF 2)	ADS	S	radians		
AA8	8	555	8	0	7	16	+YSADPAA	PYSADPAA	+Y ACTUAL SADPOT (2 OF 2)	ADS	S	radians		
AA8	8	754	8	0	7	16	+YSADPAA	PYSADPAA	+Y ACTUAL SADPOT (1 OF 2)	ADS	S	radians		
AA8	8	755	8	0	7	16	+YSADPAA	PYSADPAA	+Y ACTUAL SADPOT (2 OF 2)	ADS	S	radians		
AA8	8	562	8	0	7	16	+YSADPAB	PYSADPAB	+Y ACTUAL SADPOT (1 OF 2)	ADS	S	radians		
AA8	8	563	8	0	7	16	+YSADPAB	PYSADPAB	+Y ACTUAL SADPOT (2 OF 2)	ADS	S	radians		
AA8	8	762	8	0	7	16	+YSADPAB	PYSADPAB	+Y ACTUAL SADPOT (1 OF 2)	ADS	S	radians		
AA8	8	763	8	0	7	16	+YSADPAB	PYSADPAB	+Y ACTUAL SADPOT (2 OF 2)	ADS	S	radians		
AA8	8	454	8	0	7	16	+YSADPEA	PYSADPEA	+Y ESTIMATED SADPOT (1 OF 2)	ADS	S	radians		
AA8	8	455	8	0	7	16	+YSADPEA	PYSADPEA	+Y ESTIMATED SADPOT (2 OF 2)	ADS	S	radians		
AA8	8	452	8	0	7	16	+YSADPEA	PYSADPEA	+Y ESTIMATED SADPOT (1 OF 2)	ADS	S	radians		
AA8	8	453	8	0	7	16	+YSADPEA	PYSADPEA	+Y ESTIMATED SADPOT (2 OF 2)	ADS	S	radians		
AA8	8	462	8	0	7	16	+YSADPEB	PYSADPEB	+Y ESTIMATED SADPOT (1 OF 2)	ADS	S	radians		
AA8	8	463	8	0	7	16	+YSADPEB	PYSADPEB	+Y ESTIMATED SADPOT (2 OF 2)	ADS	S	radians		
AA8	8	460	8	0	7	16	+YSADPEB	PYSADPEB	+Y ESTIMATED SADPOT (1 OF 2)	ADS	S	radians		
AA8	8	461	8	0	7	16	+YSADPEB	PYSADPEB	+Y ESTIMATED SADPOT (2 OF 2)	ADS	S	radians		
AA2	2	359	8	0	7	8	+YSADT	PYSADT	+Y SAD TEMP	SAD	AP	Celsius		
AA6	6	855	1	0	0	1	+YSADVAA	PYSADVAA	+Y SADPOT A VALID INDICATOR	SPU A	S		0=Not Valid 1=Valid	Power Flag Word
AA6	6	863	1	0	0	1	+YSADVAB	PYSADVAB	+Y SADPOT A VALID INDICATOR	SPU B	S		0=Not Valid 1=Valid	Power Flag Word
AA6	6	855	1	1	1	1	+YSADVBA	PYSADVBA	+Y SADPOT B VALID INDICATOR	SPU A	S		0=Not Valid 1=Valid	Power Flag Word
AA6	6	863	1	1	1	1	+YSADVBB	PYSADVBB	+Y SADPOT B VALID INDICATOR	SPU B	S		0=Not Valid 1=Valid	Power Flag Word
AA8	8	654	8	0	7	16	+YSAERRA	PYSAERRA	+Y SOLAR ARRAY ERROR (1 OF 2)	ADS	S	radians		
AA8	8	655	8	0	7	16	+YSAERRA	PYSAERRA	+Y SOLAR ARRAY ERROR (2 OF 2)	ADS	S	radians		
AA8	8	652	8	0	7	16	+YSAERRA	PYSAERRA	+Y SOLAR ARRAY ERROR (1 OF 2)	ADS	S	radians		
AA8	8	653	8	0	7	16	+YSAERRB	PYSAERRB	+Y SOLAR ARRAY ERROR (1 OF 2)	ADS	S	radians		
AA8	8	662	8	0	7	16	+YSAERRB	PYSAERRB	+Y SOLAR ARRAY ERROR (2 OF 2)	ADS	S	radians		
AA8	8	663	8	0	7	16	+YSAERRB	PYSAERRB	+Y SOLAR ARRAY ERROR (1 OF 2)	ADS	S	radians		
AA8	8	660	8	0	7	16	+YSAERRB	PYSAERRB	+Y SOLAR ARRAY ERROR (2 OF 2)	ADS	S	radians		
AA5	5	659	8	0	7	8	+YSAIHGT	PYSAIHGT	+Y S/A INNER HNGE DMP TMP	S/A	AP	Celsius		Zero-filled in Format 1
AA3	3	659	8	0	7	8	+YSAMHGT	PYSAMHGT	+Y S/A MIDDLE HNGE DMP TMP	S/A	AP	Celsius		Zero-filled in Format 1
AA1	1	659	8	0	7	8	+YSAOHGT	PYSAOHGT	+Y S/A OUTER HNGE DMP TMP	S/A	AP	Celsius		Zero-filled in Format 1

6	5	56	8	0	7	8	+YSAT	PYSAT	+Y S/A PNL TEMP (INBOARD)	EPS	S/A	AH	All Power-Up	Celsius
1	1	58	8	0	7	8	+YSATAP1	PYSATAP1	+Y SAD POS POT 1 TAP	EPS	SAD	AP	All Power-Up	Celsius
1	1	59	8	0	7	8	+YSATAP2	PYSATAP2	+Y SAD POS POT 2 TAP	EPS	SAD	AP	All Power-Up	degrees
1	3	58	8	0	7	8	+YSATOP1	PYSATOP1	+Y SAD POS POT 1 TAP	EPS	SAD	AP	All Power-Up	degrees
1	3	59	8	0	7	8	+YSATOP2	PYSATOP2	+Y SAD POS POT 2 TAP	EPS	SAD	AP	All Power-Up	degrees
6	6	56	8	0	7	8	+YSAUNC	PYSAUNC	+Y S/A UNSHUNTED CURRENT	EPS	S/A	AH	All Power-Up	amps
3	3	59	8	0	7	8	+YSHINT	PYSHINT	+Y SHUNT TEMP	EPS	SBA	AP	All Power-Up	Celsius
A	1	32	8	0	7	8	+YSHVT1	PYSHVT1	+Y SHUNT TAP VOLTAGE (I2259)	EPS	SBA	AH	All Power-Up	volts
A	5	32	8	0	7	8	+YSHVT2	PYSHVT2	+Y SHUNT TAP VOLTAGE (I2260)	EPS	SBA	AH	All Power-Up	volts
6	7	58	8	0	7	8	-X+YACCT	MXPYACCT	-X+Y ACCESS PNL TEMP	MSS	TCS	AP	All Power-Up	Celsius
5	6	58	8	0	7	8	-X-YACCT	MXMYACCT	-X-Y ACCESS PNL TEMP	MSS	TCS	AP	All Power-Up	Celsius
7	1	58	8	0	7	8	-X-YCYLT	MXMYCYLT	-X-Y CENTER CYL TEMP	MSS	TCS	AP	All Power-Up	Celsius
7	8	57	8	0	7	8	-XPNLDT	MXPNLDT	-X PAYLOAD PNL TEMP D	MSS	TCS	AP	All Power-Up	Celsius
2	1	58	8	0	7	8	-XPNLET	MXPNLET	-X PAYLOAD PNL TEMPE	MSS	TCS	AP	All Power-Up	Celsius
A	3	10	1	1	1	1	-YSADAST	MYSADAST	SPU A -Y SAD STEPPED	EPS	SAD	DL	All Power-Up	1=No Step 0=Step
A	3	11	1	1	1	1	-YSADBST	MYSADBST	SPU B -Y SAD STEPPED	EPS	SAD	DL	All Power-Up	1=No Step 0=Step
6	8	55	1	6	6	1	-YSADDA	MYSADDA	-Y SADPOT A DEADBAND INDICATOR	TT&C	SPU A	S	Normal	0=Not in Deadband 1=In Deadband
6	8	63	1	6	6	1	-YSADDB	MYSADDB	-Y SADPOT B DEADBAND INDICATOR	TT&C	SPU B	S	Normal	0=Not in Deadband 1=In Deadband
6	8	55	1	7	7	1	-YSADDBA	MYSADDBA	-Y SADPOT B DEADBAND INDICATOR	TT&C	SPU A	S	Normal	0=Not in Deadband 1=In Deadband
6	8	63	1	7	7	1	-YSADDBB	MYSADDBB	-Y SADPOT B DEADBAND INDICATOR	TT&C	SPU B	S	Normal	0=Not in Deadband 1=In Deadband
8	6	52	8	0	7	16	-YSADPAA	MYSADPAA	-Y ACTUAL SADPOT (1 OF 2)	ADS	SPU A	S	Normal	radians
8	6	53	8	0	7	16	-YSADPAA	MYSADPAA	-Y ACTUAL SADPOT (2 OF 2)	ADS	SPU A	S	Normal	radians
8	7	52	8	0	7	16	-YSADPAA	MYSADPAA	-Y ACTUAL SADPOT (1 OF 2)	ADS	SPU A	S	Normal	radians
8	7	53	8	0	7	16	-YSADPAA	MYSADPAA	-Y ACTUAL SADPOT (2 OF 2)	ADS	SPU A	S	Normal	radians
8	6	60	8	0	7	16	-YSADPAB	MYSADPAB	-Y ACTUAL SADPOT (1 OF 2)	ADS	SPU B	S	Normal	radians
8	6	61	8	0	7	16	-YSADPAB	MYSADPAB	-Y ACTUAL SADPOT (2 OF 2)	ADS	SPU B	S	Normal	radians
8	7	60	8	0	7	16	-YSADPAB	MYSADPAB	-Y ACTUAL SADPOT (1 OF 2)	ADS	SPU B	S	Normal	radians
8	7	61	8	0	7	16	-YSADPAB	MYSADPAB	-Y ACTUAL SADPOT (2 OF 2)	ADS	SPU B	S	Normal	radians
8	5	52	8	0	7	16	-YSADPEA	MYSADPEA	-Y ESTIMATED SADPOT (1 OF 2)	ADS	SPU A	S	Normal	radians
8	5	53	8	0	7	16	-YSADPEA	MYSADPEA	-Y ESTIMATED SADPOT (2 OF 2)	ADS	SPU A	S	Normal	radians
8	4	54	8	0	7	16	-YSADPEA	MYSADPEA	-Y ESTIMATED SADPOT (1 OF 2)	ADS	SPU A	S	Normal	radians
8	4	55	8	0	7	16	-YSADPEA	MYSADPEA	-Y ESTIMATED SADPOT (2 OF 2)	ADS	SPU A	S	Normal	radians
8	5	60	8	0	7	16	-YSADPEB	MYSADPEB	-Y ESTIMATED SADPOT (1 OF 2)	ADS	SPU B	S	Normal	radians
8	5	61	8	0	7	16	-YSADPEB	MYSADPEB	-Y ESTIMATED SADPOT (2 OF 2)	ADS	SPU B	S	Normal	radians
8	4	62	8	0	7	16	-YSADPEB	MYSADPEB	-Y ESTIMATED SADPOT (1 OF 2)	ADS	SPU B	S	Normal	radians
8	4	63	8	0	7	16	-YSADPEB	MYSADPEB	-Y ESTIMATED SADPOT (2 OF 2)	ADS	SPU B	S	Normal	radians
2	4	59	8	0	7	8	-YSADT	MYSADT	-Y SAD TEMP	EPS	SAD	AP	All Power-Up	Celsius
6	8	55	1	2	2	1	-YSADVA	MYSADVA	-Y SADPOT A VALID INDICATOR	TT&C	SPU A	S	Normal	0=Not Valid 1=Valid
6	8	63	1	2	2	1	-YSADVAB	MYSADVAB	-Y SADPOT A VALID INDICATOR	TT&C	SPU B	S	Normal	0=Not Valid 1=Valid
6	8	55	1	3	3	1	-YSADVBA	MYSADVBA	-Y SADPOT B VALID INDICATOR	TT&C	SPU A	S	Normal	0=Not Valid 1=Valid
6	8	63	1	3	3	1	-YSADVBB	MYSADVBB	-Y SADPOT B VALID INDICATOR	TT&C	SPU B	S	Normal	0=Not Valid 1=Valid
8	7	52	8	0	7	16	-YSAERRA	MYSAERRA	-Y SOLAR ARRAY ERROR (1 OF 2)	ADS	SPU A	S	Normal	radians
8	7	53	8	0	7	16	-YSAERRA	MYSAERRA	-Y SOLAR ARRAY ERROR (2 OF 2)	ADS	SPU A	S	Normal	radians
8	8	54	8	0	7	16	-YSAERRA	MYSAERRA	-Y SOLAR ARRAY ERROR (1 OF 2)	ADS	SPU A	S	Normal	radians
8	8	55	8	0	7	16	-YSAERRA	MYSAERRA	-Y SOLAR ARRAY ERROR (2 OF 2)	ADS	SPU A	S	Normal	radians
8	7	60	8	0	7	16	-YSAERRB	MYSAERRB	-Y SOLAR ARRAY ERROR (1 OF 2)	ADS	SPU B	S	Normal	radians
8	7	61	8	0	7	16	-YSAERRB	MYSAERRB	-Y SOLAR ARRAY ERROR (2 OF 2)	ADS	SPU B	S	Normal	radians



6	1	57	8	0	7	8	9VT	L9VT	REA09 VALVE TEMP CDU COMMAND ACCEPT/REJECT STATUS	RCS	REA	AP	All Power-Up	Celsius	1=Ccmd Accepted 0=Ccmd Rejected	ADS Flag Word
A	A	8	1	0	0	1	ACPTSTAT	ACPTSTAT		TT&C	CDU	S	All Power-Up Normal		0=RWA 1=Thruster	ADS Flag Word
3	4	55	1	4	4	1	ACTINDA	ACTINDA	ACTUATOR INDICATOR	TT&C	SPU A	S	Normal Thruster		0=RWA 1=Thruster	ADS Flag Word
3	4	63	1	4	4	1	ACTINDB	ACTINDB	ACTUATOR INDICATOR	TT&C	SPU B	S	Normal Thruster		0=RWA 1=Thruster	ADS Flag Word
6	8	52	1	1	1	1	ADAERRA	ADAERRA	ADA ERROR INDICATOR	TT&C	SPU A	S	Early Orbit Normal		0=No ADA Error 1=ADA Error	TLM (Error) Flag Word 52 (first word)
3	6	52	1	1	1	1	ADAERRA	ADAERRA	ADA ERROR INDICATOR	TT&C	SPU A	S	Normal Thruster		0=No ADA Error 1=ADA Error	TLM (Error) Flag Word 52 (first word)
6	8	60	1	1	1	1	ADAERRB	ADAERRB	ADA ERROR INDICATOR	TT&C	SPU B	S	Early Orbit Normal		0=No ADA Error 1=ADA Error	TLM (Error) Flag Word 60 (first word)
3	6	60	1	1	1	1	ADAERRB	ADAERRB	ADA ERROR INDICATOR	TT&C	SPU B	S	Normal Thruster		0=No ADA Error 1=ADA Error	TLM (Error) Flag Word 60 (first word)
NA	NA	NA	NA	4	NA	1	ADAEXSM	ADAEXSM	ADA EXCEPTION REPORT	NDS	BDP	S	SSOH			3062
NA	NA	NA	NA	0	NA	16	ADATAEND	ADATAEND	SEC A.16 DATAENDADDR	NDS	BDP-MP	S	SSOH			85
NA	NA	NA	NA	0	NA	8	ADCERROR	ADCERROR	ADC ERROR CUMU COUNT	NDS	BDP-IP	S	SSOH			157
6	8	52	1	5	5	1	ADEENA	ADEENA	ARRAY DRIVE ELECTRONICS	TT&C	SPU A	S	Normal		0=Disabled	RDMGMT Flag Word 52 (lower half-first word)
7	4	54	1	5	5	1	ADEENA	ADEENA	ARRAY DRIVE ELECTRONICS	TT&C	SPU A	S	Thruster		1=Enabled	RDMGMT Flag Word 54 (lower half-first word)
6	8	60	1	5	5	1	ADEENB	ADEENB	ARRAY DRIVE ELECTRONICS	TT&C	SPU B	S	Normal		0=Disabled	RDMGMT Flag Word 60 (lower half-first word)
7	4	62	1	5	5	1	ADEENB	ADEENB	ARRAY DRIVE ELECTRONICS	TT&C	SPU B	S	Thruster		1=Enabled	RDMGMT Flag Word 62 (lower half-first word)
6	8	52	1	2	2	1	ADEXSTRA	ADEXSTRA	SPU ADE XSTRAP	TT&C	SPU A	S	Normal		0=Test Disabled	RDMGMT Flag Word 52 (lower half-first word)
7	4	54	1	2	2	1	ADEXSTRA	ADEXSTRA	SPU ADE XSTRAP	TT&C	SPU A	S	Thruster		1=Test Enabled	RDMGMT Flag Word 54 (lower half-first word)
6	8	60	1	2	2	1	ADEXSTRB	ADEXSTRB	SPU ADE XSTRAP	TT&C	SPU B	S	Normal		0=Test Disabled	RDMGMT Flag Word 60 (lower half-first word)
7	4	62	1	2	2	1	ADEXSTRB	ADEXSTRB	SPU ADE XSTRAP	TT&C	SPU B	S	Thruster		1=Test Enabled	RDMGMT Flag Word 62 (lower half-first word)
3	4	54	1	4	4	1	ADLBKUPA	ADLBKUPA	ADL BACKUP MODE INDICATOR	TT&C	SPU A	S	Normal Thruster		0=Not Using B/U Ephem 1=Using B/U Ephem	ADS Flag Word
3	4	62	1	4	4	1	ADLBKUPB	ADLBKUPB	ADL BACKUP MODE INDICATOR	TT&C	SPU B	S	Normal Thruster		0=Not Using B/U Ephem 1=Using B/U Ephem	ADS Flag Word
4	4	56	1	4	4	1	ADLMODEA	ADLMODEA	ADL SUBMODE	TT&C	SPU A	S	Normal		0=Ideal SNP 1=Low Beta SNP	Mode Flag Word
3	4	53	1	4	4	1	ADLMODEA	ADLMODEA	ADL SUBMODE	TT&C	SPU A	S	Thruster		0=Ideal SNP 1=Low Beta SNP	Mode Flag Word
4	4	63	1	4	4	1	ADLMODEB	ADLMODEB	ADL SUBMODE	TT&C	SPU B	S	Normal		0=Ideal SNP 1=Low Beta SNP	Mode Flag Word
4	4	61	1	4	4	1	ADLMODEB	ADLMODEB	ADL SUBMODE	TT&C	SPU B	S	Thruster		0=Ideal SNP 1=Low Beta SNP	Mode Flag Word
4	4	54	3	0	2	3	ADSMODEA	ADSMODEA	CURRENT ADS MODE	TT&C	SPU A	S	Normal		0=Off 1=RN 2=SSH 3=SHES 4=EAH 5=SK 6=SNP 7=EHYS	Mode Flag Word
3	4	52	3	0	2	3	ADSMODEA	ADSMODEA	CURRENT ADS MODE	TT&C	SPU A	S	Thruster		0=Off 1=RN 2=SSH 3=SHES 4=EAH 5=SK 6=SNP 7=EHYS	Mode Flag Word

4	4	62	3	0	2	3	ADSMODEB		ADSMODEB	CURRENT ADS MODE	TT&C	SPU B	S	Normal	0=Off 2=SSH 4=EAH 6=SNP 1=RN 3=SHES 5=SK 7=EHYS	Mode Flag Word
3	4	60	3	0	2	3	ADSMODEB		ADSMODEB	CURRENT ADS MODE	TT&C	SPU B	S	Thruster	0=Off 2=SSH 4=EAH 6=SNP 1=RN 3=SHES 5=SK 7=EHYS	Mode Flag Word
4	4	54	2	3	4	2	ADSSUBMA		ADSSUBMA	CURRENT ADS SUBMODE	TT&C	SPU A	S	Normal	0=EA 2=SS 1=EH 3=SA	Mode Flag Word
3	4	52	2	3	4	2	ADSSUBMA		ADSSUBMA	CURRENT ADS SUBMODE	TT&C	SPU A	S	Thruster	0=EA 2=SS 1=EH 3=SA	Mode Flag Word
4	4	62	2	3	4	2	ADSSUBMB		ADSSUBMB	CURRENT ADS SUBMODE	TT&C	SPU B	S	Normal	0=EA 2=SS 1=EH 3=SA	Mode Flag Word
3	4	60	2	3	4	2	ADSSUBMB		ADSSUBMB	CURRENT ADS SUBMODE	TT&C	SPU B	S	Thruster	0=EA 2=SS 1=EH 3=SA	Mode Flag Word
4	1	57	8	0	7	8	AKM1AT		AKM1AT	AKM TEMP 1A	PSS	AKM	AP	All Power-Up	Celsius	
4	2	57	8	0	7	8	AKM1BT		AKM1BT	AKM TEMP 1B	PSS	AKM	AP	All Power-Up	Celsius	
4	3	57	8	0	7	8	AKM2AT		AKM2AT	AKM TEMP 2A	PSS	AKM	AP	All Power-Up	Celsius	
2	1	57	8	0	7	8	AKM2BT		AKM2BT	AKM TEMP 2B	PSS	AKM	AP	All Power-Up	Celsius	
A	4	10	1	7	7	1	AKMARMA		AKMARMA	OCU A PYRO (AKM) ARMED	PSS	AKM	DL	All Power-Up	1=Armed 0=Disarmed	
A	4	11	1	7	7	1	AKMARMB		AKMARMB	OCU B PYRO (AKM) ARMED	PSS	AKM	DL	All Power-Up	1=Armed 0=Disarmed	
A	2	16	1	2	2	1	AKMHTRA		AKMHTRA	AKM HEATER HIGH POWER ON/OFF	PSS	AKM	S	All Power-Up	1=On 0=Off	
A	2	16	1	6	6	1	AKMHTRB		AKMHTRB	AKM HEATER LOW POWER ON/OFF	PSS	AKM	S	All Power-Up	1=On 0=Off	
7	5	52	8	0	7	16	ALPHA		ALPHA	ALPHA ANGLE (1 OF 2)	ADS	SPU A	S	Normal	radians	
7	5	53	8	0	7	16	ALPHA		ALPHA	ALPHA ANGLE (2 OF 2)	ADS	SPU A	S	Normal	radians	
6	5	54	8	0	7	16	ALPHA		ALPHA	ALPHA ANGLE (1 OF 2)	ADS	SPU A	S	Thruster	radians	
6	5	55	8	0	7	16	ALPHA		ALPHA	ALPHA ANGLE (2 OF 2)	ADS	SPU A	S	Thruster	radians	
7	5	60	8	0	7	16	ALPHAB		ALPHAB	ALPHA ANGLE (1 OF 2)	ADS	SPU B	S	Normal	radians	
7	5	61	8	0	7	16	ALPHAB		ALPHAB	ALPHA ANGLE (2 OF 2)	ADS	SPU B	S	Normal	radians	
6	5	62	8	0	7	16	ALPHAB		ALPHAB	ALPHA ANGLE (1 OF 2)	ADS	SPU B	S	Thruster	radians	
6	5	63	8	0	7	16	ALPHAB		ALPHAB	ALPHA ANGLE (2 OF 2)	ADS	SPU B	S	Thruster	radians	
A	7	10	1	0	0	1	AMEOKB1		AMEOKB1	SPU A MEOK BIT1	TT&C	SPU	DL	All Power-Up	1=CPU A Not OK 0=CPU A OK	
A	7	10	1	1	1	1	AMEOKB2		AMEOKB2	SPU A MEOK BIT2	TT&C	SPU	DL	All Power-Up	1=CPU A Not OK 0=CPU A OK	
A	7	64	1	3	3	1	ANTSCLA		ANTSCLA	S-BAND ANT SW A POSITION	TT&C	SBT	DL	All Power-Up	1=Pos 1 Selected 0=Pos 2 Selected	See Antenna Config Table
A	8	64	1	3	3	1	ANTSCLB		ANTSCLB	S-BAND ANT SW B POSITION	TT&C	SBT	DL	All Power-Up	1=Pos 1 Selected 0=Pos 2 Selected	See Antenna Config Table
NA	NA	NA	NA	4	NA	1	ASOHIMSK		ASOHIMSK	ANALOG SOH INT MASK	NDS	BDY	S	SSOH		211
NA	NA	NA	NA	7	NA	1	ASOHSERR		ASOHSERR	BDY-P INTERSTATBT:ANSOHS	NDS	BDY	S	SSOH		254
A	1	52	4	0	3	4	ATMESIDA		ATMESIDA	ATTITUDE MEASUREMENT ID	TT&C	SPU A	S	Early Orbit	1=CEP 3=HCl 1 TE 5=HCl 2 TE AND 6-15=SPARE	ATTMON Record Word (first word)
A	3	52	4	0	3	4	ATMESIDA		ATMESIDA	ATTITUDE MEASUREMENT ID	TT&C	SPU A	S	Early Orbit	1=CEP 3=HCl 1 TE 5=HCl 2 TE AND 6-15=SPARE	ATTMON Record Word (first word)

A	5	52	4	0	3	4	ATMESIDA	ATMESIDA	ATTITUDE MEASUREMENT ID	TT&C	SPU A	S	Early Orbit	1=CEP 3=HCI 1 TE 5=HCI 2 TE AND 6-15=SPARE	2=HCI 1 LE 4=HCI 2 LE	0	ATTMON Record Word (first word)
A	7	52	4	0	3	4	ATMESIDA	ATMESIDA	ATTITUDE MEASUREMENT ID	TT&C	SPU A	S	Early Orbit	1=CEP 3=HCI 1 TE 5=HCI 2 TE AND 6-15=SPARE	2=HCI 1 LE 4=HCI 2 LE	0	ATTMON Record Word (first word)
A	1	60	4	0	3	4	ATMESIDB	ATMESIDB	ATTITUDE MEASUREMENT ID	TT&C	SPU B	S	Early Orbit	1=CEP 3=HCI 1 TE 5=HCI 2 TE AND 6-15=SPARE	2=HCI 1 LE 4=HCI 2 LE	0	ATTMON Record Word (first word)
A	3	60	4	0	3	4	ATMESIDB	ATMESIDB	ATTITUDE MEASUREMENT ID	TT&C	SPU B	S	Early Orbit	1=CEP 3=HCI 1 TE 5=HCI 2 TE AND 6-15=SPARE	2=HCI 1 LE 4=HCI 2 LE	0	ATTMON Record Word (first word)
A	5	60	4	0	3	4	ATMESIDB	ATMESIDB	ATTITUDE MEASUREMENT ID	TT&C	SPU B	S	Early Orbit	1=CEP 3=HCI 1 TE 5=HCI 2 TE AND 6-15=SPARE	2=HCI 1 LE 4=HCI 2 LE	0	ATTMON Record Word (first word)
A	7	60	4	0	3	4	ATMESIDB	ATMESIDB	ATTITUDE MEASUREMENT ID	TT&C	SPU B	S	Early Orbit	1=CEP 3=HCI 1 TE 5=HCI 2 TE AND 6-15=SPARE	2=HCI 1 LE 4=HCI 2 LE	0	ATTMON Record Word (first word)
A	4	16	1	3	3	1	ATO1	ATO1	S-BAND DWNLNK 1 ATO	TT&C	SBT	S	All Power-Up	1=Disabled 0=Enabled			
A	4	16	1	7	7	1	ATO2	ATO2	S-BAND DWNLNK 2 ATO	TT&C	SBT	S	All Power-Up	1=Disabled 0=Enabled			
2	8	55	1	7	7	1	ATTMONA	ATTMONA	ATTMON RUNNING FLAG	ADS	SPU A	S	Early Orbit	1=Running 0=Not Running			
2	8	63	1	7	7	1	ATTMONB	ATTMONB	ATTMON RUNNING FLAG	ADS	SPU B	S	Early Orbit	1=Running 0=Not Running			
NA	NA	NA	NA	7	NA	1	AUTOCMD	AUTOCMD	OVERRIDE AUTO CMDING	NDS	BDP	S	SSOH				3012
A	2	11	1	7	7	1	B1C17BY	B1C17BY	-X BATT 1 CELL 17 BYPASSED	EPS	BATT	DL	All Power-Up	1=Not Bypassed 0=Bypassed			
A	2	11	1	0	0	1	B1C17OP	B1C17OP	-X BATT1 CELL 17 BYPASS OPEN	EPS	BATT	DL	All Power-Up	1=Diode	0=Short		
5	3	59	8	0	7	8	B1P8AT	B1P8AT	-X BATT 1-8 TEMP A	EPS	BATT	AP	All Power-Up	Celsius			
7	3	59	8	0	7	8	B1P8BT	B1P8BT	-X BATT 1-8 TEMP B	EPS	BATT	AP	All Power-Up	Celsius			
5	4	59	8	0	7	8	B1P9AT	B1P9AT	-X BATT 1-9 TEMP A	EPS	BATT	AP	All Power-Up	Celsius			
7	4	59	8	0	7	8	B1P9BT	B1P9BT	-X BATT 1-9 TEMP B	EPS	BATT	AP	All Power-Up	Celsius			
7	6	56	8	0	7	8	B1PK9V	B1PK9V	-X BATT 19-PACK VOLTAGE	EPS	BATT	AH	All Power-Up	volts			
A	2	10	1	7	7	1	B2C17BY	B2C17BY	-X BATT 2 CELL 17 BYPASSED	EPS	BATT	DL	All Power-Up	1=Not Bypassed 0=Bypassed			
A	2	10	1	0	0	1	B2C17OP	B2C17OP	+X BATT2 CELL 17 BYPASS OPEN	EPS	BATT	DL	All Power-Up	1=Diode	0=Short		
4	3	59	8	0	7	8	B2P8AT	B2P8AT	+X BATT 2-8 TEMP A	EPS	BATT	AP	All Power-Up	Celsius			
6	4	59	8	0	7	8	B2P8BT	B2P8BT	+X BATT 2-8 TEMP B	EPS	BATT	AP	All Power-Up	Celsius			
4	4	59	8	0	7	8	B2P9AT	B2P9AT	+X BATT 2-9 TEMP A	EPS	BATT	AP	All Power-Up	Celsius			
6	4	59	8	0	7	8	B2P9BT	B2P9BT	+X BATT 2-9 TEMP B	EPS	BATT	AP	All Power-Up	Celsius			
7	2	56	8	0	7	8	B2PK9V	B2PK9V	+X BATT 2 9-PACK VOLTAGE	EPS	BATT	AH	All Power-Up	volts			
NA	NA	NA	NA	2	NA	1	BANDSLCT	BANDSLCT	HIGH BAND/LOW BAND	NDS	BDP	S	SSOH				3051
4	5	58	8	0	7	8	BASPNLBT	BASPNLBT	BASE PNL TEMP B	MSS	TCS	AP	All Power-Up	Celsius			
6	6	54	8	0	7	16	BAT1AHDA	BAT1AHDA	AHD BATT1 (1 OF 2)	EPS	SPU A	S	Normal Thruster	amp-hours			
6	6	55	8	0	7	16	BAT1AHDA	BAT1AHDA	AHD BATT1 (2 OF 2)	EPS	SPU A	S	Normal Thruster	amp-hours			

6	6	62	8	0	7	16	BAT1AHDB	BAT1AHDB	AHD BATT1 (1 OF 2)	EPS	SPU B	S	Normal Thruster	amp-hours	
6	6	63	8	0	7	16	BAT1AHDB	BAT1AHDB	AHD BATT1 (2 OF 2)	EPS	SPU B	S	Normal Thruster	amp-hours	
A	8	33	8	0	7	8	BAT1CUR	BAT1CUR	-X BATT 1 CURR	EPS	BATT	AH	All Power-Up	amps	
6	7	54	8	0	7	16	BAT1NDA	BAT1NDA	AHD AT NIGHT/DAY BATT1 (1 OF 2)	EPS	SPU A	S	Thruster	amp-hours	
6	7	55	8	0	7	16	BAT1NDA	BAT1NDA	AHD AT NIGHT/DAY BATT1 (2 OF 2)	EPS	SPU A	S	Thruster	amp-hours	
6	7	62	8	0	7	16	BAT1NDB	BAT1NDB	AHD AT NIGHT/DAY BATT1 (1 OF 2)	EPS	SPU B	S	Thruster	amp-hours	
6	7	63	8	0	7	16	BAT1NDB	BAT1NDB	AHD AT NIGHT/DAY BATT1 (2 OF 2)	EPS	SPU B	S	Thruster	amp-hours	
6	4	52	8	0	7	16	BAT1PREA	BAT1PREA	BATT1 PRESSURE AT NIGHT/DAY (1 OF 2)	EPS	SPU A	S	Thruster	counts	Updated leaving eclipse only
6	4	53	8	0	7	16	BAT1PREA	BAT1PREA	BATT1 PRESSURE AT NIGHT/DAY (2 OF 2)	EPS	SPU A	S	Thruster	counts	Updated leaving eclipse only
6	4	60	8	0	7	16	BAT1PREB	BAT1PREB	BATT1 PRESSURE AT NIGHT/DAY (1 OF 2)	EPS	SPU B	S	Thruster	counts	Updated leaving eclipse only
6	4	61	8	0	7	16	BAT1PREB	BAT1PREB	BATT1 PRESSURE AT NIGHT/DAY (2 OF 2)	EPS	SPU B	S	Thruster	counts	Updated leaving eclipse only
8	6	56	8	0	7	8	BAT1PRES	BAT1PRES	-X BATT 1 CELL PRESSURE	EPS	BATT	AH	All Power-Up	counts	Updated leaving eclipse only
7	6	54	8	0	7	16	BAT1VLTA	BAT1VLTA	BATT1 VOLTAGE AT NIGHT/DAY (1 OF 2)	EPS	SPU A	S	Thruster	volts	
7	6	55	8	0	7	16	BAT1VLTA	BAT1VLTA	BATT1 VOLTAGE AT NIGHT/DAY (2 OF 2)	EPS	SPU A	S	Thruster	volts	
7	6	62	8	0	7	16	BAT1VLTB	BAT1VLTB	BATT1 VOLTAGE AT NIGHT/DAY (1 OF 2)	EPS	SPU B	S	Thruster	volts	
7	6	63	8	0	7	16	BAT1VLTB	BAT1VLTB	BATT1 VOLTAGE AT NIGHT/DAY (2 OF 2)	EPS	SPU B	S	Thruster	volts	
7	5	56	8	0	7	16	BAT1VOLT	BAT1VOLT	-X BATT 1 VOLTAGE	EPS	BATT	AH	All Power-Up	volts	
6	8	54	1	3	3	1	BAT1VTLA	BAT1VTLA	BATT 1 VT LOWER CMDS EXECUTED	TT&C	SPU A	S	Normal Thruster		0=Cmnds Not Executed 1=Cmnds Executed
6	8	62	1	3	3	1	BAT1VTLB	BAT1VTLB	BATT 1 VT LOWER CMDS EXECUTED	TT&C	SPU B	S	Normal Thruster		0=Cmnds Not Executed 1=Cmnds Executed
6	7	52	8	0	7	16	BAT2AHDA	BAT2AHDA	AHD BATT2 (1 OF 2)	EPS	SPU A	S	Normal Thruster	amp-hours	
6	7	53	8	0	7	16	BAT2AHDA	BAT2AHDA	AHD BATT2 (2 OF 2)	EPS	SPU A	S	Normal Thruster	amp-hours	
6	7	60	8	0	7	16	BAT2AHDB	BAT2AHDB	AHD BATT2 (1 OF 2)	EPS	SPU B	S	Normal Thruster	amp-hours	
6	7	61	8	0	7	16	BAT2AHDB	BAT2AHDB	AHD BATT2 (2 OF 2)	EPS	SPU B	S	Normal Thruster	amp-hours	
A	8	32	8	0	7	8	BAT2CUR	BAT2CUR	+X BATT 2 CURR	EPS	BATT	AH	All Power-Up	amps	
6	8	52	8	0	7	16	BAT2NDA	BAT2NDA	AHD AT NIGHT/DAY BATT2 (1 OF 2)	EPS	SPU A	S	Thruster	amp-hours	
6	8	53	8	0	7	16	BAT2NDA	BAT2NDA	AHD AT NIGHT/DAY BATT2 (2 OF 2)	EPS	SPU A	S	Thruster	amp-hours	
6	8	60	8	0	7	16	BAT2NDB	BAT2NDB	AHD AT NIGHT/DAY BATT2 (1 OF 2)	EPS	SPU B	S	Thruster	amp-hours	
6	8	61	8	0	7	16	BAT2NDB	BAT2NDB	AHD AT NIGHT/DAY BATT2 (2 OF 2)	EPS	SPU B	S	Thruster	amp-hours	
6	4	54	8	0	7	16	BAT2PREA	BAT2PREA	BATT2 PRESSURE AT NIGHT/DAY (1 OF 2)	EPS	SPU A	S	Thruster	counts	Updated leaving eclipse only
6	4	55	8	0	7	16	BAT2PREA	BAT2PREA	BATT2 PRESSURE AT NIGHT/DAY (2 OF 2)	EPS	SPU A	S	Thruster	counts	Updated leaving eclipse only
6	4	62	8	0	7	16	BAT2PREB	BAT2PREB	BATT2 PRESSURE AT NIGHT/DAY (1 OF 2)	EPS	SPU B	S	Thruster	counts	Updated leaving eclipse only
6	4	63	8	0	7	16	BAT2PREB	BAT2PREB	BATT2 PRESSURE AT NIGHT/DAY (2 OF 2)	EPS	SPU B	S	Thruster	counts	Updated leaving eclipse only
7	4	56	8	0	7	8	BAT2PRES	BAT2PRES	+X BATT 2 CELL PRESSURE	EPS	BATT	AH	All Power-Up	counts	Updated leaving eclipse only
7	7	52	8	0	7	16	BAT2VLTA	BAT2VLTA	BATT2 VOLTAGE AT NIGHT/DAY (1 OF 2)	EPS	SPU A	S	Thruster	volts	
7	7	53	8	0	7	16	BAT2VLTA	BAT2VLTA	BATT2 VOLTAGE AT NIGHT/DAY (2 OF 2)	EPS	SPU A	S	Thruster	volts	

7	7	60	8	0	7	16	BAT2VLTB	BAT2VLTB	BAT2VLTB	BATT2 VOLTAGE AT NIGHT/DAY (1 OF 2)	EPS	SPU B	S	Thruster	volts				
7	7	61	8	0	7	16	BAT2VLTB	BAT2VLTB	BATT2 VOLTAGE AT NIGHT/DAY (2 OF 2)		EPS	SPU B	S	Thruster	volts				
7	1	56	8	0	7	8	BAT2VOLT	BAT2VOLT	+X BATT 2 VOLTAGE EXECUTED		EPS	BATT	AH	All Power-Up	volts				
6	8	54	1	4	4	1	BAT2VTLA	BAT2VTLA	BATT 2 VT LOWER CMDS EXECUTED		TT&C	SPU A	S	Normal Thruster				0=Cmnds Not Executed	Power Flag Word
6	8	62	1	4	4	1	BAT2VTLB	BAT2VTLB	BATT 2 VT LOWER CMDS EXECUTED		TT&C	SPU B	S	Normal Thruster				1=Cmnds Not Executed	Power Flag Word
6	8	54	1	0	0	1	BC1CHGRA	BC1CHGRA	BCC 1 CHARGE RATE		TT&C	SPU A	S	Normal Thruster				0=Trickle Charge Rate	Power Flag Word
6	8	62	1	0	0	1	BC1CHGRB	BC1CHGRB	BCC 1 CHARGE RATE		TT&C	SPU B	S	Normal Thruster				1=High Charge Rate	Power Flag Word
A	2	10	1	3	3	1	BC1RATE	BC1RATE	BCC 1 CHARGE RATE TRICK/HIGH		EPS	PRU	DL	All Power-Up				1=Low Rate	
A	2	10	1	1	1	1	BC1VT	BC1VT	BCC 1 V/T ENABLED/DISABLED		EPS	PRU	DL	All Power-Up				0=High Rate	
A	2	10	1	4	4	1	BC1VT1	BC1VT1	BCC 1 V/T BIT 1 ON/OFF		EPS	PRU	DL	All Power-Up				1=Enabled	
A	2	10	1	5	5	1	BC1VT2	BC1VT2	BCC 1 V/T BIT 2 ON/OFF		EPS	PRU	DL	All Power-Up				0=Disabled	
A	2	10	1	6	6	1	BC1VTSF	BC1VTSF	BCC 1 SHFT V/T 16/17 CELL		EPS	PRU	DL	All Power-Up				1=On	
A	2	10	1	1	1	1	BC2CHGRA	BC2CHGRA	BCC 2 CHARGE RATE		TT&C	SPU A	S	Normal				0=Off	
6	8	54	1	1	1	1	BC2CHGRB	BC2CHGRB	BCC 2 CHARGE RATE		TT&C	SPU B	S	Normal				1=Normal (17-Cell)	Power Flag Word
6	8	62	1	1	1	1	BC2RATE	BC2RATE	BCC 2 CHARGE RATE TRICK/HIGH		EPS	PRU	DL	All Power-Up				0=Shifted (16-Cell)	
A	2	11	1	3	3	1	BC2VT	BC2VT	BCC 2 V/T ENABLED/DISABLED		EPS	PRU	DL	All Power-Up				0=Trickle Charge Rate	
A	2	11	1	4	4	1	BC2VT1	BC2VT1	BCC 2 V/T BIT 1 ON/OFF		EPS	PRU	DL	All Power-Up				1=High Charge Rate	
A	2	11	1	5	5	1	BC2VT2	BC2VT2	BCC 2 V/T BIT 2 ON/OFF		EPS	PRU	DL	All Power-Up				0=Trickle Charge Rate	
A	2	11	1	6	6	1	BC2VTSF	BC2VTSF	BCC 2 SHFT V/T 16/17 CELL		EPS	PRU	DL	All Power-Up				1=High Charge Rate	
6	8	54	1	2	2	1	BCBCHGRA	BCBCHGRA	BCC B/U CHARGE RATE		TT&C	SPU A	S	Normal				0=Trickle Charge Rate	Power Flag Word
6	8	62	1	2	2	1	BCBCHGRB	BCBCHGRB	BCC B/U CHARGE RATE		TT&C	SPU B	S	Normal				0=Trickle Charge Rate	
A	2	64	1	5	5	1	BCBUBAT1	BCBUBAT1	BCC B/U CHARGE ON/BCC1 OFF		EPS	PRU	DL	All Power-Up				1=B/U BCC Off Batt 1	
A	2	64	1	6	6	1	BCBUBAT2	BCBUBAT2	BCC B/U CHARGE ON/BCC2 OFF		EPS	PRU	DL	All Power-Up				0=B/U BCC On Batt 1	
A	2	64	1	1	1	1	BCBURATE	BCBURATE	BCC B/U CHARGE RATE TRICK/HIGH		EPS	PRU	DL	All Power-Up				1=B/U BCC Off Batt 2	
A	2	64	1	0	0	1	BCBUVT	BCBUVT	BCC B/U V/T ENABLED/DISABLED		EPS	PRU	DL	All Power-Up				1=Low	
A	2	64	1	2	2	1	BCBUVT1	BCBUVT1	BCC B/U V/T BIT 1 ON/OFF		EPS	PRU	DL	All Power-Up				0=High	
A	2	64	1	3	3	1	BCBUVT2	BCBUVT2	BCC B/U V/T BIT 2 ON/OFF		EPS	PRU	DL	All Power-Up				1=Enable	
A	2	64	1	4	4	1	BCBUVTSF	BCBUVTSF	BCC B/U SHFT V/T 16/17 CELL		EPS	PRU	DL	All Power-Up				0=Disable	
A	2	10	1	2	2	1	BCC1	BCC1	BCC 1 CHARGER ON/OFF		EPS	PRU	DL	All Power-Up				1=On	

A	2	11	1	2	2	1	BCC2	BCC2	BCC2	BCC 2 CHARGER ON/OFF	EPS	PRU	DL	All Power-Up	volts	1=On 0=Off	SSOH Byte
6	4	24	8	0	7	8	BC+12V	BC+12V	BCC2	BDD/BDX +12V ANALOG MONITOR	NDS	BDD/X	S	All Power-Up	volts	1=On	SSOH Byte 3422
6	4	24	8	0	7	8	BD+250V	BDP250V	BCC2	BDD/BDX +25V ANALOG MONITOR	NDS	BDD/X	S	All Power-Up	volts	0=Off	SSOH Byte 3425
2	6	24	8	0	7	8	BD+28C	BDP28C	BCC2	BDD/BDX +28V CURRENT	NDS	BDD/X	S	All Power-Up	mA	1=On	SSOH Byte 3395
5	7	24	8	0	7	8	BD+5V	BDP5V	BCC2	BDD/BDX +5V LOGIC VOLTAGE	NDS	BDD/X	S	All Power-Up	volts	1=On	SSOH Byte 3420
6	2	24	8	0	7	8	BD-12V	BDM12V	BCC2	BDD/BDX -12V ANALOG MONITOR	NDS	BDD/X	S	All Power-Up	volts	1=On	SSOH Byte 3423
5	8	24	8	0	7	8	BD-5V	BDM5V	BCC2	BDD/BDX -5V LOGIC VOLTAGE	NDS	BDD/X	S	All Power-Up	volts	1=On	SSOH Byte 3421
6	5	24	8	0	7	8	BD2T	BD2T	BCC2	BDD/BDX TEMP 1	NDS	BDD/X	S	All Power-Up	Celsius	1=On	SSOH Byte 3426
6	6	24	8	0	7	8	BD2T	BD2T	BCC2	BDD/BDX TEMP 2	NDS	BDD/X	S	All Power-Up	Celsius	1=On	SSOH Byte 3427
NA	NA	NA	NA	0	NA	16	BDATAEND	BDATAEND	BCC2	SEC B.16 DATAENDADDR	NDS	BDD/BDX	S	All Power-Up	volts	1=On	SSOH Byte 3424
6	3	24	8	0	7	8	BBV	BBV	BCC2	BDD/BDX BIAS VOLTAGE	NDS	BDD/MP	S	SSOH		1=On	87
NA	NA	NA	NA	0	NA	8	BDCMDR	BDCMDR	BCC2	COMMAND ERROR COUNT	NDS	BDD/X	S	All Power-Up	volts	1=On	256
NA	NA	NA	NA	1	NA	1	BDCONER	BDCONER	BCC2	IP BDX/D GIM CNTRL FLG	NDS	BDD/MP	S	SSOH		1=On	145
A	1	64	1	1	1	1	BDDATA	BDDATA	BCC2	BDP BDD/BDX DATA I/O	NDS	BDD/X	S	All Power-Up		0=Output 1=Input	SSOH Byte 31 L3 Format
NA	NA	NA	NA	2	NA	2	BDDINTVL	BDDINTVL	BCC2	BDD COLLECT INTERVAL	NDS	BDD/MP	S	SSOH		1=On	3001
NA	NA	NA	NA	5	NA	1	BDDLTHR	BDDLTHR	BCC2	BDD LOW THRESHOLD	NDS	BDD/MP	S	SSOH		1=On	3001
NA	NA	NA	NA	4	NA	1	BDDMOVRT	BDDMOVRT	BCC2	DISABDD MEMOVERWRIT	NDS	BDD/MP	S	SSOH		1=On	3013
NA	NA	NA	NA	7	NA	1	BDDSUBFR	BDDSUBFR	BCC2	SELECT BDD SUB FRAME	NDS	BDD/MP	S	SSOH		1=On	3001
NA	NA	NA	NA	5	NA	1	BDEOMER	BDEOMER	BCC2	BDX/D EOM ERROR FLAG	NDS	BDD/MP	S	SSOH		1=On	158
NA	NA	NA	NA	6	NA	1	BDGIMAC	BDGIMAC	BCC2	GIM RESET ACKNOW-BDX/D	NDS	BDD/MP	S	SSOH		1=On	169
NA	NA	NA	NA	0	NA	1	BDGIMPAR	BDGIMPAR	BCC2	BDX/D GIM PARITY	NDS	BDD/MP	S	SSOH		1=On	260
NA	NA	NA	NA	1	NA	1	BDGIMPEN	BDGIMPEN	BCC2	BDX/D GIM PARITY ENABLE	NDS	BDD/MP	S	SSOH		1=On	260
NA	NA	NA	NA	5	NA	1	BDGIMRQ	BDGIMRQ	BCC2	GIM RESET REQUEST-BDX/D	NDS	BDD/MP	S	SSOH		1=On	169
NA	NA	NA	NA	0	NA	8	BDNOERR	BDNOERR	BCC2	NO OPERATION ERR CNT	NDS	BDD/MP	S	SSOH		1=On	257
1	7	24	8	0	7	8	BDP+15V	BDP15V	BCC2	BDP +15V ANALOG MONITOR	NDS	BDD/MP	S	All Power-Up	volts	1=On	SSOH Byte 3388
1	6	24	8	0	7	8	BDP+5V	BDP5V	BCC2	BDP +5V LOGIC VOLTAGE	NDS	BDD/MP	S	All Power-Up	volts	1=On	SSOH Byte 3387
1	1	24	8	0	7	8	BDP+5VR	BDP5VR	BCC2	BDP +5V REGULATED	NDS	BDD/MP	S	All Power-Up	volts	1=On	SSOH Byte 3382
1	4	24	8	0	7	8	BDP-15V	BDP15V	BCC2	BDP -15V ANALOG MONITOR	NDS	BDD/MP	S	All Power-Up	volts	1=On	SSOH Byte 3385
1	5	24	8	0	7	8	BDP-5V	BDP5V	BCC2	BDP -5V LOGIC VOLTAGE	NDS	BDD/MP	S	All Power-Up	volts	1=On	SSOH Byte 3386
A	3	16	1	0	0	1	BDPAPWR	BDPAPWR	BCC2	BDP A 28 VDC ON/OFF	NDS	BDD/MP	S	All Power-Up		1=On 0=Off	
A	4	16	1	0	0	1	BDPBPWR	BDPBPWR	BCC2	BDP B 28 VDC ON/OFF	NDS	BDD/MP	S	All Power-Up		1=On 0=Off	
2	2	24	8	0	7	8	BDPEXSNS	BDPEXSNS	BCC2	BDP EXTRA SENSOR POWER	NDS	BDD/MP	S	All Power-Up	volts	1=On	SSOH Byte 3391
2	1	24	8	0	7	8	BDPFGND	BDPFGND	BCC2	BDP GROUND	NDS	BDD/MP	S	All Power-Up	volts	1=On	SSOH Byte 3390
4	7	58	8	0	7	8	BDPIFT	BDPIFT	BCC2	-X BUS PNL/GBD(BDP) I/F TEMP A	MSS	TCS	AP	All Power-Up	Celsius	1=On	
1	8	24	8	0	7	8	BDPIPPV	BDPIPPV	BCC2	BDP IP PROGRAMMING VOLTAGE	NDS	BDD/MP	S	All Power-Up	volts	1=On	SSOH Byte 3389
NA	NA	NA	NA	5	NA	1	BDPL3EVT	BDPL3EVT	BCC2	BDP L3 EVINITXFERFLG	NDS	BDD/MP	S	SSOH		1=On	2972
NA	NA	NA	NA	0	NA	1	BDPL3MRO	BDPL3MRO	BCC2	START L3 MRO	NDS	BDD/MP	S	SSOH		1=On	3014
A	1	64	1	7	7	1	BDPL3XFR	BDPL3XFR	BCC2	BDP TO L3 DATA XFER IN PROGRESS	NDS	BDD/MP	S	All Power-Up		0=Off 1=On	SSOH Byte 31 L3 Format
NA	NA	NA	NA	2	NA	1	BDPLNK	BDPLNK	BCC2	BDX/D LAST EV MSG XFER	NDS	BDD/MP	S	SSOH		1=On	165
2	3	24	8	0	7	8	BDPMPFV	BDPMPFV	BCC2	BDP MP PROGRAMMING VOLTAGE	NDS	BDD/MP	S	All Power-Up	volts	1=On	SSOH Byte 3392
NA	NA	NA	NA	7	NA	1	BDPOWER	BDPOWER	BCC2	BDX/D POWER	NDS	BDD/MP	S	SSOH		1=On	6
NA	NA	NA	NA	0	NA	1	BDPWR	BDPWR	BCC2	BDP POWER	NDS	BDD/MP	S	SSOH		1=On	6
NA	NA	NA	NA	7	NA	1	BDPROIN	BDPROIN	BCC2	RECENT PROC INIT-BDX/D	NDS	BDD/MP	S	SSOH		1=On	169
1	3	24	8	0	7	8	BDPSA28V	BDPSA28V	BCC2	BDP/BDX POWER SUPPLY A VDC	NDS	BDD/MP	S	All Power-Up	volts	1=On	SSOH Byte 3384
1	2	24	8	0	7	8	BDPSB28V	BDPSB28V	BCC2	BDP/BDX POWER SUPPLY B VDC	NDS	BDD/MP	S	All Power-Up	volts	1=On	SSOH Byte 3383
2	4	24	8	0	7	8	BDPT	BDPT	BCC2	BDP TEMP	NDS	BDD/MP	S	All Power-Up	Celsius	1=On	SSOH Byte 3393
NA	NA	NA	NA	5	NA	1	BDQPLNK	BDQPLNK	BCC2	BDX/D PLINK EV XFERFLG	NDS	BDD/MP	S	SSOH		1=On	166
NA	NA	NA	NA	5	NA	1	BDRECER	BDRECER	BCC2	IP BDX/D GIM ERROR FLG	NDS	BDD/MP	S	SSOH		1=On	145
NA	NA	NA	NA	0	NA	8	BDSDERR	BDSDERR	BCC2	SERIAL DATA ERR CNT	NDS	BDD/MP	S	SSOH		1=On	255
NA	NA	NA	NA	6	NA	1	BDSELECT	BDSELECT	BCC2	BDX/D POWER SELECT	NDS	BDD/MP	S	SSOH		1=On	6

NA	NA	NA	NA	5	NA	1	BDSSENSOR	BDXD/INDICATOR	NDS	BDD/X	S	SSOH	6
NA	NA	NA	NA	4	NA	4	BDSHRCV	BDXD/ SOH RECEIVAL CNT	NDS	BDD-IP	S	SSOH	149
7	1	24	8	0	7	8	BDW+12V	BDW +12V ANALOG MONITOR	NDS	BDW	S	All Power-Up	SSOH Byte 3430
6	8	24	8	0	7	8	BDW+5V	BDW +5V LOGIC VOLTAGE	NDS	BDW	S	All Power-Up	SSOH Byte 3428
NA	NA	NA	NA	2	NA	1	BDW-5.2V	BDW -5.2V ANALOG MONITOR	NDS	BDW	S	All Power-Up	SSOH Byte 3429
NA	NA	NA	NA	2	NA	1	BDWADAEX	ADA EXCEPTION-BDW	NDS	BDD-IP	S	SSOH	170
A	3	16	1	4	4	1	BDWAPWR	BDW A 28 VDC ON/OFF	NDS	BDW	S	All Power-Up	1=On 0=Off
NA	NA	NA	NA	0	NA	1	BDWARIER	1705A ARITH ERR-BDW	NDS	BDD-IP	S	SSOH	170
7	4	24	8	0	7	8	BDWAUXBT	BDW AUX BOARD TEMP	NDS	BDW	S	All Power-Up	SSOH Byte 3433
A	4	16	1	4	4	1	BDWBPWR	BDW B 28 VDC ON/OFF	NDS	BDW	S	All Power-Up	1=On 0=Off
7	6	24	8	0	7	8	BDWCHAST	BDW CHASSIS TEMP	NDS	BDW	S	All Power-Up	
NA	NA	NA	NA	2	NA	1	BDWCONER	IP BDW GIM CNTRL FLG	NDS	BDD-IP	S	SSOH	SSOH Byte 3435
NA	NA	NA	NA	6	NA	1	BDWCVCFG	BDW CONF/ELECSTAT	NDS	BDW	S	SSOH	145
A	1	64	1	2	2	1	BDWDATA	BDP BDW DATA I/O	NDS	BDW	S	All Power-Up	O=Output 1=Input
NA	NA	NA	NA	5	NA	1	BDWDIAG	DIAG SUCCESSFUL-BDW	NDS	BDD-IP	S	SSOH	171
7	5	24	8	0	7	8	BDWDIGBT	BDW DIGITAL BOARD TEMP	NDS	BDW	S	All Power-Up	SSOH Byte 3434
NA	NA	NA	NA	6	NA	1	BDWDSST	DISCRETE ST	NDS	BDP	S	SSOH	3065
NA	NA	NA	NA	0	NA	1	BDWDUMP	LONG MEMORY DUMP	NDS	BDP	S	SSOH	3061
NA	NA	NA	NA	4	NA	1	BDWEEEXR	EEPROMXERSUCCESS-BDW	NDS	BDD-IP	S	SSOH	171
NA	NA	NA	NA	6	NA	1	BDWEOMER	BDW EOM ERROR FLAG	NDS	BDD-IP	S	SSOH	158
NA	NA	NA	NA	2	NA	1	BDWFUNC	DISABLE BDW FUNCTION	NDS	BDP	S	SSOH	3010
NA	NA	NA	NA	5	NA	1	BDWGIMRQ	GIM RESET REQUEST-BDW	NDS	BDD-IP	S	SSOH	170
NA	NA	NA	NA	3	NA	5	BDWHACER	HARD ASIC CMD ERROR	NDS	BDD-IP	S	SSOH	172
NA	NA	NA	NA	1	NA	1	BDWHBCFC	HI BAND FREQCAL FAIL	NDS	BDD-IP	S	SSOH	173
NA	NA	NA	NA	3	NA	1	BDWHBDC	HI BAND DELAYCAL FAIL	NDS	BDD-IP	S	SSOH	173
NA	NA	NA	NA	7	NA	1	BDWHBGC	HIGH BAND GAINCAL FAIL	NDS	BDD-IP	S	SSOH	173
NA	NA	NA	NA	5	NA	1	BDWHBTC	HI BAND THRESHCAL FAIL	NDS	BDD-IP	S	SSOH	173
NA	NA	NA	NA	4	NA	1	BDWHEEPR	HARD EEPROM FAIL-BDW	NDS	BDD-IP	S	SSOH	170
NA	NA	NA	NA	0	NA	1	BDWHFTUN	HIF TUNE CAL FAIL	NDS	BDD-IP	S	SSOH	172
NA	NA	NA	NA	1	NA	1	BDWHMER	HARD MEMORY ERR-BDW	NDS	BDD-IP	S	SSOH	171
3	6	58	8	0	7	8	BDWIFT	-X BUS PNL/GBD(BDW) I/F TEMP B	MSS	TCS	AP	All Power-Up	
NA	NA	NA	NA	3	NA	1	BDWINIT	BDW PROCESSOR INIT	NDS	BDP	S	SSOH	3009
NA	NA	NA	NA	0	NA	1	BDWLBCFC	LO BAND FREQCAL FAIL	NDS	BDD-IP	S	SSOH	173
NA	NA	NA	NA	7	NA	1	BDWLBCV	BDW LO BAND STAT	NDS	BDW	S	SSOH	7
NA	NA	NA	NA	2	NA	1	BDWLBDG	LO BAND DELAYCAL FAIL	NDS	BDD-IP	S	SSOH	173
NA	NA	NA	NA	6	NA	1	BDWLBCG	LOW BAND GAINCAL FAIL	NDS	BDD-IP	S	SSOH	173
NA	NA	NA	NA	4	NA	1	BDWLBTC	LO BAND THRESHCAL FAIL	NDS	BDD-IP	S	SSOH	173
NA	NA	NA	NA	6	NA	1	BDWMRO	DISABLE BDW MRO MSG	NDS	BDP	S	SSOH	3064
NA	NA	NA	NA	5	NA	1	BDWPAR	BDW PARITY ENABLE	NDS	BDD-IP	S	SSOH	147
NA	NA	NA	NA	1	NA	1	BDWPARER	MEMORY PARITY ERR-BDW	NDS	BDD-IP	S	SSOH	170
NA	NA	NA	NA	4	NA	1	BDWPAROE	BDW ODD/EVEN PARITY	NDS	BDD-IP	S	SSOH	147
NA	NA	NA	NA	7	NA	1	BDWPROE	RESET BDW PROCESSOR	NDS	BDP	S	SSOH	3066
NA	NA	NA	NA	6	NA	1	BDWPRSTR	PROCESSOR RESTART-BDW	NDS	BDD-IP	S	SSOH	171
NA	NA	NA	NA	6	NA	1	BDWRECER	IP BDW GIM ERROR FLG	NDS	BDD-IP	S	SSOH	145
7	2	24	8	0	7	8	BDWRFHBT	BDW RF HIGH BAND TEMP	NDS	BDW	S	All Power-Up	SSOH Byte 3431
7	3	24	8	0	7	8	BDWRFLLT	BDW RF LOW BAND TEMP	NDS	BDW	S	All Power-Up	SSOH Byte 3432
NA	NA	NA	NA	6	NA	1	BDWRSTAC	USART RESET ACKNW-BDW	NDS	BDD-IP	S	SSOH	170
NA	NA	NA	NA	3	NA	1	BDWSACMD	SOFTASIC CMD FAIL-BDW	NDS	BDD-IP	S	SSOH	171
NA	NA	NA	NA	3	NA	1	BDWSEEP	SOFT EEPROM FAIL-BDW	NDS	BDD-IP	S	SSOH	170
NA	NA	NA	NA	0	NA	4	BDWSHRCV	BDW SOH RECEIVAL CNT	NDS	BDD-IP	S	SSOH	150
NA	NA	NA	NA	5	NA	1	BDWSLCT	BDW ELEC STATUS	NDS	BDW	S	SSOH	7
NA	NA	NA	NA	2	NA	1	BDWSMER	SOFT MEMORY ERR-BDW	NDS	BDD-IP	S	SSOH	171
NA	NA	NA	NA	4	NA	1	BDWSMSG	DISABLE BDW STAT MSG	NDS	BDP	S	SSOH	3064
NA	NA	NA	NA	5	NA	1	BDWSOH	DISABLE BDW SOH MSG	NDS	BDP	S	SSOH	3064



NA	NA	NA	NA	6	NA	1	BDYGMCK	BDYGMCK	ENBLBDY GIM ERCHKING	NDS	BDP	S	SSOH	2972
NA	NA	NA	NA	2	NA	1	BDYGMFAR	BDYGMFAR	BDY CHAN GIM PARITY	NDS	BDP	S	SSOH	2972
NA	NA	NA	NA	1	NA	1	BDYGMRST	BDYGMRST	BDY CHAN GIM RESET	NDS	BDP	S	SSOH	2972
3	8	24	8	0	7	8	BDYGN	BDYGN	BDY GROUND	NDS	BDY	S	All Power-Up	SSOH Byte 3405
NA	NA	NA	NA	0	NA	1	BDYINIT	BDYINIT	BDY PROCESSOR INIT	NDS	BDP	S	SSOH	3009
NA	NA	NA	NA	1	NA	1	BDYITYPE	BDYITYPE	BDY PROCESSOR INIT SEL	NDS	BDP	S	SSOH	3009
NA	NA	NA	NA	4	NA	1	BDYL3TOC	BDYL3TOC	L3 TURNONCONDIMET-BDY	NDS	BDP-IP	S	SSOH	168
NA	NA	NA	NA	5	NA	1	BDYMRO	BDYMRO	DISABLE BDY MRO	NDS	BDP	S	SSOH	2971
NA	NA	NA	NA	0	NA	8	BDYNOERR	BDYNOERR	NO OPERATION ERR CNT	NDS	BDY	S	SSOH	253
NA	NA	NA	NA	1	NA	1	BDYPAR	BDYPAR	BDY PARITY ENABLE	NDS	BDP-IP	S	SSOH	147
NA	NA	NA	NA	0	NA	1	BDYPAROE	BDYPAROE	BDY ODD/EVEN PARITY	NDS	BDP-IP	S	SSOH	147
NA	NA	NA	NA	2	NA	1	BDYPINL3	BDYPINL3	BDY-P INTERNAL L3FLG	NDS	BDY	S	SSOH	215
NA	NA	NA	NA	7	NA	1	BDYPROIN	BDYPROIN	RECENT PROC INIT-BDY	NDS	BDP-IP	S	SSOH	168
NA	NA	NA	NA	0	NA	1	BDYPRW	BDYPRW	BDY POWER	NDS	BDY	S	SSOH	7
2	8	24	8	0	7	8	BDYPSA28	BDYPSA28	BDY POWER SUPPLY A 28VDC	NDS	BDY	S	All Power-Up	SSOH Byte 3397
3	7	24	8	0	7	8	BDYPSB28	BDYPSB28	BDY POWER SUPPLY B28VDC	NDS	BDY	S	All Power-Up	SSOH Byte 3396
3	7	24	8	0	7	8	BDYPV	BDYPV	BDY PROGRAMMING VOLTAGE	NDS	BDY	S	All Power-Up	SSOH Byte 3404
NA	NA	NA	NA	2	NA	1	BDYRASWP	BDYRASWP	BDY RAM SWAP	NDS	BDP	S	SSOH	7
NA	NA	NA	NA	4	NA	1	BDYRECER	BDYRECER	IP BDY GIM ERROR FLG	NDS	BDP-IP	S	SSOH	145
NA	NA	NA	NA	1	NA	1	BDYROSWP	BDYROSWP	BDY ROM SWAP	NDS	BDY	S	SSOH	7
NA	NA	NA	NA	1	NA	1	BDYRPRGC	BDYRPRGC	REPROG COMPLETE-BDY	NDS	BDP-IP	S	SSOH	168
NA	NA	NA	NA	2	NA	1	BDYRPRGS	BDYRPRGS	REPROG START-BDY	NDS	BDP-IP	S	SSOH	168
NA	NA	NA	NA	0	NA	8	BDYSDERR	BDYSDERR	SERIAL DATA ERR CNT	NDS	BDY	S	SSOH	251
NA	NA	NA	NA	0	NA	4	BDYSHRCV	BDYSHRCV	BDY SOH RECEIVAL CNT	NDS	BDP-IP	S	SSOH	149
NA	NA	NA	NA	6	NA	1	BDYSOH	BDYSOH	DISABLE BDY SOH	NDS	BDP	S	SSOH	2971
NA	NA	NA	NA	7	NA	1	BDYSOHSD	BDYSOHSD	SEND BDY SOH	NDS	BDP	S	SSOH	2972
NA	NA	NA	NA	7	NA	1	BDYSTAT	BDYSTAT	DISABLE BDY STAT MSG	NDS	BDP	S	SSOH	2971
NA	NA	NA	NA	5	NA	1	BDYSTST	BDYSTST	ENABLE BDY SYS TEST	NDS	BDP	S	SSOH	2984
4	8	24	8	0	7	8	BDYT	BDYT	BDY TEMP	NDS	BDY	S	All Power-Up	SSOH Byte 3413
NA	NA	NA	NA	5	NA	1	BDYUPLD	BDYUPLD	UPLOAD BDY	NDS	BDP	S	SSOH	2993
NA	NA	NA	NA	1	NA	1	BDYUPLN	BDYUPLN	ENABLE BDY UPLD	NDS	BDP	S	SSOH	2992
NA	NA	NA	NA	0	NA	5	BDYDCKP	BDYDCKP	BDY YD SKIP COUNT	NDS	BDP-IP	S	SSOH	151
NA	NA	NA	NA	5	NA	11	BDYFCKP	BDYFCKP	BDY YF SKIPCNT:HIBYT	NDS	BDP-IP	S	SSOH	151
7	5	54	8	0	7	16	BETAA	BETAA	BETA ANGLE (1 OF 2)	ADS	SPU A	S	Normal	radians
7	5	55	8	0	7	16	BETAA	BETAA	BETA ANGLE (2 OF 2)	ADS	SPU A	S	Normal	radians
6	6	52	8	0	7	16	BETAA	BETAA	BETA ANGLE (1 OF 2)	ADS	SPU A	S	Thruster	radians
6	6	53	8	0	7	16	BETAA	BETAA	BETA ANGLE (2 OF 2)	ADS	SPU A	S	Thruster	radians
7	5	62	8	0	7	16	BETAB	BETAB	BETA ANGLE (1 OF 2)	ADS	SPU B	S	Normal	radians
7	5	63	8	0	7	16	BETAB	BETAB	BETA ANGLE (2 OF 2)	ADS	SPU B	S	Normal	radians
6	6	60	8	0	7	16	BETAB	BETAB	BETA ANGLE (1 OF 2)	ADS	SPU B	S	Thruster	radians
6	6	61	8	0	7	16	BETAB	BETAB	BETA ANGLE (2 OF 2)	ADS	SPU B	S	Thruster	radians
A	1	52	2	6	7	26	BITCNTRA	BITCNTRA	26 BIT COUNTER	TT&C	SPU A	S	Early Orbit	ATTOMAN Record Word (first word)
A	1	53	8	0	7	26	BITCNTRA	BITCNTRA	26 BIT COUNTER	TT&C	SPU A	S	Early Orbit	ATTOMAN Record Word (second word)
A	1	54	8	0	7	26	BITCNTRA	BITCNTRA	26 BIT COUNTER	TT&C	SPU A	S	Early Orbit	ATTOMAN Record Word (third word)
A	1	55	8	0	7	26	BITCNTRA	BITCNTRA	26 BIT COUNTER	TT&C	SPU A	S	Early Orbit	ATTOMAN Record Word (fourth word)
A	3	52	2	6	7	26	BITCNTRA	BITCNTRA	26 BIT COUNTER	TT&C	SPU A	S	Early Orbit	ATTOMAN Record Word (first word)
A	5	52	2	6	7	26	BITCNTRA	BITCNTRA	26 BIT COUNTER	TT&C	SPU A	S	Early Orbit	ATTOMAN Record Word (first word)
A	7	52	2	6	7	26	BITCNTRA	BITCNTRA	26 BIT COUNTER	TT&C	SPU A	S	Early Orbit	ATTOMAN Record Word (first word)
A	3	53	8	0	7	26	BITCNTRA	BITCNTRA	26 BIT COUNTER	TT&C	SPU A	S	Early Orbit	ATTOMAN Record Word (second word)

A 5	53	8	0	7	26	BITCNTRA	BITCNTRA	BITCNTRA	26 BIT COUNTER	TT&C	SPU A	S	Early Orbit	µsec	ATTOMAN Record Word (second word)
A 7	53	8	0	7	26	BITCNTRA	BITCNTRA	BITCNTRA	26 BIT COUNTER	TT&C	SPU A	S	Early Orbit	µsec	ATTOMAN Record Word (second word)
A 3	54	8	0	7	26	BITCNTRA	BITCNTRA	BITCNTRA	26 BIT COUNTER	TT&C	SPU A	S	Early Orbit	µsec	ATTOMAN Record Word (third word)
A 5	54	8	0	7	26	BITCNTRA	BITCNTRA	BITCNTRA	26 BIT COUNTER	TT&C	SPU A	S	Early Orbit	µsec	ATTOMAN Record Word (third word)
A 7	54	8	0	7	26	BITCNTRA	BITCNTRA	BITCNTRA	26 BIT COUNTER	TT&C	SPU A	S	Early Orbit	µsec	ATTOMAN Record Word (third word)
A 3	55	8	0	7	26	BITCNTRA	BITCNTRA	BITCNTRA	26 BIT COUNTER	TT&C	SPU A	S	Early Orbit	µsec	ATTOMAN Record Word (fourth word)
A 5	55	8	0	7	26	BITCNTRA	BITCNTRA	BITCNTRA	26 BIT COUNTER	TT&C	SPU A	S	Early Orbit	µsec	ATTOMAN Record Word (fourth word)
A 7	55	8	0	7	26	BITCNTRA	BITCNTRA	BITCNTRA	26 BIT COUNTER	TT&C	SPU A	S	Early Orbit	µsec	ATTOMAN Record Word (fourth word)
A 1	60	2	6	7	26	BITCNTRB	BITCNTRB	BITCNTRB	26 BIT COUNTER	TT&C	SPU B	S	Early Orbit	µsec	ATTOMAN Record Word (first word)
A 1	61	8	0	7	26	BITCNTRB	BITCNTRB	BITCNTRB	26 BIT COUNTER	TT&C	SPU B	S	Early Orbit	µsec	ATTOMAN Record Word (second word)
A 1	62	8	0	7	26	BITCNTRB	BITCNTRB	BITCNTRB	26 BIT COUNTER	TT&C	SPU B	S	Early Orbit	µsec	ATTOMAN Record Word (third word)
A 1	63	8	0	7	26	BITCNTRB	BITCNTRB	BITCNTRB	26 BIT COUNTER	TT&C	SPU B	S	Early Orbit	µsec	ATTOMAN Record Word (third word)
A 3	60	2	6	7	26	BITCNTRB	BITCNTRB	BITCNTRB	26 BIT COUNTER	TT&C	SPU B	S	Early Orbit	µsec	ATTOMAN Record Word (fourth word)
A 5	60	2	6	7	26	BITCNTRB	BITCNTRB	BITCNTRB	26 BIT COUNTER	TT&C	SPU B	S	Early Orbit	µsec	ATTOMAN Record Word (first word)
A 7	60	2	6	7	26	BITCNTRB	BITCNTRB	BITCNTRB	26 BIT COUNTER	TT&C	SPU B	S	Early Orbit	µsec	ATTOMAN Record Word (first word)
A 3	61	8	0	7	26	BITCNTRB	BITCNTRB	BITCNTRB	26 BIT COUNTER	TT&C	SPU B	S	Early Orbit	µsec	ATTOMAN Record Word (second word)
A 5	61	8	0	7	26	BITCNTRB	BITCNTRB	BITCNTRB	26 BIT COUNTER	TT&C	SPU B	S	Early Orbit	µsec	ATTOMAN Record Word (second word)
A 7	61	8	0	7	26	BITCNTRB	BITCNTRB	BITCNTRB	26 BIT COUNTER	TT&C	SPU B	S	Early Orbit	µsec	ATTOMAN Record Word (second word)
A 3	62	8	0	7	26	BITCNTRB	BITCNTRB	BITCNTRB	26 BIT COUNTER	TT&C	SPU B	S	Early Orbit	µsec	ATTOMAN Record Word (third word)
A 5	62	8	0	7	26	BITCNTRB	BITCNTRB	BITCNTRB	26 BIT COUNTER	TT&C	SPU B	S	Early Orbit	µsec	ATTOMAN Record Word (third word)
A 7	62	8	0	7	26	BITCNTRB	BITCNTRB	BITCNTRB	26 BIT COUNTER	TT&C	SPU B	S	Early Orbit	µsec	ATTOMAN Record Word (third word)
A 3	63	8	0	7	26	BITCNTRB	BITCNTRB	BITCNTRB	26 BIT COUNTER	TT&C	SPU B	S	Early Orbit	µsec	ATTOMAN Record Word (fourth word)
A 5	63	8	0	7	26	BITCNTRB	BITCNTRB	BITCNTRB	26 BIT COUNTER	TT&C	SPU B	S	Early Orbit	µsec	ATTOMAN Record Word (fourth word)
A 7	63	8	0	7	26	BITCNTRB	BITCNTRB	BITCNTRB	26 BIT COUNTER	TT&C	SPU B	S	Early Orbit	µsec	ATTOMAN Record Word (fourth word)
A 7	11	1	0	0	1	BMEOKB1	BMEOKB1	BMEOKB1	SPU B MEOK BIT 1	TT&C	SPU	DL	All Power-Up	µsec	1=CPU A Not OK 0=CPU A OK
A 7	11	1	1	1	1	BMEOKB2	BMEOKB2	BMEOKB2	SPU B MEOK BIT 2	TT&C	SPU	DL	All Power-Up	µsec	1=CPU A Not OK 0=CPU A OK
A 1	41	1	1	1	1	BMINRM	BMINRM	BMINRM	MDU CONV A TO BMI A (AND B TO B) NORM	TNP	MDU	DL	All Power-Up		1=Normal 0=Xstrap
A 1	42	1	1	1	1	BMIKST	BMIKST	BMIKST	MDU CONV B TO BMI A (AND A TO B) XSTRAP	TNP	MDU	DL	All Power-Up		1=Xstrap 0=Normal
8	2	56	8	0	7	8	BUSVOLT	BUSVOLT	SV BUS VOLTAGE (AT PRU)	EPS	PRU	AH	All Power-Up	volts	

8	1	58	8	0	7	8	CAFSIFT	CAFSIFT	-X PAYLOAD PNI/CAFS I/F TEMP B	MSS	TCS	AP	All Power-Up	Celsius	
NA	NA	NA	NA	7	NA	1	CALFALSM	CALFALSM	CAL FAILED REPORTS	NDS	BDP	S	SSOH		3062
NA	NA	NA	NA	5	NA	3	CARESPWR	CARESPWR	C-BAND ARIES PWR SETTIN	NDS	BDP	S	SSOH		2978
NA	NA	NA	NA	4	NA	1	CBDPDATA	CBDPDATA	DISABLE BDP DATA C-BAND	NDS	BDP	S	SSOH		2979
NA	NA	NA	NA	5	NA	1	CBWDATA	CBWDATA	DISABLE BDW DATA C-BAND	NDS	BDP	S	SSOH		2978
NA	NA	NA	NA	4	NA	1	CBNDATES	CBNDATES	ENABLE ARIES POWER	NDS	BDP	S	SSOH		2977
NA	NA	NA	NA	7	NA	1	CBNDHPA	CBNDHPA	HPA SELECT A/B	NDS	BDP	S	SSOH		2978
NA	NA	NA	NA	0	NA	1	CBNDNDM	CBNDNDM	ENABLE NDM POWER	NDS	BDP	S	SSOH		2978
NA	NA	NA	NA	0	NA	1	CBNDXMTR	CBNDXMTR	ENABLE C-BAND XMIT PWR	NDS	BDP	S	SSOH		2977
NA	NA	NA	NA	0	NA	16	CDATAEND	CDATAEND	SEC C,16 DATAENDADDR	NDS	BDP-MP	S	SSOH		89
1	1	56	8	0	7	8	CDUACV5V	CDUACV5V	CDU A CONV +5VDC OUT	TT&C	CDU	AH	All Power-Up	volts	
3	8	58	8	0	7	8	CDUACVT	CDUACVT	CDU A CONV TEMP	TT&C	CDU	AP	All Power-Up	Celsius	
A	7	16	1	1	1	1	CDUAPWR	CDUAPWR	CDU A CONFIGURE PWR	TT&C	CDU	S	All Power-Up	1=Enabled 0=Disabled	Local mnemonic = APWR
4	2	56	8	0	7	8	CDUBCV5V	CDUBCV5V	CDU B CONV +5VDC OUT	TT&C	CDU	AH	All Power-Up	volts	
4	2	58	8	0	7	8	CDUBCVT	CDUBCVT	CDU B CONV TEMP	TT&C	CDU	AP	All Power-Up	Celsius	
A	7	16	1	5	5	1	CDUBPWR	CDUBPWR	CDU B CONFIGURE PWR	TT&C	CDU	S	All Power-Up	1=Enabled 0=Disabled	Local mnemonic = BPWR
A	A	8	7	1	7	7	CDUCMDCT	CDUCMDCT	CDU COMMAND COUNT	TT&C	CDU	S	All Power-Up		Binary equivalent of decimal values 0 to 127
A	8	34	8	0	7	8	CDUCUR	CDUCUR	BUS CURR TO CDU	EPS	PRU	AH	All Power-Up	amps	
6	8	52	1	0	0	1	CDUCVA	CDUCVA	CDU COMMAND VERIFICATION	TT&C	SPU A	S	Normal	0=Test Disabled 1=Test Enabled	RDMGMT Flag Word 52 (lower half-first word)
7	4	54	1	0	0	1	CDUCVA	CDUCVA	CDU COMMAND VERIFICATION	TT&C	SPU A	S	Thruster	0=Test Disabled 1=Test Enabled	RDMGMT Flag Word 54 (lower half-first word)
6	8	60	1	0	0	1	CDUCVB	CDUCVB	CDU COMMAND VERIFICATION	TT&C	SPU B	S	Normal	0=Test Disabled 1=Test Enabled	RDMGMT Flag Word 60 (lower half-first word)
7	4	62	1	0	0	1	CDUCVB	CDUCVB	CDU COMMAND VERIFICATION	TT&C	SPU B	S	Thruster	0=Test Disabled 1=Test Enabled	RDMGMT Flag Word 62 (lower half-first word)
6	8	53	1	0	0	1	CDUENA	CDUENA	COMMAND DECODER UNIT	TT&C	SPU A	S	Normal	0=Disabled 1=Enabled	RDMGMT Flag Word 53 (lower half-second word)
7	4	55	1	0	0	1	CDUENA	CDUENA	COMMAND DECODER UNIT	TT&C	SPU A	S	Thruster	0=Disabled 1=Enabled	RDMGMT Flag Word 55 (lower half-second word)
6	8	61	1	0	0	1	CDUENB	CDUENB	COMMAND DECODER UNIT	TT&C	SPU B	S	Normal	0=Disabled 1=Enabled	RDMGMT Flag Word 61 (lower half-second word)
7	4	63	1	0	0	1	CDUENB	CDUENB	COMMAND DECODER UNIT	TT&C	SPU B	S	Thruster	0=Disabled 1=Enabled	RDMGMT Flag Word 63 (lower half-second word)
4	1	58	8	0	7	8	CDUIFT	CDUIFT	+X BUS PNI/CDU I/F TEMP B	MSS	TCS	AP	All Power-Up	Celsius	
A	A	43	1	4	4	1	CDUOVR	CDUOVR	CDU DPC OVERCURRE FAULT	TT&C	CDU	S	All Power-Up	1=Overcurrent 0=No Overcurrent	
6	7	55	1	6	6	1	CDUPWRA	CDUPWRA	CDU POWER	TT&C	SPU A	S	Normal	0=Test Disabled 1=Test Enabled	RDMGMT Flag Word 55 (upper half-second word)
6	5	53	1	6	6	1	CDUPWRA	CDUPWRA	CDU POWER	TT&C	SPU A	S	Thruster	0=Test Disabled 1=Test Enabled	RDMGMT Flag Word 53 (upper half-second word)
6	7	63	1	6	6	1	CDUPWRB	CDUPWRB	CDU POWER	TT&C	SPU B	S	Normal	0=Test Disabled 1=Test Enabled	RDMGMT Flag Word 63 (upper half-second word)
6	5	61	1	6	6	1	CDUPWRB	CDUPWRB	CDU POWER	TT&C	SPU B	S	Thruster	0=Test Disabled 1=Test Enabled	RDMGMT Flag Word 61 (upper half-second word)
NA	NA	NA	NA	0	NA	1	CEVTMEM	CEVTMEM	CLEAR EVENT MEMORY	NDS	BDP	S	SSOH		2988
NA	NA	NA	NA	1	NA	7	CFGCHDRH	CFGCHDRH	DURATION OF CONFIGING-HI	NDS	BDP	S	SSOH		3004
NA	NA	NA	NA	0	NA	8	CFGCHDRL	CFGCHDRL	DURATION OF CONFIGING-LO	NDS	BDP	S	SSOH		3005
NA	NA	NA	NA	0	NA	8	CFGCHINH	CFGCHINH	TININTXTCOFIGING-LSB	NDS	BDP	S	SSOH		3037
NA	NA	NA	NA	0	NA	8	CFGCHINL	CFGCHINL	TININTXTCOFIGING-MSB	NDS	BDP	S	SSOH		3038
NA	NA	NA	NA	0	NA	8	CFGCHSTH	CFGCHSTH	ZTIME FOR CONFIGING-LSB	NDS	BDP	S	SSOH		3006
NA	NA	NA	NA	0	NA	8	CFGCHSTL	CFGCHSTL	ZTIME FOR CONFIGING-MSB	NDS	BDP	S	SSOH		3007
NA	NA	NA	NA	0	NA	1	CFGCHG	CFGCHG	CONFIGURATION CHANGE EN	NDS	BDP	S	SSOH		3004
NA	NA	NA	NA	1	NA	1	CFGERR	CFGERR	CONFIG CHANGE_ERR	NDS	BDP-MP	S	SSOH		47

NA	NA	NA	4	NA	1	CHANPAR	CHANPAR	CHANPAR	BDW CHANNEL PARITY	NDS	BDP	S	SSOH	1=U/L Over Range 0=U/L In Range	3066
A	4	15	1	7	7	1	CHKOVERA	CHKOVERA	FLAG INDIC U/L OVER MAX ALLOWED	TT&C	SPU A	S	Power-Up	1=U/L Over Range 0=U/L In Range	
A	4	23	1	7	7	1	CHKOVERB	CHKOVERB	FLAG INDIC U/L OVER MAX ALLOWED	TT&C	SPU B	S	Power-Up	1=U/L Over Range 0=U/L In Range	
A	5	12	8	0	7	16	CHKSUMA	CHKSUMA	RESULTS OF MEM CHECKSUM COMMAND	TT&C	SPU A	S	Power-Up		Word 1 of 2 (first 8 bits)
A	5	13	8	0	7	16	CHKSUMA	CHKSUMA	RESULTS OF MEM CHECKSUM COMMAND	TT&C	SPU A	S	Power-Up		Word 2 of 2 (second 8 bits)
A	5	20	8	0	7	16	CHKSUMB	CHKSUMB	RESULTS OF MEM CHECKSUM COMMAND	TT&C	SPU B	S	Power-Up		Word 1 of 2 (first 8 bits)
A	5	21	8	0	7	16	CHKSUMB	CHKSUMB	RESULTS OF MEM CHECKSUM COMMAND	TT&C	SPU B	S	Power-Up		Word 2 of 2 (second 8 bits)
5	8	54	8	0	7	16	CKSUMA	CKSUMA	COMMANDDED CHECKSUM RESULT (1 OF 2)	TT&C	SPU A	S	Early Orbit	counts	
5	8	55	8	0	7	16	CKSUMA	CKSUMA	COMMANDDED CHECKSUM RESULT (2 OF 2)	TT&C	SPU A	S	Early Orbit	counts	
7	8	54	8	0	7	16	CKSUMA	CKSUMA	COMMANDDED CHECKSUM RESULT (1 OF 2)	TT&C	SPU A	S	Normal	counts	
7	8	55	8	0	7	16	CKSUMA	CKSUMA	COMMANDDED CHECKSUM RESULT (2 OF 2)	TT&C	SPU A	S	Normal	counts	
7	4	52	8	0	7	16	CKSUMA	CKSUMA	COMMANDDED CHECKSUM RESULT (1 OF 2)	TT&C	SPU A	S	Thruster	counts	
7	4	53	8	0	7	16	CKSUMA	CKSUMA	COMMANDDED CHECKSUM RESULT (2 OF 2)	TT&C	SPU A	S	Thruster	counts	
5	8	62	8	0	7	16	CKSUMB	CKSUMB	COMMANDDED CHECKSUM RESULT (1 OF 2)	TT&C	SPU B	S	Early Orbit	counts	
5	8	63	8	0	7	16	CKSUMB	CKSUMB	COMMANDDED CHECKSUM RESULT (2 OF 2)	TT&C	SPU B	S	Early Orbit	counts	
7	8	62	8	0	7	16	CKSUMB	CKSUMB	COMMANDDED CHECKSUM RESULT (1 OF 2)	TT&C	SPU B	S	Normal	counts	
7	8	63	8	0	7	16	CKSUMB	CKSUMB	COMMANDDED CHECKSUM RESULT (2 OF 2)	TT&C	SPU B	S	Normal	counts	
7	4	60	8	0	7	16	CKSUMB	CKSUMB	COMMANDDED CHECKSUM RESULT (1 OF 2)	TT&C	SPU B	S	Thruster	counts	
7	4	61	8	0	7	16	CKSUMB	CKSUMB	COMMANDDED CHECKSUM RESULT (2 OF 2)	TT&C	SPU B	S	Thruster	counts	
6	8	52	6	2	7	6	CKSUMERA	CKSUMERA	CHECKSUM ERROR-4K BLOCK NUMBER	TT&C	SPU A	S	Early Orbit	Binary equivalent of values 0-32	TLM (Error) Flag Word 52 (first word) Range = 0-32
3	6	52	6	2	7	6	CKSUMERA	CKSUMERA	CHECKSUM ERROR-4K BLOCK NUMBER	TT&C	SPU A	S	Normal	Binary equivalent of values 0-32	TLM (Error) Flag Word 52 (first word) Range = 0-33
6	8	60	6	2	7	6	CKSUMERB	CKSUMERB	CHECKSUM ERROR-4K BLOCK NUMBER	TT&C	SPU B	S	Early Orbit	Binary equivalent of values 0-32	TLM (Error) Flag Word 60 (first word) Range = 0-34
3	6	60	6	2	7	6	CKSUMERB	CKSUMERB	CHECKSUM ERROR-4K BLOCK NUMBER	TT&C	SPU B	S	Normal	Binary equivalent of values 0-32	TLM (Error) Flag Word 60 (first word) Range = 0-35
A	1	12	3	4	6	3	CKSUMSTA	CKSUMSTA	UPLINK CHECKSUM STATUS	TT&C	SPU A	S	All	0=No Comp (No U/L) 1=Checksum Match 2=Checksum Error 3=Match Curr U/L 4=Err Curr U/L	TLM Flag Word 12 (first word)
A	1	20	3	4	6	3	CKSUMSTB	CKSUMSTB	UPLINK CHECKSUM STATUS FLAG INDICAT U/L RCVD AND AWAIT PROC	TT&C	SPU B	S	All	0=No Comp (No U/L) 1=Checksum Match 2=Checksum Error 3=Match Curr U/L 4=Err Curr U/L	TLM Flag Word 20 (first word)
A	8	13	1	7	7	1	CMDAVALA	CMDAVALA		TT&C	SPU A	S	Power-Up	1=U/L Cmd Recd 0=U/L Cmd Not Recd	

NA	A	8	21	1	7	7	1	CMDVALB	CMDCHECK	FLAG INDICAT U/L RCVD AND AWAIT PROC DISAB AUTO CMD CHKING	TT&C	SPU B	S	Power-Up	1=U/L Cmd Recd 0=U/L Cmd Not Recd
NA	NA	NA	NA	NA	6	NA	1	CMDERRA	CMDERRA	PCE A CMD PARITY ERROR	TT&C	PCE	DL	All Power-Up	1=No Error 0=Error
NA	NA	NA	NA	NA	5	5	1	CMDERRB	CMDERRB	PCE B CMD PARITY ERROR	TT&C	PCE	DL	All Power-Up	1=No Error 0=Error
NA	NA	NA	NA	NA	1	NA	1	CMDINTER	CMDINTER	INT ERR FLG(CMD RDY)	TT&C	BDP-MP	S	SSOH	41
NA	NA	NA	NA	NA	4	NA	1	CMDL3RO	CMDL3RO	L3 OP FLAG CMD	NDS	BDP-MP	S	SSOH	49
NA	NA	NA	NA	NA	0	NA	8	CMDR00H	CMDR00H	COMMAND REGISTER 00	NDS	BDP	S	SSOH	2944
NA	NA	NA	NA	NA	0	NA	8	CMDR1FH	CMDR1FH	COMMAND REGISTER 1F	NDS	BDP	S	SSOH	2975
NA	NA	NA	NA	NA	0	NA	8	CMDR20H	CMDR20H	COMMAND REGISTER 20	NDS	BDP	S	SSOH	2976
NA	NA	NA	NA	NA	0	NA	8	CMDR35H	CMDR35H	COMMAND REGISTER 35	NDS	BDP	S	SSOH	2997
NA	NA	NA	NA	NA	0	NA	8	CMDR36H	CMDR36H	COMMAND REGISTER 36	NDS	BDP	S	SSOH	2998
NA	NA	NA	NA	NA	0	NA	8	CMDR37H	CMDR37H	COMMAND REGISTER 37	NDS	BDP	S	SSOH	2999
NA	NA	NA	NA	NA	0	NA	8	CMDR5FH	CMDR5FH	COMMAND REGISTER 5F	NDS	BDP	S	SSOH	3039
NA	NA	NA	NA	NA	0	NA	8	CMDR60H	CMDR60H	COMMAND REGISTER 60	NDS	BDP	S	SSOH	3040
NA	NA	NA	NA	NA	0	NA	8	CMDR61H	CMDR61H	COMMAND REGISTER 61	NDS	BDP	S	SSOH	3041
NA	NA	NA	NA	NA	0	NA	8	CMDR62H	CMDR62H	COMMAND REGISTER 62	NDS	BDP	S	SSOH	3042
NA	NA	NA	NA	NA	0	NA	8	CMDR70H	CMDR70H	COMMAND REGISTER 70	NDS	BDP	S	SSOH	3066
NA	NA	NA	NA	NA	0	NA	8	CMDR71H	CMDR71H	COMMAND REGISTER 71	NDS	BDP	S	SSOH	3067
NA	NA	NA	NA	NA	0	NA	8	CMDR72H	CMDR72H	COMMAND REGISTER 72	NDS	BDP	S	SSOH	3068
NA	NA	NA	NA	NA	0	NA	8	CMDR73H	CMDR73H	COMMAND REGISTER 73	NDS	BDP	S	SSOH	3069
NA	NA	NA	NA	NA	0	NA	8	CMDR74H	CMDR74H	COMMAND REGISTER 74	NDS	BDP	S	SSOH	3060
NA	NA	NA	NA	NA	0	NA	8	CMDRECVD	CMDRECVD	CMD RECEIVE COUNTER	NDS	BDP-MP	S	SSOH	38
A	A	1	64	1	4	4	1	CMDUPMON	CMDUPMON	BDP COMMAND/UPLOAD MONITOR	NDS	BDP	S	All Power-Up	0=Even 1=Odd
NA	NA	NA	NA	NA	1	NA	1	CMXFRMSG	CMXFRMSG	XFER MSG FLAG CMD	NDS	BDP-MP	S	SSOH	46
NA	NA	NA	NA	NA	1	NA	3	CNDMPWR	CNDMPWR	C-BAND NDM POWER SETTIN	NDS	BDP	S	SSOH	2978
NA	NA	NA	NA	NA	7	NA	1	CNPMDATA	CNPMDATA	DISABL NPMMS DATA C-BAND	NDS	BDP	S	SSOH	2979
A	A	43	1	2	2	1	1	CNTRLSA	CNTRLSA	CMD LINK CNTRL FROM SPU A	TT&C	CDU	S	All Power-Up	1=SPU A Active 0=SPU A Inactive
A	A	43	1	3	3	1	1	CNTRLSB	CNTRLSB	CMD LINK CNTRL FROM SPU B	TT&C	CDU	S	All Power-Up	1=SPU B Active 0=SPU B Inactive
A	A	43	1	0	0	1	1	CNTRLU1	CNTRLU1	CMD LINK CNTRL FROM UPLINK 1	TT&C	CDU	S	All Power-Up	1=S-Band 1 Active 0=S-Band 1 Inactive
A	A	43	1	1	1	1	1	CNTRLU2	CNTRLU2	CMD LINK CNTRL FROM UPLINK 2	TT&C	CDU	S	All Power-Up	1=S-Band 2 Active 0=S-Band 2 Inactive
NA	NA	NA	NA	NA	4	NA	1	COMRELAY	COMRELAY	ENABLE COM RELAY POWER	NDS	BDP	S	SSOH	2977
NA	NA	NA	NA	NA	3	NA	1	CONCMEM	CONCMEM	BDW VHS CONC MEM SEP	NDS	BDP	S	SSOH	3013
NA	NA	NA	NA	NA	0	NA	1	CONCUR	CONCUR	CONCURRENCE ENABLE	NDS	BDP	S	SSOH	3051
NA	NA	NA	NA	NA	5	NA	3	CONCWIND	CONCWIND	CH CONCURRENCE WINDOW	NDS	BDP	S	SSOH	3051
NA	NA	NA	NA	NA	3	NA	1	CONSTBB	CONSTBB	CONCSTRATBUILDBUFFOPEN	NDS	BDP-MP	S	SSOH	48
A	A	41	1	2	2	1	1	CPUNRM	CPUNRM	MDU CONV A TO CPU A (AND B TO BNORM)	TNP	MDU	DL	All Power-Up	1=Normal 0=Xstrap
A	A	42	1	2	2	1	1	CPUXST	CPUXST	MDU CONV B TO CPU A (AND A TO BXSTRAP)	TNP	MDU	DL	All Power-Up	1=Xstrap 0=Normal
NA	NA	NA	NA	NA	6	NA	1	CSOHDATA	CSOHDATA	DISABLE SOH DATA C-BAND	NDS	BDP	S	SSOH	2979
1	3	57	8	0	7	8	8	CSSPYT	CSSPYT	CSS +Y TEMP	ADS	CSS	AP	All Power-Up	Celsius
1	4	57	8	0	7	8	8	CSSYIT	CSSYIT	CSS -Y TEMP	ADS	CSS	AP	All Power-Up	Celsius
6	7	54	1	5	5	1	1	CSSDRA	CSSDRA	CSS DATA READY	TT&C	SPU A	S	Normal	0=Test Disabled 1=Test Enabled
6	5	52	1	5	5	1	1	CSSDRA	CSSDRA	CSS DATA READY	TT&C	SPU A	S	Thruster	0=Test Disabled 1=Test Enabled
6	7	62	1	5	5	1	1	CSSDRB	CSSDRB	CSS DATA READY	TT&C	SPU B	S	Normal	0=Test Disabled 1=Test Enabled

6	5	60	1	5	5	1	CSSDRB	CSSDRB	CSS DATA READY	TT&C	SPU B	S	Thrustrer	0=Test Disabled 1=Test Enabled	RDMGMT Flag Word 60 (upper half-first word)
6	8	52	1	4	4	1	CSSENA	CSSENA	COARSE SUN SENSOR	TT&C	SPU A	S	Normal	0=Disabled 1=Enabled	RDMGMT Flag Word 52 (lower half-first word)
7	4	54	1	4	4	1	CSSENA	CSSENA	COARSE SUN SENSOR	TT&C	SPU A	S	Thrustrer	0=Disabled 1=Enabled	RDMGMT Flag Word 54 (lower half-first word)
6	8	60	1	4	4	1	CSSENB	CSSENB	COARSE SUN SENSOR	TT&C	SPU B	S	Normal	0=Disabled 1=Enabled	RDMGMT Flag Word 60 (lower half-first word)
7	4	62	1	4	4	1	CSSENB	CSSENB	COARSE SUN SENSOR	TT&C	SPU B	S	Thrustrer	0=Disabled 1=Enabled	RDMGMT Flag Word 62 (lower half-first word)
4	4	52	1	3	3	1	CSSEYEA	CSSEYEA	CSS EYE SELECT	TT&C	SPU A	S	Thrustrer	1=Side A B	Ground Select Flag Word 52 (first word)
5	4	54	1	3	3	1	CSSEYEA	CSSEYEA	CSS EYE SELECT	TT&C	SPU A	S	Normal	0=Side A B	Ground Select Flag Word 54 (first word)
5	4	62	1	3	3	1	CSSEYEB	CSSEYEB	CSS EYE SELECT	TT&C	SPU B	S	Normal	0=Side A B	Ground Select Flag Word 62 (first word)
4	4	60	1	3	3	1	CSSEYEB	CSSEYEB	CSS EYE SELECT	TT&C	SPU B	S	Thrustrer	0=Side A B	Ground Select Flag Word 60 (first word)
6	7	54	1	6	6	1	CSSHSUMA	CSSHSUMA	CSS HIGH EYE SUM	TT&C	SPU A	S	Normal	0=Test Disabled 1=Test Enabled	RDMGMT Flag Word 54 (upper half-first word)
6	5	52	1	6	6	1	CSSHSUMA	CSSHSUMA	CSS HIGH EYE SUM	TT&C	SPU A	S	Thrustrer	0=Test Disabled 1=Test Enabled	RDMGMT Flag Word 52 (upper half-first word)
6	7	52	1	6	6	1	CSSHSUMB	CSSHSUMB	CSS HIGH EYE SUM	TT&C	SPU B	S	Normal	0=Test Disabled 1=Test Enabled	RDMGMT Flag Word 62 (upper half-first word)
6	5	60	1	6	6	1	CSSHSUMB	CSSHSUMB	CSS HIGH EYE SUM	TT&C	SPU B	S	Thrustrer	0=Test Disabled 1=Test Enabled	RDMGMT Flag Word 60 (upper half-first word)
6	7	55	1	0	0	1	CSSLLOUTA	CSSLLOUTA	CSS LOW EYE OUTPUT	TT&C	SPU A	S	Normal	0=Test Disabled 1=Test Enabled	RDMGMT Flag Word 55 (upper half-second word)
6	5	53	1	0	0	1	CSSLLOUTA	CSSLLOUTA	CSS LOW EYE OUTPUT	TT&C	SPU A	S	Thrustrer	0=Test Disabled 1=Test Enabled	RDMGMT Flag Word 53 (upper half-second word)
6	7	63	1	0	0	1	CSSLLOUTB	CSSLLOUTB	CSS LOW EYE OUTPUT	TT&C	SPU B	S	Normal	0=Test Disabled 1=Test Enabled	RDMGMT Flag Word 63 (upper half-second word)
6	5	61	1	0	0	1	CSSLLOUTB	CSSLLOUTB	CSS LOW EYE OUTPUT	TT&C	SPU B	S	Thrustrer	0=Test Disabled 1=Test Enabled	RDMGMT Flag Word 61 (upper half-second word)
6	7	54	1	7	7	1	CSSLSUMA	CSSLSUMA	CSS LOW EYE SUM	TT&C	SPU A	S	Normal	0=Test Disabled 1=Test Enabled	RDMGMT Flag Word 54 (upper half-first word)
6	5	52	1	7	7	1	CSSLSUMA	CSSLSUMA	CSS LOW EYE SUM	TT&C	SPU A	S	Thrustrer	0=Test Disabled 1=Test Enabled	RDMGMT Flag Word 52 (upper half-first word)
6	7	62	1	7	7	1	CSSLSUMB	CSSLSUMB	CSS LOW EYE SUM	TT&C	SPU B	S	Normal	0=Test Disabled 1=Test Enabled	RDMGMT Flag Word 62 (upper half-first word)
6	5	60	1	7	7	1	CSSLSUMB	CSSLSUMB	CSS LOW EYE SUM	TT&C	SPU B	S	Thrustrer	0=Test Disabled 1=Test Enabled	RDMGMT Flag Word 60 (upper half-first word)
2	6	52	8	0	7	16	CSSPFILA	CSSPFILA	FILTERED CSS PITCH OUTPUT (1 OF 2)	ADS	SPU A	S	Normal		
2	6	53	8	0	7	16	CSSPFILA	CSSPFILA	FILTERED CSS PITCH OUTPUT (2 OF 2)	ADS	SPU A	S	Normal		
2	6	60	8	0	7	16	CSSPFILB	CSSPFILB	FILTERED CSS PITCH OUTPUT (1 OF 2)	ADS	SPU B	S	Normal		
2	6	61	8	0	7	16	CSSPFILB	CSSPFILB	FILTERED CSS PITCH OUTPUT (2 OF 2)	ADS	SPU B	S	Normal		
2	8	54	4	7	12	CSSPITMA	CSSPITMA	CSS PITCH OUTPUT B (1 OF 2)	ADS	SPU A	S	Normal		0.2959 $\mu$ A/count (-Y)	
2	8	55	8	0	7	12	CSSPITMA	CSSPITMA	CSS PITCH OUTPUT B (2 OF 2)	ADS	SPU A	S	Normal		0.2959 $\mu$ A/count (-Y)
2	4	54	4	7	12	CSSPITMA	CSSPITMA	CSS PITCH OUTPUT B (1 OF 2)	ADS	SPU A	S	Thrustrer		0.2959 $\mu$ A/count (-Y)	
2	4	55	8	0	7	12	CSSPITMA	CSSPITMA	CSS PITCH OUTPUT B (2 OF 2)	ADS	SPU A	S	Thrustrer		0.2959 $\mu$ A/count (-Y)
2	8	62	4	7	12	CSSPITMB	CSSPITMB	CSS PITCH OUTPUT B (1 OF 2)	ADS	SPU B	S	Normal		0.2959 $\mu$ A/count (-Y)	
2	8	63	8	0	7	12	CSSPITMB	CSSPITMB	CSS PITCH OUTPUT B (2 OF 2)	ADS	SPU B	S	Normal		0.2959 $\mu$ A/count (-Y)
2	4	62	4	7	12	CSSPITMB	CSSPITMB	CSS PITCH OUTPUT B (1 OF 2)	ADS	SPU B	S	Thrustrer		0.2959 $\mu$ A/count (-Y)	

2	4	63	8	0	7	12	CSSPITMB	CSSPITMB	CSS PITCH OUTPUT B (2 OF 2)	ADS	SPUB	S	Thruster	µA	0.2959 µA/count -Y)
2	4	54	4	4	7	12	CSSPITPA	CSS PITCH OUTPUT A (1 OF 2)	ADS	SPUA	S	Normal	µA	0.2959 µA/count +Y)	
2	4	55	8	0	7	12	CSSPITPA	CSS PITCH OUTPUT A (2 OF 2)	ADS	SPUA	S	Normal	µA	0.2959 µA/count +Y)	
2	4	52	4	4	7	12	CSSPITPA	CSS PITCH OUTPUT A (1 OF 2)	ADS	SPUA	S	Thruster	µA	0.2959 µA/count +Y)	
2	4	53	8	0	7	12	CSSPITPB	CSS PITCH OUTPUT A (2 OF 2)	ADS	SPUB	S	Thruster	µA	0.2959 µA/count +Y)	
2	4	62	4	4	7	12	CSSPITPB	CSS PITCH OUTPUT A (1 OF 2)	ADS	SPUB	S	Normal	µA	0.2959 µA/count +Y)	
2	4	63	8	0	7	12	CSSPITPB	CSS PITCH OUTPUT A (2 OF 2)	ADS	SPUB	S	Normal	µA	0.2959 µA/count +Y)	
2	4	60	4	4	7	12	CSSPITPB	CSS PITCH OUTPUT A (1 OF 2)	ADS	SPUB	S	Thruster	µA	0.2959 µA/count +Y)	
2	4	61	8	0	7	12	CSSPITPB	CSS PITCH OUTPUT A (2 OF 2)	ADS	SPUB	S	Thruster	µA	0.2959 µA/count +Y)	
1	6	52	8	0	7	16	CSSRFILA	FILTERED CSS ROLL OUTPUT (1 OF 2)	ADS	SPUA	S	Normal	radians		
1	6	53	8	0	7	16	CSSRFILA	FILTERED CSS ROLL OUTPUT (2 OF 2)	ADS	SPUA	S	Normal	radians		
1	6	60	8	0	7	16	CSSRFILB	FILTERED CSS ROLL OUTPUT (1 OF 2)	ADS	SPUB	S	Normal	radians		
1	6	61	8	0	7	16	CSSRFILB	FILTERED CSS ROLL OUTPUT (2 OF 2)	ADS	SPUB	S	Thruster	radians		
1	8	54	4	4	7	12	CSSROLMA	CSS ROLL OUTPUT B (1 OF 2)	ADS	SPUA	S	Normal	µA	0.2959 µA/count -Y)	
1	8	55	8	0	7	12	CSSROLMA	CSS ROLL OUTPUT B (2 OF 2)	ADS	SPUA	S	Normal	µA	0.2959 µA/count -Y)	
1	4	54	4	4	7	12	CSSROLMA	CSS ROLL OUTPUT B (1 OF 2)	ADS	SPUA	S	Thruster	µA	0.2959 µA/count -Y)	
1	4	55	8	0	7	12	CSSROLMA	CSS ROLL OUTPUT B (2 OF 2)	ADS	SPUA	S	Thruster	µA	0.2959 µA/count -Y)	
1	8	62	4	4	7	12	CSSROLMB	CSS ROLL OUTPUT B (1 OF 2)	ADS	SPUB	S	Normal	µA	0.2959 µA/count -Y)	
1	8	63	8	0	7	12	CSSROLMB	CSS ROLL OUTPUT B (2 OF 2)	ADS	SPUB	S	Normal	µA	0.2959 µA/count -Y)	
1	4	62	4	4	7	12	CSSROLMB	CSS ROLL OUTPUT B (1 OF 2)	ADS	SPUB	S	Thruster	µA	0.2959 µA/count -Y)	
1	4	63	8	0	7	12	CSSROLMB	CSS ROLL OUTPUT B (2 OF 2)	ADS	SPUB	S	Thruster	µA	0.2959 µA/count -Y)	
1	4	54	4	4	7	12	CSSROLPA	CSS ROLL OUTPUT A (1 OF 2)	ADS	SPUA	S	Normal	µA	0.2959 µA/count +Y)	
1	4	55	8	0	7	12	CSSROLPA	CSS ROLL OUTPUT A (2 OF 2)	ADS	SPUA	S	Normal	µA	0.2959 µA/count +Y)	
1	4	52	4	4	7	12	CSSROLPA	CSS ROLL OUTPUT A (1 OF 2)	ADS	SPUA	S	Thruster	µA	0.2959 µA/count +Y)	
1	4	53	8	0	7	12	CSSROLPA	CSS ROLL OUTPUT A (2 OF 2)	ADS	SPUA	S	Thruster	µA	0.2959 µA/count +Y)	
1	4	62	4	4	7	12	CSSROLPB	CSS ROLL OUTPUT A (1 OF 2)	ADS	SPUB	S	Normal	µA	0.2959 µA/count +Y)	
1	4	63	8	0	7	12	CSSROLPB	CSS ROLL OUTPUT A (2 OF 2)	ADS	SPUB	S	Normal	µA	0.2959 µA/count +Y)	
1	4	61	4	4	7	12	CSSROLPB	CSS ROLL OUTPUT A (1 OF 2)	ADS	SPUB	S	Thruster	µA	0.2959 µA/count +Y)	
1	4	61	8	0	7	12	CSSROLPB	CSS ROLL OUTPUT A (2 OF 2)	ADS	SPUB	S	Thruster	µA	0.2959 µA/count +Y)	
A	5	54	8	0	7	16	CV10A	CV BUFFER	TT&C	SPUA	S	Power-Up	µA	Word 1 of 2 (first 8 bits)	
A	5	55	8	0	7	16	CV10A	CV BUFFER	TT&C	SPUA	S	Power-Up	µA	Word 2 of 2 (second 8 bits)	
A	5	62	8	0	7	16	CV10B	CV BUFFER	TT&C	SPUB	S	Power-Up	µA	Word 1 of 2 (first 8 bits)	
A	5	63	8	0	7	16	CV10B	CV BUFFER	TT&C	SPUB	S	Power-Up	µA	Word 2 of 2 (second 8 bits)	
A	6	52	8	0	7	16	CV11A	CV BUFFER	TT&C	SPUA	S	Power-Up	µA	Word 1 of 2 (first 8 bits)	
A	6	53	8	0	7	16	CV11A	CV BUFFER	TT&C	SPUA	S	Power-Up	µA	Word 2 of 2 (second 8 bits)	
A	6	60	8	0	7	16	CV11B	CV BUFFER	TT&C	SPUB	S	Power-Up	µA	Word 1 of 2 (first 8 bits)	
A	6	61	8	0	7	16	CV11B	CV BUFFER	TT&C	SPUB	S	Power-Up	µA	Word 2 of 2 (second 8 bits)	
A	6	54	8	0	7	16	CV12A	CV BUFFER	TT&C	SPUA	S	Power-Up	µA	Word 1 of 2 (first 8 bits)	
A	6	55	8	0	7	16	CV12A	CV BUFFER	TT&C	SPUA	S	Power-Up	µA	Word 2 of 2 (second 8 bits)	
A	6	62	8	0	7	16	CV12B	CV BUFFER	TT&C	SPUB	S	Power-Up	µA	Word 1 of 2 (first 8 bits)	
A	6	63	8	0	7	16	CV12B	CV BUFFER	TT&C	SPUB	S	Power-Up	µA	Word 2 of 2 (second 8 bits)	
A	7	52	8	0	7	16	CV13A	CV BUFFER	TT&C	SPUA	S	Power-Up	µA	Word 1 of 2 (first 8 bits)	
A	7	53	8	0	7	16	CV13A	CV BUFFER	TT&C	SPUA	S	Power-Up	µA	Word 2 of 2 (second 8 bits)	
A	7	60	8	0	7	16	CV13B	CV BUFFER	TT&C	SPUB	S	Power-Up	µA	Word 1 of 2 (first 8 bits)	
A	7	61	8	0	7	16	CV13B	CV BUFFER	TT&C	SPUB	S	Power-Up	µA	Word 2 of 2 (second 8 bits)	
A	7	54	8	0	7	16	CV14A	CV BUFFER	TT&C	SPUA	S	Power-Up	µA	Word 1 of 2 (first 8 bits)	
A	7	55	8	0	7	16	CV14A	CV BUFFER	TT&C	SPUA	S	Power-Up	µA	Word 2 of 2 (second 8 bits)	
A	7	62	8	0	7	16	CV14B	CV BUFFER	TT&C	SPUB	S	Power-Up	µA	Word 1 of 2 (first 8 bits)	
A	7	63	8	0	7	16	CV14B	CV BUFFER	TT&C	SPUB	S	Power-Up	µA	Word 2 of 2 (second 8 bits)	
A	8	52	8	0	7	16	CV15A	CV BUFFER	TT&C	SPUA	S	Power-Up	µA	Word 1 of 2 (first 8 bits)	
A	8	53	8	0	7	16	CV15A	CV BUFFER	TT&C	SPUA	S	Power-Up	µA	Word 2 of 2 (second 8 bits)	
A	8	60	8	0	7	16	CV15B	CV BUFFER	TT&C	SPUB	S	Power-Up	µA	Word 1 of 2 (first 8 bits)	
A	8	61	8	0	7	16	CV15B	CV BUFFER	TT&C	SPUB	S	Power-Up	µA	Word 2 of 2 (second 8 bits)	

A	8	54	8	0	7	16	CV16A	CV16A	CV BUFFER	TT&C	SPU A	S	Power-Up	Word 1 of 2 (first 8 bits)
A	8	55	8	0	7	16	CV16A	CV BUFFER	CV BUFFER	TT&C	SPU A	S	Power-Up	Word 2 of 2 (second 8 bits)
A	8	62	8	0	7	16	CV16B	CV BUFFER	CV BUFFER	TT&C	SPU B	S	Power-Up	Word 1 of 2 (first 8 bits)
A	8	63	8	0	7	16	CV16B	CV BUFFER	CV BUFFER	TT&C	SPU B	S	Power-Up	Word 2 of 2 (second 8 bits)
A	1	52	8	0	7	16	CV1A	CV BUFFER	CV BUFFER	TT&C	SPU A	S	Power-Up	Word 1 of 2 (first 8 bits)
A	1	53	8	0	7	16	CV1A	CV BUFFER	CV BUFFER	TT&C	SPU A	S	Power-Up	Word 2 of 2 (second 8 bits)
A	1	60	8	0	7	16	CV1B	CV BUFFER	CV BUFFER	TT&C	SPU B	S	Power-Up	Word 1 of 2 (first 8 bits)
A	1	61	8	0	7	16	CV1B	CV BUFFER	CV BUFFER	TT&C	SPU B	S	Power-Up	Word 2 of 2 (second 8 bits)
A	1	54	8	0	7	16	CV2A	CV BUFFER	CV BUFFER	TT&C	SPU A	S	Power-Up	Word 1 of 2 (first 8 bits)
A	1	55	8	0	7	16	CV2A	CV BUFFER	CV BUFFER	TT&C	SPU A	S	Power-Up	Word 2 of 2 (second 8 bits)
A	1	62	8	0	7	16	CV2B	CV BUFFER	CV BUFFER	TT&C	SPU B	S	Power-Up	Word 1 of 2 (first 8 bits)
A	1	63	8	0	7	16	CV2B	CV BUFFER	CV BUFFER	TT&C	SPU B	S	Power-Up	Word 2 of 2 (second 8 bits)
A	2	52	8	0	7	16	CV3A	CV BUFFER	CV BUFFER	TT&C	SPU A	S	Power-Up	Word 1 of 2 (first 8 bits)
A	2	53	8	0	7	16	CV3A	CV BUFFER	CV BUFFER	TT&C	SPU A	S	Power-Up	Word 2 of 2 (second 8 bits)
A	2	60	8	0	7	16	CV3B	CV BUFFER	CV BUFFER	TT&C	SPU B	S	Power-Up	Word 1 of 2 (first 8 bits)
A	2	61	8	0	7	16	CV3B	CV BUFFER	CV BUFFER	TT&C	SPU B	S	Power-Up	Word 2 of 2 (second 8 bits)
A	2	54	8	0	7	16	CV4A	CV BUFFER	CV BUFFER	TT&C	SPU A	S	Power-Up	Word 1 of 2 (first 8 bits)
A	2	55	8	0	7	16	CV4A	CV BUFFER	CV BUFFER	TT&C	SPU A	S	Power-Up	Word 2 of 2 (second 8 bits)
A	2	62	8	0	7	16	CV4B	CV BUFFER	CV BUFFER	TT&C	SPU B	S	Power-Up	Word 1 of 2 (first 8 bits)
A	2	63	8	0	7	16	CV4B	CV BUFFER	CV BUFFER	TT&C	SPU B	S	Power-Up	Word 2 of 2 (second 8 bits)
A	3	52	8	0	7	16	CV5A	CV BUFFER	CV BUFFER	TT&C	SPU A	S	Power-Up	Word 1 of 2 (first 8 bits)
A	3	53	8	0	7	16	CV5A	CV BUFFER	CV BUFFER	TT&C	SPU A	S	Power-Up	Word 2 of 2 (second 8 bits)
A	3	60	8	0	7	16	CV5B	CV BUFFER	CV BUFFER	TT&C	SPU B	S	Power-Up	Word 1 of 2 (first 8 bits)
A	3	61	8	0	7	16	CV5B	CV BUFFER	CV BUFFER	TT&C	SPU B	S	Power-Up	Word 2 of 2 (second 8 bits)
A	3	54	8	0	7	16	CV6A	CV BUFFER	CV BUFFER	TT&C	SPU A	S	Power-Up	Word 1 of 2 (first 8 bits)
A	3	55	8	0	7	16	CV6A	CV BUFFER	CV BUFFER	TT&C	SPU A	S	Power-Up	Word 2 of 2 (second 8 bits)
A	3	62	8	0	7	16	CV6B	CV BUFFER	CV BUFFER	TT&C	SPU B	S	Power-Up	Word 1 of 2 (first 8 bits)
A	3	63	8	0	7	16	CV6B	CV BUFFER	CV BUFFER	TT&C	SPU B	S	Power-Up	Word 2 of 2 (second 8 bits)
A	4	52	8	0	7	16	CV7A	CV BUFFER	CV BUFFER	TT&C	SPU A	S	Power-Up	Word 1 of 2 (first 8 bits)
A	4	53	8	0	7	16	CV7A	CV BUFFER	CV BUFFER	TT&C	SPU A	S	Power-Up	Word 2 of 2 (second 8 bits)
A	4	60	8	0	7	16	CV7B	CV BUFFER	CV BUFFER	TT&C	SPU B	S	Power-Up	Word 1 of 2 (first 8 bits)
A	4	61	8	0	7	16	CV7B	CV BUFFER	CV BUFFER	TT&C	SPU B	S	Power-Up	Word 2 of 2 (second 8 bits)
A	4	54	8	0	7	16	CV8A	CV BUFFER	CV BUFFER	TT&C	SPU A	S	Power-Up	Word 1 of 2 (first 8 bits)
A	4	55	8	0	7	16	CV8A	CV BUFFER	CV BUFFER	TT&C	SPU A	S	Power-Up	Word 2 of 2 (second 8 bits)
A	4	62	8	0	7	16	CV8B	CV BUFFER	CV BUFFER	TT&C	SPU B	S	Power-Up	Word 1 of 2 (first 8 bits)
A	4	63	8	0	7	16	CV8B	CV BUFFER	CV BUFFER	TT&C	SPU B	S	Power-Up	Word 2 of 2 (second 8 bits)
A	5	52	8	0	7	16	CV9A	CV BUFFER	CV BUFFER	TT&C	SPU A	S	Power-Up	Word 1 of 2 (first 8 bits)
A	5	53	8	0	7	16	CV9A	CV BUFFER	CV BUFFER	TT&C	SPU A	S	Power-Up	Word 2 of 2 (second 8 bits)
A	5	60	8	0	7	16	CV9B	CV BUFFER	CV BUFFER	TT&C	SPU B	S	Power-Up	Word 1 of 2 (first 8 bits)
A	5	61	8	0	7	16	CV9B	CV BUFFER	CV BUFFER	TT&C	SPU B	S	Power-Up	Word 2 of 2 (second 8 bits)
A	1	13	1	2	2	1	CVERRA	CVERRA	COMMAND VERIFICATION ERROR	TT&C	SPU A	S	All	TLM Flag Word 13 (second word)
A	1	21	1	2	2	1	CVERRB	CVERRB	COMMAND VERIFICATION ERROR	TT&C	SPU B	S	All	TLM Flag Word 21 (second word)
A	4	12	8	0	7	16	CVF1A	CVF1A	FIRST CVF	TT&C	SPU A	S	All	First CVF (first word)
A	4	13	8	0	7	16	CVF1A	CVF1A	FIRST CVF	TT&C	SPU A	S	All	First CVF (second word)
A	4	20	8	0	7	16	CVF1B	CVF1B	FIRST CVF	TT&C	SPU B	S	All	First CVF (first word)
A	4	21	8	0	7	16	CVF1B	CVF1B	FIRST CVF	TT&C	SPU B	S	All	First CVF (second word)
A	5	12	8	0	7	16	CVF2A	CVF2A	SECOND CVF	TT&C	SPU A	S	All	Second CVF (first word)
A	5	13	8	0	7	16	CVF2A	CVF2A	SECOND CVF	TT&C	SPU A	S	All	Second CVF (second word)
A	5	20	8	0	7	16	CVF2B	CVF2B	SECOND CVF	TT&C	SPU B	S	All	Second CVF (first word)
A	5	21	8	0	7	16	CVF2B	CVF2B	SECOND CVF	TT&C	SPU B	S	All	Second CVF (second word)
A	6	12	8	0	7	16	CVF3A	CVF3A	THIRD CVF	TT&C	SPU A	S	All	Third CVF (first word)
A	6	13	8	0	7	16	CVF3A	CVF3A	THIRD CVF	TT&C	SPU A	S	All	Third CVF (second word)
A	6	20	8	0	7	16	CVF3B	CVF3B	THIRD CVF	TT&C	SPU B	S	All	Third CVF (first word)
A	6	21	8	0	7	16	CVF3B	CVF3B	THIRD CVF	TT&C	SPU B	S	All	Third CVF (second word)
A	7	12	8	0	7	16	CVF4A	CVF4A	FOURTH CVF	TT&C	SPU A	S	All	Fourth CVF (first word)

A	7	13	8	0	7	16	CVF4A	CVF4A	FOURTH CVF	TT&C	SPU A	S	All	Fourth CVF (second word)
A	7	20	8	0	7	16	CVF4B	CVF4B	FOURTH CVF	TT&C	SPUB	S	All	Fourth CVF (first word)
A	7	21	8	0	7	16	CVF4B	CVF4B	FOURTH CVF	TT&C	SPUB	S	All	Fourth CVF (second word)
A	8	12	8	0	7	16	CVF5A	CVF5A	FIFTH CVF	TT&C	SPU A	S	All	Fifth CVF (first word)
A	8	13	8	0	7	16	CVF5A	CVF5A	FIFTH CVF	TT&C	SPU A	S	All	Fifth CVF (second word)
A	8	20	8	0	7	16	CVF5B	CVF5B	FIFTH CVF	TT&C	SPUB	S	All	Fifth CVF (first word)
A	8	21	8	0	7	16	CVF5B	CVF5B	FIFTH CVF	TT&C	SPUB	S	All	Fifth CVF (second word)
A	3	12	8	0	7	29	CVFLOWA	CVTMSPTA	CVF TIME STAMP LOWER (3 OF 4)	TT&C	SPU A	S	All	CVF Time Stamp (third word)
A	3	13	8	0	7	29	CVFLOWA	CVTMSPTA	CVF TIME STAMP LOWER (4 OF 4)	TT&C	SPU A	S	All	CVF Time Stamp (fourth word)
A	3	20	8	0	7	29	CVFLOWB	CVTMSPTB	CVF TIME STAMP LOWER (3 OF 4)	TT&C	SPUB	S	All	CVF Time Stamp (third word)
A	3	21	8	0	7	29	CVFLOWB	CVTMSPTB	CVF TIME STAMP LOWER (4 OF 4)	TT&C	SPUB	S	All	CVF Time Stamp (fourth word)
A	2	12	5	3	7	29	CVFTUPA	CVTMSPTA	CVF TIME STAMP UPPER (1 OF 4)	TT&C	SPU A	S	All	CVF Time Stamp (first word)
A	2	13	8	0	7	29	CVFTUPA	CVTMSPTA	CVF TIME STAMP UPPER (2 OF 4)	TT&C	SPU A	S	All	CVF Time Stamp (second word)
A	2	20	5	3	7	29	CVFTUPB	CVTMSPTB	CVF TIME STAMP UPPER (1 OF 4)	TT&C	SPUB	S	All	CVF Time Stamp (first word)
A	2	21	8	0	7	29	CVFTUPB	CVTMSPTB	CVF TIME STAMP UPPER (2 OF 4)	TT&C	SPUB	S	All	CVF Time Stamp (second word)
A	1	13	1	1	1	1	CVFULLA	CVFULLA	COMMAND VERIFICATION FULL	TT&C	SPU A	S	All	0=CVF Buffer Not Full 1=CVF Buffer Full
A	1	21	1	1	1	1	CVFULLB	CVFULLB	COMMAND VERIFICATION FULL	TT&C	SPUB	S	All	0=CVF Buffer Not Full 1=CVF Buffer Full
A	1	13	1	3	3	1	CVWAITA	CVWAITA	CDU CMD CONTENTION	TT&C	SPU A	S	All	0=No CDU Contention 1=CDU Contention
A	1	21	1	3	3	1	CVWAITB	CVWAITB	CDU CMD CONTENTION	TT&C	SPUB	S	All	0=No CDU Contention 1=CDU Contention
NA	NA	NA	NA	1	NA	3	CXMTRPWR	CXMTRPWR	C-BAND XMIT PWR SETTING	NDS	BDP	S	SSOH	TLM Flag Word 21
A	1	16	1	2	2	1	DAMPHTRA	DAMPHTRA	DAMPER HEATER A ON/OFF	TT&C	CDU	S	All Power-Up	TLM Flag Word 13
A	1	16	1	6	6	1	DAMPHTRB	DAMPHTRB	DAMPER HEATER B ON/OFF	TT&C	CDU	S	All Power-Up	TLM Flag Word 21
A	3	16	1	3	3	1	DARCVR1	DARCVR1	S-BAND UPLINK 1 ACTIVE	TT&C	SBT	S	All Power-Up	TLM Flag Word 13
A	3	16	1	7	7	1	DARCVR2	DARCVR2	S-BAND UPLINK 2 ACTIVE	TT&C	SBT	S	All Power-Up	TLM Flag Word 21
8	7	58	8	0	7	8	DCDCIFT	DCDCIFT	+X PAYLOAD PNL/DC-DC CONV I/F TEMP F	MSS	TCS	AP	All Power-Up	2977
NA	NA	NA	NA	5	NA	1	DCMDL3RO	DCMDL3RO	L3 OP FLAG DLYD CMD	NDS	BDP-MP	S	SSOH	49
NA	NA	NA	NA	6	NA	2	DCMDMRO	DCMDMRO	DELCDML3MROEN&INTSEL	NDS	BDP	S	SSOH	3019
NA	NA	NA	NA	2	NA	1	DCONL3RO	DCONL3RO	L3 OP FLG DLYD CONST	NDS	BDP-MP	S	SSOH	49
NA	NA	NA	NA	2	NA	2	DCONSMRO	DCONSMRO	DELCONL3MROEN&INTSEL	NDS	BDP	S	SSOH	3019
NA	NA	NA	NA	0	NA	8	DCONSTSH	DCONSTSH	Z&CNTTIMEDELCONSTL3	NDS	BDP	S	SSOH	3022
NA	NA	NA	NA	0	NA	8	DCONSTSL	DCONSTSL	Z&CNTTIMEDELCONSTL3	NDS	BDP	S	SSOH	3023
NA	NA	NA	NA	0	NA	16	DDATAEND	DDATAEND	SEC D.16 DATAENDADR	NDS	BDP-MP	S	SSOH	91
NA	NA	NA	NA	6	NA	1	DELCMD	DELCMD	DELAYED COMMANDED	NDS	BDP-MP	S	SSOH	48
NA	NA	NA	NA	7	NA	1	DELCNSTL	DELCNSTL	DELAYED CONSTELLATION	NDS	BDP-MP	S	SSOH	48
NA	NA	NA	NA	5	NA	1	DELSOHH	DELSOHH	DELAYED SSOH	NDS	BDP-MP	S	SSOH	48
A	7	16	1	2	2	1	DL1	DL1	S-BAND DOWNLINK 1 ON/OFF	TT&C	SBT	S	All Power-Up	1=COM 0=ATO
A	7	16	1	6	6	1	DL2	DL2	S-BAND DOWNLINK 2 ON/OFF	TT&C	SBT	S	All Power-Up	1=COM 0=ATO
NA	NA	NA	NA	0	NA	8	DLSSOHH	DLSSOHH	Z&CNTTIMEDELSSOHL3	NDS	BDP	S	SSOH	3024

NA	NA	NA	NA	0	NA	8	DLSOHL	DLSOHL	Z&CNTTIMEDELSSOHL3	NDS	BDP	S	SSOH			3025
NA	NA	NA	NA	0	NA	8	DMROH	DMROH	Z&CNTTIMEDELGMDL3MRO	NDS	BDP	S	SSOH			3026
NA	NA	NA	NA	0	NA	8	DMROL	DMROL	Z&CNTTIMEDELGMDL3MRO	NDS	BDP	S	SSOH			3027
NA	NA	NA	NA	3	NA	1	DSSH3RO	DSSH3RO	L3 OP FLAG DLYD SSOH	NDS	BDP-MIP	S	SSOH			49
NA	NA	NA	NA	4	NA	2	DSSOHMRO	DSSOHMRO	DLSSOHL3MROEN&INTSEL	NDS	BDP	S	SSOH			3019
NA	NA	NA	NA	6	NA	1	DSTSTPAR	DSTSTPAR	BDD SYSTEM TEST	NDS	BDP	S	SSOH			3001
NA	NA	NA	NA	0	NA	2	DSYSTST	DSYSTST	DELSYSTSTEN&INTERSEL	NDS	BDP	S	SSOH			3019
NA	NA	NA	NA	7	NA	1	DSYSTST	DSYSTST	DELATED SYSTEM TEST	NDS	BDP-IP	S	SSOH			146
NA	NA	NA	NA	0	NA	8	DSYSTSTH	DSYSTSTH	Z&CNTTIMEDELSYSTST	NDS	BDP	S	SSOH			3020
NA	NA	NA	NA	0	NA	8	DSYSTSTL	DSYSTSTL	Z&CNTTIMEDELSYSTST	NDS	BDP	S	SSOH			3021
4	4	54	2	2	3	2	DVFACEA	DVFACEA	DELTA VELOCITY THRUSTER FACE SELECT	TT&C	SPU A	S	Thruster	0=Y 1=X 2=X 3=Z face		Thruster Flag Word 54 (first word)
4	4	62	2	2	3	2	DVFACEB	DVFACEB	DELTA VELOCITY THRUSTER FACE SELECT	TT&C	SPU B	S	Thruster	0=Y 1=X 2=X 3=Z face		Thruster Flag Word 62 (first word)
4	4	54	2	4	5	2	DVTHRA	DVTHRA	DELTA VELOCITY THRUSTER SELECT	TT&C	SPU A	S	Thruster	0=Odd Half 1=Even Half 2=Both Halves		Thruster Flag Word 54 (first word)
4	4	62	2	4	5	2	DVTHRB	DVTHRB	DELTA VELOCITY THRUSTER SELECT	TT&C	SPU B	S	Thruster	0=Even Half 1=Odd Half 2=Both Halves		Thruster Flag Word 62 (first word)
A	1	10	4	4	7	12	DWELADR	DWELADR	DUMP/DWELL ADDRESS FIRST 4 BITS	TT&C	TIU	S	All Power-Up			Dwell Address (first 4 of 12 bits)
A	1	11	8	0	7	12	DWELADR	DWELADR	DUMP/DWELL ADDRESS LAST 8 BITS	TT&C	TIU	S	All Power-Up			Dwell Address (last 8 of 12 bits)
4	4	52	1	1	1	1	EAABRTA	EAABRTA	EARTH ACQUISITION ABORT INDICATOR	TT&C	SPU A	S	Thruster	0=Do Not Abort EA Mode 1=Abort EA Mode		Ground Select Flag Word 52 (first word)
5	4	54	1	1	1	1	EAABRTA	EAABRTA	EARTH ACQUISITION ABORT INDICATOR	TT&C	SPU A	S	Normal	0=Do Not Abort EA Mode 1=Abort EA Mode		Ground Select Flag Word 54 (first word)
5	4	62	1	1	1	1	EAABRTB	EAABRTB	EARTH ACQUISITION ABORT INDICATOR	TT&C	SPU B	S	Thruster	0=Do Not Abort EA Mode 1=Abort EA Mode		Ground Select Flag Word 62 (first word)
4	4	60	1	1	1	1	EAABRTB	EAABRTB	EARTH ACQUISITION ABORT INDICATOR	TT&C	SPU B	S	Thruster	0=Do Not Abort EA Mode 1=Abort EA Mode		Ground Select Flag Word 60 (first word)
8	5	58	8	0	7	8	EAPNLAT	EAPNLAT	EARTH PNL TEMP A	MSS	TCS	AP	All Power-Up			Celsius
3	4	54	1	1	1	1	EARTHILKA	EARTHILKA	EARTH LOCK	TT&C	SPU A	S	Normal	0=No Earth Lock 1=Earth Lock		ADS Flag Word
3	4	62	1	1	1	1	EARTHILKB	EARTHILKB	EARTH LOCK	TT&C	SPU B	S	Normal	0=No Earth Lock 1=Earth Lock		ADS Flag Word
3	4	54	1	2	2	1	ECLIPSEA	ECLIPSEA	ECLIPSE INDICATOR	TT&C	SPU A	S	Normal	0=Not In Eclipse 1=In Eclipse		ADS Flag Word
3	4	62	1	2	2	1	ECLIPSEB	ECLIPSEB	ECLIPSE INDICATOR	TT&C	SPU B	S	Normal	0=Not In Eclipse 1=In Eclipse		ADS Flag Word
NA	NA	NA	NA	0	NA	16	EDATAEND	EDATAEND	SEC E.16 DATAENDADDR	NDS	BDP-MIP	S	SSOH			93
NA	NA	NA	NA	7	NA	1	EEPRGERR	EEPRGERR	EE REPROG STATUS ERR	NDS	BDP-IP	S	SSOH			164
NA	NA	NA	NA	6	NA	1	EEWRTRERR	EEWRTRERR	EE NOTVFLASTPGWRITE	NDS	BDP-IP	S	SSOH			164
A	6	11	1	5	5	1	ELVSEPA	ELVSEPA	ELV/SV SEPARATED A	TT&C	TIU	DL	All Power-Up	1=Not Separated 0=Separated		Word 1 of 2 (first 8 bits)
A	6	10	1	5	5	1	ELVSEPB	ELVSEPB	ELV/SV SEPARATED B	TT&C	TIU	DL	All Power-Up	1=Not Separated 0=Separated		Word 2 of 2 (second 8 bits)
NA	NA	NA	NA	0	NA	1	EMXFRMSG	EMXFRMSG	XFER MSG FLAG EOM	NDS	BDP-MIP	S	SSOH			46
NA	NA	NA	NA	0	NA	8	EOMERROR	EOMERROR	EOM ERROR COUNTER	NDS	BDP-MIP	S	SSOH			42
A	8	14	8	0	7	16	ERRBUFIA	ERRBUFIA	SECOND ELEMENT OF ERROR BUFFER	TT&C	SPU A	S	Power-Up			Word 1 of 2 (first 8 bits)
A	8	15	8	0	7	16	ERRBUFIA	ERRBUFIA	SECOND ELEMENT OF ERROR BUFFER	TT&C	SPU A	S	Power-Up			Word 2 of 2 (second 8 bits)
A	8	22	8	0	7	16	ERRBUFIB	ERRBUFIB	SECOND ELEMENT OF ERROR BUFFER	TT&C	SPU B	S	Power-Up			Word 1 of 2 (first 8 bits)

A	8	23	8	0	7	16	ERRBUF1B	ERRBUF1B	SECOND ELEMENT OF ERROR BUFFER	TT&C	SPU B	S	Power-Up	Word 2 of 2 (second 8 bits)
A	7	14	8	0	7	16	ERRBUFA	ERRBUFA	FIRST ELEMENT OF ERROR BUFFER	TT&C	SPU A	S	Power-Up	Word 1 of 2 (first 8 bits)
A	7	15	8	0	7	16	ERRBUFA	ERRBUFA	FIRST ELEMENT OF ERROR BUFFER	TT&C	SPU A	S	Power-Up	Word 2 of 2 (second 8 bits)
A	7	22	8	0	7	16	ERRBUFB	ERRBUFB	FIRST ELEMENT OF ERROR BUFFER	TT&C	SPU B	S	Power-Up	Word 1 of 2 (first 8 bits)
A	7	23	8	0	7	16	ERRBUFB	ERRBUFB	FIRST ELEMENT OF ERROR BUFFER	TT&C	SPU B	S	Power-Up	Word 2 of 2 (second 8 bits)
A	2	12	8	0	7	16	ERRNUMA	ERRNUMA	NUM ERR IN ERR BUFF SINCE LAST DUMP	TT&C	SPU A	S	Power-Up	Word 1 of 2 (first 8 bits)
A	2	13	8	0	7	16	ERRNUMA	ERRNUMA	NUM ERR IN ERR BUFF SINCE LAST DUMP	TT&C	SPU A	S	Power-Up	Word 2 of 2 (second 8 bits)
A	2	20	8	0	7	16	ERRNUMB	ERRNUMB	NUM ERR IN ERR BUFF SINCE LAST DUMP	TT&C	SPU B	S	Power-Up	Word 1 of 2 (first 8 bits)
A	2	21	8	0	7	16	ERRNUMB	ERRNUMB	NUM ERR IN ERR BUFF SINCE LAST DUMP	TT&C	SPU B	S	Power-Up	Word 2 of 2 (second 8 bits)
A	4	10	1	0	0	1	ESA1HCI	ESA1HCI	ESA 1 HCI ON/OFF	ADS	ESA	DL	All Power-Up	
A	1	40	8	0	7	8	ESA1ORSV	ESA1ORSV	ESA 1 ORS INTEGRATOR VOLTAGE	ADS	ESA	AH	All Power-Up	
2	6	56	8	0	7	8	ESA1RNGT	ESA1RNGT	ESA 1 THERMAL RING TEMP	ADS	ESA	AH	All Power-Up	
A	4	10	1	1	1	1	ESA1STAT	ESA1STAT	ESA 1 STATIC MODE ON/OFF	ADS	ESA	DL	All Power-Up	
A	4	11	1	0	0	1	ESA2HCI	ESA2HCI	ESA 2 HCI ON/OFF	ADS	ESA	DL	All Power-Up	
A	1	48	8	0	7	8	ESA2ORSV	ESA2ORSV	ESA 2 ORS INTEGRATOR VOLTAGE	ADS	ESA	AH	All Power-Up	
5	5	56	8	0	7	8	ESA2RNGT	ESA2RNGT	ESA 2 THERMAL RING TEMP	ADS	ESA	AH	All Power-Up	
A	4	11	1	1	1	1	ESA2STAT	ESA2STAT	ESA 2 STATIC MODE ON/OFF	ADS	ESA	DL	All Power-Up	
4	4	52	1	2	2	1	ESABIASA	ESABIASA	ESA RADIANCE BIAS	TT&C	SPU A	S	Thrustr	Ground Select Flag Word 52 (first word)
5	4	54	1	2	2	1	ESABIASA	ESABIASA	ESA RADIANCE BIAS	TT&C	SPU A	S	Normal	Ground Select Flag Word 54 (first word)
5	4	62	1	2	2	1	ESABIASB	ESABIASB	ESA RADIANCE BIAS	TT&C	SPU B	S	Normal	Ground Select Flag Word 62 (first word)
4	4	60	1	2	2	1	ESABIASB	ESABIASB	ESA RADIANCE BIAS	TT&C	SPU B	S	Thrustr	Ground Select Flag Word 60 (first word)
6	7	54	1	1	1	1	ESADRA	ESADRA	ESA DATA READY	TT&C	SPU A	S	Normal	RDMGMT Flag Word 54 (upper half-first word)
6	5	52	1	1	1	1	ESADRA	ESADRA	ESA DATA READY	TT&C	SPU A	S	Thrustr	RDMGMT Flag Word 52 (upper half-first word)
6	7	62	1	1	1	1	ESADRB	ESADRB	ESA DATA READY	TT&C	SPU B	S	Normal	RDMGMT Flag Word 62 (upper half-first word)
6	5	60	1	1	1	1	ESADRB	ESADRB	ESA DATA READY	TT&C	SPU B	S	Thrustr	RDMGMT Flag Word 60 (upper half-first word)
4	5	52	5	3	7	13	ESAE1A	ESAE1A	ESA E1 DETECTOR OUTPUT (1 OF 2)	ADS	SPU A	S	Normal	Segmented cal curve to volts
4	5	53	8	0	7	13	ESAE1A	ESAE1A	ESA E1 DETECTOR OUTPUT (2 OF 2)	ADS	SPU A	S	Normal	Segmented cal curve to volts
4	5	60	5	3	7	13	ESAE1B	ESAE1B	ESA E1 DETECTOR OUTPUT (1 OF 2)	ADS	SPU B	S	Thrustr	Segmented cal curve to volts
4	5	61	8	0	7	13	ESAE1B	ESAE1B	ESA E1 DETECTOR OUTPUT (2 OF 2)	ADS	SPU B	S	Thrustr	Segmented cal curve to volts
4	7	52	5	3	7	13	ESAE2A	ESAE2A	ESA E2 DETECTOR OUTPUT (1 OF 2)	ADS	SPU A	S	Thrustr	Segmented cal curve to volts

4	7	53	8	0	7	13	ESAE2A	ESAE2A	ESA E2 DETECTOR OUTPUT (2 OF 2)	ADS	SPU A	S	Normal Thruster	volts	Segmented cal curve to volts
4	7	60	5	3	7	13	ESAE2B	ESAE2B	ESA E2 DETECTOR OUTPUT (1 OF 2)	ADS	SPU B	S	Normal Thruster	volts	Segmented cal curve to volts
4	7	61	8	0	7	13	ESAE2B	ESAE2B	ESA E2 DETECTOR OUTPUT (2 OF 2)	ADS	SPU B	S	Normal Thruster	volts	Segmented cal curve to volts
4	5	54	5	3	7	13	ESAE3A	ESAE3A	ESA E3 DETECTOR OUTPUT (1 OF 2)	ADS	SPU A	S	Normal Thruster	volts	Segmented cal curve to volts
4	5	55	8	0	7	13	ESAE3A	ESAE3A	ESA E3 DETECTOR OUTPUT (2 OF 2)	ADS	SPU A	S	Normal Thruster	volts	Segmented cal curve to volts
4	5	62	5	3	7	13	ESAE3B	ESAE3B	ESA E3 DETECTOR OUTPUT (1 OF 2)	ADS	SPU B	S	Normal Thruster	volts	Segmented cal curve to volts
4	5	63	8	0	7	13	ESAE3B	ESAE3B	ESA E3 DETECTOR OUTPUT (2 OF 2)	ADS	SPU B	S	Normal Thruster	volts	Segmented cal curve to volts
4	7	54	5	3	7	13	ESAE4A	ESAE4A	ESA E4 DETECTOR OUTPUT (1 OF 2)	ADS	SPU A	S	Normal Thruster	volts	Segmented cal curve to volts
4	7	55	8	0	7	13	ESAE4A	ESAE4A	ESA E4 DETECTOR OUTPUT (2 OF 2)	ADS	SPU A	S	Normal Thruster	volts	Segmented cal curve to volts
4	7	62	5	3	7	13	ESAE4B	ESAE4B	ESA E4 DETECTOR OUTPUT (1 OF 2)	ADS	SPU B	S	Normal Thruster	volts	Segmented cal curve to volts
4	7	63	8	0	7	13	ESAE4B	ESAE4B	ESA E4 DETECTOR OUTPUT (2 OF 2)	ADS	SPU B	S	Normal Thruster	volts	Segmented cal curve to volts
4	6	52	5	3	7	13	ESAE5A	ESAE5A	ESA E5 DETECTOR OUTPUT (1 OF 2)	ADS	SPU A	S	Normal Thruster	volts	Segmented cal curve to volts
4	6	53	8	0	7	13	ESAE5A	ESAE5A	ESA E5 DETECTOR OUTPUT (2 OF 2)	ADS	SPU A	S	Normal Thruster	volts	Segmented cal curve to volts
4	6	60	5	3	7	13	ESAE5B	ESAE5B	ESA E5 DETECTOR OUTPUT (1 OF 2)	ADS	SPU B	S	Normal Thruster	volts	Segmented cal curve to volts
4	6	61	8	0	7	13	ESAE5B	ESAE5B	ESA E5 DETECTOR OUTPUT (2 OF 2)	ADS	SPU B	S	Normal Thruster	volts	Segmented cal curve to volts
4	8	52	5	3	7	13	ESAE6A	ESAE6A	ESA E6 DETECTOR OUTPUT (1 OF 2)	ADS	SPU A	S	Normal Thruster	volts	Segmented cal curve to volts
4	8	53	8	0	7	13	ESAE6A	ESAE6A	ESA E6 DETECTOR OUTPUT (2 OF 2)	ADS	SPU A	S	Normal Thruster	volts	Segmented cal curve to volts
4	8	60	5	3	7	13	ESAE6B	ESAE6B	ESA E6 DETECTOR OUTPUT (1 OF 2)	ADS	SPU B	S	Normal Thruster	volts	Segmented cal curve to volts
4	8	61	8	0	7	13	ESAE6B	ESAE6B	ESA E6 DETECTOR OUTPUT (2 OF 2)	ADS	SPU B	S	Normal Thruster	volts	Segmented cal curve to volts
4	6	54	5	3	7	13	ESAE7A	ESAE7A	ESA E7 DETECTOR OUTPUT (1 OF 2)	ADS	SPU A	S	Normal Thruster	volts	Segmented cal curve to volts
4	6	55	8	0	7	13	ESAE7A	ESAE7A	ESA E7 DETECTOR OUTPUT (2 OF 2)	ADS	SPU A	S	Normal Thruster	volts	Segmented cal curve to volts
4	6	62	5	3	7	13	ESAE7B	ESAE7B	ESA E7 DETECTOR OUTPUT (1 OF 2)	ADS	SPU B	S	Normal Thruster	volts	Segmented cal curve to volts
4	6	63	8	0	7	13	ESAE7B	ESAE7B	ESA E7 DETECTOR OUTPUT (2 OF 2)	ADS	SPU B	S	Normal Thruster	volts	Segmented cal curve to volts
4	8	54	5	3	7	13	ESAE8A	ESAE8A	ESA E8 DETECTOR OUTPUT (1 OF 2)	ADS	SPU A	S	Normal Thruster	volts	Segmented cal curve to volts
4	8	55	8	0	7	13	ESAE8A	ESAE8A	ESA E8 DETECTOR OUTPUT (2 OF 2)	ADS	SPU A	S	Normal Thruster	volts	Segmented cal curve to volts
4	8	62	5	3	7	13	ESAE8B	ESAE8B	ESA E8 DETECTOR OUTPUT (1 OF 2)	ADS	SPU B	S	Normal Thruster	volts	Segmented cal curve to volts
4	8	63	8	0	7	13	ESAE8B	ESAE8B	ESA E8 DETECTOR OUTPUT (2 OF 2)	ADS	SPU B	S	Normal Thruster	volts	Segmented cal curve to volts
6	8	52	1	3	3	1	ESAENA	ESAENA	EARTH SENSOR ASSEMBLY	TT&C	SPU A	S	Normal		Segmented cal curve to volts RDMGMT Flag Word 52 (lower half-first word)

7	4	54	1	3	3	1	ESAENA	ESAENA	ESAENA	EARTH SENSOR ASSEMBLY	TT&C	SPUA	S	Thruster		0=Disabled 1=Enabled	RDMGMT Flag Word 54 (lower half-first word)
6	8	60	1	3	3	1	ESAENB	ESAENB	ESAENB	EARTH SENSOR ASSEMBLY	TT&C	SPUB	S	Normal		0=Disabled 1=Enabled	RDMGMT Flag Word 60 (lower half-first word)
7	4	62	1	3	3	1	ESAENB	ESAENB	ESAENB	EARTH SENSOR ASSEMBLY	TT&C	SPUB	S	Thruster		0=Disabled 1=Enabled	RDMGMT Flag Word 62 (lower half-first word)
6	7	54	1	2	2	1	ESALOCKA	ESALOCKA	ESALOCKA	ESA EARTH LOCK LOST	TT&C	SPUA	S	Normal		0=Test Disabled 1=Test Enabled	RDMGMT Flag Word 54 (upper half-first word)
6	5	52	1	2	2	1	ESALOCKA	ESALOCKA	ESALOCKA	ESA EARTH LOCK LOST	TT&C	SPUA	S	Thruster		0=Test Disabled 1=Test Enabled	RDMGMT Flag Word 52 (upper half-first word)
6	7	62	1	2	2	1	ESALOCKB	ESALOCKB	ESALOCKB	ESA EARTH LOCK LOST	TT&C	SPUB	S	Normal		0=Test Disabled 1=Test Enabled	RDMGMT Flag Word 62 (upper half-first word)
6	5	60	1	2	2	1	ESALOCKB	ESALOCKB	ESALOCKB	ESA EARTH LOCK LOST	TT&C	SPUB	S	Thruster		0=Test Disabled 1=Test Enabled	RDMGMT Flag Word 60 (upper half-first word)
A	6	14	8	0	7	16	ESAPITA	ESAPITA	ESAPITA	FILTERED ESA PITCH OUTPUT (1 OF 2)	ADS	SPUA	S	Normal			
A	6	15	8	0	7	16	ESAPITA	ESAPITA	ESAPITA	FILTERED ESA PITCH OUTPUT (2 OF 2)	ADS	SPUA	S	Normal			
A	1	54	8	0	7	16	ESAPITA	ESAPITA	ESAPITA	FILTERED ESA PITCH OUTPUT (1 OF 2)	ADS	SPUA	S	Thruster			
A	1	55	8	0	7	16	ESAPITA	ESAPITA	ESAPITA	FILTERED ESA PITCH OUTPUT (2 OF 2)	ADS	SPUA	S	Thruster			
A	6	22	8	0	7	16	ESAPITB	ESAPITB	ESAPITB	FILTERED ESA PITCH OUTPUT (1 OF 2)	ADS	SPUB	S	Normal			
A	6	23	8	0	7	16	ESAPITB	ESAPITB	ESAPITB	FILTERED ESA PITCH OUTPUT (2 OF 2)	ADS	SPUB	S	Normal			
A	1	62	8	0	7	16	ESAPITB	ESAPITB	ESAPITB	FILTERED ESA PITCH OUTPUT (1 OF 2)	ADS	SPUB	S	Thruster			
A	1	63	8	0	7	16	ESAPITB	ESAPITB	ESAPITB	FILTERED ESA PITCH OUTPUT (2 OF 2)	ADS	SPUB	S	Thruster			
A	5	14	8	0	7	16	ESAROLA	ESAROLA	ESAROLA	FILTERED ESA ROLL OUTPUT (1 OF 2)	ADS	SPUA	S	Normal			
A	5	15	8	0	7	16	ESAROLA	ESAROLA	ESAROLA	FILTERED ESA ROLL OUTPUT (2 OF 2)	ADS	SPUA	S	Normal			
A	1	52	8	0	7	16	ESAROLA	ESAROLA	ESAROLA	FILTERED ESA ROLL OUTPUT (1 OF 2)	ADS	SPUA	S	Thruster			
A	1	53	8	0	7	16	ESAROLA	ESAROLA	ESAROLA	FILTERED ESA ROLL OUTPUT (2 OF 2)	ADS	SPUA	S	Thruster			
A	5	22	8	0	7	16	ESAROLB	ESAROLB	ESAROLB	FILTERED ESA ROLL OUTPUT (1 OF 2)	ADS	SPUB	S	Normal			
A	5	23	8	0	7	16	ESAROLB	ESAROLB	ESAROLB	FILTERED ESA ROLL OUTPUT (2 OF 2)	ADS	SPUB	S	Normal			
A	1	60	8	0	7	16	ESAROLB	ESAROLB	ESAROLB	FILTERED ESA ROLL OUTPUT (1 OF 2)	ADS	SPUB	S	Thruster			
A	1	61	8	0	7	16	ESAROLB	ESAROLB	ESAROLB	FILTERED ESA ROLL OUTPUT (2 OF 2)	ADS	SPUB	S	Thruster			
5	5	52	5	3	7	13	ESAS1A	ESAS1A	ESAS1A	ESA S1 DETECTOR OUTPUT (1 OF 2)	ADS	SPUA	S	Normal			Segmented cal curve to volts
5	5	53	8	0	7	13	ESAS1A	ESAS1A	ESAS1A	ESA S1 DETECTOR OUTPUT (2 OF 2)	ADS	SPUA	S	Normal			Segmented cal curve to volts
5	5	60	5	3	7	13	ESAS1B	ESAS1B	ESAS1B	ESA S1 DETECTOR OUTPUT (1 OF 2)	ADS	SPUB	S	Normal			Segmented cal curve to volts
5	5	61	8	0	7	13	ESAS1B	ESAS1B	ESAS1B	ESA S1 DETECTOR OUTPUT (2 OF 2)	ADS	SPUB	S	Normal			Segmented cal curve to volts
5	7	52	5	3	7	13	ESAS2A	ESAS2A	ESAS2A	ESA S2 DETECTOR OUTPUT (1 OF 2)	ADS	SPUA	S	Normal			Segmented cal curve to volts

5	7	53	8	0	7	13	ESAS2A	ESAS2A	ESA S2 DETECTOR OUTPUT OF 2)	(2	ADS	SPU A	S	Normal Thrustor	volts	Segmented cal curve to volts
5	7	60	5	3	7	13	ESAS2B	ESAS2B	ESA S2 DETECTOR OUTPUT OF 2)	(1	ADS	SPU B	S	Normal Thrustor	volts	Segmented cal curve to volts
5	7	61	8	0	7	13	ESAS2B	ESAS2B	ESA S2 DETECTOR OUTPUT OF 2)	(2	ADS	SPU B	S	Normal Thrustor	volts	Segmented cal curve to volts
5	5	54	5	3	7	13	ESAS3A	ESAS3A	ESA S3 DETECTOR OUTPUT OF 2)	(1	ADS	SPU A	S	Normal Thrustor	volts	Segmented cal curve to volts
5	5	55	8	0	7	13	ESAS3A	ESAS3A	ESA S3 DETECTOR OUTPUT OF 2)	(2	ADS	SPU A	S	Normal Thrustor	volts	Segmented cal curve to volts
5	5	62	5	3	7	13	ESAS3B	ESAS3B	ESA S3 DETECTOR OUTPUT OF 2)	(1	ADS	SPU B	S	Normal Thrustor	volts	Segmented cal curve to volts
5	5	63	8	0	7	13	ESAS3B	ESAS3B	ESA S3 DETECTOR OUTPUT OF 2)	(2	ADS	SPU B	S	Normal Thrustor	volts	Segmented cal curve to volts
5	7	54	5	3	7	13	ESAS4A	ESAS4A	ESA S4 DETECTOR OUTPUT OF 2)	(1	ADS	SPU A	S	Normal Thrustor	volts	Segmented cal curve to volts
5	7	55	8	0	7	13	ESAS4A	ESAS4A	ESA S4 DETECTOR OUTPUT OF 2)	(2	ADS	SPU A	S	Normal Thrustor	volts	Segmented cal curve to volts
5	7	62	5	3	7	13	ESAS4B	ESAS4B	ESA S4 DETECTOR OUTPUT OF 2)	(1	ADS	SPU B	S	Normal Thrustor	volts	Segmented cal curve to volts
5	7	63	8	0	7	13	ESAS4B	ESAS4B	ESA S4 DETECTOR OUTPUT OF 2)	(2	ADS	SPU B	S	Normal Thrustor	volts	Segmented cal curve to volts
5	6	52	5	3	7	13	ESAS5A	ESAS5A	ESA S5 DETECTOR OUTPUT OF 2)	(1	ADS	SPU A	S	Normal Thrustor	volts	Segmented cal curve to volts
5	6	53	8	0	7	13	ESAS5A	ESAS5A	ESA S5 DETECTOR OUTPUT OF 2)	(2	ADS	SPU A	S	Normal Thrustor	volts	Segmented cal curve to volts
5	6	60	5	3	7	13	ESAS5B	ESAS5B	ESA S5 DETECTOR OUTPUT OF 2)	(1	ADS	SPU B	S	Normal Thrustor	volts	Segmented cal curve to volts
5	6	61	8	0	7	13	ESAS5B	ESAS5B	ESA S5 DETECTOR OUTPUT OF 2)	(2	ADS	SPU B	S	Normal Thrustor	volts	Segmented cal curve to volts
5	8	52	5	3	7	13	ESAS6A	ESAS6A	ESA S6 DETECTOR OUTPUT OF 2)	(1	ADS	SPU A	S	Normal Thrustor	volts	Segmented cal curve to volts
5	8	53	8	0	7	13	ESAS6A	ESAS6A	ESA S6 DETECTOR OUTPUT OF 2)	(2	ADS	SPU A	S	Normal Thrustor	volts	Segmented cal curve to volts
5	8	60	5	3	7	13	ESAS6B	ESAS6B	ESA S6 DETECTOR OUTPUT OF 2)	(1	ADS	SPU B	S	Normal Thrustor	volts	Segmented cal curve to volts
5	8	61	8	0	7	13	ESAS6B	ESAS6B	ESA S6 DETECTOR OUTPUT OF 2)	(2	ADS	SPU B	S	Normal Thrustor	volts	Segmented cal curve to volts
5	6	54	5	3	7	13	ESAS7A	ESAS7A	ESA S7 DETECTOR OUTPUT OF 2)	(1	ADS	SPU A	S	Normal Thrustor	volts	Segmented cal curve to volts
5	6	55	8	0	7	13	ESAS7A	ESAS7A	ESA S7 DETECTOR OUTPUT OF 2)	(2	ADS	SPU A	S	Normal Thrustor	volts	Segmented cal curve to volts
5	6	62	5	3	7	13	ESAS7B	ESAS7B	ESA S7 DETECTOR OUTPUT OF 2)	(1	ADS	SPU B	S	Normal Thrustor	volts	Segmented cal curve to volts
5	6	63	8	0	7	13	ESAS7B	ESAS7B	ESA S7 DETECTOR OUTPUT OF 2)	(2	ADS	SPU B	S	Normal Thrustor	volts	Segmented cal curve to volts
5	8	54	5	3	7	13	ESAS8A	ESAS8A	ESA S8 DETECTOR OUTPUT OF 2)	(1	ADS	SPU A	S	Normal Thrustor	volts	Segmented cal curve to volts
5	8	55	8	0	7	13	ESAS8A	ESAS8A	ESA S8 DETECTOR OUTPUT OF 2)	(2	ADS	SPU A	S	Normal Thrustor	volts	Segmented cal curve to volts
5	8	62	5	3	7	13	ESAS8B	ESAS8B	ESA S8 DETECTOR OUTPUT OF 2)	(1	ADS	SPU B	S	Normal Thrustor	volts	Segmented cal curve to volts
5	8	63	8	0	7	13	ESAS8B	ESAS8B	ESA S8 DETECTOR OUTPUT OF 2)	(2	ADS	SPU B	S	Normal Thrustor	volts	Segmented cal curve to volts
4	4	54	2	6	7	2	ESASUBMA	ESASUBMA	ESA SUBMODE		TT&C	SPU A	S	Normal		Mode Flag Word

0=Null No Earth  
1=Acquisition Process  
2=Normal Process

3	4	52	2	6	7	2	ESASUBMA	ESASUBMA	ESASUBMA	ESA SUBMODE	TT&C	SPU A	S	Thruster	0=Null No Earth 1=Acquisition Process 2=Normal Process	Mode Flag Word
4	4	62	2	6	7	2	ESASUBMB	ESASUBMB	ESASUBMODE	TT&C	SPU B	S	Normal	0=Null No Earth 1=Acquisition Process 2=Normal Process	Mode Flag Word	
3	4	60	2	6	7	2	ESASUBMB	ESASUBMB	ESASUBMODE	TT&C	SPU B	S	Thruster	0=Null No Earth 1=Acquisition Process 2=Normal Process	Mode Flag Word	
A	6	10	1	4	4	1	EVEN2PWR	EVEN2PWR	REA EVEN 0.2 LB POWER ENABLED	RCS	REA	DL	All Power-Up	1=Disabled 0=Enabled		
A	6	10	1	0	0	1	EVEN2X	EVEN2X	REA EVEN 0.2 LB X ENABLED	RCS	REA	DL	All Power-Up	1=Disabled 0=Enabled		
A	6	10	1	1	1	1	EVEN2Y	EVEN2Y	REA EVEN 0.2 LB Y ENABLED	RCS	REA	DL	All Power-Up	1=Disabled 0=Enabled		
A	6	10	1	6	6	1	EVEN5PWR	EVEN5PWR	REA EVEN 5.0 LB POWER ENABLED	RCS	REA	DL	All Power-Up	1=Disabled 0=Enabled		
A	6	10	1	2	2	1	EVEN5Z	EVEN5Z	REA EVEN 5.0 LB Z ENABLED	RCS	REA	DL	All Power-Up	1=Disabled 0=Enabled		
A	7	12	8	0	7	16	EVENTNA	EVENTNA	NUM OF GLOBAL EVENTS DUR	TT&C	SPU A	S	Power-Up	counts	Word 1 of 2 (first 8 bits)	
A	7	13	8	0	7	16	EVENTNA	EVENTNA	BOOT	TT&C	SPU A	S	Power-Up	counts	Word 2 of 2 (second 8 bits)	
A	7	20	8	0	7	16	EVENTNB	EVENTNB	NUM OF GLOBAL EVENTS DUR	TT&C	SPU B	S	Power-Up	counts	Word 1 of 2 (first 8 bits)	
A	7	21	8	0	7	16	EVENTNB	EVENTNB	BOOT	TT&C	SPU B	S	Power-Up	counts	Word 2 of 2 (second 8 bits)	
NA	NA	NA	NA	0	NA	1	EVIL3RO	EVIL3RO	L3 OP FLAG EV 1	NDS	BDP-MP	S	SSOH	counts	49	
NA	NA	NA	NA	3	NA	1	EVMEPNT	EVMEPNT	CLEAR EVMEM&RSTPOINT	NDS	BDP	S	SSOH	counts	3066	
A	6	10	1	3	3	1	EVNCBTR	EVNCBTR	REA EVEN CATBED HEATER	RCS	REA	DL	All Power-Up	1=Disabled 0=Enabled		
NA	NA	NA	NA	1	NA	1	EVSC3RO	EVSC3RO	L3 OP FLAG EV SCHEM	NDS	BDP-MP	S	SSOH	counts	49	
NA	NA	NA	NA	0	NA	2	EVTSTORE	EVTSTORE	STORE ALL DATA	NDS	BDP	S	SSOH	counts	3013	
NA	NA	NA	NA	0	NA	16	FDATAEND	FDATAEND	SEC F,16 DATA/ENDADDR	NDS	BDP-MP	S	SSOH	counts	95	
NA	NA	NA	NA	5	NA	1	FIFORST	FIFORST	PARALLEL FIFO RESET	NDS	BDP	S	SSOH	counts	3010	
NA	NA	NA	NA	4	NA	4	FREQSET	FREQSET	QFMODE=1, FREQ SETTING	NDS	BDP	S	SSOH	counts	3063	
4	5	27	8	0	7	8	FS1CAVO	FS1CAVO	FREQ STD1 RB CAVITY OVEN	TNP	RAFS	AH	All Power-Up	volts		
4	4	27	8	0	7	8	FS1FILTO	FS1FILTO	FREQ STD1 RB FILTER OVEN	TNP	RAFS	AH	All Power-Up	volts		
4	1	27	8	0	7	8	FS1LITE	FS1LITE	FREQ STD1 RB DC LIGHT	TNP	RAFS	AH	All Power-Up	volts		
4	3	27	8	0	7	8	FS1LMPO	FS1LMPO	FREQ STD1 RB LAMP OVEN	TNP	RAFS	AH	All Power-Up	volts		
A	7	41	1	1	1	1	FS1PWR	FS1PWR	RAFS 1 28 VDC ON/OFF	TNP	RAFS	DL	All Power-Up	1=On 0=Off		
4	2	27	8	0	7	8	FS1VCXOV	FS1VCXOV	FREQ STD1 VCXO CNTRL COLT	TNP	RAFS	AH	All Power-Up	volts		
7	4	27	8	0	7	8	FS2CAVO	FS2CAVO	FREQ STD2 RB CAVITY OVEN	TNP	RAFS	AH	All Power-Up	volts		
5	7	27	8	0	7	8	FS2FILTO	FS2FILTO	FREQ STD2 RB FILTER OVEN	TNP	RAFS	AH	All Power-Up	volts		
5	4	27	8	0	7	8	FS2LITE	FS2LITE	FREQ STD2 RB DC LIGHT	TNP	RAFS	AH	All Power-Up	volts		
5	6	27	8	0	7	8	FS2LMPO	FS2LMPO	FREQ STD2 RB LAMP OVEN	TNP	RAFS	AH	All Power-Up	volts		
A	7	42	1	1	1	1	FS2PWR	FS2PWR	RAFS 2 28 VDC ON/OFF	TNP	RAFS	DL	All Power-Up	1=On 0=Off		
5	5	27	8	0	7	8	FS2VCXOV	FS2VCXOV	FREQ STD2 VCXO CNTRL VOLT	TNP	RAFS	AH	All Power-Up	volts		
A	7	42	1	0	0	1	FS3HTR	FS3HTR	CAFS HEATER 28 VDC ON/OFF	TNP	CAFS	DL	All Power-Up	1=On 0=Off		
A	7	41	1	0	0	1	FS3PWR	FS3PWR	CAFS 28 VDC ON/OFF	TNP	CAFS	DL	All Power-Up	1=On 0=Off		
A	5	10	1	7	7	1	FSS1CEP	FSS1CEP	FSS 1 CEP STATUS	ADS	FSS	DL	All Power-Up	1=CEP	Not displayed, used for	
A	4	40	8	0	7	8	FSS1COSV	FSS1COSV	FSS 1 FINE COSINE VOLTAGE	ADS	FSS	AH	All Power-Up	0=No CEP	SPINRT	

A	5	10	7	0	6	7	FSS1CRSE	FSS1CRSE	FSS 1 COARSE SUN ANGLE GRAY CODE	ADS	FSS	DL	All Power-Up	Gray Code equivalent value	Not displayed, used for SUNZ-lookup
A	3	16	1	6	6	1	FSS1PWR	FSS1PWR	FSS-1 28VDC ON/OFF	ADS	FSS	S	All Power-Up	1=On 0=Off	
A	2	40	8	0	7	8	FSS1REFV	FSS1REFV	FSS1 FINE REF BIAS VOLTAGE	ADS	FSS	AH	All Power-Up	volts	
A	3	40	8	0	7	8	FSS1SINV	FSS1SINV	FSS 1 FINE SINE VOLTAGE	ADS	FSS	AH	All Power-Up	volts	
A	5	11	1	7	7	1	FSS2CEP	FSS2CEP	FSS 2 CEP STATUS	ADS	FSS	DL	All Power-Up	1=CEP 0=No CEP	Not displayed, used for SPINRT
A	4	48	8	0	7	8	FSS2COSV	FSS2COSV	FSS 2 FINE COSINE VOLTAGE	ADS	FSS	AH	All Power-Up	volts	
A	5	11	7	0	6	7	FSS2CRSE	FSS2CRSE	FSS 2 COARSE SUN ANGLE GRAY CODE	ADS	FSS	DL	All Power-Up	Gray Code equivalent value	Not displayed, used for SUNZ-lookup
A	4	16	1	6	6	1	FSS2PWR	FSS2PWR	FSS-2 28 VDC ON/OFF	ADS	FSS	S	All Power-Up	1=On 0=Off	
A	2	48	8	0	7	8	FSS2REFV	FSS2REFV	FSS 2 FINE REF VOLTAGE	ADS	FSS	AH	All Power-Up	volts	
A	3	48	8	0	7	8	FSS2SINV	FSS2SINV	FSS 2 FINE SINE VOLTAGE	ADS	FSS	AH	All Power-Up	volts	
A	1	41	1	4	4	1	FSUNRM	FSUNRM	MDU CONV A TO VCXO/FSU A (AND B TO B) NORM	TNP	MDU	DL	All Power-Up	1=Normal 0=Xstrap	
A	1	42	1	4	4	1	FSUXST	FSUXST	MDU CONV B TO VCXO/FSU A (AND A TO B) XSTRAP	TNP	MDU	DL	All Power-Up	1=Normal 0=Xstrap	
NA	NA	NA	NA	3	NA	1	GBDDATA	GBDDATA	BDD DATA DISABLE	NDS	BDP	S	SSOH		2981
NA	NA	NA	NA	4	NA	1	GBDPDATA	GBDPDATA	BDP DATA DISABLE	NDS	BDP	S	SSOH		2981
NA	NA	NA	NA	4	NA	1	GBWDATA	GBWDATA	BDW DATA DISABLE	NDS	BDP	S	SSOH		2981
NA	NA	NA	NA	0	NA	1	GBDWPAP	GBDWPAP	BDW PARITY FLAG	NDS	BDP	S	SSOH		2980
NA	NA	NA	NA	2	NA	1	GBDXDATA	GBDXDATA	BDX DATA DISABLE	NDS	BDP	S	SSOH		2981
NA	NA	NA	NA	1	NA	1	GBDYDATA	GBDYDATA	BDY DATA DISABLE	NDS	BDP	S	SSOH		2981
NA	NA	NA	NA	0	NA	8	GD-5.25V	GD-5.25V	DIG -5.25 VDC SWITCH	NDS	GDR	S	SSOH		366
NA	NA	NA	NA	0	NA	1	GDEERFEN	GDEERFEN	EN GDR EEPROM REFRES	NDS	BDP	S	SSOH		2992
8	2	24	8	0	7	8	GDR+10V	GDRP10V	GDR DIGITAL +10 VDC	NDS	GDR	S	All Power-Up	volts	SSOH Byte 3439
NA	NA	NA	NA	0	NA	8	GDR+28V	GDRP28V	GDR +28 VDC	NDS	GDR	S	SSOH		365
8	4	24	8	0	7	8	GDR+5.25	GDRP525V	GDR DIGITAL +5.25 VDC	NDS	GDR	S	All Power-Up	volts	SSOH Byte 3437
8	5	24	8	0	7	8	GDR+7V	GDRP7V	GDR RF +7 VDC	NDS	GDR	S	All Power-Up	volts	SSOH Byte 3441
8	3	24	8	0	7	8	GDR-10V	GDRM10V	GDR DIGITAL -10 VDC	NDS	GDR	S	All Power-Up	volts	SSOH Byte 3440
8	1	24	8	0	7	8	GDR-5.25	GDRM525V	GDR DIGITAL -5.25 VDC	NDS	GDR	S	All Power-Up	volts	SSOH Byte 3438
8	6	24	8	0	7	8	GDR-7V	GDRM7V	GDR RF -7 VDC	NDS	GDR	S	All Power-Up	volts	SSOH Byte 3443
NA	NA	NA	NA	0	NA	8	GDRAPWR	GDRAPWR	DIG ARIES PWRSETTING	NDS	GDR	S	SSOH		372
NA	NA	NA	NA	0	NA	8	GDRASTAT	GDRASTAT	ARIES STATE 1	NDS	GDR	S	SSOH		373
NA	NA	NA	NA	2	NA	14	GDRBDYC	GDRBDYC	NPMS BDY BYTES/IEPOCHCNT	NDS	GDR	S	SSOH		375
7	7	24	8	0	7	8	GDRC	GDRC	GDR CURRENT	NDS	GDR	S	All Power-Up	amps	SSOH Byte 3436
NA	NA	NA	NA	0	NA	8	GDRCMDER	GDRCMDER	COMMAND ERROR COUNT	NDS	GDR	S	SSOH		382
NA	NA	NA	NA	5	NA	1	GDRCMRST	GDRCMRST	RESET GDR SET COMMANDS	NDS	BDP	S	SSOH		2977
NA	NA	NA	NA	3	NA	1	GDRCONER	GDRCONER	IP GDR GIM CNTRL FLG	NDS	BDP-IP	S	SSOH		145
A	1	64	1	3	3	1	GDRDATA	GDRDATA	BDP GDR DATA I/O	NDS	GDR	S	All Power-Up	0=Output 1=Input	SSOH Byte 31 L3 Format
NA	NA	NA	NA	0	NA	8	GDRDATER	GDRDATER	SERIAL DATA ERR CNT	NDS	GDR	S	SSOH		381
NA	NA	NA	NA	0	NA	8	GDRDPST	GDRDPST	DIGITAL PWR SUPPLY TEMP	NDS	GDR	S	SSOH		367
NA	NA	NA	NA	0	NA	1	GDRREERF	GDRREERF	GDR EEPROM REFRESH	NDS	BDP	S	SSOH		2993
NA	NA	NA	NA	7	NA	1	GDRREOMER	GDRREOMER	GDR EOM ERROR FLAG	NDS	BDP-IP	S	SSOH		158
NA	NA	NA	NA	6	NA	1	GDRFLRST	GDRFLRST	RST GDR POINTERS & FLGS	NDS	BDP	S	SSOH		2977
NA	NA	NA	NA	6	NA	1	GDRFLUNC	GDRFLUNC	DISABLE GDR FUNCTIONS	NDS	BDP	S	SSOH		3010
NA	NA	NA	NA	6	NA	1	GDRGIMAC	GDRGIMAC	GIM RESET ACKNOW-GDR	NDS	BDP-IP	S	SSOH		174
NA	NA	NA	NA	5	NA	1	GDRGIMRQ	GDRGIMRQ	GIM RESET REQ-GDR	NDS	BDP-IP	S	SSOH		174
NA	NA	NA	NA	3	NA	1	GDRGMECK	GDRGMECK	ENABLE GDR GIM ERR CHK	NDS	BDP	S	SSOH		2980
NA	NA	NA	NA	2	NA	1	GDRGMPAR	GDRGMPAR	SELECT GDR CHAN PARITY	NDS	BDP	S	SSOH		2980
NA	NA	NA	NA	1	NA	1	GDRGMRST	GDRGMRST	GDR CHANNEL GIM RESET	NDS	BDP	S	SSOH		2980
NA	NA	NA	NA	4	NA	1	GDRINIT	GDRINIT	GDR PROCESSOR INIT	NDS	BDP	S	SSOH		3009
NA	NA	NA	NA	5	NA	1	GDRITYPE	GDRITYPE	GDR PROCESSORINITSEL	NDS	BDP	S	SSOH		3009

NA	NA	NA	NA	5	NA	1	GDRL4ARM	L4 EED ARM	GDR4ARM	GDR4ARM	NDS	GDR	S	SSOH	374
NA	NA	NA	NA	7	NA	1	GDRL4DEP	L4 DEPLOYED	GDRL4DEP	GDRL4DEP	NDS	GDR	S	SSOH	374
NA	NA	NA	NA	4	NA	1	GDRL4ENA	L4 EED ENABLE	GDRL4ENA	GDRL4ENA	NDS	GDR	S	SSOH	374
NA	NA	NA	NA	6	NA	1	GDRL4STO	L4 STOWED	GDRL4STO	GDRL4STO	NDS	GDR	S	SSOH	374
NA	NA	NA	NA	0	NA	8	GDRMPWR	DIG NUC DETMONPWRSET	GDRMPWR	GDRMPWR	NDS	GDR	S	SSOH	371
NA	NA	NA	NA	0	NA	1	GDRMRO	DISABLE GDR MRO MSGS	GDRMRO	GDRMRO	NDS	BDP	S	SSOH	2980
NA	NA	NA	NA	0	NA	8	GDROPNP	OP NOT PERFORMED CNT	GDROPNP	GDROPNP	NDS	GDR	S	SSOH	383
NA	NA	NA	NA	7	NA	1	GDRPAR	GDR PARITY ENABLE	GDRPAR	GDRPAR	NDS	BDP-IP	S	SSOH	147
NA	NA	NA	NA	6	NA	1	GDRPAROE	GDR ODD/EVEN PARITY	GDRPAROE	GDRPAROE	NDS	BDP-IP	S	SSOH	147
NA	NA	NA	NA	7	NA	1	GDRPROIN	RECENT PROC INIT-GDR	GDRPROIN	GDRPROIN	NDS	BDP-IP	S	SSOH	174
8	7	24	8	0	7	8	GDRPSAV7	GDR POWER SUPPLY A 7 VDC	GDRPSAV7	GDRPSAV7	NDS	GDR	S	All Power-Up	SSOH Byte 3444
8	8	24	8	0	7	8	GDRPSB7V	GDR POWER SUPPLY B 7 VDC	GDRPSB7V	GDRPSB7V	NDS	GDR	S	All Power-Up	SSOH Byte 3445
NA	NA	NA	NA	7	NA	1	GDRRECER	IP GDR GIM ERROR FLG	GDRRECER	GDRRECER	NDS	BDP-IP	S	SSOH	145
NA	NA	NA	NA	0	NA	4	GDRRFPST	RF POWER SUPPLY TEMP	GDRRFPST	GDRRFPST	NDS	GDR	S	SSOH	368
NA	NA	NA	NA	4	NA	1	GDRSHRCV	GDR SOH RECEIVAL CNT	GDRSHRCV	GDRSHRCV	NDS	BDP-IP	S	SSOH	150
NA	NA	NA	NA	4	NA	1	GDRSLCT	GDR SELECTION	GDRSLCT	GDRSLCT	NDS	BDP	S	SSOH	2988
NA	NA	NA	NA	6	NA	1	GDRSOH	DISABLE GDR SOH MSGS	GDRSOH	GDRSOH	NDS	BDP	S	SSOH	2980
NA	NA	NA	NA	4	NA	1	GDRSOHSD	SEND GDR SOH	GDRSOHSD	GDRSOHSD	NDS	BDP	S	SSOH	2980
NA	NA	NA	NA	7	NA	1	GDRSTAT	DISABLE GDR STAT MSG	GDRSTAT	GDRSTAT	NDS	BDP	S	SSOH	2980
NA	NA	NA	NA	0	NA	8	GDRSTAT1	DIGITAL STATE 1	GDRSTAT1	GDRSTAT1	NDS	GDR	S	SSOH	377
NA	NA	NA	NA	0	NA	8	GDRSTAT2	DIGITAL STATE 2	GDRSTAT2	GDRSTAT2	NDS	GDR	S	SSOH	378
NA	NA	NA	NA	0	NA	8	GDRSTAT3	DIGITAL STATE 3	GDRSTAT3	GDRSTAT3	NDS	GDR	S	SSOH	379
NA	NA	NA	NA	0	NA	8	GDRSTAT4	DIGITAL STATE 4	GDRSTAT4	GDRSTAT4	NDS	GDR	S	SSOH	380
NA	NA	NA	NA	7	NA	1	GDRSTST	ENABLE GDR SYSTEM TEST	GDRSTST	GDRSTST	NDS	BDP	S	SSOH	2984
NA	NA	NA	NA	1	NA	1	GDRSYLK1	SYNTH LOCK 1	GDRSYLK1	GDRSYLK1	NDS	GDR	S	SSOH	374
NA	NA	NA	NA	2	NA	1	GDRSYLK2	SYNTH LOCK 2	GDRSYLK2	GDRSYLK2	NDS	GDR	S	SSOH	374
NA	NA	NA	NA	3	NA	1	GDRSYLK3	SYNTH LOCK 3	GDRSYLK3	GDRSYLK3	NDS	GDR	S	SSOH	374
NA	NA	NA	NA	0	NA	8	GDRTPWR	BOX TEMPERATURE	GDRTPWR	GDRTPWR	NDS	GDR	S	SSOH	369
NA	NA	NA	NA	0	NA	8	GDRUPLD	DIG C-BANDXMITPWRSET	GDRUPLD	GDRUPLD	NDS	GDR	S	SSOH	370
NA	NA	NA	NA	4	NA	1	GDRUPLEN	UPLOAD BDR	GDRUPLEN	GDRUPLEN	NDS	BDP	S	SSOH	2993
2	2	58	8	0	7	8	GEDPX1T	ENABLE GDR UPLOAD	GEDPX1T	GEDPX1T	NDS	BDP	S	SSOH	2992
2	2	58	8	0	7	8	GEDPX2T	+X+Y GED TEMP A	GEDPX2T	GEDPX2T	TT&C	GED	AP	All Power-Up	Celsius
2	3	58	8	0	7	8	GEDX1T	-X+Y GED TEMP B	GEDX1T	GEDX1T	TT&C	GED	AP	All Power-Up	Celsius
2	4	58	8	0	7	8	GEDX2T	-X+Y GED TEMP A	GEDX2T	GEDX2T	TT&C	GED	AP	All Power-Up	Celsius
A	7	15	8	0	7	16	GEDCNTA	GLOBAL EVENT COUNTER (1 OF 2)	GEDCNTA	GEDCNTA	TT&C	SPU A	S	Early Orbit	counts
A	7	15	8	0	7	16	GEDCNTB	GLOBAL EVENT COUNTER (2 OF 2)	GEDCNTB	GEDCNTB	TT&C	SPU A	S	Early Orbit	counts
3	8	54	8	0	7	16	GEDCNTA	GLOBAL EVENT COUNTER (1 OF 2)	GEDCNTA	GEDCNTA	TT&C	SPU A	S	Normal	counts
3	8	55	8	0	7	16	GEDCNTA	GLOBAL EVENT COUNTER (2 OF 2)	GEDCNTA	GEDCNTA	TT&C	SPU A	S	Normal	counts
5	4	54	8	0	7	16	GEDCNTA	GLOBAL EVENT COUNTER (1 OF 2)	GEDCNTA	GEDCNTA	TT&C	SPU A	S	Thruster	counts
5	4	55	8	0	7	16	GEDCNTA	GLOBAL EVENT COUNTER (2 OF 2)	GEDCNTA	GEDCNTA	TT&C	SPU A	S	Thruster	counts
A	7	23	8	0	7	16	GEDCNTB	GLOBAL EVENT COUNTER (1 OF 2)	GEDCNTB	GEDCNTB	TT&C	SPU B	S	Early Orbit	counts
A	7	23	8	0	7	16	GEDCNTB	GLOBAL EVENT COUNTER (2 OF 2)	GEDCNTB	GEDCNTB	TT&C	SPU B	S	Early Orbit	counts
3	8	62	8	0	7	16	GEDCNTB	GLOBAL EVENT COUNTER (1 OF 2)	GEDCNTB	GEDCNTB	TT&C	SPU B	S	Normal	counts
3	8	63	8	0	7	16	GEDCNTB	GLOBAL EVENT COUNTER (2 OF 2)	GEDCNTB	GEDCNTB	TT&C	SPU B	S	Normal	counts
5	4	62	8	0	7	8	GEDCNTB	GLOBAL EVENT COUNTER (1 OF 2)	GEDCNTB	GEDCNTB	TT&C	SPU B	S	Thruster	counts
5	4	63	8	0	7	8	GEDCNTB	GLOBAL EVENT COUNTER (2 OF 2)	GEDCNTB	GEDCNTB	TT&C	SPU B	S	Thruster	counts
NA	NA	NA	NA	0	NA	1	GIMPAR	GIM PARITY	GIMPAR	GIMPAR	NDS	BDY	S	SSOH	211
NA	NA	NA	NA	1	NA	1	GIMPAREN	GIM PARITY ENABLE	GIMPAREN	GIMPAREN	NDS	BDY	S	SSOH	211
A	5	14	8	0	7	16	GNDCMCTA	GROUND CMD ACCEPT COUNT (1 OF 2)	GNDCMCTA	GNDCMCTA	TT&C	SPU A	S	Early Orbit	counts
A	5	15	8	0	7	16	GNDCMCTA	GROUND CMD ACCEPT COUNT (2 OF 2)	GNDCMCTA	GNDCMCTA	TT&C	SPU A	S	Early Orbit	counts
8	8	52	8	0	7	16	GNDCMCTA	GROUND CMD ACCEPT COUNT (1 OF 2)	GNDCMCTA	GNDCMCTA	TT&C	SPU A	S	Normal	counts
8	8	53	8	0	7	16	GNDCMCTA	GROUND CMD ACCEPT COUNT (2 OF 2)	GNDCMCTA	GNDCMCTA	TT&C	SPU A	S	Normal	counts

7	8	52	8	0	7	16	GNDCMCTA	GNDCMCTA	GROUND CMD ACCEPT COUNT (1 OF 2)	TT&C	SPU A	S	Thruster	counts	
							GNDCMCTA	GNDCMCTA	GROUND CMD ACCEPT COUNT (2 OF 2)	TT&C	SPU A	S	Thruster	counts	
A	5	22	8	0	7	16	GNDCMCTB	GNDCMCTB	GROUND CMD ACCEPT COUNT (1 OF 2)	TT&C	SPU B	S	Early Orbit	counts	
A	5	23	8	0	7	16	GNDCMCTB	GNDCMCTB	GROUND CMD ACCEPT COUNT (2 OF 2)	TT&C	SPU B	S	Early Orbit	counts	
8	8	60	8	0	7	16	GNDCMCTB	GNDCMCTB	GROUND CMD ACCEPT COUNT (1 OF 2)	TT&C	SPU B	S	Normal	counts	
8	8	61	8	0	7	16	GNDCMCTB	GNDCMCTB	GROUND CMD ACCEPT COUNT (2 OF 2)	TT&C	SPU B	S	Normal	counts	
7	8	60	8	0	7	16	GNDCMCTB	GNDCMCTB	GROUND CMD ACCEPT COUNT (1 OF 2)	TT&C	SPU B	S	Thruster	counts	
7	8	61	8	0	7	16	GNDCMCTB	GNDCMCTB	GROUND CMD ACCEPT COUNT (2 OF 2)	TT&C	SPU B	S	Thruster	counts	
4	4	55	3	0	2	3	GNDMODEA	GNDMODEA	GROUND COMMANDED ADS MODE	TT&C	SPU A	S	Normal		Mode Flag Word
3	4	53	3	0	2	3	GNDMODEA	GNDMODEA	GROUND COMMANDED ADS MODE	TT&C	SPU A	S	Thruster		Mode Flag Word
4	4	63	3	0	2	3	GNDMODEB	GNDMODEB	GROUND COMMANDED ADS MODE	TT&C	SPU B	S	Normal		Mode Flag Word
3	4	61	3	0	2	3	GNDMODEB	GNDMODEB	GROUND COMMANDED ADS MODE	TT&C	SPU B	S	Thruster		Mode Flag Word
A	1	15	1	7	7	1	GRDCONTA	GRDCONTA	FLAG INDIC AT LEAST ONE GND CMD RCVD	TT&C	SPU A	S	Power-Up		Ground Contract Flag Word 15 (second word)
A	1	23	1	7	7	1	GRDCONTB	GRDCONTB	FLAG INDIC AT LEAST ONE GND CMD RCVD	TT&C	SPU B	S	Power-Up		Ground Contract Flag Word 23 (second word)
NA	NA	NA	NA	0	NA	8	GRPXFER	GRPXFER	GROUP TRANSFER FLAG	NDS	BDP-IP	S	SSOH		161
NA	NA	NA	NA	3	NA	1	GSTSTIEX	GSTSTIEX	GDR SYSTEM TEST EXECUTE	NDS	BDP	S	SSOH		2984
NA	NA	NA	NA	0	NA	1	GSTSTZEX	GSTSTZEX	GDR DISCRETE SYS TEST	NDS	BDP	S	SSOH		2985
NA	NA	NA	NA	0	NA	1	HBABUFF	HBABUFF	TURNOFFHIBAND A BUFF	NDS	BDP	S	SSOH		3064
NA	NA	NA	NA	1	NA	1	HBBBFDAT	HBBBFDAT	DONTSNDHIBAND B DATA	NDS	BDP	S	SSOH		3064
NA	NA	NA	NA	1	NA	1	HBCONCUR	HBCONCUR	THREE CH CONCURRENCE	NDS	BDP	S	SSOH		3051
NA	NA	NA	NA	0	NA	2	HBFARCH	HBFARCH	HI BAND CHANNEL SEL	NDS	BDP	S	SSOH		3047
NA	NA	NA	NA	2	NA	6	HBFARTH	HBFARTH	HIBANDFALSEALARMRATE	NDS	BDP	S	SSOH		3047
NA	NA	NA	NA	0	NA	4	HBFREQDL	HBFREQDL	HIBANDFREQSTEPAUXDEL COR	NDS	BDW	S	SSOH		345
NA	NA	NA	NA	4	NA	4	HBFREQST	HBFREQST	HIGH BAND FREQ STEP	NDS	BDW	S	SSOH		345
NA	NA	NA	NA	0	NA	16	HBHCACMD	HBHCACMD	LACC - HIGH BAND CH1	NDS	BDW	S	SSOH		325
NA	NA	NA	NA	0	NA	16	HBHCADC	HBHCADC	HIBANDCH1AUXDEL CORR CTI	NDS	BDW	S	SSOH		359
NA	NA	NA	NA	0	NA	24	HBHCCF	HBHCCF	CENTERFREQ-HIBANDCH2	NDS	BDW	S	SSOH		291
NA	NA	NA	NA	0	NA	16	HBHCCDC	HBHCCDC	DELAY CORRECT-HIBANDCH1	NDS	BDW	S	SSOH		306
NA	NA	NA	NA	0	NA	16	HBHCFCTC	HBHCFCTC	FTCV HIBAND CH1:HILO	NDS	BDW	S	SSOH		268
NA	NA	NA	NA	0	NA	8	HBHCGAIN	HBHCGAIN	GAIN SET HIBAND CH1	NDS	BDW	S	SSOH		278
NA	NA	NA	NA	0	NA	16	HBHCCGAL	HBHCCGAL	A/D VALUE-HIBAND CH1	NDS	BDW	S	SSOH		283

NA	NA	NA	NA	0	NA	16	HBHRCMD	HBHRCMD	MID A/D VAL-HIBNDCH1	NDS	BDW	S	SSOH		316
NA	NA	NA	NA	5	NA	3	HBHRCNM	HBHRCNM	BDW HIGH BAND CH1	NDS	BDD/X	S	SSOH		265
NA	NA	NA	NA	0	NA	16	HBHRCMD	HBHRCMD	LRCC - HIGH BAND CH1	NDS	BDW	S	SSOH		335
NA	NA	NA	NA	0	NA	8	HBHCRTH	HBHCRTH	HIGH BAND CH1 THRESSET	NDS	BDW	S	SSOH		346
NA	NA	NA	NA	0	NA	8	HBHCTHOF	HBHCTHOF	HIGH BAND CH1 THRESSET	NDS	BDW	S	SSOH		351
NA	NA	NA	NA	5	NA	1	HBHCTRIG	HBHCTRIG	EN HIGH BAND CHAN 1	NDS	BDP	S	SSOH		3065
NA	NA	NA	NA	0	NA	16	HBHRCMD	HBHRCMD	LACC - HIGH BAND CH3	NDS	BDW	S	SSOH		329
NA	NA	NA	NA	0	NA	16	HBHRCMD	HBHRCMD	HIBANDCH3AUXDELORRE CT1	NDS	BDW	S	SSOH		363
NA	NA	NA	NA	0	NA	24	HBHRCF	HBHRCF	CENTERFREQ-HIBANDCH3	NDS	BDW	S	SSOH		297
NA	NA	NA	NA	0	NA	16	HBHRCMD	HBHRCMD	DELAY CORRECT - HIBANDCH3	NDS	BDW	S	SSOH		310
NA	NA	NA	NA	0	NA	16	HBHRCMD	HBHRCMD	FTCV HIBAND CH3 HILO	NDS	BDW	S	SSOH		272
NA	NA	NA	NA	0	NA	16	HBHRCMD	HBHRCMD	GAIN SET HIBAND CH3	NDS	BDW	S	SSOH		280
NA	NA	NA	NA	0	NA	16	HBHRCMD	HBHRCMD	A/D VALUE-HIBAND CH3	NDS	BDW	S	SSOH		287
NA	NA	NA	NA	0	NA	16	HBHRCMD	HBHRCMD	MID A/D VAL-HIBNDCH3	NDS	BDW	S	SSOH		320
NA	NA	NA	NA	5	NA	3	HBHRCNM	HBHRCNM	BDW HIGH BAND CH3	NDS	BDW	S	SSOH		266
NA	NA	NA	NA	0	NA	16	HBHRCMD	HBHRCMD	LRCC - HIGH BAND CH3	NDS	BDW	S	SSOH		339
NA	NA	NA	NA	0	NA	8	HBHCRTH	HBHCRTH	HIGH BAND CH 3 THRESSET	NDS	BDW	S	SSOH		348
NA	NA	NA	NA	0	NA	8	HBHCTHOF	HBHCTHOF	HIGH BAND CH 3 THRESSET	NDS	BDW	S	SSOH		353
NA	NA	NA	NA	7	NA	1	HBHCTRIG	HBHCTRIG	EN HIGH BAND CHAN 2	NDS	BDW	S	SSOH		3065
NA	NA	NA	NA	0	NA	16	HBHRCMD	HBHRCMD	LACC - HIGH BAND CH2	NDS	BDW	S	SSOH		327
NA	NA	NA	NA	0	NA	16	HBHRCMD	HBHRCMD	HIBANDCH2AUXDELORRE CT1	NDS	BDW	S	SSOH		361
NA	NA	NA	NA	0	NA	24	HBHRCF	HBHRCF	CENTERFREQ-HIBANDCH2	NDS	BDW	S	SSOH		294
NA	NA	NA	NA	0	NA	16	HBHRCMD	HBHRCMD	DELAY CORRECT - HIBANDCH2	NDS	BDW	S	SSOH		308
NA	NA	NA	NA	0	NA	16	HBHRCMD	HBHRCMD	FTCV HIBAND CH2 HILO	NDS	BDW	S	SSOH		270
NA	NA	NA	NA	0	NA	8	HBHRCGAIN	HBHRCGAIN	GAIN SET HIBAND CH2	NDS	BDW	S	SSOH		279
NA	NA	NA	NA	0	NA	16	HBHRCMD	HBHRCMD	A/D VALUE-HIBAND CH2	NDS	BDW	S	SSOH		285
NA	NA	NA	NA	0	NA	16	HBHRCMD	HBHRCMD	MID A/D VAL-HIBNDCH2	NDS	BDW	S	SSOH		318
NA	NA	NA	NA	2	NA	3	HBHRCNM	HBHRCNM	BDW HIGH BAND CH 2	NDS	BDW	S	SSOH		265
NA	NA	NA	NA	0	NA	16	HBHRCMD	HBHRCMD	LRCC - HIGH BAND CH2	NDS	BDW	S	SSOH		337
NA	NA	NA	NA	0	NA	8	HBHCRTH	HBHCRTH	HIGH BAND CH 2 THRESSET	NDS	BDW	S	SSOH		347
NA	NA	NA	NA	0	NA	8	HBHCTHOF	HBHCTHOF	HIGH BAND CH 2 THRESSET	NDS	BDW	S	SSOH		352
NA	NA	NA	NA	6	NA	1	HBHCTRIG	HBHCTRIG	EN HIGH BAND CHAN 2	NDS	BDW	S	SSOH		3065
NA	NA	NA	NA	0	NA	2	HBHNOISCH	HBHNOISCH	HI BAND CHAN SELECT	NDS	BDW	S	SSOH		3046
NA	NA	NA	NA	2	NA	6	HBHNOISTH	HBHNOISTH	AUTO HI BAND OFFSET	NDS	BDW	S	SSOH		3046
A	4	10	1	2	2	1	HC1RATE	HC1RATE	ESA 1 HC1 HIGH/LOW RATE	ADS	ESA	DL	All Power-Up		1=Low 0=High
A	4	11	1	2	2	1	HC2RATE	HC2RATE	ESA 2 HC1 HIGH/LOW RATE	ADS	ESA	DL	All Power-Up		1=Low 0=High
NA	NA	NA	NA	0	NA	8	HDRERCNT	HDRERCNT	EVENT HEADER ERR CNT	NDS	BDP-MP	S	SSOH		43
NA	NA	NA	NA	0	NA	32	HEADER	HEADER	FAH, F3H, BEH, 10H	NDS	BDP	S	SSOH		0
NA	NA	NA	NA	0	NA	1	HRDASCSM	HRDASCSM	HARDASIC CMDERREPORT	NDS	BDP	S	SSOH		3063
NA	NA	NA	NA	2	NA	1	HRDEESM	HRDEESM	HARDEEPROM FAIL REPORT	NDS	BDP	S	SSOH		3062
NA	NA	NA	NA	0	NA	1	HRMEMMSM	HRMEMMSM	HARD MEM ERR REPORTS	NDS	BDP	S	SSOH		3062
NA	NA	NA	NA	0	NA	16	I16KDMPP	I16KDMPP	IP DUMP 16K POINTER	NDS	BDP-IP	S	SSOH		191
NA	NA	NA	NA	0	NA	8	IBDDUMP	IBDDUMP	BDX/D EV CUM DMP COUNT	NDS	BDP-IP	S	SSOH		141
NA	NA	NA	NA	0	NA	16	IDLELOOP	IDLELOOP	LASTIDLELOOPCNT:LOHI	NDS	BDD/X	S	SSOH		261
NA	NA	NA	NA	0	NA	8	ILGHTDMP	ILGHTDMP	YF LIGHTNING EVDMPCNT	NDS	BDP-IP	S	SSOH		144
2	8	54	8	0	7	16	IMPPITA	IMPPITA	IMPULSE DEMAND PITCH (1 OF 2)	ADS	SPU A	S	Thruater		in-lbf-sec
2	8	55	8	0	7	16	IMPPITA	IMPPITA	IMPULSE DEMAND PITCH (2 OF 2)	ADS	SPU A	S	Thruater		in-lbf-sec
2	8	62	8	0	7	16	IMPPITB	IMPPITB	IMPULSE DEMAND PITCH (1 OF 2)	ADS	SPU B	S	Thruater		in-lbf-sec
2	8	63	8	0	7	16	IMPPITB	IMPPITB	IMPULSE DEMAND PITCH (2 OF 2)	ADS	SPU B	S	Thruater		in-lbf-sec
1	8	54	8	0	7	16	IMPROLA	IMPROLA	IMPULSE DEMAND ROLL (1 OF 2)	ADS	SPU A	S	Thruater		in-lbf-sec
1	8	55	8	0	7	16	IMPROLA	IMPROLA	IMPULSE DEMAND ROLL (2 OF 2)	ADS	SPU A	S	Thruater		in-lbf-sec
1	8	62	8	0	7	16	IMPROLB	IMPROLB	IMPULSE DEMAND ROLL (1 OF 2)	ADS	SPU B	S	Thruater		in-lbf-sec
1	8	63	8	0	7	16	IMPROLB	IMPROLB	IMPULSE DEMAND ROLL (2 OF 2)	ADS	SPU B	S	Thruater		in-lbf-sec
3	8	54	8	0	7	16	IMPYAWA	IMPYAWA	IMPULSE DEMAND YAW (1 OF 2)	ADS	SPU A	S	Thruater		in-lbf-sec
3	8	55	8	0	7	16	IMPYAWA	IMPYAWA	IMPULSE DEMAND YAW (2 OF 2)	ADS	SPU A	S	Thruater		in-lbf-sec

3	8	62	8	0	7	16	IMPYAWB	IMPYAWB	IMPYAWB	IMPULSE DEMAND YAW (1 OF 2)	ADS	SPU B	S	Thruster	in-lbf-sec		
3	8	63	8	0	7	16	IMPYAWB	IMPYAWB	IMPULSE DEMAND YAW (2 OF 2)	ADS	SPU B	S	Thruster	in-lbf-sec			
6	8	52	1	0	0	1	INTERRA	INTERRA	INTERRUPT ERROR INDICATOR	TT&C	SPU A	S	Early Orbit		O=No Interrupt Error Rcvd 1=Interrupt Error Rcvd	TLM (Error) Flag Word 52 (first word)	
3	6	52	1	0	0	1	INTERRA	INTERRA	INTERRUPT ERROR INDICATOR	TT&C	SPU A	S	Normal Thruster		O=No Interrupt Error Rcvd 1=Interrupt Error Rcvd	TLM (Error) Flag Word 52 (first word)	
6	8	60	1	0	0	1	INTERRB	INTERRB	INTERRUPT ERROR INDICATOR	TT&C	SPU B	S	Early Orbit		O=No Interrupt Error Rcvd 1=Interrupt Error Rcvd	TLM (Error) Flag Word 60 (first word)	
3	6	60	1	0	0	1	INTERRB	INTERRB	INTERRUPT ERROR INDICATOR	TT&C	SPU B	S	Normal Thruster		O=No Interrupt Error Rcvd 1=Interrupt Error Rcvd	TLM (Error) Flag Word 60 (first word)	
NA	NA	NA	NA	5	NA	3	INTPER	INTPER	INTEGRATION PERIOD	NDS	BDP	S	SSOH		1=Invalid U/L Status	3050	
NA	NA	NA	NA	6	NA	9	INTRQERR	INTRQERR	BDY-P INTERSTATBT:UNDIN	NDS	BDY	S	SSOH		1=Invalid U/L Status	254	
A	5	15	1	7	7	1	INVSTATA	INVSTATA	FLAG INDIC INVALID U/L STATUS	TT&C	SPU A	S	Power-Up		0=Valid U/L Status 1=Invalid U/L Status		
A	5	23	1	7	7	1	INVSTATB	INVSTATB	FLAG INDIC INVALID U/L STATUS	TT&C	SPU B	S	Power-Up		0=Valid U/L Status 1=Invalid U/L Status		
NA	NA	NA	NA	1	NA	1	IPADINT	IPADINT	DISABLE IP A/D INTER	NDS	BDP	S	SSOH			3008	
NA	NA	NA	NA	2	NA	2	IPATRN	IPATRN	INCREMENTING PATTERN	NDS	BDP	S	SSOH			2988	
NA	NA	NA	NA	1	NA	1	IPATTST	IPATTST	MARCHING RAM TEST	NDS	BDP	S	SSOH			2988	
NA	NA	NA	NA	3	NA	1	IPBDEVLD	IPBDEVLD	BDXD EVLD DISABL FLG1	NDS	BDP-IP	S	SSOH			159	
NA	NA	NA	NA	6	NA	1	IPBDEWECK	IPBDEWECK	ENIP BDWGIM ERCHKING	NDS	BDP	S	SSOH			3008	
NA	NA	NA	NA	5	NA	1	IPBDXECK	IPBDXECK	ENIP BDXGIM ERCHKING	NDS	BDP	S	SSOH			3008	
NA	NA	NA	NA	4	NA	1	IPBDYECK	IPBDYECK	ENIP BDYGIM ERCHKING	NDS	BDP	S	SSOH			3008	
NA	NA	NA	NA	0	NA	16	IPC MHSTP	IPC MHSTP	CMD HISTORY POINTER	NDS	BDP-IP	S	SSOH			153	
NA	NA	NA	NA	0	NA	1	IPDUMP	IPDUMP	IP DUMP REQ	NDS	BDP-MP	S	SSOH			47	
NA	NA	NA	NA	2	NA	1	IPEEERF	IPEEERF	BDP IP EEPROM REFRES	NDS	BDP	S	SSOH			2993	
NA	NA	NA	NA	2	NA	1	IPEEERFEN	IPEEERFEN	ENBDP IP EEPROM REFR	NDS	BDP	S	SSOH			2992	
NA	NA	NA	NA	2	NA	1	IPEQCRST	IPEQCRST	IP EV&ERRQUEUECNTRST	NDS	BDP	S	SSOH			3036	
NA	NA	NA	NA	7	NA	1	IPGDRECK	IPGDRECK	ENIP GDRGIM ERCHKING	NDS	BDP	S	SSOH			3008	
NA	NA	NA	NA	4	NA	1	IPHSEVLD	IPHSEVLD	WHX E LD DISABL FLG1	NDS	BDP-IP	S	SSOH			159	
NA	NA	NA	NA	6	NA	1	IPHXEVL	IPHXEVL	WHX E LD DISABL FLG1	NDS	BDP-IP	S	SSOH			159	
NA	NA	NA	NA	0	NA	3	IPINIT	IPINIT	INTRPROCINT&SWAPSEL	NDS	BDP	S	SSOH			3011	
NA	NA	NA	NA	5	NA	1	IPLSEVLD	IPLSEVLD	WLS EVLD DISABL FLG1	NDS	BDP-IP	S	SSOH			159	
NA	NA	NA	NA	7	NA	1	IPLXEVL	IPLXEVL	WLX EVLD DISABL FLG1	NDS	BDP-IP	S	SSOH			159	
NA	NA	NA	NA	0	NA	1	IPMFSINT	IPMFSINT	DISABIPWASFRMSYNCINT	NDS	BDP-IP	S	SSOH			3008	
NA	NA	NA	NA	3	NA	1	IPPFLRST	IPPFLRST	RESET IP POINT&FLAGS	NDS	BDP	S	SSOH			3036	
NA	NA	NA	NA	2	NA	1	IPRAMSWP	IPRAMSWP	IP RAM SWAPPED	NDS	BDP	S	SSOH			6	
NA	NA	NA	NA	1	NA	1	IPROMSWP	IPROMSWP	IP ROM SWAP	NDS	BDP-IP	S	SSOH			6	
NA	NA	NA	NA	0	NA	1	IPSCMRST	IPSCMRST	IP SET COMMAND RESET	NDS	BDP	S	SSOH			3036	
NA	NA	NA	NA	4	NA	4	IPSHXFR	IPSHXFR	IP SOH XFER COUNTER	NDS	BDP-IP	S	SSOH			148	
NA	NA	NA	NA	2	NA	1	IPSOHREQ	IPSOHREQ	SELECT DSOH FOR IP	NDS	BDP	S	SSOH			3008	
NA	NA	NA	NA	1	NA	1	IPSTACKP	IPSTACKP	IP SOH REQUEST	NDS	BDP-IP	S	SSOH			167	
NA	NA	NA	NA	0	NA	16	IPSTRACKP	IPSTRACKP	IP STACK POINTER	NDS	BDP-IP	S	SSOH			185	
NA	NA	NA	NA	1	NA	1	IPSTRACKP	IPSTRACKP	IP STACK POINTER	NDS	BDP-IP	S	SSOH			3036	
NA	NA	NA	NA	0	NA	8	IPTRSRST	IPTRSRST	IP TMBUFFSETUPRESET	NDS	BDP	S	SSOH			142	
NA	NA	NA	NA	0	NA	8	IPTRSRST	IPTRSRST	MOTONPITCH EVDMPCNT	NDS	BDP-IP	S	SSOH			3008	
NA	NA	NA	NA	3	NA	1	IPTOINT	IPTOINT	INHIP HRDWRTIMOUTINT	NDS	BDP	S	SSOH			2993	
NA	NA	NA	NA	6	NA	1	IPUPLD	IPUPLD	UPLOAD BDP IP	NDS	BDP	S	SSOH			2992	
NA	NA	NA	NA	6	NA	1	IPUPLEN	IPUPLEN	ENABLE BDP IP UPLOAD	NDS	BDP	S	SSOH			146	
NA	NA	NA	NA	0	NA	1	IPUPLOAD	IPUPLOAD	UPLOAD ALLOW	NDS	BDP-IP	S	SSOH			159	
NA	NA	NA	NA	2	NA	1	IPYDEVL	IPYDEVL	YD EVLD DISABLE FLG1	NDS	BDP-IP	S	SSOH			160	
NA	NA	NA	NA	2	NA	1	IPYLEVLD	IPYLEVLD	YLT EVLD DISABLE FLG2	NDS	BDP-IP	S	SSOH				

NA	NA	NA	0	NA	1	IPYREVLD	IPYREVLD	YMP EVLD DISABL FLG2	NDS	BDP-IP	S	SSOH		160
NA	NA	NA	1	NA	1	IPYREVLD	IPYREVLD	YMR EVLD DISABL FLG2	NDS	BDP-IP	S	SSOH		160
NA	NA	NA	0	NA	1	IPYSEVLD	IPYSEVLD	YS EVLD DISABLE FLG1	NDS	BDP-IP	S	SSOH		159
NA	NA	NA	1	NA	1	IPYTEVLD	IPYTEVLD	YT EVLD DISABLE FLG1	NDS	BDP-IP	S	SSOH		159
5	1	27	8	0	7	8	IRCVAAAGC	CTDU A RCVR AGC VOLTAGE	TNP	CTDU	AH	All Power-Up	volts	
A	3	41	1	0	0	1	IRCVAAANT	CTDU A RCVR TO RCVR ANT	TNP	CTDU	DL	All Power-Up	volts	1=Good
5	2	27	8	0	7	8	IRCVACV	CTDU A RCVR CONV VOLTAGE	TNP	CTDU	AH	All Power-Up	volts	0=Bad
A	7	41	1	3	3	1	IRCVAPWR	CTDU A RCVR 28VDC ON/OFF	TNP	CTDU	DL	All Power-Up	volts	1=On
5	1	28	8	0	7	8	IRCVBAGC	CTDU B RCVR AGC VOLTAGE	TNP	CTDU	AH	All Power-Up	volts	0=Off
A	3	42	1	0	0	1	IRCVBANT	CTDU B RCVR TO RCVR ANT	TNP	CTDU	DL	All Power-Up	volts	1=Good
5	2	28	8	0	7	8	IRCVBCV	CTDU B RCVR CONV VOLTAGE	TNP	CTDU	AH	All Power-Up	volts	0=Bad
A	7	42	1	2	2	1	IRCVBPWR	CTDU B RCVR 28 VDC ON/OFF	TNP	CTDU	DL	All Power-Up	volts	1=On
A	3	41	1	1	1	1	IRCVRA	CTDU A RCVR ON/OFF	TNP	CTDU	DL	All Power-Up	volts	0=Off
A	3	42	1	1	1	1	IRCVRB	CTDU B RCVR ON/OFF	TNP	CTDU	DL	All Power-Up	volts	0=On
NA	NA	NA	0	NA	8	8	IROLLDMP	MOTION ROLL EVDMP CNT	NDS	BDP-IP	S	SSOH		143
A	6	16	1	0	0	1	ISO12ARM	ISO LATCH VALVE PWR 1&2 ARM	RCS	LV	S	All Power-Up		1=Armed
A	5	16	1	0	0	1	ISO12PWR	ISO LATCH VALVE PWR 1&2 ENAB	RCS	LV	S	All Power-Up		0=Disarmed
A	5	64	1	0	0	1	ISOCLS1	ISOLATN LATCH VALVE 1 CLOSE	RCS	LV	DL	All Power-Up		1=Enabled
A	5	64	1	1	1	1	ISOCLS2	ISOLATN LATCH VALVE 2 CLOSE	RCS	LV	DL	All Power-Up		0=Disabled
A	6	64	1	0	0	1	ISOOPN1	ISOLATN LATCH VALVE 1 OPEN	RCS	LV	DL	All Power-Up		1=Closed
A	6	64	1	1	1	1	ISOOPN2	ISOLATN LATCH VALVE 2 OPEN	RCS	LV	DL	All Power-Up		0=Open
NA	NA	NA	0	NA	16	16	IWHSADMP	WH A EV CUM DMP CNT	NDS	BDP-IP	S	SSOH		175
NA	NA	NA	0	NA	16	16	IWHSBDM	WHS B EV CUM DMP CNT	NDS	BDP-IP	S	SSOH		177
NA	NA	NA	0	NA	16	16	IWLSADMP	WL A EV CUM DMP CNT	NDS	BDP-IP	S	SSOH		179
NA	NA	NA	0	NA	16	16	IWLSBDM	WLS B EV CUM DMP CNT	NDS	BDP-IP	S	SSOH		181
A	3	41	1	3	3	1	IXMTAANT	CTDU A XMTR TO XMTR ANT	TNP	CTDU	DL	All Power-Up	volts	1=Good
A	2	25	8	0	7	8	IXMTACV	CTDU A XMTR CONV VOLTAGE MON	TNP	CTDU	AH	All Power-Up	volts	0=Bad
A	7	41	1	5	5	1	IXMTAPWR	CTDU A XMIT 28 VDC ON/OFF	TNP	CTDU	DL	All Power-Up	volts	1=On
A	1	25	8	0	7	8	IXMTARFP	CTDU A XMTR RF PWR OUT	TNP	CTDU	AH	All Power-Up	volts	0=Off
1	1	27	8	0	7	8	IXMTAT	CTDU A XMTR TEMP	TNP	CTDU	AP	All Power-Up	Celsius	
A	3	42	1	3	3	1	IXMTBANT	CTDU B XMTR TO XMTR ANT	TNP	CTDU	DL	All Power-Up	volts	1=Good
A	2	26	8	0	7	8	IXMTBCV	CTDU B XMTR CONV VOLTAGE MON	TNP	CTDU	AH	All Power-Up	volts	0=Bad
A	7	42	1	4	4	1	IXMTBPWR	CTDU B XMIT 28 VDC ON/OFF	TNP	CTDU	DL	All Power-Up	volts	1=On
A	1	26	8	0	7	8	IXMTBRFP	CTDU B XMTR RF PWR OUT	TNP	CTDU	AH	All Power-Up	volts	0=Off
3	1	28	8	0	7	8	IXMTBT	CTDU B XMTR TEMP	TNP	CTDU	AP	All Power-Up	Celsius	
A	3	41	1	2	2	1	IXMTRA	CTDU A XMTR ON/OFF	TNP	CTDU	DL	All Power-Up	volts	1=On
A	3	42	1	2	2	1	IXMTRB	CTDU B XMTR ON/OFF	TNP	CTDU	DL	All Power-Up	volts	0=Off

NA	NA	NA	NA	0	NA	8	IYDDUMP	IYDDUMP	IYDDUMP	YD EV CUM DUMP COUNT	NDS	BDP-IP	S	SSOH		140
NA	NA	NA	NA	0	NA	8	IYFDUMP	IYFDUMP	IYFDUMP	YF EV CUM DUMP COUNT	NDS	BDP-IP	S	SSOH		139
NA	NA	NA	NA	0	NA	16	IYFTBIP	IYFTBIP	IYFTBIP	YF TMPBUFF I/P POINT	NDS	BDP-IP	S	SSOH		187
NA	NA	NA	NA	0	NA	16	IYTBOP	IYTBOP	IYTBOP	YF TMPBUFF/O/P POINT	NDS	BDP-IP	S	SSOH		189
NA	NA	NA	NA	0	NA	16	IYFTBQUE	IYFTBQUE	IYFTBQUE	YF TEMP BUFF QUE CNT	NDS	BDP-IP	S	SSOH		183
7	5	52	8	0	7	16	JETIMERA	JETIMERA	JETIMERA	DELTA-V JET SECONDS TIMER (1 OF 2)	ADS	SPU A	S	Thruster	seconds	
7	5	53	8	0	7	16	JETIMERA	JETIMERA	JETIMERA	DELTA-V JET SECONDS TIMER (2 OF 2)	ADS	SPU A	S	Thruster	seconds	
7	5	60	8	0	7	16	JETIMERB	JETIMERB	JETIMERB	DELTA-V JET SECONDS TIMER (1 OF 2)	ADS	SPU B	S	Thruster	seconds	
7	5	61	8	0	7	16	JETIMERB	JETIMERB	JETIMERB	DELTA-V JET SECONDS TIMER (2 OF 2)	ADS	SPU B	S	Thruster	seconds	
7	6	52	8	0	7	16	JETSECAA	JETSECAA	JETSECAA	DELTA-V JET SECONDS ACHIEVED (1 OF 2)	ADS	SPU A	S	Thruster	seconds	
7	6	53	8	0	7	16	JETSECAA	JETSECAA	JETSECAA	DELTA-V JET SECONDS ACHIEVED (2 OF 2)	ADS	SPU A	S	Thruster	seconds	
7	6	60	8	0	7	16	JETSECBAB	JETSECBAB	JETSECBAB	DELTA-V JET SECONDS ACHIEVED (1 OF 2)	ADS	SPU B	S	Thruster	seconds	
7	6	61	8	0	7	16	JETSECBAB	JETSECBAB	JETSECBAB	DELTA-V JET SECONDS ACHIEVED (2 OF 2)	ADS	SPU B	S	Thruster	seconds	
7	5	54	8	0	7	16	JETSECDCA	JETSECDCA	JETSECDCA	DELTA-V JET SECONDS DURATION (1 OF 2)	ADS	SPU A	S	Thruster	seconds	
7	5	55	8	0	7	16	JETSECDCA	JETSECDCA	JETSECDCA	DELTA-V JET SECONDS DURATION (2 OF 2)	ADS	SPU A	S	Thruster	seconds	
7	5	62	8	0	7	16	JETSECDDB	JETSECDDB	JETSECDDB	DELTA-V JET SECONDS DURATION (1 OF 2)	ADS	SPU B	S	Thruster	seconds	
7	5	63	8	0	7	16	JETSECDDB	JETSECDDB	JETSECDDB	DELTA-V JET SECONDS DURATION (2 OF 2)	ADS	SPU B	S	Thruster	seconds	
2	7	58	8	0	7	8	KBOXIFT	KBOXIFT	KBOXIFT	BASE PNL/K-BOX I/F TEMP A	MSS	TCS	AP	All Power-Up	Celsius	
A	8	16	1	1	1	1	KG1	KG1	KG1	KG-46 (1) ON/OFF	TT&C	KG-46	S	All Power-Up	volts	1=On 0=Off
3	5	56	8	0	7	8	KG1CV5V	KG1CV5V	KG1CV5V	KG-46-1 CONV +5VDC OUT	TT&C	KG-46	AH	All Power-Up	volts	
A	8	16	1	5	5	1	KG2	KG2	KG2	KG-46 (2) ON/OFF	TT&C	KG-46	S	All Power-Up	volts	1=On 0=Off
3	6	56	8	0	7	8	KG2CV5V	KG2CV5V	KG2CV5V	KG-46-2 CONV +5VDC OUT	TT&C	KG-46	AH	All Power-Up	volts	
A	A	19	1	6	6	1	KIR1AUTH	KIR1AUTH	KIR1AUTH	VCC WORD 3 AUTHENTICATE BIT	TT&C	KIR-23	S	All Power-Up		1=Authenticated 0=Not Authenticated
A	A	19	1	7	7	1	KIR1B	KIR1B	KIR1B	VCC WORD 3 BUSY BIT	TT&C	KIR-23	S	All Power-Up		1=Authenticated 0=Not Authenticated
A	A	51	1	6	6	1	KIR2AUTH	KIR2AUTH	KIR2AUTH	VCC WORD 3 AUTHENTICATE BIT	TT&C	KIR-23	S	All Power-Up		1=Authenticated 0=Not Authenticated
A	A	51	1	7	7	1	KIR2B	KIR2B	KIR2B	VCC WORD 3 BUSY BIT	TT&C	KIR-23	S	All Power-Up		1=Authenticated 0=Not Authenticated
A	7	41	1	4	4	1	L12CAPWR	L12CAPWR	L12CAPWR	L11/L2 CONV A 28 VDC ON/OFF	TNP	LBS	DL	All Power-Up		1=On 0=Off
A	7	42	1	3	3	1	L12CBPWR	L12CBPWR	L12CBPWR	L11/L2 CONV B 28 VDC ON/OFF	TNP	LBS	DL	All Power-Up		1=On 0=Off
A	4	41	1	0	0	1	L12CVA	L12CVA	L12CVA	L11/L2 CONV A STATUS ON/STBY	TNP	LBS	DL	All Power-Up		1=On 0=Standby
A	4	42	1	0	0	1	L12CVB	L12CVB	L12CVB	L11/L2 CONV B STATUS ON/STBY	TNP	LBS	DL	All Power-Up		1=On 0=Standby
A	5	41	1	5	5	1	L1HPAA	L1HPAA	L1HPAA	L1 HPA A STATUS	TNP	LBS	DL	All Power-Up		1=Connected 0=Not Connected
1	3	27	8	0	7	8	L1HPAAT	L1HPAAT	L1HPAAT	L1 HPA A INTERNAL TEMP	TNP	LBS	AP	All Power-Up	Celsius	
A	5	42	1	5	5	1	L1HPAB	L1HPAB	L1HPAB	L1 HPA B STATUS	TNP	LBS	DL	All Power-Up		1=Connected 0=Not Connected





7	7	58	8	0	7	8	L3SYNIPT	L3SYNIPT	L3SYNIPT	L3SYNIPT	+X PAYLOAD PNL/L2261 SYNTH I/F	MSS	TCS	AP	All Power-Up	Celsius	
A	5	41	1	4	4	1	L3SYNRM	L3SYNRM	L3SYNRM	L3SYNRM	L3 CONV A TO L3 SYN A (AND B TO	TNP	LBS	DL	All Power-Up		1=Normal
7	2	27	8	0	7	8	L3SYNRF	L3SYNRF	L3SYNRF	L3SYNRF	B) NORM L3 SYNTHESIZER RF PWR OUT	TNP	LBS	AH	All Power-Up	waitts	0=Xstrap
A	5	42	1	4	4	1	L3SYNXST	L3SYNXST	L3SYNXST	L3SYNXST	L3 CONV A TO L3 SYN B (AND B TO	TNP	LBS	DL	All Power-Up		1=Xstrap
NA	NA	NA	NA	7	NA	1	L3TOCOND	L3TOCOND	L3TOCOND	L3TOCOND	A) XSTRAP	NDS	BDP-IP	S	SSOH		0=Normal
NA	NA	NA	NA	5	NA	1	L3TONRST	L3TONRST	L3TONRST	L3TONRST	L3 TURN-ON COND MET	NDS	BDP	S	SSOH		167
NA	NA	NA	NA	0	NA	8	L3WHABF	L3WHABF	L3WHABF	L3WHABF	L3 TURN-ON RESET	NDS	BDP-MP	S	SSOH		3036
NA	NA	NA	NA	0	NA	8	L3WHBBF	L3WHBBF	L3WHBBF	L3WHBBF	L3 WHS A BUFF EV CNT	NDS	BDP-MP	S	SSOH		12
NA	NA	NA	NA	0	NA	8	L3WLABF	L3WLABF	L3WLABF	L3WLABF	L3 WHS B BUFF EV CNT	NDS	BDP-MP	S	SSOH		13
NA	NA	NA	NA	0	NA	8	L3WLBBF	L3WLBBF	L3WLBBF	L3WLBBF	L3 WLA BUFF EV CNT	NDS	BDP-MP	S	SSOH		14
NA	NA	NA	NA	0	NA	8	L3XFER	L3XFER	L3XFER	L3XFER	L3 WLS B BUFF EV CNT	NDS	BDP-MP	S	SSOH		15
NA	NA	NA	NA	7	NA	1	L3XMTQVA	L3XMTQVA	L3XMTQVA	L3XMTQVA	ABORT L3 TRANSFER	NDS	BDP	S	SSOH		3009
A	5	41	1	1	1	1	L3XMTQVA	L3XMTQVA	L3XMTQVA	L3XMTQVA	L3 CONV A L3 XMT STATUS	TNP	LBS	DL	All Power-Up		1=Enabled 0=Disabled
A	5	42	1	1	1	1	L3XMTQVB	L3XMTQVB	L3XMTQVB	L3XMTQVB	L3 CONV B L3 XMT STATUS	TNP	LBS	DL	All Power-Up		1=Enabled 0=Disabled
NA	NA	NA	NA	0	NA	8	L3YDEVT	L3YDEVT	L3YDEVT	L3YDEVT	L3 YD EVENT COUNTER	NDS	BDP-MP	S	SSOH		10
NA	NA	NA	NA	0	NA	16	L3YFEVT	L3YFEVT	L3YFEVT	L3YFEVT	L3 YF EVENT COUNTER	NDS	BDP-MP	S	SSOH		8
NA	NA	NA	NA	2	NA	1	LBBUFF	LBBUFF	LBBUFF	LBBUFF	TURN OFF LO BAND A BUFF	NDS	BDP	S	SSOH		3064
NA	NA	NA	NA	3	NA	1	LBBFDDAT	LBBFDDAT	LBBFDDAT	LBBFDDAT	DONT S/D LO BAND B DATA	NDS	BDP	S	SSOH		3064
NA	NA	NA	NA	0	NA	2	LBFARCH	LBFARCH	LBFARCH	LBFARCH	LOW BAND CHAN SELECT	NDS	BDP	S	SSOH		3049
NA	NA	NA	NA	2	NA	6	LBFARTH	LBFARTH	LBFARTH	LBFARTH	LOW BAND CHAN SELECT	NDS	BDP	S	SSOH		3049
NA	NA	NA	NA	0	NA	16	LBFACMD	LBFACMD	LBFACMD	LBFACMD	LOW BAND SEALARIMATE	NDS	BDW	S	SSOH		331
NA	NA	NA	NA	0	NA	24	LBHCCF	LBHCCF	LBHCCF	LBHCCF	LACC - LOW BAND CH1	NDS	BDW	S	SSOH		300
NA	NA	NA	NA	0	NA	16	LBHDC	LBHDC	LBHDC	LBHDC	CENTER FREQ-LOBANDCH1	NDS	BDW	S	SSOH		312
NA	NA	NA	NA	0	NA	16	LBHFC	LBHFC	LBHFC	LBHFC	DELAY CORRECT-LOBANDCH1	NDS	BDW	S	SSOH		274
NA	NA	NA	NA	0	NA	8	LBHCGAIN	LBHCGAIN	LBHCGAIN	LBHCGAIN	FTCV LO BAND CH1:HILO	NDS	BDW	S	SSOH		281
NA	NA	NA	NA	0	NA	8	LBHCGCAL	LBHCGCAL	LBHCGCAL	LBHCGCAL	GAIN SET LO BAND CH1	NDS	BDW	S	SSOH		289
NA	NA	NA	NA	0	NA	8	LBHCMAD	LBHCMAD	LBHCMAD	LBHCMAD	AD VALUE-LOBAND CH1	NDS	BDW	S	SSOH		322
NA	NA	NA	NA	0	NA	3	LBHNCM	LBHNCM	LBHNCM	LBHNCM	MID A/D VAL-LOBNDCH1	NDS	BDW	S	SSOH		267
NA	NA	NA	NA	5	NA	3	LBHRCMD	LBHRCMD	LBHRCMD	LBHRCMD	BDW LOW BAND CH 1	NDS	BDW	S	SSOH		341
NA	NA	NA	NA	0	NA	16	LBHCTH	LBHCTH	LBHCTH	LBHCTH	LRCC - LOW BAND CH1	NDS	BDW	S	SSOH		349
NA	NA	NA	NA	0	NA	8	LBHCTHOF	LBHCTHOF	LBHCTHOF	LBHCTHOF	LOW BAND CH 1 THRESSET	NDS	BDW	S	SSOH		354
NA	NA	NA	NA	0	NA	8	LBHCTHOF	LBHCTHOF	LBHCTHOF	LBHCTHOF	LOW BAND CH 1 THRESSET	NDS	BDW	S	SSOH		3065
NA	NA	NA	NA	3	NA	1	LBMCTRIG	LBMCTRIG	LBMCTRIG	LBMCTRIG	EN LOW BAND CHAN 1	NDS	BDW	S	SSOH		333
NA	NA	NA	NA	0	NA	16	LBMCACMD	LBMCACMD	LBMCACMD	LBMCACMD	LACC - LOW BAND CH2	NDS	BDW	S	SSOH		303
NA	NA	NA	NA	0	NA	24	LBMCCF	LBMCCF	LBMCCF	LBMCCF	CENTER FREQ-LOBANDCH2	NDS	BDW	S	SSOH		314
NA	NA	NA	NA	0	NA	16	LBMCDC	LBMCDC	LBMCDC	LBMCDC	DELAY CORRECT-LOBANDCH2	NDS	BDW	S	SSOH		276
NA	NA	NA	NA	0	NA	16	LBMCFGC	LBMCFGC	LBMCFGC	LBMCFGC	FTCV LO BAND CH2:HILO	NDS	BDW	S	SSOH		282
NA	NA	NA	NA	0	NA	8	LBMCGAIN	LBMCGAIN	LBMCGAIN	LBMCGAIN	GAIN SET LO BAND CH2	NDS	BDW	S	SSOH		290
NA	NA	NA	NA	0	NA	8	LBMCGCAL	LBMCGCAL	LBMCGCAL	LBMCGCAL	AD VALUE-LOBAND CH2	NDS	BDW	S	SSOH		323
NA	NA	NA	NA	0	NA	8	LBMCMAD	LBMCMAD	LBMCMAD	LBMCMAD	MID A/D VAL-LOBNDCH2	NDS	BDW	S	SSOH		267
NA	NA	NA	NA	2	NA	3	LBMCMN	LBMCMN	LBMCMN	LBMCMN	BDW LOW BAND CH2	NDS	BDW	S	SSOH		343
NA	NA	NA	NA	0	NA	16	LBMCRCMD	LBMCRCMD	LBMCRCMD	LBMCRCMD	LRCC - LOW BAND CH 2	NDS	BDW	S	SSOH		350
NA	NA	NA	NA	0	NA	8	LBMCTH	LBMCTH	LBMCTH	LBMCTH	LOW BAND CH 2 THRESSET	NDS	BDW	S	SSOH		355
NA	NA	NA	NA	0	NA	8	LBMCTHOF	LBMCTHOF	LBMCTHOF	LBMCTHOF	LOW BAND CH 2 THRESSET	NDS	BDP	S	SSOH		3065
NA	NA	NA	NA	4	NA	1	LBMCTRIG	LBMCTRIG	LBMCTRIG	LBMCTRIG	EN LOW BAND CHAN 2	NDS	BDP	S	SSOH		3048
NA	NA	NA	NA	0	NA	2	LBNOSCH	LBNOSCH	LBNOSCH	LBNOSCH	LOW BAND CHAN SELECT	NDS	BDP	S	SSOH		3048
NA	NA	NA	NA	2	NA	6	LBNOSITH	LBNOSITH	LBNOSITH	LBNOSITH	AUTO LOW BAND OFFSET	NDS	BDP	S	SSOH		
6	8	54	1	5	5	1	LDSH1EXA	LDSH1EXA	LDSH1EXA	LDSH1EXA	LOAD SHED SET 1 EXECUTED	TT&C	SPU A	S	Normal		0=Not Executed 1=Executed
6	8	62	1	5	5	1	LDSH1EXB	LDSH1EXB	LDSH1EXB	LDSH1EXB	LOAD SHED SET 1 EXECUTED	TT&C	SPU B	S	Thruiter		0=Not Executed 1=Executed
6	8	54	1	6	6	1	LDSH2EXA	LDSH2EXA	LDSH2EXA	LDSH2EXA	LOAD SHED SET 2 EXECUTED	TT&C	SPU A	S	Thruiter		0=Not Executed 1=Executed

6	8	62	1	6	6	1	LDSH2EXB	LDSH2EXB	LDSH2EXB	LOAD SHED SET 2 EXECUTED	TT&C	SPU B	S	Normal	0=Not Executed 1=Executed	Power Flag Word
6	8	54	1	7	7	1	LDSH3EXA	LDSH3EXA	LDSH3EXA	LOAD SHED SET 3 EXECUTED	TT&C	SPU A	S	Normal	0=Not Executed 1=Executed	Power Flag Word
6	8	62	1	7	7	1	LDSH3EXB	LDSH3EXB	LDSH3EXB	LOAD SHED SET 3 EXECUTED LOW LEVEL EVENT COUNTER (1 OF 2)	TT&C	SPU B	S	Normal	0=Not Executed 1=Executed	Power Flag Word
A	6	14	8	0	7	16	LEDCNTA	LEDCNTA	LEDCNTA	LOW LEVEL EVENT COUNTER (2 OF 2)	TT&C	SPU A	S	Early Orbit	counts	
A	6	15	8	0	7	16	LEDCNTA	LEDCNTA	LEDCNTA	LOW LEVEL EVENT COUNTER (1 OF 2)	TT&C	SPU A	S	Early Orbit	counts	
7	4	54	8	0	7	16	LEDCNTA	LEDCNTA	LEDCNTA	LOW LEVEL EVENT COUNTER (1 OF 2)	TT&C	SPU A	S	Normal	counts	
7	4	55	8	0	7	16	LEDCNTA	LEDCNTA	LEDCNTA	LOW LEVEL EVENT COUNTER (2 OF 2)	TT&C	SPU A	S	Normal	counts	
5	4	52	8	0	7	16	LEDCNTA	LEDCNTA	LEDCNTA	LOW LEVEL EVENT COUNTER (1 OF 2)	TT&C	SPU A	S	Thruster	counts	
5	4	53	8	0	7	16	LEDCNTA	LEDCNTA	LEDCNTA	LOW LEVEL EVENT COUNTER (2 OF 2)	TT&C	SPU A	S	Thruster	counts	
A	6	22	8	0	7	16	LEDCNTB	LEDCNTB	LEDCNTB	LOW LEVEL EVENT COUNTER (1 OF 2)	TT&C	SPU B	S	Early Orbit	counts	
A	6	23	8	0	7	16	LEDCNTB	LEDCNTB	LEDCNTB	LOW LEVEL EVENT COUNTER (2 OF 2)	TT&C	SPU B	S	Early Orbit	counts	
7	4	62	8	0	7	16	LEDCNTB	LEDCNTB	LEDCNTB	LOW LEVEL EVENT COUNTER (1 OF 2)	TT&C	SPU B	S	Normal	counts	
7	4	63	8	0	7	16	LEDCNTB	LEDCNTB	LEDCNTB	LOW LEVEL EVENT COUNTER (2 OF 2)	TT&C	SPU B	S	Normal	counts	
5	4	60	8	0	7	16	LEDCNTB	LEDCNTB	LEDCNTB	LOW LEVEL EVENT COUNTER (1 OF 2)	TT&C	SPU B	S	Thruster	counts	
5	4	61	8	0	7	16	LEDCNTB	LEDCNTB	LEDCNTB	LOW LEVEL EVENT COUNTER (2 OF 2)	TT&C	SPU B	S	Thruster	counts	
2	2	57	8	0	7	8	LINAT	LINAT	LINAT	RCS LINE TEMP A	RCS	LIN	AP	All Power-Up	Celsius	
2	3	57	8	0	7	8	LINBT	LINBT	LINBT	RCS LINE TEMP B	RCS	LIN	AP	All Power-Up	Celsius	
4	7	57	8	0	7	8	LINCT	LINCT	LINCT	RCS LINE TEMP C	RCS	LIN	AP	All Power-Up	Celsius	
4	8	57	8	0	7	8	LINDT	LINDT	LINDT	RCS LINE TEMP D	RCS	LIN	AP	All Power-Up	Celsius	
A	6	64	1	7	7	1	LLEDAPWR	LLEDAPWR	LLEDAPWR	LLED A ON/OFF	TT&C	LLED	DL	All Power-Up	Celsius	
3	2	58	8	0	7	8	LLEDAT	LLEDAT	LLEDAT	LLED A TEMP	TT&C	LLED	AP	All Power-Up	Celsius	
A	8	64	1	4	4	1	LLEDBPWR	LLEDBPWR	LLEDBPWR	LLED B ON/OFF	TT&C	LLED	DL	All Power-Up	Celsius	
3	3	58	8	0	7	8	LLEDBT	LLEDBT	LLEDBT	LLED B TEMP	TT&C	LLED	AP	All Power-Up	Celsius	
NA	NA	NA	NA	6	NA	1	LPRUN	LPRUN	LPRUN	LOAD PROGRAM AND RUN	NDS	BOP	S	SSOH		3067
NA	NA	NA	NA	5	NA	1	LPWAIT	LPWAIT	LPWAIT	LOAD PROGRAM & WAIT	NDS	BOP	S	SSOH		3067
NA	NA	NA	NA	0	NA	8	LSDCMD	LSDCMD	LSDCMD	LAST SENSOR DIRECT CMD	NDS	BOP-IP	S	SSOH		163
A	3	14	8	0	7	16	LVCKSMPA	LVCKSMPA	LVCKSMPA	LAST VALID CHECKSUM (1 OF 2)	TT&C	SPU A	S	Power-up	counts	
A	3	15	8	0	7	16	LVCKSMPA	LVCKSMPA	LVCKSMPA	LAST VALID CHECKSUM (2 OF 2)	TT&C	SPU A	S	Power-up	counts	
A	3	22	8	0	7	16	LVCKSMPB	LVCKSMPB	LVCKSMPB	LAST VALID CHECKSUM (1 OF 2)	TT&C	SPU B	S	Power-up	counts	
A	3	23	8	0	7	16	LVCKSMPB	LVCKSMPB	LVCKSMPB	LAST VALID CHECKSUM (2 OF 2)	TT&C	SPU B	S	Power-up	counts	
A	8	14	8	0	7	16	LVCKSUMA	LVCKSUMA	LVCKSUMA	LAST VALID CHECKSUM (1 OF 2)	TT&C	SPU A	S	Early Orbit	counts	
A	8	15	8	0	7	16	LVCKSUMA	LVCKSUMA	LVCKSUMA	LAST VALID CHECKSUM (2 OF 2)	TT&C	SPU A	S	Early Orbit	counts	
8	8	54	8	0	7	16	LVCKSUMA	LVCKSUMA	LVCKSUMA	LAST VALID CHECKSUM (1 OF 2)	TT&C	SPU A	S	Normal	counts	
8	8	55	8	0	7	16	LVCKSUMA	LVCKSUMA	LVCKSUMA	LAST VALID CHECKSUM (2 OF 2)	TT&C	SPU A	S	Normal	counts	
7	8	54	8	0	7	16	LVCKSUMA	LVCKSUMA	LVCKSUMA	LAST VALID CHECKSUM (1 OF 2)	TT&C	SPU A	S	Thruster	counts	
7	8	55	8	0	7	16	LVCKSUMA	LVCKSUMA	LVCKSUMA	LAST VALID CHECKSUM (2 OF 2)	TT&C	SPU A	S	Thruster	counts	
A	8	23	8	0	7	16	LVCKSUMB	LVCKSUMB	LVCKSUMB	LAST VALID CHECKSUM (1 OF 2)	TT&C	SPU B	S	Early Orbit	counts	
A	8	23	8	0	7	16	LVCKSUMB	LVCKSUMB	LVCKSUMB	LAST VALID CHECKSUM (2 OF 2)	TT&C	SPU B	S	Early Orbit	counts	
8	8	62	8	0	7	16	LVCKSUMB	LVCKSUMB	LVCKSUMB	LAST VALID CHECKSUM (1 OF 2)	TT&C	SPU B	S	Normal	counts	
8	8	63	8	0	7	16	LVCKSUMB	LVCKSUMB	LVCKSUMB	LAST VALID CHECKSUM (2 OF 2)	TT&C	SPU B	S	Normal	counts	





NA	NA	NA	NA	3	NA	1	MPDXEVL	MPDXEVL	EV LD DISABLE FLG1:BDX	NDS	BDP-MP	S	SSOH	44
NA	NA	NA	NA	3	NA	1	MPEERF	MPEERF	BDP MP EEPROM REFRES	NDS	BDP	S	SSOH	2993
NA	NA	NA	NA	3	NA	1	MPEERFEN	MPEERFEN	ENBDP MP EEPROM REFR	NDS	BDP	S	SSOH	2992
NA	NA	NA	NA	0	NA	1	MPEOMER	MPEOMER	MP EOM ERROR FLAG	NDS	BDP-IP	S	SSOH	158
NA	NA	NA	NA	6	NA	1	MPEOCRST	MPEOCRST	STORE-ALL RESET	NDS	BDP	S	SSOH	3036
NA	NA	NA	NA	4	NA	1	MPIFO	MPIFO	SI HARDWARE RESET	NDS	BDP	S	SSOH	3011
NA	NA	NA	NA	4	NA	1	MPHSEVLD	MPHSEVLD	EV LD DISABLE FLG1:WHS	NDS	BDP-MP	S	SSOH	44
NA	NA	NA	NA	6	NA	1	MPHXEVL	MPHXEVL	EV LD DISABLE FLG1:WHX	NDS	BDP-MP	S	SSOH	44
NA	NA	NA	NA	0	NA	8	MPITCH	MPITCH	MOTION PITCH COUNTER	NDS	BDP-MP	S	SSOH	24
NA	NA	NA	NA	5	NA	1	MPLSEVLD	MPLSEVLD	EV LD DISABLE FLG1:WLS	NDS	BDP-MP	S	SSOH	44
NA	NA	NA	NA	7	NA	1	MPLXEVL	MPLXEVL	EV LD DISABLE FLG1:WLX	NDS	BDP-MP	S	SSOH	44
NA	NA	NA	NA	5	NA	1	MPMFSINT	MPMFSINT	DISABMFMASFRMSYMCINT	NDS	BDP	S	SSOH	3011
NA	NA	NA	NA	7	NA	1	MPPFLRST	MPPFLRST	RESET MP POINT&FLAGS	NDS	BDP	S	SSOH	3036
NA	NA	NA	NA	4	NA	1	MPPRAMSWP	MPPRAMSWP	MP RAM SWAPPED	NDS	BDP-MP	S	SSOH	6
NA	NA	NA	NA	3	NA	1	MPPROMSWP	MPPROMSWP	MP ROM SWAP	NDS	BDP-MP	S	SSOH	6
NA	NA	NA	NA	4	NA	1	MPPSCMRST	MPPSCMRST	MP SET CMDS RESET	NDS	BDP	S	SSOH	3036
NA	NA	NA	NA	0	NA	4	MPSHRCV	MPSHRCV	MP SOH RECEIVE CNT	NDS	BDP-IP	S	SSOH	148
NA	NA	NA	NA	5	NA	1	MPSOHREQ	MPSOHREQ	MP SOH REQUEST	NDS	BDP-IP	S	SSOH	167
NA	NA	NA	NA	0	NA	16	MPSTACKP	MPSTACKP	MP STACK POINTER	NDS	BDP-MP	S	SSOH	69
NA	NA	NA	NA	0	NA	8	MPTCHDMP	MPTCHDMP	MOTION PITCH EV CNT	NDS	BDP-MP	S	SSOH	34
NA	NA	NA	NA	7	NA	1	MPUPLD	MPUPLD	UPLOAD BDP MP	NDS	BDP	S	SSOH	2993
NA	NA	NA	NA	7	NA	1	MPUPLEN	MPUPLEN	ENABLE BDP MP UPLOAD	NDS	BDP	S	SSOH	2992
NA	NA	NA	NA	0	NA	1	MPUPLOAD	MPUPLOAD	UPLOAD ALLOW	NDS	BDP-MP	S	SSOH	48
NA	NA	NA	NA	2	NA	1	MPYDEVLD	MPYDEVLD	EV LD DISABLE FLG1:YD	NDS	BDP-MP	S	SSOH	44
NA	NA	NA	NA	2	NA	1	MPYLEVLD	MPYLEVLD	EV LD DISABLE FLG2:YLT	NDS	BDP-MP	S	SSOH	45
NA	NA	NA	NA	0	NA	1	MPYPEVLD	MPYPEVLD	EV LD DISABLE FLG2:YMP	NDS	BDP-MP	S	SSOH	45
NA	NA	NA	NA	1	NA	1	MPYREVLD	MPYREVLD	EV LD DISABLE FLG2:YMR	NDS	BDP-MP	S	SSOH	45
NA	NA	NA	NA	0	NA	1	MPYSEVLD	MPYSEVLD	EV LD DISABLE FLG1:YS	NDS	BDP-MP	S	SSOH	44
NA	NA	NA	NA	1	NA	1	MPYTEVLD	MPYTEVLD	EV LD DISABLE FLG1:YT	NDS	BDP-MP	S	SSOH	44
NA	NA	NA	NA	0	NA	8	MROLL	MROLL	MOTION ROLL COUNTER	NDS	BDP-MP	S	SSOH	25
NA	NA	NA	NA	0	NA	8	MROLLDMP	MROLLDMP	MOTION ROLL EV CNT	NDS	BDP-MP	S	SSOH	35
A	A	13	1	6	1	MSGMODE	MSGMODE	SERIAL MESSAGE MODE ON/OFF	TT&C	CDU	S	All Power-Up	1=On 0=Off	
NA	NA	NA	NA	6	NA	1	MTSTL3RO	MTSTL3RO	L3 OP FLAG MEM TEST	NDS	BDP-MP	S	SSOH	49
NA	NA	NA	NA	0	NA	8	MWHSADMP	MWHSADMP	WHA EVENT DUMP CNT	NDS	BDP-MP	S	SSOH	30
NA	NA	NA	NA	0	NA	8	MWHSBDM	MWHSBDM	WHS B EVENT DUMP CNT	NDS	BDP-MP	S	SSOH	31
NA	NA	NA	NA	0	NA	8	MWLSADMP	MWLSADMP	WLA EVENT DUMP CNT	NDS	BDP-MP	S	SSOH	32
NA	NA	NA	NA	0	NA	8	MWLSBDM	MWLSBDM	WLS B EVENT DUMP CNT	NDS	BDP-MP	S	SSOH	33
NA	NA	NA	NA	0	NA	8	MYDDUMP	MYDDUMP	YD EVENT DUMP COUNT	NDS	BDP-MP	S	SSOH	27
NA	NA	NA	NA	0	NA	8	MYFDUMP	MYFDUMP	YF EVENT DUMP COUNT	NDS	BDP-MP	S	SSOH	26
NA	NA	NA	NA	0	NA	16	MYFTBIP	MYFTBIP	YF TMP BUF I/P POINT	NDS	BDP-MP	S	SSOH	101
NA	NA	NA	NA	0	NA	16	MYFTBOP	MYFTBOP	YF TMP BUF O/P POINT	NDS	BDP-MP	S	SSOH	103
NA	NA	NA	NA	0	NA	8	MYFTBQUE	MYFTBQUE	YF TMP BUF QUEUE CNT	NDS	BDP-MP	S	SSOH	63
NA	NA	NA	NA	7	NA	1	NEWL3RO	NEWL3RO	L3 OP FLG NEW L3 ROL	NDS	BDP-MP	S	SSOH	49
NA	NA	NA	NA	0	NA	8	NL3BDEVT	NL3BDEVT	NON-L3 BX EV/BDX CNT	NDS	BDP-MP	S	SSOH	19
NA	NA	NA	NA	0	NA	16	NL3INPTP	NL3INPTP	NON-L3 INPUT POINTER	NDS	BDP-MP	S	SSOH	79
NA	NA	NA	NA	4	NA	4	NL3INSEC	NL3INSEC	NON-L3 INPUT SECTION	NDS	BDP-MP	S	SSOH	51
NA	NA	NA	NA	0	NA	8	NL3LIGHT	NL3LIGHT	NON-L3 LIGHTNING EV CNT	NDS	BDP-MP	S	SSOH	17
NA	NA	NA	NA	2	NA	1	NL3MOVRT	NL3MOVRT	DISABNONL3MEMOVRWRIT	NDS	BDP	S	SSOH	3013
NA	NA	NA	NA	4	NA	4	NL3NSEN1	NL3NSEN1	NONL3 NEXT SECT ENT 1	NDS	BDP-MP	S	SSOH	60
NA	NA	NA	NA	0	NA	4	NL3NSEN2	NL3NSEN2	NONL3 NEXT SECT ENT 2	NDS	BDP-MP	S	SSOH	61
NA	NA	NA	NA	4	NA	4	NL3NSEN3	NL3NSEN3	NONL3 NEXT SECT ENT 3	NDS	BDP-MP	S	SSOH	61
NA	NA	NA	NA	0	NA	8	NL3NSINP	NL3NSINP	NONL3 NEXT I/P POINT	NDS	BDP-MP	S	SSOH	55
NA	NA	NA	NA	0	NA	8	NL3WHABF	NL3WHABF	NON-L3 WH A BUF CNT	NDS	BDP-MP	S	SSOH	20
NA	NA	NA	NA	0	NA	8	NL3WHBBF	NL3WHBBF	NON-L3 WHS B BUF CNT	NDS	BDP-MP	S	SSOH	21
NA	NA	NA	NA	0	NA	8	NL3WLABF	NL3WLABF	NON-L3 WLA BUF CNT	NDS	BDP-MP	S	SSOH	22
NA	NA	NA	NA	0	NA	8	NL3VLABF	NL3VLABF	NON-L3 WLS B BUF CNT	NDS	BDP-MP	S	SSOH	23

NA	NA	NA	NA	0	NA	8	NL3YDEV1	NL3YDEV1	NL3YDEV1	NON-L3 YD EV COUNTER	NDS	BDP-MP	S	SSOH				18
NA	NA	NA	NA	0	NA	8	NL3YFEV1	NL3YFEV1	NL3YFEV1	NON-L3 YF EV COUNTER	NDS	BDP-MP	S	SSOH				16
NA	NA	NA	NA	2	NA	6	NOISETH	NOISETH	NOISETH	QFS=3, NOISE THRESH LEVEL	NDS	BDP	S	SSOH				3063
3	4	54	1	3	3	1	NOONMIDA	NOONMIDA	NOON-MIDNIGHT INDICATOR	NOON-MIDNIGHT INDICATOR	TT&C	SPU A	S	Normal Thruster		0=Not in Noon/Midnight Region 1=In Noon/Midnight Region	ADS Flag Word	
3	4	62	1	3	3	1	NOONMIDB	NOONMIDB	NOON-MIDNIGHT INDICATOR	NOON-MIDNIGHT INDICATOR	TT&C	SPU B	S	Normal Thruster		0=Not in Noon/Midnight Region 1=In Noon/Midnight Region	ADS Flag Word	
NA	NA	NA	NA	0	NA	4	NOSMONCH	NOSMONCH	NOISE MONCH/LOBAND	NOISE MONCH/LOBAND	NDS	BDP	S	SSOH				3050
NA	NA	NA	NA	6	NA	1	NPMSDATA	NPMSDATA	NPMS DATA STORE	NPMS DATA STORE	NDS	BDY	S	SSOH				221
NA	NA	NA	NA	7	NA	1	NPMSGAIN	NPMSGAIN	NPMS BAND PASS GAIN SEL	NPMS BAND PASS GAIN SEL	NDS	BDY	S	SSOH				221
NA	NA	NA	NA	6	NA	1	NPMSIMSK	NPMSIMSK	NPMS DATA INTERRUPT EN	NPMS DATA INTERRUPT EN	NDS	BDY	S	SSOH				211
NA	NA	NA	NA	6	NA	1	NPMSINT	NPMSINT	NPMS DATA TEST INTERRUPT	NPMS DATA TEST INTERRUPT	NDS	BDP	S	SSOH				2970
NA	NA	NA	NA	2	NA	1	NPMSRNG	NPMSRNG	NPMS RANGE	NPMS RANGE	NDS	BDY	S	SSOH				211
A	4	10	1	4	4	1	OCUA	OCUA	OCU A ENABLED/DISABLED	OCU A ENABLED/DISABLED	EPS	OCU	DL	All Power-Up		1=Disabled 0=Enabled		
A	4	11	1	4	4	1	OCUB	OCUB	OCU B ENABLED/DISABLED	OCU B ENABLED/DISABLED	EPS	OCU	DL	All Power-Up		1=Disabled 0=Enabled		
A	6	11	1	4	4	1	ODD2PWR	ODD2PWR	REA ODD 0.2 LBF POWER ENABLED	REA ODD 0.2 LBF POWER ENABLED	RCS	REA	DL	All Power-Up		1=Disabled 0=Enabled		
A	6	11	1	0	0	1	ODD2X	ODD2X	REA ODD 0.2 LBF X ENABLED	REA ODD 0.2 LBF X ENABLED	RCS	REA	DL	All Power-Up		1=Disabled 0=Enabled		
A	6	11	1	1	1	1	ODD2Y	ODD2Y	REA ODD 0.2 LBF Y ENABLED	REA ODD 0.2 LBF Y ENABLED	RCS	REA	DL	All Power-Up		1=Disabled 0=Enabled		
A	6	11	1	6	6	1	ODD5PWR	ODD5PWR	REA ODD 5.0 LBF POWER ENABLED	REA ODD 5.0 LBF POWER ENABLED	RCS	REA	DL	All Power-Up		1=Disabled 0=Enabled		
A	6	11	1	2	2	1	ODD5Z	ODD5Z	REA ODD 5.0 LBF Z ENABLED	REA ODD 5.0 LBF Z ENABLED	RCS	REA	DL	All Power-Up		1=Disabled 0=Enabled		
A	6	11	1	3	3	1	ODDCBTHR	ODDCBTHR	REA ODD CABTED HEATER ENABLED	REA ODD CABTED HEATER ENABLED	RCS	REA	DL	All Power-Up		1=Disabled 0=Enabled		
NA	NA	NA	NA	2	NA	1	PAGEDIS	PAGEDIS	PAGE DISABLE	PAGE DISABLE	NDS	BDP-MP	S	SSOH				47
2	8	27	8	0	7	8	PCEACAL	PCEACAL	PCE A C/S CAL MON	PCE A C/S CAL MON	TT&C	PCE	AP	All Power-Up				
1	2	56	8	0	7	8	PCEACV5V	PCEACV5V	PCE A CONV +5VDC OUT	PCE A CONV +5VDC OUT	TT&C	PCE	AP	All Power-Up				
1	5	58	8	0	7	8	PCEACVT	PCEACVT	PCE A CONV TEMP	PCE A CONV TEMP	TT&C	PCE	AP	All Power-Up				
A	8	41	1	4	4	1	PCEAOVRC	PCEAOVRC	PCE A DPC OVERCURR FAULT	PCE A DPC OVERCURR FAULT	TT&C	PCE	DL	All Power-Up		1=No Overcurrent 0=Overcurrent		
4	8	28	8	0	7	8	PCEBCAL	PCEBCAL	PCE B C/S CAL MON	PCE B C/S CAL MON	TT&C	PCE	AP	All Power-Up				
4	3	56	8	0	7	8	PCEBCV5V	PCEBCV5V	PCE B CONV +5VDC OUT	PCE B CONV +5VDC OUT	TT&C	PCE	AP	All Power-Up				
1	6	58	8	0	7	8	PCEBCVT	PCEBCVT	PCE B CONV TEMP	PCE B CONV TEMP	TT&C	PCE	AP	All Power-Up				
A	8	42	1	4	4	1	PCEBOVRC	PCEBOVRC	PCE B DPC OVERCURR FAULT	PCE B DPC OVERCURR FAULT	TT&C	PCE	DL	All Power-Up		1=No Overcurrent 0=Overcurrent		
A	1	35	8	0	7	8	PCECURH1	PCECURH1	BUS CURR TO PCE HI-PWR (T1)	BUS CURR TO PCE HI-PWR (T1)	EPS	PRU	DL	All Power-Up				
A	5	35	8	0	7	8	PCECURH2	PCECURH2	BUS CURR TO PCE HI-PWR (T2)	BUS CURR TO PCE HI-PWR (T2)	EPS	PRU	DL	All Power-Up				
A	8	35	8	0	7	8	PCECURLO	PCECURLO	BUSS CURR TO PCE LO-PWR	BUSS CURR TO PCE LO-PWR	EPS	PRU	DL	All Power-Up				
8	2	57	8	0	7	8	PCEIFT	PCEIFT	-X PAYLOAD PNL/PCE I/F TEMP A	-X PAYLOAD PNL/PCE I/F TEMP A	MSS	TCS	AP	All Power-Up				
2	8	52	8	0	7	16	PITCHMEA	PITCHMEA	PITCH MOMENTUM ERROR (1 OF 2)	PITCH MOMENTUM ERROR (1 OF 2)	ADS	SPU A	S	Thruster		in-lbf-sec		
2	8	53	8	0	7	16	PITCHMEA	PITCHMEA	PITCH MOMENTUM ERROR (2 OF 2)	PITCH MOMENTUM ERROR (2 OF 2)	ADS	SPU A	S	Thruster		in-lbf-sec		
2	8	60	8	0	7	16	PITCHMEB	PITCHMEB	PITCH MOMENTUM ERROR (1 OF 2)	PITCH MOMENTUM ERROR (1 OF 2)	ADS	SPU B	S	Thruster		in-lbf-sec		
2	8	61	8	0	7	16	PITCHMEB	PITCHMEB	PITCH MOMENTUM ERROR (2 OF 2)	PITCH MOMENTUM ERROR (2 OF 2)	ADS	SPU B	S	Thruster		in-lbf-sec		
NA	NA	NA	NA	1	NA	1	PITCHMSG	PITCHMSG	DISABLE PITCH MSGS	DISABLE PITCH MSGS	NDS	BDP	S	SSOH				2971

NA	NA	NA	NA	0	NA	1	PITCHPWR	PITCHPWR	PITCHPWR	PITCH POWER ENABLE	NDS	BDY	S	SSOH	Celsius	217
5	24	8	0	7	8	PITCH	PITCH	PITCH	PITCH ACCELEROMETER TEMP		NDS	BDY	S	All Power-Up		SSOH Byte 3418
NA	NA	NA	NA	0	NA	16	PITCHC	PITCHC	PITCH TRIGGER COUNT		NDS	BDY	S	SSOH		207
NA	NA	NA	NA	0	NA	1	PITCHTRG	PITCHTRG	PITCH TRIGGER		NDS	BDP	S	SSOH		2967
2	6	54	8	0	7	16	PITERRA	PITERRA	PITCH ATTITUDE ERROR (1 OF 2)		ADS	SPU A	S	Normal Thruster	radians	
2	6	55	8	0	7	16	PITERRA	PITERRA	PITCH ATTITUDE ERROR (2 OF 2)		ADS	SPU A	S	Normal Thruster	radians	
2	6	62	8	0	7	16	PITERRB	PITERRB	PITCH ATTITUDE ERROR (1 OF 2)		ADS	SPU B	S	Normal Thruster	radians	
2	6	63	8	0	7	16	PITERRB	PITERRB	PITCH ATTITUDE ERROR (2 OF 2)		ADS	SPU B	S	Normal Thruster	radians	
2	7	52	8	0	7	16	PITINTA	PITINTA	PITCH ATTITUDE INTEG ERROR (1 OF 2)		ADS	SPU A	S	Thruster	rad/sec	
2	7	53	8	0	7	16	PITINTA	PITINTA	PITCH ATTITUDE INTEG ERROR (2 OF 2)		ADS	SPU A	S	Thruster	rad/sec	
2	7	60	8	0	7	16	PITINTB	PITINTB	PITCH ATTITUDE INTEG ERROR (1 OF 2)		ADS	SPU B	S	Thruster	rad/sec	
2	7	61	8	0	7	16	PITINTB	PITINTB	PITCH ATTITUDE INTEG ERROR (2 OF 2)		ADS	SPU B	S	Thruster	rad/sec	
2	7	52	8	0	7	16	PITINTNA	PITINTNA	PITCH ATTITUDE INTEG ERROR (1 OF 2)		ADS	SPU A	S	Normal	rad/sec	
2	7	53	8	0	7	16	PITINTNA	PITINTNA	PITCH ATTITUDE INTEG ERROR (2 OF 2)		ADS	SPU A	S	Normal	rad/sec	
2	7	60	8	0	7	16	PITINTNB	PITINTNB	PITCH ATTITUDE INTEG ERROR (1 OF 2)		ADS	SPU B	S	Normal	rad/sec	
2	7	61	8	0	7	16	PITINTNB	PITINTNB	PITCH ATTITUDE INTEG ERROR (2 OF 2)		ADS	SPU B	S	Normal	rad/sec	
2	7	54	8	0	7	16	PITRATEA	PITRATEA	PITCH ATTITUDE RATE ERROR (1 OF 2)		ADS	SPU A	S	Normal Thruster	rad/sec	
2	7	55	8	0	7	16	PITRATEA	PITRATEA	PITCH ATTITUDE RATE ERROR (2 OF 2)		ADS	SPU A	S	Normal Thruster	rad/sec	
2	7	62	8	0	7	16	PITRATEB	PITRATEB	PITCH ATTITUDE RATE ERROR (1 OF 2)		ADS	SPU B	S	Normal Thruster	rad/sec	
2	7	63	8	0	7	16	PITRATEB	PITRATEB	PITCH ATTITUDE RATE ERROR (2 OF 2)		ADS	SPU B	S	Normal Thruster	rad/sec	
4	4	54	1	0	0	1	PITSSELA	PITSSELA	THRUST CNTRL PITS MATRIX SELECT		TT&C	SPU A	S	Thruster		Thruster Flag Word 54 (first word)
4	4	62	1	0	0	1	PITSSSELB	PITSSSELB	THRUST CNTRL PITS MATRIX SELECT		TT&C	SPU B	S	Thruster		Thruster Flag Word 62 (first word)
NA	NA	NA	NA	0	NA	8	PNUMBRAH	PNUMBRAH	PENUMBRA (8 MSB)		NDS	BDP	S	SSOH		2958
NA	NA	NA	NA	0	NA	8	PNUMBRAL	PNUMBRAL	PENUMBRA (8 LSB)		NDS	BDP	S	SSOH		2959
A	4	12	8	0	7	16	PORTRDA	PORTRDA	RESULTS OF PORT READ COMMAND		TT&C	SPU A	S	Power-Up		Word 1 of 2 (first 8 bits) format dep on port read
A	4	13	8	0	7	16	PORTRDA	PORTRDA	RESULTS OF PORT READ COMMAND		TT&C	SPU A	S	Power-Up		Word 2 of 2 (second 8 bits) format dep on port read
A	4	20	8	0	7	16	PORTRDB	PORTRDB	RESULTS OF PORT READ COMMAND		TT&C	SPU B	S	Power-Up		Word 1 of 2 (first 8 bits) format dep on port read
A	4	21	8	0	7	16	PORTRDB	PORTRDB	RESULTS OF PORT READ COMMAND		TT&C	SPU B	S	Power-Up		Word 2 of 2 (second 8 bits) format dep on port read
NA	NA	NA	NA	6	NA	1	PROCDIAG	PROCDIAG	RUN PROCESSOR DIAG		NDS	BDP	S	SSOH		3066
NA	NA	NA	NA	5	NA	1	PROCNTRL	PROCNTRL	MPIIP CONTROL		NDS	BDP-MP	S	SSOH		47
NA	NA	NA	NA	0	NA	8	PROMCKSM	PROMCKSM	PROM CHECKSUM		NDS	BDDIX	S	SSOH		264
3	5	58	8	0	7	8	PRUIFT	PRUIFT	BASE PNUMPRU I/F TEMP C		MSS	TCS	AP	All Power-Up	Celsius	
2	5	56	8	0	7	8	PTCCUR	PTCCUR	PTC COIL CURRENT		ADS	MTC	AH	All Power-Up	mA	
A	1	16	1	5	5	1	PTCFWD	PTCFWD	PTC FORWARD COIL ENABLED		ADS	MTC	S	All Power-Up		1=Enabled 0=Disabled



A 5 14	8 0 7 16	REA1PWA	REA1PWA	REA1PWA	REA 1 PULSEWIDTH ATTITUDE PAIR (1 OF 2)	ADS	SPU A	S	Thruster	seconds		
A 5 15	8 0 7 16	REA1PWA	REA1PWA	REA1PWA	REA 1 PULSEWIDTH ATTITUDE PAIR (2 OF 2)	ADS	SPU A	S	Thruster	seconds		
A 5 22	8 0 7 16	REA1PWB	REA1PWB	REA1PWB	REA 1 PULSEWIDTH ATTITUDE PAIR (1 OF 2)	ADS	SPU B	S	Thruster	seconds		
A 5 23	8 0 7 16	REA1PWB	REA1PWB	REA1PWB	REA 1 PULSEWIDTH ATTITUDE PAIR (2 OF 2)	ADS	SPU B	S	Thruster	seconds		
A 6 14	8 0 7 16	REA2PWA	REA2PWA	REA2PWA	REA 2 PULSEWIDTH ATTITUDE PAIR (1 OF 2)	ADS	SPU A	S	Thruster	seconds		
A 6 15	8 0 7 16	REA2PWA	REA2PWA	REA2PWA	REA 2 PULSEWIDTH ATTITUDE PAIR (2 OF 2)	ADS	SPU A	S	Thruster	seconds		
A 6 22	8 0 7 16	REA2PWB	REA2PWB	REA2PWB	REA 2 PULSEWIDTH ATTITUDE PAIR (1 OF 2)	ADS	SPU B	S	Thruster	seconds		
A 6 23	8 0 7 16	REA2PWB	REA2PWB	REA2PWB	REA 2 PULSEWIDTH ATTITUDE PAIR (2 OF 2)	ADS	SPU B	S	Thruster	seconds		
A 7 14	8 0 7 16	REA3PWA	REA3PWA	REA3PWA	REA 3 PULSEWIDTH ATTITUDE PAIR (1 OF 2)	ADS	SPU A	S	Thruster	seconds		
A 7 15	8 0 7 16	REA3PWA	REA3PWA	REA3PWA	REA 3 PULSEWIDTH ATTITUDE PAIR (2 OF 2)	ADS	SPU A	S	Thruster	seconds		
A 7 22	8 0 7 16	REA3PWB	REA3PWB	REA3PWB	REA 3 PULSEWIDTH ATTITUDE PAIR (1 OF 2)	ADS	SPU B	S	Thruster	seconds		
A 7 23	8 0 7 16	REA3PWB	REA3PWB	REA3PWB	REA 3 PULSEWIDTH ATTITUDE PAIR (2 OF 2)	ADS	SPU B	S	Thruster	seconds		
A 8 14	8 0 7 16	REA4PWA	REA4PWA	REA4PWA	REA 4 PULSEWIDTH ATTITUDE PAIR (1 OF 2)	ADS	SPU A	S	Thruster	seconds		
A 8 15	8 0 7 16	REA4PWA	REA4PWA	REA4PWA	REA 4 PULSEWIDTH ATTITUDE PAIR (2 OF 2)	ADS	SPU A	S	Thruster	seconds		
A 8 22	8 0 7 16	REA4PWB	REA4PWB	REA4PWB	REA 4 PULSEWIDTH ATTITUDE PAIR (1 OF 2)	ADS	SPU B	S	Thruster	seconds		
A 8 23	8 0 7 16	REA4PWB	REA4PWB	REA4PWB	REA 4 PULSEWIDTH ATTITUDE PAIR (2 OF 2)	ADS	SPU B	S	Thruster	seconds		
A 2 52	8 0 7 16	REA5PWA	REA5PWA	REA5PWA	REA 5 PULSEWIDTH ATTITUDE PAIR (1 OF 2)	ADS	SPU A	S	Thruster	seconds		
A 2 53	8 0 7 16	REA5PWA	REA5PWA	REA5PWA	REA 5 PULSEWIDTH ATTITUDE PAIR (2 OF 2)	ADS	SPU A	S	Thruster	seconds		
A 2 60	8 0 7 16	REA5PWB	REA5PWB	REA5PWB	REA 5 PULSEWIDTH ATTITUDE PAIR (1 OF 2)	ADS	SPU B	S	Thruster	seconds		
A 2 61	8 0 7 16	REA5PWB	REA5PWB	REA5PWB	REA 5 PULSEWIDTH ATTITUDE PAIR (2 OF 2)	ADS	SPU B	S	Thruster	seconds		
A 2 54	8 0 7 16	REA6PWA	REA6PWA	REA6PWA	REA 6 PULSEWIDTH ATTITUDE PAIR (1 OF 2)	ADS	SPU A	S	Thruster	seconds		
A 2 55	8 0 7 16	REA6PWA	REA6PWA	REA6PWA	REA 6 PULSEWIDTH ATTITUDE PAIR (2 OF 2)	ADS	SPU A	S	Thruster	seconds		
A 2 62	8 0 7 16	REA6PWB	REA6PWB	REA6PWB	REA 6 PULSEWIDTH ATTITUDE PAIR (1 OF 2)	ADS	SPU B	S	Thruster	seconds		
A 2 63	8 0 7 16	REA6PWB	REA6PWB	REA6PWB	REA 6 PULSEWIDTH ATTITUDE PAIR (2 OF 2)	ADS	SPU B	S	Thruster	seconds		
A 3 52	8 0 7 16	REA7PWA	REA7PWA	REA7PWA	REA 7 PULSEWIDTH ATTITUDE PAIR (1 OF 2)	ADS	SPU A	S	Thruster	seconds		
A 3 53	8 0 7 16	REA7PWA	REA7PWA	REA7PWA	REA 7 PULSEWIDTH ATTITUDE PAIR (2 OF 2)	ADS	SPU A	S	Thruster	seconds		
A 3 60	8 0 7 16	REA7PWB	REA7PWB	REA7PWB	REA 7 PULSEWIDTH ATTITUDE PAIR (1 OF 2)	ADS	SPU B	S	Thruster	seconds		
A 3 61	8 0 7 16	REA7PWB	REA7PWB	REA7PWB	REA 7 PULSEWIDTH ATTITUDE PAIR (2 OF 2)	ADS	SPU B	S	Thruster	seconds		







6	5	60	1	3	3	1	RMZRTB	RMZRTB	RMA ZERO RATE	TT&C	SPU B	S	Thruster	0=Test Disabled 1=Test Enabled	RDMGMT Flag Word 60 (upper half-first word)
NA	NA	NA	NA	2	NA	1	RMINTER	RMINTER	DISABLE RMI INTERLEAVER	NDS	BDP	S	SSOH		2979
NA	NA	NA	NA	0	NA	1	RMIOUTP	RMIOUTP	DISABLE RMI OUTPUT	NDS	BDP	S	SSOH		2979
NA	NA	NA	NA	1	NA	1	RMISCRAM	RMISCRAM	DISABLE RMI SCRAMBLER	NDS	BDP	S	SSOH		2979
NA	NA	NA	NA	3	NA	1	RMITSTPA	RMITSTPA	RMI TEST PATTERN ENABLE	NDS	BDP	S	SSOH		2979
1	7	52	8	0	7	16	ROLINTNA	ROLINTNA	ROLL ATTITUDE INTEG ERROR (1 OF 2)	ADS	SPU A	S	Normal	rad/sec	
1	7	53	8	0	7	16	ROLINTNA	ROLINTNA	ROLL ATTITUDE INTEG ERROR (2 OF 2)	ADS	SPU A	S	Normal	rad/sec	
1	7	60	8	0	7	16	ROLINTNB	ROLINTNB	ROLL ATTITUDE INTEG ERROR (1 OF 2)	ADS	SPU B	S	Normal	rad/sec	
1	7	61	8	0	7	16	ROLINTNB	ROLINTNB	ROLL ATTITUDE INTEG ERROR (2 OF 2)	ADS	SPU B	S	Normal	rad/sec	
NA	NA	NA	NA	1	NA	2	ROLLCNT	ROLLCNT	ROLL COUNT CODE	NDS	BDP	S	SSOH		2968
1	6	54	8	0	7	16	ROLLERRA	ROLLERRA	ROLL ATTITUDE ERROR (1 OF 2)	ADS	SPU A	S	Thruster	radians	
1	6	55	8	0	7	16	ROLLERRA	ROLLERRA	ROLL ATTITUDE ERROR (2 OF 2)	ADS	SPU A	S	Thruster	radians	
1	6	62	8	0	7	16	ROLLERRB	ROLLERRB	ROLL ATTITUDE ERROR (1 OF 2)	ADS	SPU B	S	Thruster	radians	
1	6	63	8	0	7	16	ROLLERRB	ROLLERRB	ROLL ATTITUDE ERROR (2 OF 2)	ADS	SPU B	S	Thruster	radians	
1	7	52	8	0	7	16	ROLLINTA	ROLLINTA	ROLL ATTITUDE INTEG ERROR (1 OF 2)	ADS	SPU A	S	Thruster	rad/sec	
1	7	53	8	0	7	16	ROLLINTA	ROLLINTA	ROLL ATTITUDE INTEG ERROR (2 OF 2)	ADS	SPU A	S	Thruster	rad/sec	
1	7	60	8	0	7	16	ROLLINTB	ROLLINTB	ROLL ATTITUDE INTEG ERROR (1 OF 2)	ADS	SPU B	S	Thruster	rad/sec	
1	7	61	8	0	7	16	ROLLINTB	ROLLINTB	ROLL ATTITUDE INTEG ERROR (2 OF 2)	ADS	SPU B	S	Thruster	rad/sec	
1	8	52	8	0	7	16	ROLLMEA	ROLLMEA	ROLL MOMENTUM ERROR (1 OF 2)	ADS	SPU B	S	Thruster	rad/sec	
1	8	53	8	0	7	16	ROLLMEA	ROLLMEA	ROLL MOMENTUM ERROR (2 OF 2)	ADS	SPU A	S	Thruster	in-lbf-sec	
1	8	60	8	0	7	16	ROLLMEB	ROLLMEB	ROLL MOMENTUM ERROR (1 OF 2)	ADS	SPU B	S	Thruster	in-lbf-sec	
1	8	61	8	0	7	16	ROLLMEB	ROLLMEB	ROLL MOMENTUM ERROR (2 OF 2)	ADS	SPU B	S	Thruster	in-lbf-sec	
NA	NA	NA	NA	2	NA	1	ROLLMSG	ROLLMSG	DISABLE ROLL MSGS	NDS	BDP	S	SSOH		2971
NA	NA	NA	NA	1	NA	1	ROLLPWR	ROLLPWR	ROLL POWER ENABLE	NDS	BDY	S	SSOH		217
1	7	54	8	0	7	16	ROLLRATA	ROLLRATA	ROLL ATTITUDE RATE ERROR (1 OF 2)	ADS	SPU A	S	Normal	rad/sec	
1	7	55	8	0	7	16	ROLLRATA	ROLLRATA	ROLL ATTITUDE RATE ERROR (2 OF 2)	ADS	SPU A	S	Normal	rad/sec	
1	7	62	8	0	7	16	ROLLRATB	ROLLRATB	ROLL ATTITUDE RATE ERROR (1 OF 2)	ADS	SPU B	S	Thruster	rad/sec	
1	7	63	8	0	7	16	ROLLRATB	ROLLRATB	ROLL ATTITUDE RATE ERROR (2 OF 2)	ADS	SPU B	S	Thruster	rad/sec	
NA	NA	NA	NA	5	NA	1	ROLLSTST	ROLLSTST	ROLL SYSTEM TEST	NDS	BDY	S	SSOH		217
5	6	24	8	0	7	8	ROLLT	ROLLT	ROLL ACCELEROMETER TEMP	NDS	BDY	S	All Power-Up	Celsius	SSOH Byte 3419
NA	NA	NA	NA	0	NA	16	ROLLTC	ROLLTC	ROLL TRIGGER COUNT	NDS	BDP	S	SSOH		209
NA	NA	NA	NA	3	NA	5	ROLLTL	ROLLTL	ROLL TRIGGER LEVEL	NDS	BDP	S	SSOH		2968
NA	NA	NA	NA	0	NA	1	ROLLTRG	ROLLTRG	ROLL TRIGGER ENABLE	NDS	BDP	S	SSOH		2968
NA	NA	NA	NA	3	NA	1	ROLLTRIG	ROLLTRIG	ROLL TRIGGER ENABLE	NDS	BDY	S	SSOH		217
NA	NA	NA	NA	7	NA	1	RPBASE	RPBASE	RUN PROGRAM BASE ADDR	NDS	BDP	S	SSOH		3067
NA	NA	NA	NA	1	NA	1	RPCOIN	RPCOIN	ROLL PITCH COINCIDEN	NDS	BDP-IP	S	SSOH		2969
NA	NA	NA	NA	5	NA	1	RST03INT	RST03INT	INTR RST 0-3	NDS	BDP-IP	S	SSOH		164
NA	NA	NA	NA	2	NA	1	RST47INT	RST47INT	RST4-7P.FIFOSTIMEADC	NDS	BDP-IP	S	SSOH		164
NA	NA	NA	NA	1	NA	1	RST55INT	RST55INT	RST 5:5 SERIAL COM	NDS	BDP-IP	S	SSOH		164



7	6	55	1	0	0	9	RWA2TCA	RWA2TCA	RWA TORQUE COMMAND 2 (2 OF 2)	ADS	SPU A	S	Normal	in-lbf			
7	6	62	8	0	7	9	RWA2TCB	RWA2TCB	RWA TORQUE COMMAND 2 (1 OF 2)	ADS	SPU B	S	Normal	in-lbf			
7	6	63	1	0	0	9	RWA2TCB	RWA2TCB	RWA TORQUE COMMAND 2 (2 OF 2)	ADS	SPU B	S	Normal	in-lbf			
6	5	54	4	7	12	RWA3A	RWA3A	RWA 3 TACH OUTPUT (1 OF 2)	ADS	SPU A	S	Normal	counts		LSB=5 rpm		
6	5	55	8	0	7	12	RWA3A	RWA3A	RWA 3 TACH OUTPUT (2 OF 2)	ADS	SPU A	S	Normal	counts		LSB=5 rpm	
6	5	62	4	7	12	RWA3B	RWA3B	RWA 3 TACH OUTPUT (1 OF 2)	ADS	SPU A	S	Normal	counts		LSB=5 rpm		
6	5	63	8	0	7	12	RWA3B	RWA3B	RWA 3 TACH OUTPUT (2 OF 2)	ADS	SPU B	S	Normal	counts		LSB=5 rpm	
1	7	57	8	0	7	8	RWA3BT	RWA3BT	RWA 3 BEARING TEMP	ADS	RWA	AP	All Power-Up	Celsius			
A	2	52	8	0	7	16	RWA3FILA	RWA3FILA	FILTERED RWA 3 TACH OUTPUT (1 OF 2)	ADS	SPU A	S	Normal	rad/sec			
A	2	53	8	0	7	16	RWA3FILA	RWA3FILA	FILTERED RWA 3 TACH OUTPUT (2 OF 2)	ADS	SPU A	S	Normal	rad/sec			
8	6	52	8	0	7	16	RWA3FILA	RWA3FILA	FILTERED RWA 3 TACH OUTPUT (1 OF 2)	ADS	SPU A	S	Thruster	rad/sec			
8	6	53	8	0	7	16	RWA3FILA	RWA3FILA	FILTERED RWA 3 TACH OUTPUT (2 OF 2)	ADS	SPU A	S	Thruster	rad/sec			
A	2	60	8	0	7	16	RWA3FILB	RWA3FILB	FILTERED RWA 3 TACH OUTPUT (1 OF 2)	ADS	SPU B	S	Normal	rad/sec			
A	2	61	8	0	7	16	RWA3FILB	RWA3FILB	FILTERED RWA 3 TACH OUTPUT (2 OF 2)	ADS	SPU B	S	Normal	rad/sec			
8	6	60	8	0	7	16	RWA3FILB	RWA3FILB	FILTERED RWA 3 TACH OUTPUT (1 OF 2)	ADS	SPU B	S	Thruster	rad/sec			
8	6	61	8	0	7	16	RWA3FILB	RWA3FILB	FILTERED RWA 3 TACH OUTPUT (2 OF 2)	ADS	SPU B	S	Thruster	rad/sec			
A	5	48	8	0	7	8	RWA3MCUR	RWA3MCUR	RWA 3 MOTOR CURRENT	ADS	RWA	AH	All Power-Up	mA			
7	7	52	8	0	7	9	RWA3TCA	RWA3TCA	RWA TORQUE COMMAND 3 (1 OF 2)	ADS	SPU A	S	Normal	in-lbf			
7	7	53	1	0	0	9	RWA3TCA	RWA3TCA	RWA TORQUE COMMAND 3 (2 OF 2)	ADS	SPU A	S	Normal	in-lbf			
7	7	60	8	0	7	9	RWA3TCB	RWA3TCB	RWA TORQUE COMMAND 3 (1 OF 2)	ADS	SPU B	S	Normal	in-lbf			
7	7	61	1	0	0	9	RWA3TCB	RWA3TCB	RWA TORQUE COMMAND 3 (2 OF 2)	ADS	SPU B	S	Normal	in-lbf			
6	6	52	4	7	12	RWA4A	RWA4A	RWA 4 TACH OUTPUT (1 OF 2)	ADS	SPU A	S	Normal	counts		LSB=5 rpm		
6	6	53	8	0	7	12	RWA4A	RWA4A	RWA 4 TACH OUTPUT (2 OF 2)	ADS	SPU A	S	Normal	counts		LSB=5 rpm	
6	6	60	4	7	12	RWA4B	RWA4B	RWA 4 TACH OUTPUT (1 OF 2)	ADS	SPU B	S	Normal	counts		LSB=5 rpm		
6	6	61	8	0	7	12	RWA4B	RWA4B	RWA 4 TACH OUTPUT (2 OF 2)	ADS	SPU B	S	Normal	counts		LSB=5 rpm	
1	8	57	8	0	7	8	RWA4BT	RWA4BT	RWA 4 BEARING TEMP	ADS	RWA	AP	All Power-Up	Celsius			
A	2	54	8	0	7	16	RWA4FILA	RWA4FILA	FILTERED RWA 4 TACH OUTPUT (1 OF 2)	ADS	SPU A	S	Normal	rad/sec			
A	2	55	8	0	7	16	RWA4FILA	RWA4FILA	FILTERED RWA 4 TACH OUTPUT (2 OF 2)	ADS	SPU A	S	Normal	rad/sec			
8	6	54	8	0	7	16	RWA4FILA	RWA4FILA	FILTERED RWA 4 TACH OUTPUT (1 OF 2)	ADS	SPU A	S	Thruster	rad/sec			
8	6	55	8	0	7	16	RWA4FILA	RWA4FILA	FILTERED RWA 4 TACH OUTPUT (2 OF 2)	ADS	SPU A	S	Thruster	rad/sec			
A	2	62	8	0	7	16	RWA4FILB	RWA4FILB	FILTERED RWA 4 TACH OUTPUT (1 OF 2)	ADS	SPU B	S	Normal	rad/sec			
A	2	63	8	0	7	16	RWA4FILB	RWA4FILB	FILTERED RWA 4 TACH OUTPUT (2 OF 2)	ADS	SPU B	S	Normal	rad/sec			
8	6	62	8	0	7	16	RWA4FILB	RWA4FILB	FILTERED RWA 4 TACH OUTPUT (1 OF 2)	ADS	SPU B	S	Thruster	rad/sec			
8	6	63	8	0	7	16	RWA4FILB	RWA4FILB	FILTERED RWA 4 TACH OUTPUT (2 OF 2)	ADS	SPU B	S	Thruster	rad/sec			

A	6	48	8	0	7	8	RWA4MCUR	RWA4MCUR	RWA 4 MOTOR CURRENT	ADS	RWA	AH	All Power-Up	mA	
7	7	54	8	0	7	9	RWA4TCA	RWA4TCA	RWA TORQUE COMMAND 4 (1 OF 2)	ADS	SPU A	S	Normal	in-lbf	
7	7	55	1	0	0	9	RWA4TCA	RWA4TCA	RWA TORQUE COMMAND 4 (2 OF 2)	ADS	SPU A	S	Normal	in-lbf	
7	7	62	8	0	7	9	RWA4TCB	RWA4TCB	RWA TORQUE COMMAND 4 (1 OF 2)	ADS	SPU B	S	Normal	in-lbf	
7	7	63	1	0	0	9	RWA4TCB	RWA4TCB	RWA TORQUE COMMAND 4 (2 OF 2)	ADS	SPU B	S	Normal	in-lbf	4
4	4	52	3	4	6	3	RWADISA	RWADISA	RWA DISABLED INDICATOR	TT&C	SPU A	S	Thrustrer		0=RWA 1 1=RWA 2 2=RWA 3 3=RWA 4 4=None
5	4	54	3	4	6	3	RWADISA	RWADISA	RWA DISABLED INDICATOR	TT&C	SPU A	S	Normal		0=RWA 1 1=RWA 2 2=RWA 3 3=RWA 4 4=None
5	4	62	3	4	6	3	RWADISB	RWADISB	RWA DISABLED INDICATOR	TT&C	SPU B	S	Normal		0=RWA 1 1=RWA 2 2=RWA 3 3=RWA 4 4=None
4	4	60	3	4	6	3	RWADISB	RWADISB	RWA DISABLED INDICATOR	TT&C	SPU B	S	Thrustrer		0=RWA 1 1=RWA 2 2=RWA 3 3=RWA 4 4=None
6	8	53	1	1	1	1	RWAENA	RWAENA	REACTION WHEEL ASSEMBLY	TT&C	SPU A	S	Normal		0=Disabled 1=Enabled
7	4	55	1	1	1	1	RWAENA	RWAENA	REACTION WHEEL ASSEMBLY	TT&C	SPU A	S	Thrustrer		0=Disabled 1=Enabled
6	8	61	1	1	1	1	RWAENB	RWAENB	REACTION WHEEL ASSEMBLY	TT&C	SPU B	S	Normal		0=Disabled 1=Enabled
7	4	63	1	1	1	1	RWAENB	RWAENB	REACTION WHEEL ASSEMBLY	TT&C	SPU B	S	Thrustrer		0=Disabled 1=Enabled
6	7	54	1	4	4	1	RWAERRA	RWAERRA	RWA RATE ERROR	TT&C	SPU A	S	Normal		0=Test Disabled 1=Test Enabled
6	5	52	1	4	4	1	RWAERRA	RWAERRA	RWA RATE ERROR	TT&C	SPU A	S	Thrustrer		0=Test Disabled 1=Test Enabled
6	7	62	1	4	4	1	RWAERRB	RWAERRB	RWA RATE ERROR	TT&C	SPU B	S	Normal		0=Test Disabled 1=Test Enabled
6	5	60	1	4	4	1	RWAERRB	RWAERRB	RWA RATE ERROR	TT&C	SPU B	S	Thrustrer		0=Test Disabled 1=Test Enabled
A	5	16	1	2	2	1	RWAHTRA	RWAHTRA	RWA HEATER A ON/OFF	ADS	RWA	S	All Power-Up		1=On 0=Off
A	5	16	1	6	6	1	RWAHTRB	RWAHTRB	RWA HEATER A ON/OFF	ADS	RWA	S	All Power-Up		1=On 0=Off
3	4	54	1	5	5	1	RWAPWLMA	RWAPWLMA	RWA POWER LIMIT INDICATOR	TT&C	SPU A	S	Normal Thrustrer		0=RWA Not Power Limited 1=RWA Power Limited
3	4	62	1	5	5	1	RWAPVLMB	RWAPVLMB	RWA POWER LIMIT INDICATOR	TT&C	SPU B	S	Normal Thrustrer		0=RWA Not Power Limited 1=RWA Power Limited
3	4	54	1	7	7	1	RWASPLMA	RWASPLMA	RWA SPEED LIMIT INDICATOR	TT&C	SPU A	S	Normal Thrustrer		0=RWA Not Speed Limited 1=RWA Speed Limited
3	4	62	1	7	7	1	RWASPLMB	RWASPLMB	RWA SPEED LIMIT INDICATOR	TT&C	SPU B	S	Normal Thrustrer		0=RWA Not Speed Limited 1=RWA Speed Limited
3	4	54	1	6	6	1	RWATQLMA	RWATQLMA	RWA TORQUE LIMIT INDICATOR	TT&C	SPU A	S	Normal Thrustrer		0=RWA Not Torque Limited 1=RWA Torque Limited

3	4	62	1	6	6	1	RWATQLMB	RWATQLMB	RWA TORQUE LIMIT INDICATOR	TT&C	SPU B	S	Normal Thruster	0=RWA Not Torque Limited 1=RWA Torque Limited	ADS Flag Word
A	5	31	8	0	7	8	RWE1CV5V	RWE1CV5V	RWE 1 DC-DC CONV +5VDC OUT	ADS	RWE	AP	All Power-Up		
8	2	58	8	0	7	8	RWE1T	RWE1T	RWE 1 TEMP	ADS	RWE	AP	All Power-Up		
A	8	48	8	0	7	8	RWE2CV5V	RWE2CV5V	RWE 2 DC-DC CONV +5VDC OUT	ADS	RWE	AP	All Power-Up		
6	6	57	8	0	7	8	RWE2T	RWE2T	RWE 2 TEMP	ADS	RWE	AP	All Power-Up		
A	8	29	8	0	7	8	RWE3CV5V	RWE3CV5V	RWE 3 DC-DC CONV +5VDC OUT	ADS	RWE	AP	All Power-Up		
7	4	58	8	0	7	8	RWE3T	RWE3T	RWE 3 TEMP	ADS	RWE	AP	All Power-Up		
A	8	30	8	0	7	8	RWE4CV5V	RWE4CV5V	RWE 4 DC-DC CONV +5VDC OUT	ADS	RWE	AP	All Power-Up		
8	5	57	8	0	7	8	RWE4T	RWE4T	RWE 4 TEMP	ADS	RWE	AP	All Power-Up		
2	4	56	8	0	7	8	RYCCUR	RYCCUR	RYC COIL CURRENT	ADS	MTC	AH	All Power-Up		
A	1	16	1	1	1	1	RYCFWD	RYCFWD	RYC FORWARD COIL ENABLE	ADS	MTC	S	All Power-Up		
A	3	64	1	3	3	1	RYCFWDA	RYCFWDA	SPU A RYC FWD ON	ADS	MTC	DL	All Power-Up		
A	4	64	1	3	3	1	RYCFWDB	RYCFWDB	SPU B RYC FWD ON	ADS	MTC	DL	All Power-Up		
A	2	16	1	1	1	1	RYCREV	RYCREV	RYC REVERSE COIL ENABLED	ADS	MTC	S	All Power-Up		
A	3	64	1	4	4	1	RYCREVA	RYCREVA	SPU A RYC REV ON	ADS	MTC	DL	All Power-Up		
A	4	64	1	4	4	1	RYCREVB	RYCREVB	SPU B RYC REV ON	ADS	MTC	DL	All Power-Up		
A	4	64	1	7	7	1	RYCSPPOL	RYCSPPOL	RYC SPR POLARITY	ADS	MTC	DL	All Power-Up		
A	3	16	1	1	1	1	RYCSPR	RYCSPR	RYC SPR COIL ENABLED	ADS	MTC	S	All Power-Up		
A	3	64	1	5	5	1	RYCSPRA	RYCSPRA	SPU A RYC SPR ON	ADS	MTC	DL	All Power-Up		
A	4	64	1	5	5	1	RYCSPRB	RYCSPRB	SPU B RYC SPR ON	ADS	MTC	DL	All Power-Up		
NA	NA	NA	NA	2	NA	1	RYSLCOIN	RYSLCOIN	ROLL-SLOW COINCIDENC	NDS	BDP	S	All Power-Up SSOH		2969
A	1	14	3	5	7	3	SA+CMDA	SAPCMDA	+Y S/A STEP STATUS	TT&C	SPU A	S	All		S/A Step Status Word
A	1	22	3	5	7	3	SA+CMDB	SA+CMDB	+Y S/A STEP STATUS	TT&C	SPU B	S	All		S/A Step Status Word
A	1	15	3	5	7	3	SA-CMDA	SAMCMDA	-Y S/A STEP STATUS	TT&C	SPU A	S	All		S/A Step Status Word
A	1	23	3	5	7	3	SA-CMDB	SAMCMDB	+Y S/A STEP STATUS	TT&C	SPU B	S	All		S/A Step Status Word
A	4	10	1	5	5	1	SAARMA	SAARMA	OCU A PYROS (S/A) ARMED	EPS	S/A	DL	All Power-Up		
A	4	11	1	5	5	1	SAARMB	SAARMB	OCU B PYROS (S/A) ARMED	EPS	S/A	DL	All Power-Up		
A	3	10	1	3	3	1	SADA	SADA	SAD A ON/ B OFF	EPS	SAD	DL	All Power-Up		
A	3	11	1	3	3	1	SADB	SADB	SAD B ON/ A OFF	EPS	SAD	DL	All Power-Up		
6	7	55	1	2	2	1	SADBNDA	SADBNDA	SADPOT DEADBAND	TT&C	SPU A	S	Normal		RDMGMT Flag Word 55 (upper half-second word)
6	5	53	1	2	2	1	SADBNDA	SADBNDA	SADPOT DEADBAND	TT&C	SPU A	S	Thru		RDMGMT Flag Word 53 (upper half-second word)
6	7	63	1	2	2	1	SADBNDB	SADBNDB	SADPOT DEADBAND	TT&C	SPU B	S	Normal		RDMGMT Flag Word 63 (upper half-second word)
6	5	61	1	2	2	1	SADBNDB	SADBNDB	SADPOT DEADBAND	TT&C	SPU B	S	Thru		RDMGMT Flag Word 61 (upper half-second word)

A	3	10	1	2	2	1	SADIRCTA	SADIRCTA	SADIRCTA	SAD A STEP DIRECTION FWD/REV	EPS	SAD	DL	All Power-Up	1=Forward 0=Reverse	
A	3	11	1	2	2	1	SADIRCTB	SADIRCTB	SADIRCTB	SAD B STEP DIRECTION FWD/REV	EPS	SAD	DL	All Power-Up	1=Forward 0=Reverse	
6	7	55	1	1	1	1	SADRSETA	SADRSETA	SADRSETA	SADPOT POSITION RESET	TT&C	SPU A	S	Normal	0=Test Disabled 1=Test Enabled	RDMGMT Flag Word 55 (upper half-second word)
6	5	53	1	1	1	1	SADRSETA	SADRSETA	SADRSETA	SADPOT POSITION RESET	TT&C	SPU A	S	Thruster	0=Test Disabled 1=Test Enabled	RDMGMT Flag Word 53 (upper half-second word)
6	7	63	1	1	1	1	SADRSETB	SADRSETB	SADRSETB	SADPOT POSITION RESET	TT&C	SPU B	S	Normal	0=Test Disabled 1=Test Enabled	RDMGMT Flag Word 63 (upper half-second word)
6	5	61	1	1	1	1	SADRSETB	SADRSETB	SADRSETB	SADPOT POSITION RESET	TT&C	SPU B	S	Thruster	0=Test Disabled 1=Test Enabled	RDMGMT Flag Word 61 (upper half-second word)
4	4	52	1	0	0	1	SASLWENA	SASLWENA	SASLWENA	SKP SNP SOLAR ARRAY SLEW ENA/DIS	TT&C	SPU A	S	Thruster	0=S/A Slew During SK if Prev SNP Disabled 1=S/A Slew During SK if Prev SNP Enabled	Ground Select Flag Word 52 (first word)
5	4	54	1	0	0	1	SASLWENA	SASLWENA	SASLWENA	SKP SNP SOLAR ARRAY SLEW ENA/DIS	TT&C	SPU A	S	Normal	0=S/A Slew During SK if Prev SNP Disabled 1=S/A Slew During SK if Prev SNP Enabled	Ground Select Flag Word 54 (first word)
5	4	62	1	0	0	1	SASLWENB	SASLWENB	SASLWENB	SKP SNP SOLAR ARRAY SLEW ENA/DIS	TT&C	SPU B	S	Normal	0=S/A Slew During SK if Prev SNP Disabled 1=S/A Slew During SK if Prev SNP Enabled	Ground Select Flag Word 62 (first word)
4	4	60	1	0	0	1	SASLWENB	SASLWENB	SASLWENB	SKP SNP SOLAR ARRAY SLEW ENA/DIS	TT&C	SPU B	S	Thruster	0=S/A Slew During SK if Prev SNP Disabled 1=S/A Slew During SK if Prev SNP Enabled	Ground Select Flag Word 60 (first word)
5	8	58	8	0	7	8	SBANIT	SBANIT	SBANIT	BASE PNL S-BAND ANT TEMP D	MSS	ICS	AP	All Power-Up		395
NA	NA	NA	NA	0	NA	8	SBDPT	SBDPT	SBDPT	BDP TEMPERATURE	NDS	BDP	S	SSOH		441
NA	NA	NA	NA	0	NA	8	SBDWT	SBDWT	SBDWT	BDW TEMP SENSOR #5	NDS	BDW	S	SSOH		397
NA	NA	NA	NA	0	NA	8	SBDXC	SBDXC	SBDXC	BDDX CURRENT	NDS	BDP	S	SSOH		418
NA	NA	NA	NA	0	NA	8	SBDXSC1	SBDXSC1	SBDXSC1	BDX S1 SINGLES COUNT	NDS	BDDX	S	SSOH		419
NA	NA	NA	NA	0	NA	8	SBDXSC2	SBDXSC2	SBDXSC2	BDX S2 SINGLES COUNT	NDS	BDDX	S	SSOH		420
NA	NA	NA	NA	0	NA	8	SBDXSC3	SBDXSC3	SBDXSC3	BDX S3 SINGLES COUNT	NDS	BDDX	S	SSOH		421
NA	NA	NA	NA	0	NA	8	SBDXSC4	SBDXSC4	SBDXSC4	BDX S4 SINGLES COUNT	NDS	BDDX	S	SSOH		416
NA	NA	NA	NA	0	NA	8	SBDXT	SBDXT	SBDXT	BDX TEMPERATURE 2	NDS	BDDX	S	SSOH		417
NA	NA	NA	NA	0	NA	8	SBDXTC	SBDXTC	SBDXTC	BDX TRIGGER COUNT	NDS	BDDX	S	SSOH		396
NA	NA	NA	NA	0	NA	8	SBDYC	SBDYC	SBDYC	BDP CURRENT	NDS	BDP	S	SSOH		407
NA	NA	NA	NA	0	NA	8	SBDYT	SBDYT	SBDYT	OPTICAL DETECTOR TEMP	NDS	BDY	S	SSOH		146
NA	NA	NA	NA	6	NA	1	SBFMRUPD	SBFMRUPD	SBFMRUPD	SUB FRAME UPDATE	NDS	BDP-IP	S	SSOH		385
NA	NA	NA	NA	0	NA	16	SBHDZWDS	SBHDZWDS	SBHDZWDS	ZTIME	NDS	BDP	S	SSOH		
6	8	53	8	0	7	8	SBTERRA	SBTERRA	SBTERRA	SINGLE BIT ERROR ROLLOVER COUNTER	TT&C	SPU A	S	Early Orbit	Binary equivalent of values 0-255	TLM (Error) Flag Word 53 (second word)
3	6	53	8	0	7	8	SBTERRA	SBTERRA	SBTERRA	SINGLE BIT ERROR ROLLOVER COUNTER	TT&C	SPU A	S	Normal Thruster	Binary equivalent of values 0-255	TLM (Error) Flag Word 53 (second word)
6	8	61	8	0	7	8	SBTERRB	SBTERRB	SBTERRB	SINGLE BIT ERROR ROLLOVER COUNTER	TT&C	SPU B	S	Early Orbit	Binary equivalent of values 0-255	TLM (Error) Flag Word 61 (second word)
3	6	61	8	0	7	8	SBTERRB	SBTERRB	SBTERRB	SINGLE BIT ERROR ROLLOVER COUNTER	TT&C	SPU B	S	Normal Thruster	Binary equivalent of values 0-255	TLM (Error) Flag Word 61 (second word)
NA	NA	NA	NA	0	NA	16	SDMPOP	SDMPOP	SDMPOP	S-BAND DMP O/P POINT	NDS	BDP-MP	S	SSOH		99
NA	NA	NA	NA	0	NA	8	SDUMPADR	SDUMPADR	SDUMPADR	S-BAND DUMP ADDRESS	NDS	BDP	S	SSOH		2995
NA	NA	NA	NA	0	NA	16	SDUMPP	SDUMPP	SDUMPP	S-BAND DUMP POINTER	NDS	BDP-IP	S	SSOH		197
4	4	24	8	0	7	8	SEGIBV	SEGIBV	SEGIBV	SEGMENT I BIAS VOLTAGE	NDS	BDY	S	All Power-Up		SSOH Byte 3409
4	6	24	8	0	7	8	SEGIFB	SEGIFB	SEGIFB	SEGMENT I FEEDBACK	NDS	BDY	S	All Power-Up		SSOH Byte 3411
NA	NA	NA	NA	3	NA	1	SEGIPWR	SEGIPWR	SEGIPWR	SEGMENT I POWER	NDS	BDY	S	SSOH		7
4	5	24	8	0	7	8	SEGJBV	SEGJBV	SEGJBV	SEGMENT J BIAS VOLTAGE	NDS	BDY	S	All Power-Up		SSOH Byte 3410

4	7	24	8	0	7	8	SEGJFB	SEGJFB	SEGJFB	SEGJFB	SEGMENT J FEEDBACK	NDS	BDY	S	All Power-Up	mA	SSOH Byte 3412
NA	NA	NA	NA	4	NA	1	SEGJFWR	SEGJFWR	SEGMENT J POWER	SEGMENT J POWER	SEGMENT J POWER	NDS	BDY	S	SSOH		7
NA	NA	NA	NA	0	NA	1	SEGMENTI	SEGMENTI	DISABLE I SEGMENT PWR	DISABLE I SEGMENT PWR	DISABLE I SEGMENT PWR	NDS	BDY	S	SSOH		2963
NA	NA	NA	NA	0	NA	1	SEGMENTJ	SEGMENTJ	J SEGMENT PWR DISABLE	J SEGMENT PWR DISABLE	J SEGMENT PWR DISABLE	NDS	BDY	S	SSOH		2965
3	4	55	1	6	6	1	SEPSIDAA	SEPSIDAA	SEPARATION SIDE A FLAG	SEPARATION SIDE A FLAG	SEPARATION SIDE A FLAG	TT&C	SPU A	S	Normal		ADS Flag Word
3	4	63	1	6	6	1	SEPSIDAB	SEPSIDAB	SEPARATION SIDE A FLAG	SEPARATION SIDE A FLAG	SEPARATION SIDE A FLAG	TT&C	SPU B	S	Normal		ADS Flag Word
3	4	55	1	7	7	1	SEPSIDBA	SEPSIDBA	SEPARATION SIDE B FLAG	SEPARATION SIDE B FLAG	SEPARATION SIDE B FLAG	TT&C	SPU A	S	Normal		ADS Flag Word
3	4	63	1	7	7	1	SEPSIDBB	SEPSIDBB	SEPARATION SIDE B FLAG	SEPARATION SIDE B FLAG	SEPARATION SIDE B FLAG	TT&C	SPU B	S	Thruster		ADS Flag Word
NA	NA	NA	NA	3	NA	1	SEQCK	SEQCK	PROPER SEQ CHECK ON	PROPER SEQ CHECK ON	PROPER SEQ CHECK ON	NDS	BDP	S	SSOH		3051
NA	NA	NA	NA	1	NA	1	SFTASCMS	SFTASCMS	SOFTASTIC CMDERREPORT	SOFTASTIC CMDERREPORT	SOFTASTIC CMDERREPORT	NDS	BDP	S	SSOH		3063
NA	NA	NA	NA	3	NA	1	SFTEESM	SFTEESM	SOFTEEPROM FAIL REPORT	SOFTEEPROM FAIL REPORT	SOFTEEPROM FAIL REPORT	NDS	BDP	S	SSOH		3062
NA	NA	NA	NA	1	NA	1	SFTMEMSM	SFTMEMSM	SOFT MEM ERR REPORTS	SOFT MEM ERR REPORTS	SOFT MEM ERR REPORTS	NDS	GDR	S	SSOH		447
NA	NA	NA	NA	0	NA	8	SGDARFWR	SGDARFWR	RF (ARIES) POWER	RF (ARIES) POWER	RF (ARIES) POWER	NDS	GDR	S	SSOH		442
NA	NA	NA	NA	0	NA	8	SGDORFWR	SGDORFWR	RF COM RELAY (CR) POWER	RF COM RELAY (CR) POWER	RF COM RELAY (CR) POWER	NDS	GDR	S	SSOH		443
NA	NA	NA	NA	0	NA	8	SGDHPAAT	SGDHPAAT	RF HIGH PWR AMP A TEMP	RF HIGH PWR AMP A TEMP	RF HIGH PWR AMP A TEMP	NDS	GDR	S	SSOH		446
NA	NA	NA	NA	0	NA	8	SGDHPABT	SGDHPABT	RF HIGH PWR AMP B TEMP	RF HIGH PWR AMP B TEMP	RF HIGH PWR AMP B TEMP	NDS	GDR	S	SSOH		444
NA	NA	NA	NA	0	NA	8	SGDNDPWR	SGDNDPWR	RF NDT MON (NDM) POWER	RF NDT MON (NDM) POWER	RF NDT MON (NDM) POWER	NDS	GDR	S	SSOH		427
NA	NA	NA	NA	0	NA	8	SGDTPXWR	SGDTPXWR	RF C-BAND XMITTER POWER	RF C-BAND XMITTER POWER	RF C-BAND XMITTER POWER	NDS	GDR	S	SSOH		422
NA	NA	NA	NA	0	NA	16	SHBFTC	SHBFTC	FLTRGCT-HIBNDCH1 2 3	FLTRGCT-HIBNDCH1 2 3	FLTRGCT-HIBNDCH1 2 3	NDS	BDW	S	SSOH		431
NA	NA	NA	NA	0	NA	16	SHBHCFC	SHBHCFC	FALALARMCNTHIBANDCH1	FALALARMCNTHIBANDCH1	FALALARMCNTHIBANDCH1	NDS	BDW	S	SSOH		424
NA	NA	NA	NA	0	NA	8	SHBHCN	SHBHCN	AVGNOISEVALHIBANDCH1	AVGNOISEVALHIBANDCH1	AVGNOISEVALHIBANDCH1	NDS	BDW	S	SSOH		429
NA	NA	NA	NA	0	NA	16	SHBLCFC	SHBLCFC	FALALARMCNTHIBANDCH3	FALALARMCNTHIBANDCH3	FALALARMCNTHIBANDCH3	NDS	BDW	S	SSOH		423
NA	NA	NA	NA	0	NA	8	SHBLCN	SHBLCN	AVGNOISEVALHIBANDCH3	AVGNOISEVALHIBANDCH3	AVGNOISEVALHIBANDCH3	NDS	BDW	S	SSOH		
NA	NA	NA	NA	0	NA	16	SHBMCFC	SHBMCFC	FALALARMCNTHIBANDCH2	FALALARMCNTHIBANDCH2	FALALARMCNTHIBANDCH2	NDS	BDW	S	SSOH		
NA	NA	NA	NA	0	NA	8	SHBMCN	SHBMCN	AVGNOISEVALHIBANDCH2	AVGNOISEVALHIBANDCH2	AVGNOISEVALHIBANDCH2	NDS	BDW	S	SSOH		
A	1	34	8	0	7	8	SHDV1T1	SHDV1T1	SHUNT DRIVE VOLTAGE #1 (T1)	SHUNT DRIVE VOLTAGE #1 (T1)	SHUNT DRIVE VOLTAGE #1 (T1)	EPS	PRU	AH	All Power-Up	volts	
A	5	34	8	0	7	8	SHDV1T2	SHDV1T2	SHUNT DRIVE VOLTAGE #2 (T1)	SHUNT DRIVE VOLTAGE #2 (T1)	SHUNT DRIVE VOLTAGE #2 (T1)	EPS	PRU	AH	All Power-Up	volts	
A	4	35	8	0	7	8	SHDV2T1	SHDV2T1	SHUNT DRIVE VOLTAGE #2 (T1)	SHUNT DRIVE VOLTAGE #2 (T1)	SHUNT DRIVE VOLTAGE #2 (T1)	EPS	PRU	AH	All Power-Up	volts	
A	8	40	8	0	7	8	SHDV2T2	SHDV2T2	SHUNT DRIVE VOLTAGE #2 (T2)	SHUNT DRIVE VOLTAGE #2 (T2)	SHUNT DRIVE VOLTAGE #2 (T2)	EPS	PRU	AH	All Power-Up	volts	
NA	NA	NA	NA	3	NA	1	SHXFRMSG	SHXFRMSG	XFER MSG FLAG MP SOH	XFER MSG FLAG MP SOH	XFER MSG FLAG MP SOH	NDS	BDP-MP	S	SSOH		46
A	7	64	1	2	2	1	SIGPRE1	SIGPRE1	S-BAND RCVR 1 SIGNAL PRESENT	S-BAND RCVR 1 SIGNAL PRESENT	S-BAND RCVR 1 SIGNAL PRESENT	TT&C	SBT	DL	All Power-Up		
A	8	64	1	2	2	1	SIGPRE2	SIGPRE2	S-BAND RCVR 2 SIGNAL PRESENT	S-BAND RCVR 2 SIGNAL PRESENT	S-BAND RCVR 2 SIGNAL PRESENT	TT&C	SBT	DL	All Power-Up		
3	4	55	1	3	3	1	SKABRTA	SKABRTA	STATIONKEEPING ABORT	STATIONKEEPING ABORT	STATIONKEEPING ABORT	TT&C	SPU A	S	Normal		ADS Flag Word
3	4	63	1	3	3	1	SKABRTB	SKABRTB	STATIONKEEPING ABORT	STATIONKEEPING ABORT	STATIONKEEPING ABORT	TT&C	SPU B	S	Thruster		ADS Flag Word
NA	NA	NA	NA	0	NA	16	SLBFTC	SLBFTC	INDICATOR	INDICATOR	INDICATOR	NDS	BDW	S	SSOH		439
NA	NA	NA	NA	0	NA	16	SLBHCFC	SLBHCFC	FALTRGNT-LOBNDCH1,2	FALTRGNT-LOBNDCH1,2	FALTRGNT-LOBNDCH1,2	NDS	BDW	S	SSOH		433
NA	NA	NA	NA	0	NA	8	SLBHCN	SLBHCN	FALALARMCNTOBANDCH1	FALALARMCNTOBANDCH1	FALALARMCNTOBANDCH1	NDS	BDW	S	SSOH		425
NA	NA	NA	NA	0	NA	16	SLBMCFC	SLBMCFC	AVGNOISEVALLOBANDCH1	AVGNOISEVALLOBANDCH1	AVGNOISEVALLOBANDCH1	NDS	BDW	S	SSOH		435
NA	NA	NA	NA	0	NA	8	SLBMCN	SLBMCN	FALALARMCNTOBANDCH2	FALALARMCNTOBANDCH2	FALALARMCNTOBANDCH2	NDS	BDW	S	SSOH		426
NA	NA	NA	NA	1	NA	7	SLOPEH	SLOPEH	AVGNOISEVALLOBANDCH2	AVGNOISEVALLOBANDCH2	AVGNOISEVALLOBANDCH2	NDS	BDP	S	SSOH		2966
NA	NA	NA	NA	0	NA	8	SLOPEL	SLOPEL	SLOPE (7 MSB)	SLOPE (7 MSB)	SLOPE (7 MSB)	NDS	BDP	S	SSOH		2967
NA	NA	NA	NA	0	NA	1	SLOPESGN	SLOPESGN	SLOPE (8 LSB)	SLOPE (8 LSB)	SLOPE (8 LSB)	NDS	BDP	S	SSOH		2966
NA	NA	NA	NA	0	NA	8	SMSGRRR	SMSGRRR	SLOPE SIGN	SLOPE SIGN	SLOPE SIGN	NDS	BDP	S	SSOH		398
NA	NA	NA	NA	6	NA	2	SOAMODE	SOAMODE	MP&SENSOR MSGRECCRCNT	MP&SENSOR MSGRECCRCNT	MP&SENSOR MSGRECCRCNT	NDS	BDP	S	SSOH		2945
NA	NA	NA	NA	0	NA	8	SOALMOFS	SOALMOFS	SOLAR INHIBIT CNTRL	SOLAR INHIBIT CNTRL	SOLAR INHIBIT CNTRL	NDS	BDP	S	SSOH		2962
NA	NA	NA	NA	4	NA	2	SOAYSCMP	SOAYSCMP	UMBRA OFFSET	UMBRA OFFSET	UMBRA OFFSET	NDS	BDP	S	SSOH		2945
NA	NA	NA	NA	0	NA	8	SOLDAY	SOLDAY	SOLAR YSLOW FB COMP RATE	SOLAR YSLOW FB COMP RATE	SOLAR YSLOW FB COMP RATE	NDS	BDY	S	SSOH		224
NA	NA	NA	NA	0	NA	8	SOLDSPAN	SOLDSPAN	SOL DAY	SOL DAY	SOL DAY	NDS	BDY	S	SSOH		223
NA	NA	NA	NA	0	NA	8	SOLENC	SOLENC	SOL DSPAN	SOL DSPAN	SOL DSPAN	NDS	BDY	S	SSOH		248
NA	NA	NA	NA	0	NA	8	SOLENC	SOLENC	SOL EN CNT	SOL EN CNT	SOL EN CNT	NDS	BDY	S	SSOH		

NA	NA	NA	NA	0	NA	8	SOLETH	SOLETH	SOLETH	SOLARINHTIME-8MSB	NDS	BDP	S	SSOH	2949
NA	NA	NA	NA	0	NA	8	SOLETL	SOLETL	SOLAR INH END TIME-LSB	SOLAR INH END TIME-LSB	NDS	BDP	S	SSOH	2951
NA	NA	NA	NA	0	NA	8	SOLETM	SOLETM	SOLARINHTIME-8MIDSB	SOLARINHTIME-8MIDSB	NDS	BDP	S	SSOH	2960
NA	NA	NA	NA	0	NA	8	SOLINCA	SOLINCA	SOL_INHCNT_A	SOL_INHCNT_A	NDS	BDY	S	SSOH	246
NA	NA	NA	NA	0	NA	8	SOLINCB	SOLINCB	SOL_INHCNT_B	SOL_INHCNT_B	NDS	BDY	S	SSOH	247
NA	NA	NA	NA	1	NA	1	SOLINHIB	SOLINHIB	SOL INHIBIT DISABLE	SOL INHIBIT DISABLE	NDS	BDY	S	SSOH	216
NA	NA	NA	NA	0	NA	16	SOLINHST	SOLINHST	SOL INHIB ST	SOL INHIB ST	NDS	BDY	S	SSOH	241
NA	NA	NA	NA	0	NA	1	SOLINPER	SOLINPER	SOLAR INHIBIT PERIOD	SOLAR INHIBIT PERIOD	NDS	BDY	S	SSOH	216
NA	NA	NA	NA	0	NA	32	SOLPEN2	SOLPEN2	SOL_RSRs-PENUMBRA*2	SOL_RSRs-PENUMBRA*2	NDS	BDY	S	SSOH	229
NA	NA	NA	NA	0	NA	8	SOLSPAN	SOLSPAN	SOL_SPAN	SOL_SPAN	NDS	BDY	S	SSOH	222
NA	NA	NA	NA	0	NA	8	SOLSTH	SOLSTH	SOLARINHSTRITM-8MSB	SOLARINHSTRITM-8MSB	NDS	BDP	S	SSOH	2946
NA	NA	NA	NA	0	NA	8	SOLSTL	SOLSTL	SOLARINHSTRITM-8LSB	SOLARINHSTRITM-8LSB	NDS	BDP	S	SSOH	2948
NA	NA	NA	NA	0	NA	32	SOLSTM	SOLSTM	SOLARINHSTRITM-8MIDSB	SOLARINHSTRITM-8MIDSB	NDS	BDP	S	SSOH	2947
NA	NA	NA	NA	0	NA	32	SOLUMB2	SOLUMB2	SOL_RERE=UMBRA*2	SOL_RERE=UMBRA*2	NDS	BDY	S	SSOH	225
NA	NA	NA	NA	0	NA	16	SOLX1	SOLX1	SOL_X1	SOL_X1	NDS	BDY	S	SSOH	233
NA	NA	NA	NA	0	NA	16	SOLX1	SOLX1	SOL_X1X1	SOL_X1X1	NDS	BDY	S	SSOH	235
NA	NA	NA	NA	0	NA	16	SOLY1	SOLY1	SOL_Y1	SOL_Y1	NDS	BDY	S	SSOH	239
1	1	28	8	0	7	8	SP00AHDW	SP00AHDW	SPARE 00 AH DWELL REGION	SPARE 00 AH DWELL REGION	TT&C	PCE	AH	All Power-Up	
8	4	27	8	0	7	8	SP00AHND	SP00AHND	SPARE 00 AH NON-DWELL REGION	SPARE 00 AH NON-DWELL REGION	TT&C	PCE	AH	All Power-Up	
4	2	27	8	0	7	8	SP00APDW	SP00APDW	SPARE 00 AP DWELL REGION	SPARE 00 AP DWELL REGION	TT&C	PCE	AP	All Power-Up	
2	2	28	8	0	7	8	SP00APND	SP00APND	SPARE 00 AP NON-DWELL REGION	SPARE 00 AP NON-DWELL REGION	TT&C	PCE	AP	All Power-Up	
A	1	31	1	0	0	1	SP00DLDW	SP00DLDW	SPARE 00 DL DWELL REGION	SPARE 00 DL DWELL REGION	TT&C	TIU	DL	All	
A	8	10	1	0	0	1	SP00DLND	SP00DLND	SPARE 00 DL NON-DWELL REGION	SPARE 00 DL NON-DWELL REGION	TT&C	TIU	DL	All	
1	2	28	8	0	7	8	SP01AHDW	SP01AHDW	SPARE 01 AH DWELL REGION	SPARE 01 AH DWELL REGION	TT&C	PCE	AH	All Power-Up	
8	5	27	8	0	7	8	SP01AHND	SP01AHND	SPARE 01 AH NON-DWELL REGION	SPARE 01 AH NON-DWELL REGION	TT&C	PCE	AH	All Power-Up	
3	6	28	8	0	7	8	SP01APDW	SP01APDW	SPARE 01 AP DWELL REGION	SPARE 01 AP DWELL REGION	TT&C	PCE	AP	All Power-Up	
1	6	27	8	0	7	8	SP01APND	SP01APND	SPARE 01 AP NON-DWELL REGION	SPARE 01 AP NON-DWELL REGION	TT&C	PCE	AP	All Power-Up	
A	1	31	1	1	1	1	SP01DLDW	SP01DLDW	SPARE 01 DL DWELL REGION	SPARE 01 DL DWELL REGION	TT&C	TIU	DL	All	
A	8	10	1	1	1	1	SP01DLND	SP01DLND	SPARE 01 DL NON-DWELL REGION	SPARE 01 DL NON-DWELL REGION	TT&C	TIU	DL	All	
1	3	28	8	0	7	8	SP02AHDW	SP02AHDW	SPARE 02 AH DWELL REGION	SPARE 02 AH DWELL REGION	TT&C	PCE	AH	All Power-Up	
8	6	27	8	0	7	8	SP02AHND	SP02AHND	SPARE 02 AH NON-DWELL REGION	SPARE 02 AH NON-DWELL REGION	TT&C	PCE	AH	All Power-Up	
3	7	28	8	0	7	8	SP02APDW	SP02APDW	SPARE 02 AP DWELL REGION	SPARE 02 AP DWELL REGION	TT&C	PCE	AP	All Power-Up	
1	7	27	8	0	7	8	SP02APND	SP02APND	SPARE 02 AP NON-DWELL REGION	SPARE 02 AP NON-DWELL REGION	TT&C	PCE	AP	All Power-Up	
A	1	31	1	2	2	1	SP02DLDW	SP02DLDW	SPARE 02 DL DWELL REGION	SPARE 02 DL DWELL REGION	TT&C	TIU	DL	All	
A	8	10	1	2	2	1	SP02DLND	SP02DLND	SPARE 02 DL NON-DWELL REGION	SPARE 02 DL NON-DWELL REGION	TT&C	TIU	DL	All	
1	4	28	8	0	7	8	SP03AHDW	SP03AHDW	SPARE 03 AH DWELL REGION	SPARE 03 AH DWELL REGION	TT&C	PCE	AH	All Power-Up	
8	7	27	8	0	7	8	SP03AHND	SP03AHND	SPARE 03 AH NON-DWELL REGION	SPARE 03 AH NON-DWELL REGION	TT&C	PCE	AH	All Power-Up	
3	8	28	8	0	7	8	SP03APDW	SP03APDW	SPARE 03 AP DWELL REGION	SPARE 03 AP DWELL REGION	TT&C	PCE	AP	All Power-Up	
1	8	27	8	0	7	8	SP03APND	SP03APND	SPARE 03 AP NON-DWELL REGION	SPARE 03 AP NON-DWELL REGION	TT&C	PCE	AP	All Power-Up	
A	1	31	1	3	3	1	SP03DLDW	SP03DLDW	SPARE 03 DL DWELL REGION	SPARE 03 DL DWELL REGION	TT&C	TIU	DL	All	
A	8	10	1	3	3	1	SP03DLND	SP03DLND	SPARE 03 DL NON-DWELL REGION	SPARE 03 DL NON-DWELL REGION	TT&C	TIU	DL	All	
1	5	28	8	0	7	8	SP04AHDW	SP04AHDW	SPARE 04 AH DWELL REGION	SPARE 04 AH DWELL REGION	TT&C	PCE	AH	All Power-Up	
8	8	27	8	0	7	8	SP04AHND	SP04AHND	SPARE 04 AH NON-DWELL REGION	SPARE 04 AH NON-DWELL REGION	TT&C	PCE	AH	All Power-Up	
4	1	28	8	0	7	8	SP04APDW	SP04APDW	SPARE 04 AP DWELL REGION	SPARE 04 AP DWELL REGION	TT&C	PCE	AP	All Power-Up	
2	1	27	8	0	7	8	SP04APND	SP04APND	SPARE 04 AP NON-DWELL REGION	SPARE 04 AP NON-DWELL REGION	TT&C	PCE	AP	All Power-Up	
A	1	31	1	4	4	1	SP04DLDW	SP04DLDW	SPARE 04 DL DWELL REGION	SPARE 04 DL DWELL REGION	TT&C	TIU	DL	All	
A	8	10	1	4	4	1	SP04DLND	SP04DLND	SPARE 04 DL NON-DWELL REGION	SPARE 04 DL NON-DWELL REGION	TT&C	TIU	DL	All	
A	4	31	8	0	7	8	SP06AHDW	SP06AHDW	SPARE 06 AH DWELL REGION	SPARE 06 AH DWELL REGION	TT&C	TIU	DL	All	
7	3	56	8	0	7	8	SP06AHND	SP06AHND	SPARE 06 AH NON-DWELL REGION	SPARE 06 AH NON-DWELL REGION	TT&C	TIU	DL	All	
3	2	57	8	0	7	8	SP06APND	SP06APND	SPARE 06 AP NON-DWELL REGION	SPARE 06 AP NON-DWELL REGION	TT&C	TIU	DL	All	
A	2	31	1	0	0	1	SP06DLDW	SP06DLDW	SPARE 06 DL DWELL REGION	SPARE 06 DL DWELL REGION	TT&C	TIU	DL	All	
A	8	11	1	0	0	1	SP06DLND	SP06DLND	SPARE 06 DL NON-DWELL REGION	SPARE 06 DL NON-DWELL REGION	TT&C	TIU	DL	All	
A	6	31	8	0	7	8	SP06AHDW	SP06AHDW	SPARE 06 AH DWELL REGION	SPARE 06 AH DWELL REGION	TT&C	TIU	DL	All	
8	5	56	8	0	7	8	SP06AHND	SP06AHND	SPARE 06 AH NON-DWELL REGION	SPARE 06 AH NON-DWELL REGION	TT&C	TIU	DL	All	
3	3	57	8	0	7	8	SP06APND	SP06APND	SPARE 06 AP NON-DWELL REGION	SPARE 06 AP NON-DWELL REGION	TT&C	TIU	DL	All	
A	2	31	1	1	1	1	SP06DLDW	SP06DLDW	SPARE 06 DL DWELL REGION	SPARE 06 DL DWELL REGION	TT&C	TIU	DL	All	
A	8	11	1	1	1	1	SP06DLND	SP06DLND	SPARE 06 DL NON-DWELL REGION	SPARE 06 DL NON-DWELL REGION	TT&C	TIU	DL	All	



8	8	63	8	0	7	32	SPMDLAYB	SPMDLAYB	SPMDLAYB	SPMCEP TO FIRST PULSE DELAY (4 OF 4)	ADS	SPU B	S	Early Orbit		Should be AF: 16-bit fixed w/scale factor
3	8	55	1	7	7	1	SPMENA	SPMENA	SPM RUN FLAG	SPM RUN FLAG	ADS	SPU A	S	Early Orbit		1=Enabled 0=Disabled
3	8	63	1	7	7	1	SPMENB	SPMENB	SPM RUN FLAG	SPM RUN FLAG	ADS	SPU B	S	Early Orbit		1=Enabled 0=Disabled
6	8	54	8	0	7	16	SPMPAIRA	SPMPAIRA	SPM PULSE PAIRS REMAINING (1 OF 2)	SPM PULSE PAIRS REMAINING (1 OF 2)	ADS	SPU A	S	Early Orbit	counts	
6	8	55	8	0	7	16	SPMPAIRA	SPMPAIRA	SPM PULSE PAIRS REMAINING (2 OF 2)	SPM PULSE PAIRS REMAINING (2 OF 2)	ADS	SPU A	S	Early Orbit	counts	
6	8	62	8	0	7	16	SPMPAIRB	SPMPAIRB	SPM PULSE PAIRS REMAINING (1 OF 2)	SPM PULSE PAIRS REMAINING (1 OF 2)	ADS	SPU B	S	Early Orbit	counts	
6	8	63	8	0	7	16	SPMPAIRB	SPMPAIRB	SPM PULSE PAIRS REMAINING (1 OF 2)	SPM PULSE PAIRS REMAINING (1 OF 2)	ADS	SPU B	S	Early Orbit	counts	
7	8	54	8	0	7	16	SPMPAWA	SPMPAWA	SPM PULSEWIDTH (1 OF 2)	SPM PULSEWIDTH (1 OF 2)	TT&C	SPU B	S	Early Orbit	seconds	
7	8	55	8	0	7	16	SPMPAWA	SPMPAWA	SPM PULSEWIDTH (2 OF 2)	SPM PULSEWIDTH (2 OF 2)	TT&C	SPU A	S	Early Orbit	seconds	
7	8	62	8	0	7	16	SPMPAWB	SPMPAWB	SPM PULSEWIDTH (1 OF 2)	SPM PULSEWIDTH (1 OF 2)	TT&C	SPU B	S	Early Orbit	seconds	
7	8	63	8	0	7	16	SPMPAWB	SPMPAWB	SPM PULSEWIDTH (2 OF 2)	SPM PULSEWIDTH (2 OF 2)	TT&C	SPU B	S	Early Orbit	seconds	
7	8	53	3	5	7	3	SPMSLCTA	SPMSLCTA	SPM THRUSTER SELECTION	SPM THRUSTER SELECTION	ADS	SPU A	S	Early Orbit		1=Off 1=Coarse Pri 2=Coarse Even 3=Coarse Odd 4=Fine Pri 5=Fine Even 6=Fine Odd
7	8	61	3	5	7	3	SPMSLCTB	SPMSLCTB	SPM THRUSTER SELECTION	SPM THRUSTER SELECTION	ADS	SPU B	S	Early Orbit		1=Off 1=Coarse Pri 2=Coarse Even 3=Coarse Odd 4=Fine Pri 5=Fine Even 6=Fine Odd
A	7	10	1	4	4	1	SPUAACONT	SPUAACONT	SPU A IN CONTROL	SPU A IN CONTROL	TT&C	SPU	DL	All Power-Up		1=CPU B in Control 0=CPU A in Control
A	7	10	1	3	3	1	SPUACPU	SPUACPU	SPU A CPU NORM / SWAP	SPU A CPU NORM / SWAP	TT&C	SPU	DL	All Power-Up		1=CPU Normal 0=CPU Swap
1	3	56	8	0	7	8	SPUACV5V	SPUACV5V	SPU A CONV +5VDC OUT	SPU A CONV +5VDC OUT	TT&C	SPU	AH	All Power-Up	volts	
1	7	58	8	0	7	8	SPUACVT	SPUACVT	SPU A CONV TEMP	SPU A CONV TEMP	TT&C	SPU	AP	All Power-Up	Celsius	
A	7	64	1	0	0	1	SPUAGED1	SPUAGED1	SPU A GED 1 ON/OFF	SPU A GED 1 ON/OFF	TT&C	GED	DL	All Power-Up		1=Off 0=On
A	8	64	1	0	0	1	SPUAGED2	SPUAGED2	SPU A GED 2 ON/OFF	SPU A GED 2 ON/OFF	TT&C	GED	DL	All Power-Up		1=Off 0=On
A	7	10	1	6	6	1	SPUAIOP	SPUAIOP	SPU A IO PWR ON/OFF	SPU A IO PWR ON/OFF	TT&C	SPU	DL	All Power-Up		1=Off 0=On
A	7	10	1	2	2	1	SPUAMEM	SPUAMEM	SPU A MEMORY NORMAL	SPU A MEMORY NORMAL	TT&C	SPU	DL	All Power-Up		1=Normal Memory 0=Swap Memory
A	7	10	1	5	5	1	SPUASEL	SPUASEL	SPU A SELECT	SPU A SELECT	TT&C	SPU	DL	All Power-Up		1=CPU B Selected 0=CPU A Selected
A	7	11	1	4	4	1	SPUBCONT	SPUBCONT	SPU B IN CONTROL	SPU B IN CONTROL	TT&C	SPU	DL	All Power-Up		1=CPU A in Control 0=CPU B in Control
A	7	11	1	3	3	1	SPUBCPU	SPUBCPU	SPU B CPU NORMAL/SWAP	SPU B CPU NORMAL/SWAP	TT&C	SPU	DL	All Power-Up		1=CPU Normal 0=CPU Swap
4	4	56	8	0	7	8	SPUBCV5V	SPUBCV5V	SPU B CONV +5VDC OUT	SPU B CONV +5VDC OUT	TT&C	SPU	AH	All Power-Up	volts	
1	8	58	8	0	7	8	SPUBCVT	SPUBCVT	SPU B CONV TEMP	SPU B CONV TEMP	TT&C	SPU	AP	All Power-Up	Celsius	
A	7	64	1	1	1	1	SPUBGED1	SPUBGED1	SPU B GED 1 ON/OFF	SPU B GED 1 ON/OFF	TT&C	GED	DL	All Power-Up		1=Off 0=On
A	8	64	1	1	1	1	SPUBGED2	SPUBGED2	SPU B GED 2 ON/OFF	SPU B GED 2 ON/OFF	TT&C	GED	DL	All Power-Up		1=Off 0=On

A	7	11	1	6	6	1	SPUBIOP	SPUBIOP	SPUBIOP	SPU B I/O FWR ON/OFF	TT&C	SPU	DL	All Power-Up	1=Off 0=On		
A	7	11	1	2	2	1	SPUBMEM	SPUBMEM	SPUBMEM	SPU B MEMORY NORMAL	TT&C	SPU	DL	All Power-Up	1=Normal Memory 0=Swap Memory		
A	7	11	1	5	5	1	SPUBSEL	SPUBSEL	SPUBSEL	SPU B SELECT	TT&C	SPU	DL	All Power-Up	1=CPU B Selected 0=CPU A Selected		
A	3	14	8	0	7	16	SPUCMCTA	SPUCMCTA	SPUCMCTA	SPU-CDU CMD ACCEPT COUNT (1 OF 2)	TT&C	SPU A	S	Early Orbit			
A	3	15	8	0	7	16	SPUCMCTA	SPUCMCTA	SPUCMCTA	SPU-CDU CMD ACCEPT COUNT (2 OF 2)	TT&C	SPU A	S	Early Orbit			
8	7	54	8	0	7	16	SPUCMCTA	SPUCMCTA	SPUCMCTA	SPU-CDU CMD ACCEPT COUNT (1 OF 2)	TT&C	SPU A	S	Normal			
8	7	55	8	0	7	16	SPUCMCTA	SPUCMCTA	SPUCMCTA	SPU-CDU CMD ACCEPT COUNT (2 OF 2)	TT&C	SPU A	S	Normal			
7	7	54	8	0	7	16	SPUCMCTA	SPUCMCTA	SPUCMCTA	SPU-CDU CMD ACCEPT COUNT (1 OF 2)	TT&C	SPU A	S	Thruster			
7	7	55	8	0	7	16	SPUCMCTA	SPUCMCTA	SPUCMCTA	SPU-CDU CMD ACCEPT COUNT (2 OF 2)	TT&C	SPU A	S	Thruster			
A	3	22	8	0	7	16	SPUCMCTB	SPUCMCTB	SPUCMCTB	SPU-CDU CMD ACCEPT COUNT (1 OF 2)	TT&C	SPU B	S	Early Orbit			
A	3	23	8	0	7	16	SPUCMCTB	SPUCMCTB	SPUCMCTB	SPU-CDU CMD ACCEPT COUNT (2 OF 2)	TT&C	SPU B	S	Early Orbit			
8	7	62	8	0	7	16	SPUCMCTB	SPUCMCTB	SPUCMCTB	SPU-CDU CMD ACCEPT COUNT (1 OF 2)	TT&C	SPU B	S	Normal			
8	7	63	8	0	7	16	SPUCMCTB	SPUCMCTB	SPUCMCTB	SPU-CDU CMD ACCEPT COUNT (2 OF 2)	TT&C	SPU B	S	Normal			
7	7	62	8	0	7	16	SPUCMCTB	SPUCMCTB	SPUCMCTB	SPU-CDU CMD ACCEPT COUNT (1 OF 2)	TT&C	SPU B	S	Thruster			
7	7	63	8	0	7	16	SPUCMCTB	SPUCMCTB	SPUCMCTB	SPU-CDU CMD ACCEPT COUNT (2 OF 2)	TT&C	SPU B	S	Thruster			
3	7	58	8	0	7	8	SPIUFT	SPIUFT	SPIUFT	+X BUS PNL/SPU I/F TEMP A	MSS	TCS	AP	Thruster		Celsius	
6	8	52	1	1	1	1	SPIUOCLA	SPIUOCLA	SPIUOCLA	SPU I/O CONTROL	TT&C	SPU A	S	Normal	0=Test Disabled 1=Test Enabled	RDMGMT Flag Word 52 (lower half-first word)	
7	4	54	1	1	1	1	SPIUOCLA	SPIUOCLA	SPIUOCLA	SPU I/O CONTROL	TT&C	SPU A	S	Thruster	0=Test Disabled 1=Test Enabled	RDMGMT Flag Word 54 (lower half-first word)	
6	8	60	1	1	1	1	SPIUOCLB	SPIUOCLB	SPIUOCLB	SPU I/O CONTROL	TT&C	SPU B	S	Normal	0=Test Disabled 1=Test Enabled	RDMGMT Flag Word 60 (lower half-first word)	
7	4	62	1	1	1	1	SPIUOCLB	SPIUOCLB	SPIUOCLB	SPU I/O CONTROL	TT&C	SPU B	S	Thruster	0=Test Disabled 1=Test Enabled	RDMGMT Flag Word 62 (lower half-first word)	
A	1	12	4	0	3	4	SPUMODEA	SPUMODEA	SPUMODEA	SPU MODE	TT&C	SPU A	S	All	1=Power-Up Orbit 3=Normal 4=Thruster 0 and 5-7 Unused	TLM Flag Word 12 (first word)	
A	1	20	4	0	3	4	SPUMODEB	SPUMODEB	SPUMODEB	SPU MODE	TT&C	SPU B	S	All	1=Power-Up Orbit 3=Normal 4=Thruster 0 and 5-7 Unused	TLM Flag Word 20 (first word)	
A	1	12	4	0	3	4	SPUMODPA	SPUMODPA	SPUMODPA	SPU MODE	TT&C	SPU A	S	Power-Up	1=Power-Up Orbit 3=Normal 4=Thruster 0 and 5-7 Unused	TLM Flag Word 12 (first word)	
A	1	20	4	0	3	4	SPUMODPB	SPUMODPB	SPUMODPB	SPU MODE	TT&C	SPU B	S	Power-Up	1=Power-Up Orbit 3=Normal 4=Thruster 0 and 5-7 Unused	TLM Flag Word 20 (first word)	
NA	NA	NA	NA	0	NA	8	SROLLTC	SROLLTC	SROLLTC	ROLL TRIGGER COUNT	NDS	BDY	S	SSOH			411
NA	NA	NA	NA	0	NA	8	SSEGIBV	SSEGIBV	SSEGIBV	I SEGMENT BIAS	NDS	BDY	S	SSOH			403

NA	NA	NA	NA	0	NA	8	SSEGIFB	SSEGIFB	I SEGMENT FEEDBACK	NDS	BDY	S	SSOH	405
NA	NA	NA	NA	0	NA	8	SSEGJBV	SSEGJBV	J SEGMENT BIAS	NDS	BDY	S	SSOH	404
NA	NA	NA	NA	0	NA	8	SSEGJFB	SSEGJFB	J SEGMENT FEEDBACK	NDS	BDY	S	SSOH	406
NA	NA	NA	NA	0	NA	1	SSOHJUMP	SSOHJUMP	SSOH DUMP	NDS	BDP-MP	S	SSOH	47
NA	NA	NA	NA	3	NA	1	SSOHINT	SSOHINT	SSOH INTERRUPT SELEC	NDS	BDP	S	SSOH	3011
NA	NA	NA	NA	0	NA	8	SSOHINTV	SSOHINTV	TIMBETWSSOHSUBRMCOL	NDS	BDP	S	SSOH	3016
NA	NA	NA	NA	0	NA	1	SSOHMODE	SSOHMODE	SSOH COLLECTION MODE	NDS	BDP	S	SSOH	3015
NA	NA	NA	NA	0	NA	16	SSOHOP	SSOHOP	SSOH OUTPUT POINTER	NDS	BDP-MP	S	SSOH	97
NA	NA	NA	NA	0	NA	8	SSOHSTH	SSOHSTH	STRZTIME SSOHFRMCOL	NDS	BDP	S	SSOH	3017
NA	NA	NA	NA	0	NA	8	SSOHSTL	SSOHSTL	STRZTIME SSOHFRMCOL	BDP	BDY	S	SSOH	3018
NA	NA	NA	NA	0	NA	16	SSOHUPIP	SSOHUPIP	SSOH SUBFRM/IP POINT	NDS	BDP-IP	S	SSOH	199
NA	NA	NA	NA	0	NA	8	SSOLENC	SSOLENC	SSOL_EN_CNT	NDS	BDY	S	SSOH	245
NA	NA	NA	NA	0	NA	8	SSOLINCA	SSOLINCA	SSOL_INHCNT_A	NDS	BDY	S	SSOH	243
NA	NA	NA	NA	0	NA	8	SSOLINCB	SSOLINCB	SSOL_INHCNT_B	NDS	BDY	S	SSOH	244
NA	NA	NA	NA	0	NA	16	STATHSIP	STATHSIP	STAT HIST I/P POINT	NDS	BDP-IP	S	SSOH	201
NA	NA	NA	NA	4	NA	1	STBBOPEN	STBBOPEN	STRATEGIC BUILDUPFOPEN	NDS	BDP-MP	S	SSOH	48
NA	NA	NA	NA	2	NA	1	STBSLCT	STBSLCT	STRATEGIC BUILDUPBUFFERS EL	NDS	BDP-MP	S	SSOH	48
NA	NA	NA	NA	7	NA	1	STDCFIG	STDCFIG	BIIR STAND CONFIG	NDS	BDP	S	SSOH	3015
NA	NA	NA	NA	0	NA	8	STMSGRCV	STMSGRCV	CUM STAT MSG REC CNT	NDS	BDP	S	SSOH	399
NA	NA	NA	NA	4	NA	2	STSTPAMP	STSTPAMP	BDY SYSTSETPULSAMP	NDS	BDP	S	SSOH	2973
NA	NA	NA	NA	2	NA	2	STSTPEAK	STSTPEAK	BDY SYSTSETRMPPEAK	NDS	BDP	S	SSOH	2973
NA	NA	NA	NA	6	NA	2	STSTPWID	STSTPWID	BDY SYSTSETPULSWID	NDS	BDP	S	SSOH	2973
NA	NA	NA	NA	4	NA	4	STSTSBIT	STSTSBIT	SYS TEST SERIES BITS	NDS	BDP	S	SSOH	2985
NA	NA	NA	NA	0	NA	8	STSTTIME	STSTTIME	SYSTEM TEST TIME	NDS	BDP	S	SSOH	2983
NA	NA	NA	NA	4	NA	1	STXFRMSG	STXFRMSG	XFER MSG FLAG STATUS	NDS	BDP-MP	S	SSOH	46
NA	NA	NA	NA	0	NA	8	SUBHDR	SUBHDR	SSOH HEXSYNCPATTERN	NDS	BDP	S	SSOH	384
3	4	5	1	0	0	1	SUNLKA	SUNLKA	SUN LOCK	TT&C	SPU A	S	Normal	ADS Flag Word
3	4	6	1	0	0	1	SUNLKB	SUNLKB	SUN LOCK	TT&C	SPU B	S	Normal	ADS Flag Word
NA	NA	NA	NA	1	NA	7	SVID	SVID	SVID	NDS	BDP	S	Thrustr	2986
A	1	13	2	5	6	2	SVSOHA	SVSOHA	REDUNDANCY MGMT SV STATE OF HEALTH	TT&C	SPU A	S	All	TLM Flag Word 13 (second word)
A	1	21	2	5	6	2	SVSOHB	SVSOHB	REDUNDANCY MGMT SV STATE OF HEALTH	TT&C	SPU B	S	All	TLM Flag Word 21 (second word)
NA	NA	NA	NA	0	NA	16	SWHAEVTR	SWHAEVTR	BDP IP WH A BUFEVCT	NDS	BDP	S	SSOH	387
NA	NA	NA	NA	0	NA	16	SWHBEVTR	SWHBEVTR	BDP IP WHS B BUFEVCT	NDS	BDP	S	SSOH	389
NA	NA	NA	NA	0	NA	16	SWLAEVTR	SWLAEVTR	BDP IP WLA BUFEVCT	NDS	BDP	S	SSOH	391
NA	NA	NA	NA	0	NA	16	SWLBEVTR	SWLBEVTR	BDP IP WLS B BUFEVCT	NDS	BDP	S	SSOH	393
NA	NA	NA	NA	0	NA	8	SWWER	SWWER	SOFTWARE VERSION	NDS	BDDX	S	SSOH	263
NA	NA	NA	NA	4	NA	1	SXFRERR	SXFRERR	BDY SERIAL XFER ERROR	NDS	BDY	S	SSOH	254
NA	NA	NA	NA	0	NA	8	SYFSTFB	SYFSTFB	YFAST FEEDBACK	NDS	BDY	S	SSOH	402
NA	NA	NA	NA	0	NA	8	SYFSTL	SYFSTL	YFAST LTINGUNTRGCNT	NDS	BDY	S	SSOH	415
NA	NA	NA	NA	0	NA	8	SYFSTN	SYFSTN	YFAST S7 NOISE	NDS	BDY	S	SSOH	401
NA	NA	NA	NA	0	NA	8	SYFSTP	SYFSTP	YFAST PARTICUNTRGCNT	NDS	BDY	S	SSOH	414
NA	NA	NA	NA	0	NA	8	SYFSTTC	SYFSTTC	YFAST TRIGGER COUNT	NDS	BDY	S	SSOH	408
A	A	1	8	0	7	24	SYNCWRD	SYNCWRD	TLM SYNC WORD (1 OF 3)	TT&C	TIU	S	All Power-Up	Sync Word 1 (FA Hex)
A	A	2	8	0	7	24	SYNCWRD	SYNCWRD	TLM SYNC WORD (2 OF 3)	TT&C	TIU	S	All Power-Up	Sync Word 2 (F3 Hex)
A	A	3	8	0	7	24	SYNCWRD	SYNCWRD	TLM SYNC WORD (3 OF 3)	TT&C	TIU	S	All Power-Up	Sync Word 3 (20 Hex)
NA	NA	NA	NA	0	NA	8	SYSLOL	SYSLOL	YSLOW LTINGUNTRGCNT	NDS	BDY	S	SSOH	413
NA	NA	NA	NA	0	NA	8	SYSLON	SYSLON	YSLOW S7 NOISE	NDS	BDY	S	SSOH	400
NA	NA	NA	NA	0	NA	8	SYSLOP	SYSLOP	YSLOW PARTICUNTRGCNT	NDS	BDY	S	SSOH	412
NA	NA	NA	NA	0	NA	8	SYSLOTC	SYSLOTC	YSLOW TRIGGER COUNT	NDS	BDY	S	SSOH	409
NA	NA	NA	NA	0	NA	1	SYSTEST	SYSTEST	TIMINXT1 EPOCSYSTST	NDS	BDP	S	SSOH	2984
NA	NA	NA	NA	7	NA	1	SYSTST21	SYSTST21	SYS TEST 2-1 (SPIKE)	NDS	BDY	S	SSOH	215
NA	NA	NA	NA	6	NA	1	SYSTST22	SYSTST22	SYS TEST 2-2 (SQUARE)	NDS	BDY	S	SSOH	215
NA	NA	NA	NA	5	NA	1	SYSTST24	SYSTST24	SYS TEST 2-4 (RAMP)	NDS	BDY	S	SSOH	215

NA	NA	NA	NA	4	NA	1	SYSTST28	SYSTST28	SYSTST28	SYS TEST 2-8 (MOTION)	NDS	BDY	S	SSOH		215
NA	NA	NA	NA	1	NA	1	SYSTSTEN	SYSTSTEN	SYSTSTEN	SYSTEM TEST ENABLE	NDS	BDY	S	SSOH		215
NA	NA	NA	NA	0	NA	1	SYSTSTEX	SYSTSTEX	SYSTSTEX	SYSTEM TEST EXECUTE	NDS	BDY	S	SSOH		215
NA	NA	NA	NA	1	NA	1	TESTMEM	TESTMEM	TESTMEM	ENABLE TEST MEMORY	NDS	BDP	S	SSOH		3015
4	4	54	2	6	7	2	THRABRTA	THRABRTA	THRABRTA	THRUST CNTRL ABORT THRUSTER SELECT	TT&C	SPU A	S	Thruster		Thruster Flag Word 54 (first word)
4	4	62	2	6	7	2	THRABRTB	THRABRTB	THRABRTB	THRUST CNTRL ABORT THRUSTER SELECT	TT&C	SPU B	S	Thruster		Thruster Flag Word 62 (first word)
A	1	13	1	4	4	1	THRONA	THRONA	THRONA	THRUSTERS ON	TT&C	SPU A	S	All		TLM Flag Word 13 (second word)
A	1	21	1	4	4	1	THRONB	THRONB	THRONB	THRUSTERS ON	TT&C	SPU B	S	All		TLM Flag Word 21 (second word)
3	4	55	1	2	2	1	THRPWLMA	THRPWLMA	THRPWLMA	THRUSTER PULSEWIDTH LIMIT	TT&C	SPU A	S	Normal Thruster		ADS Flag Word
3	4	63	1	2	2	1	THRPWLMB	THRPWLMB	THRPWLMB	THRUSTER PULSEWIDTH LIMIT	TT&C	SPU B	S	Normal Thruster		ADS Flag Word
NA	NA	NA	NA	0	NA	8	TIME0H	TIME0H	TIME0H	SOLARINHCNSTNT:@0HI	NDS	BDP	S	SSOH		2952
NA	NA	NA	NA	0	NA	8	TIME0L	TIME0L	TIME0L	SOLARINHCNSTNT:@0LO	NDS	BDP	S	SSOH		2953
NA	NA	NA	NA	0	NA	8	TIME1H	TIME1H	TIME1H	SOLARINHCNSTNT:@1HI	NDS	BDP	S	SSOH		2954
NA	NA	NA	NA	0	NA	8	TIME1L	TIME1L	TIME1L	SOLARINHCNSTNT:@1LO	NDS	BDP	S	SSOH		2955
NA	NA	NA	NA	0	NA	8	TIMINT1H	TIMINT1H	TIMINT1H	TIME INTERVAL 1 HI 8	NDS	BDP	S	SSOH		3030
NA	NA	NA	NA	0	NA	8	TIMINT1L	TIMINT1L	TIMINT1L	TIME INTERVAL 1 LO 8	NDS	BDP	S	SSOH		3031
NA	NA	NA	NA	0	NA	8	TIMINT2H	TIMINT2H	TIMINT2H	TIME INTERVAL 2 HI 8	NDS	BDP	S	SSOH		3032
NA	NA	NA	NA	0	NA	8	TIMINT2L	TIMINT2L	TIMINT2L	TIME INTERVAL 2 LO 8	NDS	BDP	S	SSOH		3033
NA	NA	NA	NA	0	NA	8	TIMINT3H	TIMINT3H	TIMINT3H	TIME INTERVAL 3 HI 8	NDS	BDP	S	SSOH		3034
NA	NA	NA	NA	0	NA	8	TIMINT3L	TIMINT3L	TIMINT3L	TIME INTERVAL 3 LO 8	NDS	BDP	S	SSOH		3035
A	6	15	1	7	7	1	TIMRDISA	TIMRDISA	TIMRDISA	FLAG INDIC IF 5 MIN BOOT TIMER IS DISABLED	TT&C	SPU A	S	Power-Up		
A	6	23	1	7	7	1	TIMRDISB	TIMRDISB	TIMRDISB	FLAG INDIC IF 5 MIN BOOT TIMER IS DISABLED	TT&C	SPU B	S	Power-Up		
A	A	9	2	0	1	2	TIU1718	TIU1718	TIU1718	TIU SERIAL CMD ECHO BITS 18/17	TT&C	TIU	S	All Power-Up		Last 2 bits of TIU serial cmd echo (unallocated)
1	4	56	8	0	7	8	TIUACV5V	TIUACV5V	TIUACV5V	TIU A CONV +5VDC OUT	TT&C	TIU	AH	All Power-Up	volts	
4	3	58	8	0	7	8	TIUACVT	TIUACVT	TIUACVT	TIU A CONV TEMP	TT&C	TIU	AP	All Power-Up	Celsius	
4	5	56	8	0	7	8	TIUBCV5V	TIUBCV5V	TIUBCV5V	TIU B CONV +5VDC OUT	TT&C	TIU	AH	All Power-Up	volts	
4	4	58	8	0	7	8	TIUBCVT	TIUBCVT	TIUBCVT	TIU B CONV TEMP	TT&C	TIU	AP	All Power-Up	Celsius	
6	8	52	1	7	7	1	TIUENA	TIUENA	TIUENA	TELEMETRY INFORMATION UNIT	TT&C	SPU A	S	Normal		RDMGMT Flag Word 52 (lower half-first word)
7	4	54	1	7	7	1	TIUENA	TIUENA	TIUENA	TELEMETRY INFORMATION UNIT	TT&C	SPU A	S	Thruster		RDMGMT Flag Word 54 (lower half-first word)
6	8	60	1	7	7	1	TIUENB	TIUENB	TIUENB	TELEMETRY INFORMATION UNIT	TT&C	SPU B	S	Normal		RDMGMT Flag Word 60 (lower half-first word)
7	4	62	1	7	7	1	TIUENB	TIUENB	TIUENB	TELEMETRY INFORMATION UNIT	TT&C	SPU B	S	Thruster		RDMGMT Flag Word 62 (lower half-first word)
6	7	56	1	5	5	1	TIUFCNTA	TIUFCNTA	TIUFCNTA	TIU FRAME COUNT	TT&C	SPU A	S	Normal		RDMGMT Flag Word 55 (upper half-second word)
6	5	53	1	5	5	1	TIUFCNTA	TIUFCNTA	TIUFCNTA	TIU FRAME COUNT	TT&C	SPU A	S	Thruster		RDMGMT Flag Word 53 (upper half-second word)
6	7	63	1	5	5	1	TIUFCNTB	TIUFCNTB	TIUFCNTB	TIU FRAME COUNT	TT&C	SPU B	S	Normal		RDMGMT Flag Word 63 (upper half-second word)

6	5	61	1	5	5	1	TIUFCNTB	TIUFCNTB	TIUFCNTB	TIU FRAME COUNT	TT&C	SPU B	S	Thrustr	0=Test Disabled 1=Test Enabled	RDMGMT Flag Word 61 (upper half-second word)
6	5	61	1	5	5	1	TIUFCNTB	TIUFCNTB	TIU POWER	TIU POWER	TT&C	SPU A	S	Normal	0=Test Disabled 1=Test Enabled	RDMGMT Flag Word 55 (upper half-second word)
6	5	53	1	4	4	1	TIUPWRA	TIUPWRA	TIU POWER	TIU POWER	TT&C	SPU A	S	Thrustr	0=Test Disabled 1=Test Enabled	RDMGMT Flag Word 53 (upper half-second word)
6	7	63	1	4	4	1	TIUPWRB	TIUPWRB	TIU POWER	TIU POWER	TT&C	SPU B	S	Normal	0=Test Disabled 1=Test Enabled	RDMGMT Flag Word 63 (upper half-second word)
6	5	61	1	4	4	1	TIUPWRB	TIUPWRB	TIU POWER	TIU POWER	TT&C	SPU B	S	Thrustr	0=Test Disabled 1=Test Enabled	RDMGMT Flag Word 61 (upper half-second word)
6	7	55	1	3	3	1	TIURDBKA	TIURDBKA	TIU READBACK	TIU READBACK	TT&C	SPU A	S	Normal	0=Test Disabled 1=Test Enabled	RDMGMT Flag Word 55 (upper half-second word)
6	5	53	1	3	3	1	TIURDBKA	TIURDBKA	TIU READBACK	TIU READBACK	TT&C	SPU A	S	Thrustr	0=Test Disabled 1=Test Enabled	RDMGMT Flag Word 53 (upper half-second word)
6	7	63	1	3	3	1	TIURDBKB	TIURDBKB	TIU READBACK	TIU READBACK	TT&C	SPU B	S	Normal	0=Test Disabled 1=Test Enabled	RDMGMT Flag Word 63 (upper half-second word)
6	5	61	1	3	3	1	TIURDBKB	TIURDBKB	TIU READBACK	TIU READBACK	TT&C	SPU B	S	Thrustr	0=Test Disabled 1=Test Enabled	RDMGMT Flag Word 61 (upper half-second word)
3	4	56	8	0	7	8	TLMI76A	TLMI76A	TIU A 1.763V TLM	TIU A 1.763V TLM	TT&C	TIU	AH	All Power-Up		
1	6	56	8	0	7	8	TLMI194A	TLMI194A	TIU A 0.194V TLM	TIU A 0.194V TLM	TT&C	TIU	AH	All Power-Up		
3	3	56	8	0	7	8	TLMI194B	TLMI194B	TIU B 0.194V TLM	TIU B 0.194V TLM	TT&C	TIU	AH	All Power-Up		
3	1	56	8	0	7	8	TLM329A	TLM329A	TIU A 3.294V TLM	TIU A 3.294V TLM	TT&C	TIU	AH	All Power-Up		
5	1	56	8	0	7	8	TLM329B	TLM329B	TIU B 3.294V TLM	TIU B 3.294V TLM	TT&C	TIU	AH	All Power-Up		
3	2	56	8	0	7	8	TLM489A	TLM489A	TIU A 4.892V TLM	TIU A 4.892V TLM	TT&C	TIU	AH	All Power-Up		
5	2	56	8	0	7	8	TLM489B	TLM489B	TIU B 4.892V TLM	TIU B 4.892V TLM	TT&C	TIU	AH	All Power-Up		
1	1	57	8	0	7	8	TLMCALA	TLMCALA	TIU A PASSIVE TLM CALIBRATE	TIU A PASSIVE TLM CALIBRATE	TT&C	TIU	AH	All Power-Up		
1	2	57	8	0	7	8	TLMCALB	TLMCALB	TIU B PASSIVE TLM CALIBRATE	TIU B PASSIVE TLM CALIBRATE	TT&C	TIU	AH	All Power-Up		
A	1	10	1	1	1	1	TLMFMT	TLMFMT	TELEMETRY FORMAT	TELEMETRY FORMAT	TT&C	TIU	S	All Power-Up	1=Format 2 0=Format 1	First word (8 bits) of TIU serial cmd echo
1	5	56	8	0	7	8	TLMGND A	TLMGND A	TIU GND TLM 1	TIU GND TLM 1	TT&C	TIU	AH	All Power-Up		
4	6	56	8	0	7	8	TLMGND B	TLMGND B	TIU GND TLM 2	TIU GND TLM 2	TT&C	TIU	AH	All Power-Up		
A	1	10	2	2	3	2	TLMMODE	TLMMODE	TELEMETRY MODE	TELEMETRY MODE	TT&C	TIU	S	All Power-Up	0=Normal 1=Dump 2=Dwell 3=Unused	First word (8 bits) of TIU serial cmd echo
A	1	10	1	0	0	1	TLMRATE	TLMRATE	500/4000	500/4000	TT&C	TIU	S	All Power-Up		First word (8 bits) of TIU serial cmd echo
NA	NA	NA	NA	3	NA	1	TMSYSTST	TMSYSTST	TIMED SYS TEST SCHED	TIMED SYS TEST SCHED	NDS	BDY	S	SSOH		215
7	1	57	8	0	7	8	TNKIT	TNKIT	RCS TANK 1 TEMP	RCS TANK 1 TEMP	RCS	TNK	AP	All Power-Up		
7	2	57	8	0	7	8	TNK2T	TNK2T	RCS TANK 2 TEMP	RCS TANK 2 TEMP	RCS	TNK	AP	All Power-Up		
A	7	40	8	0	7	8	TNKPRES1	TNKPRES1	RCS TANK 1 XDCR PRESSURE	RCS TANK 1 XDCR PRESSURE	RCS	TNK	AH	All Power-Up		
A	7	48	8	0	7	8	TNKPRES2	TNKPRES2	RCS TANK 2 XDCR PRESSURE	RCS TANK 2 XDCR PRESSURE	RCS	TNK	AH	All Power-Up		
NA	NA	NA	NA	0	NA	1	TOAPROC	TOAPROC	DISABLE TOA PROCESS	DISABLE TOA PROCESS	NDS	BDP	S	SSOH		3066
A	3	54	8	0	7	16	TORQPITA	TORQPITA	TORQUE DEMAND PITCH (1 OF 2)	TORQUE DEMAND PITCH (1 OF 2)	ADS	SPU A	S	Normal		
A	3	55	8	0	7	16	TORQPITA	TORQPITA	TORQUE DEMAND PITCH (2 OF 2)	TORQUE DEMAND PITCH (2 OF 2)	ADS	SPU A	S	Normal		
A	3	62	8	0	7	16	TORQPITB	TORQPITB	TORQUE DEMAND PITCH (1 OF 2)	TORQUE DEMAND PITCH (1 OF 2)	ADS	SPU B	S	Normal		
A	3	63	8	0	7	16	TORQPITB	TORQPITB	TORQUE DEMAND PITCH (2 OF 2)	TORQUE DEMAND PITCH (2 OF 2)	ADS	SPU B	S	Normal		
A	3	52	8	0	7	16	TORQROLA	TORQROLA	TORQUE DEMAND ROLL (1 OF 2)	TORQUE DEMAND ROLL (1 OF 2)	ADS	SPU A	S	Normal		
A	3	53	8	0	7	16	TORQROLA	TORQROLA	TORQUE DEMAND ROLL (2 OF 2)	TORQUE DEMAND ROLL (2 OF 2)	ADS	SPU A	S	Normal		
A	3	60	8	0	7	16	TORQROLB	TORQROLB	TORQUE DEMAND ROLL (1 OF 2)	TORQUE DEMAND ROLL (1 OF 2)	ADS	SPU B	S	Normal		
A	3	61	8	0	7	16	TORQROLB	TORQROLB	TORQUE DEMAND ROLL (2 OF 2)	TORQUE DEMAND ROLL (2 OF 2)	ADS	SPU B	S	Normal		
A	4	52	8	0	7	16	TORQYAWA	TORQYAWA	TORQUE DEMAND YAW (1 OF 2)	TORQUE DEMAND YAW (1 OF 2)	ADS	SPU A	S	Normal		
A	4	53	8	0	7	16	TORQYAWA	TORQYAWA	TORQUE DEMAND YAW (2 OF 2)	TORQUE DEMAND YAW (2 OF 2)	ADS	SPU A	S	Normal		
A	4	60	8	0	7	16	TORQYAWB	TORQYAWB	TORQUE DEMAND YAW (1 OF 2)	TORQUE DEMAND YAW (1 OF 2)	ADS	SPU B	S	Normal		
A	4	61	8	0	7	16	TORQYAWB	TORQYAWB	TORQUE DEMAND YAW (2 OF 2)	TORQUE DEMAND YAW (2 OF 2)	ADS	SPU B	S	Normal		
NA	NA	NA	NA	0	NA	8	TOTASK	TOTASK	TIME-OUT TASK FLAG	TIME-OUT TASK FLAG	NDS	BDP-IP	S	SSOH		162
A	8	52	8	0	7	16	TPFBURNA	TPFBURNA	TPF THRUSTER BURNTIME (1 OF 2)	TPF THRUSTER BURNTIME (1 OF 2)	TT&C	SPU A	S	Early Orbit		
A	8	53	8	0	7	16	TPFBURNA	TPFBURNA	TPF THRUSTER BURNTIME (2 OF 2)	TPF THRUSTER BURNTIME (2 OF 2)	TT&C	SPU A	S	Early Orbit		



5	8	61	1	4	4	1	TPFSL13B	TPFSL13B	TPF THRUSTER SELECTION -REA 13	ADS	SPUB	S	Early Orbit	0=Not Selected 1=Selected	
5	8	53	1	5	5	1	TPFSL14A	TPFSL14A	TPF THRUSTER SELECTION -REA 14	ADS	SPUA	S	Early Orbit	0=Not Selected 1=Selected	
5	8	61	1	5	5	1	TPFSL14B	TPFSL14B	TPF THRUSTER SELECTION -REA 14	ADS	SPUB	S	Early Orbit	0=Not Selected 1=Selected	
5	8	53	1	6	6	1	TPFSL15A	TPFSL15A	TPF THRUSTER SELECTION -REA 15	ADS	SPUA	S	Early Orbit	0=Not Selected 1=Selected	
5	8	61	1	6	6	1	TPFSL15B	TPFSL15B	TPF THRUSTER SELECTION -REA 15	ADS	SPUB	S	Early Orbit	0=Not Selected 1=Selected	
5	8	53	1	7	7	1	TPFSL16A	TPFSL16A	TPF THRUSTER SELECTION -REA 16	ADS	SPUA	S	Early Orbit	0=Not Selected 1=Selected	
5	8	61	1	7	7	1	TPFSL16B	TPFSL16B	TPF THRUSTER SELECTION -REA 16	ADS	SPUB	S	Early Orbit	0=Not Selected 1=Selected	
4	8	54	8	0	7	16	TPFTMRA	TPFTMRA	TPF COUNTDOWN TIMER (1 OF 2)	TT&C	SPUA	S	Early Orbit		seconds
4	8	55	8	0	7	16	TPFTMRA	TPFTMRA	TPF COUNTDOWN TIMER (2 OF 2)	TT&C	SPUA	S	Early Orbit		seconds
4	8	62	8	0	7	16	TPFTMRB	TPFTMRB	TPF COUNTDOWN TIMER (1 OF 2)	TT&C	SPUB	S	Early Orbit		seconds
4	8	63	8	0	7	16	TPFTMRB	TPFTMRB	TPF COUNTDOWN TIMER (2 OF 2)	TT&C	SPUB	S	Early Orbit		seconds
6	8	53	1	2	2	1	TQCENA	TQCENA	TORQUE COILS	TT&C	SPUA	S	Normal	0=Disabled 1=Enabled	RDMGMT Flag Word 53 (lower half-second word)
7	4	56	1	2	2	1	TQCENA	TQCENA	TORQUE COILS	TT&C	SPUA	S	Normal	0=Disabled 1=Enabled	RDMGMT Flag Word 55 (lower half-second word)
6	8	61	1	2	2	1	TQCENB	TQCENB	TORQUE COILS	TT&C	SPUB	S	Normal	0=Disabled 1=Enabled	RDMGMT Flag Word 61 (lower half-second word)
7	4	63	1	2	2	1	TQCENB	TQCENB	TORQUE COILS	TT&C	SPUB	S	Normal	0=Disabled 1=Enabled	RDMGMT Flag Word 63 (lower half-second word)
6	7	56	1	7	7	1	TQCHCURA	TQCHCURA	TORQUE COIL HIGH CURRENT	TT&C	SPUA	S	Normal	0=Test Disabled 1=Test Enabled	RDMGMT Flag Word 55 (upper half-second word)
6	5	53	1	7	7	1	TQCHCURA	TQCHCURA	TORQUE COIL HIGH CURRENT	TT&C	SPUA	S	Normal	0=Test Disabled 1=Test Enabled	RDMGMT Flag Word 53 (upper half-second word)
6	7	63	1	7	7	1	TQCHCURB	TQCHCURB	TORQUE COIL HIGH CURRENT	TT&C	SPUB	S	Normal	0=Test Disabled 1=Test Enabled	RDMGMT Flag Word 63 (upper half-second word)
6	5	61	1	7	7	1	TQCHCURB	TQCHCURB	TORQUE COIL HIGH CURRENT	TT&C	SPUB	S	Normal	0=Test Disabled 1=Test Enabled	RDMGMT Flag Word 61 (upper half-second word)
NA	NA	NA	NA	3	NA	1	TRAPINT	TRAPINT	TRAP	TT&C	SPUB	S	Normal	0=Test Disabled 1=Test Enabled	RDMGMT Flag Word 61 (upper half-second word)
A	1	41	1	3	3	1	TRIGGOA	TRIGGOA	MDU A TRIGGER GO	NDS	BDP-IP	S	SSOH		164
A	1	42	1	3	3	1	TRIGGOB	TRIGGOB	MDU B TRIGGER GO	TNP	MDU	DL	All Power-Up	1=Counter OK 0=Counter Overflow	
NA	NA	NA	NA	2	NA	1	TSTMEMOV	TSTMEMOV	TESTMEMOVERWRITEBYWH S	NDS	BDP	S	SSOH		3015
NA	NA	NA	NA	0	NA	8	TSTMEMTH	TSTMEMTH	ZTIME FOR TEST MEM H18	NDS	BDP	S	SSOH		3028
NA	NA	NA	NA	0	NA	8	TSTMEMTL	TSTMEMTL	ZTIME FOR TEST MEM L08	NDS	BDP	S	SSOH		3029
5	1	58	8	0	7	8	TTCXIFT	TTCXIFT	-X BUS PNL/S-BAND XPONDER I/F TEMP C	MSS	TCS	AP	All Power-Up		
NA	NA	NA	NA	6	NA	1	TWOCOMP	TWOCOMP	2'S COMPLIMENT	NDS	BDY	S	SSOH		217
3	1	58	8	0	7	8	UHFEL10T	UHFEL10T	UHF ANTENNA PNL ELEM 10 TEMP B	ANT	UHF	AP	All Power-Up		
2	5	58	8	0	7	8	UHFEL7T	UHFEL7T	UHF ANTENNA PNL ELEM 7 TEMP A	ANT	UHF	AP	All Power-Up		
2	6	58	8	0	7	8	UHFEL9T	UHFEL9T	UHF ANTENNA PNL ELEM 9 TEMP C	ANT	UHF	AP	All Power-Up		
A	1	16	1	3	3	1	ULXST0A	ULXST0A	S-BAND UPLNK/XSTP STAT 0-A	TT&C	SBT	S	All Power-Up		See S-Band Mode Table
A	1	16	1	7	7	1	ULXST0B	ULXST0B	S-BAND UPLNK/XSTP STAT 0-B	TT&C	SBT	S	All Power-Up		See S-Band Mode Table
A	2	16	1	3	3	1	ULXST1A	ULXST1A	S-BAND UPLNK/XSTP STAT 1-A	TT&C	SBT	S	All Power-Up		See S-Band Mode Table
A	2	16	1	7	7	1	ULXST1B	ULXST1B	S-BAND UPLNK/XSTP STAT 1-B	TT&C	SBT	S	All Power-Up		See S-Band Mode Table
NA	NA	NA	NA	0	NA	8	UMBRAH	UMBRAH	UMBRA (8 MSB)	NDS	BDP	S	SSOH		2960
NA	NA	NA	NA	0	NA	8	UMBRAL	UMBRAL	UMBRA (8 LSB)	NDS	BDP	S	SSOH		2961

A	1	13	1	0	0	1	UPINVLDA	UPINVLDA	UPINVLDA	INVALID STATUS	TT&C	SPU A	S	All	0=No Invalid Status 1=Invalid Status	TLM Flag Word 13 (second word)
A	1	21	1	0	0	1	UPINVLDB	UPINVLDB	UPINVLDB	INVALID STATUS	TT&C	SPU B	S	All	0=No Invalid Status 1=Invalid Status	TLM Flag Word 21 (second word)
A	1	12	1	7	7	1	UPLKBUFA	UPLKBUFA	UPLKBUFA	UPLINK BUFFER FULL	TT&C	SPU A	S	All	0=No Invalid Status 1=Invalid Status	TLM Flag Word 12 (first word)
A	1	20	1	7	7	1	UPLKBUFB	UPLKBUFB	UPLKBUFB	UPLINK BUFFER FULL	TT&C	SPU B	S	All	0=No Invalid Status 1=Invalid Status	TLM Flag Word 20 (first word)
NA	NA	NA	NA	1	NA	1	UPLKBUFB	UPLKBUFB	UPLKBUFB	UPLINK BUFFER FULL	NDS	BDP-MP	S	SSOH	0=No Invalid Status 1=Invalid Status	48
NA	NA	NA	NA	0	NA	8	UPLKBUFB	UPLKBUFB	UPLKBUFB	UPLINK BUFFER FULL	NDS	BDP-MP	S	SSOH	0=No Invalid Status 1=Invalid Status	39
NA	NA	NA	NA	5	NA	1	UPLKBUFB	UPLKBUFB	UPLKBUFB	UPLINK BUFFER FULL	NDS	BDP-MP	S	SSOH	0=No Invalid Status 1=Invalid Status	46
NA	NA	NA	NA	5	NA	1	UPLKBUFB	UPLKBUFB	UPLKBUFB	UPLINK BUFFER FULL	NDS	BDP	S	SSOH	0=No Invalid Status 1=Invalid Status	3066
A	A	18	6	0	7	21	VCC1	VCC1	VCC1	VCC WORD (2 OF 3)	TT&C	KIR-23	S	All Power-Up	0=No Invalid Status 1=Invalid Status	Loral mnemonic = "VCC-1"
A	A	19	6	0	5	21	VCC1	VCC1	VCC1	VCC WORD (3 OF 3)	TT&C	KIR-23	S	All Power-Up	0=No Invalid Status 1=Invalid Status	Loral mnemonic = "VCC-1"
A	A	17	7	1	7	21	VCC1	VCC1	VCC1	VCC WORD (1 OF 3)	TT&C	KIR-23	S	All Power-Up	0=No Invalid Status 1=Invalid Status	Loral mnemonic = "VCC-1"
A	A	50	8	0	7	21	VCC2	VCC2	VCC2	VCC WORD (2 OF 3)	TT&C	KIR-23	S	All Power-Up	0=No Invalid Status 1=Invalid Status	Loral mnemonic = "VCC-2"
A	A	51	6	0	5	21	VCC2	VCC2	VCC2	VCC WORD (3 OF 3)	TT&C	KIR-23	S	All Power-Up	0=No Invalid Status 1=Invalid Status	Loral mnemonic = "VCC-2"
A	A	49	7	1	7	21	VCC2	VCC2	VCC2	VCC WORD (1 OF 3)	TT&C	KIR-23	S	All Power-Up	0=No Invalid Status 1=Invalid Status	Loral mnemonic = "VCC-2"
A	4	10	1	6	6	1	WAARMA	WAARMA	WAARMA	OCU A PYROS (W-ANT) ARMED	ANT	WSA	DL	All Power-Up	1=Armed 0=Disarmed	
A	4	11	1	6	6	1	WAARMB	WAARMB	WAARMB	OCU B PYROS (W-ANT) ARMED	ANT	WSA	DL	All Power-Up	1=Armed 0=Disarmed	
3	8	59	8	0	7	8	WANTHESP	WANTHESP	WANTHESP	W-HI ELE SPOOL POT WIP POS	ANT	WSA	AP	All Power-Up	degrees	Zero-filled in Format 1
2	7	59	8	0	7	8	WANTHIDT	WANTHIDT	WANTHIDT	W-HI INNER HNGE DMP TEMP	ANT	WSA	AP	All Power-Up	Celsius	Zero-filled in Format 1
1	8	59	8	0	7	8	WANTHIHP	WANTHIHP	WANTHIHP	W-HI INNER HNGE POT WIP POS	ANT	WSA	AP	All Power-Up	degrees	Zero-filled in Format 1
5	7	59	8	0	7	8	WANTHODT	WANTHODT	WANTHODT	W-HI OUTER HNGE DMP TEMP	ANT	WSA	AP	All Power-Up	Celsius	Zero-filled in Format 1
2	7	59	8	0	7	8	WANTHOHP	WANTHOHP	WANTHOHP	W-HI OUTER HNGE POT WIP POS	ANT	WSA	AP	All Power-Up	degrees	Zero-filled in Format 1
1	8	59	8	0	7	8	WANTHSPT	WANTHSPT	WANTHSPT	W-HI ELEM SPOOL DMP TEMP	ANT	WSA	AP	All Power-Up	Celsius	Zero-filled in Format 1
6	8	59	8	0	7	8	WANTLESPT	WANTLESPT	WANTLESPT	W-HI ELEM SPOOL POT WIP POS	ANT	WSA	AP	All Power-Up	degrees	Zero-filled in Format 1
4	7	59	8	0	7	8	WANTLIDT	WANTLIDT	WANTLIDT	W-HI INNER HNGE DMP TEMP	ANT	WSA	AP	All Power-Up	Celsius	Zero-filled in Format 1
6	7	59	8	0	7	8	WANTLIHP	WANTLIHP	WANTLIHP	W-HI INNER HNGE POT WIP POS	ANT	WSA	AP	All Power-Up	degrees	Zero-filled in Format 1
4	7	59	8	0	7	8	WANTLOHP	WANTLOHP	WANTLOHP	W-HI OUTER HNGE DMP TEMP	ANT	WSA	AP	All Power-Up	Celsius	Zero-filled in Format 1
5	8	59	8	0	7	8	WANTLOHP	WANTLOHP	WANTLOHP	W-HI OUTER HNGE POT WIP POS	ANT	WSA	AP	All Power-Up	degrees	Zero-filled in Format 1
3	7	59	8	0	7	8	WANTLSDT	WANTLSDT	WANTLSDT	W-HI ELEM SPOOL DMP TEMP	ANT	WSA	AP	All Power-Up	Celsius	Zero-filled in Format 1
NA	NA	NA	NA	0	NA	8	WCMDERDI	WCMDERDI	WCMDERDI	CMDCRNT-DATAINCONSIST	NDS	BDW	S	SSOH	0=No Invalid Status 1=Invalid Status	357
NA	NA	NA	NA	0	NA	8	WCMDERM	WCMDERM	WCMDERM	SERDATAERNT-MSGCORRUPT	NDS	BDW	S	SSOH	0=No Invalid Status 1=Invalid Status	356
NA	NA	NA	NA	0	NA	8	WCMDERUA	WCMDERUA	WCMDERUA	NOOPERERNT-UNABLETOACT	NDS	BDW	S	SSOH	0=No Invalid Status 1=Invalid Status	358
NA	NA	NA	NA	4	NA	1	WDELCA	WDELCA	WDELCA	BDW DELAYED CALIBRAT	NDS	BDP	S	SSOH	0=No Invalid Status 1=Invalid Status	2984
NA	NA	NA	NA	1	NA	1	WDOG-TMR	WDOG-TMR	WDOG-TMR	DISABLEWATCHDOG-TIMER	NDS	BDP	S	SSOH	0=No Invalid Status 1=Invalid Status	3066
NA	NA	NA	NA	0	NA	8	WDTOERR	WDTOERR	WDTOERR	TIMER TIMEOUT ER CNT	NDS	BDP-MP	S	SSOH	0=No Invalid Status 1=Invalid Status	40
NA	NA	NA	NA	0	NA	8	WHSCDUMP	WHSCDUMP	WHSCDUMP	MATCHED WHS EV CNT	NDS	BDP-MP	S	SSOH	0=No Invalid Status 1=Invalid Status	29
NA	NA	NA	NA	1	NA	1	WHSPLNK	WHSPLNK	WHSPLNK	WHS LAST EV MSG XFER	NDS	BDP-IP	S	SSOH	0=No Invalid Status 1=Invalid Status	165
NA	NA	NA	NA	1	NA	1	WHSPLNK	WHSPLNK	WHSPLNK	WHS PLINK EVXFR FLG	NDS	BDP-IP	S	SSOH	0=No Invalid Status 1=Invalid Status	166
NA	NA	NA	NA	3	NA	1	WHSTBFTO	WHSTBFTO	WHSTBFTO	TMP BUF TAKEOUTFLGS:WHS	NDS	BDP-MP	S	SSOH	0=No Invalid Status 1=Invalid Status	162
NA	NA	NA	NA	0	NA	16	WHSTBIP	WHSTBIP	WHSTBIP	WHS TMP BUFF I/P PNT	NDS	BDP-MP	S	SSOH	0=No Invalid Status 1=Invalid Status	109
NA	NA	NA	NA	0	NA	16	WHSTBOP	WHSTBOP	WHSTBOP	WHS TMP BUFF O/P PNT	NDS	BDP-MP	S	SSOH	0=No Invalid Status 1=Invalid Status	111
NA	NA	NA	NA	0	NA	16	WHSTBQJE	WHSTBQJE	WHSTBQJE	WHS TMP BUFF QUE CNT	NDS	BDP-MP	S	SSOH	0=No Invalid Status 1=Invalid Status	113
NA	NA	NA	NA	6	NA	1	WHXTBFTO	WHXTBFTO	WHXTBFTO	TMP BUF TAKEOUTFLGS:WHX	NDS	BDP-MP	S	SSOH	0=No Invalid Status 1=Invalid Status	62
NA	NA	NA	NA	0	NA	16	WLSADD1	WLSADD1	WLSADD1	WLS SAVEADDR ENTRY 1	NDS	BDP-MP	S	SSOH	0=No Invalid Status 1=Invalid Status	119
NA	NA	NA	NA	0	NA	16	WLSADD10	WLSADD10	WLSADD10	WLS SAVEADDR ENTRY 10	NDS	BDP-MP	S	SSOH	0=No Invalid Status 1=Invalid Status	137
NA	NA	NA	NA	0	NA	16	WLSADD2	WLSADD2	WLSADD2	WLS SAVEADDR ENTRY 2	NDS	BDP-MP	S	SSOH	0=No Invalid Status 1=Invalid Status	121
NA	NA	NA	NA	0	NA	16	WLSADD3	WLSADD3	WLSADD3	WLS SAVEADDR ENTRY 3	NDS	BDP-MP	S	SSOH	0=No Invalid Status 1=Invalid Status	123
NA	NA	NA	NA	0	NA	16	WLSADD4	WLSADD4	WLSADD4	WLS SAVEADDR ENTRY 4	NDS	BDP-MP	S	SSOH	0=No Invalid Status 1=Invalid Status	125
NA	NA	NA	NA	0	NA	16	WLSADD5	WLSADD5	WLSADD5	WLS SAVEADDR ENTRY 5	NDS	BDP-MP	S	SSOH	0=No Invalid Status 1=Invalid Status	127
NA	NA	NA	NA	0	NA	16	WLSADD6	WLSADD6	WLSADD6	WLS SAVEADDR ENTRY 6	NDS	BDP-MP	S	SSOH	0=No Invalid Status 1=Invalid Status	129
NA	NA	NA	NA	0	NA	16	WLSADD7	WLSADD7	WLSADD7	WLS SAVEADDR ENTRY 7	NDS	BDP-MP	S	SSOH	0=No Invalid Status 1=Invalid Status	131
NA	NA	NA	NA	0	NA	16	WLSADD8	WLSADD8	WLSADD8	WLS SAVEADDR ENTRY 8	NDS	BDP-MP	S	SSOH	0=No Invalid Status 1=Invalid Status	133



NA	NA	NA	NA	2	NA	1	XSTST1EX	XSTST1EX	BDXD SYS TEST EXECUTIVE	NDS	BDP	S	SSOH			2984
NA	NA	NA	NA	4	NA	1	XSTST2EX	XSTST2EX	BDX DISCRETE SYSTEST	NDS	BDP	S	SSOH			2985
NA	NA	NA	NA	4	NA	1	XSTSTOFF	XSTSTOFF	BDX SYSTSTIMEBITS	NDS	BDP	S	SSOH			2982
NA	NA	NA	NA	6	NA	1	XSTSTPAR	XSTSTPAR	BDX SYSTEM TEST	NDS	BDP	S	SSOH			3000
A	1	64	1	6	6	1	XSYSTST	XSYSTST	BDX SYSTEM TEST	NDS	BDX	S	All Power-Up			SSOH Byte 31 L3 Format
NA	NA	NA	NA	5	NA	1	XYTRIG	XYTRIG	X TRIGGER Y	NDS	BDY	S	SSOH			221
3	6	54	8	0	7	16	YAWERRA	YAWERRA	YAW ATTITUDE ERROR (1 OF 2)	ADS	SPU A	S	Normal Thruster	radians		
3	6	55	8	0	7	16	YAWERRA	YAWERRA	YAW ATTITUDE ERROR (2 OF 2)	ADS	SPU A	S	Normal Thruster	radians		
3	6	62	8	0	7	16	YAWERRB	YAWERRB	YAW ATTITUDE ERROR (1 OF 2)	ADS	SPU B	S	Normal Thruster	radians		
3	6	63	8	0	7	16	YAWERRB	YAWERRB	YAW ATTITUDE ERROR (2 OF 2)	ADS	SPU B	S	Normal Thruster	radians		
3	7	52	8	0	7	16	YAWINTA	YAWINTA	YAW ATTITUDE INTEG ERROR (1 OF 2)	ADS	SPU A	S	Thruster	rad/sec		
3	7	53	8	0	7	16	YAWINTA	YAWINTA	YAW ATTITUDE INTEG ERROR (2 OF 2)	ADS	SPU A	S	Thruster	rad/sec		
3	7	60	8	0	7	16	YAWINTB	YAWINTB	YAW ATTITUDE INTEG ERROR (1 OF 2)	ADS	SPU B	S	Thruster	rad/sec		
3	7	61	8	0	7	16	YAWINTB	YAWINTB	YAW ATTITUDE INTEG ERROR (2 OF 2)	ADS	SPU B	S	Thruster	rad/sec		
3	7	52	8	0	7	16	YAWINTNA	YAWINTNA	YAW ATTITUDE INTEG ERROR (1 OF 2)	ADS	SPU A	S	Thruster	rad/sec		
3	7	53	8	0	7	16	YAWINTNA	YAWINTNA	YAW ATTITUDE INTEG ERROR (2 OF 2)	ADS	SPU A	S	Normal	rad/sec		
3	7	60	8	0	7	16	YAWINTNB	YAWINTNB	YAW ATTITUDE INTEG ERROR (1 OF 2)	ADS	SPU B	S	Normal	rad/sec		
3	7	61	8	0	7	16	YAWINTNB	YAWINTNB	YAW ATTITUDE INTEG ERROR (2 OF 2)	ADS	SPU B	S	Normal	rad/sec		
3	8	52	8	0	7	16	YAWMEA	YAWMEA	YAW MOMENTUM ERROR (1 OF 2)	ADS	SPU A	S	Normal Thruster	in-lbf-sec		
3	8	53	8	0	7	16	YAWMEA	YAWMEA	YAW MOMENTUM ERROR (2 OF 2)	ADS	SPU A	S	Normal Thruster	in-lbf-sec		
3	8	60	8	0	7	16	YAWMEB	YAWMEB	YAW MOMENTUM ERROR (1 OF 2)	ADS	SPU B	S	Normal Thruster	in-lbf-sec		
3	8	61	8	0	7	16	YAWMEB	YAWMEB	YAW MOMENTUM ERROR (2 OF 2)	ADS	SPU B	S	Normal Thruster	in-lbf-sec		
3	7	54	8	0	7	16	YAWRATA	YAWRATA	YAW ATTITUDE RATE ERROR (1 OF 2)	ADS	SPU A	S	Normal Thruster	rad/sec		
3	7	55	8	0	7	16	YAWRATA	YAWRATA	YAW ATTITUDE RATE ERROR (2 OF 2)	ADS	SPU A	S	Normal Thruster	rad/sec		
3	7	62	8	0	7	16	YAWRATB	YAWRATB	YAW ATTITUDE RATE ERROR (1 OF 2)	ADS	SPU B	S	Normal Thruster	rad/sec		
3	7	63	8	0	7	16	YAWRATB	YAWRATB	YAW ATTITUDE RATE ERROR (2 OF 2)	ADS	SPU B	S	Normal Thruster	rad/sec		
A	7	14	8	0	7	16	YAWSNPA	YAWSNPA	YAW ANGLE SUN NADIR (1 OF 2)	ADS	SPU A	S	Normal	radians		
A	7	15	8	0	7	16	YAWSNPA	YAWSNPA	YAW ANGLE SUN NADIR (2 OF 2)	ADS	SPU A	S	Normal	radians		
A	7	22	8	0	7	16	YAWSNPB	YAWSNPB	YAW ANGLE SUN NADIR (1 OF 2)	ADS	SPU B	S	Normal	radians		
A	7	23	8	0	7	16	YAWSNPB	YAWSNPB	YAW ANGLE SUN NADIR (2 OF 2)	ADS	SPU B	S	Normal	radians		
NA	NA	NA	NA	3	NA	1	YD2-10	YD2-11	DISABLE YD 2-10	NDS	BDP	S	SSOH			3015
NA	NA	NA	NA	5	NA	1	YDAUTO	YDAUTO	DISABLE AUTO YD	NDS	BDP	S	SSOH			2969
NA	NA	NA	NA	0	NA	8	YDL3OUT	YDL3OUT	YD L3 OUTPUT COUNT	NDS	BDP-MP	S	SSOH			65
NA	NA	NA	NA	0	NA	1	YDMMSG	YDMMSG	FORCE BODY STRATEGICS	NDS	BDP	S	SSOH			2971
NA	NA	NA	NA	3	NA	1	YDPLNK	YDPLNK	YD LAST EV MSG XFER	NDS	BDP-IP	S	SSOH			165
NA	NA	NA	NA	2	NA	1	YDQPLNK	YDQPLNK	YD PLINK EV XFER FLG	NDS	BDP-IP	S	SSOH			166



NA	NA	NA	NA	0	NA	1	YSEVENT	YSEVENT	YSEVENT	YLOW EVENT CONFIRMED	NDS	BDY	S	SSOH	213
NA	NA	NA	NA	6	NA	2	YSGAIN	YSGAIN	YLOW GAIN BITS	YLOW INTERRUPT MASK	NDS	BDY	S	SSOH	212
NA	NA	NA	NA	5	NA	1	YSINTMSK	YSINTMSK	YLOW INTERRUPT MASK	YLOW LIGHTNING RST INH	NDS	BDY	S	SSOH	211
NA	NA	NA	NA	7	NA	1	YSLGTRST	YSLGTRST	YLOW LIGHTNING RST INH	YLOW LIGHTNING DETECTED	NDS	BDY	S	SSOH	213
NA	NA	NA	NA	4	NA	1	YSLIGHT	YSLIGHT	YLOW LIGHTNING DETECTED	YLOW COUNT CODE	NDS	BDY	S	SSOH	213
NA	NA	NA	NA	2	NA	2	YSLCNC	YSLCNC	YLOW COUNT CODE	YLOW BF COMP RATE	NDS	BDP	S	SSOH	2963
NA	NA	NA	NA	5	NA	2	YSLCOCMP	YSLCOCMP	YLOW BF COMP RATE	YLOW INTERRUPT	NDS	BDP	S	SSOH	2964
NA	NA	NA	NA	5	NA	1	YSLCINT	YSLCINT	YLOW INTERRUPT	INHYSLOWLITNINGRESET	NDS	BDP	S	SSOH	2970
NA	NA	NA	NA	1	NA	1	YSLCIRST	YSLCIRST	INHYSLOWLITNINGRESET	YLOW LIGHTNING TEST	NDS	BDP	S	SSOH	2963
NA	NA	NA	NA	0	NA	3	YSLCINT	YSLCINT	YLOW LIGHTNING TEST	YLOW TRIGGER MODE	NDS	BDP	S	SSOH	2964
NA	NA	NA	NA	4	NA	1	YSLCINT	YSLCINT	YLOW TRIGGER MODE	YLOW NOISE	NDS	BDY	S	All Power-Up	SSOH Byte 3406
4	1	24	8	0	7	8	YSLON	YSLON	YLOW NOISE	YLOW PARTICLE TEST	NDS	BDP	S	SSOH	2964
NA	NA	NA	NA	3	NA	1	YSLCPTST	YSLCPTST	YLOW PARTICLE TEST	YLOW TRIGGER COUNT	NDS	BDP	S	SSOH	205
NA	NA	NA	NA	0	NA	16	YSLCINT	YSLCINT	YLOW TRIGGER COUNT	YLOW TRIGGER LEVEL	NDS	BDP	S	SSOH	2963
NA	NA	NA	NA	4	NA	4	YSLCINT	YSLCINT	YLOW TRIGGER LEVEL	ENABLE YLOW TRIGGER	NDS	BDP	S	SSOH	2964
NA	NA	NA	NA	7	NA	1	YSLCINT	YSLCINT	ENABLE YLOW TRIGGER	L3DTXFRIFYSLS&YSLMOT	NDS	BDP	S	SSOH	2966
NA	NA	NA	NA	4	NA	2	YSLCINT	YSLCINT	L3DTXFRIFYSLS&YSLMOT	YLOW LITNINGSTLEVBITS	NDS	BDY	S	SSOH	214
NA	NA	NA	NA	0	NA	3	YSLCINT	YSLCINT	YLOW LITNINGSTLEVBITS	YLOW TRIGGER MODE	NDS	BDY	S	SSOH	214
NA	NA	NA	NA	4	NA	1	YSLCINT	YSLCINT	YLOW TRIGGER MODE	BDY SOH INTERRUPT	NDS	BDP	S	SSOH	2970
NA	NA	NA	NA	4	NA	1	YSLCINT	YSLCINT	BDY SOH INTERRUPT	YLOW PARTICLE TEST EN	NDS	BDY	S	SSOH	214
NA	NA	NA	NA	3	NA	1	YSPST	YSPST	YLOW PARTICLE TEST EN	YLOW RECENT THRESHCHANGE	NDS	BDY	S	SSOH	214
NA	NA	NA	NA	5	NA	1	YSTRCHG	YSTRCHG	YLOW RECENT THRESHCHANGE	YTVS	NDS	BDP	S	SSOH	2966
NA	NA	NA	NA	5	NA	1	YSTORE	YSTORE	YTVS	YLOW RECENT TRIG RESET	NDS	BDY	S	SSOH	214
NA	NA	NA	NA	7	NA	1	YSTRGRST	YSTRGRST	YLOW RECENT TRIG RESET	YLOW TRIGGER ENABLE	NDS	BDY	S	SSOH	212
NA	NA	NA	NA	0	NA	1	YSTRIG	YSTRIG	YLOW TRIGGER ENABLE	BDY SYS TEST EXECUTE	NDS	BDP	S	SSOH	2984
NA	NA	NA	NA	1	NA	1	YSTSTIEX	YSTSTIEX	BDY SYS TEST EXECUTE	BDY SYSTST2-1 SPIKE	NDS	BDP	S	SSOH	2974
NA	NA	NA	NA	7	NA	1	YSTST2-1	YSTST2-1	BDY SYSTST2-1 SPIKE	BDY SYSTST2-2SQUARPUL	NDS	BDP	S	SSOH	2974
NA	NA	NA	NA	6	NA	1	YSTST2-2	YSTST2-2	BDY SYSTST2-2SQUARPUL	BDY SYSTEST 2-4 RAMP	NDS	BDP	S	SSOH	2974
NA	NA	NA	NA	5	NA	1	YSTST2-4	YSTST2-4	BDY SYSTEST 2-4 RAMP	BDY SYSTST2-8MOTIONCH	NDS	BDP	S	SSOH	2974
NA	NA	NA	NA	4	NA	1	YSTST2-8	YSTST2-8	BDY SYSTST2-8MOTIONCH	BDY DISCRETE SYSTEST	NDS	BDP	S	SSOH	2985
NA	NA	NA	NA	1	NA	1	YSTST2EX	YSTST2EX	BDY DISCRETE SYSTEST	BDY SYSTSTENTIMEBITS	NDS	BDP	S	SSOH	2982
NA	NA	NA	NA	0	NA	4	YSTSTOFF	YSTSTOFF	BDY SYSTSTENTIMEBITS	BDY SYSTEM TEST	NDS	BDY	S	All Power-Up	0=Disabled 1=Enabled
A	1	64	1	5	5	1	YSYSTST	YSYSTST	BDY SYSTEM TEST	ZTIME-LAST SUBSYSUPDATE	NDS	BDP	S	SSOH	SSOH Byte 31 L3 Format
NA	NA	NA	NA	0	NA	16	ZTIME	ZTIME	ZTIME-LAST SUBSYSUPDATE	INT ERR FLAG(ZTIME)	NDS	BDP	S	SSOH	4
NA	NA	NA	NA	4	NA	1	ZTIMEINT	ZTIMEINT	INT ERR FLAG(ZTIME)	INT ERR FLAG(ZTIME)	NDS	BDP-MP	S	SSOH	3010
NA	NA	NA	NA	4	NA	1	ZTINTER	ZTINTER	INT ERR FLAG(ZTIME)	EN ZTIME WATCHDOGINT	NDS	BDP	S	SSOH	41
NA	NA	NA	NA	7	NA	1	ZTWDGINT	ZTWDGINT	EN ZTIME WATCHDOGINT	INT ERR FLG(ZTIMEWD)	NDS	BDP-MP	S	SSOH	3010
NA	NA	NA	NA	7	NA	1	ZTWDINTR	ZTWDINTR	INT ERR FLG(ZTIMEWD)	XFER MSG FLAG ZTIME	NDS	BDP-MP	S	SSOH	41
NA	NA	NA	NA	2	NA	1	ZTXFRMSG	ZTXFRMSG	XFER MSG FLAG ZTIME		NDS	BDP-MP	S	SSOH	46

## REFERENCE

- C-1. GPS IIR Orbital Operations Handbook (OOH), Volume II - Telemetry Processing, G73-OOH-0031B, Martin Marietta Corp. Philadelphia, PA., 25 January 1995.

## DISTRIBUTION LIST

AUL/LSE  
Bldg 1405 - 600 Chennault Circle  
Maxwell AFB, AL 36112-6424 1 cy

DTIC/OCP  
8527 John J. Kingman Rd, Suite 0944  
Ft Belvoir, VA 22060-6218 2 cys

AFSAA/SAI  
1580 Air Force Pentagon  
Washington, DC 20330-1580 1 cy

PL/SUL  
Kirtland AFB, NM 87117-5776 2 cys

PL/HO  
Kirtland AFB, NM 87117-5776 1 cy

Official Record Copy  
PL/SXEA/Jesse Leitner 4 cys