

MDDC - 1180

764557

UNITED STATES ATOMIC ENERGY COMMISSION

GENERAL INFORMATION SECTION

POCKET RADIATION ALARM

by
P. R. Bell

Clinton National Laboratory

DISSEMINATION STATEMENT R
Approved for public release
Distribution Unlimited

This document consists of 8 pages.
Date Declassified: August 12, 1947

This document is for official use.
Its issuance does not constitute authority
for declassification of classified copies
of the same or similar content and title
and by the same author.

Technical Information Division, Oak Ridge Directed Operations

Printed in United States of America
AEC, Oak Ridge, Tenn. - 8-25-48-1,500

~~Price 10 cents~~

19961011 104

DTIC QUALITY INSPECTED 1

DISCLAIMER NOTICE

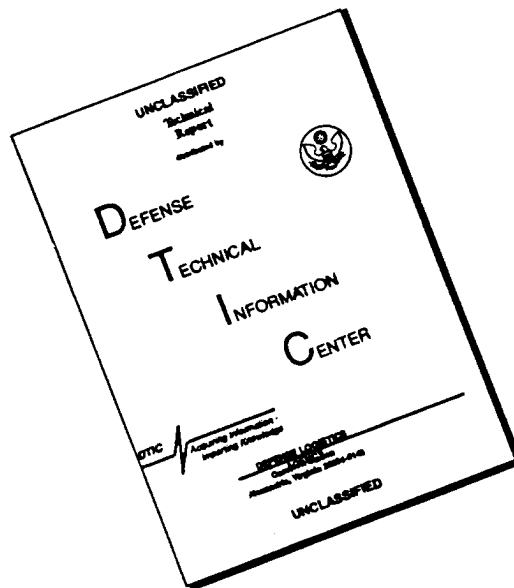

THIS DOCUMENT IS BEST QUALITY AVAILABLE. THE COPY FURNISHED TO DTIC CONTAINED A SIGNIFICANT NUMBER OF PAGES WHICH DO NOT REPRODUCE LEGIBLY.

POCKET RADIATION ALARM

By P. R. Bell

The presence of many possible sources of radiation of dangerous intensity in today's nuclear physics laboratories has resulted in the use of various kinds of radiation meters for the protection of laboratory workers.

Health Physics instruments of one class are placed in working regions to record the radiation intensity of integrated radiation; some of these instruments are designed to alarm when intensity or integrated intensity reaches the danger point. Another class of Health Physics instruments is meant to be carried on the individual workers person. These instruments are more satisfactory than the fixed instruments since they read the integrated radiation near the workers. Despite their excellent accuracy and reliability, these instruments leave a lot to be desired since they do not provide an alarm and the person wearing them may find out some morning that he received a large overexposure the preceding day. This overexposure might have been avoided if the instrument had given an alarm when the safe daily dose had been received.

Figure 1 shows the circuit diagram of a personal radiation alarm small enough to be carried in a pocket.

The VX-32 electrometer tube requires a filament current of 10 ma at 1.4 volts and during normal operation draws no plate current. The lack of plate current causes the grid current to be unusually small so that many days would be required for the grid current alone to discharge the capacity of the ionization chamber and tube ($12 \mu\mu f$). The total current tending to discharge the ionization chamber must be less than about 3×10^{-15} ampere if the instrument is to have nearly the same sensitivity at the beginning and end of the day. The first instrument constructed had a half discharge time of 2 to 5 days with moderate humidity but has not been tested under conditions of extreme humidity. The error in any case is in the direction of safety.

Operation is begun by inserting the batteries and pressing the push-button switch S connecting the chamber wall to terminal R. The grid current of the VX-32 charges the chamber so that the grid remains slightly more negative than the negative side of the filament. The chamber is thus charged to about 69 volts. When the push button is released, the wall of the chamber is connected to the positive

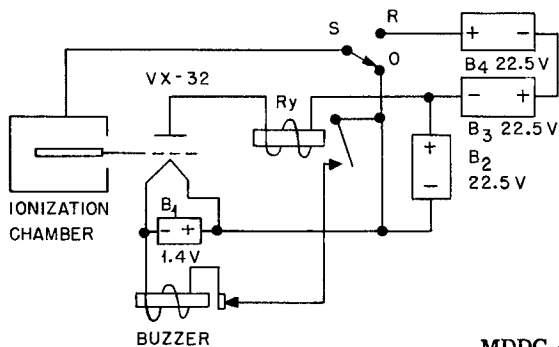

Figure 1. Circuit diagram of pocket radiation alarm

- S = Push-button switch built into case
- Ry = Sigma-Type 4-F 10,000 ohm relay
- B₁ = Mallory model RMB-3 mercury cell
- B_{2,3,4} = Eveready type No. 412 22.5 volt

side of the filament. The grid of the electrometer tube then is approximately 58 volts more negative than the filament and is far beyond cutoff bias.

Radiation produces ionization current in the chamber, slowly discharging it until the cutoff bias is reached. At this bias, plate current begins to flow and due to the rather high plate voltage (22V) the grid current becomes rather high and even if the source of radiation is removed the grid voltage will go in the positive direction until the positive ion and electronic components of the grid current are equal. This is the "floating" potential of the grid. The plate current at this floating potential is larger than the current required to close the sensitive relay (Ry). The closing of the relay operates the alarm buzzer. Depressing the push button recharges the chamber and the instrument is ready for service again. Many of the constructional details can be seen from the photographs Figures 3 to 7.

The walls and center electrode of the ionization chamber (and the lid and body of the instrument case) are constructed of Lucite or other plastic material in order to make the response to various gamma-ray energies more uniform. The walls and central electrode of the ionization chamber are made conducting by a thin coating of colloidal graphite in dioxane. This mixture of graphite in dioxane is made by mixing aquadag with slightly more than equal volume of dioxane and adding about 1/4 per cent of aerosol solution. Another coating that seems to be satisfactory is Rescon #3053 (General Electric Company).

A section of the chamber wall has a boron coating so that the instrument will respond to slow neutrons. About 10 sq cm of coating is used containing 2.5 mg sq cm of elementary boron 10. The boron coating is prepared by mixing the required amount of boron in the form of powder passed by a 325 mesh per inch screen, with a small amount of amphenol coil cement diluted by eight parts of glyptal thinner and applying the mixture with a small brush. If ordinary boron must be used about five times as large an area should be coated.

The entire case of the instrument must be made nontransparent by painting or using a nontransparent plastic because the VX-32 is extremely photosensitive and sunlight on the tube will cause the instrument to alarm in a few seconds. The shielding effect of the batteries makes it necessary to carry the instrument in the pocket in such a position that the chamber side of the instrument is away from the body. A belt clip is attached to the later models to make this automatic.

Other means of charging the ionization chamber have been tried. Figure 2 shows a circuit that was found satisfactory; here B₃ and B₄ have been replaced by a small pull switch and two 1000 μ f mica condensers. The switch and condensers must have good enough insulation to retain their charge during the short time required to pull out the switch. This action charges the condensers one at a time from battery B₂. The switch is returned to its original position by a spring. This method of charging is more

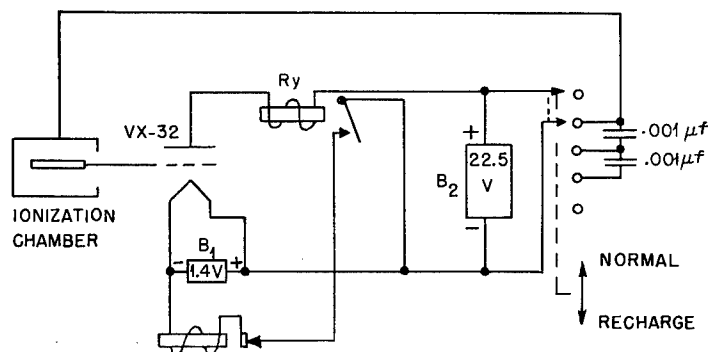

Figure 2. Circuit diagram which enables pocket radiation alarm to be charged.

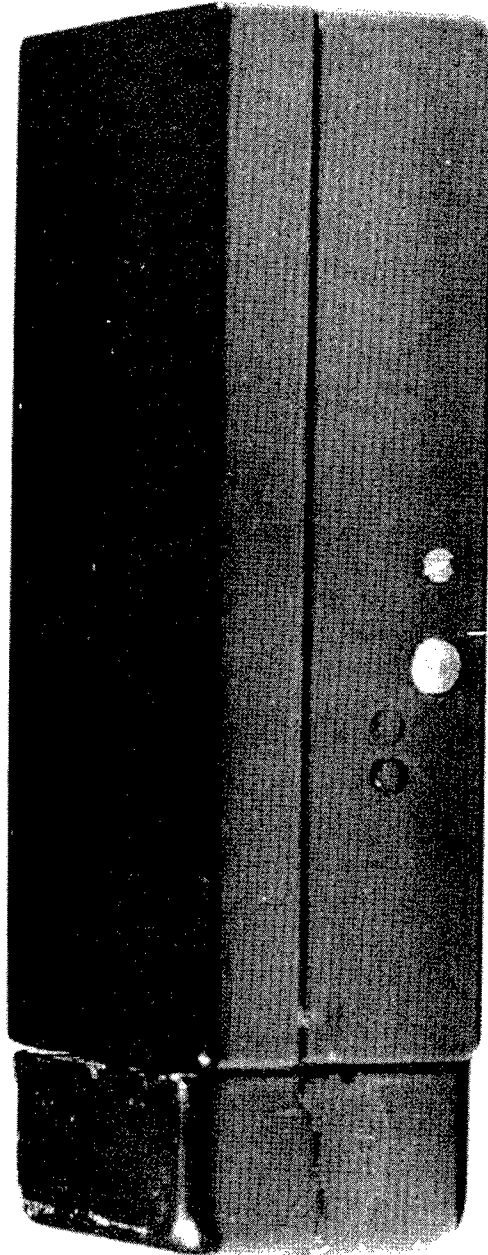

Figure 3. Case of pocket radiation alarm

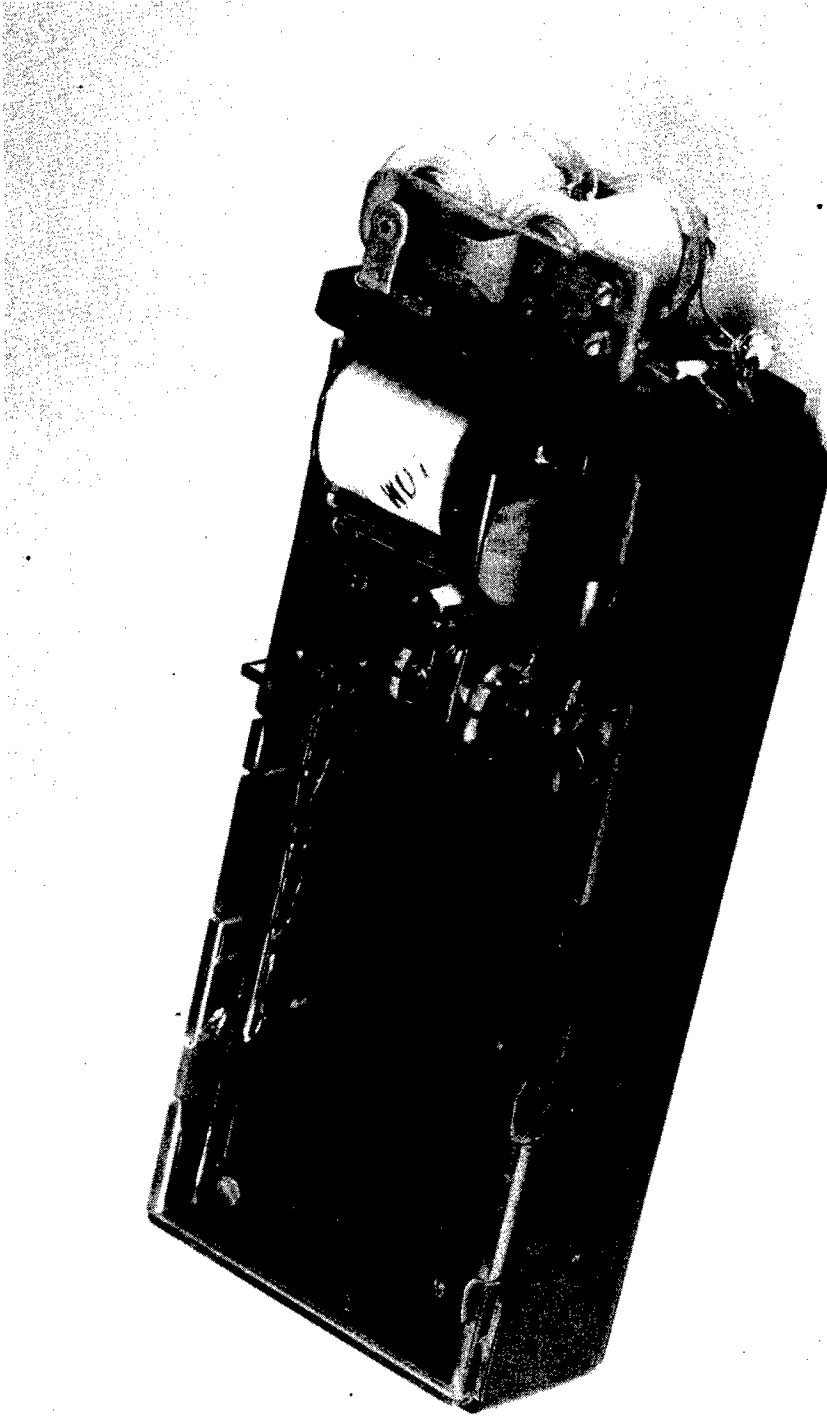

Figure 4. Constructional details of pocket radiation alarm.

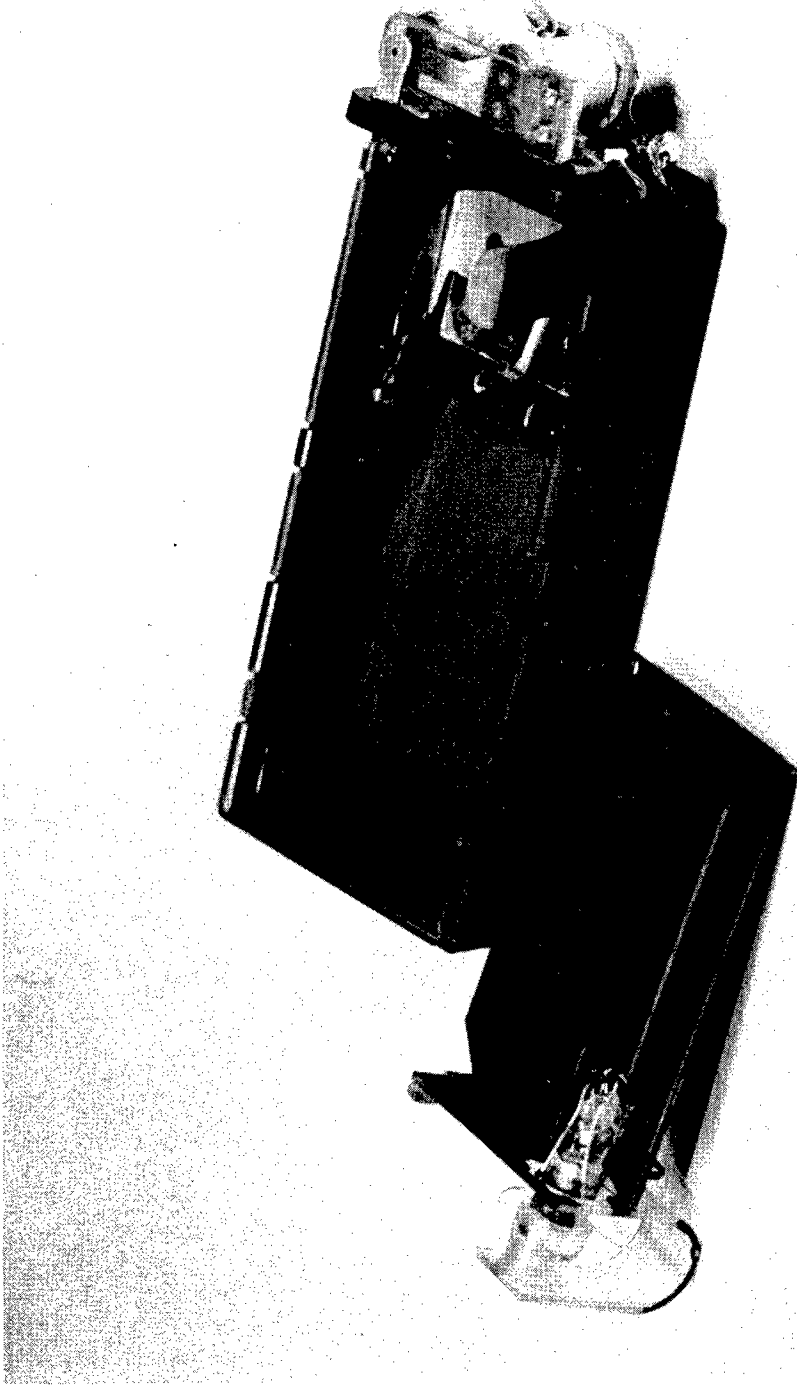

Figure 5. Constructional details of pocket radiation alarm.



Figure 6. Constructional details of pocket radiation alarm.

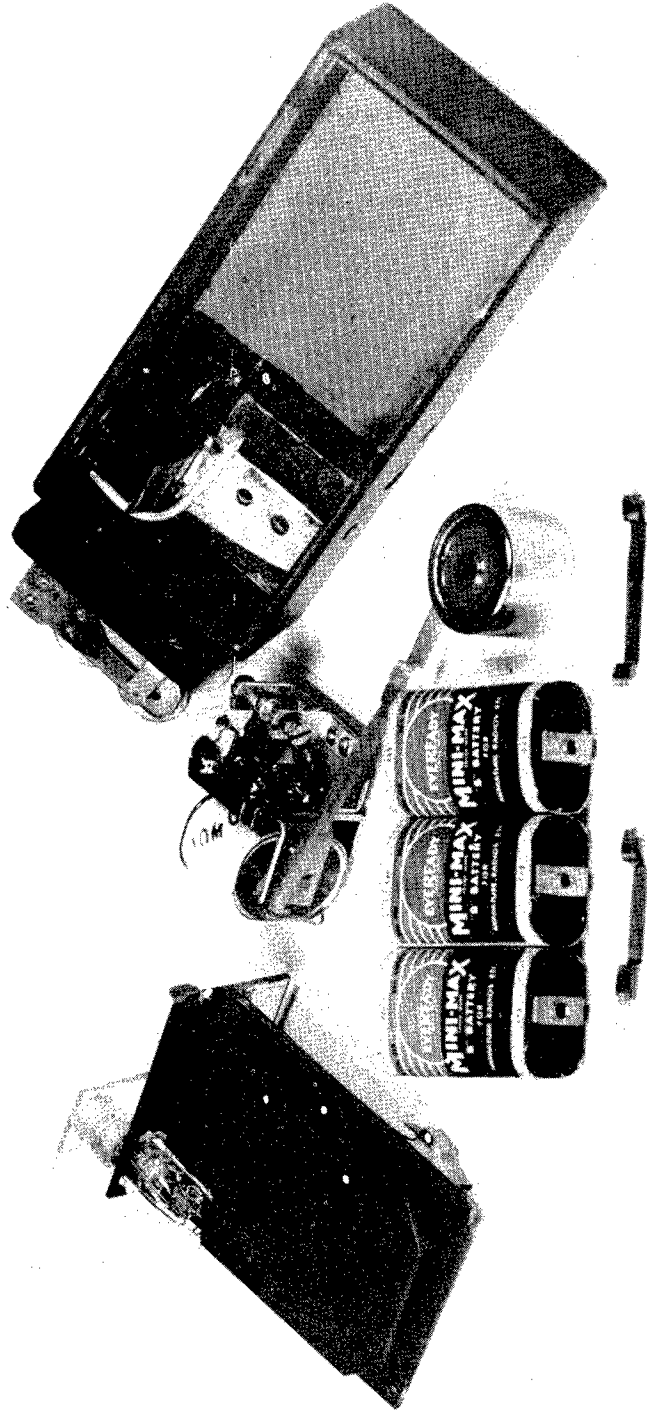

Figure 7. Constructional details of pocket radiation alarm.

satisfactory than the batteries since the switch and condensers are lighter and do not shield the chamber so much.

The weight of the completed instrument, using the circuit of Figure 1, is 386 grams and measures $1 \frac{3}{8}$ by $2 \frac{1}{4}$ by $5 \frac{3}{4}$ inches. The first unit was constructed to alarm on 50 mr of gamma-rays but the instrument can be made to operate satisfactorily at a sensitivity of 11 mr by reducing the area of the collector electrode. The instrument may be made much less sensitive by cementing a small (2 by 4 cm) lucite block onto the chamber wall (on the inner detachable unit). The sensitivity is adjusted by varying the thickness of the block until the capacity of the chamber has the desired value. This lucite block must be coated with graphite to make it conducting.