

---

---

# THE WORLD WAR II ORDNANCE DEPARTMENT'S GOVERNMENT-OWNED CONTRACTOR-OPERATED (GOCO) INDUSTRIAL FACILITIES: TWIN CITIES ORDNANCE PLANT HISTORIC INVESTIGATION

by  
Robert C. Vogel  
Deborah L. Crown  
of  
Bear Creek Archeology, Inc.

---

U.S. ARMY MATERIEL COMMAND HISTORIC CONTEXT SERIES  
REPORT OF INVESTIGATIONS  
NUMBER 8A



GEO-MARINE, INC.



US Army Corps  
of Engineers  
Fort Worth District

---

19961016 108

# DISCLAIMER NOTICE

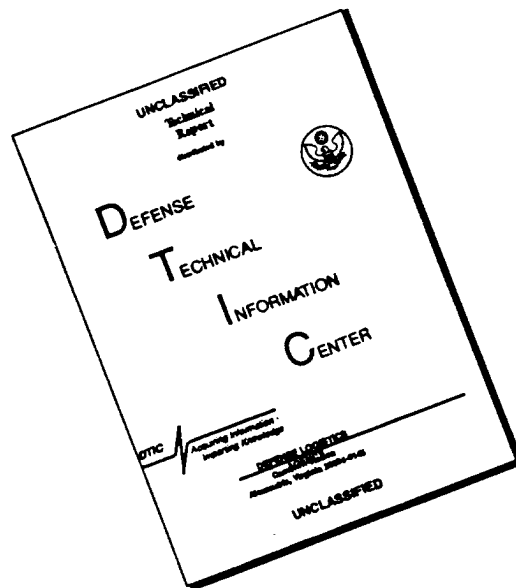

THIS DOCUMENT IS BEST QUALITY AVAILABLE. THE COPY FURNISHED TO DTIC CONTAINED A SIGNIFICANT NUMBER OF PAGES WHICH DO NOT REPRODUCE LEGIBLY.

REPORT DOCUMENTATION PAGE			Form Approved OMB No. 0704-0188		
1a. REPORT SECURITY CLASSIFICATION Unclassified		1b. RESTRICTIVE MARKINGS			
2a. SECURITY CLASSIFICATION AUTHORITY		3. DISTRIBUTION/AVAILABILITY OF REPORT Approved for public release			
2b. DECLASSIFICATION/DOWNGRADING SCHEDULE					
4. PERFORMING ORGANIZATION REPORT NUMBERS U.S. Army Materiel Command Historic Context Series Report of Investigations No. 8A		5. MONITORING ORGANIZATION REPORT NUMBER(S)			
6a. NAME OF PERFORMING ORGANIZATION Geo-Marine, Inc.	6b. OFFICE SYMBOL (if applicable)	7a. NAME OF MONITORING ORGANIZATION US Army Corps of Engineers, Ft. Worth District			
6c. ADDRESS (City, State, and Zip Code) 550 E. 15th Street / Plano, Texas / 75074		7b. ADDRESS (City, State, Zip Code) PO Box 17300 Fort Worth, Texas 76102-0300			
8a. NAME OF FUNDING/SPONSORING ORGANIZATION US Army Corps of Engineers, Fort Worth District	8b. OFFICE SYMBOL (if applicable)	9. PROCUREMENT INSTRUMENT ID NUMBER DACA63-93-D-0014, Delivery Order No. 014			
8c. ADDRESS (City, State, Zip Code) PO Box 17300 Fort Worth, Texas 76102-0300		10. SOURCE OF FUNDING NUMBERS			
		PROGRAM ELEMENT NO.	PROJECT NO.	TASK NO.	WORK UNIT ACCESSION NO.
11. TITLE (Include Security Classification) The World War II Ordnance Department's Government-Owned Contractor-Operated (GOCO) Industrial Facilities: Twin Cities Ordnance Plant Historic Investigation					
12. PERSONAL AUTHOR(S) Robert C. Vogel and Deborah L. Crown					
13a. TYPE OF REPORT Final Report	13b. TIME COVERED FROM Summer '94 to Fall '94	14. DATE OF REPORT (Year, Month, Day) December 1995	15. PAGE COUNT 66		
16. SUPPLEMENTARY NOTATION					
17. COSATI CODES		18. SUBJECT TERMS (Continue on reverse if necessary and identify by block number) Document World War II history of the Twin Cities Army Ammunition Plant			
FIELD	GROUP				SUB-GROUP
05	06				
19. ABSTRACT (Continue on reverse if necessary and identify by block number) This report presents the results of an examination of historical records related to the construction and operations of the Twin Cities Army Ammunition Plant (TCAAP), New Brighton, Minnesota. This project was undertaken as part of a larger Legacy Resource Program demonstration project to assist small installations and to aid in the completion of mitigation efforts set up in a 1993 Programmatic Agreement among the Army Materiel Command, the Advisory Council on Historic Preservation, and Multiple State Historic Preservation Officers concerning a program to cease maintenance, excess, and dispose of particular properties. As part of the larger project to develop the national historic context of seven sample installations on a state and local level, the major focus of the project at TCAAP was to document the impacts that the facility had on the state and local environments. The project was conducted by Bear Creek Archeology, Inc., under subcontract to Geo-Marine, Inc., during the summer and early fall of 1994. Duane Peter, Senior Archeologist at Geo-Marine served as Principal Investigator. Personnel at Bear Creek Archeology conducted the oral history interviews as well as the archival and historic investigations. As one of the Ordnance Department's Government-Owned Contractor-Operated industrial facilities, TCAAP was designed to provide munitions and materiel, namely small arms ammunition, for European and American forces during World War II. In addition to the technical aspects of small arms ammunition production, this report discusses the direct and indirect effects construction and operations had on New Brighton and Mound View Township, as well as the nearby urban areas of Minneapolis and St. Paul. The greatest impact was felt in the smaller communities--construction workers, clerks, police, engineers, soldiers, and defense workers flocked to these areas, placing at times heavy burdens on the local communities and their governments. Burdens that were accompanied, however, by economic prosperity. Yet, as was the case for communities near most other GOCO facilities spread across the nation, the prosperity largely evaporated with the end of the war.					
20. DISTRIBUTION/AVAILABILITY OF ABSTRACT <input type="checkbox"/> UNCLASSIFIED/UNLIMITED <input checked="" type="checkbox"/> SAME AS RPT. <input type="checkbox"/> DTIC USERS		21. ABSTRACT SECURITY CLASSIFICATION Unclassified			
22a. NAME OF RESPONSIBLE INDIVIDUAL Joseph Murphey		22b. TELEPHONE (Include Area Code) 817-885-6386	22c. OFFICE SYMBOL CESWF-PL-Murphey		

**THE WORLD WAR II ORDNANCE DEPARTMENT'S  
GOVERNMENT-OWNED CONTRACTOR-OPERATED  
(GOCO) INDUSTRIAL FACILITIES:**

**TWIN CITIES ORDNANCE PLANT  
HISTORIC INVESTIGATION**

*by*

Robert C. Vogel, Senior Historian  
Deborah L. Crown  
BEAR CREEK ARCHEOLOGY, INC.  
Cresco, Iowa  
*Subcontractor for Geo-Marine, Inc.*

Principal Investigator  
Duane E. Peter  
Geo-Marine, Inc.

*under*

U.S. ARMY CORPS OF ENGINEERS  
Fort Worth District  
Contract No. DACA63-93-D-0014

U.S. ARMY MATERIEL COMMAND HISTORIC CONTEXT SERIES  
REPORT OF INVESTIGATIONS  
NUMBER 8A

Geo-Marine, Inc.  
550 East 15th Street  
Plano, Texas 75074

December 1995

## **CONTRACT DATA**

This document was prepared under Contract No. DACA63-93-D-0014, Delivery Order No. 014 (GMI project # 1114-014), with the U.S. Army Corps of Engineers, Fort Worth District, P.O. Box 17300, Fort Worth, Texas 76102-0300.

## MANAGEMENT SUMMARY

This report presents the results of an examination of historical records related to the construction and operations of the Twin Cities Army Ammunition Plant (TCAAP), New Brighton, Minnesota. This project was undertaken as part of a larger Legacy Resource Program demonstration project to assist small installations and to aid in the completion of mitigation efforts set up in a 1993 Programmatic Agreement among the Army Materiel Command, the Advisory Council on Historic Preservation, and Multiple State Historic Preservation Officers concerning a program to cease maintenance, excess, and dispose of particular properties. As part of the larger project to develop the national historic context of seven sample installations on a state and local level, the major focus of the project at TCAAP was to document the impacts that the facility had on the state and local environments.

The project was conducted by Bear Creek Archeology, Inc., under subcontract to Geo-Marine, Inc., during the summer and early fall of 1994. Duane Peter, Senior Archeologist at Geo-Marine served as Principal Investigator. Personnel at Bear Creek Archeology conducted the oral history interviews as well as the archival and historic investigations.

As one of the Ordnance Department's Government-Owned Contractor-Operated industrial facilities, TCAAP was designed to provide munitions and materiel, namely small arms ammunition, for European and American forces during World War II. In addition to the technical aspects of small arms ammunition production, this report discusses the direct and indirect effects construction and operations had on New Brighton and Mound View Township, as well as the nearby urban areas of Minneapolis and St. Paul. The greatest impact was felt in the smaller communities--construction workers, clerks, police, engineers, soldiers, and defense workers flocked to these areas, placing at times heavy burdens on the local communities and their governments. Burdens that were accompanied, however, by economic prosperity. Yet, as was the case for communities near most other GOCO facilities spread across the nation, the prosperity largely evaporated with the end of the war.

## TABLE OF CONTENTS

MANAGEMENT SUMMARY .....	iii
ACKNOWLEDGMENTS .....	ix
1. INTRODUCTION .....	1
2. OBJECTIVES AND METHODS .....	3
3. HISTORIC CONTEXT FOR TWIN CITIES ORDNANCE PLANT, A WORLD WAR II ORDNANCE DEPARTMENT GOCO INDUSTRIAL FACILITY, 1941 - 1994 .....	5
Military/Political Background .....	8
Architecture/Engineering Design Background .....	11
Contractor Operations .....	26
Technology .....	30
Social History .....	39
Effects of the End of the War .....	57
Post-war Years .....	58
Conclusions and Recommendations .....	59
REFERENCES CITED .....	61

## LIST OF FIGURES

1.	Map showing the location of the Twin Cities Ordnance Plant/Twin Cities Army Ammunition Plant, Minnesota . . . . .	6
2.	Map of Twin Cities Army Ammunition Plant in 1974 . . . . .	7
3.	Excerpt from an 1874 map showing part of northern Ramsey County later occupied by the Twin Cities Ordnance Plant . . . . .	14
4.	Schematic Regional Geologic Cross Section of the location of the Twin Cities Army Ammunition Plant . . . . .	15
5.	1916 plat of Mound View Township . . . . .	16
6.	Ground breaking at the Twin Cities Ordnance Plant, August 1941 . . . . .	17
7.	Construction work begins at the Twin Cities Ordnance Plant . . . . .	18
8.	Beginning construction work at the Twin Cities Ordnance Plant . . . . .	19
9.	Construction work at the Twin Cities Ordnance Plant . . . . .	19
10.	Construction work at the Twin Cities Ordnance Plant . . . . .	20
11.	Unidentified construction site at the Twin Cities Ordnance Plant . . . . .	20
12.	Map showing location of the TCAAP in 1944 and a 1944 plant layout, virtually unchanged as of 1994 . . . . .	21
13.	Interior of part of Building 105, the administration building, at the Twin Cities Ordnance Plant . . . . .	22
14.	Interior of part of Building 105, the administration building, at the Twin Cities Ordnance Plant . . . . .	22
15.	Building 105 in 1994 . . . . .	23
16.	Plant 2 building in 1994 . . . . .	24
17.	Building 130, located in the primer manufacturing area of the Twin Cities Ordnance Plant . . . . .	25
18.	View of Twin Cities Ordnance Plant location during construction . . . . .	27
19.	View of Twin Cities Ordnance Plant location during construction . . . . .	27
20.	Charles L. Horn, President of Federal Cartridge Corporation . . . . .	29
21.	Photograph of the type of area in which Mr. Seth (oral history informant) worked . . . . .	30
22.	Draw machines at the Twin Cities Ordnance Plant . . . . .	31
23.	Small arms ammunition production at the Twin Cities Ordnance Plant . . . . .	32
24.	Small arms ammunition production at the Twin Cities Ordnance Plant. Packing .50 cal. ammunition . . . . .	33
25.	Small arms ammunition production at the Twin Cities Ordnance Plant. Inspecting .50 cal. ammunition . . . . .	33
26.	Employee at the Twin Cities Ordnance Plant . . . . .	34
27.	Small arms ammunition production at the Twin Cities Ordnance Plant . . . . .	35

List of Figures  
(cont'd)

28.	Small arms ammunition production at the Twin Cities Ordnance Plant . . . . .	35
29.	Gage and weigh machine . . . . .	36
30.	Detail of gage and weigh machine . . . . .	37
31.	Ammunition manufactured at the Twin Cities Ordnance Plant, packed and ready for shipment . . . . .	38
32.	View of the Twin Cities Ordnance Plant in its early days, possibly during the winter of 1941-1942 . . . . .	40
33.	A group (commonly referred to as a "unit") of production workers at the Twin Cities Ordnance Plant . . . . .	43
34.	Copy of an article from an unknown newspaper, possibly the <i>Twin Cities Ordnance News</i> . . . . .	44
35.	President Franklin Roosevelt visiting the Twin Cities Ordnance Plant in September 1942 . . . . .	45
36.	Typical employee locker room at the Twin Cities Ordnance Plant during 1941-1945 . . . . .	49
37.	World War II poster at the Twin Cities Ordnance Plant . . . . .	50
38.	World War II poster at the Twin Cities Ordnance Plant . . . . .	51
39.	World War II poster at the Twin Cities Ordnance Plant . . . . .	51
40.	World War II poster at the Twin Cities Ordnance Plant . . . . .	52
41.	World War II poster at the Twin Cities Ordnance Plant . . . . .	53
42.	The Twin Cities Ordnance Plant receiving an Army-Navy "E" Award . . . . .	55

## ACKNOWLEDGMENTS

Many individuals were instrumental in the successful completion of this document. We thank the employees of both the Federal Cartridge Corporation and the federal government whose work at the Twin Cities Army Ammunition Plant was often interrupted for our convenience. Ms. Barbara Gertsema, Public Information Officer for the Federal Cartridge Corporation, provided information and generously cooperated in scheduling the oral interviews. We also acknowledge the oral history informants: Mr. Everett Needles, Mr. Ted Seth, Mr. Harold Stassen, Mr. Carl Holmberg, Ms. Julia Kohler, and Mrs. Laura Peterson. These individuals provided invaluable information concerning everyday life at the small arms ammunition manufacturing plant during World War II. This document would be incomplete without their generous contributions.

We would like to thank Joseph Murphey of the U.S. Army Corps of Engineers, Fort Worth District, who was most supportive of our efforts. He provided constructive criticism and management direction throughout this project. In the Bear Creek Archeology, Inc., Cresco, Iowa, office, Ms. Deborah Crown undertook the editing of the draft report and Mr. Colin Betts drafted the figures which accompany the report. In the Geo-Marine, Inc., office in Plano, the final editing and overall production of the report were the responsibilities of Ms. Sharlene Allday and Ms. Denise Pemberton generated the computerized format for the layout and design of the book.

# CHAPTER 1

## INTRODUCTION

This report presents the results of research into the historical record of Twin Cities Army Ammunition Plant, New Brighton, Minnesota, 1941-1994. The purpose of this report was to partially fulfill the goals of a larger project that entails not only this specific historic investigation, but also a national context for the World War II Ordnance Department's government-owned contractor-operated (GOCO) industrial facilities, 1939-1945 (Kane 1995); detailed investigations into the history of seven former World War II-era Ordnance Department GOCO industrial facilities (present-day Badger, Indiana, Joliet, Kansas, Radford, Ravenna, and Twin Cities army ammunition plants); and photographic documentation of the same sample installations. Goals of the larger project included investigation and documentation of World War II and pre-World War II buildings and structures now under the jurisdiction of Army Materiel Command (AMC) as part of a Legacy Resource demonstration program of assistance to small installations, as well as the completion of mitigation efforts stipulated in a 1993 Programmatic Agreement among the AMC, the Advisory Council on Historic Preservation, and multiple State Historic Preservation Officers concerning a program to cease maintenance, excess, and dispose of particular properties. The detailed historic investigation of Twin Cities Army Ammunition Plant, like the detailed historic investigations for the other sample installations, was undertaken in order to develop the national historic context on a state and local level. Its major focus was upon the impacts of the facility on state and local history.

In September 1993, Geo-Marine, Inc. (GMI), was contracted by the Army Corps of Engineers, Fort Worth District, to complete the national historic context, detailed historic investigations, and photographic documentation. The research for the Twin Cities Army Ammunition Plant detailed historic investigation was conducted by Bear Creek Archeology, Inc., under contract to Geo-Marine, Inc., during the summer and fall of 1994. Duane Peter, Director of the Cultural Resources Division at GMI, served as Principal Investigator. Robert C. Vogel, Senior Historian at Bear Creek Archeology, Inc., conducted the archival and historic investigations and wrote the report. Deborah L. Crown, also of Bear Creek Archeology, Inc., undertook the oral history interviews connected with the project. The work was performed under Delivery Order No. 014 of Contract No. DACA63-93-D-0014.

Chapter 2 of this report describes the objectives of and the methods used in the detailed historic investigations. Chapter 3, the historic context portion of the report, is divided into eight basic sections. The first discusses the military/political background of the Twin Cities facility. The second provides details on the architectural/engineering design background of the Twin Cities plant, and in the third section, contractor operations are described. The fourth section delineates technology at the facility. Social history is the focus of discussion in the fifth section. The following sections detail the effects of the end of the war and the post-

war years. The eighth and final section of Chapter 3 consists of conclusions and recommendations. A list of references cited follows the main body of the report.

## CHAPTER 2

### OBJECTIVES AND METHODS

Historic contexts are the cornerstone of the historic preservation planning process in the United States. The Secretary of the Interior's Standards for Preservation Planning state:

Decisions about the identification, evaluation, registration, and treatment of historic properties are most reliably made when the relationship of individual properties to other similar properties is understood. Information about historic properties representing aspects of history, architecture, archeology, engineering, and culture must be collected and organized to define these relationships. This organizational framework is called a "historic context." The historic context organizes information based on a cultural theme and its geographical and chronological limits. Contexts describe the significant broad patterns of development in an area that may be represented by historic properties [NPS 1983:44717].

Historic context development results in a document that is designed to serve both the technical and informational needs of preservation planners. A single historic context describes one or more significant historical themes or patterns of historical development represented by individual historic properties. Historic contexts are developed at a variety of scales, delineating important themes relating to the heritage of a neighborhood, town, county, region, state, or the nation as a whole (NPS n.d.:9-10). Thematic, geographical, and chronological boundaries between historic contexts often overlap. While the goal of historic context development is the creation of a complete, fully documented, comprehensive study of a particular set of cultural resources, it is assumed that historic contexts will need to be refined and modified as more data become available.

Historic context research and writing involves five basic steps: (1) identify conceptual, geographical, and temporal boundaries; (2) define research questions; (3) assemble and analyze existing data about the historic context; (4) synthesize the data in the form of a written narrative; and (5) identify information needs. These activities should be carefully planned in order to produce a useful final product and must take into account the sponsoring agency's planning needs, its legal obligations under the National Historic Preservation Act, Executive Order 11593 and other preservation regulations, time and funding limits, and the nature of the cultural resources under investigation.

Development of the historic context for the Twin Cities Ordnance Plant (TCOP) involved archival research in both primary and secondary source materials. Primary sources of information concerning the TCOP included published and unpublished documents and graphic material generated by various agencies of the U.S. government and its contractors, state and local governments, and individuals connected with the TCOP.

Of particular interest were the textual and graphic records of the property's physical development and operation. Much of this material has been deposited in the National Archives or the Minnesota Historical Society; some is archived at the Twin Cities Army Ammunition Plant (TCAAP) in Arden Hills and at the U.S. Army Corps of Engineers, Rock Island and Fort Worth District offices.

Secondary sources consisted of books, monographs, and pamphlets; articles in scholarly and professional journals and magazines; articles in newspapers and popular periodicals; maps, atlases, and plans; and unpublished research papers and reports. A limited number of general works on U.S. military history, wartime arms production, and industrial architecture were also consulted. Bibliographic control for research in secondary source materials was provided by a number of standard reference works, the most useful of which were those compiled by Higham (1975) and Higham and Mrozek (1993).

Research utilized the facilities of the Minnesota Historical Society research center in St. Paul and the University of Minnesota libraries in Minneapolis. A substantial amount of archival material from the National Archives was photocopied and delivered to the present writers by Geo-Marine, Inc. Some archival research was also carried out at the TCAAP in Arden Hills, and at the Minneapolis, St. Paul, and Ramsey County public libraries.

Oral histories were conducted by Bear Creek Archeology, Inc. (BCA), personnel in September of 1994 in the Minneapolis/St. Paul area. With the generous cooperation and assistance of Ms. Barbara Gertsema, Public Information Officer for the Federal Cartridge Corporation, five interviews were scheduled with former employees of the Twin Cities Ordnance Plant. Interviews with three men and two women, all of whom were employed at the TCOP during World War II, were recorded for approximately 90 minutes each, using a high quality tape recorder, and copies of the taped interviews were immediately made. A sixth, 45-minute interview was conducted with Mr. Harold Stassen, Governor of Minnesota from 1938 to 1943. The questions asked during the interviews were reviewed by Geo-Marine, Inc., personnel prior to conducting the interviews. Informants were asked about working at the plant and about general conditions of the local area during the war. The tapes were indexed, but not transcribed. Data obtained from the oral histories are incorporated into the "Social History" section of this document.

Historical documents and oral histories should both be viewed as important tools for understanding the past, and the present study is not an argument for the superiority of one over the other. Middle range theory suggests that the disparity between certain data sets, in this case documentary and oral tradition evidence, be considered as "ambiguity" (Leone and Potter 1988). This ambiguity can only be clarified through a critical use of all available resources. This middle range theory has been criticized as reductionism (Beaudry 1990:116; Hodder 1986:4), however, interpretation, like any form of human perception, is reductionist. This reduction is lessened by acknowledging the diversity of biases inherent in both documentary records and oral history tradition as well as the multiplicity of possible and potential interpretations. The present study intends to use both in a complimentary fashion, in order to create a richer interpretation of the socio-cultural history of the people who were involved with the Twin Cities Ordnance Plant.

### **CHAPTER 3**

## **HISTORIC CONTEXT FOR TWIN CITIES ORDNANCE PLANT, A WORLD WAR II ORDNANCE DEPARTMENT GOCO INDUSTRIAL FACILITY, 1941 - 1994**

The Twin Cities Ordnance Plant (TCOP), also known as the Twin Cities Arsenal and the Twin Cities Army Ammunition Plant (TCAAP), is a complex of industrial buildings, structures, sites, and landscapes located in Ramsey County, Minnesota, near the northern edge of the Twin Cities metropolitan area (Figures 1 and 2). The property's historic boundaries encompass approximately 2,400 acres. In 1994 the federal reservation totals about 2,300 acres. Although commonly referred to as the New Brighton plant, TCOP actually lies within the boundaries of the City of Arden Hills (pop. 9,200), with New Brighton (pop. 22,000) being the nearest post office. The installation is owned by the federal government and is presently part of the U.S. Army Armament, Munitions, and Chemical Command (AMCCOM).

Contextually, the TCOP is a product of the Government-Owned Contractor-Operated (GOCO) war materials production program established by the War Department during World War II. TCOP was one of six GOCO plants built to produce small arms ammunition during World War II, and was operated by Federal Cartridge Corporation (FCC) under contract to the War Department. Construction of the plant began in August 1941 and production of small arms ammunition began in February 1942. The plant remained in production for 42 months, producing .30, .50, and .45 cal. ammunition. In 1944 the facility was expanded to manufacture components for artillery shells and opened an important small arms ammunition reclamation center. The work force reached its peak in July 1943, when employment totaled about 26,000 people, more than half of whom were women.

After V-J Day, the TCOP was placed in reserve status and "mothballed." Renamed the Twin Cities Arsenal, it was operated by the U.S. Army from 1946 to 1950, when the installation was brought back into production to manufacture small arms and artillery ammunition for the Korean Conflict. The Arsenal remained in service until 1957, when it was again closed down. In 1965, during the Vietnam War, the plant was re-tooled for the manufacture of new types of small arms ammunition. It has been on standby status since 1976. Federal Cartridge Company, formerly known as Federal Cartridge Corporation, has been the prime operating contractor since 1941. During its 22 years of production, Federal Cartridge produced 16,513,000,000 rounds of small arms ammunition accepted by the U.S. government.

The TCOP is historically significant because of its historical, physical, and social association with U.S. industrial mobilization during World War II and the development of the military industrial complex during the post-war and Cold War periods. World War II industrial mobilization and its long-term effects on

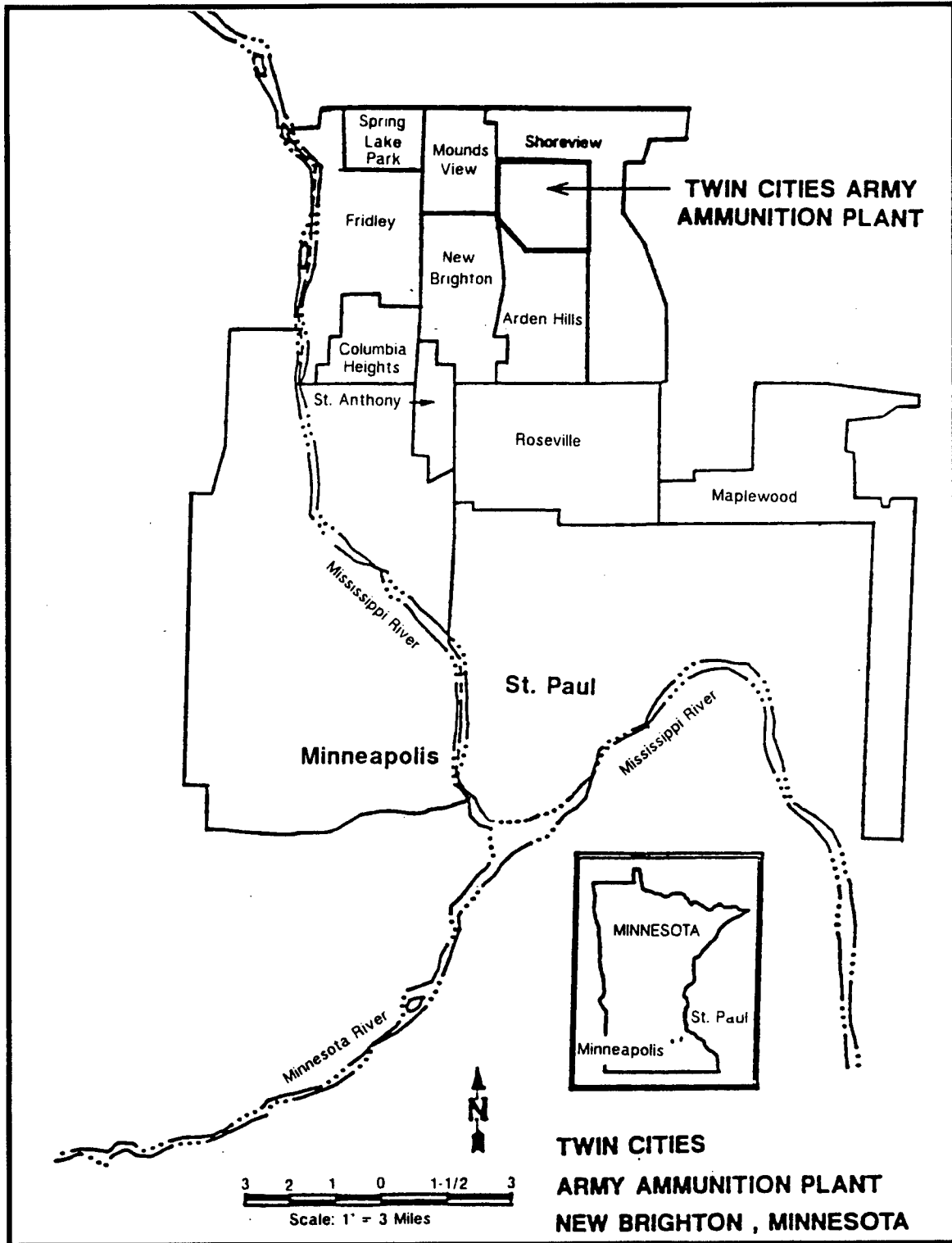

Figure 1. Map showing the location of the Twin Cities Ordnance Plant/Twin Cities Army Ammunition Plant, Minnesota (TCAAP Public Information Office).

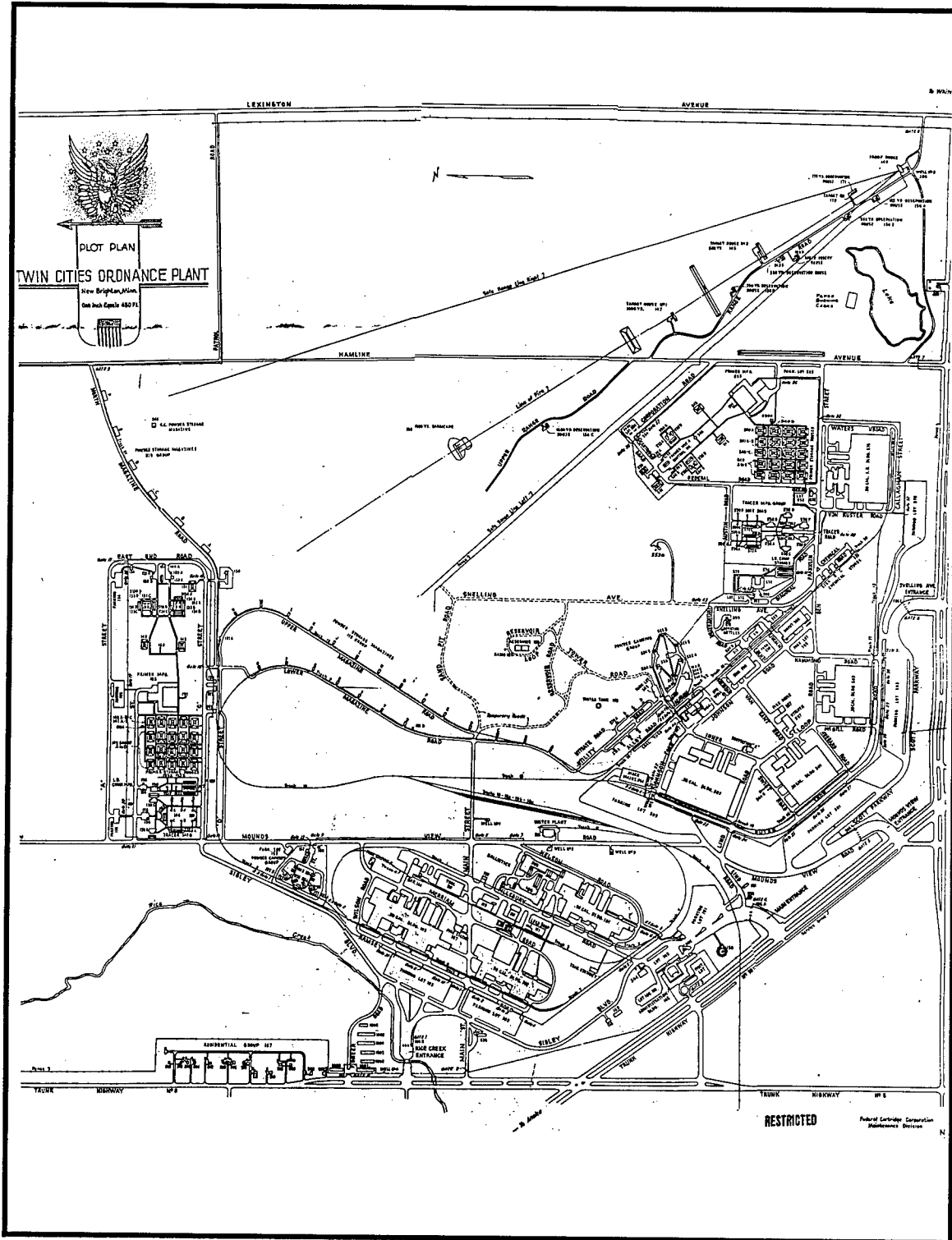

Figure 2. Map of Twin Cities Army Ammunition Plant in 1974. This is the most recent map available (Facilities Engineering Office, TCAAP).

American culture and society represent a significant broad pattern of events, and the TCOP reflects the importance of the war on the home front as evidenced by the oral histories conducted during the course of this investigation. Architecturally, the property is significant as a product of mid-twentieth century industrial design, and the plant buildings and grounds retain much of their 1940s character. Most of the 262 buildings at the TCAAP were constructed between 1941 and 1942. While most lack architectural distinction, they collectively represent a specific historical environment. Although most of the ammunition production machinery has been removed, some of the remaining hardware is also of World War II vintage and may be important to engineering history research because of the TCOP's role in the development and implementation of new arms production technologies.

### **MILITARY/POLITICAL BACKGROUND**

The first global war of 1914-1918 mobilized whole societies in the pursuit of victory and the military application of industrial technology produced revolutionary effects, both on the battlefield and the home front. The U.S. entry into the war in 1917 forced the military to launch a crash program for arming the nation. Eventually, an army of nearly 5 million was raised, 1 million of whom were sent "over there." In its effort to arm, clothe, feed and transport the military, the federal government created a giant new bureaucracy to run a managed national economy. Under the energetic leadership of Bernard Baruch, the War Industries Board (WIB) allocated strategic resources, set factory production schedules, and established a comprehensive government purchasing policy. Millions went to work in factories where government contracts guaranteed high wages, an eight-hour work day and equal pay for comparable work. The demands of war production brought unprecedented numbers of women, African-Americans, Hispanics, and other non-traditional industrial workers into the job market. To forestall worker discontent, the Wilson Administration created the National War Labor Board (NWLB), appointing Samuel Gompers of the American Federation of Labor (AFL) to one of the seats on the Board. The NWLB guaranteed the rights of unions to organize and bargain collectively on behalf of war industry workers. By any standard, the logistical achievements of the U.S. in World War I were impressive, with more than 8 million tons of military supplies delivered to Europe in less than 19 months (Baruch 1941).

With the signing of the armistice on November 11, 1918, most Americans genuinely believed that the Great War had been the "war to end all wars," and the national military establishment was promptly dismantled, along with much of the centralized economic and industrial planning bureaucracy. U.S. industries quickly invested their wartime profits into the production of consumer goods, and the small military establishment was content to make do with surplus equipment and stores. With the national debt running at \$20 billion in 1920, roughly ten times its prewar level, Congress was little inclined to invest more in defense planning or preparation (Fussel 1975).

The National Defense Act of June 4, 1920 literally turned back the clock for the U.S. military by reverting control of logistical functions to the individual service supply departments. Procurement was taken out of the hands of the services and placed under civilian control, and the Office of the Assistant Secretary of War (OASW) was made responsible for planning (Risch 1989:562-585). Fourteen Ordnance Districts were created and charged with undertaking industrial surveys and mobilization plans (Cambell 1946:23); Minnesota was included in the Chicago District (Murphey 1993:2). From 1920 until 1942, there was no centralized command over the supply bureaus and virtually no coordination of the national defense logistics system below the level of the Secretary of War (Green et al. 1955).

"In the early 1920s, America's industrial mobilization plan and records consisted of a few notecards in an old shoebox" (Murphey 1993:2). The Army-Navy Munitions Board, the brainchild of Assistant Secretary of War Dwight F. Davis, was created in June 1922 in an attempt to facilitate inter-service planning, but was underfunded and lacked the necessary political support to be effective. The Munitions Board sponsored a series of Industrial Mobilization Plans (IMPs) and championed the concept of a centralized command

authority for economic and industrial mobilization but otherwise accomplished very little that would serve the nation's interests in the next war. It was not until the 1930s that the War Department began to undertake realistic planning for another global war. Even then, however, the General Staff was preoccupied with manpower issues and neglected problems of industrial mobilization and supply (Smith 1959:39-45).

During the two decades between the world wars, the U.S. was a minor producer and supplier of military hardware. Armaments production between 1920 and 1940 was concentrated in six "old line" arsenals with production facilities dating back to the early nineteenth century. Before Lend-Lease, arms exports were negligible, and U.S. army units relied upon World War I stockpiles of weapons and ammunition. Several factors contributed to this situation. First and foremost, the traditional American ambivalence toward involvement in foreign affairs fostered isolationist policies that caused the U.S. to adopt a posture of military neglect. At the same time, successive Congresses showed little inclination toward funding anything more than the most rudimentary national defense establishment, particularly land-based forces. This reflected a basic conviction, held by the majority of Americans during the inter-war period, that a large peacetime military establishment was antithetical to traditional American notions of what constituted the national defense. Another reason for military neglect was the cost of the armaments themselves. Consequently, the low priority the national leadership assigned to military affairs served to dampen the army's own institutional desire to modernize and prepare (Watson 1950:15-56).

A renewal of the arms race among the great powers occurred in the 1930s, with the U.S. the most reluctant participant. From 1931 onward the Japanese aggressively expanded their empire at the expense of the Chinese, while in Europe the rise of Italian and German fascism made a general war inevitable by the time Hitler's forces occupied the Rhineland in 1936. Encouraged by the British and French governments' policy of appeasement, the Nazi dictator marched his troops into Austria in 1938 and Czechoslovakia in 1939. On September 1, 1939, the Germans invaded Poland, and on September 3 Great Britain and France declared war on Germany. Within a year, German forces had overrun Denmark, Norway, and the Low Countries and had forced the capitulation of France. Only the British Isles remained unconquered. In June 1941 Hitler turned against the Soviet Union, bringing the British some reprieve from a situation that had appeared hopeless. After the fall of France, Japan secured control of French Indo-China, and when the U.S. and Great Britain responded with economic sanctions, including an oil embargo, Japanese leaders set in motion plans that would culminate in the December 1941 strikes against Hawaii, the Philippines, Malaysia, and the Dutch East Indies.

Frustrated by neutrality legislation and opposed by isolationist political forces, President Franklin D. Roosevelt formed the War Resources Board (WRB) in August 1939, but its recommendations were largely ignored, and it disbanded after a few months. The German invasion of Poland provided Roosevelt with his first opportunity to ask Congress to authorize additional funds for national defense. Roosevelt also sent his Secretary of War, Henry L. Stimson, to ask Congress to amend the National Defense Act to give the Secretary complete authority over military procurement. This was accomplished, and on May 25, 1940, the Roosevelt Administration created the Office for Emergency Management. Four days later Congress established the Advisory Commission of National Defense, in effect the first war mobilization superagency, whose functions were shortly thereafter absorbed by the Office of Production Management (OPM), which was itself replaced by the Supply Priorities and Allocations Board (SPAB) in August 1941. The Military Supply Act passed by Congress on June 13, 1940, contained a \$1.8 billion appropriation for defense projects and put the U.S. on the path to becoming the world's foremost producer of armaments (Green et al. 1955; Thomson and Mayo 1960).

On December 29, 1940, in a famous year-end "fireside chat," Roosevelt proclaimed that the U.S. must be the "arsenal of democracy" for Great Britain. Five months later, the President declared an unlimited state of national emergency, shortly after signing into law the Lend-Lease Act. Based upon a 1940 agreement between the Roosevelt Administration and the government of Prime Minister Winston Churchill, the U.S. "loaned" Great Britain 50 obsolete destroyers in exchange for base rights in the British Commonwealth and

committed the industrial power of the U.S. to the defeat of Nazi Germany and Fascist Italy. Although the U.S. was still technically neutral, Lend-Lease "jump started" the U.S. war machine (Murphey 1993:5) and initiated direct American involvement in World War II (Catton 1969; Drummond 1955; Green et al. 1955:65-82).

By late 1941 it was obvious that the existing War Department logistical organization was not up to the demands being placed upon it, but when the Japanese raided Pearl Harbor on December 7, 1941, the Army-Navy Munitions Board was still the only functioning industrial mobilization organization in place. The structure of the logistics system soon changed, however. The War Production Board (WPB) was created in January 1942 and quickly emerged as the chief coordinating agency for national defense. The WPB controlled war plant construction and supervised contracting, and its Controlled Materials Plan (CMP) became the centerpiece of the federal government's control of the wartime economy. The old Army-Navy Munitions Board, meanwhile, was reorganized in February 1942 and became a sort of liaison office between the War Department staff and civilian mobilization agencies (Watson 1950:126-182).

Far more important than the administrative shuffle involving the Munitions Board and the WPB was the so-called Marshall reorganization of the U.S. Army. By presidential executive order issued on 9 March 1942, the army was divided into three major commands: the Army Air Forces (AAF), the Army Ground Forces (AGF), and the Services of Supply. The latter, in part because of its unfortunate acronym (SOS), was soon rechristened the Army Service Forces (ASF). The War Plans Division (renamed Operations Division or OPD) became the central War Department planning entity, with the Logistics Group in the OPD responsible for implementing procurement and distribution policies. Under the command of Lt. Gen. Brehon B. Somervell, ASF was assigned responsibility for administering the supply and service operations of six technical services, eight administrative services, nine corps areas (i.e., service commands), six ports of embarkation, and nine general depots. Creation of the ASF represented a major step toward centralized planning and is widely regarded as a major victory in the fight against the Axis (Smith 1959:48-72).

The decision was made to construct a national system of armament manufacturing plants in 1940, and the first GOCO plant contract was awarded in July 1940 to Du Pont to construct the Indiana Ordnance Works smokeless powder factory. Twelve of the new arms plants were planned as producers of small arms ammunition (Thomson and Mayo 1960:203). At that time, there were just six "old line" military arsenals devoted to arms production (Cambell 1946:38), and only one of these, the Frankford Arsenal in Philadelphia, was set up to manufacture small arms ammunition (Herb 1943). In 1937-1938 new machinery was installed at Frankford, which had produced much of the army's small arms ammunition since before the Civil War, and the arsenal began to develop standardized production-line processes that could be recreated in other facilities (Green et al. 1955:175-178). In 1941 the Office of Production Management (OPM) established a Plant Site Board to select locations for the new facilities (Fairchild and Grossman 1959:102-103). Site selection criteria were straightforward: plants needed to have ready access to sources of raw material, a mid-continental location, proximity to railroads, available natural gas and electric power, ample water resources, and a reliable pool of skilled and unskilled labor. Furthermore, ordnance plants producing explosives required large tracts of land in thinly populated areas, yet had to have easy access to materials, transportation, and labor. By December 1940, 22 government-owned contractor operated (GOCO) plants were under construction by the War Department (Thomson and Mayo 1960), and by the end of 1941 17 of these installations were in operation (Murphey 1993:3-4).

The GOCO Industrial Facilities Program was administered by the Ordnance Department of the U.S. Army Quartermaster Corps, one of the U.S. Army's seven technical services. The Ordnance Department was a venerable institution that traced its lineage to the Continental Army of the American Revolution (Green et al. 1955:14-64). In the twentieth century, the Ordnance Corps was concerned with supplying the army with arms, ammunition, vehicles, and fire control instruments. Another major function of the Ordnance Department during World War II was the repair and maintenance of the army's munitions. On the eve of World War II, the Office of the Chief of Ordnance was organized into four groups: the General Office, the

Technical Staff, the Industrial Service (formerly the Manufacturing Service), and the Field Service. The Industrial Service staff had broad responsibility for production and procurement as well as for research and development of new weapons technologies, and it was assigned the mission of building and operating the new system of arms manufacturing plants.

The first two waves of GOCO defense plant construction were launched by the Ordnance Department in 1940-1941. The so-called "first wave" plants included three small arms ammunition facilities: Denver Ordnance Works, Lake City Ordnance Plant, and St. Louis Ordnance Plant. All were in production by December 7, 1941, and together they had a production capacity more than six times that of the old Frankford Arsenal. Small arms ammunition stocks were still dangerously low, however, and a "second wave" of GOCO ammunition plants was authorized by the War Department in the spring of 1941. In addition to the Des Moines Ordnance Plant and the Utah Ordnance Plant, the War Department drew up plans for a Minnesota facility, to be called the Twin Cities Ordnance Plant (TCOP; Thomson and Mayo 1960:194-197).

### **ARCHITECTURE/ENGINEERING DESIGN BACKGROUND**

The Twin Cities (Minneapolis-St. Paul) area emerged as a potential GOCO candidate primarily on the basis of labor supply (Fairchild and Grossman 1959:107). The approximately 2,400-acre northern Ramsey County plant site location seems to have been selected on the basis of its rural setting and proximity to established transportation facilities. It was also less than ten miles away from the civilian ammunition manufacturing plant in Anoka operated by the Federal Cartridge Corporation (FCC) of Minneapolis, which had been selected as the new ordnance plant's prime contractor and operator.

On July 14, 1941, FCC signed a cost-plus-fixed-fee (CPFF) contract with the War Department to manufacture small arms ammunition at the proposed Twin Cities Ordnance Plant. Initially, design and construction work on the Twin Cities project was overseen by a Construction Quartermaster (CQM) from the U.S. Army Quartermaster Corps. However, shortly before Pearl Harbor, supervision of construction of the GOCO plants was assigned to the U.S. Army Corps of Engineers. Early work at the TCOP was done under the supervision of CQM Joe S. Underwood, who assumed his duties on July 17, 1941, and was relieved on November 11, 1941, by Lynn C. Barnes. Barnes, then a captain in the Quartermaster Corps, came to the Army with a background in private contracting in the 1930s and had been employed in the Army Reserves building Civilian Conservation Corps (CCC) camps in Oklahoma. In 1940, he was assigned to work on the Lake City Ordnance Plant, the GOCO facility at Independence, Missouri, where he earned "a reputation as a competent construction foreman whose crews did excellent work ahead of projected deadlines" (Merritt 1976:398). Barnes was transferred to the TCOP as CQM but was soon placed under the command of J. W. Moreland of the Corps of Engineers St. Paul District. (The Corps of Engineers took over the construction duties from the Quartermaster Corps on December 15, 1941.) As Area Engineer, Barnes supervised construction of the plant until he was relieved on November 28, 1942. On January 5, 1943, he replaced Col. Moreland as District Engineer (COE 1943; Ordnance Department 1942a).

The contract to design the installation was awarded to the firm of Smith, Hinchman & Grylls of Detroit, Michigan, which also designed all of the other GOCO plants except St. Louis (BTI 1984:39). This firm had been founded in 1853 and had an established track record of designing large industrial plants (Murphey 1993:5; see Holleman and Gallagher 1978). The St. Paul architecture and engineering firm of Toltz, King & Day was responsible for plant layout and design. Foley Brothers, Inc., of St. Paul, and Walbridge, Aldinger Company of Detroit were the plant's original builders. Commonwealth Electric of St. Paul was the electrical subcontractor, and Reuben L. Anderson, Inc., of St. Paul, was the plumbing and mechanical subcontractor. A work force of more than 5,000 construction workers, the majority of them from St. Paul, Minneapolis and surrounding communities, was hired to build the plant (Ordnance Department 1942a, 1942b).

The design and construction of the TCOP closely followed specific requirements set by the Ordnance Department. These requirements were designed to make the TCOP "one of the world's largest suppliers of .30 cal. and .50 cal. shells. The goal was to put between 18,000 and 40,000 men and women to work there producing over three million shells a day" (Merritt 1976:399). The imminent threat of open war between the U.S. and the Axis powers in late 1941 contributed to a considerable demand for new small arms ammunition to replace the dwindling and increasingly unstable World War I stocks. Because of the anticipation of a shooting war, the War Department took steps to speed up construction work at the TCOP and other plants.

As originally designed, the TCOP consisted of more than 100 buildings and structures totaling 1.25 million square feet of floor space (Voight 1945:298). Murphey (1993:5) has described the TCOP as being virtually identical to six other small arms ammunition plants constructed by the War Department in the Midwest, but according to Voight:

It was originally decided that Twin Cities Ordnance Plant was to be as nearly an exact duplicate of Lake City Ordnance Plant [located near Independence, Missouri] as possible and that the Lake City plans and specifications were to be used. However, except for a few minor details an entirely new set of plans and specifications had to be developed [Voight 1945:299].

A public statement from Smith, Hinchman & Grylls was more to the point:

Design variations were never introduced by the architects for the sake of variety: considerations of speed and economy made imperative exactly the reverse. Whenever it was possible to repeat a detail of one plant in another, or even entire buildings, it was done [Smith, Hinchman & Grylls 1942:63].

Three large plant buildings were designed to house the main manufacturing production lines, the largest measuring more than 920 by 330 feet. Production plant buildings were literally designed from the inside out:

A carefully prepared template for each machine is cut out of cardboard and these are then assembled into plans of departments. The machine templates are in color, so that each type may be identified instantly, and colored strips are used to indicate the movement of the materials from one bank of machines to another. Ultimately these department layouts are assembled to form the entire production unit housed in the manufacturing building. Until this point the building exists only as a grid of regularly spaced columns with no limiting walls around them . . . . As the machine layout becomes more definitely established the template plans begin to take the outlines of actual buildings, and where the process requires several stories the plans are set up accordingly. Only at this point does the work . . . move to the main drafting room, where working drawings are begun and orders are placed for hard-to-get items [Smith, Hinchman & Grylls 1942:65].

Before plant construction could begin, a suitable reservation had to be acquired. War Department planners decided upon a tract in northern Ramsey County, located roughly equidistant from the Twin Cities of St. Paul and Minneapolis:

The site selected for the Plant lies about one and one-half miles Northeast of the Village of New Brighton, Minnesota. It is bounded by United States Highways Nos. 8 and 10 and State Highway No. 96 on the South and West, by County Road "I" on the North, and Lexington Avenue on the East [COE 1943:1].

The government quickly proceeded to obtain about 2,425 acres of land, nearly all of it held by private owners; the tract included approximately 125 buildings and structures, a sand and gravel quarry, a tree nursery and a small wildlife preserve (Ordnance Department 1942a: see also Merritt 1976:402; Voight

1945:298). The Ordnance Department officially took possession of the TCOP site on August 4, 1941 (Ordnance Department 1942a).

The area selected for the TCOP formed part of the original Mound View Township (Figure 3), which had been settled in the 1840s. The railway village of New Brighton, named after the town in Massachusetts, was founded in the late nineteenth century and had become an important stockyards and meat-packing center before the turn of the century (Upham 1969:437). In 1940 New Brighton had a population of about 500 and called itself "the squash center of Minnesota" (Federal Writers' Project 1985:459). Brooklyn Acres, an addition to the original village plat, was included in the arms plant acquisition, but most of the town was outside the TCOP boundaries. The TCOP had a New Brighton mailing address because it was the nearest post office. After World War II, the township was subdivided into the cities of Mounds View, New Brighton, and Arden Hills, with the ordnance plant falling within the corporate boundaries of Arden Hills since 1951.

In addition to its strategic geographic attributes, the New Brighton site was very attractive to the War Department because of its physiography and land use (Figure 4). In terms of physiography, the TCOP site was situated on the Anoka Sand Plain, a gently undulating glacial outwash plain interrupted by the North Ramsey Mounds, a low range of the ancient Superior Lobe terminal moraine that one early landscape historian described as a "tract of hills or morainic drift [i.e., glacial till] extending from south to north about three miles through its central part, affording a fine panoramic view from their northern and highest points, which are about 200 feet above the surrounding country" (Upham 1969:437). The Ordovician-aged sedimentary bedrock strata are covered by a thick mantle of consolidated glacial and postglacial deposits; at the TCOP site, this glacial overburden is 150-350 feet deep. Glacial and bedrock aquifers provided excellent groundwater resources, although it was later discovered that the water table beneath the TCOP was highly sensitive to pollution. The land surface was dotted with small lakes, marshes, and peat bogs (Meyer and Swanson 1992; Vinar 1980).

The natural vegetation of northern Ramsey County was oak woodland and brushland interspersed with small upland prairies and prairie wetlands, the ecotonal type between the expansive tallgrass prairie and the deciduous forest that is sometimes called "oak savanna" (Wendt and Coffin 1988). Farming had been the dominant land use and leading economic enterprise in Mound View Township since the mid-nineteenth century, with many relatively small family holdings, typically from 40 to 80 acres in extent (Figure 5). In the late 1930s agricultural output consisted of modest quantities of corn, oats, hay, squash, and potatoes. Some farmers supplemented their income by raising livestock and dairy cattle. By 1940, the area's many lakes had become desirable as the sites for summer cottages, and much of the shoreline around Turtle Lake had been subdivided into small lakefront lots.

"The GOCO plants were built in record time, between five and eighteen months from ground-breaking to initial production, with an average construction time of nine months" (Murphey 1993:3). The Twin Cities plant was no exception. Site preparation work started on August 15, 1941, and a ground breaking ceremony was held at the TCOP site on August 28, with Col. Underwood turning the first shovelful of dirt while a small crowd of dignitaries, including Governor Harold Stassen, looked on (*St. Paul Dispatch* 5 November 1941; see Ordnance Department 1942b; Figures 6 and 7). For the first few months the Constructing Quartermaster and the contractors worked out of temporary offices in the Federal Courts Building (now the Landmark Center) in downtown St. Paul, with field offices set up in various farm buildings and taverns at the TCOP work site (*St. Paul Dispatch* 15 August 1941; *St. Paul Pioneer Press* 6 August 1941). Work immediately began on five "temporary office buildings of the standard, two-story barracks type," into which the CQM, architect-engineers, and constructors moved in late September (COE 1943:2). All work originally planned was completed before the Area Engineer ordered construction halted on January 15, 1943 (COE 1943:3). Four and one-half months passed between the time the land was acquired by the War Department and the first bullets came off the TCOP production line.

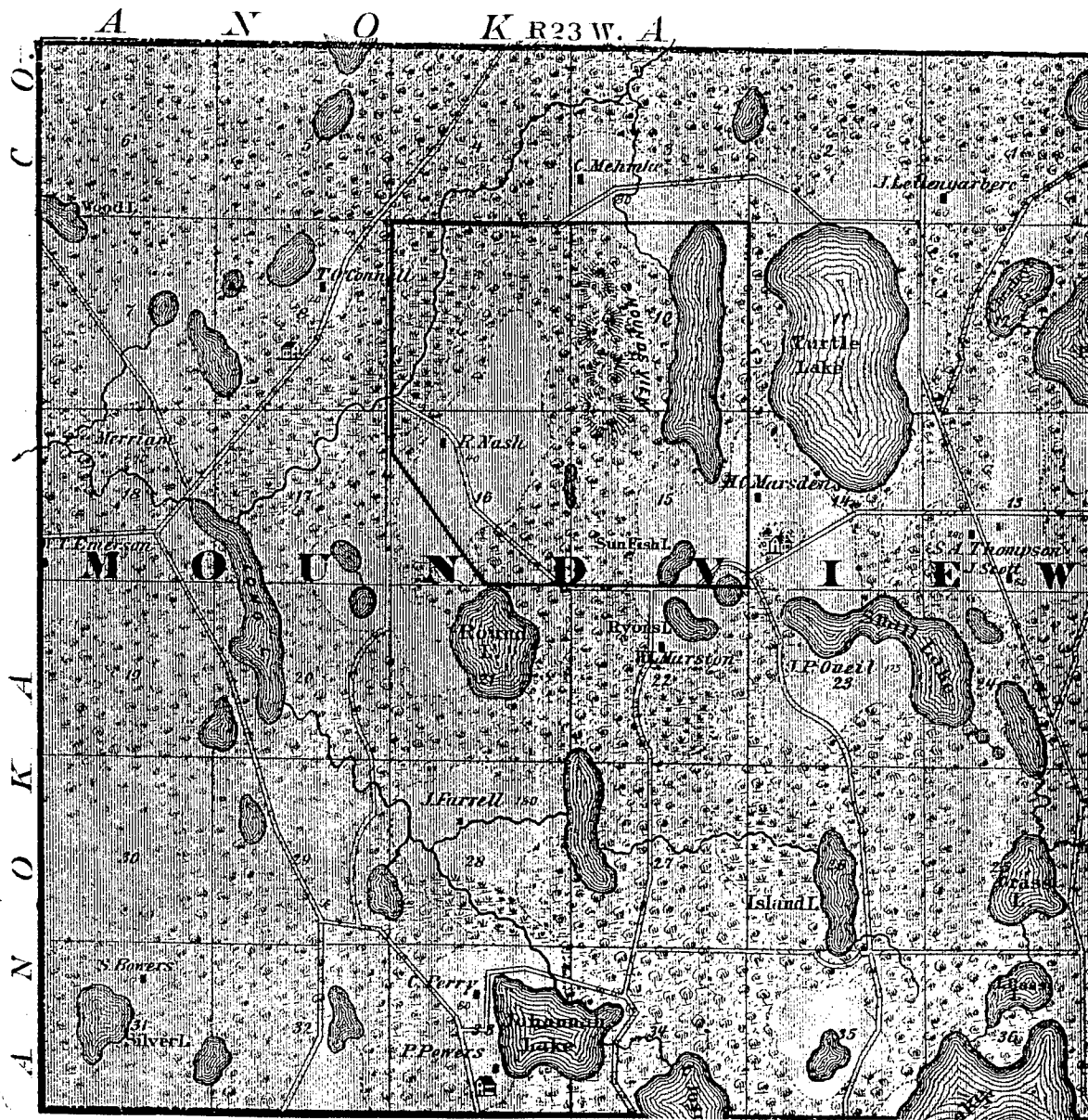

Figure 3. Excerpt from an 1874 map showing part of northern Ramsey County later occupied by the Twin Cities Ordnance Plant (Andreas 1874). The future location of the plant boundaries is noted.

After site preparation work was completed, the ammunition factory was built in three parts, commonly referred to as Plant 1 and Plant 2, with a major expansion to Plant 2 added in 1942 (Figures 8-11; see Figure 7). Plants 1 and 2 each consisted of three large manufacturing buildings with accessory buildings and structures, while the Plant 2 expansion consisted of a large manufacturing building and outbuildings. Each main manufacturing building had five lines of production (COE 1943:2).

GEOLOGIC UNIT

SOUTHWEST

NORTHEAST

| SITE

Unit 1 RECENT ALLUVIUM

fill, recent alluvium and peat

NEW BRIGHTON FORMATION

fine sands overlying  
lacustrine silts

- local water table aquifer  
0-50 feet thick

Unit 2 TWIN CITIES FORMATION

reddish brown to gray

silty clay, clayey sand till

- regional aquitard  
0-150 feet thick

Unit 3 HILLSIDE SAND

reddish brown medium to  
course sand with occasional  
gravels, silty sands and red  
sandy tills

- regional aquifer  
0-500 feet thick

Unit 4 PRAIRIE DU CHIEN GROUP

Dolomite, sandy dolomite;

light brown to white

thin to thickly bedded;

variably fractured

- regional aquifer  
0-250 feet thick

JORDAN SANDSTONE

Sandstone, white to

yellowish fine to

coarse-grained; loosely

to well cemented

- regional aquifer

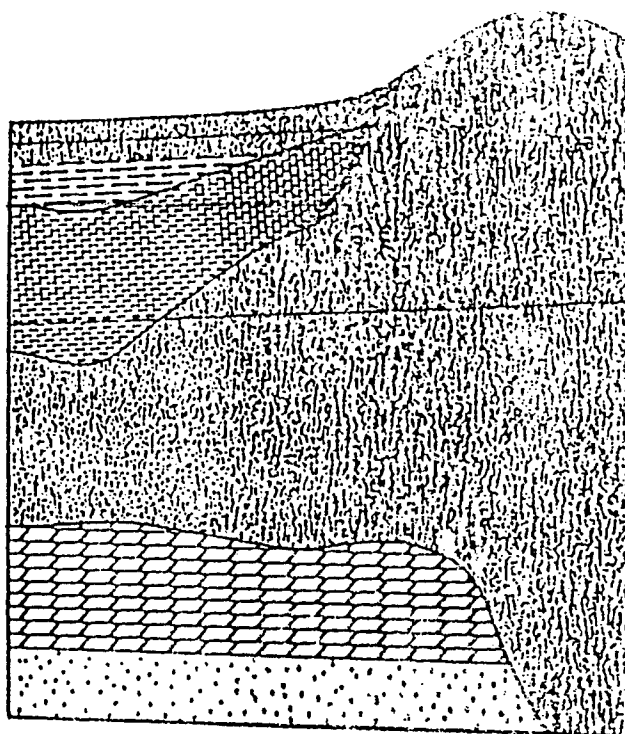

**SCHEMATIC REGIONAL GEOLOGIC  
CROSS SECTION**

0-100 feet thick

*Twin Cities Army Ammunition Plant*

Figure 4. Schematic Regional Geologic Cross Section of the location of the Twin Cities Army Ammunition Plant (TCAAP Public Information Office).

More than 100 buildings and structures were erected at the TCOP between August 1941 and January 1942 (Figure 12). These included an administration and service building (Figures 13 and 14), manufacturing buildings and shops, guard and gate houses, garages, a boiler house, powder magazines, powder canning houses, chemical storage buildings, a water treatment plant, well houses, storehouses, laboratories, fire station, radio house, residences, explosion barricades, and a commissary. The project also included infrastructure and utilities such as roads, railroads, parking lots, sidewalks, bridges, fences, gas, water, electric power and telephone lines; a freshwater distribution system; and a steam power plant. The plant water supply was provided by a system of wells, seven of which were drilled into the bedrock and one into

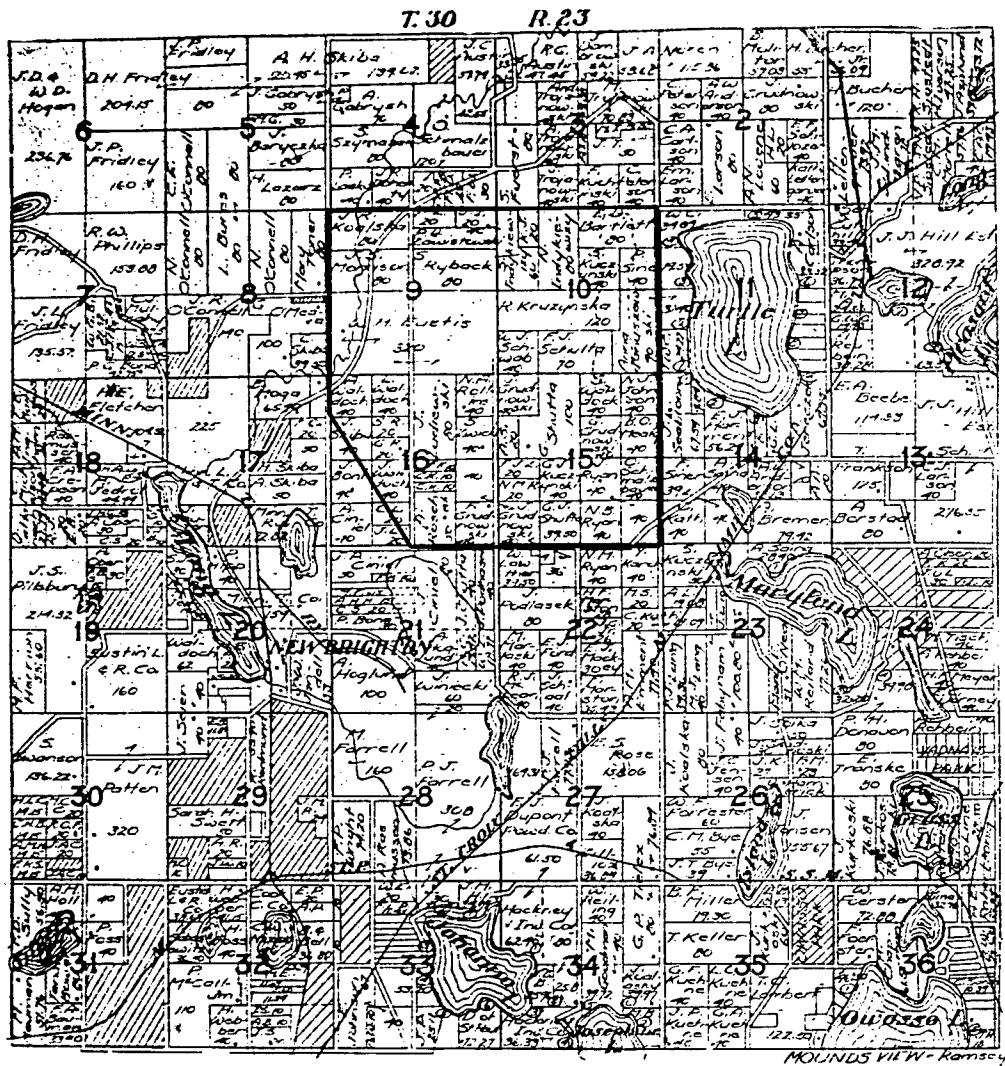

Figure 5. 1916 plat of Mound View Township (Hixon 1916). Note future location of plant boundaries.

the shallow glacial aquifer. Natural gas for fuel and manufacturing processes was purchased from Northern Natural Gas Company, and a line was built connecting the TCOP to the gas main in Minneapolis. Electrical power for the plant was purchased from Northern States Power Company, and transmitted over two separate 50,000-volt power lines. As befitted a mid-sized town, the TCOP had its own sanitary sewer and storm sewer systems. Since there was no sewage treatment plant within the TCOP, the sanitary sewer was connected to the Minneapolis municipal system, and the storm sewer collected runoff and discharged it into nearby wetlands. Steam heat was supplied by a central heating system with boilers designed to burn coal, fuel oil, or natural gas (COE 1943; Ordnance Department 1942a, 1943a).

Construction work was only slightly hampered by weather and, to a lesser extent, by shortages of labor and material. In Minnesota, winters are very cold and the summers are warm but fairly short. Annual precipitation averages about 20 inches and is fairly well distributed throughout the year, reaching its peak



Figure 6. Ground breaking at the Twin Cities Ordnance Plant, August 1941. *Minneapolis Star Journal* photograph (Minnesota Historical Society).

in early summer. Average annual snowfall is about 50 inches and snow covers the ground much of the time from late fall through early spring. In winter the average temperature is 17 degrees F, with an average daily low of 8 degrees, although the thermometer frequently drops below 0 and may dip into the -10s or -20s degrees with "wind chills" as low as -50 degrees F. Soil occasionally freezes to a depth of several feet when very cold weather occurs before the ground is covered with snow, but usually the frost level is within a foot of the surface (Vinar 1980:1-2). Cursory review of Twin Cities area newspapers suggests that weather conditions were more or less normal during the TCOP construction period. While the TCOP historical summary for this period noted that the "1941-1942 winter season was fairly open and there seldom was sufficient snow to seriously hamper construction operations" (Ordnance Department 1942a:5), late October 1941 was wet, and much of the building site became a quagmire. The author of the Corps of Engineers project completion report lamented:

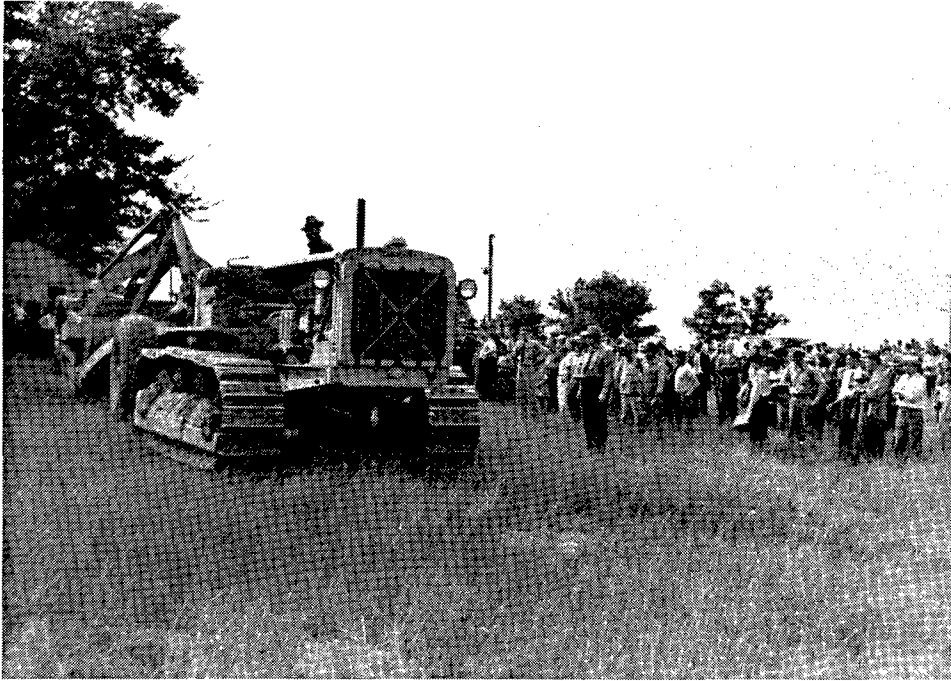

Figure 7. Construction work begins at the Twin Cities Ordnance Plant. *Minneapolis Star Journal* photograph. This photograph is undated, but is probably from August 1941 (Minnesota Historical Society).

Loads of black muck and peat, which would not dry up, had to be hauled out and replaced with gravel. Conditions were especially difficult during the pouring of the foundations and erection of the steel work. Much work had to be done to dry up the site so that trucks and equipment could operate. At the northwest corner of the building [No. 101], a bad pocket was encountered which made it necessary to excavate ten to fourteen feet to a good bearing soil [COE 1943:7].

The footings and foundations for several plant buildings were poured during November and December, requiring erection of temporary shelters heated by portable firebox boilers (COE 1943:7). In spite of the fact that all construction materials required by the ordnance plant were assigned an A-1-A priority, the highest rating that could be given, there were critical, if temporary, shortages of materials and supplies.

Most of the TCOP buildings were fairly simple, utilitarian structures, but the major plant buildings exhibit design elements reflective of the Modern movement in architectural history (Figure 15). Twentieth-century industrial architecture turned its back on historical design precedent in favor of elegantly simplified, functional buildings emphasizing the Machine Age. Hallmarks of Machine Age architecture included absence of all non-functional decoration, standardization of building parts, flat roofs and smooth wall surfaces. The plant buildings at the TCOP are outstanding examples of this austere modernism: "Constructed of brick, steel, and concrete, these buildings exhibited a clean-lined, industrial style that was typical of Smith, Hinchman & Grylls' work during the late 1930s and early 1940s" (BTI 1984:21). One architect has referred to the design elements at the TCOP as a paradigm of modern rational design:

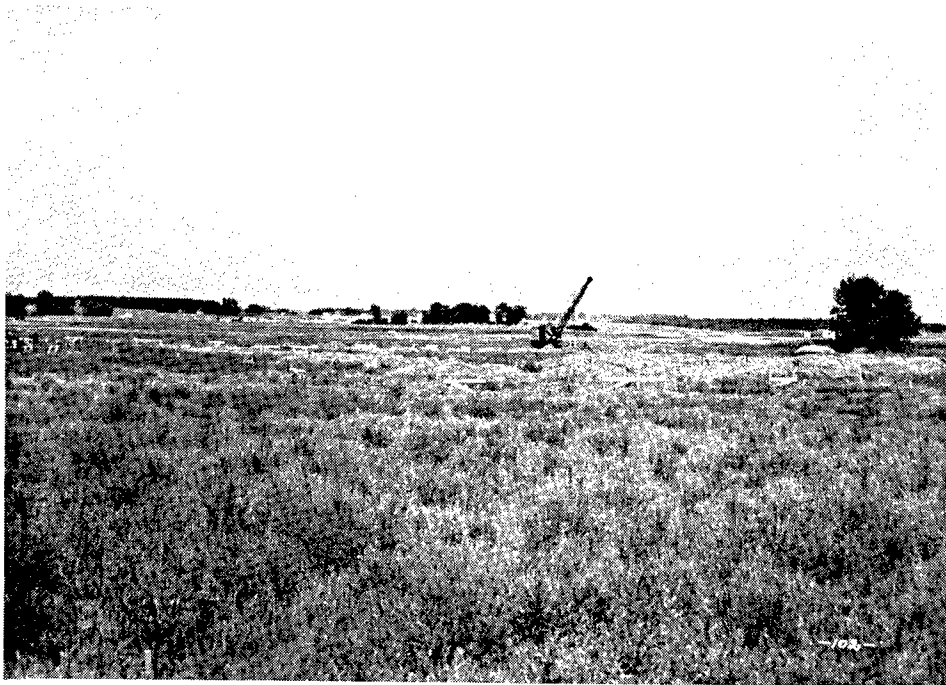

Figure 8. Beginning construction work at the Twin Cities Ordnance Plant. Photograph is most likely from July or August of 1941 (Minnesota Historical Society).



Figure 9. Construction work at the Twin Cities Ordnance Plant. Grading the building site. *Minneapolis Star Journal* photograph, undated but probably from August 1941 (Minnesota Historical Society).

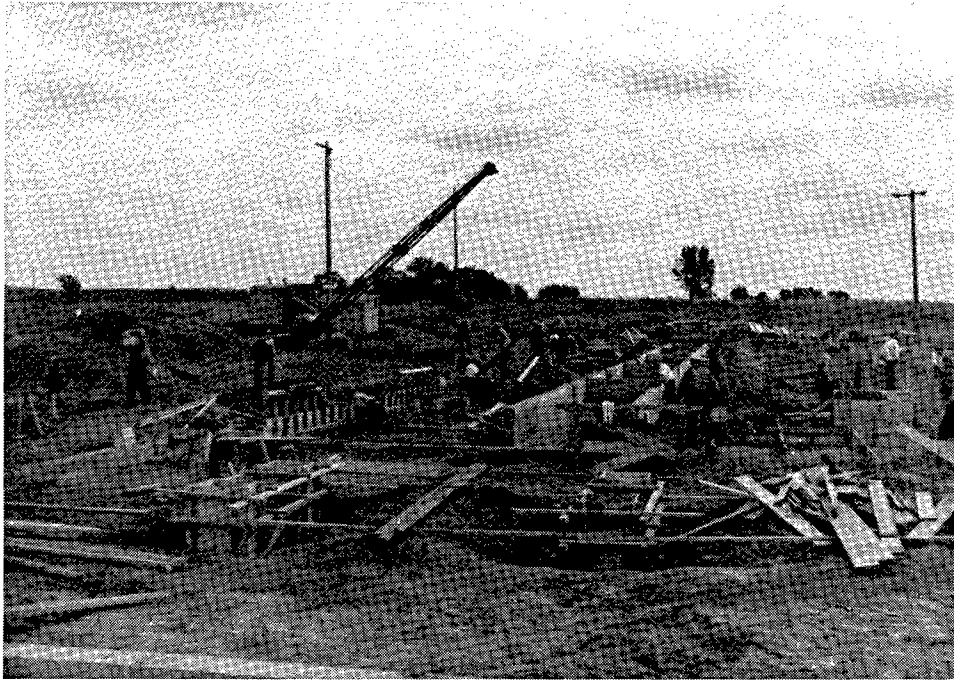

Figure 10. Construction work at the Twin Cities Ordnance Plant. Footings for unidentified plant building. *Minneapolis Star Journal* photograph, undated but probably from late summer 1941 (Minnesota Historical Society).

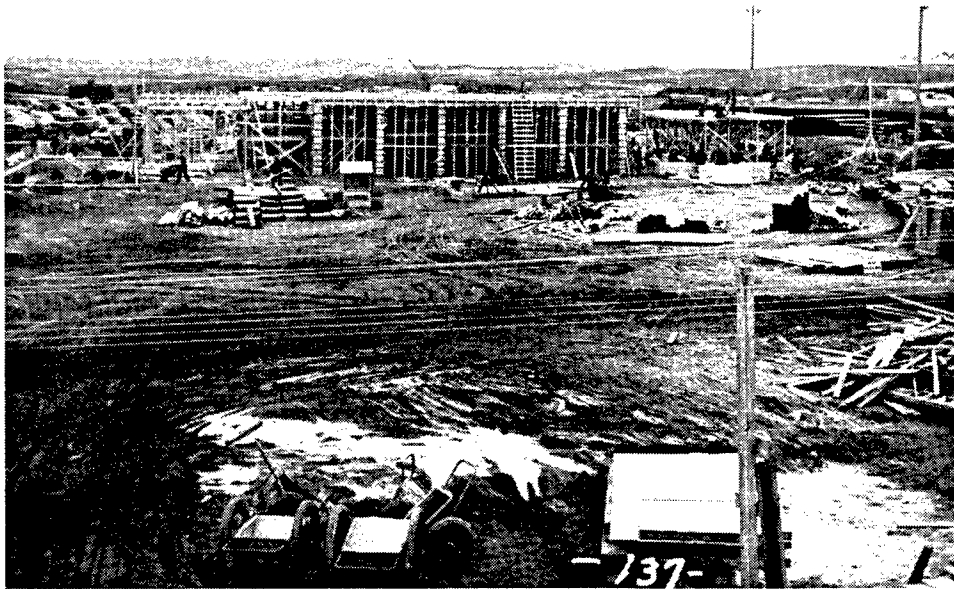

Figure 11. Unidentified construction site at the Twin Cities Ordnance Plant. Probably dates from fall of 1941 (TCAAP Public Information Office).

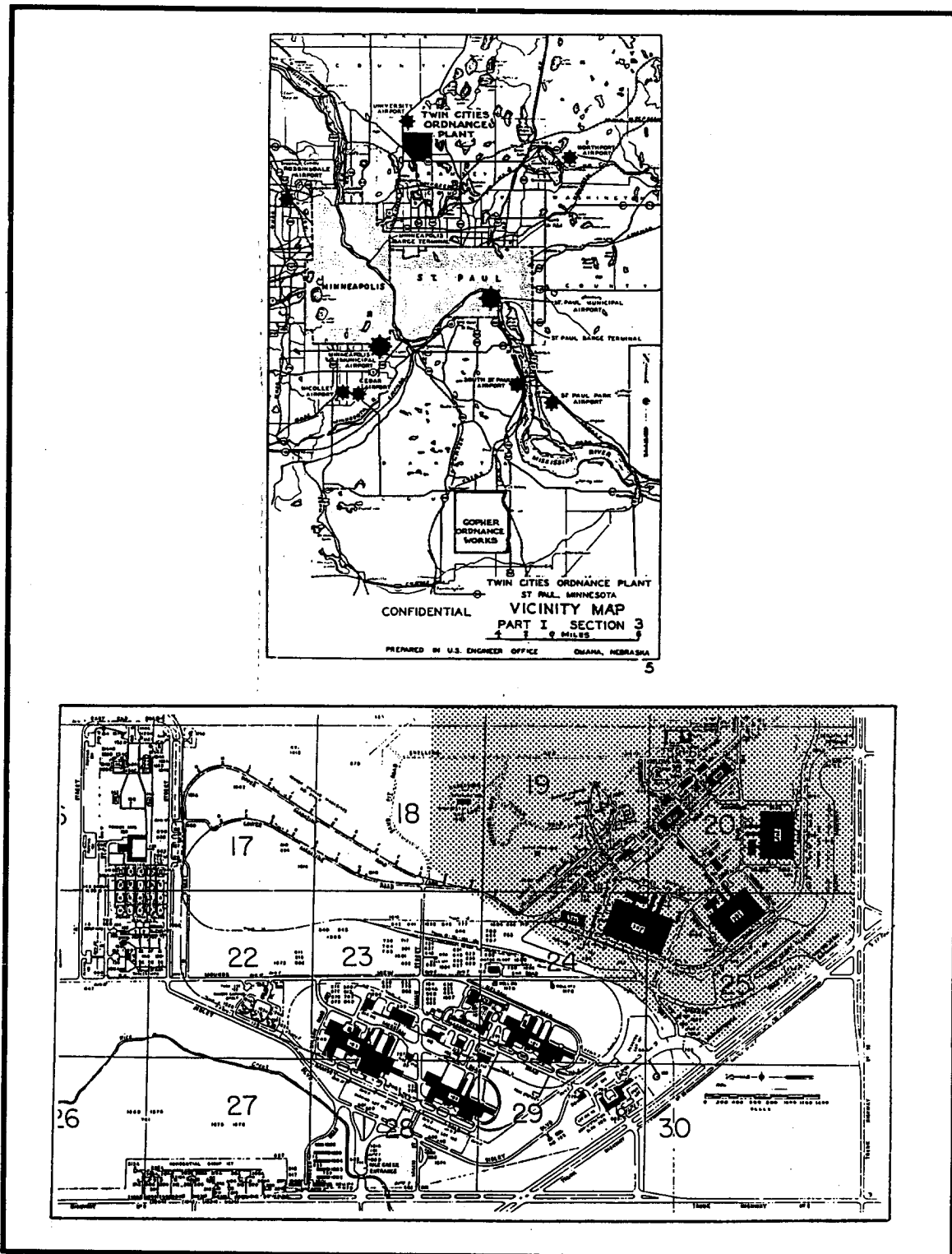

Figure 12. Map showing location of the TCAAP in 1944 and a 1944 plant layout, virtually unchanged as of 1994. The shaded area of the map on the right represents the area of the “temporary” second plant built out of timber after the war began (from Murphey et al. 1993).



Figure 13. Interior of part of Building 105, the administration building, at the Twin Cities Ordnance Plant. Photograph is undated, but was probably taken between 1942-1945 (TCAAP Public Information Office).

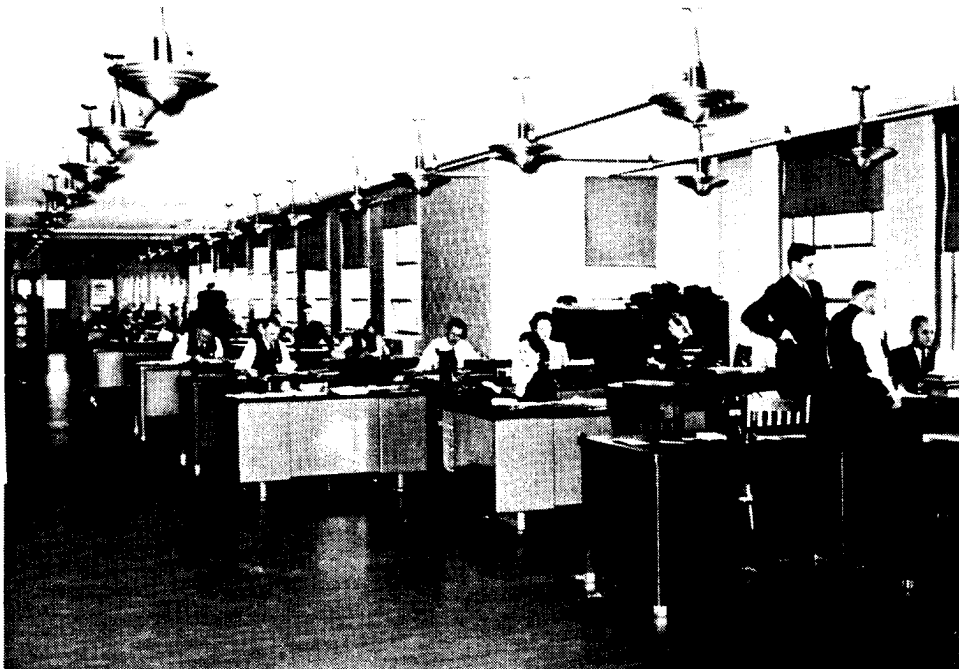

Figure 14. Interior of part of Building 105, the administration building, at the Twin Cities Ordnance Plant. Photograph is undated, but was probably taken between 1942-1945 (TCAAP Public Information Office).

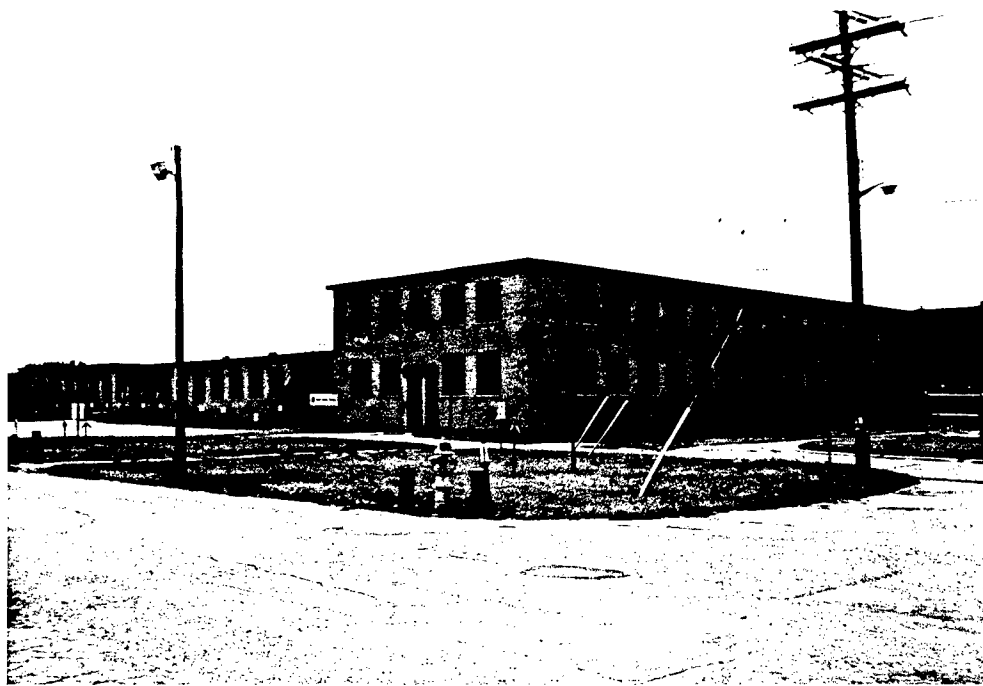

Figure 15. Building 105 in 1994 (Bear Creek Archeology, Inc.).

Aesthetically, the buildings go far beyond pure functionalism. Sweeping expanses of industrial steel sash provide natural light to every recess of the interior. Integration of natural light in the factory environment was at the core of modern architectural theory where fresh air and ventilation provided hygienic conditions for increased worker productivity [Murphey 1993:6].

The prototype small arms plant was a long, one story building with mezzanines, and most of the TCOP buildings designed to house manufacturing processes were little more than a foundation, walls and a roof, with entrance openings in the walls for doors and windows (Figure 16). Some accessory buildings, however, incorporated additional architectural details, including some modest decorative details designed to enrich the external appearance of the buildings. The walls of the plant buildings had two separate and distinct functions: to screen the production lines, material storage spaces, and other plant functions from weather and observation, and to provide protection against the effects of blast and fire resulting from bombardment or internal explosion. In the ammunition manufacturing spaces, the lower wall provided blast protection while the upper wall areas were essentially screening. Upper wall areas were given over to windows designed to provide light, ventilation and protection against the weather. Wall foundations rested on reinforced poured concrete foundations and footings; most were practically on ground level. Wall cladding was masonry, although wood framing and siding were used in "temporary" factory building construction at the TCOP. Masonry walls were composite structures of brick and fired clay tile. On Buildings 101, 102, and 103, for example, outside walls were 12.5 inches thick and consisted of six courses of brick on top of a concrete foundation; above this, sand-lime brick backed with red-clay tile block was used. The structural system of the original plant buildings was steel framing with steel columns set on 30-foot centers. Roofs were flat and supported by steel frameworks (wooden in the temporary buildings) and covered with bitumen. Mezzanines and roofs were supported by wide flange girders and I-beams. Window and door framing was steel, and sills were of precast concrete. Interior non-load-bearing walls were clay tile or wood. Shop floors were reinforced concrete, except in powder-handling areas, where the floors were covered with spark-proof composition flooring (BTI 1984; COE 1943).



Figure 16. Plant 2 building in 1994 (Bear Creek Archeology, Inc.).

The unique production requirements and safety hazards associated with arms manufacturing exerted a profound influence on the TCOP's architecture. Ground floor walls surrounding production areas, for example, were constructed of heavy masonry to ensure that workers would be protected from bomb splinters in the event of enemy attack (BTI 1984:21). Upper walls were covered by large expanses of industrial steel sash and monitor skylights, which were designed to blow outward in case of accidental detonations on the production lines (BTI 1984:21, 22). Explosive-handling processes were housed in self-contained wings designed to minimize damage from accidental explosions. Mr. Everett Needels, powder mixer at the TCOP, describes the unique area in which he worked:

The primer-tracer area was all fenced in, and we had special badges that nobody would come into our area. Everybody was scared of it . . . The area was located on the northeast corner of the plant. There was a fence around it, and it was all by itself . . . Nobody could get in unless the guards let you in. So we were secluded all by ourselves. There was a cave built in the side of the hillside which they stored their raw materials in; [the raw materials] came in by boxcar. And that had a special fence around it too so that even I couldn't get in unless I had the keys. And then there was one ( . . . ) locker room and where we ate lunch and changed clothes and a foreman was in there; it was a small building, probably 30 feet by 30 feet. And the rest of the place was these bunkers that was out in the area, and they were quite a ways apart [Figure 17]. They were covered with earth. They were all above ground, but they had built up the building, and then they had covered the whole thing with dirt and grass. And the only thing that was open in the center [of the building] was a skylight. So if the explosive powder would blow up, it would go up in the air . . . We would have to stay in there until 11 o'clock at night [or, the end of the shift] and the guard would come down and let us out again. So once we were in there we were *there*. We didn't leave the area [E. Needels, interview 1994].

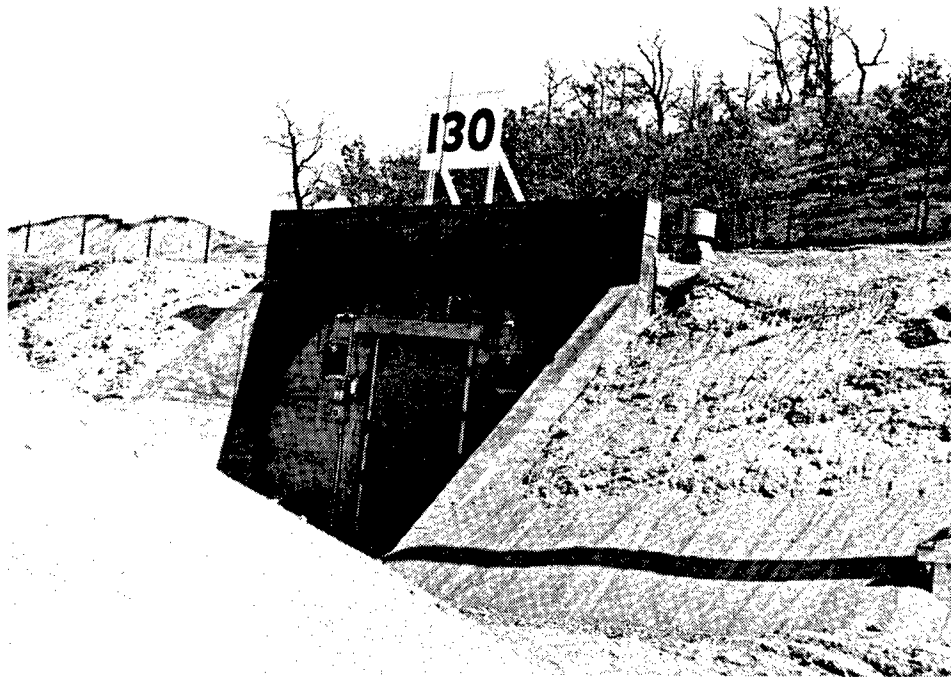

Figure 17. Building 130, located in the primer manufacturing area of the Twin Cities Ordnance Plant (TCAAP Public Information Office).

Special care was taken to design an installation with a silhouette that made aerial observation of the plant difficult: the stacks of the power plant were deliberately shortened, “making possible the elimination of the telltale stacks whose long shadows are so useful to hostile bombers in locating the target” (Smith, Hinchman & Grylls 1942:75-76).

In early January 1942 the War Department ordered an expansion of the TCOP, more than doubling the number of buildings (*St. Paul Dispatch* 23 December 1941). Under pressure to complete the project as quickly as possible, the Chief of Ordnance, Lt. Gen. Leven H. Cambell, canceled plans for new brick and steel buildings at the TCOP and issued specifications for temporary structures with a design life of at least five years (Fine and Remington 1972:317). “Because of critical material shortages and accelerated construction schedules, Smith, Hinchman & Grylls designed almost all of the new buildings as ‘temporary’ wooden structures, paying little attention to style or architectural detailing” (BTI 1984:25). The expansion was completed by the summer of 1942 and included additional ammunition shops, a primer manufacturing building and a power plant. These buildings were conspicuous for their squarish ground plans, heavy timber framing and unpainted weatherboard siding. In early 1943 a large wooden shop designed to house .50 cal. manufacturing was erected, the last major World War II construction at the TCOP (Ordnance Department 1942b; see Smith, Hinchman & Grylls 1942:82).

The local media marveled at the scale of construction work at the TCOP and devoted hundreds of column inches to text and photographs of the work in progress. Press coverage of the construction was peppered with statistics. In fifteen months, construction crews, working two 10-hour shifts and toiling by floodlights (“sun-dodgers”) after dusk, erected 323 buildings and structures, built 21.4 miles of new roadway, laid 21.7 miles of railroad track, moved 2.5 million cubic yards of earth, laid more than an acre of concrete a day and put up more than 3,650,000 bricks. Additionally, 31.3 miles of sewer line, 14.1 miles of natural gas line, 16.8 miles of steam lines, 28.9 miles of electrical wires and 11.1 miles of telephone lines were installed.

The plant had its own wells, connected to a 6.5 million gallon hilltop reservoir and moved the old Fort Snelling water tower to the TCOP site (Ordnance Department 1942b; Public Relations Section n.d.; Figures 18 and 19). Because much of the plant site was in crops when construction began, the Army sent troops to harvest the potatoes, hay, apples, oats, corn, and garden vegetables (*Minneapolis Star Journal* 15 September 1941).

An interesting sidebar to the construction history of the TCOP is the lavish attention given to public relations (Ordnance Department 1942a, 1942b; Public Relations Section n.d.). The TCOP public information office was headed by Earl D. Jeneke, whose staff orchestrated a media campaign in late 1941: "Over 500 articles on the role of the New Brighton project appeared in the Twin City [sic] press in the three-month period" (October 1941-January 1942). Media coverage produced a sense of mission and a spirit of participation and co-operation. The articles brought over 25,000 applications for jobs (Merritt 1976:400). So much public interest was generated that an exhibit of construction photographs was opened at the Walker Art Gallery in Minneapolis early in 1942 (Fine and Remington 1972:375).

Based on figures reported by the Corps of Engineers at the end of 1943, construction costs charged to the TCOP amounted to \$42,886,903 (Voight 1945:299). It was the tenth most expensive of all GOCO plants (Murphey 1993:5).

### CONTRACTOR OPERATIONS

The TCOP was built and operated by FCC under contract W-ORD-527 signed July 14, 1941 (Voight 1945:297). This was a cost-plus-a-fixed-fee (CPFF) or "fixed fee" contract, one of the six emergency contract forms developed by the War Department in 1940 as a means of "reforming" military procurement practices (Smith 1959:48-72). The CPFF contract allowed greater flexibility in pricing, as compared with the standard fixed-price supply contract. Because many wartime contractors had little or no experience in defense contracting and were engaged in manufacturing material that had never before been produced on the scale required by the government, they were reluctant to pursue fixed-price contracts. CPFF allowed the government and contractors to bypass competitive bidding and made pricing "flexible." The official history of Ordnance Department procurement and supply in World War II describes the CPFF as follows:

Each company was reimbursed at regular intervals for approved expenses in operating the plant, and in addition was paid a fee based on the number of rounds of ammunition or pounds of explosive produced. Under this arrangement the contractors ran no risk of failing to make a profit. To protect the government's interest, teams of auditors at each plant checked the company's accounts and approved or disallowed every item of expense in accordance with policies established in Washington [Thomson and Mayo 1960:113].

The liberal provisions of CPFF contracts came under criticism and were the subject of a series of Congressional inquiries known as the Truman Committee hearings (Fine and Remington 1972:562-585; Smith 1959:280-283; Thomson and Mayo 1960:113, 130). CPFF contracts provided incentives for quality control but not for cost-efficiency. It comes as no surprise, therefore, to find criticism of FCC's early operation of the TCOP:

Production reports of the Twin Cities Ordnance Plant indicate that there was a lack of organization, planning and aggressiveness in the Prime Contractor's organization during the early months of 1942. The Contractor's administrative departments did not include personnel in sufficient number to handle the extremely large volume of business which developed during that period. As a result of an investigation by Office of the Chief of Ordnance many changes were made in the Federal Cartridge Corporation's organization. Thereafter, plant operation was considerably improved by the end of August, 1942 [Voight 1945:299-300].



Figure 18. View of Twin Cities Ordnance Plant location during construction. Note Fort Snelling water tower (TCAAP Public Information Office).



Figure 19. View of Twin Cities Ordnance Plant location during construction. Note Fort Snelling water tower (TCAAP Public Information Office).

Throughout the war the Ordnance Department's Field Director of Ammunition Plants (FDAP) endeavored to have GOCO contractors compete with each other in the hope that pride would replace profit as the defense contractors' motivation for improved plant efficiency, a scheme which seems to have worked (Thomson and Mayo 1960:127-128).

TCOP construction was ahead of schedule, and plant managers rushed installation of production machinery in January 1942. The Administration Building was occupied on January 31, and Plant No. 1 was soon up and running (Ordnance Department 1942a:6). Production of ammunition began at the TCOP on March 9, 1942, and increased rapidly:

An outstanding milestone in the history of the Twin Cities Ordnance Plant was reached on March 18, 1942, when the first lot of ammunition, .30 caliber ball M2 from Building 101, was accepted by Ordnance Department inspectors as Grade B. The first lot of .50 caliber was armor piercing and was accepted as Grade B on April 19, 1942 [Ordnance Department 1942a:8].

Construction work continued into mid-1943 (Ordnance Department 1943c). Plant activity reached an all-time high that same year before production was scaled back as part of an Ordnance Department-planned curtailment of ammunition production. Another milestone was reached on March 13, 1944, when the three billionth cartridge, a .50 cal. armor-piercing incendiary round, was accepted by Army Ordnance inspectors (Ordnance Department 1944a). Peak employment was reached in July 1943, when there were about 26,000 people on the FCC payroll. The number of employees decreased from 14,328 at the end of 1943 to 9,875 on March 31, 1944 (Ordnance Department 1944a). Work force levels remained at that level until the end of the war (Ordnance Department 1945a, 1945c). During World War II, the U.S. government invested a total of \$76,771,144 in building and operating the facility (Smith 1959:501).

Federal Cartridge Corporation was a Twin Cities manufacturer of sporting ammunition with a plant in Anoka and corporate offices in the fashionable Foshay Tower in downtown Minneapolis. Founded in 1918 as the Federal Cartridge Company, the Anoka factory was taken over by John Haller and Charles Horn in 1922. Charles Lilley Horn was born in Mt. Vernon, Iowa, in 1888 and graduated from the University of Minnesota in 1912, at which time he entered the manufacturing business. From 1912 until 1922, he was president of the American Ball Company of Minneapolis, and he would serve as general manager, president, and chairman of the board of FCC from 1922 until his death in 1978 (Marquis 1981:283). In comparison with Remington Arms, FCC was a small company with no background in military arms production, having been engaged in the manufacture of shotgun and small caliber rifle ammunition between the wars. One of the smallest GOCO contractor operators, as well as "the youngest ammunition company in the United States," the company was seemingly ill-equipped to take on the task of operating the TCOP under wartime conditions. Under the leadership of Horn, described as "a capable leader who was able to adapt his company to high capacity production" (Merritt 1976:400; Figure 20), FCC was reorganized in 1942 with a new management team, which included Robert B. Ehlen, a company employee since 1923, who advanced from the shipping department to General Manager of the TCOP in March 1942 (Ordnance Department 1942a:2). Mr. Harold Stassen, Governor of Minnesota between 1938 and 1943, recalls when FCC was first selected to build the TCOP:

As I remember, they first called [Mr. Horn] to Washington, and talked to him there. And they asked me as Governor whether I knew of anything bad about him: Was he a patriotic man? Was he a good citizen? I said everything I knew about him was affirmative, that he was an effective, good citizen, patriotic. And the next thing I knew, he did have that contract to go ahead and build a plant. At that time he came to me as Governor, in fact he asked me to come out and see the location. He said one of the immediate problems was to get roads put in so the employees could come and the contractors building could come. I remember vividly he said, 'When could we plan on getting started to put in some roads?' And I said, 'Tomorrow.' And he looked at me and he said, 'You mean that?' I said, 'Yes, I mean that . . .' So, literally, the very next day Minnesota highway equipment went out . . . [H. Stassen, interview 1994].



Figure 20. Charles L. Horn, President of Federal Cartridge Corporation (TCAAP Public Information Office).

According to most oral history accounts, Mr. Horn was viewed as a hard worker who was generally well liked. Some, however, were not entirely satisfied with Mr. Horn's management of the TCOP. Mr. Ted Seth, former metallurgist at the plant (Figure 21), noted Mr. Horn's tight control on costs:

He let people know that he was interested in saving a lot of money . . . A note came through to the heads of the department that said that from this certain day on, the office supply department will not issue new pencils unless you turn in the used stub that cannot be over two inches long, or something on that order [T. Seth, interview 1994].

Mrs. Laura Peterson, former telephone operator at the TCOP, remembers Mr. Horn fondly: "We were just treated wonderfully. Mr. Horn, he'd come and visit us and he'd sit and have coffee and he'd talk . . . he was always proud of his operators" (L. Peterson, interview 1994). Under the name of Federal Cartridge Company, FCC is still the prime contractor at the New Brighton facility.



Figure 21. Photograph of the type of area in which Mr. Seth (oral history informant) worked (TCAAP Public Information Office).

## TECHNOLOGY

During World War II the Ordnance Department constructed 77 GOCO industrial facilities in 26 states. These included small arms ammunition plants at Denver, Des Moines, Lake City, Lowell, Kings Mills, Milwaukee, St. Louis, and the Twin Cities (Thomson and Mayo 1960:111). GOCO planning commenced in mid-June 1940, and construction began on the 29 "first wave" plants that same year. During the months leading up to the U.S. entry into the war, the "second wave" of small arms ammunition plants came off the planning boards (Fine and Remington 1972:309-341; Thomson and Mayo 1960:45-59).

The mission of the TCOP was to produce .30, .50 and .45 cal. ammunition. During World War II, the small arms carried into battle by U.S. troops had not appreciably changed in their basic design since the inter-war period, though numerous modifications to existing arms were made between 1940 and 1945. These modifications mostly involved the use of more reliable ammunition and improved ammunition feeding systems for automatic weapons. The basic World War II infantry weapons included the standard equipment .30 cal. M-1 or Garand rifle that had gone into service in 1932; the older .30 cal. Springfield rifle of World War I vintage; the .30 cal. M-1A1 carbine designed in 1940; the .30 cal. Browning Automatic Rifle (BAR) adopted by the U.S. Army in 1918; the .45 cal. automatic pistol, standard issue since 1911; the .45 cal. Thompson submachine gun, which had entered service in the early 1920s; the .50 cal. Browning air-cooled machine gun, developed in 1918; the .30 cal. Browning water-cooled machine gun that had been developed in the 1910s; and the air-cooled version of the .30 cal. machine gun. Many of these weapons were also in service with Allied forces, particularly the .30 and .50 cal. machine guns (Thomson and Mayo 1960:154-182). Most of these were rapid-firing, semi-automatic or automatic weapons fed by clip, magazine, or belt loading systems holding between five and 250 rounds.

The heart of the TCOP was the production line and its modernistic linear process (Figures 22-28). Much attention has been given to the development of the small arms ammunition production line machinery installed at the TCOP during World War II (Ammunition Branch n.d.; Murphey et al. 1993).

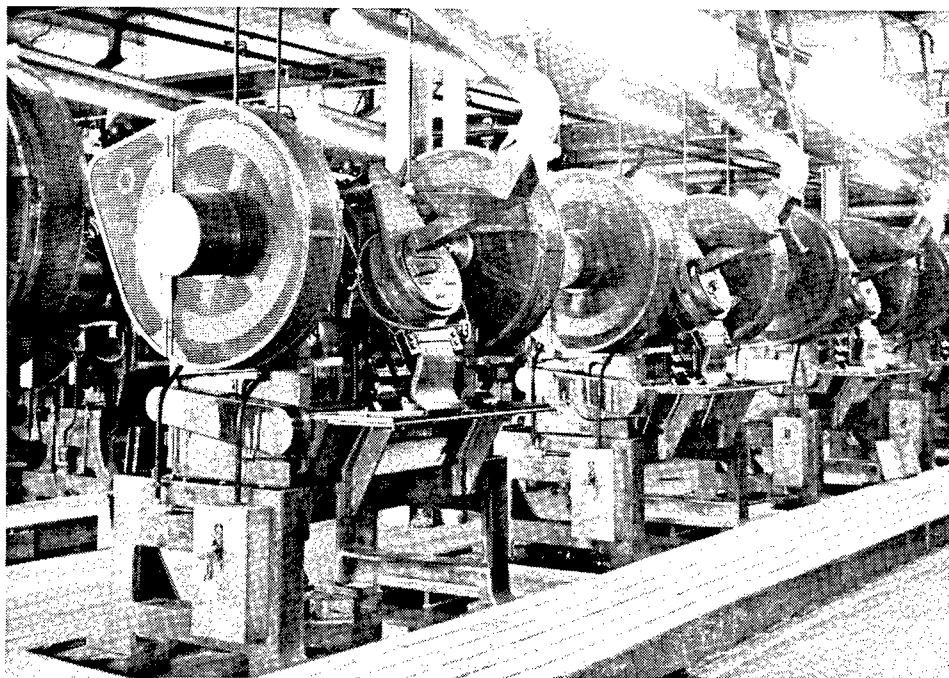

Figure 22. Draw machines at the Twin Cities Ordnance Plant (TCAAP Public Information Office).

Substantial advances were made in the pre-war period to improve the quality of small arms ammunition. New materials and processes had been adopted for the manufacture of rifle, pistol, and machine gun bullets, expanding production line capabilities, improving quality control, and conserving strategic materials (Green et al. 1955:487-494; Thomson and Mayo 1960:213-217). The original machines built for the TCOP were derived from prototypes developed at the Frankford Arsenal in the late 1930s and early 1940s (Murphey et al. 1993:8). The Corps of Engineers Completion Report for the TCOP states:

The Plant was built in three parts -- Plant 1, Plant 2 and Plant 2 Expansion. Plant No. 1 and Plant No. 2 each consist of large manufacturing buildings, with the necessary additional buildings. Plant No. 2 Expansion consists of one large manufacturing building, with the necessary additional buildings. Each main manufacturing building has five lines of production and the entire Plant has a total of 35 lines [COE 1943:2].

The original plant contained two .30 cal. ammunition shops, a .50 cal. ammunition shop, a lead shop, a primer manufacturing building, and a powder house. The plant expansion housed two additional .30 cal. shops, a .45 cal. shop, a .50 cal. shop, a lead shop, a primer manufacturing building, and a power plant. The final addition, another .50 cal. ammunition shop, was completed early in 1943. The World War II production process at the TCOP has been described by Krippner (in Murphey et al. 1993:13-19) and was identical to that of the St. Louis Ordnance Plant operated by the U.S. Cartridge Company (Thomson and Mayo 1960:204-207). In 1944 two small arms ammunition shops, including the .45 cal. ammunition production lines, were closed down and converted into shops for tooling components for 105 mm and 155 mm artillery projectiles. However, production of artillery shells was a fairly small scale operation.

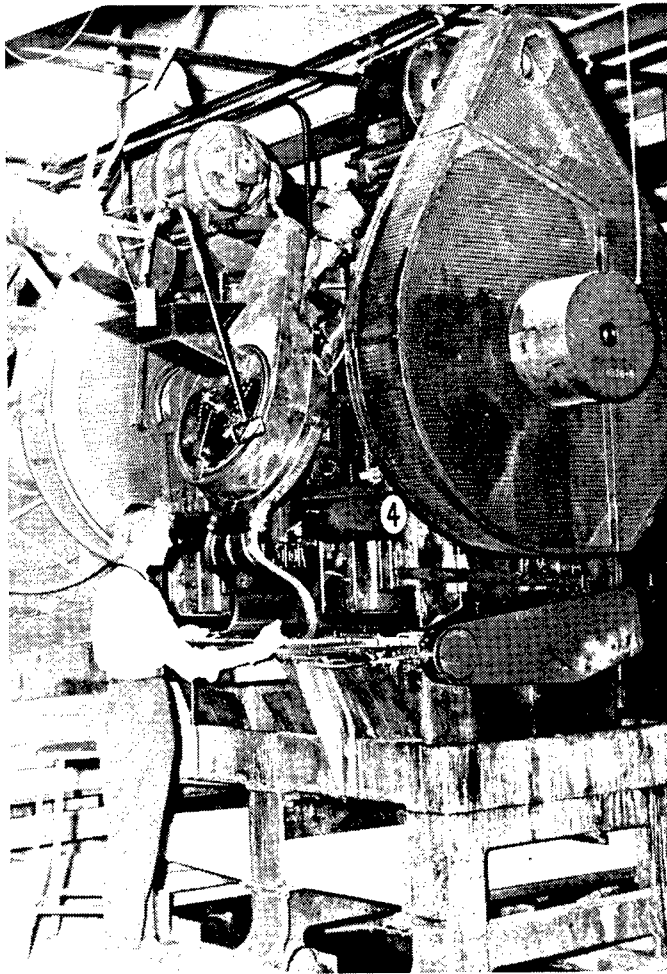

Figure 23. Small arms ammunition production at the Twin Cities Ordnance Plant (TCAAP Public Information Office).

At the TCOP, workers developed more efficient manufacturing, quality control, plant management, and shipping systems, both to increase production capacity and to improve plant safety. Plant workers developed an automatic inspection machine that replaced handwork and increased inspection rates ten-fold (Murphey 1993:7). According to a 1945 report, the TCOP made a significant contribution to small arms manufacturing technology in the form of a gage and weight machine (Figures 29 and 30) developed for acceptance (Voight 1945:300). In retrospect, however, it appears that the Twin Cities innovation was of “relatively minor” importance (Murphey et al. 1993:13).

More important, both in terms of its contribution to the war effort and the historical significance of the TCOP, was the opening of the TCOP reclamation center in 1944. TCOP workers designed a cartridge-disassembly machine that replaced a process previously done by hand. In 1949, two TCAAP employees invented an electric-powered disassembly machine that extracted the bullet with a vertically mounted rotary wheel, a technology that became an industry standard (Murphey et al. 1993:9-10). The design of the .30 and .50 cal. cartridge-disassembly machines by TCAAP personnel in the late 1940s represented a significant technological advance in small arms salvage technology (Murphey et al. 1993:9-10). Development in ammunition salvage begun during World War II continued at the Twin Cities facility during the Cold War period.



Figure 24. Small arms ammunition production at the Twin Cities Ordnance Plant. Packing .50 cal. ammunition. *St. Paul Dispatch* photograph taken in April 1944 (Minnesota Historical Society).

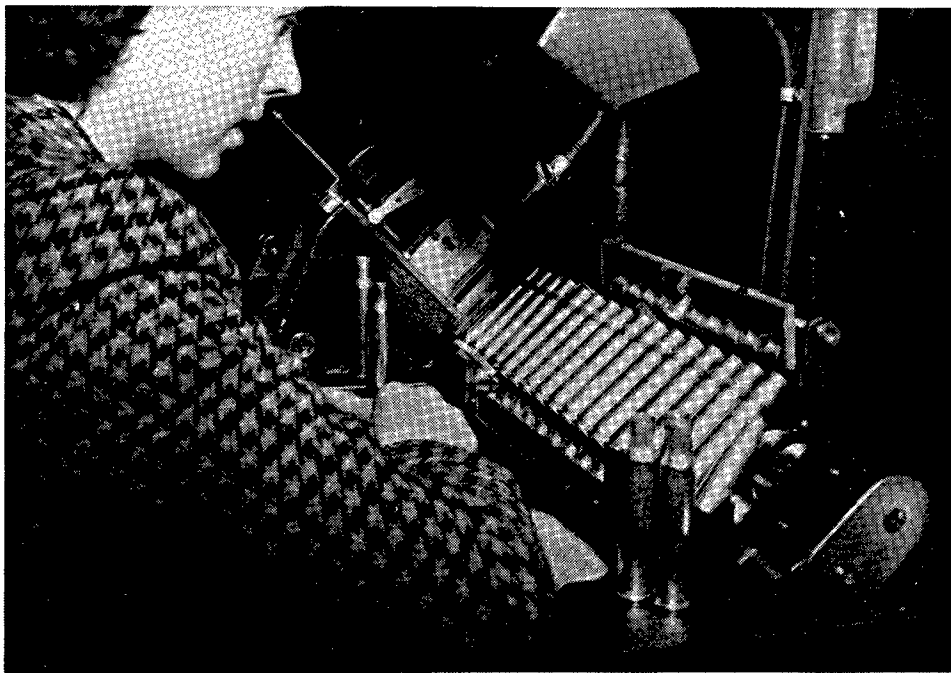

Figure 25. Small arms ammunition production at the Twin Cities Ordnance Plant. Inspecting .50 cal. ammunition. *Minneapolis Star Journal* photograph, undated but probably from 1942 (Minnesota Historical Society).

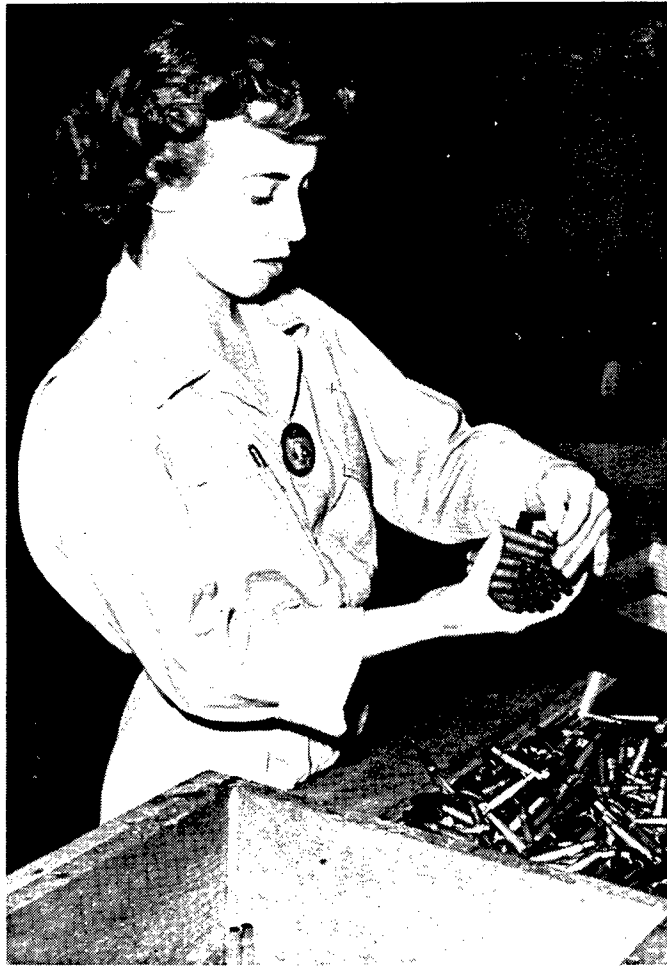

Figure 26. Employee at the Twin Cities Ordnance Plant. Note identification badge. Undated photograph (TCAAP Public Information Office).

Between 1942 and 1945, the TCOP produced over four billion rounds of small arms ammunition of every standard caliber then in military service, amounting to about 10 percent of all of the small arms ammunition used by Allied forces during the war (Murphey 1993:5). Types of ammunition produced included all five main small arms types: ball, armor piercing, tracer, incendiary, and blanks (War Department 1948:83-127). Tons of ammunition manufactured at the TCOP were shipped to combat forces in every theatre of wartime operations; tons were shipped to friendly nations under Lend-Lease. Significantly, the TCOP produced ammunition of high quality, and 94.3 percent of the cartridges manufactured were accepted as "Grade A" (Voight 1945:300). The plant posted several weeks where all ammunition accepted by the Ordnance Department was given the highest rating (Figure 31).

The TCOP output in 1942-1945 reflects the staggering small arms ammunition requirements of the Allied war machine. U.S. soldiers fighting their way across Europe in 1944-1945 expended more than 293 million rounds of rifle and machine gun ammunition in a single month at the peak of the fighting. Deliveries of .30 cal. ammunition reached more than 800 million rounds in one month. The TCOP's original designed daily production capacity, based on a 24-hour day, was two million rounds of .30 cal. (65 percent ball, 20 percent



Figure 27. Small arms ammunition production at the Twin Cities Ordnance Plant. *Minneapolis Star Journal* photograph, undated (Minnesota Historical Society).

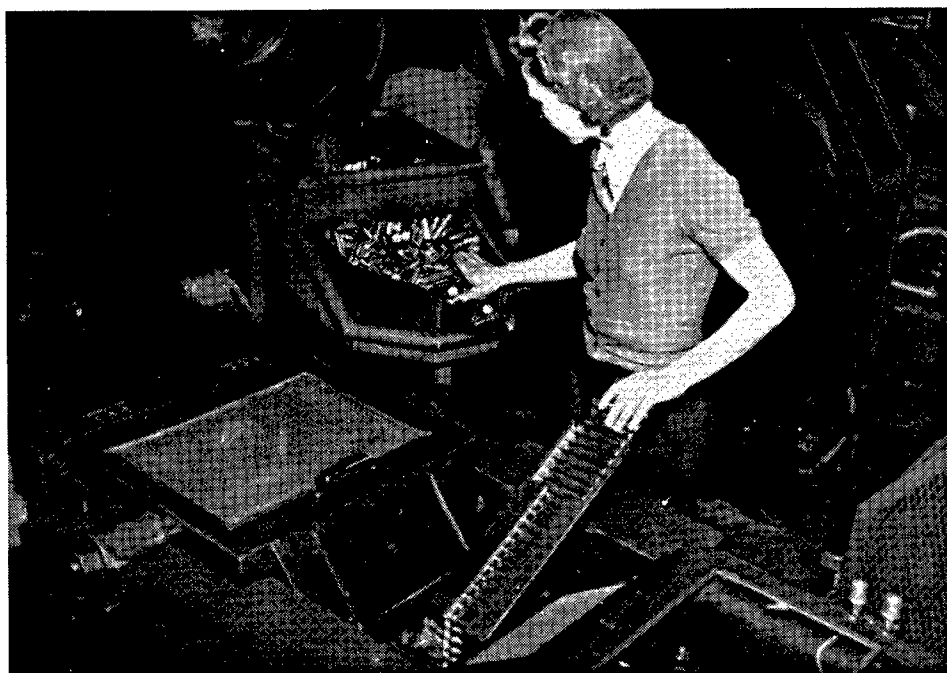

Figure 28. Small arms ammunition production at the Twin Cities Ordnance Plant. Worker placing cartridges on conveyor belt. *Minneapolis Star Journal* photograph, undated (Minnesota Historical Society).

# MAIN ASSEMBLY (FRONT VIEW)

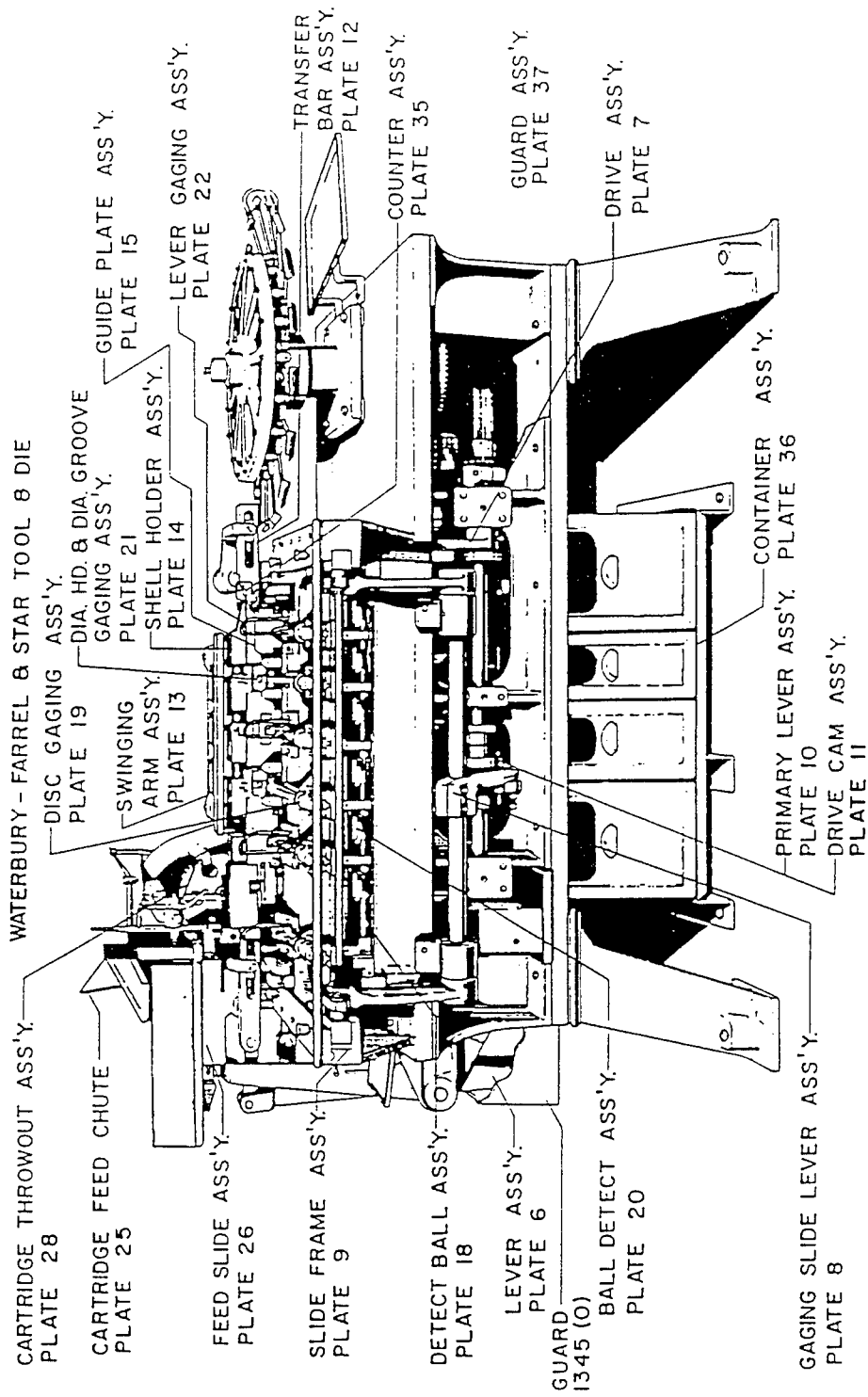

Figure 29. Gage and weigh machine (from Murphey et al. 1993).

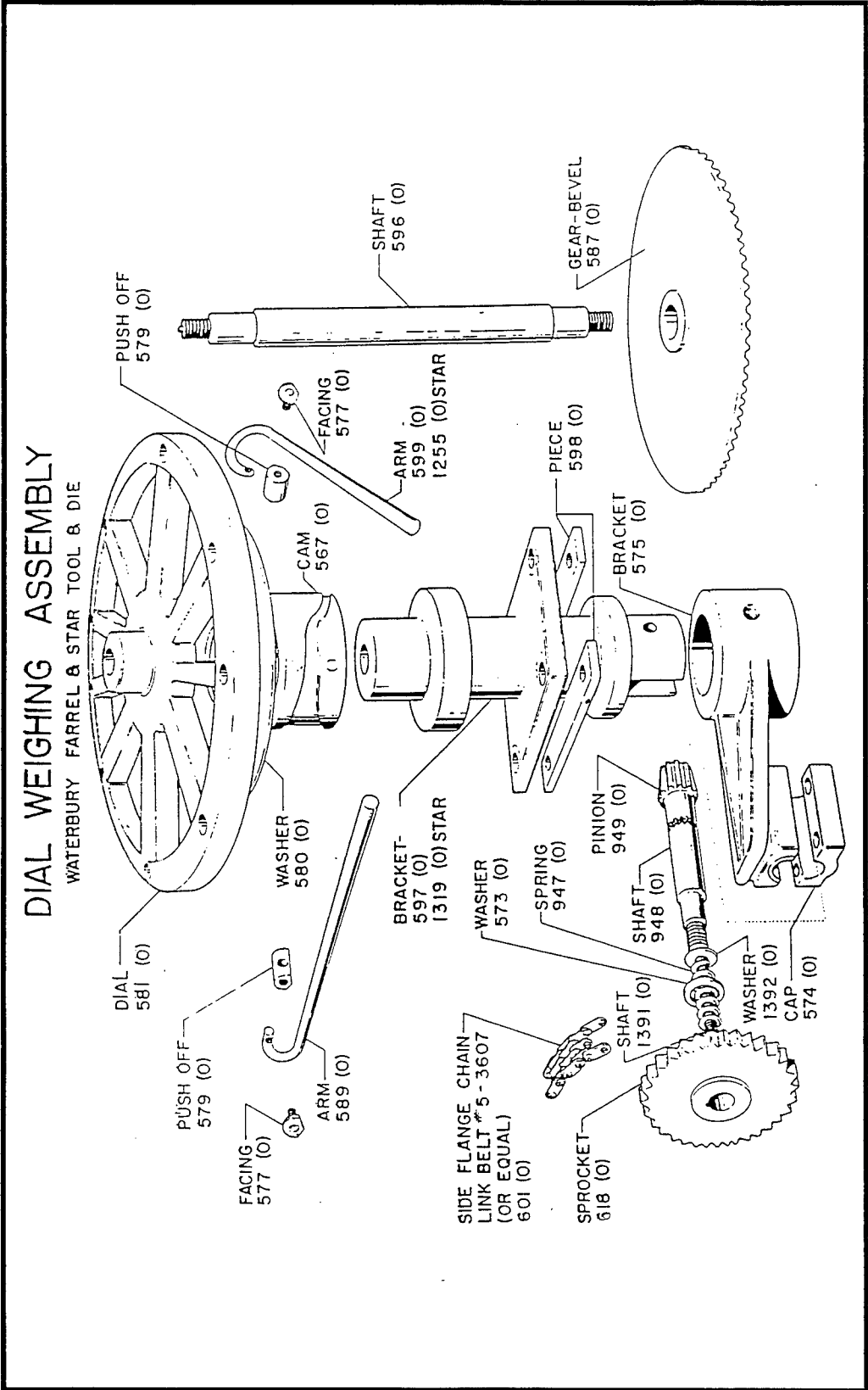

Figure 30. Detail of gage and weigh machine (from Murphey et al. 1993).

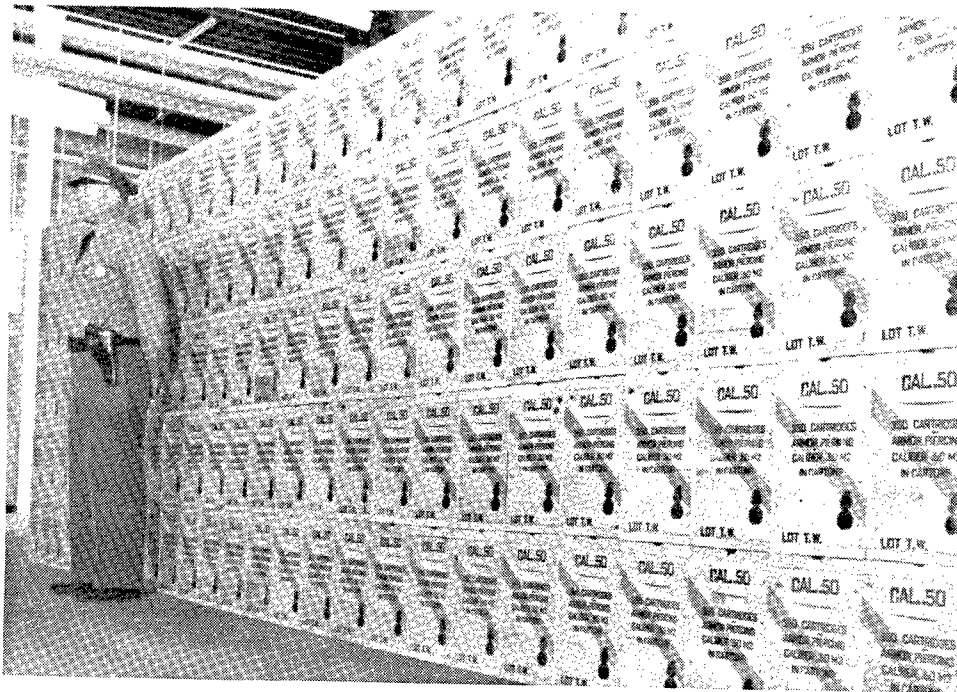

Figure 31. Ammunition manufactured at the Twin Cities Ordnance Plant, packed and ready for shipment. *Minneapolis Star Journal* photograph, undated (Minnesota Historical Society).

armor piercing, 15 percent tracer) and 600,000 rounds of .50 cal. (80 percent armor piercing, 20 percent tracer) packed and ready for shipment (Voight 1945:298). The authors of the official history of the Ordnance Department in World War II provide the context for interpreting these figures:

Rounds of small arms ammunition were produced during World War II in greater numbers than any other item of Army supply. Where as most Ordnance material was counted in the thousands or millions, small arms ammunition was numbered in the billions of rounds, total production for the 1940-45 period amounting to more than forty-one billion. Some measure of the magnitude of small arms ammunition production may be gained by comparing it with total wartime production of artillery ammunition (excluding bombs, grenades, and mines) of one billion rounds, or with procurement of high-volume Quartermaster items such as men's socks, about 145,000,000 pairs. If fired at a rate of twenty rounds per minute, night and day, year after year, the small arms ammunition procured by Ordnance in World War II would have lasted for almost forty centuries [Thomson and Mayo 1960:188].

Between 1940 and 1945, the Ordnance Department delivered 10,042,259,000 rounds of .50 cal. and 25,065,834,000 rounds of .30 cal. ammunition. During World War II, the U.S. spent \$184.5 billion on munitions, \$18.1 billion of which went to the production of ammunition, most of which was purchased by the U.S. Army. In addition, \$8.2 billion was invested in war plants, and another \$7.9 billion went to purchases of industrial machinery and equipment (Smith 1959:6-13).

## SOCIAL HISTORY

Inexpensive land was the magnet that drew the first Euro-American settlers to northern Ramsey County in the 1840s. The land shaped the local patterns of settlement, and ownership and use of the land was always one of the major concerns of nearly all of those who lived there. In the summer of 1940, most of the countryside around the village of New Brighton was under the stewardship of family farmers, many of whom were the descendants of nineteenth-century settlers. Much of the land was not particularly well suited to twentieth-century commercial agriculture; however, in comparison to other rural outliers of St. Paul and Minneapolis, farmland in northern Ramsey County was very inexpensive.

Former Governor of Minnesota, Mr. Harold Stassen recalls the selection of the Minneapolis/St. Paul area for the building of the TCOP:

When they began to talk about moving the development of some of the defense industries into the center of the country, representatives of the Department of War and Navy and so forth came out talking about locating plants in Minnesota . . . of course, we assured them of cooperation, and they began to look around. And in that process they also then asked about locations around the Twin Cities areas and about cooperation from the state and the communities and also about individuals who might be involved in such an effort. It's my recollection that, in that process they came to me and asked me whether I knew Mr. Horn . . . The next I knew about it, they were then negotiating with him for the building of an ordnance plant [H. Stassen, interview 1994].

The land for the TCOP was acquired by the U.S. government from individual landowners by condemnation. Because the land was regarded as vital to the national defense, few landowners turned down the government's initial offering, which totaled \$133,685, and by the late summer of 1941 several dozen families had begun the painful process of leaving behind their homes, farms, and businesses (Merritt 1976:401; Murphey 1993:8; *St. Paul Pioneer Press* 21 July 1941 and 11 September 1941). Mr. Carl Holmberg, long-time area resident and former ambulance driver at the TCOP, recalls very little objection to the government acquisition:

Inasmuch as the wars with the accompanying atrocities and everything that went with it ( . . . ) it more or less geared the people to the fact, well, if we can do something, we will. And basically, there was very few objections heard around [C. Holmberg, interview 1994].

Former Governor Stassen agrees: "I do know that there were no unresolved problems as to the way in which the land became used for an ordnance plant" (H. Stassen, interview 1994).

This situation was by no means unique, but was part of a pattern of events that was taking place throughout the U.S. where more than seven million acres of land, much of it privately owned farmland or ranchland, was purchased for military bases and defense plants during World War II. Mr. Carl Holmberg remembers the local landscape before the construction of the plant (see Figure 8):

I guess the best description you can give of it was ma and pa farms. And of course there were several farms that were owned by people of the same family name . . . And, while there was some good land, this big Marsden Lake took up a portion of the area, and that never was farmable. And then, there was a big gravel pit [that] was found on this property [approximately 2-3 square miles in size] so that was marginal [for farming]. But these people were hard-working, and they farmed, they had some dairy cattle, [and] they fed some cattle for beef purposes [C. Holmberg, interview 1994].

Within weeks, a small army of construction workers had transformed the original rural landscape into, according to some accounts, a rather chaotic industrial site (Figure 32; see Figures 8-11 and 18-19). When asked about the conditions at the construction site, Mr. Holmberg responded:



Figure 32. View of the Twin Cities Ordnance Plant in its early days, possibly during the winter of 1941-1942 (TCAAP Public Information Office).

Wheeeee! [laughter] Well, when you have earth-moving machinery leveling off property you have to look out for them because they can't look out for you. And they moved thousands and thousands and thousands of yards of ground to make the roads, make the parking lots, make the building sites . . . This all had to be coordinated . . . There was eighteen thousand construction workers scattered all over these four square miles. When you could go up on top of the hill over there where the water tower was, there used to be a guard coop up there, and you'd go up there and look down, and it was literally looking like ants working around . . . Tractors going this way and tractors going thataway . . . [C. Holmberg, interview 1994].

Some vestiges of previous land uses persisted, however. The TCOP boundaries took in the waterfowl refuge that had been established by the Izaak Walton League some years earlier, as well as the 40-acre arboretum of Jonas L. Christensen, a University of Minnesota plant pathologist. Prof. Christensen was allowed to "evacuate" more than 25,000 trees, shrubs and plants. (By a cruel irony, the site he selected for reestablishing his arboretum lay in Rosemount, south of St. Paul, on the site selected for the Gopher Ordnance Plant in 1942 [Merritt 1976:402].) The TCOP site also included at least two taverns (*St. Paul Pioneer Press* 6 August 1941), a supper club, and a sand and gravel quarry.

Wherever war industries were located, boom towns sprang up seemingly overnight. Like other towns across the country, New Brighton became a boom town with prefabricated houses and offices. The TCOP was connected by paved highways to both Minneapolis and St. Paul, both downtowns being about ten miles away, and traffic congested local roads at all hours of the day and night (*Minneapolis Star Journal* 3 March 1942). Mr. Carl Holmberg remembers that "the highways couldn't handle all this traffic," and that the roads were congested constantly. As an ambulance driver for the TCOP, Mr. Holmberg was occasionally called upon

to assist with potentially dangerous traffic situations which sometimes developed along the crowded route to the plant:

Part of the powder mixing . . . was done at the Anoka facility. And they would make up a batch and put it in a truck and bring it [to the TCOP] in the truck that was properly marked and had warning signals. But every once in a while somebody would smack one of those powder trucks [on the highway] and it would scare the daylights out of people . . . The powder was packed in isolated compartments, very cold compartments . . . and if the powder truck stops on the road and the temperature starts to rise . . . that could create problems . . . There was three different times after the plant went into production when these powder trucks . . . were disabled out on the highway . . . But as time was winding out [before the powder became dangerously warmer], they recruited the ambulance and we put this powder in the ambulance . . . all we could do was move. So we put this powder keg in the ambulance and bring it to the arsenal and put it where it belonged! [C. Holmberg, interview 1994].

War work rejuvenated the regional economy, of course, but it also brought on problems in housing, law enforcement, and health care. Even war plant workers with money could not find suitable housing, and the local school districts could not hope to keep pace with the population explosion (*St. Paul Pioneer Press* 14 January 1942). New Brighton town officials did not quickly recover from the shock of their having to deal with their new neighbor, and local government efforts to impose some kind of control over the TCOP became mired in endless controversy (e.g., *Minneapolis Times* 3 December 1941; *St. Paul Pioneer Press* 23 December 1941 and 10 February 1942).

Much of what happened to New Brighton and the other communities surrounding the TCOP happened without any kind of realistic planning. The momentum of the rapid construction and start-up of the TCOP revolutionized the local economy and landscape. New Brighton quickly learned of the uncertainties which beset a boomtown, for within a few weeks the village was flooded with government agents, contractors, construction workers, job seekers, and hangers-on. Most of these were Twin Citians, about 45 percent from St. Paul and 55 percent from Minneapolis, according to one estimate (*St. Paul Pioneer Press* 19 February 1942), but thousands were from elsewhere, according to the scanty data available. Shortly there were several thousand workers within a half dozen miles of the village, and a trailer city of perhaps 2,000 inhabitants grew with the construction work (*Minneapolis Times* 14 January 1942). No final accounting of the number of construction workers employed at the TCOP has been found, but one source, citing Corps of Engineers records, reports that at one time over 5,000 workers were employed on the project (Merritt 1976:400). Other estimates indicate that as many as 11,000 or more construction workers were employed at the TCOP (B. Gertsema, personal communication 1994).

The process of starting up production was far from smooth. Construction crews were still heavily engaged at the TCOP when another army converged on New Brighton to report for work in the manufacturing plant. The bustle and confusion of the newly built industrial site was increased by throngs of workers being trained to operate the facility. For a time, TCOP employment grew by the thousands every month (Ordnance Department 1942b, 1943a, 1943b, 1943c, 1943d).

Labor supply was an important factor in determining GOCO plant locations, and the TCOP tapped a large and diverse regional labor pool. While the typical Midwestern factory worker in the 1940s was undoubtedly more mobile than the preceding generation, the expense of moving and the attachment to home and friends tended to keep Twin Cities workers relatively close to home. The decline of farm labor as a viable source of employment freed many rural folk for factory work, and this rural labor supply was further augmented by former inhabitants of small towns who had swelled the urban labor force during the 1920s. It is believed that upwards of 75,000 men and women applied for jobs at the TCOP. Part of the lore of the TCOP is the stories of lines of job-seekers snaking upwards into the Foshay Tower where FCC had its offices. Prospective employees were screened by a battery of FCC, army, and medical personnel. Applicants had to be at least 21 years of age, U.S. citizens, physically healthy, and (if male) had to hold a draft deferment.

Each prospective employee was given a written test of general intelligence, similar to that required of draftees by the Army. FBI background checks were required to weed out "questionable aliens," convicted felons, and other undesirables. The type of work performed at the TCOP also drew skilled laborers, artisans, and professional workers. As the plant became established, skilled labor was trained on-site.

Production began in March 1942 (Voight 1945:297). At the height of the war, the TCOP employed 26,000 workers in three shifts, and its greatest immediate effect was to create a labor shortage. Immigration to Minnesota had declined dramatically since 1915, eliminating an historic source of cheap labor. At the same time, tens of thousands of young men had been called into national service by the draft, which had begun in 1940. The supply of available factory workers was consequently declining just at the time that industry was expanding. This labor supply shortfall was partly filled by women, African-Americans, the elderly, and other formerly excluded groups. Ms. Julia Kohler, a production worker at the TCOP, does not remember if there were serious labor shortages at the plant, but she does recall that "they seemed to always get enough applications to fill in what they needed. Some of the women were quite old, but they seemed to keep up and do their work. There was one little old man, I don't know where they found him, he was a little old grandpa . . . There were very few able young men around unless they were 4F . . . physically unfit for service" (J. Kohler, interview 1994). The general labor shortage persisted in spite of the new faces in the work force. As a consequence, unemployment virtually disappeared, the bargaining position of workers improved, and wages were forced upwards.

The TCOP and other war industries created unprecedented opportunities for women, African-Americans, Hispanics and other minorities to earn a livelihood. "Additional employees for factory operations in Plant 2 and expansion were being recruited as the year 1942 ended, and the plant management found that the dwindling supply of men workers made necessary the employment of a larger percentage of women," states the introduction to the plant history compiled by the Ordnance Department. It further notes that of the 16,495 plant employees at work on December 31, 1942, 43 percent were women and .033 percent were African-Americans (Ordnance Department 1942a:9; Figure 33).

During the first decades of the twentieth century, the number of women employed outside the home had increased substantially, but much of the advance had come in middle-class occupations such as teaching, nursing and secretarial work, rather than in the traditionally male-dominated smokestack industries (Wertheimer 1977). Although World War I had drawn hundreds of thousands of women into industry, most did not stay on after the end of the war. World War II brought more women into the work force than ever before. "Rosie the Riveter" became a national symbol and by 1944, 31.5 percent of the women in the U.S. were employed outside the home (Bingham 1989:452; cf. Thomson and Mayo 1960:112), many in defense work. While early plans projected that 40 percent of the wartime work force would be female, over 60 percent of those eventually employed at the TCOP during World War II were women (see Figure 27). Most of the people employed at the TCOP had husbands and family members in the war; thus, many believed the work that they did at the plant had a direct impact on their loved ones' success in battle. Propaganda reinforced this belief (Figure 34). Mrs. Laura Peterson, a telephone operator at the plant, recalls that many of the conversations she had with her co-workers revolved around the war:

We'd talk about the war. Some of them [her co-workers], their husbands were in the war, too. My husband . . . I wrote every day and he wrote every day . . . every day, every day. And so all of a sudden you'd get a big batch, probably six, seven letters at one time, even more . . . The girls would talk about that [L. Peterson, interview 1994].

Unlike today's working environment and its supporting social institutions, neither the TCOP nor the local community readily offered daycare facilities. Mrs. Peterson, who was raising two young boys, moved in with her mother and father during the war: "It had to be like [my situation], living with my mother. I worked day hours so I was with [my children] in the evenings. I really can't say what [others] did with their



Figure 33. A group (commonly referred to as a “unit”) of production workers at the Twin Cities Ordnance Plant. Note that there are several women and one African-American in this group. Also note the uniforms and special shoes issued to the workers. The shoes are designed to not generate any static electricity (TCAAP Public Information Office).

children . . . but they somehow managed; somebody must have taken care of their children” [L. Peterson, interview 1994]. Page 10 of the 9 October 1942 issue of *Twin Cities Ordnance News* contains a small article which reports that social agencies of the city of St. Paul were planning to set up “foster homes with care ‘just like mother gives’” for TCOP workers. “For a nominal amount the foster mother will see that the youngster gets to school - if a school-age child - will get one main meal and perhaps a between-meal snack, a rest period and will promise that a responsible person is always in charge.”

The importance of the women workers at the TCOP was duly noted by government officials and reported in the media (e.g., *Minneapolis Star Journal* 22 February 1942; *St. Paul Dispatch* 4 February 1943 and 7 July 1943). When President Roosevelt made his secret inspection tour of the TCOP in September 1942 (Figure 35), the plant newsletter reported that the women ordnance workers had made an impression on the president who “told newspaper correspondents at his press conference upon returning to Washington that he was struck by the fact the Twin Cities Ordnance Plant employed women to work with machines not only of the sewing machine variety, but also larger machines” (*Twin Cities Ordnance News* 9 October 1942:6).

The Fair Employment Practices Committee was established by the Roosevelt Administration in June 1941 to prevent racial discrimination in defense industries. With the war effort depending so heavily on the labor of African-Americans and Hispanics, patriotic posters exhorted them to support the troops overseas. When the president visited the TCOP in October 1943 he commented on the fine job Federal Cartridge Corp. had done putting almost 500 African-Americans to work at the plant (*Twin Cities Ordnance News* 9 October 1942:6). One former worker at the TCOP interviewed during the course of this investigation noted that he

## TCOP TELEPHONE OPERATORS HANDLE 20,000 CALLS A DAY

Twenty million calls in three years—20,000 calls per day at the present time—is the record of TCOP telephone service. This volume of business, coupled with an acute shortage of operators and the consequent overworking of those available, explains why plant telephone service is not as good as the Communications department would like it to be.

With each operator handling more calls per hour than is considered good practice, the forced operation of the switchboard often results in slow disconnects, cut-offs, ring-backs and wrong numbers. The overload of business has caused more than average wear and tear on equipment. Unless the volume of calls can be cut down, much of the equipment will have to be replaced or repaired before long.

A few suggestions are given here from the Communications department to relieve the telephone situations:

Do not use the telephone for

visiting. Use the pay stations for personal calls.

Rather than hold the line open when you wait for needed information, have the person on the other end of the line call you back.

Make your call as short as possible.

Answer promptly. If you are going to be out, arrange to have someone answer in your place. When you are in, answer your phone yourself because the party calling wants to talk to you and not to anyone else.

When you have completed a call, hang up for at least 30 seconds before trying to make another. This indicates to the operator that you are through on that connection and she will get the disconnect signal promptly.

Remember that the operator is human, that she is probably handling over 300 calls per hour with a terrific strain on her mind and nervous system and that she is always trying to give you perfect service in spite of all handicaps.

Left to right: Lucille Jennrich, Laura Peterson, Marie Miscera and Helen Gruber.

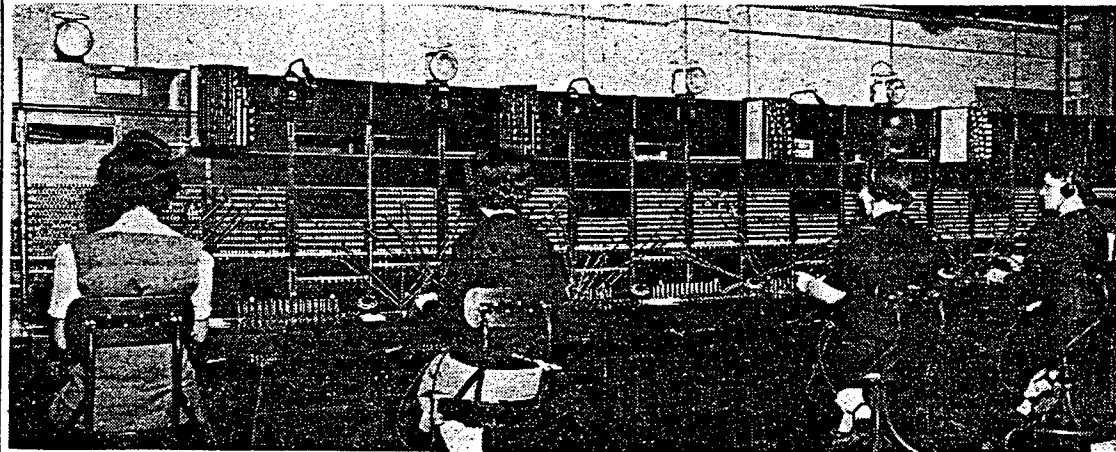

eq...  
making necessary  
used the drive, the HAZARD  
would be minimized.

Greetings and a Happy New Year to the old-timers who have come back as well as the newcomers who have just arrived! Our *Safety* record was good in 1944. Will you help us make it better in 1945?

### From Somewhere in Germany

To All Workers of Twin Cities  
Ordnance Plant:

We boys over here are very proud of you. In our drive through France, Belgium and Germany, I've noticed a lot of our ammunition comes from your plant. We know that the Company and its workers are doing a wonderful, good and a big share of the burden that it will take to bring this war to an early conclusion. Now that we are fighting the enemy on his own soil we must double our efforts. We will continue doing our best and hope you continue doing as well as you have in the past, or if there's a possibility of doing better, the boys over here would be grateful to you. Couple things a man needs here is ammunition and of course—mail.

Wishing you a lot of success in the future.

I remain—

Pvt. Leonard E. Skiba  
Co. C 23rd Arm'd Engrs.  
APO 253 c/o Postmaster  
New York, N. Y.

Figure 34. Copy of an article from an unknown newspaper, possibly the *Twin Cities Ordnance News*. Note the inserted letter from the United States soldier. Also note that Laura Peterson, oral history informant during this investigation, is the second telephone operator from the left (photocopy on file, Bear Creek Archeology, Inc.).



Figure 35. President Franklin Roosevelt visiting the Twin Cities Ordnance Plant in September 1942. Peggy Johlfs, forewoman of the Building 101 A-shift, presenting the President with a cluster of .30 and .50 cal. cartridges while FCC President Charles Horn looks on (TCAAP Public Information Office).

tried to go out of his way to make sure that a person of a different ethnic background felt comfortable. Mr. Holmberg stated that race was never a consideration to him in the business of driving an ambulance. Despite the government's good intentions, some racial discrimination likely continued. When asked if there were "problems between the races" or not, another interviewee recalled the dismissal of an African-American woman from the unit when the woman's co-workers complained that she was not doing her job very well.

The "industrial equation" for the TCOP included organized labor. During the construction phase, the CQM had to wrestle with the building trade unions from the Twin Cities. Because the wage scale in St. Paul was 13.5 cents per hour lower than that for Minneapolis, union contractors from Minneapolis were effectively excluded from consideration for jobs at the TCOP. This problem was quickly worked out to the satisfaction of all parties concerned, and for the duration work was divided between the different union contractors (Merritt 1976:402). There were also persistent rumors that jobs at the TCOP were being sold for a \$75 kickback. Upon investigation by the Ordnance Department, these allegations were proved to be false (cf. Merritt 1976:402; *Minneapolis Times* 18 December 1941; *Minneapolis Tribune* 30 January 1942; *St. Paul Dispatch* 18 December 1941). Most of the informants interviewed during the course of this investigation did not recall the selling of jobs, although they admitted that such practices could easily have occurred without their knowledge. Most labor-management confrontations were handled on-site, with the War Department officials playing a critical role.

The federal government forced the operators of the GOCO plants to allow for union organization and collective bargaining (Fairchild and Grossman 1959:130). Nationwide, more than 12 million workers were organized in the CIO and AFL during the war. Labor-management committees were set up in most factories, but these seem to have been little more than window dressing (Zinn 1980:408). The Fair Labor Standards

Act of 1938, which called for a 40-hour week, also went into effect late in 1940. Organized labor at all levels realized that while the unemployment, economic distress, and social turmoil that had marked the 1930s had been overcome by the war, the biggest gains were in corporate profits, which far outstripped rising wages.

While most workers at the TCOP appear to have felt that the system was doing well enough for them, some objected vehemently to wage and price controls. From a national perspective, it is interesting to note that despite the overwhelming atmosphere of patriotism and total dedication to winning the war, many of the nation's workers went on strike. Indeed, during World War II there were more than 14,000 strikes, involving 6,770,000 workers, more than in any comparable period in American history (Zinn 1980:408).

TCOP workers honored the no-strike clause in their contracts and there were no reported major work actions at the plant. Proceedings of the plant Grievance Committee were reported in each quarterly historical report prepared for the Ordnance Department, and there were generally relatively few major grievances. During the month of March 1944, for example, when there were just under 10,000 workers employed at the plant, there were just 218 grievance hearings (Ordnance Department 1945b). It should be noted, however, that the number of grievances submitted to the committee climbed steadily after 1944.

By the standard of the time, FCC paid its workers top wages, up to more than a dollar an hour. Mr. Everett Needels' starting pay was "78 cents an hour. Our pay was \$1.20 after I got promoted to Powder 2. \$1.20 an hour and time-and-a-half for Saturday. The rumors, I don't know whether they were true or not but I presume they were, that our area was the highest paid production area in the plant" (E. Needels, interview 1994). Although Mrs. Laura Peterson does not recall exactly how much she was paid, "it was more than what I was making . . . at Northwestern Bell." In fact, the higher pay at the plant was one of the reasons she left Northwestern Bell for the TCOP (L. Peterson, interview 1994).

While it would seem that increased worker buying power, even in a wartime economic environment characterized by rationing and shortages of consumer goods, would increase and stimulate non-defense businesses, this does not seem to be the case according to the oral interviews. Due to the comparatively high wages many of them earned, some of workers at the TCOP may have experienced a rise in their standard of living and may have been able to buy some "luxury items." However, most of the informants interviewed during the course of this investigation said that they saved their money during the war; some said it was due to low availability of goods because of the rationing, and others seemed to be waiting for the war to end, waiting for their lives to begin again:

I was waiting for my husband to get home and to get on with my life. He would send money to me, and I had a separate account so that we had a good down payment for a home [once he returned from the war] . . . You know, you couldn't buy nylons. (Well, at that time it was 'rayons.') There was a lot of things that you couldn't buy . . . You were rationed. My mother was given stamps that you could only buy so much meat a week, and for sugar ( . . . ) for a lot of things ( . . . ) and cigarettes you couldn't get . . . Everything was rationed. You couldn't buy a new car; gasoline was rationed ( . . . ) because we had a lot of boys over there to feed. People had to do their part [L. Peterson, interview 1994].

Mr. Everett Needels also stated that most people that he knew tended to save money during the war because:

There was nothing to spend it for. You couldn't buy anything. You couldn't buy any coffee, women couldn't buy any silk socks, they couldn't buy any lipstick. Meat was rationed; you could only buy so much meat. Gasoline-- you had to have a coupon to buy. You could get the bare essentials to eat on. That's the way it was. We all got enough to eat. Margarine was just coming in at that time. Butter was 35 cents a pound and margarine was 15 cents a pound so everybody was using margarine (It was white then. You've probably never seen white oley, have you?) . . . You couldn't buy a car. There was no

new automobiles; they quit making them . . . It was hard to spend anything [E. Needels, interview 1994].

Mr. Needels goes on to recall the difficulties in being able to buy lumber during the war for a much needed home improvement project:

I bought this house in Hyland Park in '32, and it was a poor little house. Not very big; 24 by 28 [feet] approximate. And I had two sons, and we needed more room. I had to apply to some government agency that would allow us to buy lumber to build an addition on it. It was quite a struggle to get permission to do this. And we finally had to have a fellow come out to the house and look at our house. We had two kids and one bedroom and one closet. And when he saw that he said, 'Well, I guess you need some more room.' So he gave us the okay to get a permit to buy lumber [E. Needels, interview 1994].

According to Mrs. Peterson, the rationing did not bother people: "You never heard people complain. No, because you were helping, you were helping the war effort to bring those boys back . . . We were more patriotic, I guess" (L. Peterson, interview 1994).

The work place environment at the TCOP was probably not drastically different from that of a comparably large civilian manufacturing enterprise. The development of American manufacturing in the industrial era had been influenced by several factors, not the least important of which was scarcity of labor, which inevitably favored the creation of labor-saving machinery and the standardization of manufacturing processes. Just as important was freedom from tradition, which enabled manufacturers to develop and adopt new methods and products (Noble 1984).

The TCOP was one of the more efficient GOCO plants in terms of worker productivity and safety. The historian of the St. Paul District Corps of Engineers, which oversaw defense contracts in the Twin Cities area, relates that "lost time due to accidents was only 20.66 per million man-hours [sic] compared to the national average of 33.47" (Merritt 1976:402). Mr. Carl Holmberg, ambulance driver at the TCOP, recalls the safe operation of the plant:

Each one of these production buildings, or production areas, had a nurse and a first aid station, and that was operated 24 hours a day. So what she couldn't handle would have to come up here for X-rays or for doctors' review, and if he [the injured person] didn't have to lose time, why, he'd go right back to work again [C. Holmberg, interview 1994].

However, during the construction period, there was only one first aid station set up in an old school house, and one newly constructed home located along Highway 96 and Hamline Avenue was set up as a hospital (C. Holmberg, interview 1994). There were, apparently, several serious construction-period accidents, and in November 1942 a civilian was killed in his yard on Turtle Lake by a stray round from inside the TCOP (*St. Paul Pioneer Press* 12 November 1942). The first production-related fatality occurred in early 1945, when two male plant workers were involved in an explosion while handling scrap ammunition; one was killed, the other critically injured, and as a result a new procedure for disposing of scrap explosives was implemented (Ordnance Department 1945a). Although the rate of accidents at the TCOP was less than in most defense plants engaged in comparably dangerous work, accidents did occur. Mr. Everett Needels, powder mixer at the plant, personally recalls only three fatalities during production:

One of the fellows that I worked with . . . After I'd left the plant in '45, he evidently did something wrong and the building blew up on him, and the door flew off, and he was out at the switch<sup>1</sup> which was fifty feet away, and the door hit him. Killed him . . . The explosion of this 12 pounds [of powder chemicals] had enough force that it blew the door off the building. And then I also heard, I'm not positive about it, but at night when they were moving some primer caps that were already loaded with powder . . . there was two other guys that got careless, and they blew up the truck. They were killed too. You had to be pretty careful with the stuff. It was hot. It was a long four years, I'll say [E. Needels, interview 1994].

When asked if major accidents and deaths were publicized, Mr. Needels stated that "there was nothing in the paper and it was only through the rumor mill that we got it, but I know that if they were careless with [powder], it could happen" (E. Needels, interview 1994). For the most part, however, the workers interviewed during this investigation did not recall many serious accidents or fatalities. An ambulance driver working at the TCOP recalls "surprisingly few" fatalities while the plant was in operation:

Considering as highly explosive as what they were working with, why, they had a remarkable safety record. The insurance company had a whale of a safety engineer out here . . . They had surprisingly few fires. Oh, there was a few puffs here and there in the ammunition loading ranks, but that was to be expected [C. Holmberg, interview 1994].

According to Mr. Holmberg, there were many safety precautions taken by plant workers. Mr. Needels describes the special protective clothing they were required to wear:

My wife used to call them 'pajamas.' They were a kind of a gray uniform which had no pockets, and the pants had a drawstring on them that tied it up. The shirts were just a short-sleeved shirt. We had to have special shoes so that we wouldn't generate any static electricity. They were hard shoes; they weren't the most comfortable things, but I think that the plant furnished them to us. I know that they furnished the uniforms. We were supposed to take a shower every night before we went home to get cleaned up [E. Needels, interview 1994; Figure 36].

Ms. Julia Kohler, a production employee who worked in the primer loading area, a relatively dangerous area of the plant, also recalls her uniform (see Figure 33):

We had to wear hair nets. And then after while the people working in powder-tracer they all wore coveralls, like a one-piece thing like a jumpsuit, and kerchiefs on their head. After while they were taking measurements in loading where I was working for the powder chargers. We people that worked in the wings, tracer and primer loading where you put the powder in the shell, we were the only ones that were issued [special] shoes [J. Kohler, interview 1994].

In addition to the "excellent management" by Mr. John Funk, Aetna Insurance Company safety engineer at the plant, Mr. Carl Holmberg credits Federal Cartridge for setting a high safety standard at its Anoka plant which was "very well managed and very well run, so that came down here." He also believes that the employees at the plant had a special incentive to do their best work: "When this [plant] was going at its full blast, people were taking pride in doing good work because they had friends and neighbors and relatives in the services; they wanted to do good work" [C. Holmberg, interview 1994].

---

<sup>1</sup>According to Mr. Needels, the powder mixer employee went outside of the building to turn on a switch which started the mixer. This switch was located fifty feet away from the building to protect the worker in case a blow up occurred during the mixing process.



Figure 36. Typical employee locker room at the Twin Cities Ordnance Plant during 1941-1945 (TCAAP Public Information Office).

While no statistics are available on the number of commuter traffic deaths and injuries, anecdotal evidence from newspaper accounts and the recollections of plant workers suggests that the most serious threat to the health of TCOP workers during World War II was driving to and from work at the plant (e.g., *Minneapolis Star Journal* 3 March 1942).

Much has been made of the fact that the TCOP, like many large defense plants, was a veritable self-contained town, with its own fire department, water system, radio station, telephone exchange, hospital, police force, bus system, and railway terminal. A large security force combined traditional police and military-industrial security functions and included a number of women and at least one African-American (*St. Paul Dispatch* 7 July 1943). There was a plant newspaper, *Twin Cities Ordnance News*, a radio station, and a Recreation Office which organized several intramural sports leagues and club activities. Northwestern Bell placed a cable from its St. Paul system into the TCOP administration building, where FCC employees manned the switchboard (see Figure 34). Trash and production waste were collected and disposed of within the TCOP. A well-staffed infirmary, commissary, and canteen rounded out the plant's support services.

Beginning in December 1941 and continuing very nearly until the end of the war, the unrelenting message that the TCOP was critical to the war effort was a staple of worker life (Figures 37-41). Mr. Carl Holmberg states that "this was just a little plant. [Other plants dealt with] higher explosives that had more fire power. This was not the largest plant, but, oh! What a contribution it made to the armed forces and to the general victory of the country. I think that all the employees that were out here . . . took a pride in supplying a product that was going to do the job and do it right" [C. Holmberg, interview 1994]. Although the practical message of the GOCO propaganda campaign was that everyone needed to demonstrate their unswerving commitment to victory or risk the downfall of American civilization, most workers at the TCOP did not need posters and shop-floor speeches to convince them that their work was important. Even so, the propaganda

*TCO Peqqy Says...*  
**I HAVEN'T BEEN  
ABSENT WITHOUT  
A GOOD REASON!**



Figure 37. World War II poster at the Twin Cities Ordnance Plant. (TCAAP Public Information Office).



Figure 38. World War II poster at the Twin Cities Ordnance Plant. Undated Ordnance Department photograph (TCAAP Public Information Office).



Figure 39. World War II poster at the Twin Cities Ordnance Plant. Undated Ordnance Department photograph (TCAAP Public Information Office).

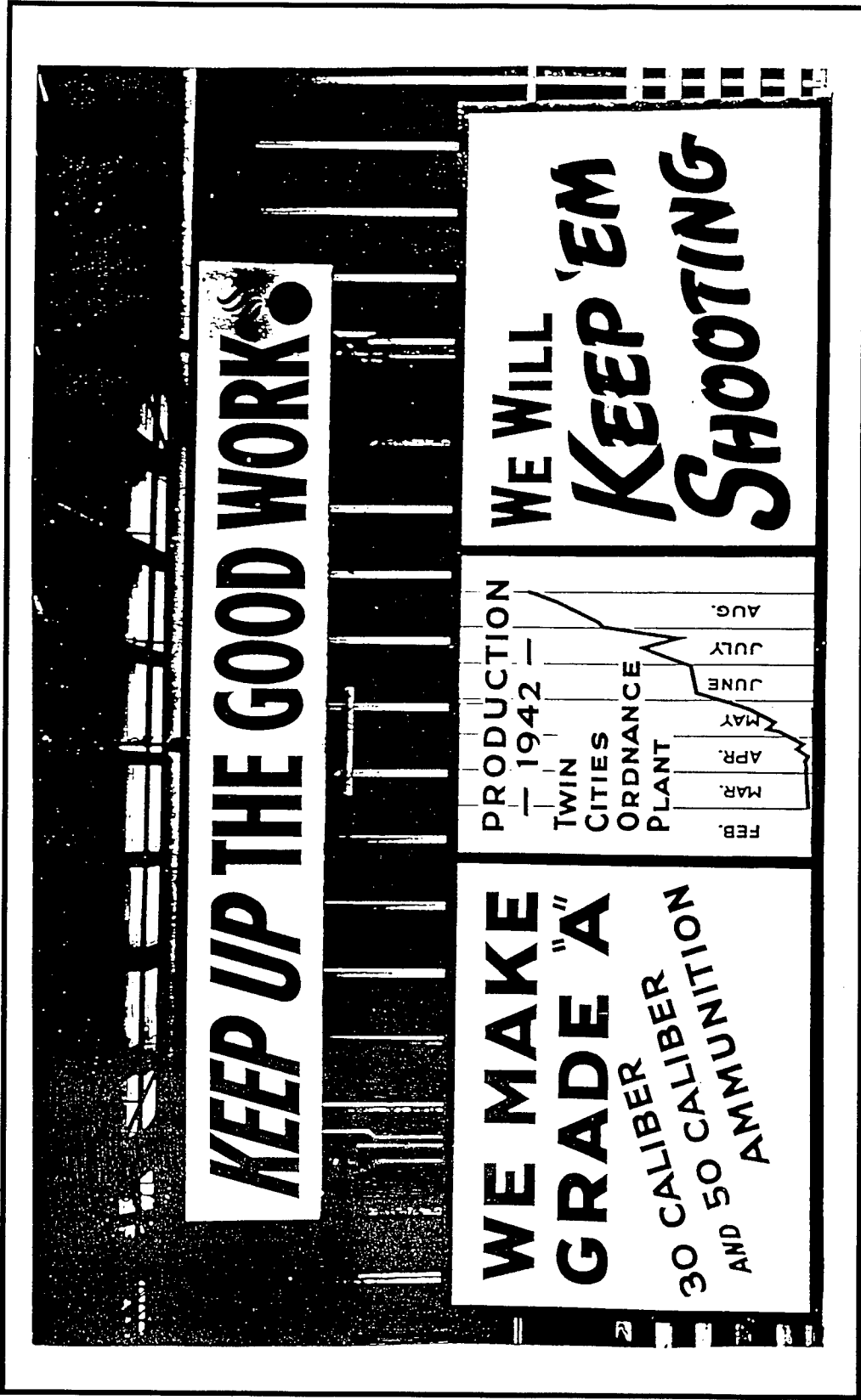

Figure 40. World War II poster at the Twin Cities Ordnance Plant. Undated Ordnance Department photograph (TCAAP Public Information Office).

campaign was unrelenting. Some of the workers recalled that they were continually asked to buy war bonds with a certain portion of their paycheck; many of them did. Ms. Julia Kohler, a TCOP production worker, recalls a promotion during a bond drive that was meaningful to her:

One day my line was broke, my machine was broke down, and somebody told me to go to the office. And I thought 'What's going to happen to me now?' And he said, 'Go down to the cafeteria.' And here they had built a little stage. It was Thursday, March 11, 1943. And the mother and father of the five who had died, the Sullivans, brothers who had gone down in that ship; and the sister, Genevieve, was along, she was the only survivor in that family. She had broke her arm, and she had her arm in a sling that day. But they were all talking about the boys going down; all five went down on that ship. And we were all feeling really bad. Five sons who were 20-28 years old, all five of them went down. [The Sullivans were there] for a war bond drive . . . [J. Kohler, interview 1994].

According to Ms. Kohler, a movie about the Sullivans has been made and has aired many times. The Sullivans were not the only notable visitors to the plant. President Roosevelt also made a surprise night visit to the plant on September 19, 1942 (see Figure 35). Former Governor of Minnesota, Harold Stassen recalls the visit:



**KEEP UP THE GOOD WORK.**

**WE MAKE  
GRADE "A"  
30 CALIBER  
AND 50 CALIBER  
AMMUNITION**

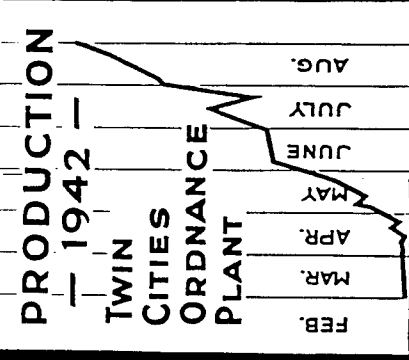

**WE WILL  
KEEP 'EM  
SHOOTING**

Figure 41. World War II poster at the Twin Cities Ordnance Plant. (TCAAP Public Information Office).

The Secret Service came to my office and told me that President Roosevelt was planning a trip to defense industries, and that he had planned to come to visit this particular defense plant in the course of that. And they wanted me to know about it, and wanted our cooperation (which I of course told them immediately they would have) and that there should be no public announcement of it; nor should the news of it spread widely ahead of time.<sup>2</sup> They would let me know just when he was coming in, so that I could meet him and greet him when he did . . . I was there at the train when the train was backed in and President Roosevelt came off the train and greeted me and I greeted him. They had his special car . . . he got in the front seat, and Mr. Horn, the manager of the plant, and I got in the back seat. We drove up to the plant, and at the plant, they had removed a part of the brick wall in order to leave a way for the car to drive right into the plant . . . [H. Stassen, interview 1994].

Mr. Stassen goes on to relate a rather humorous account of their conversation in the car which illustrates Mr. Horn's determination to continually upgrade plant productivity:

As we entered the plant, the President said, 'You've got quite a few women working here.' And Mr. Horn said, 'Yes, Mr. President. Our only problem is we need more brass, Mr. President. We need more brass for production.' We went down a little farther . . . then to turn the car and get into another part of the plant was quite difficult . . . The President said, 'Obviously the plant wasn't built for cars to drive through like this.' And Mr. Horn said, 'No, Mr. President. It wasn't built like that. But we do need more brass, Mr. President. We need more brass.' And we got a little farther along, and some other question came up about the way in which the production machines kept going . . . The President asked [Mr. Horn] another question, and he said, 'No. That's being worked out all right . . . All we need, Mr. President, for more production is more brass.' He must've said that five times. And we got the President back down and onto the train. Mr. Horn turned to me and said, 'Do you think the President got the point that we need more brass allocation?' I said, 'Mr. Horn, if he *didn't* get that impression, we can say it wasn't your fault' [H. Stassen, interview 1994].

Although some of the plant workers interviewed claimed that the president's visit really did not have too much of an effect on them, others seemed to be quite proud that the Commander-in-Chief had stopped by to give them praise and encouragement. A special commemorative edition of the *Twin Cities Ordnance News* included an article about the president's visit to the plant, naming September 19, 1942, the TCOP's "shining hour" (*Twin Cities Ordnance News* 10 October 1992 [9 October 1942]).

Most of the informants interviewed during the course of the investigation did not recall the plant winning any awards during the production period, but Ms. Julia Kohler remembers the "E" award given to the plant on a very hot day in June of 1943 "for good production, or a lot of production. I suppose all the ammunition plants were up there, but I think they just tell you [that] you were doing a good job" (J. Kohler, interview 1994; Figure 42). Ms. Kohler still has her "E" award pin along with her identification badge and several newspaper clippings.

The "best war ever" consensus on this point included both Democrats and Republicans, unions and management, and men and women. For the typical, if not statistically average, TCOP employee World War II bolstered his/her pride in his/her American values and way of life. Former Governor Harold Stassen remembers World War II as a unique moment in American politics as well, where government leaders were very willing to transcend party lines for the good of the country:

---

<sup>2</sup>Publicity of the president's visit to the TCOP was finally allowed on Thursday, October 1, 1942, when the president was safely back in the White House (*Twin Cities Ordnance News* 10 October 1992 [9 October 1942]).



Figure 42. The Twin Cities Ordnance Plant receiving an Army-Navy "E" Award (TCAAP Public Information Office).

The Administration at that time was of the Democratic Party and our state was of the Republican Party. But following our long-time broad policy of cooperation between political parties (we on the one hand had produced good results from cooperation) and President Roosevelt and his administration wisely made the decision not to just try to do a political twist in where they located plants and so forth. I think there is a strong lesson here that location of plants and of big government projects should not be influenced in an undesirable way by political considerations. They should be focused on the ultimate result to be obtained [H. Stassen, interview 1994].

Virtually all vestiges of the Great Depression disappeared. Although many workers experienced personal tragedy when husbands, sons, brothers, and fathers failed to return from the battlefields of Europe and the Pacific, most war workers viewed the years 1942-1945 as their country's finest hour (Adams 1994).

It would be impossible to overstate the importance of the "winds of war" in changing the basic lifeways of Americans. The war dislocated the lives of thousands of TCOP workers and their families. While many young men entered the military services, tens of thousands of men and women moved to the Twin Cities to work in the war industries. For most workers, employment at the TCOP was their first exposure to high wages and safe working conditions, and their newfound prosperity made it much easier to live with wartime restrictions. "With the exception of some low-paid workers -- the canners and the food processors in the so-called farm bloc are among the worst offenders -- and a stratum of white-collar workers with fixed incomes, there is not a class or a group in this country which has not benefited by the war, which is not eating better --yes, eating better -- and living better than it did before," declared I.F. Stone in a 1943 essay in *The Nation* (Stone 1988:198) Average household incomes of plant employees jumped as much as 100 percent between 1939 and 1945 and many workers were able to save money that was used to pay for homes, cars, and college tuition in the post-war period.

World War II had other important consequences for American institutions and values, some of which were apparent at the time and others that became evident only after the passage of time. From the perspective of working class people, the TCOP and other defense establishments represented the permanent presence and pervasive influence of the federal government and large corporations. Employment in defense work also created enlarged expectations and triggered a frenzy of consumerism. Liquor consumption increased (legend has it that the bars in Minneapolis ran completely out of whiskey at one point in 1942), and night clubs, dance halls, and road houses proliferated. Attendance at movie theatres reached new peaks, and downtown department stores expanded their business hours to accommodate the newly bulging pocketbooks of defense plant workers. However, the plant workers interviewed during the course of this investigation did not recall doing much for entertainment during those times. Many, if not most, worked a regular six day per week schedule and claimed that they did not have much time to spare for entertainment. They did, however, enjoy some activities. Mr. Ted Seth, metallurgist at the TCOP remembers light gambling with the check numbers of their paychecks at the plant (T. Seth, interview 1994), and Mr. Everett Needels recalls that he and his co-workers played "Penny Ante Poker" during their lunch breaks some days (E. Needels, interview 1994). Mrs. Laura Peterson, telephone operator at the TCOP, whose husband was fighting in the war, spent time with her two sons on weekends: "On Sunday afternoon I'd take the boys and we'd go downtown and go to a movie. We never did it during the week, though. And we'd have chow mein after. Boy, that was a big treat for them. They thought that was wonderful" (L. Peterson, interview 1994).

In spite of rationing imposed by the Office of Price Administration (OPA) and the "General Max" ceiling on consumer prices, inflation skyrocketed. A lively black market traffic in cigarettes, gasoline, meat, sugar, and shoes emerged and local bootleggers came out of retirement to satisfy the increased desire for homemade liquor.

Some consider World War II to be another step toward the women's liberation movement, but a definitive answer to that statement is beyond the scope of this investigation. (It is the opinion of this writer, however, that the two women interviewed during this investigation would not have known how to respond if asked whether or not they thought World War II made them "liberated." I hesitate to believe that they would have considered themselves "oppressed" before the war.) Although most of the informants interviewed during this investigation were unsure of exactly how many women at the plant continued to work after the war, Mr. Everett Needels guessed that many women became accustomed to the extra income and to the way of life of the working individual. Mrs. Laura Peterson chose to return to work herself as soon as her husband returned from the war and they had settled their family. When asked if he had heard of any discriminatory acts against women at the plant, former Governor Harold Stassen responded:

No, just the opposite, I would say. I've always felt that Minnesota is an area where the liberation of women preceded the liberation movement. In other words, it goes way, way back. There's a tradition. I remember my wife one time was asked when did she become a liberated woman, and she said when she was three years old . . . I think there's been a minimum of discrimination against women in Minnesota in comparison to other areas. And that certainly applied when you had the added matter that for national defense you needed to expand defense industries, and women, with the men going off to war, were needed [H. Stassen, interview 1994].

Not only did men and women work side-by-side, but female war workers redefined the norms for dress at home and at work: sleeveless blouses, two-piece swimsuits, trousers, and shorts reflected a redefinition of gender roles that would have a profound impact on post-war America.

The war also led plant workers to the verge of a sexual revolution. The many unsubstantiated rumors circulating during plant operation, which today linger on as legend, include the story of a man and woman who stole away to a rooftop for a brief, yet apparently passionate tryst during their 15-minute break. According to some, those two were photographed, and the photos were enlarged in order to read their respective badge numbers. Once the identities of the lovebirds were determined, they were both fired (B. Gertsema, personal communication 1994).

Finally, the TCOP left a legacy of environmental problems that are as yet unresolved. Throughout its half-century of existence, the facility disposed of waste on-site. While ammunition manufacturing was underway, scrap munitions and equipment were buried in landfills, along with a wide range of industrial byproducts, including lead and other metals, polychlorinated biphenyls (PCBs), and solvents. Although environmental degradation was something of a consideration during plant construction and operation during World War II, no one seems to have considered it a problem worthy of utilizing public money to find a solution. Indeed, state and local government agencies paid scant attention to surface or groundwater pollution caused by the TCOP until more than a generation had passed. No special effort was made to monitor or control the spread of industrial contaminants from the plant. Before 1978, the chief ecological issue concerning the plant was the "Great Whitetail Deer Flap" of 1967 which broke out when the state department of conservation proposed eliminating the arsenal's growing herd (*St. Paul Pioneer Press* 5 December 1967).

In the early 1980s it was discovered that pollutants from the ammunition plant had contaminated a significant area of topsoil and the deep groundwater aquifer from which residents of the cities of New Brighton, St. Anthony and Arden Hills drew their drinking water (*St. Paul Dispatch* 23 July 1981; *St. Paul Pioneer Press* 17 December 1982). Initially, the Army and FCC disputed that the TCAAP was the source of the pollution and came under intense criticism from both the state and federal Pollution Control Agencies. Some plant clean-up work began in 1984 after the TCAAP was designated a federal Superfund site. After years of foot-dragging, the federal government was compelled to take responsibility for the groundwater contamination when the state attorney general brought suit in federal court against the Army in 1987 (*St. Paul Pioneer Press* 25 March 1987 and 30 April 1987). After years of wrangling, the federal government and the City of New Brighton agreed to a TCAAP clean-up accord that included an \$18 million settlement to the city (*St. Paul Pioneer Press Dispatch* 26 November 1987). Meanwhile, the Corps of Engineers provided New Brighton residents with safe drinking water.

The controversy over the TCOP/TCAAP pollution of local groundwater aquifers reflects, more than anything else, a conservation ethic shared by a majority of the citizenry since the beginning of the environmental movement in the 1960s. Minnesotans have long prided themselves for their tradition of conservation and progressive politics, and this political culture made possible the actions taken by state and local governments against the Corps of Engineers in the 1980s and 1990s.

### EFFECTS OF THE END OF THE WAR

Although some GOCO facilities were closed before the end of the war and most ammunition plants had reduced production, the TCOP kept putting out .30 and .50 cal. rounds for the duration. With victory in sight, cancellation of orders and declining worker productivity reduced output at the TCOP.

The Returned Material Center at the TCOP was deactivated on February 20, 1945 (Ordnance Department 1945a). While production slowed, the Axis powers collapsed. Hitler committed suicide in his Berlin bunker on April 30, 1945, and two weeks later Allied commanders accepted Germany's surrender. In the Pacific Theatre, the noose around Japan was tightened with the capture of Okinawa in June and the annihilation of the remnants of the imperial navy. On August 6, the first atomic bomb was used to destroy the city of Hiroshima and three days later a second device was exploded over Nagasaki. On September 3, Japanese and Allied delegations signed the document of surrender ending World War II.

The reconversion from a wartime to a peacetime economy actually began before the war ended. As early as 1943, the Ordnance Department had been carefully planning for the closure and disposal of the GOCO plants (Thomson and Mayo 1960:229-230). "A curious atmosphere is visible in the world of business," wrote I.F. Stone. "Though we are only ankle-deep in the war, the impression is growing that the job of war production has passed its peak, and that we can now begin to think of a return to greater civilian production" (Stone 1988:164). No reconversion work was actually undertaken at the TCOP until late in 1945. On

August 18, 1945, the Ordnance Department issued notice to FCC terminating its War Department contract, effective from the date the last ammunition in production on V-J Day was inspected and packed. Plant equipment was placed in standby condition and the facility was placed in the Industrial War Reserve and reverted to the U.S. Army, which renamed it the Twin Cities Arsenal in 1946 (Ammunition Branch 1945; see *Minneapolis Star Journal* 24 May 1946). Some of the army housing used by officers at the TCOP was sold off (*St. Paul Dispatch* 3 May 1946), but otherwise the facility was simply vacated.

The reconversion to peace also produced dislocations in the Twin Cities. Returning veterans, nearly all males, were easily absorbed into industry, particularly when some of the women returned home. Under social pressure to return to their traditional roles, the great majority of the women defense plant workers went back to being housewives or resumed low-paying, part-time jobs. For the first few months following the closure of the TCOP, the regional business cycle generally pursued an upward swing, with comparatively low unemployment and rising wages.

The boom of 1941-1945, with its accompanying rise in wages and prices, was followed in 1946-1950 by a corresponding bust period in the Twin Cities. Just as the wave of prosperity had been the result of war work, so was the economic downturn the result of peace. The TCOP work force declined rapidly after V-J Day and many local plant workers who had spent freely during the war years now retrenched. What amounted to a localized recession ensued.

### POST-WAR YEARS

After World War II, the Twin Cities and Lake Cities ordnance plants were placed on standby and the other ten GOCO ammunition plants were converted to new uses. Ammunition salvage work continued at the TCOP through the late 1940s under the control of the U.S. Army. In 1949 two plant employees invented an electric-powered cartridge-disassembly machine. This machine is described in the Corps of Engineers assessment of the production equipment at the Twin Cities plant as a "vertically mounted rotary wheel that took the bullet through a series of steel rollers which extracted the bullet. The first machines were built at the TCAAP plant and their design proved so successful that it became a standard in the industry" (Murphey et al. 1993:9-10).

The TCOP, renamed the Twin Cities Arsenal as of April 1, 1946, was reactivated in August of 1950 at the beginning of the Korean Conflict, with Federal Cartridge Corporation reinstated as the contractor operator (*St. Paul Pioneer Press* 1 December 1951). In contrast to the World War II experience, the Korean Conflict was marked by labor disputes (*St. Paul Dispatch* 27 February 1951). The plant remained in production until December 1957, manufacturing 3.5 billion rounds of small arms ammunition, 3.2 million 105 mm shell parts, and 715,000 155 mm shell parts. Federal Cartridge Corporation continued as the contractor operator for the small arms plant, while Minneapolis-Moline Company and Donovan Company operated the artillery lines. Several major building construction and remodeling projects were also undertaken during this period. In 1963 the facility was renamed the Twin Cities Army Ammunition Plant (TCAAP). The plant was kept in layaway until December 1965 (*Minneapolis Star* 8 December 1965), when it was reactivated and re-tooled to produce 5.56 mm and 7.62 mm ammunition, at which time the old .30, .45, and .50 cal. production lines, as well as the artillery shell lines, were dismantled and removed. Federal Cartridge remained as the Vietnam War contractor, employing about a thousand persons at the TCAAP.

Several accessory buildings and an indoor firing range were constructed at the facility between 1965 and 1976, when the TCAAP was finally deactivated (BTI 1984:35-38). The TCAAP was also the site of several small-scale and peaceful protests organized by opponents of the Vietnam War (*Minneapolis Star* 8 September 1972; *St. Paul Dispatch* 29 August 1972). Although on standby, on the eve of its fiftieth anniversary, the plant produced small arms ammunition for Operation Desert Storm, its last production run before moving to modified caretaker status (B. Gertsema, personal communication 1994).

The TCAAP was an integral part of the Cold War "military industrial complex," a permanent armaments industry unparalleled in modern history. After 1945, a consensus emerged in the U.S. that America had a responsibility to lead the "Free World" against Communism. In the hands of politicians, this grass roots feeling translated into national policies that made defense the highest priority of the federal government for almost 50 years. Reflecting the Cold War mentality, the Army continued to pour millions of dollars into maintaining the TCAAP and other World War II era facilities.

As of 1994 the TCAAP is in a modified caretaker status, with most of the former TCOP manufacturing and support buildings vacant. Most of the small arms production line machinery has been dismantled, along with parts of the plant infrastructure, and several buildings have been demolished or are slated for imminent removal. While the Army and FCC presence has been reduced to a skeleton caretaker force, two industrial tenants continue to utilize parts of the installation. Alliant Techsystems, Inc. (formerly part of Honeywell, Inc.), and 3M Company (formerly Minnesota Mining and Manufacturing Company), have both had a presence at the TCAAP since the 1950s. Several areas and buildings have been leased for storage by various entities, including a historic railroad restoration group (B. Gertsema, personal communication 1994).

### CONCLUSIONS AND RECOMMENDATIONS

More than any other conflict in human history, World War II was a war of industrial maximum effort and logistics, and the work of the GOCO war industries was as important to the Allied victory as any battle. The TCOP symbolizes the miracle of production that overwhelmed Germany and Japan and transformed the industrial landscape of the U.S. The alliance between big business and the federal government that developed and intensified between 1941 and 1945 produced the largest sustained expansion in history. While the GOCO program relied heavily on large contractors with traditional links to the military, smaller businesses like the Federal Cartridge Corporation, a manufacturer of sporting ammunition, played a vital role in the war economy.

The national historical significance of the TCOP is perhaps best understood within the context of U.S. rearmament in 1940-1942 and the role of supply and logistics in the defeat of the Axis powers. The U.S. was largely bereft of defense industries in 1940 when it began to rearm, but by 1941 it was sending large shipments of war materiel to its overseas allies. The shift in public opinion that made the GOCO program politically acceptable in 1940 was signaled by the fall of France and orchestrated by the Roosevelt Administration.

The Twin Cities location was chosen for a GOCO ammunition manufacturing facility for strategic, technical, and economic reasons. War Department planners seem to have taken little account of the architectural design, aesthetic or ecological consequences of their decision, let alone the social or environmental impacts of building and operating the TCOP in northern Ramsey County. Construction and operation of the plant entailed significant monetary and operational costs unforeseen by the government or the contractor operator, but it was constructed in record time and established records for production. However, there is no reason to suspect that the TCOP World War II experience was fundamentally different from that of, for example, the Lake City Ordnance Plant. The TCOP was only one of many war industries, and while some aspects of the TCOP World War II history illustrate important themes in national history, it differs from other GOCO plants only in the context of its local history. Almost by definition, the technological history of the plant is closely related to that of other, similar small arms manufacturing facilities.

For Americans, World War II was a "people's war" against totalitarianism, militarism, and expansionism. Fifty years after the war, TCOP worker veterans still exude pride in work done during 1942-1945. Defense plant work paid high wages and brought prosperity to thousands of people whose increased purchasing power compensated somewhat for the wartime disruption of society. Nevertheless, it is apparent that the chief economic beneficiary of the war were the "economic royalists" who controlled the largest corporations. FCC's lucrative CPFF contract made its owners and managers rich. TCOP employee dissatisfaction with

the way the plant was run and the level of resentment against corporate profiteering is difficult to document, given the data at hand. Of the six interviews conducted during this investigation, only one interviewee (an employee who was closer to management than a production worker) expressed blatant dissatisfaction with FCC management. He eventually left the plant voluntarily because of that dissatisfaction. There apparently were no strikes or other labor actions at the TCOP during the war, in stark contrast to other war industry plants.

The present writers would call attention to the difference between the economic and social history effects of the TCOP on plant operators, workers, and neighbors. War production brought prosperity to the Twin Cities but not without high costs in environmental degradation and massive social disruption. Nearly as significant as the economic benefits from rising wages, increased savings, and better working conditions were the social impacts of war work at the TCOP. Faced by recurrent labor shortages, Federal Cartridge Corporation (like other defense contractors across the nation) welcomed women and minorities into the work force. This was part of a recurring historic pattern in which large numbers of women had been temporarily incorporated into the industrial labor force during times of national emergency, a process that social historian Howard Zinn has described as the "escape from the prison of wifeliness, motherhood, femininity, housework, beautification, isolation, when their services have been desperately needed" (Zinn 1980:493). It is true that World War II brought more women than ever before out of the home and into the work place, although it is beyond the scope of this investigation to determine whether or not the employment of women at the TCOP and other defense plants was another step forward for the women's rights movement.

Several "information gaps" are evident in the historic context of the TCOP. First and foremost, most of what has been written about the GOCO program, the World War II "miracle of production," and the defense industries is establishment or institutional history written from the perspective of the federal government, the military, or the defense industry. While data on TCOP plant management and production are voluminous, its social history is recorded largely in the propaganda disseminated by the wartime newspapers, little of which was written from the point of view of the plant workers. A written "people's history" of the TCOP would allow researchers to compare and contrast the information from the archival record with oral history information. Efforts to record the workers' impressions of everyday life (whether they are substantiated by the archival record or not) should be initiated in a timely fashion, as many of the people working during World War II are now in their seventies and eighties.

In July 1941 Mound View Township and the Village of New Brighton were little more than rural hamlets on the outskirts of two mid-sized provincial cities. By the summer of 1942, the entire Twin Cities area had been overrun by an army of construction workers, clerks, police, engineers, soldiers, and defense plant workers. The TCOP does not appear to have attracted especially large numbers of workers from outside the Twin Cities, but the plant certainly created disruption in communities and strained local government resources, particularly with regard to transportation. While the effects of the home front culture on families has been studied at some length, the impact of the defense plants on local units of government has largely escaped the attention of social historians. New Brighton would seem to offer a unique opportunity to examine the war-time phenomenon in a setting substantially different from that of a much larger urban area.

Other areas of further research include an examination of worker discontent at this and other plants throughout the country during World War II. Zinn notes that during World War II there were over 14,000 strikes, more than that which occurred in any comparable period in American history (Zinn 1980:408). Reasons for worker discontent, steps taken to solve problems, and effects of worker discontent on the family and on the society could be examined. Perhaps there were also notable regional differences in the way some of the plants were managed, causing workers to strike more often in particular geographical areas of the country. Worker discontent during World War II would be an interesting avenue of future research, especially given the general atmosphere of patriotism which appears to have dominated the World War II years.

## REFERENCES CITED

- Adams, M. C. C.  
1994 *The Best War Ever: America and World War II.* Johns Hopkins University Press, Baltimore.
- Ammunition Branch  
n.d. *Small Arms Ammunition: A History of an Industry 1918-1944.* Vols. 1 and 2. Office of the Chief of Ordnance, Small Arms Division.  
  
1945 *Disposition of the Twin Cities Ordnance Plant.* Small Arms Division, Ordnance Department, Army Service Forces. Record Group 156, National Archives, Suitland, Maryland.
- Andreas, A. T.  
1874 *Illustrated Historical Atlas of the State of Minnesota.* Andreas Atlas Company, Chicago.
- Baruch, B. M.  
1941 *American Industry in the War.*
- Beaudry, M. C.  
1990 Review of *The Recovery of Meaning: Historical Archaeology in the Eastern United States*, edited by M.P. Leone and P.B. Potter, Jr. In *Historical Archeology* 24(3):115-118.
- Bingham, M.  
1989 Keeping At It: Minnesota Women in a Century of Change. In *Minnesota in a Century of Change*, edited by Clifford E. Clark, Jr., pp. 433-472. Minnesota Historical Society, St. Paul.
- Building Technology, Inc. (BTI)  
1984 *Historic Properties Report Twin Cities Army Ammunition Plant New Brighton, Minnesota.* MacDonald and Mack Partnership, Minneapolis. Submitted to the Historic American Buildings Survey/Historic American Engineering Record, National Park Service.
- Cambell, L. H.  
1946 *The Industry-Ordnance Team.* McGraw-Hill, New York.

- Catton, B.  
1969 *The War Lords of Washington*. Greenwood Press, New York.
- Corps of Engineers (COE)  
1943 *Completion Report: Twin Cities Ordnance Plant, New-Brighton, Minn.* Unpublished report. Record Group 77, National Archives (Office of the Chief of Engineers), Completion Reports 1917-1943, Box 92.
- Drummond, D. F.  
1955 *The Passing of American Neutrality: 1937-1941*. University of Michigan Press, Ann Arbor.
- Fairchild, B., and J. Grossman  
1959 *The Army and Industrial Manpower*. The United States Army in World War II. Office of the Chief of Military History, Department of the Army, Washington, D.C.
- Federal Writers' Project  
1985 *The WPA Guide to Minnesota: Compiled and Written by the Federal Writers' Project of the Works Progress Administration*. Minnesota Historical Society Press, St. Paul. (Reprint of the 1938 edition.)
- Fine, L., and J. A. Remington  
1972 *The Corps of Engineers: Construction in the United States*. The United States Army in World War II: The Technical Services. Office of the Chief of Military History, Department of the Army, Washington, D.C.
- Fussel, P.  
1975 *The Great War and Modern Memory*. Oxford University Press, New York.
- Green, C. McL., H. C. Thomson, and P. C. Roots  
1955 *The Ordnance Department: Planning Munitions for War*. The United States Army in World War II: the Technical Services. Office of the Chief of Military History, Department of the Army, Washington, D.C.
- Herb, C. O.  
1943 Small Arms Ammunition. *Machinery* 49 (April).
- Higham, R. (editor)  
1975 *A Guide to the Sources of United States Military History*. Archon Books, Hamden, Connecticut.
- Higham, R., and D. J. Mrozek (editors)  
1981 *A Guide to the Sources of United States Military History*, Supplement I. Archon Books, Hamden, Connecticut.  
  
1986 *A Guide to the Sources of United States Military History*, Supplement II. Archon Books, Hamden, Connecticut.  
  
1993 *A Guide to the Sources of United States Military History*, Supplement III. Archon Books, Hamden, Connecticut.

- Hixon, W. W.  
1916 *Plat Book of the State of Minnesota*. W. C. Hixon & Co., Minneapolis.
- Hodder, I.  
1986 *Reading the Past*. Cambridge University Press, Cambridge.
- Holleman and Gallagher  
1978 *Smith, Hinchman & Grylls*. Wayne State University Press, Detroit.
- Holmberg, Carl  
1994 World War II employee of TCOP. Oral history interview conducted at the Twin Cities Army Ammunition Plant on September 19, 1994 by personnel of Bear Creek Archeology, Inc., for Geo-Marine, Inc. Tape on file at U.S. Army Corps of Engineers, History Office, Fort Belvoir.
- Kane, K.L.  
1995 *Historic Context for the World War II Ordnance Department's Government-Owned Contractor-Operated (GOCO) Industrial Facilities, 1939-1945*. Geo-Marine, Inc., Plano, Texas. Report submitted to the U.S. Army Corps of Engineers, Fort Worth District.
- Kohler, Julia  
1994 World War II employee of TCOP. Oral history interview conducted at Ms. Kohler's home on September 21, 1994 by personnel of Bear Creek Archeology, Inc., for Geo-Marine, Inc. Tape on file at U.S. Army Corps of Engineers, History Office, Fort Belvoir.
- Leone, M. P., and P. B. Potter, Jr. (editors)  
1988 Introduction: Issues in Historical Archaeology. In *The Recovery of Meaning: Historical Archaeology in the Eastern United States*, edited by M.P. Leone and P.B. Potter, Jr., pp. 1-22. Smithsonian Institution Press, Washington, D.C.
- Marquis  
1981 *Who's Who in America with World Notables*. Marquis Who's Who, Inc., Chicago.
- Merritt, R. H.  
1976 *Creativity, Conflict & Controversy: A History of the St. Paul District U.S. Army Corps of Engineers*. Government Printing Office, Washington, D.C.
- Meyer, G. N., and L. Swanson (editors)  
1992 *Geologic Atlas Ramsey County, Minnesota*. County Atlas Series C-7. Minnesota Geological Survey, University of Minnesota, Minneapolis.
- Minneapolis Star*. Morgue files, Minneapolis Public Library.
- Minneapolis Star Journal*. Morgue files, Minneapolis Public Library.
- Minneapolis Times*. Morgue files, Minneapolis Public Library.
- Minneapolis Tribune*. Morgue files, Minneapolis Public Library.

- Murphey, J. S.  
 1993 *Building the Arsenal of Democracy: A Survey of the World War II Military-Industrial Army Ordnance Complex.* Unpublished manuscript, U.S. Army Corps of Engineers, Ft. Worth District. [Copy in possession of Geo-Marine, Inc.]
- Murphey, J. S., K. Kachel, and R. Krippner  
 1993 *Inventory and Assessment of Small Arms Production Equipment of the Twin Cities Army Ammunition Plant, New Brighton, Minnesota.* Unpublished report. U.S. Army Corps of Engineers, Ft. Worth District.
- National Park Service (NPS)  
 n.d. *How to Apply the National Register Criteria for Evaluation.* National Register Bulletin 15. National Park Service, U.S. Department of the Interior, Washington, D.C.
- 1983 Secretary of the Interior's Standards and Guidelines for Preservation Planning, Identification, Evaluation, and Registration. *Federal Register*, Part IV, Thursday, 29 September 1983, pp. 44716-44742.
- Noble, D. F.  
 1984 *Forces of Production: A Social History of Industrial Automation.* Alfred A. Knopf, New York.
- Ordnance Department  
 1942a *Twin Cities Ordnance Plant Historical Report General Introduction. 14 July 1941 - 31 December 1942.* Record Group 156, National Archives, Suitland, Maryland. [Public Relations Section newsletters and news releases.]
- 1942b *Twin Cities Ordnance Plant Historical Report. 14 July 1941 - 31 December 1942.* Pt. 1. Record Group 156, National Archives, Suitland, Maryland.
- 1943a *Twin Cities Ordnance Plant Historical Report. 1 January 1943 - 31 March 1943.* Vol. 2. Record Group 156, National Archives, Suitland, Maryland.
- 1943b *Twin Cities Ordnance Plant History. 1 April 1943 - 30 June 1943.* Vol. 3, pt. 1. Record Group 156, National Archives, Suitland, Maryland.
- 1943c *Twin Cities Ordnance Plant Historical Report. 1 April 1943 - 30 June 1943.* Vol. 3, pt. 3. Record Group 156, National Archives, Suitland, Maryland.
- 1943d *Twin Cities Ordnance Plant History. 1 July 1943 - 30 September 1943.* Vol. 4. Record Group 156, National Archives, Suitland, Maryland.
- 1943e *Twin Cities Ordnance Plant History. 1 October 1943 - 31 December 1943.* Vol. 5, pt. 1. Record Group 156, National Archives, Suitland, Maryland.
- 1944a *Twin Cities Ordnance Plant History. 1 January 1944 - 31 March 1944.* Vol. 6, pt. 1. Record Group 156, National Archives, Suitland, Maryland.
- 1945a *Twin Cities Ordnance Plant: History. 1 January 1945 - 31 March 1945.* Vol. 10. Record Group 156, National Archives, Suitland, Maryland.

- 1945b *Twin Cities Ordnance Plant: History. 1 April 1945 - 30 June 1945.* Vol. 2. Record Group 156, National Archives, Suitland, Maryland.
- 1945c *Twin Cities Ordnance Plant: History. 1 July 1945 - 30 September 1945.* Vol. 12. Record Group 156, National Archives, Suitland, Maryland.
- Peterson, Laura  
 1994 World War II employee of TCOP. Oral history interview conducted at Mrs. Peterson's home on September 20, 1994 by personnel of Bear Creek Archeology, Inc., for Geo-Marine, Inc. Tape on file at U.S. Army Corps of Engineers, History Office, Fort Belvoir.
- Public Relations Section  
 n.d. Twin Cities Ordnance Plant Newspaper Clippings. Record Group 156, National Archives, Suitland, Maryland.
- Risch, E.  
 1989 *Quartermaster Support of the Army: A History of the Corps 1775-1939.* U.S. Army Center for Military History, Washington, D.C.
- St. Paul Dispatch.* Morgue files, St. Paul Public Library.
- St. Paul Pioneer Press.* Morgue files, St. Paul Public Library.
- Scope of Work (SOW)  
 1993 Scope of Work provided by the U.S. Army Corps of Engineers to Geo-Marine, Inc., for cultural resources investigations to be carried out under Contract # DACA63-93-D-0014, Delivery Order # 014, dated 10 September 1993.
- Seth, Ted  
 1994 World War II employee of TCOP. Oral history interview conducted at Mr. Seth's home on September 20, 1994 by personnel of Bear Creek Archeology, Inc., for Geo-Marine, Inc. Tape on file at U.S. Army Corps of Engineers, History Office, Fort Belvoir.
- Smith, R. E.  
 1959 *The Army and Economic Mobilization.* The United States Army in World War II. Office of the Chief of Military History, Department of the Army, Washington.
- Smith, Hinchman & Grylls, Inc.  
 1942 Small Arms Ammunition Plant. *Architectural Forum* 77(December):61-92.
- Stassen, Harold  
 1994 Former Governor of Minnesota. Oral history interview conducted at the Minneapolis Club on September 22, 1994 by personnel of Bear Creek Archeology, Inc., for Geo-Marine, Inc. Tape on file at U.S. Army Corps of Engineers, History Office, Fort Belvoir.
- Stone, I.F.  
 1988 *The War Years. 1939-1945: A Nonconformist History of Our Times.* Little, Brown and Co., Boston.

- Thomson, H. C., and L. Mayo  
 1960 *The Ordnance Department: Procurement and Supply*. The United States Army in World War II. Office of the Chief of Military History, Department of the Army, Washington, D.C. (Reprinted 1991.)
- Twin Cities Ordnance News*  
 1992 Reprinted. Minnesota Historical Society, St. Paul. Originally published 1942, vol. 1(11). Twin Cities Army Ammunition Plant, New Brighton.
- Upham, W.  
 1969 *Minnesota Geographic Names: Their Origin and Historic Significance*. Reprint edition. Minnesota Historical Society, St. Paul. (Originally published in 1920.)
- Vinar, K. R.  
 1980 *Soil Survey of Washington and Ramsey Counties, Minnesota*. U.S.D.A. Soil Conservation Service and Minnesota Agricultural Experiment Station, St. Paul.
- Voight, W., Jr.  
 1945 *The Ordnance Organization in World War II: Facilities: GOCO Facilities - Directory*. Ordnance War Administration History, Series II, Study no. 11, Monograph no. 1. Unpublished manuscript on microfiche in the ARRCOM archives, Rock Island Arsenal, Rock Island, Illinois
- War Department  
 1948 *Small-Arms Ammunition*. War Department Technical Manual TM9-1990, issued September 1947. Government Printing Office, Washington, D.C.
- Wendt, K. M., and B. A. Coffin  
 1988 *The Natural Vegetation of Minnesota at the Time of the Public Land Survey: 1847-1907*. Biological Report No. 1. Minnesota Department of Natural Resources, St. Paul.
- Wertheimer, B.  
 1977 *We Were There: The Story of Working Women in America*. Pantheon, New York.
- Zinn, H.  
 1980 *A People's History of the United States*. Harper & Row, New York.