

O

AR-009-665

DSTO-TN-0035

T

The Measurement of
Airblast Parameters on the
Minor Uncle Explosion Event
using Passive Instrumentation

J.S. Howe

S

APPROVED FOR PUBLIC RELEASE

DTIC QUALITY INSPECTED 4

© Commonwealth of Australia

D

THE UNITED STATES NATIONAL
TECHNICAL INFORMATION SERVICE
IS AUTHORISED TO
REPRODUCE AND SELL THIS REPORT

The Measurement of Airblast Parameters on the MINOR UNCLE Explosion Event Using Passive Instrumentation

J. S. Howe

**Ship Structures and Materials Division
Aeronautical and Maritime Research Laboratory**

DSTO-TN-0035

ABSTRACT

This report covers the measurement by the author of two of the fundamental blast parameters associated with explosions in air, i.e., dynamic pressure impulse (DPI), and blast pressure. The report illustrates how valuable a role inexpensive, passive instrumentation can play in measurement, especially in large scale field experiments. The gauges which form the subjects of this report were used most recently on the multi-national, large scale field event, MINOR UNCLE, which was a high explosive test at White Sands Missile Range, New Mexico, on 10 June, 1993. Both of the gauges used for these measurements were developed at AMRL but at different times, to satisfy vastly different requirements.

Australia was requested to participate in MU by carrying out the measurement of DPI for comparison with other measurements of the same parameter. The range of interest to overseas scientists was 0.5 kPa s to well in excess of 20 kPa s. This range greatly exceeded the capability of the Australian gauge. This is discussed fully in the report.

The Australian DPI gauge was a modification of a design which was developed for the BLOWDOWN airblast experiment which was held in 1963 in a tropical rain forest in northern Australia. This gauge was also used on the DISTANT PLAIN series at Defence Research Establishment, Suffield(S) and Hinton, Alberta, Canada, in 1966/7. Although the gauge was not designed originally for use with explosions having a yield much greater than 500 tonnes TNT equivalence, its use in a modified form has proven quite successful on MINOR UNCLE (MU).

The second gauge, a self recording, peak reading, blast pressure gauge, was developed in the 1980s to provide a simple means of blast measurement for use by relatively unskilled military people engaged in training exercises.

This report explains the changes to the original design of the DPI gauge and the results achieved with its use, as well as the successful deployment of the overpressure gauge in the form in which it was originally designed. Both forms of measurement gave very satisfactory outcomes.

RELEASE LIMITATION

Approved for public release

DEPARTMENT OF DEFENCE

DEFENCE SCIENCE AND TECHNOLOGY ORGANISATION

19961217 064

Published by

*DSTO Aeronautical and Maritime Research Laboratory
PO Box 4331
Melbourne Victoria 3001*

*Telephone: (03) 9626 8111
Fax: (03) 9626 8999
© Commonwealth of Australia 1996
AR No. 009-665
March 1996*

APPROVED FOR PUBLIC RELEASE

The Measurement of Airblast Parameters on the MINOR UNCLE Explosion Event Using Passive Instrumentation

Executive Summary

MINOR UNCLE (MU) was planned by the US Defence Nuclear Agency (DNA) to be the last of the large scale conventional explosive events. It was conducted at the White Sands Missile Range in New Mexico. It had participants from US, UK, Canada, Norway, Sweden, Switzerland and Australia. The explosive charge had a yield approximately equivalent to a 4kt nuclear explosion or 2kt of TNT.

The author's participation in MU was requested by DNA specifically to carry out measurements of the airblast parameter, dynamic pressure impulse, using passive instrumentation which had been used on several similar events in the past involving TTCP countries. The author also used this opportunity to field test a blast pressure gauge developed at AMRL some years ago. The data obtained on MU compared very favourably with that measured by the other countries.

Although Australia has not been very active in airblast research in recent times, our previous involvement with US and other scientists through TTCP (TLG-3) in particular, has left a lasting impression of respect for Australian capabilities in this area. This was especially true in the area of airblast measurements on small and large explosive events. The Australian participation at MU has provided a small contribution to airblast measurement technology in the international scientific community.

At the time of the author's visit, there was a requirement at SSMD, Maribyrnong, to review our ageing high speed instrumentation used for gathering field experiment data and make the correct choice for replacing it. MU was particularly timely in that regard and allowed extensive discussions with users of a variety of instruments all on the one site. Based on those discussions we have upgraded our instrumentation to state-of-the-art, digital equipment, with little risk of making wrong decisions. This newly acquired instrumentation has since been proven by its use in the experiments of the SSEP, our underwater shock research and copious other field and laboratory applications.

Contents

1. INTRODUCTION	1
2. MINOR UNCLE EVENT	1
3. DYNAMIC PRESSURE IMPULSE MEASUREMENT	4
4. CHANGES TO DPI GAUGE DESIGN	4
5. DPI MEASUREMENT LOCATIONS	7
6. GAUGE INSTALLATION	7
7. RESULTS OF DPI MEASUREMENTS	8
8. COMMENTS ON DPI RESULTS	8
9. BLAST PRESSURE MEASUREMENT	9
10. RESULT FROM BLAST PRESSURE GAUGE	10
11. CONCLUSIONS	10
12. ACKNOWLEDGEMENTS	11
13. REFERENCES	11
14. APPENDIX 1	12

1. Introduction

Although there have been major changes in measurement instrumentation, principally due to developments in electronic technology, passive instrumentation still fulfills a function, particularly in large scale testing requiring a large number of measurements and generally over a large area. This is especially applicable if the prime requirements are for comparative measurements or those not requiring high levels of accuracy. Recording field data with passive instrumentation is often fraught with difficulties and limitations but nonetheless there are distinct applications where its use can fill in large data gaps and maybe even surpass more sophisticated methods of measurement. Passive methods should not be too readily dismissed in favour of more sophisticated methods, or even no measurement at all, as they have much to offer; such methods are usually simple in design, inexpensive to manufacture and easy to install. For the past thirty years or so, the author has observed the use of passive methods in the measurement of airblast data and MU was a good showcase of how the simple application of sound physical principles and engineering initiatives has not totally been replaced by higher technology. In a complementary way, MU also displayed state-of-the-art instrumentation which is usually essential for best achievable accuracy in field data measurement.

Australia was requested to participate in MU by carrying out the measurement of DPI for comparison with other measurements of the same parameter. For the purposes of MU participation, this project was designated as Defence Nuclear Agency (DNA) Project #6705.

2. MINOR UNCLE Event

The MINOR UNCLE test was executed on 10th June, 1993, at 0910 hrs Mountain Daylight Time at the Permanent High Explosive Test Site (PHETS) site, White Sands New Mexico.

The event simulated a 4 kt nuclear detonation (the simulation was most accurate in the 7 kPa overpressure region) by detonating a hemispherical charge of 2472 tonnes of ammonium nitrate and fuel oil (ANFO) mixture initiated by a 125 kg octol booster. The charge which was detonated at its centre, was contained by a fibreglass hemispherical shell which was located at ground zero. The average charge density was 0.85g/cm³ and the average fuel oil content was 6.1% by weight. Further charge details are given in ref 5.

MU brought together scientists and engineers from seven countries. It was planned to be the final, large scale, conventional explosive airblast to be held in the USA by DNA. That US agency has conducted many similar tests at its permanent high explosive test site on the White Sands Missile Range.

One of the main claims to fame for White Sands, or as it was formerly called, the Alamogordo Bombing and Gunnery Range, is that it was the site of the world's first atomic explosion, the Trinity test, on 16 July, 1945. Indeed the Trinity test, carried out

under the Manhattan Project, occurred with the bomb placed atop a 30m tower which was located only a few kilometres from where the MU site is. Likewise, the MacDonald ranch house (still standing), where the plutonium core was assembled prior to being transported to the Trinity site for insertion into the bomb casing, was also very close to the site. At ground zero at the Trinity site, there are still some memorabilia from that momentous event in the world's history.

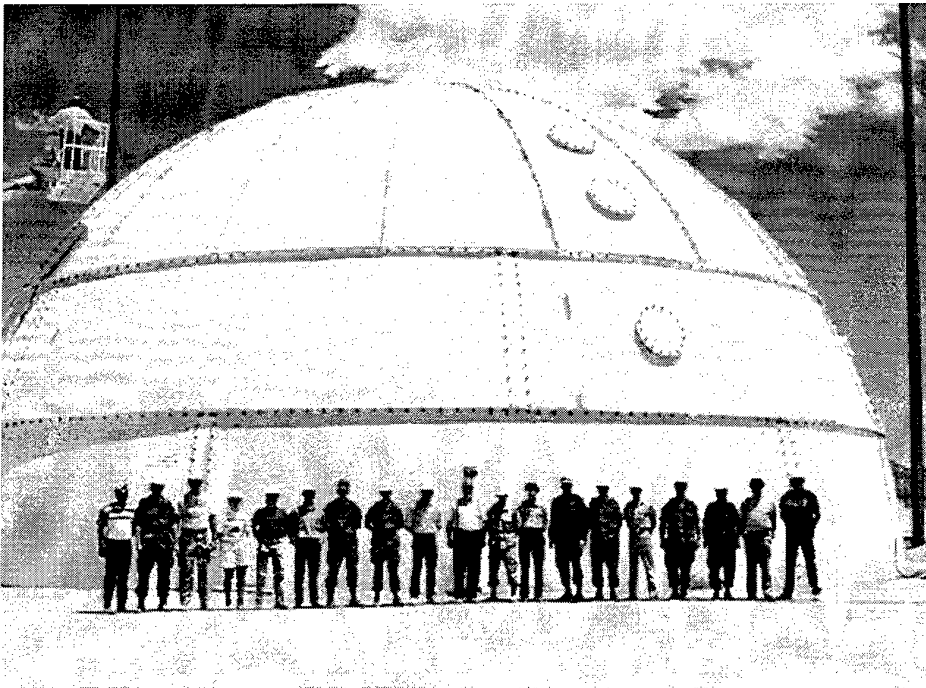

Figure 1. Charge inside fibreglass casing

Projects in MU included the exposure of blast resistant structures both above ground level and buried. Norway, Sweden Canada and Switzerland had specific interests in this work. Various items of military hardware and vehicles were exposed to the airblast; so too were manikins representing military personnel dressed and equipped for combat. It became apparent during the on-site preparation period on MU that the real "drive" came from Norway for the various forms of passive airblast instrumentation to be deployed on the same radial at the test site. The north radial of the test site contained passive gauges of various types from Australia, Canada and the US. This arrangement was designed to enable a comparison of results from the various measurement methods. Such a comprehensive comparison of gauges had not been carried out before, so MU provided this unique opportunity.

In addition to airblast exposure, some items were also exposed to thermal radiation from installed gas burners, to simulate the dual energy from a nuclear event of similar yield. The thermal radiation sources were activated just prior to the detonation, so that the heat was experienced by the targets prior to the arrival of the airblast, as in a nuclear attack.

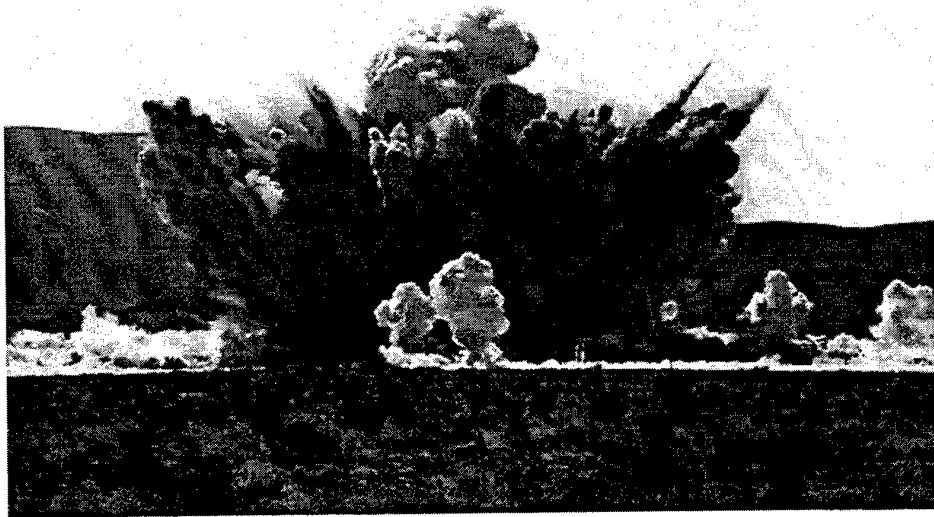
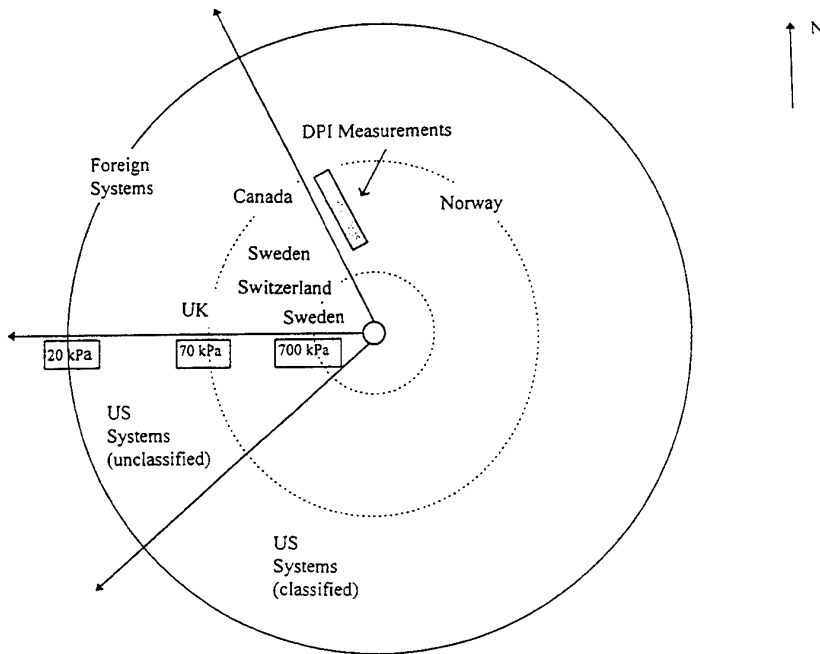

Figure 2. View after detonation



MINOR UNCLE Test Layout

3. Dynamic Pressure Impulse Measurement

The gauge employed to do the measurement was a drag type, consisting of an upright rigid stem and a cylindrical head. The base of the stem was supported by a flexible aluminium strip or hinge, the lower end of which was clamped rigidly. When the blast wave passed the gauge, it impinged on the front surface of the head which responded to the impulse from the dynamic pressure component, causing the gauge to deflect backward until the energy imparted to the gauge was lost in the elastic and plastic deformation of the hinge. The final bend of the hinge was a measure of the DPI of the blast wave. The gauge is depicted in Figure 3.

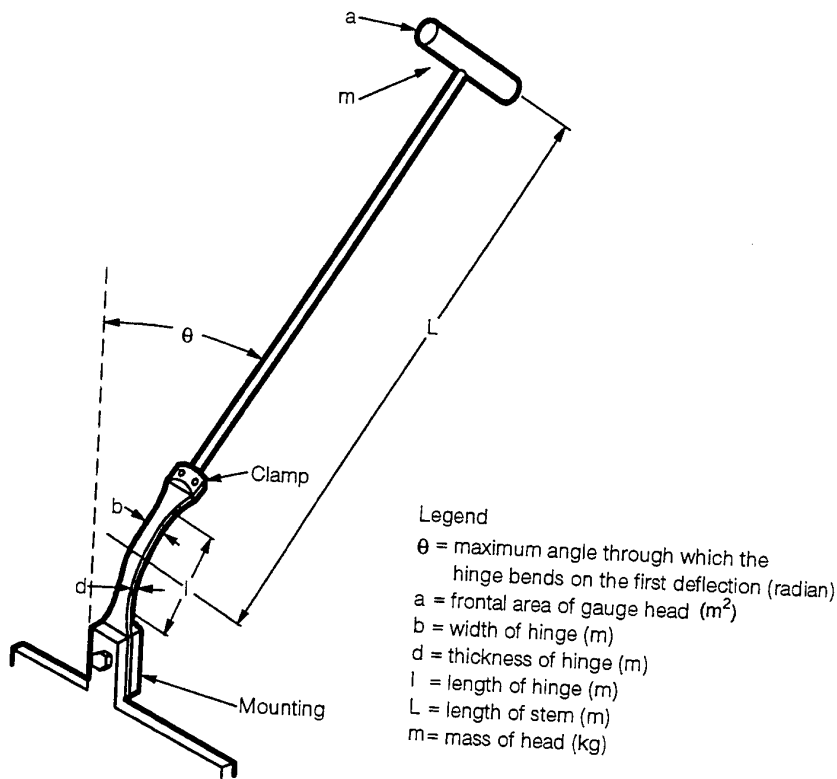

Figure 3. DPI Gauge

4. Changes to DPI Gauge Design

One important factor in this gauge design is that the head should provide the predominant drag surface, responding to the airblast impulse. A second important factor is that the airblast wave should pass the gauge before the latter undergoes any substantial deflection, otherwise the drag area presented to the blast wave will have

been reduced by the gauge's angular deflection backwards. Corrections for gauge deflection are dependant on the airblast waveform, both amplitude and duration.

The DPI gauge as designed in the early 1960s was designed to undertake measurements on events with explosive yields from 50 - 500 tonnes of TNT equivalence. This design was not readily useable on an event such as MU without modification. MU was a hemispherical surface charge consisting of 2.4kT of ammonium nitrate and fuel oil (ANFO). Measurements of DPI on MU using these gauges were required at locations where the DPI values far exceeded the maximum range of the existing gauge design. In addition, the large positive phase duration would introduce inaccuracies because of the presented drag area variation mentioned above.

The original gauge was designed for a DPI range of 0.8 - 1.7 kPa s and a natural period of 0.75 s. The request for participation in MU required the measurement of DPI to span a much higher range, preferably 1.4 - 8.6 MPa s. Clearly a new or modified design was required. Time and resources did not allow a new design, so a modification to the existing design was the only option available.

The equations defining the response of the gauge to impulse loading are as follows;

$$\theta_{\max} = \frac{2(I_q a)^2}{\sigma_y^1 m b d^2} \quad (1)$$

and

$$\omega^2 = \frac{YI}{l m L^2} \quad (2)$$

where θ_{\max} = maximum angle through which the hinge bends on the first deflection (radian)

I_q = dynamic pressure impulse (kPa s)

a = frontal area of gauge head (m²)

σ_y^1 = nominal yield stress of hinge material (kPa/m²)

m = mass of head (kg)

b = width of hinge (m)

d = thickness of hinge (m)

ω = natural frequency of oscillation of the installed gauge (radian/s)

Y = modulus of elasticity of the hinge material (kg/m²)

I = second moment of area of hinge cross-section (m⁴)

l = length of hinge (m)

L = length of stem (m)

The choice of modified design for a Mk 2 gauge for use on MU was very much based on expediency and the final outcome was one of compromise. The original design had options for heads of four different sizes. For MU only one head size was achievable in

the circumstances. The simplest choices to achieve an increase in the DPI range whilst maintaining a moderately low natural frequency of oscillation were to increase the head mass and to change the hinge material and thickness. The former was achieved by making the head from lead, instead of steel. This had the effect of extending the DPI range of the gauge as well as increasing its natural time constant. Increasing the yield stress and thickness of the hinge material also increased the DPI range, but caused some reduction in the natural time constant. All other dimensions and geometry were kept the same as for the original design. The modified design seemed a satisfactory compromise.

With these changes the equations 1 and 2 can be simplified as follows;

$$\theta_{\max} \propto \frac{I_g^2}{\sigma_y^1 m d^2} \quad (3)$$

and

$$\omega^2 \propto \frac{d^3}{m} \quad (4)$$

The replacement hinge material was type 2024-T62 aluminium alloy. This provided an increase in nominal yield stress of ~17%. The hinge thickness was increased to 3.2 mm, or an increase of 95%. The head was fabricated from lead which gave a mass increase of ~40%.

These changes had an overall effect of shifting the DPI sensitivity range upwards by a factor of ~2.5. The Mk 2 gauge design then had a range of 2 - 4.3 kPa s with a natural period of oscillation of about 0.33 s.

These changes were discussed with MU contacts before the Mk 2 gauges were manufactured and they agreed to this compromise.

The major shortcoming in changing the design parameters was that no calibration could be carried out before the gauges were required for installation for the MU event. However, the basic theory had been well proven by their use on BLOWDOWN and DISTANT PLAIN and the risk of using uncalibrated gauges on MU was considered acceptable. Tentative arrangements were discussed whereby there would be limited calibration carried out after MU in the shock tube facility at the Army Research Laboratory, Aberdeen Proving Ground, using funding generously provided by the US, Defence Nuclear Agency(DNA). This calibration was subsequently carried out and the results vindicated the confidence in using the modified gauges.

In general the shock tube calibration indicated agreement to within 15% of the predicted sensitivity of the gauges. The shock tube calibration of the Mk 2 gauges is covered in detail in Appendix 1. The calibrated deflection sensitivity of the Mk 2 gauge is illustrated in Figure 4.

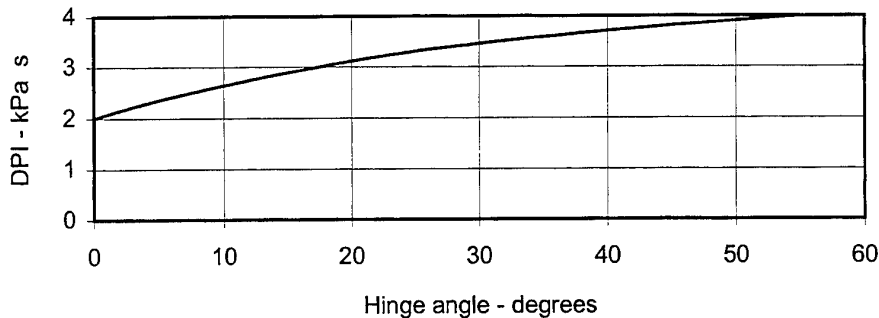

Figure 4. Calibrated Sensitivity of DPI Gauge

5. DPI Measurement Locations

The gauges were mounted along the north radial, as near as practicable to other passive and active dynamic pressure instrumentation. This provided the opportunity for direct inter-comparison of results stated above. The DPI gauges were installed in groups of 3 and 4 at radial distances of 270 m, 322 m, 369 m, 451 m and 665 m. They were in lines, transverse to the blast flow. These locations corresponded to expected peak blast overpressures of 210 kPa, 140 kPa, 100 kPa, 70 kPa and 34 kPa.

The predicted values for DPI at the gauge locations were;

5.6 kPa s, 3.7 kPa s, 2.7 kPa s, 1.6 kPa s and 0.62 kPa s.

It was expected that the gauges would be overdriven at the location closest to the charge if the full explosive yield was achieved from the detonation. At the furthest location, the gauges were expected to operate only within their elastic range.

6. Gauge Installation

Each gauge was clamped to a steel peg which was fixed rigidly into the ground. The gauge heads at each location were kept at the same absolute height, however the installed heights of the heads above their immediate ground surface varied over the range 550 - 600 mm, with variations due to the local ground surface undulations. At the average gauge head height of 575 mm, the boundary layer effect was expected to cause a reduction in DPI levels, compared with those levels immediately above the layer, ranging from 5% to 0%, at radii 270 m - 665 m respectively. This was based on predictive calculations carried out by S-Cubed (ref 3).

Gauge installations at 322 m and 665 m are shown in Figures 5(a) and 5(b). In each case the airblast flow is from the left and normal to the line of gauges.

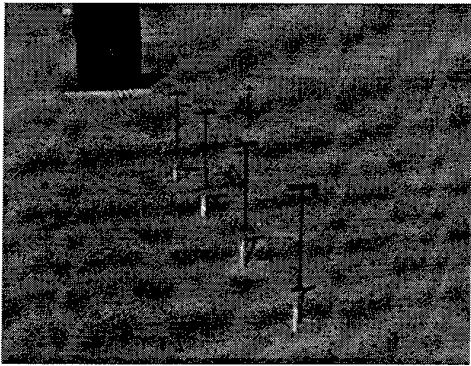

Figure 5(a) Gauges at 322 m before test.

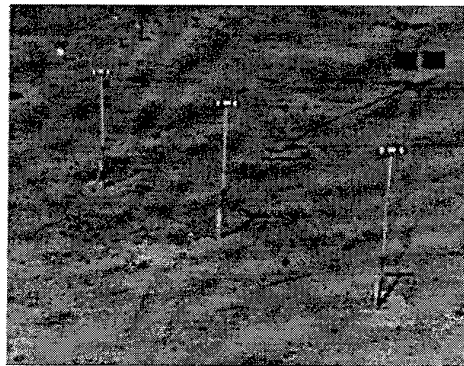

Figure 5(b) Gauges at 665 m after test.

7. Results of DPI Measurements

The following results, being averages for each radial distance, were obtained from these DPI gauges, together with results from other countries;

Table 1. Results

Radius m	Predicted O/P kPa	Predicted DPI kPa s	Measured DPI kPa s			
			<i>Australia</i>	<i>Canada</i> ³	<i>US</i> ⁴	<i>Electronic</i> ⁵
270	207	5.6	gauges damaged	5.0	5.0	5.2
322	138	3.7	3.2 ¹	3.2	3.2	3.2
369	103	2.7	2.4	2.6	2.5	2.3
451	69	1.6	2.1	-	1.6	1.4
665	34	0.6	note 2	0.6	0.6	0.5

Notes:

1. All gauge stems were badly distorted, indicating a transverse component of impulse. The values of DPI interpreted from hinge deflections are unreliable.
2. Gauges were operating within their elastic range and motions were expected to be recorded by a nearby high speed camera. However, the gauges were obscured by ground dust picked up by the blast wave and no motion records were obtainable.
3. Horizontally mounted, bending rod type cantilever gauges.
4. Solid cubes displaced by blast wave.
5. Measurements by Allied Signal Technical Services Corporation, Arizona, for DNA.

8. Comments on DPI Results

There was ample evidence of crater ejecta at the gauge sites. At the 270 m (886') location, all gauges were damaged either by crater ejecta or debris swept up by the

blast wave. At 322 m (1058') two of the four gauges were clearly struck by large earth projectiles and all stems were distorted. At all locations there was abrasion of frontal surfaces caused by high velocity dirt particles. In addition, there was a build-up of dirt particles adhering to the front surfaces of gauges and mounts, but offset from the radial line to GZ. This indicated a non-idealised flow along the DPI gauge line. Comments by Mr Robin Williamson (Williamson Air) on high speed aerial photography taken of the MU event included ".....a large number of jets coming from the event. Jet phenomena are common on such events. Some extend in front of the main shock and they may or may not be luminous. They occurred at different elevation angles and some touched the ground surface at a distance from ground zero. They all seemed to dissipate at about the 450 m radius."

There were in fact 22 observed surface jets on MU. There were three surface jets with centre lines directed within 2 m of the DPI gauge positions, which is consistent with the non-radial deflections and non-radial deposits of attached dirt particles on the gauges. This phenomenon almost certainly influenced the final angle of bend in the hinges at the 270 m and 322 m locations, however the effects further away from GZ were greatly reduced and probably had negligible influence on the measurements of DPI at these locations.

9. Blast Pressure Measurement

MU provided an opportunity to evaluate the AMRL diaphragm type blast gauge. The gauge was developed principally to measure blast from very small explosions, typically those associated with the detonation of 1 to 5 kg of explosive material. However, its design did not preclude it from providing useful measurements for much larger events. Its principle of operation is simply that the arrival of a suitable level of airblast causes the rupture of a thin aluminium foil which is stretched and clamped over a sealed air cavity within a metal block. The air in that cavity approximates the ambient atmospheric condition. For a given diaphragm material, the level at which the diaphragm ruptures and the diaphragm diameter are directly related. The mode of rupture is that for blast pressures just exceeding the foil strength, tears radiate from the diaphragm centre. For pressures greatly exceeding its strength, the diaphragm tears around its circular edge.

The metal body of the gauge itself has a number of separate cylindrical cavities with differing diameters; the diaphragm for each cavity ruptures at a pressure level different from the others. Consequently the gauge can provide a capability of measurement over a range of pressure values. The gauge is used with its face normal to the shock flow. Consequently, the diaphragm responds to the sum of the overpressure and the dynamic pressure. It can be calibrated for overpressure alone because of the relationship between overpressure and dynamic pressure in a shock wave. This gauge has a useful overpressure range of 23-90 kPa. The calculation of the actual overpressure experienced by the gauge in an explosive event is interpreted as the value midway between those values required to just rupture the smallest diaphragm which fails and the largest one which does not.

The assembled gauge is shown below. The two photographs were taken before and after the MU event.

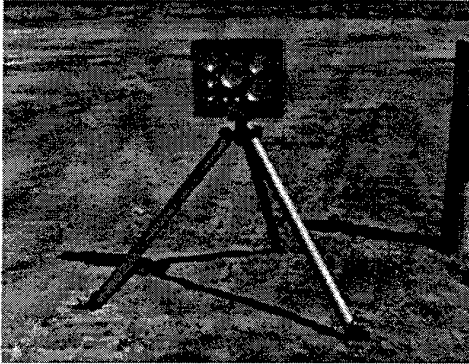

Figure 6(a). Gauge before exposure to blast

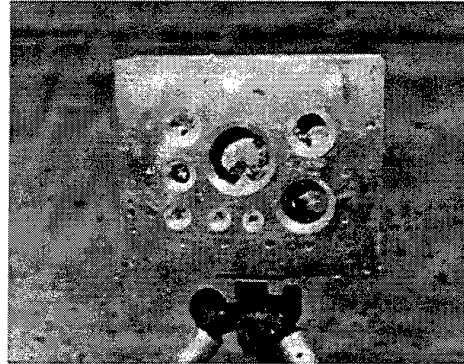

Figure 6(b). Gauge after blast

10. Result from Blast Pressure Gauge

A single blast pressure gauge was installed at the 665 m metre mark along the north radial, close to the DPI gauges and other instrumentation at that location. After the explosion event, the front of the gauge showed ample evidence of impact from particles of dirt, as did all other objects along the radial. However, inspection of the diaphragms enabled a separation of effects due to the airblast and due to the solid particles. In Figure 2(b), the three largest diaphragms have been ruptured by airblast loading, whereas the others show evidence of damage due to dirt particles alone. The overpressure recorded by the gauge was 38.6 kPa. The value obtained from electronic measurements at that location was reported (ref 4) as 35.8 kPa. This is very good agreement.

11. Conclusions

DPI Gauges

1. The results from the use of the DPI gauges are in general agreement with the data available from other sources of passive and active instrumentation.
2. The suitability of these gauges for DPI measurements has been proven for experiments with explosive yields higher than formerly experienced.
3. The damage and influence caused by dust and debris transported by the blast wave poses an obvious limitation to the use of these gauges for accurately estimating DPI. This does not however totally inhibit their usefulness in obtaining DPI data rapidly and on a large scale.
4. Although the gauges were influenced by the total experience of the main airblast, jetting and debris loading, so too are all other targets and structures in the path of

the blast wave, at least to the height of these gauges. Such occurrences are the practical reality of a ground burst explosion.

Blast Overpressure Gauge

1. The diaphragm type blast gauge also gave results comparable with those from other measurements.
2. These gauges are also sensitive to dust and debris contained in the blast wave, but those effects can usually be substantially disregarded or even eliminated in the interpretation of the rupture mechanism.
3. Although developed for a special purpose and especially for small yield explosions, they also have clearly proven useful for much larger explosions.

12. Acknowledgements

I wish to express my appreciation for assistance given me on this project by staff from DNA, ARA (especially John Keefer and Bob Flory), ARL, and Dewey McMillin and Associates.

My thanks to Mr Richard Hodge of DSTO, formerly at the Embassy of Australia, Washington, DC, for his assistance at White Sands.

13. References

1. D.A. Williams, "A Deformation Gauge For Measurement of Dynamic Pressure Impulse of Shock Waves", (U) DSL Technical Note 72, 1964.
2. J.S. Howe, "Air Blast Dynamic Pressure Impulse Measurements With Passive Instrumentation", (U) Proceedings of the Operation Distant Plain Symposium, DASA 1947-1, September, 1967.
3. R.G. Ekler, L.W. Kennedy, C.E. Needham, "MINOR UNCLE Boundary Layer Test Simulation", SSS-DTR-93-13958, report by S-Cubed, a Division of Maxwell Laboratories, April, 1993.
4. R.A. McCrory, Minor Uncle Symposium Report, volumes 1,2 4 and 5, Defence Nuclear Agency, POR 74531, 74532, 74534 and 74535, January 1995.
5. J.S. Howe, "Measurement of Dynamic Pressure Impulse Using Passive Deformation Gauges", Volume 4 - Foreign Experiments, MINOR UNCLE Symposium, DNA, February 1994.
6. R. McCrory, MINOR UNCLE Symposium Report, Volume 1 - Event Diagnostics, DNA, January 1995

14. Appendix 1

DPI Gauge Calibration

The Mk 2 gauges were calibrated in a shock tube at the Army Research Laboratory, Aberdeen Proving Ground, Maryland. The calibration was funded by the Defence Nuclear Agency.

The following is an edited version of a report by Mr John Keefer on that calibration. Editing has been necessary to remove irrelevant information and to change the units to SI.

Preliminary Results

CALIBRATION OF THE AUSTRALIAN DPI GAUGES

The calibration of the Australian dynamic pressure impulse (DPI) gauges has been undertaken. The shock tube used was the air-driven 61mm diameter shock tube at the Army Research Laboratory (formerly the Ballistic Research Laboratory), Aberdeen Proving Ground, Maryland.

The shock tube was fitted with an 11m compression chamber. The durations of the positive phases of the overpressure waveforms were near those observed on the Minor Uncle field test. The maximum shock overpressure normally produced was 173 kPa. The overpressure range required to produce dynamic pressure impulses between 2 and 4 kPa s was 97 to 131 kPa.

The interior height of the test section was 560 mm. The bottom of the gauge hinge rested on the floor of the tube and was clamped to a machined bar which was fastened firmly to the floor of the shock tube. The bar backed the hinge to the same height as was done by the stake used in MU. The head of the DPI gauge was at the height of the differential pressure probe, and was aligned with the nose of the probe. The differential pressure probe was 100 mm below the interior top surface of the shock tube. A second differential pressure probe faced to the rear to measure the dynamic pressure magnitude and impulse produced by flow from the rear.

The particular differential pressure probe used had a side-on overpressure gauge located 5 mm to the rear of the nose. The side-on overpressure gauge in the rear-facing probe was not used. The differential pressures measured were corrected for compressibility effects to generate the dynamic pressure waveforms and impulses.

The outputs from the gauges were recorded on a Honeywell 101 magnetic tape recorder. The data were digitised and fed into a computer for processing and plotting.

Preliminary tests were fired to determine the dynamic pressure impulse versus overpressure curve and to check how much impulse was being produced by the flow from the rear. The results indicated that the use of a rarefaction wave eliminator (RWE) was desirable for the lower pressures. An existing plate with a large opening was placed on the end of the tube. This reduced the rear flow considerably.

DPI gauges were installed in the tube and four shots were fired that appear to have produced satisfactory results. The overpressure levels were selected to span the range of interest. When trying for shots to produce deflections of about 20°, diaphragms from a new batch were used. Unfortunately they produced large chunks of debris which travelled through the test section, damaging gauges. A halt was called in testing the gauges until the problem was resolved.

Table 1 is the listing of all the shots considered valid for the calibration, with the exception of shot 11 as noted in the table. These shots were all made with the same stem. This gauge was broken on the last shot attempted. The stem broke loose from the clamp and the gauge head and stem bounced down the tube.

The agreement of the Australian theoretical curve with the shock tube data is excellent. The slight offset could be due to several things, such as a slightly lower drag coefficient, or slight differences in characteristics of the hinges.

John H. Keefer
Applied Research Associates, Inc.
30 Centennial Lane
Aberdeen, MD 21001

January, 1994.

Table 1. Tests of the Australian DPI Gauge in the 61 mm Shock Tube

Series Shot Number	To (deg C)	Po (kPa)	Nominal Shock Overpressure (kPa)	Measured** Shock Overpressure (kPa)	DPI (kPa s)	Hinge Angle (deg)
10	10.4	101.8	104	104	2.44	6.5
11	10.4	102.0	124	130	3.67	30.0*
12	20.9	101.8	117	117	2.82	14.0
13	20.8	101.8	110	110	2.62	8.5
19	21.9	100.9	124	121	3.31	28.5
20	22.2	101.0	117	116-121	3.02	17.5
21	22.3	101.1	128	126	3.42	33.0
23	22.0	101.1	128	129	3.70	38.0
24	22.0	101.1	121	120	3.15	20.8
25	22.6	101.1	124	122	3.38	27.5

To = air temperature inside the test section.

Po = ambient atmospheric pressure.

* It is known that this gauge was hit from the rear by a piece of the diaphragm during the return flow.

** Measured shock overpressure is that near the shock front. At later times in some of the records higher pressures may occur. See shot 20.

DISTRIBUTION LIST

The Measurement of Airblast Parameters on the MINOR UNCLE Explosion Event
Using Passive Instrumentation

J.S. Howe

AUSTRALIA

TASK SPONSOR: DGF (Joint)

DEFENCE ORGANISATION

Defence Science and Technology Organisation

Chief Defence Scientist	} shared copy
FAS Science Policy	
AS Science Industry and External Relations	
AS Science Corporate Management	
Counsellor Defence Science, London (Doc Data Sheet only)	
Counsellor Defence Science, Washington (Doc Data Sheet only)	
Scientific Adviser to Thailand MRD (Doc Data Sheet only)	
Senior Defence Scientific Adviser/Scientific Adviser Policy and Command (shared copy)	
Navy Scientific Adviser (3 copies Doc Data Sheet and one copy of distribution list)	
Scientific Adviser - Army (Doc Data Sheet and distribution list only)	
Air Force Scientific Adviser	
Director Trials	

Aeronautical and Maritime Research Laboratory

Director
Chief, SSMD
Research Leader
Task Manager
J.S. Howe

Electronics and Surveillance Research Laboratory

Director

DSTO Library

Library Fishermens Bend
Library Maribyrnong
Main Library DSTOS (2 copies)
Library, MOD, Pyrmont (Doc Data sheet only)

Defence Central

OIC TRS, Defence Central Library
Officer in Charge, Document Exchange Centre (DEC), 1 copy
DEC requires the following copies of public release reports to meet exchange agreements under their management:
*US Defence Technical Information Centre, 2 copies
*UK Defence Research Information Centre, 2 copies
*Canada Defence Scientific Information Service, 1 copy

*NZ Defence Information Centre, 1 copy
National Library of Australia, 1 copy
Defence Intelligence Organisation
Library, Defence Signals Directorate (Doc Data Sheet only)

Air Force

Director General Force Development (Air) (Doc Data Sheet only)

Army

Director General Force Development (Land) (Doc Data Sheet only)
ABCA Office, G-1-34, Russell Offices, Canberra (4 copies)

Navy

Director General Force Development (Sea)
SO (Science), Director of Naval Warfare, Maritime Headquarters Annex, Garden
Island, NSW 2000. (Doc Data Sheet only)

UNIVERSITIES AND COLLEGES

Australian Defence Force Academy
Library
Head of Aerospace and Mechanical Engineering
Senior Librarian, Hargrave Library, Monash University

OTHER ORGANISATIONS

NASA (Canberra)
AGPS

ABSTRACTING AND INFORMATION ORGANISATIONS

INSPEC: Acquisitions Section Institution of Electrical Engineers
Library, Chemical Abstracts Reference Service
Engineering Societies Library, US
American Society for Metals
Documents Librarian, The Center for Research Libraries, US

INFORMATION EXCHANGE AGREEMENT PARTNERS

Acquisitions Unit, Science Reference and Information Service, UK
Library - Exchange Desk, National Institute of Standards and Technology, US

SPARES (10 copies)

DEFENCE SCIENCE AND TECHNOLOGY ORGANISATION DOCUMENT CONTROL DATA					1. PRIVACY MARKING/CAVEAT (OF DOCUMENT)
2. TITLE The Measurement of Airblast Parameters on the MINOR UNCLE Explosion Event Using Passive Instrumentation			3. SECURITY CLASSIFICATION (FOR UNCLASSIFIED REPORTS THAT ARE LIMITED RELEASE USE (L) NEXT TO DOCUMENT CLASSIFICATION) Document (U) Title (U) Abstract (U)		
4. AUTHOR(S) J. S. Howe			5. CORPORATE AUTHOR Aeronautical and Maritime Research Laboratory PO Box 4331 Melbourne Vic 3001		
6a. DSTO NUMBER DSTO-TN-0544		6b. AR NUMBER AR-009-665	6c. TYPE OF REPORT Technical Report		7. DOCUMENT DATE March 1996
8. FILE NUMBER 510/207/0544	9. TASK NUMBER ADF 94/173	10. TASK SPONSOR DGFD (JOINT)	11. NO. OF PAGES 15		12. NO. OF REFERENCES 6
13. DOWNGRADING/DELIMITING INSTRUCTIONS			14. RELEASE AUTHORITY Chief, Ship Structures and Materials Division		
15. SECONDARY RELEASE STATEMENT OF THIS DOCUMENT <p style="text-align: center;">Approved for public release</p> OVERSEAS ENQUIRIES OUTSIDE STATED LIMITATIONS SHOULD BE REFERRED THROUGH DOCUMENT EXCHANGE CENTRE, DIS NETWORK OFFICE, DEPT OF DEFENCE, CAMPBELL PARK OFFICES, CANBERRA ACT 2600					
16. DELIBERATE ANNOUNCEMENT <p style="text-align: center;">No limitations</p>					
17. CASUAL ANNOUNCEMENT <p style="text-align: center;">Yes</p>					
18. DEFTEST DESCRIPTORS Measurement technology, Air Blast, Blast pressure, Dynamic Pressure Impulse Gauge, Pressure measurement, Shock wave					
19. ABSTRACT This report covers the measurement by the author of two of the fundamental blast parameters associated with explosions in air, i.e., dynamic pressure impulse (DPI), and blast pressure. The report illustrates how valuable a role inexpensive, passive instrumentation can play in measurement, especially in large scale field experiments. The gauges which form the subjects of this report were used most recently on the multi-national, large scale field event, MINOR UNCLE, which was a high explosive test at White Sands Missile Range, New Mexico, on 10 June, 1993. Both of the gauges used for these measurements were developed at AMRL but at different times, to satisfy vastly different requirements. Australia was requested to participate in MU by carrying out the measurement of DPI for comparison with other measurements of the same parameter. The range of interest to overseas scientists was 0.5 kPa s to well in excess of 20 kPa s. This range greatly exceeded the capability of the Australian gauge. This is discussed fully in the report. The Australian DPI gauge was a modification of a design which was developed for the BLOWDOWN airblast experiment which was held in 1963 in a tropical rain forest in northern Australia. This gauge was also used on the DISTANT PLAIN series at Defence Research Establishment, Suffield(S) and Hinton, Alberta, Canada, in 1966/7. Although the gauge was not designed originally for use with explosions having a yield much greater than 500 tonnes TNT equivalence, its use in a modified form has proven quite successful on MINOR UNCLE (MU). The second gauge, a self recording, peak reading, blast pressure gauge, was developed in the 1980s to provide a simple means of blast measurement for use by relatively unskilled military people engaged in training exercises. This report explains the changes to the original design of the DPI gauge and the results achieved with its use, as well as the successful deployment of the overpressure gauge in the form in which it was originally designed. Both forms of measurement gave very satisfactory outcomes.					