

copy 93

U-14483

AECD-2707

UNITED STATES ATOMIC ENERGY COMMISSION

REPORT OF TRIANGLE COMPUTER

by

H. G. Weiss

Los Alamos Scientific Laboratory

19970102 121

NAVY RESEARCH SECTION  
SCIENCE DIVISION  
REFERENCE DEPARTMENT  
LIBRARY OF CONGRESS

copy # 93

20 FEB 1950

NOTICE

This document is the property of the United States Government. It is furnished on a loan basis and shall be returned as specified, or upon recall by ASTIA to the following address: ASTIA Reference Center, Technical Information Division, Library of Congress, Washington 25, D.C.

This document is reproduced as a project report and is without editorial preparation. The manuscript has been submitted to Review of Scientific Instruments for possible publication.

Date of Manuscript: June 10, 1948  
Date Declassified: September 16, 1949

Issuance of this document does not constitute authority for declassification of classified copies of the same or similar content and title and by the same author.

FILE COPY  
NAVY RESEARCH SECTION  
SCIENCE DIVISION  
LIBRARY OF CONGRESS  
TO BE RETURNED

RETURN TO:  
ASTIA REFERENCE CENTER  
LIBRARY OF CONGRESS  
WASHINGTON 25, D.C.

Technical Information Division, ORE, Oak Ridge, Tennessee  
AEC, Oak Ridge, Tenn., 2-10-50--850-A14033

PRINTED IN USA  
PRICE 10 CENTS

DTIC QUALITY INSPECTED 1

FOR PUBLIC RELEASE

# DISCLAIMER NOTICE

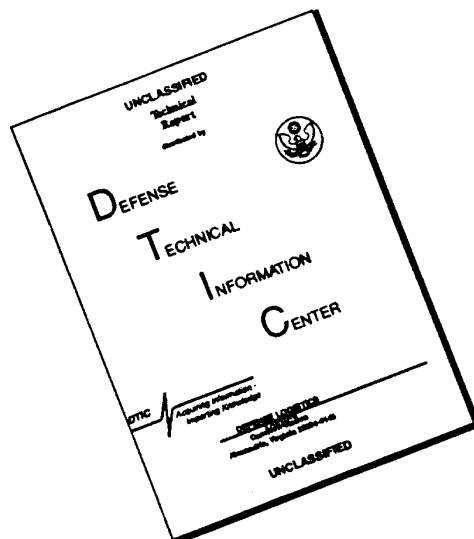

**THIS DOCUMENT IS BEST QUALITY AVAILABLE. THE COPY FURNISHED TO DTIC CONTAINED A SIGNIFICANT NUMBER OF PAGES WHICH DO NOT REPRODUCE LEGIBLY.**

Triangle Computer

The Problem. The problem is to solve for the third side of a triangle whose two sides and included angle are known. A graphical method can be used for this problem, but this paper describes a simple, electrical analog computer which has been developed to speed up such computation.

The problem calls for the solution of the equation:

$$C = \sqrt{A^2 + B^2 + 2AB \cos \theta}$$

when A, B, and  $\cos \theta$  are known. The geometrical relationship between the terms in the above equation is shown in Fig. 1 below.

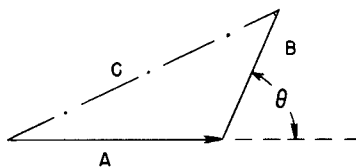

Figure 1

In this problem,  $\cos \theta$  was restricted to 10 values; namely,  $-0.9, -0.7, -0.5, -0.3, -0.1, +0.1, +0.3, +0.5, +0.7,$  and  $+0.9$ . The values of A and B could vary from 0 to 1,000, and it was desired to determine C to an accuracy of 1 per cent.

Principle of Operation. The basic phase shifting circuit used in the computer is shown in Fig. 2, and the vector diagram is given in Fig. 3.

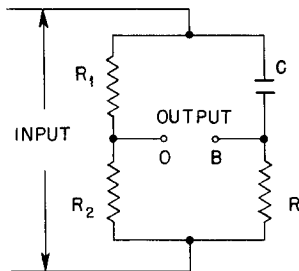

Figure 2

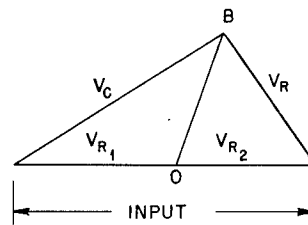

Figure 3

In our application, the  $R_1$  is made equal to  $R_2$ , and the impedance placed across the output terminals OB is high compared with  $R_1$ ,  $R_2$ ,  $R$ , and  $C$ . Since the voltage drop across  $C$  must be exactly 90 deg out of phase with the voltage across  $R$ , and since  $R_1$  equals  $R_2$ , it can be proved that point B travels around a circle having a radius OB equal in magnitude to one-half the input voltage.

In the actual circuit, the resistors  $R_1$  and  $R_2$  are replaced by a center-tapped transformer. It will be noted that this change does not affect the electrical performance but does eliminate the power which would otherwise be expended in  $R_1$  and  $R_2$ .

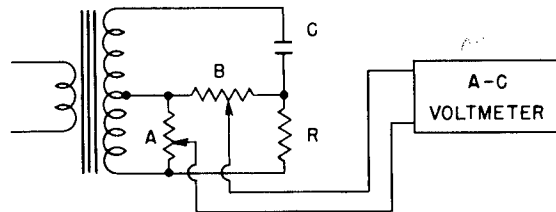

Figure 4

It can be seen from the simplified circuit of the computer (Fig. 4) that if some of the phase-shifted voltage (B) is combined with some of the transformer voltage that has not been shifted in phase (A), the sum of these voltages will be a vector with a magnitude equal to C. The magnitude of the voltage at C could be measured directly with a voltmeter, as shown in Fig. 4. A simplified computer of this type would be subject to the errors introduced by the meters and would require a well stabilized ac supply voltage. These difficulties can be overcome by the use of a reference voltage which is obtained from the common supply line and a null balance indicator as shown in Fig. 5.

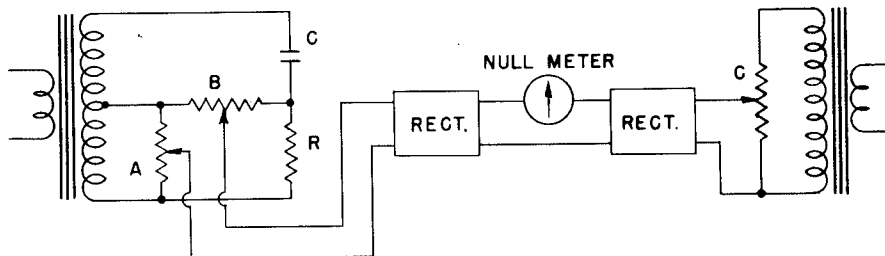

Figure 5

This method requires that the ac voltages first be rectified and then their magnitudes compared in a dc null circuit. The voltmeters used to measure voltages A and B can be replaced with precision potentiometers (Helipot) that are relatively inexpensive and have excellent linearity (0.1 per cent). Ten-turn Helipot dials can be used to provide readings of A, B, and C having values from 0 to 1,000. It is necessary that the ac voltages across these potentiometers be made precisely equal by proper choice of the transformer voltages or by the use of balancing resistors.

Since the magnitude of  $A \angle 0^\circ + B \angle \cos^{-1}(-x)$  is equal to the magnitude of  $A \angle 180^\circ + B \angle \cos^{-1}(x)$ , the same RC phase-shift network can be used for the angle whose cosine is equal to  $x$  and  $-x$ ,

providing the vector A is shifted 180 deg. Fortunately, vector A can be shifted 180 deg simply by switching a connection from one end of the center-tapped transformer winding to the other. By this means, it is possible to obtain the 10 required angles with five RC networks and a switch.

It will be noted that for some angles the comparison voltage (C) must be almost twice as large as A or B; and, therefore, provision is made to "add 1,000" to the reading of C by increasing the potential across the C potentiometer.

Actual Circuit. The final circuit of the Triangle Computer is given in Fig. 6. This circuit closely follows the basic arrangement shown in Fig. 5.

In order to obtain high accuracy with the computer, it is necessary that the potentiometer R-104 have a high impedance compared with that of the phase-shift network (C-101, R-105 to R-114). It is also necessary that the detector load circuits have a very high impedance compared with R-104. In practice, a 50,000-ohm Helipot is used for R-104, and the impedance of the phase-shift network is approximately 300 ohms. It is important for high accuracy that the voltage obtained from the center-tapped transformer T-102 be independent of changes in load caused by switching the R's in The RC network. Considerable difficulty was encountered in finding a suitable transformer, but a compromise was finally made by using a 500-watt auto-transformer. Since we were unable to locate a center-tapped transformer which produced identical voltages in each half of the winding, a small filament transformer (T-101) was used to achieve balance. The transformer load current varied from about 0.25 amperes to 0.35 amperes as the phase shift networks were switched and the regulation of the transformer voltage was constant to  $\pm 0.75$  per cent. This small change in the transformer secondary voltage is responsible for the largest part of the errors remaining in the computer.

The A voltage component was obtained directly from the one-half of the autotransformer winding. The phase of the A voltage was automatically reversed by the switch S-102A when the angle  $\theta$  was switched from positive to negative values. Each of the five angles in the phase-shift network could be independently adjusted by means of rheostats (R-105, R-107, R-109, R-111, and R-113).

The comparison voltage is obtained from T-103. For low voltage values, the resistors R-115 and R-116 are used to adjust the potential across the C-voltage Helipot (R-120). For high voltage values, R-117, R-118, and R-119 are used to adjust the total C voltage across the Helipot.

The 6AL5 double diode tube is used to rectify each of the ac voltage components. Very long time constants R-122, C-102; and R-124, C-103 are employed in the detector circuit to prevent cross coupling of ac voltages from the cathode of one diode section to that of the other. R-122 and R-124, the diode load resistors, are made very large compared with the driving source resistance, since the driving source resistance varies as the Helipot dials are rotated.

Adjustment of Computer. The adjustment of the computer can most easily be carried out by proceeding according to the steps outlined below:

1. Set the "Add 1,000" switch to the OFF position, the A and C dials to 500, and the B dial to 000. The transformer balance potentiometer R-101 is then adjusted to show no change in meter reading as the  $\theta$  switch is varied from plus to minus values.
2. Set A to 000, and B and C to 500, and adjust R-115 to make the meter reading 0. This balance should be independent of the  $\theta$  switch position.
3. With B set at 000, and A and C set at 500, adjust R-102 for meter balance.
4. The phase angle adjusting potentiometers R-105, R-107, R-109, R-111, and R-113 are adjusted with the A and B dials set at 500 to make the reading of C correspond as well as possible with the calculated values of C for each of the nine switch positions.
5. It is advisable to recheck steps 1 to 4 above to correct for any minor changes introduced in the alignment process.
6. The "Add 1,000" switch is thrown to the ON position. A problem is set up with values of A, B, and  $\theta$  which would make C fall at some known value in the range from 1.300 to 1.700. R-119 is adjusted until the actual value of C is made to correspond with the indicated value.

Over-all Accuracy. In the present instrument, the accuracy is not completely independent of the position of the phase angle switch. Nearly all of the error is caused by the imperfect regulation of the autotransformer T-102. If the errors are reduced to a minimum (0.3 per cent), with the cosine switch in the  $\pm 0.3$ ,  $\pm 0.5$ , and  $\pm 0.7$  positions, it has been found that the C dial reads approximately 0.6 per cent low when cosine  $\theta$  equals  $\pm 0.1$ . When cosine  $\theta$  equals  $\pm 0.9$ , the error is approximately 1.25 per cent and causes the C dial to read high. These errors can be reduced by use of a better regulated transformer for T-102 or by modification of the phase shift circuits.

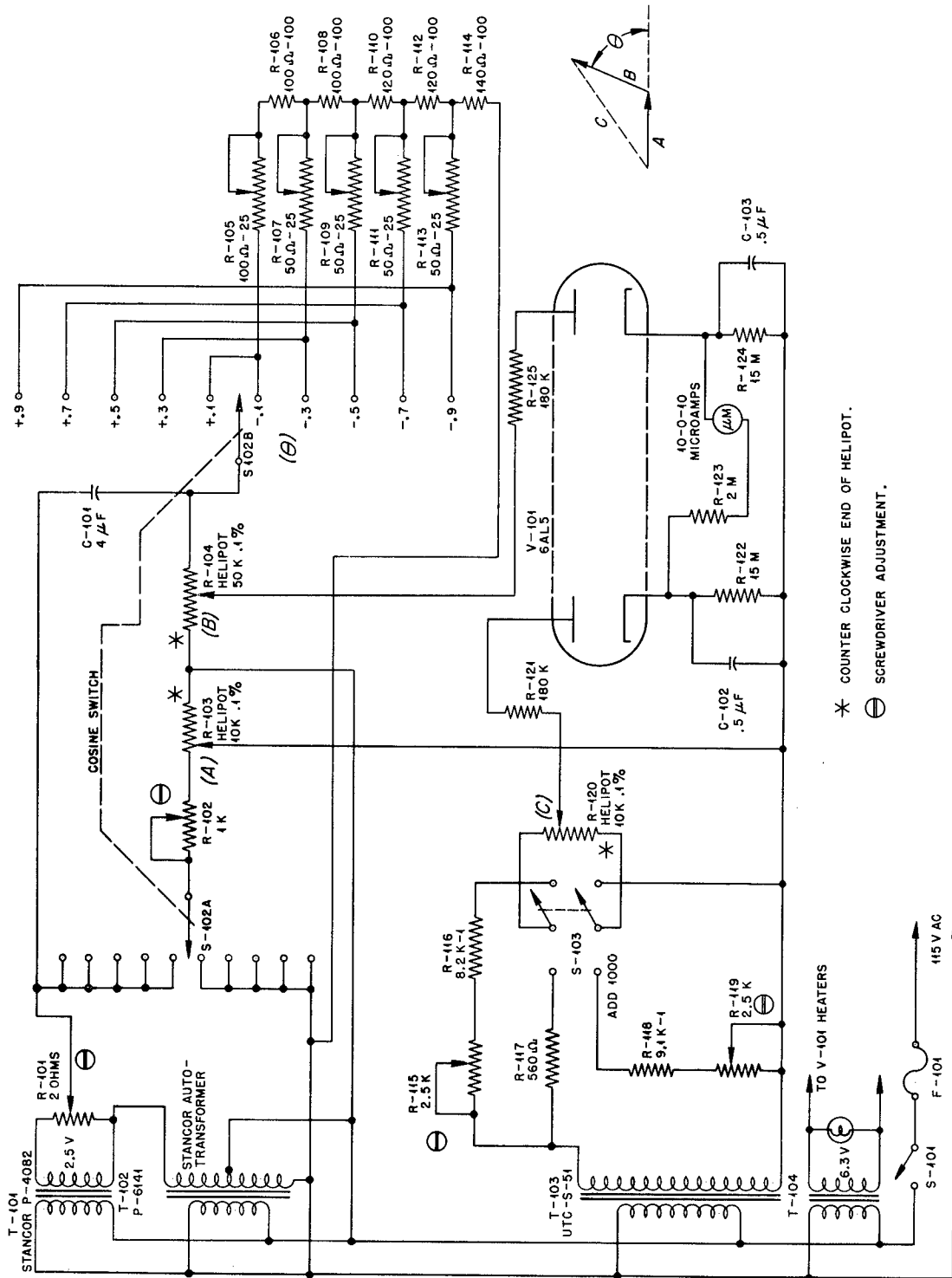

\* COUNTER CLOCKWISE END OF HELIPOT.  
 ⊖ SCREWDRIVER ADJUSTMENT.

Figure 6

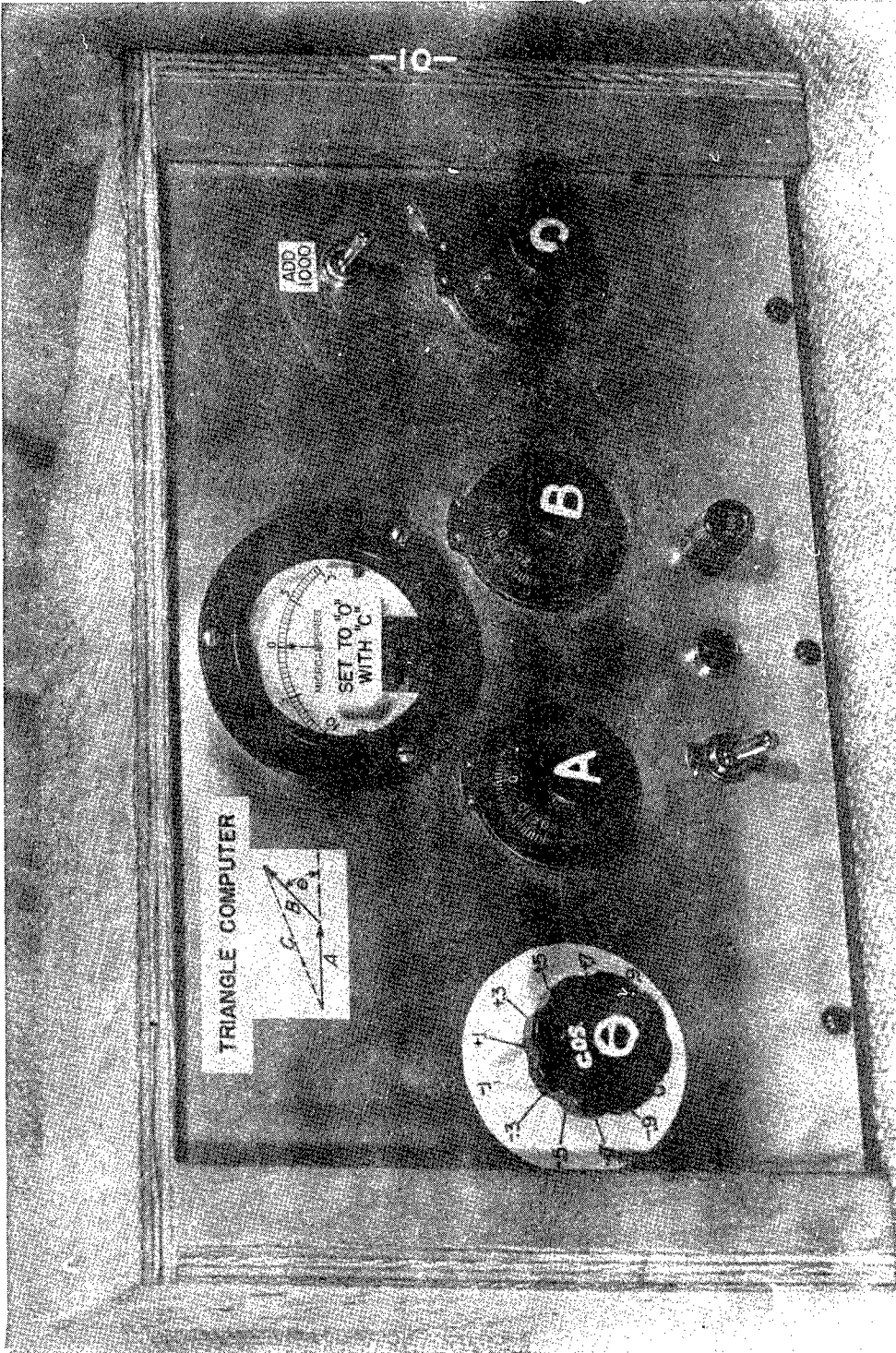

Figure 7

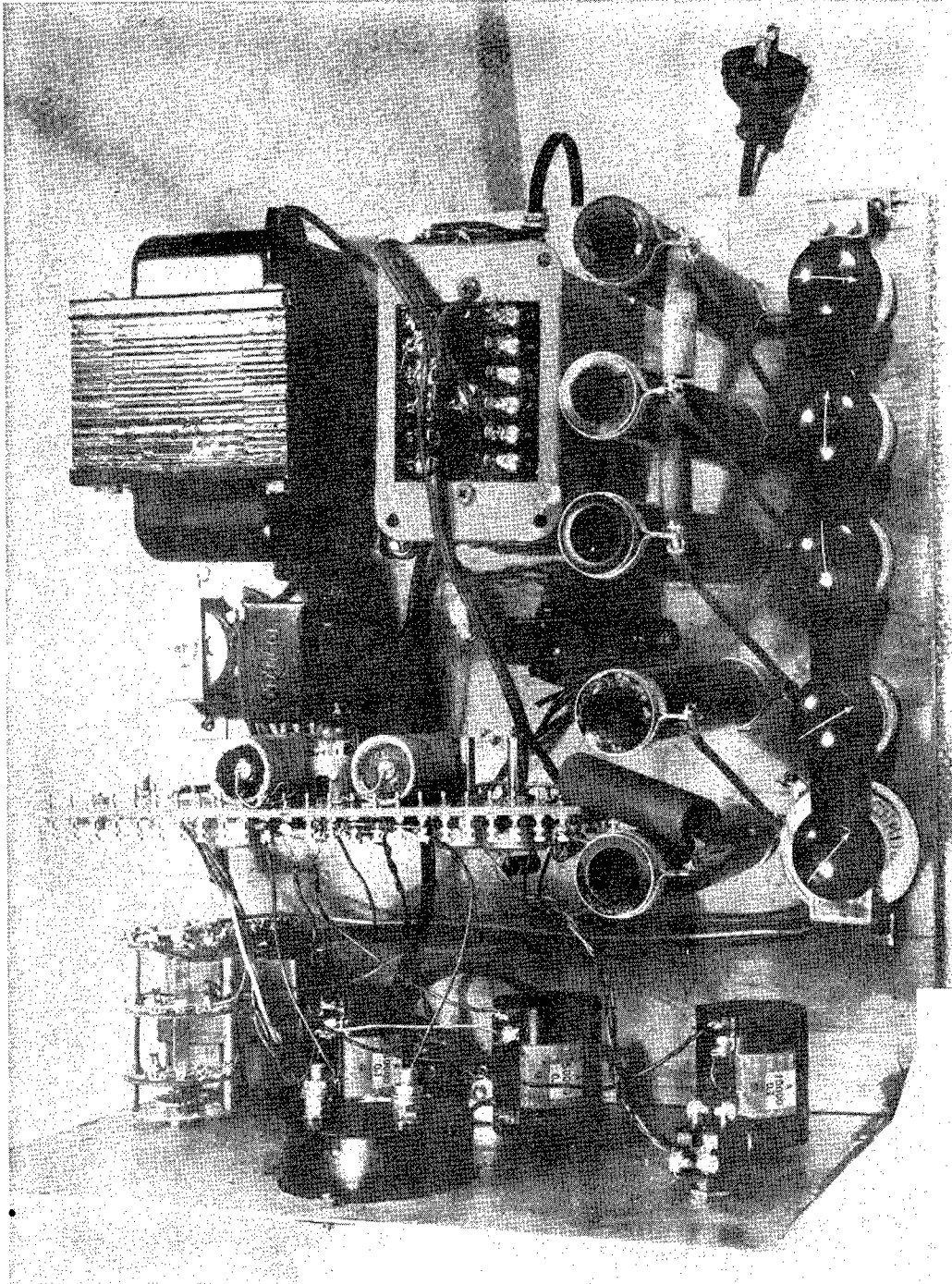

Figure 8

END OF DOCUMENT