

VOLUME II
FLYING QUALITIES PHASE

CHAPTER 5
LONGITUDINAL STATIC STABILITY

DISTRIBUTION STATEMENT A
Approved for public release
Distribution Unlimited

OCTOBER 1990

USAF TEST PILOT SCHOOL
EDWARDS AFB CA

19970117 032

EXERCISE QUALITY INSPECTED 1

5.1 DEFINITION OF LONGITUDINAL STATIC STABILITY

Static stability is the reaction of a body to a disturbance from equilibrium. To determine the static stability of a body, the body must be initially disturbed from its equilibrium state. If, when disturbed from equilibrium, the initial tendency of the body is to return to its original equilibrium position, the body displays positive static stability or is stable. If the initial tendency of the body is to remain in the disturbed position, the body is said to be neutrally stable. However, should the body, when disturbed, initially tend to continue to displace from equilibrium, the body has negative static stability or is unstable.

Longitudinal static stability or "gust stability" of an aircraft is determined in a similar manner. If an aircraft in equilibrium is momentarily disturbed by a vertical gust, the resulting change in angle of attack causes changes in lift coefficients on the aircraft (velocity is constant for this time period). The changes in lift coefficients produce additional aerodynamic forces and moments in this disturbed position. If the aerodynamic forces and moments created tend to return the aircraft to its original undisturbed condition, the aircraft possesses positive static stability or is stable. Should the aircraft tend to remain in the disturbed position, it possesses neutral stability. If the forces and moments tend to cause the aircraft to diverge further from equilibrium, the aircraft possesses negative longitudinal static stability or is unstable. Pictorial examples of static stability as related to the gust stability of an aircraft are shown in Figure 5.1.

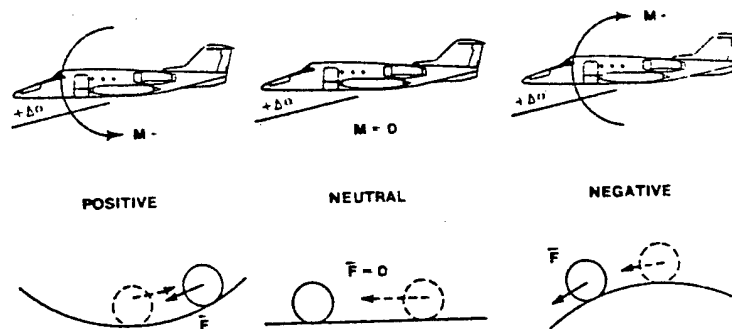

FIGURE 5.1. STATIC STABILITY AS RELATED TO GUST STABILITY OF AIRCRAFT

5.2 DEFINITIONS

Aerodynamic center. The point of action of the lift and drag forces such that the value of the moment coefficient does not change with angle of attack.

Apparent stability. The value of dF_s/dV_s about trim velocity. Also referred to as "speed stability".

Aerodynamic balancing. Designing or tailoring $C_{h_{\delta}}$ and $C_{h_{\alpha t}}$ to either increase or decrease hinge moments and floating tendency.

Center of pressure. The point along the chord of an airfoil, or on an aircraft itself, where the lift and drag forces act, and there is no moment produced.

Dynamic elevator balancing. Designing $C_{h_{\alpha t}}$ (the floating moment coefficient) to be small or zero.

Dynamic overbalancing. Designing $C_{h_{\alpha t}}$ to be negative (tail to rear aircraft only).

Elevator effectiveness. The change in tail angle of attack per degree of change in elevator deflection. $\tau = d\alpha_t/d\delta_e$ and equals -1.0 for the all moving horizontal tail or "stabilizer".

Elevator power. A control derivative. $C_{m_{\delta_e}} = -aV_H \eta_t \tau$

Hinge moments. The moment about the hinge line of a control surface.

Longitudinal static stability (or "gust" stability). The initial tendency of an aircraft to return to trim when disturbed in pitch. $dC_m/dC_L < 0$ for the airplane to be statically stable. The airplane must also be able to trim at a useful positive C_L .

Static elevator balancing. Balancing the elevator so that the C_h contribution due to the weight of the surface is zero.

Stick-fixed neutral point. The cg location when $dC_m/dC_L = 0$ for the stick-fixed airplane.

Stick-fixed stability. The magnitude of dC_m/dC_L for the stick-fixed airplane.

Stick-fixed static margin. The distance, in percent MAC, between the cg and the stick-fixed neutral point.

Stick force gradient. The value of dF_s/dV_s about trim velocity. Also referred to as "speed stability" and "apparent stability".

Stick-free neutral point. The cg position where $dC_m/dC_L = 0$ for the stick-free airplane.

Tail efficiency factor. $\eta_t = q_t/q_w$, the ratio of tail dynamic pressure to wing dynamic pressure.

Tail volume coefficient. $V_H = l_t S_t / C_w S_w$

5.3 MAJOR ASSUMPTIONS

1. Aerodynamic characteristics are linear (C_{L_α} , dC_m/dC_L , $C_{m_{\delta_e}}$, etc.)

2. The aircraft is in steady, straight (not defined as in Chapter 4 but $\beta = 0^\circ$, $\phi = 0^\circ$), unaccelerated flight (q , p , r are all zero).

3. Power is at a constant setting.

4. Jet engine thrust does not change with velocity or angle of attack.

5. The lift curve slope of the tail is very nearly the same as the slope of the normal force curve.

6. $C_{m_\alpha} = C_{L_\alpha} (dC_m/dC_L)$ is true for rigid aircraft at low Mach when thrust effects are small.

7. X_w , Z_w , V_H , and η_t do not vary with C_L .

8. C may be neglected since it is 1/10 the magnitude of C_w and 1/100 the magnitude of N_w .

9. Fighter-type aircraft and most low wing, large aircraft have cg's very close to the top of the mean aerodynamic chord.

10. Elevator effectiveness and elevator power are constant.
Symmetric Horizontal Tail ($M_{a_{c_t}} = 0$).

5.4 ANALYSIS OF LONGITUDINAL STATIC STABILITY

Longitudinal static stability is only a special case for the total equations of motion of an aircraft. Of the six equations of motion, longitudinal static stability is concerned with only one, the pitch equation, describing the aircraft's motion about the y axis.

$$G_y = \dot{Q}I_y - PR(I_z - I_x) + (P^2 - R^2)I_{xz} \quad (5.1)$$

The fact that theory pertains to an aircraft in straight, steady, symmetrical flight with no unbalance of forces or moments permits longitudinal static stability motion to be independent of the lateral and directional equations of motion. This is not an oversimplification since most aircraft spend much of the flight under symmetric equilibrium conditions. Furthermore, the disturbance required for determination and the measure of the aircraft's response takes place about the axis or in the longitudinal plane. Under these conditions, Equation 5.1 reduces to:

$$G_y = 0$$

Since longitudinal static stability is concerned with resultant aircraft pitching moments caused by momentary changes in angle of attack and lift coefficients, the primary stability derivatives become C_{m_α} or $C_{m_{c_L}}$. The value of either derivative is a direct indication of the longitudinal static stability of the particular aircraft.

To determine an expression for the derivative $C_{m_{c_L}}$, an aircraft in stabilized equilibrium flight with horizontal stabilizer control surface fixed will be analyzed. A moment equation will be determined from the forces and moments acting on the aircraft. Once this equation is nondimensionalized, in moment coefficient form, the derivative with respect to C_L will be taken. This differential equation will be an expression for $C_{m_{c_L}}$ and will relate directly to the aircraft's stability. Individual term contributions to

stability will, in turn, be analyzed. A flight test relationship for determining the stability of an aircraft will be developed followed by a repeat of the entire analysis for an aircraft with a free control surface.

5.5 THE STICK FIXED STABILITY EQUATION

To derive the longitudinal pitching moment equation, refer to the aircraft in Figure 5.2. Writing the moment equation using the sign convention of pitch-up being a positive moment

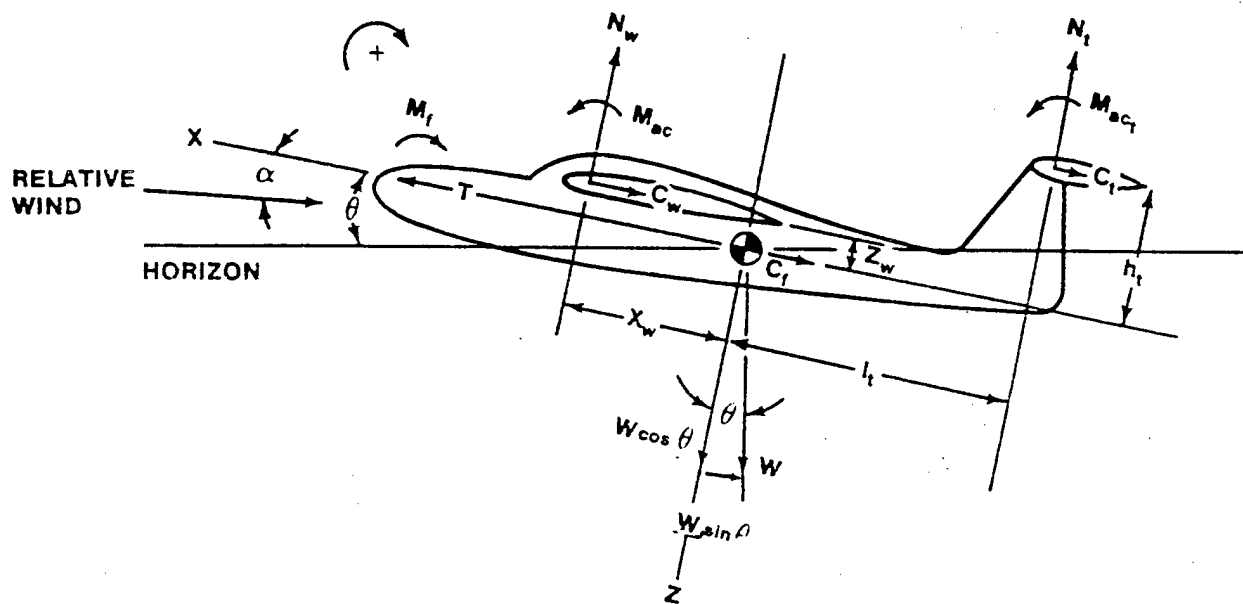

FIGURE 5.2. AIRCRAFT PITCHING MOMENTS

$$\begin{array}{c}
 \curvearrowright \\
 + \\
 M_{cg} = N_w X_w + C_w Z_w - M_{ac} + M_f - N_t l_t + C_t h_t - M_{act} \quad (5.2)
 \end{array}$$

If an order of magnitude check is made, some of the terms can be logically eliminated because of their relative size. C_t can be omitted since

$$C_t \approx \frac{C_w}{10} \approx \frac{N_w}{100}$$

M_{act} is zero for a symmetrical airfoil horizontal stabilizer section.

Rewriting the simplified equation

$$\begin{array}{c}
 \curvearrowright \\
 + \\
 M_{cg} = N_w X_w + C_w Z_w - M_{ac} + M_f - N_t l_t \quad (5.3)
 \end{array}$$

It is convenient to express Equation 5.3 in nondimensional coefficient form by dividing both sides of the equation by $q_w S_w c_w$

$$\frac{M_{cg}}{q_w S_w c_w} = \frac{N_w X_w}{q_w S_w c_w} + \frac{C_w Z_w}{q_w S_w c_w} - \frac{M_{ac}}{q_w S_w c_w} + \frac{M_f}{q_w S_w c_w} - \frac{N_t l_t}{q_w S_w c_w} \quad (5.4)$$

Substituting the following coefficients in Equation 5.4

$$C_{m_{cg}} = \frac{M_{cg}}{q_w S_w c_w} \quad \text{total pitching moment coefficient about the cg}$$

$$C_{m_{ac}} = \frac{M_{ac}}{q_w S_w c_w} \quad \text{wing aerodynamic pitching moment coefficient}$$

$$C_{m_f} = \frac{M_f}{q_w S_w c_w} \quad \text{fuselage aerodynamic pitching moment coefficient}$$

$$C_N = \frac{N_w}{q_w S_w} \quad \text{wing aerodynamic normal force coefficient}$$

$$C_{N_t} = \frac{N_t}{q_t S_t} \quad \text{tail aerodynamic normal force coefficient}$$

$$C_c = \frac{C_w}{q_w S_w} \quad \text{wing aerodynamic chordwise force coefficient}$$

Equation 5.4 may now be written

$$C_{m_{cg}} = C_N \frac{X_w}{c} + C_c \frac{Z_w}{c} - C_{m_{ac}} + C_{m_f} - \frac{N_t l_t}{q S c}$$

where the subscript w is dropped. (Further equations, unless subscripted, will be with reference to the wing.) To have the tail indicated in terms of a coefficient, multiply and divide by $q_t S_t$

$$\frac{N_t l_t}{q_w S_w c_w} \cdot \frac{q_t S_t}{q_t S_t}$$

Substituting tail efficiency factor $\eta_t = q_t/q_w$ and designating tail volume coefficient $V_H = l_t S_t/cS$ Equation 5.5 becomes

$$C_{m_{cg}} = C_N \frac{X_w}{c} + C_c \frac{Z_w}{c} - C_{m_{ac}} + C_{m_f} - C_{N_t} V_H \eta_t \quad \boxed{\text{BALANCE EQUATION}} \quad (5.6)$$

Equation 5.6 is referred to as the equilibrium equation in pitch. If the magnitudes of the individual terms in the above equation are adjusted to the proper value, the aircraft may be placed in equilibrium flight where $C_{m_{cg}} = 0$

Taking the derivative of Equation 5.6 with respect to C_L and assuming that X_w, Z_w, V_H and η_t do not vary with C_L ,

$$\frac{dC_{m_{cg}}}{dC_L} = \underbrace{\frac{dC_N}{dC_L} \frac{X_w}{c} + \frac{dC_c}{dC_L} \frac{Z_w}{c} - \frac{dC_{m_{ac}}}{dC_L}}_{\text{WING}} + \underbrace{\frac{dC_{m_f}}{dC_L}}_{\text{FUSELAGE}} - \underbrace{\frac{dC_{N_t}}{dC_L} V_H \eta_t}_{\text{TAIL}} \quad \boxed{\text{STABILITY EQUATION}} \quad (5.7)$$

Equation 5.7 is the stability equation and is related to the stability derivative C_{m_α} by the slope of the lift curve, a . Theoretically,

$$C_{m_\alpha} = \frac{dC_m}{d\alpha} = \frac{dC_L}{d\alpha} \frac{dC_m}{dC_L} = a \frac{dC_m}{dC_L} = C_{L_\alpha} \frac{dC_m}{dC_L} \quad (5.8)$$

Equation 5.8 is only true for a rigid aircraft at low Mach when thrust effects are small; however, this relationship does provide a useful index of stability.

Equation 5.6 and Equation 5.7 determine the two criteria necessary for longitudinal stability:

Criteria 1. The aircraft is balanced.

Criteria 2. The aircraft is stable.

The first condition is satisfied if the pitching moment equation can be forced to $C_{m_{cg}} = 0$ for useful positive values of C_L .

This condition is achieved by adjusting elevator deflection so that moments about the center of gravity are zero (i.e., $M_{cg} = 0$).

The second condition is satisfied if Equation 5.7 or $dC_{m_{cg}}/dC_L$ has a negative value. From Figure 5.3, a negative value for Equation 5.7 is necessary if the aircraft is to be stable. Should a gust cause an angle of attack increase (and a corresponding increase in C_L), a negative $C_{m_{cg}}$ should be produced to return the aircraft to equilibrium, or $C_{m_{cg}} = 0$. The greater the slope or the negative value, the more restoring moment is generated for an increase in C_L . The slope of $dC_{m_{cg}}/dC_L$ is a direct measure of the "gust stability" of the aircraft. (In further stability equations, the c.g. subscript will be dropped for ease of notation).

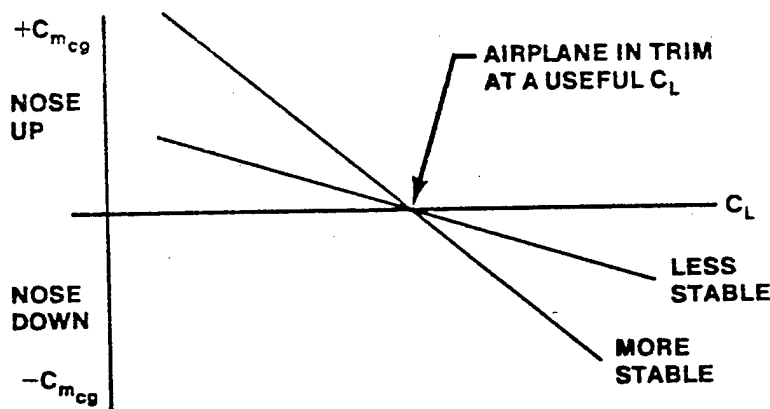

FIGURE 5.3. STATIC STABILITY

If the aircraft is retrimmed from one angle of attack to another, the basic stability of the aircraft or slope dC_m/dC_L does not change. Note Figure 5.4.

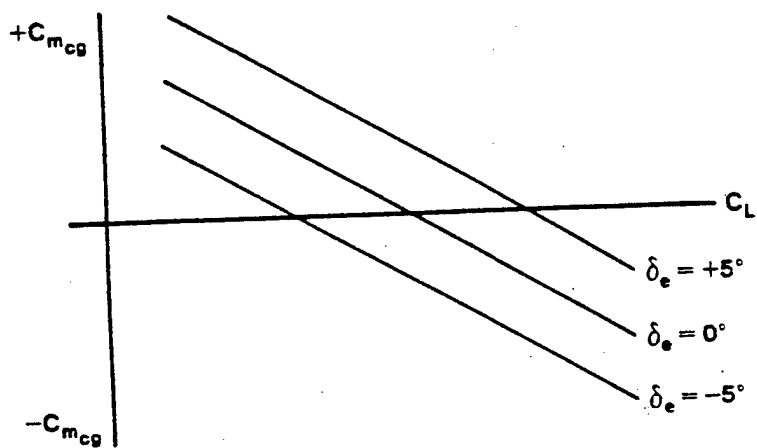

FIGURE 5.4. STATIC STABILITY WITH TRIM CHANGE

However, if moving the cg is changing the values of X_v or Z_v , or if V_H is changed, the slope or stability of the aircraft is changed. See Equation 5.7. For no change in trim setting, the stability curve may shift as in Figure 5.5.

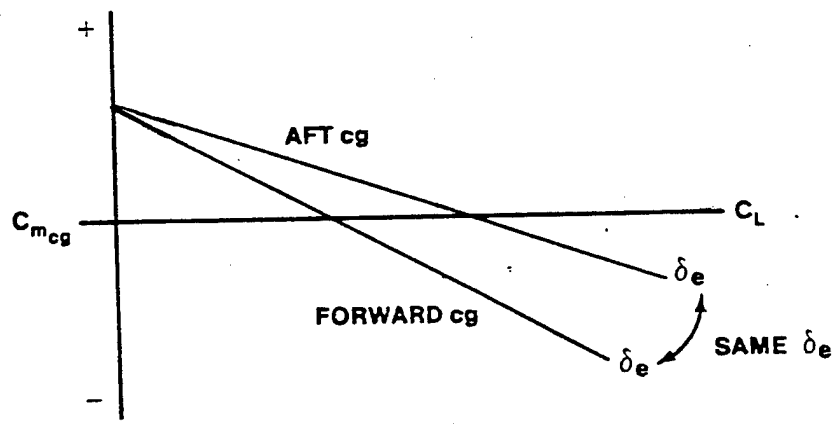

FIGURE 5.5. STATIC STABILITY CHANGE WITH CG CHANGE

5.6 AIRCRAFT COMPONENT CONTRIBUTIONS TO THE STABILITY EQUATION

5.6.1 The Wing Contribution to Stability

The lift and drag are by definition always perpendicular and parallel to the relative wind. It is therefore inconvenient to use these forces to obtain moments, for their arms to the center of gravity vary with angle of attack. For this reason, all forces are resolved into normal and chordwise forces whose axes remain fixed with the aircraft and whose arms are therefore constant.

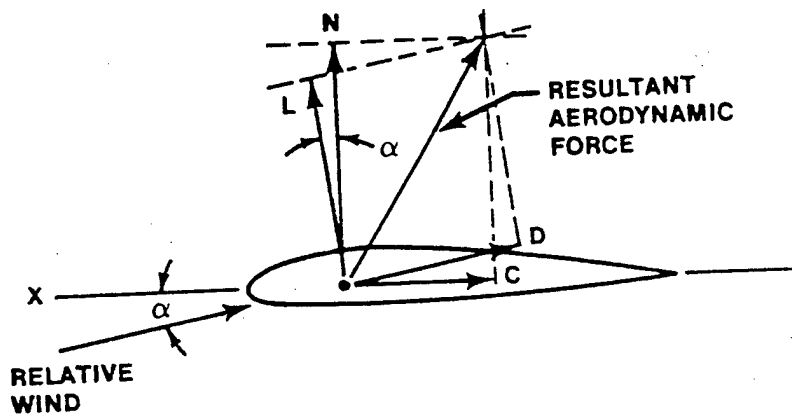

FIGURE 5.6. WING CONTRIBUTION TO STABILITY

Assuming the wing lift to be the airplane lift and the wing's angle of attack to be the airplane's angle of attack, the following relationship exists between the normal and lift forces (Figure 5.6)

$$N = L \cos \alpha + D \sin \alpha \quad (5.9)$$

$$C = D \cos \alpha - L \sin \alpha \quad (5.10)$$

Therefore, the coefficients are similarly related

$$C_N = C_L \cos \alpha + C_D \sin \alpha \quad (5.11)$$

$$C_C = C_D \cos \alpha - C_L \sin \alpha \quad (5.12)$$

The stability contributions, dc_N/dc_L and dc_C/dc_L , are obtained

$$\frac{dC_N}{dC_L} = \frac{dC_L}{dC_L} \cos \alpha - C_L \frac{d\alpha}{dC_L} \sin \alpha + \frac{dC_D}{dC_L} \sin \alpha + C_D \frac{d\alpha}{dC_L} \cos \alpha \quad (5.13)$$

$$\frac{dC_C}{dC_L} = \frac{dC_D}{dC_L} \cos \alpha - C_D \frac{d\alpha}{dC_L} \sin \alpha - \frac{dC_L}{dC_L} \sin \alpha - C_L \frac{d\alpha}{dC_L} \cos \alpha \quad (5.14)$$

Making an additional assumption that

$$C_D = C_{D_p} + \frac{C_L^2}{\pi AR e} \quad \text{and that } C_{D_p} \text{ is constant with changes in } C_L$$

$$\text{Then } \frac{dC_D}{dC_L} = \frac{2C_L}{\pi AR e}$$

If the angles of attack are small such that $\cos \alpha = 1.0$ and $\sin \alpha = \alpha$, Equations 5.13 and 5.14 become

$$\frac{dC_N}{dC_L} = 1 + C_L \alpha \left(\frac{2}{\pi AR e} - \frac{d\alpha}{dC_L} \right) + C_D \frac{d\alpha}{dC_L} \quad (5.15)$$

$$\frac{dC_C}{dC_L} = \frac{2}{\pi AR e} C_L - C_D \frac{d\alpha}{dC_L} \alpha - \alpha - C_L \frac{d\alpha}{dC_L} \quad (5.16)$$

Examining the above equation for relative magnitude,

C_D is on the order of 0.02 to 0.30

C_L usually ranges from 0.2 to 2.0

α is small, ≤ 0.2 radians

$\frac{d\alpha}{dC_L}$ is nearly constant at 0.2 radians

$\frac{2}{\pi AR e}$ is on the order of 0.1

Making these substitutions, Equations 5.15 and 5.16 have magnitudes of

$$\frac{dC_N}{dC_L} = 1 - 0.04 + 0.06 = 1.02 \approx 1.0 \quad (5.17)$$

$$\frac{dC_C}{dC_L} = 0.1 C_L - 0.012 - 0.2 - 0.2C_L = -0.41 \quad (5.18)$$

$$\text{at } C_{L_{\max}} = 2.0$$

The moment coefficient about the aerodynamic center is invariant with respect to angle of attack (see definition of aerodynamic center). Therefore

$$\frac{dC_{m_{ac}}}{dC_L} = 0$$

Rewriting the wing contribution of the Stability Equation, Equation 5.7,

$$\frac{dC_{m_{\text{WING}}}}{dC_L} = \frac{X_w}{c} - 0.41 \frac{Z_w}{c} \quad \text{at } C_{L_{\max}} = 2.0 \quad (5.19)$$

From Figure 5.6 when α increases, the normal force increases and the chordwise force decreases. Equation 5.19 shows the relative magnitude of these changes. The position of the cg above or below the aerodynamic center (ac) has a much smaller effect on stability than does the position of the cg ahead of or behind the ac. With cg ahead of the ac, the normal force is stabilizing. From Equation 5.19, the more forward the cg location, the more stable the aircraft. With the cg below the ac, the chordwise force is stabilizing since this force decreases as the angle of attack increases. The further the cg is located below the ac, the more stable the aircraft or the more negative the value of dC_m/dC_L . The wing contribution to stability depends on the cg and the ac relationship shown in Figure 5.7.

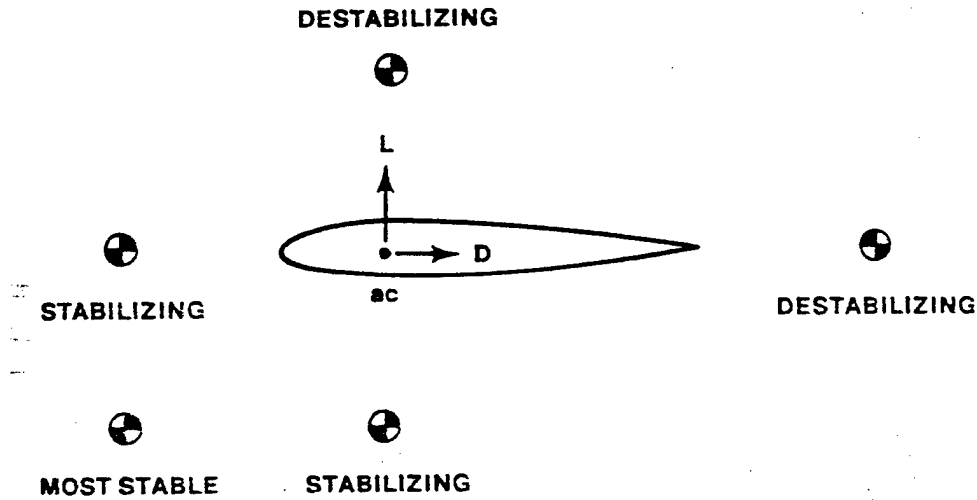

FIGURE 5.7. CG EFFECT ON WING CONTRIBUTION TO STABILITY

For a stable wing contribution to stability, the aircraft would be designed with a high wing aft of the center of gravity.

Fighter type aircraft and most low wing, large aircraft have cg's very close to the top of the mean aerodynamic chord. z_w/c is on the order of 0.03. For these aircraft the chordwise force contribution to stability can be neglected. The wing contribution then becomes

$$\frac{dC_m}{dC_{L_{WING}}} = \frac{X_w}{c} \quad (5.20)$$

5.6.2 The Fuselage Contribution to Stability

The fuselage contribution is difficult to separate from the wing terms because it is strongly influenced by interference from the wing flow field. Wind tunnel tests of the wing-body combination are used by airplane designers to obtain information about the fuselage influence on stability.

A fuselage by itself is almost always destabilizing because the center of pressure is usually ahead of the center of gravity. The magnitude of the destabilization effects of the fuselage requires their consideration in the equilibrium and stability equations. In general, the effect of combining the wing and fuselage results in the combination aerodynamic center being forward of quarter-chord and the $C_{m_{ac}}$ of the combination being more negative than the wing value alone.

$$\frac{dC_m}{dC_L} = \text{Positive quantity}$$

FUSELAGE

5.6.3 The Tail Contribution to Stability

From equation 5.7, the tail contribution to stability was found to be

$$\frac{dC_N}{dC_{L_{TAIL}}} = - \frac{dC_{N_t}}{dC_{L_t}} V_H \eta_t$$

For small angles of attack, the lift curve slope of the tail is very nearly the same as the slope of the normal force curve.

$$a_t = \frac{dC_{L_t}}{d\alpha_t} = \frac{dC_{N_t}}{d\alpha_t} \quad (5.22)$$

Therefore

$$C_N = a_t \alpha_t \quad (5.23)$$

An expression for α_t in terms of C_L is required before solving for dC_{N_t}/dC_L

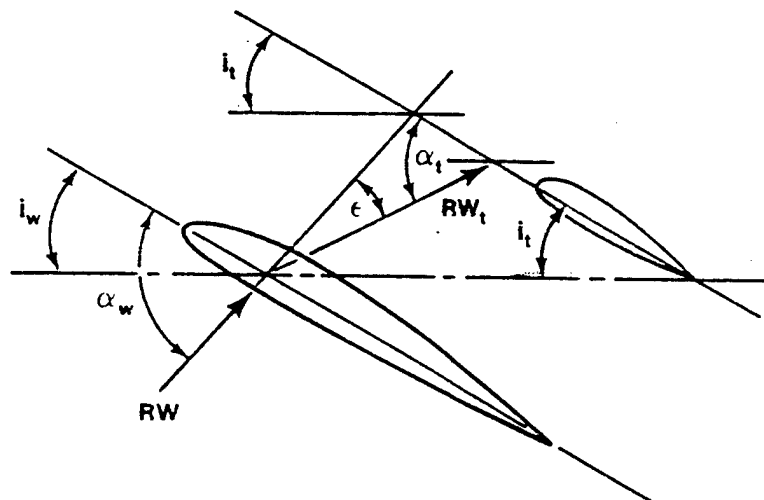

FIGURE 5.8. TAIL ANGLE OF ATTACK

From Figure 5.8

$$\alpha_t = \alpha_w - i_w + i_t - \epsilon \quad (5.24)$$

Substituting Equation 5.24 into 5.23 and taking the derivative with respect to C_L , where $a_w = dC_L/d\alpha$

$$\frac{dC_{N_t}}{dC_L} = a_t \left(\frac{d\alpha_w}{dC_L} - \frac{d\epsilon}{dC_L} \right) = a_t \left(\frac{1}{a_w} - \frac{d\epsilon}{d\alpha} \frac{1}{a_w} \right) \quad (5.25)$$

upon factoring out $1/a_w$

$$\frac{dC_{N_t}}{dC_L} = \frac{a_t}{a_w} \left(1 - \frac{d\epsilon}{d\alpha} \right) \quad (5.26)$$

Substituting Equation 5.26 into 5.21, the expression for the tail contribution becomes

$$\frac{dC_m}{dC_L} = - \frac{a_t}{a_w} \left(1 - \frac{d\epsilon}{d\alpha} \right) V_H \eta_t \quad (5.27)$$

TAIL

The value of a_t/a_w is very nearly constant. These values are usually obtained from experimental data.

The tail volume coefficient, V_H , is a term determined by the geometry of the aircraft. To vary this term is to redesign the aircraft.

$$V_H = \frac{l_t S_t}{cS} \quad (5.28)$$

The further the tail is located aft of the cg (increase l_t) or the greater the tail surface area (S_t), the greater the tail volume coefficient (V_H), which increases the tail contribution to stability.

The expression, η_t , is the ratio of the tail dynamic pressure to the wing dynamic pressure and η_t varies with the location of the tail with respect to wing wake, prop slipstream, etc. For power-off considerations, η_t varies from 0.65 to 0.95 due to boundary layer losses.

The term $(1 - d\epsilon/d\alpha)$ is an important factor in the stability contribution of the tail. Large positive values of $d\epsilon/d\alpha$ produce destabilizing effects by reversing the sign of the term $(1 - d\epsilon/d\alpha)$ and consequently, the sign of dc_m/dC_L .

For example, at high angles of attack the F-104 experiences a sudden increase in $d\epsilon/d\alpha$. The term $(1 - d\epsilon/d\alpha)$ goes negative causing the entire tail contribution to be positive or destabilizing, resulting in aircraft pitchup. The stability of an aircraft is definitely influenced by the wing vortex system. For this reason, the downwash variation with angle of attack should be evaluated in the wind tunnel.

The horizontal stabilizer provides the necessary positive stability contribution (negative dc_m/dC_L) to offset the negative stability of the wing-fuselage combination and to make the entire aircraft stable and balanced (Figure 5.9).

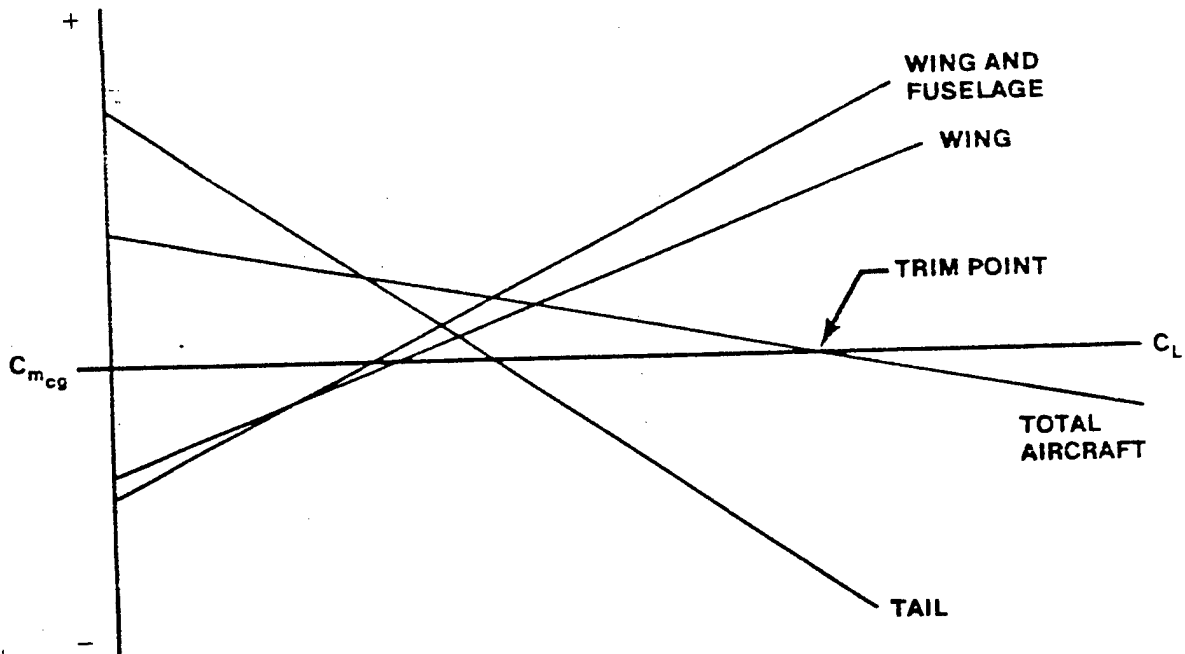

FIGURE 5.9. AIRCRAFT COMPONENT CONTRIBUTIONS TO STABILITY

The stability may be written as,

$$\frac{dC_m}{dC_L} = \frac{X_v}{c} + \frac{dC_m}{dC_L}_{fus} - \frac{a_t}{a_v} v_H \eta_t \left(1 - \frac{dc}{d\alpha}\right) \quad (5.29)$$

5.6.4 The Power Contribution to Stability

The addition of a power plant to the aircraft may have a decided effect on the equilibrium as well as the stability equations. The overall effect may be quite complicated. This section will be a qualitative discussion of power effects. The actual end result of the power effects on trim and stability should come from large scale wind tunnel models or actual flight tests.

5.6.4.1 Power Effects of Propeller Driven Aircraft - The power effects of a propeller driven aircraft which influence the static longitudinal stability of the aircraft are:

1. Thrust effect - effect on stability from the thrust acting along the propeller axis.
2. Normal force effect - effect on stability from a force normal to the thrust line and in the plane of the propeller.
3. Indirect effects - power plant effects on the stability contribution of other parts of the aircraft.

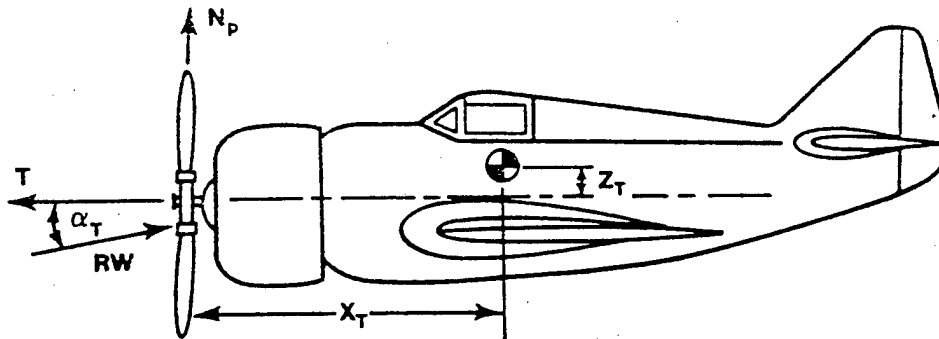

FIGURE 5.10. PROPELLER THRUST AND NORMAL FORCE

Writing the moment equation for the power terms as

$$\begin{array}{c}
 \curvearrowright + \\
 M_{c_g} = T Z_T + N_P X_T
 \end{array}
 \quad (5.30)$$

In coefficient form

$$C_{m_{c_g}} = C_T \frac{Z_T}{c} + C_{N_P} \frac{X_T}{c}
 \quad (5.31)$$

The direct power effect on the aircraft's stability equation is then

$$\frac{dC_m}{dC_L}_{\text{POWER}} = \frac{dC_T}{dC_L} \frac{Z_T}{c} + \frac{dC_{N_P}}{dC_L} \frac{X_T}{c}
 \quad (5.32)$$

The sign of dC_m/dC_L then depends on the sign of the derivatives dC_{N_P}/dC_L and dC_T/dC_L .

First consider the dC_T/dC_L derivative. If the speed varies at different flight conditions with throttle position held constant, then C_T varies in a manner that can be represented by dC_T/dC_L . The coefficient of thrust for a reciprocating power plant varies with C_L and propeller efficiency. Propeller efficiency, which is available from propeller performance estimates in the manufacturer's data, decreases rapidly at high C_L . Coefficient of thrust variation with C_L is nonlinear (it varies with $C_L^{3/2}$) with the derivative large at low speeds. The combination of these two variations approximately linearize C_T versus C_L (Figure 5.11). The sign of dC_T/dC_L is positive.

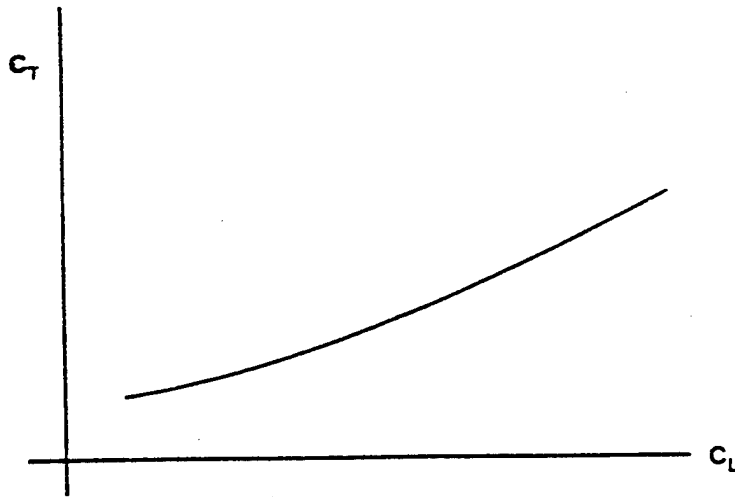

FIGURE 5.11. COEFFICIENT OF THRUST CURVE FOR A RECIPROCATING POWER PLANT WITH PROPELLER

The derivative dc_N/dc_L is positive since the normal propeller force increases linearly with the local angle of attack of the propeller axis, α_p . The direct power effects are then destabilizing if the cg is as shown in Figure 5.10 where the power plant is ahead and below the cg. The indirect power effects must also be considered in evaluating the overall stability contribution of the propeller power plant. No attempt will be made to determine their quantitative magnitudes. However, their general influence on the aircraft's stability and trim condition can be great.

5.6.4.1.1 Increase in angle of downwash, ϵ . Since the normal force on the propeller increases with angle of attack under powered flight, the slipstream is deflected downward, netting an increase in downwash on the tail.

The downwash in the slipstream will increase more rapidly with the angle of attack than the downwash outside the slipstream. The derivative $d\epsilon/d\alpha$ has a positive increase with power. The term $(1 - d\epsilon/d\alpha)$ in Equation 5.27 is reduced causing the tail trim contribution to be less negative or less stable than the power-off situation.

5.6.4.1.2 Increase of $\eta_t = (q_t/q_w)$. The dynamic pressure, q_t , of the tail is increased by the slipstream and η_t is greater than unity. From equation 5.27, the increase of η_t with an application of power increases the tail contribution to stability.

Both slipstream effects mentioned above may be reduced by locating the

horizontal stabilizer high on the tail and out of the slipstream at operating angles of attack.

5.6.4.2 Power effects of the turbojet/turbofan/ramjet. The magnitude of the power effects on jet powered aircraft are generally smaller than on propeller driven aircraft. By assuming that jet engine thrust does not change with velocity or angle of attack, and by assuming constant power settings, smaller power effects would be expected than with a similar reciprocating engine aircraft.

There are three major contributions of a jet engine to the equilibrium static longitudinal stability of the aircraft. These are:

1. Direct thrust effects.
2. Normal force effects at the air duct inlet and at angular changes in the duct.
3. Indirect effects of induced flow at the tail.

The thrust and normal force contribution may be determined from Figure 5.12.

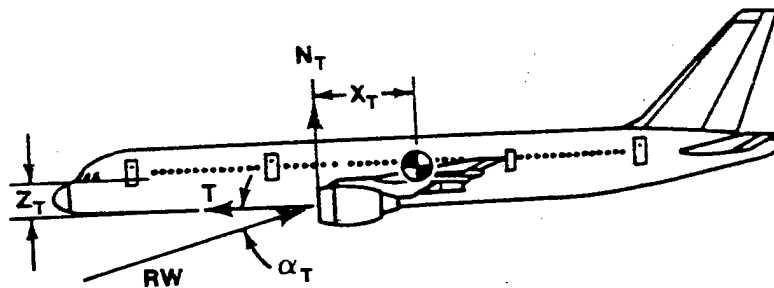

FIGURE 5.12. JET THRUST AND NORMAL FORCE

Writing the equation

$$\overset{+}{\curvearrowright} M_{cg} = TZ_T + N_T X_T \quad (5.33)$$

or

$$C_{m_{cg}} = \frac{T}{qSc} Z_T + C_{N_T} \frac{X_T}{c} \quad (5.34)$$

With the aircraft in unaccelerated flight, the dynamic pressure is a function of lift coefficient.

$$q = \frac{W}{C_L S} \quad (5.35)$$

Therefore,

$$C_{m_{cg}} = \frac{T}{W} \frac{Z_T}{c} C_L + C_{N_T} \frac{X_T}{c} \quad (5.36)$$

If thrust is considered independent of speed, then

$$\frac{dC_m}{dC_L} = \frac{T}{W} \frac{Z_T}{c} + \frac{dC_{N_T}}{dC_L} \frac{X_T}{c} \quad (5.37)$$

POWER

The thrust contribution to stability then depends on whether the thrust line is above or below the cg. Locating the engine below the cg causes a destabilizing influence.

The normal force contribution depends on the sign of the derivative dC_{N_T}/dC_L . The normal force N_T is created at the air duct inlet to the turbojet engine. This force is created as a result of the momentum change of the free stream which bends to flow along the duct axis. The magnitude of the

force is a function of the engine's airflow rate, W_a , and the angle α_T between the local flow at the duct entrance and the duct axis.

$$N_T = \frac{W_a}{g} U_0 \alpha_T \quad (5.38)$$

With an increase in α_T , N_T will increase, causing dC_N/dC_L to be positive. The normal force contribution will be destabilizing if the inlet duct is ahead of the center of gravity. The magnitude of the destabilizing moment will depend on the distance the inlet duct is ahead of the center of gravity.

For a jet engine to definitely contribute to positive longitudinal stability (dC_m/dC_L negative), the jet engine would be located above and behind the center of gravity.

The indirect contribution of the jet unit to longitudinal stability is the effect of the jet induced downwash at the horizontal tail. This applies to the situation where the jet exhaust passes under or over the horizontal tail surface. The jet exhaust as it discharges from the tailpipe spreads outward. Turbulent mixing causes outer air to be drawn in towards the exhaust area. Downwash at the tail may be affected. The F-4 is a good example where entrained air from the jet exhaust causes downwash angle at the horizontal tail.

5.6.4.3 Power Effects of Rocket Aircraft. Rocket powered aircraft such as the Space Shuttle, and rocket augmented aircraft such as the C-130 with JATO installed, can be significantly affected longitudinally depending on the magnitude of the rocket thrust involved. Since the rocket system carries its oxidizer internally, there is no inlet or incoming mass flow and no normal force contribution. The thrust contribution may be determined from Figure 5.13.

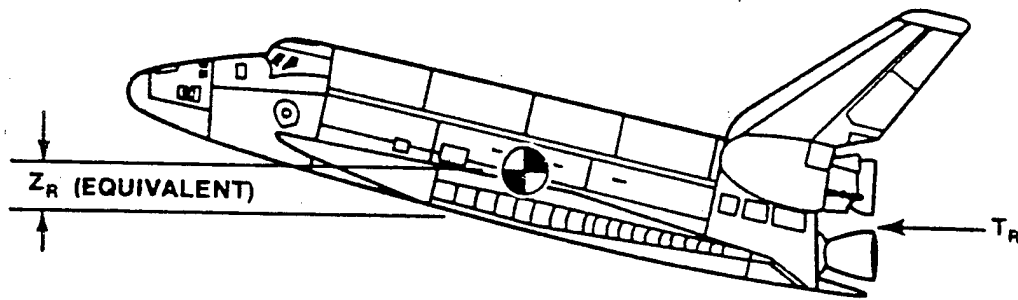

FIGURE 5.13. ROCKET THRUST EFFECTS

Writing the equation

$$\begin{array}{c}
 \curvearrowright \\
 + \\
 M_{cg} = T_R Z_R \quad \text{or} \quad C_{m_{cg}} = \frac{T_R Z_R}{qSc}
 \end{array}
 \quad (5.39)$$

Assuming that the rocket thrust is constant with changes in airspeed, the dynamic pressure is a function of lift coefficient.

$$q = \frac{W}{C_L S} \quad \text{therefore} \quad C_{m_{cg}} = \frac{T_R Z_R C_L}{W c}$$

and

$$\left. \frac{dC_m}{dC_L} \right)_{\text{POWER}} = \frac{T_R Z_R}{W c} \quad (5.40)$$

From the above discussion, it can be seen that several factors are important in deciding the power effect on stability. Each aircraft must be examined individually. This is the reason that aircraft are tested for stability in several configurations and at different power settings.

5.7 THE NEUTRAL POINT

The stick fixed neutral point is defined as the center of gravity position at which the aircraft displays neutral stability or where $dc_m/dc_L = 0$

The symbol h is used for the center of gravity position where

$$h = \frac{X_{cg}}{c} \quad (5.41)$$

The stability equation for the powerless aircraft is

$$\frac{dc_m}{dc_L} = \frac{X_w}{c} + \frac{dc_m}{dc_L}_{fus} - \frac{a_t}{a_w} v_H \eta_t \left(1 - \frac{d\epsilon}{d\alpha}\right) \quad (5.29)$$

Looking at the relationship between cg and ac in Figure 5.14

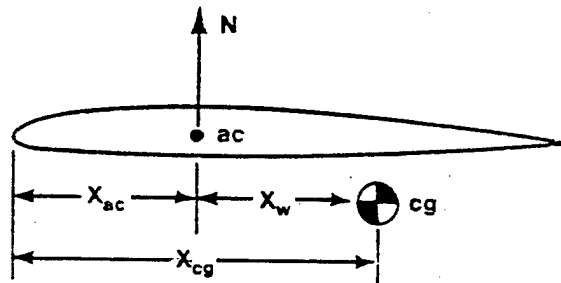

FIGURE 5.14. CG AND AC RELATIONSHIP

$$\frac{X_w}{c} = h - \frac{X_{ac}}{c} \quad (5.42)$$

Substituting Equation 5.42 into Equation 5.29,

$$\frac{dC_m}{dC_L} = h - \frac{X_{ac}}{c} + \frac{dC_m}{dC_{L_{FUS}}} - \frac{a_t}{a_w} v_H \eta_t \left(1 - \frac{d\epsilon}{d\alpha} \right) \quad (5.43)$$

If we set $dC_m/dC_L = 0$, then $h = h_n$ and Equation 5.43 gives

$$h_n = \frac{X_{ac}}{c} - \frac{dC_m}{dC_{L_{FUS}}} + \frac{a_t}{a_w} v_H \eta_t \left(1 - \frac{d\epsilon}{d\alpha} \right) \quad (5.44)$$

This is the cg location where the aircraft exhibits neutral static stability: the neutral point.

Substituting Equation 5.44 back into Equation 5.43, the stick-fixed stability derivative in terms of cg position becomes

$$\frac{dC_m}{dC_L} = h - h_n \quad (5.45)$$

The stick-fixed static stability is equal to the distance between the cg position and the neutral point in percent of the mean aerodynamic chord. "Static Margin" refers to the same distance, but is positive in sign for a stable aircraft.

$$\text{Static Margin} = h_n - h \quad (5.46)$$

It is the test pilot's responsibility to evaluate the aircraft's handling qualities and to determine the acceptable static margin for the aircraft.

5.8 ELEVATOR POWER

For an aircraft to be a usable flying machine, it must be stable and

balanced throughout the useful C_L range. For trimmed, or equilibrium flight, $C_{m_{cg}}$ must be zero. Some means must be available for balancing the various terms in Equation 5.47

$$C_{m_{cg}} = C_N \frac{X_w}{c} + C_c \frac{Z_w}{c} - C_{m_{ac}} + C_{m_f} - (a_t \alpha_t V_H \eta_t) \quad (5.47)$$

(Equation 5.47 is obtained by substituting Equation 5.23 into Equation 5.6.)

Several possibilities are available. The center of gravity could be moved fore and aft, or up and down, thus changing X_w/c or Z_w/c . However, this would not only affect the equilibrium lift coefficient, but would also change dC_m/dC_L in Equation 5.48. This is undesirable.

$$\frac{dC_m}{dC_L} = \frac{dC_N}{dC_L} \frac{X_w}{c} + \frac{dC_c}{dC_L} \frac{Z_w}{c} + \frac{dC_{m_{fus}}}{dC_L} - \frac{a_t}{a_w} V_H \eta_t \left(1 - \frac{d\epsilon}{d\alpha} \right) \quad (5.48)$$

Equation 5.48 is obtained by substituting Equation 5.26 into Equation 5.7. The pitching moment coefficient about the aerodynamic center could be changed by effectively changing the camber of the wing by using trailing edge flaps as is done in flying wing vehicles. On the conventional tail-to-the-rear aircraft, trailing edge wing flaps are ineffective in trimming the pitching moment coefficient to zero. The combined use of trailing edge flaps and trim from the tail may serve to reduce drag, as used on some sailplanes and the F-5E.

The remaining solution is to change the angle of attack of the horizontal tail to achieve a $(C_{m_{cg}} = 0)$ without a change to the basic aircraft stability.

The control means is either an elevator on the stabilizer or an all moving stabilizer (slab or stabilator). The slab is used on most high speed aircraft and is the most powerful means of longitudinal control.

Movement of the slab or elevator changes the effective angle of attack of the horizontal stabilizer and, consequently, the lift on the horizontal tail. This in turn changes the moment about the center of gravity due to the horizontal tail. It is of interest to know the amount of pitching moment change associated with an increment of elevator deflection. This may be determined by differentiating Equation 5.47 with respect to δ_e .

$$\frac{dC_m}{d\delta_e} = -a_t V_H \eta_t \frac{d\alpha_t}{d\delta_e} \quad (5.49)$$

$$C_{m_{\delta_e}} = -a_t V_H \eta_t \tau \quad (5.50)$$

This change in pitching moment coefficient with respect to elevator deflection $C_{m_{\delta_e}}$ is referred to as "elevator power". It indicates the capability of the elevator to produce moments about the center of gravity. The term $d\alpha_t/d\delta_e$ in Equation 5.49 is termed "elevator effectiveness" and is given the shorthand notation τ . The elevator effectiveness may be considered as the equivalent change in effective tail plane angle of attack per unit change in elevator deflection. The relationship between elevator effectiveness τ and the effective angle of attack of the stabilizer is seen in Figure 5.15.

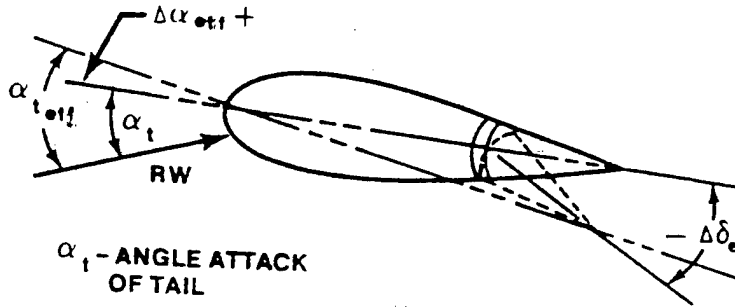

FIGURE 5.15. CHANGE WITH EFFECTIVE ANGLE OF ATTACK WITH ELEVATOR DEFLECTION

Elevator effectiveness is a design parameter and is determined from wind tunnel tests. Elevator effectiveness is a negative number for all tail-to-the-rear aircraft. The values range from zero to the limiting case of the all moving stabilizer (slab) where τ equals -1 . The tail angle of attack would change plus one degree for every minus degree the slab moves. For the elevator-stabilizer combination, the elevator effectiveness is a function of the ratio of overall elevator area to the entire horizontal tail area.

5.9 ALTERNATE CONFIGURATIONS

Although tail-to-the-rear is the configuration normally perceived as standard, two other configurations merit some discussion. The tailless aircraft, or flying wing, has been used in the past, and some modern designs contemplate the use of this concept. The canard configuration has also been used over the past several years with mixed results.

5.9.1 Flying Wing Theory

In order for a flying wing to be a usable aircraft, it must be balanced (fly in equilibrium at a useful positive C_L) and be stable. The problem may be analyzed as follows:

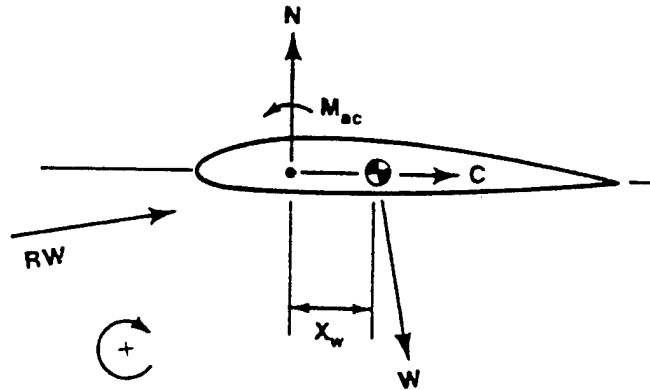

FIGURE 5.16. AFT CG FLYING WING

For the wing in Figure 5.16, assuming that the chordwise force acts through the cg, the equilibrium in pitch may be written

$$M_{cg} = NX_w - M_{ac} \quad (5.51)$$

or in coefficient form

$$C_{m_{cg}} = C_N \frac{X_w}{c} - C_{m_{ac}} \quad (5.52)$$

For controls fixed, the stability equation becomes

$$\frac{dC_{m_{cg}}}{dC_L} = \frac{dC_N}{dC_L} \frac{X_w}{c} \quad (5.53)$$

Equations 5.52 and 5.53 show that the wing in Figure 5.16 is balanced and unstable. To make the wing stable, or dC_m/dC_L negative, the center of gravity must be ahead of the wing aerodynamic center. Making this cg change, however, now changes the signs in Equation 5.51. The equilibrium and stability equations become

$$C_{m_{cg}} = -C_N \frac{X_w}{c} - C_{m_{ac}} \quad (5.54)$$

$$\frac{dC_{m_{cg}}}{dC_L} = -\frac{dC_N}{dC_L} \frac{X_w}{c} \quad (5.55)$$

The wing is now stable but unbalanced. The balanced condition is possible with a positive $C_{m_{ac}}$.

Three methods of obtaining a positive $C_{m_{ac}}$ are:

1. Use a negative camber airfoil section. The positive $C_{m_{ac}}$ will give a flying wing that is stable and balanced (Figure 5.17).

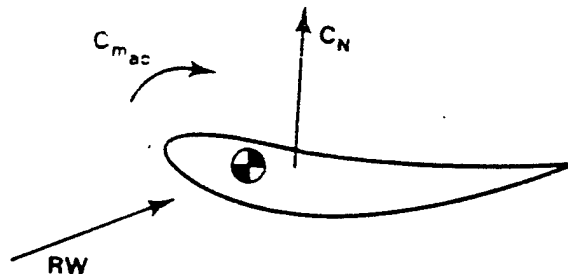

FIGURE 5.17. NEGATIVE CAMBERED FLYING WING

This type of wing is not realistic because of unsatisfactory dynamic characteristics, small cg range, and extremely low C_L maximum capability.

2. A reflexed airfoil section reduces the effect of camber by creating a download near the trailing edge. Similar results are possible with an upward deflected flap on a symmetrical airfoil.

3. A symmetrical airfoil section in combination with sweep and wingtip washout (reduction in angle of incidence at the tip) will produce a positive $C_{m_{ac}}$ by virtue of the aerodynamic couple produced between the downloaded tips and the normal lifting force. This is shown in Figure 5.18.

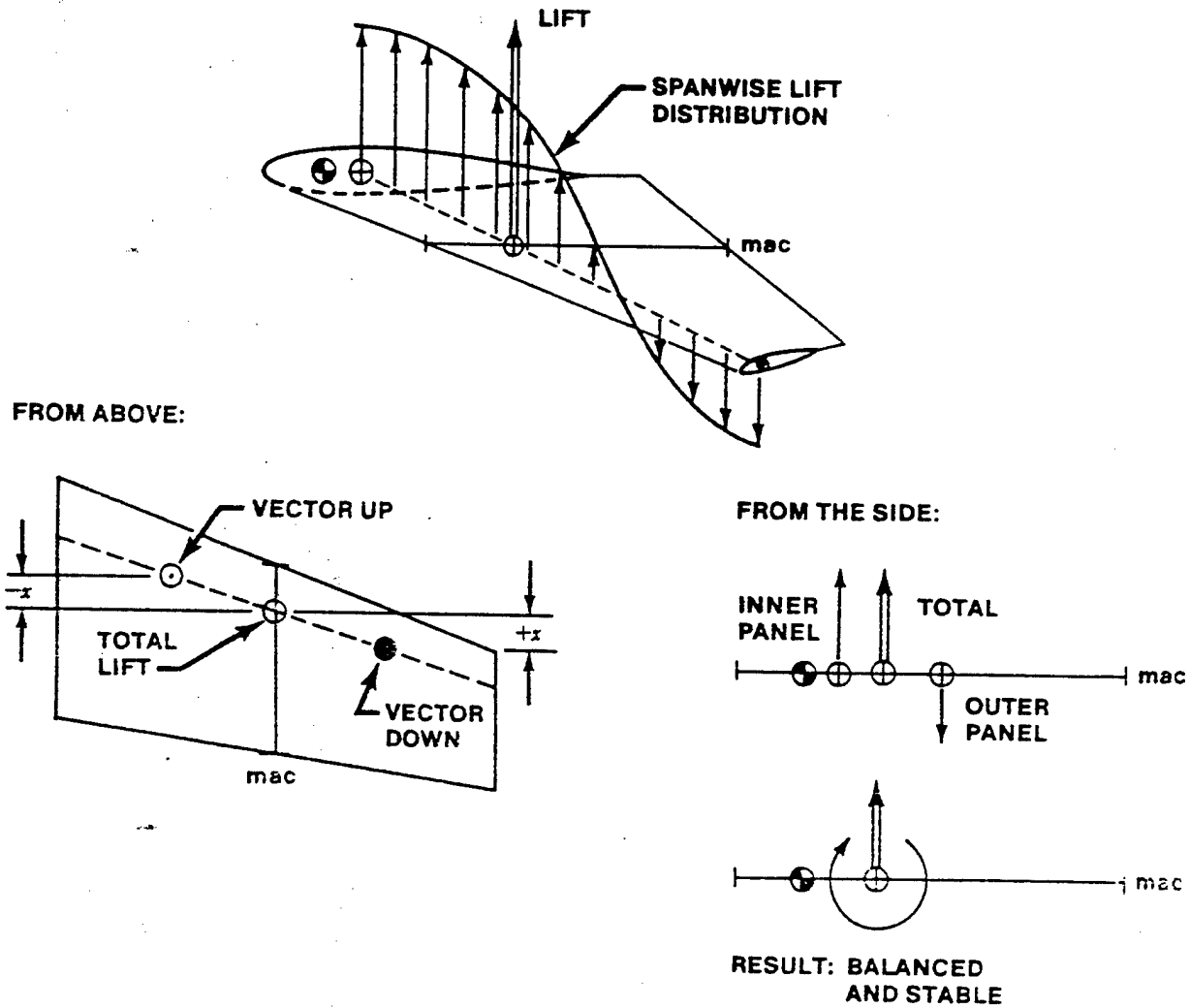

FIGURE 5.18. THE SWEEP AND TWISTED FLYING WING

Figure 5.19 shows idealized $C_{m_{ac}}$ versus C_L for various wings in a control fixed position. Only two of the wings are capable of sustained flight.

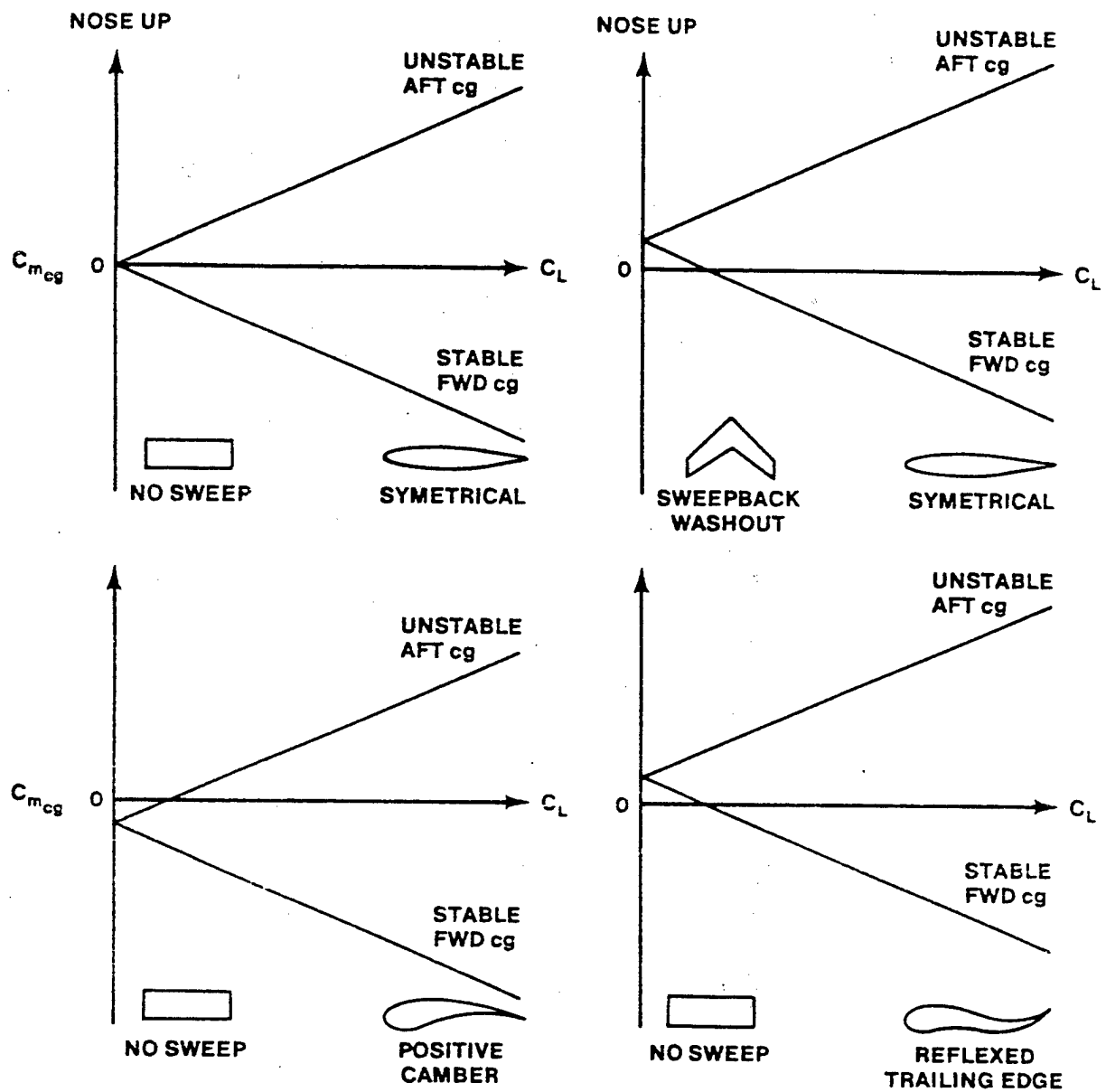

FIGURE 5.19. VARIOUS FLYING WINGS

5.9.2 The Canard Configuration

Serious work on aircraft with the canard configuration has been sporadic from the time the Wright brothers' design evolved into the tail to the rear airplanes of World War I, until the early 1970's. One of the first successful canard airplanes in quantity production was the Swedish JA-37 "Viggen" fighter. Other projects of significance were the XB-70, the Mirage Milan, and the TU-144. The future seems to indicate that we may see more of the canard configuration, as evidenced by the X-29 Forward Swept Wing project.

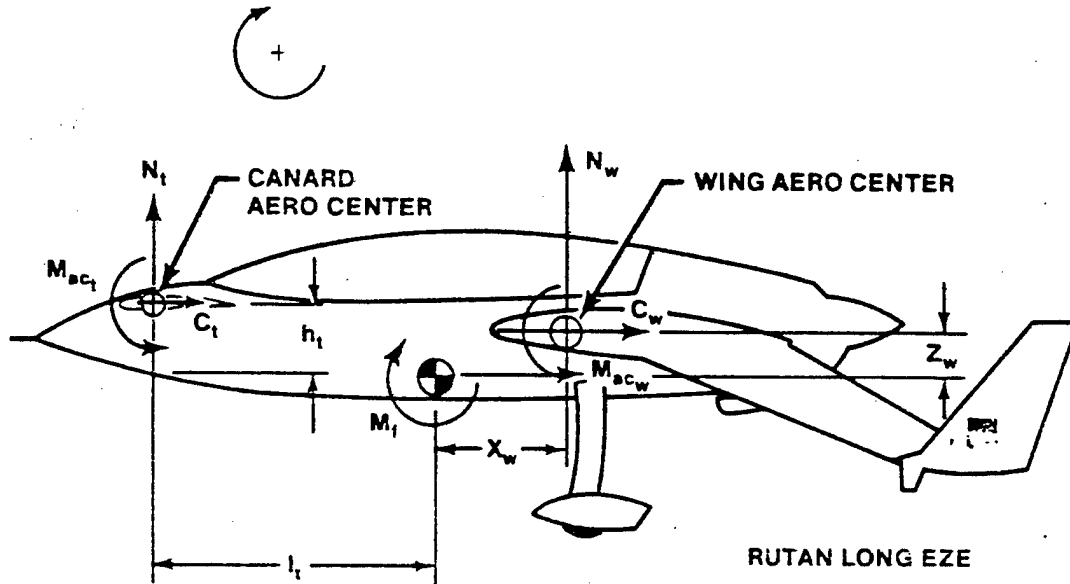

FIGURE 5.20. BALANCE COMPARISON

5.9.2.1 The Balance Equation. From Figure 5.20 the balance equation can be written as follows:

$$M_{cg} = -N_w x_w + C_w z_w - M_{ac_w} + M_t + N_t l_t + C_t h_t - M_{ac_t} \quad (5.56)$$

Simplifying assumptions are

$C_t h_t$ and M_{ac_t} are small and may be neglected

Then

$$C_{m_{cg}} = \frac{M_{cg}}{q_w S_w c_w} = -C_N \frac{X_w}{c} + C_c \frac{Z_w}{c} - C_{m_{ac_w}} + C_{m_f} + \frac{N_t l_t}{q_w S_w c_w} \frac{q_t S_t}{q_t S_t} \quad (5.57)$$

Combining Terms:

$$C_{m_{cg}} = -C_N \frac{X_w}{c} + C_c \frac{Z_w}{c} - C_{m_{ac_w}} + C_{m_f} + C_{N_t} V_H h_t \quad \begin{array}{l} \text{BALANCE} \\ \text{EQUATION} \end{array} \quad (5.58)$$

5.9.2.2 The Stability Equation. Although the canard can be a balanced configuration, it remains to be seen if it demonstrates static stability or "gust stability". By taking the derivative with respect to C_L , Equation 5.58 becomes

$$\frac{dC_{m_{cg}}}{dC_L} = -\frac{dC_N}{dC_L} \frac{x_w}{c} + \frac{dC_c}{dC_L} \frac{z_w}{c} + \frac{dC_{m_f}}{dC_L} + \frac{dC_{N_t}}{dC_L} V_H h_t \quad \begin{array}{l} \text{STABILITY} \\ \text{EQUATION} \end{array} \quad (5.59)$$

Equation 5.59 indicates that the normal (or lift) force of the wing now has a stabilizing influence (negative in sign), and the canard term is destabilizing due to its positive sign. It is obviously a misnomer to call the canard a horizontal stabilizer, because in reality it is a "destabilizer"! The degree of instability must be overcome by the wing-fuselage combination in order for the airplane to exhibit positive static stability dC_m/dC_L (negative in sign). This is shown graphically in Figure 5.21.

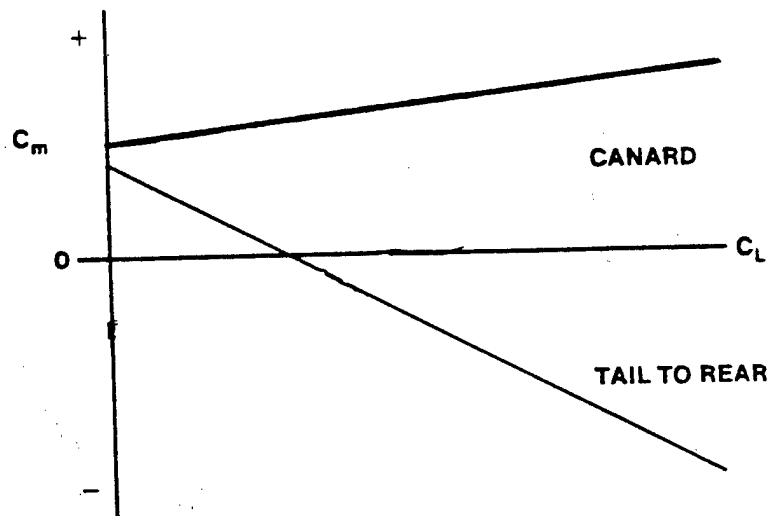

FIGURE 5.21. CANARD EFFECTS ON dc_m/dc_L

5.9.2.3 Upwash Contribution to Stability. In a manner similar to the way a rear mounted horizontal tail experiences a downwash field from the wake of the wing, the canard will see upwash ahead of the wing. This upwash field has a destabilizing effect on longitudinal stability because it makes the tail term in the stability equation more positive.

The tail contribution from Equation 5.61 can be examined for the effects of upwash, ϵ'

$$\frac{dc_{L_t}}{dc_L} v_H \eta_t = \frac{d(a_t \alpha_t)}{dc_L} v_H \eta_t = a_t v_H \eta_t \frac{d\alpha_t}{dc_L}$$

The tail angle of attack, α_t , can be expressed in terms of incidence and upwash, as described in Figure 5.22.

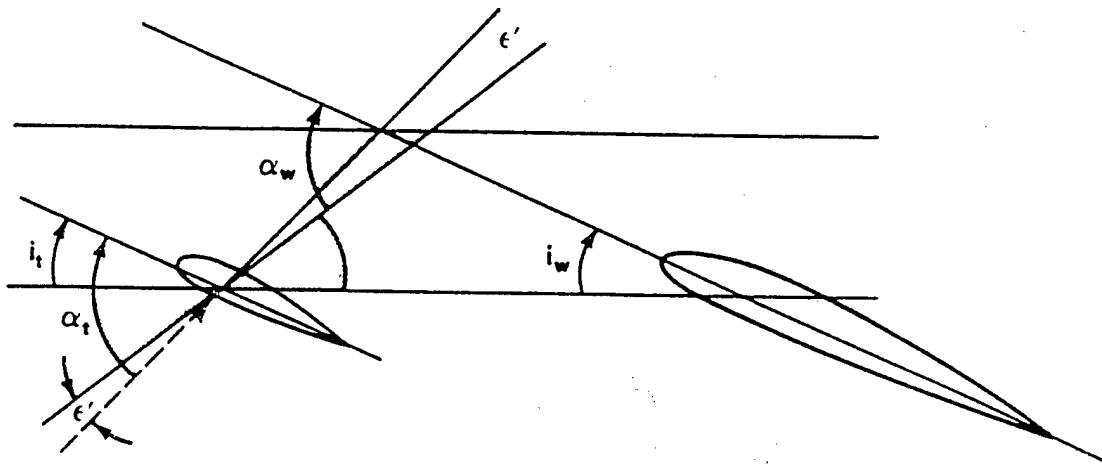

FIGURE 5.22. CANARD ANGLE OF ATTACK

$$\alpha_t - i_t - \epsilon' = \alpha_w - i_w \quad (5.62)$$

Therefore

$$\alpha_t = \alpha_w - i_w + i_t + \epsilon' \quad (5.63)$$

The tail contribution now becomes

$$\begin{aligned} &= a_t v_H \eta_t \frac{d(\alpha_w - i_w + i_t + \epsilon')}{dC_L} \\ &= a_t v_H \eta_t \left(\frac{1}{a_w} + \frac{d\epsilon'}{d\alpha_w} \frac{d\alpha_w}{dC_L} \right) \\ &= a_t v_H \eta_t \left(\frac{1}{a_w} + \frac{d\epsilon'}{d\alpha_w} \frac{1}{a_w} \right) \end{aligned}$$

Therefore,

$$\frac{dC_{L_t}}{dC_L} V_H \eta_t = \frac{a_t}{a_w} V_H \eta_t \left(1 + \frac{d\epsilon'}{d\alpha_w} \right) \quad (5.64)$$

It is extremely important to note that the upwash and downwash interaction between the canard and the wing are critical to the success of the design. The wing will see a downwash field from the canard over a portion of the leading edge. Aerodynamic tailoring and careful selection of the airfoil is required for the airplane to meet its design objectives at all canard deflections and flap settings on the wing. Designs which tend to be tandem-wing become even more sensitive to upwash and downwash.

5.10 STABILITY CURVES

Figure 5.23 is a wind tunnel plot of C_m versus C_L for an aircraft tested under two cg positions and two elevator positions.

Assuming the elevator effectiveness and the elevator power to be constant, equal elevator deflections will produce equal moments about the cg. Points A and B represent the same elevator deflection corresponding to the $C_{m_{cg}}$ needed to maintain equilibrium. For an elevator deflection of 10° , in the aft cg condition, the aircraft will fly in equilibrium or trim at point B. If the cg is moved forward with no change to the elevator deflection the equilibrium is now at A and at a new C_L . Note the increase in the stability of the aircraft (greater negative slope of dC_m/dC_L).

For equilibrium at a lower C_L or at A without changing the cg, the elevator is deflected to 5° . The stability level of the aircraft has not changed (same slope).

A cross plot of Figure 5.23 is elevator deflection versus C_L for $C_m = 0$. This is shown in Figure 5.24. The slopes of the cg curves are indicative of the aircraft's stability.

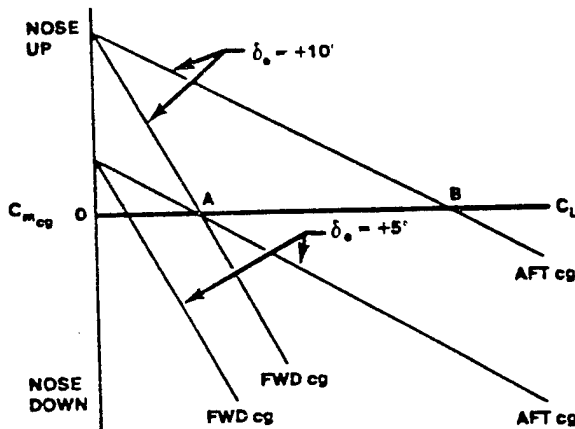

FIGURE 5.23. cg AND δ_o VARIATION OF STABILITY

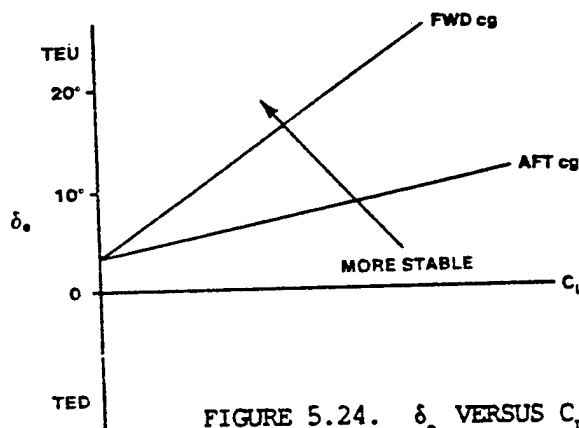

FIGURE 5.24. δ_o VERSUS C_L

5.11 FLIGHT TEST RELATIONSHIP

The stability equation previously derived cannot be directly used in flight testing. There is no aircraft instrumentation which will measure the change in pitching moment coefficient with change in lift coefficient or angle of attack. Therefore, an expression involving parameters easily measurable in flight is required. This expression should relate directly to the stick-fixed longitudinal static stability, dC_m/dC_L , of the aircraft.

The external moment acting longitudinally on an aircraft is

$$M = f(U, \alpha, \dot{\alpha}, Q, \delta_e)$$

Assuming that the aircraft is in equilibrium and in unaccelerated flight, then

$$M = f(\alpha, \delta_e) \quad (5.65)$$

Therefore, using a Taylor series expansion,

$$\Delta M = \frac{\partial M}{\partial \alpha} \Delta \alpha + \frac{\partial M}{\partial \delta_e} \Delta \delta_e \quad (5.66)$$

and

$$C_m = C_{m_\alpha} \Delta \alpha + C_{m_{\delta_e}} \Delta \delta_e = 0 \quad (5.67)$$

where

$$\Delta \alpha = \alpha - \alpha_0 = \alpha$$

$$\Delta \delta_e = \delta_e - \delta_{e_0} = \delta_e$$

assuming

$$\alpha_0 = 0$$

$$\delta_{e_0} = 0$$

The elevator deflection required to maintain equilibrium is,

$$\delta_e = - \frac{C_{m_\alpha} \alpha}{C_{m_{\delta_e}}} \quad (5.68)$$

Taking the derivative of δ_e with respect to C_L ,

$$\frac{d\delta_e}{dC_L} = - \frac{\frac{dC_m}{d\alpha} \frac{d\alpha}{dC_L}}{C_{m_{\delta_e}}} = - \frac{\frac{dC_m}{dC_L}}{C_{m_{\delta_e}}} \quad (5.69)$$

In terms of the static margin, the flight test relationship is,

$$\frac{d\delta_e}{dC_L} = \frac{h_n - h}{C_{m_{\delta_e}}} = \frac{\text{static margin}}{\text{elevator power}} \quad (5.70)$$

The amount of elevator required to fly at equilibrium varies directly as the amount of static stick-fixed stability and inversely as the amount of elevator power.

5.12 LIMITATION TO DEGREE OF STABILITY

The degree of stability tolerable in an aircraft is determined by the physical limits of the longitudinal control. The elevator power and amount of elevator deflection is fixed once the aircraft has been designed. If the relationship between δ_e required to maintain the aircraft in equilibrium flight and C_L is linear, then the elevator deflection required to reach any C_L is,

$$\delta_e = \delta_{e_{\text{zero Lift}}} + \frac{d\delta_e}{dC_L} C_L \quad (5.71)$$

The elevator stop determines the absolute limit of the elevator deflection available. Similarly, the elevator must be capable of bringing the airplane into equilibrium at $C_{L_{Max}}$.

Recalling Equation 5.69

$$\frac{d\delta_e}{dC_L} = \frac{-\frac{dC_m}{dC_L}}{C_{m_\delta}} \quad (5.69)$$

Substituting Equation 5.69 into 5.71 and solving for $dC_m/dC_{L_{(Max)}}$ corresponding to $C_{L_{Max}}$

$$\frac{dC_m}{dC_{L_{Max}}} = \left(\frac{\delta_{\text{Zero Lift}} - \delta_{\text{Limit}}}{C_{L_{Max}}} \right) C_{m_\delta} \quad (5.72)$$

Given a maximum C_L required for landing approach, Equation 5.72 represents the maximum stability possible, or defines the most forward cg position. A cg forward of this point prevents obtaining maximum C_L with limit elevator.

If a pilot were to maintain $C_{L_{Max}}$ for the approach, the value of dC_m/dC_L corresponding to this $C_{L_{Max}}$ would be satisfactory. However, the pilot usually desires additional elevator deflection to compensate for gusts and to flare the aircraft. This requirement then dictates a $dC_m/dC_{L_{Max}}$ less than the value required for $C_{L_{Max}}$ only.

In addition to maneuvering the aircraft in the landing flare, the pilot must adjust for ground effect. The ground imposes a boundary condition which affects the downwash associated with the lifting action of the wing. This ground interference places the horizontal stabilizer at a reduced negative angle of attack. The equilibrium condition at the desired C_L is disturbed.

To maintain the desired C_L , the pilot must increase δ_e to obtain the original tail angle of attack. The maximum stability dc_n/dc_L must be further reduced to obtain additional δ_e to counteract the reduction in downwash.

The three conditions that limit the amount of static longitudinal stability or most forward cg position for landing are:

1. The ability to land at high C_L in ground effect.
2. The ability to maneuver at landing C_L (flare capability).
3. The total elevator deflection available.

Figure 5.25 illustrates the limitation in dc_n/dc_L _{Max}

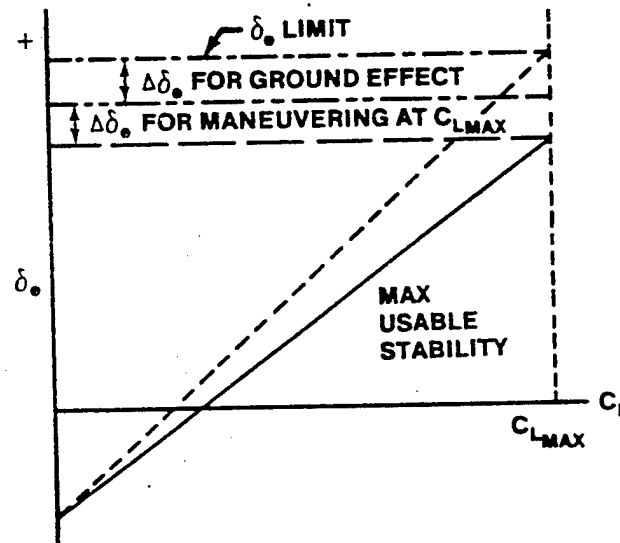

FIGURE 5.25. LIMITATIONS ON dc_n/dc_L _{Max}

5.13 STICK-FREE STABILITY

The name stick-free stability comes from the era of reversible control systems and is that variation related to the longitudinal stability which an aircraft could possess if the longitudinal control surface were left free to float in the slipstream. The control force variation with a change in airspeed is a flight test measure of this stability.

If an airplane had an elevator that would float in the slipstream when the controls were free, then the change in the pressure pattern on the stabilizer would cause a change in the stability level of the airplane. The change in the tail contribution would be a function of the floating characteristics of the elevator. Stick-free stability depends on the elevator hinge moments caused by aerodynamic forces which affect the total moment on the elevator.

An airplane with an irreversible control system has very little tendency for its elevator to float. Yet the control forces presented to the pilot during flight, even though artificially produced, appear to be the effects of having a free elevator. If the control feel system can be altered artificially, then the pilot will see only good handling qualities and be able to fly what would normally be an unsatisfactory flying machine.

Stick-free stability can be analyzed by considering the effect of freeing the elevator of a tail-to-the-rear aircraft with a reversible control system. In this case, the feel of stick-free stability would be indicated by the stick forces required to maintain the airplane in equilibrium at some speed other than trim.

The change in stability due to freeing the elevator is a function of the floating characteristics of the elevator. The floating characteristics depend upon the elevator hinge moments. These moments are created by the change in pressure distribution over the elevator associated with changes in elevator deflection and tail angle of attack.

The following analysis looks at the effect that pressure distribution has on the elevator hinge moments, the floating characteristics of the elevator, and the effects of freeing the elevator.

Previously, an expression was developed to measure the longitudinal

static stability using elevator surface deflection, δ_e . This expression represented a controls locked or stick-fixed flight test relationship where the aircraft was stabilized at various lift coefficients and the elevator deflections were then measured at these equilibrium values of C_L . The stick-free flight test relationship will be developed in terms of stick force, F_s , the most important longitudinal control parameter sensed by the pilot. In a reversible control system, the motion of the cockpit longitudinal control creates elevator control surface deflections which in turn create aerodynamic hinge moments, felt by the pilot as control forces. There is a direct feedback from the control surfaces to the cockpit control. The following analysis assumes a simple reversible flight control system as shown in Figure 5.26.

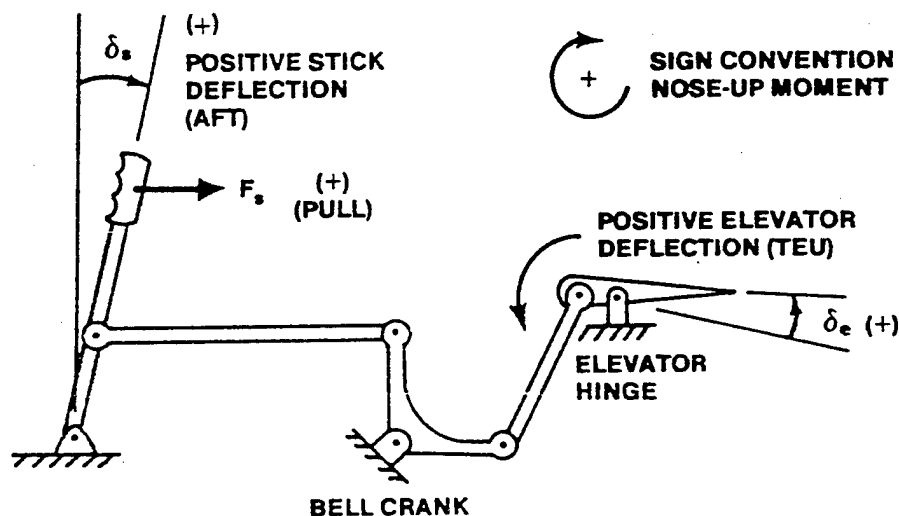

FIGURE 5.26. TAIL-TO-THE-REAR AIRCRAFT WITH A REVERSIBLE CONTROL SYSTEM

A discussion of hinge moments and their effect on the pitching moment and stability equations must necessarily precede analysis of the stick-free flight test relationship.

5.13.1 Aerodynamic Hinge Moment

An aerodynamic hinge moment is a moment generated about the control surface as a consequence of surface deflection and angle of attack. Figure 5.27 depicts the moment at the elevator hinge due to tail angle of attack ($\delta_e = 0$). Note the direction that the hinge moment would tend to rotate the elevator if the stick were released.

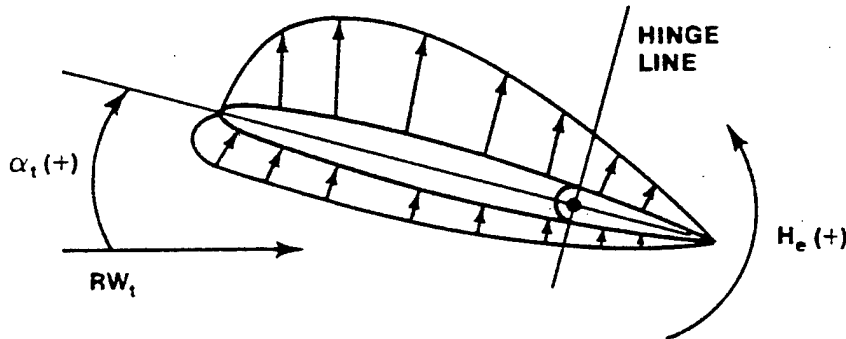

FIGURE 5.27. HINGE MOMENT DUE TO TAIL ANGLE OF ATTACK

If the elevator control were released in this case, the hinge moment, H_e , would cause the elevator to rotate trailing edge up (TEU). Since the elevator TEU was previously determined to be positive, a positive hinge moment is that which, if the elevator control were released would cause the elevator to

deflect TEU. The general hinge moment equation may be expressed as

$$H_e = C_h q_t S_e c_e \quad (5.73)$$

Where S_e is elevator surface area aft of the hinge line and c_e is the root mean square chord of the elevator aft of the hinge line. The hinge moments due to elevator deflection, δ_e , and tail angle of attack, α_t , will be analyzed separately and each expressed in coefficient form.

5.13.2 Hinge Moment Due to Elevator Deflection

Figure 5.28 depicts the pressure distribution due to elevator deflection. This condition assumes $\alpha_t = 0$. The elevator is then deflected, δ_e . The resultant force aft of the hinge line produces a hinge moment, H_e , which is due to elevator deflection.

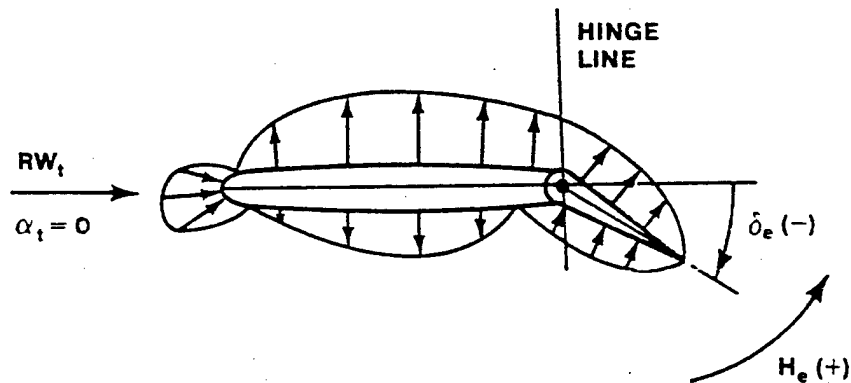

FIGURE 5.28. HINGE MOMENT DUE TO ELEVATOR DEFLECTION

Given the sign convention specified earlier, Figure 5.29 depicts the relationship of hinge moment coefficient to elevator deflection, where

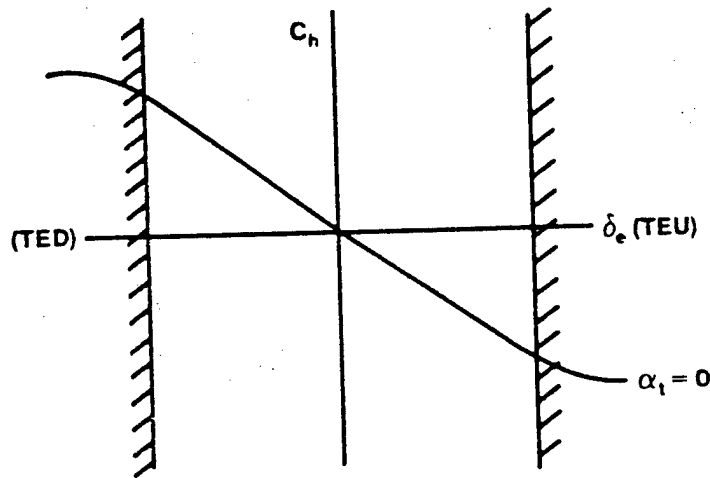

FIGURE 5.29. HINGE MOMENT COEFFICIENT DUE TO ELEVATOR DEFLECTION

most hinge moment curves are nonlinear at the extremes of elevator deflection or tail angle of attack. The boundaries shown on Figure 5.29 signify that only the linear portion of the curves is considered. The usefulness of this assumption will be apparent when the effect of elevator deflection and tail angle of attack are combined.

The slope of the curve in Figure 5.29 is $C_{h_{\delta_e}}$, the hinge moment coefficient due to elevator deflection. It is negative in sign and constant in the linear region. The term $C_{h_{\delta_e}}$ is generally called the "restoring" moment coefficient.

5.13.3 Hinge Moment Due to Tail Angle of Attack

Figure 5.30 depicts the pressure distribution due to tail angle of attack. This condition assumes $\delta_e = 0$. The tail is placed at some angle of

attack. As in the previous case, the lift distribution produces a resultant force aft of the hinge line, which in turn generates a hinge moment. The term, $C_{h_{\alpha_t}}$, is generally referred to as the "floating" moment coefficient.

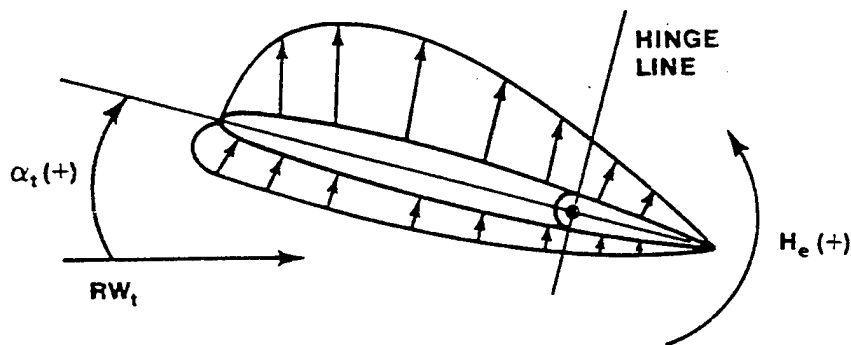

FIGURE 5.30. HINGE MOMENT DUE TO TAIL ANGLE OF ATTACK

Figure 5.31 depicts the relationship of hinge moment coefficient to tail angle of attack, where

$$C_h = \frac{H_e}{q_t S_e c_e}$$

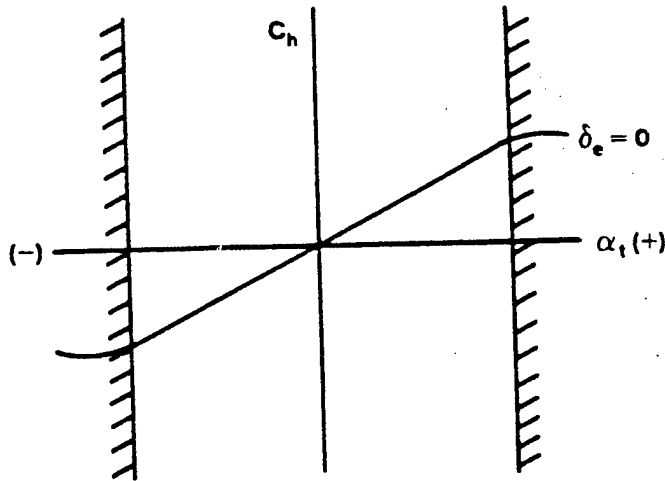

FIGURE 5.31. HINGE MOMENT COEFFICIENT DUE TO TAIL ANGLE OF ATTACK

5.13.4 Combined Effects of Hinge Moments

Given the previous assumption of linearity, the total aerodynamic hinge moment coefficient for a given elevator deflection and tail angle of attack may be expressed as

$$C_h = C_{h_0} + C_{h_{\delta_e}} \delta_e + C_{h_{\alpha_t}} \alpha_t \quad (5.74)$$

Figure 5.32 is a graphical depiction of the above relationship, assuming a symmetrical tail so that $C_{h_0} = 0$.

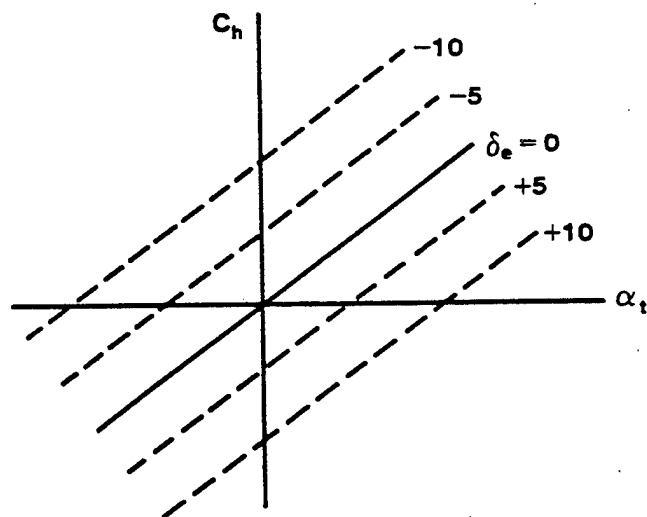

FIGURE 5.32. COMBINED HINGE MOMENT COEFFICIENTS

The "e" and "t" subscripts on the restoring and floating hinge moment coefficients are often dropped in the literature. For the remainder of this chapter:

Restoring Coefficient

$$\frac{\partial C_h}{\partial \delta_e} = C_{h_{\delta_e}} = C_{h_{\delta}} \quad (5.75)$$

Floating Coefficient

$$\frac{\partial C_h}{\partial \alpha_t} = C_{h_{\alpha_t}} = C_{h_{\alpha}} \quad (5.76)$$

Examining a floating elevator, it is seen that the total hinge moment coefficient is a function of elevator deflection, tail angle of attack, and mass distribution.

$$H_o = f(\delta_o, \alpha_t, W) \quad (5.77)$$

If the elevator is held at zero elevator deflection and zero angle of attack, there may be some residual aerodynamic hinge moment, C_{h_o} . If W is the weight of the elevator and x is the moment arm between the elevator cg and elevator hinge line, then the total hinge moment is,

$$C_h = C_{h_o} + C_{h_{\alpha}} \alpha_t + C_{h_{\delta}} \delta_o - \frac{W}{qS} \frac{x}{c} \quad (5.78)$$

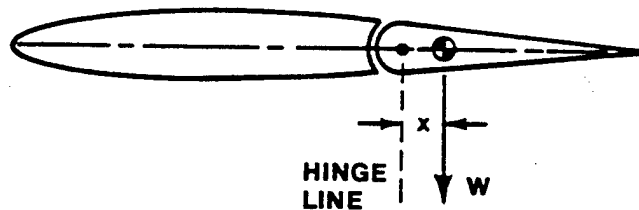

FIGURE 5.33. ELEVATOR MASS BALANCING REQUIREMENT

The weight effect is usually eliminated by mass balancing the elevator (Figure 5.33). Proper design of a symmetrical airfoil will cause C_{h_0} to be negligible.

When the elevator assumes its equilibrium position, the total hinge moment will be zero and solving for the elevator deflection at this floating position, which is shown in Figure 5.34

$$\delta_{e_float} = - \frac{C_{h_\alpha}}{C_{h_\delta}} \alpha_t \quad (5.79)$$

The stability of the aircraft with the elevator free is going to be affected by this floating position.

If the pilot desires to hold a new angle of attack from trim, he will have to deflect the elevator from this floating position to the position desired.

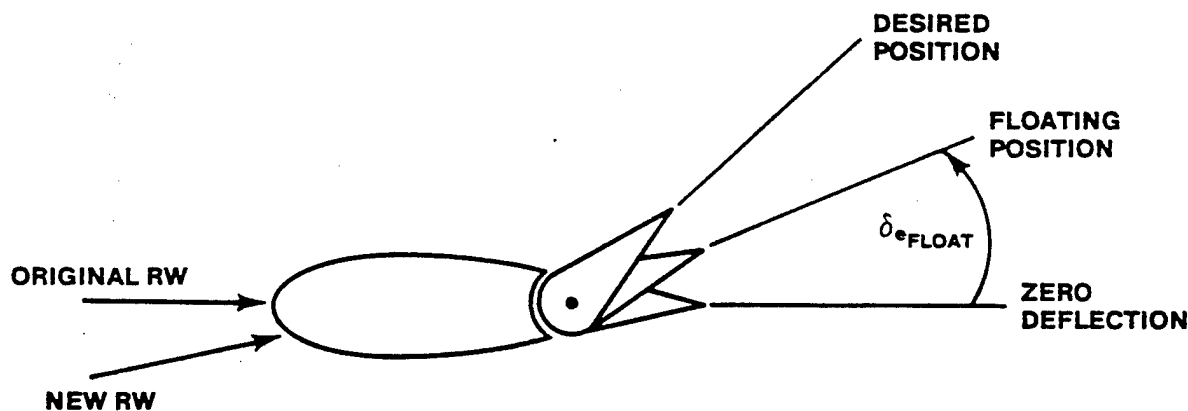

FIGURE 5.34. ELEVATOR FLOAT POSITION

The floating position will greatly affect the forces the pilot is required to use. If the ratio C_{h_e} / C_{h_δ} can be adjusted, then the forces required of the pilot can be controlled.

If C_{h_e} / C_{h_δ} is small, then the elevator will not float very far and the stick-free stability characteristics will be much the same as those with the stick fixed. But C_{h_δ} must be small or the stick forces required to hold deflection will be unreasonable. The values of C_{h_e} and C_{h_δ} can be controlled by aerodynamic balance. Types of aerodynamic balancing will be covered in a later section.

One additional method for altering hinge moments is through the use of a trim tab. There are numerous tab types that will be discussed in a later section. A typical tab installation is presented in Figure 5.35.

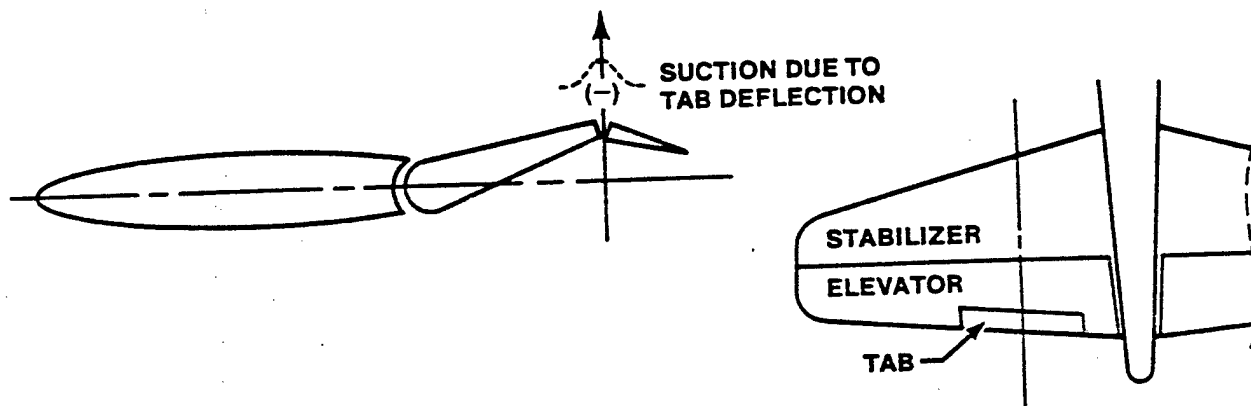

FIGURE 5.35. ELEVATOR TRIM TAB

Deflecting the tab down will result in an upward force on the trailing edge of the elevator. This tends to make the control surface float up. Thus a down tab deflection (tail-to-the-rear) results in a nose up pitching moment and is positive. This results in a positive hinge moment, and the slope of control hinge moment versus tab deflection must be positive.

The hinge moment contribution from the trim tab is thus,

$$\frac{\partial C_h}{\partial \delta_T} \delta_T \quad \text{or} \quad C_{h_{\delta_T}} \delta_T$$

and continuing with our assumption of linearity, the control hinge moment coefficient equation becomes,

$$C_h = C_{h_0} + C_{h_\alpha} \alpha_t + C_{h_\delta} \delta_e + C_{h_{\delta_T}} \delta_T \quad (5.80)$$

for a mass balanced elevator.

(5.81)

5.14 THE STICK-FREE STABILITY EQUATION

The stick-free stability may be considered the summation of the stick-fixed stability and the contribution to stability of freeing the elevator.

$$\frac{dc_m}{dc_L}_{\text{stick-free}} = \frac{dc_m}{dc_L}_{\text{stick-fixed}} + \frac{dc_m}{dc_L}_{\text{free-elev}} \quad (5.82)$$

The stability contribution of the free elevator depends upon the elevator floating position. Equation 5.83 relates to this position

$$\delta_{\text{float}} = - \frac{C_{h\alpha}}{C_{h\delta}} \alpha_t \quad (5.83)$$

Substituting for α_t from Equation 5.24

$$\delta_{\text{float}} = - \frac{C_{h\alpha}}{C_{h\delta}} (\alpha_w - i_w + i_t - \epsilon) \quad (5.84)$$

Taking the derivative of Equation 5.84 with respect to C_L

$$\frac{d\delta_e}{dC_L} = - \frac{C_{h\alpha}}{C_{h\delta}} \left(\frac{1 - \frac{d\epsilon}{d\alpha}}{a_w} \right) \quad (5.85)$$

Substituting the expression for elevator power, (Equation 5.50) into Equation 5.69 and combining with Equation 5.85.

$$C_{m\delta} = - a_t V_H \eta_t \tau \quad (5.50)$$

$$\frac{dC_{m\delta}}{dC_{L_{\text{Free Elev}}}} = \frac{a_t}{a_w} V_H \eta_t \left(1 - \frac{d\epsilon}{d\alpha} \right) \left(\tau \frac{C_{h\alpha}}{C_{h\delta}} \right) \quad (5.86)$$

Substituting Equation 5.86 and Equation 5.29 into Equation 5.82, the stick-free stability becomes

$$\frac{dC_m}{dC_{L_{Stick-Free}}} = \frac{X_v}{c} + \frac{dC_m}{dC_{L_{Fus}}} - \frac{a_t}{a_w} V_H \eta_t \left(1 - \frac{d\epsilon}{d\alpha}\right) \left(1 - \tau \frac{C_{h_\alpha}}{C_{h_\delta}}\right) \quad (5.87)$$

The difference between stick-fixed and stick-free stability is the multiplier in Equation 5.87 $1 - \tau C_{h_\alpha} / C_{h_\delta}$, called the "free elevator factor" which is designated F. The magnitude and sign of F depends on the relative magnitudes of τ and the ratio of $C_{h_\alpha} / C_{h_\delta}$. An elevator with only slight floating tendency has a small $C_{h_\alpha} / C_{h_\delta}$ giving a value of F around unity. Stick-fixed and stick-free stability are practically the same. If the elevator has a large floating tendency (ratio of $C_{h_\alpha} / C_{h_\delta}$ large), the stability contribution of the horizontal tail is reduced ($dC_m / dC_{L_{Stick-Free}}$ is less negative). For instance, a ratio of $C_{h_\alpha} / C_{h_\delta} = -2$ and a τ of -0.5 , the floating elevator can eliminate the whole tail contribution to stability. Generally, freeing the elevator causes a destabilizing effect. With elevator free to float, the aircraft is less stable.

The stick-free neutral point, h'_n , is that cg position at which $dC_m / dC_{L_{Stick-Free}}$ is zero. Continuing as in the stick-fixed case, the stick-free neutral point is,

$$h'_n = \frac{X_{ac}}{c} - \frac{dC_m}{dC_{L_{Fus}}} + \frac{a_t}{a_w} V_H \eta_t \left(1 - \frac{d\epsilon}{d\alpha}\right) F \quad (5.88)$$

and

$$\frac{dC_m}{dC_L} = h - h'_n \quad (5.89)$$

Stick-
Free

The stick-free static margin is defined as

$$\text{Static Margin} = h'_n - h \quad (5.90)$$

5.15 FREE CANARD STABILITY

While it is not the intent of this paragraph to go into stick-free stability aspects of the canard, it is useful to present a summary of the effects of freeing the elevator. Remember that the tail term will be multiplied by the free elevator factor F

$$F = 1 - \tau \frac{C_{h\alpha}}{C_{h\delta}}$$

As F becomes less than unity, the tail (canard) contribution to stability becomes less positive, making the airplane more stable. In turbulence, stick free, the nose tends to fall slightly from an up gust, resulting in a sort of load alleviation or ride smoothing characteristic (reversible control system). If this characteristic is desired in a tail to the rear aircraft, it can easily be obtained by dynamic overbalancing as described in Paragraph 5.17.6.4, page 5.84.

Table 5.1 compares the differences in stability derivatives and control terms between the canard and tail to the rear aircraft.

TABLE 5.1
STABILITY AND CONTROL DERIVATIVE COMPARISON

	Tail-to-Rear	Canard
$C_{m_{\alpha}}$	(-)	(-)
$C_{m_{\delta}}$	(+)	(+)
$C_{h_{\delta}}$	(-)	(-)
$C_{h_{\alpha}}$	(+)	(-)

5.16 STICK-FREE FLIGHT TEST RELATIONSHIP

As was done for stick-fixed stability, a flight test relationship is required that will relate measurable flight test parameters with the stick-free stability of the aircraft, dC_m/dC_L .

Stick-
Free

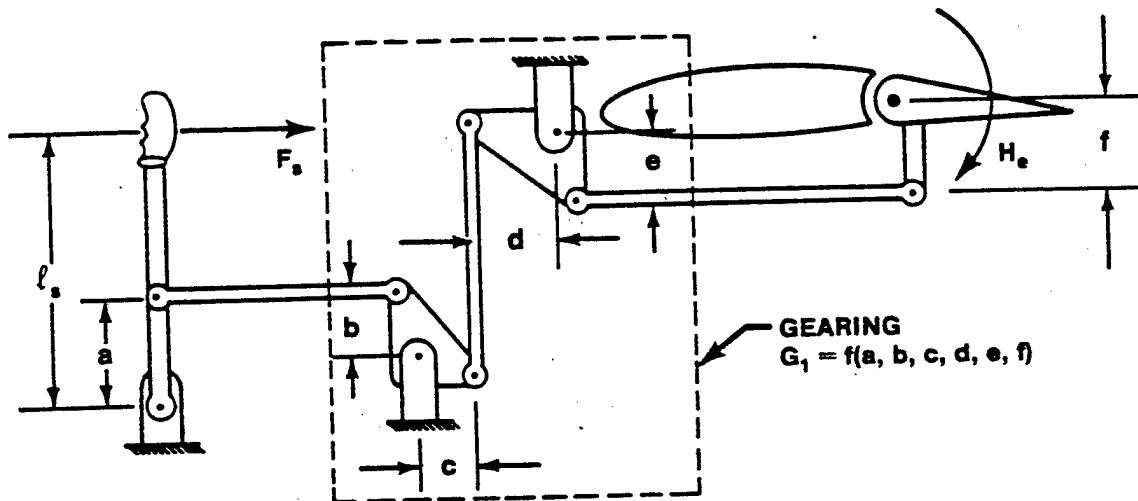

FIGURE 5.36. ELEVATOR-STICK GEARING

The pilot holds a stick deflected with a stick force F_s . The control system transmits the moment from the pilot through the gearing to the elevator Figure 5.36. The elevator deflects and the aerodynamic pressure produces a hinge moment at the elevator that exactly balances the moment produced by the pilot with force F_s .

$$F_s l_s = - G_1 H_e$$

If the length l_s is included with the gearing, the stick force becomes

$$F_s = - GH_e$$

(5.91)

The hinge moment H_h may be written

$$H_h = C_h q S_o c_o \quad (5.92)$$

Equation 5.91 then becomes

$$F_s = -G C_h q S_o c_o \quad (5.93)$$

Substituting

$$C_h = C_{h_o} + C_{h_\alpha} \alpha_t + C_{h_\delta} \delta_o + C_{h_{\delta_T}} \delta_T \quad (5.80)$$

and using

$$\delta_o = \delta_{o_{\text{Zero Lift}}} + \frac{d\delta_o}{dC_L} C_L \quad (5.71)$$

and

$$\alpha_t = \alpha_w - i_w + i_t - \epsilon \quad (5.24)$$

With no small amount of algebraic manipulation, Equation 5.93 may be written

$$F_s = Aq \left(B + C_{h_{\delta_T}} \delta_T - \frac{C_L C_{h_\delta}}{C_{m_{\delta_o}}} \frac{dC_m}{dC_L} \right) \quad (5.94)$$

stick-
Free

where

$$A = -GS_o c_o$$

$$B = C_{h_0} + C_{h_\alpha} (\alpha_{0L} - i_w + i_t) + C_{h_\delta} \delta_{\text{zero Lift}}$$

Writing Equation 5.94 as a function of airspeed and substituting for unaccelerated flight, $C_L q = W/S$ and using equivalent airspeed, V_e ,

$$F_s = \frac{1}{2} \rho_0 V_e^2 A \left(B + C_{h_{\delta_T}} \delta_T \right) - A \frac{W}{S} \frac{C_{h_\delta}}{C_{m_\delta}} \frac{dC_m}{dC_L} \text{Stick-Free} \quad (5.95)$$

Simplifying Equation 5.95 by combining constant terms,

$$F_s = K_1 V_e^2 + K_2 \quad (5.96)$$

K_1 contains δ_T which determines trim speed. K_2 contains dC_m/dC_L Stick-Free

Equation 5.96 gives a relationship between an in-flight measurement of stick force gradient and stick-free stability. The equation is plotted in Figure 5.37.

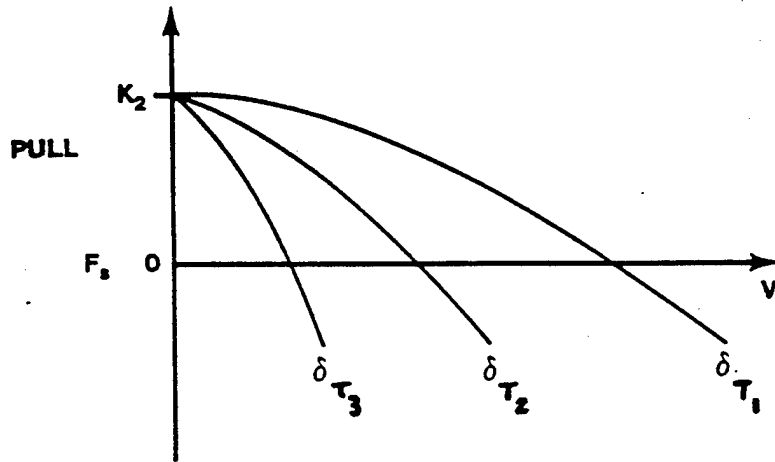

FIGURE 5.37. STICK FORCE VERSUS AIRSPEED

The plot is made up of a constant force springing from the stability term plus a variable force proportional to the velocity squared, introduced through constants and the tab term $C_{h_{\delta_T}} \delta_T$. Equation 5.96 introduces the interesting fact that the stick-force variation with airspeed is apparently dependent on the first term only and independent in general of the stability level. That is, the slope of the F_s versus V is not a direct function of $\frac{dC_{h_{\delta_T}}}{dC_{L_{stick-free}}}$. If the derivative of Equation 5.96 is taken with respect to V , the second term containing the stability drops out. For constant stability level and trim tab setting, stick force gradient is a function of trim airspeed.

$$\frac{dF_s}{dV} = \rho_0 V_0 A \left(B + C_{h_{\delta_T}} \delta_T \right) \quad (5.97)$$

However, dF_s/dV is a function of the stability term if the trim tab setting, δ_T , is adjusted to trim at the original trim airspeed after a change in stability level, e.g., movement of the aircraft cg. The tab setting, δ_T , in Equation 5.95 should be adjusted to obtain $F_s = 0$ at the original trim velocity.

$$\delta_T = f \left(v_{Trim}, \frac{dC_n}{dC_{L_{Stick-Free}}} \right) \quad (5.98)$$

This new value of δ_T for $F_s = 0$ is then substituted into Equation 5.97 so

$$\frac{dF_s}{dv_{Trim}} = f \left(v_{Trim}, \frac{dC_n}{dC_{L_{Stick-Free}}} \right) \quad (5.99)$$

Thus, it appears that if an aircraft is flown at two cg locations and dF_s/dv_{Trim} is determined at the same trim speed each time, then one could extrapolate or interpolate to determine the stick-free neutral point h_n . Unfortunately, if there is a significant amount of friction in the control system, it is impossible to precisely determine this trim speed. In order to investigate briefly the effects of friction on the longitudinal control system, suppose that the aircraft represented in Figure 5.38 is perfectly trimmed at v_1 i.e., ($\delta_e = \delta_{e_1}$ and $\delta_T = \delta_{T_1}$). If the elevator is used to decrease or increase airspeed with no change to the trim setting, the friction in the control system will prevent the elevator from returning all the way back to δ_{e_1} when the controls are released. The aircraft will return

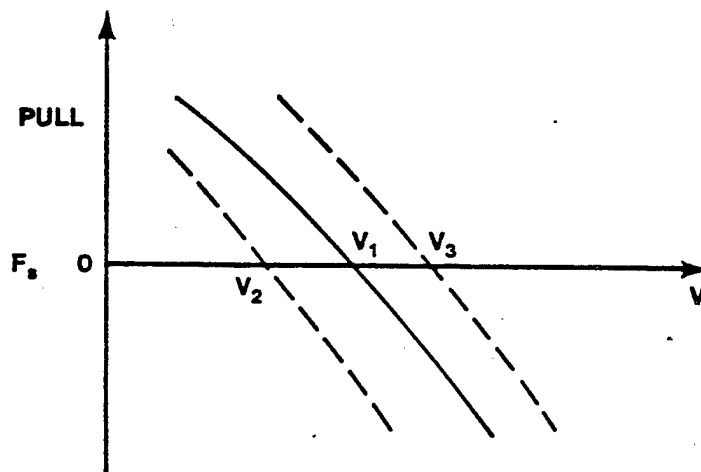

FIGURE 5.38. CONTROL SYSTEM FRICTION

only to V_2 or V_3 . With the trim tab at δ_{T_1} , the aircraft is content to fly at any speed between V_2 and V_3 . The more friction that exists in the system, the wider this speed range becomes. If you refer to the flight test methods section of this chapter, you will find that the F_s versus V_s plot shown in Figure 5.38 matches the data plotted in Figure 5.65 (pg 5.102). In theory, dF_s/dV_s is the slope of the parabola formed by Equation 5.96. With that portion of the parabola from $V = 0$ to V_{stall} removed, Figures 5.37 and 5.38 predict flight test data quite accurately.

Therefore, if there is a significant amount of friction in the control system, it becomes impossible to say that there is one exact speed for which

the aircraft is trimmed. Equation 5.99 is something less than perfect for predicting the stick-free neutral point of an aircraft. To reduce the undesirable effect of friction in the control system, a different approach is made to Equation 5.94.

If Equation 5.94 is divided by the dynamic pressure, q , then,

$$F_s/q = A (B + C_{h_{\delta_T}}) - \frac{AC_L C_{h_{\delta}}}{C_{n_{\delta}}} \frac{dC_m}{dC_{L_{\text{Stick-Free}}}} \quad (5.100)$$

Differentiating with respect to C_L ,

$$\frac{d(F_s/q)}{dC_L} = - \frac{AC_{h_{\delta}}}{C_{n_{\delta}}} \frac{dC_m}{dC_{L_{\text{Stick-Free}}}} \quad (5.101)$$

or

$$\frac{d(F_s/q)}{dC_L} = f \left(\frac{dC_m}{dC_{L_{\text{Stick-Free}}}} \right) \quad (5.102)$$

Trim velocity is now eliminated from consideration and the prediction of stick-free neutral point h'_n is exact. A plot of $(dF_s/q)/dC_L$ versus cg position may be extrapolated to obtain h'_n .

5.17 APPARENT STICK-FREE STABILITY

Speed stability or stick force gradient dF_s/dV , in most cases does not reflect the actual stick-free stability $dC_m/dC_{L_{\text{Stick-Free}}}$ of an aircraft. In

fact, this apparent stability dF_s/dV , may be quite different from the actual stability of the aircraft. Where the actual stability of the aircraft may be marginal (dC_m/dC_L stick-Free small), or even unstable (dC_m/dC_L stick-Free positive),

apparent stability of dF_s/dV may be such as to make the aircraft quite acceptable. In flight, the test pilot feels and evaluates the apparent stability of the aircraft and not the actual stability, dC_m/dC_L stick-Free.

The apparent stability dF_s/dV is affected by:

1. Changes in dC_m/dC_L stick-Free
2. Aerodynamic balancing
3. Downsprings, bob weights, etc.

The apparent stability of the stick force gradient through a given trim speed increases if dC_m/dC_L stick-Free is made more negative. The constant K_2 of Equation 5.96 is made more positive and in order for the stick force to continue to pass through the desired trim speed, a more positive tab selection is required. An aircraft operating at a given cg with a tab setting δ_{T_1} is shown in Figure 5.39, Line 1.

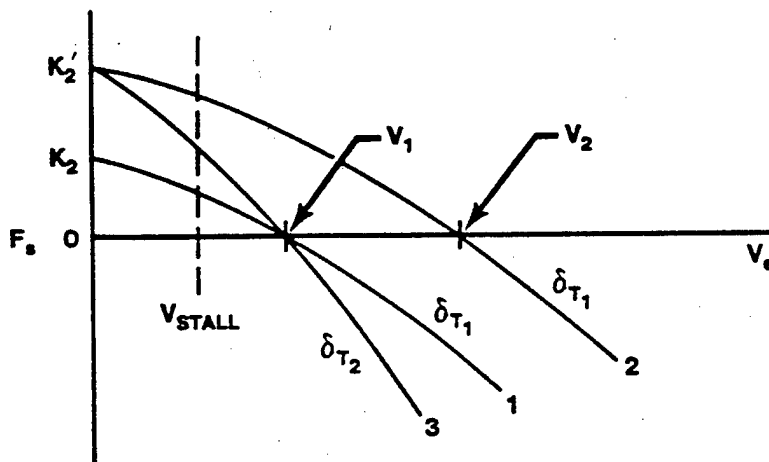

FIGURE 5.39. EFFECT ON APPARENT STABILITY

If $\frac{dC_m}{dC_L}_{Stick-Free}$ is increased by moving the cg forward, then K_2 (which is a function of $\frac{dC_m}{dC_L}_{Stick-Free}$ in Equation 5.95) becomes more positive or increases, and the equation becomes

$$F_s = K_1 V_e^2 + K_2' \quad (5.103)$$

This equation plots as Line 2 in Figure 5.39. The aircraft with no change in tab setting δ_{T_1} operates on Line 2 and is trimmed to V_2 . Stick forces at all airspeeds have increased. At this juncture, although the actual stability $\frac{dC_m}{dC_L}_{Stick-Free}$ has increased, there has been little effect on the stick force gradient or apparent stability. (The slopes of Line 1 and Line 2 being about the same.) So as to retrim to the original trim airspeed V_1 , the pilot applies additional nose up tab to δ_{T_2} . The aircraft is now operating on line

3. The stick force gradient through V_1 has increased because of an increase in the K_1 term in Equation 5.96. The apparent stability dF_s/dV has increased.

Aerodynamic balancing of the control surface affects apparent stability in the same manner as cg movement. This is a design means of controlling the hinge moment coefficients, C_{h_α} and C_{h_δ} . The primary reason for aerodynamic balancing is to increase or reduce the hinge moments and, in turn, to control stick forces. Changing C_{h_δ} affects the stick forces as seen in Equation 5.100. In addition to the influence on hinge moments, aerodynamic balancing affects the real and apparent stability of the aircraft. Assuming that the restoring hinge moment coefficient C_{h_δ} is increased by an appropriate aerodynamically balanced control surface, the ratio of $C_{h_\alpha}/C_{h_\delta}$ in Equation 5.87 is decreased.

$$\frac{dC_m}{dC_L}_{\text{Stick Free}} = \frac{X_w}{c} + \frac{dC_m}{dC_{L_{fus}}} - \frac{a_t}{a_w} V_H \eta_t \left(1 - \frac{d\varepsilon}{d\alpha}\right) \left(1 - \tau \frac{C_{h_\alpha}}{C_{h_\delta}}\right) \quad (5.87)$$

The combined increase in $dC_m/dC_{L_{\text{Stick-Free}}}$ and C_{h_δ} , increases the K_2 term in Equation 5.96 since

$$K_2 = -A \frac{W}{S} \frac{C_{h_\delta}}{C_{m_{\delta_0}}} \frac{dC_m}{dC_{L_{\text{Stick-Free}}}} \quad (5.104)$$

Figure 5.39 shows the effect of increased K_2 . The apparent stability is not affected by the increase in K_2 if the aircraft stabilizes at V_2 . However, once the aircraft is retrimmed to the original airspeed V_1 by increasing the tab setting to δ_{T_2} , the apparent stability is increased.

5.17.1 Set-Back Hinge

Perhaps the simplest method of reducing the aerodynamic hinge moments is to move the hinge line rearward. The hinge moment is reduced because the moment arm between the elevator lift and the elevator hinge line is reduced. (One may arrive at the same conclusion by arguing this part of the elevator lift acting behind the hinge line has been reduced, while that in front of the hinge line has been increased.) The net result is a reduction in the absolute value of both C_{h_a} and C_{h_b} . In fact, if the hinge line is set back far enough, the sign of both derivatives can be changed. A set-back hinge is shown in Figure 5.40.

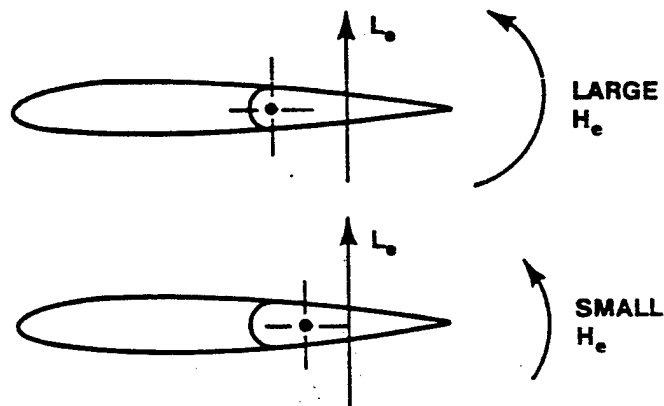

FIGURE 5.40. SET-BACK HINGE

5.17.2 Overhang Balance

This method is simply a special case of set-back hinge in which the

elevator is designed so that when the leading edge protrudes into the airstream, the local velocity is increased significantly, causing an increase in negative pressure at that point. This negative pressure peak creates a hinge moment which opposes the normal restoring hinge moment, reducing $C_{h\delta}$. Figure 5.41 shows an elevator with an overhang balance.

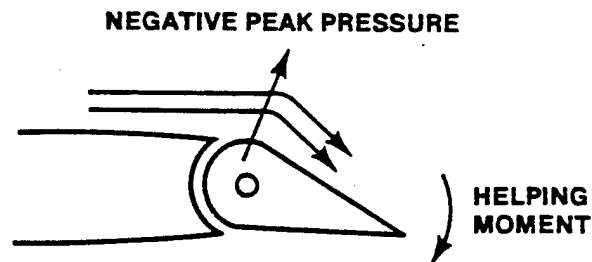

FIGURE 5.41. OVERHANG BALANCE

5.17.3 Horn Balance

The horn balance works on the same principle as the set-back hinge; i.e., to reduce hinge moments by increasing the area forward of the hinge line. The horn balance, especially the unshielded horn, is very effective in reducing $C_{h\alpha}$ and $C_{h\delta}$. This arrangement shown in Figure 5.42 is also a handy way of improving the mass balance of the control surface.

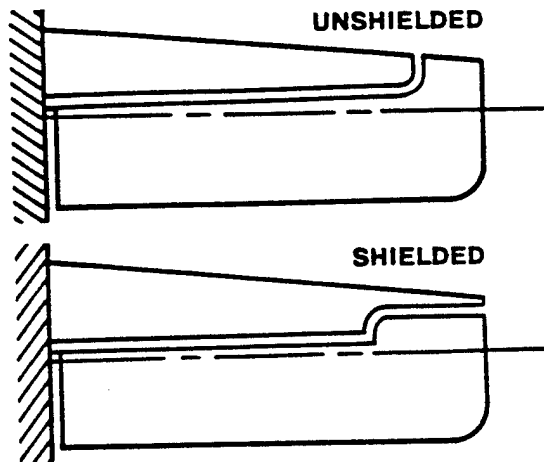

FIGURE 5.42. HORN BALANCE

5.17.4 Internal Balance or Internal Seal

The internal seal allows the negative pressure on the upper surface and the positive pressure on the lower surface to act on an internally sealed surface forward of the hinge line in such a way that a helping moment is created, again opposing the normal hinge moments. As a result, the absolute values of C_{h_a} and C_{h_b} are both reduced. This method is good at high indicated airspeeds, but is sometimes troublesome at high Mach. Figure 5.43 shows an elevator with an internal seal.

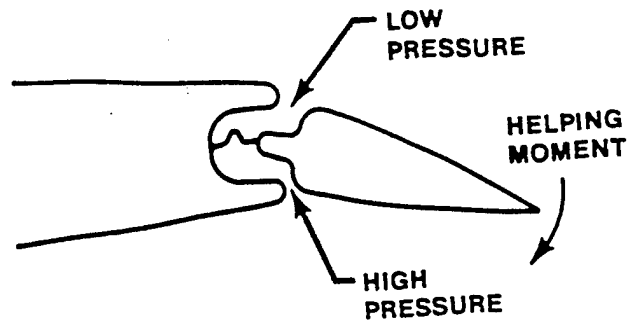

FIGURE 5.43. INTERNAL SEAL

5.17.5 Elevator Modifications

Bevel Angle on Top or on Bottom of the Stabilizer. This device which causes flow separation on one side, but not on the other, reduces the absolute values of $C_{h\alpha}$ and $C_{h\delta}$.

Trailing Edge Strips. This device increases both $C_{h\alpha}$ and $C_{h\delta}$. In combination with a balance tab, trailing edge strips produce a very high positive $C_{h\alpha}$, but still a low $C_{h\delta}$. This results in what is called a favorable "Response Effect," (i.e., it takes a lower control force to hold a deflection than was originally required to produce it).

Convex Trailing Edge. This type surface produces a more negative $C_{h\delta}$, but tends as well to produce a dangerous short period oscillation.

5.17.6 Tabs

A tab is simply a small flap which has been placed on the trailing edge of a larger one. The tab greatly modifies the flap hinge moments, but has only a small effect on the lift of the surface or the entire airfoil. Tabs in general are designed to modify stick forces, and therefore $C_{h\delta}$, but will not affect $C_{h\alpha}$ very much.

5.17.6.1 Trim Tab. A trim tab is a tab which is controlled independently of the normal elevator control by means of a wheel or electric motor. The purpose of the trim tab is to alter the elevator hinge moment and in doing so drive the stick force to zero for a given flight condition. A properly designed trim tab should be allowed to do this throughout the flight envelope and across the allowable cg range. The trim tab reduces stick forces to zero primarily by changing the elevator hinge moment at the elevator deflection required for trim. This is illustrated in Figure 5.44.

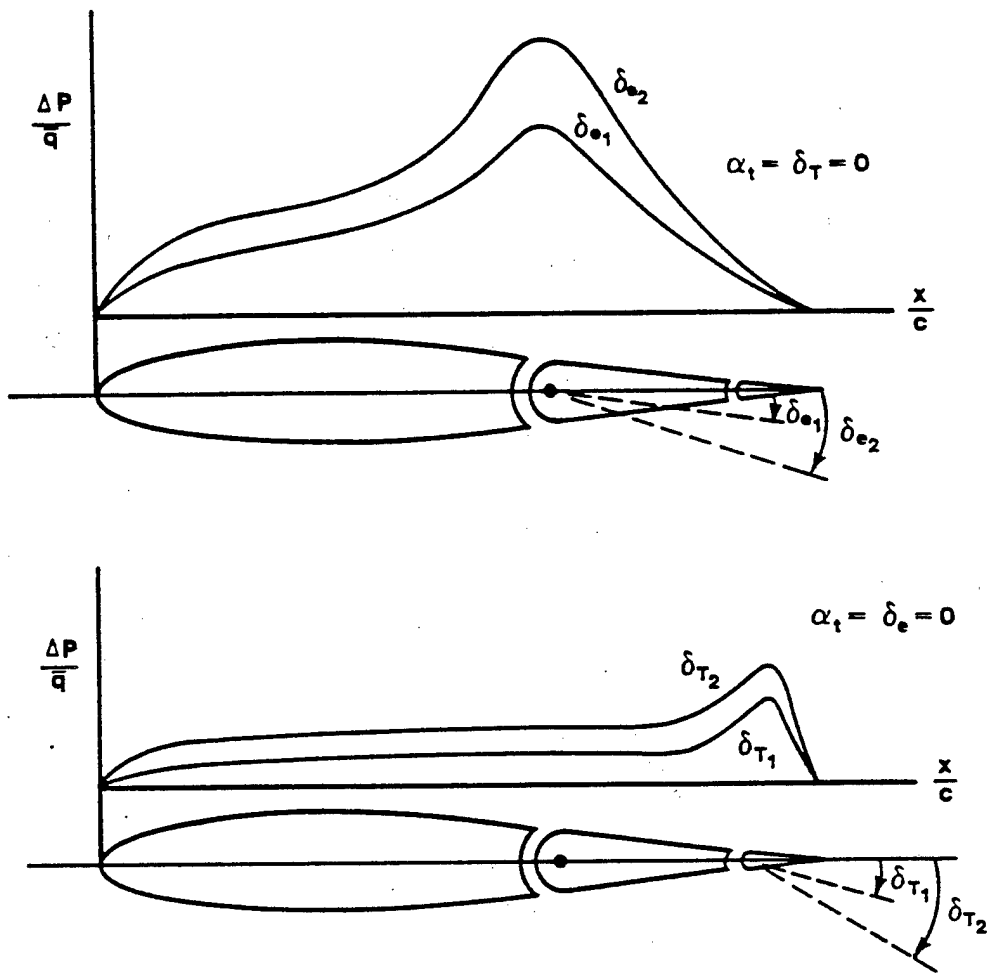

FIGURE 5.44. TRIM TAB

5.17.6.2 Balance Tab. A balance tab is a simple tab, not a part of the longitudinal control system, which is mechanically geared to the elevator so that a certain elevator deflection produces a given tab deflection. If the tab is geared to move in the same direction as the surface, it is called a leading tab. If it moves in the opposite direction, it is called a lagging tab. The purpose of the balance tab is usually to reduce the hinge moments and stick force (lagging tab) at the price of a certain loss in control effectiveness. Sometimes, however, a leading tab is used to increase control effectiveness at the price of increased stick forces. The leading tab may also be used for the express purpose of increasing control force. Thus C_{h_s} may be increased or decreased, while C_{h_e} remains unaffected. If the linkage shown in Figure 5.45 is made so that the length may be varied by the pilot, then the tab may also serve as a trimming device.

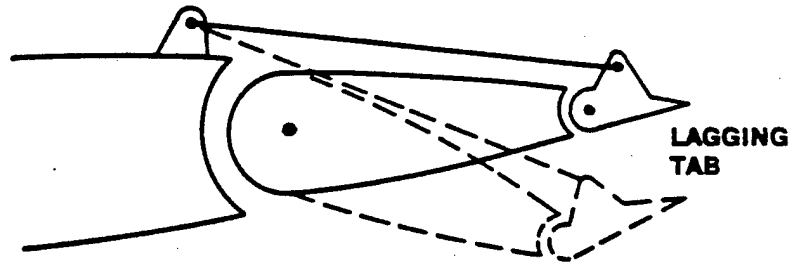

FIGURE 5.45. BALANCE TAB

5.17.6.3 Servo or Control Tab. The servo tab is linked directly to the aircraft longitudinal control system in such a manner that the pilot moves the tab and the tab moves the elevator, which is free to float. The summation of elevator hinge moment due to elevator deflection just balances out the hinge moments due to α_t and δ_t . The stick forces are now a function of the tab hinge moment or $C_{h_{\delta_t}}$. Again $C_{h_{\alpha}}$ is not affected.

5.17.6.4 Spring Tab. A spring tab is a lagging balance tab which is geared in such a way that the pilot receives the most help from the tab at high speeds where he needs it the most; i.e., the gearing is a function of dynamic pressure. The spring tab is shown in Figure 5.46.

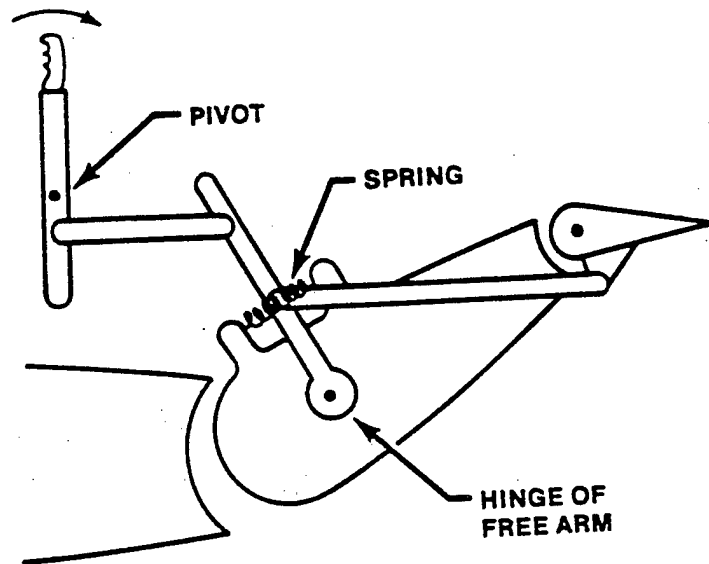

FIGURE 5.46. SPRING TAB

The basic principles of its operation are:

1. An increase in dynamic pressure causes an increase in hinge moment and stick force for a given control deflection.
2. The increased stick force causes an increased spring deflection and, therefore, an increased tab deflection.
3. The increased tab deflection causes a decrease in stick force. Thus an increased proportion of the hinge moment is taken by the tab.
4. Therefore, the spring tab is a geared balance tab where the gearing is a function of dynamic pressure.
5. Thus, the stick forces are more nearly constant over the speed range of the aircraft. That is, the stick force required to produce a given deflection at 300 knots is still greater than at 150 knots, but not by as much as before. Note that the pilot cannot tell what is causing the forces he feels at the stick. This appears to change "speed stability," but in fact changes actual stability or dC_m/dC_L .
6. After reaching full spring or tab deflection the balancing feature is lost and the pilot must supply the full force necessary for further deflection. (This acts as a safety feature.)

A plot comparing the relative effects of the various balances on hinge moment parameters is given in Figure 5.47 below. The point indicated by the circle represents the values of a typical plain control surface. The various lines radiating from that point indicate the manner in which the hinge moment parameters are changed by addition of various kinds of balances. Figure 5.48 is also a summary of the effect of various types of balances on hinge moment coefficients.

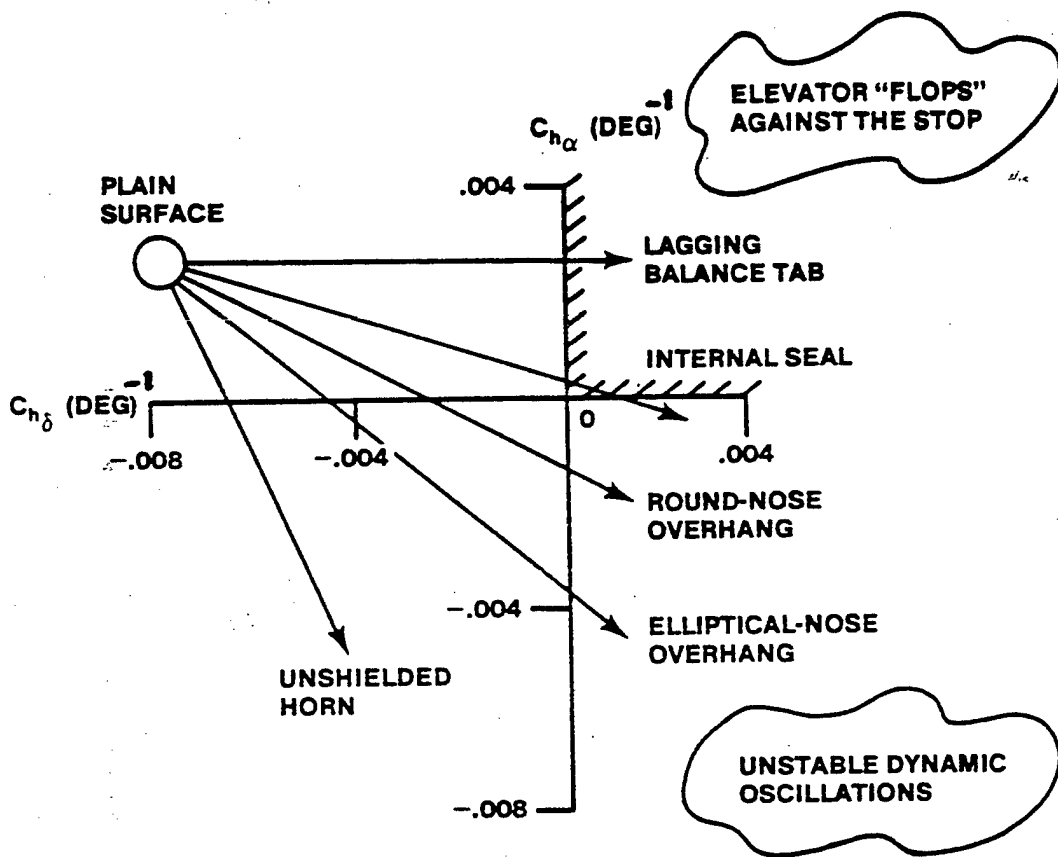

FIGURE 5.47. TYPICAL HINGE MOMENT COEFFICIENT VALUES









NOMENCLATURE	$C_{h\alpha}$	$C_{h\delta}$	
	SIGN NORMALLY (+)	SIGN ALWAYS (-)	
SET-BACK HINGE	REDUCED	REDUCED	
OVERHANG	REDUCED	REDUCED	
UNSHIELDED HORN	REDUCED	REDUCED	
INTERNAL SEAL	REDUCED	REDUCED	
BEVEL ANGLE STRIPS	REDUCED	REDUCED	
TRAILING EDGE STRIPS	INCREASED	INCREASED	
CONVEX TRAILING EDGE	NO CHANGE	INCREASED	
TABS	NO CHANGE	INCREASED OR DECREASED	
LAGGING BALANCE TAB	NO CHANGE	DECREASED	
LEADING BALANCE TAB	NO CHANGE	INCREASED	
BLOW DOWN TAB OR SPRING TAB	NO CHANGE	INCREASED, DECREASES WITH "q"	

FIGURE 5.48. METHODS OF CHANGING AERODYNAMIC HINGE
MOMENT COEFFICIENT MAGNITUDES
(TAIL-TO-THE-REAR AIRCRAFT)

In summary, aerodynamic balancing is "tailoring" the values of C_{h_α} and C_{h_δ} during the aircraft design phase in order to increase or decrease hinge moments. It is a method of controlling stick forces and affects the real and apparent stability of the aircraft. In the literature, dynamic control balancing is often defined as making C_{h_α} small or just slightly positive. Note from Figure 5.47 that the addition of an unshielded horn balance changes C_{h_α} without affecting C_{h_δ} very much. If C_{h_α} is made exactly zero, the aircraft's stick-fixed and stick-free stability are the same.

Making C_{h_α} negative is defined as overbalancing. If C_{h_α} is made slightly negative, then the aircraft is more stable stick-free than stick-fixed. Early British flying quality specifications permitted an aircraft to be unstable stick-fixed as long as stick-free stability was maintained. Overbalancing increases stick forces.

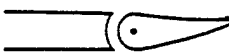
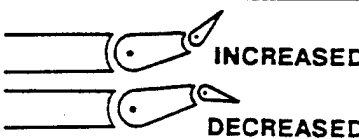
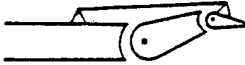
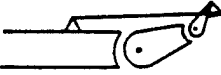
Because of the very low force gradients in most modern aircraft at the aft center of gravity, improvements in stick-free longitudinal stability are obtained by devices which produce a constant pull force on the stick independent of airspeed which allows a more noseup tab setting and steeper stick force gradients. Two devices for increasing the stick force gradients are the downspring and bobweight. Both effectively increase the apparent stability of the aircraft.

5.17.7 Downspring

A virtually constant stick force may be incorporated into the control system by using a downspring or bungee which tends to pull the top of the stick forward. From Figure 5.49 the force required to counteract the spring is

$$F_{\text{Downspring}} = T \frac{l_1}{l_2} = K_3 \text{Downspring} \quad (5.106)$$

If the spring is a long one, the tension in it will be increased only slightly as the top moves rearward and can be considered to be constant.

The equation with the downspring in the control system becomes,

$$F_s = K_1 V_o^2 + K_2 + K_3 \text{ Downsprings} \quad (5.107)$$

As shown in Figure 5.39, the apparent stability will increase when the aircraft is once again retrimmed by increasing the tab setting. Note that the downspring increases apparent stability, but does not affect the actual stability of the aircraft ($dc_a/dc_{L_{stick-free}}$; no change to K_2).

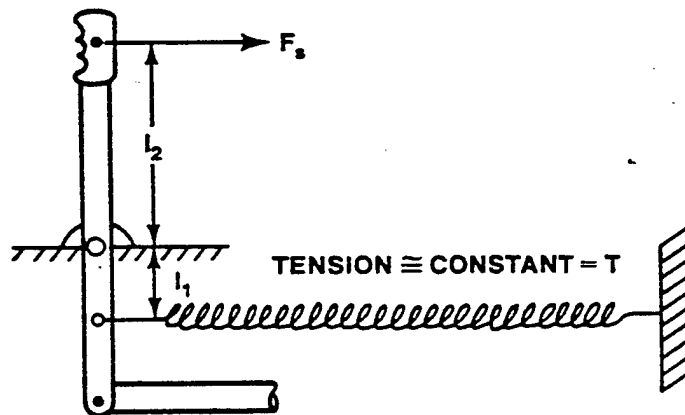

FIGURE 5.49. DOWNSPRING

5.17.8 Bobweight

Another method of introducing a nearly constant stick force is by placing a bobweight in the control system which causes a constant moment (Figure 5.50). The force to counteract the bobweight is,

$$F_s \text{ Bobweight} = nW \frac{l_1}{l_2} = K_3 \quad (5.108)$$

Like the downspring, the bobweight increases the stick force throughout the airspeed range and, at increased tab settings, the apparent stability or stick force gradient. The bobweight has no effect on the actual stability of the aircraft $(\frac{dC_m}{dC_L}_{stick})$.

Free

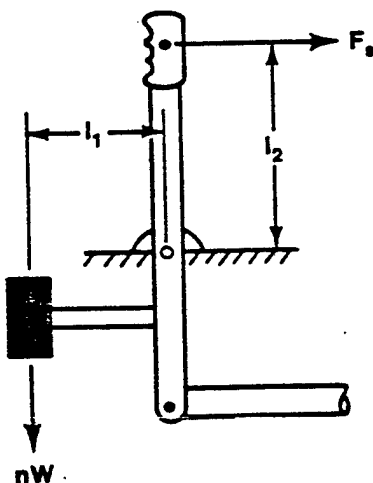

FIGURE 5.50. BOBWEIGHT

A spring may be used as an "upspring," and a bobweight may be placed on the opposite side of the stick in the control system. Those configurations are illustrated in Figure 5.51. In this configuration, the stick force would be decreased, and the apparent stability also decreased. It should again be emphasized that regardless of spring or bobweight configuration, there is no effect on the actual stability $(\frac{dC_m}{dC_L}_{stick})$ of the aircraft.

Free

Further use of these control system devices will be discussed in Chapter 6, Maneuvering Flight.

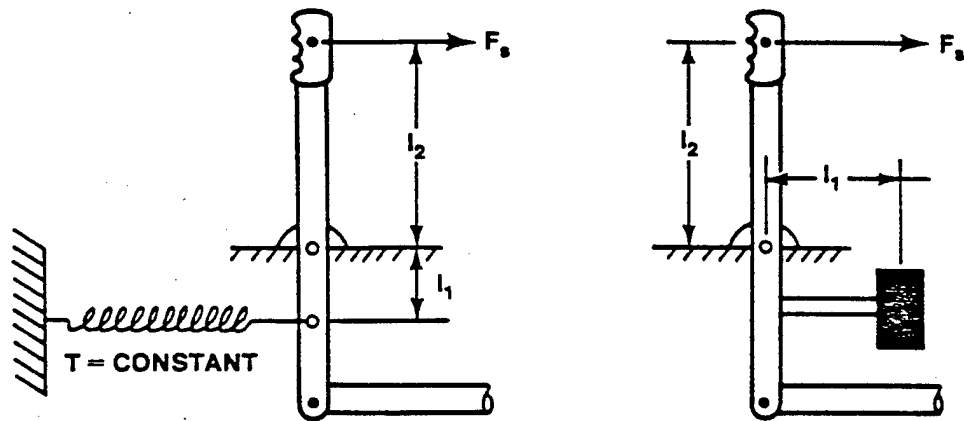

FIGURE 5.51. ALTERNATE SPRING & BOBWEIGHT CONFIGURATIONS

To examine the effect of the stick force gradient dF_s/dV on Equation 5.102 and to find h'_n , Equation 5.94 is rewritten with a control system device

$$F_s = Aq(B + C_{h_{\delta_T}} \delta_T) - AC_L q \frac{C_{h_{\delta}}}{C_{m_{\delta}}} \frac{dC_m}{dC_{L \text{ Stick-Free}}} + K_3 \text{ Device} \quad (5.109)$$

$$F_s/q = A(B + C_{h_{\delta_T}} \delta_T) - AC_L \frac{C_{h_{\delta}}}{C_{m_{\delta}}} \frac{dC_m}{dC_{L \text{ Stick-Free}}} + \frac{K_3 C_L}{W/S} \quad (5.110)$$

$$\frac{d(F_s/q)}{dC_L} = K_4 \frac{dC_m}{dC_{L \text{ Stick-Free}}} + \frac{K_3}{W/S} \quad (5.111)$$

The cg location at which $(dF_g/q)/dC_L$ goes to zero will not be the true h'_n when a device such as a spring or a bobweight is included.

5.18 HIGH SPEED LONGITUDINAL STATIC STABILITY

The effects of high speed (transonic and supersonic) on longitudinal static stability can be analyzed in the same manner as that done for subsonic speeds. However, the assumptions that were made for incompressible flow are no longer valid.

Compressibility effects both the longitudinal static stability, dC_m/dC_L (gust stability) and speed stability, dF_g/dV . The gust stability depends mainly on the contributions to stability of the wing, fuselage, and tail in the stability equation below during transonic and supersonic flight.

$$\frac{dC_m}{dC_L} = \frac{X_w}{c} + \frac{dC_m}{dC_L}_{fus} - \frac{a_t}{a_w} V_H \eta_t \left(1 - \frac{d\epsilon}{d\alpha}\right) \quad (5.29)$$

5.18.1 The Wing Contribution

In subsonic flow the aerodynamic center is at the quarter chord. At transonic speed, flow separation occurs behind the shock formations causing the aerodynamic center to move forward of the quarter chord position. The immediate effect is a reduction in stability since X_w/c increases. As speed increases further the shock moves off the surface and the wing recovers lift. The aerodynamic center moves aft towards the 50% chord position. There is a sudden increase in the wing's contribution to stability since X_w/c is reduced.

The extent of the aerodynamic center shift depends greatly on the aspect ratio of the aircraft. The shift is least for low aspect ratio aircraft. Among the planforms, the rectangular wing has the largest shift for a given aspect ratio, whereas the triangular wing has the least (Figure 5.52).

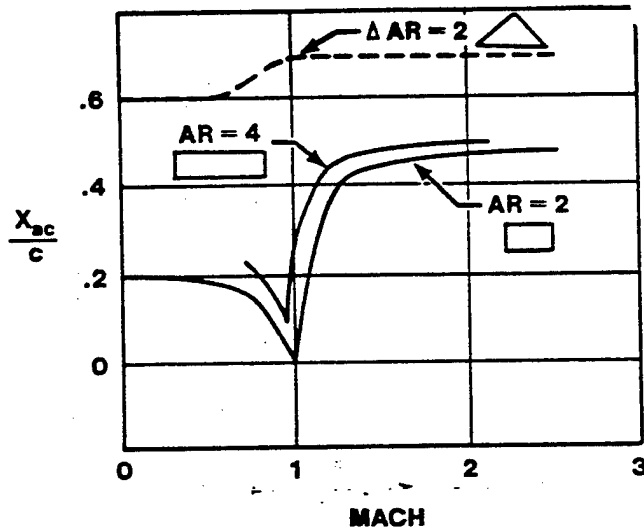

FIGURE 5.52. AC VARIATION WITH MACH

5.18.2 The Fuselage Contribution

In supersonic flow, the fuselage center of pressure moves forward causing a positive increase in the fuselage dC_m/dC_L or a destabilizing influence on the fuselage term. Variation with Mach is usually small and will be ignored.

5.18.3 The Tail Contribution

The tail contribution to stability depends on the variation of lift curve slopes, a_w and a_t , plus downwash ϵ with Mach during transonic and supersonic flight. It is expressed as:

$$(-a_t/a_v) V_H \eta_t (1 - de/d\alpha)$$

During subsonic flight a_t/a_v remains approximately constant. The slope of the lift curve, a_v , varies as shown in Figure 5.53. This variation of a_v in the transonic speed range is a function of geometry (i.e., aspect ratio, thickness, camber, and sweep). a_t varies in a similar manner. Limiting further discussion to aircraft designed for transonic flight or aircraft which employ airfoil shapes with small thickness to chord ratios, then a_v and a_t increase slightly in the transonic regime. For all airfoil shapes, the values of a_v and a_t decrease as the airspeed increases supersonically.

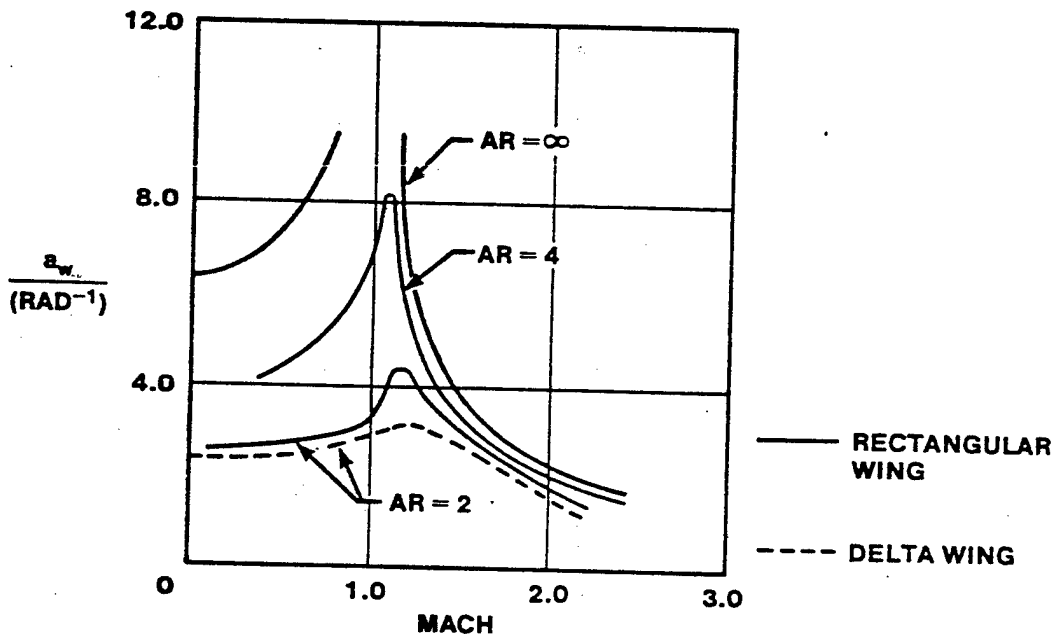

FIGURE 5.53. LIFT CURVE SLOPE VARIATION WITH MACH

The tail contribution is further affected by the variation in downwash, ϵ , with Mach increase. The downwash at the tail is a result of the vortex system associated with the lifting wing. A sudden loss of downwash occurs transonically with a resulting increase in tail angle of attack. The effect requires the pilot to apply additional up elevator with increasing airspeed to maintain altitude. This additional up elevator contributes to speed instability. (Speed stability will be covered more thoroughly later.) Typical downwash variation with Mach is seen in Figure 5.54.

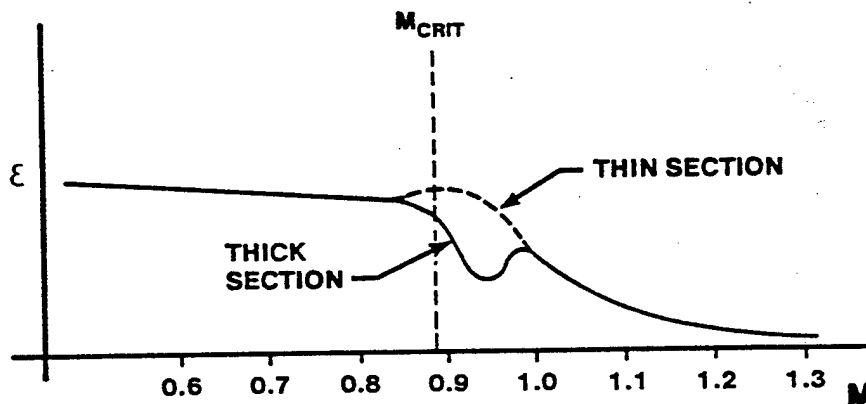

FIGURE 5.54. TYPICAL DOWNWASH VARIATION WITH MACH

The variation of $d\epsilon/d\alpha$ with Mach greatly influences the aircraft's gust stability dC_m/dC_L . Recalling from subsonic aerodynamics,

$$\epsilon = \frac{114.6C_L}{\pi AR} \quad \text{and} \quad \frac{d\epsilon}{d\alpha} = \frac{114.6a_v}{\pi AR}$$

Since the downwash angle behind the wing is directly proportional to the lift coefficient of the wing, it is apparent that the value of the derivative $d\epsilon/d\alpha$ is a function of a_v . The general trend of $d\epsilon/d\alpha$ is an initial increase with

Mach starting at subsonic speeds. Above Mach 1.0, $d\epsilon/d\alpha$ decreases and approaches zero. This variation depends on the particular wing geometry of the aircraft. As shown in Figure 5.55, $d\epsilon/d\alpha$ may dip for thicker wing sections where considerable flow separation occurs. Again, $d\epsilon/d\alpha$ is very much dependent upon a_v .

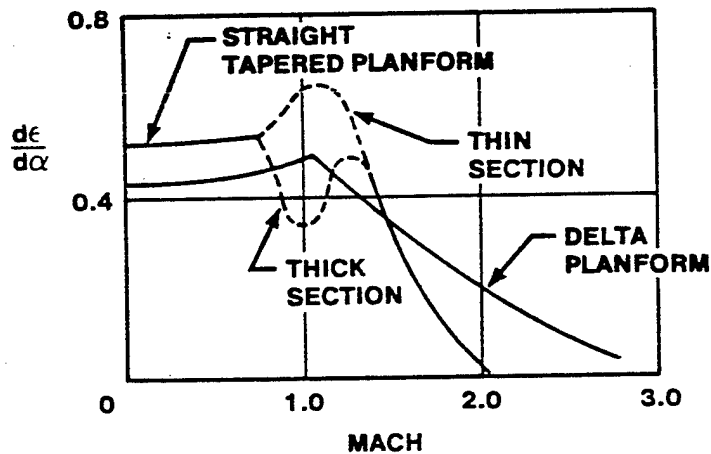

FIGURE 5.55. DOWNWASH DERIVATIVE VS MACH

For an aircraft designed for high speed flight, the variation of $d\epsilon/d\alpha$ with increasing Mach results in a slight destabilizing effect in the transonic regime and contributes to increased stability in the supersonic speed regime; therefore, the overall tail contribution to stability is difficult to predict.

A loss of stabilizer effectiveness is experienced in supersonic flight as it becomes a less efficient lifting surface. The elevator power, $C_{m\delta_e}$, increases as airspeed approaches Mach 1. Beyond Mach 1, elevator effectiveness decreases. Typical variations in $C_{m\delta_e}$ with Mach are shown in Figure 5.56.

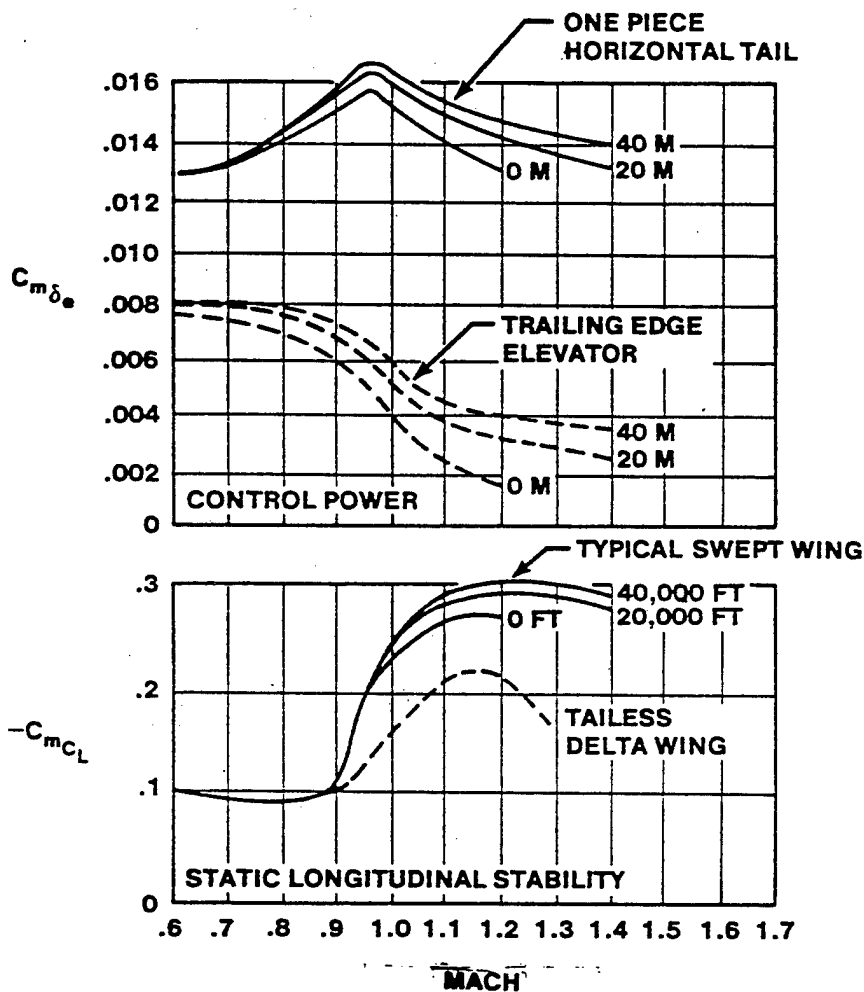

FIGURE 5.56. MACH VARIATIONS ON $C_{m\delta_e}$ AND C_{mCL}

The overall effect of transonic and supersonic flight on gust stability or dC_m/dC_L is also shown in Figure 5.56. Static longitudinal stability increases supersonically. The speed stability of the aircraft is affected as well. The pitching moment coefficient equation developed in Chapter 4 can be written,

$$C_m = C_{m_\alpha} \alpha + C_{m_{\dot{\alpha}}} \frac{\dot{\alpha} c}{2U_0} + C_{m_\mu} \frac{\mu}{U_0} + C_{m_{\dot{\beta}}} \frac{\dot{\beta} c}{2U_0} + C_{m_{\delta_e}} \delta_e \quad (5.112)$$

Assuming no pitch rates, Equation 5.112 can be written

$$C_m = C_{m_\alpha} \alpha + C_{m_\mu} \frac{\mu}{U_0} + C_{m_{\delta_e}} \delta_e \quad (5.113)$$

All three of the stability derivatives in Equation 5.113 are functions of Mach. The elevator deflection required to trim as an aircraft accelerates from subsonic to supersonic flight depends on how these derivatives vary with Mach. For supersonic aircraft, speed stability is provided entirely by the artificial feel system. However, it usually depends on how δ_e varies with Mach. A reversal of elevator deflection with increasing airspeed usually requires a relaxation of forward pressure or even a pull force to maintain altitude or prevent a nose down pitch tendency.

Elevator deflection versus Mach curves for several supersonic aircraft are shown in Figure 5.57. The important point from this figure is that supersonically $d\delta_e/dC_L$ is no longer a valid indication of gust stability. All of the aircraft shown in Figure 5.57 are more stable supersonically than subsonically, if you were to look purely at neutral points or values of the stability derivative C_{m_α} .

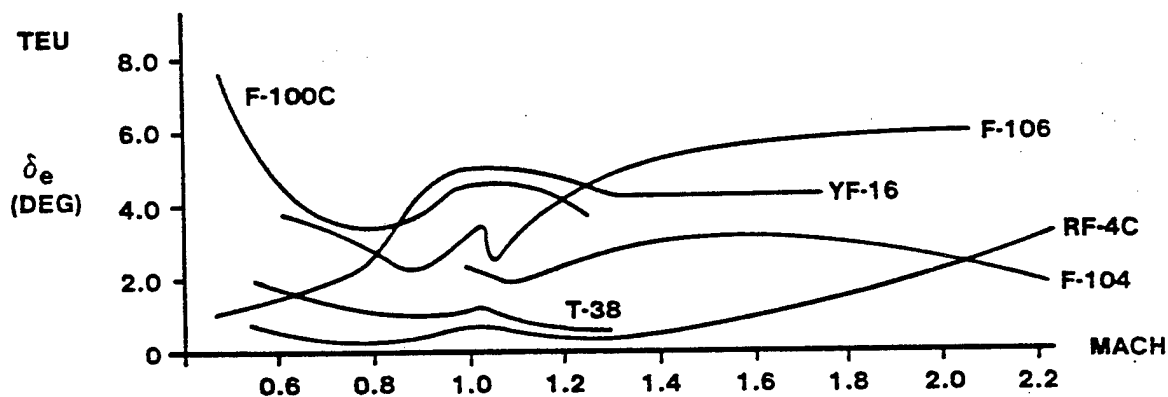

FIGURE 5.57. STABILIZER DEFLECTION VS MACH FOR SEVERAL SUPERSONIC AIRCRAFT

Whether the speed instability or reversal in elevator deflections and stick forces are objectionable depends on many factors such as magnitude of variation, length of time required to transverse the region of instability, control system characteristics, and conditions of flight.

In the F-100C, a pull of 14 pounds was required when accelerating from Mach 0.87 to 1.0. The test pilot described this trim change as disconcerting while attempting to maneuver the aircraft in this region and recommended that a "q" or Mach sensing device be installed to eliminate this characteristic. Consequently, a mechanism was incorporated to automatically change the artificial feel gradient as the aircraft accelerates through the transonic range. Also, the longitudinal trim is automatically changed in this region by the use of a "Mach Trimmer."

F-104 test pilots stated that F-104 transonic trim changes required an aft stick movement with increasing speed and a forward stick movement when decreasing speed but described this speed instability as acceptable.

F-106 pilots stated that the Mach 1.0 to 1.1 region is characterized by a moderate trim change to avoid large variations in altitude during accelerations. Minor speed instabilities were not unsatisfactory.

T-38 test pilots described the transonic trim change as being hardly perceptible.

Aircraft design considerations are influenced by the stability aspects of high speed flight. It is desirable to design an aircraft where trim changes through transonic speeds are small. A tapered wing without camber, twist, or incidence or a low aspect ratio wing and tail provide values of X_w/c , a_w , a_t , and $d\epsilon/d\alpha$ which vary minimally with Mach. An all-moving tail (slab) gives negligible variation of C_{n_s} with Mach and maximum control effectiveness. A full power, irreversible control system is necessary to counteract the erratic changes in pressure distribution which affect C_{n_α} and C_{n_δ} .

5.19 LONGITUDINAL STATIC STABILITY FLIGHT TESTS

The purpose of these flight tests is to determine the longitudinal static stability characteristics of an aircraft. These characteristics include gust stability, speed stability, and friction/breakout. Trim change tests will also be discussed.

An aircraft is said to be statically stable longitudinally (positive gust stability) if the moments created when the aircraft is disturbed from trimmed flight tend to return the aircraft to the condition from which it was disturbed. Longitudinal stability theory shows the flight test relationships for stick-fixed and stick-free gust stability, dC_{n_s}/dC_L , to be

stick-fixed:
$$\frac{d\delta}{dC_L} = - \frac{1}{C_{m\delta}} \frac{dC_m}{dC_L} \quad (5.69)$$

$\begin{matrix} \text{Stick} \\ \text{Fixed} \end{matrix}$

stick-free:
$$\frac{d(F_s/q)}{dC_L} = - A \frac{C_{h\delta}}{C_{m\delta}} \frac{dC_m}{dC_L} \quad (5.101)$$

$\begin{matrix} \text{Stick} \\ \text{Free} \end{matrix}$

Stick force (F_s), elevator deflection (δ), equivalent velocity (V_e) and gross weight (W) are the parameters measured to solve the above equations. When $d\delta/dC_L$ is zero, an aircraft has neutral stick-fixed longitudinal static stability. As $d\delta/dC_L$ increases, the stability of the aircraft increases. The same statements about stick-free longitudinal static stability can be made with respect to $d(F_s/q)/dC_L$. The neutral point is the cg location which gives neutral stability, stick-fixed or stick-free. These neutral points are determined by flight testing at two or more cg locations, and extrapolating the curves of $d\delta/dC_L$ and $d(F_s/q)/dC_L$ versus cg to zero.

The neutral point so determined is valid for the trim altitude and airspeed at which the data were taken and may vary considerably at other trim conditions. A typical variation of neutral point with Mach is shown in Figure 5.63.

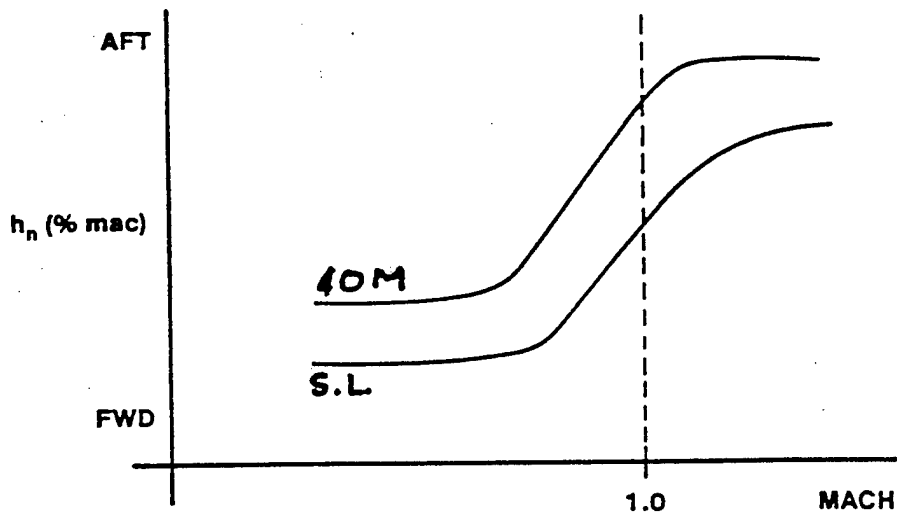

5.63. STICK-FIXED NEUTRAL POINT VERSUS MACH

The use of the neutral point theory to define gust stability is therefore time consuming. This is especially true for aircraft that have a large airspeed envelope and aeroelastic effects.

Speed stability is the variation in control stick forces with airspeed changes. Positive stability requires that increased aft stick force be required with decreasing airspeed and vice versa. It is related to gust stability but may be considerably different due to artificial feel and stability augmentation systems. Speed stability is the longitudinal static stability characteristic most apparent to the pilot, and it therefore receives the greatest emphasis.

Flight-path stability is defined as the variation in flight-path angle when the airspeed is changed by use of the elevator alone. Flight-path stability applies only to the power approach flight phase and is basically determined by aircraft performance characteristics. Positive flight-path stability ensures that the aircraft will not develop large changes in rate of descent when corrections are made to the flight-path with the throttle fixed. The exact limits are prescribed in MIL-STD-1797A, paragraph 4.3.1.2

An aircraft likely to encounter difficulty in meeting these limits would be one whose power approach airspeed was far up on the "backside" of the power required curve. A corrective action might be to increase the power approach airspeed, thereby placing it on a flatter portion of the curve or by installing an automatic throttle.

5.19.1 Military Specification Requirements

The 1954 version of MIL-F-8785, the specification which preceeded the current MIL-STD-1797A, established longitudinal stability requirements in terms of neutral point. This criteria is still valid for testing aircraft with reversible control systems, and many aircraft with irreversible control systems which are not highly augmented. MIL-STD-1797A is not written in terms of neutral point. Instead, section 4.4.1 specifies longitudinal stability with respect to speed and

pitch attitude. The requirements of this section are relaxed in the transonic speed range except for those aircraft which are designed for prolonged transonic operation. As technology progresses, highly augmented aircraft and aircraft with fly-by-wire control systems may be designed with neutral speed stability. The F-15, F-16, and F-20 are examples of aircraft with neutral speed stability. For these aircraft, the program manager may require a mil spec written specifically for the aircraft and control system involved.

5.19.2 Flight Test Methods

There are two general test methods (stabilized and acceleration/deceleration) used to determine either speed stability or neutral points.

5.19.2.1 Stabilized Method. This method is used for aircraft with a small airspeed range in the cruise flight phase and virtually all aircraft in the power approach, landing or takeoff flight phases. Propeller type aircraft are normally tested by this method because of the effects on the elevator control power caused by thrust changes. It involves data taken at stabilized airspeeds at the trim throttle setting with the airspeed maintained constant by a rate of descent or climb. As long as the altitude does not vary excessively (typically $\pm 1,000$ ft) this method gives good results, but it is time consuming.

The aircraft is trimmed carefully at the desired altitude and airspeed, and a trim shot is recorded. Without moving the throttle or trim setting, the pilot changes aircraft pitch attitude to achieve a lower or higher airspeed (typically in increments of ± 10 knots) and maintains that airspeed.

Aircraft with both reversible and irreversible hydro-mechanical control systems exhibit varying degrees of friction and breakout force about trim. The breakout force is the force required to begin a tiny movement of the stick. This initial movement will not cause an aircraft motion as observed on the windscreen. The friction force is that additional amount of pilot-applied force required to produce the first tiny movement of the elevator. These small forces, friction and breakout, combine to form what is generally termed the "friction band."

Since the pilot has usually moved the control stick fore and aft through the friction band, he must determine which side of the friction band he is on before recording the test point data. The elevator position for this airspeed will not vary, but stick force varies relative to the instantaneous position within the friction band at the time the data is taken. Therefore, the pilot should (assuming an initial reduction in airspeed from the trim condition) increase force carefully until the nose starts to rise. The stick should be frozen at this point (where any increase in stick force will result in elevator movement and thus nose rise) and data recorded. The same technique should be used for all other airspeed points below trim. For airspeed above trim airspeed, the same technique is used although now the stick is frozen at a point where any increase in push force will result in nose drop.

5.19.2.2 Acceleration/Deceleration Method. This method is commonly used for aircraft that have a large airspeed envelope. It is always used for transonic testing. It is less time consuming than the stabilized method but introduces thrust effects. The U.S. Navy uses the acceleration/deceleration method but maintains the throttle setting constant and varies altitude to change airspeed. The Navy method minimizes thrust effects but introduces altitude effects.

The same trim shot is taken as in the stabilized method to establish trim conditions. MIL-STD-1797A requires that the aircraft exhibit positive speed stability only within ± 50 knots or ± 15 percent of the trim airspeed, whichever is the less. This requires very little power change to traverse this band and maintain level flight unless the trim airspeed is near the back side of the thrust required curve. Before the 1968 revision to MIL-F-8785, the flight test technique commonly used to get acceleration/deceleration data was full military power or idle, covering the entire airspeed envelope. Unfortunately, this technique cannot be used to determine the requirements under the current standard with the non-linearities that usually exist in the control system. Therefore a series of trim points must be selected to cover the envelope with a typical plot (friction and breakout excluded) shown in Figure 5.64.

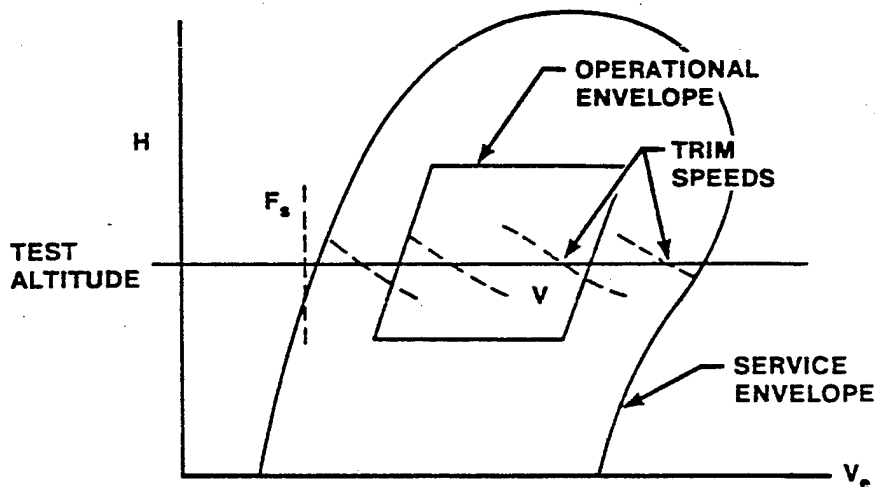

FIGURE 5.64. SPEED STABILITY DATA

The most practical method of taking data is to note the power setting required for trim and then either decrease or increase power to overshoot the data band limits slightly. Then turn on the instrumentation and reset trim power, and a slow acceleration or deceleration will occur back towards the trim point. The data will be valid only during the acceleration or deceleration with trim power set. A small percent change in the trim power setting may be required to obtain a reasonable acceleration or deceleration without introducing gross power effects. The points near the trim airspeed point will be difficult to obtain but they are not of great importance since they will probably be obscured by the control system breakout and friction (Figure 5.65).

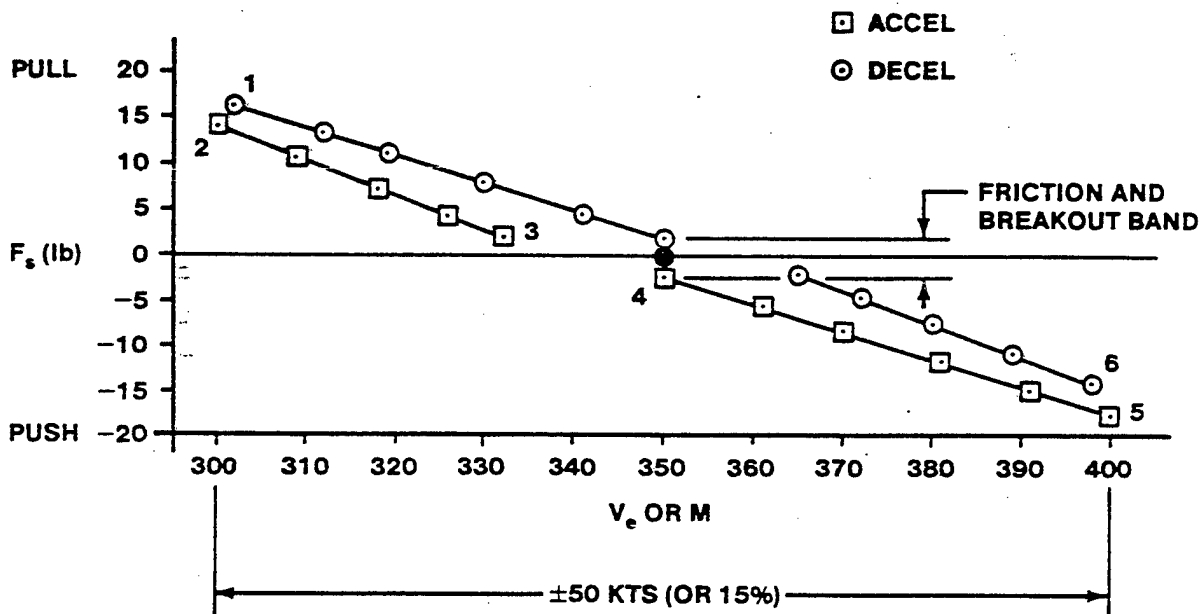

FIGURE 5.65. ACCELERATION/DECELERATION DATA ONE TRIM SPEED, c_g , ALTITUDE

Throughout the acceleration or deceleration, the primary parameter to control is stick force. It is important that the friction band not be reversed during the test run. A slight change in altitude is preferable (i.e. to let the aircraft climb slightly throughout an acceleration) to avoid the tendency to reverse the stick force by over-rotating the nose. The opposite is advisable during the deceleration.

There is a relaxation in the requirement for speed stability in the transonic area unless the aircraft is designed for continued transonic operation. The best way to define where the transonic range occurs is to determine the point where the F_s versus V goes unstable. In this area, MIL-STD-1797A allows a specified maximum instability. The purpose of the transonic longitudinal static stability flight test in the transonic area is to determine the degree of instability.

The transonic area flight test begins with a trim shot at some high subsonic airspeed. The power is increased to maximum thrust and an acceleration is begun.

It is important that a stable gradient be established before entering the transonic area. Once the first sensation of instability is felt by the pilot, his primary control parameter changes from stick force to attitude. From this point until the aircraft is supersonic, the true altitude should be held as closely as possible. This is because the unstable stick force being measured will be in error if a climb or descent occurs. A radar altimeter output on an over-water flight or keeping a flight path on the horizon are precise ways to hold constant altitude, but if these are not available, the pilot will have to use the outside references to maintain level flight.

Once the aircraft goes supersonic, the test pilot should again concern himself with not reversing the friction band and with establishing a stable gradient. The acceleration should be continued to the limit of the service envelope to test for supersonic speed stability. The supersonic data will also have to be shown at $\pm 15\%$ of the trim airspeed, so several trim shots may be required. A deceleration from V_{max} to subsonic speed should be made with a careful reduction in power to decelerate supersonically and transonically. The criteria for decelerating through the transonic region are the same as for

the acceleration. Power reductions during this deceleration will have to be done carefully to minimize thrust effects and still decelerate past the Mach drag rise point to a stable subsonic gradient.

5.19.3 Flight-Path Stability

Flight-path stability is a criterion applied to power approach and landing qualities. It is primarily determined by the performance characteristics of the aircraft and related to stability and control only because it places another requirement on handling qualities. The following is one way to look at flight-path stability. Thrust required curves are shown for two aircraft with the recommended final approach speed marked in Figure 5.66.

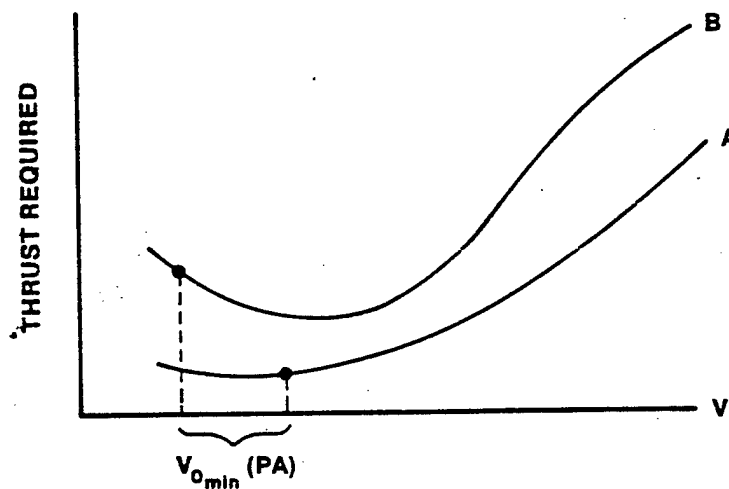

FIGURE 5.66. THRUST REQUIRED VS VELOCITY
(TWO AIRCRAFT)

If both aircraft A and B are located on the glidepath shown in Figure 5.67, their relative flight-path stability can be shown.

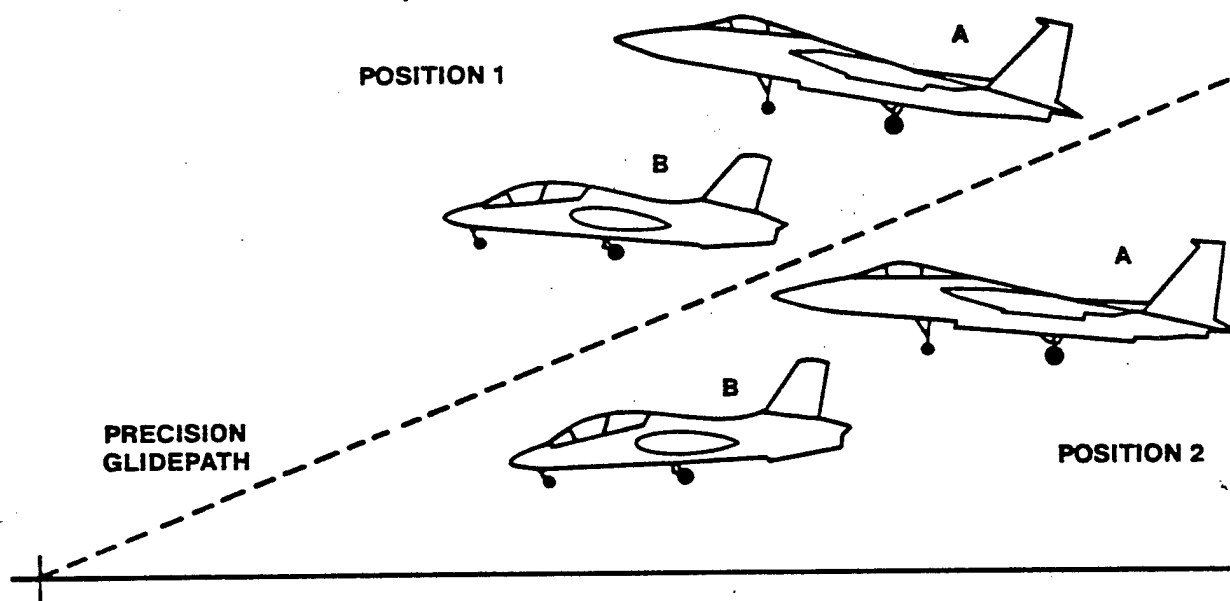

FIGURE 5.67. AIRCRAFT ON PRECISION APPROACH

At Position 1 the aircraft are in stable flight above the glidepath, but below the recommended final approach speed. If Aircraft A is in this position, the pilot can nose the aircraft over and descend to glidepath while the airspeed increases. Because the thrust required curve is flat at this point, the rate of descent at this higher airspeed is about the same as before the correction, so he does not need to change throttle setting to maintain the glidepath. Aircraft B, under the same conditions, will have to be flown differently. If the pilot noses the aircraft over, the airspeed will increase to the recommended airspeed as the glidepath is reached. The rate of descent

at this power setting is less than it was before so the pilot will go above glidepath if he maintains this airspeed.

At Position 2 the aircraft are in stable flight below the glidepath but above the recommended airspeed. Aircraft A can be pulled up to the glidepath and maintained on the glidepath with little or no throttle change. Aircraft B will develop a greater rate of descent once the airspeed decreases while coming up to glidepath and will fall below the glidepath again.

If the aircraft are in Position 1 with the airspeed higher than recommended instead of lower, the same situation will develop when correcting back to flight-path, but the required pilot compensation is increased. In all cases Aircraft A has better flight-path stability than Aircraft B. As mentioned earlier in this chapter, aircraft which have unsatisfactory flight-path stability can be improved by increasing the recommended final approach airspeed or by adding an automatic throttle.

Another way of looking at flight-path stability is by investigating the difficulty that a pilot has in maintaining glidepath even when using the throttles. This problem is seen in large aircraft for which the time lag in pitching the aircraft to a new pitch attitude is quite long. In these instances, incorporation of direct lift allows the pilot to correct the glidepath without pitching the aircraft. Direct lift control will also affect the influence of performance on flight-path stability.

5.19.4 Trim Change Tests

The purpose of this test is to determine the control-force changes associated with normal configuration changes, trim system failure, or transfer to alternate control systems in relation to specified limits. It must also be determined that no undesirable flight characteristics accompany these configuration changes. Pitching moments on aircraft are normally associated with changes in the condition of any of the following: landing gear, flaps, speed brakes, power, bomb bay doors, rocket and missile doors, or any jettisonable device. The magnitude of the change in control forces resulting from these pitching moments is limited by MIL-STD-1797A, and it is the responsibility of the testing organization to determine if the actual forces are within the specified limits.

The pitching moment resulting from a given configuration change will normally vary with airspeed, altitude, cg loading, and initial configuration of the aircraft. The control forces resulting from the pitching moment will further depend on the aircraft parameters being held constant during the configuration change. These factors should be kept in mind when determining the conditions under which the given configuration change should be tested. Even though the specification lists the altitude, airspeed, initial conditions, and parameter to be held constant for most configuration changes, some variations may be necessary on a specific aircraft to provide information on the most adverse conditions encountered in operational use of the aircraft.

The altitude and airspeed should be selected as indicated in the specifications or for the most adverse conditions. In general, the trim change will be greatest at the highest airspeed and the lowest altitude. The effect of cg location is not so readily apparent and usually has a different effect for each configuration change. A forward loading may cause the greatest trim change for one configuration change, and an aft loading may be most severe for another. Using the build up approach, a mid cg loading is normally selected since rapid movement of the cg in flight will probably not be possible. If a specific trim change appears marginal at this loading, it may be necessary to test it at other cg loadings to determine its acceptability.

Selection of the initial aircraft configurations will depend on the anticipated normal operational use of the aircraft. The conditions given in the specifications will normally be sufficient and can always be used as a guide, but again variations may be necessary for specific aircraft. The same holds true for selection of the aircraft parameter to hold constant during the change. The parameter that the pilot would normally want to hold constant in operational use of the aircraft is the one that should be selected. Therefore, if the requirements of MIL-STD-1797A do not appear logical or complete, then a more appropriate test should be added or substituted.

In addition to the conditions outlined above, it may be necessary to test for some configuration changes that could logically be accomplished

simultaneously. The force changes might be additive and could be objectionably large. For example, on a go-around, power may be applied and the landing gear retracted at the same time. If the trim changes associated with each configuration change are appreciable and in the same direction, the combined changes should definitely be investigated. The specifications require that no objectionable buffet or undesirable flight characteristics be associated with normal trim changes. Some buffet is normal with some configuration changes, e.g., gear extension, however, it would be considered if this buffet tended to mask the buffet associated with stall warning. The input of the pilot is the best measure of what actually constitutes "objectionable," but anything that would interfere with normal use of the aircraft would be considered objectionable. The same is true for "undesirable flight characteristics." An example would be a strong nose-down pitching moment associated with gear or flap retraction after take-off.

The standard also sets limits on the trim changes resulting from transfer to an alternate control system. The limits vary with the type of alternate system and the configuration and speed at the time of transfer but in no case may a dangerous flight condition result. A good example of this is the transfer to manual reversion in the A-10. It will probably be necessary for the pilot to study the operation of the control system and methods of effecting transfer in order to determine the conditions most likely to cause an unacceptable trim change upon transferring from one system to the other. As in all flight testing, a thorough knowledge of the aircraft and the objectives of the test will improve the quality and increase the value of the test results.

PROBLEMS

5.1 In Subsonic Aerodynamics the following approximation was developed for the Balance Equation

$$C_{m_{cg}} = C_{m_{ac}} + C_L (cg - ac) + C_{m_{tail}}$$

where $C_{m_{tail}}$ is the total stability contribution of the tail.

- (a) Sketch the location of the forces, moments, and cg required to balance an airplane using the above equation.
- (b) Using the data shown below, what contribution is required from the tail to balance the airplane?

$$\begin{array}{ll} C_{m_{ac}} = -0.12 & C_{m_{tail}} = ? \\ ac = 0.25 \text{ (25\%)} & C_L = 0.5 \\ cg = 0.188 \text{ (18.8\%)} & \end{array}$$

- (c) If this airplane were a fixed hang-glider and a $C_L = 1.3$ were required to flare and land, how far aft must the cg be shifted to obtain the landing C_L without changing the tail contribution?
- (d) If a 4% margin were desired between max aft cg and the aerodynamic center for safety considerations, how much will the tail contribution have to increase for the landing problem presented in (c)?
- (e) List four ways of increasing the tail contribution to stability.

5.2 Given the aircraft configurations shown below, write the Balance and Stability Equations for the thrust contributions to stability. Sketch the forces involved and state which effects are stabilizing and which are destabilizing.

(a) DC-10

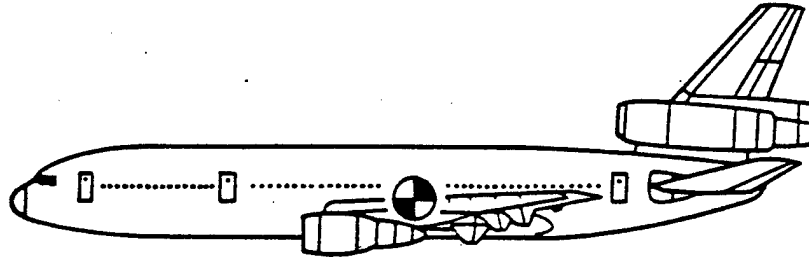

(b) Britten-Norman Trislander

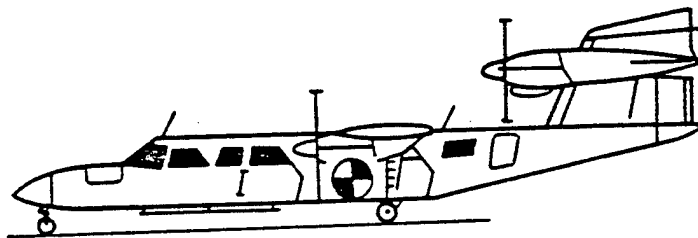

5.3 (a) Are the two expressions below derived for the tail-to-the-rear aircraft valid for the canard aircraft configuration?

$$\frac{dC_{n,cg}}{dC_L} = h - h_n$$

$$\text{Static margin} = h_n - h$$

(b) Derive an expression for elevator power for the canard aircraft configuration. Determine its sign.

(c) What is the expression for elevator effectiveness for the canard aircraft configuration? Determine its sign.

5.4 During wind tunnel testing, the following data were recorded:

C_L	δ_e (deg)	δ_e (deg)	δ_e (deg)
	$h = 0.20$	$h = 0.25$	$h = 0.30$
0.2	-2	-3	-4
0.6	4	1	-2
1.0	10	5	0

Elevator limits are $\pm 20^\circ$

- A. Find the stick-fixed static margin for $h = 0.20$
- B. Find the numerical value for elevator power.
- C. Find the most forward cg permissible if it is desired to be able to stabilize out of ground effect at a $C_{Lmax} = 1.0$.

5.5 Given the flight test data below from the aircraft which was wind tunnel tested in Problem 5.4, answer the following questions:

A. Find the aircraft neutral point. Was the wind tunnel data conservative?

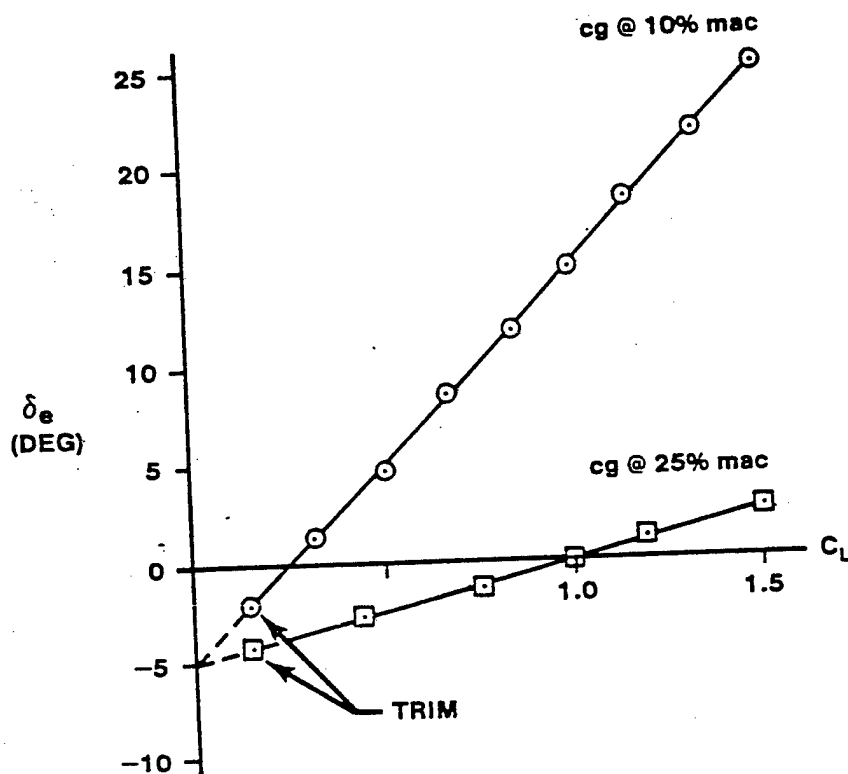

B. What is the flight test determined value of $C_{n_{\delta}}$.

C. If the lift curve slope is determined to be 0.1, what is the flight test determined value of $C_{n_{\delta}}$ (per deg) at a cg of 25%?

5.6 Given geometric data for the canard design in Problem 5.5, calculate an estimate for elevator power.

HINT:

$$C_{m_{\delta}} = a_T V_H \eta_T \frac{d\alpha_T}{d\delta}$$

Assume:

$a_T = a =$ wind tunnel value

$\eta_T = 1.0$

Given:

Slab canard

$l_T = 14\text{ft}$

$S_T = 10\text{ft}^2$

$c = 7\text{ft}$

$S = 200\text{ft}^2$

5.7 The Forward Swept Wing (FWS) technology aircraft designed by North American is shown below. The aerodynamic load is shared by the two "wings" with the forward wing designed to carry about 30% of the aircraft weight. For this design condition, answer the following multiple choice questions by circling the number of correct answer(s).

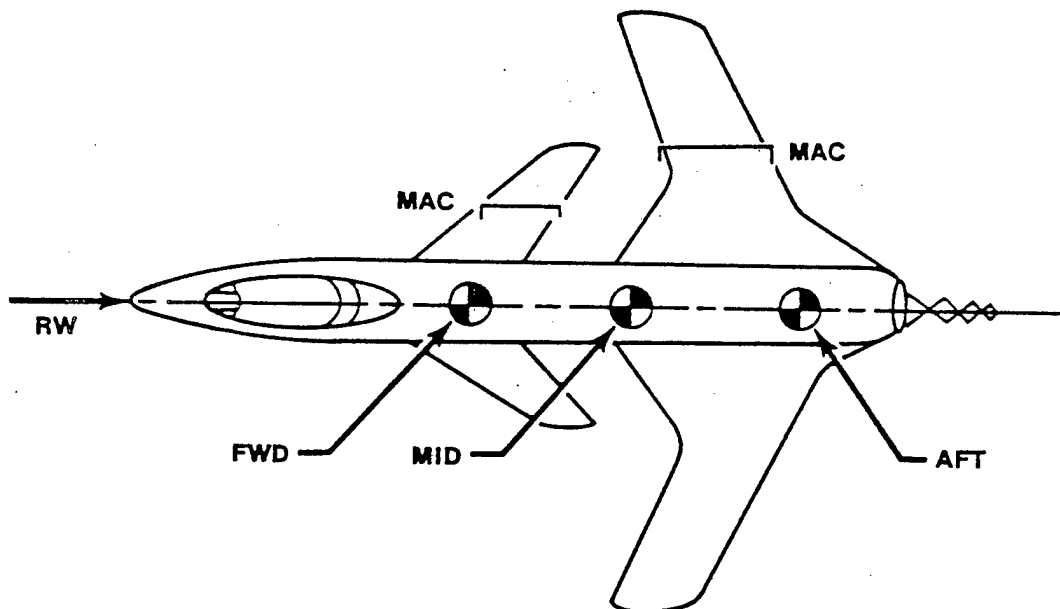

- A. At the cg location marked FWD the aircraft:
- (1) Can be balanced and is stable.
 - (2) Can be balanced and is stable only if the cg is ahead of the neutral point.
 - (3) Can be balanced and is unstable.
 - (4) Cannot be balanced.
- B. At the cg location marked MID the aircraft:
- (1) Can be balanced and is stable.
 - (2) Can be balanced and is stable only if the cg is ahead of the neutral point.
 - (3) Can be balanced and is unstable.
 - (4) Cannot be balanced.
- C. At the cg location marked AFT the aircraft:
- (1) Can be balanced and is stable.
 - (2) Can be balanced and is stable only if the cg is ahead of the neutral point.
 - (3) Can be balanced and is unstable.
 - (4) Cannot be balanced.
- D. For this design the sign of control power is:
- (1) Negative.
 - (2) Positive.
 - (3) Dependent on cg location.

5.8 Given the Boeing 747/Space Shuttle Columbia combination as shown below, is the total shuttle orbiter wing contribution to the combination stabilizing or destabilizing if the cg is located as shown? Briefly explain the reason for the answer given.

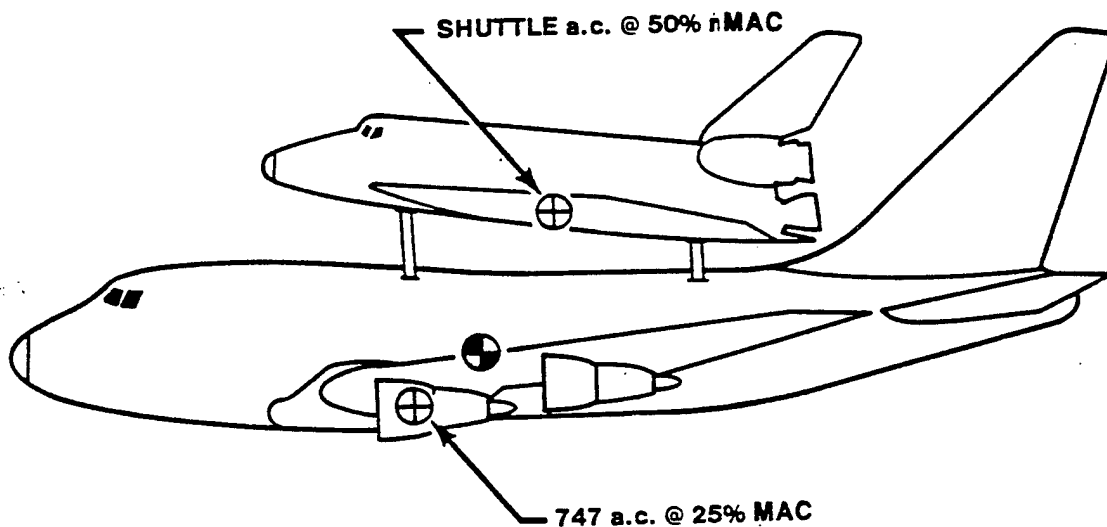

5.9 Given below is wind tunnel data for the YF-16.

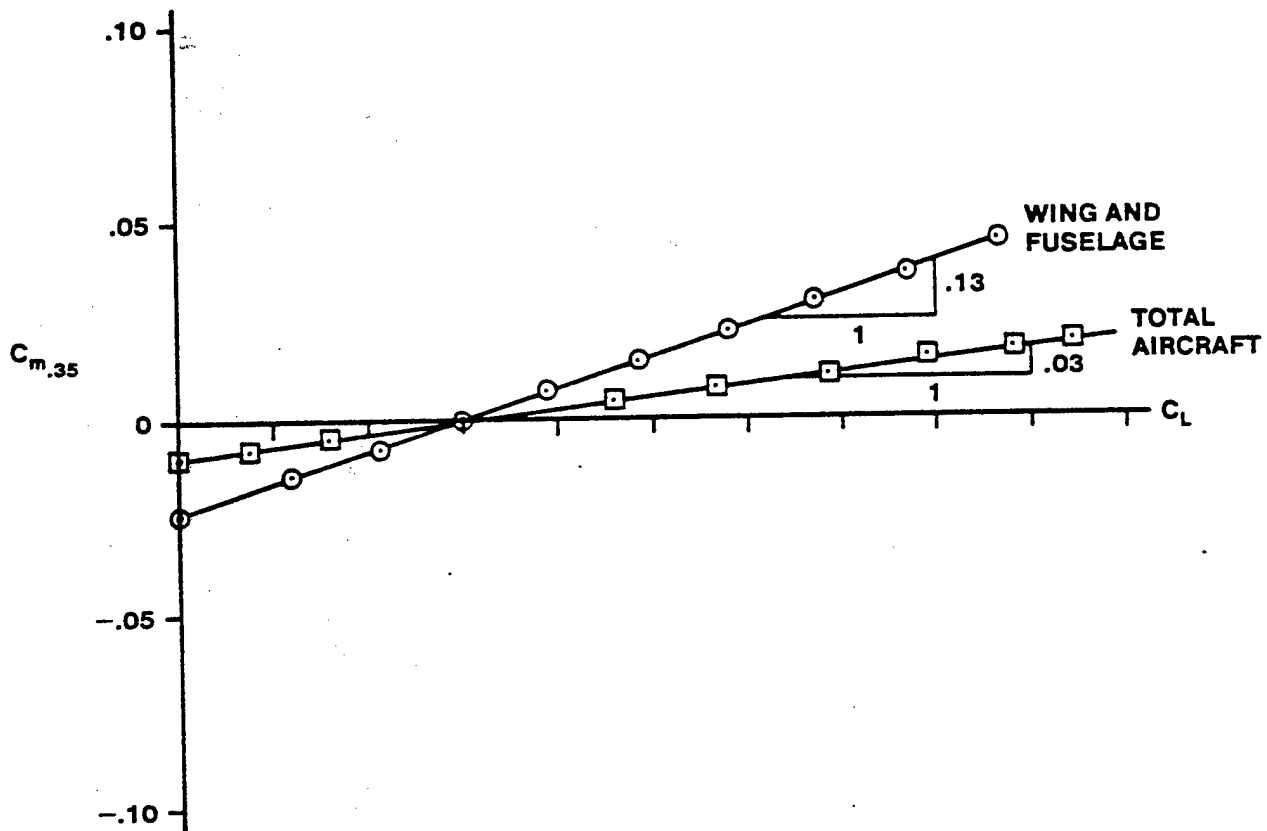

- A. Answer the following questions YES or NO:
- Is the total aircraft stable?
 - Is the wing-fuselage combination stable?
 - Is the tail contribution stabilizing?

- B. How much larger (in percent) would the horizontal stabilizer have to be to give the F-16 a static margin of 2% at a cg of 35% MAC? Assume all other variables remain constant.

5.10 Given below is a $C_{m_{cg}}$ versus C_L curve for a rectangular flying wing from wind tunnel tests and a desired TOTAL AIRCRAFT trim curve.

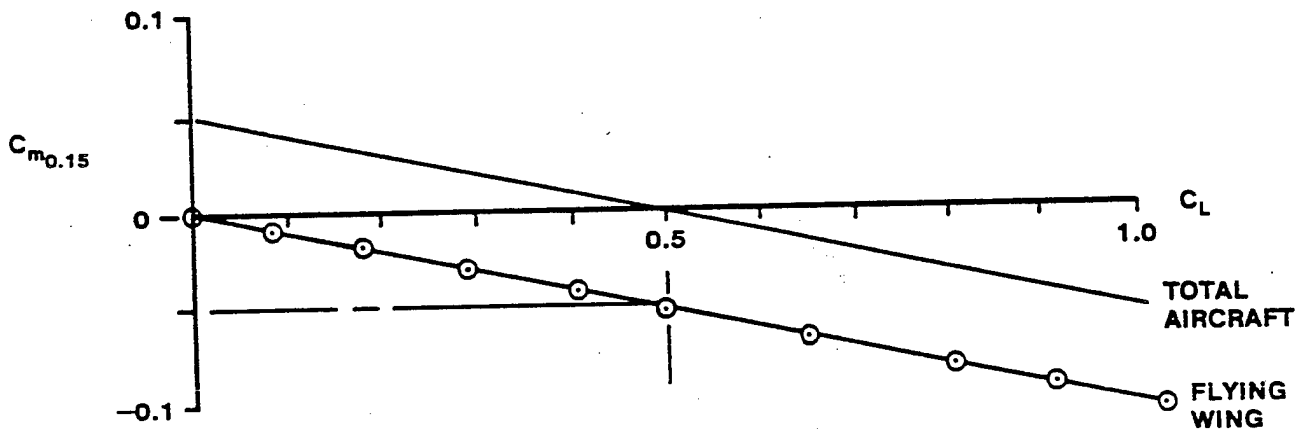

- A. Does the flying wing need a TAIL or CANARD added or can it attain the required TOTAL aircraft stability level by ELEVON deflection?
- B. Is the TOTAL aircraft stable?
- C. Is $C_{m_{cg}}$ positive or negative?
- D. Does the flying wing have a symmetric wing section?

5.12 Given the curve shown below, show the effect of:

- A. Shifting the cg FWD and retrimming to trim velocity.
- B. Increasing C_{n_s} and retrimming to trim velocity.
- C. Adding a downspring and retrimming to trim velocity.
- D. Adding a bobweight and retrimming to trim velocity.

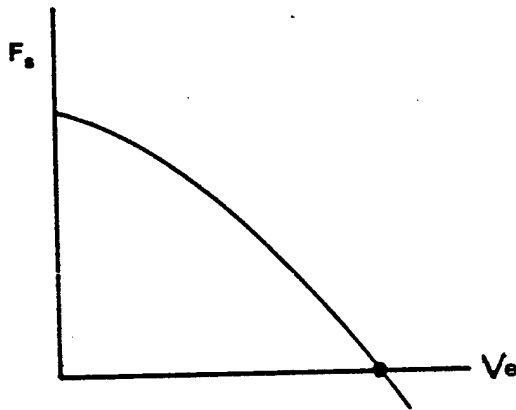

5.13 Which changes in Problem 5.12 affect:

apparent stability	actual stability
--------------------	------------------

5.14 Read the question and answer true (T) or false (F).

- T F If a body disturbed from equilibrium remains in the disturbed position it is statically unstable.
- T F Longitudinal static stability and "gust stability" are the same thing.
- T F Static longitudinal stability is a prerequisite for dynamic longitudinal stability.
- T F Aircraft response in the X-Z plane (about the Y axis) usually cannot be considered as independent of the lateral directional motions.
- T F Although $C_{n\alpha}$ is a direct indication of longitudinal static stability, $C_{n c_L}$ is relatively unimportant.
- T F At the USAF Test Pilot School elevator TEU and nose pitching up are positive in sign by convention. CAREFUL.
- T F Tail efficiency factor and tail volume coefficient are not normally considered constant.
- T F With the cg forward, an aircraft is more stable and maneuverable.
- T F There are no well defined static stability criteria.
- T F To call a canard surface a horizontal stabilizer is a misnomer.
- T F The most stable wing contribution to stability results from a low wing forward of the cg.
- T F With the cg aft, an aircraft is less maneuverable and more stable.
- T F A thrust line below the cg is destabilizing for either a prop or turbojet.
- T F The normal force contribution of either a prop or turbojet is destabilizing if the prop or inlet is aft of the aircraft cg.
- T F A positive value of downwash derivatives causes a tail-to-the-rear aircraft to be less stable if $d\epsilon/d\alpha$ is less than 1.0 than it would be if $d\epsilon/d\alpha$ were equal to zero.
- T F Verifying adequate stability and maneuverability at established cg limits is a legitimate flight test function.
- T F An aircraft is balanced if it is forced to a negative value of $C_{n_{cg}}$ for some useful positive value of C_L .

- T F An aircraft is considered stable if $dC_{n_{cg}}/dC_L$ is positive.
- T F The slope of the $C_{n_{cg}}$ versus C_L curve of an aircraft is a direct measure of "gust stability."
- T F Aircraft center of gravity position is only of secondary importance when discussing longitudinal static stability.
- T F Due to the advance control system technology such as fly-by-wire, a basic knowledge of the requirements for natural aircraft stability is of little use to a sophisticated USAF test pilot.
- T F Most contractors would encourage an answer of true (T), to the above question.
- T F For an aircraft with a large vertical cg travel, the chordwise force contribution of the wing to stability probably cannot be neglected.
- T F FWD and AFT cg limits are often determined from flight test.
- T F A canard is a hoax.
- T F The value of stick-fixed static stability is equal to cg minus h_n in percent MAC.
- T F The stick-fixed static margin is stick-fixed stability with the sign reversed.
- T F A slab tail (or stabilizer) is a more powerful longitudinal control than a two-piece elevator.
- T F Elevator effectiveness and power are the same thing.
- T F Elevator effectiveness is negative in sign for a canard configuration.
- T F Static margin is negative for a statically stable canard configuration.
- T F Elevator power is positive in sign for either a tail-to-the-rear or a canard configuration.
- T F Upwash causes a canard to be more destabilizing.
- T F The main effect on longitudinal stability when accelerating to supersonic flight is caused by the shift in wing ac from 25% MAC to about 50% MAC.
- T F The elevator of a reversible control system is normally statically balanced.

- T F $C_{h\delta}$ is always negative and is known as the "restoring" moment coefficient.
- T F $C_{h\alpha}$ is always negative and is known as the "floating" moment coefficient.
- T F With no pilot applied force a reversible elevator will "float" until hinge moments are zero.
- T F A free elevator factor of one results in the stick-fixed and stick-free stability being the same.
- T F Generally, freeing the elevator is destabilizing (tail-to-the-rear).
- T F Speed stability and stick force gradient about trim are the same.
- T F Speed stability and apparent stability are the same.
- T F Speed stability and stick-free stability are the same.
- T F Dynamic control balancing is making $C_{h\delta}$ small or just slightly positive.
- T F cg movement affects real and apparent stability (after retrimming).
- T F Aerodynamic balancing affects real and apparent stability (after retrimming).
- T F Downsprings and bobweights affect real and apparent stability (after retrimming).
- T F In general, an aircraft becomes more stable supersonically which is characterized by an AFT shift in the neutral point.
- T F Even though an aircraft is more stable supersonically (neutral point further AFT) it may have a speed instability.
- T F The neutral point of the entire aircraft is analogous to the aerodynamic center of the wing by itself.
- T F Aerodynamic balancing is "adjusting" or "tailoring" $C_{h\delta}$ and $C_{h\alpha}$.
- T F Neutral point is a constant for a given configuration and is never a function of C_L .
- T F The cg location where $dF_s/dV = 0$ is the actual stick-free neutral point regardless of control system devices.

- T F The effects of elevator weight on hinge moment coefficient are normally eliminated by static balance.
- T F A positive δ_e is a deflection causing a nose-up pitching moment.
- T F A positive C_h is one defined as deflecting or trying to deflect the elevator in a negative direction.
- T F $C_{h_{\alpha_t}}$ is normally negative (tail-to-the-rear).
- T F $C_{h_{\delta_e}}$ is always negative (tail-to-the-rear and canard).
- T F $C_{h_{\alpha_t}}$ and $C_{h_{\delta_e}}$ are under control of the aircraft designer and can be varied to "tailor" stick-free stability characteristics.
- T F $C_{h_{\alpha_t}}$ and $C_{h_{\alpha}}$ are identical.
- T F $C_{h_{\delta_e}}$ and $C_{h_{\delta_e}}$ are not the same.
- T F dF_s/dV does not necessarily reflect actual stick-free stability characteristics.
- T F There are many ways to alter an aircraft's speed stability characteristics.
- T F A bobweight can only be used to increase stick-force gradient.
- T F $C_{h_{\delta_e}}$ cannot be determined from flight test.

ANSWERS

- 5.1. b. $C_{n_{tail}} = +0.151$
c. $cg = 0.226$ or 22.6%
d. $C_{n_{tail}} = +.172$, 14% inc.

- 5.4. A. $SM = 0.15$
B. $C_{n_{\delta}} = .01/\text{deg}$ or $.57/\text{rad}$
C. $h = 10\%$

- 5.5. A. $h_n = 30\%$
B. $C_{n_{\delta}} = 0.01/\text{deg}$
C. $C_{n_{\alpha}} = -0.005/\text{deg}$

- 5.6. $C_{n_{\delta}} = 0.01/\text{deg}$

- 5.9. B. 50% larger

- 5.10. E. $h_n = 0.25$
G. $SM = 0.10$

Bibliography

1. Perkins, C. D., and Hage, R. E., Airplane Performance Stability and Control, John Wiley & Sons, Inc., New York NY, 1949.
2. Phillips, W. H., Appreciation and Prediction of Flying Qualities, NACA Report 927, National Advisory Committee for Aeronautics, Washington DC, 1949.
3. Etkin, B., Dynamics of Atmospheric Flight, John Wiley & Sons, Inc., New York NY, 1972.
4. Kolk, W. R., Modern Flight Dynamics, Prentice-Hall, Inc., Englewood Cliffs NJ, 1961.
5. Perkins, C. D., Editor, Flight Testing, Volume II, Stability and Control, North Atlantic Treaty Organization, Pergamon Press, New York NY, 1962.
6. Anon., Military Standard, Flying Qualities of Piloted Aircraft, MIL-STD-1797A, Department of Defense, Washington DC 20402, 30 Jan 90.