

# NATIONAL AIR INTELLIGENCE CENTER



AUTOMATION OF TELEMETRY SUBSYSTEM MONITORING AND  
CONTROL IN SPACE FLIGHT TELEMETRY AND CONTROL SYSTEMS

by

Li Xiaodong

*DTIC QUALITY INSPECTED 3*



19970206 055

Approved for public release:  
distribution unlimited

**HUMAN TRANSLATION**

NAIC-ID(RS)T-0300-96

16 December 1996

MICROFICHE NR:

AUTOMATION OF TELEMETRY SUBSYSTEM MONITORING AND  
CONTROL IN SPACE FLIGHT TELEMETRY AND CONTROL SYSTEMS

By: Li Xiaodong

English pages: 13

Source: Cama, China Astronautics and Missilery Abstracts,  
Vol. 3, Nr. 1, 1996; pp. 21-26

Countrh of origin: China

Translated by: SCITRAN

F33657-84-D-0165

Requester: NAIC/TASC/Lt Lori A. Thorson

Approved for public release: distribution unlimited.

THIS TRANSLATION IS A RENDITION OF THE ORIGINAL FOREIGN TEXT WITHOUT ANY ANALYTICAL OR EDITORIAL COMMENT STATEMENTS OR THEORIES ADVOCATED OR IMPLIED ARE THOSE OF THE SOURCE AND DO NOT NECESSARILY REFLECT THE POSITION OR OPINION OF THE NATIONAL AIR INTELLIGENCE CENTER.

PREPARED BY:

TRANSLATION SERVICES  
NATIONAL AIR INTELLIGENCE CENTER  
WPAFB, OHIO

**GRAPHICS DISCLAIMER**

All figures, graphics, tables, equations, etc. merged into this translation were extracted from the best quality copy available.

AUTOMATION OF TELEMETRY SUBSYSTEM MONITORING AND CONTROL IN  
SPACE FLIGHT TELEMETRY AND CONTROL SYSTEMS

Li Xiaodong

Translation of "Hang Tian Ce Kong Xi Tong Zhong Yao Ce Fen Xi Tong Jian Kong Zi Dong Hua"; Telemetry and Remote Control, Vol.15, No.5, October 1994, pp 21-26

**ABSTRACT** This article introduces the realization of space flight telemetry and control system monitoring and control automation. Specific discussions are made of methods to realize automation of monitoring and control associated with monitoring and control processors for main system control units and telemetry subsystems as well as the interiors of telemetry subsystems. The realizing of control and monitoring automation simplifies telemetry and control station management and reduces telemetry and control system operating and maintenance personnel, providing advantages for telemetry and control system operation and maintenance.

**KEY WORDS** Monitoring and control automation technology  
Computer communications

## 1 INTRODUCTION

Following along with the breakneck development of computer technology with every passing day, space flight telemetry and control system performance not only depends on its communications channel indices, orbital measurement precision, signal acquisition time, telemetry error code rates, and so on. It also depends, moreover, on such utilization properties as practical utility as well as ease of maintenance, and so forth. Monitoring and control automation realizes centralized management for systems as a whole and unified control. Causing control, which was originally dispersed in each subsystem to be concentrated in main control units reduces total system control and maintenance personnel, improving the level of automation. Moreover, it is capable of discovering in a timely manner changes in the statuses of various subsystems, finding the sources of malfunctions in a timely way, and causing the elimination of malfunctions early on. The realization of monitoring and control automation very, very greatly improves telemetry and control system performance. Following along with the step by step development of China's space flight enterprises, in order to catch up to and surpass advanced levels associated with world space flight telemetry and control technologies, in 1990, the national defense science and industry committee put forward a tasking associated with the development of

a new generation C wave band standard model telemetry and control system. The tasking documents pointed out that the primary characteristic of a new generation of C wave band telemetry and control systems is nothing else than that the level of monitoring and control automation must achieve a new leap. Telemetry and control systems as a whole are composed of such various subsystems as main control units, angular measurements, range measurements, telemetry, remote control, centralizers, receivers, transmitters, and so on. Main control unit subsystems control the entire telemetry and control system operation. Control processes are realized through communication between main control units and monitoring and control processors associated with various subsystems. Through communication, the various subsystems take their own operational statuses, such technical indices as operational parameters, and so on and transmit them to central control units. Operating personnel are capable of directly comprehending, at the central control units, the operating statuses of the entire system. Various subsystems are also capable of receiving commands put out by central control units in order to alter their own operating status, operating parameters, and so on. In this way, telemetry and control stations only need one or two people and, at central control units, it is then possible to monitor and control the operation of the entire system--making it possible for the tasks that were originally able to be completed by several tens of personnel to then be capable of being finished by one or two people. The completion and delivery of this telemetry and control system improved the level of China's space flight telemetry and control system automation of monitoring and control.

## 2 OVERALL COMPOSITION

In situations where control devices have given rise to malfunctions--in order to make systems operate normally, guaranteeing system reliability as well as the realization of centralized control--telemetry and control systems realize three level monitoring and control. The line and block chart is shown in Fig.1.

Level 1 Control is carried out on the panels of various assembly casings.

Level 2 In various subsystem monitoring and control processors, control is carried out with regard to different combinations of the subsystems in question. That is, parameter settings and configuration inquiries are carried out on various assemblies. In conjunction with that, parameters and configurations are taken and sent to central control units.

Level 3 At main control unit locations, control is carried out with regard to entire telemetry and control systems. During control at this level, subsystem monitoring and control processors are located at very important positions. They realize up and down transmission functions. They receive different types of commands sent from main control units. In conjunction with that, they transmit down to subsystems inside the various assembly cases. At

the same time, they also automatically query at fixed intervals the operating statuses of different assembly housings. In conjunction with that, transmissions are made as necessary to main control units in order to realize automatic monitoring and control with regard to various assembly casings. /22

The priority ranking associated with the three levels of monitoring and control operations is that Level 1 is highest, Level 2 is next, and Level 3 is lowest. It is also sometimes said that the key control operations carried out on the panels of various assembly housings are capable of shielding from remote control operation commands that are sent from subsystem monitoring and control processors or the main control stations of the entire system. By the same reasoning, operations on subsystem monitoring and control processors are also capable of screening commands sent from main control units of the entire system. However, in order to facilitate unified control and management of the operations of different subsystems, subsystems are normally always operating in remote control mode. That is, commands sent from main control units are not screened. This article primarily discusses the role of telemetry subsystem monitoring and control processors in the telemetry and control system as a whole as well as the realization of telemetry subsystem monitoring and control automation.

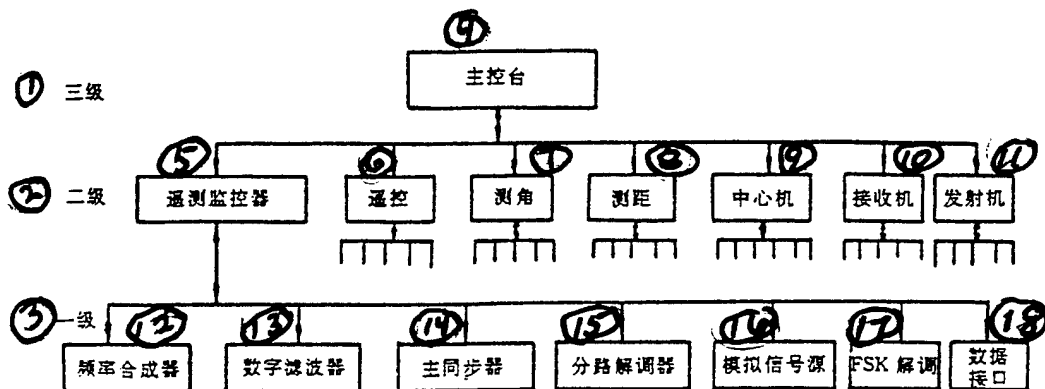

Fig.1 Three Levels of Telemetry and Control System (1) Level 3 (2) Level 2 (3) Level 1 (4) Main Control Unit (5) Telemetry and Monitoring Device (6) Remote Control (7) Angular Measurement (8) Range Measurement (9) Centralizer (10) Receiver (11) Transmitter (12) Frequency Synthesizer (13) Digital Wave Filter (14) Main Synchronizer (15) Shunt Demodulator (16) Analog Signal Source (17) FSK Demodulation (18) Data Port

With regard to telemetry subsystems, the content associated with monitoring and control is mainly the two items set out below.

(1) Selection and Control of System and Equipment Operating Parameters. Principal operating parameters include the several types that follow--secondary carrier frequencies, code speed, code form, character length, frame length, frame synchronous code group length, input mode, and so on. Controls set these basic parameters, making telemetry systems operate in stable parameter configurations.

(2) Automatic Checks of Equipment Parameters and Configurations. During operational processes, automatic checks are carried out with regard to equipment parameters and configurations to be able to discover abnormalities in a timely manner and provide solutions in a timely way. For example, a certain assembly shows the appearance of malfunction. After automatic checks, the point of malfunction will immediately be displayed, letting operating personnel discover the malfunction in a timely and accurate manner and eliminate the malfunction in a timely way.

In sections below, introduction is made of the realization of software and hardware associated with communication between monitoring and control processors of telemetry subsystems as well as between other assemblies inside telemetry subsystems in order to realize automation of monitoring and control.

### 3 HARDWARE REALIZATION

#### 3.1 Telemetry Subsystem Monitoring and Control Processors and Main Control Units

(1) Agreements on Physics Levels. Physics levels are the lowest levels associated with communications agreements. Agreements on physics levels refer to agreements associated with connection electric levels and connection devices. Generally, there are the three types below.

The first type is EIA RS-232C. This is a type of serial port standard commonly used between computers. The utilization limits associated with this type of port are that maximum communication distances are not greater than 15m and baud rates are not greater than 19.2kbps.

The second type is EIA RS-422A. This is also a type of commonly used port standard. This type of port opts for the use of difference circuitry transmission. Limiting utilization parameters are that transmission distances not be greater than 120m and that baud rates not be larger than 1Mbps. The biggest advantages associated with this type of port are that it can be used in multiple point port methods and that it is suitable for use in communications between multiple processors.

The third type is 20mA current loop serial ports. The biggest advantages associated with this type of port are that low resistance transmission lines are not sensitive to electrical noise and that the realizing of photoelectric isolation is easy. However, each time data is transmitted, it is necessary to use a

currentless initial position to act as the first position of each group. When receiving terminals check initial positions, they then begin to receive a data group. /23

Among the three types of commonly used port standards described above--on the basis of utilization requirements--we opt for the use of the second type of port standard, which is simple, easy to use, and capable of carrying out multiple processor communications. Due to serial porting of single chip devices in monitoring and control processors used in internal communications associated with telemetry subsystems, therefore, use is made of 8251A in order to expand serial porting in this regard so as to realize communication between telemetry subsystems and main control units. As far as port chips are concerned, MC3486 and MC3487 were selected for use. Their connection situation is shown in Fig.2. In order not to influence data transmission on communication trunk lines, there is a requirement that telemetry monitoring and control devices--when not transmitting data--should be in states of high resistance as associated with their transmission terminals sending to communication trunk lines. That is, telemetry monitoring and control devices let trunk lines out in order to facilitate not interfering with communications between main control units and monitoring and control devices associated with other subsystems. Here, use is made of 8251A output line DTR in order to control MC3487 outputs to make it possible for terminals to realize this function. With regard to 8251A single chip device control--when not transmitting data--the DTR terminal output is made a high electric level. In this way, MC3487 output terminals are high resistance states. After telemetry monitoring and control devices receive system main control unit commands, single chip device 8251A control makes the DTR outputs low electric levels, thereby causing MC3487 output terminals to be open states.

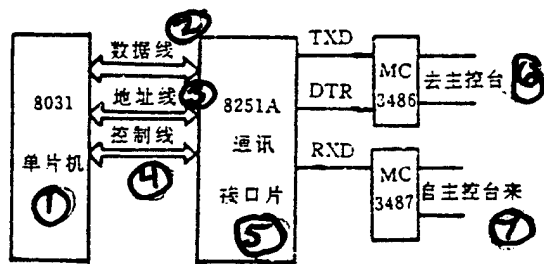

Fig.2 Line and Block Chart of the Realization of Hardware Circuitry Associated with Communication Between Main Control Units and Telemetry Monitoring and Control Devices (1) Single Chip Device (2) Data Line (3) Address Line (4) Control Line (5) Communication Port Chip (6) Going to Main Control Unit (7) Coming from Main Control Unit

(2) Key Circuit Level Agreements. This part of agreements refers to data group and data frame agreements.

In monitoring and control systems, communications between microcomputers opt for the use of asynchronous methods. Character groups are specified as follows. Position one is the initial position. Seven positions are data bits. One position is an odd parity bit. And, one position is the halt position. For the convenience of test measurements and debugging, full frame verification opts for the use of comparatively advanced international verification methods, thereby making all communications character groups be displayable and printable ASCII code--that is, making all ASCII code values associated with communications character groups exist in the interval 20H-7EH.

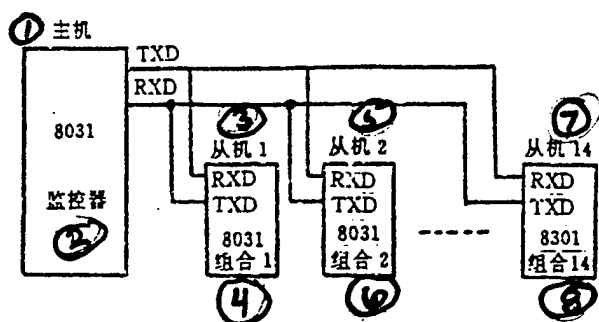
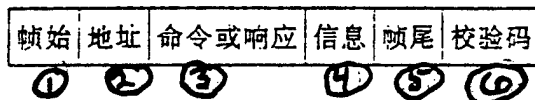

Fig.3 Hardware Connection Diagram for Communications to Main From Single Chip Devices Within Telemetry Subsystems (1) Master Device (2) Monitoring and Control Device (3) Slave Device 1 (4) Assembly 1 (5) Slave Device 2 (6) Assembly 2 (7) Slave Device 14 (8) Assembly 14

The data frame format is as follows.



(1) Frame Start (2) Address (3) Command or Response (4) Information (5) Frame End (6) Verification Code

Each data frame includes the six format blocks described above. In order to obtain displayable and printable verification codes, option is made for the use of the formula below to calculate verification codes (FCB).

$$FCB = \text{MOD}[\sum(\text{CHA}-32), 95] + 32$$

In this, CHA includes all the character groups between frame start and frame end.

(3) Agreements on Network Level and Above. During communications, we have made no use of functions at network level and above. Therefore, this is omitted.

### 3.2 Communications Between Monitoring and Control Processors Within Telemetry Subsystems and Various Assembly Device Housings

Monitoring and control processors must carry out communications with 14 (dual sets of thermal spare systems) assemblies. This type of communication makes use of 8031 single chip devices and is completed by TXD and RXD serial port communications lines. The communication method is master slave type asynchronous communication. The baud rate is 9.6kpbs. During master slave single chip device communications, 8031's in monitoring and control devices are used as masters. The connection method is shown in Fig.3.

/24

## 4 SOFTWARE DESIGN

As far as monitoring and control processors within telemetry subsystems are concerned, they are connected up to telemetry and control system main control units and connected down to 14 telemetry assembly device casings. There is a need to realize several tens of status inquiries and parameter settings. It is also necessary to complete configurations associated with 14 assembly device housings, automatically search for and check on malfunctions, and report up. In conjunction with this, there is a need for real time display of points of malfunction. In order to complete these numerous and complicated tasks, shorten single chip device waiting times, and improve single chip device operating efficiencies, in software design, option is made for the use of design methods combining suspensions and inquiries. In this way, telemetry monitoring and control processors are made able to respond in a timely manner to various types of commands coming from system main control units and also able to make single chip devices process other commands in a timely way. In order to improve communications reliability and counter interference performance, software designs opt for the use of software filter design methods. With regard to actual methods of realization, they are introduced hereafter.

### 4.1 Software Associated with Main Control Units and Telemetry Monitoring and Control Processors

This portion of software is used in receiving information sent from main control units. In order to respond rapidly to commands sent from main control units--with respect to data reception--option is made for the use of suspension methods in order to accomplish it. Moreover, after completing reception--with regard to data processing--option is made for the use of query methods for realization. During main programs associated with monitoring and

control devices, determinations are made at fixed times of whether or not suspended indices are set in position. During service suspension procedures, after monitoring and control devices finish receiving a data frame, this index is then set in position. After main programs determine that the suspended index is already set in position, implementation of a "process suspension index program section" is then gone into. In this section of program, first of all, address groups are determined. After this, verification is made of determinations of this group. Finally, command groups are determined. Distribution is carried out on the basis of commands received. If it is a setting command, in that case, a reply is first given to main control units, showing that data frames have already been received in their entirety. After that, there is a turning to the implementation of communications programs associated with the carrying out of communications with different assembly device housings, carrying out setting commands with regard to various assembly device casings. If it is a query command, then, query results required by main control stations will be sent. Fig.4 is the service suspension program flow chart. Fig.5 is the flow chart for "process suspension index program phases".

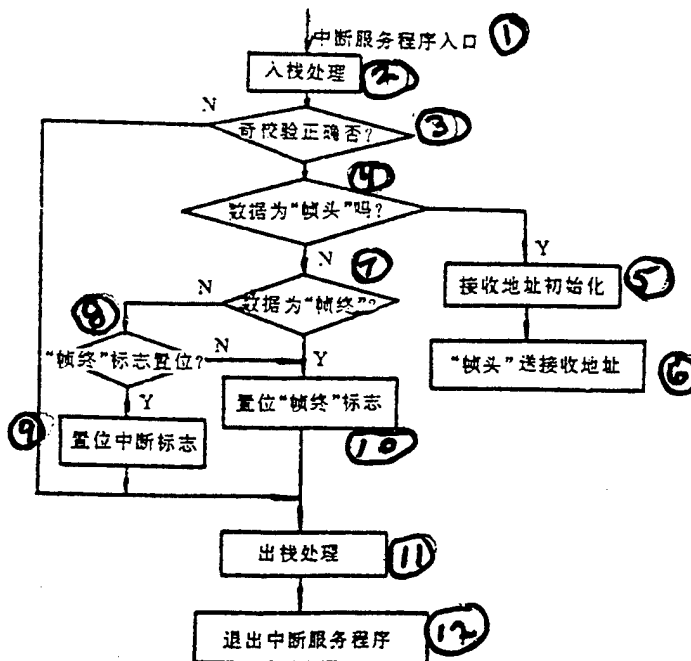

Fig.4 Service Suspension Program Flow Chart (1) Service Suspension Program Input (2) Input to Storage for Processing (3) Odd Parity Correct of Not? (4) Is Data "Frame Header"? (5) Received Address Initialization (6) "Frame Header" Send and Receive Addresses (7) Is Data "Frame End"? (8) "Frame End" Index in Position? (9) Suspension Index Set (10) "Frame End" Index In Position (11) Leave Storage for Processing (12) Leave Service Suspension Program

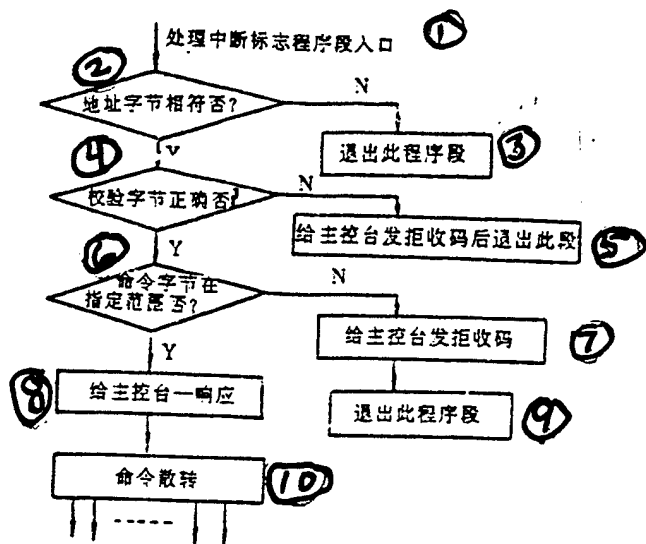

Fig.5 Flow Chart for Processing Suspension Index Program Sections  
 (1) Process Suspension Index Program Section Input (2) Address Groups Match or Not? (3) Leave This Program Section. (4) Group Verification Correct or Not? (5) After Sending Transmission Refused Code to Main Control Unit, Leave This Section. (6) Command Group Within Specified Range or Not? (7) Transmit Reception Refused Code to Main Control Unit. (8) Give a Response to Main Control Unit. (9) Leave This Program Section. (10) Command Dissemination

#### 4.2 Communications Software Associated with Telemetry Monitoring and Control Processors and Various Assembly Device Casings

This portion of communications makes use of serial port 8031 single chip devices for realization. Option is made for the use of master slave response communications methods. 8031's inside monitoring and control processors are the master devices. The 8031's inside the other assemblies are the slave devices. Fig.6 is the flow chart associated with master device and slave device communications. When master devices need to carry out /25 communications with slave devices, they first of all send out the slave device address to implement contact. After receiving slave device address responses, that shows that contact was successful. At this time, the master device is then able to continue to transmit data commands to slave devices. If N iterations of contact are not successful, it clearly shows that this slave device is not turned on or has shown the appearance of communications malfunctions. At this time, master devices then automatically take the news of this slave device showing the appearance of malfunctions and report it up to main control units. Fig.7 is the flow chart for slave device and master device communications. Slave devices make use of interruption methods to receive data sent from master devices. After receiving addresses sent from master devices, comparisons are made with the address of the receiver in question. If they are consistent, then, the suspension is withdrawn. Data commands sent out later are no longer received. After slave devices finish receiving data commands, on the basis of the commands received, dissemination is carried out, implementing different functions. After implementation is complete, a response is given to the master device. During communications, in order to improve the reliability of transmissions as well as counter jamming characteristics--besides opting for the use of bit parity in character group transmissions--in data frame transmissions, option is made for verification codes. Use is also made of software filter methods--that is, option is made for the use of methods of taking 2 in order to improve transmission reliability and counter interference characteristics. Making use of these three types of methods, transmission reliability and counter jamming characteristics are effectively improved.

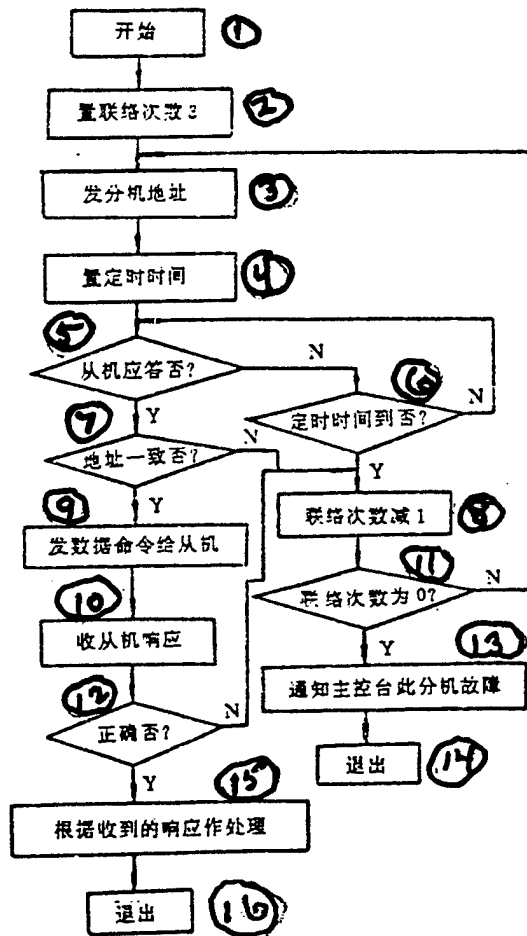

Fig.6 Master Device and Slave Device Communication Flow Chart  
 (1) Start (2) Set Contact Iteration Number 3 (3) Send Out Extension Device Addresses (4) Set Timing Periods (5) Slave Devices Respond or Not? (6) Timing Periods Met or Not? (7) Addresses Match or Not? (8) Contact Iteration Number Reduced to 1 (9) Data Commands Sent Out to Slave Devices (10) Slave Unit Response Received (11) Contact Iteration Number Is 0? (12) Correct or Not? (13) Notify Main Control Unit that This Extension Device Has Malfunctioned (14) Get Out (15) Do Processing on the Basis of Response Received (16) Get Out

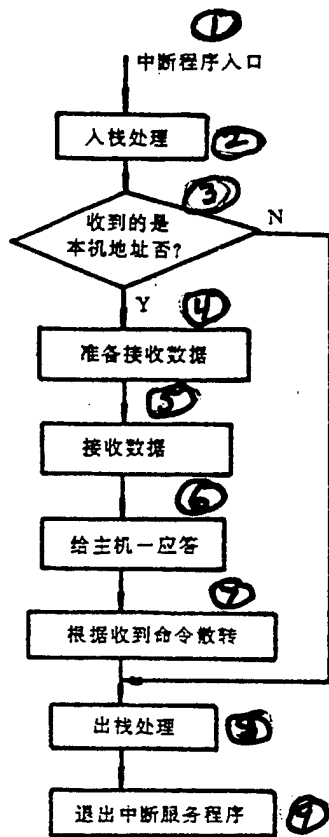

Fig.7 Slave Device and Master Device Communication Flow Chart (1) Suspension Program Entry (2) Enter Storage and Processing (3) Received Address of the Device in Question or Not? (4) Prepare to Receive Data (5) Receive Data (6) Give Response to Master Device (7) Disseminate on the Basis of Commands Received (8) Exit Storage and Processing (9) Leave Service Suspension Program

## 5 CONCLUDING REMARKS

This article introduced the setting up of monitoring and control nets in telemetry and control systems. Specific discussions were made of the realization of software and hardware corresponding to monitoring and control processors within telemetry subsystems. This set of systems is already applied in several telemetry and control stations associated with national defense science and industry committees. Satisfactory results have been achieved through test measurements, contact regulation, and test flights. The primary drawback is that speeds during operation are not fast enough. In particular, in situations where objects that need to be controlled are comparatively numerous, improving operating speeds is very necessary. In order to solve this problem, option is made for the use of even higher speed processor chips as a solution method.

## REFERENCES

### 参考文献

[1]李明芬等,“TW-215 测控系统 JK 与 YC 监控器接口控制文件”,机电部十所,1990.

[2] Andrew S. Tanenbaum,“Computer Networks”,Prentice-Hall,1981.