

PL-TR-96-2255

SPACECRAFT INTERACTIONS MODELING AND POST-MISSION DATA ANALYSIS

N. A. Bonito
K. H. Bounar
W. J. McNeil
C. J. Roth
M. F. Tautz
R. P. Vancour

Radex, Inc.
Three Preston Court
Bedford, MA 01730

15 August 1996

Final Report
15 July 1993 to 15 July 1996

Approved for public release; distribution unlimited

19970509 035



PHILLIPS LABORATORY
Directorate of Geophysics
AIR FORCE MATERIEL COMMAND
HANSCOM AIR FORCE BASE, MA 01731-3010

DTIC QUALITY INSPECTED 1

"This technical report has been reviewed and is approved for publication"



EDWARD C. ROBINSON
Contract Manager
Data Analysis Division



ROBERT E. McINERNEY, Director
Data Analysis Division

This report has been reviewed by the ESD Public Affairs Office (PA) and is releasable to the National Technical Information Service (NTIS).

Qualified requestors may obtain additional copies from the Defense Technical Information Center. All others should apply to the National Technical Information Service.

If your address has changed, or if you wish to be removed from the mailing list, or if the addressee is no longer employed by your organization, please notify PL/IM, 29 Randolph Road, Hanscom AFB, MA 01731-3010. This will assist us in maintaining a current mailing list.

Do not return copies of this report unless contractual obligations or notices on a specific document requires that it be returned.

DISCLAIMER NOTICE

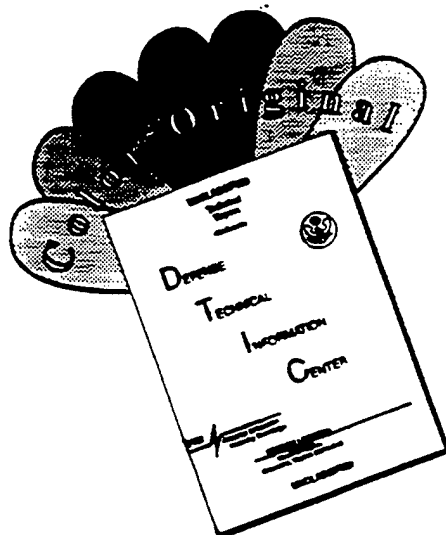

THIS DOCUMENT IS BEST QUALITY AVAILABLE. THE COPY FURNISHED TO DTIC CONTAINED A SIGNIFICANT NUMBER OF COLOR PAGES WHICH DO NOT REPRODUCE LEGIBLY ON BLACK AND WHITE MICROFICHE.

REPORT DOCUMENTATION PAGE

Form Approved
OMB No. 0704-0188

Public reporting burden for this collection of information is estimated to average 1 hour per response, including the time for reviewing instructions, searching existing data sources, gathering and maintaining the data needed, and completing and reviewing the collection of information. Send comments regarding this burden estimate or any other aspect of this collection of information, including suggestions for reducing this burden, to Washington Headquarters Services, Directorate for Information Operations and Reports, 1215 Jefferson Davis Highway, Suite 1204, Arlington, VA 22202-4302, and to the Office of Management and Budget, Paperwork Reduction Project (0704-0188), Washington, DC 20503.

1. AGENCY USE ONLY (Leave blank)		2. REPORT DATE 15 August 1996	3. REPORT TYPE AND DATES COVERED Final Report (15 July 1993 - 15 July 1996)	
4. TITLE AND SUBTITLE Spacecraft Interactions Modeling And Post-Mission Data Analysis			5. FUNDING NUMBERS PE 63410F PR S321 TA GY WU AB Contract F19628-93-C-0091	
6. AUTHOR(S) N. A. Bonito K. H. Bounar W. J. McNeil C. J. Roth M. F. Tautz R. P. Vancour				
7. PERFORMING ORGANIZATION NAME(S) AND ADDRESS(ES) RADEX, Inc. Three Preston Court Bedford, MA 01730			8. PERFORMING ORGANIZATION REPORT NUMBER RXR-96081	
9. SPONSORING / MONITORING AGENCY NAME(S) AND ADDRESS(ES) Phillips Laboratory 29 Randolph Road Hanscom AFB, MA 01731-3010 Contract Manager: Edward C. Robinson/GPD			10. SPONSORING / MONITORING AGENCY REPORT NUMBER PL-TR-96-2255	
11. SUPPLEMENTARY NOTES				
12a. DISTRIBUTION / AVAILABILITY STATEMENT Approved for Public Release Distribution Unlimited			12b. DISTRIBUTION CODE	
13. ABSTRACT (Maximum 200 words) Software systems were designed and developed for data management, data acquisition, interactive visualization and analysis of solar arrays, tethered objects, and large object space plasma interactions. Simulations were performed and models were constructed for spacecraft interactions with the ambient environment. In support of these analyses, models for satellite ephemeris, attitude determination, magnetic fields, atmospheric composition, and particle precipitation were designed and developed, using PL computational resources extensively. The SPREE experiments were two electrostatic analyzers and the SPREE Particle Correlator Experiment (SPACE) which were part of the Tethered Satellite System (TSS-1) on the STS-46 Shuttle mission. During the TSS-1 Mission, SPREE was used to study the effects of a potential being induced between the tethered satellite and the Shuttle by the motion of the conductive tether across Earth's magnetic field lines. These effects included investigations of return currents and wave-particle interactions. Subsequently, revisions and pre-mission testing was completed to support the TSS-1R Experiment on STS-75. Calibration of the interaction of ion beams with the ambient plasma were studied for shuttle missions STS-60 and STS-69. The MUMBO vacuum chamber measurements using the CALSYS system were analyzed. Methods and routines were developed to build calibration files which depict the average aperture response as a function of the polar and azimuth angles with respect to the aperture normal. The CHAWS experiment data was plotted and analyzed using the CHAPS, CHOMPS and CHUNKS programs.				
14. SUBJECT TERMS SPREE, CHAWS, Visualization, ESA, SPACE, RPA, SIDAT, FFT, ACF, Trending, Wake Studies Facility, CHAPS, CHOMP, Calibrations, PL-GEOSpace, MSM, MODVIEW			15. NUMBER OF PAGES 70	
			16. PRICE CODE	
17. SECURITY CLASSIFICATION OF REPORT Unclassified	18. SECURITY CLASSIFICATION OF THIS PAGE Unclassified	19. SECURITY CLASSIFICATION OF ABSTRACT Unclassified	20. LIMITATION OF ABSTRACT Unlimited	

TABLE OF CONTENTS

<u>Section</u>	<u>Page</u>
1. INTRODUCTION	1
2. SHUTTLE POTENTIAL AND RETURN ELECTRON EXPERIMENT (SPREE)	1
2.1 SPREE POST-FLIGHT PROCESSING TECHNIQUES	1
2.1.1 Sun SPARC 1+ Workstation	1
2.1.2 SPREE ESA Data Display Process	2
2.1.2.1 Enhancements to the SPREE ESA Data Display	2
2.1.2.2 The SPREE Trending Display Process	3
2.1.2.3 Modification to Data Display Zone Spectrum Overlays	3
2.1.3 SPREE Interactive Data Analysis Tool (SIDAT)	3
2.1.3.1 SIDAT Updated Version	3
2.1.3.2 Orbiter Event Display Process	4
2.1.4 Distribution Function	4
2.1.4.1 Enhancements to Distribution Function	6
2.1.5 Flight Data Recorder (FDR)	6
2.1.6 Summary	6
2.2 SPREE DATA ANALYSIS	7
2.2.1 Fast Fourier Transform (FFT) Display Tool	7
2.2.1.1 FFT Display Upgrades	7
2.2.2 Probability Distribution	11
2.2.3 SPACE High Frequency Correlation	11
2.2.3.1 Despiking	17
2.2.3.2 Standard Deviation	19
2.2.3.2 Power Spectral Density	19
2.2.4 Shuttle Body Coordinates	20
2.2.4.1 SPREE ESA Zone Measurements	21
2.2.4.2 Thermal Data	21

TABLE OF CONTENTS (Cont'd)

<u>Section</u>	<u>Page</u>
2.2.5 SPREE Flight STS-75 (TSS-1R)	21
2.2.5.1 Review and Revisions for STS-75	21
2.2.5.2 Data Collection Requirements	21
2.2.5.3 Mission Sequence Test	22
2.2.5.4 SunSPARC20 Workstations	22
2.2.5.5 DEC Alpha Workstation	22
2.2.5.6 SPREE Real-Time Network Listener Software Modifications	22
2.2.5.7 Real-Time Version of SIDAT Software	23
2.2.5.8 New Feature for SPREE ESA Data Display	24
2.2.5.9 SPREE B-Angle Display Process	24
2.2.5.10 GPS NIS Domain	25
2.2.5.11 Mission Support and Pre-Mission Testing	25
2.2.5.12 Smart Flex Multiplier (SFM)	26
3. CHAWS ANALYSIS and WAKE STUDIES (CHAWS)	27
3.1 CHAWS MISSION SUPPORT	27
3.1.1 Wake Studies Facility (WSF) PDI Data	27
3.1.1.1 PCDecom Processing and Configuration	27
3.1.2 CHAWS Data Structure Definition	27
3.1.3 SPREE Data Processes Rehoused for Support of CHAWS	28
3.1.3.1 Retool Trending Display for CHAWS	28
3.1.3.2 The SPREE Trajectory Process	28
3.1.4 CHAWS Data Display Software	28
3.1.4.1 Additions to CHAWS Data Display Software	28
3.1.4.2 Enhancements to Attitude Display Process	29
3.1.5 CHAWS Mission Support Hardware	30
3.1.5.1 Shuttle Remote Manipulator System (RMS)	30
3.1.5.2 Components for JIS #1	30
3.1.5.2 Additional Equipment for JIS #4	30
3.1.6 Support of WSF/CHAWS Instrument on STS-60	31
3.1.6.1 Pre-Flight Support	31
3.1.6.2 Launch and Post-Flight Support for STS-60	35
3.1.6.3 CHAWS/STS-60 Post-Flight Software Enhancements	38

TABLE OF CONTENTS (Cont'd)

<u>Section</u>	<u>Page</u>
3.1.7 Preparation for CHAWS STS-69 Mission	40
3.1.7.1 A Real-Time Version of the CHAPS Software	40
3.1.7.2 New Requirements for PCDecom	40
3.1.7.3 JIS #5	40
3.1.7.4 Third Sun and TRACKER Workstations	41
3.1.7.5 Real-Time CAS Data Archive Files Format	41
3.1.7.6 The CHAWS Calibration Globe Display	41
3.1.7.7 Revisions for MCP Data and Langmuir Probe Data Display Processes	41
3.1.7.8 JIS #7	41
3.1.8 Preparation for Launch and Post-Launch of STS-69 WSF/CHAWS ..	42
3.1.8.1 Modifications for Post-Flight Software	42
3.2 WAKE SHIELD/CHAWS DATA ANALYSIS	42
3.2.1 Software Testing and Development	42
3.2.1.1 X windows Coding	42
3.2.1.2 DYNAPAC Code	43
3.2.1.3 Further Software Upgrades and Development	43
3.2.1.4 Additional Preparations for STS-69 Launch	48
3.2.2 Post-Launch Support for STS-69 WSF/CHAWS	49
3.2.2.1 STS-69 Flight Data Collection and Processing	49
3.2.2.2 Post-Flight Modifications of Software Routines	51
4. VISUALIZATION	52
4.1 ENHANCEMENT OF AURORAL ION AND ELECTRON DISTRIBUTION DATA	52
4.1.1 Development of Technical Approaches	52
4.1.1.1 The PROSPECT Coordinate Transformation Package	53
4.1.1.2 EXPLORER and IDL Data Programs	53
4.1.1.3 Magnetic Field Studies	53
4.1.1.4 MODVIEW	54
4.1.1.5 Intel Graphics Library	54
4.1.1.6 Integration of CRRESRAD Models into Visualization Program	55
4.1.1.7 Benchmark Tests for IDL and EXPLORER	56
4.1.2 Magnetospheric Specification Model (MSM)	56
4.1.2.1 Development of 3-D Modeling of MSM	56
4.1.2.2 Use of MODVIEW and MSM	57
4.1.2.3 Further Development of GEOSpace	57

TABLE OF CONTENTS (Cont'd)

<u>Section</u>	<u>Page</u>
4.1.3 PL-GEOSPACE (Formerly SGI)	57
4.1.3.1 Results and Use of PL-GEOSpace	57
4.1.3.2 Reduced Version of CRRES3D	57
4.1.3.3 Time-Dependent Science Models	58
4.1.3.4 The CRRESELE Model	58
4.1.3.5 Module to Trace Particle Orbits	59
5. REFERENCES	60

LIST OF FIGURES

<u>Figure</u>	<u>Page</u>
1. Sample Real-Time SIDAT Workspace	5
2a. Azimuth-Based ESA Data Display	8
2b. Time-Based ESA Data Display	8
2c. Orbiter Potential Display	8
2d. Orbiter Potential Playback Display	8
3a. SPACE Energy versus Pattern Display	9
3b. SPACE Pattern versus Time Display	9
3c. Sample Partial Orbit ESA Survey	9
4a. Postflight ESA Data Display	10
4b. Postflight Partial Orbit ESA Survey	10
5. SPACE FFT color raster images and FFT and ACF line plots for LF ACF on August 2, 1992 at 20:08	12
6. SPACE FFT color raster images and FFT and ACF line plots for HF ACF on August 2, 1992 at 20:08	13
7. ACF and FFT processing tool of LF SPACE data on August 3, 1992 at 20:09:19	14
8. ACF and FFT processing tool of HF SPACE data on August 3, 1992 at 20:08:37	15
9. SPACE FFT survey raster color display of HF electrons for Julian day 216.	16
10. Schematic of CHAWS RPA Detectors	32
11. Ram center detector CALSYS data for Nov 17, 29, 30	33
12. Wake end detector data lines	34

ACKNOWLEDGEMENTS

The work described in this report required the involvement and guidance of numerous individuals at PL, and their interest and encouragement is gratefully acknowledged.

Ed Robinson of the Data Analysis Division initiated and coordinated activities as Contract Monitor. His continuing contributions are deeply appreciated. Bob McInerney, Director of the Data Analysis Division for his guidance throughout the lifetime of the contract.

Various investigators were involved throughout the projects, and provided essential support and challenging studies in their fields:

Dave Hardy, Gary Mullen, Space Particle Environment Branch
and M. R. Oberhardt

David Cooke and Bill Pakula Space Interactions Branch

M. P. Gough University of Sussex, U.K.

The efforts of Susan Cline in the compilation of this report is greatly appreciated.

LIST OF ACRONYMS

ACF	Autocorrelation Function
AITS	AFGL Intractive Targeting System
ASCII	American Standard Code Information Interchange
CAS	Calibration Ancillary System
CDD	Continuous Data Devices
CHAPS	CHAWS Analysis Postflight Survey
CHAWS	Charging Hazards and Wake Studies
CHOMP	CHAWS On-orbiting Monitoring Process
DEC	Digital Equipment Corporation
DFT	Discrete Fourier Transform
DPU	Data Processing Unit
ECI	Earth-Centered Inertial
ESA	Electrostatic Analyzer
FDR	Flight Data Recorder
FES	Flash Evaporator System
FFT	Fast Fourier Transform
FPEG	Fast Pulsed Electron Generator
GUI	Graphical user Interface
GPS	Space Physics Division, PL
GSE	Ground Support Equipment
IDL	Interactive Data Language
IPC	Inter-Process Communication
JIS	Joint Integration Simulation
JSC	Johnson Space Center
KSC	Kennedy Space Center
LAN	Local Area Network
LEPA	Low Energy Plasma Program
LOKANGL	Ephemeris Program
LVLH	Local Vertical Local Horizontal

MET	Mission Elapsed Time
MODVIEW	Magnetic Field Models Visualization
MSM	Magnetospheric Specification Models
MST	Mission Sequence Test
NASA	National Aeronautical Space Administration
NIS	Network Information Service
PATH	Postflight Attitude and Trajectory History
PDI	Payload Data Interleaver
PIM	Parameterized Ionospheric Model
PL	Phillips Laboratory
POLAR	Potential of Large Objects in the Polar Region
RMS	Remote Manipulator System
RPA	Retarding Potential Analyzer
RTMD	Rotary Table Motor Drive
SATEPH	Satellite Ephemeris Program
SFM	Smart Flex Multiplexer Demultiplexer
SGI	Silicon Graphics Workstation
SIDAT	SPREE Interactive Data Analysis Tool
SOC	Science Operations Center
SPACE	SPREE Particle Correlator Experiment
SPREE	Shuttle Potential and Return Electron Experiment
STS	Space Transportation System
SYSCAL	System Calibrations Program
TCVM	Tethered Current and Voltage Monitor
TSS	Tethered Satellite System
UCAT	User Calibrated Ancillary Tape
WPI	Wave Particle Interaction
WSF	Wake Shield Facility

1. INTRODUCTION

The work on this contract was performed to provide software systems and models for the Shuttle Potential and Return Electron Experiment (SPREE) space flights STS-46 and STS-75, flown as part of the tethered satellite system (TSS-1). Electrostatic Analyzer (ESA) data was acquired and fed through the Space Particle Correlator Experiment (SPACE). The work on SPREE was done in two segments, namely, post-flight processing techniques and data analysis. In the former, various display processes were developed and enhanced, including the SPREE Interactive Data Analysis Tool (SIDAT). In the latter, various programs were developed to analyze and interpret the ESA and SPACE data. In addition, support was given for the pre-flight, launch and post-flight missions of the two space vehicles. A similar pattern of work was accomplished for the CHAWS experiment, Retarding Potential Analyzers (RPAs). PCDecom processing and configuration, data structure definition, various processes for data, trending, trajectory, attitude, etc., were developed and enhanced. Mission support was given for STS-60 and STS-69 pre-flight, launch, and post-flight of these two space missions. Further work was performed for the visualization program. Technical approaches were developed for plotting processes, coordinate transformations, magnetic field studies, magnetospheric specification models (MSM), development and use of the PL-GEOSpace programs, and other models for data analysis

2. SHUTTLE POTENTIAL AND RETURN ELECTRON EXPERIMENT (SPREE)

2.1 SPREE POST-FLIGHT PROCESSING TECHNIQUES

2.1.1 Sun SPARC 1+ Workstation

A Sun SPARC 1+ workstation and a disk expansion pedestal with 5 - 2.1 GB disks were installed to store and process SPREE data. The new Sun SPARC 1+ is called "GPSSERVER" and had SPREE - PATH and UCAT data, in addition to processed data. All SPREE processed flight recorder data was transferred to the "gpsserver" SUN workstation. The system's final configuration consists of flight recorder processed data and the real-time captured data. This gave access to all collected data sets, previously unavailable due to limitation of disk space to all SPREE users. A SunOS 4.1.3 operating system with Open Windows V3.0 and FORTRAN 1.3.1 were loaded to enable the SPREE SIDAT software to be run.

Later, three 2.1 GB DSCSI disks, an Exabyte 8500 8mm tape drive, and a CD-rom drive were installed in the disk expansion pedestal connected to GPSSERVER. The disks were formatted, partitioned and mounted as new file systems. This aided in processing SPREE post flight data. The SPACE FFT display tool was integrated with the SPREE display and analysis software on the Sun workstation.

2.1.2 SPREE ESA Data Display Process

The pop-up line graph of the SPREE ESA Data Display process was totally reworked, using a CHAWS line graph process software as a framework. On the ESA Data Display process window, the user graphically selects vertical and/or horizontal slices of data to plot via the mouse pointer. The vertical data slice plots the data at the selected time versus energy steps or zones, depending on the type of data displayed. The user may increment or decrement the time of data being plotted via the graphical user interface (GUI) buttons. Additional buttons are available for specifying the sweep number of the fast sweeping post-flight data being plotted. The horizontal data slice, a new graph feature, plots the data of the selected zone or energy step over a 30-second time period, centered at the user selected time. Several GUI items allow the user to increment or decrement the starting time, or specify the zone or energy step of the energy step being plotted. The user may examine each data value plotted in the time series by moving the mouse pointer along the time axis. The data being plotted in each type of line graph may be updated by subsequent data selections via the mouse pointer in the ESA Data Display process window. Another new line graph feature allows the user to create an ASCII file containing the numeric values of the data currently plotted. These files may then be used as input to other software. The Description of real-time telemetry and real-time data analysis processes are described by *Roth and Bonito [1992]*.

2.1.2.1 Enhancements to the SPREE ESA Data Display

Several enhancements have been made. The Number Density and Energy Density selections have been added to the available data calibration choices.

The calculation of the Integral Number Flux, Integral Energy Flux, Current Flux, Number Density, and Energy Density calibrated values require the ESA particle data for each zone to be integrated over energy. For these calibrations, a new option allows the user to specify the start and stop energy steps for the integration calculations. Corresponding changes were made in the associated line graph process, adding the two new data calibration types and the integration limit feature. When the line graph updates occur, the current integration limits are also transferred for the specified calibration types. The user may alter these line graph process energy integration limits independently of the ESA Data Display process limits. Other enhancements of the line graph process allow the user to select a linear or logarithmic energy scale on the distribution function plots. The linear energy scale minimum and maximum axis values may be specified by the user. The line graph process ASCII file generation feature was improved to include "View" and "Print" options for the generated files.

Further enhancements developed for the ESA Data Display process include performing three-dimensional numerical integrations over a graphically specified region of the displayed ESA data spectrum, and applying a uniform color scale to the ESA data spectra displays. This allows easier comparison of data from the two ESA units. A new long-duration survey tool, similar to the Partial Orbit Survey process, was also developed.

The associated pull-out line graphs have been enhanced to add a feature for calculating the central energy value of a selected energy range.

2.1.2.2 The SPREE Trending Display Process

The SPREE Trending Display Process has been enhanced to include a window resizing feature. This option allows multiple trending displays of different parameters to be stacked for comparison.

2.1.2.3 Modification to Data Display Zone Spectrum Overlays

The first option now traces the plane perpendicular to the magnetic field direction with a line, marks the spectrum region parallel to the magnetic field direction with an "O" symbol, and marks the spectrum region parallel to the vehicle ram direction with an "X" symbol. The second option now traces the plane defined by the parallel to magnetic field point of the spectrum and the perpendicular to magnetic field point of the spectrum at zone angle 0. This defined plane is also used as the view plane for the Distribution Function Contour Display for the "Parallel" option.

2.1.3 SPREE Interactive Data Analysis Tool (SIDAT)

2.1.3.1 SIDAT Updated Version

The SPREE Interactive Data analysis Tool (SIDAT) was used in real-time support of SPREE during the STS-46 shuttle mission. SIDAT captured and processed all of the SPREE and Calibrated Ancillary System (CAS) telemetry data received at the Johnson Space Center (JSC) Science Operations Center (SOC). The SIDAT data analysis display processes allowed the user to view the real-time SPREE and SPACE data in a variety of formats, and the trajectory process to display the current position and attitude of the orbiter. SIDAT was used in the postflight support of SPREE. The postflight data display processes, which are nearly identical to those used in the real-time support, were used to review the SPREE and SPACE data acquired during the mission. Two postflight data bases became available, namely, the data acquired from the real-time telemetry, and the data archived by the two on-board Flight Data Recorders (FDRs).

An updated version of the SPREE Interactive Data Analysis Tool (SIDAT) software was released. Many of the SIDAT processes had been reworked to improve the interprocess communication facility management for more efficient use of the workstation resources and for accessing the common configuration data files from the multiple workstation hosts. This enabled the SPREE Data Survey process to broadcast the CAS or PATH orbiter data as well as the SPREE ESA and SPACE data. The Attitude and Trajectory Display processes were reworked allowing the user to view the orbiter information in a "Survey Slave" mode or "Independent" mode. When in "Survey Slave" mode, the displayed orbiter information is controlled by the SPREE Data Survey process, allowing the user to track the orbiter information in parallel with the SPREE ESA data displays.

In "Independent" mode, the user selects the source and time for the orbiter information display, and may view the sub-second thruster firing information from the PATH data base. The orbiter information display may be stepped forward or backward in various increments. The line Graph processes, called from the ESA Data Display process, was enhanced to include a color map inversion capability. This allows creation of publication-ready plots of black lines on a white background.

An algorithm was developed to determine the B-field perpendicular plane as a function of SPREE ESA azimuth and zone. The technique implements a direct solve for ESA zone based on the ESA azimuth and parallel B-field ESA polar coordinate. Several enhancements of the SIDAT software were completed and installed on GPSSERVER. Figure 1 depicts a typical SIDAT workspace [Roth and Bonito, 1992].

2.1.3.2 Orbiter Event Display Process

The Orbiter Event Display process was added to the SIDAT software package. The orbiter thruster firings, water dumps, and FES usage events are presented in a time-based display where the active events are indicated by colored blocks in their appropriate row or rows. The Orbiter Event Display is sized identically to the SPREE ESA Data Display, and marks the ESA turnaround points and times for correlation references. The user may graphically pick times of the event data on the display, invoking a scrolling text window. This text window shows the water dump status, FES status, and sub-second thruster firing information for the selected time. The user may step forward or backward in time, as in the ESA Data Display pullout line graphs.

2.1.4 Distribution Function

Distribution Function values in color-coded pie wedges were presented by creating two new forms of ESA data display which required development work. The first form presents a view looking directly at the B-field, displaying the calibrated values of the ESA data determined to be perpendicular to the B-field. The second form presents the ESA data determined to be in a plane containing the B-field and perpendicular to the B-field for the current ESA azimuth. These processes will be integrated into the SIDAT software environment upon completion and verification. The color-coded pie wedges consist of a semi-circular contour region corresponding to a full 180-degree scan of the selected ESA, where the radial direction is particle velocity. Each wedge of the contour presents the color-scaled distribution function versus velocity the ESA azimuth and zone determined to be in a selected plane. As with the Attitude and Trajectory processes, the Distribution Function Contour display may be used in "Survey Slave" or in "Independent" modes.

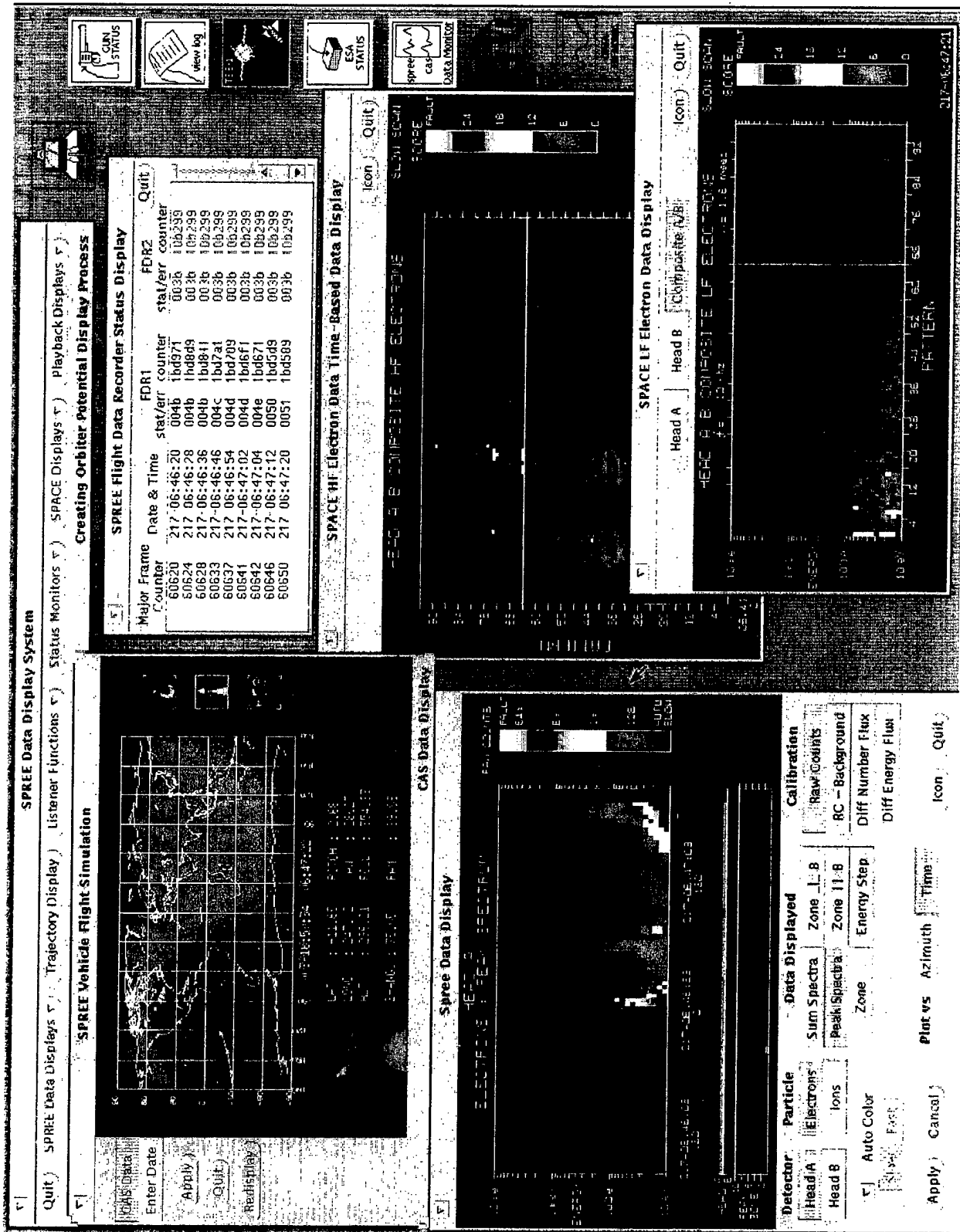

Figure 1. Sample Real-Time SIDAT Workspace.

2.1.4.1 Enhancements to Distribution Function

Two new enhancements of the SIDAT Distribution Function Contour Display process were implemented. The first enhancement is the addition of a contour summation feature which allows the user to sum the data contours of many successive ESA scans, where the start and stop time is controlled by the user. A completed contour summation presents the average data contour, the ram direction minimum, maximum and mean, a small histogram relating the azimuthal data distribution, and annotations of the summation start and stop times and mean B-field direction values.

The second enhancement allows the user to specify the contour radial velocity scaling method, either logarithmic or linear. Logarithmic scaling for the radial velocity values produces uniformly sized colored blocks for each of the energy step values. Linear scaling produces blocks which increase exponentially with the step number. For either scaling type, minimum and maximum velocity values of the contour display are annotated.

The annotation of the sun angle to the orbiter bay normal was added to the attitude Display process. An indication of the orbiter being "sunlit" or "eclipsed" is also annotated.

2.1.5 Flight Data Recorder

The routines for the Flight Data Recorder were modified to significantly improve their performance over the network. A random access method for reading the data was implemented, using an expanded database information table. This allows quick data response even in heavy network traffic.

2.1.6 Summary

The ESA Data, Orbiter Potential, Partial Orbit Survey, and SPACE Pattern Displays were enhanced to use X-Window fonts, providing larger and clearer annotation of titles, times, and data scale values.

The display of the real-time data was changed at the request of the researcher. Due to the limited bandwidth of the telemetry stream, only a portion of the ESA data is available in real-time. The multiplexing of the real-time data results in data displays resembling picket fences or checkerboards, depending on the type of display chosen. This effect was eliminated by displaying both the "new" data and the "aged" data, essentially stretching the data forward in time. This change affects only the ESA Data, Partial Orbit Survey, and Distribution Function Contour Display processes.

The current version of the SIDAT postflight display software was adapted for use in real-time,

in preparation for the SPREE reflight. A few postflight features were removed in the real-time version due to their requirement for the full postflight data stream.

The SPREE data bases, STS-46 orbiter data, and SIDAT were collected as multiple archive files and copied to exabyte tape as a data distribution format. A description of the tape contents and installation procedure for the data and analysis software was prepared to accompany the distribution tapes.

The SIDAT Report [*Roth and Bonito, 1992*] describes X-Windows applications, interprocess communication methods, real-time telemetry, real-time data analysis processes, real-time telemetry data processing, the ESA data display, the orbiter potential display, trajectory display, listener process monitors, SPREE status monitors, SPACE data displays, partial orbit ESA surveys, trending displays, Flight Data Recorder (FDR) information processing, and the above-mentioned data analysis processes for post-flight data.

Figures 2, 3, and 4 show some results of the SPREE/SIDAT programs [*Roth and Bonito, 1992*].

2.2 SPREE DATA ANALYSIS

2.2.1 Fast Fourier Transform (FFT) Display Tool

A Fast Fourier Transform display tool was developed to display line plots of raw Autocorrelation Function (ACF), filtered ACF and FFT amplitude spectra. The open windows display allows the user to select options for the processing method in the filtering stage and the tapering method used to obtain the FFT transforms. The program may be used for a more detailed study of the ACF SPACE data. Some of the developed features are the panels containing information on the energy level, unit number, type of ACF processing to be done, and the windowing scheme before FFT transformation. There are three drawable windows displaying raw ACF, processed ACF and their FFT amplitude spectra. What remains to be done is the integration of all the software routines needed in the processing of the raw ACF and the tapering schemes prior to the FFT transformation. The SPACE FFT display tool was fully debugged and integrated with the SPREE display and analysis software on the Sun workstation. A Technical Report [*Bounar, et al., 1994*] was written to describe the software developed to analyze and display the SPACE autocorrelation in the frequency domain.

2.2.1.1 FFT Displays Upgrades

To improve the FFT displays, annotations were added to the X Window displays of the Fourier transformed SPACE data, was modified by adding an additional canvas in order to invert the foreground and background colors to generate hard copies.

Color plots of the probability of occurrence of precipitating electrons, distributed over the average

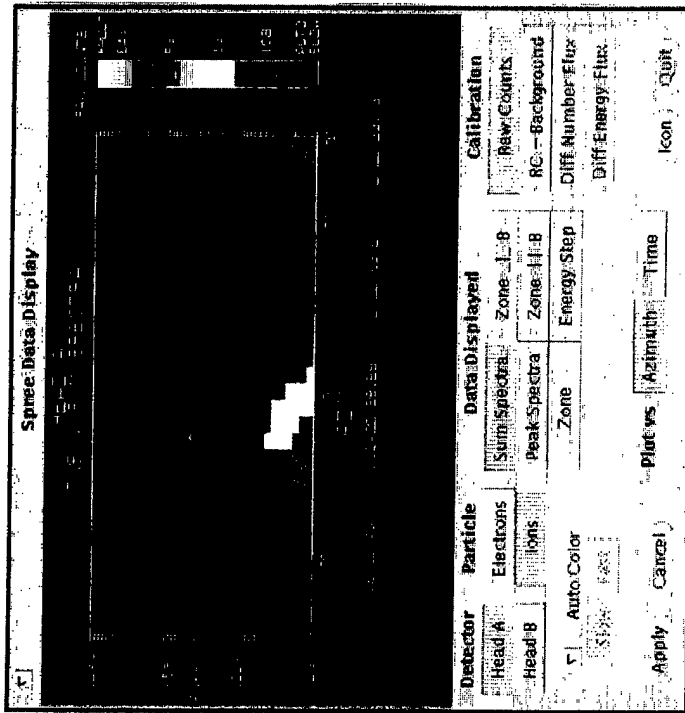

2a. Azimuth-Based ESA Data Display

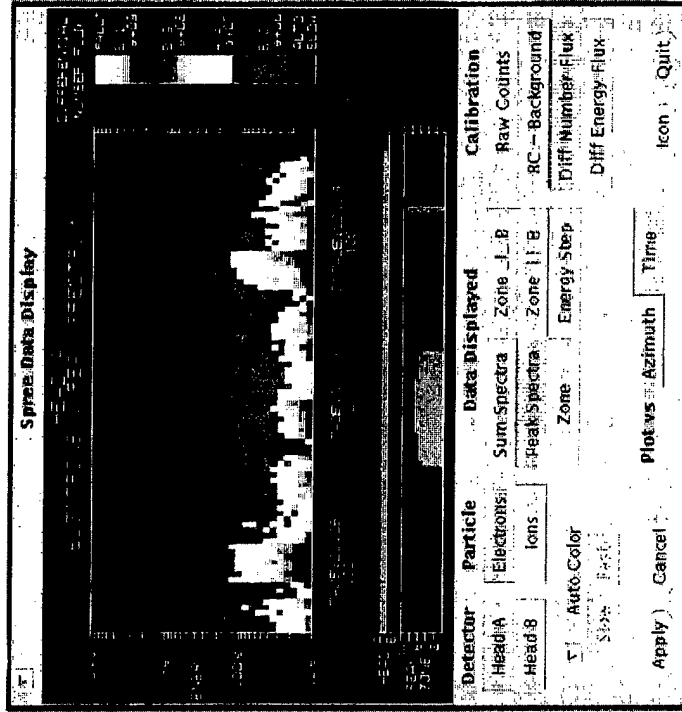

2b. Time-Based ESA Data Display

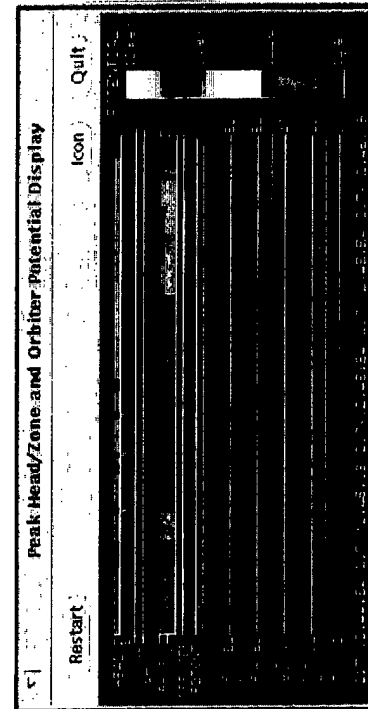

2c. Orbiter Potential Display

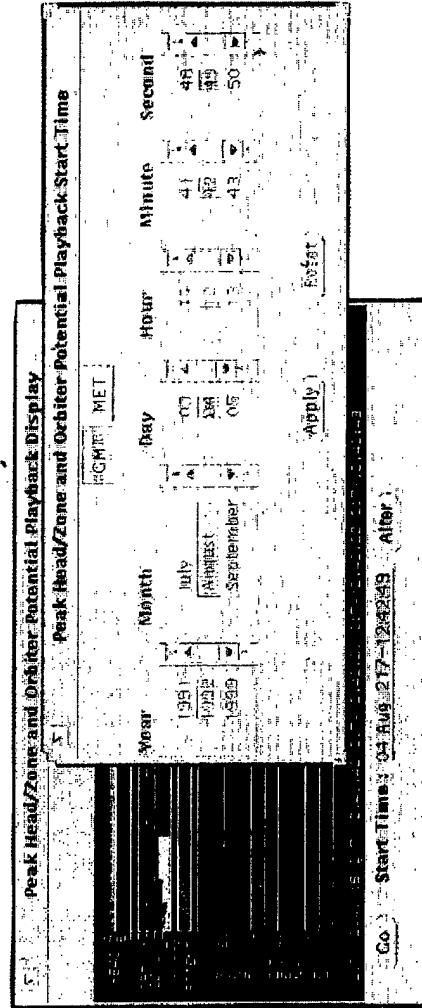

2d. Orbiter Potential Playback Display

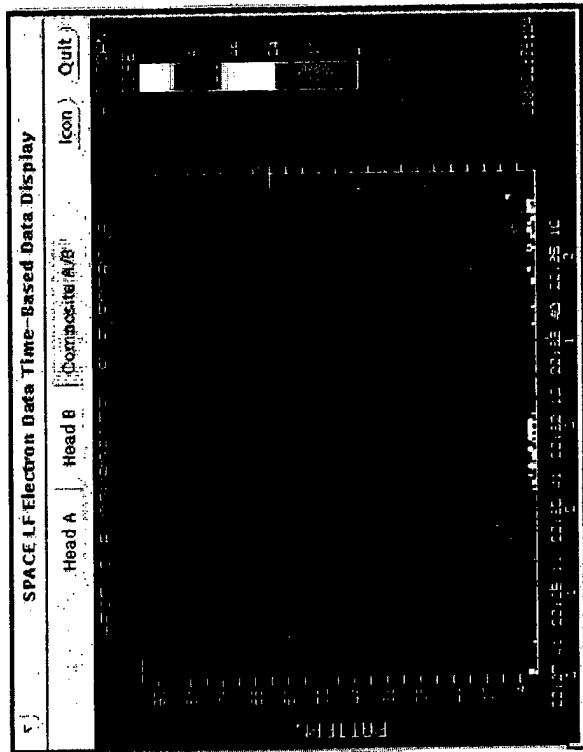

3b. SPACE Pattern versus Time Display

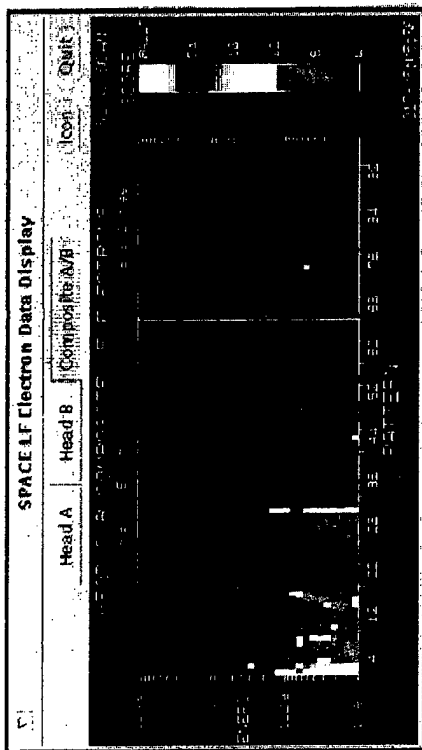

3a. SPACE Energy versus Pattern Display

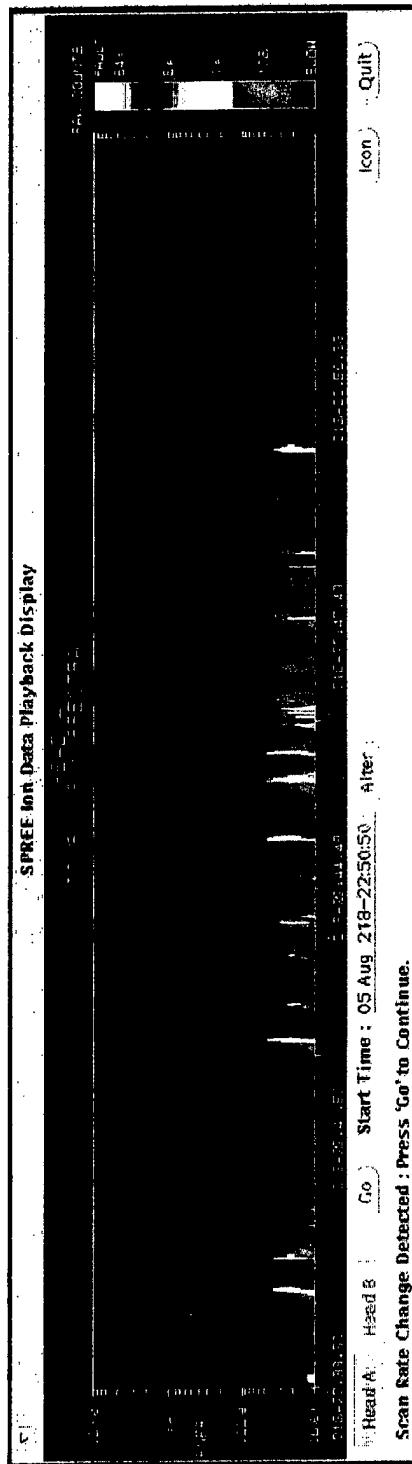

3c. Sample Partial Orbit ESA Survey

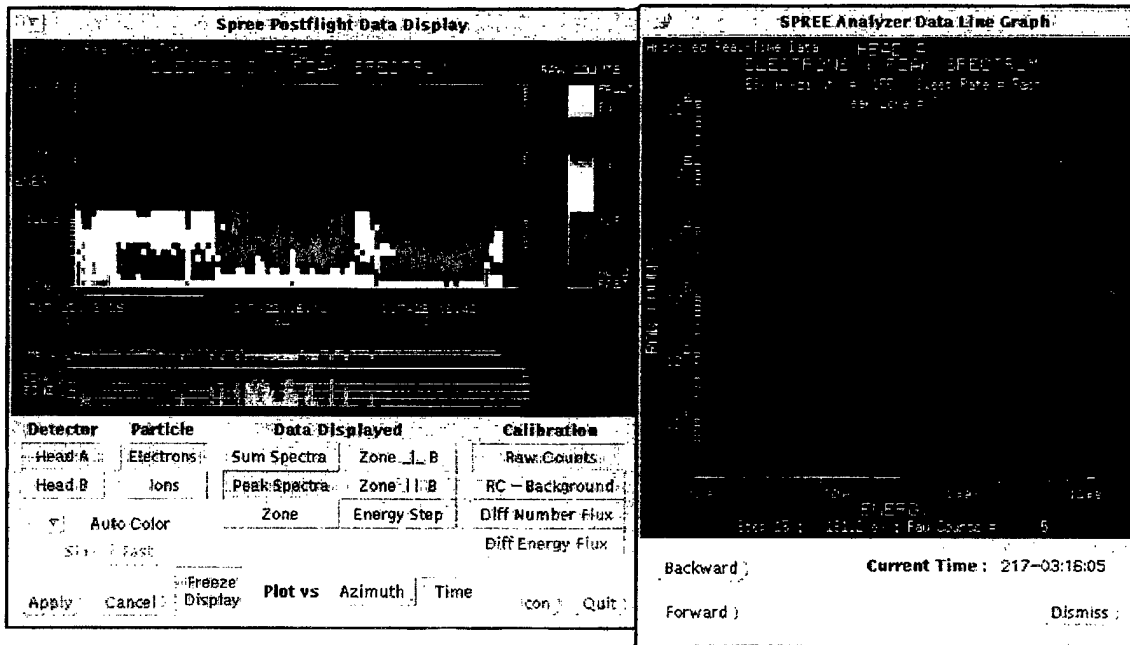

4a. Postflight ESA Data Display

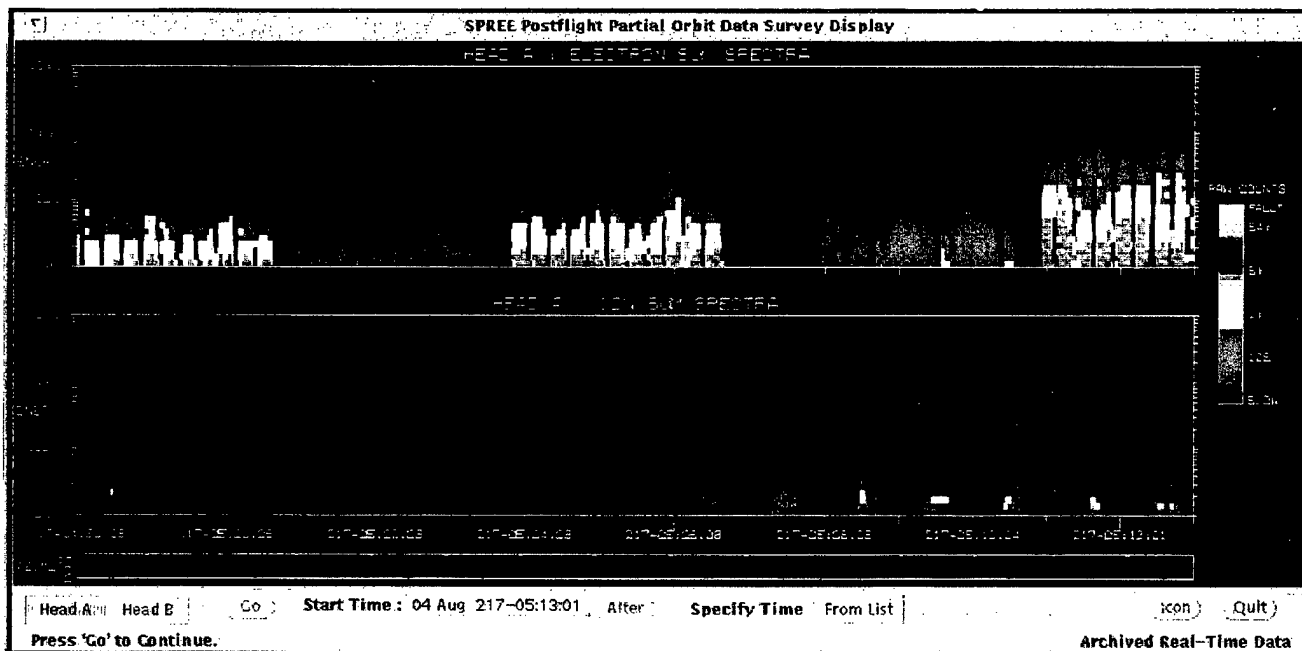

4b. Postflight Partial Orbit ESA Survey

energy and the number flux were generated. The SPACE FFT tool was upgraded with two additional enhancements, namely, saving ASCII files of ACFs and FFTs, and, stepping forward or backward in time. Another upgrade to the SPACE FFT tool is a panel button to invert the foreground and background colors to obtain publication quality hardcopy. Saving ASCII files in the SPACE FFT tool was upgraded by adding a pop-up window for creating, appending, or viewing the results.

Figures 5 through 9 from the Technical Report [Bounar, *et al.*, 1994] shows SPACE FFT color raster images and FFT and ACF line plots for LF ACF and HF ACF; ACF and FFT processing tool of lf and HF SPACE data, and SPACE FFT survey raster color display of HF electrons.

2.2.2 Probability Distribution

Programs were written to develop a database of parameters defining the probability distribution of two log-normal functions. The probability of occurrence of the integral number flux is computed for specified geomagnetic location and activity. This probability of occurrence can be generally approximated by two log-normal distributions. A database containing the initial estimated parameters for the probability of occurrence of auroral integral number flux was generated. Six parameters for each possible input condition are sufficient to fully describe a two log-normal distribution.

A generalized algorithm, using a steepest descent method for fitting the distributions, is executed with nine different scenarios, where some parameters are frozen and others varied to minimize the χ^2 value. After all 4800 geomagnetic positions times 8 Kp possibilities are examined, a different algorithm is used to improve the parametric fitting by taking into account the proper variational trends from one location to another. This allows the user to decide which of the parameters is to be frozen, and which must be varied. Another program was developed to stack the distribution and the fitted results over the local time or latitude. This was done to help analyze the trends as the location in the geomagnetic coordinates is varied.

2.2.3 SPACE High Frequency Correlation

C routines were developed to edit the SPACE high-Frequency correlation data. Algorithms for removal of the spikes and most-significant bit problems in the HF autocorrelations (ACF) were devised. First, the value of the 64th HF ACF lag $\rho(64)$ is replaced by the 63rd lag $\rho(63)$. Second, an algorithm to detect and remove spikes of 2050 counts or higher was developed. The algorithm is based on 5 samples at a time, where the middle sample is tested to determine if it is a spike. To be a spike, this sample must have an absolute difference with each of the other 4 samples that must exceed a threshold value $\theta = 2050$ counts. Third, the ACFs are corrected whenever the loss of the most significant bit in the HF ACFs is detected. Fourth, an algorithm to detect and remove shorter spikes is used to remove spikes of $\theta = 300$ counts or higher. Each

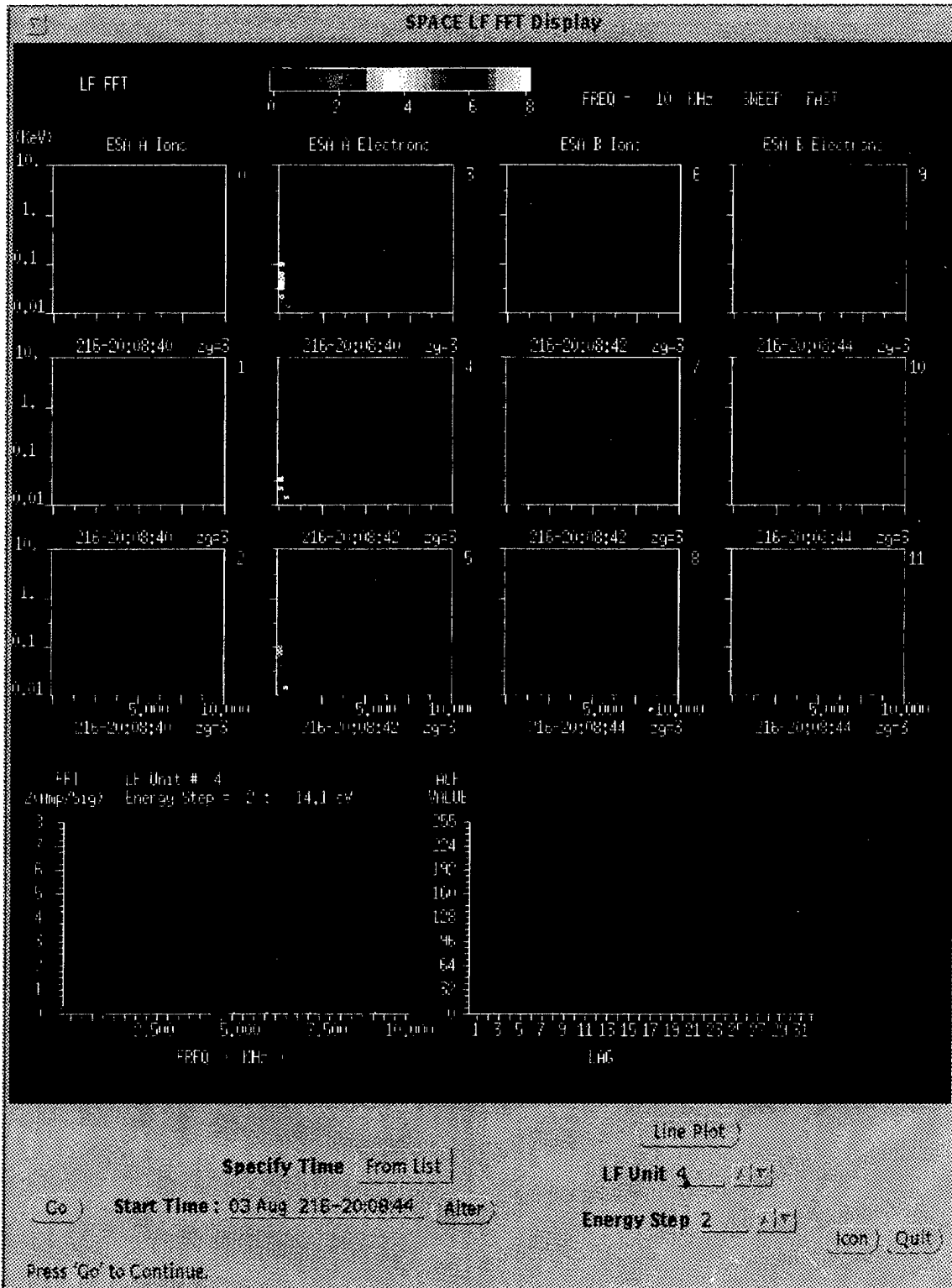

Figure 5. SPACE FFT color raster images and FFT and ACF line plots for LF ACF on August 2, 1992 at 20:08.

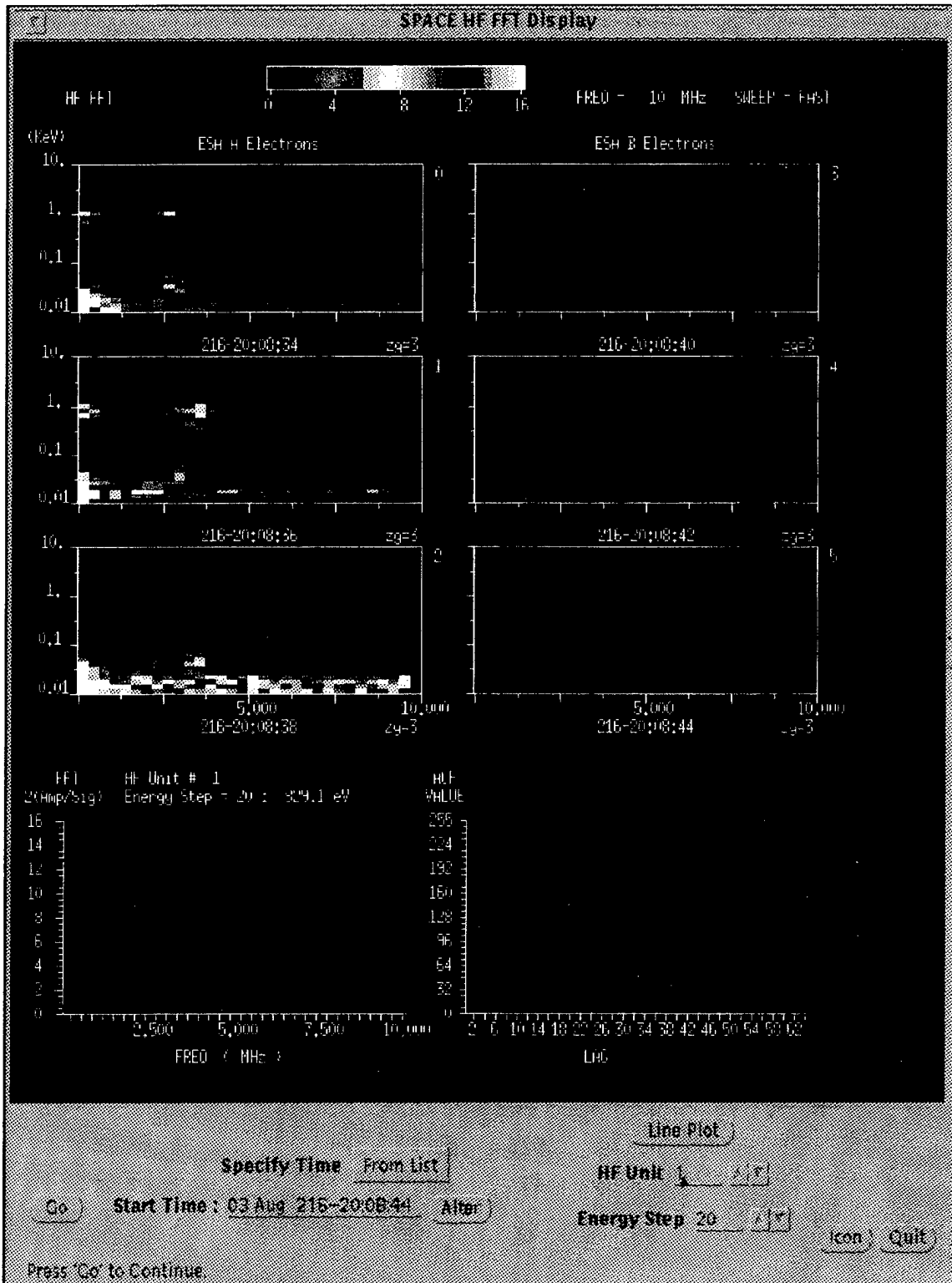

Figure 6. SPACE FFT color raster images and FFT and ACF line plots for HF ACF on August 2, 1992 at 20:08.

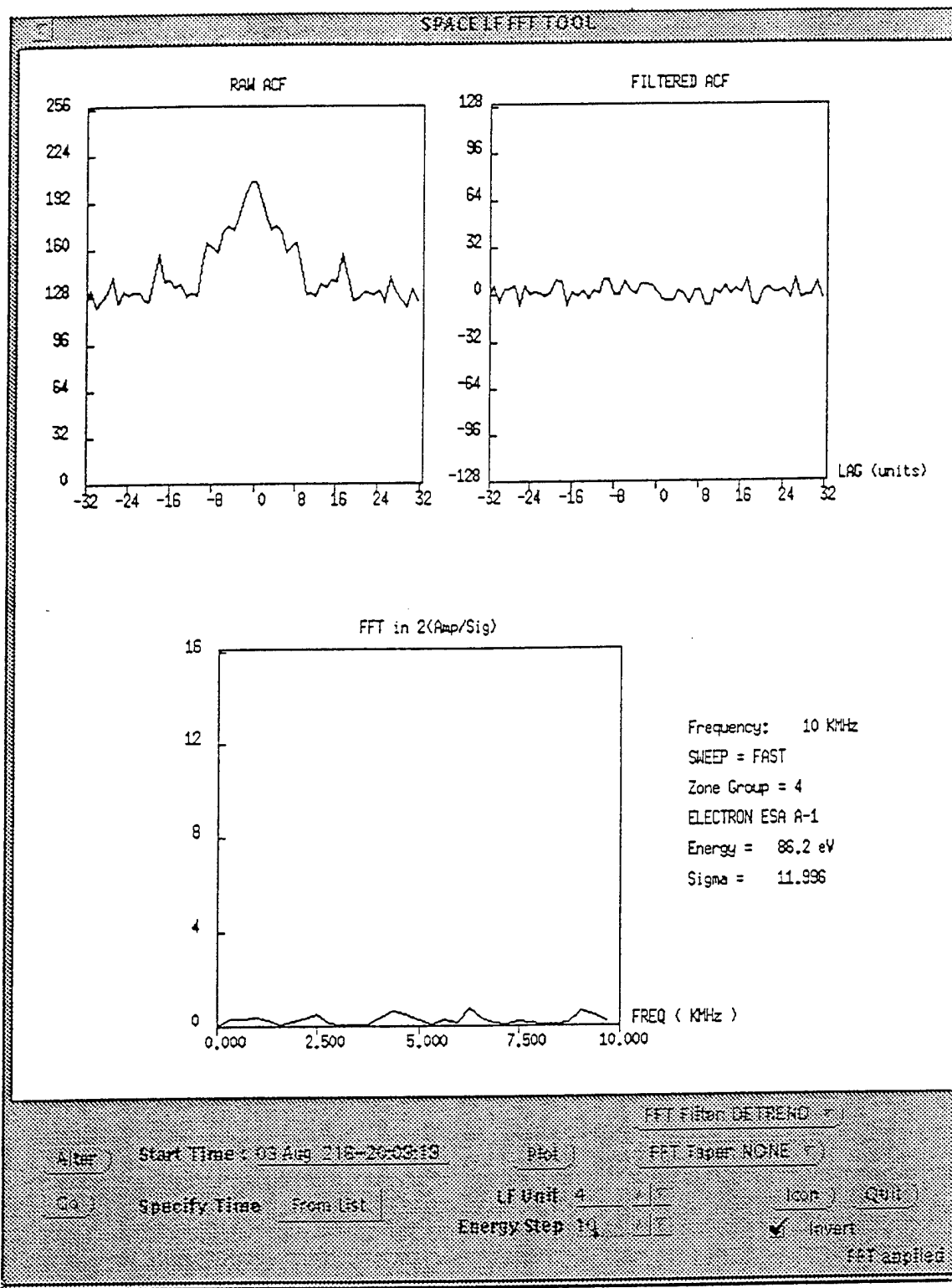

Figure 7. ACF and FFT processing tool of LF SPACE data on August 3, 1992 at 20:09:19. The filtering option selected is detrending only and no tapering was applied.

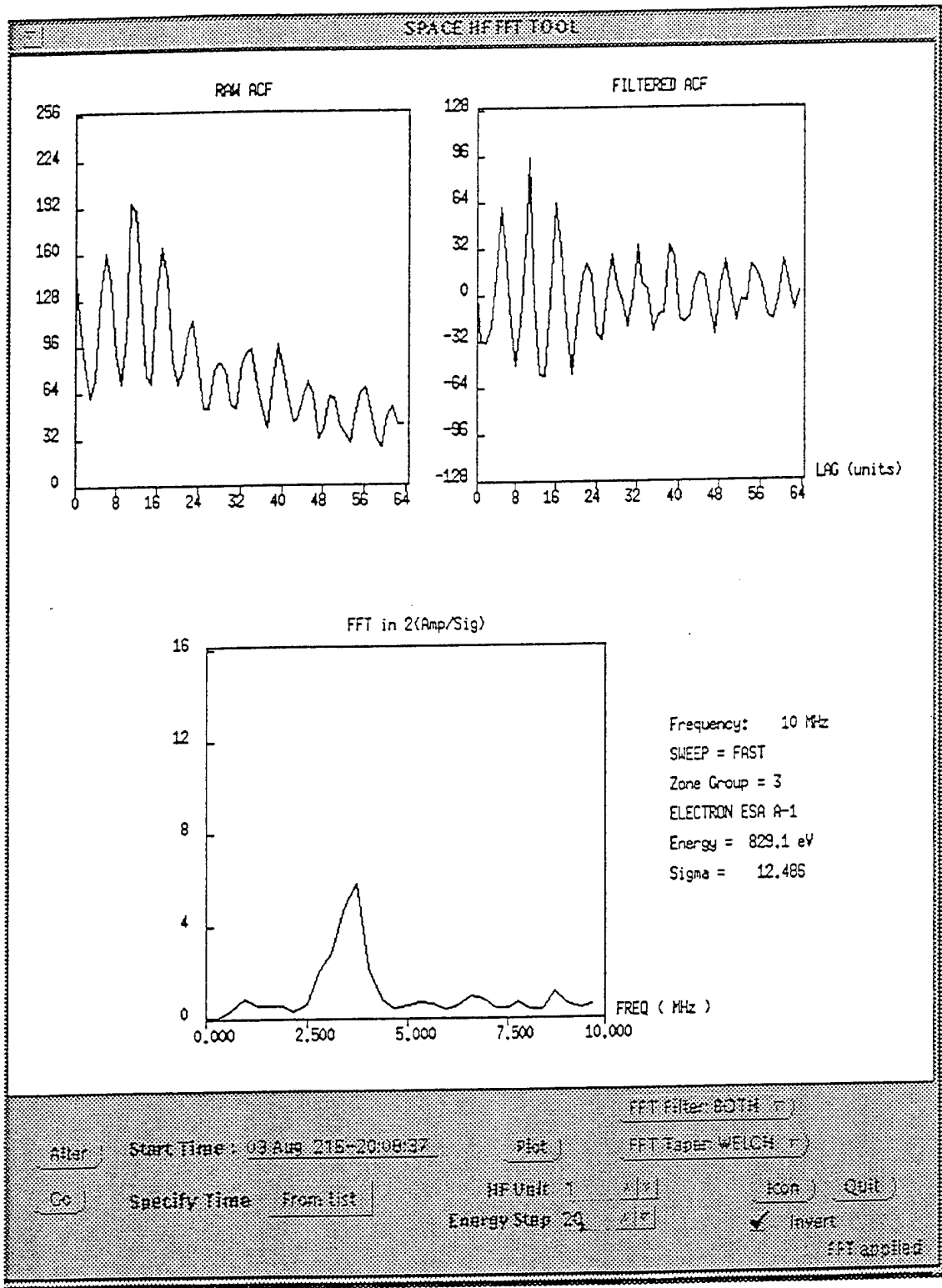

Figure 8. ACF and FFT processing tool of HF SPACE data on August 3, 1992 at 20:08:37. Both despiking and detrending were selected on "Filtering" option and the Welch taper function was applied to the ACF prior to the Fourier transform operation.

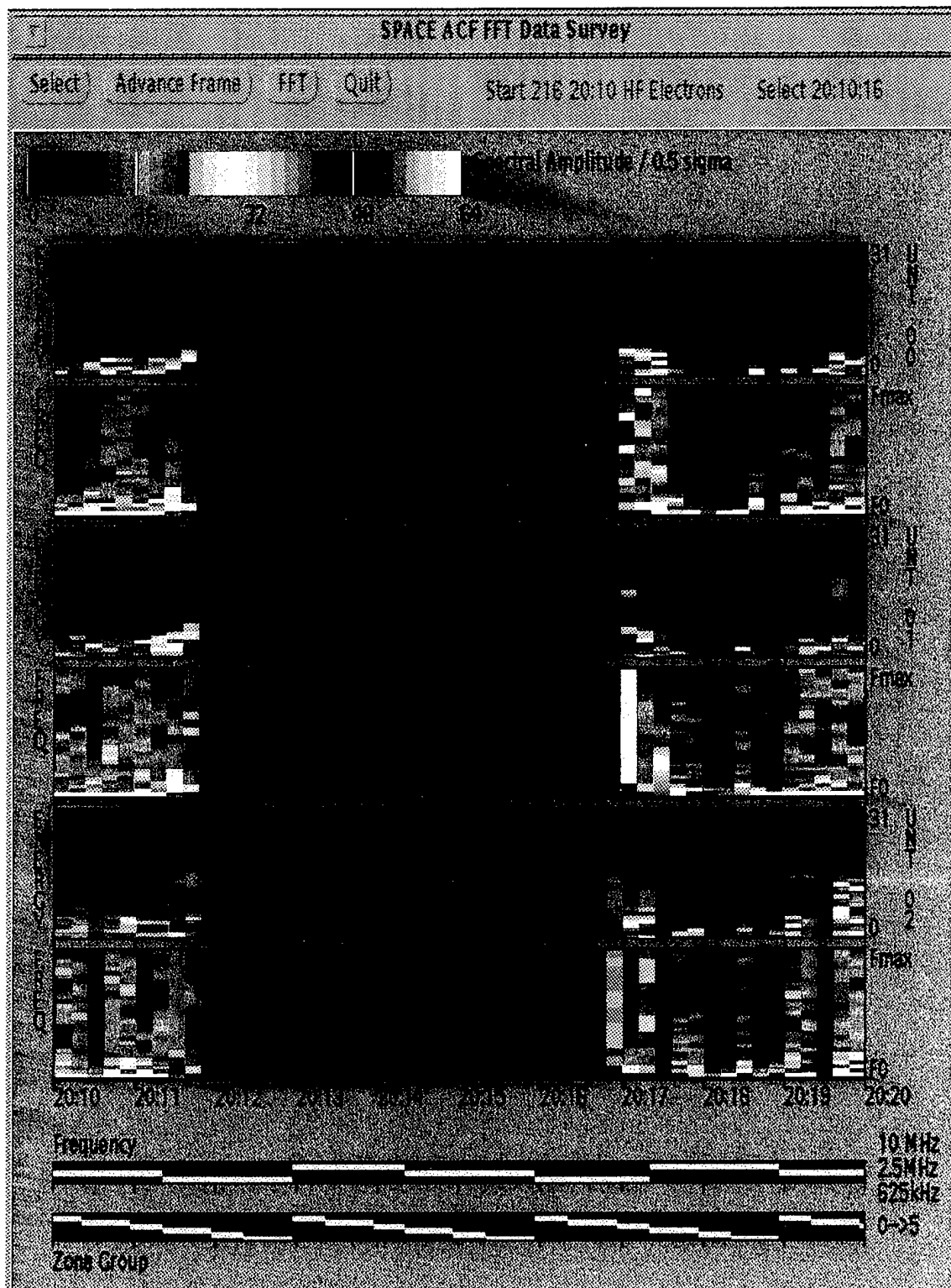

Figure 9. SPACE FFT survey raster color display of HF electrons for Julian day 216. The Energy and Frequency at peak FFT amplitudes are shown for ESA units 0-2. The Bottom panels show the Maximum Frequency (0.625, 2.5. or 10MHz), and the Zone Group (0-5) for the same time interval.

correlation sequence ρ has 64 lags, or

$$\rho(I), I = 1, 2, \dots, 64. \quad (1)$$

2.2.3.1 Despiking

All algorithms used to detect and remove spikes consider five samples at a time. The middle sample is tested to determine if it is a spike. Large spikes are removed first. As stated above, the threshold value is $\theta_L = 2050$.

Consider the autocorrelation sequence, Eq. (1) above. To detect and remove samples considered to be spikes, the following is done:

For $I = 3, 4, \dots, 62$, compute

$$\begin{aligned} \Delta_{-2} &= | \rho(I) - \rho(I-2) | \\ \Delta_{-1} &= | \rho(I) - \rho(I-1) | \\ \Delta_{+1} &= | \rho(I) - \rho(I+1) | \\ \Delta_{+2} &= | \rho(I) - \rho(I+2) | \end{aligned} \quad (2a)$$

$$\begin{aligned} & \text{If } (\Delta_{-2} > \theta_L, \Delta_{-1} > \theta_L, \Delta_{+1} > \theta_L, \text{ and } \Delta_{+2} > \theta_L) \\ & \text{then } \rho(I) = \frac{1}{2} [\rho(I-1) + \rho(I+1)]. \end{aligned} \quad (2b)$$

If more than 3 samples satisfy the above condition, i.e., more than three spikes are detected, filtering does not occur on these large spikes, in order to avoid filtering out real signatures.

The second step is to apply the roll-over correction algorithm which corrects for the loss of the most significant bit when the ACF counts become large and exceed the 12-bit word. The detection and correction of roll-over samples is done as follows:

For $I = 63, \dots, 1$,

$$\begin{aligned} & \text{If } (| \rho(I) - \rho(I+1) | > | \rho(I) + 4096 - \rho(I+1) |), \\ & \text{then } \rho(I) = \rho(I) + 4096. \end{aligned} \quad (3)$$

This correction is applied only after despiking of large spikes is completed.

To remove small spikes, the threshold value is $\theta_s = 300$.

For autocorrelation sequence $\rho(I) = 1, 2, \dots, 64$, detection and removal is done as follows:

For $I = 3, \dots, 62$, compute using Equation (2a), and

$$\begin{aligned} \text{if } \Delta_{-2} > \theta_s \text{ and } \Delta_{-1} > \theta_s \text{ and } \Delta_1 > \theta_s \text{ and } \Delta_2 > \theta_s \\ \text{then } \rho(I) = \frac{1}{2}[\rho(I-1) + \rho(I+1)] \end{aligned} \quad (4)$$

To see if the first sample in the autocorrelation function is a spike, the first six samples of the autocorrelation sequence $\rho(I)$, $I = 1, 2, \dots, 64$ is considered. The threshold value in this case is $\theta_F = 100$. Detection and removal of a spiked sample in the first lag is done as follows:

$$\begin{aligned} \Delta_1 &= |\rho(0) - \rho(1)| \\ \Delta_2 &= |\rho(0) - \rho(2)| \\ \Delta_3 &= |\rho(0) - \rho(3)| \\ \Delta_4 &= |\rho(0) - \rho(4)| \\ \Delta_5 &= |\rho(0) - \rho(5)| \end{aligned} \quad (5a)$$

and

$$\Delta_A = \left| \rho(0) - \frac{1}{5} \sum_{i=1}^5 \rho(i) \right| \quad (5b)$$

The sample in the first lag is considered a spike if the following condition is satisfied. If so, then the sample is replaced by the mean of the next 5 lags.

$$\begin{aligned} \text{If } (\Delta_1 > \theta_F; \Delta_2 > \theta_F; \Delta_3 > \theta_F; \Delta_4 > \theta_F; \Delta_5 > \theta_F; \text{ and } \Delta_A > \theta_F), \\ \text{then } \rho(0) = \left(\frac{1}{5} \right) \sum_{i=1}^5 \rho(i) \end{aligned} \quad (6)$$

Note, if more than 3 spikes were taken in the cases of θ_s and θ_F , then, no filtering is actually done on these small spikes.

Each of the LF SPACE correlation sequences is stored in 32 lags. To obtain the two-sided correlation sequence, the available correlation samples are folded over. Thus, the correlation sequence is expressed as

$$\begin{aligned} \rho(j) \text{ for lags } j = -31, \dots, -1, 0, 1, 32 \\ \text{where} \\ \rho(j) = \rho(1-j), j = 1, \dots, 32. \end{aligned} \quad (7)$$

The ACF samples are considered to have lags ranging from 1 to 64. No despiking is done on the LF correlation sequences.

2.2.3.2 Standard Deviation

When the editing of the ACFs is complete, the standard deviation σ is then obtained from the ACF sample mean. Using the FFT algorithm, the Discrete Fourier transform (DFT) is computed. From this, the amplitude response of the ACFs is obtained and is, then, normalized by $\frac{1}{2}$. Sometimes, the HF ACF in the first 5 lags may need to be corrected due to saturation in the electronic instruments. The ACFs must be detrended. Removing the trend from the upper ACF lags tends to distort some of the signatures in the lower lags.

The standard deviation (σ) is obtained by computing the ACF mean value. It equals the square root of the sample mean. The mean is given by

$$\mu = \left(\frac{1}{64}\right) \sum_i \rho(I), \text{ where } I = 1, 2, \dots, 64, \quad (8a)$$

and the standard deviation is

$$\sigma = (\mu)^{1/2} \quad (8b)$$

C routines to edit the SPACE High Frequency correlation data were modified. Algorithms for removal of the spikes and most-significant bit problems in the HF autocorrelations (ACF) were improved. The user has an option to use the window that results in the best spectral estimate.

2.2.3.3 Power Spectral Density

The power spectral density (PSD) of the corrected ACF are computed from the periodogram. Prior to taking the transform, windowing is used to reduce the effects of sidelobe leakage and aliasing. There are 6 optional windows that may be selected by the user: Square window, Parzen window, Welch window, Blackman window, Hanning window, Hamming window, Bartlett window, and Gaussian window. One window may result in a better spectral estimate than another.

Detrending may be used to filter out the low frequency components for either LF or HF correlation SPACE data, [Bounar, et al., 1994] using the FFT algorithm, one computes the discrete Fourier Transform (DFT) of the ACFs. To obtain the amplitude, the DFT is defined by

$$F_k = (1/n) \sum_{n=0}^{N-1} \rho(n)w(n) \exp[-jk(2\pi/N)n], \quad (9)$$

where $k = 0, 1, \dots, N-1$.

The amplitude of the frequency response is

$$A_k = \sqrt{(F_k F_k^*)}$$

The tapering function is denoted by $w(n)$, and is defined [Bounar, et al., 1994] for the above named windows.

The Low Frequency (LF) FFT window displays a color raster image of energy versus frequency of the Discrete Fourier Transform (DFT) of ACF data as shown in Figure 5 [Bounar, et al., 1994]. The energy range is from 10 eV to 10 KeV. In the low frequency mode, 12 raster images are shown representing data from ESA A and ESA B, for both ion and electron fluxes.

The High Frequency (HF) FFT window display is similar to the LF FFT window display. The only difference is the number of units. Since only electron data are processed in the HF case, there are only 6 raster images representing data from both the ESA A and ESA B electron fluxes. A specific energy level and unit from one of the raster images can be picked to display the line plots of both the ACFs and their Fourier Transforms in the bottom pf the drawable window. In Figure 6, the line plots are those of the energy bin 20 corresponding to 0.83 KeV, and ESA A electron unit #1. Some of the discussion and all of the mathematical equations in the entire section 2.2.3 are from Bounar, et al. [1994].

2.2.4 Shuttle Body Coordinates

A stand alone utility was written to extract from the STS-46 PATH data files the needed information to produce shuttle body (reference coordinates for the orbiter velocity vector. The package will tabulate the coordinates along with orbiter LVLH attitude values for the time period required by the user.

2.2.4.1 SPREE ESA Zone Measurements

SPREE ESA zone Measurements were tabulated for periods that a measurement was reformed parallel to the velocity vector and perpendicular to the B-field. Each measurement was further annotated with thruster firing information for the periods of occurrence. Tabulation of information is not constrained by the need to satisfy exact angles, since selected parameters are used to accommodate for minor variation of ESA azimuth versus velocity, or velocity versus perpendicular B-field.

2.2.4.2 Thermal Data

Thermal data for specific hardware components of SPREE were extracted and examined for their variations during the STS-46 flight. The data was further organized by solar line of flight in local shuttle body coordinates. Local body coordinate bins were produced and a mean, minimum, and maximum temperature was determined for each bin. Color plots were produced to aid in the visualization of this material. This information was used in the reflight evaluation of thermal stability.

A set of SPREE FAR tapes were received to determine if the recorders exhibited an effect from the thermal testing that was done. Both FAR tapes were tested for tape readability, tape file segmentation, and ratio of telemetry drop-outs. The tapes were processed using the method planned for post mission data product generation. The only data maintained was the flight recorded and system housekeeping parameters for the purpose of reviewing pressure and temperatures with respect to possible drop out periods. Initial examination shows no significant residual effect from the thermal testing.

2.2.5 SPREE Flight STS-75 (TSS-1R)

2.2.5.1 Review and Revisions for STS-75

SPACE data formats and interfaces were reviewed with the experimenter in preparation for the SPREE flight on TSS-1R. The TSS-1R (STS-75 mission) CAS parameter list was revised to reflect the required real-time and UCAT needs of SPREE.

2.2.5.2 Data Collection Requirements

Data collection requirements were reviewed with the Project Manager to determine the effect of MSFC proposed changes to the SOC environment. The KSC Level-IV testing platforms were reviewed. The proposed SOC network and data transfer method at both locations were evaluated, in document format and effect to existing software. Pre-mission system preparation was done for the STS-75 mission in support of SPREE.

2.2.5.3 Mission Sequence Test

The STS-75 SPREE Mission Sequence Test (MST) was supported at KSC with the installation of the original STS-46, SPREE real-time data collection (GSE) software. The MSFC configured workstation (SOC) also required the installation of a FORTRAN compiler, and the further installation of Open Windows support files was needed to allow for the rebuilding of the GSE software. Both SPREE and CAS telemetry were tested, even though SPREE telemetry would be the only stream available during MST.

2.2.5.4 Sun SPARC20 Workstations

The two new Sun SPARC20 workstations were installed and configured after the AUI Ethernet adapter cables were received. The workstations, known as SPREER and SPREEST, are configured as NIS clients of GPSSERVER making them accessible to all who have accounts in the GPS domain. The Solaris compatible C and Fortran compilers were needed to develop applications and run the SPREE and CHAWS display packages locally. Until then, the packages would be run on GPSSERVER or GPSSER2 with the displays exported to either of the SPARC20s.

General support was performed for the users of the new SPARC20 workstations and GPSSERVER, including debugging network problems, disk maintenance, and system administration.

The C and FORTRAN compilers and SPARCworks software development package were loaded onto the SPREER and SPREEST workstations. This enabled these machines to run the SPREE and CHAWS Data Display packages locally instead of exporting the displays from GPSSERVER. This allows these packages to run much faster, and reduces the workload on GPSSERVER.

2.2.5.5 DEC Alpha Workstation

A new DEC Alpha workstation was set up at PL, and was assembled and configured to run the Open VMS operating system.

2.2.5.6 SPREE Real-Time Network Listener Software Modifications

The SPREE real-time network listener software was modified to process 100% orbiter downlink in a manner equivalent to the capability used during the CHAWS mission. This required the modification of CAS data formats and method of data collection used to produce an equivalent PATH data structure. CHAWS shared memory and structures were used, but further modifications of the real-time SIDAT is required to use the new format. To maintain the original SPREE mission listener capabilities, while adapting the improved CHAWS methods will be a continuing effort. This will allow for the use of one network listener for both the SOC and the SPREE analysis workstations. The current plan for the mission indicates both the 100% orbiter

data and the SOC processed data packets will be captured. The use of the same listener process on both workstations will allow for redundancy in workstation hardware and usage of SIDAT applications by the SOC workstation regardless of data source. A continuing effort was made for processing the SFMDM and satellite data streams. Minor changes were identified for the archived SPREE data which was captured during the STS-46 mission. STS-46 real-time data files had to be modified to comply with the new format, and allow end to end testing of SIDAT in the postflight manner. The linear software modification continued to allow the processing of 128 kbit orbiter downlink (OD), while maintaining the SOC data flow compatibility. These new changes pertain to the data source sensing (OD or SOC), and had not previously been implemented. PCDecom configurations were completed, allowing the OD source definition to be applied. The new CAS data, produced from the OD data stream, was revised, but without modifying the original data record. This allows for compatibility with the postflight software and usage of STS-46 flight data. The SOC CAS data record was not defined at the time, but the STS-46 format was maintained until it is revised. The original design requirement for a single listener software package with the capability to process both the SOC or OD was maintained.

Listener procedures which produce the SPREE real-time data archive were updated for the new record format. SPREE parameters derived from CAS items were added to the shared memory structure. This update allows for compatibility with the new real-time SIDAT and new parameters in shared memory.

PCDecom configurations were developed for the 128 kbit OD data stream, and the segmentation of the SPREE telemetry from the SFMDM data fields. The previous configuration was developed to support MST at KSC and did not handle the extraction of SFMDM data from the OD. These configurations were tested at MSFC.

2.2.5.7 Real-Time Version of SIDAT Software

A real-time version of the SIDAT software was prepared for the STS-75/SPREE-1A flight. This real-time version of SIDAT was adapted from the current postflight SIDAT software. Several changes in the SPREE data shared memory segment and archive data file formats were necessary to support some of the newer features of the postflight SIDAT during real-time operation. The SPREE data base reading routines were modified accordingly. The CAS data shared memory segment and archive data file formats were changed to match those used for the STS-69/CHAWS-2 flight. This allowed many of the orbiter information displays used during CHAWS real-time operations to be re-hosted for SPREE with only minor modifications. However, the orbiter attitude display process required the addition of the Tethered Satellite object to the animations.

The postflight version of the SIDAT software installation was modified for the addition of the two Solaris workstations as SPREE data analysis platforms. Two SPARC 20s, named SPREER and SPREEst, are running the Solaris 2.4 operating system, while GPSSERVER is running the SunOS4.1.3 operating system. A script was installed to determine the architecture of the machine the user is logged into, and then, run the appropriate version of the SIDAT software.

A real-time version of the SIDAT software was prepared for the STS-75/TSS-1R/SPREE flight. The attitude display process was updated with the addition of a Tethered Satellite object and the removal of the orbiter RMS arm.

The Attitude display process was later enhanced to include a graphical depiction of the magnetic field direction vector and the TSS deployment. The magnetic field direction vector is drawn as a colored line pointing into the center of the orbit, and is capped by a diamond-shaped parasol. The parasol and color of the line aid in the three-dimensional visualization. The B-field direction azimuth and elevation angles of this vector, with respect to the orbiter body, are numerically annotated. With the addition of the tether information from the SFM data stream, the deployment of the tethered satellite can be simulated, including extension of the deployment boom. The tethered satellite status is annotated as either "Stowed" or "Deployed". The tether length, in kilometers and feet, is annotated when deployed. The preliminary release of the STS-75 SPREE real-time software was used during a Joint Integration Simulation (JIS) during December 1995.

2.2.5.8 New Features for SPREE ESA Data Display

Two new features were added to the line graph pullout of the SPREE ESA Data Display process. The first feature allows the user to calculate a linear least squares fit for the selected portion of the currently displayed line graph. The calculated fitting parameters are displayed in equation form. The log-versus-log plots use the power law form of the equation to describe a straight line, while the linear-versus-log plots use a Maxwellian distribution form. The second feature for the line graph pullout is the addition of a mini-plot of the pitch angle superimposed on plots displaying integrated energy data versus zones at a specific time or versus time for a specific zone. Two more features were added, namely, the least squares fit line, supplementing the calculation of the least squares fit parameters. This addition of the line allows the quality of the least squares fit to be judged. The second added feature enables the construction of a composite line graph up to five graphs of data. The user has the option to arrange these graphs in a staggered or aligned format. This composite graph is useful for demonstrating trends or features over several data records.

2.2.5.9 SPREE B-Angle Display Process

A new type of SPREE display was requested by the researcher. This new display presents several running line plots of the angle between the local magnetic field direction and other defined directions, such as the velocity vector or FPEG firing direction. This process was designed to be very flexible and allows the user to easily interchange the number of line plots and/or the specific data values being displayed. This SPREE B-Angle Display process was made available in the real-time and postflight environments of the SIDAT software. The B-Angle display process was developed and presents several running line plots of the angle between the local magnetic field direction and other defined directions, such as the velocity vector or FPEG firing direction. This process was designed to be very flexible, allowing the user to easily change the number of line plots and/or the specific data values being displayed.

2.2.5.10 GPS NIS Domain

General support for the users of the GPS NIS domain, including debugging network problems and system administration was performed. The Sun workstations in the GPS NIS domain became isolated to the local PL subnet when TX turned off the 'proxy ops' function of the subnet router. Due to an OS problem, the proper netmasks and broadcast addresses were not being loaded at boot. As a result, the router needed to be designated as a default and the netmask and broadcast address needed to be explicitly set in the boot file on each machine.

2.2.5.11 Mission Support and Pre-Mission Testing

A 486 PC and an 8mm tape drive were sent to MSFC. The PC will run the PCDecom software while the 8mm drive will be attached to one of the Sun workstations at MSFC. After the system was configured, the most recent versions of the SPREE Realtime software and PCDecom were loaded and tested. Various hardware and software configuration changes were made before and during the SIM and JIS that were performed between 7-12 December, 1995. During these simulations, the SPREE Data team began the necessary mission training and collected test data which was brought back for analysis. The SOC9D workstation was to be integrated into the SPREE GSE.

The real-time network listener software was tested during the STS-75 JIS and Closed-Loop Test held at MSFC. The listener processing of either SOC generated packets or PCDecom packets was compared. The primary indication was that there is a two second delay in the packets from the SOC network. The SOC packets were monitored for drop out consistency with respect to the PCDecom processed of the 128 kbit orbiter downlink (OD).

PCDecom processing errors, which occur after a data loss, were isolated for the purpose of determining the impact on further JIS and testing support. The errors are primarily related to the processing after a data loss and affect only the GNC and SM segment of the OI data stream, which are the orbiter related parameters for a CAS data packet. The isolation of the problem allowed for the continuation of payload data packet development, but impacted the testing for a compatible CAS data packet. The PCDecom corrections are being worked.

SPREE instrument monitoring and tethered measurement parameters within the SFMDM telemetry data stream were identified for an independent PCDecom packet. The PCDecom packet generation and Sun listener processing of the packet parameters were completed, along with the development of various text display monitors.

A new version of the PCDecom software was installed to support STS-75 JIS 2 and JIS 3. The new version corrects various problems that are mentioned above. Other improvements to the PCDecom software were applied for the SOC environment, since the SOC computer was unable to process the inward stream without dropping portions of the stream. This condition was not evident on the SPREE PCDecom, since the computers have different processor speeds. The SOC

performs other levels of PC processing, which are not performed by the SPREE PC since the SUN manages the generation of the CAS data packet. The PCDecom multi-tasker was improved and can process a constant two OI stream without any data loss.

2.2.5.12 SmartFlex Multiplier (SFM)

A new data stream, SmartFlex Multiplier (SFM), was made available for the real-time SIDAT display processes. This data stream contains several values external to the SPREE data, such as the SPREE relay switch states and TSS tether information. A few of the SIDAT interprocess communication (IPC) routines were modified to incorporate this addition. Routines to read the SFM data archive files were also developed.

A status process was developed for the SFM data stream. A line of text containing the current time and parameter values is added to a scrolling list when a change is detected in one or more of the displayed parameter values. This log is periodically saved to an ASCII file. Three modes of the SFM Status process are available: the Tether Current and Voltage Monitor (TCVM) mode displays the current settings of the four resistor relays; The SPREE mode displays items such as the SPREE main power state, operating mode, and FAR error signals; the SPREE Relay mode displays the power state of the various SPREE components, such as the Rotary Table Motor Drive (RTMD), MicroChannel Plate (MCP) and Flight Data Recorder (FDR) units.

The SFM Monitor process was developed and displays the current time and the numeric values of various SFM values, such as the magnetic field measurements, tether length, and velocity. In addition, the current state of the four TCVM resistor relays is graphically depicted.

The Trending display process was enhanced to perform data trending of SFM data parameters. The SFM Trending choice was added to the real-time SPREE command bar panel. A new type of trending display was requested for use during the STS-75 orbiter mission. This XY Plot display process is capable of plotting one user-selected data parameter against another over a specified time span.

The "Command Echo" mode was added to the SPREE Status Monitor process. In this mode, the SPREE instrument commands echoed through the telemetry are converted from numeric code to the corresponding text and displayed in a scrolling list. The contents of this log are periodically saved in an ASCII file.

3. CHAWS ANALYSIS and WAKE STUDIES (CHAWS)

3.1 CHAWS MISSION SUPPORT

3.1.1 Wake Shield Facility (WSF) PDI Data

3.1.1.1 PCDecom Processing and Configuration

The PCDecom processing of Wake Shield Facility PDI data was enhanced with the extraction of WSF system parameters. This enables the Sun workstation to receive a separate data packet with only WSF system parameters, which include the attitude control system, magnetometers, and WSF housekeeping. A shared memory structure was designed for the WSF parameter interface to the display processes. WSF specific processes were designed for monitoring power consumption, attitude determination, and WSF contamination parameter calculation. Integration of WSF was developed.

The PCDecom configuration for processing CAS data involves the modification of available STS-46 (TSS-1) PCDecom configurations to allow the processing of STS-39 (CIRRIS-1A/IBSS) CAS data. The STS-39 CAS data for IBSS deployed and on the RMS are the primary test data set that was generated.

A 3-D WSF model, using available structure schematics development began which allows a visual interpretation of the WSF orientation with respect to the magnetic field, velocity, thermal, and shuttle separation.

3.1.2 CHAWS Data Structure Definition

The CHAWS data structure definition was modified to include Greenwich Mean Time, in addition to the CHAWS time code. This data structure is used by the Listener process to place the data into the shared memory segment, and to write the CHAWS real-time archive data files. The real-time CHAWS data display processes, which use the data in the shared memory segment, were updated to properly utilize the dual time codes. The routines to read the ethernet Listener/generated files were updated to reflect the new data structure definition.

The ethernet listener software was enhanced to contain the new 128k data rate parameters. The 128k data stream replaces the previous CAS data parameters and generates the equivalent data structure elements. The processes for loading the shared memory data structure were altered to allow for new parameters and data passage. PCDecom was used to simulate the new data stream passage to the SUN workstation listener process.

3.1.3 SPREE Data Processes Rehosted for Support of CHAWS

3.1.3.1 Retool Trending Display for CHAWS

The Trending display process, initially developed to support the SPREE project, was retooled to display the CHAWS data. This rehosting required only a few minor changes of the source code, and the use of the CHAWS archive file reading routines. The Trending process has been modified to use program arguments to determine the trending dictionary and data archive files to read. This is required for the trending of CHAWS or WSF data parameters, which are stored in separate archive files.

3.1.3.2 The SPREE Trajectory Process

The SPREE Trajectory Process was rehosted, and the Orbiter Attitude Display process for SPREE postflight analysis reworked for CHAWS. The latter was done to use real-time CAS data for CHAWS.

3.1.4 CHAWS Data Display Software

3.1.4.1 Additions to CHAWS Data Display Software

Two processes were added to the CHAWS Data Display software. The Data Monitor process displays the current times of each of the three data streams being captured by the Listener process. The Langmuir Probe Status process generates a list of changes in the status of the Langmuir probe in a scrolling text window. The Langmuir probe status log is periodically saved in an ASCII text file.

CHOMP, PC EGSE software, was altered to remove the low and high Langmuir voltage display capability.

The Beta version of the CHAWS Data Display software was released for use at JSC during the STS-60 End-to-End test.

A new process was added to CHAWS Data Display software. The WSF Echo Command process lists the latest WSF commands echoed in the real-time telemetry. This command echo log is periodically saved in an ASCII text file.

The WSF System Status process was added to the CHAWS Data Display software. It lists the current state of the WSF battery usage indicators and instrument power indicators. This WSF system status log is periodically saved in an ASCII text file.

The CHAWS Real-Time Data Display software, Release #1, was delivered for use at JSC during the STS-60 JIS #4, which was attended. Release #2 was delivered for use at JSC during the STS-

60 JIS #6. Release #3 was delivered for use at JSC during the STS-60 flight.

The Rendezvous Profile display was enhanced to include a plot range scaling feature, which allows the user to expand or shrink the range of the v-bar or R-bar in 10% increments. After each rescaling, the current profile plot is redrawn in the new scale.

3.1.4.2 Enhancements to Attitude Display Process

Several enhancements were made in the Shuttle/WSF Attitude Display process. Icon and text indicators were added for signaling orbiter events, such as thruster firings, water dumps, and FES usage. Also, for each event, a small colored plume is drawn on the graphic rendition of the shuttle at the appropriate location. Due to the intensive graphic operations performed, the Attitude display process consumes a sizable portion of the CPU, and sometimes interferes with the normal operations of other processes. By allowing small error tolerances in the shuttle attitude being depicted, the amount of CPU usage was dramatically decreased. For future enhancement, a child process was created for displaying a rendezvous profile plot. This display shows detailed ranging information during the WSF retrieval operations. Other enhancements, such as the integration of the RMS arm and WSF objects in the Attitude display, was accomplished.

The Shuttle Attitude process was upgraded to reduce the CPU usage required to determine when a panel is visible. The alteration increased the memory required, but eliminates various redundant numeric operations. The number of panels to define the shuttle body was reduced to further decrease the processing.

An algorithm to calculate particle direction with respect to the ram side sensors was applied. It implements "piece wise" linear equations to derive the angle measured from the sensor zenith. The dependent variable is based on the ratio of two detector measurements, with the selection of detectors based on maximum data counts.

A Sun/Unix -based process was developed to process CAS telemetry captured during the STS-39 Shuttle mission. This process was enhanced to extract additional CAS data values, such as the RMS arm joint angles, RMS end reference point and attitude, and the KU-band radar values. These values will be used during the real-time attitude display process for depicting the orbiter, RMS arm, and the WSF in their relative positions.

The "alpha" version of the CHAWS software was released for use during the first STS-60 Mission simulation at JSC. This release caused the CHAWS software to be under version control.

Two new processes were added to the CHAWS Data Display software, namely, the WSF CDD Status process, and the CHAWS Ram Direction Display Process.

The latter process lists the experiment data packets being loaded in the eleven "Continual Data Device" (CDD) slots of the WSF telemetry data frames. This WSF CDD log is periodically saved

in an ASCII text file. The CHAWS Ram Direction Display process gives a schematic representation of the relative amount of particles being detected by the CHAWS ram side MCP units. Based on these particle counts, the direction of these particles is calculated and annotated. The ram and B-field angles, as calculated based on the WSF attitude values, are also annotated.

3.1.5 CHAWS Mission Support Hardware

3.1.5.1 Shuttle Remote Manipulator System (RMS)

Real time data for the shuttle remote manipulator system (RMS) known as the arm, will be processed to visualize various WSF operations. The visualization process required the development of various routines to convert the arm joints through their respective sequences. CAS data will be the only source for arm information during the CHAWS mission and postflight as the UCAT data product. Individual joint angles are represented in the CAS data stream as integer counts, and required the derivation of conversion constants.

3.1.5.2 Components for JIS #1

The components that make up the CHAWS Mission Support hardware for JIS #1 were shipped, assembled, and tested in time for the simulation on October 5, 1993 at JSC, Houston, TX. This included the task of making special cables to connect the PDI and CAS data cables to the PCDecom break-out cables on the PC GSE. The special cables were only temporary equipment and were replaced by two cross-over boxes with bulkhead connectors. During the JIS, all components performed as expected.

3.1.5.3 Additional Equipment for JIS #4

The second Sun workstation, DSSUN1, and a Tektronix color screen printer were connected to the existing Sun and PC at PL. The latest release of the CHAWS software was loaded onto the two Suns and tested. A test set of previously recorded data was run to test the data flow through the entire system. In December 1993, JIS-4 was conducted and supported by the CHAWS mission support team by listening to the necessary voice loops and verifying that all relevant commands were executed correctly and received in the data stream. During the JIS, the PCDecom and CHAWS software packages were upgraded to receive and process 128K downlink data. The existing cables, that were presently being used to receive CAS and PDI data, had to be traced by cable number and label to the proper CIP panel to repatch them for 128K real-time (RT) data and 128K playback (PB) data.

3.1.6 Support of WSF/CHAWS Instrument on STS-60

3.1.6.1 Pre-Flight Support

Final preparations were made to support the upcoming flight of the WSF/CHAWS instrument on STS-60, scheduled for launch for February 3, 1994. All Ground Support Equipment (GSE) was assembled and tested, as well as the PCDecom telemetry software and CHAWS Data Analysis and Processing Software (CHAPS). An 8mm tape drive was added to the existing system to provide a means of archiving all data to be collected. The latest release of CHAPS was installed on both Sun workstations.

A Technical Report [Tautz, 1996] discusses calibration files development for the Retarding Potential Analyzers (RPAs) for the CHAWS Experiment. These files were used as inputs to further programs which calculate the detector efficiencies as a function of Mach number. The detector efficiency files have subsequently been used as inputs to the CHAPS and CHUNKS codes [Roth, 1996] to allow for the calculation of particle fluxes and densities.

The CHAWS experiment has sixteen RPA sensors. Eight sensors are on the ram side of the shielding disk and eight more are on the wake side. The locations and orientations are shown in Figure 10. The arrows in the figure depict the outward normals for the apertures. The ram side detector normals are at angles of -40 and 40 degrees from the center normal. The diagram is not to scale. Calibrations data for both, the ram and wake sides, was taken using the CALSYS 2 system and the MUMBO vacuum chamber [Pakula and Cooke, 1995]. This data consisted of counts /sec in each of the sixteen detectors for varying beam currents and different orientations with respect to the beam. The data was processed in terms of the summed response of each of the detector apertures. The calibration data for the RPA sensors was analyzed by reducing the data to a manageable form by implementing an averaging procedure. The ram side averaging is based on a method which generates interpolated calibration data along emanating outwards from the center of each aperture. This line data can then be averaged down to represent the response of each detector, as a function of the polar and azimuth angles with respect to the aperture normal. Thus, the resulting calibration files consist of a matrix of numbers, with the rows representing the response along the aperture polar angle and the columns giving the response with respect to the azimuth angle. Files of the same format were constructed for the wake side detectors, but the method of averaging varied according to each detector due to the sparsity of the data. The analysis was done on a Silicon Graphics workstation under the UNIX operating system.

Figure 11 shows CALSYS data from the ram center detector and Figure 12 shows wake end detector data lines.

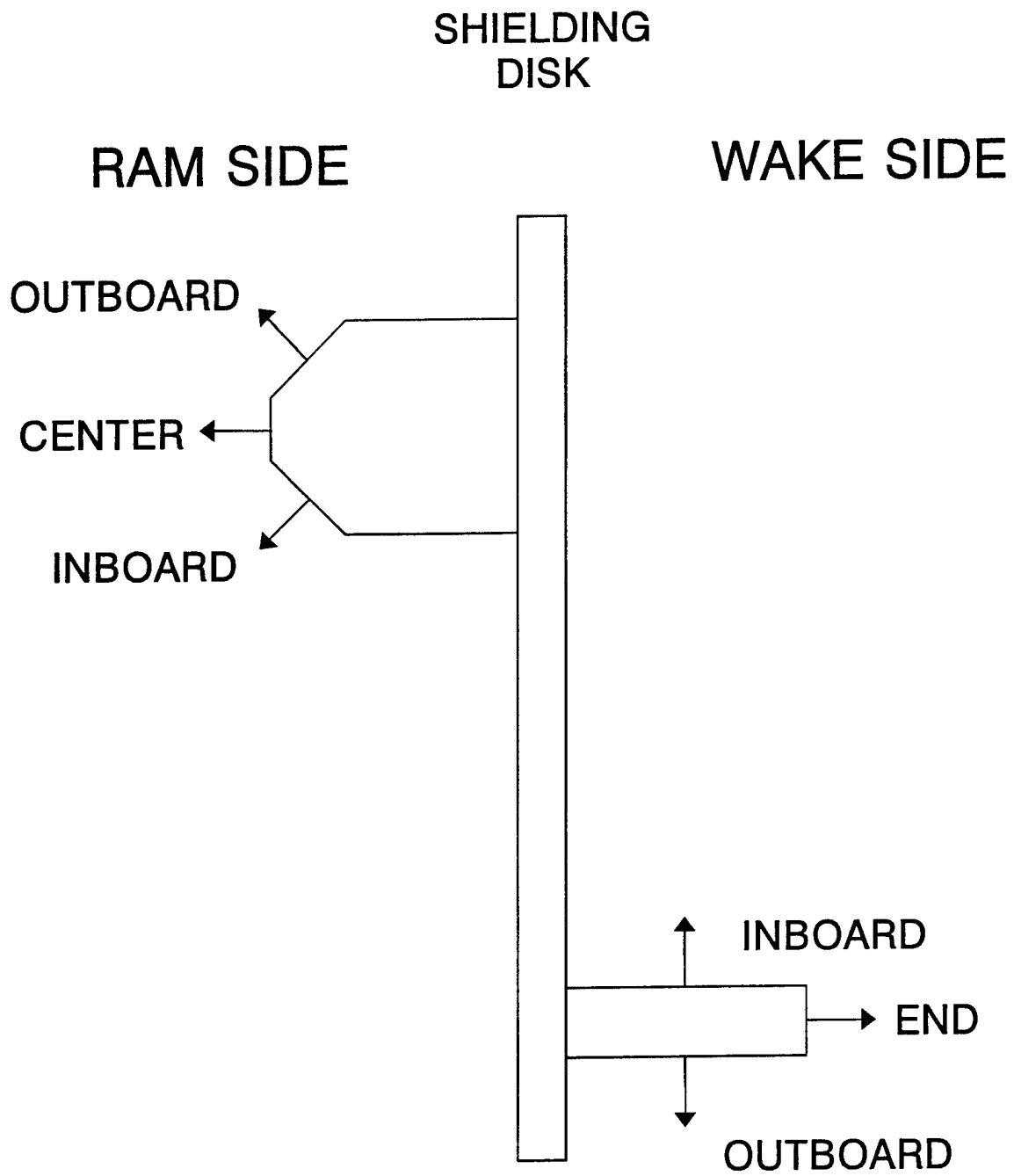

Figure 10. Schematic of CHAWS RPA detectors.

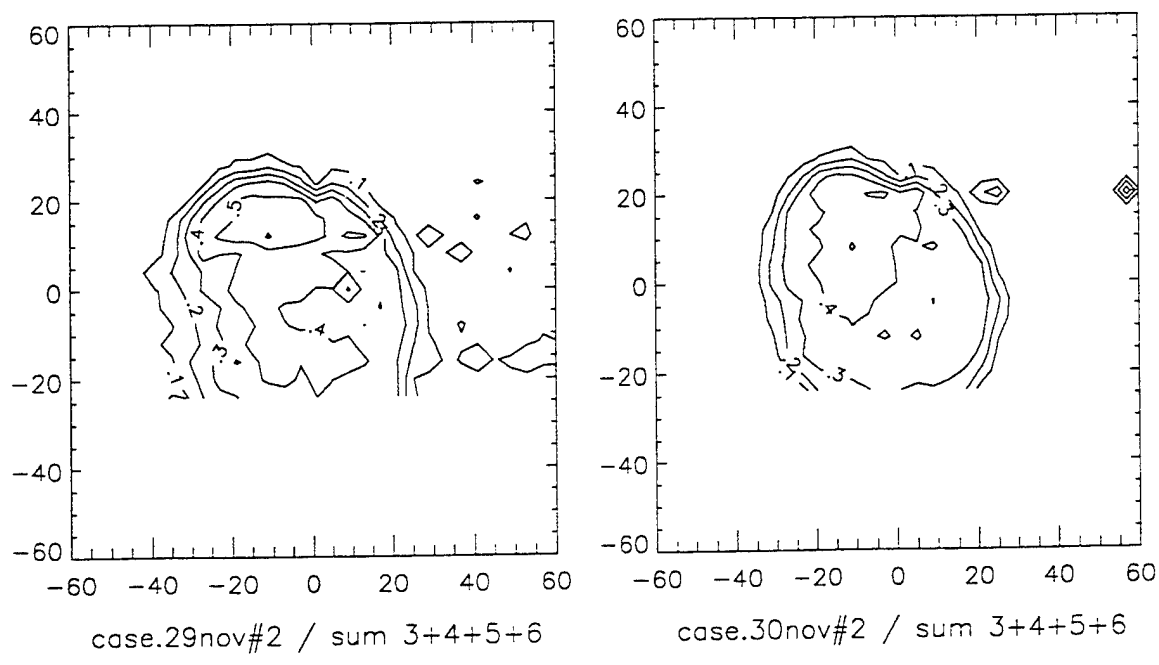
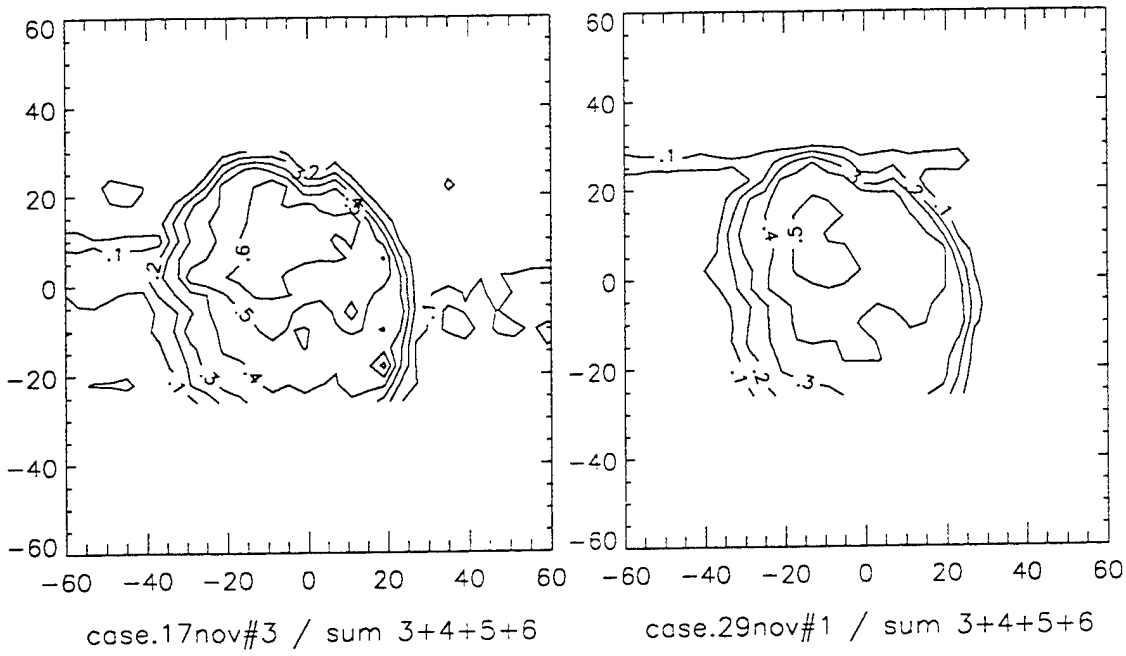

Figure 11. Ram center detector CALSYS data for nov 17,29,30.

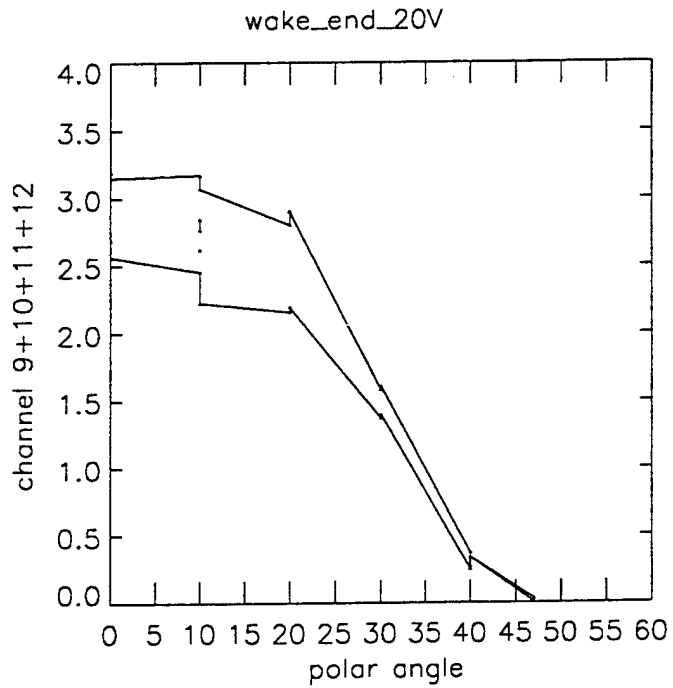
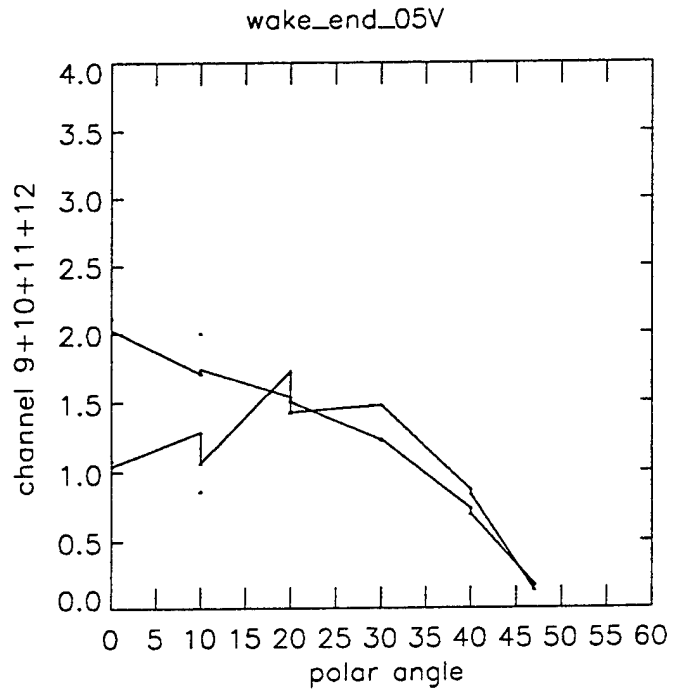

Figure 12. Wake end detector data lines.

While testing and configuring the entire CHAWS GSE system, data was collected and archived as an exercise in preparation for collection of CHAWS instrument data. Additional tasks performed during the time between power up and power down included: 1) Keeping a running log of GMT times for all LOS periods such as periods of bad communications, start and stop times of all playbacks, data dumps to the 8mm tape, and any significant system maintenance events or problems; 2) Requesting playback of data that was unable to be collected in real-time due to system maintenance; 3) providing technical support to CHAPS users; and 4) maintaining the CHAWS GSE hardware and software.

3.1.6.2 Launch and Post-Flight Support for STS-60

CHAWS data was successfully obtained from the 128k data directly from the SCR data downlink in real-time. To accomplish this, the 128k downlink data was decommutated by the PCDecom software and broadcast to the two Sun workstations and a laptop PC. The downlink was processed into separate 100% Real Time (RT) and Playback (PB) streams, as well as various CAS and PSI streams. During the mission, the CHAWS data team collected approximately 8 gigabytes of 100% RT and PB data, and about 1 gigabyte of CAS and PI data. This includes about 18 hours of CHAWS instrument data.

The CHAPS package provided useful information in real-time including graphical displays of orbiter attitude and trajectory data, Ram and Wake MCP data, Langmuir Probe current and voltage data, text displays showing CHAWS and WSF system status, and an echo log of commands sent to the WSF.

The software allowed the science team to analyze the data as it was being collected, which enabled them to maximize the amount of quality data that was obtained. They were able to monitor vital system parameters which allowed them to prevent possible damage to the instrument.

The collected RT and PB data files were merged to build a contiguous data set. The files were extracted from tape, merged and stored on GPSSERVER. A chronological time map was built to allow the CHAPS post-flight analysis tools to navigate through the data files to find specific time periods of data. Some of the merged files were run back through PCDecom to create the data base needed to run the CHAPS software for post-flight CHAWS processing.

The CHAWS network listener process was altered to generate new parameters required as substitutes for the PATH and UCAT data products.

Stand-alone utility routines were developed to process the command status field of the WSF PDI data stream. This generates an ASCII data file that can be accessed to determine the WSF commanding during the mission. Other routines were developed to rename the reprocessed data files back to the required mission GMT, and consolidate numerous small files into fewer larger files.

A separate process was developed that corrects the resolution of the orbiter downlink (OD) trajectory data fields. The resolution contained in the telemetry is about 4 seconds and the OD data resolution is 1 second. The final data resolution will contain 1 second resolution trajectory derived from the 4 second resolution data. A linear interpolation routine would have assumed the time period calculated was within the current and next trajectory sample. The technique applied performs a propagation of the shuttle state vector for the associated 1 second data set time. This method used a second order Nystrom-Lear Integrator with simplified Earth gravitational model (J2 term only). The results were compared for long propagation time period differences, and found to be the best method with the least computational burden.

A postflight data survey process was developed to access the CAS, CHAWS, and WSF data bases in a time-synchronized fashion. This process emulates the listener process, filling the appropriate shared memory segments with the data accessed from the data bases, then setting the corresponding semaphore signals. This allows the real-time data display processes to be used for postflight virtually unchanged. The postflight data survey process was installed after its final testing and the completion of the postflight data bases.

The Orbiter Down link data header was updated prior to processing by the PCDecom to correct the imbedded time code and status bits, which was required to compensate for the playback and real-time data merge procedure that was not updating these parameters. The data headers were updated only to use in the reprocessing by the PCDecom.

A process was written to correctly name the Network Listener generated files, since they are normally identified by the SUN workstation software with receipt time. The process examines the data for the first valid internal data time and applies that time for the file name convention. All Listener processed data files were merged to produce less data files containing larger time periods.

WSF command logs were produced from the Listener generated files to process the WSF system packets "RT_WSF", and extracting non-aged command echo strings. The output was further reduced by the elimination of "DGERR" messages from the command logs.

An updated version of the CHAWS Analysis and Postflight Survey (CHAPS) Software was released. Many software enhancements are to access the 100% postflight data base and to improve the interprocess communication facility management for more efficient use of the workstation resources. The previously developed Data Survey process, which accesses only the real-time CHAWS data base, was replaced by the Merged Data Survey process, which accesses the CHAWS, WSF, and PATH data bases in a time-synchronous fashion. A switch was added on the command panel to allow the user to choose the color scaling form of the graphical CHAWS data displays, full color or grayscale. The trending process was enhanced to allow a longer time period and to enable the display window to be shortened.

The Attitude and Trajectory Display processes were reworked to allow the user to view the orbiter information in a "Survey Slave" mode or "Independent" mode. When in the "Survey Slave" mode, the displayed orbiter information is controlled by the Merged Data Survey process and allows the user to track the orbiter information in parallel with the CHAWS instrument data displays. In "Independent" mode, the user selects the time for the orbiter information display, and may view the sub-second thruster firing information. The user may step the time of the orbiter information display forward or backward in various increments. Other minor enhancements were made to improve the clarity of the CHAWS instrument data presented in the various displays.

The STS-60/CHAWS Merged Database was completed and installed on the GPSSERVER workstation for use with the CHAPS software. To complete this task, the raw merged downlink data files were run through the PCDecom package and produced processed files for the CHAWS, WSF, and PATH data streams. These data files were then merged into, approximately, 12-hour segments to aid in referencing the data. After backing up all data to 8mm tape, the database was configured on disk partitions of GPSSERVER.

The data and postflight software partitions were exported, with read-only mount permissions, to the CHAWS, SPREE, and SOC9D workstations. A backup copy of the data and postflight software was also copied onto the CHAWS workstation to use only in case of a problem with the primary server, GPSSERVER. The system was tested on each of the client machines, as well as the server.

A similar approach was taken to export the STS-46/SPREE data and software from the GPSSERVER to the same three clients. The reasons for exporting data and software to client machines are: 1) to allow multiple machines to access common data sets without requiring additional disk space; 2) to allow the postflight software to be run on the client CPUs, thus, freeing up the server's CPU to allow it to provide faster data base access; 3) Changes to the software or data need to be made on only one machine.

The PATH-equivalent data base was changed to include the local magnetic field strength. All data base routines were updated to reflect this change.

The revised CHAWS data base, featuring a corrected GMT, was installed on the GPSSERVER workstation to use with the CHAPS software. All CHAWS data access and presentation is now based on this corrected GMT, rather than the CHAWS PDI time. A new release of the CHAPS software (release 5) has been installed on GPSSERVER, and includes the above-mentioned enhancements and the modifications necessary to access and display data from the revised CHAWS data base. Routines were written to correct the CHAWS internal time code into the actual GMT time code. The initial approach applied the CHAWS DPU "power on" PDI time as the

The line graph pullouts from the CHAWS MCP Data Display were enhanced to include a "Linear" or "Logarithmic" data scaling choice and a data smoothing capability.

A special routine was developed that processes test chamber data, captured by CHOMP. It produces data files for use by the SUN CHAPS software via a modified data survey process. This allows a comparison of calibration data with actual flight data.

The Sun SPARCstation 1+, SOC9D, was upgraded from SunOS 4.1.1 with Open Windows v.2 to SunOS 4.1.3 with Open Windows v.3. This was done to allow the CHAWS and SPREE postflight software to run more efficiently, directly on SOC9D.

An Alphasatronix 32-cartridge optical jukebox was installed and configured for GPS on Sun workstation, AMENRA. The jukebox will provide many GPS projects, including CHAWS, with approximately 32GB of additional online storage and allows for storage of additional large data sets external to the machine while keeping them in the jukebox inventory catalog.

Routines were needed and written to extract the WSF Continuous Data Devices (CDD) from the PDI data stream and store the data in device specific files. Mass Spectrometer and Pressure Gauge data were the primary data devices required for further correlation analysis with the CHAWS data. However, there was no Pressure Gauge CDDs in the PDI data set, but pressure gauge data is present at 2 second resolution in the main WSF telemetry. The Mass Spectrometer CDD data was also processed by spectrum and channel to produce continuous spectrum data files, which are to be used to generate spectrograms of mass spectrometer measurements for the CHAWS periods of operation.

The Orbiter/WSF Attitude Display process was revised to calculate and display the "I" and "VxB.L" (DOT should be raised) values that relate to the spacecraft charging effects. The "L" is the distance between the center of the WSF and the Main Propulsion System (MPS) engines of the orbiter.

3.1.6.3 CHAWS/STS-60 Post-Flight Software Enhancements

CHAWS time code corrections were made to compensate for the effects of commanding, and this revealed the need for further improvements of the integration technique. The initial approach would only integrate the known drift error during operation periods and not correct for time code delays due to commanding. The complete CHAWS data base was divided into time segments and linear regression performed. The new results indicated substantial differences for periods when CHAWS data was acquired after long idle periods. The CHAWS telemetry buffering system can handle 4 frames, 30 seconds of data, prior to suspending transmission of data to the WSF data handler. This effect was identified as the cause for discontinuities in the drift correction, since the data remains in the buffer until the next acquisition period occurs. These factors indicated that the CHAWS time code counter, not universal time, was the appropriate dependent variable. The complete CHAWS mission data base has been regenerated using this method to produce a corrected time code, and to confirm that the association of universal time was properly performed with respect to shuttle thruster events.

Several enhancements of the CHAWS data calibration routines were done. A new configuration file, containing the efficiency factors of the ram MCP detectors, was added for use with the CHAPS software. The detector efficiency factors are used when calculating the ram MCP "Calibrated Counts" value. A new calibration type, "Count Rate", was added to the calibration choices in the MCP Data Display process. This calibration is defined as the product of the raw counts and the time calibration factor. For the ram side MCP units only, a factor of two was inserted in the data calibration definitions of "Count Rate" and "Calibrated Counts". The procedure for calibrating data from multiple MCP units was revised to sum the individually calibrated data values, rather than calibrate the summed data values.

The Orbiter Event Display process was added to the CHAWS and Postflight Survey (CHAPS) software package. The orbiter thruster firings, water dumps, and FES usage event as are presented in a time-based display, where the active events are indicated colored blocks in their appropriate row or rows. The OED is sized identically to the MCP data display and Langmuir Data display and contains periodic time annotation for correlation reference. The user may graphically "pick" times of the event data on the display, invoking a scrolling text window, which shows the water dump status, FES status, and sub-second thruster firing information for the selected time. The user may step forward or backward in time, as in the MCP or Langmuir Display pullout line graphs.

The annotation of the sun angle to the orbiter bay normal was added to the Attitude Display process. an indication of the orbiter being "Sunlit" or "Eclipsed" is also annotated.

The revised CHAWS data base, featuring a corrected GMT, was installed on the GPSSERVER workstation to use with the CHAPS software.. All CHAWS data access and presentation is now based on this corrected GMT, rather than the previously used CHAWS PDI time. A new release of the CHAPS software (release 5) was also installed on GPSSERVER. This release includes the enhancements mentioned above and the modifications necessary to access and display data from the revised CHAWS data base.

The CHOMP documentation and Users Guide were improved to reflect the added features of the new version. The document and CHOMP were collected in preparation for crew training for the months ahead. This new version of CHOMP should reflect all of the capabilities that the crew will use on orbit to monitor the health and status of the CHAWS instrument.

Data files captured during the WSF MRT test were processed for command history and data dropout ratios. The CHAWS telemetry data rate was reviewed for data rate delays due to the effects of the telemetry band width of other instruments.

3.1.7 Preparation for CHAWS/STS-69 Mission

3.1.7.1 A Real-Time Version of the CHAPS Software

A real-time version of the CHAPS software was prepared for the flight of CHAWS on WSF-2 for the STS-69 mission. Several revisions were made. The attitude process was enhanced to display two values of the orbiter-to-WSF range. The first range is calculated from the difference of the vehicle state vectors, and the second is obtained from the Ku-band radar range data. The display of both enables consistency checking between the two values. The current-vs-voltage graph of the CHAWS line graph process was clarified by using averaging for both the current and voltage values. The application of a new CHAWS data calibration scheme, based on the WSF ram direction, replaced the previous detector-based data calibration scheme.

A new aperture-based CHAWS MCP data calibration method was integrated into the real-time version of the CHAPS software, which was used for CHAWS on WSF-2 during the STS-69 orbiter mission. Previously a MCP-based detector efficiency calibration method was used. The flux and density calibration tables for each of the six apertures, for five different Mach numbers, were obtained from the researcher. The calibrated MCP flux or density values are calculated by multiplying the MCP corrected count values by a calibration factor obtained from the appropriately loaded table. The calibration factor extracted from the table is determined by the aperture of the selected MXP unit, the ram direction azimuth and elevation angles in relation to the aperture, and the user-selected calibration Mach number.

3.1.7.2 New Requirements for PCDecom

PCDecom configurations were updated to meet new requirements for rendezvous and proximity operation accuracy. The configuration changes were applied with other modifications to satisfy the postflight requirement of high data rate thruster information.

3.1.7.3 IIS #5

The IIS #5 for STS-69 WSF Rendezvous, Proximity Operations, and Retrieval was held at JSC, Houston, TX on 6 June 1995. The 12 hour simulation allowed for the first opportunity to test the proximity operations calculations and displays within CHAPS > These items were developed for STS-60, but were not tested with real orbiter downlink data. The availability of new range distance parameters was compared to the original Ku-Radar range. The SNAP range contains less noise than the Ku-Radar range and tracked closely with the data on the NASA display in the POCC. The calculation of range from the relative target position continually showed an undeterminable offset, could be a result of the target and orbiter position being known only to within the update state vector quality and the resolution of the propagation performed. The relative target position is sufficient as an estimate for rendezvous. However, for proximity operations, less than 200 feet, the use of the SNAP range is required. A method to transform SNAP azimuth, elevation and range to relative target position was developed and made available

for testing during the JIS #7 schedule.

3.1.7.4 Third Sun and TRACKER Workstations

The third Sun workstation was used during STS-69/CHAWS. The TRACKER workstation was used to display CHAWS and Wake Shield data to the modeling team and served as a backup to the archiving and science workstations. In order for TRACKER to become available for use, the SPAS3A workstation needed to be reconfigured.

3.1.7.5 Real-Time CAS Data Archive Files Format

The real-time format of the CAS at archive files were changed to match the postflight format. This was required for the pullout line graph process to display the calibrated MCP flux or density values, as the orbiter attitude and RMS joint angles are used to determine the MCP aperture ram direction angles. This file format change enabled the orbiter event display textual pullout feature to be available during real-time operations.

3.1.7.6 The CHAWS Calibration Globe Display

A new process was added to CHAPS, namely, the CHAWS Calibration Globe Display, which presents the calibration values for a specific CHAWS aperture, calibration type, and Mach number for as a color-coded sphere based on the aperture ram direction elevation and azimuth angles. The user may interactively select the CHAWS aperture, calibration type, and/or Mach number for display. The user may also vary the viewing position, specified in terms in terms of the aperture ram direction elevation and azimuth, via GUI sliders. Alternatively, the user may query the orbiter/WSF/CHAWS data loaded in the shared memory to calculate the current ram direction angles for the selected CHAWS aperture.

3.1.7.7 Revisions for MCP Data and Langmuir Data Display Processes

The data value-color scale conversion method was revised for the CHAWS MCP Data and Langmuir Data display processes. Instead of all data values exceeding the scale maximum being mapped to white, a data saturation region was included at the top of the color scale, ranging from the data maximum to 10 times the data maximum. All values exceeding this saturation maximum are now mapped in gray. The CHAWS MCP Data display was modified to reduce the number of data image panels from four to three.

3.1.7.8 JIS #7

JIS #7 was supported at JSC in July 1995. During this JIS the target range algorithm was tested. The results indicate that the target information contained in the orbiter down link is sufficient for the relative position and distance between the WSF and the orbiter. The only discrepancy occurs when the WSF is within 100 feet of the orbiter's primary measurement point. There is no known

requirement for target position information within this distance, since the CHAWS experiment is not operational during this period.

3.1.8 Preparation for Launch and Post-Launch of STS-69 WSF/CHAWS

Additional preparations were made for the CHAWS mission after a delay of the launch. This added time allowed for further review of the mission operations procedures for the hardware and software.

PCDecom configurations for STS-69 orbiter downlink and WSF-02 telemetry were developed.

3.1.8.1 Modifications for Postflight Software

The postflight version of the CHAWS Analysis and Postflight Survey (CHAPS) software installation was modified for the addition of the two Solaris workstations as CHAWS data analysis platforms. Two Sparc20s, named SPREER and SPREEST, ran the Solaris 2.4 operating system, while GPSSERVER ran the SunOS4.1.3 operating system. A script was installed to first determine the architecture of the machine into which the user is logged, and then run the appropriate version of the CHAPS software.

More work was done on the CHUNKS program. In order to improve the statistics of the counts in the wake RPA sensors, an option was written to accumulate the data over a number of CHAWS frames. The same file format is used for the normal CHUNKS channel output. The difference being that the file is continually overwritten with the accumulated data, instead of being displayed sequentially. The file header lines contain the start and stop times for the run and the number of data frames that have accumulated.

3.2 WAKE SHIELD/CHAWS DATA ANALYSIS

3.2.1 Software Testing and Development

3.2.1.1 X Windows Coding

A small test code was written to experiment with X windows coding and to compare to an existing IDL program for display of magnetospheric models. The graphics interface is based on OSF/Motif widgets and uses the User Interface Language (UIL) to set up the widgets. Three types of widgets were implemented: one for control of the observer's viewpoint, one for toggling objects, and one for implementing rotations and scale factors. The code utilizes routines taken from the graphics program IRMA to build the graphical objects.

3.2.1.2 DYNAPAC Code

The DYNAPAC code runs were continued. A test case was done which converged after eight Poisson-Vlasov cycles. The same current was obtained as would be from a comparable S-cubed run. Some of the convergence parameters are varied to attempt to speed up the Poisson algorithm, which seems to use many more "space charge" iterations than POLAR typically uses. A high density case was started to test the limits of the code. This case had difficulties with unphysical density variations at the inner grid boundaries (the problem has 15 nested inner grids). To alleviate the problem, the number of space charge iterations was increased in the Poisson solution, to smooth the charge. Also, the number of subdivisions of the particle generator cells was increased so that the source ion distribution would send more trajectories into the sensitive regions. Neither of these attempts resolved the problem.

A DYNAPAC simulation of the CHAWS ion collection for a -2KV probe was done. The ion ambient density was allowed to vary by a factor of 10. The run were done by making small steps in the density, so that convergence could be monitored at each step.

The DYNAPAC executables were transferred from the INDIGO computer to the newly acquired INDIGO 2 workstation (they have compatible CPUs) and timing tests were done. The new machine provides over a factor of three increase in speed.

Two DYNAPAC auxiliary routines were obtained from S-Cubed for analysis of particle trajectories that hit the probe. These routines were compiled and tested on our CHAWS simulation output files. The routines allow one to study the currents to selected probe cells and to plot a histogram of the angular distribution of impinging particles.

The convergence properties of the DYNAPAC solutions were investigated by continuing the runs to higher iteration numbers. It was found that the previous convergence test (two consecutive stable cycles) is not always adequate, and it takes about 12 iterations to obtain a steady state.

Parametric studies of DYNAPAC simulation of the CHAWS ion collection behavior was transitioned to simulations of post flight data. The data was examined with a view towards selecting the most suitable cases for study.

3.2.1.3 Further Software Upgrades and Development

Necessary routines were written to correct the CHAWS internal time code into the actual GMT time code. Initially, the CHAWS DPU "power on" PDI time was used as the initial reference and the CHAWS internal time code was added to obtain the GMT. This produced results that showed a slow drift in the CHAWS internal time code. There was still a decay coefficient present when the instrument was powered on but not transmitting data. A general estimate was applied to the data to give consistent results.

WSF Mass Spectrometer data displays were prepared to assist in the correlation of events seen by CHAWS. A generic raster image display routine was developed to perform the graphical displays.

The Sun workstation AMENRA was upgraded to improve the data analysis capabilities of GPS. The Boot PROM was upgraded to prevent problems that could be caused by the optical jukebox. All existing file systems were transferred to the new devices. The existing operating system, SunOS4.1.2, did not provide support for the new 2.1GB disk, so it was upgraded to SunOS4.1.3 prior to the disk installation. A new release of the jukebox software was installed with the necessary OS patches.

A prototype program was developed to access the CHAWS data base and to output plot files. The code is modeled on the existing merge data routine. The program writes up to four output files to represent data and calculations derived from the orbiter CAS, wake shield WSF, and CHAWS data bases. There are two CHAWS output files, one giving summary information for each 7.5 second data frame, and the other giving the detailed channel information for each frame. The program reads an input file that specifies which CAS, WSF, and CHAWS variables to be output. All of the CHAWS data records are available and selected variables can be chosen from the other two data bases. The time range for reading the data can be set from a GUI menu, as well as options for controlling the data flow rate and an option for interlacing the data. This program will be used to scan the data for correlations and to test algorithms for computing physical variables of interest, such as ambient particles.

The CHUNKS program, for accessing and plotting CHAWS data, was enhanced. A command line batch mode option was added to allow for easier trending. The start and stop times and format controls are now read from an input file, instead of being set by the GUI. The GUI mode is still available, in which case the input file specifies the GUI menu defaults. A directory was set up on the GPSSERVER for general access, with instruction files and sample input files. The program was upgraded to adjust to CHAPS modifications, such as the change in the CAS data base structure, and to incorporate the post flight calibrations obtained for the ram side RPA detectors.

An improved fitting procedure for CHAWS RPA calibrations, using two passes, was developed for the ram-side sensors. The first pass does all fits that have a complete range of data available. The second pass treats the incomplete data samples, using information from the first pass to help fill in the gaps. Fits were made for each of the four central ram-facing sensors and for the summed response of these detectors.

The input data base for CHUNKS was expanded to include more variables, and the user interface was made more robust. The calculation of ion density was upgraded to reflect the new calibrations and documentation files that were written. The following analysis scheme was set up in order to use the CHUNKS program to look at CHAWS data: A preliminary CHUNKS run is done to generate a file containing the raw trending information for the mission. The UNIX AWK

utility is then used to extract the time limits for all of the IV sweeps, about 60. The times-list file that is generated is input into another UNIX script which runs CHUNKS to extract the data surrounding each IV sweep. Typically, the data is selected for a range extending from 2.5 minutes before and after each sweep, and hence, gives a picture of the experimental conditions that prevails during the time span when the data was being taken. The data files from the above script are then read by an IDL line plot package which was developed in the program. This IDL program can display the characteristics, along with various panels which depict the measured and calculated variables for the given time range.

The merge algorithm for CHUNKS was adjusted to be based on CHAWS time, the same as in CHAPS, rather than PDI time. The input file format was made much more flexible by implementing a name parser that recognizes the string labels identifying each variable. This allows the input file to be much shorter, since only the active variables need to be listed. In addition, one can disable the output column ordering with a logical switch to choose or not to choose a variable. A first pass was made through the CHAWS data to extract start and stop times for current-voltage sweeps. This information was input to an IDL plotting package and used to generate a set of about 50 plots containing the IV curves and surrounding background information.

A second pass on CHAWS data using CHUNKS was made through the day 39 data to generate IV curves and surrounding background information. To aid in the study of the on-board instruments, plots of the four recorded CHAWS temperatures versus time were generated for days 37, 38, and 39. These plots gave an indication of the temperature ranges and fluctuations during the mission.

The CHAWS internal time code correction process was continued in order to correct various time code delays and the lack of continuity. This brought about the application of an alternative approach to calculate the delta time correction. The new method differs from the original integration of drift rates, since each operation segment is fitted to a linear equation. The two methods were compared and tabulated to determine which method or combination will represent the actual operation of the CHAWS internal time code unit.

A VT 320 terminal and an Uninterruptible Power Supply (UPS) were added to the GPSSERVER workstation. The terminal provides direct access to the machine for easier system administration. The UPS will protect the machine and keep it operational during "brown-outs" and power outages. In addition, the BootPROMS were upgraded in the SPREE and CHAWS workstations to make them compatible with future software and hardware upgrades. The "pcnfsd" daemon was added to the AMENRA workstation to allow its file systems to be accessed by any PC in GPS.

A new BootPROM was installed in the GPSSERVER workstation which allows the workstation to fully boot automatically after a power failure, or reboot of the machine. The prior version would cause the machine to stop booting until the second SCII bus was physically detached and, then, reattached.

A SPARCstation 1+ was configured and installed in GPS for use as a file server, known as GPSSER2, which has 27 gigabytes (GB) of disk space and will be used as a staging area for GPS project data.

The on-orbit CHAWS data processing capability, CHOMP, was modified to accept test chamber data files as input. This allows for the processing of data captured during chamber calibration and checkout. The original method required various operations to process the data and generate data files that could be transferred to the SUN for use with CHAPS. The current method is more direct, since the package operates on the P that captured the data from the instrument. This could be further improved by eliminating the interface and producing a CHOMP which would perform commanding and data capture for the instrument in the chamber.

A CD-ROM was crated containing the CHAPS package, including the CHAWS postflight software and related STS-60 CHAWS data files. The CD-ROM allows faster off-site analysis by eliminating the need for an Internet connection to GPSSERVER in order to access the package.

CHOMP was tested on a ZEOS-386 for use during the integration of CHAWS-2 with the Wake Shield Facility (WSF). The ZEOS showed processing limitations possibly due to the need of CPU cycles required to process the PDI data. Further testing indicated the ZEOS could receive the data but was unable to unpack the PDI data and extract the CHAWS data packets. CHOMP software was modified to decrease the processing but was still excessive for the ZEOS. Similar testing was performed on the development LapTop 386 with success. The solution for the integration period was to use an available Color Gateway-486, which also tested successfully. The software and Borland "C" compiler was installed on the Gateway-486.

CHOMP was used to confirm the WSF commanding of CHAWS during the integration. Three versions of CHOMP were used with each performing differently. However, these differences did not affect the data capture feature of CHOMP. The presence of multiple versions indicated the lack of proper configuration control, which was corrected. The integration data collected was evaluated and it was determined that the CHAWS data placement within the PDI data had been changed. This placement difference would have produced the differences noted, and could account for the statement of different results from the three versions.

CHOMP software was modified for the new PDI format. This version was installed on the Gateway Nomad LapTop and used during a January 1995 test. Data from this test were returned to PL for evaluation, since there were indications of problems with CHAWS packet transmission and processing by the CHOMP. An initial review of the files indicated data losses, but did not supply sufficient information to determine the cause. Software was developed to process the archived data and examine the individual packets for their received sequence. This revealed a periodic repetition of previously transmitted data. The original data formats defined an age byte which was set after transmission of data. This was found to be true for the majority of the data, excluding a set of transmissions at a 60 second resolution. This was confirmed with the WSF data representative.

The Sun workstation GOSSERVER2 has been implemented as a secondary NIS server for the GPS NIS domain. It will take over the NIS file serving duties if GPSSERVER goes down for any reason. CHOMP was improved with the capability to monitor all the received CDD packets contained in a PDI frame. The method was desired to monitor the age byte error noted during previous testing. The addition of the PDI monitor prompted a further addition, which tracks the received telemetry frames as a function of time and CHAWS frame position. This option will track CHAWS frames versus time, which can be used to determine lag due to the internal buffering of CHAWS.

The Sun workstation AMENRA was moved from the Central Site's PLH.AF.MIL NIS domain to the GPS domain. Now it gets NIS files from either GPSSERVER or GPSSER2. Thus, AMENRA is a member of a locally configured domain, which is easier to control and customize. Also, it frees AMENRA from facility problems.

A QMS Magicolor laser printer was installed next to the CHAWS workstation. The printer was connected to the network and the TCP/IP Unit Host software was installed on all machines that are currently in the GPS NIS domain. The software will be loaded on SGI workstations BRUCE and NASHOBA.

To comply with network security regulations, the workstations in the GPS domain had their operating systems upgraded and/or patched to eliminate specific network vulnerabilities.

Calibrations for the CHAWS ram-side and wake-side sensors were analyzed. Measurements from the MUMBO vacuum chamber were put into a set of data files on a UNIX workstation for analysis. An IDL program was written to read in the data and display it in the form of line plots or 2D contour plots. Some preliminary work was done to fit the data with trial functions.

Further work was done analyzing the calibrations for the CHAWS ram-side sensors. The measured data for the central channels consists as counts as a function of the angle of the impinging source beam. The behavior of the sensors was explored by projecting radial lines through the four quadrants of the angle space, calculating the interpolates along the lines, and fitting the lines with various functions. It was found that the lines can be adequately fit using a five harmonic trigonometric expansion. Also, the mapping between detector polar coordinates and measured SYSCAL coordinates was corrected for a small error and the data lines were recalculated. A new modeling function was developed and fitted to the calibration data. This function requires fewer fit parameters and gives a simpler representation of the data than a previous trigonometric function.

In order to comply with recent network security regulations, the workstations in the GPS domain had their operating systems upgraded and/or patched to eliminate specific network vulnerabilities. The SPREE, CHAWS, and GPSSER2 workstations were upgraded to SunOS4.1.3_U1 with Open Windows 3.0_u1. All patches recommended by Sun were installed and all AFCERT regulations were met. The GPSSERVER, SOC9D and AMENRA workstations ran SunOS4.1.3 and had the

major network vulnerabilities patched. They had to be upgraded, too, to comply with all AFCERT regulations.

Testing of WSF-2 data communication with CHAWS was performed in February, 1995 at the integrator facility in Houston, TX. All data collected during the test was sent to PL for evaluation. A complete command history was generated from the hand logs and the telemetry command echo field. This information was used to evaluate the internal CHAWS buffering and the effect of other instruments on the data transmission.

Three CD-ROMS were produced, each containing the CHAWS Postflight Software and STS-60 WSF/CHAWS data. A copy was sent to S-Cubed and SVEC to provide them with quicker access times when reviewing the data. The third copy was kept for archiving purposes. The CD-ROMS were produced to overcome a slow response when using packages remotely.

Pre-mission system preparation was done for the STS-69 mission in support of the CHAWS project.

CHOMP Version 5.2 was delivered for use in crew training sessions. It contains 5.1 with the requested feature for a confirmed exit prompt, and does not halt or hamper the collection of incoming data. CHOMP Version 6.0, the baseline version for flight, was developed, tested and delivered. It contains all of the features of the prior versions, but is designed to use with the PCDecom flight data formats, which were changed from the first flight, STS-60, since other WSF experiments require data from the PCDecom concurrent with CHAWS operation. The new PCDecom asynchronous transfer will now contain other experiment packets which CHOMP must ignore.

3.2.1.4 Additional Preparations for STS-69 Launch

The third Sun workstation to be used during the STS-69/CHAWS was used in the final simulation in July 95. The workstation, TRACKER, was set up and connected to the existing systems. The system was booted and ethernet connectivity was established to the CHAWS GSE LAN. An updated version of the CHAPS software was loaded onto each of the three workstations. Hardware and software support was provided during the 12 hour simulation. During the simulation, certain features of the Attitude and Rendezvous Profile displays were exercised for the first time with actual simulation data. These displays had not been previously exercised due to lack of Rendezvous test data. Some system parameters were fine-tuned to enhance overall performance. Simulation data was archived, copied to 8mm tape, and brought back for analysis. The full CHAWS GSE was tested and ready for the STS-69 mission.

A final pass was made through the CHAWS RPA detector data to produce a set of pre-flight calibration files, using a central averaging technique that was developed earlier. The ram side measurements were chosen to represent only the data after the last changes made to the detectors. Two passes were made through the data to first estimate and then subtract the background levels.

The radial lines data for each detector were partitioned into four quadrants with any incomplete lines being extended, using an average profile obtained from the neighbor lines in the quadrant. The wake side measurements were averaged over all available data. The resulting calibration files were input to a program to calculate detector efficiency as a function of Mach number.

WSF Kernco and Balzer pressure gauge data extraction was developed for the plume impingement periods as a stand alone process. This was an independent process, since there was no other access to the real time 100% PDI data frames without major modifications to the CHAWS data stream processor. The 100% PDI archive file produced independently of the CHAWS processing contains all the needed information, and can be accessed while being written.

The eight CDD data packets contained in a PDI master frame are searched for pressure data parameters and the command echo section is examined for indication of commanding for the plume experiment. The pressure data is further calibrated and processed for display in color. The graphical process will annotate the display with the calculated plume time determined from the command echo which defines the timing until the planned plume occurrence. Other features added to the display processing include the ability to step backward and forward through the PDI data file, and the option to expand or compress the dynamic scale of the color scale for the display data.

Final preparations were made for the CHAWS2 mission, scheduled for 31 Aug 95. Mission supplies and the most recent version of the CHAPS software were shipped to JSC. A CD-ROM containing the current CHAPS and the STS-60/CHAWS data was made in order for the PIs to compare the incoming real-time CHAWS data with the STS-60 data running from the CD-ROM.

The algorithms developed for CHAPS to calculate flux and density from detector efficiency tables were incorporated into CHUNKS. Since the structure of these two codes is different, some adjustments were made in handling the input data. The speed of the frame processing could be increased greatly by reading in all of the required calibration tables once in an initialization step, and then, restore them from memory as needed.

3.2.2 Post-Launch Support for STS-69 WSF/CHAWS

3.2.2.1 STS-69 Flight Data Collection and Processing

After a successful STS-69 WSF/CHAWS mission, all data was transported to PL and installed on the GPSSERVER workstation. All data sets were modified to comply with the postflight CHAPS format. CAS data was processed to generate the PATH product used by CHAPS. The WSF attitude information was collected and the proper data files generated for CHAPS. CHAPS requires the attitude and position data bases to properly determine the CHAWS sensor ram direction for usage in the calibration of the data. The real-time collected CHAWS data was also further processed to contain a preliminary universal time code. The final time code reconstruction

process was performed on the 100% reconstructed data base. The complete orbiter downlink data was processed to produce the contiguous data bases for the mission.

The orbiter downlink (OD) realtime and playback data files that were collected during the STS-69 WSF/CHAWS mission were merged to create a contiguous raw data set. The merged OD files were then replayed through PCDecom and CHAPS to generate a complete set of processed data, which will be the data source for the CHAPS post-flight analysis tools, once the time code corrections are completed. The OD data previously processed to generate the 100% reconstructed data base of CAS parameters was used to produce the final PATH data product. The initial step was the generation of a time contiguous orbiter trajectory using the STS-60 PATH data processing method. This procedure performs the time code correction for the association of orbiter state vector to the proper data record time, since the state vector resolution is approximately four seconds, while the data records are approximately one second.

STS-60 PATH data processing did not involve the production of a free flyer trajectory but STS-69 required it. A second pass through the PATH data was applied for the collection of target vectors for the free flyer during the periods of available Ku-Band radar data. These vectors were further processed to obtain their Keplerian equivalent. Using simple graphics for spike rejection and orbital element trending, a small set of elements was obtained that could be used by SATEPH, an orbital propagator.

The deployed period was processed to derive the free flyer trajectory and range distance from the orbiter. These items were further compared to the available range data to evaluate the computed trajectory for the free flyer. During the evaluation phase, it was noted that the range distance over the deployed period was not a contiguous function and contained excursions greater than 15 kms. A further evaluation of the selected free flyer elements was performed, but revealed no indication of an outlier. The source of the excursions was determined to be the orbiter trajectory obtained from the original CAS parameter stream. This was confirmed by examination of all orbiter state vectors for time periods when the differential velocity transitions are greater than 1.5 km/sec, and then, applying those points as input elements for SATEPH to propagate. This comparison of the orbiter state vector and a propagated trajectory from elements revealed the non-contiguous orbiter data was the source, since the range distance excursions reduced to sub-second velocity effects of less than 7 kms. The replacement of the orbiter state vector with the propagated from elements was not performed, since range to the free flyer was determined by the researcher as a non-critical parameter for the WSF/CHAWS analysis.

WSF-02 CHAWS telemetry data was processed to convert the internal time counter into an equivalent universal time. The approach used was similar to the WSF-01 effort. Since there was much less data in a collection period, each segment was reviewed for consistency. Least square fits for the CHAWS counter drift were individually adjusted by selecting different start and end points within the collection period. The adjustments were performed to produce a contiguous drift rate between the data collection periods, which physically represented the operation of the CHAWS time counter.

3.2.2.2 Post-Flight Modifications of Software Routines

A new algorithm for calculating the current-voltage (IV) curves developed for CHAPS was put into CHUNKS. The method of extracting IV curves from the CHAWS data stream are also being revised. Previously, this had been done by running CHUNKS through the data one time, and then, using the UNIX "awk" utility to read the output file to identify start and stop times for the IV sweeps. Then a second set of CHUNKS runs were done to extract selected IV curves. This procedure is now being developed within CHUNKS so that one can select and print the IV data in one pass. This requires reading the CHAWS frame data into a buffer, using test logic to decide when a sweep has begun and finished, and flushing the frame buffer for the completed sweeps to a file. A prototype routine was written to implement this method. Improvements were made to the CHUNKS routines used to identify and print IV curves. The code writes an ASCII output file containing Langmuir probe voltage and current and other information that allows one to help evaluate the data. This information includes counters to identify and label the IV sweeps, and flags for signaling other events that may be of interest for further analysis. The IV sweeps are characterized by a Langmuir voltage above a specified threshold and a monotonic voltage over a sufficiently wide span of CHAWS frames. The program was made more flexible by enabling one to reset the event and IV sweep counters on a restart at any convenient point.

Additional improvements were made to the CHUNKS program. The common line arguments were modified to allow for more flexible operation. The path to supporting input files now can be set from the command line, along with the switch that toggles between the interactive and batch mode. A preliminary scan of the CHAWS post-flight data base turned up a few bugs that were fixed. The documentation was updated and a reference input file was made which contains a list of the available strings and corresponding explanatory comments. On the CHUNKS program, variables specifying the sun angle with respect to the WSF were added, using the CHAPS formulation. In order to understand the differences between the densities calculated by the ram RPA center detectors and the side detectors, the calibration files were redone, without any background subtraction for the large polar angles, which produced better agreement. This indicates that the response curves contain significant data above background at the high angles.

The CHUNKS code output was compared with CHAPS runs at a fixed time. Most of the variables correlate, but a bug was found and corrected for two orbiter angles. The wake data counts were consistently unfolded from telemetry log format.

The Attitude Display process was modified to calculate the solar direction and sun angles, as measured on the WSF body. The angles are defined in polar coordinate format with the WSF ram side normal defining the positive z-axis direction. The x-axis direction is defined as the vector aligned through the ram side sensor. The sun angles are computed regardless of the WSF eclipse condition and will require the user to monitor the eclipse indicator associated with the shuttle.

The CHAWS and SPREE Sun workstations were returned to GPS after being purged and reconfigured following the STS-75/SPREE mission.

A 1.0 GB disk drive was temporarily connected to the AMENRA workstation in order to transfer the data contained across the network to one of the Silicon Graphics workstations. Mounting the disk on AMENRA was easier than connecting the 10Base1 network port of the source workstation to the 10Base2 that still exists in GPS. After transferring the data, the disk was removed from AMENRA.

The CHAWS and SPREE workstations were set up and configured as NIS clients of GPSSERVER. They were assigned IP addresses on a new subnet: 146.153.44. Using the existing netmask prevents the machines from receiving IS table information from GPSSERVER. To remedy this problem, the netmask would need to be changed to an undesirable value or all of the GPS UNIX workstations would need to be moved to the new subnet. Since the latter is TX's long term plan, this is the more logical solution. Plans have been made to coordinate a simultaneous transfer to the new subnet.

4. VISUALIZATION

4.1 ENHANCEMENT OF AURORAL ION AND ELECTRON DISTRIBUTION DATA

4.1.1 Development of Technical Approaches

Evaluation of using the Silicon Graphics (SGI) workstation architecture to enhance the understanding of the auroral ion and electron distribution data.

A method for fitting arbitrary functions to data was acquired using MATLAB on the SUN architecture. MATLAB is a program designed to help scientists analyze data arrays with complex algorithms. The data arrays can be very large, and are easily manipulated using MATLAB.

The ability to read binary versions of the Auroral data files into Explorer on the SGI was added. This allows for more efficient storage of data, and modularization of the modeling process.

Radex acquired a demonstration platform of the SGI workstation which allowed us to evaluate if a purchase is appropriate to assist PL projects in the future, particularly , in the area of visualization.

Methods of smoothing or fixing the mismatch of the auroral model in the geomagnetic equatorial region was investigated, and several algorithms were tested.

4.1.1.1 The PROSPECT Coordinate Transformation Package

The PROSPECT coordinate transformation package underwent further testing to check the accuracy of the ECI routines. The largest errors encountered in latitude and longitude were on the order of $10(\text{exp } -3)$ degrees, while the maximum errors in Earth radius were on the order of $10(\text{exp } -8) R_E$.

A final specification was developed for the PROSPECT package, and the software was modified accordingly. In addition to some minor changes, this involved the addition of the following options:

- * PQW coordinates may be input in spherical coordinates,
- * Input distances may now be given in either kilometers or Earth radii.

On completion, the coordinate transformation portion was linked to the pre-existing L-computation routine. Coding of a subroutine to interpolate the model, as function of the L-shell parameters, was put in.

4.1.1.2 EXPLORER and IDL Data Programs

Work was done on the EXPLORER and IDL data visualization programs. The two-dimensional display window for EXPLORER was further enhanced and the format of the control bar was simplified. The IDL code was upgraded to improve the iso-surface display and the associated color legend. An effort was made to modify the front ends of these two programs so that they present essentially the same user face. Work on the upgrade of the IDL version of the magnetospheric models demo movie was performed.

4.1.1.3 Magnetic Field Studies

A video tape of the Tsyganenko '87 (T87) magnetospheric model was created. The tape shows an animation of the field potential in 3-D space.

Some C code was developed to implement smooth surface models of T87, which requires commutation of the polygons and surface normals of the fields. These algorithms apply to any field line tracing algorithm. Several plots of the smoothed version of the auroral models were created.

Methods to generate video tapes using a Silicon Graphics workstation were developed.

Conjunctions between DMSP-8 and DMSP-9 and the CRRES satellite were requested for the period October 10-25, 1990. These conjunctions were defined as close approaches in corrected geomagnetic (C.G.) coordinates at points determined by tracing along magnetic field lines from the satellite locations down to an altitude of 100 Km. Encounters with spans of 10 minutes were desired.

Using LOKANGL, complete DMSP orbits were computed at one minute steps for the entire period of interest. Field line tracing to 100 Km had to be performed for all points before comparisons with CRRES data could be made. Most of the CRRES data, including 100 Km footprint locations for north and south hemispheres, was taken from existing ephemeris files. To be consistent with the DMSP orbits, CRRES data was interpolated to one minute intervals where necessary. Encounter spans approaching 10 minutes were achieved only when the encounter window was widened to ± 5 degrees in C.G. latitude and ± 10 degrees in C.G. longitude.

Tables, giving solar zenith angle, and geodetic and C.G. coordinates at the 100 Km footprint locations were delivered. Satellite location, in geographic coordinates, and L-shell were provided, too. CRRES footprints were provided only for the hemisphere corresponding to DMSP.

The code developed for visualizing the Tsyganenko 87 (T87) model was converted for general use. The generalized visualization tool allows the use of an arbitrary field model to produce spatial information which is then used to create a 3-dimensional rendering of the model. The user provides parameters for the field model, as well as input for the visual presentation. In addition, the tool provides an input/output interface to allow use of the field model data for external programs. Mixed Fortran and C source code is provided.

The Hilmer-Voigt magnetic field model is used as a core for the development of a generalized field model visualization tool. The SI architecture is used as the platform.

4.1.1.4 MODVIEW

The magnetic field model visualization tool MODVIEW version 2.0 was delivered to PL 26 Sept. 94. The tool provides full shaded 3-D modeling of the Hilmer-Voigt Magnetospheric model. Other field models, such as Olsen-Pfitzer and Tsyganenko '87, can be easily incorporated into the code.

The tool is available to PL in both binary and source distribution formats. Binary System requirements are Silicon Graphics Platform with Irix 5.2. Motif, Open GL. Source Code System requirements are Motif, Open GL, Fortran 77, and ANSI C compilers.

The MODVIEW magnetic field model visualization tool was extensively revised, to version 5.0. This new version allows viewing of field lines in the noon-midnight plane, and allows stepping through a geomagnetic storm. The data for field lines may be stored optionally in an ASCII file for use in other applications.

4.1.1.5 Intel Graphics Library

The Intel Graphics Library (iGL) was implemented on the Linux[®] operating system. An X-Window interface was added to allow viewing of the frame buffer. Source code for iGL was placed on the MS-DOS operating system, in order to facilitate future development under DOS,

if necessary.

4.1.1.6 Integration of CRRESRAD Models into Visualization Program

The probability of occurrence of the integral number flux is computed for specified geomagnetic location and activity. This probability of occurrence generally, can be approximated by two known log-normal distributions. The database containing the estimated parameters for the probability of occurrence of auroral integral number flux was improved.

Software for integration of the CRRESRAD models into the visualization program has been completed. The task involves, first, tracing field lines using the IGRF internal field with the Olsen-Pfitzer Quiet external field model. Then, with L-shell and B/B_0 calculated for each point on the three-dimensional grid, the model is evaluated with a separate routine. Along with the CRRESRAD models, the equivalent NASA dose models based on AP/E8-MAX are included. While the NASA dose models give very good isosurfaces, the CRRESRAD models tend to give jagged edges because of requirements that nearest-neighbor approximations be used, and because of the inherent noise in the models. It is desirable to maintain the discrete nature of the CRRESRAD models because they represent "data". The validity of this is recognized. However, it is desirable to allow the models to be presented in a form which approximates the spatial extent of the radiation belts, which do not have jagged edges. In order to satisfy both requirements, the software will be built to allow for, either, the presentation of the raw "data", or, smoothing and/or functional fitting of the CRRESRAD models prior to their evaluation on the grid. It remains to incorporate the CRRESPRO ion flux models.

A subroutine to interpolate model radiation belt proton flux as a function of L-shell and equatorial pitch angle was developed. This was linked into the TRANS code to compute model proton distributions at user specified time and location, as part of the PROSPEC package developed by PL. A preliminary version of TRANS was completed and delivered to PL.

Documentation of key LEPA software packages and to collect appropriate background information to execute the codes is an ongoing effort.

Software was completed for the generation of CRRESPRO gridded model files. This completed the model generation portion with the exception of the CRRES electron models. These will be incorporated later.

Software for PROSPEC was completed, tested, and delivered to PL, along with documentation, including User's Guides and description of mathematical processing. The software includes program TRANS, which computes radiation belt spectra and pitch angle distribution at an arbitrary point, or selected points, and a front-end program which generates a set of 8 input points for TRANS from a satellite orbit.

Some verification runs were made on the visualization system, to demonstrate capability and to

ensure that the models and algorithms perform adequately. The first run involved the calculation of total dose for the APEX satellite and the comparison of those results with the results of CRRESRAD. Results were favorable with the visualization system, producing total dose results within 10% of the CRRESRAD numbers. Since use of this system involves interpolation from geocentric gridded model files along the satellite track, while CRRESRAD traces field lines explicitly from the satellite position, exact agreement is not expected. In a second application, data was obtained from the APEX dosimeter and fed into the visualization system. Using the line plot option, the data could be compared directly to predictions of the models for the corresponding APEX orbit. Comparisons here were also favorable with peak dose rates within about 20 % of the measured values. Measured dose rates were variably higher or lower than the model doses on various passes, which is not surprising considering that APEX is presently encountering the radiation belts at low altitude, where details of the internal field can cause variations in the radiation environment that are not included in the static models.

4.1.1.7 Benchmark Tests for IDL and EXPLORER

Benchmark tests were done for stripped down versions of IDL and EXPLORER visualization programs, and a pure SGI code, that was being developed at PL at that time. These tests indicated that the IDL version had significantly slower graphics performance. For this reason, a decision was made to focus on the SGI options. A completed version of the IDL code was configured, and then, work was shifted to the SGI-based programs.

The IDL data visualization program was updated, which included the added features of the capability to: treat multiple models and multiple orbits; enhancement of the line plot widget; implementation of an object control widget, and creation of a widget for resizing the displays. A package was put together containing the latest version of the code, along with models and orbits, and was distributed to the investigators. Further work was done where the color map was extended to four bands, three for shading iso-surfaces and one for color contours. The level slider was modified to input percentage of the data, enabling one to uniformly handle the wide range of data values. A 'snap' option was added allowing one to capture the main window image into a separate window, and thus, it can be used to save multiple images for comparisons.

4.1.2 Magnetospheric Specification Model (MSM)

4.1.2.1 Development of 3D Modeling of MSM

Work began on 3D modeling of the Magnetospheric Specification Model (MSM). The source code for MSM 3D was provided to Radex by Dr. Robert Hilmer. Radex intends to use this code to generate 3D visualization of the results.

4.1.2.2 Use of MODVIEW and MSM

The MODVIEW magnetic field model visualization tool and the MSM were used to map a 3-D representation of the magnetosphere. The August 1990 storm was chosen as an event appropriate for a 3-D movie subject. The movie presented 36 frames over a 36 hour period on days 238-239 of 1990. Each frame showed the MSM 3-D map and a set of field lines from the Hilmer-Voigt magnetic field model.

4.1.2.3 Further Development of GEOSpace

Specified steps were taken to further develop GEOSpace, the environmental simulation package. Methods of integrating more models and displays were investigated.

4.1.3 PL-GEOSPACE (formerly SGI)

4.1.3.1 Results and Use of PL-GEOSpace

The SGI data visualization program, now called PL-GEOSPACE, was worked on extensively. PL-GEOSPACE is based on C++, motif widgets, and OpenGL. Material was put together to describe this code. A prototype GEOSPACE widget was written to handle line plots. This widget implements the plotting of interpolated values as a function of time, given a satellite orbit and a 3D grid of data values.

A paper entitled "Three-Dimensional Visualization of the Dynamic Space Environment", which summarized the status of the PL-GEOSpace program, was presented at the Spring 1995 AGU Meeting. The NASA model source data files for the PL-GEOSpace were entirely replaced by NSSDC ASCII files. These files include the solar minimum, as well as solar maximum data.

4.1.3.2 Reduced Version of CRRES3D

In connection with the PL-GEOSpace code, a reduced version of a program called CRRES3D, which features the radiation belt models, was worked on. The main parts of CRRES3D will be the CRRES and NASA proton and electron flux data bases and the dosage calculations. Further options will be added to simplify and enhance the presentations. Work was done to develop an animation capability to view satellites in transit through the radiation belt models, in both geocentric and inertial reference frames. The code structure was revised to enable multiple satellite tracks to be followed. The graphical object for displaying coordinate axes was upgraded to display the axes for an Earth-centered inertial (ECI) system, and a sun direction vector was also added. The ECI axes orientation and sun direction were determined at UT using routines derived from the LOKANGL code. A new orbit slice object was created to plot interpolated data in a plane coincident with a given orbit plane. The orbit slice graphical object was upgraded to enable one to view interpolated data in the three orthogonal planes that form the co-moving coordinate

system at the current position of the satellite. The NASAPRO and NASAELE science modules were modified to display a more complete representation of the data. The energy bins and L-shell ranges were originally set identical to those used in the CRRESPRO and CRRESELE modules. A low and high end energy bin was added to pick up flux contributions outside the CRRES limits, and the L-shell ranges were extended to span the NSSDC file limits.

4.1.3.3 Time-Dependent Science Models

The main effort was toward developing a method for display of time-dependent science models. A prototype was implemented to treat the time-dependent behavior of the Hardy auroral models. Given a start and stop time and a time increment, the code loops over time and writes an auroral data file at each step. The auroral models require as input a value of K_p of each step. This is read from a master data file of time vs K_p . The coordinate slice graphical object was modified in order to display the time-dependent auroral data. A widget toggle was added which enables one to obtain the data files. To read back the data, the code first reads in an index file, which specifies the times for each of the data files, and then selects the file corresponding to a time nearest to the requested time. The selected data file is then read in and displayed, using the same visualization routines as used for data from memory. This method works without any modification of the animation module, which can be used to set the time for stepping or looping through the data files.

4.1.3.4 The CRRESELE Model

The CRRESELE model for display of CRRES electron data was upgraded. The L-shell range was extended out to $6.8 R_E$ to enable geosynchronous orbits to be included in the analysis. The prototype for display of time-dependent science models was further developed. The top portion of the PL-GEOSpace program was split into two parts, one environment for presenting the static models and a new environment for treating the dynamic modes. An environment manager allows one to selectively run these two options. The two environments are similar, except that the dynamic models have a different way of treating the global input parameters, and can create and read back time-dependent data files. A more generic code and a better widget interface for this prototype was being developed. Further updating the data files of the CRRESELE model to put them in agreement with modified PC files. A widget was created for displaying and manipulating the master time file, which contains the global time-dependent parameters, using a scrolled window. The window can be edited and the changes saved to a disk file, which can be retrieved by the widget for further usage. Another option allows one to create a template parameter file, using parameter values obtained from an on-line data base. These tools enable one to control the global parameters interactively. The graphical object that displays magnetic field lines was upgraded to handle the time-dependent models. The master time file was upgraded to handle more parameters, and the coding was restructured to enable easier conversion of modules into the time-dependent mode. The Parameterized Ionospheric Model (PIM) module was subsequently converted into a time-dependent module.

4.1.3.5 Module to Trace Particle Orbits

A new module to trace particle orbits through a given magnetic field was developed. The routines that integrate the equations of motion are based on the guiding center approximation and were written by R. Hilmer. To set up the trace model in PL-GEOSpace, a widget was constructed to read in the input parameters, including the field model, species, initial conditions for the orbit, and time step controls. The trace routine is implemented via a UNIX pipe. An output lines file is written and this data is subsequently read back into memory and the trace is displayed using the same technique as for magnetic field line plotting. The trajectory tracing model was updated through a number of revisions to make the code more efficient.

REFERENCES

Boumar, K. H., W. J. McNeil, N. A. Bonito, "FFT Space Processing for the ACF of SPREE Particle Flux Measurements", PL-TR-94-2230, 31 August 1994, ADA290166.

Pakula, B. And D. L. Cooke, *Private Communication*, June 1995.

Roth, C. J., and N. A. Bonito, "SPREE Interactive Data Analysis Tool (SIDAT)", PL-TR-92-2331, 30 October 1992, ADA262782.

Roth, C. J., *Private Communication*, February 1996.

Tautz, M. F., "Construction of Retarding Potential Analyzer Calibrations Files for the CHAWS Experiment", PL-TR-96-2068, 29 February 1996, ADA311337.