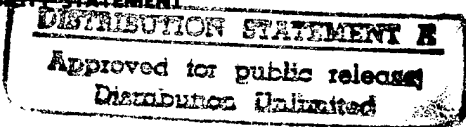

Public reporting burden for this collection of information is estimated to average 1 hour per response, including the time for reviewing the data needed, and completing and reviewing the collection of information. Send comments regarding this burden estimate or any aspect of this collection of information, including suggestions for reducing this burden to Washington Headquarters Services, Directorate for Information Operations and Reports, 1215 Jefferson Davis Highway, Suite 1204, Arlington, VA 22202-4302 and to the Office of Management and Budget, Paperwork Project (0704-0188).

0276

1. AGENCY USE ONLY (Leave blank)		2. REPORT DATE 27 September 1996	3. REPORT TYPE AND DATES COVERED Final Report Sep 94 - Aug 96	
4. TITLE AND SUBTITLE Problem of Instability and Scale in Media with Microstructure			5. FUNDING NUMBERS DOD-G-F49620-94-1-0402	
6. AUTHOR(S) Nicolas Triantafyllidis				
7. PERFORMING ORGANIZATION NAME(S) AND ADDRESS(ES) Aerospace Engineering Department The University of Michigan 1320 Beal Ave Ann Arbor, MI 48109-2118			8. PERFORMING ORGANIZATION REPORT NUMBER	
9. SPONSORING / MONITORING AGENCY NAME(S) AND ADDRESS(ES) Air Force Office of Scientific Research Directorate of Aerospace and Materials Sciences AFOSR/NA, 110 Duncan Ave., Suite B115 Bolling AFB, Washington DC 20332-8080			10. SPONSORING / MONITORING AGENCY REPORT NUMBER NA 94-1-0402	
11. SUPPLEMENTARY NOTES				
12a. DISTRIBUTION / AVAILABILITY STATEMENT Unlimited			12b. DISTRIBUTION CODE	
				
13. ABSTRACT (Maximum 200 words) Report covers research activities of principal investigator in relation to above project. Effects of scale are carefully quantified for media with periodic microstructure in which the scale parameter is the unit cell size over the representative volume dimension. Failure surfaces are defined for idealized truss-like composites and their dependence on scale has been explored. Concepts developed have been subsequently applied to aluminum honeycombs. The technical part of the work is reported in four papers. The present final report includes the final presentation given at AFOSR on September 13, 1996 and other relevant information				
14. SUBJECT TERMS			15. NUMBER OF PAGES 34	
			16. PRICE CODE	
17. SECURITY CLASSIFICATION OF REPORT Unclassified		18. SECURITY CLASSIFICATION OF THIS PAGE Unclassified	19. SECURITY CLASSIFICATION OF ABSTRACT Unclassified	20. LIMITATION OF ABSTRACT UL

19970616 141

DTIC QUALITY INSPECTED 2

Sanders *File Copy*

Final Report on AFOSR Grant:
DOD-G-F49620-94-1-0402

Project title: **PROBLEM OF INSTABILITY AND SCALE
IN MEDIA WITH MICROSTRUCTURE**

Investigator: **N. Triantafyllidis**

Institution: **Aerospace Engineering Department
The University of Michigan
Ann Arbor, MI 48105-2118**

Grant Duration: **Started on Sept. 1994, ended on Aug. 1996**

Grant Budget: **\$ 82,100**

Report Date: **September, 1996**

Contents: **1. Objectives**
2. Work completed
3. Accomplishments
4. Personnel Supported
5. Publications/Reports
6. Interactions/Transitions
7. Attachments (Reports & Presentation)

1. Objectives

Objective of present work is to quantify the "scale size effect" on the macroscopic behavior and on the failure modes of media with regular microstructures. Of interest are media with regular microstructures (e.g. fiber reinforced composites, honeycombs etc.) with failure mechanisms that are due to bifurcation (buckling type) phenomena. This objective is to be achieved by the quantitative comparison of stresses, strains and other relevant variables at the onset of instability and at failure predicted by an appropriate averaged (macroscopic) model to the values of the same quantities corresponding to the onset of instability or at failure predicted by the corresponding exact (microscopic) model. In addition, we also plan to compare the above obtained theoretical predictions to experimental results obtained for cellular solids and for fiber reinforced composites.

The novelty in the proposed approach lies in the consistency of modeling of these media and the repeatability of the corresponding experiments, due to their well defined microstructures. Because of their high stiffness and light weight, these materials enjoy a wide applicability in aerospace and transportation industries. The more accurate modeling of these materials' microstructures is expected to lead eventually to optimal designs of their unit cells.

2. Work completed

We have proposed to study scale size effects in three different classes of applications: a) *truss type models* (relevant aerospace applications: large space structures) b) *frame type models* (relevant aerospace applications: honeycombs and foams) and c) *continuum models with periodic microstructures* (relevant applications: fiber reinforced composites).

Work on a) *truss type models*: :

Finished investigation on influence of scale size and initial imperfections on i) macroscopic properties of these models and on ii) failure surfaces for these models in macroscopic strain space. All the work is documented in a two papers which have just been submitted to the Journal of Applied Mechanics (see attached papers #2 and #3).

Work on b) *frame type models* :

i) We finished detailed calculations for failure surfaces for aluminum honeycombs of infinite extent under arbitrary macroscopic stresses and distinguished several types of initial failure modes. ii) We studied the influence of the size of the specimen on the onset of failure (scale size effect). iii) From geometry measurements in actual specimens, we have calculated the failure surfaces for actual honeycombs. Also we

have calculated deformation patterns well past the initial failure, all the way to the localized deformation regime. The results are documented the attached paper # 4 which has just been submitted to the Journal of the Mechanics and Physics of Solids

Work on c) *continuum models with periodic microstructures* :

c1/ *Plane strain models for fiber reinforced materials* : We have calculated the exact microscopic failure load and modes of axially loaded fiber reinforced perfect composites under compression. The calculations are for finite size specimens and their constitutive laws have been experimentally provided by the work of S. Kyriakides. Of particular interest were the influence of fiber ratios on the type of first buckling instability (local or global modes) since the latter type of modes can be predicted from the macroscopic properties of the composite. In addition the global type of failure is the precursor to the catastrophic kinkband failure mode. We will like to prove that the local type of failure mode does not evolve to a catastrophic type of post-buckling failure.

c2/ *General homogenization theory for periodic composites including scale size effects (Higher Order Gradient Theories)* : Of interest here is the scale size effect on the stability of finitely strained, rate-independent solids with three-dimensional periodic microstructures. Using a multiple scales asymptotic technique, we express the critical load at the onset of the first instability and the corresponding eigenmode in terms of the scale size parameter ϵ . The zeroth order ϵ terms in these expansions depend on the standard (first order gradient) macroscopic moduli tensor, while all the higher order ϵ terms require the determination of higher order gradient macroscopic moduli. These macroscopic moduli, which are calculated by solving appropriate boundary value problems on the unit cell, relate the macroscopic (unit cell average) stress rate increment to the macroscopic displacement rate gradients.

The proposed general theory is subsequently applied to the investigation of the failure surfaces in periodic solids of infinite extent. A detailed example is given for the case of layered composites, in view of the possibility of obtaining closed form expressions for all the required macroscopic moduli and in view of the existence of an analytical solution to the microscopic failure problem. Two applications are presented, one for a foam rubber composite and another for a graphite-epoxy composite whose properties have been determined experimentally by S. Kyriakides. The above work has been accepted for publication in the Journal of the Mechanics and Physics of Solids (see attached paper #1)

3. Accomplishments

One significant achievement of our work so far is that for the first time in the literature we came up with a consistent derivation of higher order gradient theories for continua with periodic microstructures. These theories are useful in modeling scale size effects in the localization failure of media with microstructures and up to now their form has always been postulated. We also came up with a useful application of these higher order gradient theories, which consists of predicting the macroscopic stress states that lead to a localization type failure in these materials. We validated this novel application by calculations in fiber reinforced composites with experimentally measured properties.

Another significant achievement is the calculation of the theoretical microscopic (i.e. exact) failure surface for aluminum honeycombs under arbitrary compressive stresses. It should be pointed out that the onset of failure surface concept is novel and that it is applicable to all periodic composites where buckling is the mechanism of initiation of failure. In addition we compared our results with experimental results which are available for the special case of uniaxial compression. We also calculated the influence of initial imperfections of these honeycombs on the failure surface of the perfect structure based on measurements conducted on real specimens.

4. Personnel Supported

Professor Nicolas Triantafyllidis (summer support)

Doctoral student Mark W. Schraad (full research assistantship, Ph.D. requirements completed on Aug. 1996)

5. Publications

1/ THE INFLUENCE OF SCALE SIZE ON THE STABILITY OF PERIODIC SOLIDS AND THE ROLE OF ASSOCIATED HIGHER ORDER GRADIENT CONTINUUM MODELS (with S. Bardenhagen, to appear: Journal of Mechanics & Physics of Solids)

2/ SCALE EFFECTS IN MEDIA WITH PERIODIC AND NEARLY PERIODIC MICROSTRUCTURES I- MACROSCOPIC PROPERTIES (with M. Schraad, submitted to: J. Appl. Mechanics)

3/ SCALE EFFECTS IN MEDIA WITH PERIODIC AND NEARLY PERIODIC MICROSTRUCTURES II- FAILURE MECHANISMS (with M. Schraad, submitted to: J. Appl. Mechanics)

#4/ ONSET OF FAILURE IN ALUMINUM HONEYCOMBS UNDER GENERAL IN-PLANE LOADING

(with M. Schraad, submitted to: Journal of Mechanics & Physics of Solids)

6. Interactions/Transitions

a) *Presentations* :

Nov. 1994, ASME Winter Annual Meeting in Chicago, IL

Prof. Triantafyllidis presented work on onset of kinkband failure in axially compressed composites

Feb. 1995, Ecole Polytechnique, Paris FRANCE

Prof. Triantafyllidis presented work on higher order gradient theories and scale size effects in stability of periodic composites.

Mar. 1995, Ecole Federale Polytechnique, Lausanne SWITZERLAND

Prof. Triantafyllidis gave a short presentation on modeling scale size effects in stability of periodic composites.

Apr. 1995, Cornell University, Ithaca NY

Prof. Triantafyllidis presented work on higher order gradient theories and scale size effects in stability of periodic composites.

Jun. 1995, ALCOA TECH CENTER, Monroeville, PA

Prof. Triantafyllidis presented work on higher order gradient theories and scale size effects in stability of periodic composites. Also discussed work on aluminum honeycombs

Sep. 1995, Directorate of Research, Solid Mech. Div. E.D.F., Paris FRANCE

Prof. Triantafyllidis presented work on higher order gradient theories and scale size effects in stability of periodic composites.

Oct. 1995, Soc. Eng. Science Meeting, New Orleans, LA

Doctoral student Mark Schraad gave a presentation on the work on aluminum honeycombs

Mar. 1996, Harvard University, Cambridge MA

Prof. Triantafyllidis presented work on higher order gradient theories and scale size effects in stability of periodic composites.

Mar. 1996, MIT, Cambridge MA

Prof. Triantafyllidis presented work on higher order gradient theories and scale size effects in stability of periodic composites.

May 1996, Ecole Centrale de Paris, Paris France

Prof. Triantafyllidis presented work on failure surfaces of aluminum composites

b) *Industrial Interest* :

The initial support for the work in scale effects on periodic media was supported by a small grant from ALCOA (in the form of summer student support and some travel money). As a result of my research activities in this area, Owen Richmond, ALCOA's highest scientific officer (his title is corporate fellow) and myself have organized an Institute for Mechanics and Materials workshop for the problems of stability and scale in mechanics last June in San Diego. ALCOA's past support permitted Scott Bardenhagen (by now a PhD of the Department), Mark Schraad (a Doctoral student who just completed his degree) and myself to do the initial calculations on the simple periodic truss models that allowed us to illustrate and understand some novel ideas, which subsequently formed the basis of the AFOSR proposal.

The work on the failure surfaces on aluminum honeycombs is of great interest to ALCOA, as is also the work on higher order gradient (H.O.G.) theories. There is a strong interest on the part of several groups at ALCOA to pursue this work further.

7. Attachments (Reports & Presentation)

(A copy of the four papers and the presentation given at AFOSR Office in Washington DC on Sep. 13, 1996 are included)

**PROBLEMS OF INSTABILITY AND SCALE
IN MEDIA WITH MICROSTRUCTURE**

AFOSR Grant DOD-G-F49620-94-1-0402 (9/94 - 5/96)

NICOLAS TRIANTAFYLIDIS (Principal Investigator)

MARK W. SCHRAAD (Graduate Student, Ph.D. August 1996)

Department of Aerospace Engineering

The University of Michigan

Ann Arbor, Michigan 48109-2118

Final Report and Future Directions, September 13, 1996

PRESENTATION OUTLINE

1.) INTRODUCTION AND PROBLEM STATEMENT

2.) RESEARCH WORK COMPLETED

3.) FUTURE WORK

4.) CONCLUDING REMARKS

1.) INTRODUCTION AND GENERAL PROBLEM STATEMENT

- CLASSICAL AVERAGING METHODS FOR OVERALL PROPERTIES OF COMPOSITES AND MICROSTRUCTURED MEDIA ARE UNSUCCESSFUL AT PREDICTING FAILURES RELATED TO THE MICROSCOPIC SCALE (SCALE EFFECTS)
- QUESTION 1: IS IT POSSIBLE TO CONSTRUCT THEORETICAL “FAILURE SURFACES” BASED ON MICROSTRUCTURE GEOMETRY AND PROPERTIES?
- QUESTION 2: IS IT POSSIBLE TO IMPROVE ON EXISTING AVERAGING SCHEMES IN ORDER TO INCLUDE SCALE EFFECTS IN FAILURE PREDICTIONS?
- REQUIREMENT: MODELING SHOULD INVOLVE MINIMUM “INTUITION” AND MAXIMUM “CAREFUL” MECHANICS

1.) INTRODUCTION (CONTINUED)

- **ANSWER: CONCENTRATE ON MEDIA WITH WELL DEFINED REGULAR (PERIODIC OR NEARLY PERIODIC) MICROSTRUCTURES**
- **USE A CONSISTENT DEFINITION FOR ONSET OF FAILURE**
- **ADVANTAGES: WELL DEFINED SCALE SIZE, MODELING ACCURACY AND CONTROLLABLE EXPERIMENTS. APPROACH CAN BE USED NEXT FOR OPTIMAL MICROSTRUCTURE DESIGN.**
- **APPLICATIONS: PERIODIC COMPOSITE MATERIALS (LAYERED COMPOSITES, FIBER REINFORCED COMPOSITES) AND CELLULAR MATERIALS (HONEYCOMBS, FOAMS, ETC.)**

1.) INTRODUCTION (CONTINUED)

- WORK IN CONJUNCTION WITH PROFESSOR S. KYRIAKIDES, AT THE UNIVERSITY OF TEXAS AT AUSTIN, UNDER AFOSR GRANT: "THE ROLE OF INSTABILITIES ON THE MECHANICAL RESPONSE OF CELLULAR SOLIDS AND STRUCTURES"
- USES: AEROSPACE STRUCTURES (SANDWICH CORES), SHOCK RELIEF AND ENERGY ABSORPTION
- ISSUES: ONSET OF INSTABILITY (BUCKLING), CRITICAL LOAD AND MODE DEPENDENCE ON THE MACROSCOPIC STRESS STATE, LOCALIZATION OF DEFORMATION (POST-BUCKLING), IMPERFECTION SENSITIVITIES AND BOUNDARY EFFECTS

2.) RESEARCH WORK COMPLETED

- AVERAGING TECHNIQUES THAT INCLUDE SCALE INFORMATION
- *EXACT DERIVATION OF HIGHER ORDER GRADIENT THEORIES IN PERIODIC MEDIA - PUBL. #1
- FAILURE SURFACES FOR CELLULAR MATERIALS
- *TWO-DIMENSIONAL LATTICES (IDEALIZED MODELS) - PUBL. #2,3
- *ALUMINUM HONEYCOMBS (PRESENTATION FOLLOWS) - PUBL. #4
- COMPARISON OF ONSET OF FAILURE PREDICTIONS BASED ON MACROSCOPIC THEORIES AND EXACT MICROSCOPIC CALCULATIONS IN FIBER REINFORCED COMPOSITES - PUBL. #1,3

2.) RESEARCH PUBLICATIONS

- PUBL. #1 - THE INFLUENCE OF SCALE SIZE ON THE STABILITY OF PERIODIC SOLIDS AND THE ROLE OF ASSOCIATED HIGHER ORDER GRADIENT CONTINUUM MODELS
(with S. Bradenham) to appear in J. Mech. Phys. Solids
- PUBL. #2 - SCALE EFFECTS IN MEDIA WITH PERIODIC AND NEARLY PERIODIC MICROSTRUCTURES - I. MACROSCOPIC PROPERTIES
(with M. Schraad) submitted to J. Appl. Mech.
- PUBL. #3 - SCALE EFFECTS IN MEDIA WITH PERIODIC AND NEARLY PERIODIC MICROSTRUCTURES - II. FAILURE MECHANISMS
(with M. Schraad) submitted to J. Appl. Mech.
- PUBL. #4 - ONSET OF FAILURE IN ALUMINUM HONEYCOMBS UNDER GENERAL IN-PLANE LOADING
(with M. Schraad) submitted to J. Mech. Phys. Solids

***ONSET OF FAILURE IN ALUMINUM HONEYCOMBS**

- **INFINITE MODELS WITH PERFECTLY PERIODIC MICROSTRUCTURE
(FAILURE SURFACE - ANALYTICAL)**
- **FINITE MODELS WITH PERFECTLY PERIODIC MICROSTRUCTURE
(SCALE SIZE EFFECTS - NUMERICAL)**
- **FINITE MODELS WITH PERTURBED MICROSTRUCTURE
(IMPERFECTION SENSITIVITY - NUMERICAL)**

GENERAL DEFINITION FOR ONSET OF FAILURE SURFACE IN PERIODIC SOLIDS

- SOLIDS WITH PERIODIC MICROSTRUCTURES POSSESS A WELL DEFINED SCALE SIZE, $\epsilon = l/L$

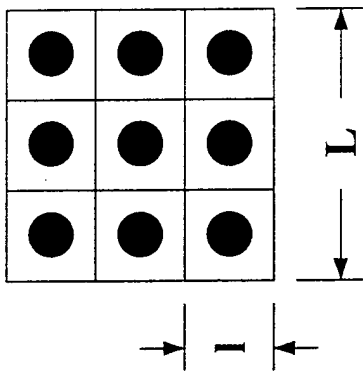

- FAILURE IS DEFINED AS THE INITIAL BIFURCATION IN THE PRINCIPAL SOLUTION WHICH CORRESPONDS TO THE ONSET OF THE ULTIMATE FAILURE MECHANISM

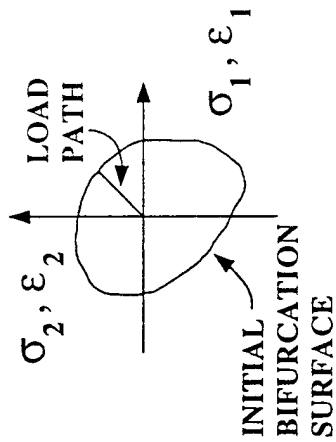
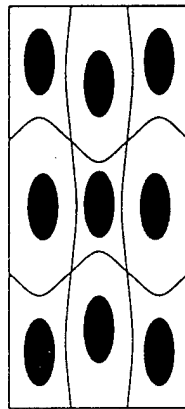
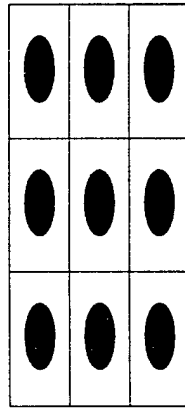

PRINCIPAL SOLUTION

BIFURCATED SOLUTION

- HONEYCOMB WALLS ARE MODELED AS NONLINEAR, ELASTO-PLASTIC BEAMS

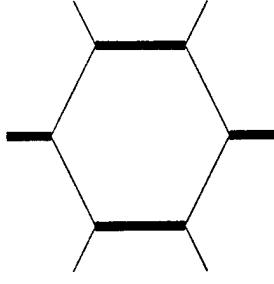

- KINEMATIC RELATIONS (ELEMENT STRAINS)

- ACCOMMODATE LARGE STRAINS AND ROTATIONS

$$- \epsilon = \epsilon_n + \epsilon_b z, \quad \epsilon_n = \lambda - 1, \quad \epsilon_b = [(1 + u_s)w_{,ss} - w_s u_s] / \lambda^2$$

$$- \lambda = [(1 + u_s^2) + w_s^2]^{1/2}$$

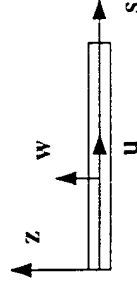

- CONSTITUTIVE RELATIONS (ELEMENT STRESSES)

- BILINEAR CONSTITUTIVE MODEL - $E_t = 0.01E$

- ALUMINUM 5052 - H39 HONEYCOMB (MADE BY HEXCEL)

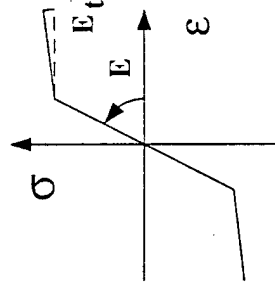

INFINITE MODEL GEOMETRY

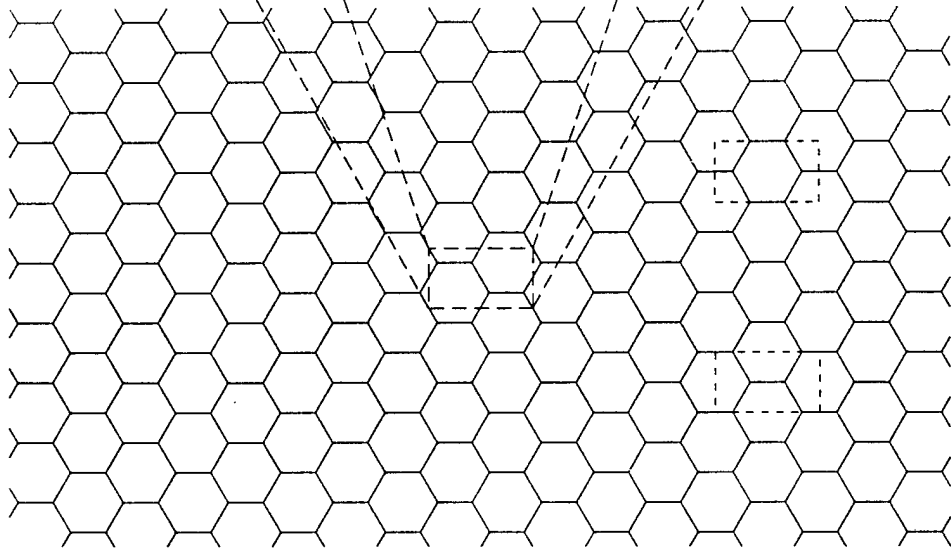

PERIODIC MICROSTRUCTURE

UNIT CELL

MACROSCOPIC STRESS-STRAIN RESPONSE ($\Pi_{22}/\Pi_{11} = \tan 70^\circ \approx 2.75$)

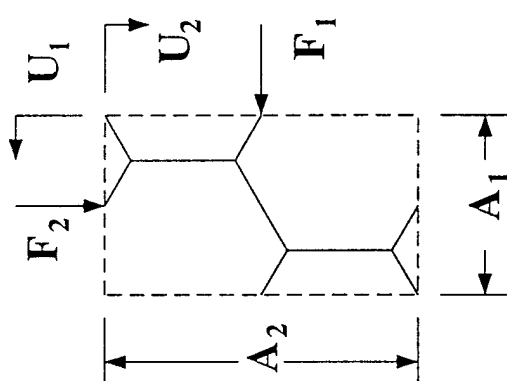
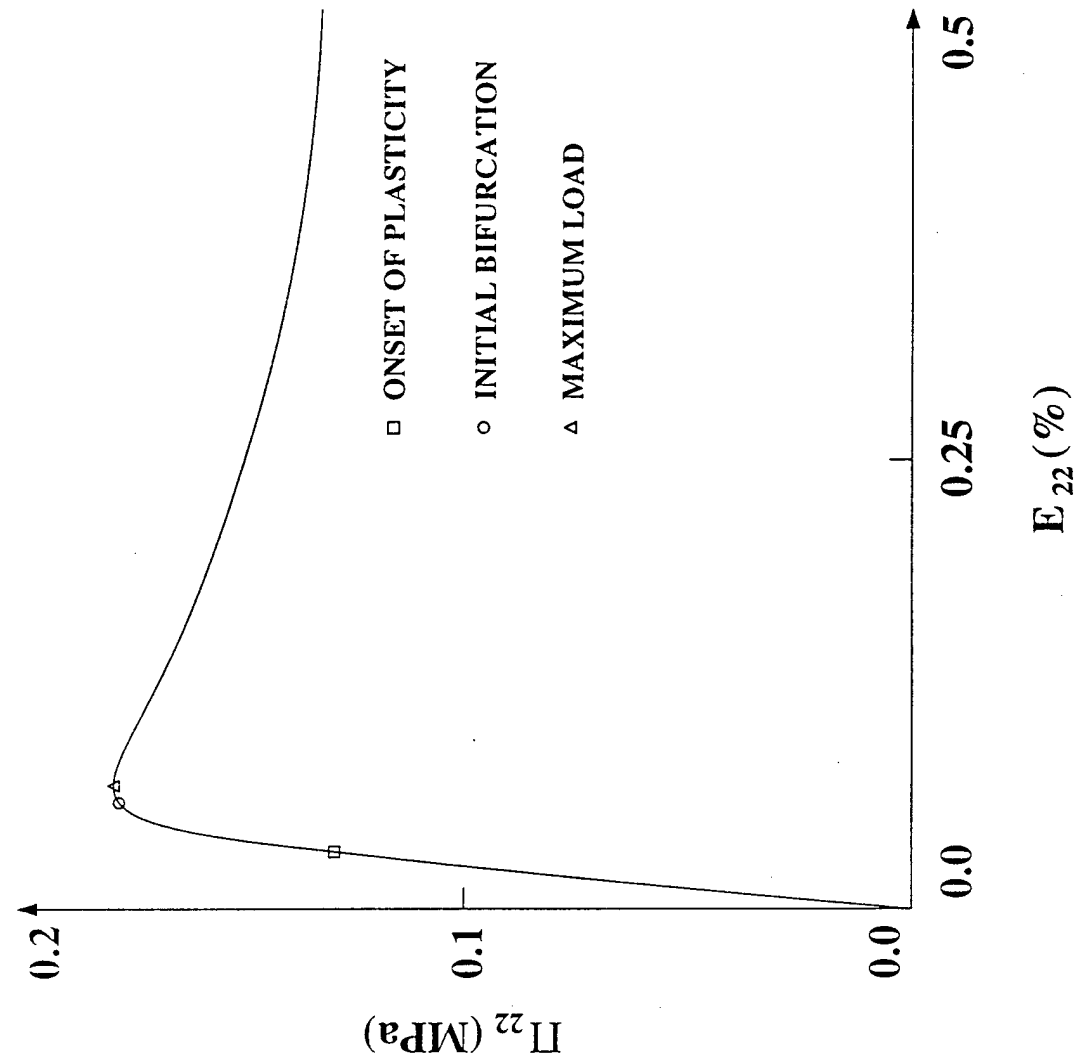

MACROSCOPIC STRESS COMPONENTS

$$\Pi_{11} = F_1/A_2 \quad \Pi_{22} = F_2/A_1$$

MACROSCOPIC STRAIN COMPONENTS

$$E_{11} = U_1/A_1 \quad E_{22} = U_2/A_2$$

INITIAL BIFURCATION OF THE INFINITE MODEL (BLOCH WAVE)

THE EIGENMODE IS OF THE FORM

$$u(x_1, x_2) = e^{i(\omega_1 x_1 + \omega_2 x_2)} p(x_1, x_2)$$

p IS PERIODIC WITH THE SAME PERIODICITY AS THE UNIT CELL

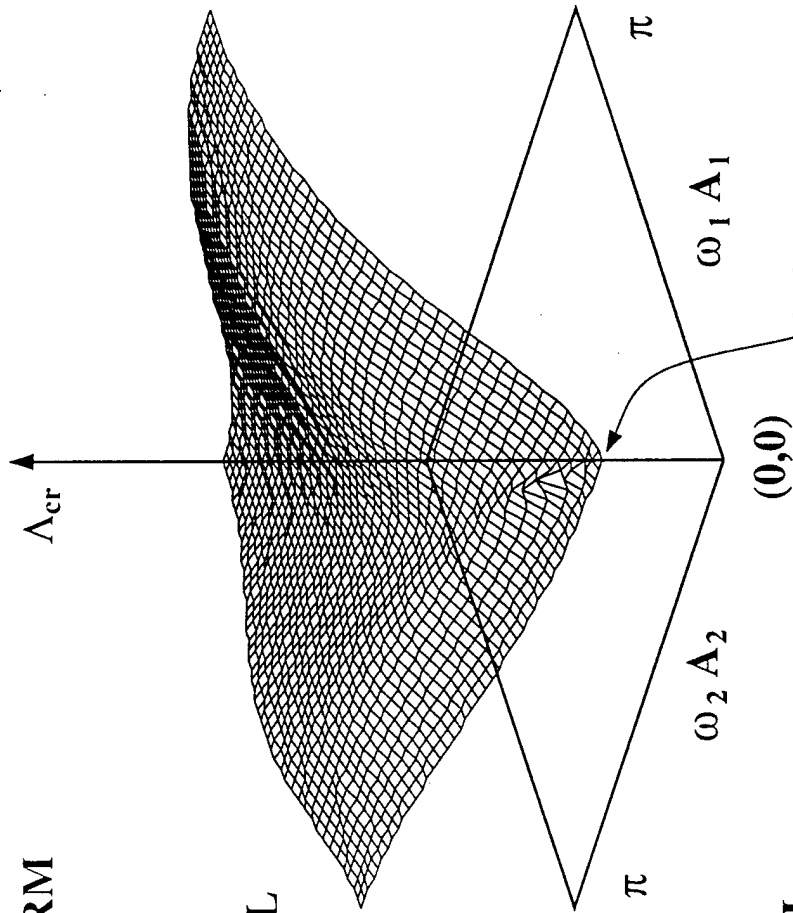
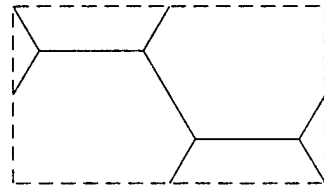

AT BIFURCATION A NONTRIVIAL SOLUTION EXISTS FOR $\det[K(\Lambda_{cr}, \omega_1, \omega_2)] = 0$

K IS THE COMPLEX STIFFNESS MATRIX OF THE UNIT CELL FOUND IN RESPONSE TO THE EIGENMODE u

INITIAL BIFURCATION OF THE INFINITE MODEL (BLOCH WAVE)

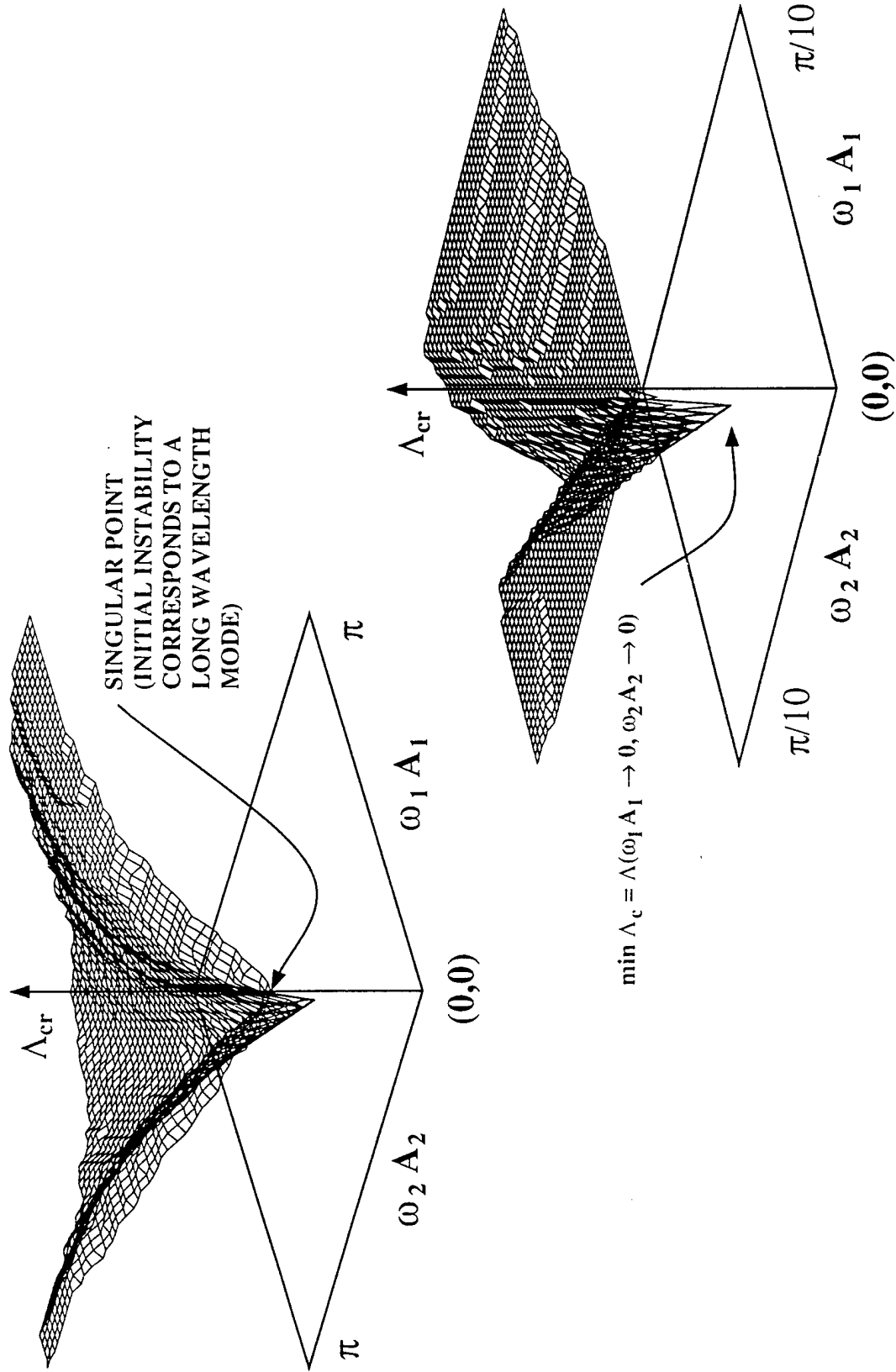

FAILURE SURFACES IN MACROSCOPIC STRESS SPACE

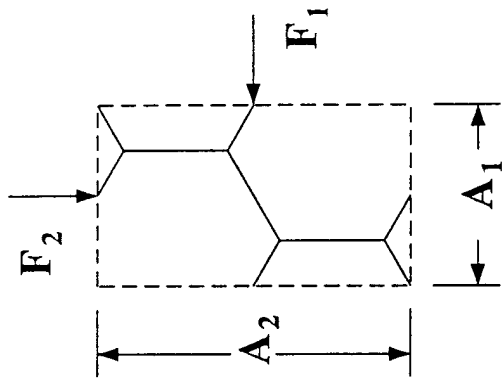
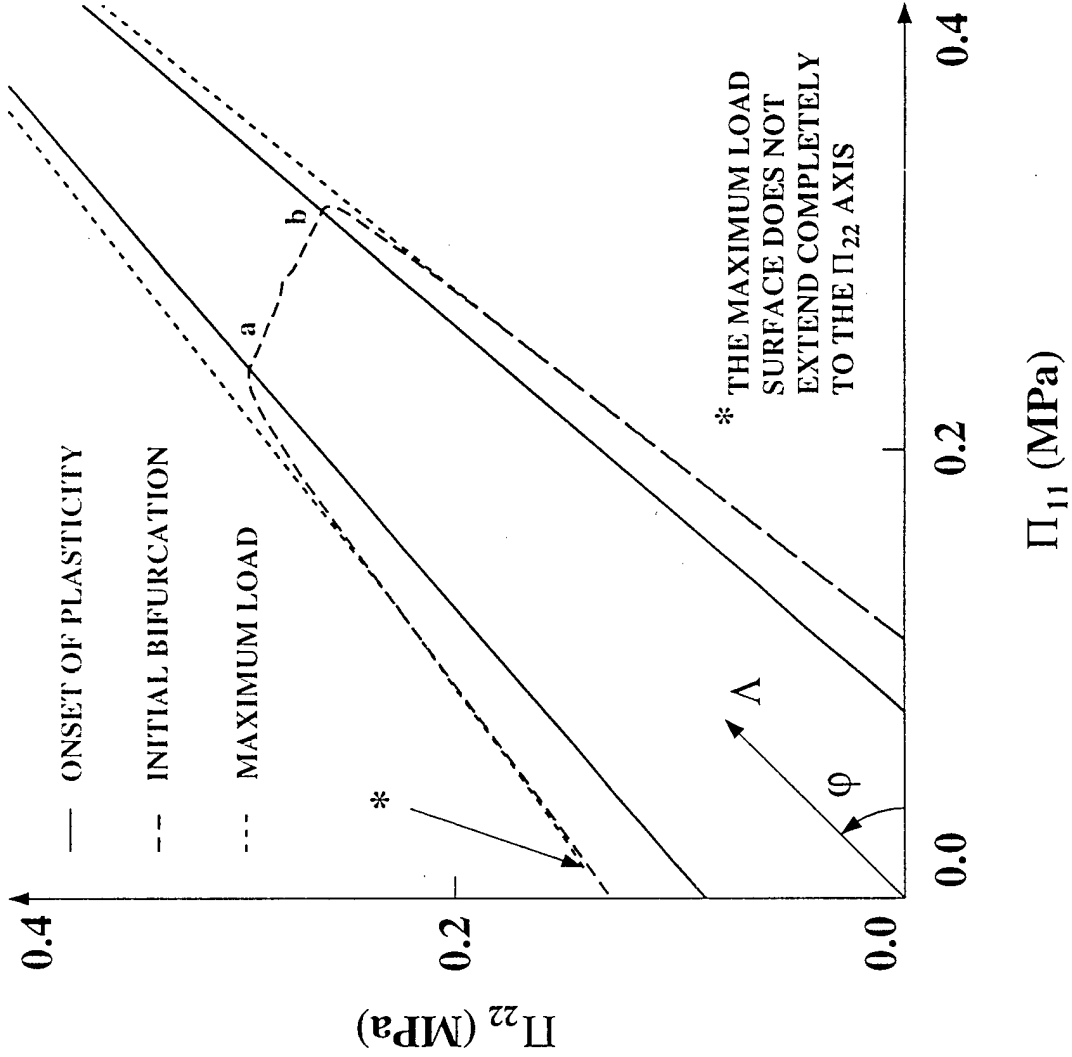

MACROSCOPIC STRESS COMPONENTS

$$\Pi_{11} = \Lambda \cos \varphi = F_1 / A_2$$

$$\Pi_{22} = \Lambda \sin \varphi = F_2 / A_1$$

(NO MACRO-SHEAR)

FAILURE SURFACES IN MACROSCOPIC STRAIN SPACE

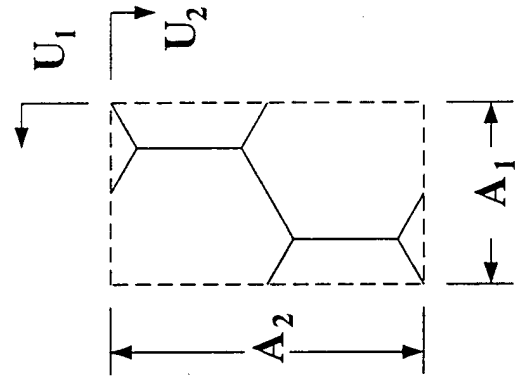

MACROSCOPIC STRAIN COMPONENTS

$$E_{11} = U_1/A_1$$

$$E_{22} = U_2/A_2$$

(NO MACRO-SHEAR)

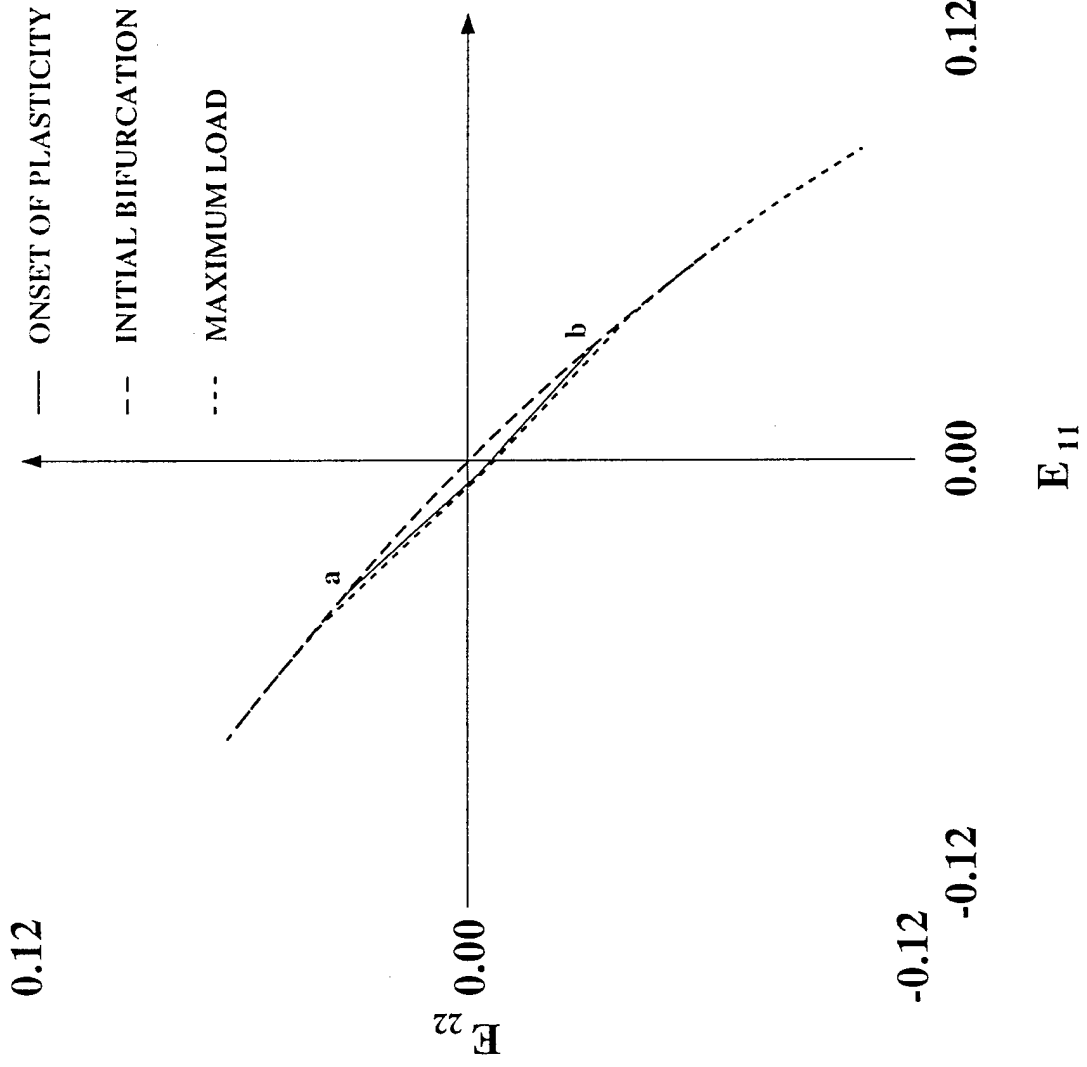

EFFECTS OF SHEAR ON THE ONSET OF FAILURE SURFACE

MAXIMUM LOAD
REACHED FOR ALL
LOAD PATH ANGLES

NO BIFURCATION
INSTABILITY FOUND
FOR LARGE RANGE
OF LOAD PATH
ANGLES

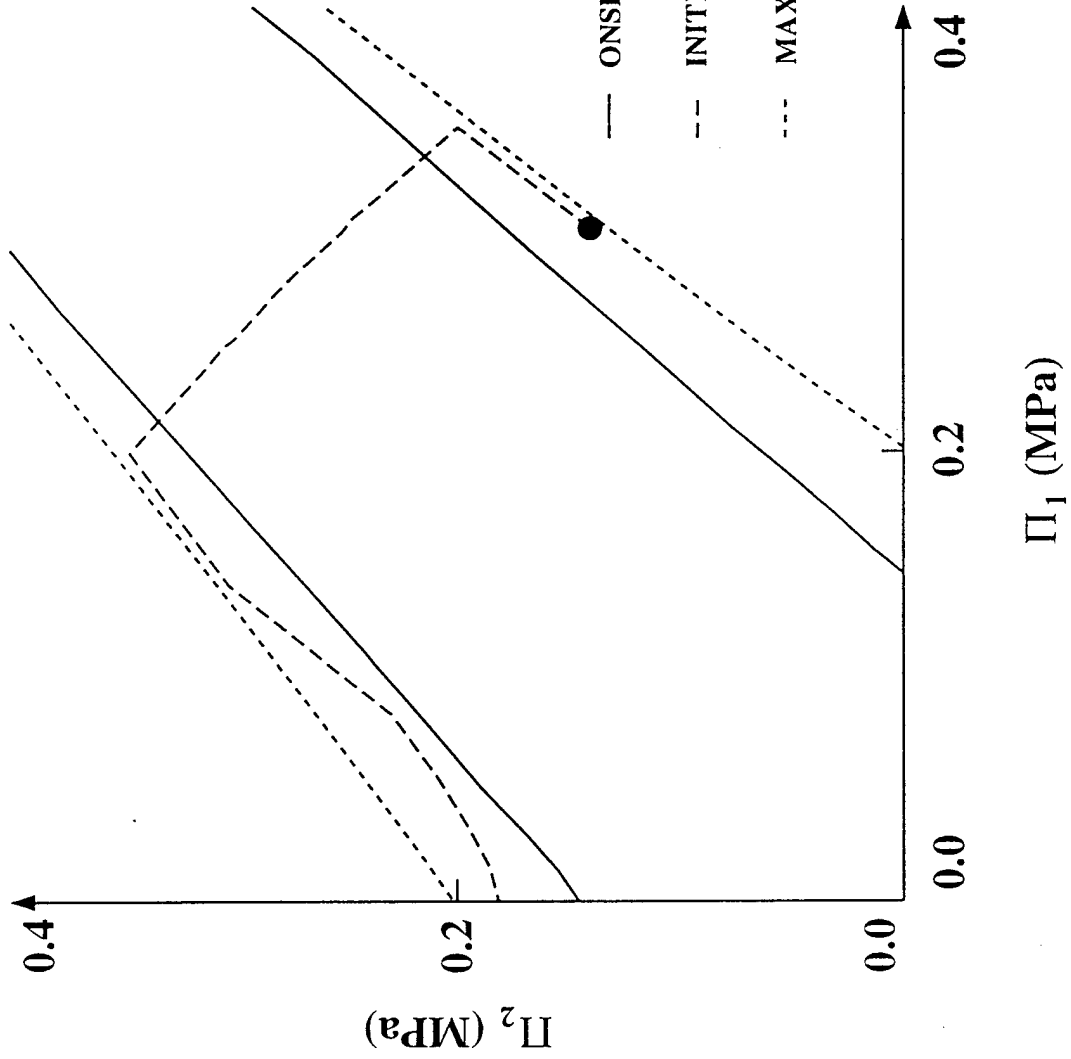

FINITE MODEL GEOMETRY AND BOUNDARY CONDITIONS

F_2, U_2

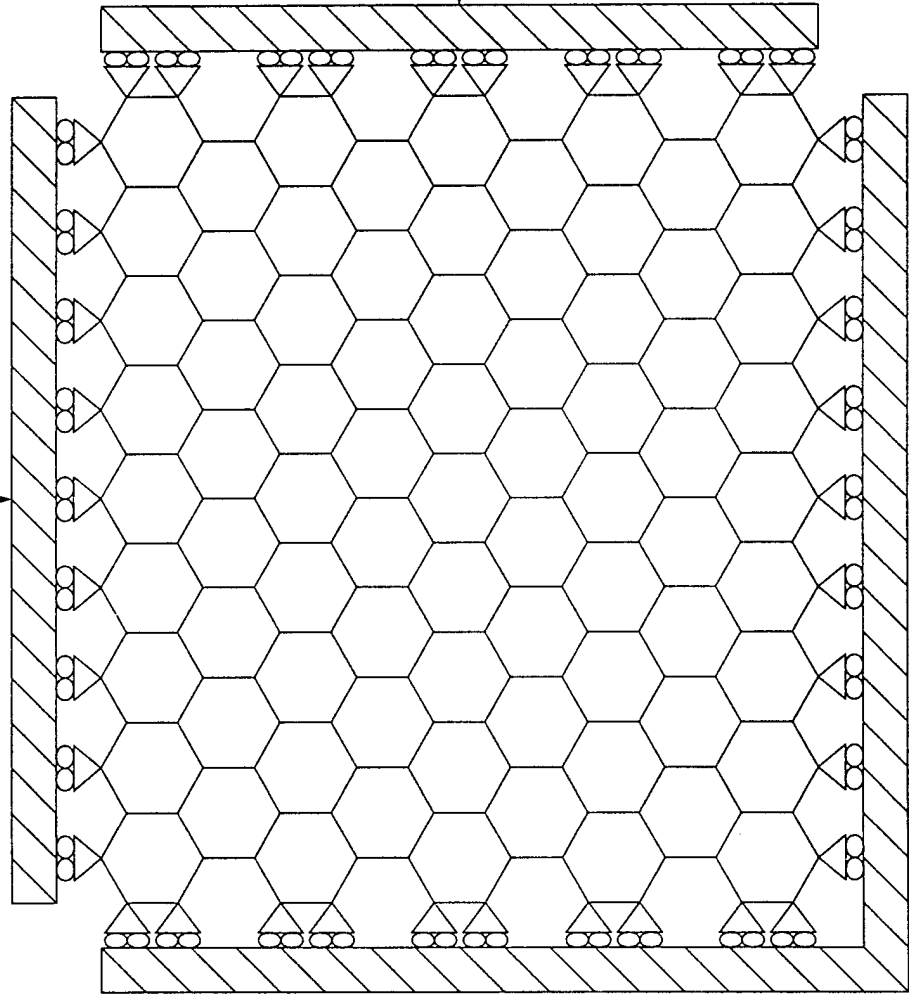

F_1, U_1

BOUNDARY CONDITIONS:

- 1.) CONSTRAIN U_1 AND U_2
- 2.) CONSTRAIN F_1 AND F_2
- 3.) CONSTRAIN Δ

Δ IS THE WORK
CONJUGATE OF THE
LOAD PARAMETER Λ

MACROSCOPIC STRESS COMPONENTS

$$\Pi_{11} = \Lambda \cos \phi = F_1 / A_2$$

$$\Pi_{22} = \Lambda \sin \phi = F_2 / A_1$$

INFLUENCE OF SCALE SIZE ON THE FAILURE SURFACE

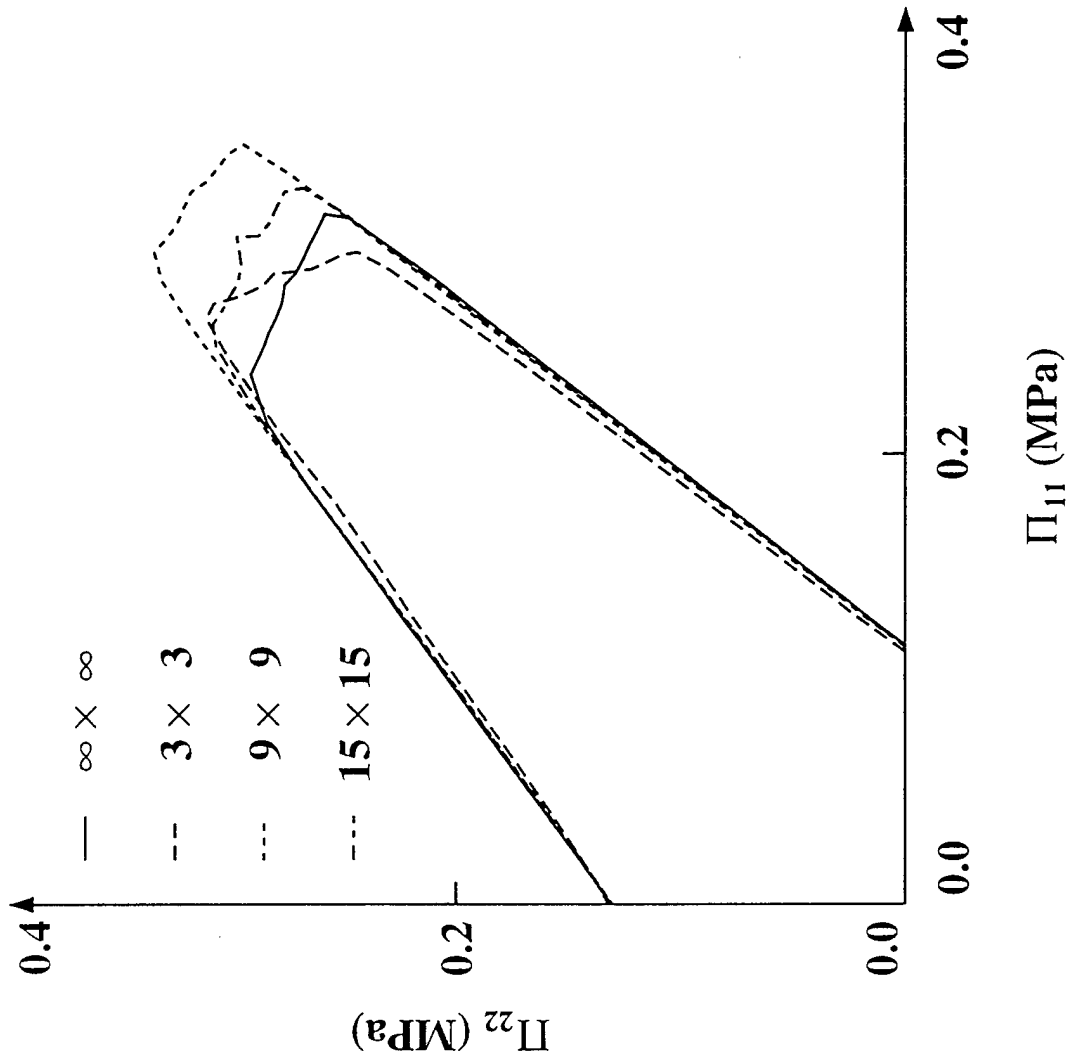

BIFURCATION MODE SHAPES

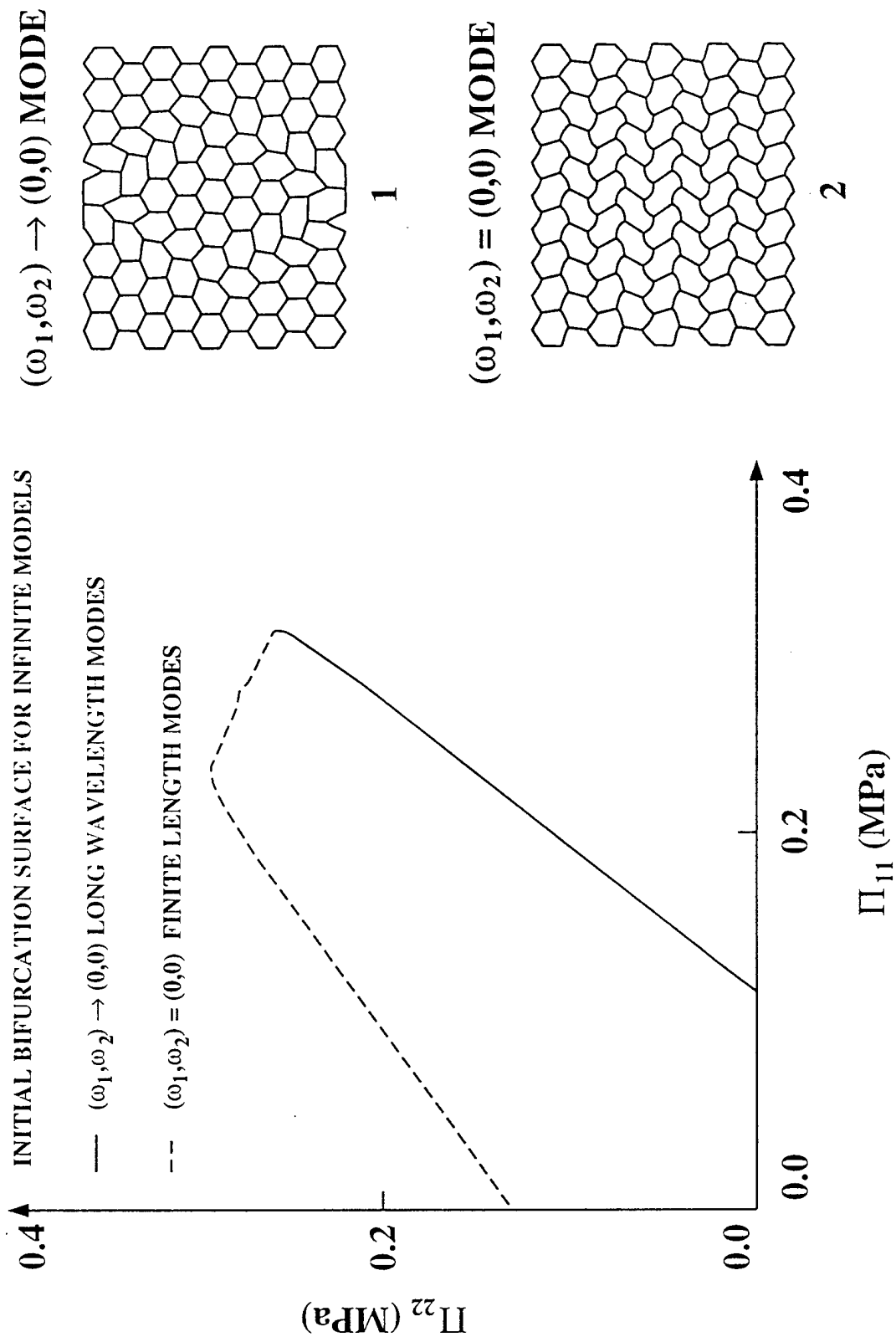

PERFECT AND PERTURBED MODEL GEOMETRIES

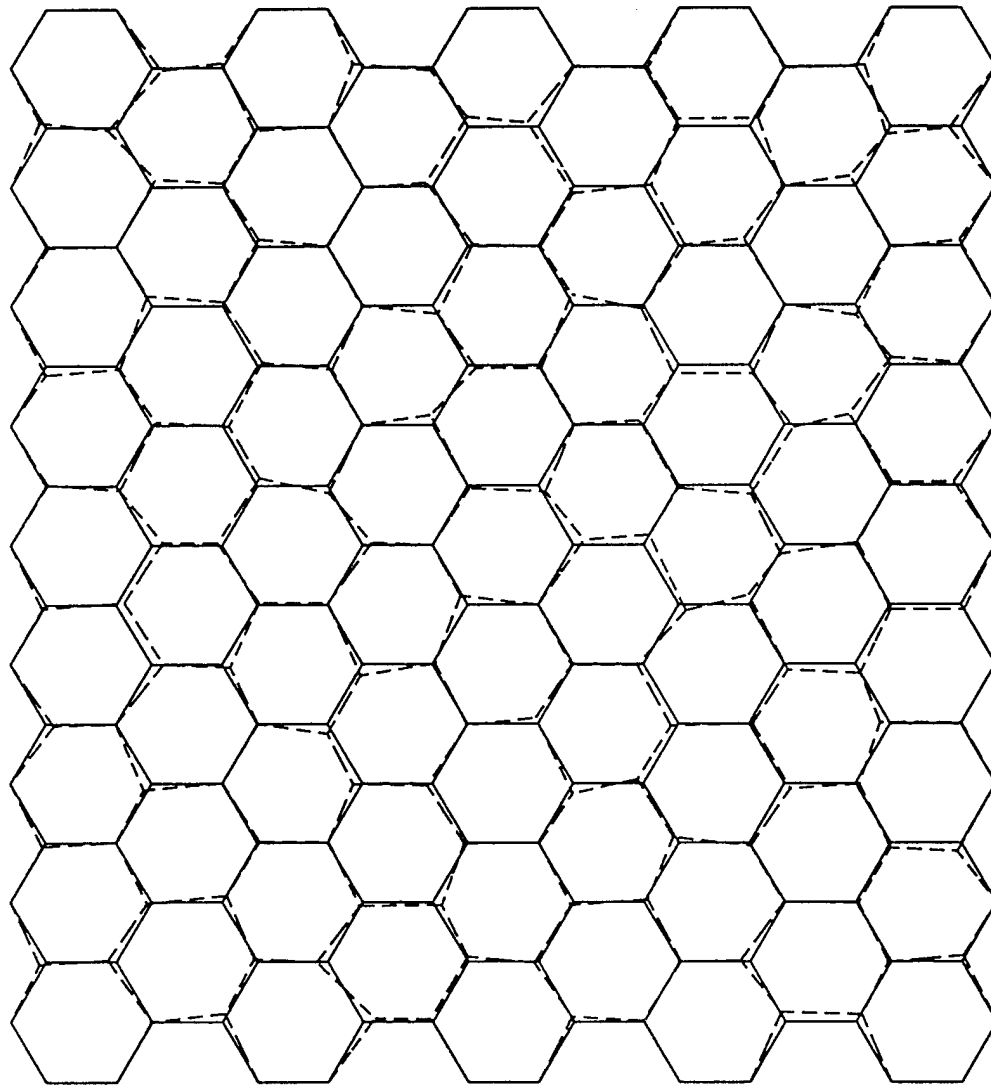

— PERFECT

-- PERTURBED

THE COORDINATES
OF EACH NODE ARE
PERTURBED BY

$$\bar{x}_1 = x_1 + \delta A_1 r \cos(2\pi q)$$

$$\bar{x}_2 = x_2 + \delta A_1 r \sin(2\pi q)$$

δ IS THE PERTURBATION
AMPLITUDE, AND r AND
 q ARE RANDOMLY
SELECTED NUMBERS

$$0 \leq r, q \leq 1$$

INFLUENCE OF PERTURBATIONS ON THE MACROSCOPIC BEHAVIOR

ANALYSIS PERFORMED
FOR FINITE (9×9)
MODELS

$$\Pi_{22} / \Pi_{11} = \tan 70^\circ \approx 2.75$$

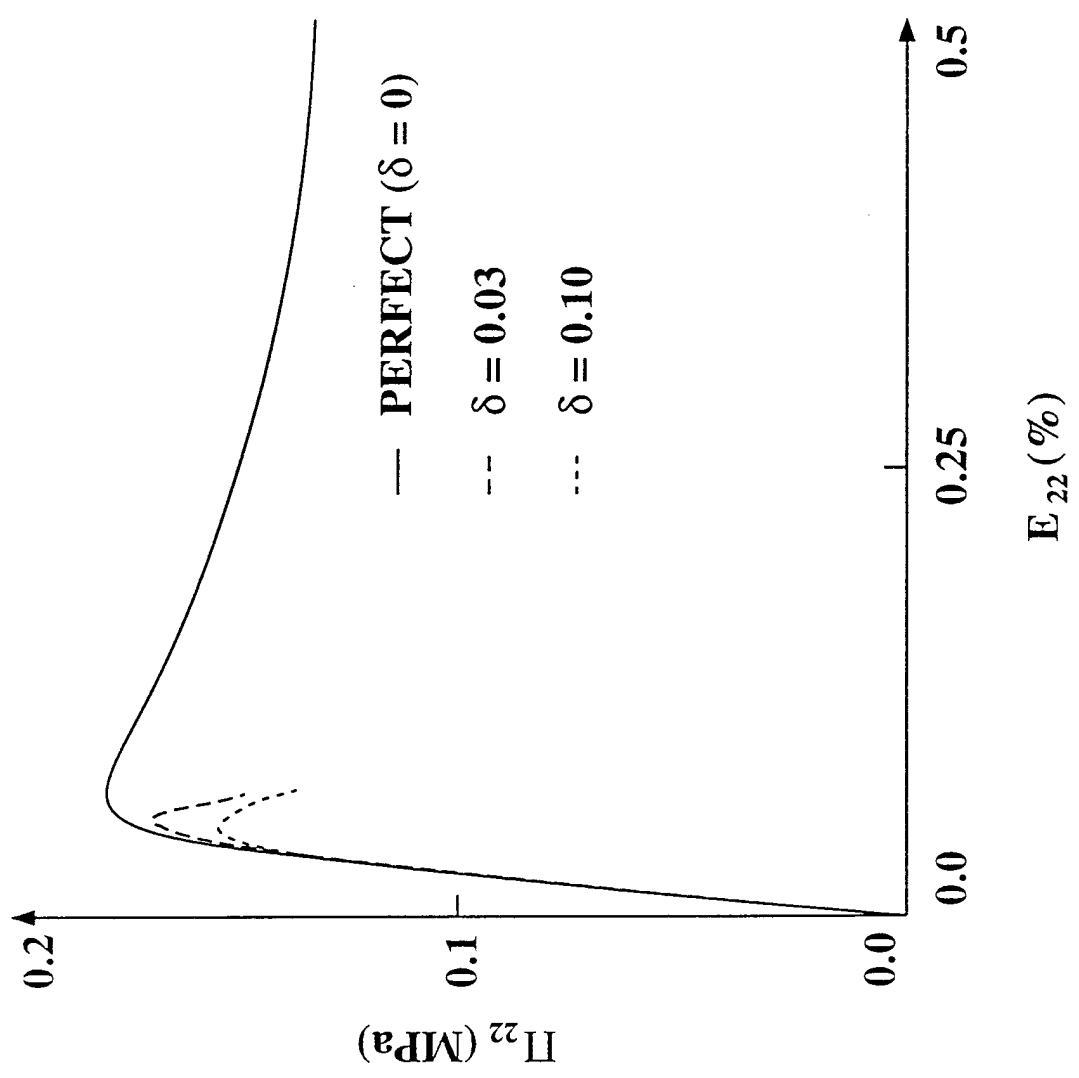

INFLUENCE OF PERTURBATIONS ON THE FAILURE SURFACES

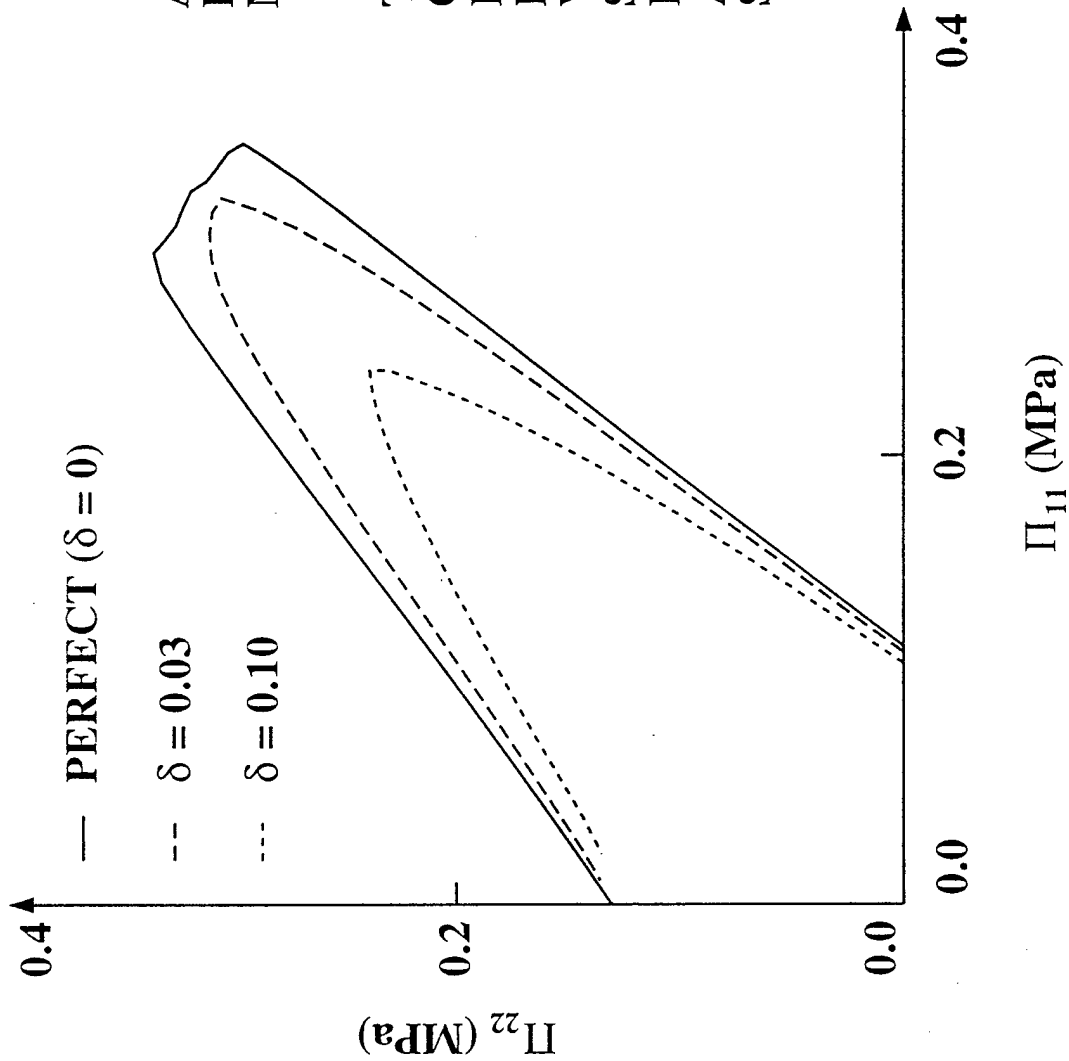

ANALYSIS PERFORMED FOR FINITE (9×9) MODELS

THE FAILURE SURFACE OF THE PERFECT MODEL IS AN INITIAL BIFURCATION SURFACE WHILE THE FAILURE SURFACES OF THE PERTURBED MODELS ARE MAXIMUM LOAD SURFACES

LOCALIZATION OF DEFORMATION ($\phi = 20^\circ$, $\delta = 0.03$)

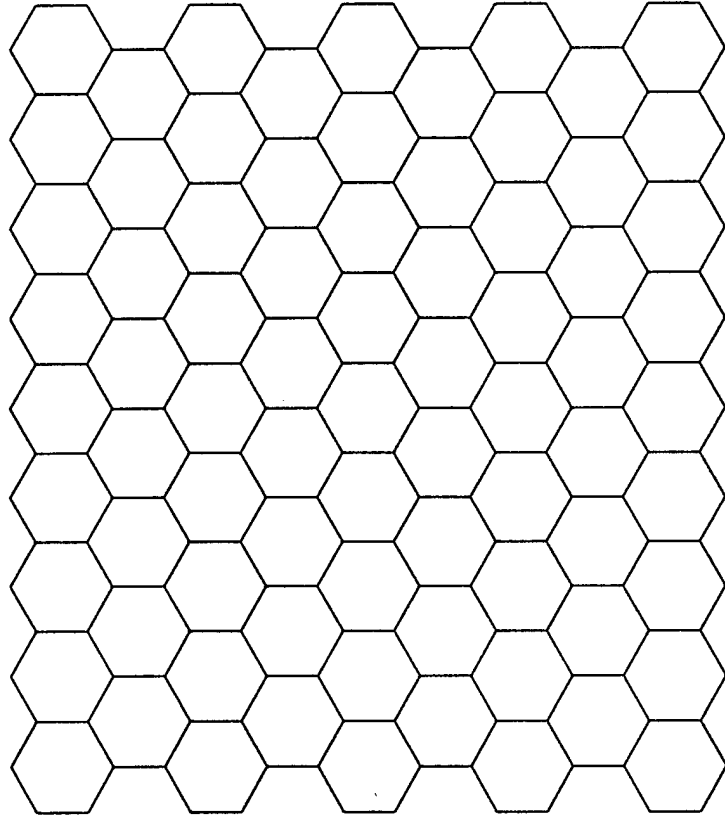

UNDEFORMED CONFIGURATION

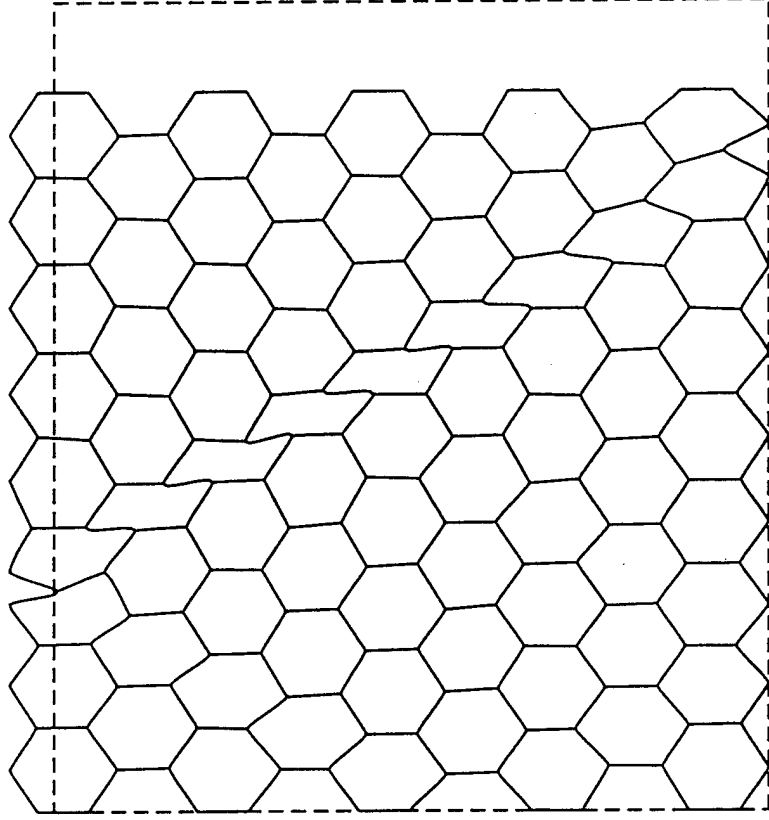

DEFORMED CONFIGURATION

3.) FUTURE WORK

- **THREE-DIMENSIONAL MICROSTRUCTURES**
- ***FIBER-REINFORCED COMPOSITES**
- ***METALLIC FOAMS**
- **CALCULATION OF LOCALIZED FAILURE MODES USING HIGHER ORDER GRADIENT CONTINUUM THEORIES (KINKBANDS IN FIBER COMPOSITES)**
- **INFLUENCE OF RATE EFFECTS (CIRCULAR HONEYCOMBS)**
- **COMPARISON OF CALCULATIONS WITH EXPERIMENTS ON BIAXIALLY LOADED HONEYCOMBS (EXPERIMENTS PERFORMED BY S. KYRIAKIDES)**

4.) CONCLUDING REMARKS

- EXPERIMENTAL COMPONENT
 - *FINITE STRAIN BIAXIALLY LOADED MACHINE DEVELOPED BY S. KYRIAKIDES TO TEST MULTIAXIAL FAILURE (EXTREME SENSITIVITY OF FAILURE TO LOADING ORIENTATION)
 - *FOR FUTURE WORK, AXIAL TOMOGRAPHY EQUIPMENT DEVELOPED AT U OF M BY PROFESSOR PETER WASHBAUGH TO LOOK AT MICROSTRUCTURE DEVELOPMENT DURING LOADING
- INDUSTRIAL COMPONENT
 - *ALCOA INTERESTED IN LIGHTWEIGHT STRUCTURES (SPONSORED INITIAL RESEARCH)
 - *DARPA HAS ULTRALIGHTWEIGHT (METAL FOAM) INITIATIVE (UM - BOEING CONNECTION)

4.) CONCLUDING REMARKS (CONTINUED)

- **NOVEL APPROACH**
- ***GENERAL (ANY REGULAR MICROSTRUCTURE, LOAD ORIENTATION)**
- ***CONSISTENT (AVOIDS INTUITIVE STEPS, ADJUSTABLE PARAMETERS – BASED ON MICROGEOMETRY AND MATERIAL PROPERTIES ONLY)**
- **RESEARCH BACKED BY EXPERIMENTS**
- **RELEVANCE TO AEROSPACE INDUSTRY (CURRENT MATERIALS THRUST)**
- ***DIRECT CONTACT WITH INDUSTRY**
- ***IDEAS DEVELOPED USED IN OTHER INDUSTRY – UNIVERSITY RESEARCH**
- **MODEST INVESTMENT FROM AFOSR (ONE GRADUATE STUDENT AND MINIMUM FACULTY SUPPORT TO DATE)**