



UNITED STATES ARMY  
COMMUNICATIONS-  
ELECTRONICS  
COMMAND

# ADVANCE PLANNING BRIEFING FOR INDUSTRY

19970718 162

DISTRIBUTION STATEMENT A

Approved for public release;  
Distribution Unlimited

MAY 28-29, 1997

# **NOTICE**

**This publication contains the briefings presented during this Advance Planning Briefing for Industry (APBI). Following the APBI, you may obtain a Proceedings Book for a minimal fee by contacting the Defense Technical Information Center (DITC). The telephone number is: (800) 225-3842.**

**We hope that the above publication proves beneficial to your long-range planning efforts. If you have any additional questions and/or suggestions, please contact the Program Analysis and Evaluation Directorate, AMSEL-PE-OD, ATTN: Mari Aufseeser, (908) 532-5054.**



**DEPARTMENT OF THE ARMY**  
HEADQUARTERS, US ARMY COMMUNICATIONS-ELECTRONICS COMMAND  
AND FORT MONMOUTH  
FORT MONMOUTH, NEW JERSEY 07703-5000

REPLY TO  
ATTENTION OF

Office of the Commanding General

Ladies and Gentlemen:

On behalf of the Army C4IEW and Sensors Team, I am pleased to present these proceedings of the 1997 Advance Planning Briefing for Industry (APBI) entitled "Information Dominance for the Full Spectrum Force." The objective of this publication is to provide industry with a comprehensive overview of our research and development programs, sustainment efforts and corresponding contract opportunities available to industry within the next five years.

Technology is the critical component to attaining full-spectrum operations. The Department of Defense must team with private industry at every opportunity in order to ensure advanced technologies for our forces in the 21st century.

I welcome your participation in our APBI program.

Sincerely,

A handwritten signature in black ink, appearing to read "Gerard P. Brohm".

Gerard P. Brohm  
Major General, U.S. Army  
Commanding

Title: "Advanced Planning Briefing for Industry"  
May 1997

PLEASE CHECK THE APPROPRIATE BLOCK BELOW:

AO # 497-09-5349

1 copies are being forwarded. Indicate whether Statement A, B, C, D, E, F, or X applies.

DISTRIBUTION STATEMENT A:  
APPROVED FOR PUBLIC RELEASE: DISTRIBUTION IS UNLIMITED

DISTRIBUTION STATEMENT B:  
DISTRIBUTION AUTHORIZED TO U.S. GOVERNMENT AGENCIES ONLY; (Indicate Reason and Date). OTHER REQUESTS FOR THIS DOCUMENT SHALL BE REFERRED TO (Indicate Controlling DoD Office).

DISTRIBUTION STATEMENT C:  
DISTRIBUTION AUTHORIZED TO U.S. GOVERNMENT AGENCIES AND THEIR CONTRACTORS; (Indicate Reason and Date). OTHER REQUESTS FOR THIS DOCUMENT SHALL BE REFERRED TO (Indicate Controlling DoD Office).

DISTRIBUTION STATEMENT D:  
DISTRIBUTION AUTHORIZED TO DoD AND U.S. DoD CONTRACTORS ONLY; (Indicate Reason and Date). OTHER REQUESTS SHALL BE REFERRED TO (Indicate Controlling DoD Office).

DISTRIBUTION STATEMENT E:  
DISTRIBUTION AUTHORIZED TO DoD COMPONENTS ONLY; (Indicate Reason and Date). OTHER REQUESTS SHALL BE REFERRED TO (Indicate Controlling DoD Office).

DISTRIBUTION STATEMENT F:  
FURTHER DISSEMINATION ONLY AS DIRECTED BY (Indicate Controlling DoD Office and Date) or HIGHER DoD AUTHORITY.

DISTRIBUTION STATEMENT X:  
DISTRIBUTION AUTHORIZED TO U.S. GOVERNMENT AGENCIES AND PRIVATE INDIVIDUALS OR ENTERPRISES ELIGIBLE TO OBTAIN EXPORT-CONTROLLED TECHNICAL DATA IN ACCORDANCE WITH DoD DIRECTIVE 5230.25, WITHHOLDING OF UNCLASSIFIED TECHNICAL DATA FROM PUBLIC DISCLOSURE, 6 Nov 1984 (Indicate date of determination). CONTROLLING DoD OFFICE IS (Indicate Controlling DoD Office).

This document was previously forwarded to DTIC on \_\_\_\_\_ (date) and the AD number is \_\_\_\_\_.

In accordance with provisions of DoD instructions, the document requested is not supplied because:

It will be published at a later date. (Enter approximate date, if known).

Other. (Give Reason)

DoD Directive 5230.24, "Distribution Statements on Technical Documents," 18 Mar 87, contains seven distribution statements, as described briefly above. Technical Documents must be assigned distribution statements.

Phone Conversation 7/28/97  
8:20 AM  
per HENRY T. KEARNEY  
Print or Type Name / Chief of Public Affairs

908-532-1258  
Telephone Number

Joyce J. Cheras  
Authorized Signature/Date

# **DISCLAIMER**

**The use of trade names in this report does not constitute official endorsement of any products. This report may not be cited for purpose of advertisement.**

**The information provided is accurate as of the time of publication, and may be subject to change.**

**THE OVERALL CLASSIFICATION  
OF THIS PUBLICATION  
IS UNCLASSIFIED**

**ADVANCE PLANNING BRIEFING FOR INDUSTRY**  
**“INFORMATION DOMINANCE FOR THE FULL SPECTRUM FORCE”**

MAY 28-29, 1997  
OCEAN PLACE HILTON RESORT AND SPA  
LONG BRANCH, NEW JERSEY

MEETING CHAIRMAN  
MG GERARD P. BROHM  
COMMANDING GENERAL, CECOM AND FORT MONMOUTH

AGENDA

**TUESDAY, MAY 27, 1997**

1800-2000 CHECK-IN - HILTON

**WEDNESDAY, MAY 28, 1997**

0630 CHECK-IN

0800 ADMINISTRATIVE REMARKS

0810 WELCOMING REMARKS  
MG Gerard P. Brohm  
Commanding General, CECOM

0820 GUEST SPEAKER  
General Johnnie E. Wilson  
Commanding General, U.S. Army Materiel Command

0900 THE NEW CECOM  
MG Gerard P. Brohm

0930 BREAK

**SESSION I: OUR AMC PARTNERS**

0950 PARTNERING WITH A PURPOSE  
Mr. Louis D. Ligeno  
Industrial Base Analyst  
Business Development Office  
U.S. Army Industrial Operations Command

1005 DIRECT SALE PROGRAM  
Mr. Robert A. Katulka  
Electronics Engineer  
Directorate of Business Management  
Tobyhanna Army Depot

- 1015            FORCE XXI LAND WARRIOR  
 Mr. Patrick R. Snow, Jr.  
 Force XXI Land Warrior Program Manager  
 U.S. Army Soldier Systems Command
- 1035            TECOM's VIRTUAL PROVING GROUND  
 Mr. Richard S. Cozby  
 Engineer  
 Simulation and Technology Division  
 U.S. Army Test and Evaluation Command
- 1100            STRICOM OVERVIEW  
 Mr. James M. Skurka  
 Deputy to the Commander  
 U.S. Army Simulation, Training and Instrumentation Command
- 1120            QUESTIONS AND ANSWERS
- 1130            LUNCH

**SESSION II: ACQUISITION STREAMLINING INITIATIVES**

- 1300            THE NEW ACQUISITION CENTER AND LATEST INITIATIVES  
 o MISSION EXPANSION  
 o COST REALISM  
 o COMMERCIAL PRACTICES  
 o INTERNET  
 o UPDATE OF AUGUST 1996 LEVEL I APBI CONTRACT OPPORTUNITIES  
 Mr. Edward G. Elgart - MODERATOR  
 Deputy Assistant Secretary of the Army - Procurement (Acting)
- 1320            CECOM AND SMALL BUSINESS PROGRAM  
 Mr. Arthur C. Widmaier  
 Acting Chief  
 Small and Disadvantaged Business Utilization Office, CECOM
- 1335            QUESTIONS AND ANSWERS
- 1345            BREAK

**SESSION III: BATTLEFIELD SUSTAINMENT**

- 1405            THE NEW CECOM LOGISTICS AND READINESS CENTER  
 Mr. Anthony A. LaPlaca - MODERATOR  
 Director, CECOM Logistics and Readiness Center
- 1420            VALUE MANAGEMENT PROGRAM  
 Mr. Richard Riccelli  
 Chief, Technical Policy and Programs Branch  
 Logistics and Engineering Operations Directorate, CECOM

- 1435            YEAR 2000  
                 Mr. Raoul Cordeaux  
                 AMC Year 2000 Information Management Infrastructure Project Coordinator  
                 Directorate for Corporate Information, CECOM
- 1455            SMALL COMPUTER PROGRAM  
                 o ARMY PERSONAL COMPUTER-3 (PC-3)  
                 o ARMY PORTABLE COMPUTER (PORT-3)  
                 o INFRASTRUCTURE ARCHITECTURE SOLUTIONS-1 (IAS-1)  
                 o ARMY VIDEO TELECONFERENCING-1 (VTC-1)  
                 o NETWORKS-1 (NET-1)  
                 o STANDARD SYSTEMS TECHNOLOGY SUPPORT-2 (SSTS-2)  
                 o MAXI-MINIS AND DATABASES-1 (MMAD-1)  
                 LTC Mary Fuller  
                 Product Manager, Small Computer Program
- 1530            PENTAGON RENOVATION INFORMATION MANAGEMENT AND  
                 TELECOMMUNICATIONS PROJECT  
                 COL Scipio de Kanter  
                 Project Manager, Information Management & Telecommunications, Pentagon  
                 Renovation
- 1545            PEO STANDARD ARMY MANAGEMENT INFORMATION SYSTEMS  
                 Mrs. Mary Kelly  
                 Acting Deputy Program Executive Officer  
                 Standard Army Management Information Systems
- 1600            QUESTIONS AND ANSWERS
- 1610            BREAK
- 1620            EXECUTIVE PANEL
- MG Gerard P. Brohm  
                 Commanding General  
                 U.S. Army Communications-Electronics Command
- MG David R. Gust  
                 Program Executive Officer  
                 Intelligence, Electronic Warfare and Sensors
- Mr. Eugene Famolari, Jr.  
                 Associate Technical Director  
                 CECOM Research, Development and Engineering
- Mr. Edward G. Elgart  
                 Deputy Assistant Secretary of the Army - Procurement (Acting)
- Mrs. Kathryn T. H. Szymanski  
                 Chief Counsel, CECOM
- Mr. Anthony A. LaPlaca  
                 Director  
                 CECOM Logistics and Readiness Center

Mr. Robert R. Lehnes  
Deputy Program Executive Officer, Communications Systems  
Program Executive Office, Command, Control and Communications Systems

Mr. Thomas J. Michelli  
Acting Director  
Systems Management Center, CECOM

1715 RECEPTION

**THURSDAY, MAY 29, 1997**

0800 ADMINISTRATIVE REMARKS

**SESSION IV: INTELLIGENCE AND ELECTRONIC WARFARE AND  
SENSORS TECHNOLOGIES AND MODERNIZATION**

0805 PEO, INTELLIGENCE, ELECTRONIC WARFARE AND SENSORS OVERVIEW  
Mr. Edward T. Bair - MODERATOR  
Deputy Program Executive Officer  
Intelligence, Electronic Warfare and Sensors

0820 FIREFINDER BLOCK II, PRE-PLANNED PRODUCT IMPROVEMENT (P3I)  
LTC Thomas M. Cole  
Product Manager, FIREFINDER

0835 NIGHT VISION & ELECTRONIC SENSOR SYSTEMS  
o THERMAL OMNIBUS  
oo DRIVER'S VISION ENHANCER (DVE)  
oo THERMAL WEAPON SIGHT (TWS)  
o LIGHTWEIGHT VIDEO RECONNAISSANCE SYSTEM (LVRS)  
o OMNIBUS V  
Mr. Brian Murray  
Chief, Logistics Branch  
Project Manager, Night Vision/Reconnaissance Surveillance and Target Acquisition

0905 QUESTIONS AND ANSWERS

0915 BREAK

**SESSION V: RDE OPPORTUNITIES**

0935 THE CECOM RESEARCH, DEVELOPMENT AND ENGINEERING (RD&E)  
ORGANIZATION  
Mr. Eugene Famolari, Jr. - MODERATOR  
Associate Technical Director  
CECOM Research, Development and Engineering

- 0950 SOFTWARE ENGINEERING CENTER  
Mr. Dennis Turner  
Director, Software Engineering, CECOM
- 1010 INFORMATION SYSTEMS ENGINEERING COMMAND  
Dr. Frank Jenia  
Technical Director, Information Systems Engineering Command, CECOM
- 1030 THE CECOM RESEARCH, DEVELOPMENT AND ENGINEERING CENTER ORGANIZATIONS  
Dr. Louis Marquet  
Director, Night Vision and Electronic Sensors, CECOM
- 1050 INTELLIGENCE AND ELECTRONIC WARFARE DIRECTORATE  
Dr. Richard A. Poisel  
Deputy Director, Intelligence and Electronic Warfare, CECOM
- 1110 NIGHT VISION AND ELECTRONIC SENSORS DIRECTORATE  
Mr. Larry L. Fillian  
Deputy Director, Night Vision and Electronic Sensors, CECOM
- 1130 COMMAND, CONTROL AND SYSTEMS INTEGRATION DIRECTORATE  
Mr. George R. Oliva, Jr.  
Director, Command, Control and Systems Integration, CECOM
- 1150 SPACE & TERRESTRIAL COMMUNICATIONS DIRECTORATE  
COL Kenneth A. Thomas  
Acting Director, Space and Terrestrial Communications, CECOM
- 1200 QUESTIONS AND ANSWERS
- 1210 LUNCH
- SESSION VI: COMMAND, CONTROL AND COMMUNICATIONS TECHNOLOGIES AND MODERNIZATION**
- 1330 PEO C3S OVERVIEW  
Mr. Robert R. Lehnes - MODERATOR  
Deputy Program Executive Officer, Communications Systems  
Program Executive Office, Command, Control and Communications Systems
- 1345 AREA COMMON USER SYSTEM (ACUS) RADIO MODERNIZATION PROGRAM  
Mr. Kenneth Chaney  
Project Leader  
Project Manager, Joint Tactical Area Communications Systems
- 1405 SINGLE CHANNEL ANTI-JAM MANPORTABLE (SCAMP) BLOCK II  
Mr. Carl M. Swenson  
Project Leader, SCAMP Block II  
Project Manager, Milsatcom

1425	DEFENSE SATELLITE COMMUNICATIONS SYSTEM (DSCS) SPECTRUM MANAGEMENT SYSTEM COMMON NETWORK PLANNING SOFTWARE AN/GSC-52 MODERNIZATION PROGRAM Mr. Ronald F. Johnson Product Manager, DSCS Control Project Manager, Milsatcom
1450	QUESTIONS AND ANSWERS
1500	CLOSING REMARKS MG Gerard P. Brohm
1515	ADJOURN

## CONTENTS

	Page
WELCOMING REMARKS .....	1
GUEST SPEAKER.....	5
THE NEW CECOM.....	9
<b>SESSION I: OUR AMC PARTNERS.....</b>	<b>37</b>
<b>SESSION II: ACQUISITION STREAMLINING INITIATIVES .....</b>	<b>41</b>
The New Acquisition Center and Latest Initiatives .....	43
CECOM and Small Business Program.....	71
<b>SESSION III: BATTLEFIELD SUSTAINMENT.....</b>	<b>79</b>
The New CECOM Logistics and Readiness Center .....	81
Value Management Program.....	91
Year 2000.....	109
Small Computer Program.....	121
Pentagon Renovation Information Management and Telecommunications Project .....	169
PEO Standard Army Management Information Systems .....	185
<b>SESSION IV: INTELLIGENCE AND ELECTRONIC WARFARE AND SENSORS TECHNOLOGIES AND MODERNIZATION .....</b>	<b>201</b>
PEO Intelligence, Electronic Warfare and Sensors Overview.....	203
FIREFINDER Block II, Pre-planned Product Improvement (P3I) .....	225

	Page
Night Vision & Electronic Sensor Systems.....	237
<b>SESSION V: RDE OPPORTUNITIES</b> .....	<b>277</b>
The CECOM Research, Development and Engineering (RD&E) Organization.....	279
Software Engineering Center.....	295
Information Systems Engineering Command.....	321
The CECOM Research, Development and Engineering Center Organizations.....	339
Intelligence and Electronic Warfare Directorate.....	355
Night Vision and Electronic Sensors Directorate.....	377
Command, Control and Systems Integration Directorate.....	433
Space & Terrestrial Communications Directorate.....	449
<b>SESSION VI: COMMAND, CONTROL AND COMMUNICATIONS TECHNOLOGIES AND MODERNIZATION</b> .....	<b>463</b>
PEO C3S Overview.....	465
Area Common User System (ACUS) Radio Modernization Program.....	479
Single Channel Anti-Jam Manportable (SCAMP) Block II.....	495
Defense Satellite Communications System (DSCS) Spectrum Management System, Common Network Planning Software and AN/GSC-52 Modernization Program.....	507
EXECUTIVE PANEL.....	529
SYMPOSIUM PARTICIPANTS.....	531
LIST OF ACRONYMS.....	537

# **WELCOMING REMARKS**

**MG GERARD P. BROHM**

**COMMANDING GENERAL  
CECOM**

# NOTES

# **GUEST SPEAKER**

**GENERAL JOHNNIE E. WILSON**

**COMMANDING GENERAL  
U.S. ARMY MATERIEL COMMAND**

# NOTES

**THE US ARMY  
COMMUNICATIONS-ELECTRONICS COMMAND  
(CECOM)**

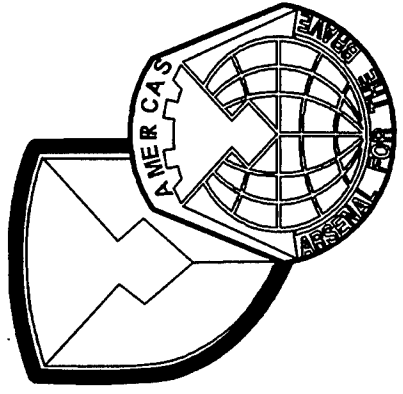
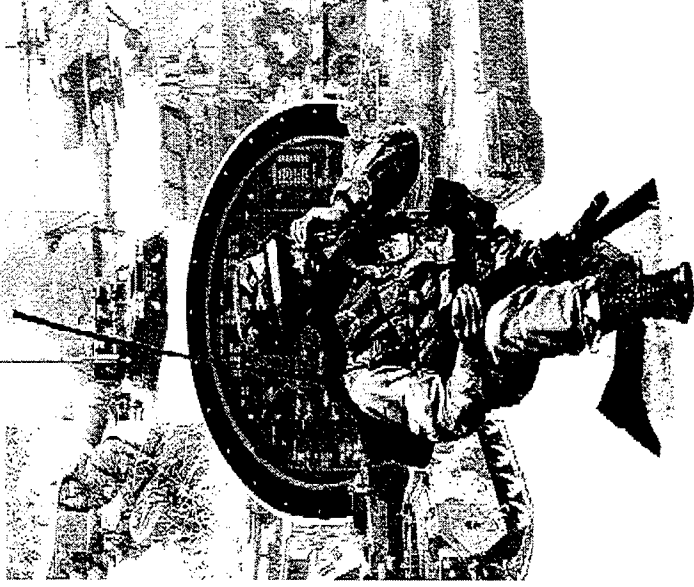

**The New CECOM**

**BUILDING TOMORROW'S ARMY TODAY,  
SUSTAINING TODAY'S ARMY EVERYDAY**

# Outline

- *Background*
  - *Changing DoD and Army (Vision 2010)*
  - *Changing C4IEWS Technologies*
- *Organizational Impacts to CECOM*
  - *Decisions Impacting CECOM*
  - *Organizing to address Impacts*
  - *Operational Impacts*
- *What are the benefits*
  - *TFXXI - Returns*
  - *Alliances*
  - *Partnerships*
  - *Technologies*
- *Potential Impacts*
  - *Vision 21*
  - *QDR*
- *Summary*

# BACKGROUND - JOINT & ARMY VISION 2010

JOINT VISION 2010

Dominant Maneuver

Precision Engagement

Technological Innovations

Focused Logistics

Full-Dimensional Protection

Massed

Effects

Information Superiority

Information Dominance  
is the "KEY ENABLER"  
in 21st Century Operations

"The Power of Information will allow the ultimate weapon -- the individual soldier -- to successfully meet the challenges of the 21st Century and achieve decisive victory."

Gen Reimer  
CSA

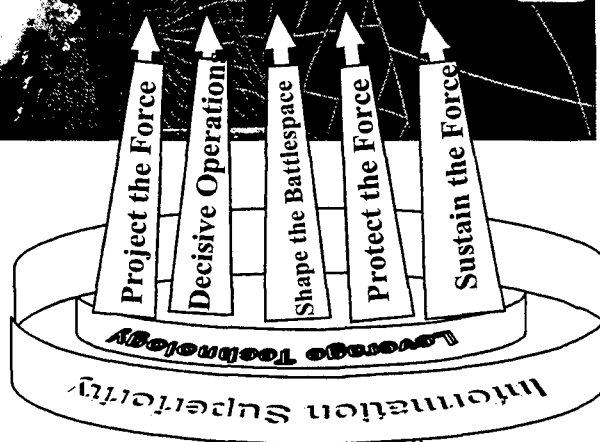

ARMY VISION 2010

# Background

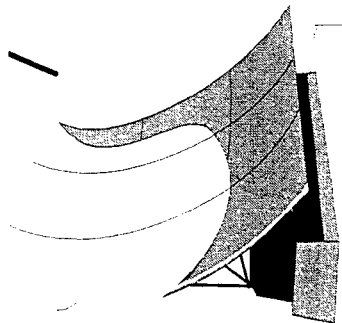
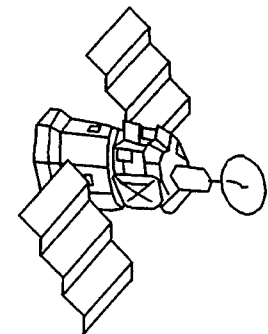

**1960--70s  
DoD Driven  
Unique Technology**

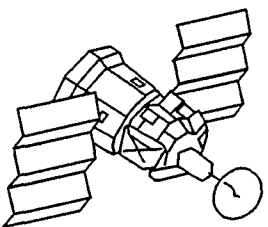
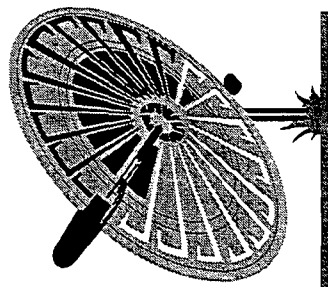

**1980s--90s  
Commerical Market  
Drives Technology**



**DoD Is No Longer the Driver  
in C4I/EWS Technologies**

# Background

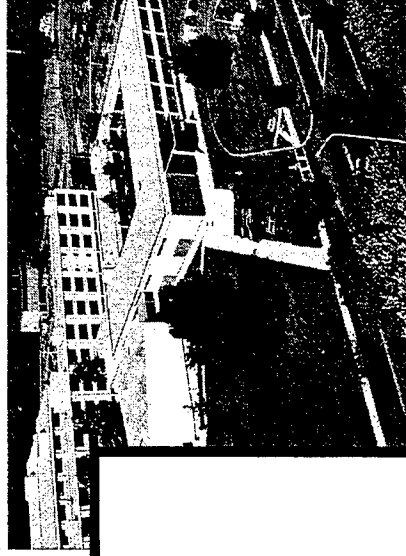

**Emerging Information  
Technologies will change how  
DoD:**

- **Processes Information**
- **Is organized**



**Initial Organizational  
Impacts are being  
implemented.**

# The NEW CECOM: Organizational Impacts

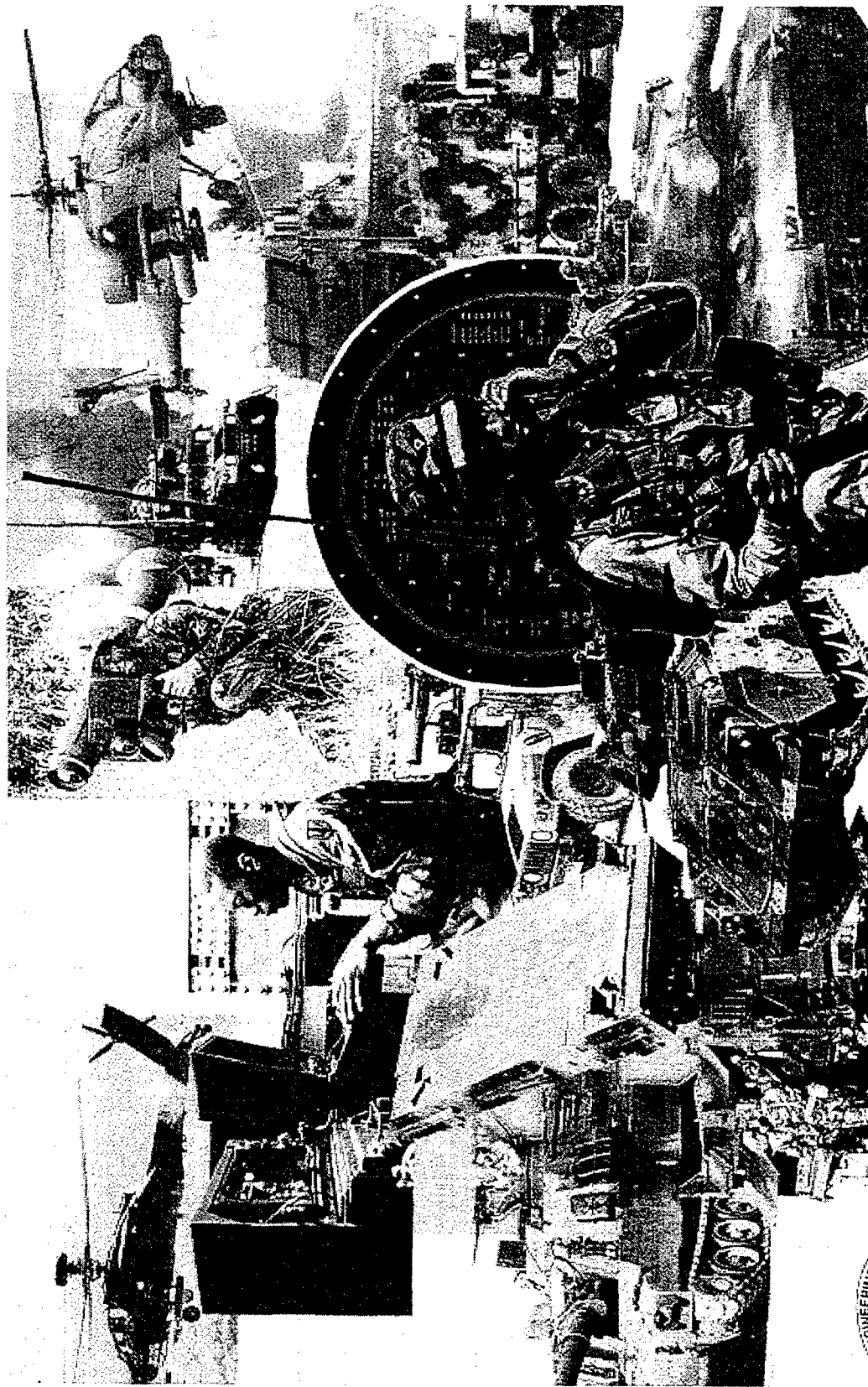

# Organizational Impacts to CECOM

## Information Management Functional Area Assessment

- ISSAA
- ISC HQ Elements
- ISC - Contracting
  - Engineering
  - Software
  - Systems

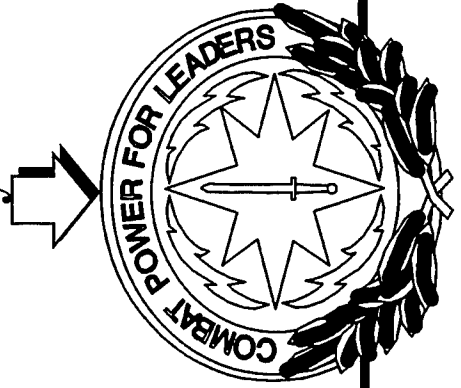

## HQ DA Directed PM Transfers

ISC/ISMA

ALL PMs

PEO C3S

PMs: GPS, JTACS, DSCS

PEO IEW

PMs: Info Warfare  
& Firefighter

ATCOM

Programs: 7

PEO STAMIS

Programs: ALL

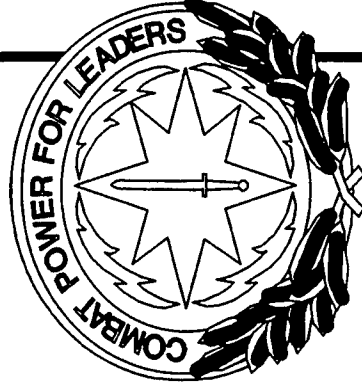

# Organizational Impacts to CECOM

## Central Design Activities:

- AMC EA for Corporation Information (ISEC)

↑ Implement Army technical Architecture (IM)

↑ Provide System Integration Support

- Standard Automated Business Systems

ILSC

LSSC

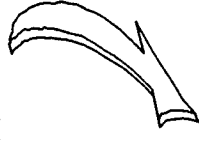

# Organizational Impacts to CECOM

## BRAC IMPLEMENTATION

IMMC  
IEWD

CECOM  
Ft. Monmouth

PEO IEW

Ft. Monmouth

ATCOM  
PM MEP  
LOGISTICS

CECOM  
Ft. Belvoir

ISEC CONUS

CECOM  
Ft. Huachuca

TECH APP OFFICE  
AND IMA BRAC

CECOM  
Ft. Detrick

# Organizing to Meet C4IEWs Mission: NOTIONAL ORGANIZATION CHANGES

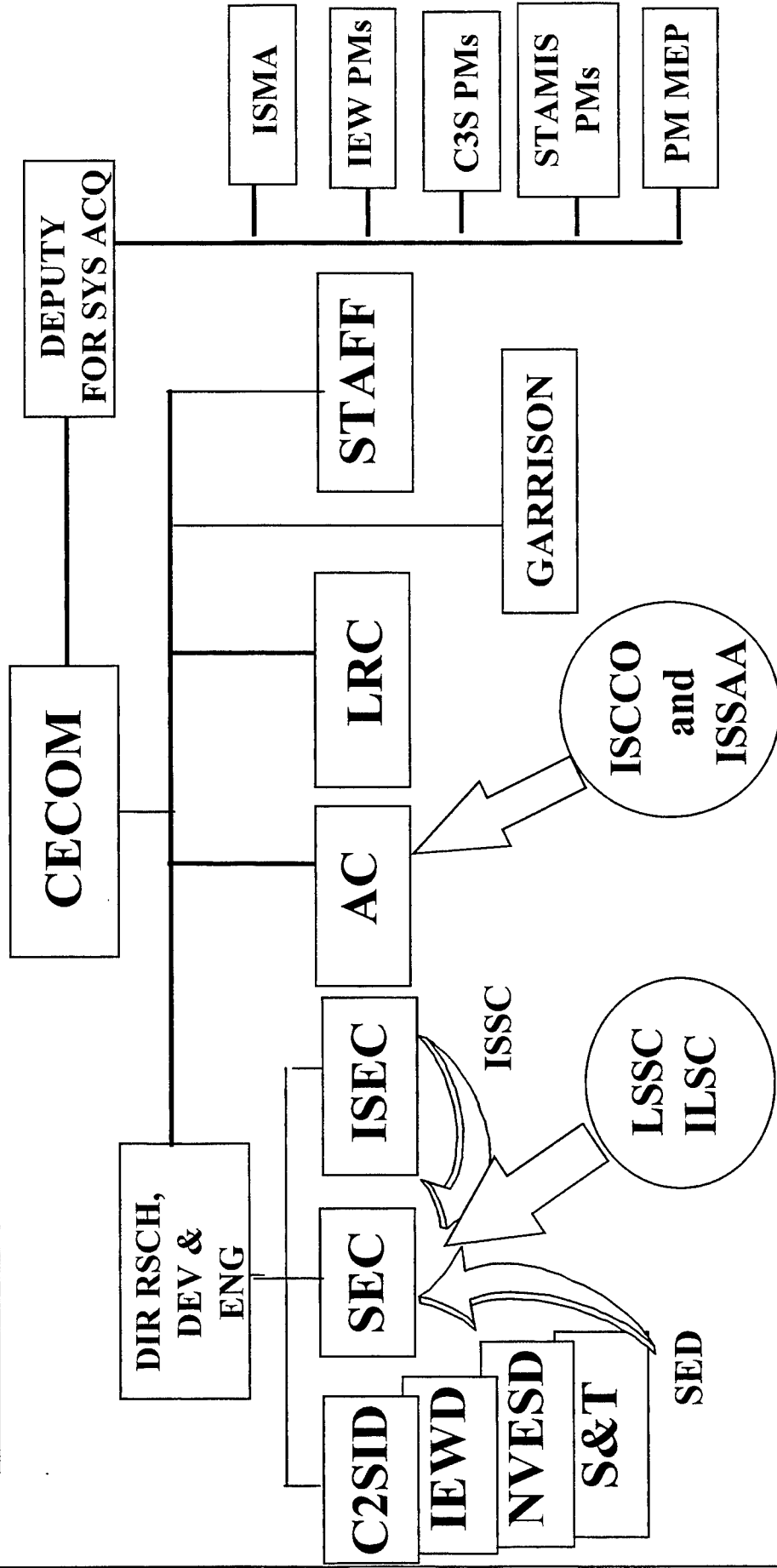

# Impact to CECOM MISSION:

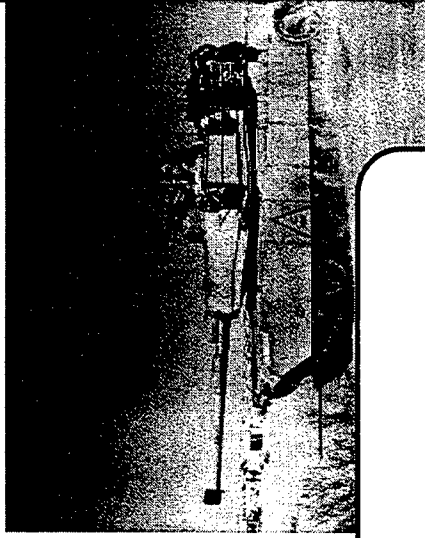
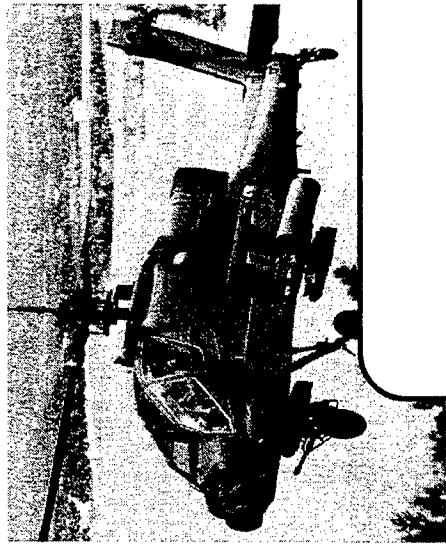

## CECOM Mission: Provide Information Dominance for America's Warfighter

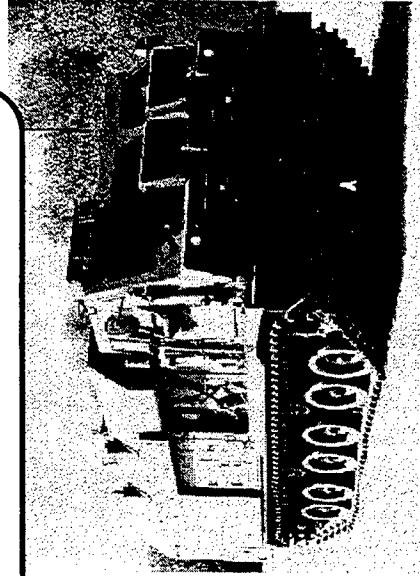
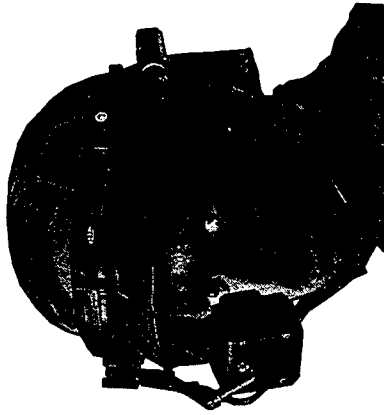

# New Mission - CECOM Provides Total System Integration



Other Bases,  
Installations,  
& HQs

**Garrisons**

*Operations Domain*

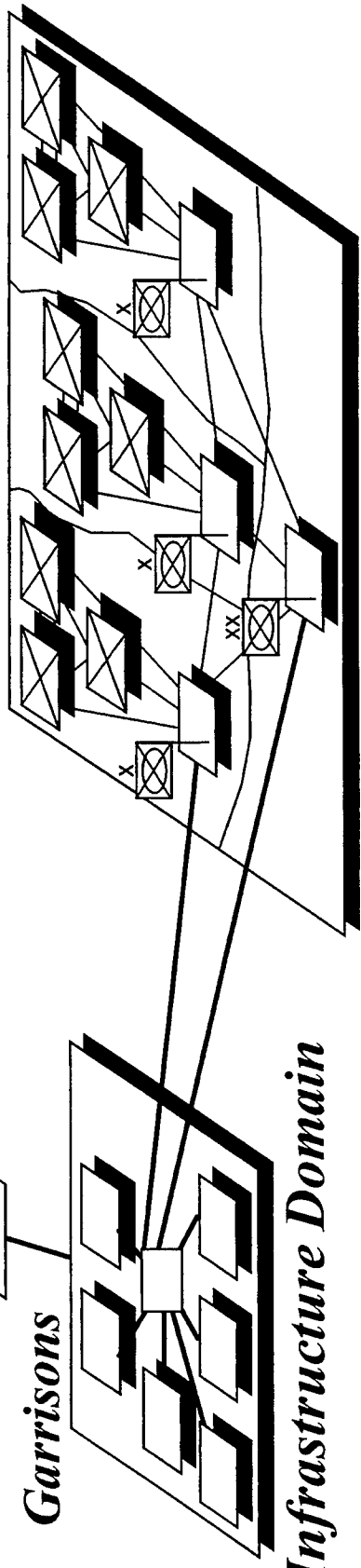

*Infrastructure Domain*

- Sustaining Base Info Sys
- Defense Communications
- Combat Support Systems
- Installation Infrastructure
- Software

- Communications
- Command & Control
- Electronic Combat
- Sensors
- Software
- Intelligence

**Helps Achieve Seamless, Interoperable, C4 & IM Capabilities**

**To Meet Our VISION, We Are An  
INTEGRATED TEAM Working TOGETHER**

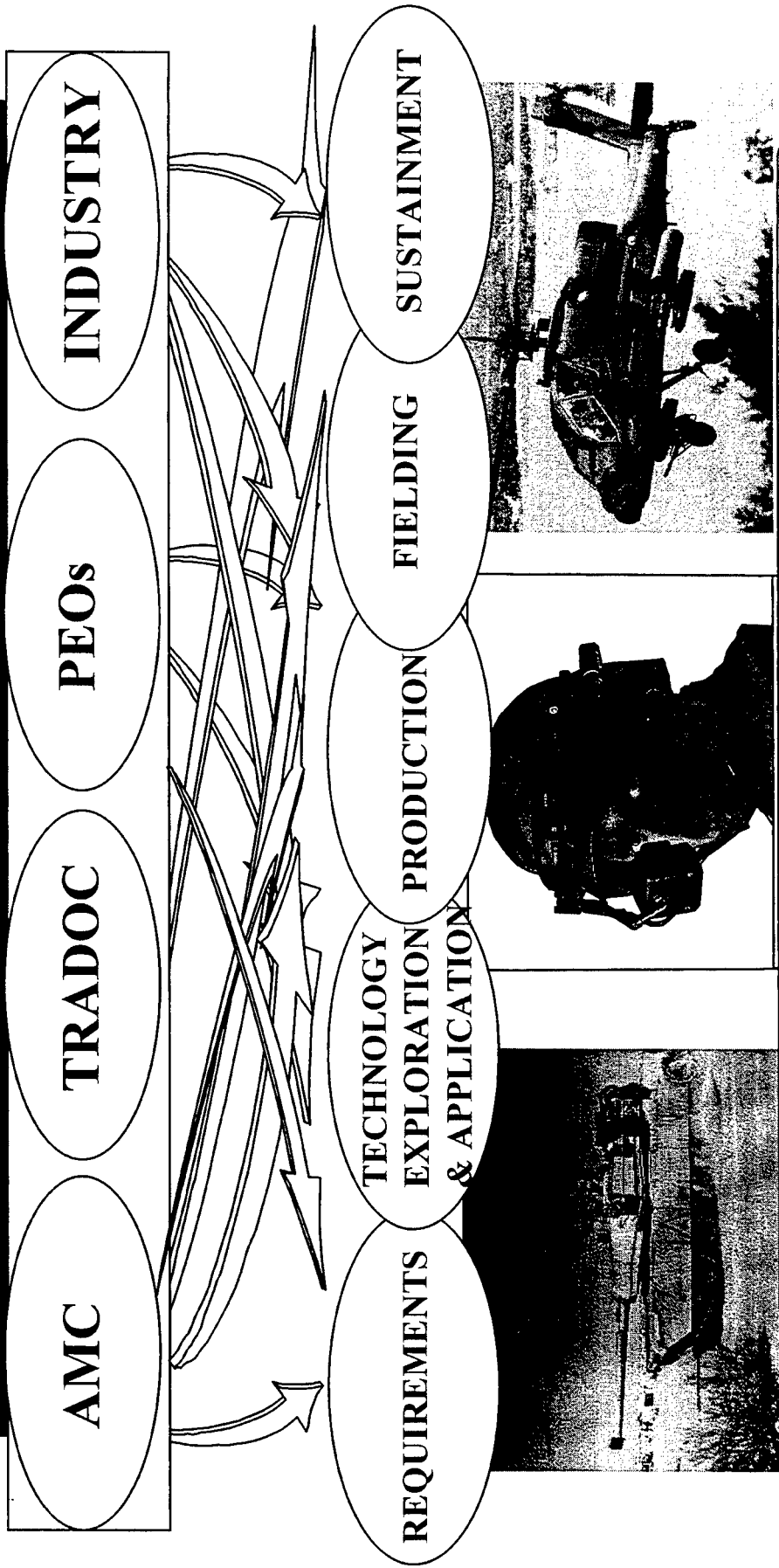

**Partnering To Provide & Sustain Relevant Technology  
to America's Warfighters...FASTER, BETTER,  
SMARTER, CHEAPER**



# What Are the Benefits - Alliances

## Technical Alliances - Digital Integrated Lab & Technology Integration Center

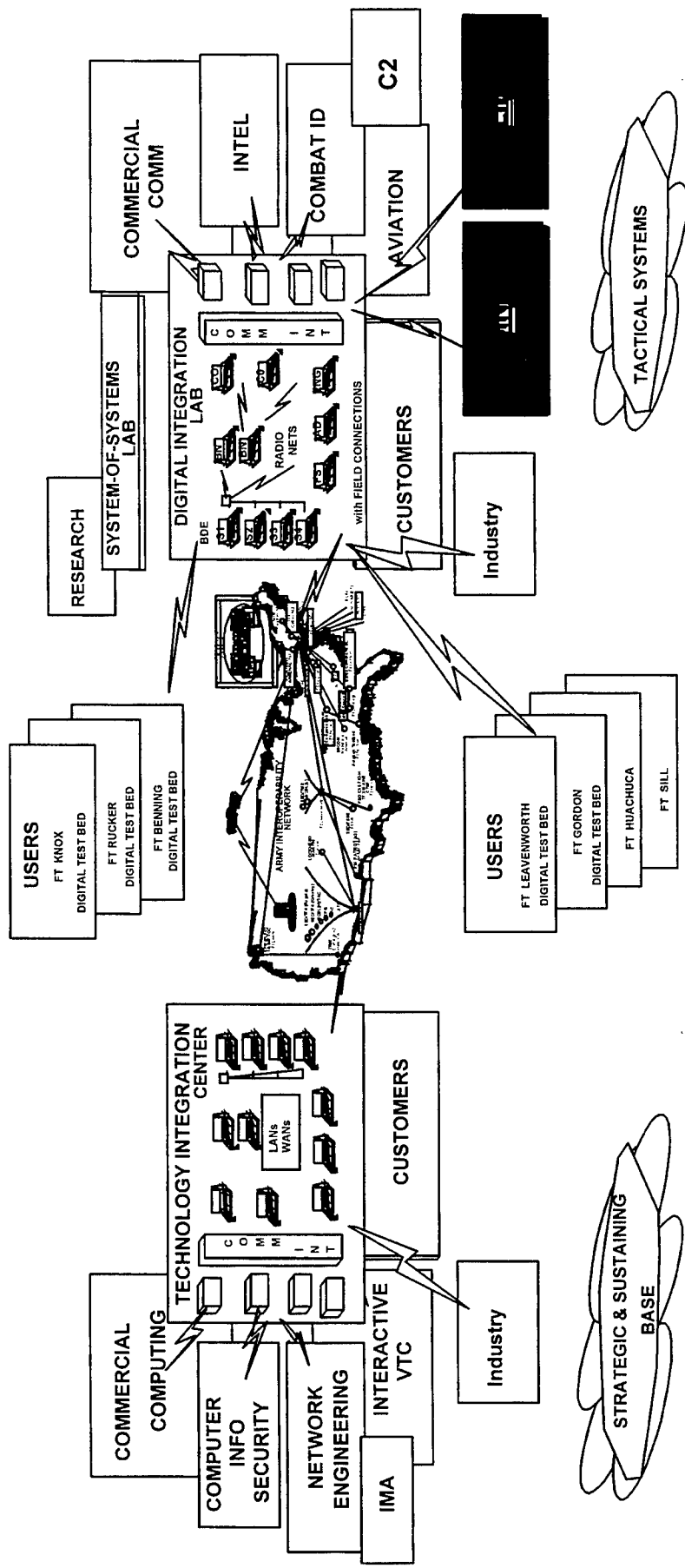

# What Are the Benefits - Integrated Efforts

## Information Management - Site Solution

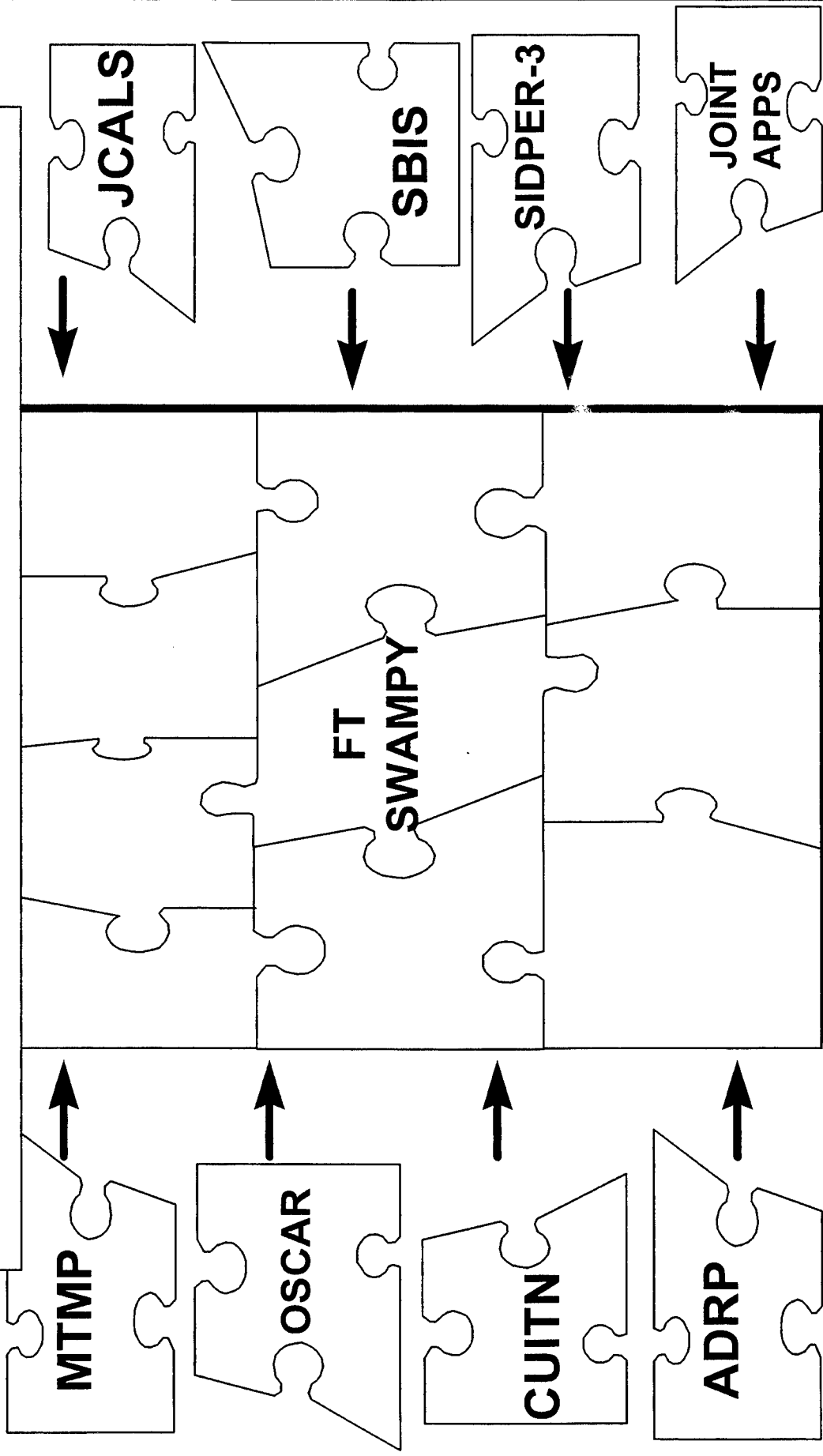

# What Are the Benefits - Strategic Alliances

## Wireless Interworking Testbed (WIT)

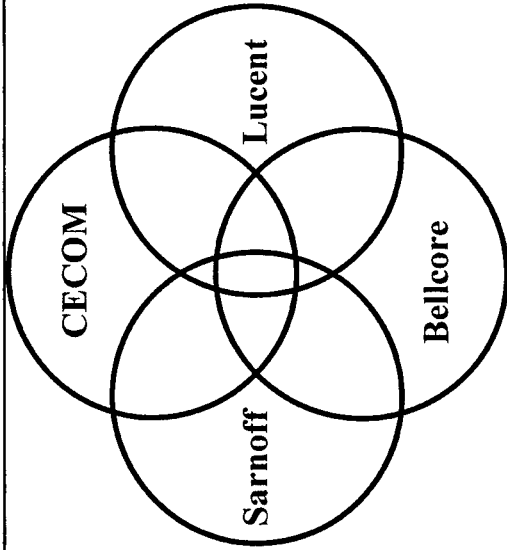

Industry / Government

Testbed to Promote

Emerging Dual Use

Communications Technologies

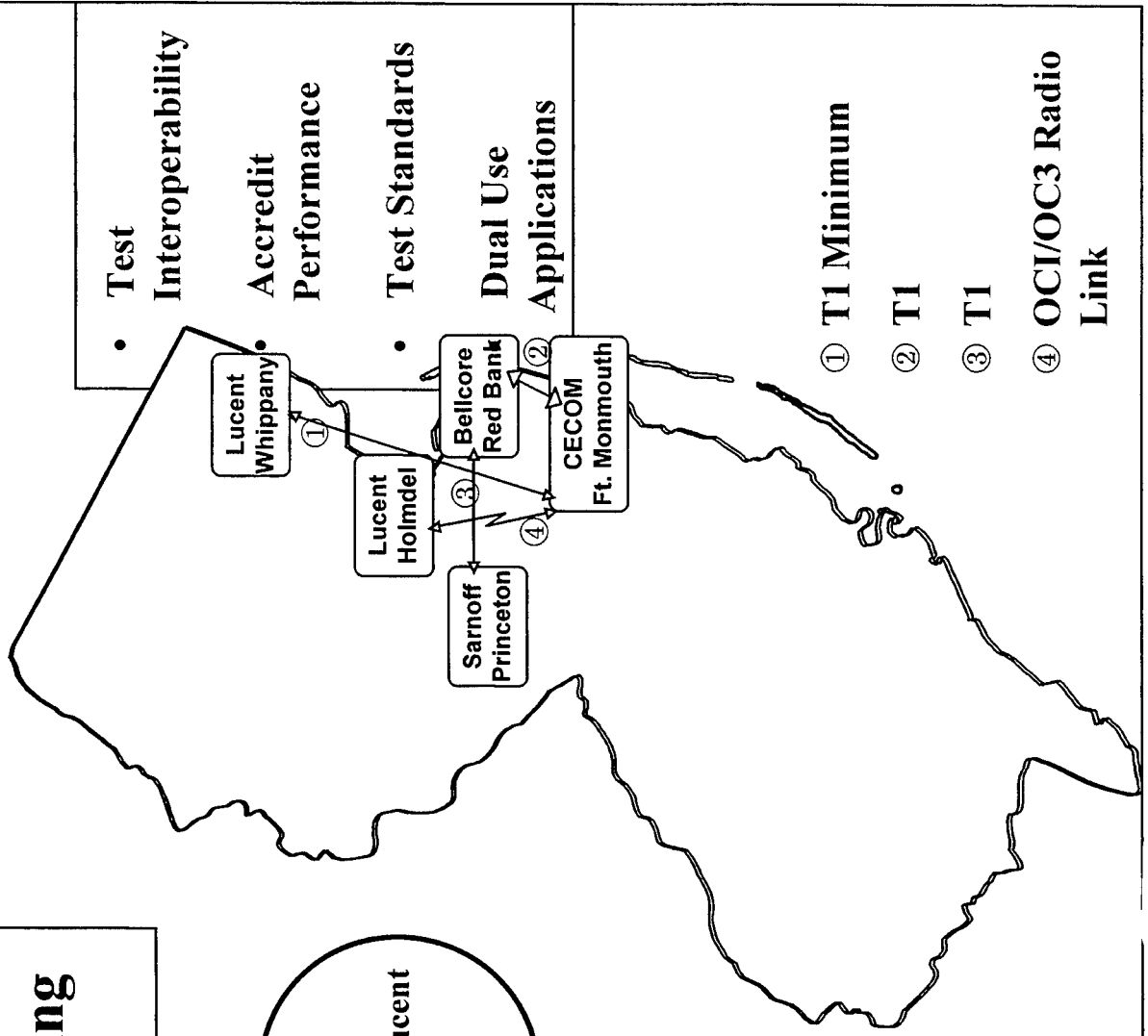

# What Are the Benefits - Partnering to Common Goal

## Over Arching Partnerships

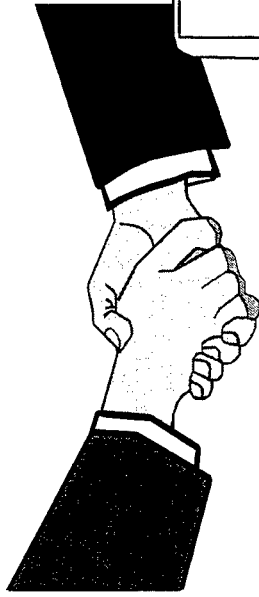

### Formal Commitment

- Establish positive & productive relationships.
- Ensure programs more forward to mutual Goal!

### Completed:

- Hughes
- Mitre

### In Process:

- Lockheed Martin

We Will Continue to Work Partnership Agreements

# What Are the Benefits - Industry/COTS Emphasis

## Commerical-off-the Shelf

- Limited “unique” DoD research
- Broader market for Products

Broaden Applications:  
Extend Wireless Interworking  
Testbeds to Universities  
and “Incubators”

## Greater R&D Return:

We Will Continue to  
Review IR&D

## Provide “Seed Funds”:

Small Business  
Innovative Research

# What the Benefits - Mutual Goals

**Cooperative R&D  
Agreements**

**Data Fusion Technologies**

**3-D Modeling**

**Infrared Imaging**

**Advanced Software  
Applications**

**Fuel Cells**

**43 Active Agreements**

**12 CRDA's Signed  
over past year**

# Potential Future Impacts

**Quadrennial Defense  
Review (QDR)**

**VISION 21**



# Potential Future Impacts

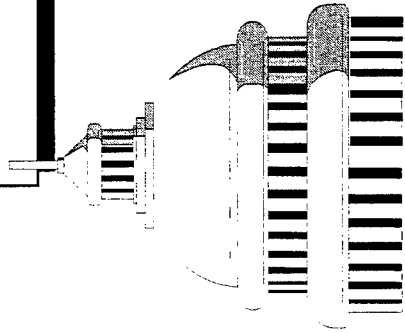

*QDR results to  
Congress 15 May 97*

**QDR**



*15 Dec 97*

Develop foundation for  
Alternative Force  
Structures through  
FY 2010

## Based On Discussions:

- Major emphasis on privatization
- Infrastructure Reduction may require request for additional BRACs
- Focus on Hi-Tech Solutions to Warfighting Issues
- Possibility of additional cuts to Force Structure

# Potential Future Impacts

**VISION 21:**

→ Reduce Infrastructure costs of Laboratory and Test

and Evaluation Centers



20% Cost Reduction

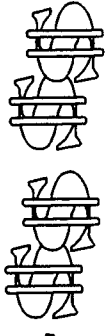

→ Inter Service Restructuring

ARMY

NAVY

AIR FORCE



DoD Lab

→ Modernize Facilities



1977 - Initiated

Jan 1999

2000

Jul 98 to SecDef  
for Approval

Approved

Input for Budget

## Summary

- Changes to CECOM will benefit the Soldier...focusing our C4IEWS efforts.

- We are not at an “End State”  
Changes will continue:  
Technology, Processes &  
Products

- Industry is a Key  
Partner to best  
serve our customer  
and we look forward  
to working  
**TOGETHER**

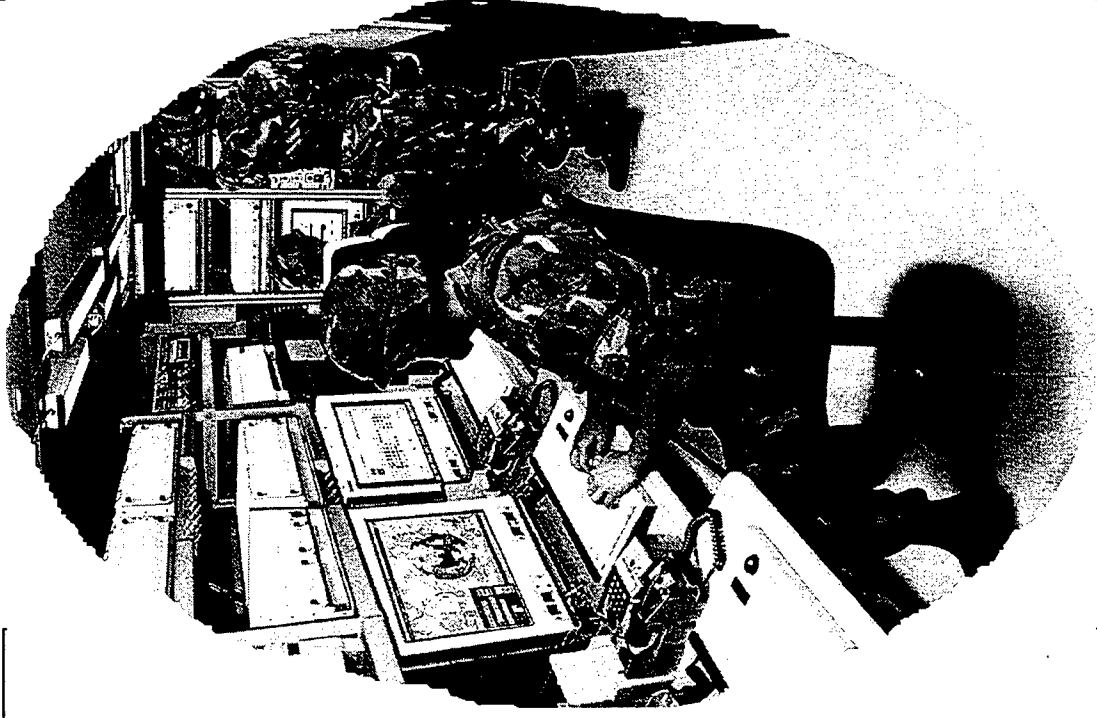

# Summary - CECOM: Providing Seamless, Interoperable C4IEWS & IM Capabilities

**STRATEGIC and SUSTAINING BASE - IM SYS**  
Systems Engineering & Integration

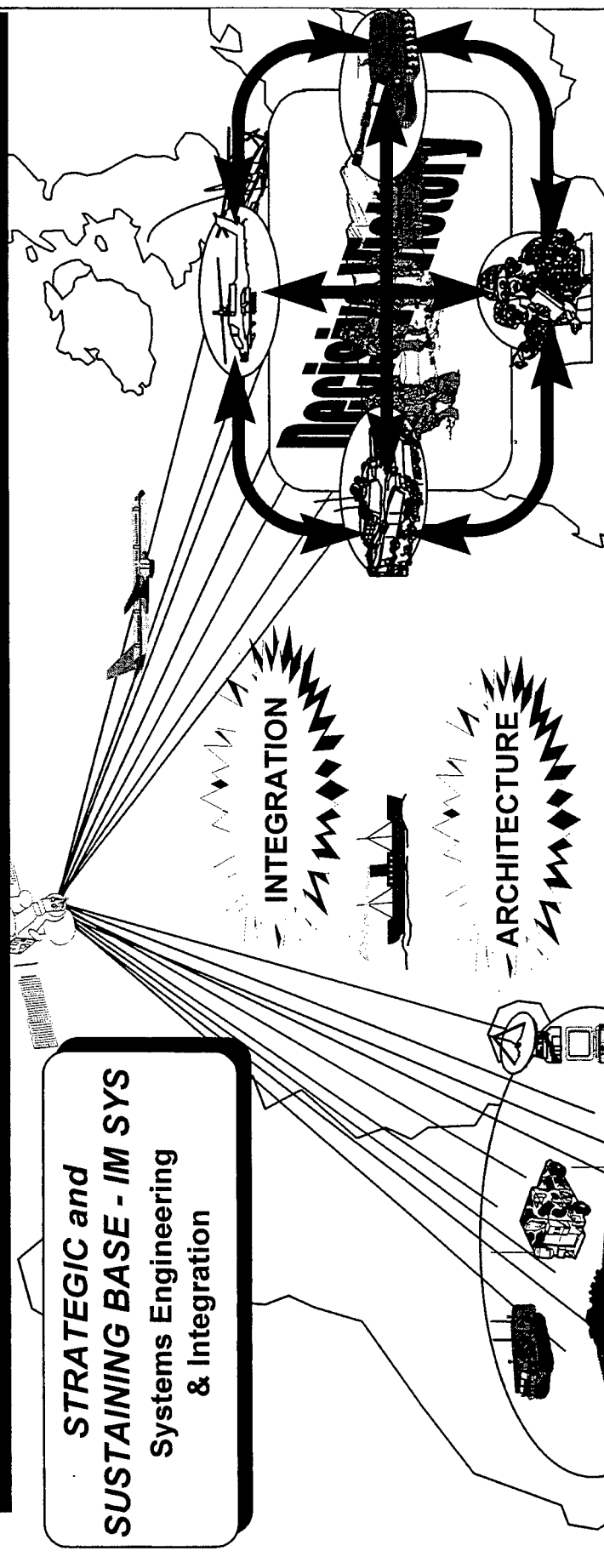

**Tactical - C4IEWS Sys**  
Army Systems Engineer

INTEGRATION

ARCHITECTURE

SYSTEMS ENGINEERING

CONTRACTING

POWER PROJECTION PLATFORM

HARDWARE / SOFTWARE

# NOTES

# **SESSION I**

## **OUR AMC PARTNERS**

**PRESENTATIONS WILL BE  
PROVIDED AT THE  
CONFERENCE**

# **SESSION II**

## **ACQUISITION STREAMLINING INITIATIVES**

### **MODERATOR**

**MR. EDWARD G. ELGART  
DEPUTY ASSISTANT SECRETARY  
OF THE ARMY-PROCUREMENT  
(ACTING)**

# THE NEW ACQUISITION CENTER AND LATEST INITIATIVES

28 MAY 97



MR. EDWARD G. ELGART  
DEPUTY ASSISTANT SECRETARY  
OF THE ARMY-PROCUREMENT(ACTING)

UNCLASSIFIED

# **AGENDA**

- **MISSION EXPANSION**
- **COST REALISM**
- **COMMERCIAL PRACTICES**
- **INTERNET**
- **UPDATE AUG 96 LEVEL I APBI -  
CONTRACT OPPORTUNITIES**

# MISSION EXPANSION

30 SEP 96

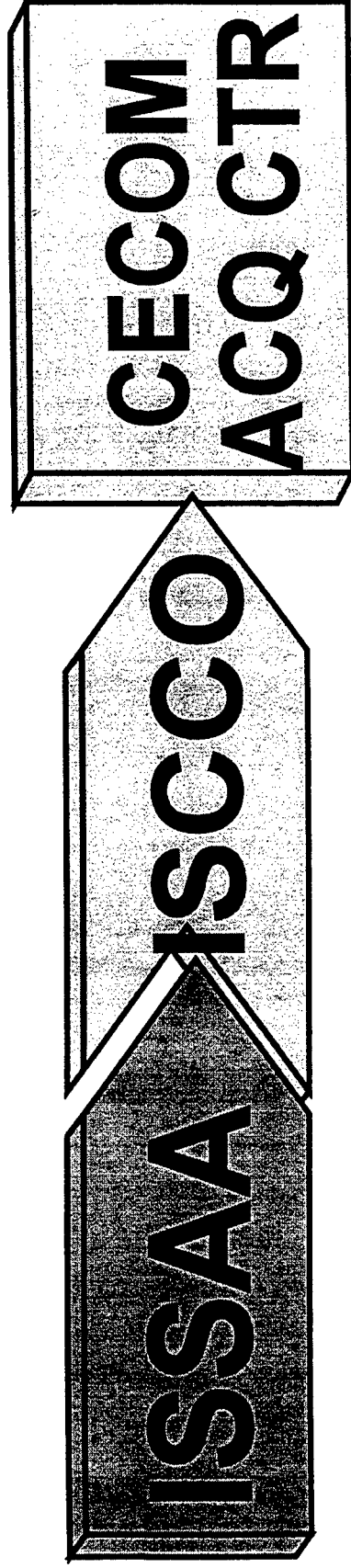

- ◆ INFORMATION MANAGEMENT - \$.8B
- ◆ COMMUNICATIONS-ELECTRONICS - \$3.2B

**TOTAL OBLIGATIONS INCREASE**

**\$3.2B -> \$4B**

**EXPERTS POSITIONED TO DEAL WITH  
CONTRACTING CHALLENGES**

# ACQUISITION CENTER, SATELLITE LOCATIONS

FT. MONMOUTH, NJ



WASHINGTON,  
DC

FT. HUACHUCA, AZ

# LATEST INITIATIVES

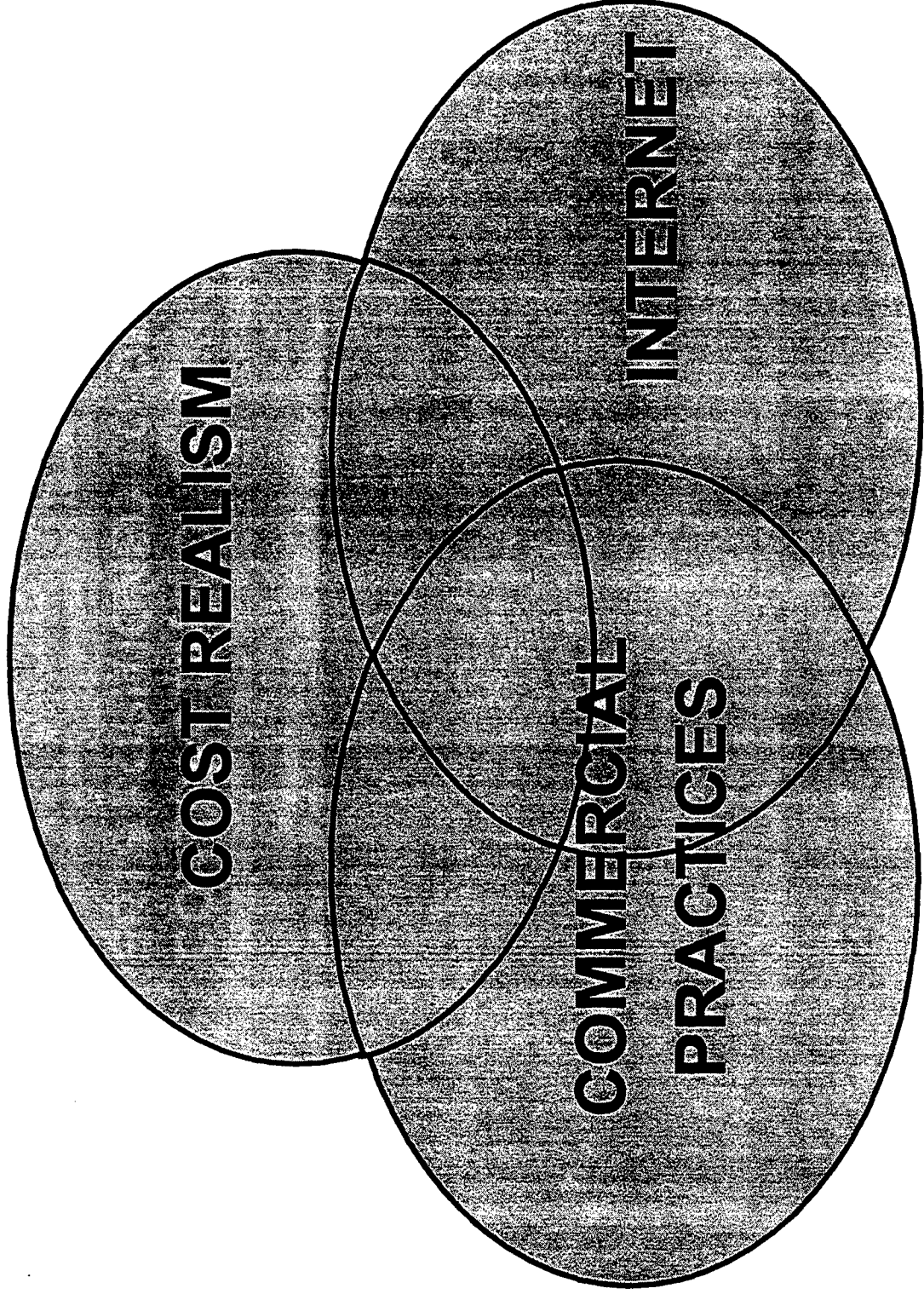

# COST REALISM EQUALS MANAGED RISK

CONTRACTOR  
ABSORBED OVERRUN

SHARED  
OVERRUN



FREE

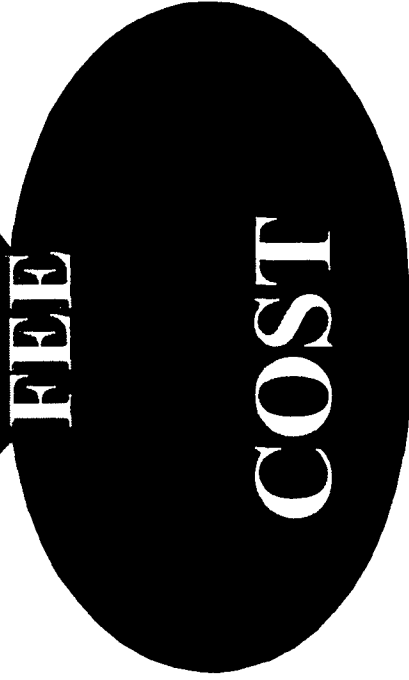

VERSUS

SHARED  
OVERRUN

CONTRACTOR  
ABSORBED OVERRUN

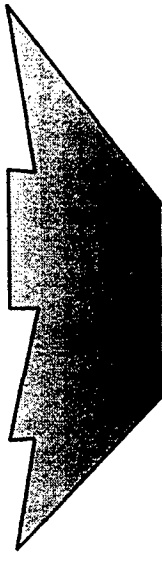

FREE

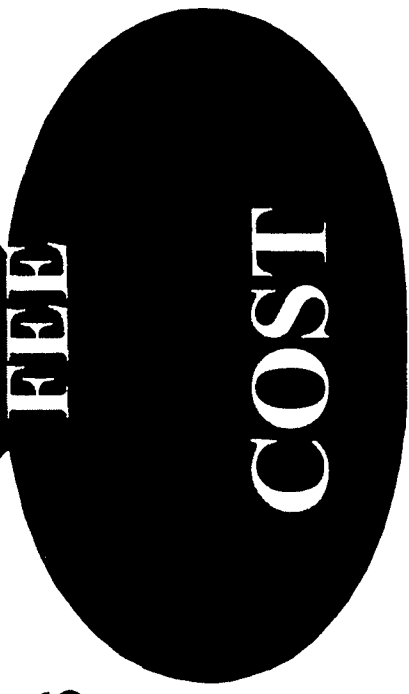

# **COMMERCIAL PRACTICES**

- **PRE-PRICED CATALOG CONTRACTS**
  - **TECHNOLOGY REFRESHER PROVISION**
  - **CONTRACT PRICE ADJUSTMENT**
  - **CREDIT CARD PROVISION**
  - **TOLL FREE NUMBER ORDERING**

# **COMMERCIAL PRACTICES: MASTER CONTRACTS**

- **“LIKE TECHNOLOGY”**
- **FLEXIBLE LONG TERM CONTRACTS**
- **INDEFINITE DELIVERY/INDEFINITE QUANTITY  
WITH DELIVERY ORDERS**
- **COMPETITIVE BEST VALUE**
- **MOVE FROM SINGLE SERVICE TO  
CONTRACTS FOR ALL DoD, OTHER  
AGENCIES**
- **LOWER OVERHEAD**

# COMMERCIAL PRACTICE: SPARES EVALUATION

COST AS AN INDEPENDENT VARIABLE  
SCHEDULE AS AN INDEPENDENT VARIABLE  
PERFORMANCE RISK ASSESSMENT

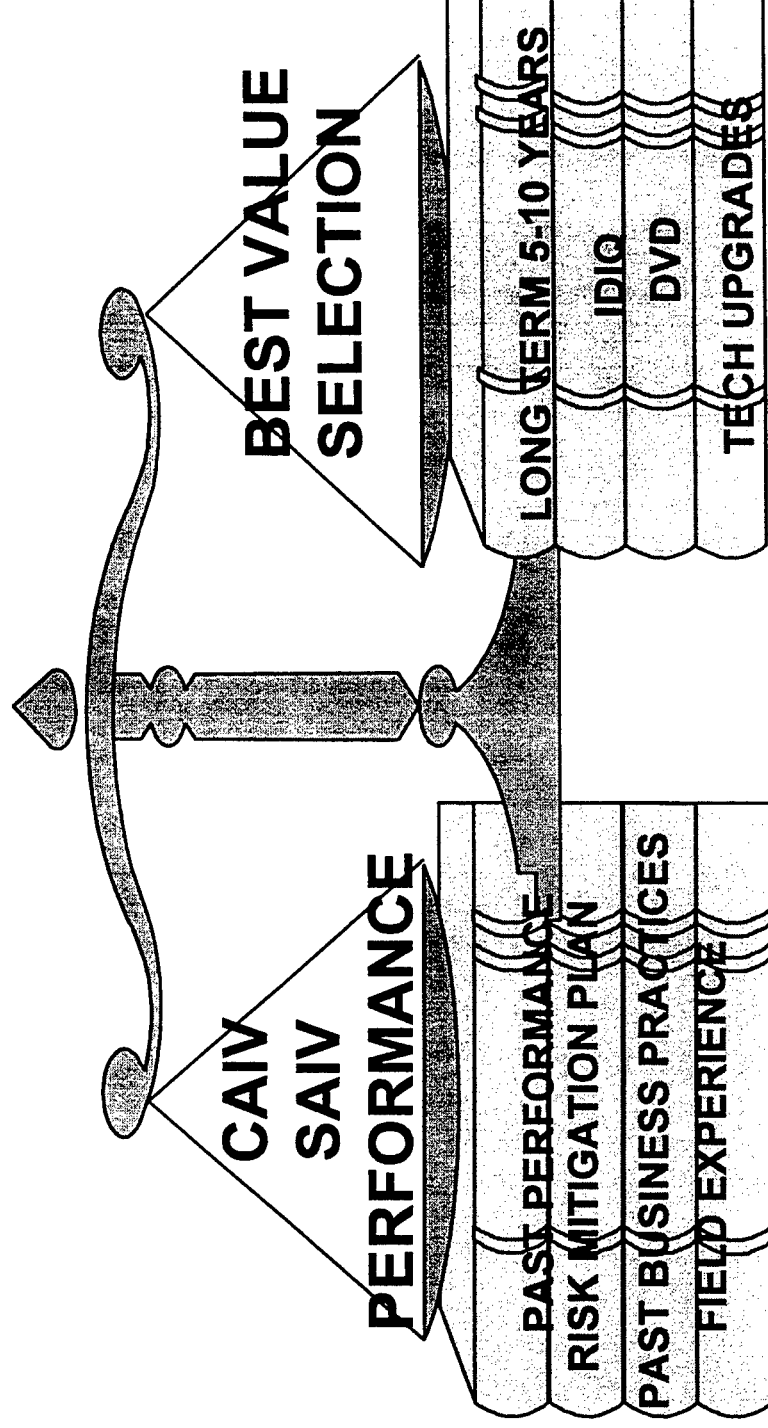

# **ELECTRONIC BULLETIN BOARD (EBB) MIGRATES TO THE WORLD WIDE WEB (WWW)**

- **FORT MONMOUTH'S INTERNET  
TEST BED - APRIL 97  
– DIGITAL SWITCH SYSTEMS  
MODERNIZATION PROGRAM**



# **FY96 BEST VALUE**

**83% TECHNICALLY SUPERIOR  
OFFEROR OF WHICH 39%  
AWARDED TO THE LOW OFFEROR**

**UPDATE OF 1996 LEVEL I APBI  
CONTRACT OPPORTUNITIES**

**AWARDED  
1996 REQUIREMENTS**

**TITLE: ADVANCED INTERCEPT TECHNIQUES  
CUSTOMER: RDEC**

**SPLIT AWARD**

**AWARDED: 04 NOV 96  
DOLLAR AMT \$99,597  
CONTRACTOR: S.T. RESEARCH CORPORATION**

**AWARDED: 04 NOV 96  
DOLLAR AMT: \$99,758  
CONTRACTOR: LASER POWER CORPORATION**

**TITLE: ADVANCED INTERCEPT TECHNIQUES(CONTD)**  
**CUSTOMER: RDEC**

**AWARDED: 13 DEC 96**  
**DOLLAR AMT: \$99,990**  
**CONTRACTOR: QUICK REACTION CORP**

**AWARDED: 08 NOV 96**  
**DOLLAR AMT: \$100,000**  
**CONTRACTOR: NEOCERA, INC**

**AWARDED: 05 NOV 96**  
**DOLLAR AMT: \$99,460**  
**CONTRACTOR: TECHNOLOGY SERVICE CORP**

**TITLE: ELECTRONIC WARFARE TECHNIQUES  
CUSTOMER: RDEC**

**SPLIT AWARD**

**AWARDED: 05 NOV 96  
DOLLAR AMT \$99,037  
CONTRACTOR: GREEN MOUNTAIN RADIO  
RESEARCH COMPANY**

**AWARDED: 04 NOV 96  
DOLLAR AMT: \$99,028  
CONTRACTOR: TMS TECHNOLOGIES, INC**

**TITLE: ELECTRONIC WARFARE  
TECHNIQUES(CONTD)**

**CUSTOMER: RDEC**

**AWARDED: 05 NOV 96**

**DOLLAR AMT \$99,958**

**CONTRACTOR: ATLANTIC AEROSPACE  
ELECTRONICS CORPORATION**

**TITLE: HIGH CAPACITY TRUNK RADIO  
CUSTOMER: RDEC**

**AWARDED: 2 APR 97  
DOLLAR AMT \$3M  
CONTRACTOR: HARRIS CORP**

**TITLE: NEXT GENERATION LITHIUM BATTERIES  
CUSTOMER: LRC**

**SPLIT AWARD**

**AWARDED: 10 SEP 96  
DOLLAR AMT ID/IQ; D.O. 0001 \$24.2M  
CONTRACTOR: PCI INCORPORATED**

**AWARDED: 10 SEP 96  
DOLLAR AMT: ID/IQ; D.O. 0001 \$5.0M  
CONTRACTOR: BLUESTAR**

**TITLE: TACTICAL INTELLIGENCE DATA FUSION  
CUSTOMER: RDEC**

**SPLIT AWARD**

**AWARDED: 04 NOV 96  
DOLLAR AMT \$96,980  
CONTRACTOR: PLANNING SYSTEMS, INC**

**AWARDED: 15 NOV 96  
DOLLAR AMT: \$99,999  
CONTRACTOR: CHARLES RIVER ANALYTICS**

**TITLE: UNIVERSAL MODEM SYSTEM (UMS)  
CUSTOMER: C3S**

**AWARDED: 21 FEB 96  
DOLLAR AMT \$19.9M  
CONTRACTOR: ROCKWELL COLLINS**

**CANCELLED  
1996 REQUIREMENTS**

**TITLE: ARMY WORKSTATION - 2 (WS-2)**  
**CUSTOMER: ISMA**

**REASON: THE REQUIREMENTS WILL BE SATISFIED  
THROUGH A VARIETY OF CONTRACT  
VEHICLES**

**TITLE: AN/APR-39 RADAR DETECTING  
SET**

**CUSTOMER: LRC**

**REASON: THE REQUIREMENT DID NOT  
MATERIALIZE**

**TITLE: AN/PPPS-5B, BATTLEFIELD SURVEILLANCE  
RADAR**

**CUSTOMER: LRC  
REASON: WORK SENT TO DEPOT**

**TITLE: AN/USD-9A,B,C,D (GUARDRAIL/AQL)  
CUSTOMER: LRC**

**REASON: SOLE SOURCE DUE TO RAPIDLY  
CHANGING BASELINE**

# NOTES

**CECOM AND THE SMALL BUSINESS  
PROGRAM**

**ARTHUR C. WIDMAIER**

**ACTING CHIEF**

**SMALL AND DISADVANTAGED BUSINESS  
UTILIZATION OFFICE**

**UNCLASSIFIED**

# CECOM AND THE SMALL BUSINESS PROGRAM

## FY97 GOALS:

	ASSIGNED GOALS	ATTAINMENT THRU 2Q97
SMALL BUSINESS	14.0%	14.4%
SMALL BUSINESS SET-ASIDES	4.5%	6.9%
WOMEN-OWNED SMALL BUSINESS	1.5%	1.7%
SMALL DISADV BUS	4.5%	4.9%
SMALL BUS R&D AWARDS	12.8%	8.3%
HBCU/MI	15.1%	2.8%

**CECOM AND THE SMALL BUSINESS  
PROGRAM**

**SMALL AND DISADVANTAGED BUSINESS  
UTILIZATION OFFICES**

**FORT HUACHUCA, AZ  
MICHAEL DEAN (520) 538-7866**

**WASHINGTON OPERATION OFFICE  
STANLEY DAISE (703) 325-5793**

**CECOM AND THE SMALL BUSINESS  
PROGRAM**

**CENTRAL CONTRACTOR REGISTRATION**

**HTTP://WWW.ACQ.OSD.MIL/EC  
1(800) 334-3414**

**CECOM AND THE SMALL BUSINESS  
PROGRAM**

**ARTHUR C. WIDMAIER  
BLDG 1207E, ROOM G41  
TELEPHONE: (908)-532-4511  
FAX: (908) 532-8732  
E-MAIL:**

**WIDMAIER@DOIM6.MONMOUTH.ARMY.MIL**

# NOTES

# **SESSION III**

## **BATTLEFIELD SUSTAINMENT**

### **MODERATOR**

**MR. ANTHONY A. LaPLACA**  
**DIRECTOR**  
**CECOM LOGISTICS AND**  
**READINESS CENTER**

**United States Army  
Communications-Electronics Command  
Logistics and Readiness Center**

**Session III - Battlefield Sustainment**

*presented by  
Anthony A. LaPlaca, Director*

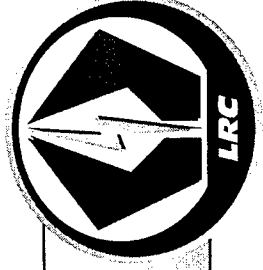

**Proud recipients of the 1996  
Quality Improvement Prototype Award**

**Unclassified**

# LRC UPDATE

IMMC  
(VHFS)  
JUN 97

ATCOM  
(ST. LOUIS)  
SEP 97

*Elec. Power Generation  
Environmental Control  
Topographic Survey  
Counter Intrusion  
Physical Security  
Countermines*

LRC

[WWW.MONMOUTH.ARMY.MIL/CECOM/LRC](http://WWW.MONMOUTH.ARMY.MIL/CECOM/LRC)

# SPARES

# **FLEXIBLE LONG TERM CONTRACTS (FLTCs)**

- **One or more NSNs**
- **Period of 3-5 years**
- **Allows the procuring activity to purchase supplies within specified ranges**
  - **Indefinite Delivery Indefinite Quantity**
  - **Requirements contract**
  - **Ordering officers**

# FLEXIBLE LONG TERM CONTRACTING % OF AWC\* DOLLARS/NSNS

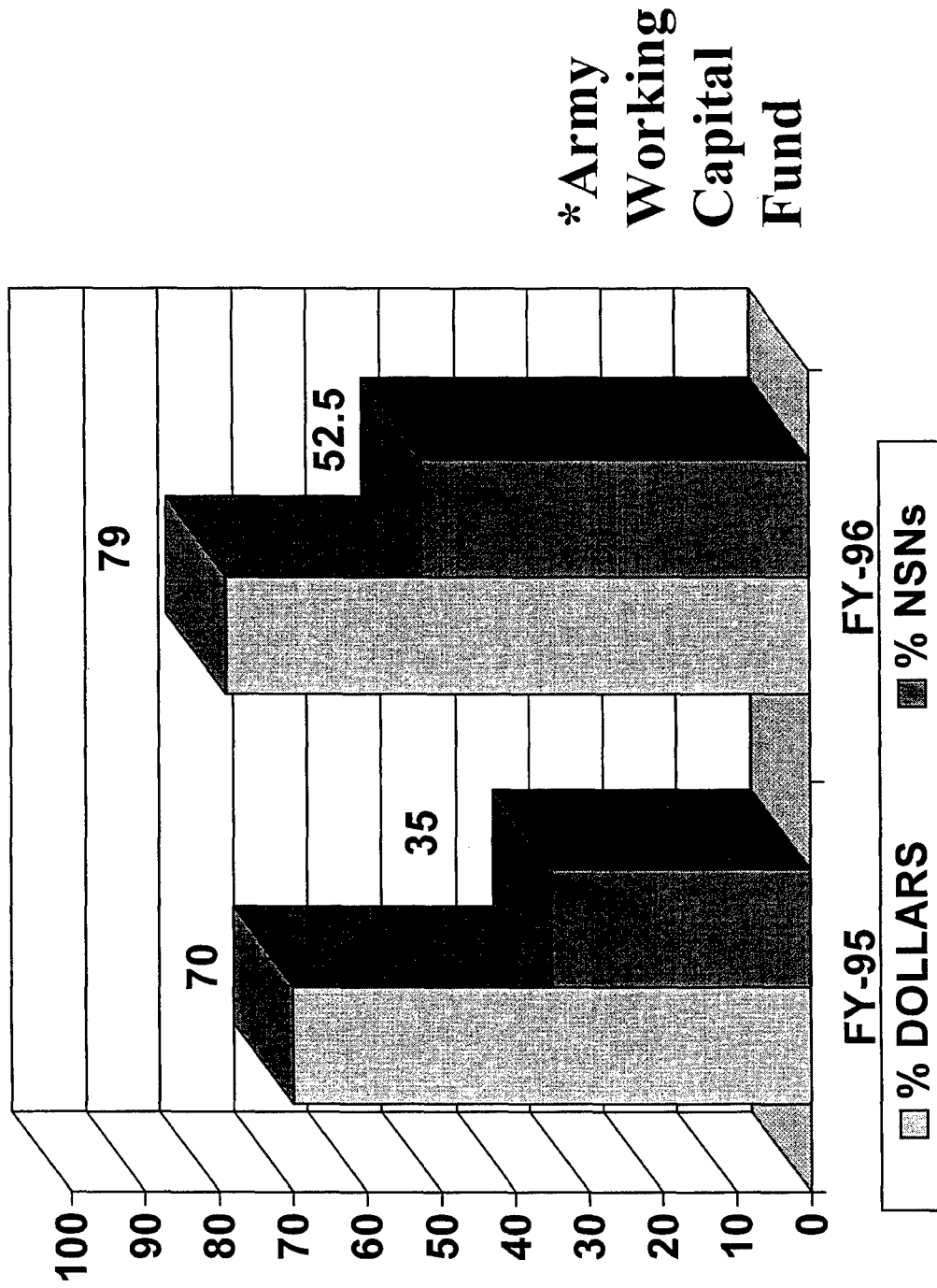

## Current FLTC Contracts

<b>YEAR</b>	<b>VALUE</b>	<b>COMMODITY</b>
<b>EXPIRING</b>	<b>QTY</b>	<b>(MAX)</b>
<b>FY98</b>	<b>1</b>	<b>\$2M</b>
<b>FY99</b>	<b>7</b>	<b>\$84M</b>
<b>FY00</b>	<b>3</b>	<b>\$29M</b>
<b>FY01</b>	<b>3</b>	<b>\$117M</b>
<b>FY02</b>	<b>1</b>	<b>\$345M</b>

# **STATUS**

**Title: H-250 Handset**

**Release RFP: 4QFY97**

**Forecasted Award: 1QFY98**

**Title: AN/PSN-11 Global Positioning System**

**Release RFP: 10 Jul 97**

**Forecasted Award: 31 Jul 97**

**Title: Digital Switched Systems Modernization Program**

**Release RFP: 4 Apr 97**

**Forecasted Award: 30 Jun 97**

## **SESSION III - PANEL MEMBERS**

- **Value Engineering, Mr. Richard Riccelli, CECOM LRC**
- **Year 2000, Mr. Raoul Cordeaux, Director, Corporate Information**
- **Small Computer Program, LTC Mary Fuller, Project Manager, Small Computer Program**
- **Pentagon Renovation Information and Telecommunications Project, COL Scipio de Kanter, Project Manager, Information Management & Telecommunication, Pentagon Renovation**
- **PEO Standard Army Management Information Systems, Mrs. Mary Kelly, Acting Deputy Program Executive Officer, Standard Army Management Information Systems**

# NOTES

# VALUE MANAGEMENT PROGRAM

*Mr. Richard Riccelli*  
*Technical Policy & Programs*  
*Logistics and Readiness Center*



UNCLASSIFIED

## POINT PAPER

AMSEL-LC-LEO-EP  
19 MAY 1997

SUBJECT: C4IEWS Value Management Program

PURPOSE: To inform participants at the Advanced Planning Briefing for Industry (APBI) of recommended improvements being implemented in the C4IEWS Value Management Program and Value Engineering Change Proposal (VECP) review and approval process. Industry feedback will be solicited and new Value Management Program business opportunities will be highlighted.

### FACTS.

1. Team C4IEWS is currently re-inventing the Value Management Program to serve as a tool in implementing DOD Acquisition Reform Initiatives on new and existing C4IEWS equipment and processes. This is being accomplished via a series of innovative Mentorship Programs and Value Management Workshops. The Mentorship Programs serve as a test bed and example for the work force in how to achieve Logistics and Acquisition Reform on programs with definable products. Here DOD Initiatives such as the Modernization Through Spares (MTS), Technology Insertion (TI), Dual Use Application Program (DUAP), Specifications and Standards Acquisition Reform (SSAR) and Operating and Support Cost Reduction (OSCR) effort are integrated, as needed, and applied to actual C4IEWS equipment to yield "Better, Faster and Cheaper" results. To further foster the application of these "new" ideas and reform initiatives, Team C4IEWS is also utilizing the Value Management Workshop Concept. These workshops convene with all process and/or equipment owners, users and functional support elements to include Industry and are facilitated by a certified Value Specialist. The goals of the workshops are to employ the Value Management Philosophy via the Function Analysis System Technique (FAST) to identify process/product improvements, reduce lead times, and generate cost saving ideas.

2. During the week of 21 through 25 Apr 97, one such Value Management Workshop was coordinated by the C4IEWS Value Management Office (VMO) to critique the Value Engineering Change Proposal (VECP) Process. The objective of this workshop was to identify ways to reduce the lead time involved with the preparation, review, approval and negotiation of contractor submitted VECPs. The workshop participants

included representatives from diversified functional areas such as the Acquisition Center, Directorate for Resource Management (DRM), Program Analysis & Evaluation (PA & E), VMO and the LRC Weapon System Directorates. In addition to Team C4IEWS participation, a consultant specializing in the Contractual Aspects of VE (CAVE) and the Air Force VE Program Manager were also present to provide "lessons learned" and expertise in dealing with the VE process. The workshop participants were divided into two teams. One team focused on the current "technical review process" and the other team focused on the "contract settlement process". After one week of intense process study, both teams concluded that Team C4IEWS should adopt a more proactive role in partnering with the contractors in the early stages of VECP development. The Work Group concluded that a dedicated team (including both government and contractor personnel) should be established to develop the VECP(s) from the beginning until the end of the processing cycle. A list of team recommendations and implementation plans were presented to Mr. Ferlise, CECOM Deputy Commander, and senior LRC management at the conclusion of the 5 day workshop. At the conclusion of the out brief, Mr. Ferlise requested that a similar presentation be given to Industry during the May 97 APBI.

3. At the Advance Planning Briefing for Industry, participants will be presented the following:

- An overview of Acquisition Reform Initiatives being implemented via the C4IEWS Value Management Program.
- A critique of the inefficiencies inherent in the current VECP preparation, review, and approval process.
- A presentation of an innovative team solution to identified process problems, along with a discussion of savings, business opportunities and advantages to be achieved via an improved process.
- An invitation to feedback Industry comments and recommendations regarding the proposed improvements to the VECP process.

ACTION OFFICER:  
RICHARD RICCELLI  
CHIEF, TECHNICAL POLICY  
& PROGRAM BR.  
AMSEL-LC-LEO-E-EP  
DSN: 992-3056

# A NEW WAY OF DOING BUSINESS

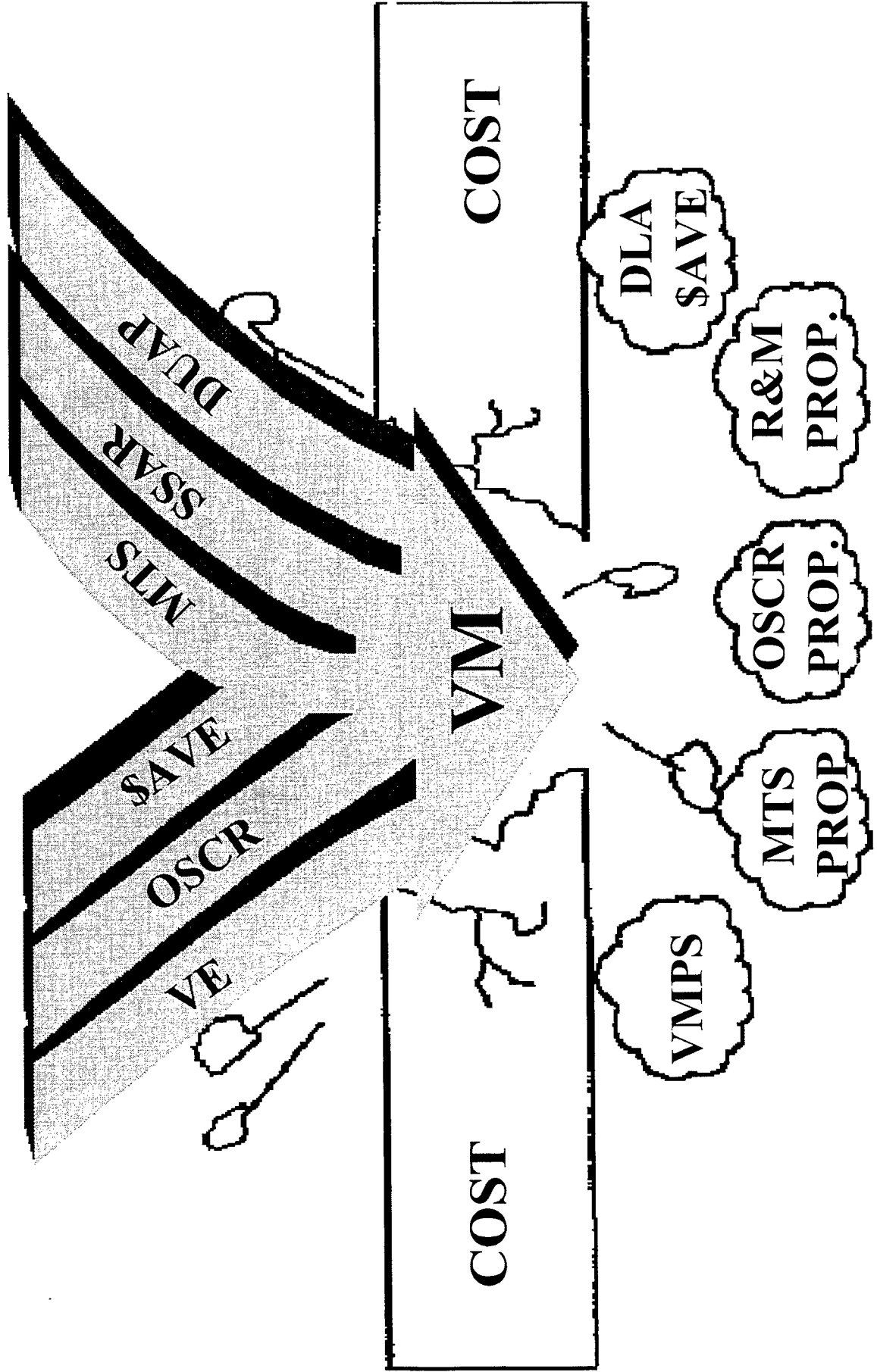

# Re-Inventing an Old Initiative

## The VECP Process

**What is currently wrong:**

- **Process requires too much time**
- **Many steps to the process**
- **Too many “gates”**
- **Not well understood**
- **Evaluation and criteria not uniform**

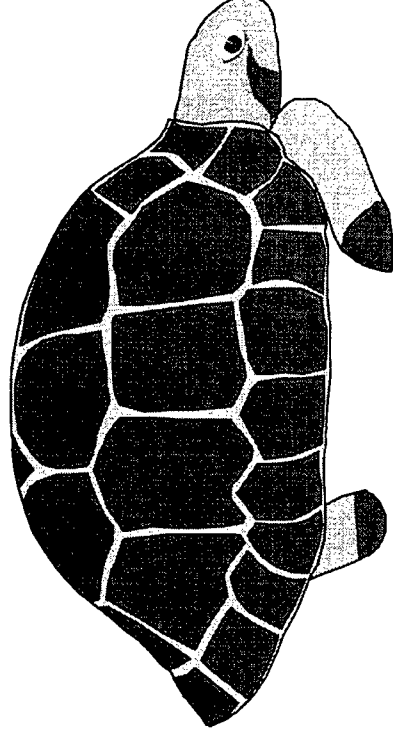

# VECP Process Improvement

- Evaluation of Value Management Proposals is on the critical path
  - ◆ Evaluation is not always focused on key areas/issues
  - ◆ No overall ownership of the process
  - ◆ Lack of consistency from beginning to end of evaluation (and implementation)

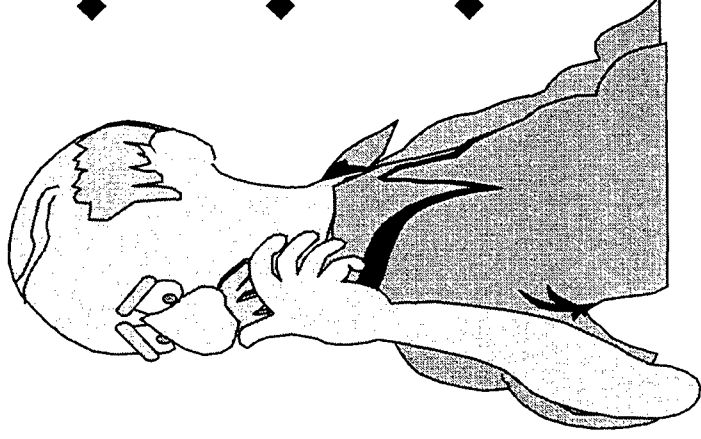

# **VECP Process Improvement (Cont.)**

- ◆ **Dual redundant review is not uncommon**
- ◆ **Evaluators don't always understand item/ideas as well as contractor**
- ◆ **Contractor is not always familiar with all system and logistics impacts**
- ◆ **Lack of focus for timely response**

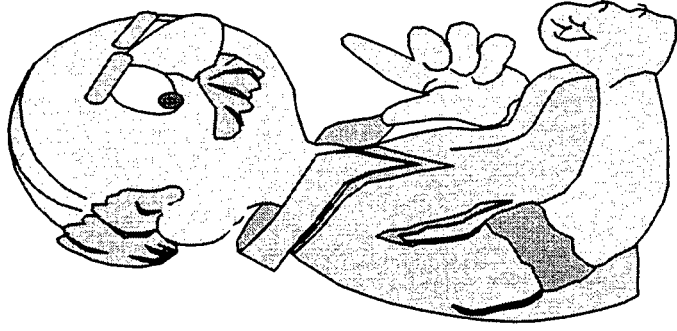

# SO WHAT DID WE DO?



# Analysis

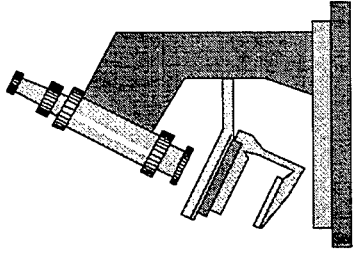

- **Re-Invention Workshop of Government and Industry Representatives held to critique the process.**

# Recommended Solution

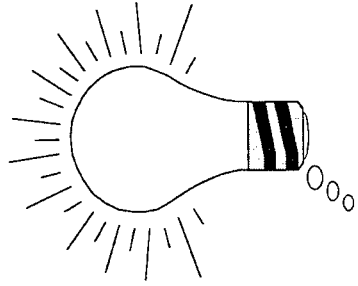

- **The Value Management Council**

# What is the Value Management Council?

- True Government/Industry Partnership Team
  - ◊ Weapon System Integrated Product Team
    - (Item Manager, Eng, Maintenance, Log...)
  - ◊ Acquisition Center
  - ◊ Legal
  - ◊ Cost Analysis
  - ◊ Contractor Team
- Jointly researches, prepares, pre-evaluates and pre-negotiates VMPs



# **What is the Value Management Council? (Cont.)**

- **Mandated in Solicitation/Contract**
- **Convenes at Contract Inception**  
(Meeting/Value Management Workshops)
- **In effect from “cradle-to-grave”**
- **A virtually “Pre-Approved” VMPs is submitted**

# Advantages

- No surprises
- Greatly accelerated formal approval lead time
- Better proposals
- Reduced PLT by continuously reengineering the product
- Better product for the warfighter
- Speeds and increases contractor incentives - \$\$\$

Was  
50% of Acq Savings  
3 years



Now  
Up to 75%  
5 years

20% of Collateral (O&S) Savings



Up to 100%

# WHY SHOULD YOU PARTICIPATE?

- ◆ New business opportunity
- ◆ Team with Gov't to provide "Function oriented performance environment"
- ◆ Share in the savings
- ◆ Better products for the soldier

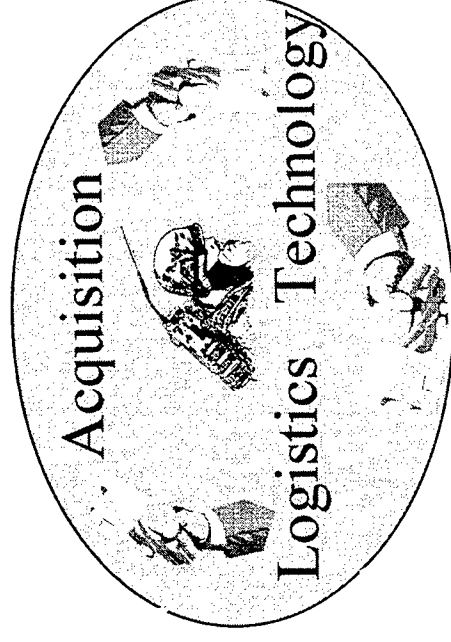

**Your Bottom Line**

**INCREASING CONTRACTOR  
PROFITABILITY IN A  
DOWNSIZING ENVIRONMENT**

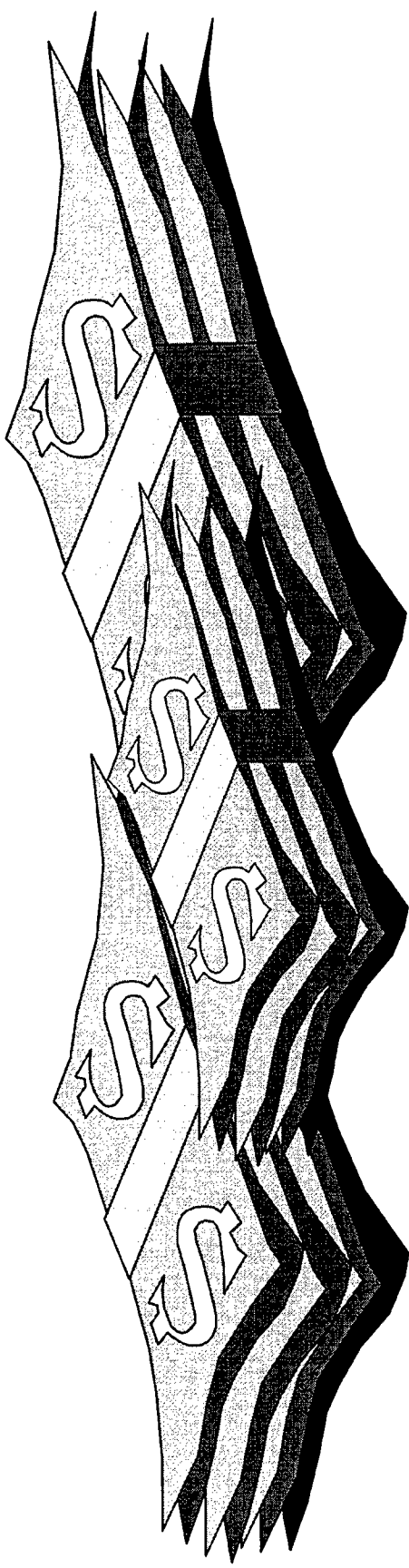

**POCS**

**GIUSEPPE SGROI**

*VM Office Manager*

*(908) 532-2810*

*e-mail: [sgroi@doim6.monmouth.army.mil](mailto:sgroi@doim6.monmouth.army.mil)*

**RICHARD RICCELLI**

*Chief, Technical Policy and Programs Br.*

*(908) 532-3056*

*e-mail: [riccelli@doim6.monmouth.army.mil](mailto:riccelli@doim6.monmouth.army.mil)*

# NOTES

**YEAR 2000**

**RAOUL CORDEAUX**

**AMC YEAR 2000  
INFORMATION MGT  
INFRASTRUCTURE PROJECT  
COORDINATOR**

**DIRECTORATE FOR  
CORPORATE INFORMATION**

**UNCLASSIFIED**

# AGENDA

- CECOM'S YEAR 2000 ROLE
- DA YEAR 2000 MILESTONES
- AMC YEAR 2000 STAFF LEADS
- AMC MSC/SRA LEADS
- CECOM STAFF LEADS
- YEAR 2000 BUSINESS OPPORTUNITIES
- SUMMARY

# CECOM'S YEAR 2000 ROLE

CECOM IS ACTIVELY INVOLVED IN 3 OF 8 FUNCTIONAL AREAS IDENTIFIED BY AMC IN ITS EFFORTS TO MEET THE CHANGE OF CENTURY (Y2K) CHALLENGE. CECOM IS BOTH A PROponent FOR SPECIFIC MISSION AREAS AND AMC STAFF LEAD FOR INFRASTRUCTURE.

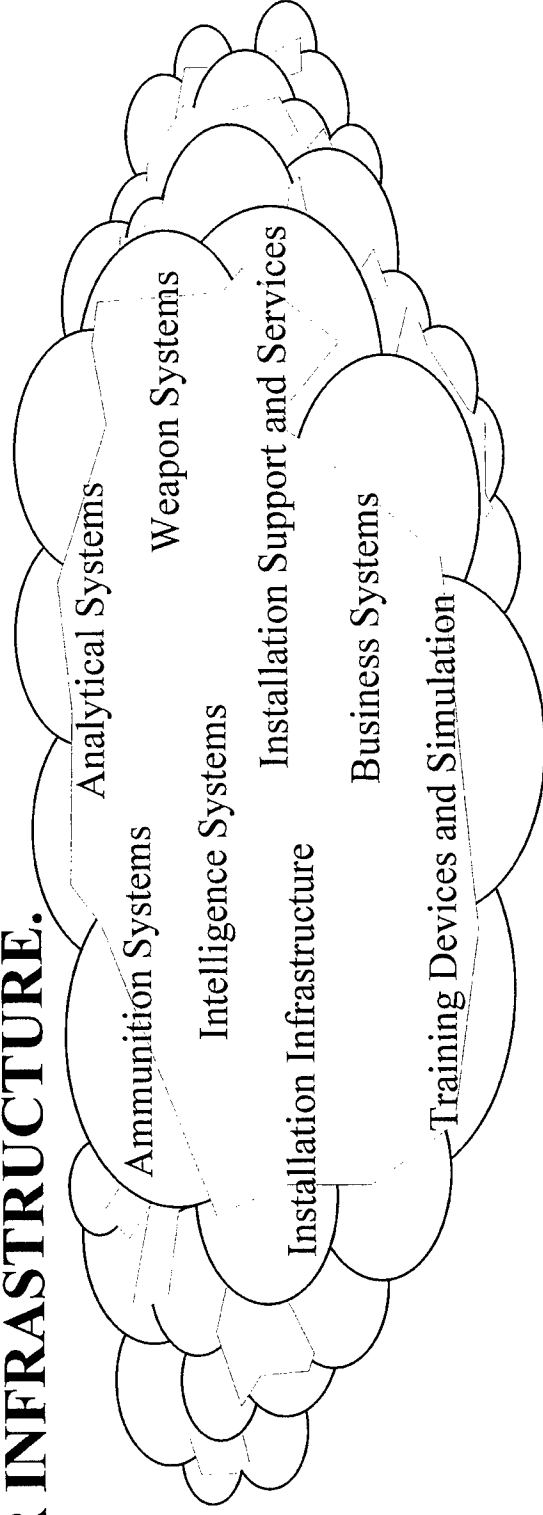

# DA YEAR 2000 MILESTONES

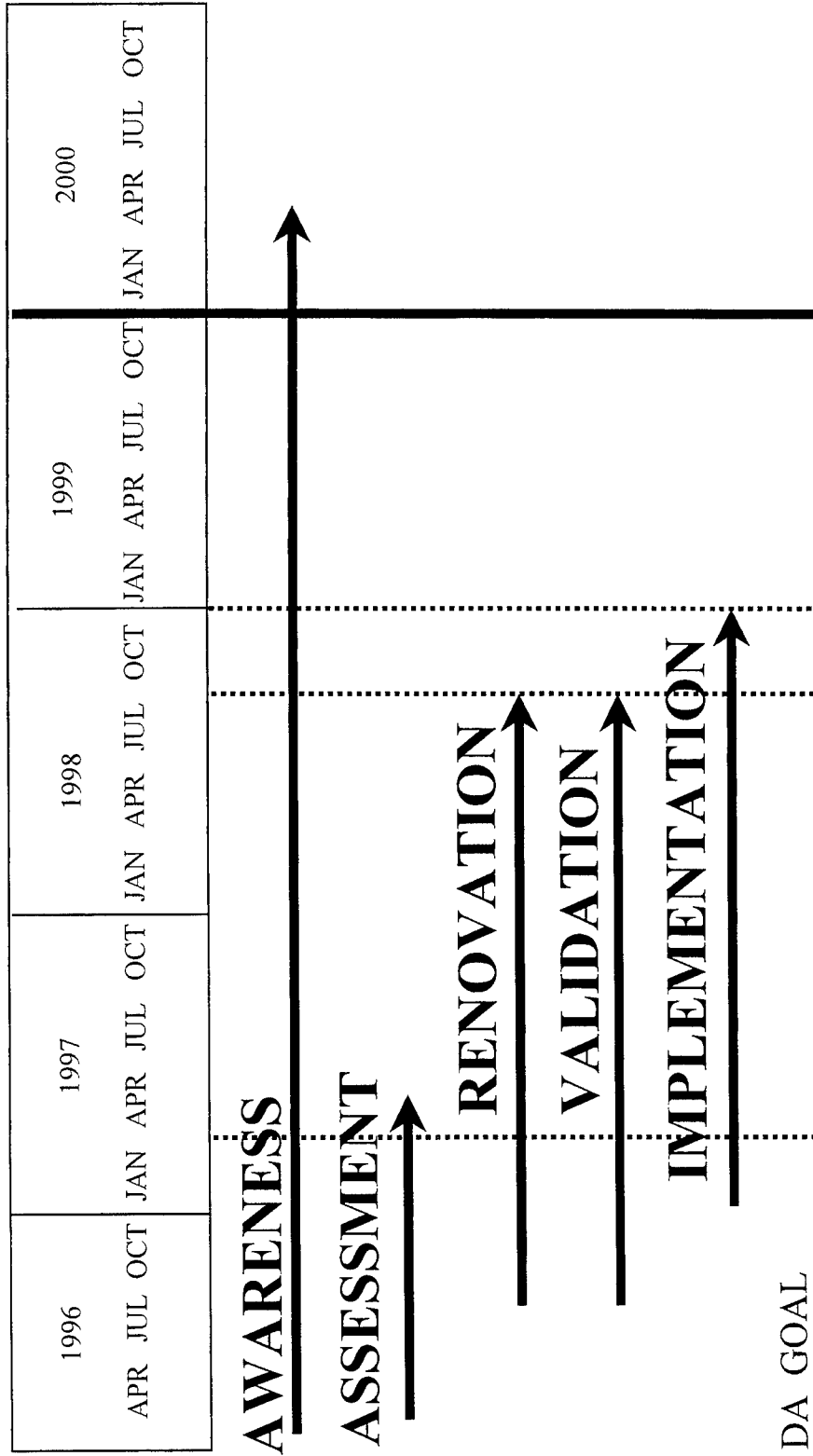

# AMC YEAR 2000 STAFF LEADS

- AMMUNITION SYSTEMS, PLANTS & ARSENALS - MR. CSERI,  
(703) 617-5130
- ALL BUSINESS SYSTEMS - MS. LEGARE, (703) 617-8339
- WEAPON SYSTEMS; SUPPORT COMPONENTS & TEST, SCIENTIFIC  
APPLICATIONS, & SUPER COMPUTERS - MR. LEFF, (703) 617-9651
- INTELLIGENCE SYSTEMS - MS. WILSON-GALLEHER, (703) 617-5971
- ANALYTICAL SYSTEMS - MR. PETER NORMAN, (410) 278-2497
- TRAINING DEVICES & SIMULATION - MR. MAZZA, (407) 384-3802
- INSTALLATION SUPPORT & SERVICES - MR. LOUQUE, (703) 617-8610
- INSTALLATION INFRASTRUCTURE - MR. CORDEAUX, (908) 532-1126

# AMC MSC/SRA LEADS

- AMCOM - MR. FINAFROCK, (205) 876-0028
- AMC FAST - MS. BALDERSON, (703) 704-2653
- AMC, HQ - MS. KYNARD (703) 617-3448
- AMC ISA - MR. GOBERHARDT, (309) 782-6126
- AMC MEA - MS HARRISON, (205) 876-7093
- ARL - MR. STALLINGS, (301) 394-4170
- CECOM - COL OLDHAM, (908) 427-1706
- CBDCOM - MR. HARTMAN, (410) 671-2807
- IOC - MR. DUNN, (309) 782-0252
- LOGSA - MR. BILLINGS, (205) 313-0506
- SSCOM - MS. BOURASSA, (508) 233-5591
- STRICOM - MS. HOTZ, (407) 384-5351
- TACOM - MR. UHAZIE, (810) 574-8848
- TECOM - MS. DEFRANKS, (717) 895-1070
- USASAC - MS. SHELPARD, (717) 895-3329

# CECOM STAFF LEADS

- CECOM Y2K PM - COL OLDHAM, (908) 427-1706
- INFRASTRUCTURE - MR. RAOUL CORDEAUX,  
(908) 532-1126
- WEAPON SYSTEMS - MR. RAY REYNOLDS,  
(908) 427-2229
- BUSINESS CODE - MR. JOHN COLLINS,  
(908) 532-8166



# SUMMARY

- YEAR 2000 TOP PRIORITY IN THE ARMY
- AGGRESSIVE PROJECT MANAGEMENT EFFORT
- AMC COMPLETING ASSESSMENT PHASE
- RENOVATION PHASE STARTED
- BUSINESS OPPORTUNITIES ACROSS AMC

# NOTES

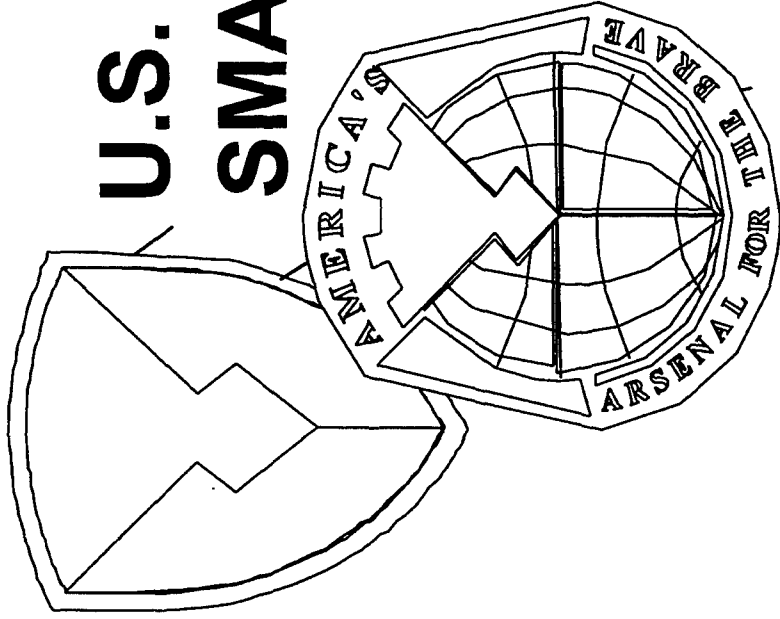

---

**U.S. ARMY**  
**SMALL COMPUTER PROGRAM**

---

**ADVANCE PLANNING  
BRIEFING TO INDUSTRY**

PRESENTED BY

**LTC MARY FULLER  
PRODUCT MANAGER**

---

**UNCLASSIFIED**

---

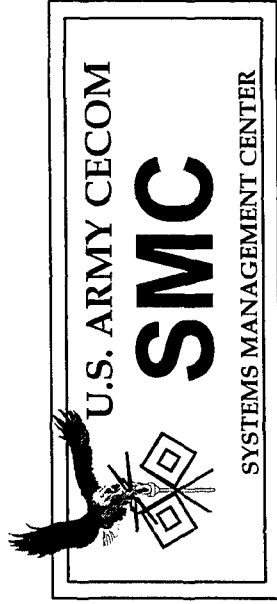

## POINT PAPER

SUBJECT: Army Personal Computer-3 (PC-3)

OBJECTIVE: PC-3 is the acquisition of Commercial-Off-The-Shelf (COTS) general purpose, office automation technology to support the next generation of software under DOS and Multi-user operating systems to satisfy Army, Navy, Air Force, DOD agencies and Civilian federal agencies' personal computer requirements.

## FACTS:

- Army Technical Architecture (ATA) certified products that will support worldwide Army/DOD/Civilian agencies' personal computer requirements. This acquisition will follow the Army Personal Computer-2 (PC-2) contract which is scheduled to expire in the 2nd Qtr FY99.
- All monitors and printers will be Energy Star compliant.
- All equipment provided will be Year 2000 compliant.
- Complies with all DOD technical directives/standards, including the Technical Architecture Framework for Information Management (TAFIM).
- Milestones listed below reflect the planned schedule for PC-3. All schedules are planned to provide procurement coverage for Army, DOD and Civilian agency users worldwide.

** RFP Release	1ST QTR FY99
** Contract Award	3RD QTR FY99
- This will be a Best Value evaluation with a minimum of 2 awards. The procurement is planned to run for 2 years for ordering, Electronic Order Processing is projected. The procurement will be a FFP ID/IQ award.

BRIEFER: LTC Mary Fuller, Product Manager, Army Small Computer Program, AMSEL-IS-SCP, (908) 427-6791.

Product Manager:  
LTC Mary Fuller  
Small Computer Program  
(908) 427-6791

POINT PAPER

SUBJECT: Army Portable Computer-3 (Port-3)

OBJECTIVE: Port-3 is the acquisition of Commercial-Off-The-Shelf (COTS) general purpose Notebook and Handheld computers and peripherals to satisfy Army, Navy, Air Force, DOD agencies and Civilian federal agencies' mobile computing missions.

FACTS:

- Army Technical Architecture (ATA) certified products that will support worldwide Army/DOD/Civilian agencies' portable computer requirements. This acquisition will follow the Army Portable Computer-2 (Port-2) contract which is scheduled to expire in the 2nd Qtr FY99.
- All monitors and printers will be Energy Star compliant.
- All equipment provided will be Year 2000 compliant.
- Complies with all DOD technical directives/standards, including the Technical Architecture Framework for Information Management (TAFIM).
- Milestones listed below reflect the planned schedule for Port-3. All schedules are planned to provide procurement coverage for Army, DOD and Civilian agency users worldwide.

* * RFP Release	1ST QTR FY99
* * Contract Award	3RD QTR FY99
- This will be a Best Value evaluation with a minimum of 2 awards. The procurement is planned to run for 2 years for ordering, Electronic Order Processing is projected. The procurement will be a FFP ID/IQ award.

BRIEFER: LTC Mary Fuller, Product Manager, Army Small Computer Program, AMSEL-IS-SCP, (908) 427-6791.

Product Manager:  
LTC Mary Fuller  
Small Computer Program  
(908) 427-6791

## POINT PAPER

SUBJECT: Army Infrastructure Architecture Solutions-1 (IAS-1)

OBJECTIVE: IAS-1 is the acquisition of Commercial-Off-The-Shelf (COTS) multiuser-server and network server computer equipment including software, networking components, and technical support services to satisfy Army, Navy, Air Force, DOD agencies and Civilian federal agencies office automation networking requirements.

## FACTS:

- Army Technical Architecture (ATA) certified products that will support worldwide Army/DOD/Civilian agencies' network server/software requirements. This acquisition will follow the Small Multiuser Computer-II (SMC-II) contract which is scheduled to expire at the end of FY98.
- All monitors and printers will be Energy Star compliant.
- All equipment provided will be Year 2000 compliant.
- Complies with all DOD technical directives/standards, including the Technical Architecture Framework for Information Management (TAFIM).
- Milestones listed below reflect the planned schedule for IAS-1. All schedules are planned to provide procurement coverage for Army, DOD and Civilian agency users worldwide.

** RFP Release	2ND QTR FY98
** Contract Award	4TH QTR FY98

- This will be a Best Value evaluation with a minimum of 2 awards. The procurement is planned to run for three years for ordering, Electronic Order Processing is projected. The procurement will be a FFP ID/IQ award.

BRIEFER: LTC Mary Fuller, Product Manager, Army Small Computer Program, AMSEL-IS-SCP, (908) 427-6791.

Product Manager:  
LTC Mary Fuller  
Small Computer Program  
(908) 427-6791

POINT PAPER

SUBJECT: Army Video TeleConferencing-1 (VTC-1)

OBJECTIVE: VTC-1 is the acquisition of Commercial-Off-The-Shelf (COTS) video teleconferencing products and services both CONUS and OCONUS to satisfy Army, Navy, Air Force, DOD agencies and Civilian federal agencies' rapidly-evolving remote-site meeting missions.

FACTS:

- Army Technical Architecture (ATA) certified products that will support worldwide Army/DOD/Civilian agencies' office video teleconferencing requirements. This acquisition will follow the Army's two current Video Teleconferencing contracts which are scheduled to expire in the 3rd Qtr FY98.
- All monitors, roll-abouts and multi-camera systems will be upgradable.
- All equipment provided will be Year 2000 compliant.
- Complies with all DOD technical directives/standards, including the Technical Architecture Framework for Information Management (TAFIM).
- Milestones listed below reflect the planned schedule for VTC-1. All schedules are planned to provide procurement coverage for Army, DOD and Civilian agency users worldwide.

* * RFP Release	2ND QTR FY98
* * Contract Award	3RD QTR FY98
- This will be a Best Value evaluation with a minimum of 2 awards. The procurement is planned to run from 2 to 3 years for ordering, Electronic Order Processing is projected. The procurement will be a FFP ID/IQ award.

BRIEFER: LTC Mary Fuller, Product Manager, Army Small Computer Program, AMSEL-IS-SCP, (908) 427-6791.

Product Manager:  
LTC Mary Fuller  
Small Computer Program  
(908) 427-6791

## POINT PAPER

SUBJECT: Army Networks-1 (NET-1)

OBJECTIVE: NET-1 is the acquisition of Commercial-Off-The-Shelf (COTS) network servers and networking products to support existing LANS/WANS as well as new development projects to satisfy Army, Navy, Air Force, DOD agencies and Civilian federal agencies' specific network requirements.

## FACTS:

- Army Technical Architecture (ATA) certified products that will support worldwide Army/DOD/Civilian agencies' specific LAN/WAN/MAN requirements. This acquisition will follow the Army's current participation in the ULANA-II contracts which are scheduled to expire in the 4th Qtr FY98.
- All state-of-the-art solutions from major networking vendors.
- All equipment provided will be Year 2000 compliant.
- Complies with all DOD technical directives/standards, including the Technical Architecture Framework for Information Management (TAFIM).
- Milestones listed below reflect the planned schedule for NET-1. All schedules are planned to provide procurement coverage for Army, DOD and Civilian agency users worldwide.

** RFP Release	4TH QTR FY98
** Contract Award	1ST QTR FY99

- This will be a Best Value evaluation with a minimum of 2 awards. The procurement is planned to run from 2 to 3 years for ordering, Electronic Order Processing is projected. The procurement will be a FFP ID/IQ award.

BRIEFER: LTC Mary Fuller, Product Manager, Army Small Computer Program, AMSEL-IS-SCP, (908) 427-6791.

Product Manager:  
LTC Mary Fuller  
Small Computer Program  
(908) 427-6791

## POINT PAPER

SUBJECT: Army Standard Systems Technology Support-2 (SSTS-2)

OBJECTIVE: SSTS-2 is the acquisition of Commercial-Off-The-Shelf (COTS) peripherals, CPU upgrades, SW upgrades, and new technology to support Army, Navy, Air Force, DOD agencies and Civilian federal agencies' investment in their respective standard, fielded computer base.

## FACTS:

- Army Technical Architecture (ATA) certified products that will support worldwide Army/DOD/Civilian standard, installed-base ADP systems. This acquisition will follow the Army's current participation in the SSTS-1 contract which is scheduled to expire in the 4th Qtr FY99.
- Latest state-of-the-art technology and upgrades from major vendors.
- All equipment provided will be Year 2000 compliant.
- Complies with all DOD technical directives/standards, including the Technical Architecture Framework for Information Management (TAFIM).
- Milestones listed below reflect the planned schedule for SSTS-2. All schedules are planned to provide procurement coverage for Army, DOD and Civilian users worldwide.

** RFP Release	2ND QTR FY99
** Contract Award	4TH QTR FY99
- This will be a Best Value evaluation with a minimum of 2 awards. The procurement is planned to run from 2 to 3 years for ordering, Electronic Order Processing is projected. The procurement will be a FFP ID/IQ award.

BRIEFER: LTC Mary Fuller, Product Manager, Army Small Computer Program, AMSEL-IS-SCP, (908) 427-6791.

Product Manager:  
LTC Mary Fuller  
Small Computer Program  
(908) 427-6791

## POINT PAPER

SUBJECT: Army Maxi-Minis and Databases-1 (MMAD-1)

OBJECTIVE: MMAD-1 is the acquisition of Commercial-Off-The-Shelf (COTS) products and software to replace the main-focus items of the Navy's Super-Mini-II and Database-1 contracts which support Army, Navy, Air Force, DOD agencies and Civilian federal agencies' larger mini-system requirements.

## FACTS:

- Army Technical Architecture (ATA) certified products that will upgrade worldwide Army/DOD/Civilian standard, installed-base ADP configurations. This acquisition will follow the Army's current play in the Super-Mini-II and Database-1 contracts which are scheduled to expire in the 2nd Qtr FY98.
- All monitors and printers will be Energy Star compliant.
- All equipment provided will be Year 2000 compliant.
- Complies with all DOD technical directives/standards, including the Technical Architecture Framework for Information Management (TAFIM).
- Milestones listed below reflect the planned schedule for MMAD-1. All schedules are planned to provide procurement coverage for Army, DOD and Civilian agency users worldwide.

** RFP Release	1ST QTR FY98
** Contract Award	3RD QTR FY98
- This will be a Best Value evaluation with a minimum of 2 awards. The procurement is planned to run from 3 to 5 years for ordering, Electronic Order Processing is projected. The procurement will be a FFP ID/IQ award.

BRIEFER: LTC Mary Fuller, Product Manager, Army Small Computer Program, AMSEL-IS-SCP, (908) 427-6791.

Product Manager:  
LTC Mary Fuller  
Small Computer Program  
(908) 427-6791

# **PROGRAM OBJECTIVE**

**Provide a source of small and medium size Commercial Off-the-Shelf computers (Hardware, Software, Networking, Infrastructure support services) for the Army Power Projection Base, Strategic and Theater Tactical users.**

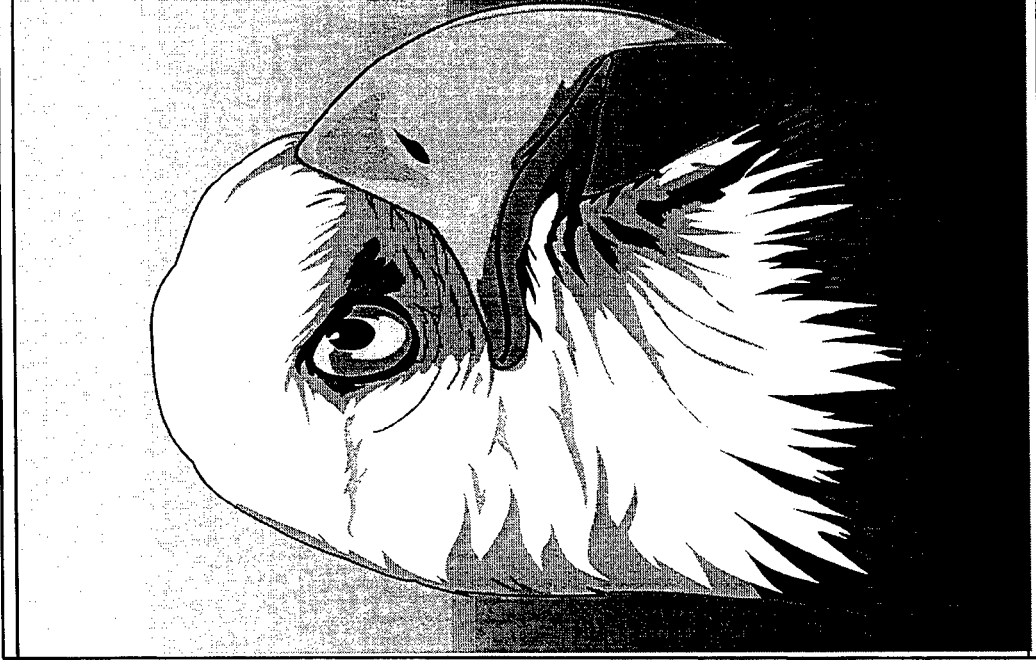

# CONTRACT ACTIVITIES

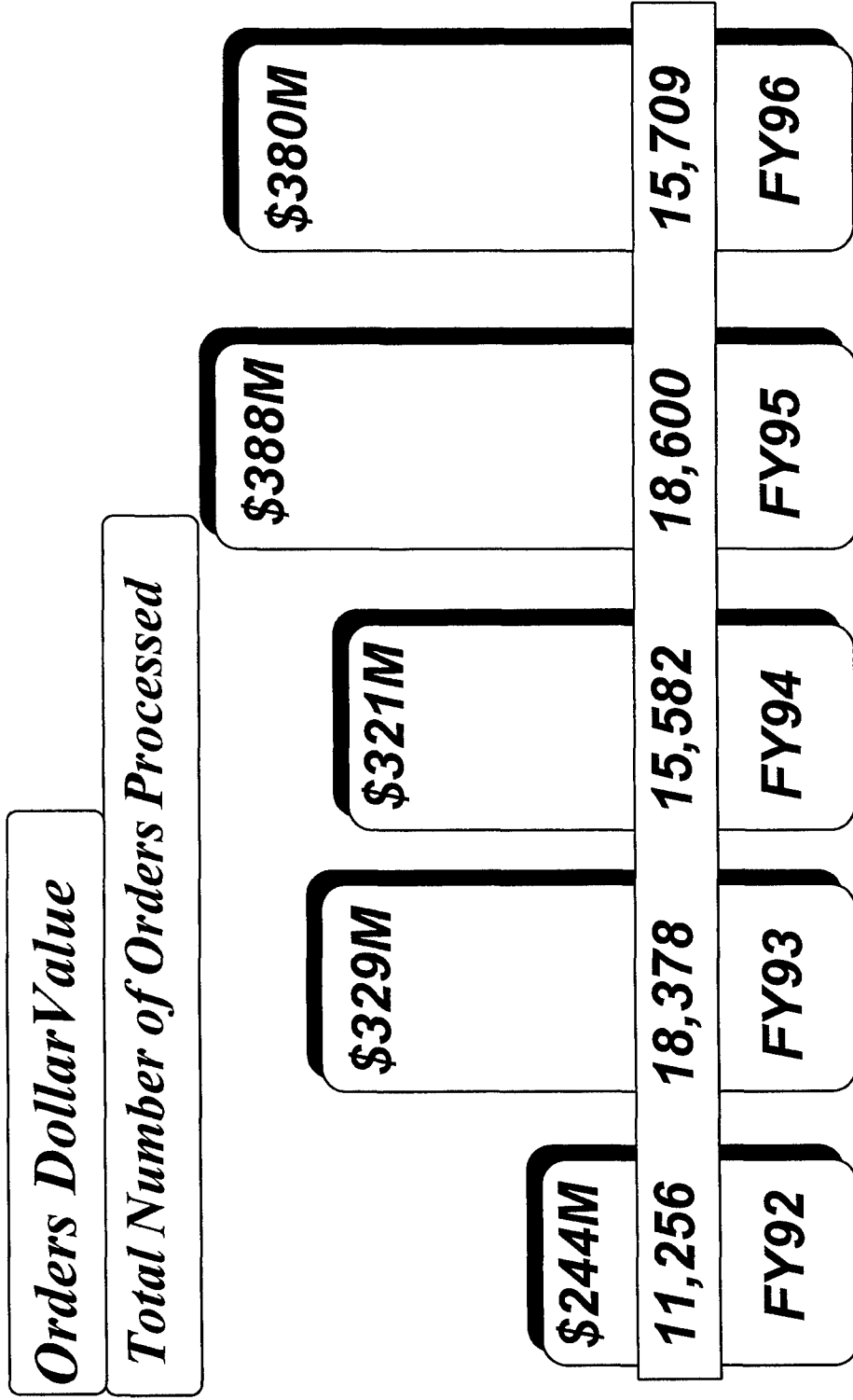

# PERSONAL COMPUTER - 3

## PC-3

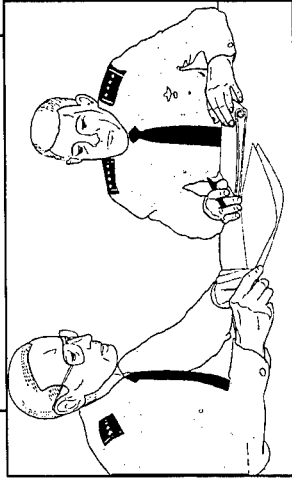
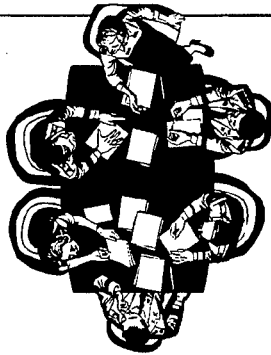
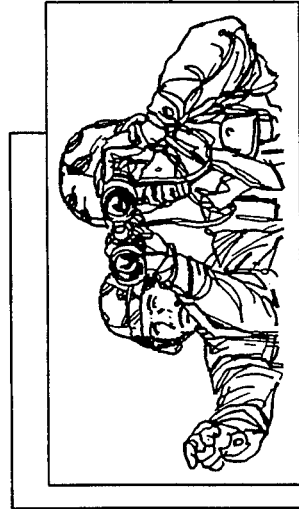

**STRATEGIC MISSIONS**

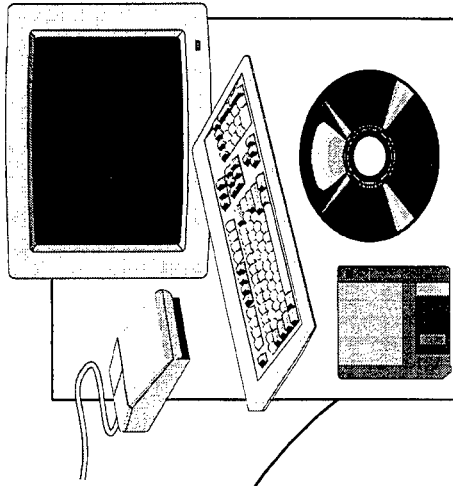
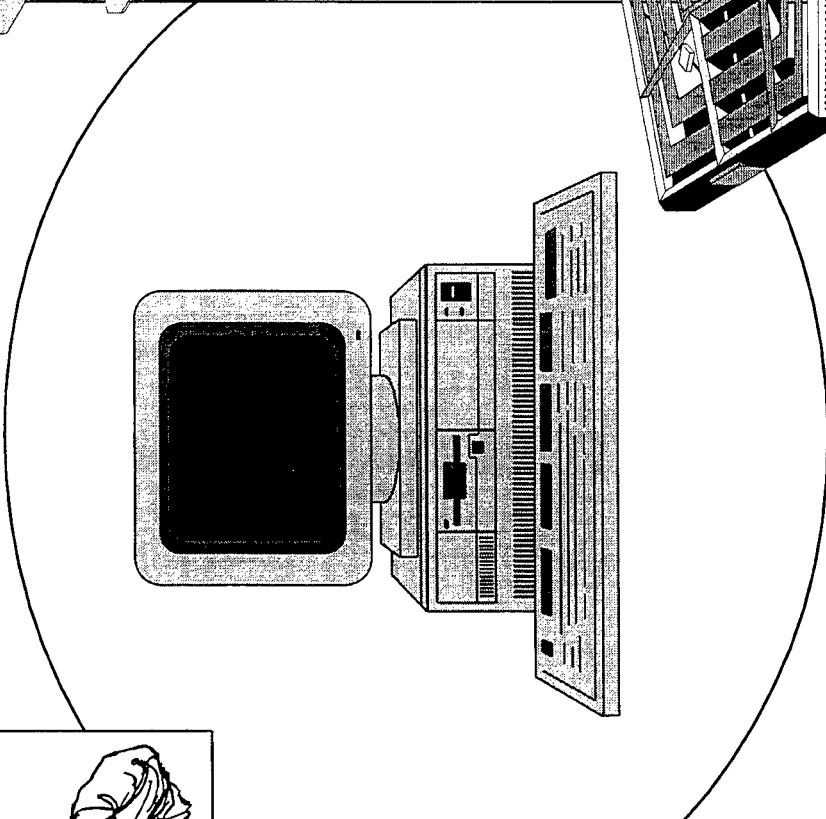

**SOFTWARE & PERIPHERALS**

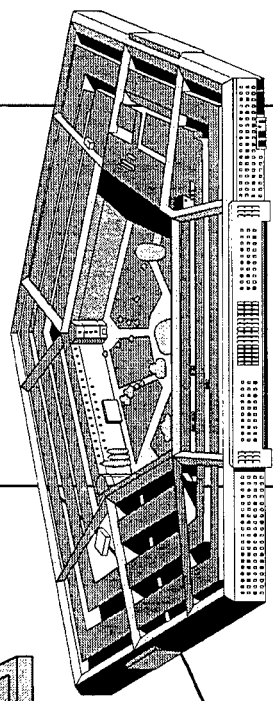

**POWER PROJECTION**

## **PC-3 DEFINITION**

**ACQUISITION OF COMMERCIAL-OFF-THE-SHELF (COTS)  
GENERAL PURPOSE, OFFICE AUTOMATION TECHNOLOGY  
TO SUPPORT THE NEXT GENERATION OF SOFTWARE  
UNDER POSIX AND DOS OPERATING SYSTEMS.**

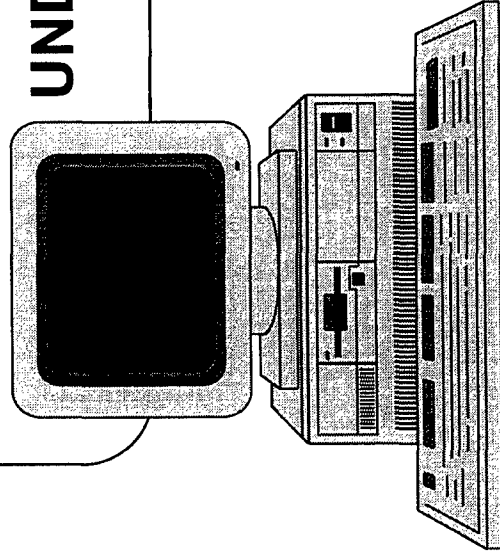

# PC-3 OBJECTIVES

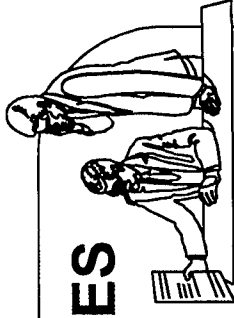

- COMPLY WITH ALL DOD TECHNOLOGY MANDATES

- 2 OR MORE AWARDS

- 2 YEAR HARDWARE/SOFTWARE ORDERING

- 36 MONTH MINIMUM WARRANTY

- ELECTRONIC ORDER PROCESSING PROJECTED

- FIRM-FIXED-PRICE (FFP) INDEFINITE DELIVERY/  
INDEFINITE QUANTITY (ID/IQ) (BEST VALUE  
AWARDS)

- Y2K MANDATORY

1997						
	U	2	3	4	5	6
1	7	8	9	10	11	12
13	14	15	16	17	18	19
20	21	22	23	24	25	26
27	28	29	30	31		

1998						
	U	2	3	4	5	6
7	8	9	10	11	12	13
14	15	16	17	18	19	20
21	22	23	24	25	26	27
28	29	30	31			

1999						
	U	2	3	4	5	6
7	8	9	10	11	12	13
14	15	16	17	18	19	20
21	22	23	24	25	26	27
28	29	30	31			

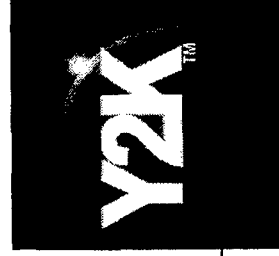

# PC-3 REQUIREMENTS

- **STATE-OF-THE-ART PLATFORMS-COTS**

HARDWARE, SOFTWARE, SINGLE & MULTI-USER OPERATING SYSTEMS

- **OPEN SYSTEMS STANDARDS COMPLIANCE**

TECHNICAL ARCHITECTURE FRAMEWORK FOR INFORMATION MANAGEMENT (TAFIM) INCLUDES POSIX, ETC.

- **SYSTEMS CONFIGURATIONS:**

BUNDLED PC AND/OR USER-CONFIGURED PC

- **PERIPHERALS:**

17" AND 21" MONITORS, PRINTERS, (PCMCIA) INTERFACE/PC-CARD

- **DVTC (POTS/ISDN) OPERATIONAL**

- **OS WITH INTEGRATED BROWSERS**

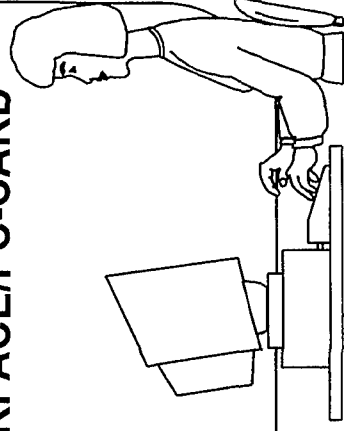
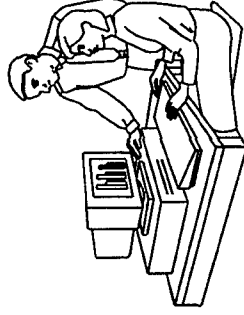
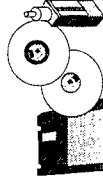
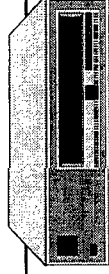

# CONTRACT OPPORTUNITY

**TITLE:** ARMY PERSONAL COMPUTER - 3

**OBJECTIVE:** SUPPORT NEXT GENERATION OF SOFTWARE UNDER POSIX/DOS OS

**PROPOSED CONTRACT TYPE:** FFP ID/IQ (BEST VALUE AWARDS) COTS HW/SW

**KEY MILESTONES:** RFP RELEASE 1ST QTR FY 99  
AWARD 3RD QTR FY 99

**ESTIMATED VALUE:** \$200-\$300M

**POC:** HELEN GARAMONE, CACWOO (703) 325-9762

# PORTABLE-3

## PORTABLE COMMUNICATION

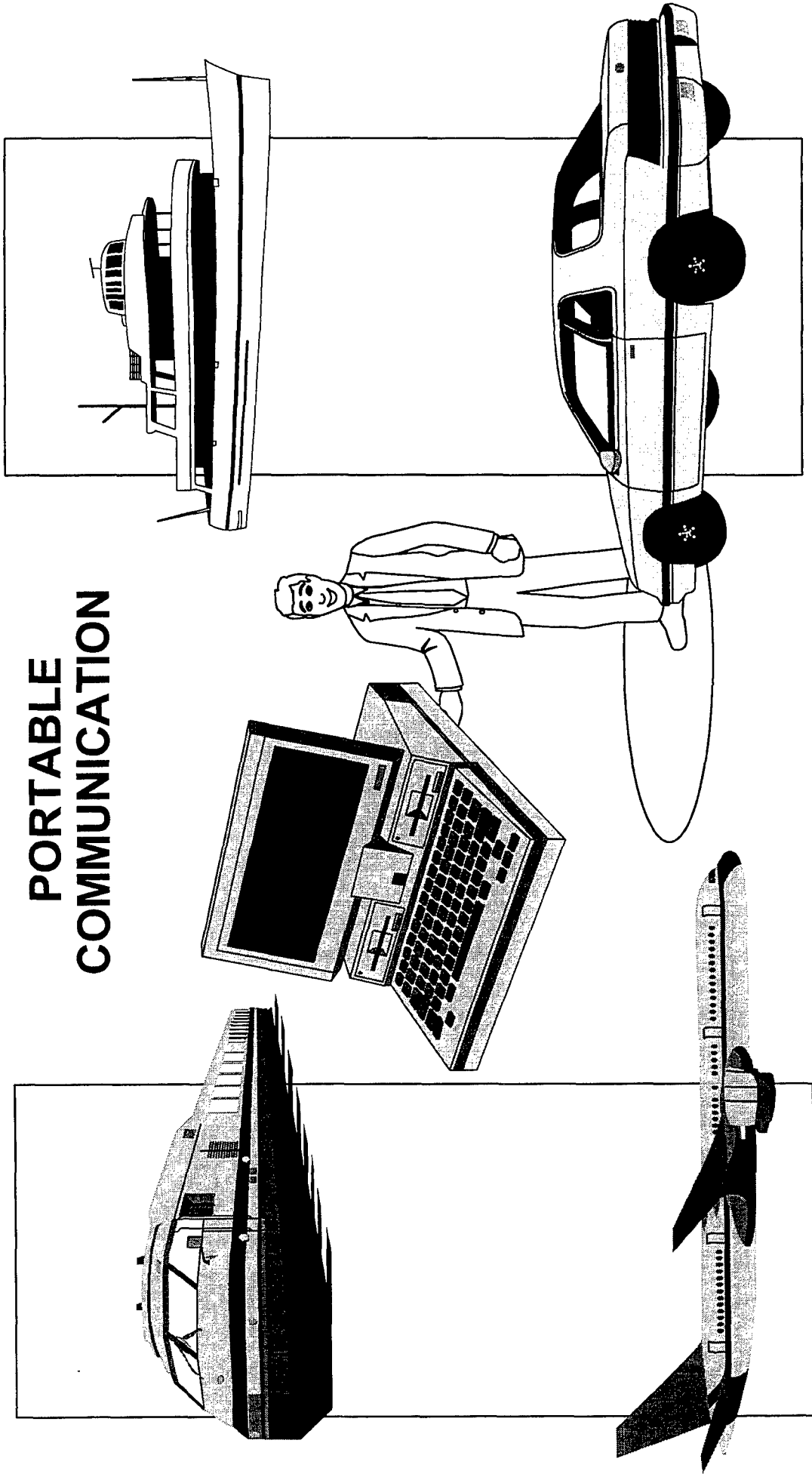

# **PORTABLE-3 DEFINITION**

**ACQUISITION OF COMMERCIAL-OFF-THE-SHELF  
(COTS) GENERAL PURPOSE NOTEBOOK AND  
HANDHELD COMPUTERS AND PERIPHERALS  
IN SUPPORT OF THE ARMY'S PORTABLE  
COMMUNICATION AND COMPUTING MISSIONS.**

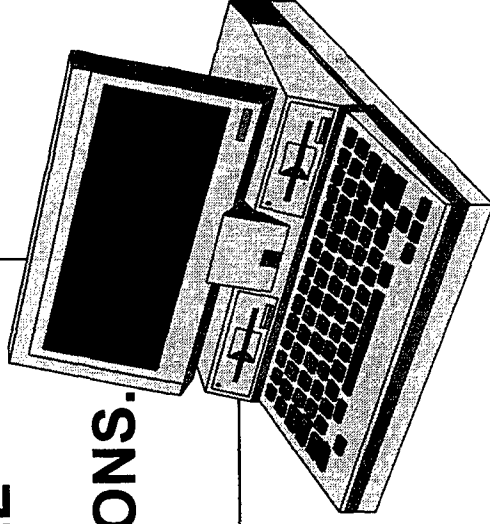

# PORTABLE-3 OBJECTIVES

- SUPPORT THE ARMY'S PORTABLE MISSIONS
- ALL COMMERCIAL-OFF-THE-SHELF (COTS)
- FFP ID/IQ (BEST VALUE AWARDS)
- 2 OR MORE AWARDS
- Y2K MANDATORY
- 2 YEAR HW/SW ORDERING
- 36 MONTH MINIMUM WARRANTY
- ELECTRONIC ORDER PROCESSING PROJECTED

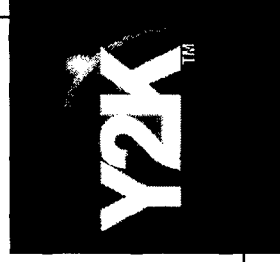
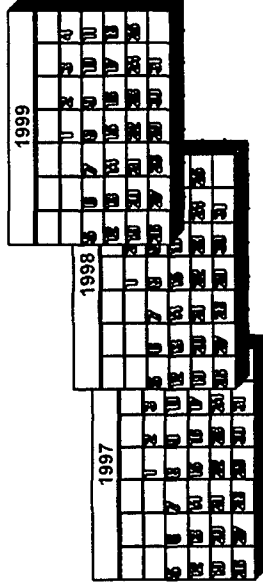
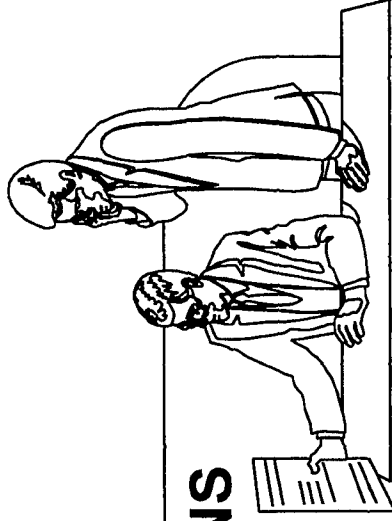

# PORTABLE-3 REQUIREMENTS

- **STATE-OF-THE-ART PLATFORMS-COTS  
HARDWARE, SOFTWARE, DOCKING STATIONS**
- **SYSTEMS CONFIGURATIONS:  
NOTEBOOK (COLOR) WITH MULTI-MEDIA**
- **UPGRADES  
CPU OPTION, SCREEN OPTION**
- **HANDHELD (PALMTOP) COMPUTER**
- **PCMCIA, INTERFACE/PC-CARD:  
MODEM WITH SOFTWARE, RANDOM ACCESS MEMORY (RAM)  
HARD DRIVE, FAX WITH SOFTWARE, NETWORK INTERFACE  
CARD**

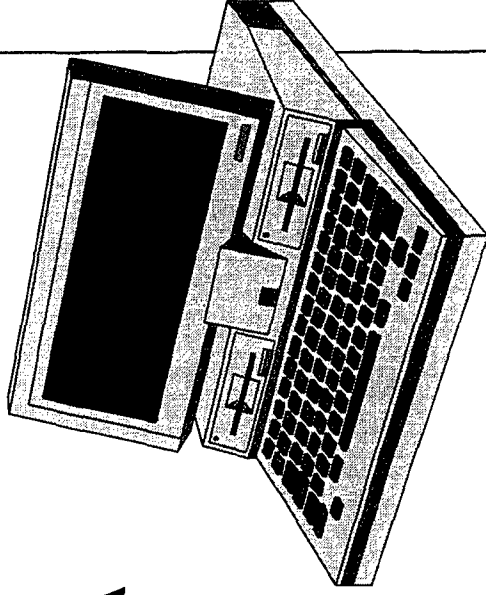

# CONTRACT OPPORTUNITY

**TITLE:** ARMY PORTABLE COMPUTER - 3  
(PORT-3)

**OBJECTIVE:** SUPPORT THE ARMY'S  
REQUIREMENT FOR PORTABLE  
COMMUNICATION AND COMPUTING  
CAPABILITIES

**PROPOSED  
CONTRACT  
TYPE:** FFP ID/IQ (BEST VALUE AWARDS)  
COTS HW/SW

**KEY MILESTONES:** RFP RELEASE 1ST QTR FY 99  
AWARD 3RD QTR FY 99

**ESTIMATED VALUE: \$100M - \$150M**

**POC: HELEN GARAMONE, CACWOO (703) 325-9762**

# INFRASTRUCTURE ARCHITECTURE SOLUTIONS-1 (IAS-1)

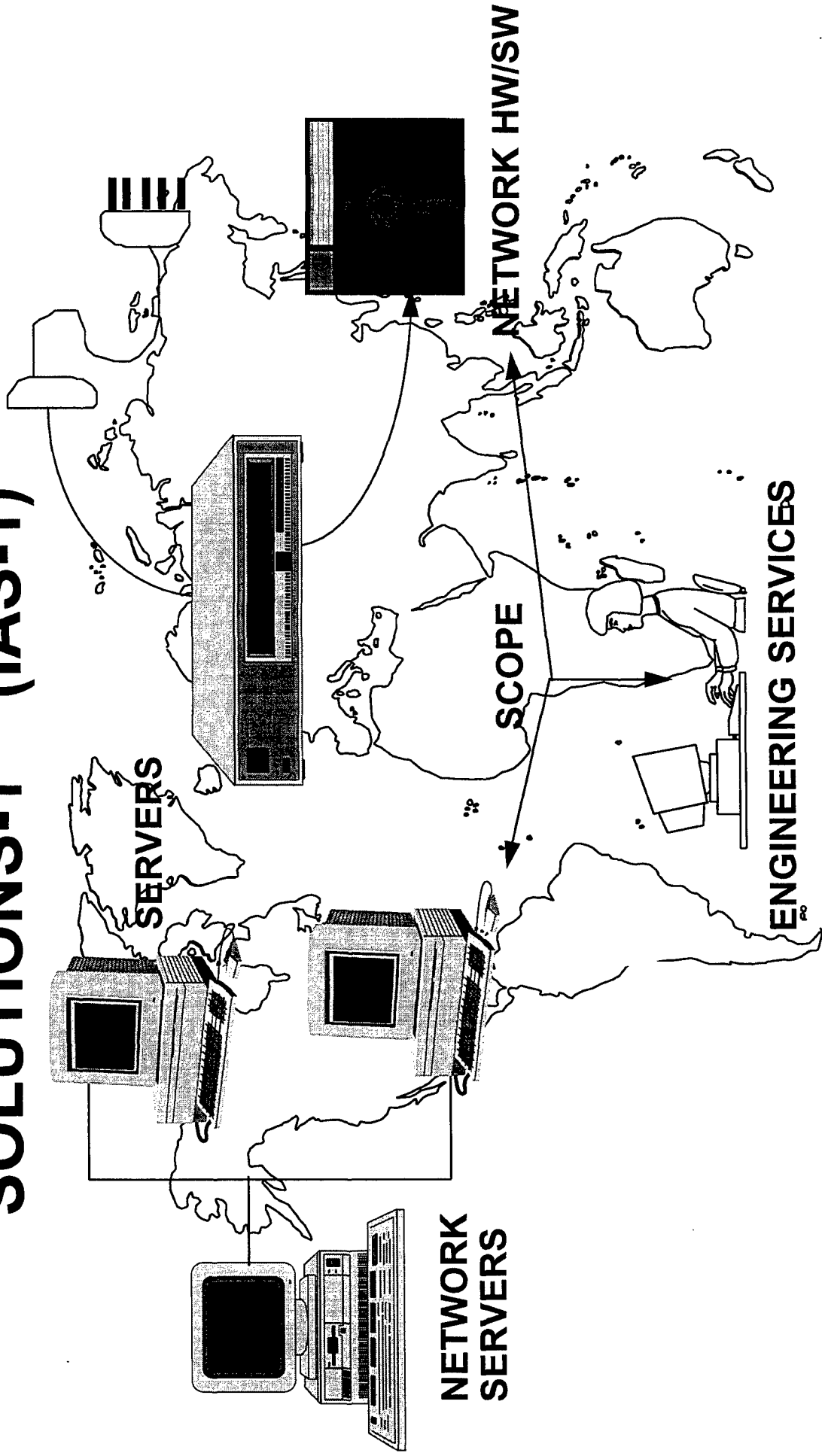

# **IAS-1 DEFINITION**

**ACQUISITION OF COMMERCIAL-OFF-THE-SHELF  
(COTS) SERVER AND NETWORK SERVER  
COMPUTER EQUIPMENT, SOFTWARE, NETWORKING  
COMPONENTS, AND TECHNICAL SUPPORT SERVICES  
TO SUPPORT ARMY, NAVY, AIR FORCE, DOD, AND CIVILIAN  
AGENCIES' INTEGRATED DESKTOP MANAGEMENT  
REQUIREMENTS.**

# IAS-1 OBJECTIVES

- SUPPORT ARMY, NAVY, AIR FORCE, DOD AND CIVILIAN AGENCIES' NETWORK SERVER REQUIREMENTS

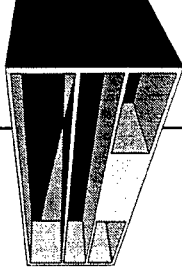

- ALL COMMERCIAL-OFF-THE-SHELF (COTS)

- FFP ID/IQ (BEST VALUE AWARD)



- 2 OR MORE AWARDS



- 3 YEAR ORDERING WINDOW

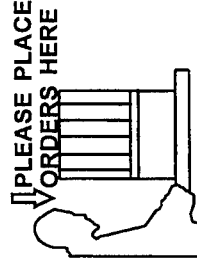

- 36 MONTH MINIMUM WARRANTY

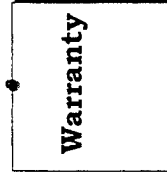

- ELECTRONIC ORDER PROCESSING PROJECTED

# IAS-1 REQUIREMENTS

- STATE-OF-THE-ART PLATFORMS (COTS)
- OPEN SYSTEMS STANDARDS COMPLIANCE
- NETWORK SERVERS W/CLUSTER SW
- DESKTOP MANAGEMENT SOFTWARE
- NETWORKING COMPONENTS
- SECURITY - FIREWALLS
- CLIENT/SERVER APPLICATIONS
- Y2K MANDATORY
- TECHNICAL SUPPORT SERVICES

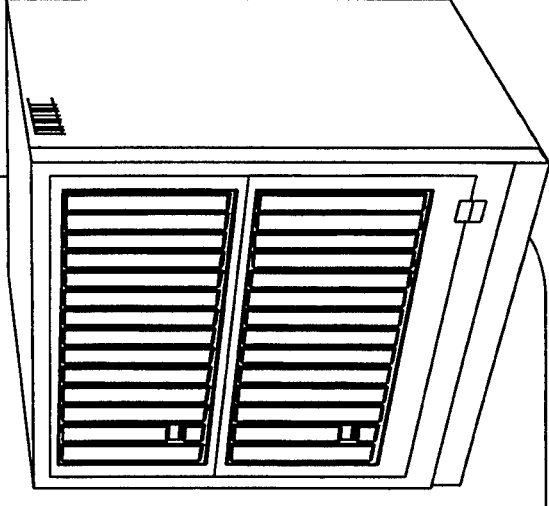

# CONTRACT OPPORTUNITY

**TITLE:**

**INFRASTRUCTURE ARCHITECTURE SOLUTIONS-1 (IAS-1)**

**OBJECTIVE:**

**ARMY/JOINT SERVICE NETWORK SERVERS/SOLUTIONS FOR OFFICE AUTOMATION REQUIREMENTS**

**PROPOSED CONTRACT TYPE:**

**FFP ID/IQ (BEST VALUE AWARD)**

**KEY MILESTONES: RFP RELEASE - 2ND QTR FY98, AWARD - 4TH QTR FY 98**



**ESTIMATED VALUE: \$200-\$250M**

**POC: HELEN GARAMONE, CACWOO (703) 325-9762**

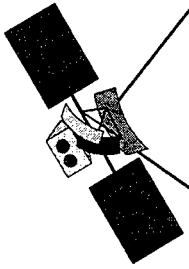

# ARMY VIDEO TELECONFERENCING-1 (VTC-1)

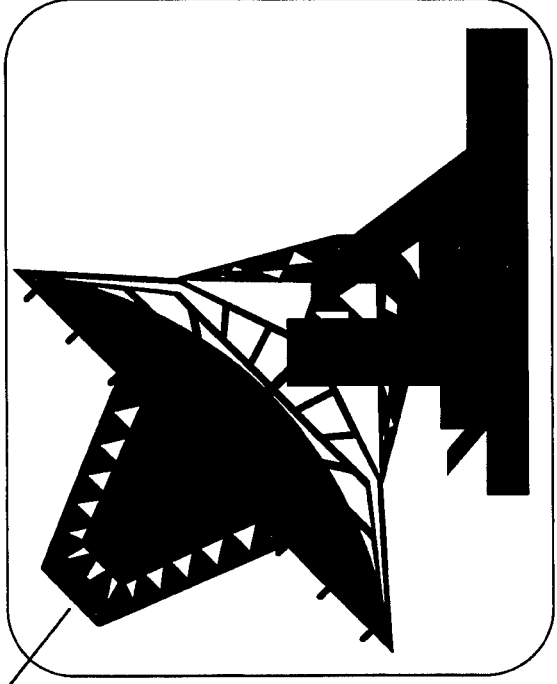

# **VTC-1 DEFINITION**

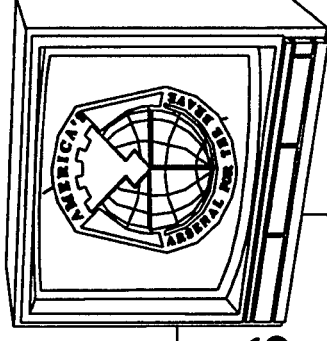

**ACQUISITION OF PRODUCTS AND SERVICES  
TO SUPPORT THE ARMY'S RAPIDLY-EVOLVING  
VIDEO TELECONFERENCING REQUIREMENTS  
TO BE USED BY THE ARMY, DOD, AND CIVILIAN  
AGENCIES WITH BOTH CONUS AND OCONUS  
PERSPECTIVES.**

# VTC-1 OBJECTIVES

- PROVIDE VTC PRODUCTS AND SERVICES TO THE DOD AND CIVILIAN AGENCIES

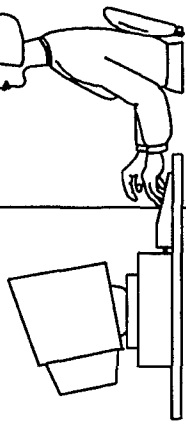

- WORK MUST:  
COMPLY WITH THE TAFIM, THE JTA/ATA,  
AND THE DII COE

- WORLD-WIDE FOCUS - FOLLOW-ON TO ARMY DVTC CONTRACTS HELD BY DELTA AND TRW

- 2 OR MORE VENDORS

- 2-3 YEAR ORDERING WINDOW

- ELECTRONIC ORDER PROCESSING PROJECTED

- SOLUTIONS BASED

- Y2K MANDATORY

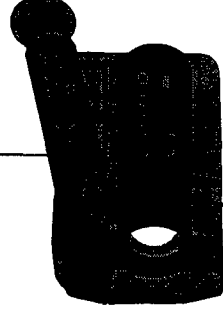
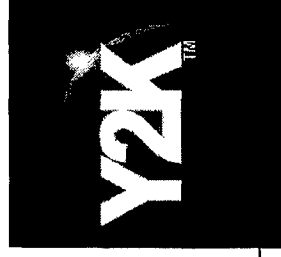

# VTC-1 REQUIREMENTS

- ENHANCEMENTS/UPGRADES TO EXISTING SYSTEMS
- ROLL-ABOUT AND MULTI-CAMERA SYSTEMS
- SUPPORT OF DISTANCE LEARNING
- INTERFACES FOR:

- ATM
- POTS
- SATELLITE LINKS
- INTERNET/INTRANET
- ISDN

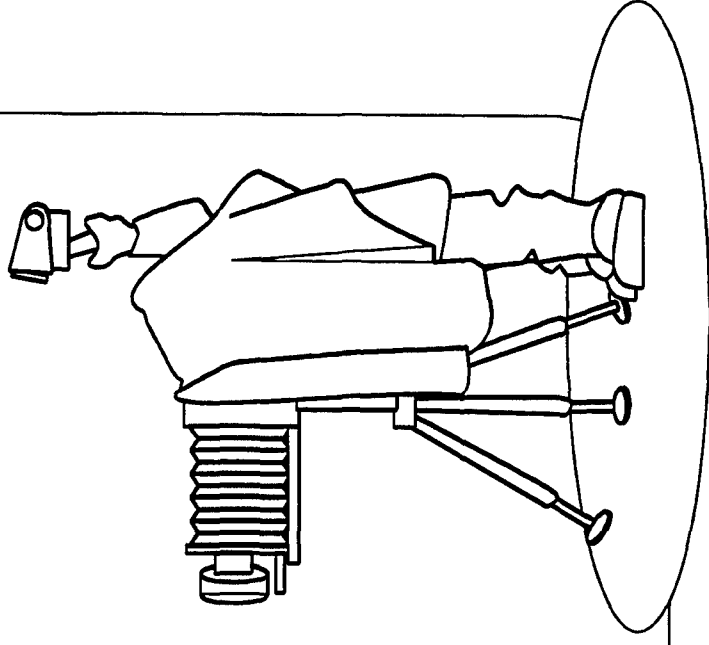

# CONTRACT OPPORTUNITY

**TITLE:** ARMY VIDEO TELECONFERENCING-1  
(VTC-1)

**OBJECTIVE:** VIDEO TELECONFERENCING FOR  
ARMY/DOD/CIVILIAN AGENCIES  
FOR INFO TECHNOLOGY PROGRAMS

**PROPOSED  
CONTRACT  
TYPE:** FFP ID/IQ (BEST VALUE AWARDS)  
COTS HW/SW

**KEY MILESTONES:** RFP RELEASE 2ND QTR FY 98  
AWARD 3RD QTR FY 98

**ESTIMATED VALUE: \$25 - \$75M**

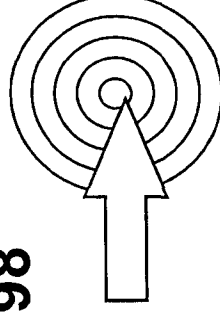

**POC: HELEN GARAMONE, CACWOO (703) 325-9762**



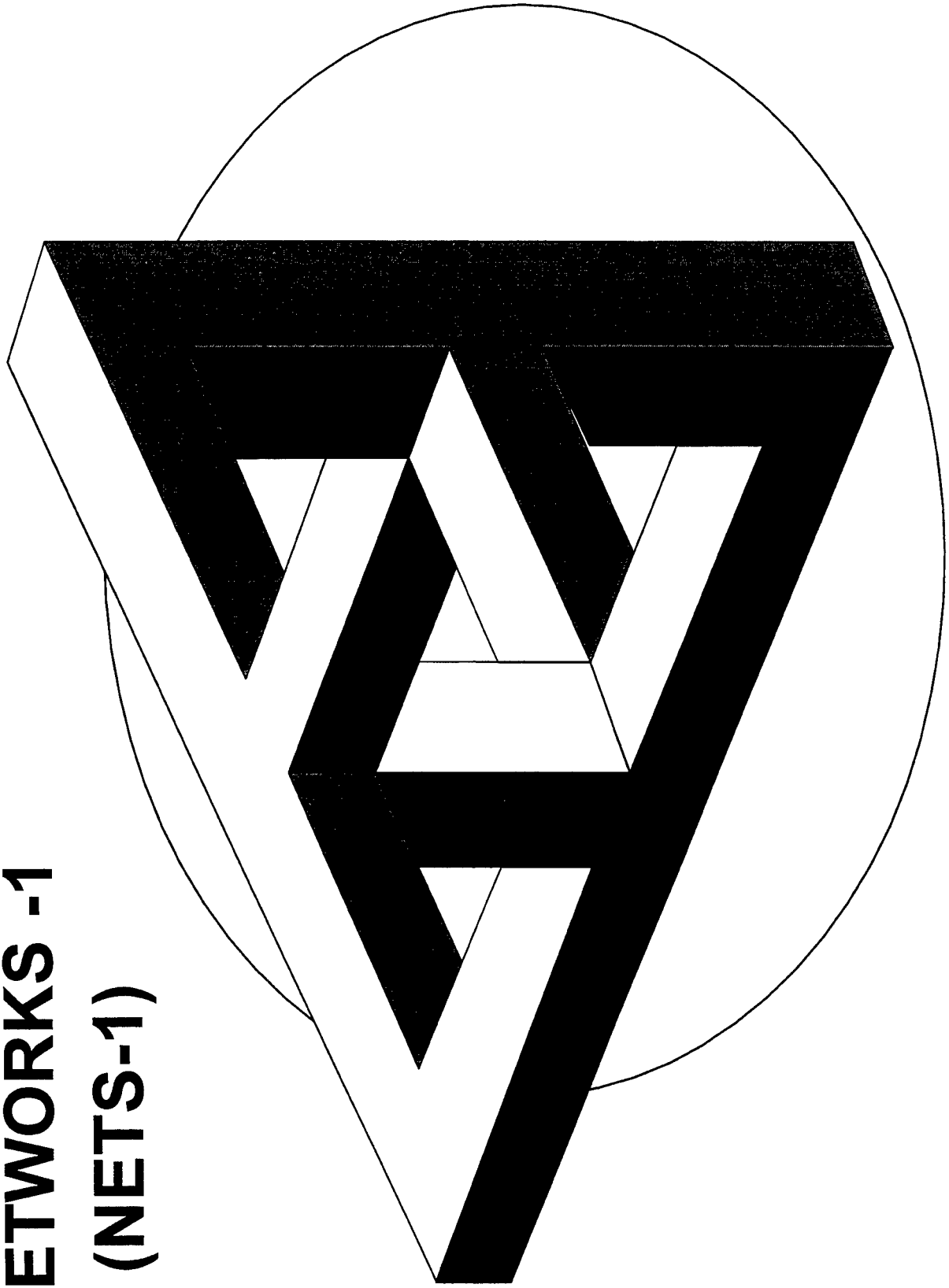

**NETWORKS -1**  
**(NETS-1)**

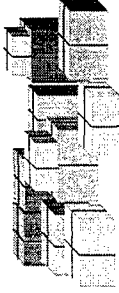
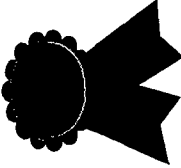

# **NET-1 DEFINITION**

**ACQUISITION OF COMMERCIAL-OFF-THE-SHELF  
(COTS) NETWORK SERVERS AND NETWORKING PRODUCTS  
TO SUPPORT  
SPECIFIC ARMY, DOD, AND CIVILIAN PROGRAMS  
THAT EXIST UNDER ESTABLISHED LANS/WANS TODAY  
AS WELL AS THOSE UNDER DEVELOPMENT.**

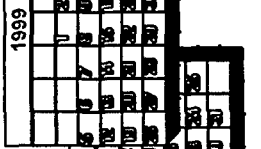
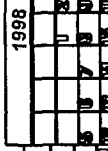
# NET-1 OBJECTIVES

- SUPPORT THE DOD/CIVILIAN NETWORKING MISSIONS
- ALL COMMERCIAL-OFF-THE-SHELF (COTS) 
- Y2K MANDATORY 
- 2 OR MORE VENDORS 
- 2-YEAR BASE, THIRD YEAR OPTION 
- 36 MONTH MINIMUM WARRANTY
- ELECTRONIC ORDER PROCESSING PROJECTED

# **NET-1 REQUIREMENTS**

- **STATE-OF-THE-ART SOLUTIONS-COTS**
  - **MAJOR VENDOR PARTICIPATION**
  - **LANS/WANS/MAN**
  - **WIRELESS**

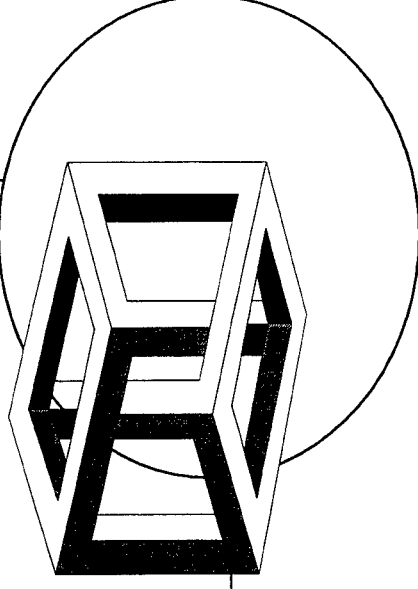

# CONTRACT OPPORTUNITY

**TITLE:** NETWORKS-1 (NET-1)

**OBJECTIVE:** NETWORKS OF CHOICE FOR ARMY,  
DOD, AND CIVILIAN AGENCIES

**PROPOSED CONTRACT TYPE:** FFP ID/IQ (BEST VALUE AWARDS)  
COTS HW/SW

**KEY MILESTONES:** RFP RELEASE 4TH QTR FY 98  
AWARD 1ST QTR FY 99

**ESTIMATED VALUE:** \$75M - \$100M

**POC:** HELEN GARAMONE, CACWOO (703) 325-9762

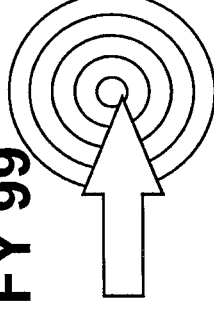

# STANDARD SYSTEMS TECHNOLOGY SUPPORT - 2 (SSTS-2)

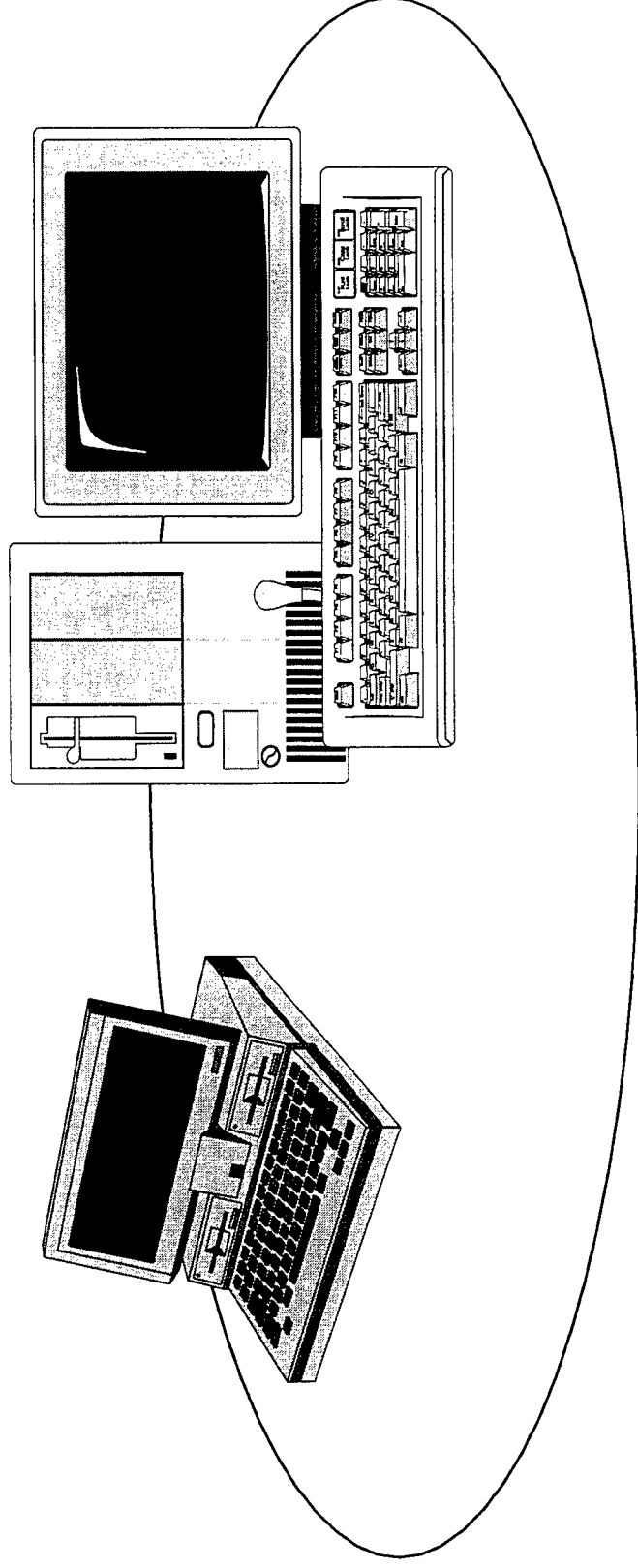

## **SSTS-2 DEFINITION**

**ACQUISITION OF COMMERCIAL-OFF-THE-SHELF (COTS)  
PERIPHERALS, CPU UPGRADES, SW UPGRADES, AND  
NEW TECHNOLOGY TO SUPPORT THE ARMY'S AND DOD'S  
FIELDED STANDARD COMPUTER BASE.**

# **SSTS-2 OBJECTIVES**

- **ARMY (LEAD), DOD (ALL), CIVILIAN AGENCIES**
- **2-YEAR BASE ORDERING WINDOW, 1-YEAR  
OPTION**
- **2 OR MORE VENDORS**
- **3-YEAR MINIMUM WARRANTY**
- **Y2K MANDATORY**
- **WIDE-OPEN TECHNOLOGY INSERTION**

# **SSTS-2 REQUIREMENTS**

- **MAXIMIZE GOVERNMENT (TAXPAYER)  
INVESTMENT IN CURRENT STANDARD ADP**
- **EXTEND USEFUL LIFE OF PCs, SERVERS  
3 - 5 YEARS**
- **SUPPORT THE TECHNOLOGY OF:**
  - **PC-2, PORTABLE-2, SMC-II**
  - **OTHER STANDARD SYSTEMS**
  - **JOINT SERVICE CONTRACTS**
    - DTIV, SMSRC, SBIS
- **STANDARDIZED SOFTWARE DISTRIBUTION  
SERVICE (DESKTOP MANAGEMENT)**

# CONTRACT OPPORTUNITY

**TITLE:**

**STANDARD SYSTEMS TECHNOLOGY  
SUPPORT - 2 (SSTS-2)**

**OBJECTIVE:**

**COTS, EQUIPMENT/SW TO SUPPORT  
ARMY/DOD REQUIREMENTS TO EXTEND  
FIELDDED ADP BASE INVESTMENT LIFE**

**PROPOSED  
CONTRACT  
TYPE:**

**FFP ID/IQ (BEST VALUE AWARDS)  
COTS HW/SW**

**KEY MILESTONES: RFP RELEASE 2ND QTR FY 99  
AWARD 4TH QTR FY 99**



**ESTIMATED VALUE: \$75 - \$100M**

**POC: HELEN GARAMONE, CACWOO (703) 325-9762**

# MAXI-MINIS AND DATABASES-1 (MMAD-1)

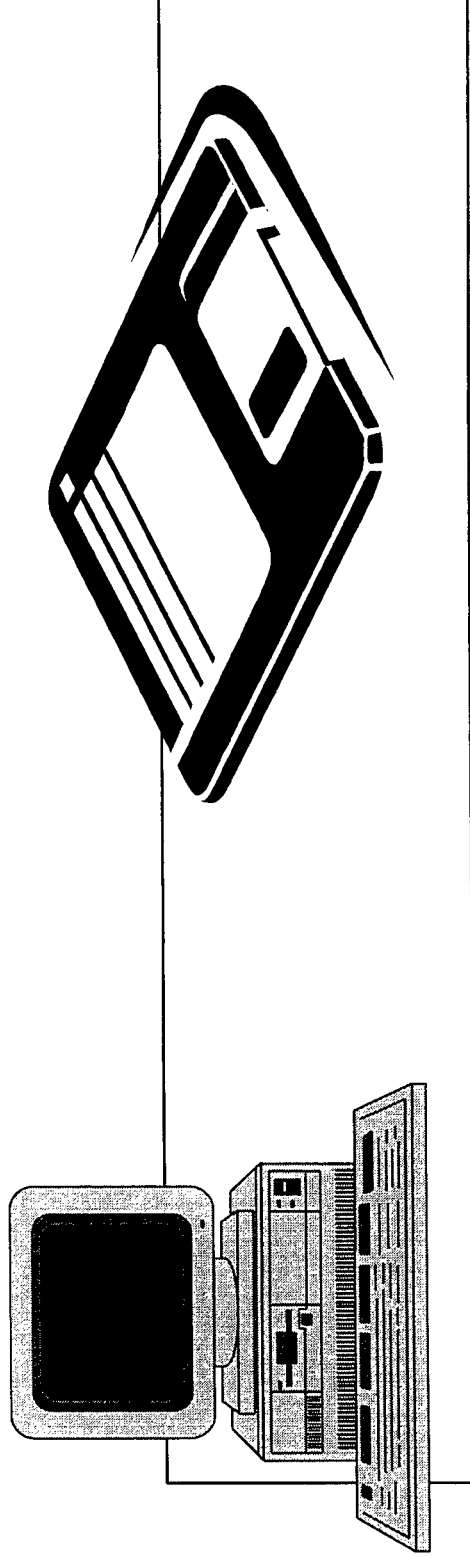

# **MMAD-1 DEFINITION**

**THIS ACQUISITION WILL BE THE ARMY'S FOLLOW-ON  
TO THE NAVY'S SUPER-MINI CONTRACT AND  
TO THE NAVY'S DATABASE MACHINES CONTRACTS.  
IT WILL BE OPEN TO THE ARMY, THE DOD,  
AND ALL CIVILIAN AGENCIES**

# **MMAD-1 OBJECTIVES**

- **SUPPORT THE ARMY'S MULTIPLE USER SYSTEMS AND DATABASES TO THE LEVELS OF SUPERMINI-II AND DBM-I**
- **ALL COMMERCIAL-OFF-THE-SHELF (COTS) PRODUCTS, 3-YEAR MINIMUM WARRANTY**
- **COMPLY WITH ALL DOD TECHNOLOGY MANDATES**
- **2 OR MORE AWARDS**
- **3 BASE YEAR ORDERING, 4-5TH YEAR OPTIONS**
- **Y2K MANDATORY**
- **ELECTRONIC ORDER PROCESSING PROJECTED**

# MMAD-1 REQUIREMENTS

- STATE-OF-THE-ART PLATFORMS-COTS

- HARDWARE

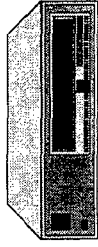

- SOFTWARE

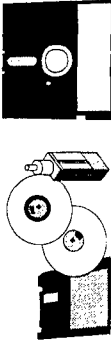

- MULTIPLE DATABASE SYSTEMS

- MULTI-USER OPERATING SYSTEMS

## OPEN SYSTEMS STANDARDS COMPLIANCE:

- TECHNICAL ARCHITECTURE FRAMEWORK
- ARMY/JOINT TECH ARCHITECTURES
- DII - COMMON OPERATING ENVIRONMENT

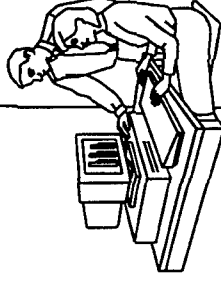
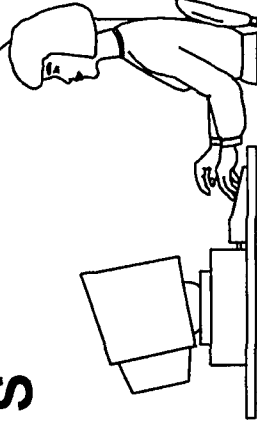

# CONTRACT OPPORTUNITY

**TITLE:** MAXI-MINIS AND DATABASES-1  
(MMAD-1)

**OBJECTIVE:** SUPPORT ARMY/JOINT SERVICE  
HIGHER MINI-COMPUTER AND  
DATABASE NEEDS

**PROPOSED CONTRACT TYPE:** FFP ID/IQ (BEST VALUE AWARDS)  
COTS HW/SW

**KEY MILESTONES:** RFP RELEASE 1ST QTR FY 98  
AWARD 3RD QTR FY 98



**ESTIMATED VALUE: \$100 - \$200M**

**POC: HELEN GARAMONE, CACWOO (703) 325-9762**

# NOTES

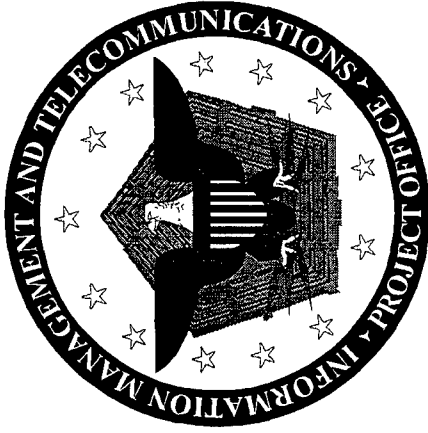
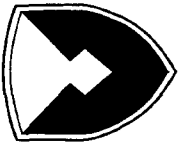

# *Pentagon Renovation Information Management and Telecommunications Project*

*COL Scipio de Kanter  
Project Manager  
PM IM&T*

**UNCLASSIFIED**

POINT PAPER

SUBJECT: Pentagon Renovation Information Management & Telecommunications (IM&T)

OBJECTIVE: The Alternate Technical Control Facility contract for Pentagon Renovation is the acquisition of design, installation, and testing services for commercial-off-the-shelf wide area / point to point network components to support an alternate technical control facility in the renovated Pentagon.

FACTS:

Information Mission Area products will support Defense Communications System telecommunications requirements for DoD Services and Agencies in the Pentagon.

The Alternate Technical Control Facility contract will provide engineering, implementation, and testing services of commercial-off-the-shelf equipment. The Alternate Technical Control Facility will provide a sound telecommunications demarkation point for internal and external communications for the renovated Pentagon.

Milestones listed below reflect the planned schedule for the release of the Alternate Technical Control Room contract.

CBD Announcement	FY04
DRAFT RFP Release	TBD
FINAL RFP Release	TBD
Contract Award	TBD

BRIEFER: COL Scipio de Kanter, Project Manager, Information Management and Telecommunications for Pentagon Renovation, (703) 607-9094.

POINT PAPER

SUBJECT: Pentagon Renovation Information Management & Telecommunications (IM&T)

OBJECTIVE: The Above ground Telecommunications Backbone contract for Pentagon Renovation is the acquisition of design, installation, and testing of commercial-off-the-shelf network components to support DoD telecommunications requirements in the renovated Pentagon.

FACTS:

Information Mission Area products will support telecommunications requirements for DoD Services and Agencies in the Pentagon.

The Above ground Telecommunications Backbone contract will provide engineering, implementation, and testing services. It will also furnish the required commercial-off-the-shelf equipment to provide a robust telecommunications infrastructure for the renovated Pentagon.

Milestones listed below reflect the planned schedule for the release of the Above ground Telecommunications Backbone contract.

CBD Announcement	17 Jan 97
DRAFT RFP Release	31 Mar 97
FINAL RFP Release	Aug 97
Contract Award	3 QFY98

BRIEFER: COL Scipio de Kanter, Project Manager, Information Management and Telecommunications for Pentagon Renovation, (703) 607-9094.

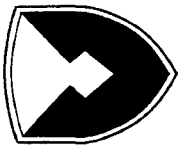

# **Project Manager, Information Management & Telecommunications**

## **Mission**

**The Washington Headquarters Services, assisted by the U.S. Army Corps of Engineers and the U.S. Army Information Systems Command will execute a comprehensive renovation of the Pentagon to transform the facility, including all Information Management and Telecommunications services, into a modern office environment.**

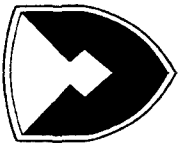

# **Project Manager, Information Management & Telecommunications**

## **Background**

### **• IM&T Deficiencies**

- Some Communications Systems Outdated and Overworked**
- Building Wiring Systems Inadequate**
- Data Systems User Oriented and Independent of Building Wiring System**
- Wire Closets, Ceiling Access, Riser Shafts Inadequate**
- Communications Pathways Extremely Congested**
- Riser System Is Obsolete and Over Utilized**
- Grounding Systems of Poor Quality**

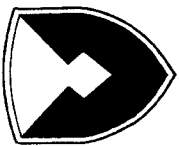

# Pentagon Renovation Program

**7 Phase Program**

**10-12 Year Duration**

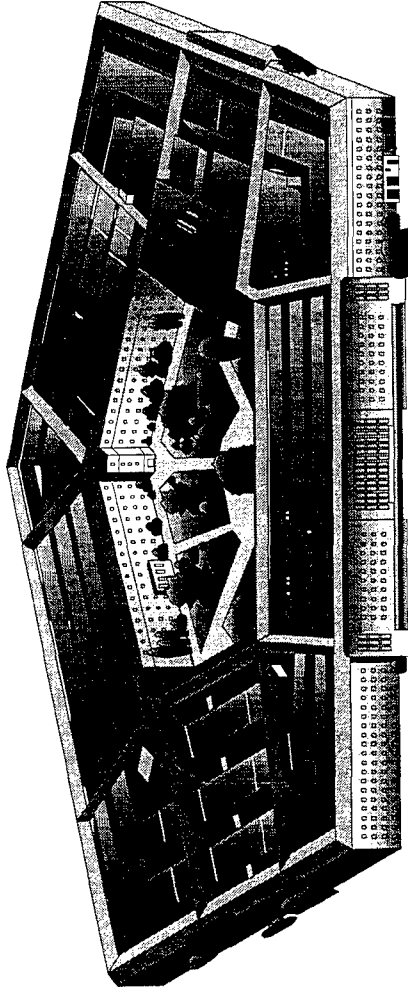

**Washington Headquarters Services**

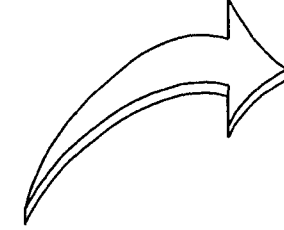

**US Army**

**US Army  
Corps of Engineers**

**PM, Information Management &  
Telecommunications**

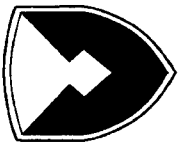

# Construction Concept

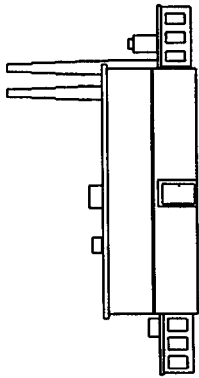

Heating & Refrigeration  
Plant

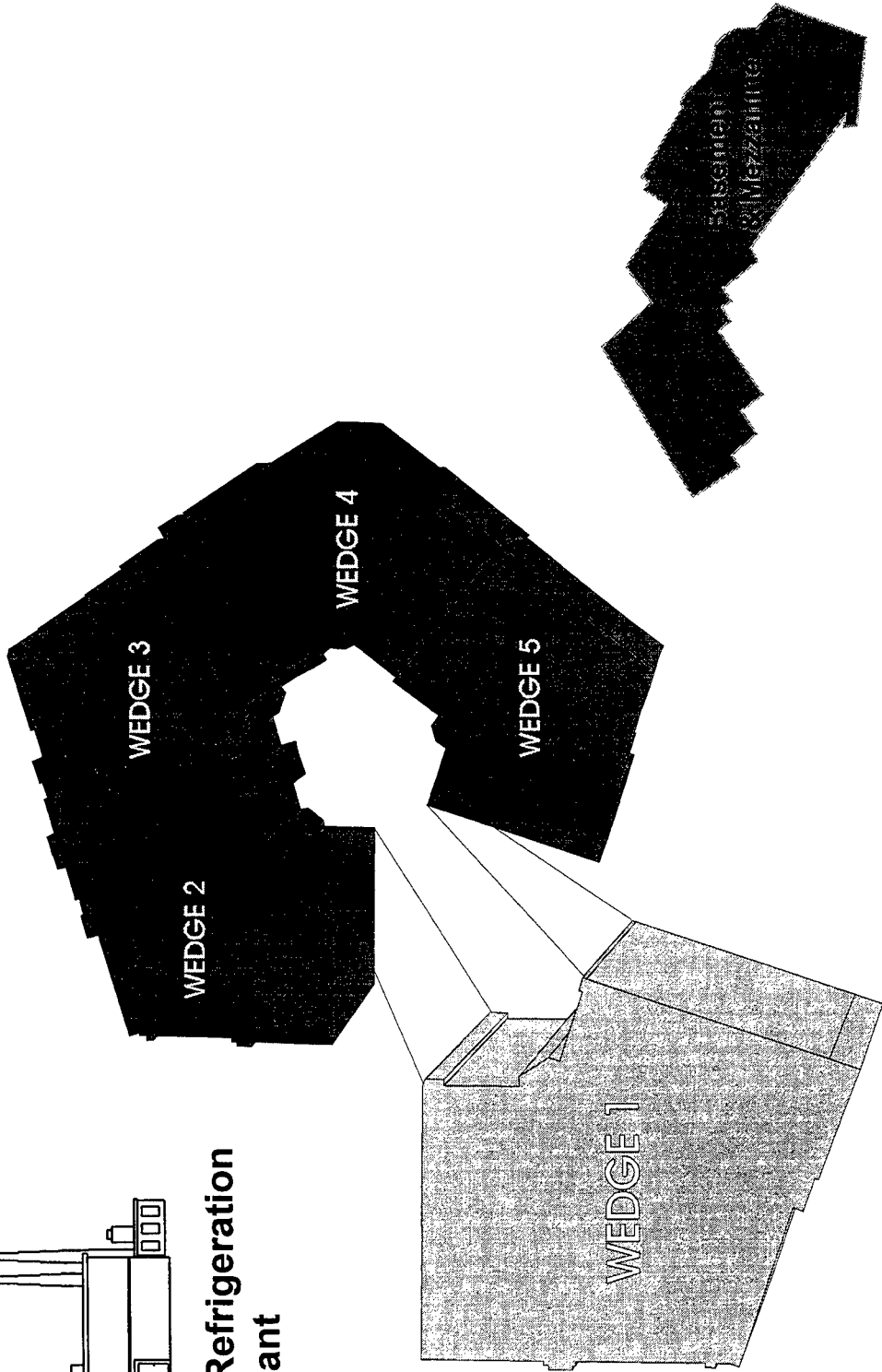

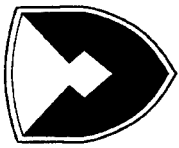

# Current Pentagon IM&T

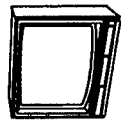

2 CATV  
Broadcast Systems

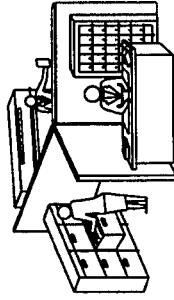

11 ADP Ctrs  
3 C2 ADP Ctrs

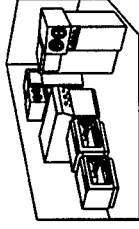

Multiple Network  
Management Centers

6 Command/Operation Centers

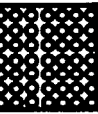
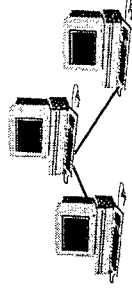

7 Tech Control Facilities

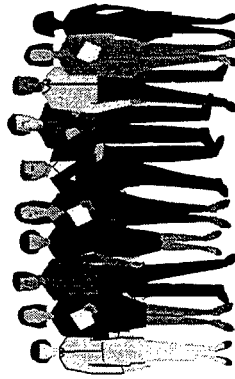

25,000 +/- Tenants

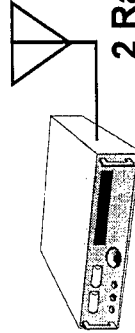

2 Radio Rooms



AVIC's

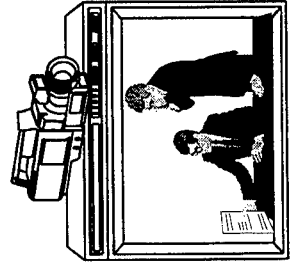

VTCs

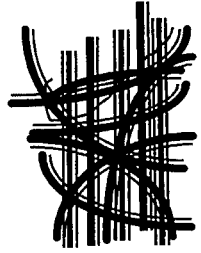

Unstructured, Undocumented  
Distribution Systems  
(Fiber, Copper, Coax)



Message Ctrs



Black Red

15 Telephone Switches

Multiple LANs  
-Classified  
-Unclassified

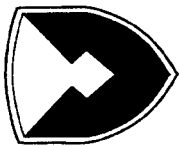

# Future Pentagon IM&T



8 Telephone Switches



Black Red

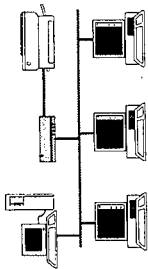

Single Backbone

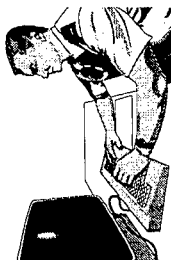

Consolidated Tech Control Facility

1 Radio Room

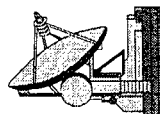

AVICS

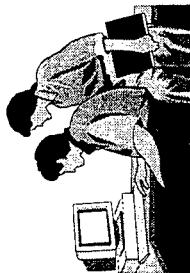

6 Command/Operations Centers

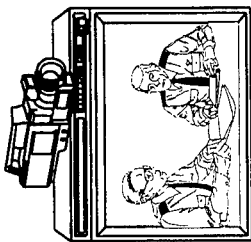
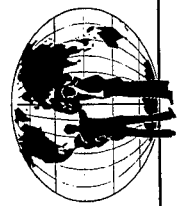

VTCs

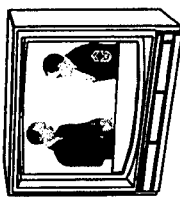

Single CATV Broadcast System

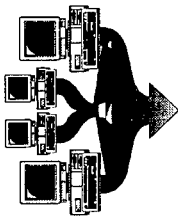

Network & Systems Management Center

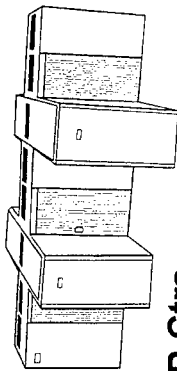

2 ADP Ctrs  
2 C<sup>2</sup>ADP Ctrs

Consolidated Message Support Center

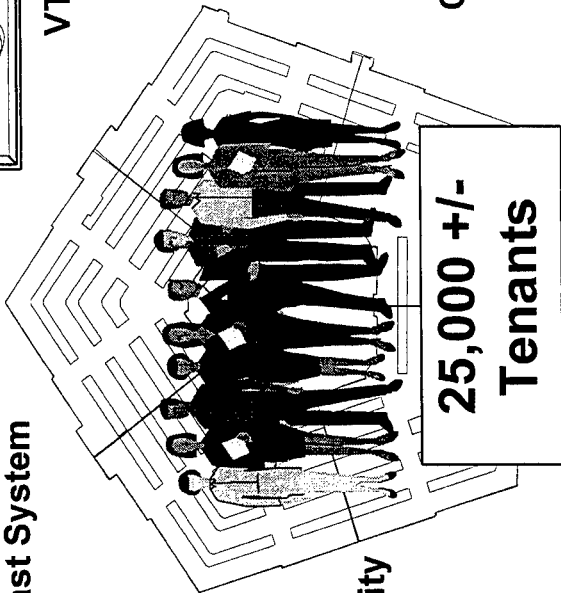

25,000 +/- Tenants



Structured Wiring With Configuration Management Control

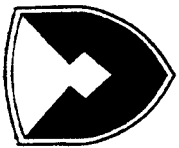

# PM-IM&T: Enabling the Future

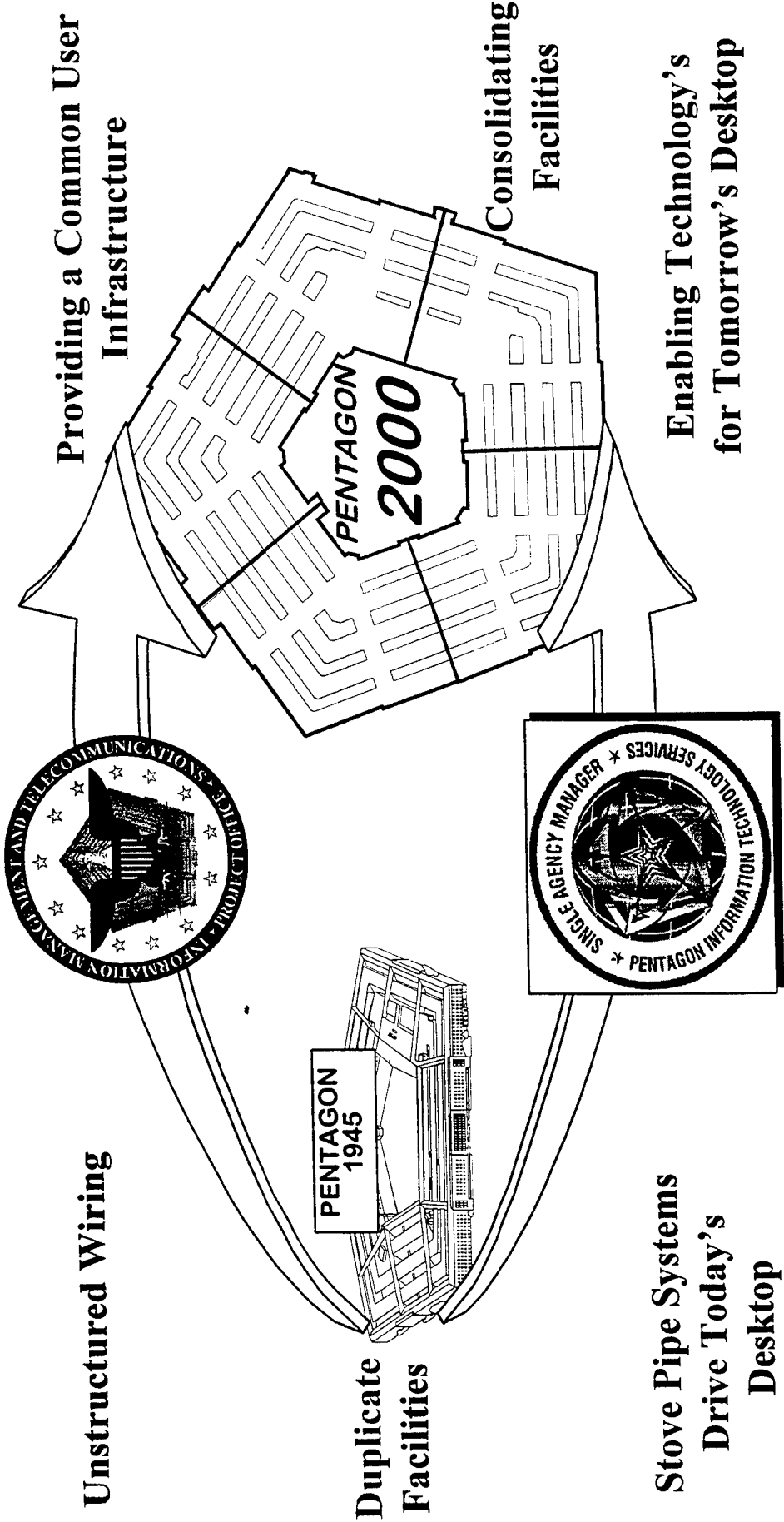

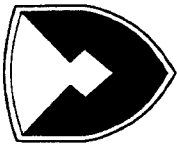

# Project Manager, Information Management & Telecommunications

## Program Status

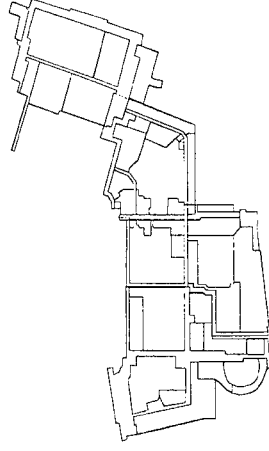

- **Basement**
- Segment 1 IM&T Installation Began Jul 96
- Segment 2 TBD
- Segment 3 TBD

- **Above Ground**

- Wedge 1 COE Demolition Begins 2QFY98
- Wedge 2 TBD
- Wedge 3 TBD
- Wedge 4 TBD
- Wedge 5 TBD

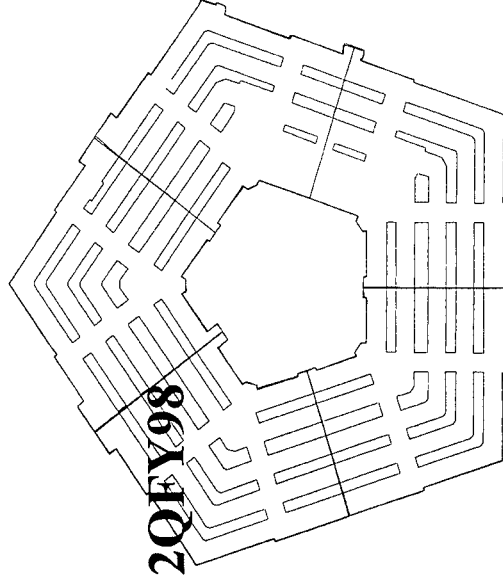

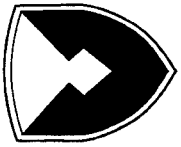

# **Project Manager, Information Management & Telecommunications**

## **Potential Opportunity**

- **Alternative Technical Control Room (a.k.a. - The Radio Room)**
- **Objective: To Design, Engineer, Install/Move, Test, and Cutover a State of the Art Alternate Technical Control Facility Whose Primary Mission Will Be to Consolidate the Pentagon's Radio Assets**
- **Proposed Contract Type: Under Review**
- **Key Milestones: Site Selection - TBD**
- **POC Name/Number: Ms. Pat Hanson (703) 607-9016**

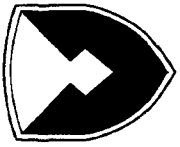

# **Project Manager, Information Management & Telecommunications**

## **Current Opportunity**

- **Above-Ground Telecommunications Backbone  
Infrastructure For the Pentagon Renovation**
  - **CBD Announcement - 17 Jan 97 RFP # DASW01-97-R-0041**
  - **POC Name/Number: Ms. Pat Hanson (703) 607-9016**
  - **Written Request For RFP Must Be Submitted to:  
IM&T/DSS-W, 100 Boundary Channel Drive, Arlington, VA 22202-  
3712**

# NOTES

**STANDARD ARMY MANAGEMENT  
INFORMATION SYSTEM**

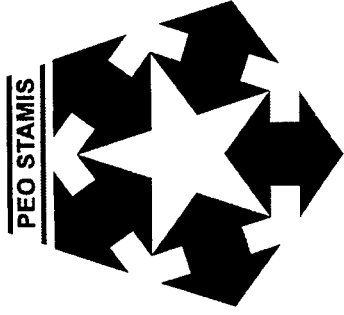

**Ms. Mary Kelly  
Acting Deputy PEO STAMIS**

**PEO STAMIS**

**UNCLASSIFIED**

## Topics

- ★ **PEO STAMIS Product Line**
- ★ **STAMIS Characteristics**
- ★ **Challenges**
- ★ **Goal**
- ★ **Intent**
- ★ **What We Need/Contract Opportunities**
- ★ **Summary**

# PEO STAMIS Programs

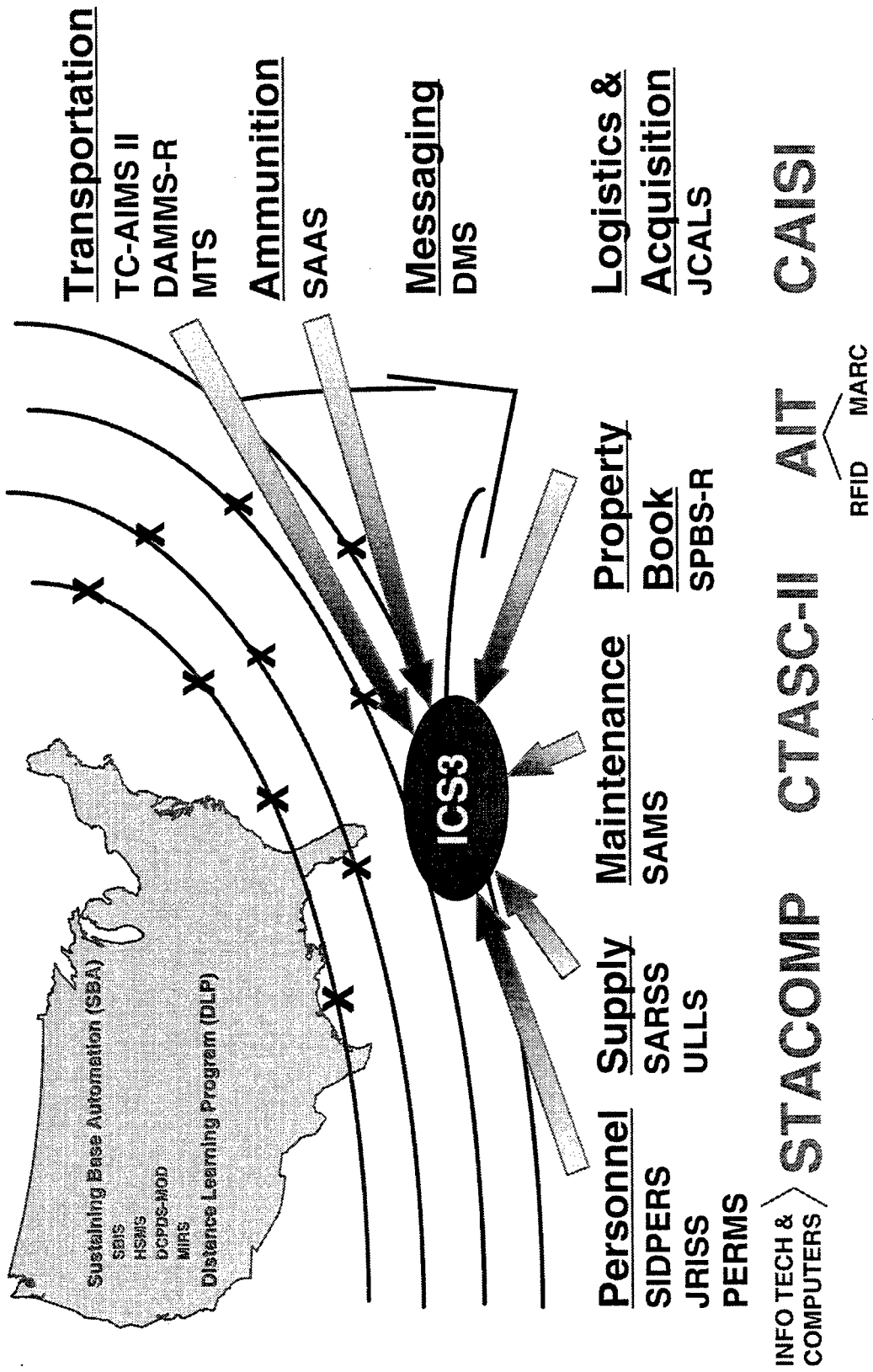

## STAMIS Characteristics

- ☆ **Complex**
  - **Diverse heterogeneous systems**
  - **Technology sensitive**
- ☆ **Multi-threaded integration function (vertical & horizontal)**
- ☆ **Critical to management of:**
  - **Retail logistics**
  - **Personnel**
  - **Sustaining Base**

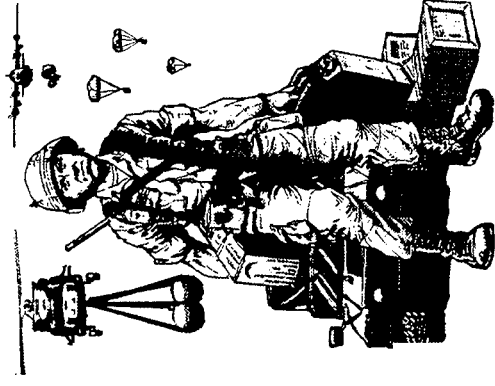

*Supports the warfighters' requirement for effective combat service support and power projection*

# The Challenges to the Future of Army Information Systems

★ Continue to find ways to get the most out  
of every dollar!

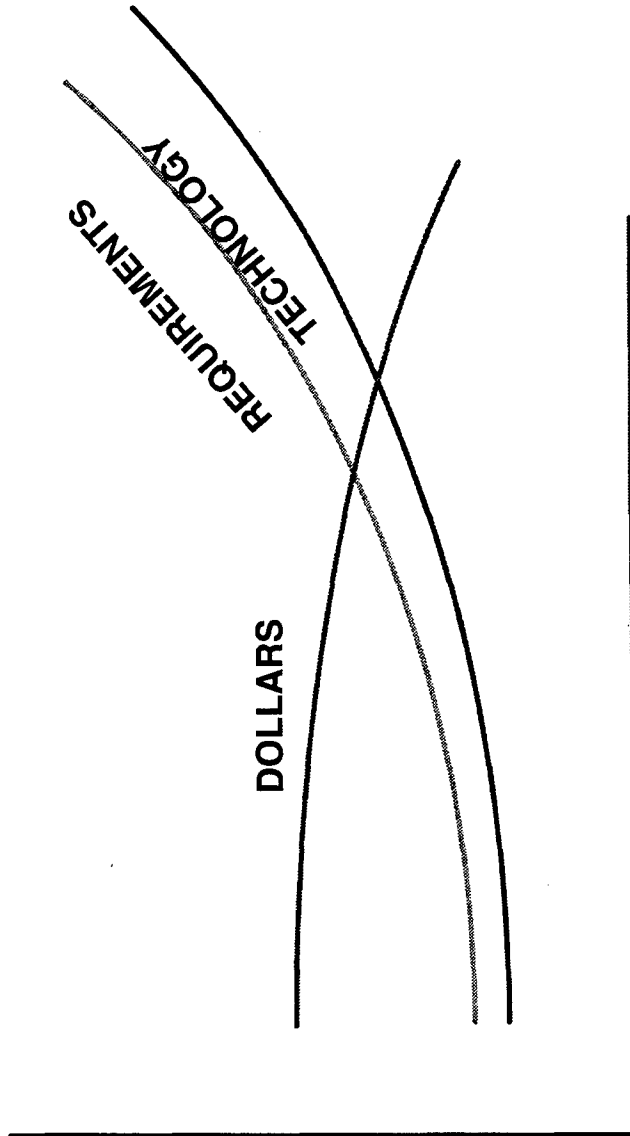

- Response
- ★ Design for Change
  - ★ Leverage Commercial Products
  - ★ Reuse
  - ★ Synchronize Infrastructure
  - ★ Cost as Independent Variable (CAIV)

# The Challenges (Continued)

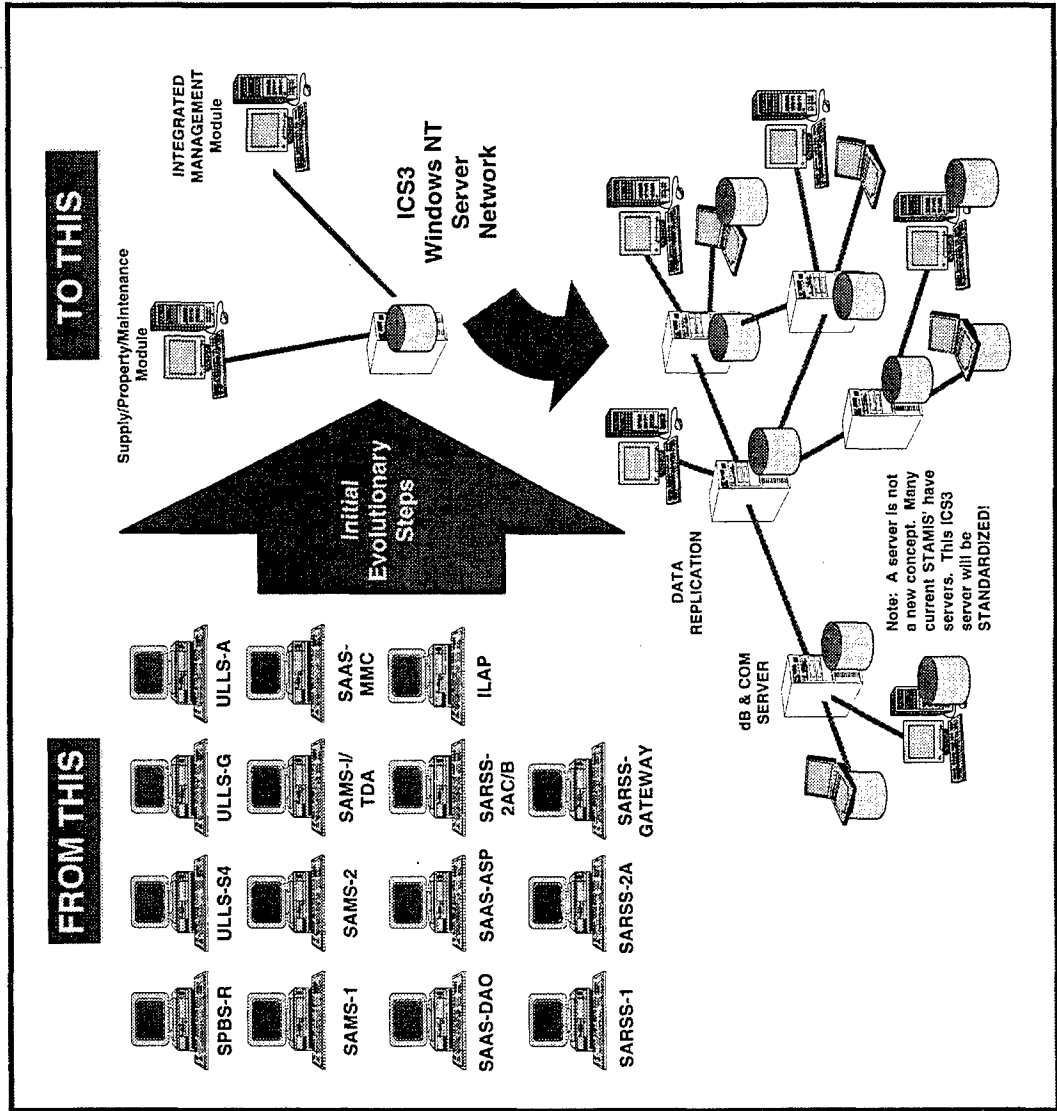

## The Goal

- ★ Build higher *quality, integrated, open* software
- ★ **Software Best Practices** as part of the culture
  - Capability Maturity Model (CMM) Level 3 in all project offices and deliveries
- ★ Leverage **Commercial-Off-The-Shelf (COTS)** software/technologies
  - Leverage high productivity development environments
  - Seek applications matched to key business processes
- ★ Guarantee *interoperability* of legacy and new systems

## The Intent

### *Focus on technology insertion*

- ★ Keep new ideas flowing
- ★ Use or modify existing contracts
  - IDIQ/umbrella
  - Avoid lengthy/expensive source selections

### *Invest in areas of high payoff*

- ★ Technologies
- ★ Reuse, commercial applications
- ★ Improved acquisition and development

### *Increase outsourcing: must rely more on industry*

- ★ Essential to quality: getting it right the first time; doing all the right things
- ★ Transfer expertise to government workforce

Re-engineer the way we do business

## What We Need

- ★ **Seamless interface between SECRET and Unclassified systems**
  - **STAMIS business systems ride secret area common user system and interface to CSSCS**
- ★ **Wireless LAN**
- ★ **Year 2000 support: testing/certification**
- ★ **Industry acknowledged experts in:**
  - **Requirements engineering/business process redesign**
  - **Data modeling**
  - **Design/architecture**
  - **Rapid applications development**

## Contract Opportunity

**Title:** STAMIS Computer Contract II (SCCII)

**Objective:** SCCII will provide commercial hardware, software, integration, maintenance and technical support services to meet worldwide STAMIS requirements.

**Contract Type:** Integration and Support Services / IDIQ

### **Key Milestones:**

Draft RFP Released to Industry - Feb 97

Final RFP Release - May 97

Proposals due - Jul 97

Contract Award - Sept 97

**Estimated Value:** 300M to 500M

➤ **Ordering period - 4 years**

**PM POC:** Major Brooke Oestreich (703)339-5587

**CECOM Acquisition - Washington POC:** Kevin Sommer  
325-3328

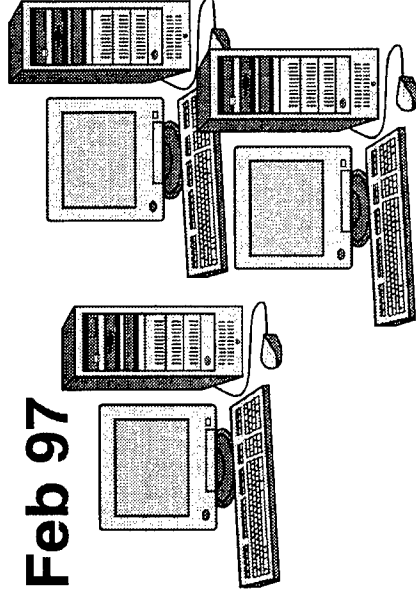

## Contract Opportunity

**Title:** Movement Tracking System (MTS)

**Objective:** MTS will provide a suite of commercial off the shelf hardware and software to track the location of vehicles via the GPS, communicate with vehicle operators and redirect movements based upon battlefield requirements. Initially, MTS will be fielded to two Divisions and a Corps slice as a part of the Palletized Load System - Enhanced (PLS-E)

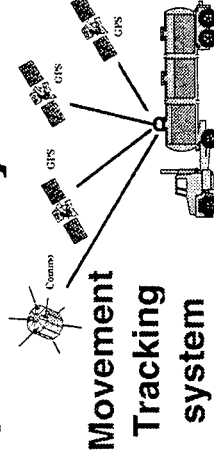

**Contract Type:** IDIQ/Firm Fixed Price

**Key Milestones:**

Warfighter Rapid Acquisition Program (WRAP) ASARC approved procurement of 432 MTS sets for PLS-E - Dec 96

Market Survey to be conducted - Apr-May 97

Award - Jun/Jul 97

**Estimated Value:** \$2.78M FY97 RDT&E approved by WRAP ASARC

**PM POC:** Mr. Herb Andresen (804) 734-6047

**CECOM Acquisition - Washington POC:** Diane Lytle 325-3346

## Summary

- ★ **We are building a technical architecture based on open system standards**
- ★ **We are making significant changes in our business practices**
- ★ **We must leverage commercial technology**
- ★ **Need industry participation to make it a reality**

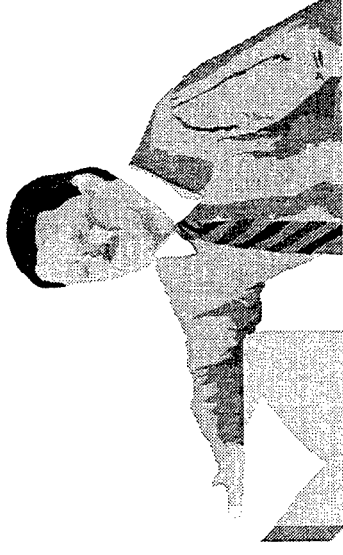



# Program Executive Office Standard Army Management Information Systems

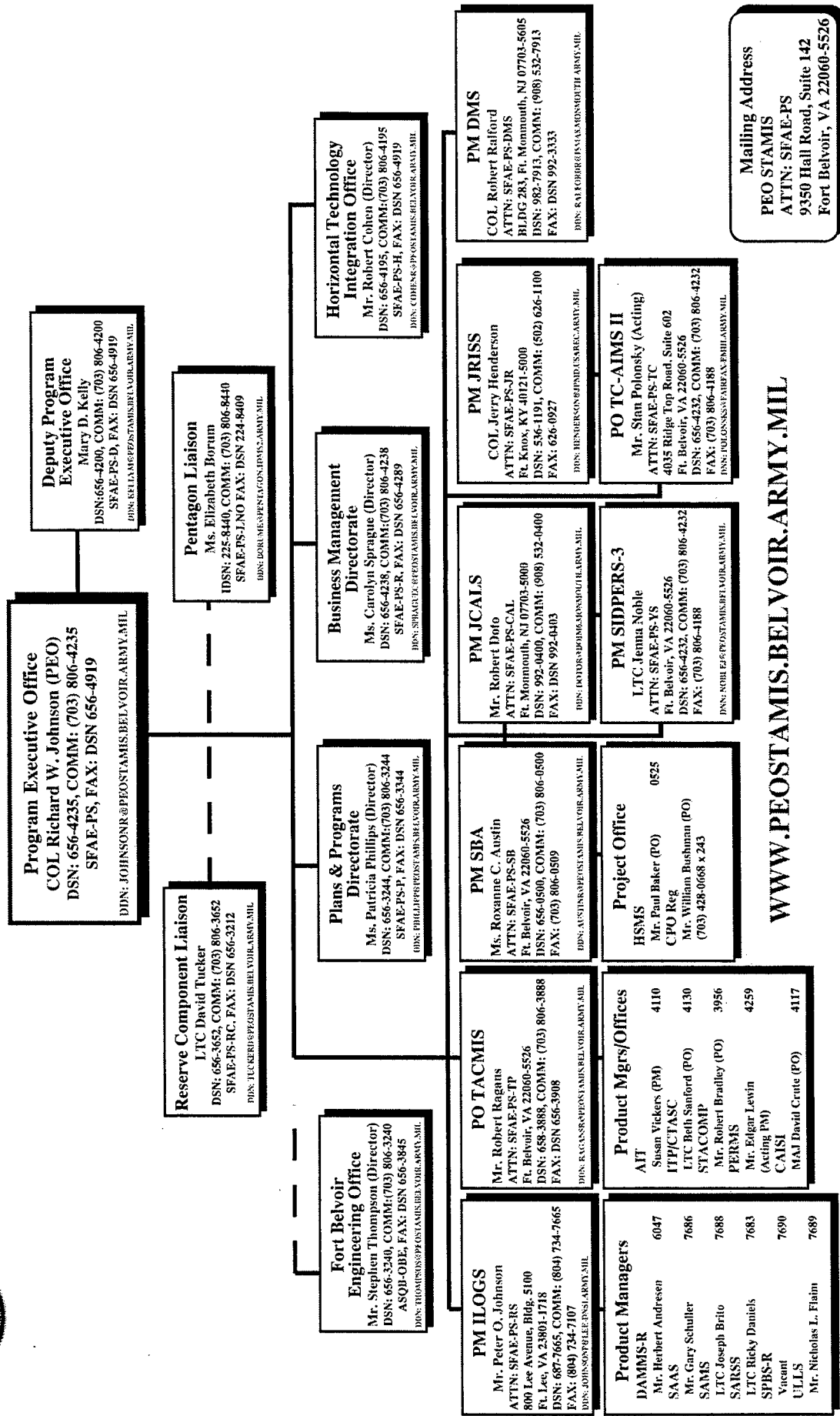

WWW.PEOSTAMIS.BELVOIR.ARMY.MIL

# System List

- Defense Messaging System (DMS)  
Distance Learning Program (DLP)  
Integrated Combat Service Support System (ICS3)  
Integrated Logistics Systems (ILOGS)
- (1) Department Army Movements Management System - Redesign (DAMMS-R)
  - (2) Movement Tracking System (MTS)
  - (3) Standard Army Ammunition System (SAAS)
  - (4) Standard Army Maintenance System (SAMS)
  - (5) Standard Army Retail Supply System (SARSS)
  - (6) Standard Property Book System - Redesign (SPBS-R)
  - (7) Unit Level Logistics System (ULLS)
  - (8) Integrated Logistics Analysis Program (ILAP)
- Joint Computer-Aided Acquisition and Logistics Support (JCALs)  
Joint Recruiting Information Support System (JRISs)  
Sustaining Base Information Services (SBIS)
- (1) Defense Civilian Personnel Data System-Modernization (DCPDS-MOD)
  - (2) Hazardous Substance Management System (HSMS)
  - (3) MEPCOM Integrated Resource System (MIRS)
- Standard Installation/Division Personnel System -3 (SIDPERS-3)  
Tactical Management Information Systems (TACMIS)
- (1) Automated Identification Technology (AIT)
  - (2) Combat Service Support Automated Information Systems Interface (CAISI)
  - (3) Corps Theater ADP Service Center, Phase II (CTASC-II)
  - (4) Personnel Electronic Record Management System (PERMS)
  - (5) STAMIS Tactical Computers (STACOMP)
- Transportation Coordinators' Automated Information for Movements System II (TC-AIMS II)  
Combat Service Support Control System (CSSCS)

# NOTES

# **SESSION IV**

## **INTELLIGENCE AND ELECTRONIC WARFARE AND SENSORS TECHNOLOGIES AND MODERNIZATION**

### **MODERATOR**

**MR. EDWARD T. BAIR  
DEPUTY  
PROGRAM EXECUTIVE OFFICER  
INTELLIGENCE, ELECTRONIC  
WARFARE AND SENSORS**



Program Executive Office

Intelligence, Electronic Warfare & Sensors

# IEW&S Overview

Mr. Edward T. Bair  
Deputy Program Executive Officer  
May 1997

UNCLASSIFIED

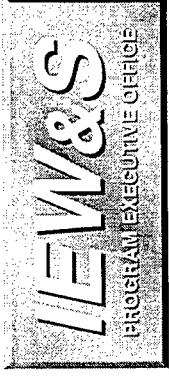

# PEO IEW&S Agenda



## **Overview - Mr. Edward Bair**

- Modernization Strategy
- Causing Change

## **Program Opportunities**

- PM FIREFINDER - LTC Thomas Cole
- PM NV/RSTA - Mr. Brian Murray

# *PEO IEW&S Vision*

**To be the Army's Premier Provider of Sensor Capabilities and Products to the American Warfighter in the Most Efficient and Effective Manner**



## *Mission*

**To Field and Insert State-of-the-Art, Interoperable Sensor Capabilities and Products Which Enable the Land Component Commander to Control Time, Space and the Environment, While Enhancing Survivability and Lethality, Through Continuous Technology Evolution and Warfighter Focus, In the Right Place and Right Time, and at the Best Value for the US Taxpayer**

# Why We're Here

Field and Support the Most Modern  
Technology to the Soldier Now

Relevant

Do the Mission,  
Second to None...  
HOOAH!!!  
Ready



Effective

Efficient

# What is Our Role?

Nuclear War

General War

MRC

Strike Raid

Peace Enforcement

Peacekeeping

NEO

Humanitarian Ops

Disaster Relief

Emergencies

Support to the Nation

Access & Influence

OOTW

MRC

Spectrum of Military Operations

DCSOPS

*The Army has been living the 21st century for the last seven years!*

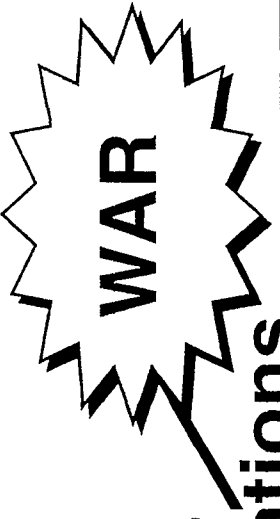

Utility

Intensity

# **Modernizing The Army...** *to ensure tomorrow's capability*

**Implementing a modernization strategy with restructured investment priorities**

- ✓ **Attaining information dominance**
- ✓ **Maintaining and focusing the Technology Base**
- ✓ **Funding recapitalization and technology insertion**
- ✓ **Investing in fewer new systems**
- ✓ **Funding systems which provide capabilities across the spectrum of potential Army Missions**



*Providing the Nation a cost-effective, properly sized, well-equipped and ready force -- now and into the 21st Century*

# Changing to Meet the Army's Needs

## Modernization Strategy

### Army XXI Overmatch

#### Full-Spectrum Dominance

Product Improved  
version of  
today's Army

- Training
- Doctrine
- Force Design
- Info Technology

#### Revolutionary Change...

- Leap Ahead Capabilities
- Greater Lethality
- Greater Strategic/Operational Mobility
- Logistically Agile
- Greater Versatility

#### Army After

#### Next Overmatch

Regional Competitors to Major Competitors

C A P A B I L I T Y

1997

2010

TIME

2020

2025

# **What Has Been Our Guidance?**

- **“Info Tech-up” Current Platforms**
- **Block Enhancement Strategy**
- **Extend Useful Life of Current Systems**
- **HTI**
- **New Requirements Reinvention**
- **Provide for Affordable Systems Through Acquisition and Over Total Program Life Cycle**
- **Maintain Overmatch Capability**

# Funded Modernization Capabilities Trend

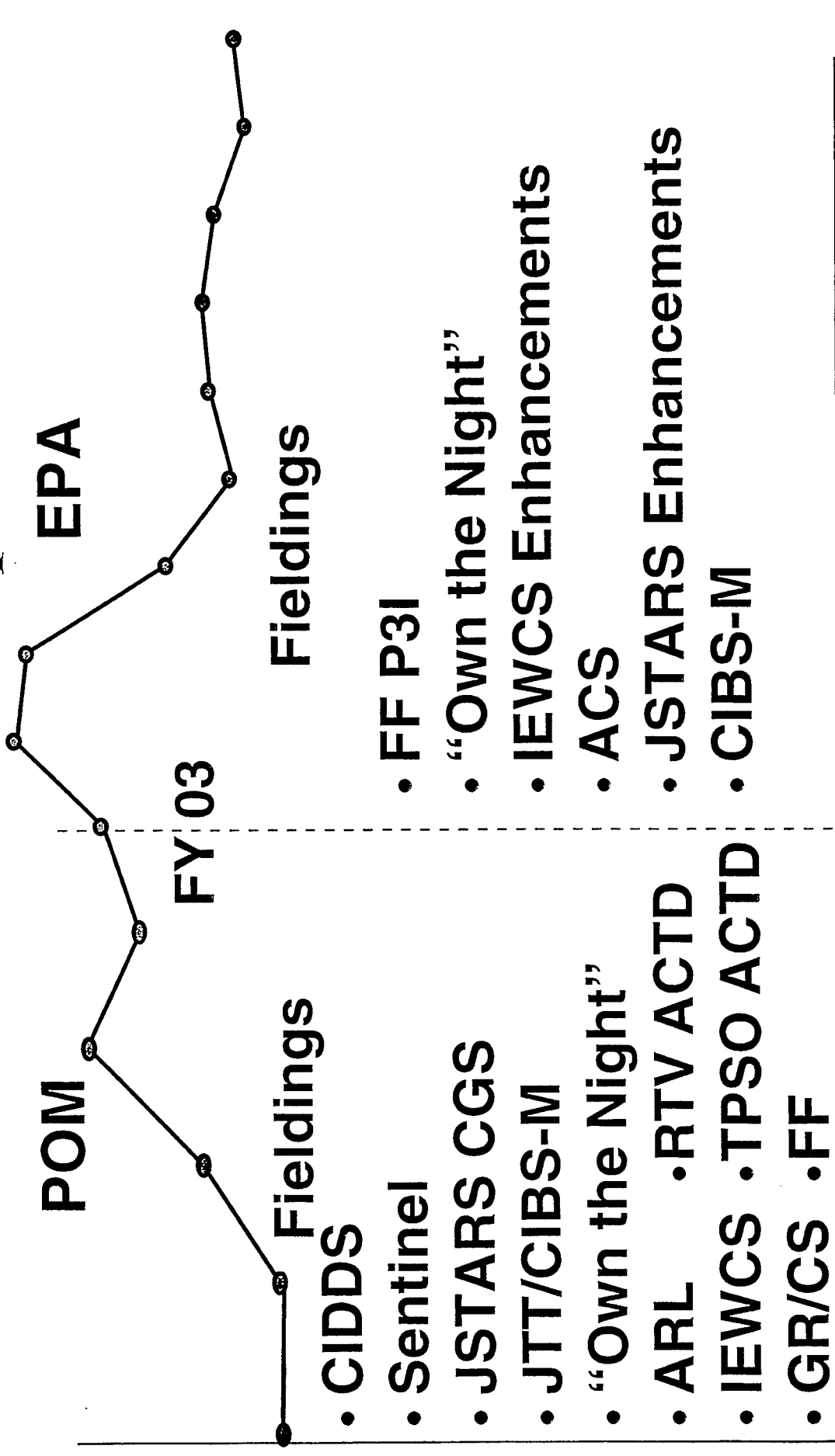

**POM**

**FY 03**

**EPA**

**Fieldings**

**Fieldings**

- CIDDS
- Sentinel
- JSTARS CGS
- JTT/CIBS-M
- “Own the Night”
- ARL
- IEWCS
- GR/CS
- RTV ACTD
- TPISO ACTD
- FF

- FF P3I
- “Own the Night”
- IEWCS Enhancements
- ACS
- JSTARS Enhancements
- CIBS-M

**FY98**

**4.8 B**

**6.5 B**

**FY12**

**Years**

# IEW & S Capabilities Enablers

Reconnaissance

Targeting

Surveillance

SIGINT

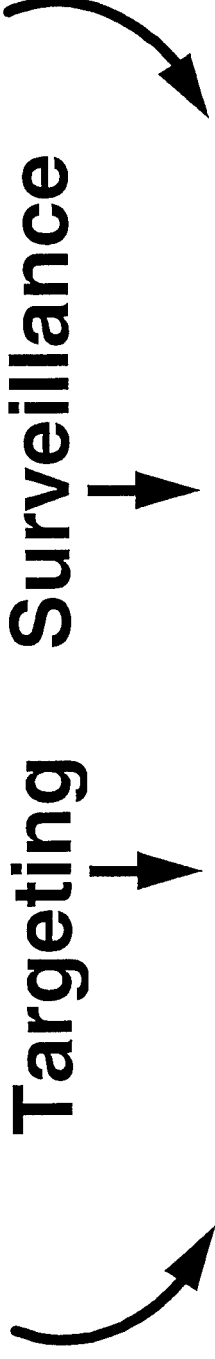

Common Relevant Picture  
“The Essence of Force XXI”

Control

Tempo

Battlespace

Environment

*Difficult to Deceive Multiple Sensors*

# The Acquisition Challenge

*Cultural Change Needed to Bring  
Force XXI to Reality*

**Declining  
Resources**

**Changing  
Threat**

Technologically Superior Army  
**F O R C E**  
National Industrial Base  
With the Right  
Capabilities



Force  
XXI

**Exploding  
Technology**

*Future Battle Vision*

# **Culture Change The Acquisition Revolution**

**“...Incremental Change is What We’re Used to; The Kind We Could Manage Gradually, With Careful Planning, Broad Consensus - Building, and Controlled Execution. Now, we Must Not Only Manage Change, We Must Create Change - *Big Change* - and Fast. If We Stop For Leisurely Consideration of the Issues, The Situation Will Alter in Front of Our Eyes and Our Careful Judgements Will Not Apply. Everything is in Question.”**

# Reducing Cost of Ownership

~Affordability~

•There are Some Effective Techniques to Reduce Life Cycle Costs:

- CAIV
- Reuse
- Reduced Testing Through Modeling
- SPI
- Multi Year Contracts
- Leveraging Commercial Technology



*Our Challenge is to Apply Business Thinking and Parametric Tools, Reduce the Overall Cost of Ownership, and to Be Able to Articulate the ‘Whole’ Story*

# **I'm Pushing...**

- CAIV**
- Supportability Efficiencies**
- Intelligent Product Data (IPD)**
- Orals (Proposals and/or IFNs)**
- Software Capabilities Risk Assessment**
- Performance Based Progress Payment**
- Multi-Year Procurements**
- On-Line Access to Mngt. Data**

# **I'm Pushing...**

**(Cont'd)**

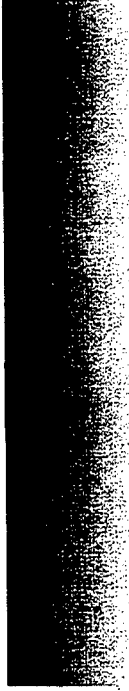
- **Contract Performance Metrics**
  - **ATA/JTA**
  - **Modeling and Simulation**
  - **Developing the Workforce**
  - **LCC Measurement**
  - **Environmentals/EMI-EMC Performance**
- Criteria**
- 

*There are More Consequential Efficiencies to be Had  
~ Leadership Needs to Push and Focus ~*

# Acquisition Reform Campaign

## PEO IEW&S Acquisition Reform Efficiencies

- \$1.9B in Cost Saving
- \$1.8B in Cost Avoidance
- 68% Average SOW/SPEC Size Reduction
- 75% Average Number CDRLs Reduction
- 30% Cycle Time Reduction

*“Your cost reduction plans are an outstanding effort”*  
~ LTG Hite, April 1997

# Open Dialogue With Industry Campaign

- Establish Government-Industry Partnership in Acquisition Reform Process
- Seeking Frank Feedback
  - What Is Working
  - What Is Not
  - Lessons Learned
  - Missed Opportunities
- Multiple Letters Sent to Over 40 of Our Contractors Spanning All PMs



*If You Haven't Received a DPEO Letter To Initiate a Dialogue, Let Me Know*

**PEO IEW&S**  
**APBI Report Card**

<b>Current Opportunities</b>	<b>95 APBI</b>	<b>96 APBI</b>	<b>97 APBI</b>
LRAS3	X	X	RFP Released
Thermal Omnibus	X	X	X
TLOS	X	X	RFP Released
FIREFINDER	X	X	X
LVRS			X
Omnibus V			X
INOD	<b>Not Briefed Due to Accelerated Award Process</b>		
CIDDS			
LLDR			

X = Briefed at APBI

# Dominant Maneuver

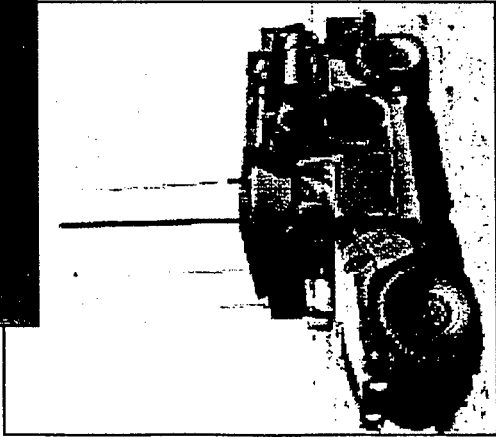
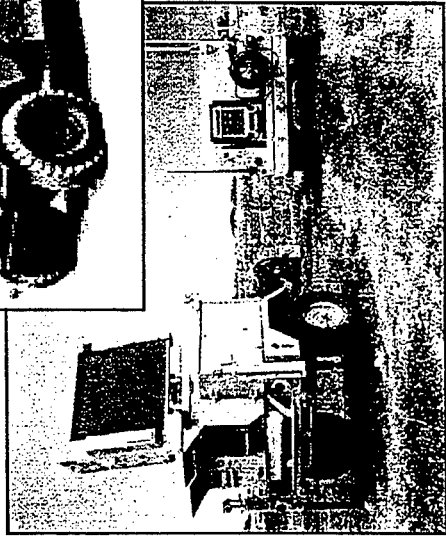
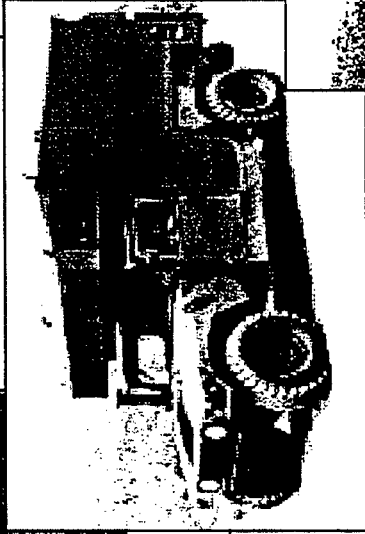
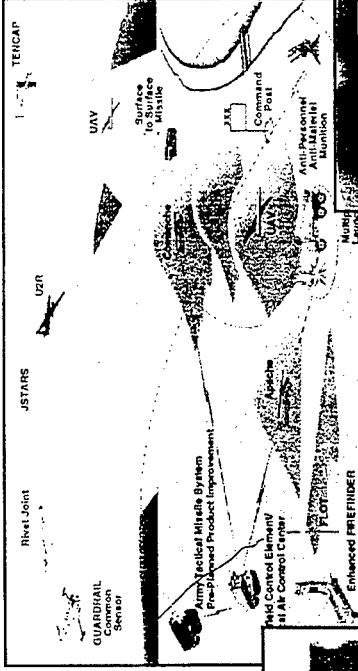

*“Sensors Will Allow our Forces to Gain a Decisive Advantage by Influencing the Breadth, Depth and Height of the Battlespace.”*

*~ Joint Vision 2010*

# World Wide Web Page



<http://www.monmouth-army-mil/peiew/peiew.html>

# NOTES

# Firefinder Block II Pre-Planned Product Improvement (P3I)



**LTC Thomas M. Cole**  
Product Manager Firefinder

UNCLASSIFIED

## INFORMATION PAPER

SUBJECT: FIREFINDER BLOCK II, Pre-Planned Product Improvement (P3I)

OBJECTIVE: P3I is a new ACAT III program scheduled for award in FY 98 that responds to Army requirements to upgrade the AN/TPQ-37 radar system to increase range and accuracy, reduce life cycle costs and improve operational availability. P3I will design and produce a new antenna group for the current fielded radar system. The P3I radar must be capable of getting to the battlefield and fit on C-130 aircraft without disassembly. Enhanced performance will support a new mission requirement to detect short range Tactical Ballistic Missiles (TBMs) and allow FIREFINDER to support improved Field Artillery delivery systems such as Crusader, to respond to longer range threats.

### FACTS:

#### \* Planned Milestones

Draft RFP Release	3rd Qtr, FY97
RFP Release	4th Qtr, FY97
Contract Award	2nd Qtr, FY98

\* An open competition will be conducted to award a cost plus incentive fee type contract. The evaluation will be best value with one award. The contract duration is approximately 36 months to produce and test 3 production representative systems.

\* Use of non-developmental items (NDI) and commercial off-the-shelf (COTS) equipment is emphasized to reduce development timelines and minimize performance risk.

\* P3I will be compliant with the Army Technical Architecture.

\* The AN/TPQ-36(V)8 shelter will be provided as Government Furnished Equipment.

BRIEFER: LTC Tom Cole, Product Manager FIREFINDER, (908) 427-5618



# Operational Scenario

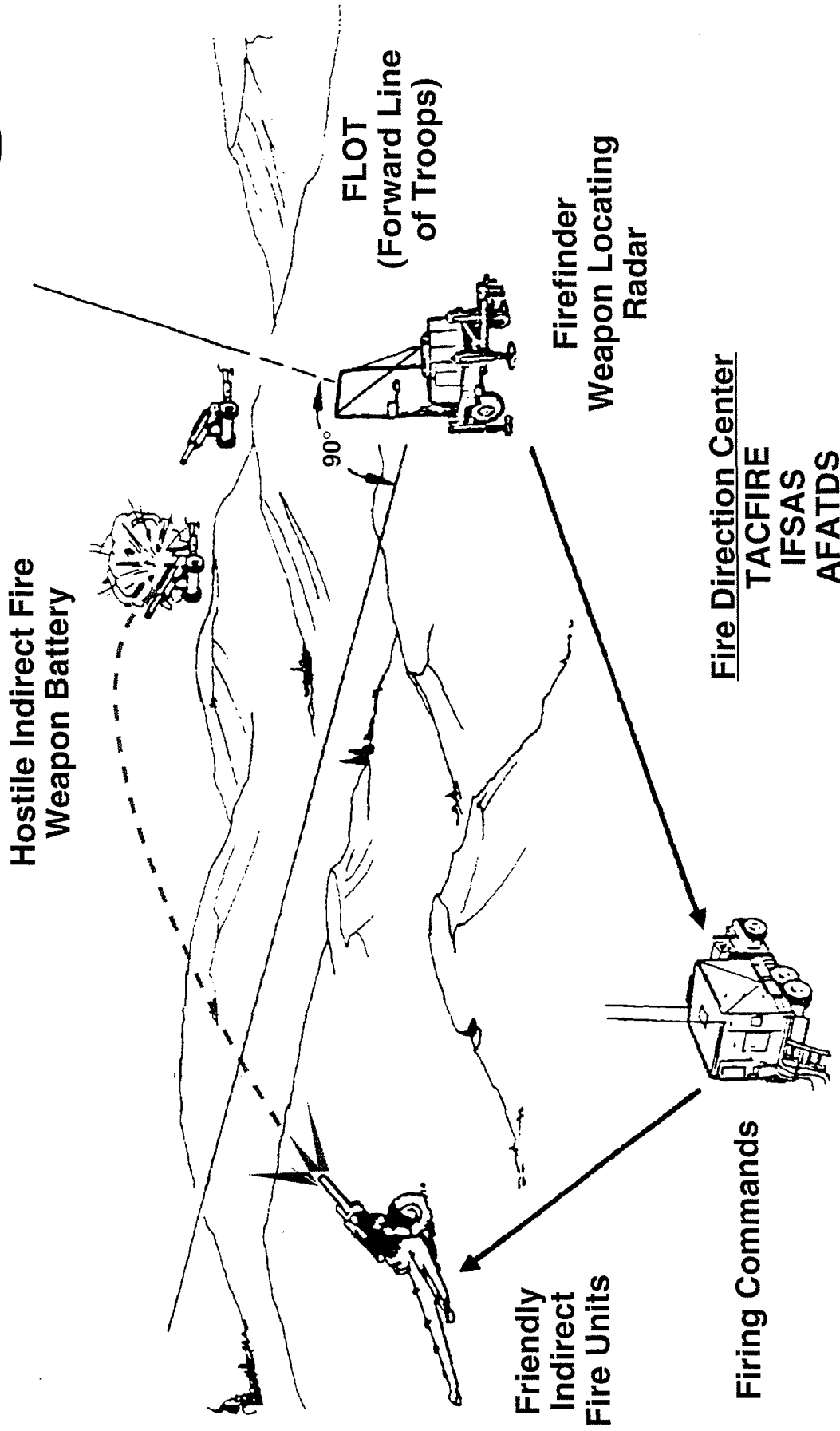



# Program Definition



- **Shoot**

- **Increase Range and Accuracy for Detection of Mortars, Artillery, Rockets and Missiles**

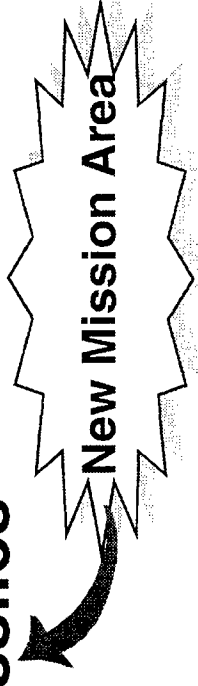

- **Move**

- **Get to the Fight and Keep Pace with Maneuver Forces**

- **Communicate**

- **Meet Demands of Joint Digitized Battlefield for Timely and Accurate Target Information**



## **Program Definition (Cont'd)**



- **Produce 3 (Each) Production Representative Antenna Transceiver Groups**
- **Utilize Standard Army Vehicles and Power Generators**
- **AN/TPQ-36(V)8 LMS Shelter and Contents Provided as GFE**
- **Maximize Use of COTS/NDI**

# Program Schedule



	FY96	FY97	FY98	FY99	FY00	FY01	FY02	FY03
RFI	□							
ORD Approval	△							
MS II		△						
Solicitation		△						
SSEB			□					
EMD Award			△					
EMD (Qty 3)								
MS III						△		
Production								
IOC								△



## Program Requirements



- **Increase Range and Accuracy**
- **Improve Target Classification**
- **Improve Transportability and Mobility**
- **Reduce False Locations**
- **Reduce Life Cycle Costs**
- **Increase Target Throughput**
- **Improve Operator Utility**
- **Improve Survivability**

# Contractor Challenges



- Radar Development and Design
  - Antennas
  - Receiver/Exciter
  - Radar Signal Processing
  - Power Amplifier
- Software Management Development
  - Data Processing
  - Joint Technical Architecture Compliance
- System Integration
  - Common Hardware/Software
  - Operator Environment



# Contract Opportunity



**Title:** Firefinder Block II P3I Program

**Objective:** Improved Antenna Transceiver Group

**Proposed Contract Type:** EMD - Cost Plus

**Key Milestones:** MS II - 4QFY97  
RFP - 4QFY97  
CA - 2QFY98

**Estimated Value:** EMD 70-80M  
Production 400-500M

**Point of Contact:** Stan Dobies (Technical)  
**Telephone:** 908-427-5224  
Yvonne Bova (Contracts)  
908-532-3569

# NOTES

# *Night Vision & Electronic Sensor Systems*

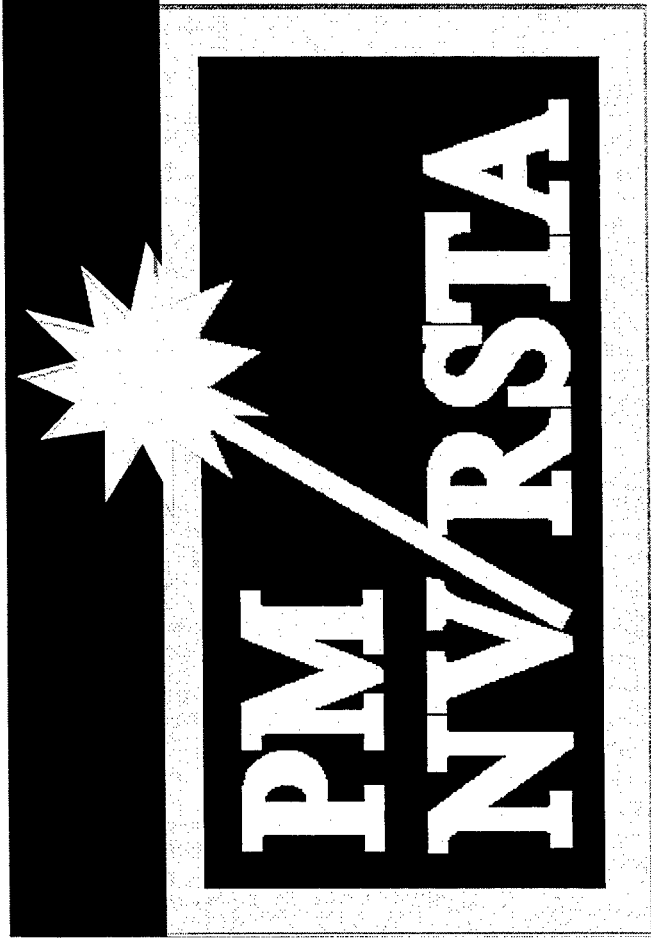

*Presented by:* Brian Murray  
Chief, Logistics Branch  
PM NV/RSTA

# **UNCLASSIFIED**

SFAE-IEW&S-NV

POINT PAPER

SUBJECT: Thermal Omnibus

OBJECTIVE: The intent of PM NV/RSTA is to solicit for full production of the Driver's Vision Enhancer (DVE) and Thermal Weapon Sight (TWS) under a multi-year Thermal Omnibus procurement with anticipated award in 2nd quarter, FY98. Thermal Omnibus is a single procurement action that permits procurement of more than one end item (e.g., series of image intensifier omnibus procurements in which ground and air goggles, sights, and spares were all bought under one procurement action). The DVE is a thermal imaging device designed to provide GO versus NO GO mobility for combat and tactical vehicles in day, night and degraded battlefield conditions. TWS is a family of weapon mounted thermal sights used to engage targets through adverse weather and battlefield obscurants during daylight and total darkness. This omnibus procurement will seek to leverage economies of scale and common processes through the use of performance specifications and acquisition reform (i.e. Horizontal Technology Integration (HTI), Horizontal Contracting Integration (HCI) and Horizontal Production Integration (HPI)).

FACTS:

- Full and open competition (foreign restrictions may apply)
- Performance specification and best value selection
- Sample hardware subjected to Government laboratory and user field test
- Potential for one or more award
- Draft RFP AUG 97, Final RFP SEP 97
- Proposed contract: fixed price

BRIEFER: Mr. Brian Murray, Chief, Logistics Branch, Project Manager, Night Vision/Reconnaissance, Surveillance & Target Acquisition, SFAE-IEW&S-NV, (903) 704-3498.

ACTION OFFICER:  
Alex Matejka  
Contracting Officer  
(908) 532-5207

SFAE-IEW&S-NV

POINT PAPER

SUBJECT: Lightweight Video Reconnaissance System (LVRS)

OBJECTIVE: LVRS is a video reconnaissance system which transfers still frame imagery from a manportable Out Station to a vehicle installed Base Station over tactical radio. The LVRS consists of commercially ruggedized components loaded with mature software which incorporates robust forward error correction and imagery compression algorithms to allow the operator to transmit images in harsh battlefield conditions. Potential recompete of LVRS will be a fixed priced 2 year multi-year contract award with two options for the delivery and testing of Base Stations and Out Stations.

FACTS:

- Program Status -
  - Initial Production Contract Award                      FY 95
  - Option Award    FY 96
  - Follow-on Award    FY 97
  - Contract Award (2 year Multi-Year)                      FY 98
  - Option Award    FY 00
  - Option Award    FY 01
  
- Program Requirements -
  - 54 Base Stations
  - 146 Out Stations

BRIEFER: Brian Murray, Chief Logistics Branch, Project Manager, Night Vision/Reconnaissance Surveillance and Target Acquisition (PM-NV/RSTA) 703-704-3498

Action Officer:  
Jaime Gonzalez  
LVRS Project Leader  
703-703-3212

SFAE-IEW&S-NV

POINT PAPER

SUBJECT: Omnibus V

OBJECTIVE: The intent of PM NV/RSTA is to solicit production of the Night Vision Goggle, Aviator's Night Vision Imaging System, Monocular Night Vision Device, Ground Binocular System, MX-11620/UV, Image Intensifier Assembly under a competitive best value type procurement in resulting in at least one firm fixed price contract.

FACTS:

- Full and open competition (foreign restrictions may apply)
- Performance specification and best value selection
- Keep to Government laboratory and user field test
- Potential for one or more award
- Draft RFP 1Qtr 98, RFP 1Qtr 98, contract award 2Qtr FY98
- Proposed contract: fixed price

BRIEFER: Mr. Brian Murray, Chief, Logistics Branch, Project Manager, Night Vision/Reconnaissance, Surveillance & Target Acquisition, SFAE-IEW&S-NV, (&03) 704-3498.

ACTION OFFICER:  
Jack Kulaga  
Contracting Officer  
(908) 532-5207

# Agenda

- ★ Thermal Omnibus
- ★ LVRS
- ★ Omnibus V

# Thermal Omnibus

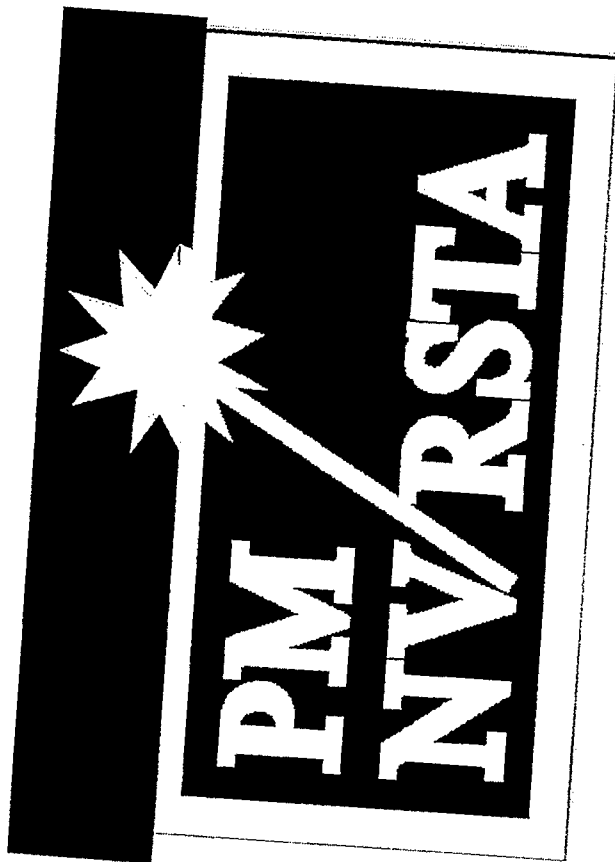

# **Thermal Omnibus**

- **Thermal Omnibus Is Comprised Of Two Major Systems:**
  - **AN/VAS-5, Driver’s Vision Enhancer (DVE)**
  - **AN/PAS-13, Thermal Weapon Sight (TWS)**

**AN/VAS-5  
Driver's Vision Enhancer (DVE)**

- **ABRAMS**
- **AAV**
- **LAV**
- **AVLB**
- **HERCULES**
- **BFVS**
- **M58 SMOKE**
- **GRIZZLY**



- **M56**
- **WOLVERINE**
- **PLS**
- **HMMWV**
- **HEMTT**
- **HETS**
- **FMTV**

**Common Technical Solution Ensures All Drivers Have Same View of Battlespace**

# **Driver's Vision Enhancer (DVE)**

**The DVE Provides Low-Cost Thermal Imagery That Gives the Drivers of Combat and Tactical Wheeled Vehicles the Capability of Continuing Operations During Degraded Visibility in All Weather Conditions, Day or Night.**

# Thermal Weapon Sight (TWS)

- LWTS
- MWTS
- HWTS
- M249



- P3I
- MK19
- MK19/  
HMMWV
- M16

*Dismounted / Mounted Applications*

# **Thermal Weapon Sight (TWS)**

**The TWS Is a Lightweight, Self Contained, Day/Night Thermal Imaging Device That Uses an Advanced Sensor and Solid State Thermoelectric Cooler. TWS Operates in Adverse Weather and Battlefield Scenarios Including Light Foliage, Smoke, Dust and Camouflage.**

# Thermal Omnibus Program Requirements

<u>FY</u>	<u>DVE</u>	<u>TWS</u>
98	400	1400
99	700	1300
00	600	2200
01	700	1900
02	<u>700</u>	<u>2400</u>
<b>Totals</b>	<b>3100</b>	<b>9200</b>

## Basic Contract Quantities

# **Thermal Omnibus Concept**

- **What Is Omnibus?**
  - **A Single Procurement Action That Permits Procurement of More Than One End Item (I.E., Image Intensifier Omnibus Procurements)**
- **Thermal Omnibus Objective:**
  - **Obtain Best Value to the Government Via a Single Procurement Action for DVE and TWS That Encourages Enhancements, Bundling, Economy of Scale, and Maximizes Competition**

# Contract Opportunity

- **Thermal Omnibus Will Be a Fixed Price, Multi Year Procurement.**
- **Draft RFP (*Request for Proposal*)**      **Aug 97**
- **Final RFP (*Request for Proposal*)**      **Sep 97**
- **Proposal & Sample Hardware**      **Oct 97**
- **Contract Award**      **Feb 98**

# **Contract Opportunity Cont.**

- **Thermal Omnibus POC Is: David Troxel  
703-704-3452.**
- **CECOM Acquisition POC Is: Alex Matejka,  
908-532-5207.**

# **Contract Opportunity Cont.**

- **18 Prototypes**                      **1Q FY98 - 4Q FY98**
- **Milestone III**                      **2Q FY99**
- **FUE (*First Unit Equip*)**      **2Q FY00**
- **INOD POC Is: Jack Lillie 703-704-3059.**
- **CECOM Acquisition POC: Alex Matejka,  
908-532-5207**

# Agenda

- ★ Thermal Omnibus
- ★ LVRS
- ★ Omnibus V

# Lightweight Video Reconnaissance System (LVRS)

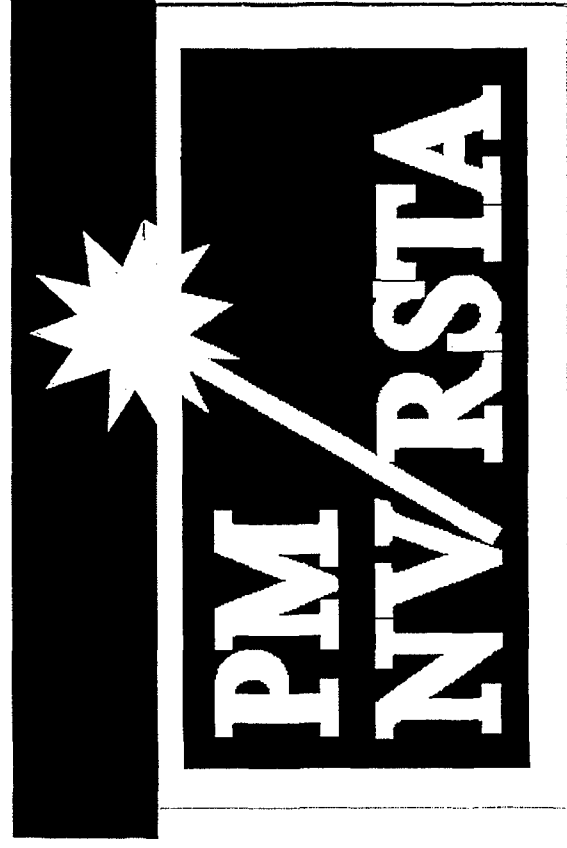

# Lightweight Video Reconnaissance System (LVRS)

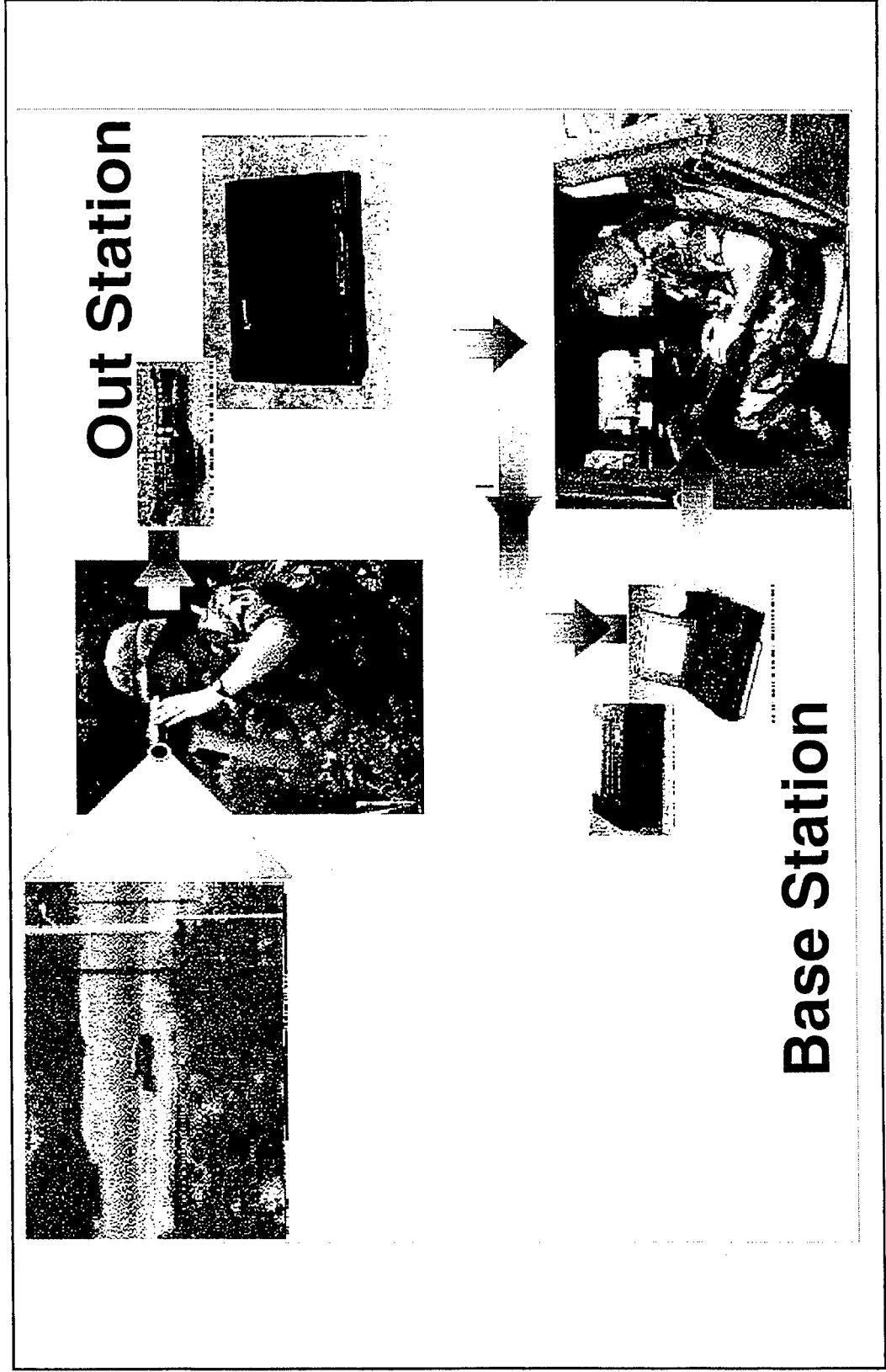

# **Lightweight Video Reconnaissance System (LVRS)**

**LVRS Is a Video Reconnaissance System Which Transfers Still Frame Imagery From a Manportable Out Station to a Vehicle Installed Base Station Over Tactical Radio. The LVRS Consists of Ruggedized Commercial Components Loaded With Mature Software Which Incorporates Robust Forward Error Correction and Imagery Compression Algorithms to Allow the Operator to Transmit Images in Harsh Battlefield Conditions.**

# **LVRS Program Requirements**

- **FY98-99      54 Base Stations**
- 146 Out Stations**

# Contract Opportunity

## Potential Recompete of LVRS

- LVRS Would Be a Fixed Priced 2 Year Multi-Year Contract Award With Two Options for the Delivery and Testing of Base Stations and Out Stations. Estimated Value Is in Excess of \$5M.
- Initial Production Contract Award      FY95
- Option Award      FY96/97
- Possible Recompete in FY98

# **Contract Opportunity Cont.**

- **Contract Award (2 yr Multi-Year)      FY98**
- **Option Award      FY00**
- **Option Award      FY01**
- **LVRS POC: Tim McCaffery 703-704-3466**
- **CECOM Acquisition POC: Jack Kulaga  
908-427-1371**

# Omnibus V

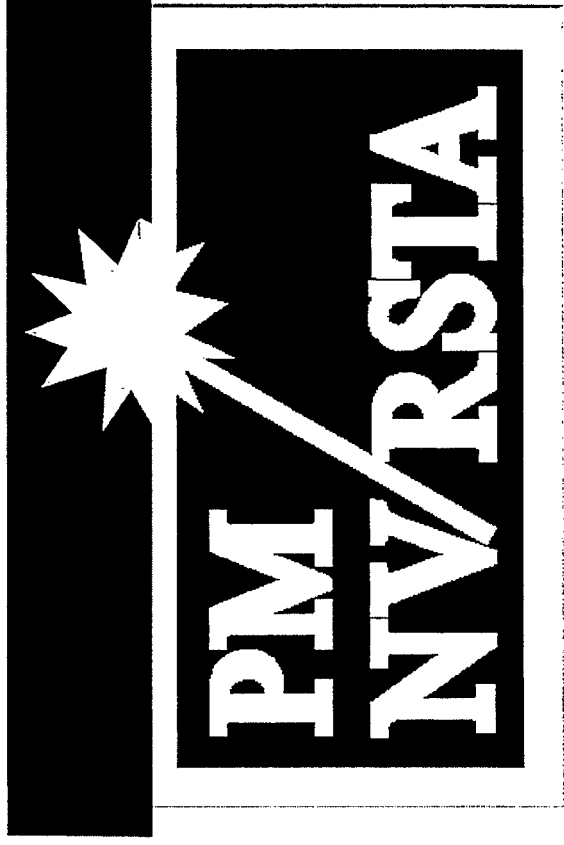

# Omnibus V

- **Omnibus V Will Satisfy Tri-Service Requirements for the Following Systems and Their Corresponding Spare Parts:**
  - **The AN/AVS-6(V)1A and 1B; and AN/AVS-9 Aviator’S Night Vision Imaging Systems (ANVIS)**
  - **AN/PVS-14, Monocular Night Vision Device (MNVD)**
  - **AN/PVS-7D, Night Vision Goggle**
  - **AN/PVS-XX, Ground Binocular System**
  - **MX-11620/UV, Image Intensifier Assembly**

# The AN/AVS-6(V)1A and 1B; and AN/AVS-9 Aviator's Night Vision Imaging Systems (ANVIS)

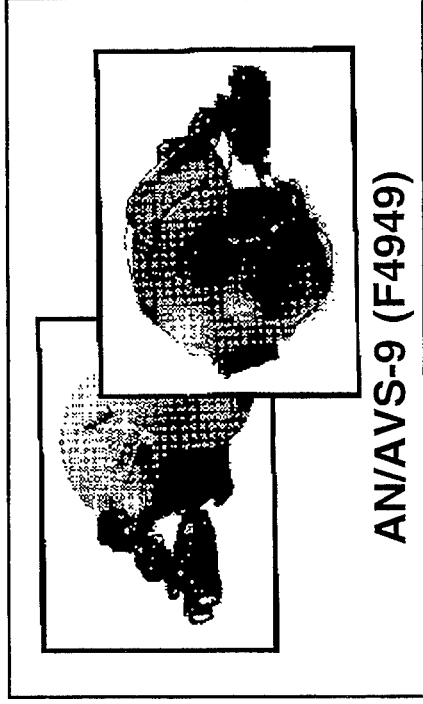

AN/AVS-6(V)1A

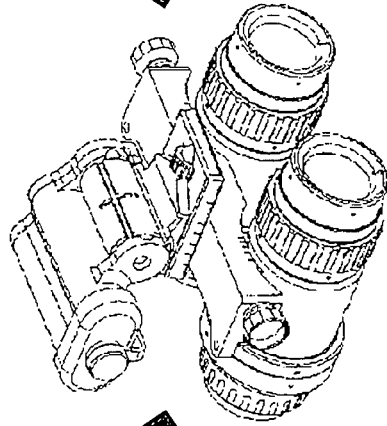
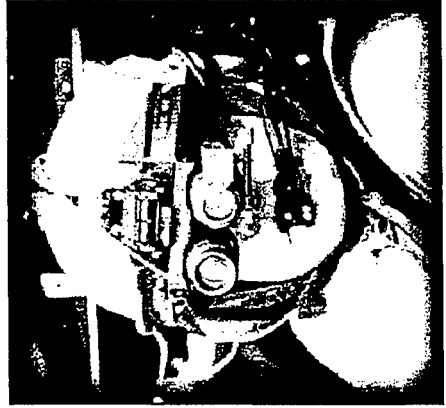

Shown w/(V)1 Binocular's Clip  
on Power Source

AN/AVS-6(V)1B

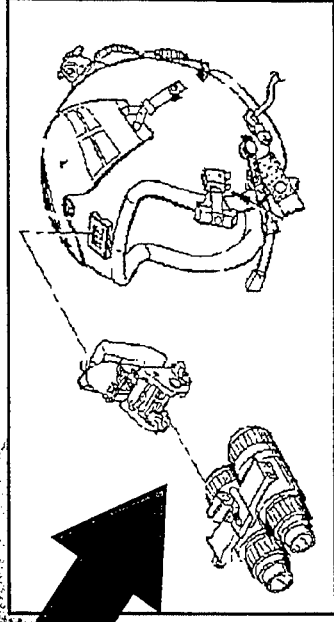

# **ANVIS**

**ANVIS Is a Lightweight, Self-Contained Night Vision System. ANVIS Provides Imagery Sufficient for an Aviator to Complete Night Time Missions Down to Starlight. The AN/AVS-6(V)1A Is Designed for Direct Mounting Onto the Army's SPH-4B and HGU-56/P Helmets and the AN/AVS-6(V)1B Is Designed for the Navy's HGU-67/P and HGU-84/P Helmets. The AN/AVS-9 (F4949) Is the ANVIS Used by the Air Force and Can Be Mounted Either to the HGU-55/P or SPH-4AF Helmet.**

# AN/PVS-7D Night Vision Goggle

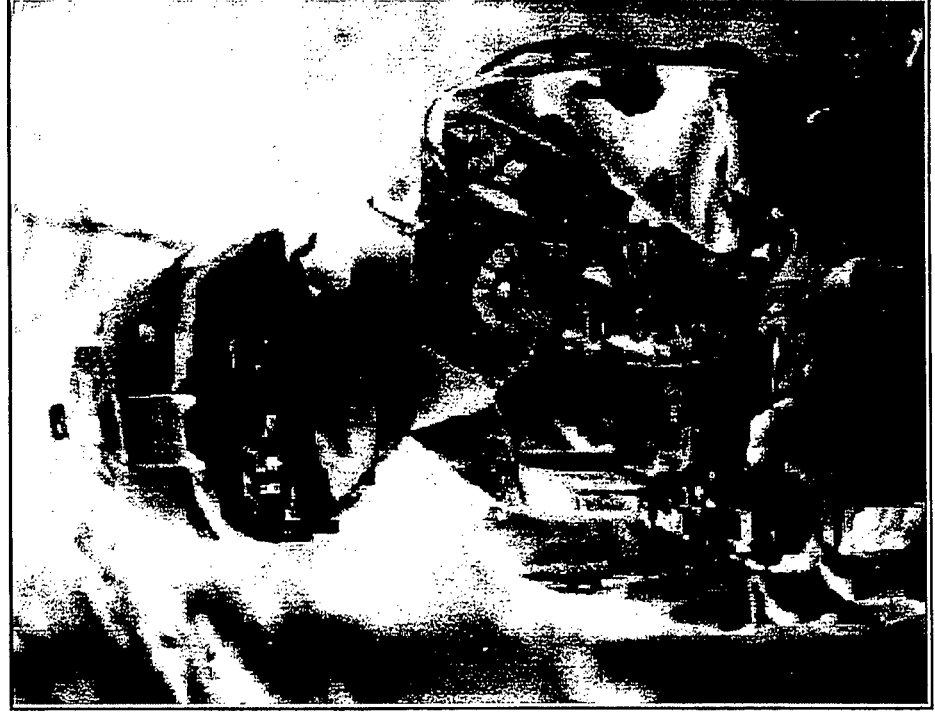

# **AN/PVS-7D**

## **Night Vision Goggle**

**This helmet mounted image intensification system is used by individual soldiers for night operations including such tasks as driving, walking, first-aid, map reading and maintenance. The system is designed for use in conjunction with rifle mounted aiming lights.**

# AN/PVS-14, Monocular Night Vision Device (MNVD)

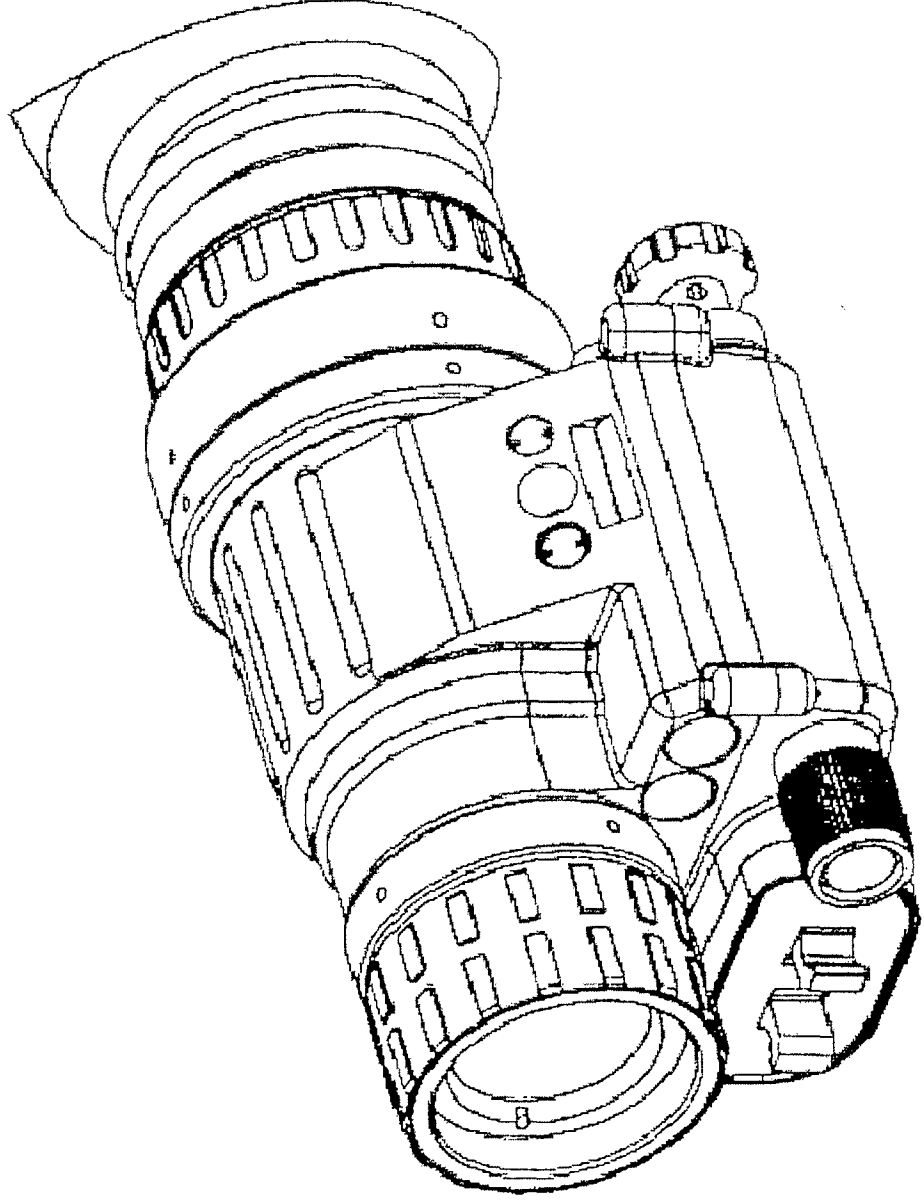

# **AN/PVS-14, Monocular Night Vision Device (MNVD)**

**The MNVD provides leaders of combat infantry units with a lightweight, third generation night vision device for use in observation, command and control. An MNVD can also be mounted to a small arms rail using the Thermal Weapon Sight (TWS) rail grabber.**

# AN/PVS-XX Ground Binocular System

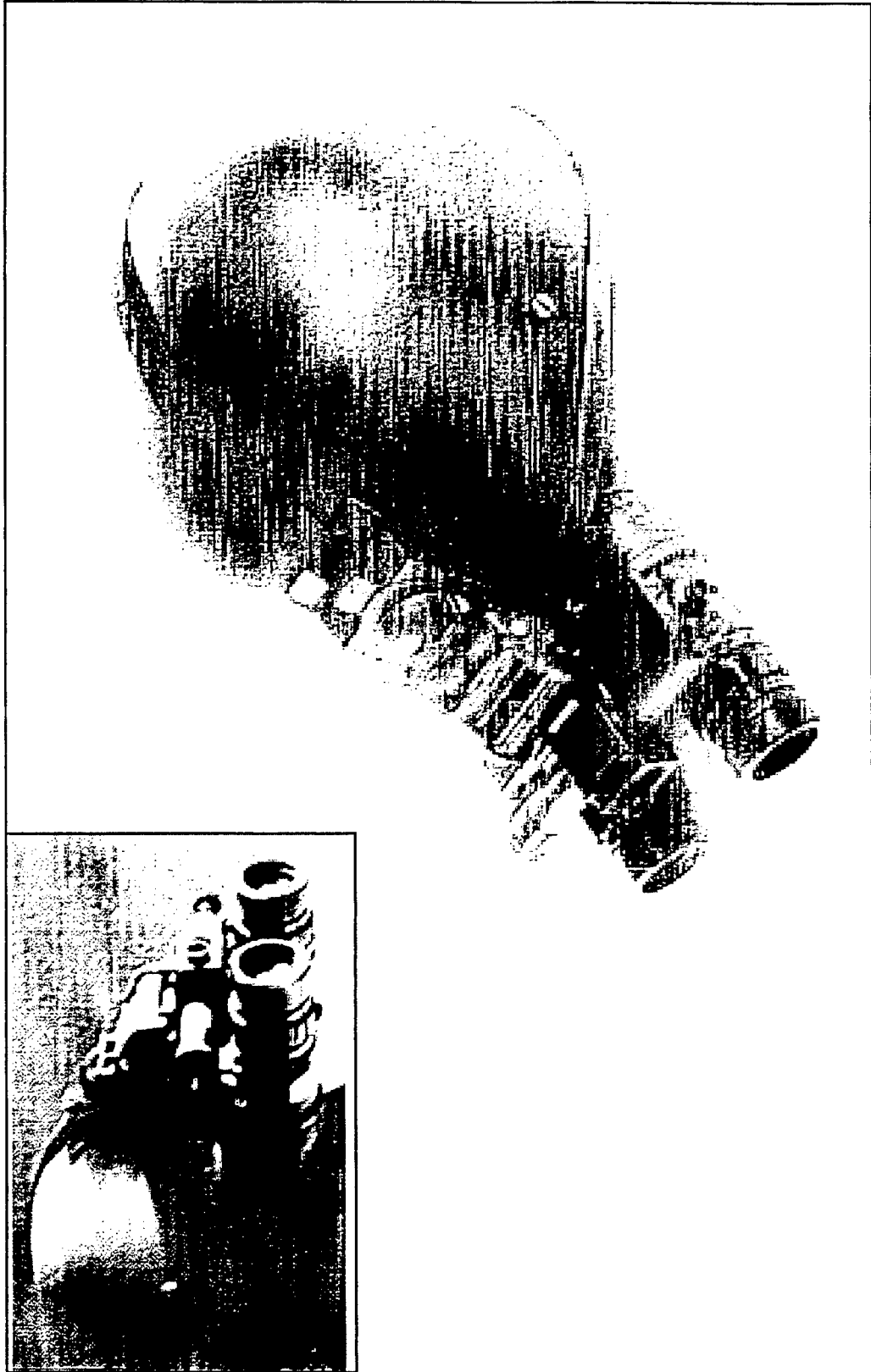

# **AN/PVS-XX Ground Binocular System**

**This helmet mounted binocular night vision goggle is designed for special application usage in driving motorcycles and other vehicles. Provides operator with ANVIS type binocular with modified shelf assembly which includes integrated AA power pack in addition to a dual field-of-view infrared source. System also provided with low profile battery pack which mounts to rear of helmet.**

# MX-11620/UV, Image Intensifier Assembly



# **MX-11620/UV, Image Intensifier Assembly**

**The MX-11620/UV is a third generation 25 MM drop-in replacement image intensification tube used in the Weapon Sights, AN/PVS-4 and AN/TVS-5.**

# Program Requirements

	<u>FY98</u>	<u>FY99</u>	<u>Total</u>
ANVIS	500	500	1,000
MNVND	5,000	1,600	6,600
AN/PVS-7D	3,000	900	3,900
AN/PVS-XX	1,000	1,000	2,000
MX-11620/UV	1,500	1,500	3,000

◆ ANVIS, MNVND and AN/PVS-7D Quantities Are Basic Only - Options Additional. AN/PVS-XX and MX-11620/UV to Be Options Only.

# Contract Opportunity

- **OMNIBUS V will be a competitive best value type procurement resulting in at least one firm fixed price contract award.**

**RFP**

**1QFY98**

**Proposals & Oral Presentations**

**1QFY98**

**Contract award**

**2QFY98**

# **Contract Opportunity Cont.**

- **OMNIBUS V POC: Jennifer McCormick,  
703-704-3455**
- **CECOM Acquisition POC: Jack Kulaga  
908-427-1356**

# NOTES

# **SESSION V**

## **RDE OPPORTUNITIES**

### **MODERATOR**

**MR. EUGENE FAMOLARI, JR.  
ASSOCIATE TECHNICAL  
DIRECTOR  
CECOM RESEARCH,  
DEVELOPMENT AND  
ENGINEERING**

# The CECOM RDE Organization

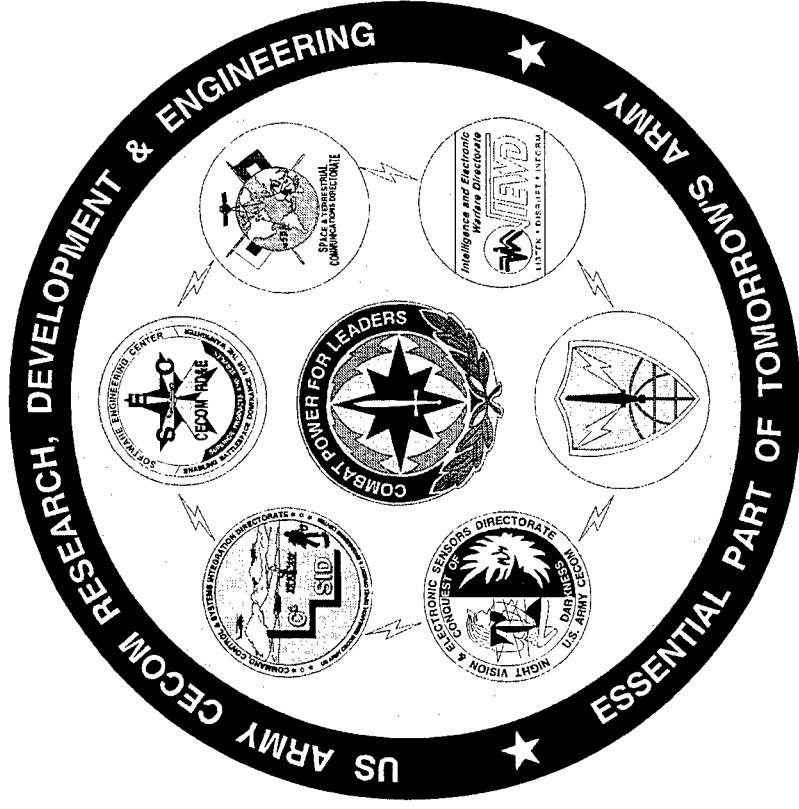

**Mr. Eugene Famolari**  
Associate Technical Director

**UNCLASSIFIED**

# The Changing Army

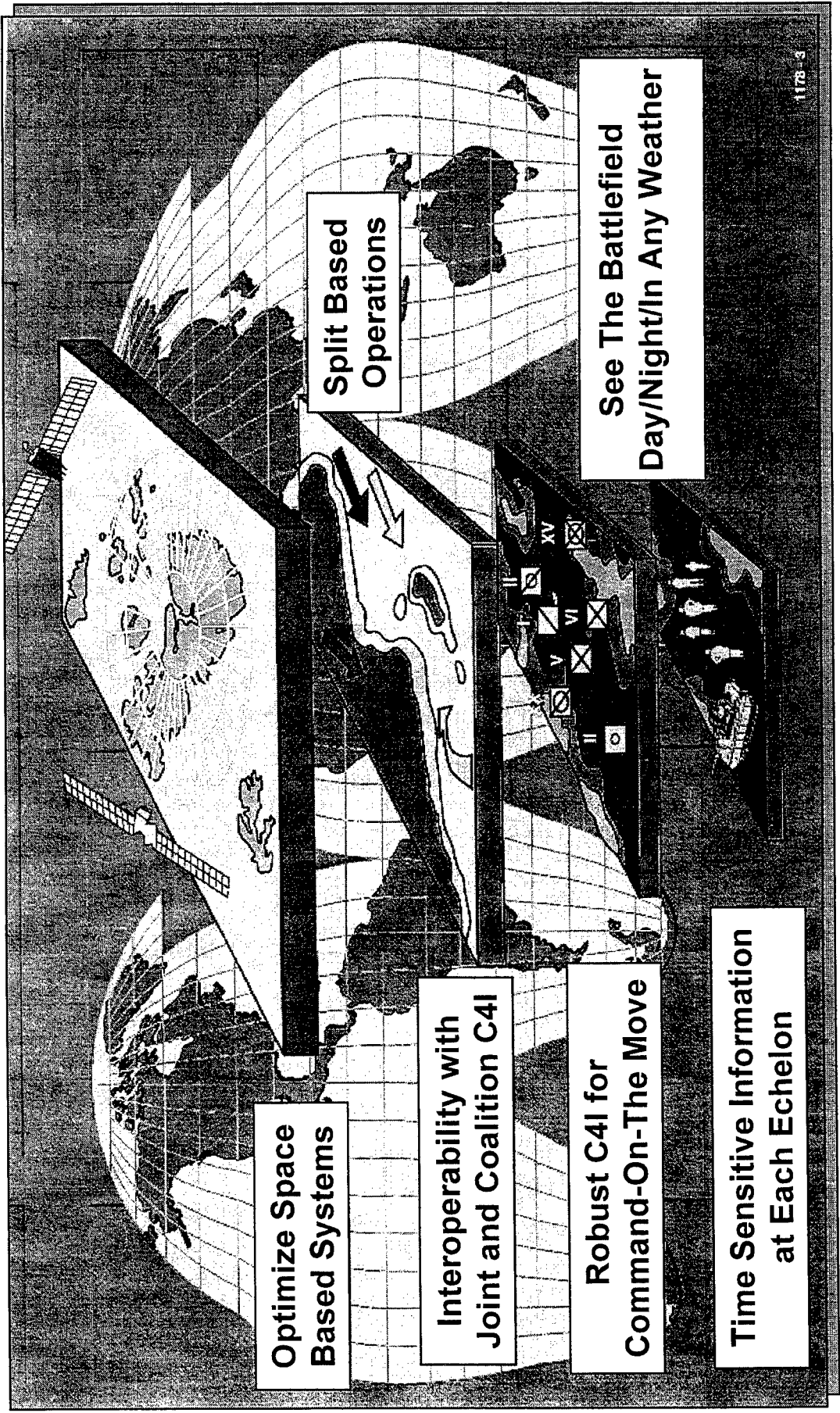

1173-3

# Providing, Seamless, Interoperable C4I/EWS

**STRATEGIC and SUSTAINING BASE - IM SYS**  
Systems Engineering & Integration

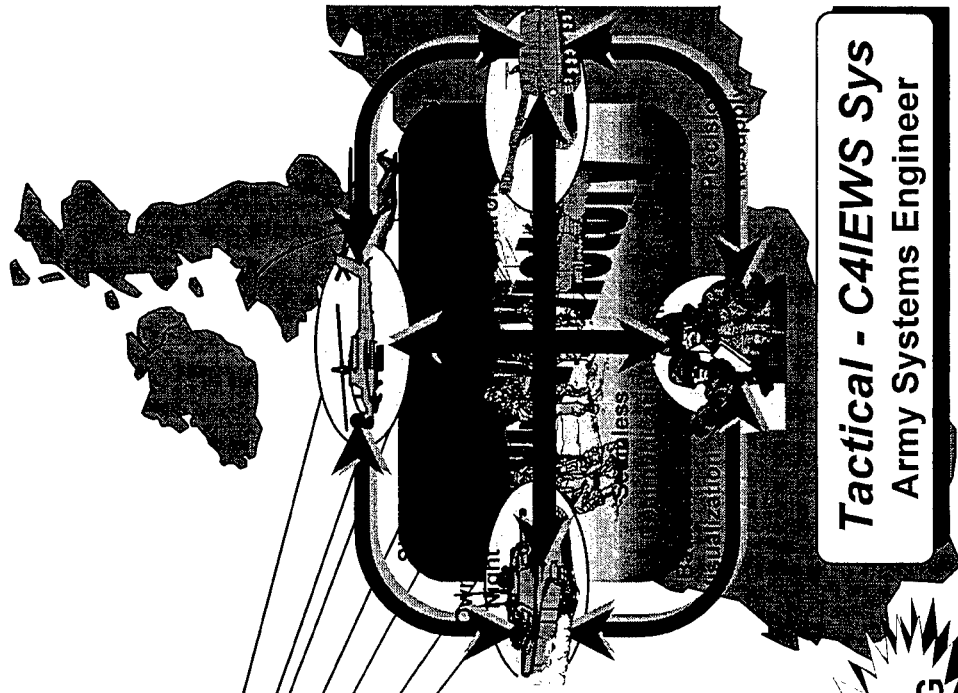

**INTEGRATION**

**ARCHITECTURE**

**SYSTEMS ENGINEERING**

**HARDWARE / SOFTWARE**

**CONTRACTING**

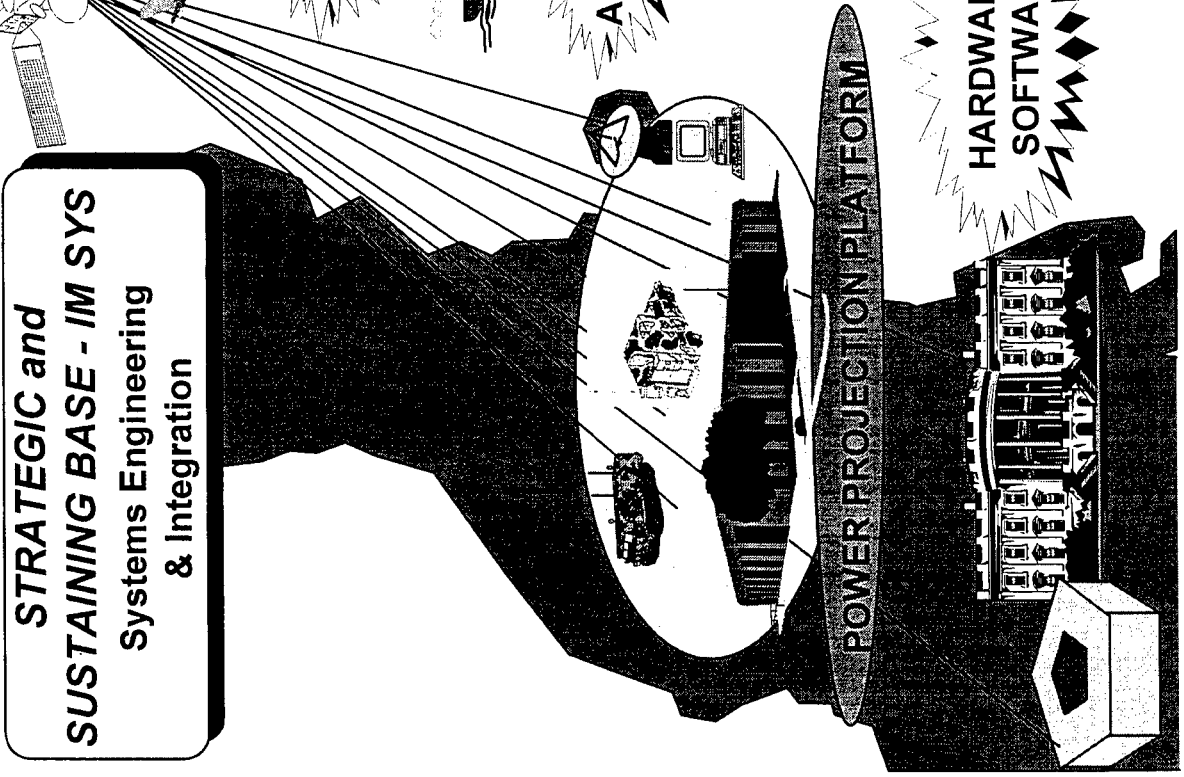

# The Glue is the Architecture and Software

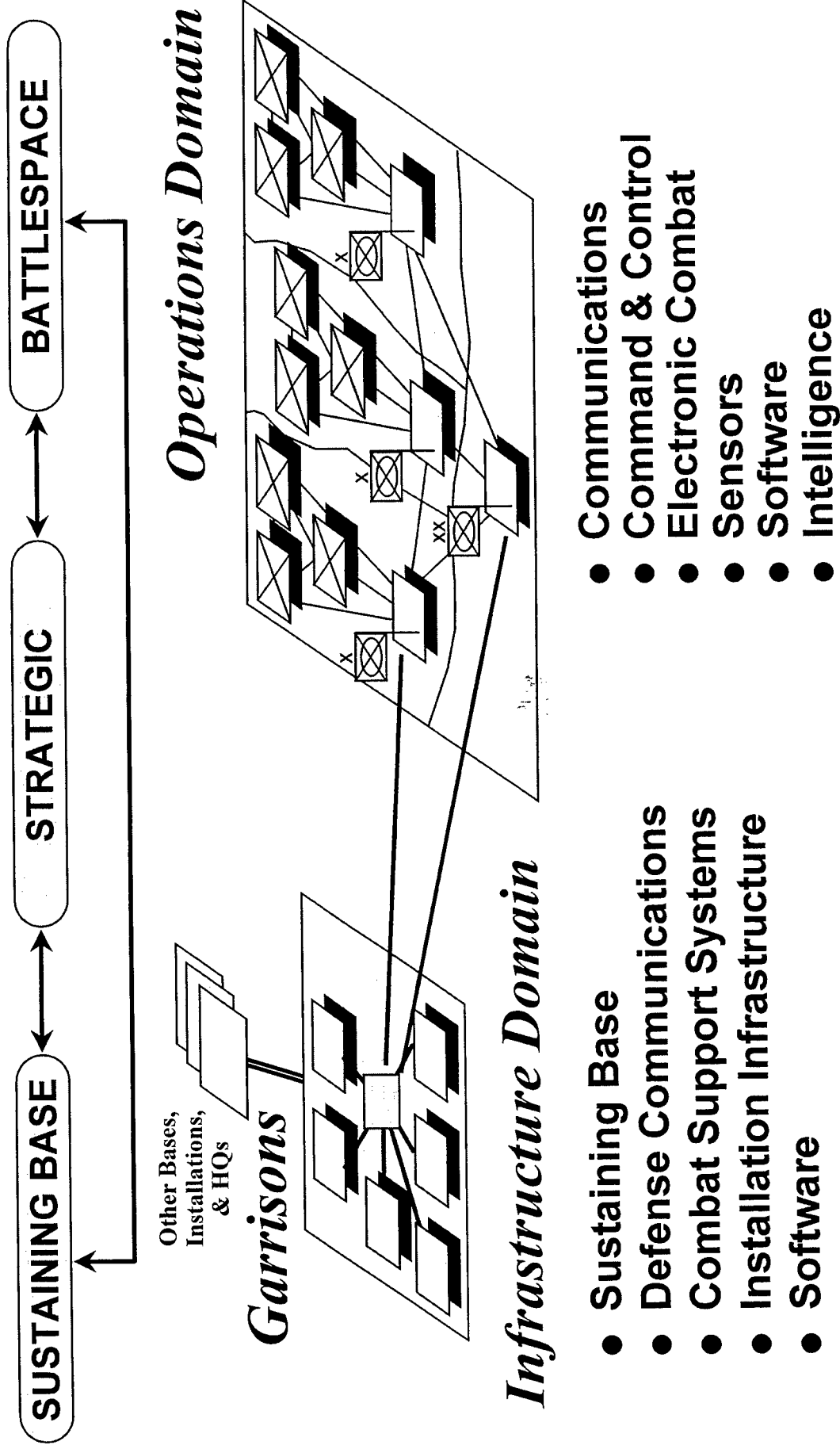

- Sustaining Base
- Defense Communications
- Combat Support Systems
- Installation Infrastructure
- Software

- Communications
- Command & Control
- Electronic Combat
- Sensors
- Software
- Intelligence

# Technical Organization

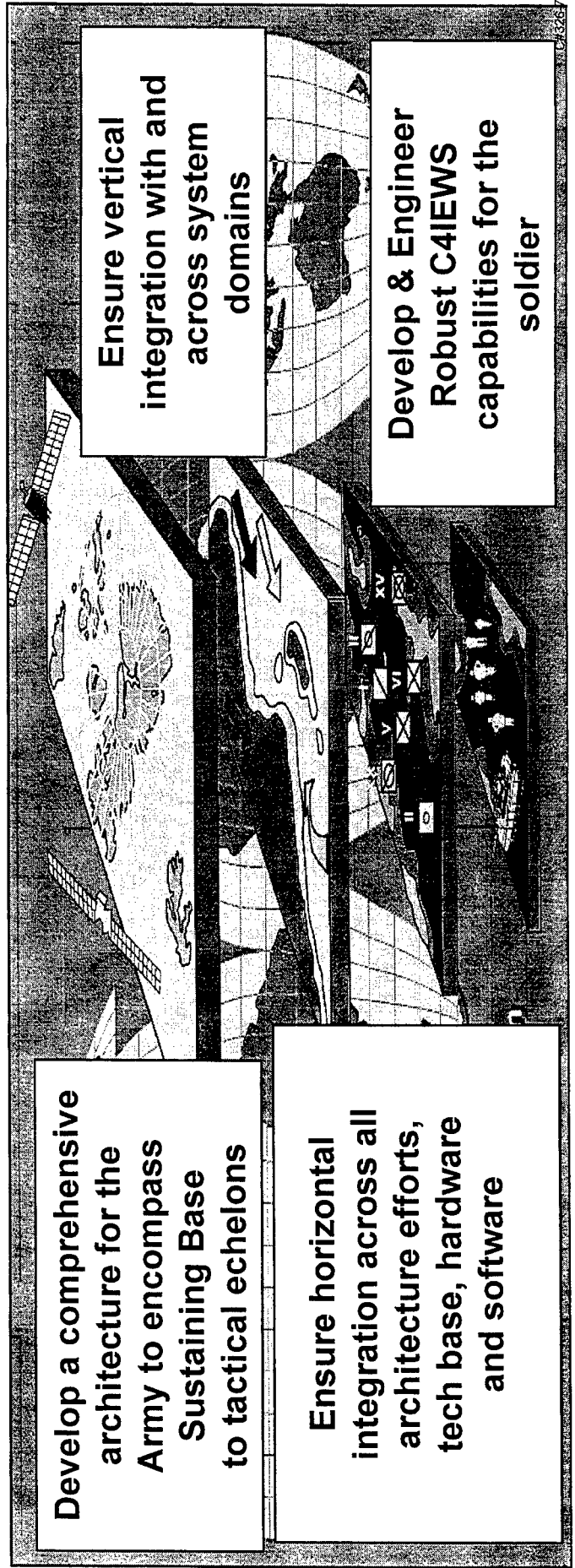
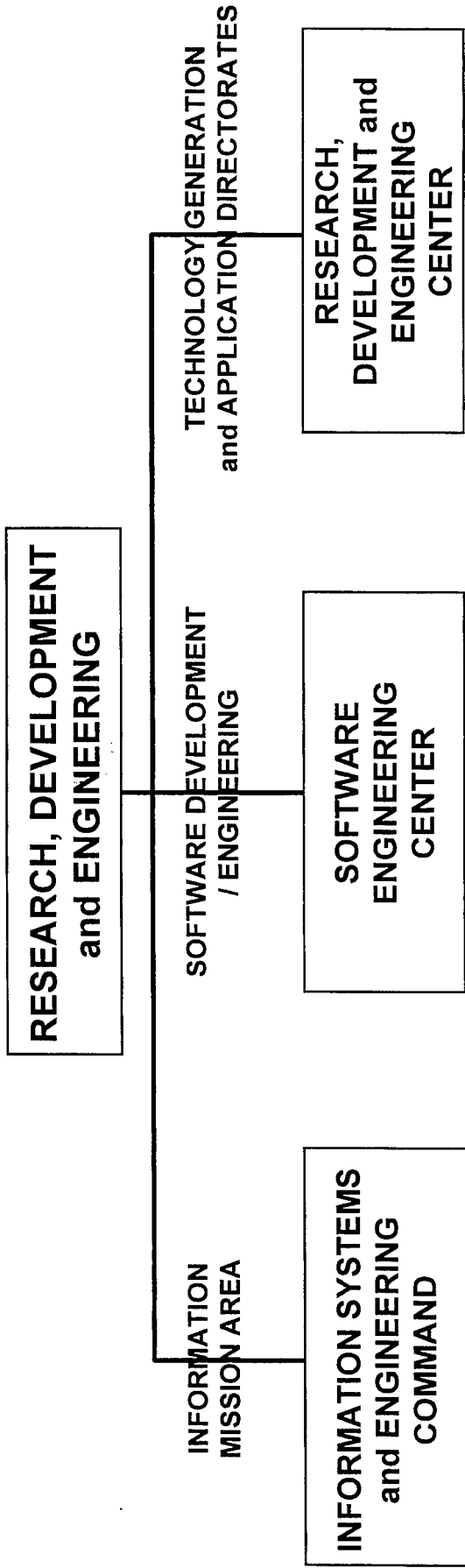

# The Vision

- Harness the Potential of Automation and Digital Technology for Use in Near-Term Applications, as well as the 21<sup>st</sup> Century, Modernized, Digitized Army.
- Develop a Comprehensive Architecture for the Army to Encompass Sustaining Base to Tactical Echelons
- Continue our Major Role in C4IEWS, Combat ID, Targeting Systems and Software Intensive Systems.
- Be the Partner that makes the "Technical Bridge" Between Operational Users, All Technology Generation, Industry and PEO/PM Programs.
- Develop and Expedite the Insertion of Advanced Technology to Provide Warfighters With the Right Information, in the Right Place, at the Right Time.

# Key Leveraging Strategies

## Alliances

- DARPA
- DoD Laboratories
- Cooperative Research and Development Agreements
- Wireless Interworking Testbed
- Information Technology Innovation Center

## Dual-Use Technologies

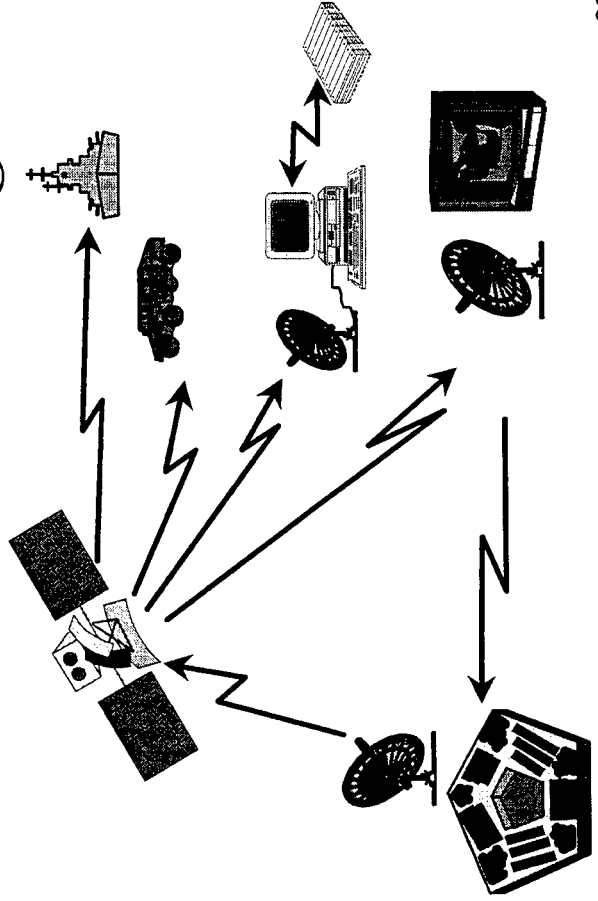

## Digital Integrated Labs

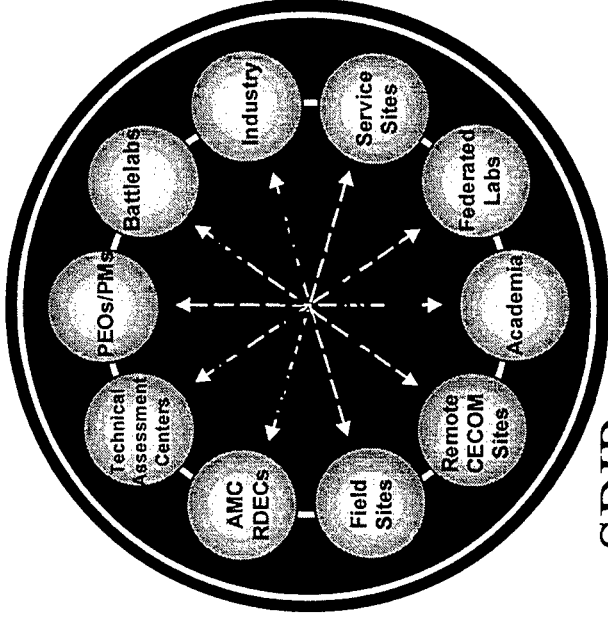

- SBIR
- Independent R&D



# Digital Integrated Lab (DIL) and Technology Integration Center (TIC)

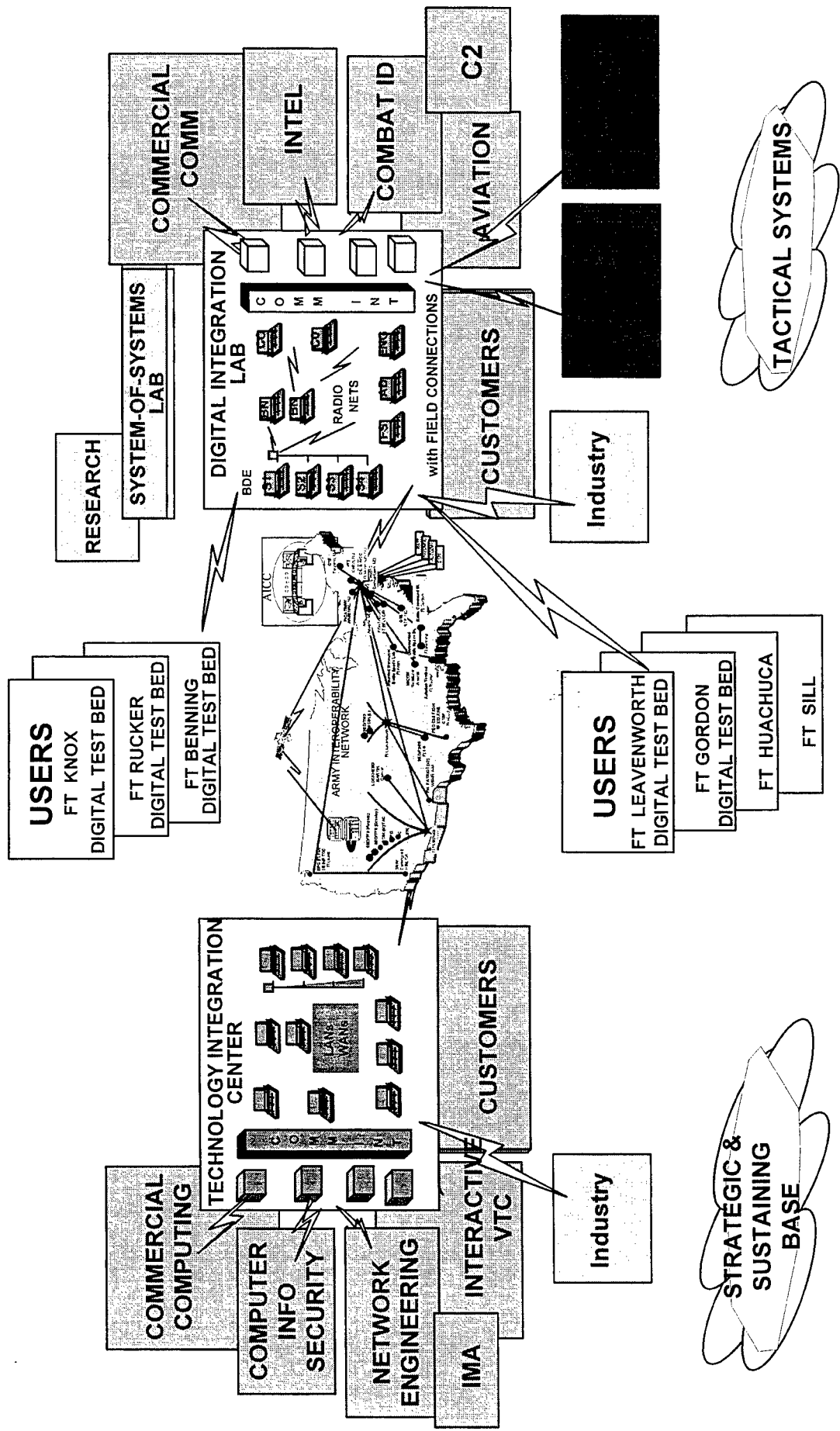

# Wireless Interworking Testbed (WIT)

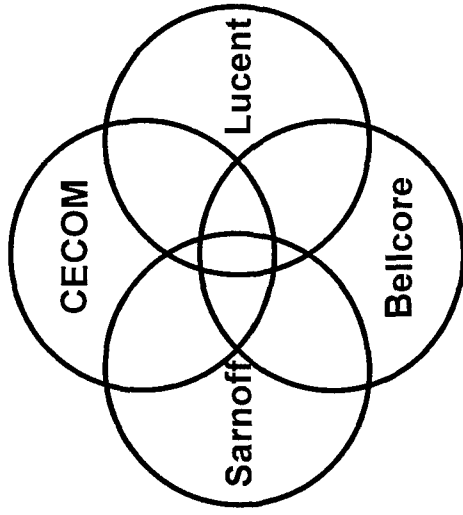

## WIT Capabilities:

- Test Planning and Execution
- Interoperability Engineering
- Standards Conformance Testing
- Consulting Services
- Certification

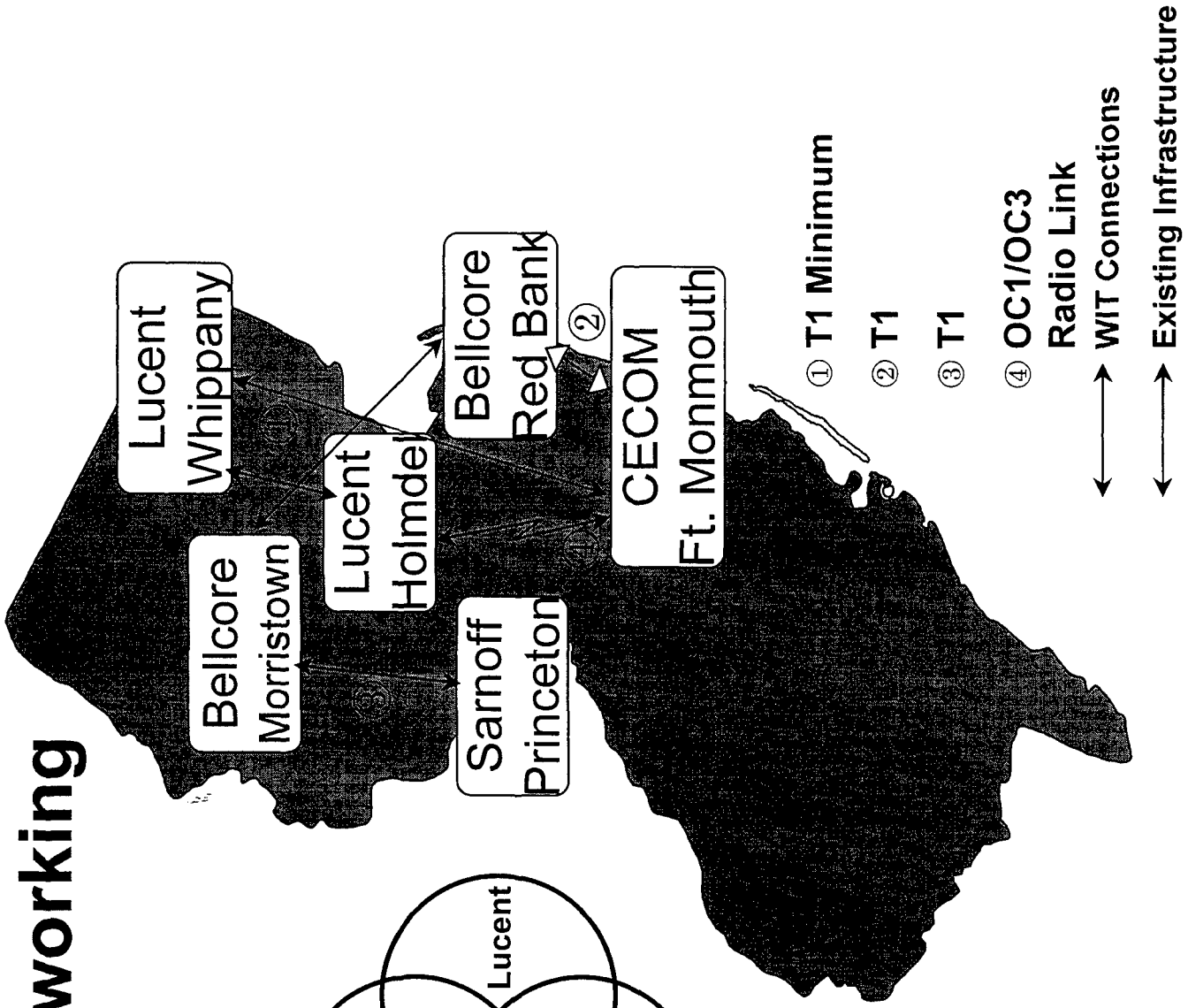

## Summary

- “Glue” the Battlefield Using Information Technology
- Revolutionary / Evolutionary Use of Commercial Products
- Software Products / New Concepts—Key to Future
- Expedite Products via Forward-Based Development Teams
- Architecture Seamless—Foundation for Future
- Strategic Partnerships
- Expedite Insertion of Technology; Joint Planning—TRADOC, PEOs, CECOM

**Commit to Excellence — Deliver What We Promise**

# **Status of FY97 Contract Opportunities** **(Briefed at August 1996 APBI)**

- **Opportunities Briefed: 13**
  - **Awarded : 5**
  - **Still Open: 8**

# Open Opportunities

- **Army Interoperability Network**
- **Systems and Software Engineering Support for AN/TTC/TYC-39 Family of Switches**
- **Life Cycle Systems and Software Engineering for Fire Support Command Control, Fire Detection, and Other Systems**
- **Mission-Critical Defense Systems Maintenance**
- **Multi-Function Staring Sensor Suite**
- **Mine Hunter Killer**
- **Lightweight, Airborne Multi-Spectral Countermine Detection System**
- **SHF Satellite Communications On-The-Move Antenna**

# Introduction of RDE Briefers

- **Mr. Dennis Turner,**  
Director, Software Engineering  
Center
- **Dr. Frank Jenia,**  
Technical Director, Information  
Systems Engineering Command
- **Dr. Louis Marquet,**  
Research, Development  
and Engineering Center
- **Dr. Richard Poisel,**  
Deputy, Intelligence and Electronic  
Warfare Directorate
- **Mr. Larry Fillian,**  
Deputy Director, Night Vision and  
Electronic Sensors Directorate
- **Mr. George Oliva, Jr.,**  
Director, Command, Control and  
Systems Integration Directorate
- **COL Kenneth Thomas,**  
Acting Director, Space and  
Terrestrial Communications  
Directorate

# NOTES



**DENNIS TURNER  
DIRECTOR, SOFTWARE ENGINEERING**

**UNCLASSIFIED**

AMSEL-RD-SE-D

POINT PAPER

SUBJECT: Software Engineering Center (SEC)

OBJECTIVE:

The CECOM Software Engineering Center was formed by combining the CECOM Software Engineering Directorate (SED), Information Software Support Center (ISSC), Logistics System Support Center (LSSC), and Industrial Logistics Systems Center (ILSC), as the Army's Center of Excellence for Software Engineering. This mission provides numerous opportunities for contractor participation in projects assigned to the SEC.

FACTS:

Life Cycle Software Engineering is committed to world wide Army readiness providing support to C4IEW Mission Critical Defense Systems (MCDS) from initial system concept through development, production, deployment, and support of fielded systems.

Sustaining base systems include software intensive systems used in the retail logistics area as well as applications used in administration and personnel resource allocation. These systems were developed by the ISSC, headquarters at Fort Belvoir, VA.

Business Systems include software utilized in Army Depot Operations and by the various Commodity Commands. These systems were developed by LSSC (St Louis, MI) and ILSC (Chambersburg PA).

The SEC contractual program represents over 1900 man-years of support disbursed throughout the various locations maintained by SEC and approximately 450 software intensive systems in development through deployment. The value of the contractual program exceeds \$200 million per year. The SEC team comprised of military, civilian and contractor personnel, strives to provide quality support to the software engineering practices and constant improvement to the software development process.

BRIEFER: Dennis J. Turner, Director, CECOM SEC, AMSEL-RS-SE-D, DSN 992-8208

ACTION OFFICER:  
Eugene J. Boyle  
Chief  
Software Contract Admin Team  
DSN 992-8220

# SEC - THE ORGANIZATION THAT UNIFIES SOFTWARE INITIATIVES

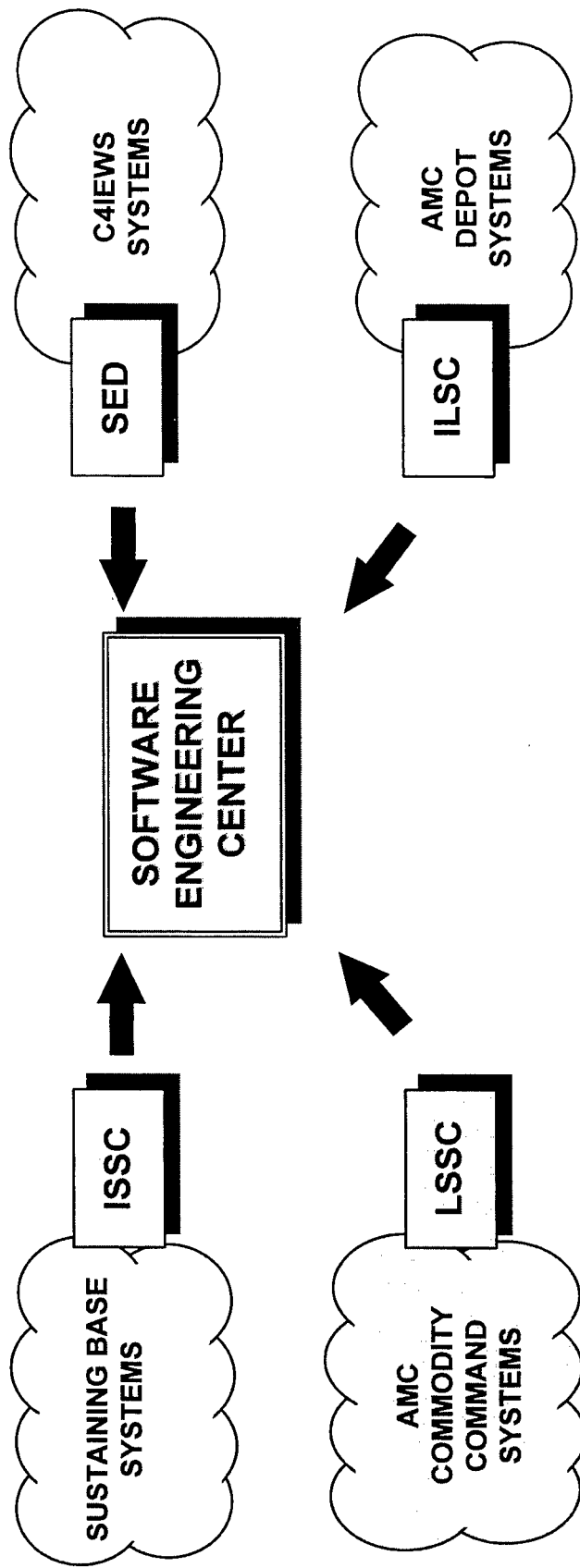

# CECOM SOFTWARE ENGINEERING CENTER

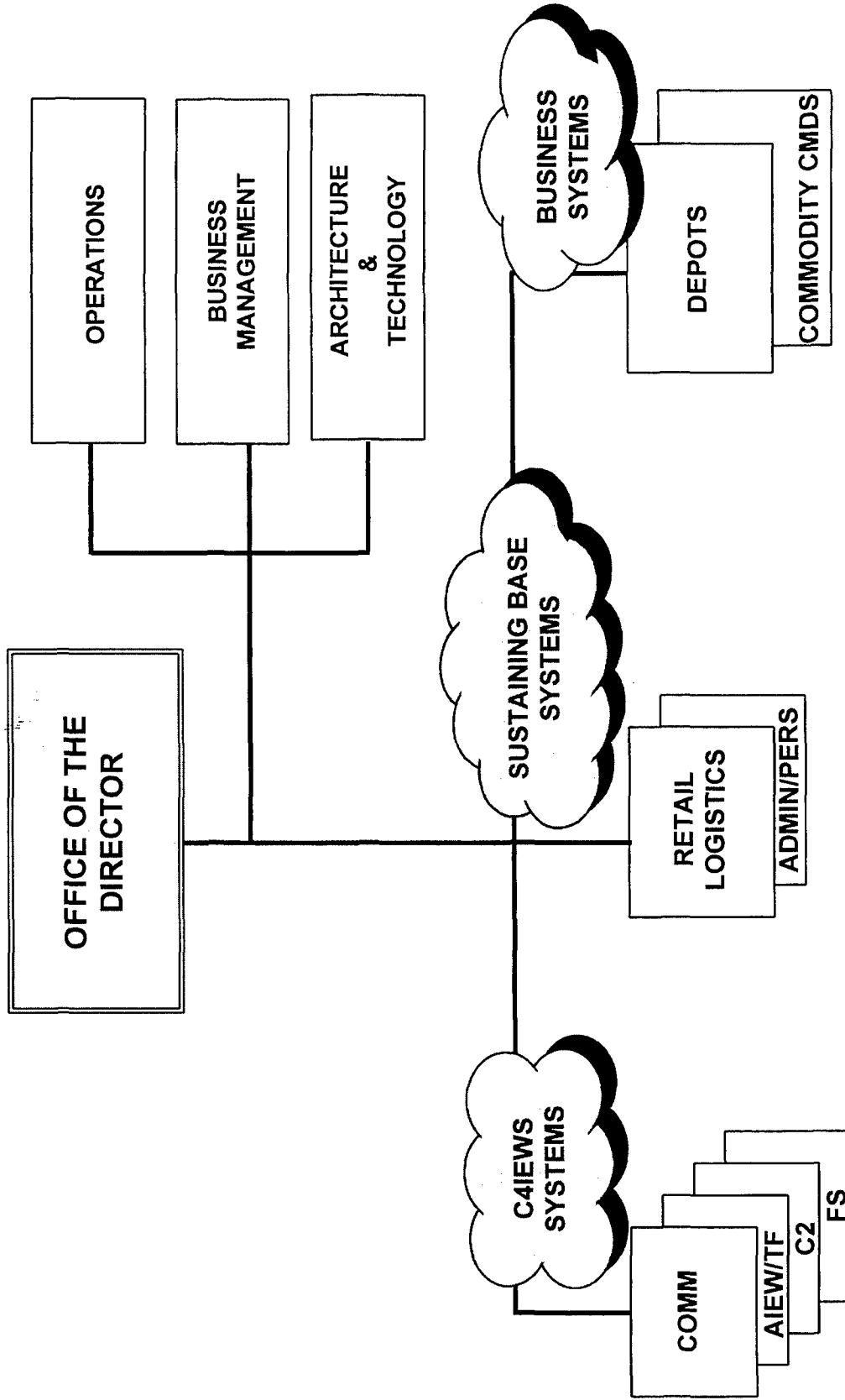

# CECOM SOFTWARE ENGINEERING CENTER

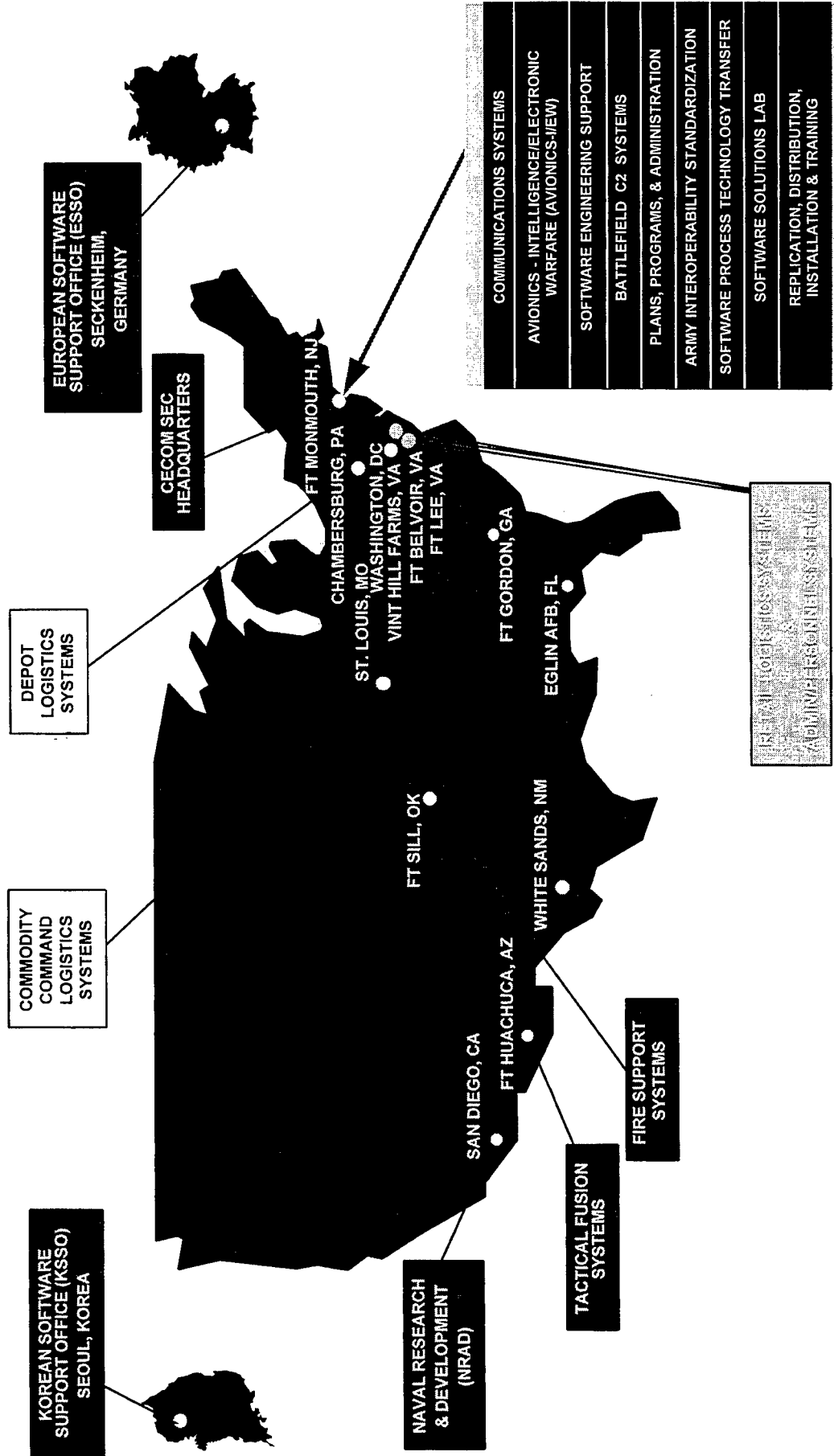

KOREAN SOFTWARE SUPPORT OFFICE (KSSO)  
SEOUL, KOREA

COMMODITY COMMAND LOGISTICS SYSTEMS

DEPOT LOGISTICS SYSTEMS

NAVAL RESEARCH & DEVELOPMENT (NRAD)

EUROPEAN SOFTWARE SUPPORT OFFICE (ESSO)  
SECKENHEIM, GERMANY

CECOM SEC HEADQUARTERS

FT MONMOUTH, NJ

CHAMBERSBURG, PA

ST. LOUIS, MO

WASHINGTON, DC

VINT HILL FARMS, VA

FT BELVOIR, VA

FT LEE, VA

SAN DIEGO, CA

FT HUACHUCA, AZ

WHITE SANDS, NM

FT GORDON, GA

EGLIN AFB, FL

TACTICAL FUSION SYSTEMS

FIRE SUPPORT SYSTEMS

COMMUNICATIONS SYSTEMS
AVIONICS - INTELLIGENCE/ELECTRONIC WARFARE (AVIONICS-IEW)
SOFTWARE ENGINEERING SUPPORT
BATTLEFIELD C2 SYSTEMS
PLANS, PROGRAMS, & ADMINISTRATION
ARMY INTEROPERABILITY STANDARDIZATION
SOFTWARE PROCESS TECHNOLOGY TRANSFER
SOFTWARE SOLUTIONS LAB
REPLICATION, DISTRIBUTION, INSTALLATION & TRAINING

RESEARCH LOGISTICS SYSTEMS  
ADMIN/PERSONNEL/HS/FLS

# IMPORTANT BUSINESS TRENDS

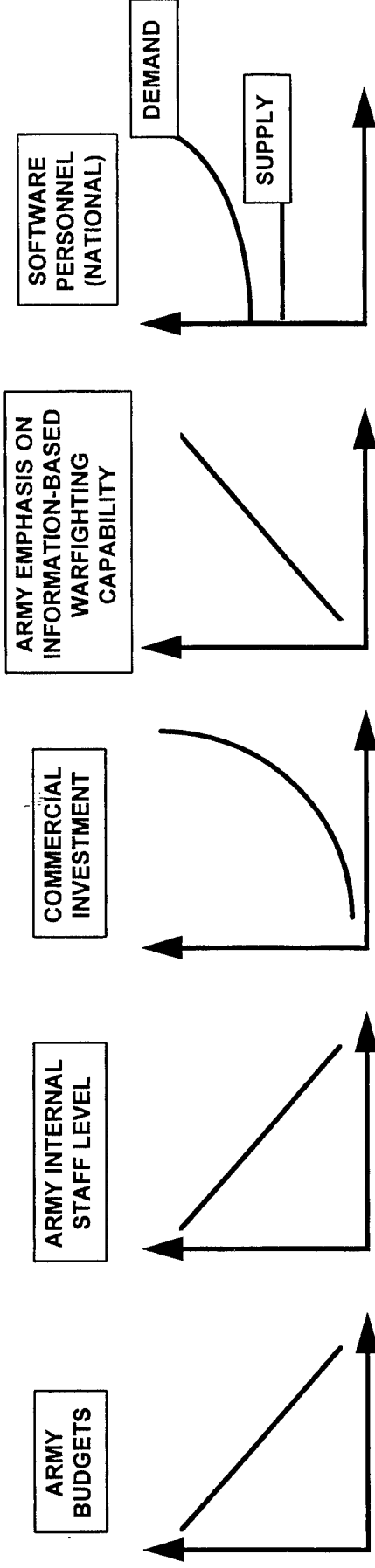

## KEY IMPLICATIONS FOR THE ARMY:

1. **LEVERAGE** COMMERCIAL INVESTMENTS  
(AND DO IT FASTER AND MORE INNOVATIVELY THAN OUR ADVERSARIES)
2. **SHIFT** TO EXTENSIVE OUTSOURCING
3. **MINIMIZE** CUSTOM SOFTWARE (A MAJOR COST DRIVER)
4. **ELEVATE** THE MANAGEMENT IMPORTANCE OF SOFTWARE
5. **SHIFT** OUR MANAGEMENT FOCUS FROM “NEW STARTS” TO “UPGRADES”
6. **CREATE** AN ENVIRONMENT TO ATTRACT/RETAIN SOFTWARE PERSONNEL IN A VERY COMPETITIVE NATIONAL MARKET

# IMPLICATIONS OF OUR RELATIONSHIP TO COMMERCIAL PRACTICES/PRODUCTS

DECOUPLED



DOD

DOD AS A MARKET OF "ONE":

- ADVANTAGE
- CONTROL
- DISADVANTAGES
- COST
- COST
- COST

WE CANNOT AFFORD TO BE A MARKET OF "ONE"

COUPLED

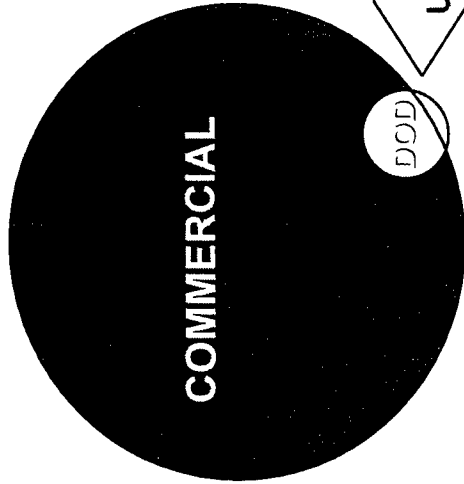

MINIMAL UNIQUENESS

DOD AS ONE CUSTOMER IN A FAR BROADER MARKET:

- ADVANTAGE
- COST
- COST
- COST
- DISADVANTAGES
- LIMITED CONTROL

# KEY SEC STRATEGIES

## PRODUCT:

- EMPHASIS ON SOFTWARE ARCHITECTURE
- MAXIMUM USE OF COTS “APPLICATION” SOFTWARE

## BUSINESS MODEL:

- MANAGED “PARTNERSHIPS” WITH INDUSTRY
- 30/70 GOVERNMENT/CONTRACTOR MIX

## GOVERNMENT PERSONNEL:

- SKILL BASE TRANSFORMATION TO PROMOTE FOCUS ON:
  - ARCHITECTURAL VALIDATION
  - INTEGRATION
  - SOFTWARE ENGINEERING

## AREAS OF FOCUS

- MARKET-DRIVEN, CONSENSUS BASED OPEN SOFTWARE ARCHITECTURES
- PC/WINDOWS NT BASED APPLICATION CLIENTS INTEGRATED INTO UNIX BASED TACTICAL ARCHITECTURE
- SOFTWARE REUSE FOR COST EFFECTIVENESS
- RAPID APPLICATION PRODUCT DEVELOPMENT
  - COMPONENT TECHNOLOGY
  - VISUAL PROGRAMMING
- TACTICAL WEB & INTRANET TECHNOLOGIES
  - SEAMLESS DISTRIBUTED APPLICATIONS

# SEC INITIATIVES

- EXECUTIVE AGENT, ARMY TACTICAL SWITCHED SYSTEMS (EA-TSS)
- DIGITAL INTEGRATION LABORATORY (DIL)/ARMY INTEROPERABILITY NETWORK (AIN)
- ARMY/JOINT INTEROPERABILITY STANDARD AND JOINT CERTIFICATION TESTING
- VARIABLE MESSAGE FORMAT (VMF) & MIL-STD-188-220
- ARMY REPROGRAMMING ANALYSIS TEAM (ARAT)
- SOFTWARE SOLUTIONS LABORATORY (SSL)
- REPLICATION, DISTRIBUTION, INSTALLATION AND TRAINING (RDIT)
- ARMY REUSE CENTER (ARC)

# SEC SYSTEM AREAS

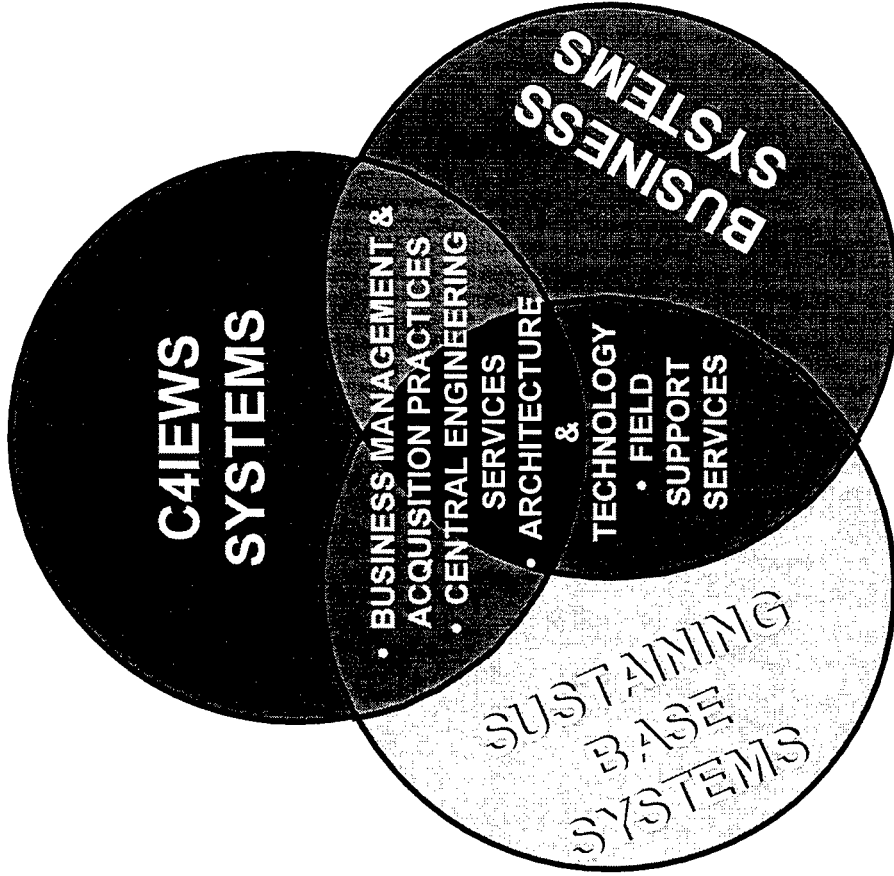

# C4IEWS SYSTEMS

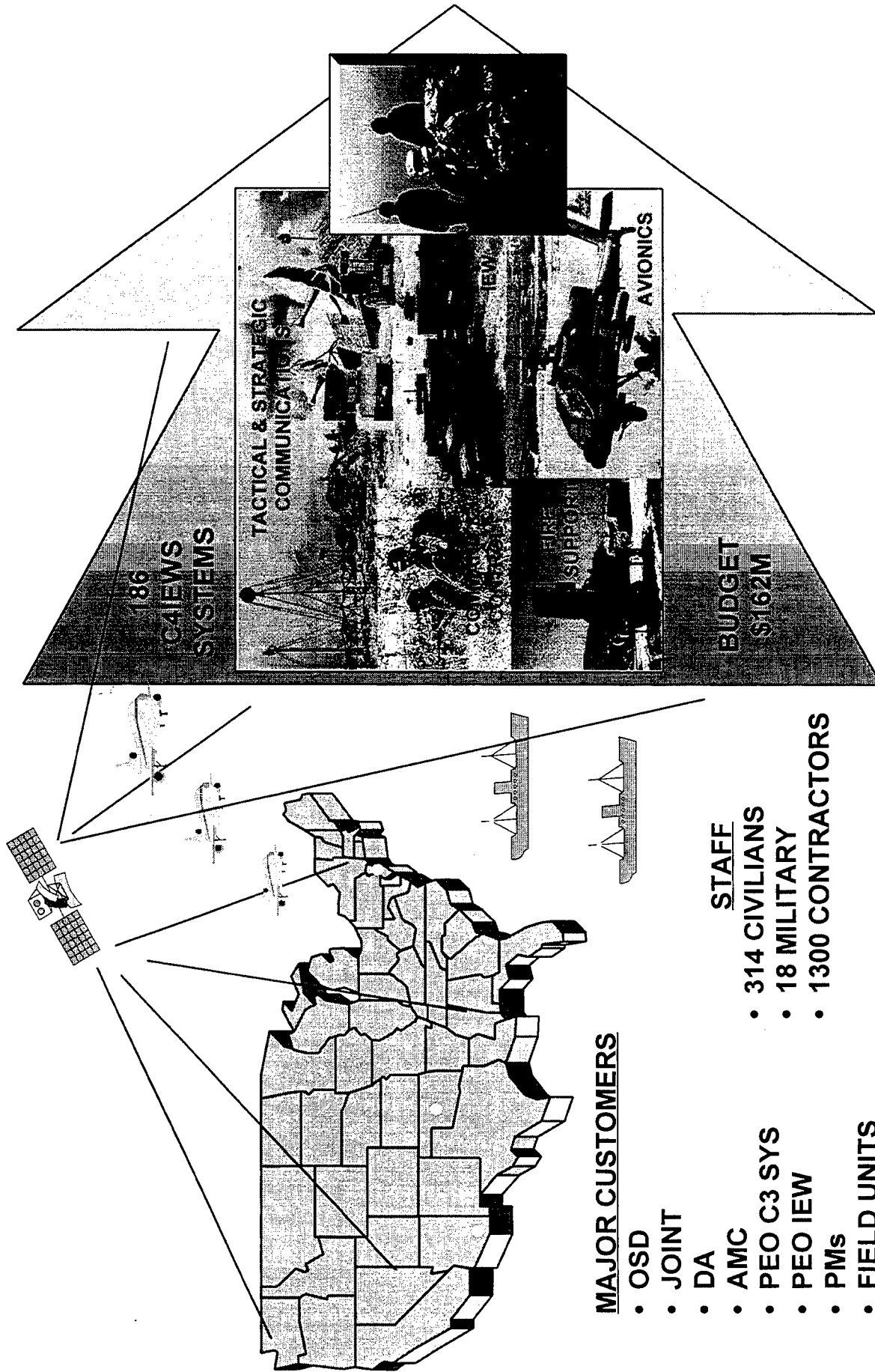

## MAJOR CUSTOMERS

- OSD
- JOINT
- DA
- AMC
- PEO C3 SYS
- PEO IEW
- PMs
- FIELD UNITS

## STAFF

- 314 CIVILIANS
- 18 MILITARY
- 1300 CONTRACTORS

# SUSTAINING BASE SYSTEMS

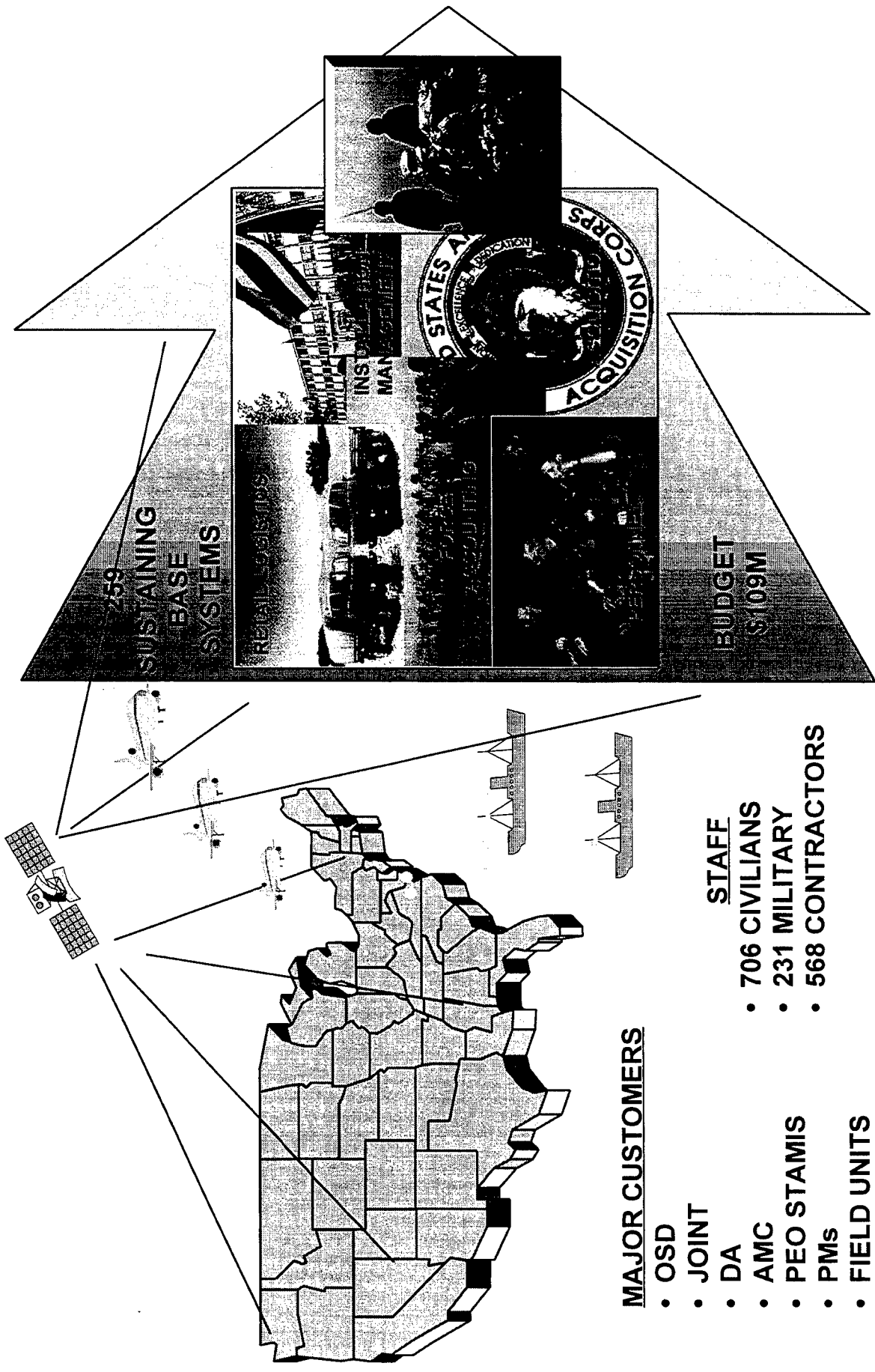

59  
SUSTAINING  
BASE  
SYSTEMS

RETAIL LOGISTICS

UNITED STATES ARMY  
ACQUISITION CORPS

BUDGET  
\$109M

**MAJOR CUSTOMERS**

- OSD
- JOINT
- DA
- AMC
- PEO STAMIS
- PMS
- FIELD UNITS

**STAFF**

- 706 CIVILIANS
- 231 MILITARY
- 568 CONTRACTORS

# BUSINESS SYSTEMS

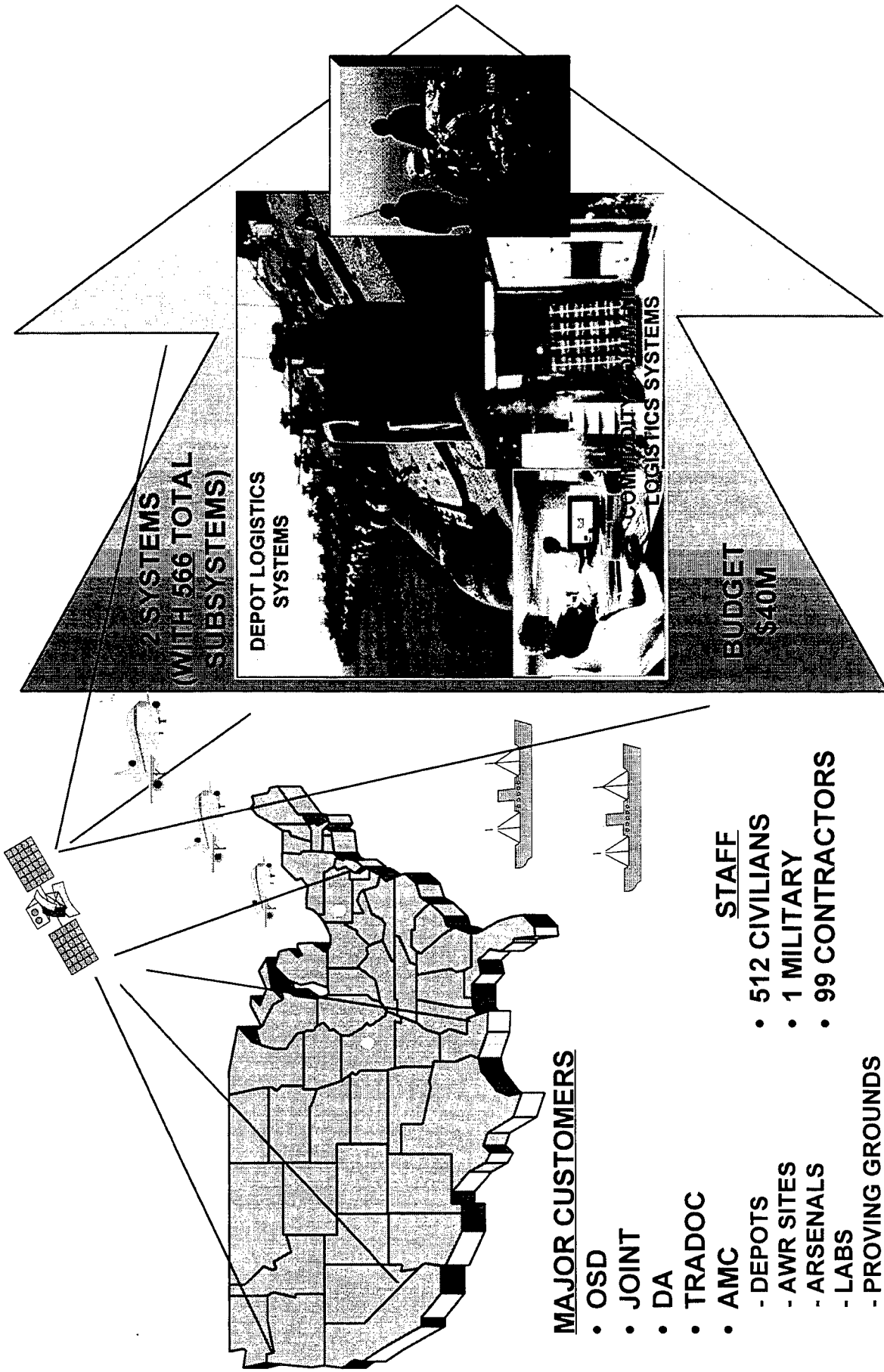

# CECOM RD&E SOFTWARE ENGINEERING CENTER

MISSION AREA	C4IEWS SYSTEMS	STANDARD ARMY SUSTAINING BASE SYSTEMS	STANDARD AMC COMMODITY COMMAND SYSTEMS	STANDARD AMC DEPOT SYSTEMS	ALL
NUMBER OF SYSTEMS	186	259	1 (WITH 539 SUBSYSTEMS)	1 (WITH 27 SUBSYSTEMS)	447
LINES OF CODE	42M	33M	9M	12M	96M
WORKFORCE	314 CIV 18 MIL 1300 CONTR	706 CIV 231 MIL 568 CONTR	313 CIV 1 MIL 41 CONTR	199 CIV 0 MIL 58 CONTR	1532 CIV 250 MIL 1967 CONTR
BUDGET	\$162M	\$109M	\$24M	\$16M	\$311M

INCLUDES, BY FAR,  
THE MAJORITY OF  
ALL ARMY SOFTWARE BUSINESS

# SEAMLESS, INTEROPERABLE SOFTWARE CAPABILITIES

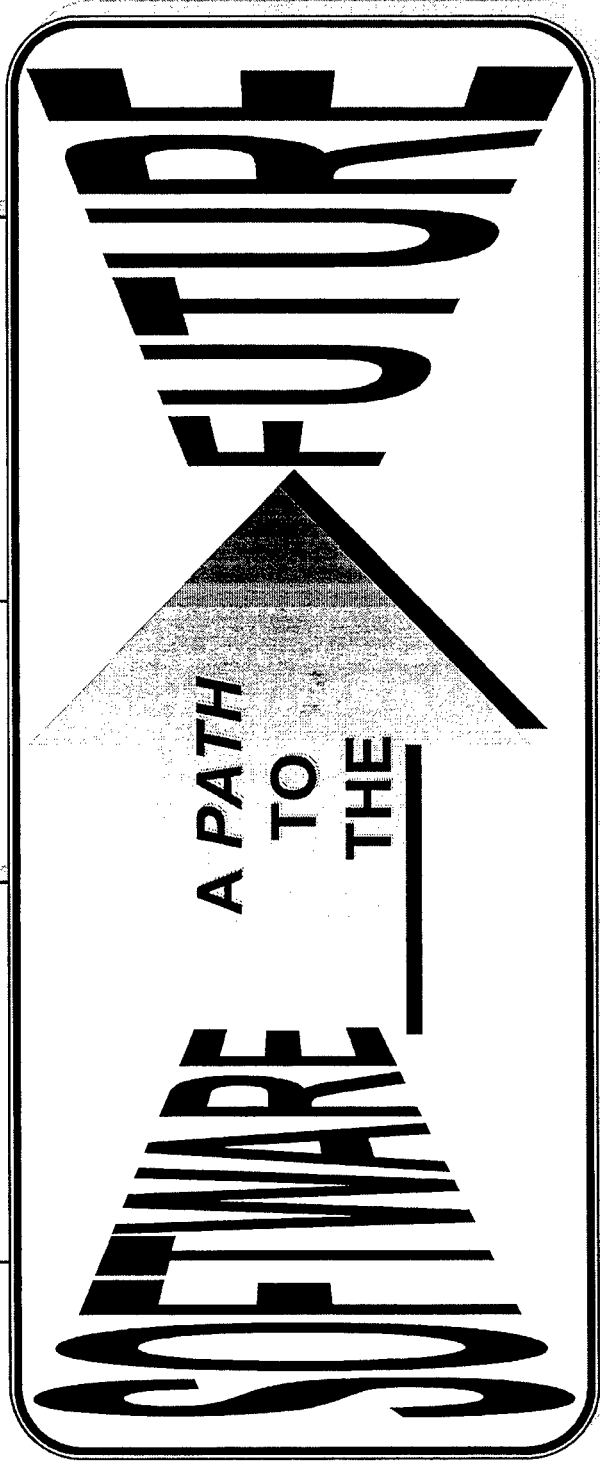
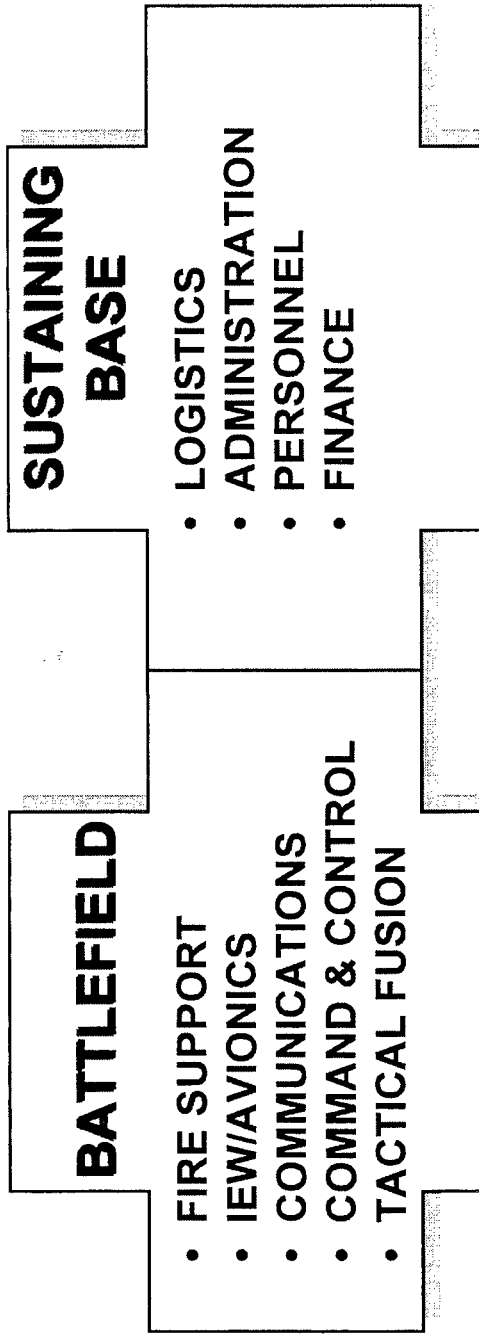

# FUTURE DIRECTIONS: PRODUCTS

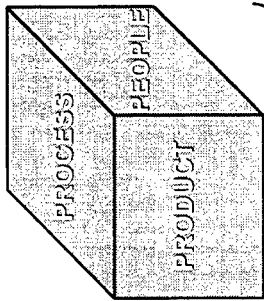

OPPORTUNITY  
TO LEVERAGE  
COMMERCIAL  
INVESTMENTS

## DEEPLY EMBEDDED SYSTEMS

## C3I SYSTEMS

## INFORMATION SYSTEMS

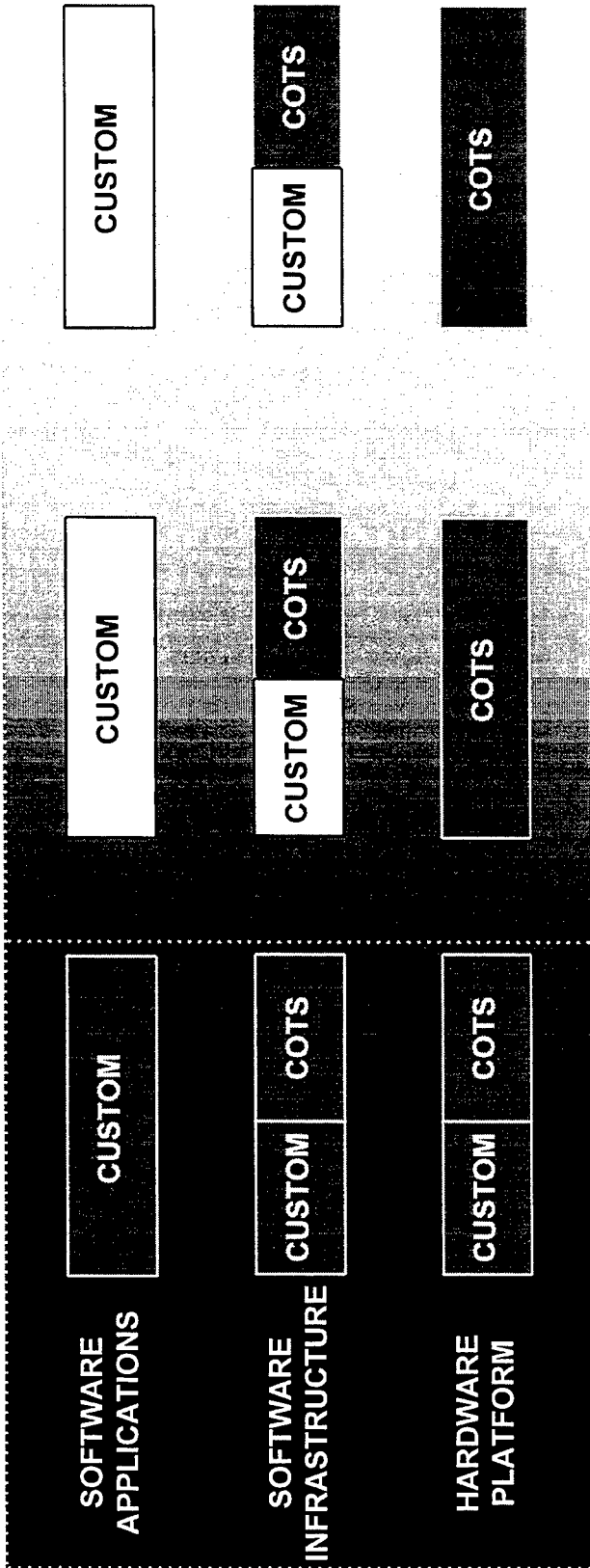

# CECOM RD&E SEC SUMMARY OF CONTRACTOR OPPORTUNITIES

YEAR		AMOUNT
98 - 03	ARMY INTEROPERABILITY ENGINEERING	\$30-\$40M
98 - 03	JTAC SYSTEMS & SOFTWARE ENGINEERING SUPPORT FOR AN-TTC/ TYC-39 FAMILY OF SWITCHES	\$40-\$45M
99 - 04	SYSTEMS & SOFTWARE ENGINEERING FOR FIRE SUPPORT COMMAND CONTROL, FIRE DIRECTION & OTHER SYSTEMS	\$100-\$125M
00 - 05	MISSION CRITICAL DEFENSE SYSTEM MAINTENANCE	\$10-\$18M
00 - 05	DEPARTMENT OF THE ARMY SOFTWARE SUPPORT SERVICES-UMBRELLA 4 (DASSS-U4)	\$100-\$125M

# **CECOM RD&E SOFTWARE ENGINEERING CENTER CONTRACT OPPORTUNITY**

**TITLE:** ARMY INTEROPERABILITY ENGINEERING (AIE) --  
DEVELOPMENT, INTEGRATION, AND TECHNICAL  
SUPPORT, FT MONMOUTH, NJ

**OBJECTIVE:** CONTINUE THE DEVELOPMENT AND APPLICATION OF THE  
ARMY INTEROPERABILITY NETWORK (AIN) TEST CAPABILITY,  
INTEROPERABILITY STANDARDS & RELATED ACTIVITIES, TO  
SUPPORT THE DEVELOPMENT & SUSTAINMENT OF INTER-  
OPERABILITY FOR MISSION CRITICAL DEFENSE SYSTEMS

**TYPE:** COMPETITIVE (UNRESTRICTED), IDIQ, TIME AND MATERIALS

**SCHEDULE:** RFP RELEASE - 2ND QUARTER FY98  
AWARD DATE - 4TH QUARTER FY98

**APPROXIMATE VALUE:** \$30-\$40M (5 YEARS)

**POC/TELEPHONE:** EUGENE J. BOYLE, 908-532-8220  
DAVE CONCILIO, CONTRACTING OFFICER, 908-532-2461

# **CECOM RD&E SOFTWARE ENGINEERING CENTER CONTRACT OPPORTUNITY**

**TITLE:** JTAC SYSTEMS AND SOFTWARE ENGINEERING SUPPORT  
FOR TACTICAL CIRCUIT/MESSAGE/PACKET SWITCHES

**OBJECTIVE:** THIS CONTRACT WILL PROVIDE SUPPORT IN THE CORRECTION  
OF SOFTWARE DEFECTS/DEFICIENCIES/ERRORS; & THE  
IMPLEMENTATION OF SOFTWARE REFINEMENTS & ENHANCE-  
MENTS TO THE OPERATIONAL AND SUPPORT SOFTWARE OF  
THESE PROGRAMS

**TYPE:** COMPETITIVE (UNRESTRICTED), IDIQ, TIME AND MATERIALS

**SCHEDULE:** RFP RELEASE - 2ND QUARTER FY98  
AWARD DATE - 4TH QUARTER FY98

**APPROXIMATE VALUE:** \$40-\$45M (5 YEARS)

**POC/TELEPHONE:** EUGENE J. BOYLE, 908-532-8220  
DAVE CONCILIO, CONTRACTING OFFICER, 908-532-2461

# **CECOM RD&E SOFTWARE ENGINEERING CENTER CONTRACT OPPORTUNITY**

**TITLE:** LIFE CYCLE SYSTEMS AND SOFTWARE ENGINEERING SUPPORT FOR FIRE SUPPORT COMMAND, CONTROL, FIRE DIRECTION AND OTHER SYSTEMS, FT SILL, OK

**OBJECTIVE:** PROVIDE SYSTEMS AND SOFTWARE ENGINEERING SERVICES IN SUPPORT OF THE DEVELOPMENT, PRODUCTION AND DEPLOYMENT OF THE FIRE SUPPORT COMMUNITY OF SYSTEMS INCLUDING SYSTEMS SUCH AS IFSAS, BATTERY COMPUTER SYSTEM (BCS), MULTIPLE LAUNCH ROCKET SYSTEM (MLRS), ADVANCED FIELD ARTILLERY TACTICAL DATA SYSTEMS (AFATDS)

**TYPE:** COMPETITIVE (UNRESTRICTED), IDIQ, TIME AND MATERIALS

**SCHEDULE:** RFP RELEASE - 3RD QUARTER FY98  
AWARD DATE - 1ST QUARTER FY99

**APPROXIMATE VALUE:** \$100-\$125M (5 YEARS)

**POC/TELEPHONE:** EUGENE J. BOYLE, 908-532-8220  
DAVE CONCILIO, CONTRACTING OFFICER, 908-532-2461

# **CECOM RD&E SOFTWARE ENGINEERING CENTER CONTRACT OPPORTUNITY**

**TITLE:** MCDS HARDWARE MAINTENANCE AND TECHNICAL SUPPORT,  
FT MONMOUTH, NJ

**OBJECTIVE:** PROVIDE TECHNICAL SERVICES FOR HARDWARE  
MAINTENANCE AND SUPPORT OF ASSIGNED MCDSS AND  
ASSOCIATED EQUIPMENT AT FT MONMOUTH, NJ; FT SILL, OK;  
AND FT HUACHUCA, AZ

**TYPE:** COMPETITIVE (UNRESTRICTED), IDIQ, TIME AND MATERIALS

**SCHEDULE:** RFP RELEASE - 3RD QUARTER FY99  
AWARD DATE - 1ST QUARTER FY00

**APPROXIMATE VALUE:** \$10-\$18M (5 YEARS)

**POC/TELEPHONE:** EUGENE J. BOYLE, 908-532-8220  
DAVE CONCILIO, CONTRACTING OFFICER, 908-532-2461

# **CECOM RD&E SOFTWARE ENGINEERING CENTER CONTRACT OPPORTUNITY**

**TITLE:** DEPARTMENT OF THE ARMY SOFTWARE SUPPORT SERVICES-  
UMBRELLA 4 (DASSS-U4)

**OBJECTIVE:** PROVIDE FOR THE ACQUISITION OF NONPERSONAL SW  
SUPPORT - SUPPORT SERVICES TO INCLUDE SOFTWARE  
COMMUNICATIONS, SYSTEMS DESIGN & ANALYSIS, SW  
DEVELOPMENT, TESTING, & MAINTENANCE, CONFIGURATION  
MANAGEMENT, RISK MANAGEMENT AND ECONOMIC ANALYSIS

**TYPE:** COMPETITIVE (UNRESTRICTED), IDIQ, TIME AND MATERIALS

**SCHEDULE:** PROJECTED - RFP RELEASE - 2ND QUARTER 2000  
AWARD DATE - 3RD QUARTER 2000

**APPROXIMATE VALUE:** \$100-\$125M (5 YEARS)

**POC/TELEPHONE:** ROBERT F. BARB, 703-806-4172  
PEGGY BUTLER, CONTRACTING OFFICER, 703-325-2858

# NOTES

**INFORMATION SYSTEMS ENGINEERING  
COMMAND**

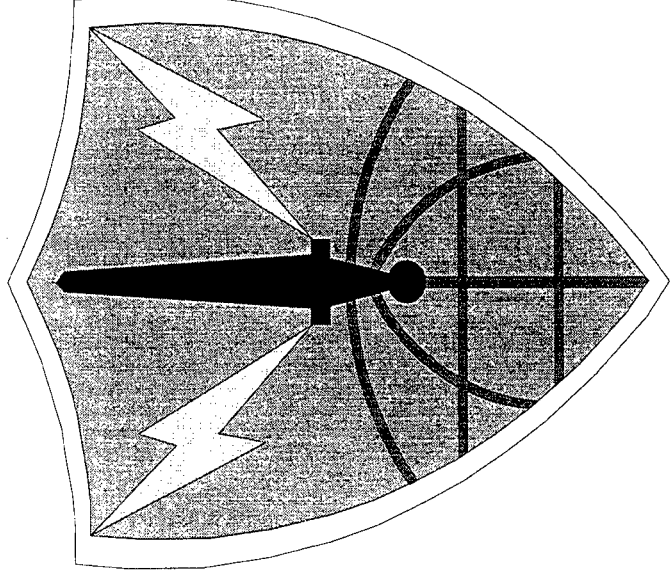

**DR. FRANK JENIA  
TECHNICAL DIRECTOR**

**UNCLASSIFIED**

29 April 1997

SUBJECT: USA Information Systems Engineering Command  
Overview for the APBI

OBJECTIVE: To provide information on ISEC's organization  
and contract opportunities in information systems  
technology.

Facts: ISEC's mission is twofold:

a. to provide highly responsive engineering,  
installation and software for all assigned information  
systems, to ensure seamless transfer of critical information  
from the battlefield to the National Command Authority  
throughout the spectrum of conflict.

b. to evaluate, integrate, and install commercial, off  
the shelf information management products into the Army  
Technical Architecture for both deployable and non-  
deployable systems.

This briefing provides general requirements and current  
funding ranges for anticipated contracts.

Briefer: Dr. Frank Jenia, Technical Director, USAISEC,  
AMSEL-IE-TD, (520) 538-8792. DSN 879-8792.

  
KATHLEEN C. LADIG  
MAJ, AD  
Operations Officer

## **USAISEC ORGANIZATION**

- **The Command Group & Staff**- Exercises command, control and staff support for all subordinate ISEC elements.
- **4 ISEC HQ's Engineering Directorates**- Provide general engineering support in their critical skill areas.
- **Technology Integration Center**- An engineering facility for technical analysis and evaluation of information systems.
- **3 Engineering Offices**- Collocated with their customers, they provide direct engineering support.
- **ISEC CONUS**- Provides site-specific engineering for systems level installation, quality assurance, testing and technical support within CONUS.

# **USAISEC's Technology Integration Facility**

- **What - An Engineering Directorate focused on insuring the technical superiority, integration and seamless operation of customer systems.**
- **Focus - COTS technology insertion, validation of system design, performance engineering, identification of critical emerging technologies.**
- **Uniqueness**
  - **Evaluate and integrate COTS products for sustaining base infrastructure and strategic information systems.**
  - **Capable of replicating literally any type of post, camp, station or headquarters infrastructure (all COTS) in our facility.**
  - **Infrastructure comes from ISEC internally, PMs, and vendors (loaned for evaluation).**
  - **Insure seamless interface of COTS products with tactical systems**

## **USAISEC Specialties**

- **Installation Infrastructure**
- **Business & Logistics Support Systems**
- **Network and Systems Management**
- **Site-Specific Installation**
- **COTS Evaluation and Technical Insertion**
- **Transmission Systems**
- **New Technology Evaluation**
- **Messaging Systems**
- **MACOM's Executive Agent**

# USAISEC Critical Skills

- Airfield Comm & Nav aids
- Command & Control
- Decision Support Systems
- Emerging Technology  
( ATM/SONET ISDN )
- Enterprise Wide Solutions
- Independent Dev Eval
- Infrastructure Implementation
- Installation
- Integration
- Local Area Networks/  
Office Automation
- Messaging Systems  
Engineering
- Messaging Systems  
Integration
- Network & Systems  
Mgmt (NSM)
- Satellite Engineering
- Security Certification
- Security Engineering
- Tactical Interfaces
- Technical Control
- Telephone Switching
- Terrestrial Transmission
- Transport Media
- Video Applications

**+ Common Skills**

# INITIATIVES

- **Cultivate information engineering critical skills to persist as the Army's expert.**
- **Develop comprehensive technical design guidance which supports compliant solutions.**
- **Conduct internal quality assurance reviews to insure system interoperability and integration.**
- **Technology Insertion**
- **Teaming with Industry**

# **ISEC**

## **CONTRACT OPPORTUNITY**

- **Title: R&D, Training and Technical Support Services**
- **Objectives:**
  - **Information Systems Technical Analyses and Studies**
  - **Information Systems Training**
  - **Information Systems Engineering Support**
- **Type: Competitive, Best Value, IDIQ, Cost Contract, HBCU/MI Set-aside Solicitation**
- **Schedule: Award Date - Feb 98**
- **Estimated Value: \$1M-6M/year (Feb 98 thru Sep 03)**
- **Contract POC: Hildegard Choate (520) 538-7456**
- **Technical POC: Jim Ellison (520) 538-3070**

# **R&D, Training and Technical Support**

## **Range of Services:**

**Engineering technical support**

**Research and development support**

**Software engineering support**

**Data management research**

**Decision support research**

**Information management support**

**Computer science and database services**

**Management information systems  
support**

**Implementation support**

## **Skills Needed:**

**Automation**

**Networking**

**Communications**

**Database mgmt**

**Programming**

**Protocols**

**AI and expert  
systems**

# ISEC

## CONTRACT OPPORTUNITY

- **Title: Quality Assurance, Acceptance Testing, and Test and Evaluation Support Services**
- **Objectives:**
  - **Developmental & Rqmts Validation Testing**
  - **Systems Analyses & Studies**
- **Type: Competitive, Best Value, IDIQ, Labor Hour, 8(a) Set-aside, Multiple Award**
- **Schedule: Award Date - Sep 97**
- **Estimated Value: \$5M-\$10M/year (Oct 97 - Sep 02)**
- **Contract POC: Sandie Wilde (520) 533-2232**
- **Technical POC: Larry Salo (520) 538-3073**

# Quality Assurance, Acceptance Testing, and Test and Evaluation Support

## **Range of Services:**

**Quality assurance support**

**MANPRINT assessments**

**Safety inspections and analyses**

**Acceptance testing**

**Reliability, Availability, and**

**Maintainability (RAM) assessments**

**Validation and Verification (V&V)**

## **Skills Needed:**

**Info systems &  
architectures**

**MANPRINT**

**Networking**

**Protocols**

**Automation  
security**

**Simulation &  
Modeling**

# **ISEC**

## **CONTRACT OPPORTUNITY**

- **Title: Information Security Engineering Spt Services**
- **Objectives:**
  - **Security Engineering for Information Systems**
  - **Information Systems Security Certification**
  - **Accreditation of Information Systems**
- **Type: Competitive, Best Value, IDIQ, Labor Hour, Small Business Set-aside**
- **Schedule: Award Date - Aug 97**
- **Estimated Value: \$2M-\$6M/year (Oct 97 - Sep 02)**
- **Contract POC: Ronnie Lopez (520) 533-2254**
- **Technical POC: Robert Wright (520) 533-3078**

# Information Securing Engineering Support

## **Range of Services:**

**Security policy**

**Security threat assessment**

**Security engineering analysis**

**Security engineering design**

**Security implementation support**

**Security operations**

**Security evaluation testing and V&V**

**Certification support**

**Accreditation support**

## **Skills Needed:**

**Security products**

**Networking**

**Communications**

**Operating**

**Systems**

**Database mgmt**

**Programming**

**Protocols**

# **ISEC**

## **CONTRACT OPPORTUNITY**

- **Title: Software Engineering and Technical Support Services**
- **Objectives:**
  - **Information Technology Insertion**
  - **Software Engineering/Maintenance**
- **Type: Competitive, Best Value, IDIQ, Labor Hour, Multiple Award with a partial Small Business Set-aside**
- **Schedule: Award Date - Oct 97**
- **Estimated Value: \$40M-\$70M/year (Oct 97-Sep 02)**
- **Contract POC: Sandie Wilde (520) 533-2232**
- **Technical POC: Roger Hughes (520) 538-7240**

# Software Engineering and Technical Support

## **Range of Services:**

**Software engineering support**

**Operational support, problem analysis  
and resolution**

**Information technology surveys and  
evaluations**

**Systems analysis and design**

**Implementation support**

**Training**

## **Skills Needed:**

**Operating  
Systems**

**Networking**

**Communications**

**Programming**

**Databases**

**Security products**

**Protocols**

# **US Army Information Systems Engineering Command**

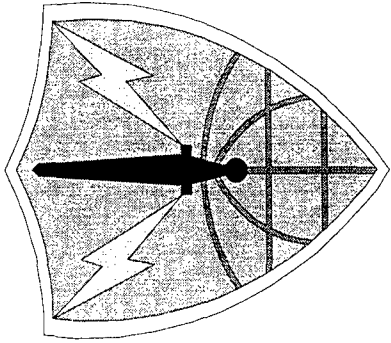

**Committed to a partnership  
with Industry in accomplishing  
our Global Mission.**

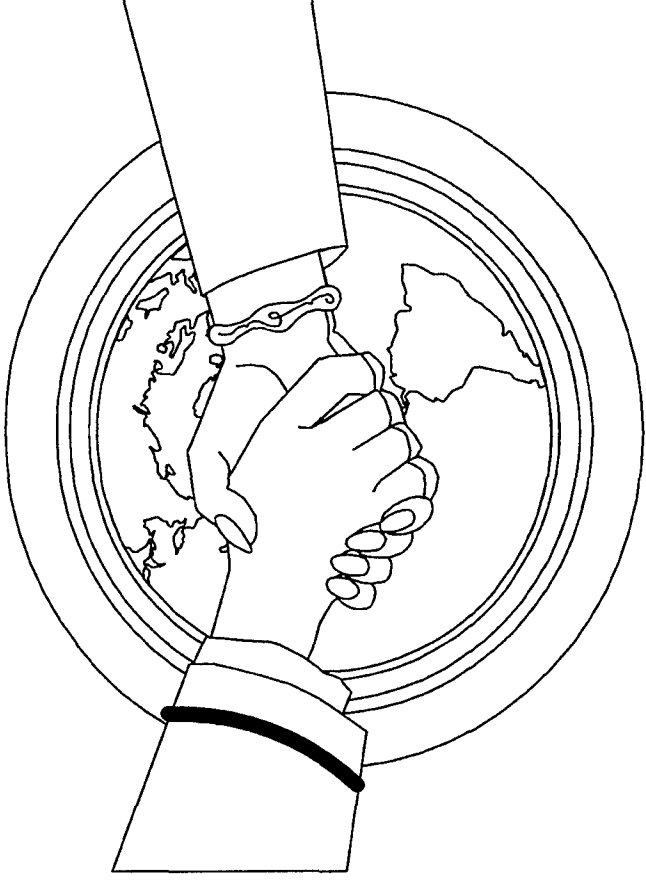

# NOTES

# The CECOM Research, Development and Engineering Center Organizations

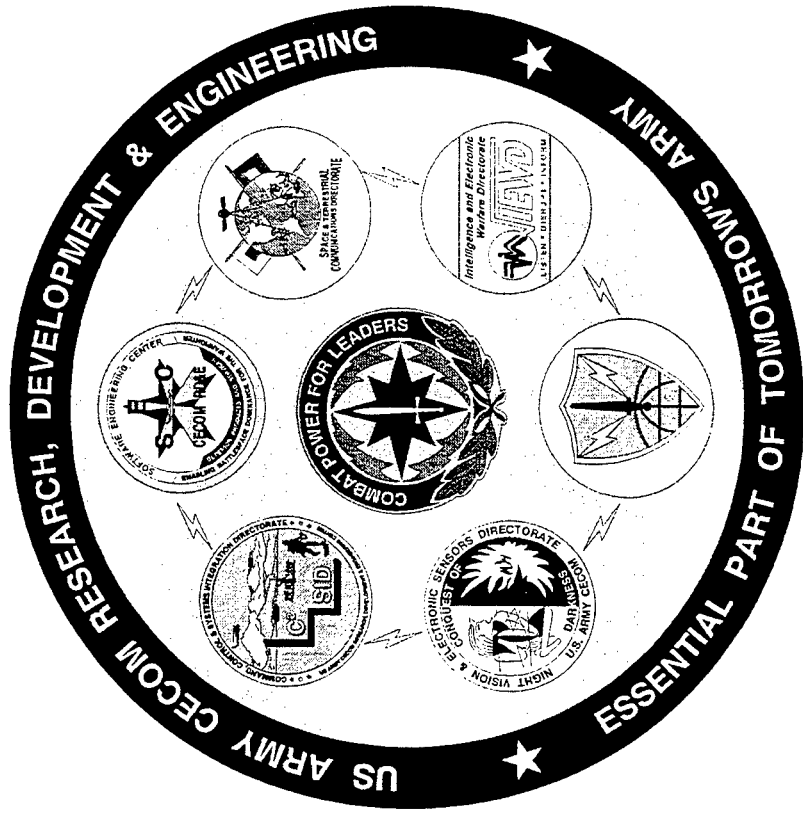

Dr. Louis Marquet

**UNCLASSIFIED**

15 May 1997

## POINT PAPER

**SUBJECT:** The CECOM RDEC Organizations

**OBJECTIVE:** To provide information on CECOM Research, Development and Engineering Center's organization and directorate technologies and how the RDEC is positioned to support the Army today and tomorrow.

**FACTS:** CECOM is developing the technologies required for U.S. Forces to achieve full spectrum dominance. The RDEC provides the bridge for these technologies from technology generation to technology application; from the combat developers to the materiel developers. The CECOM RDEC supports TF XXI with the digital integrated laboratories, modeling and simulation, advanced technology demonstrators, and on-site support. The RDEC is positioning itself to advance the current state-of-the-art in sensors, command and control, electronic warfare, and seamless communications to support the Army After Next.

**BRIEFER:** Dr. Louis C. Marquet, Director, NVESD, AMSEL-RD-NV-OD, (703) 704-1172, DSN 654-1172.

ACTION OFFICER:  
Keith Dugas  
Technical Planning Branch  
(703) 704-1200  
DSN 654-1200

# Organization

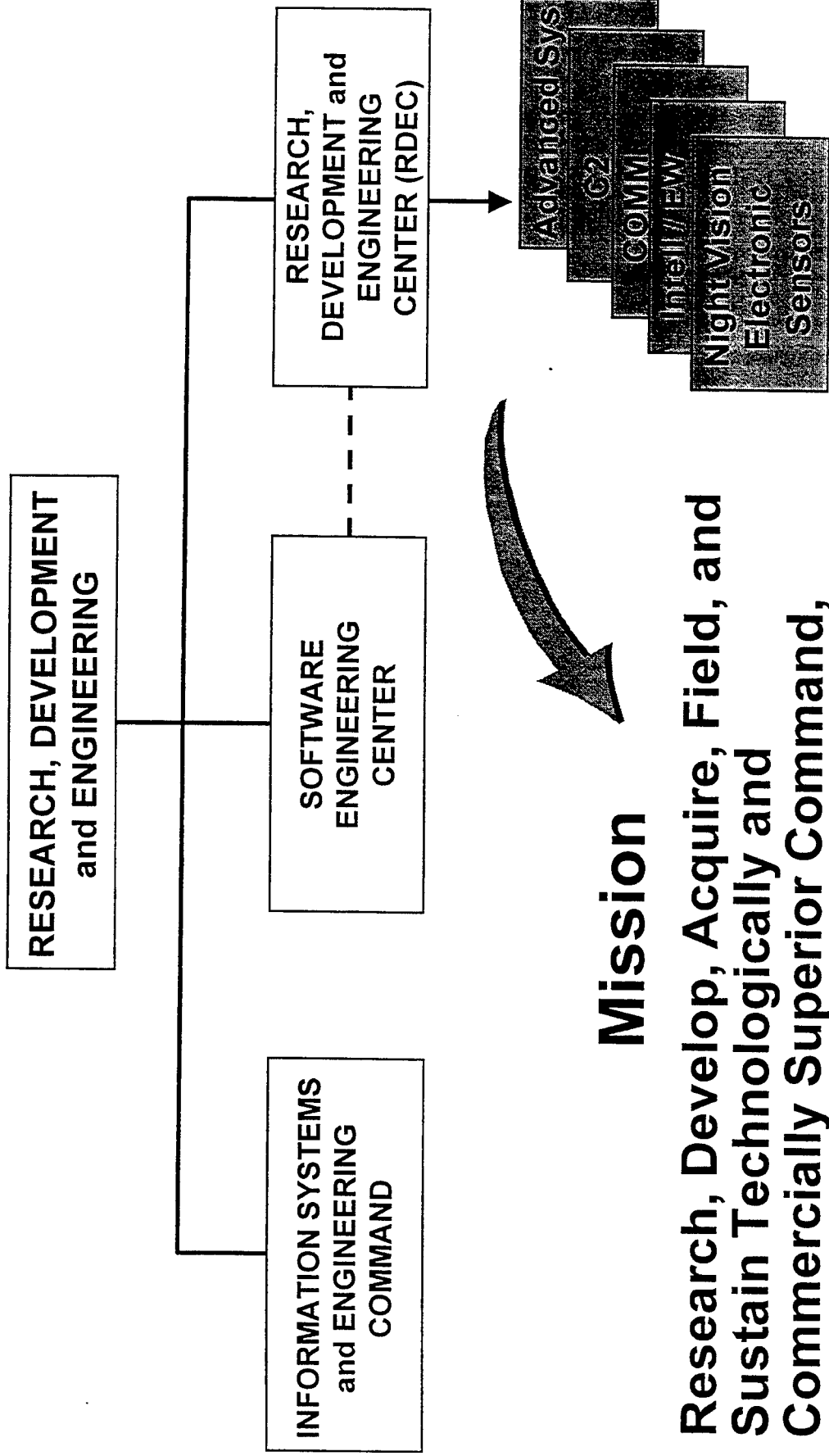

## Mission

**Research, Develop, Acquire, Field, and Sustain Technologically and Commercially Superior Command, Control, Communications, Computers, Intelligence and Electronic Warfare, and Sensor Capabilities for the Warfighter**

# CECOM RDEC

- A Key Part of Today's Army
- An Essential Part of Tomorrow's Army

## *Technology Changing the Face of the Battlefield*

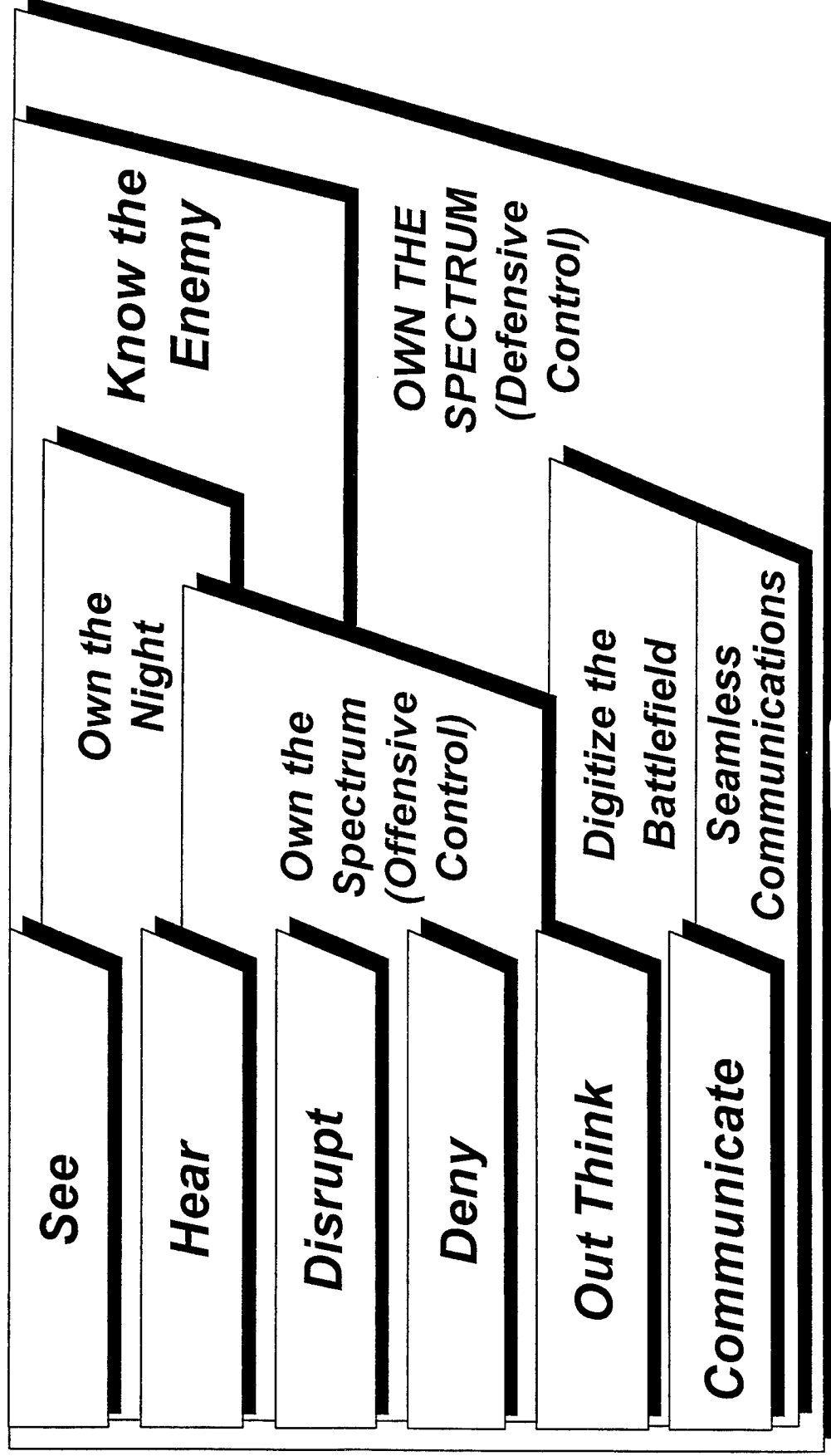

# Seamless, Interoperable C4IEWS

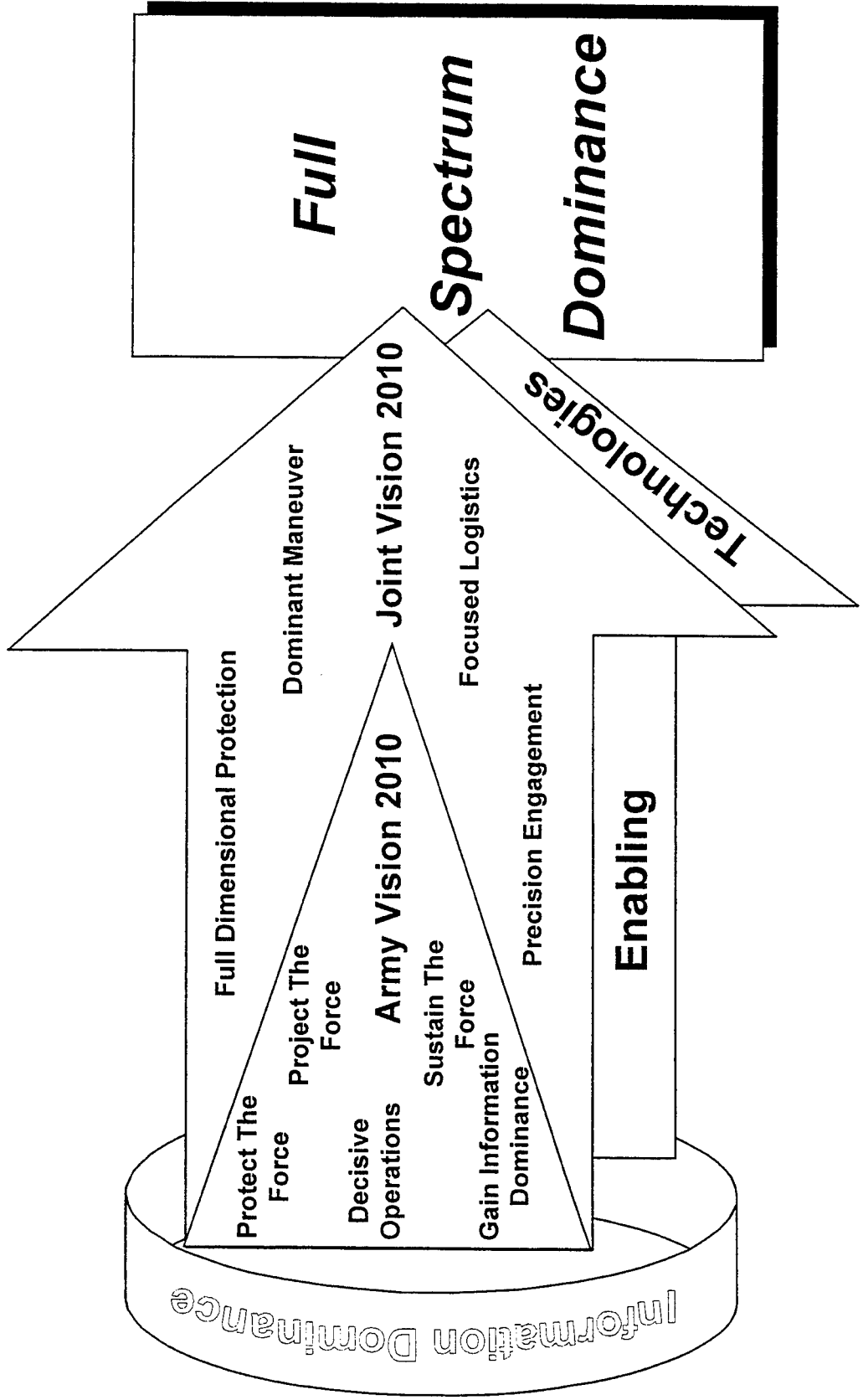

# Information Age Warfare

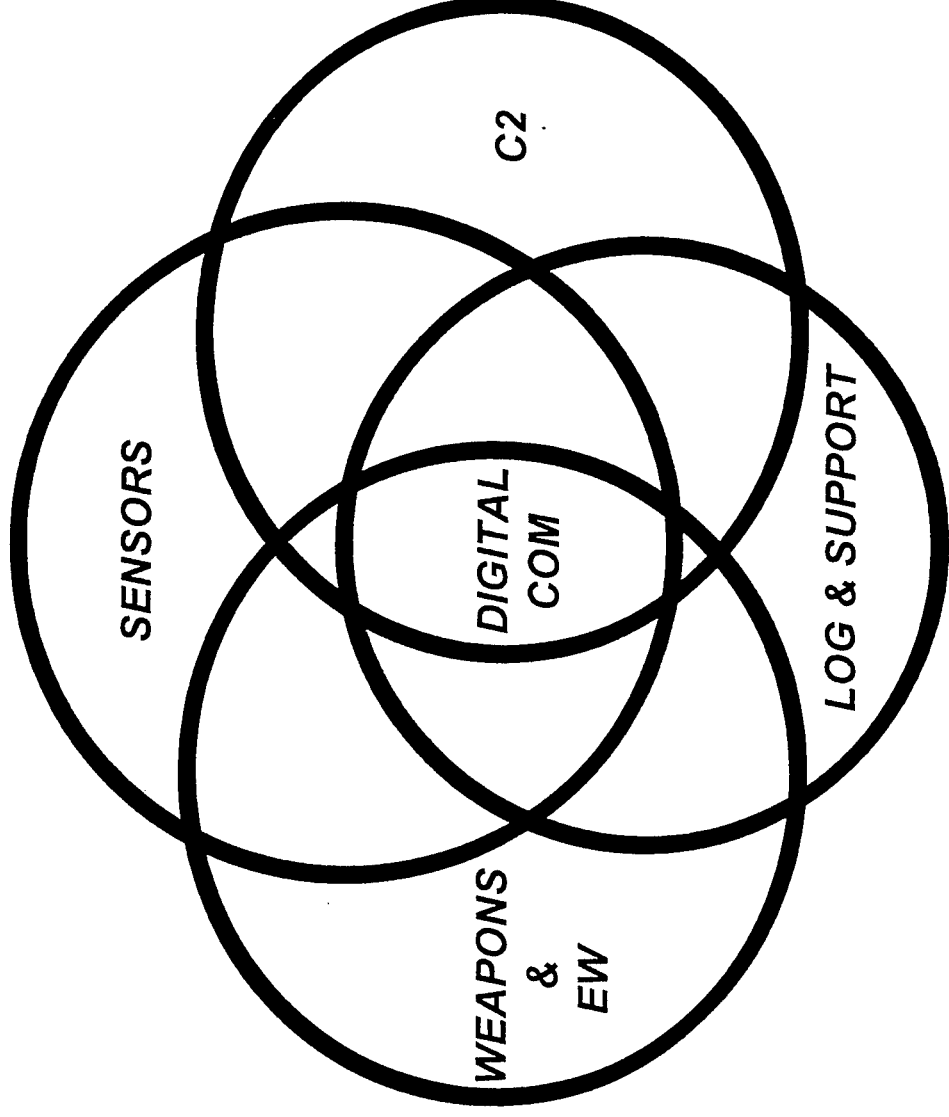

# *Integrated Digital Battlefield of the Future*

# Applying Technology

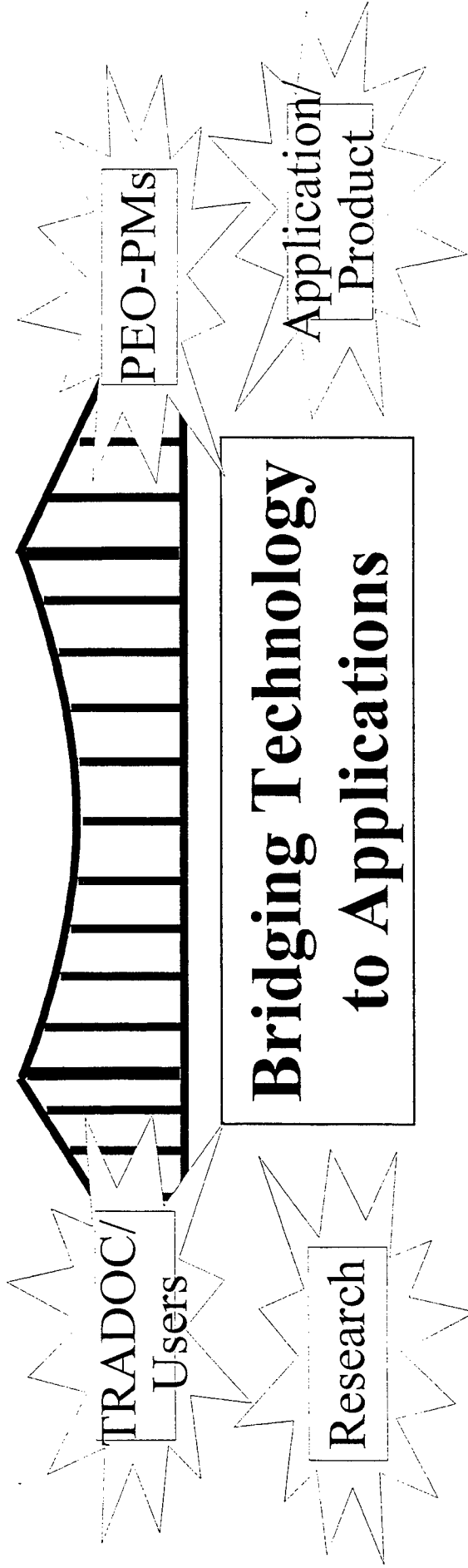

- Manage 13 of 28 Advanced Technology Demonstrations
- Key to Advanced Warfighting Experiments (Digitized Brigade)
- Horizontal Technology Integration
- Software
- Support to Task Force XXI

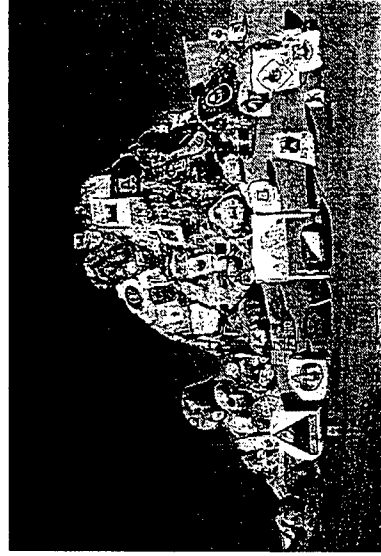

***“IF IT DOESN’T  
EARN ITS RIDE,  
IT’S A ROCK!”***



# Leveraging—A Basis for Success

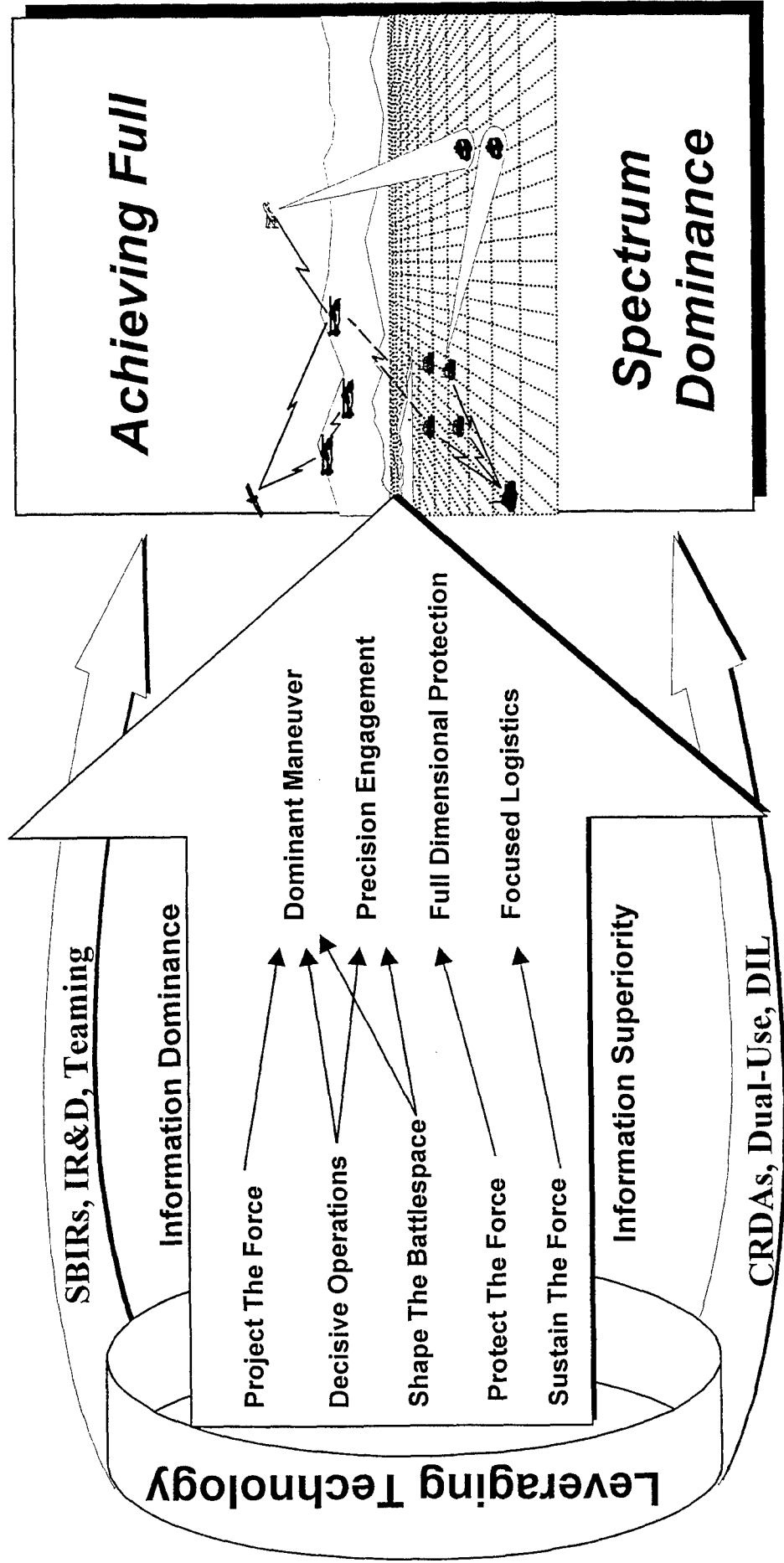

# RDEC Support to TF XXI

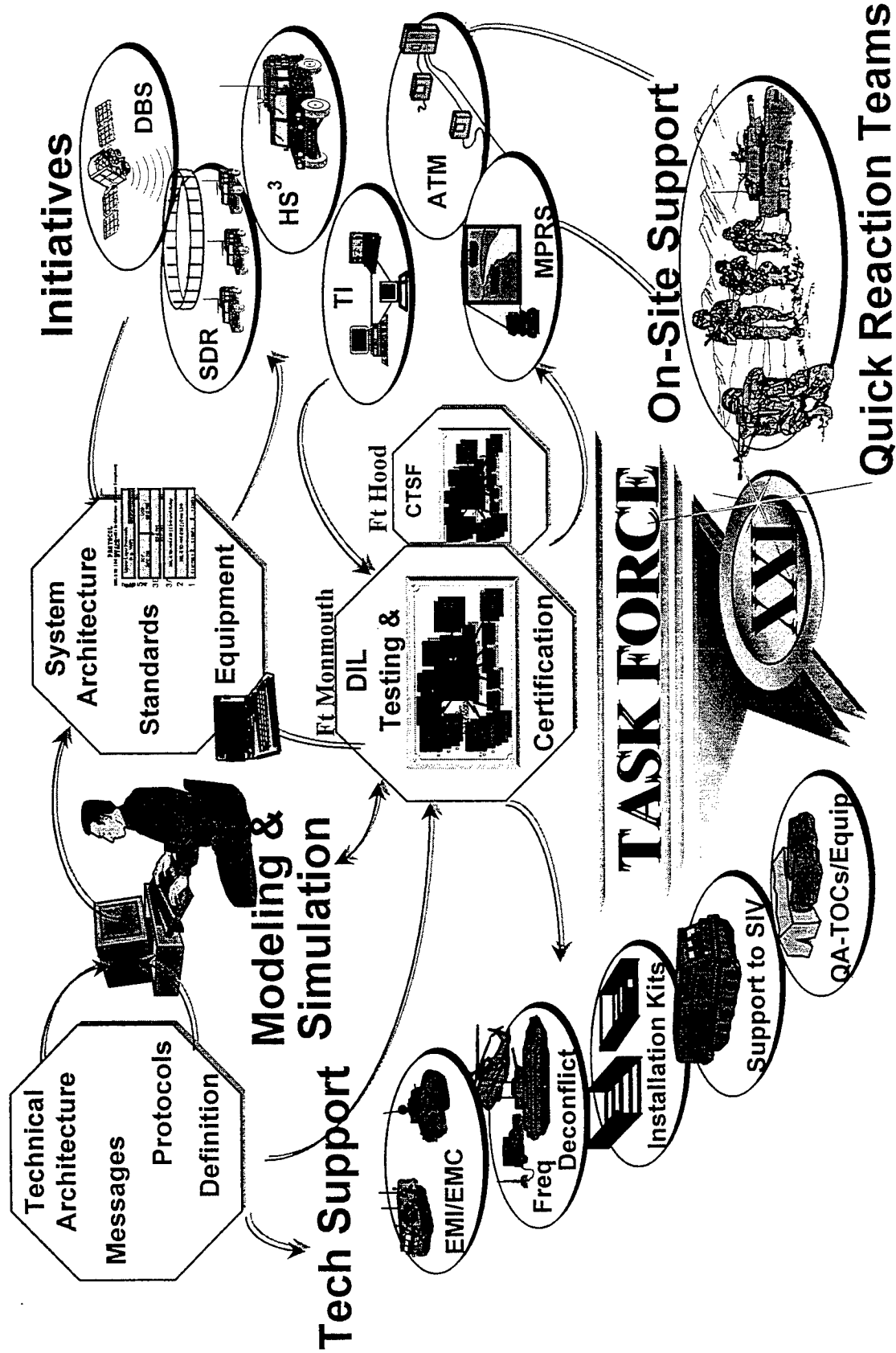

# RDEC Support to TF XXI

- Direct Broadcast Satellite / BADD
  - *Rapid Dissemination of Info*

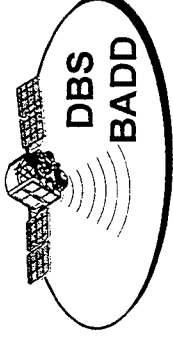

- Tactical End-to-End Encryption Device
  - *Security - Protect*

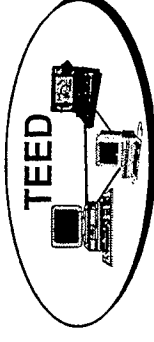

- Surrogate Digital Radio (SDR)
  - *Data Hauler*

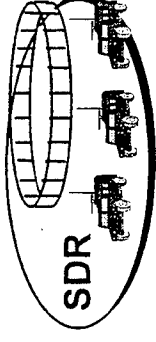

- Asynchronous Transfer Mode (ATM) Technology
  - *Multimedia*

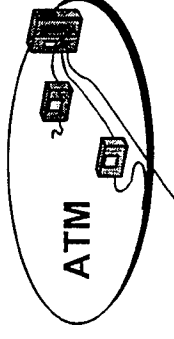

- Hunter Sensor Suite Surrogate
  - *Sensor to Shooter*

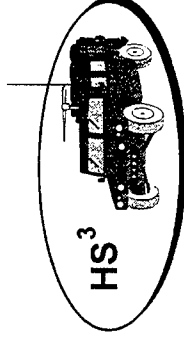

# RDEC Support to TF XXI

- Digital Integrated Laboratories (DIL)
  - *Find Problems Early*
- Modeling and Simulation (M&S)
  - *Performance Prediction*
- Mil-Std-188-220 A
  - *Joint & Interoperability*
- Variable Message Format (VMF)
  - *Efficient Info Transfer*
- Mission Planning
  - *See Over the Next Hill*
- Forward Deployed
  - *“FIND and FIX”*

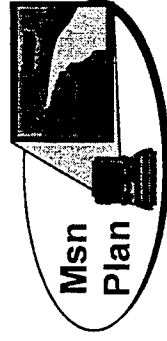
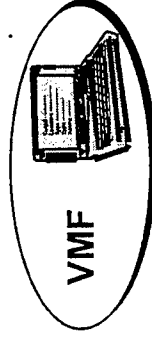
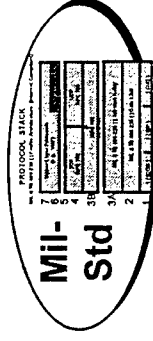
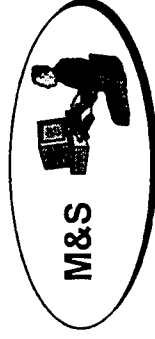
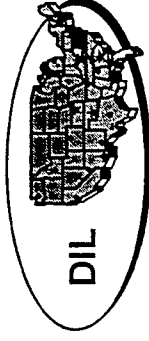

# Technologies for AAN

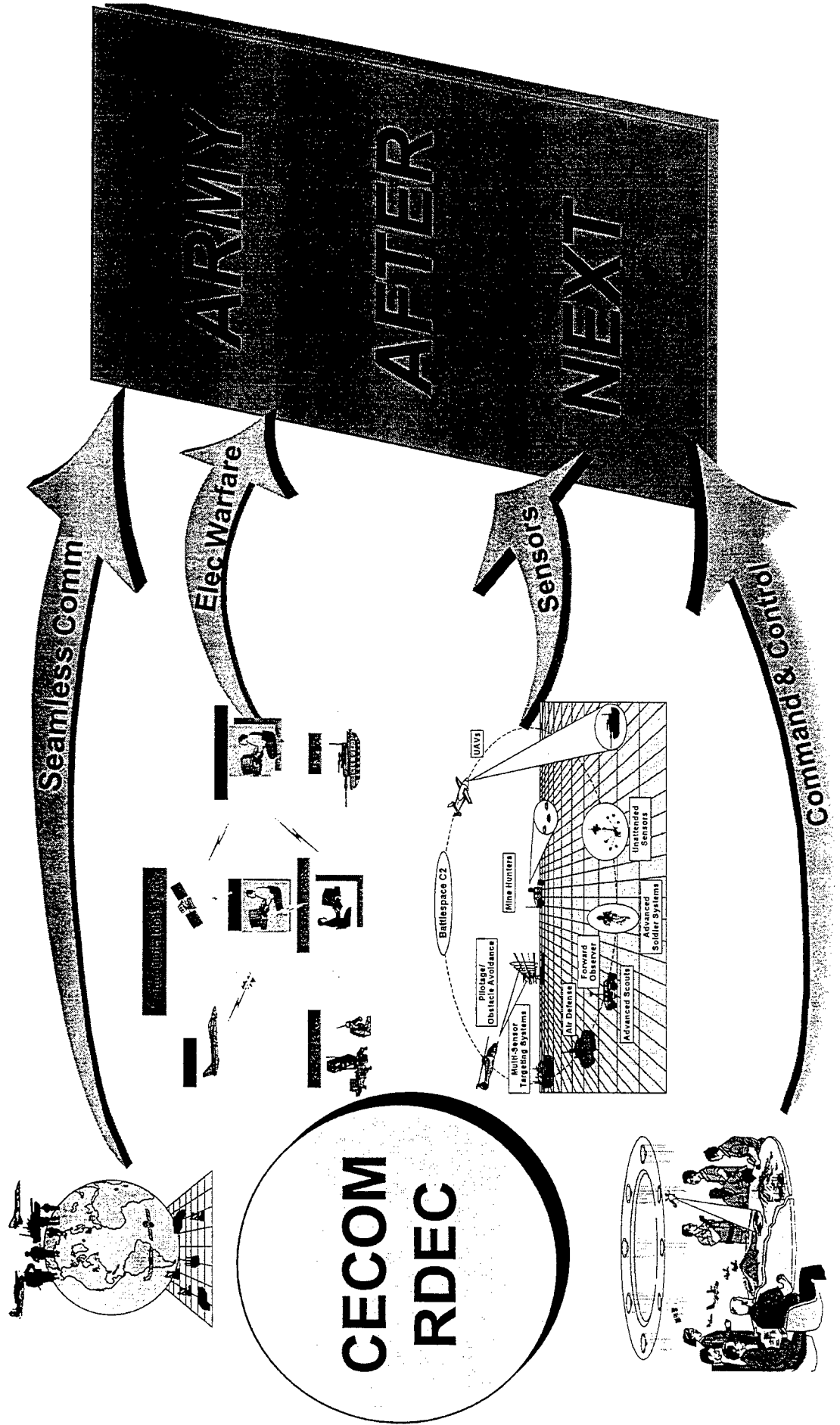

# FY97 Funding Profiles

<b>TOTAL</b>	
MISSION	235M
CUSTOMER	485M
<b>TOTAL</b>	<b>720M</b>

**Intelligence and Electronic Warfare**

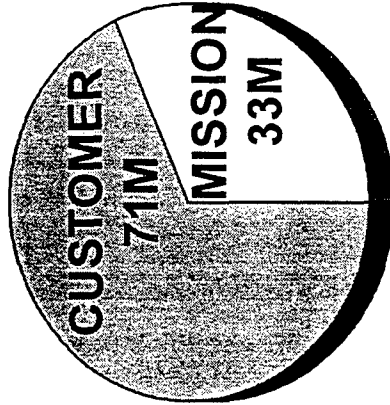

**Total 104M**

**Space and Terrestrial Communications**

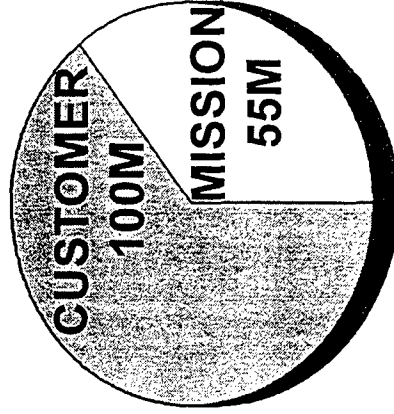

**Total 155M**

**Command, Control and Systems Integration**

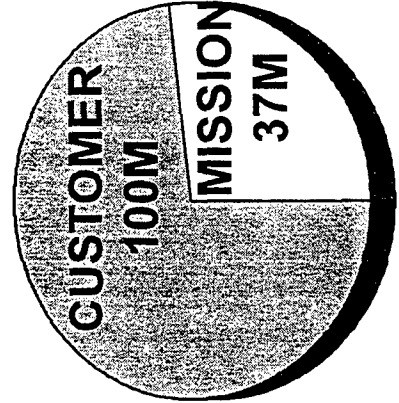

**Total 137M**

**Night Vision and Electronic Sensors**

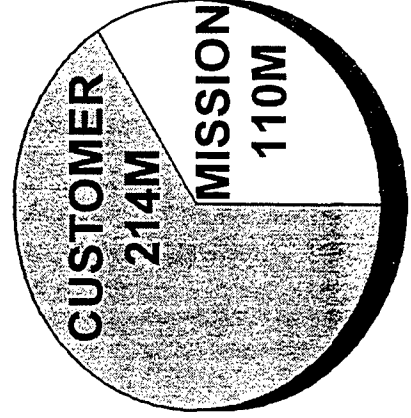

**Total 324M**

# NOTES

# INTELLIGENCE AND ELECTRONIC WARFARE DIRECTORATE



**DR. RICHARD A. POISEL**  
**DEPUTY DIRECTOR**

**UNCLASSIFIED**

14 May 1997

POINT PAPER

SUBJECT: Intelligence and Electronic Warfare Technology

OBJECTIVE: To provide information on the CECOM Intelligence and Electronic Warfare Directorate's (IEWD's) interest and contract opportunities in the areas of Intercept Technology, Electronic Warfare Technology and Tactical Intelligence Data Fusion Technology.

FACTS: IEWD is developing the technologies necessary for U.S. Army systems to locate and exploit hostile command, control, communications and electronic systems; and, to process, analyze and report battlefield intelligence.

This briefing describes the technology programs that support these three areas. It also provides general timelines for industry involvement and current funding ranges.

BRIEFER: Dr. Richard A. Poisel, AMSEL-RD-IE-DD, telephone no. 908-427-5556, DSN 987-5556.

ACTION OFFICER:

Linda Monroe

GS-9/PA

Technology Transfer Coordinator

Commercial (703)349-7370

DSN 229-7370

# NEW TECHNOLOGY

# STRATEGY

- **Develop effective exploitation techniques that offer significantly improved capabilities for application against modern communications and radar signals**
- **Develop and demonstrate a capability to deny, disrupt, degrade, and deceive Command and Control (C2), and information systems**
- **Enable Joint Forces to wage a proactive, offensive information warfare against an enemy's C2 information infrastructure**

## **STRATEGY (continued)**

- **Provide the Warfighter with an accurate and timely intelligence/information picture. Enhance Information Warfare planning and assessment capability in support of military operations**

# **FOCUS**

## **ATD's**

**(Pending) Command and Control (C2)  
Attack/Protect for Information Operations**

## **STO's**

**(Approved) ORION  
Tactical Intelligence Data Fusion**

**(Approved) Digital Communications Electronic  
Attack (EA)**

**(Approved) C2 Attack/Protect for Information  
Operations**

**(Approved) Modern Network C2 Attack**

## **FOCUS (continued)**

### **STO's (con't)**

- (Approved) Information Warfare On-The-Move**
- (Approved) Non-Communications Electronic Support/Electronic Attack (ES/EA)**
- (Pending) Intelligence Data Integration and Correlation**
- (Pending) Remote EA Methods**
- (Pending) Advanced Signal ES/EA Techniques**

# INITIATIVES

- **Improved geo-location of advanced communications and non-communication signals**
- **Wideband modulation exploitation**
- **Develop electronic attack capabilities against modern analog and digital C2 and information systems**
- **Conduct research to enhance techniques to perform electronic attack against radars**
- **Seamless multimedia database-to-database interface (DB2I)**
- **Advanced sensor placement**

# *Technology Challenges in Electronic Support/Signal Intelligence*

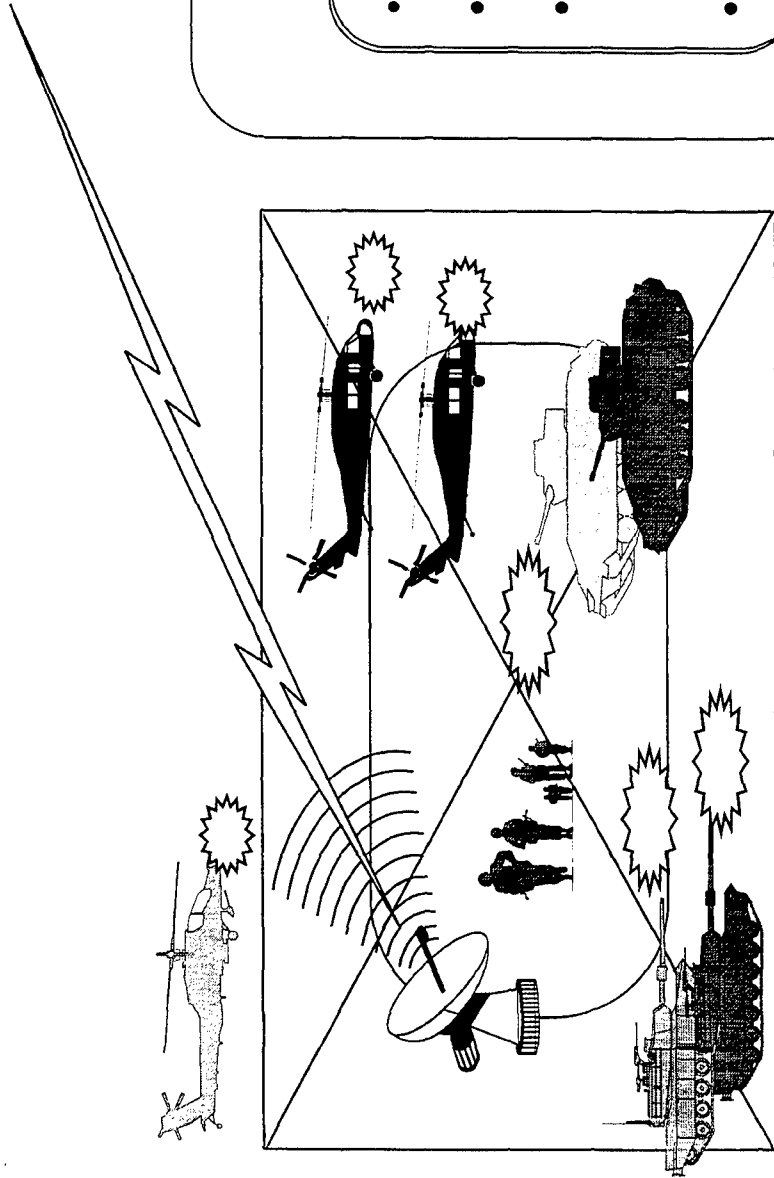
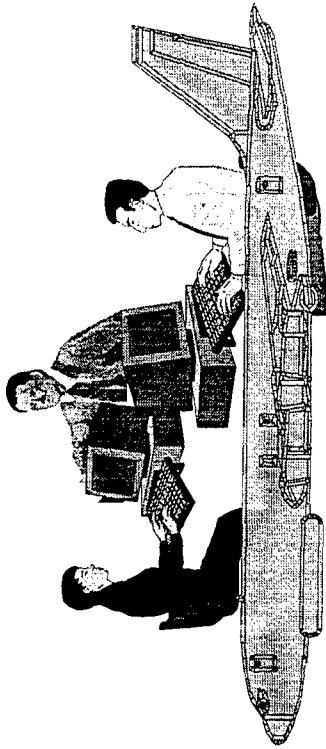

- **COMINT & ELINT**
- **Exploit modern signals**
- **Improve geo-location accuracies**
- **Automate process**

# **CONTRACT OPPORTUNITY**

- **Title: Electronic Support/Signal Intelligence**
- **Techniques**
- **Objectives:**
  - **Improve direction finding accuracies**
  - **Exploitation of modern signals**
  - **Automate the signal intercept process**
- **Type: CPEFF contracts from BAA & SBIR solicitations**
- **Schedule: Award dates: FY98-02**
- **Estimated Value: \$500K to \$1M per year thru FY02**
- **Technical POC: Bruce Bennett (540) 349-7324**
- **Contract POC: Greg Landon/908-532-4346**

# Technology Challenges in Command and Control Attack

## Communications and Non-Communications Antennas and Receivers

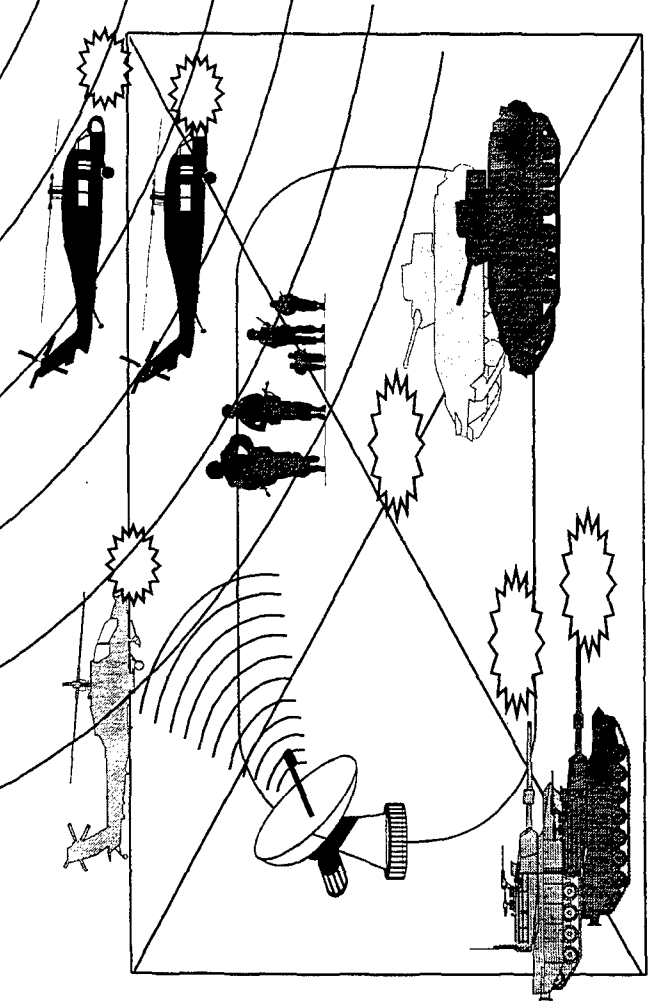
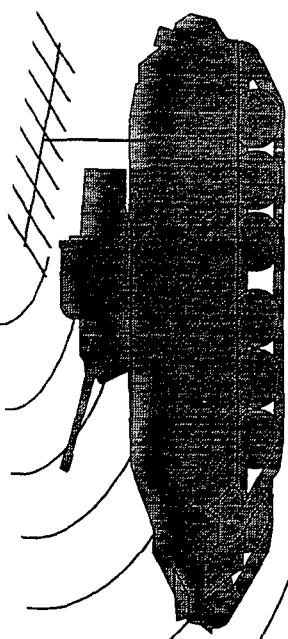

- Attack modern signals
- Electronic deception
- Friendly comms compatibility

## **CONTRACT OPPORTUNITIES**

- **Title: Command and Control Attack Techniques**
- **Objectives:**
  - **Electronic attack against new signals**
  - **Application of breakthrough technologies for electronic attack techniques against C2 and information systems**
- **Type: CPEFF contracts from BAA & SBIR solicitations**
- **Schedule - Award dates: FY98-02**
- **Estimated Value: \$1M to \$2M per year through FY02**
- **Technical POC: Bruce Bennett (540) 349-7324**
- **Contract POC: Greg Landon/908-532-4346**

# C2 ATTD OBJECTIVE

## C2 Attack

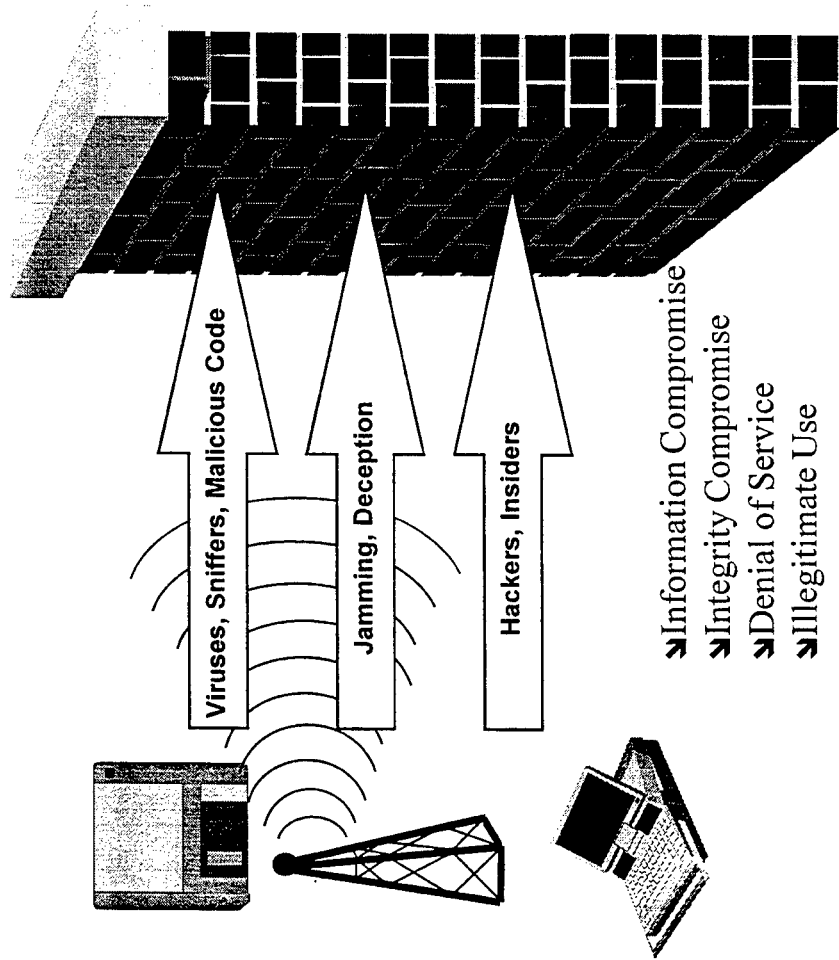

## C2 Protect

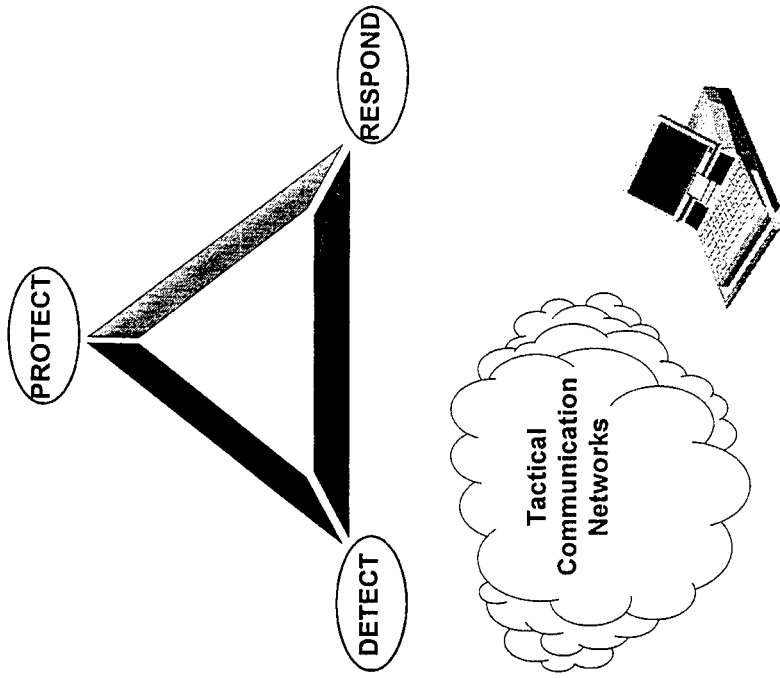

# **C2 ATD OBJECTIVES**

## **PROTECT**

- **Provide an effective security architecture for the Tactical Internet**
- **Utilize the emerging C2 Attack capabilities to continually improve the security architecture**

# **C2 ATD OBJECTIVES**

## **ATTACK**

- **Develop/Leverage COTS, GOTS, HW/SW attack tools, methods and techniques to identify/quantify the vulnerabilities of the tactical internet and First Digitized Division Systems/Networks**
- **Develop, Integrate and demonstrate C2 Attack Operational Capabilities against threat Tactical Information Systems and components**

# **C2 ATD OBJECTIVES**

## **ATTACK (continued)**

- **Develop and Demonstrate Attack capabilities against friendly Tactical Systems and Networks to validate the Security Measures/Tools developed under the C2 Protect portion of the ATD**
- **Identify TTPs and engineering strategies for developing a unified Information Warfare attack system.**

# *Technology Challenges in Data Fusion/Dissemination*

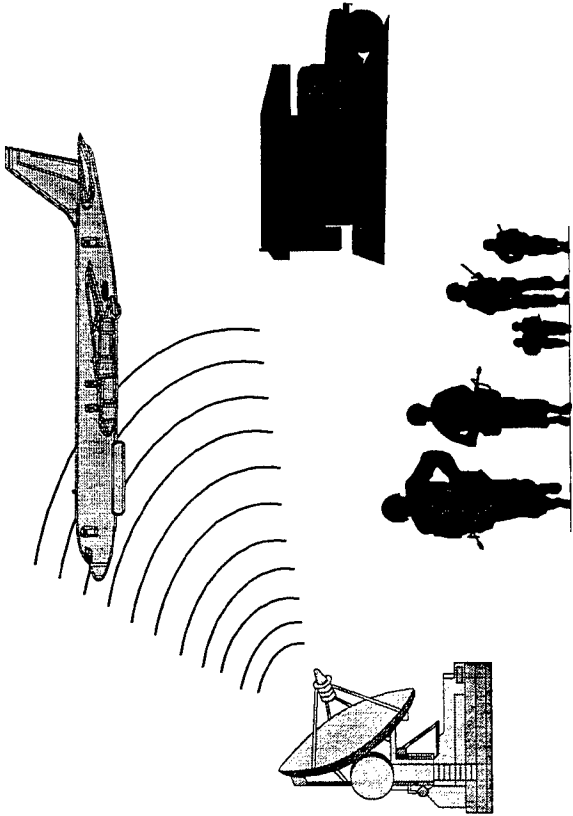
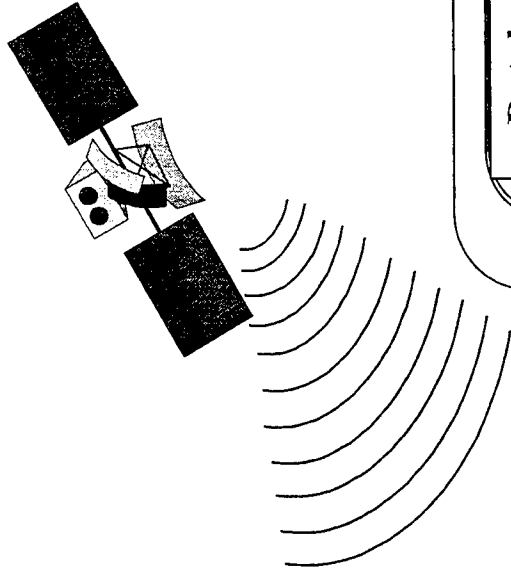
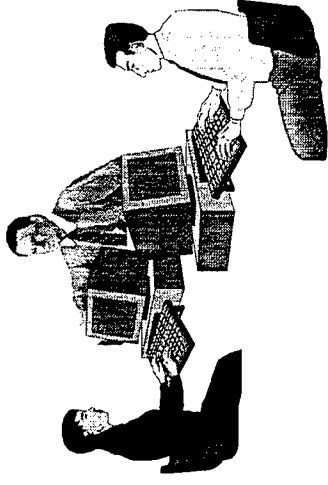

- Database to database interface
- Collector/jammer placement
- Moving Target Indicator/SIGINT Fusion
- Graphical overlay set operation generation
- Battlefield damage assessment

# **CONTRACT OPPORTUNITIES**

- **Title: Data Fusion/Dissemination Techniques**
- **Objectives:**
  - Automate the intelligence generation process
  - Situation, Threat and Process Refinement
  - Improve situational awareness
  - Efficient intelligence database management techniques
- **Type: CPFF contracts from BAA & SBIR solicitations**
- **Schedule: Award dates - FY98-02**
- **Estimated Value: \$1M to \$2M per year through FY02**
- **Technical POC: Bruce Bennett (540) 349-7324**
- **Contract POC: Greg Landon/908-532-4346**

# FUNDING PROFILE

## APPROX AMOUNT

(\$ IN MILLIONS)

YEAR TITLE

-----  
FY98-99 Electronic Spt/Signal Intell 2

FY98-99 C2 Attack 1

FY98-99 Data Fusion/Dissemination 2

-----  
TOTAL 5

# NOTES

NIGHT VISION AND ELECTRONIC  
SENSORS DIRECTORATE

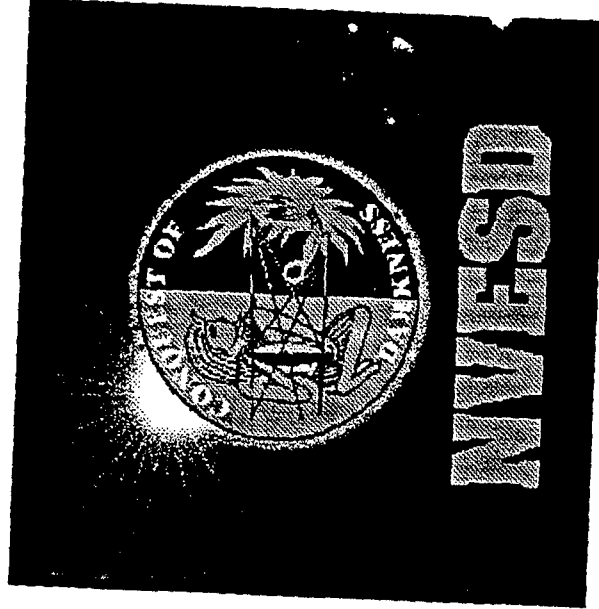
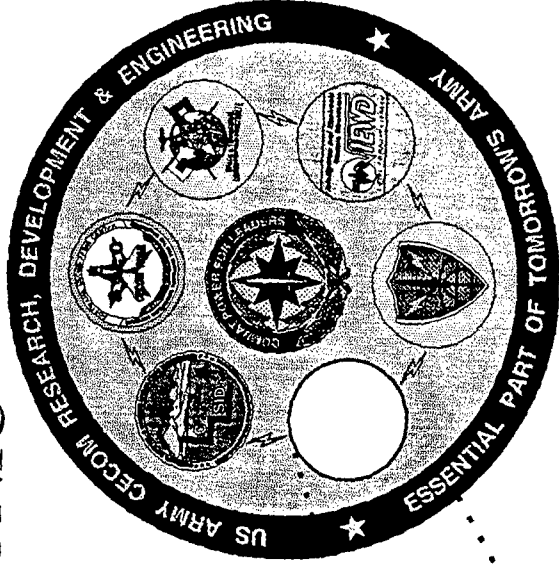

MR. LARRY L. FILLIAN  
DEPUTY DIRECTOR

UNCLASSIFIED

15 May 1997

## POINT PAPER

**SUBJECT:** Night Vision Electronic Sensors Technology Initiatives

**OBJECTIVE:** To provide information on CECOM Night Vision Electronic Sensors Directorate's (NVESD's) interest and contract opportunities in the areas of Electro-Optics, Aided Target Recognition/Sensor Fusion, Protection Suites, and Advanced Signature Management and Deception.

**FACTS:** NVESD is developing the technologies required for U.S. Forces to see and acquire enemy forces in the most challenging of battlefield conditions and environments; to provide full spectrum situational awareness, protection, targeting and combat ID assist against enemy guided/smart weapon systems; to develop lightweight, eyesafe lasers for use in micro-rangefinders, low cost ladars, combat ID and obstacle avoidance; and to develop affordable electro-optical sensors and sensor suites providing improved multi-functional capabilities of existing and new manned/unmanned weapon system platforms for ground, air and individual soldier applications.

Systems included in this briefing are the Solid State Near IR Sensors (SSNIRS), Integrated Situational Awareness and Countermeasures (ISACM) proposed, Low Cost EO/IR Countermeasures (EO/IR) proposed, Multi-Function Staring Sensor Suite (MFS3), Micro Eyesafe Solid State Laser Sources proposed, Lightweight, Airborne Multi-Spectral Countermine Detection System, and the Mine Hunter/Killer (MH/K) systems. Of these systems, MFS3 and SSNIRS are approved as-is, however, changes may underway for the ISACM and EO/IR programs. The briefing describes the technology programs that support these areas and provides general time lines for industry involvement and current funding ranges.

**BRIEFER:** Mr. Larry L. Fillian, Deputy Director, NVESD, AMSEL-RD-NV-AO-PM, (703) 704-1168, DSN 654-1168.

**ACTION OFFICER:**  
Keith Dugas  
Technical Planning Branch  
(703) 704-1200  
DSN 654-1200

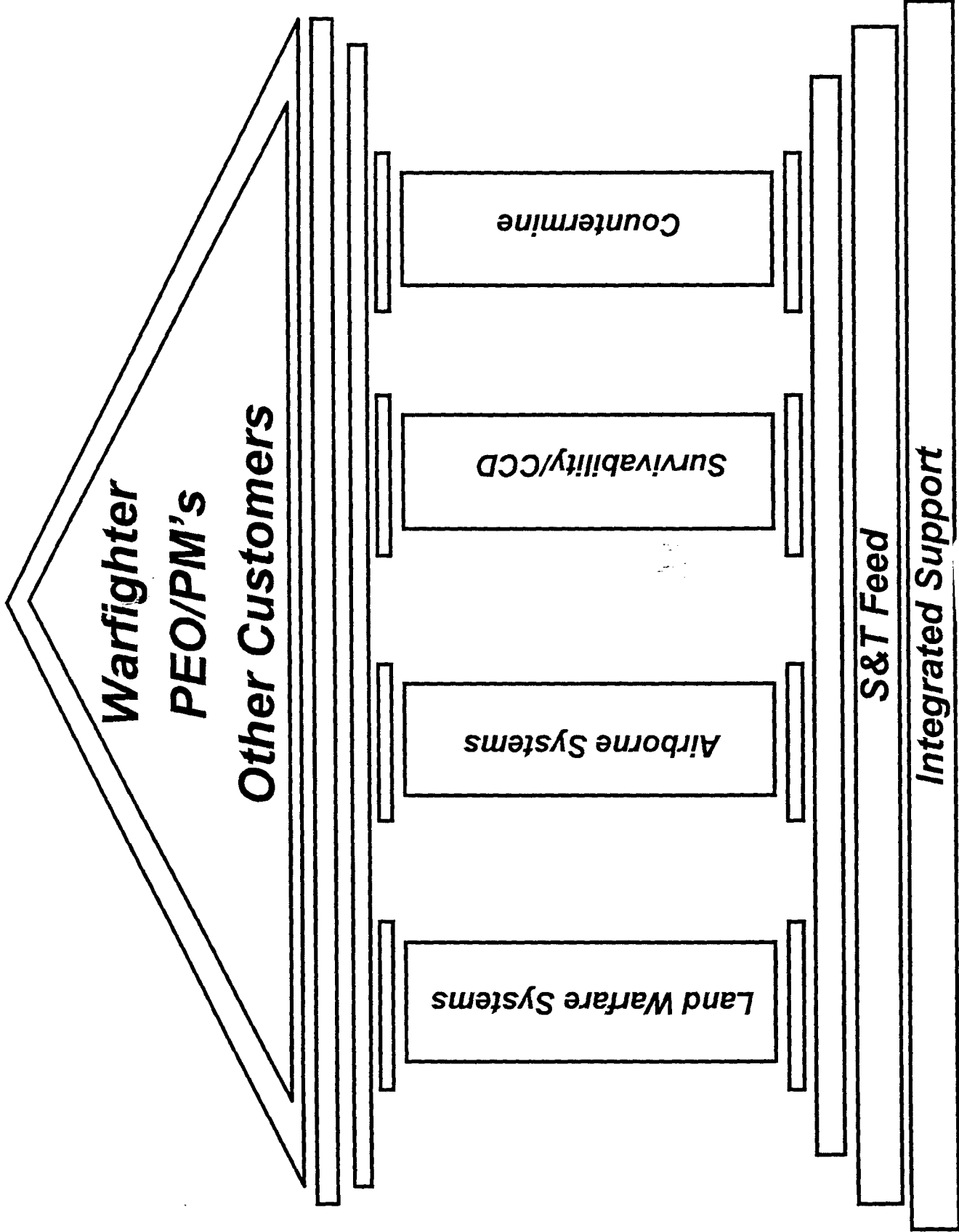

# Sensor Focus

## TECHNOLOGY

- RADAR
- ELECTRO/OPTICAL
- LASERS
- INFRARED/MULTI/HYPERSPECTRAL
- IMAGE INTENSIFICATION
- ACOUSTIC/SEISMIC
- MAGNETIC
- AROMATIC
- IMAGE TRANSMISSION
- SENSOR FUSION
- DISPLAYS
- AIDED TARGET RECOGNITION
- SIGNATURE/BACKGROUNDS
- TRANSMISSION/OBSCURATION
- MODELING & SIMULATION

## SYSTEMS & APPLICATIONS

### EXPLOIT

- BISTATIC RADAR
- II GEN FLIR
- JCM/ACTD
- ADVANCED I2
- ADV HELICOPTER PILOTAGE
- RFPI (HSS/RS)
- FSCV
- UAV (ASSI, MULTI MISSION RADAR)
- UGV
- RISTA
- TESAR
- TARGET ACQ (MFLS, MTI RADAR)
- EISS

### ACTIVE

- RF JAM (ATRJ)
- ATIRCM
- LICM
- STINGRAY
- TLOS
- SHORTSTOP

### PASSIVE

- CHEAP SUIT
- JASE
- LASER WARNING
- RF WARNING
- IR WARNING

# Program Implementation Strategy

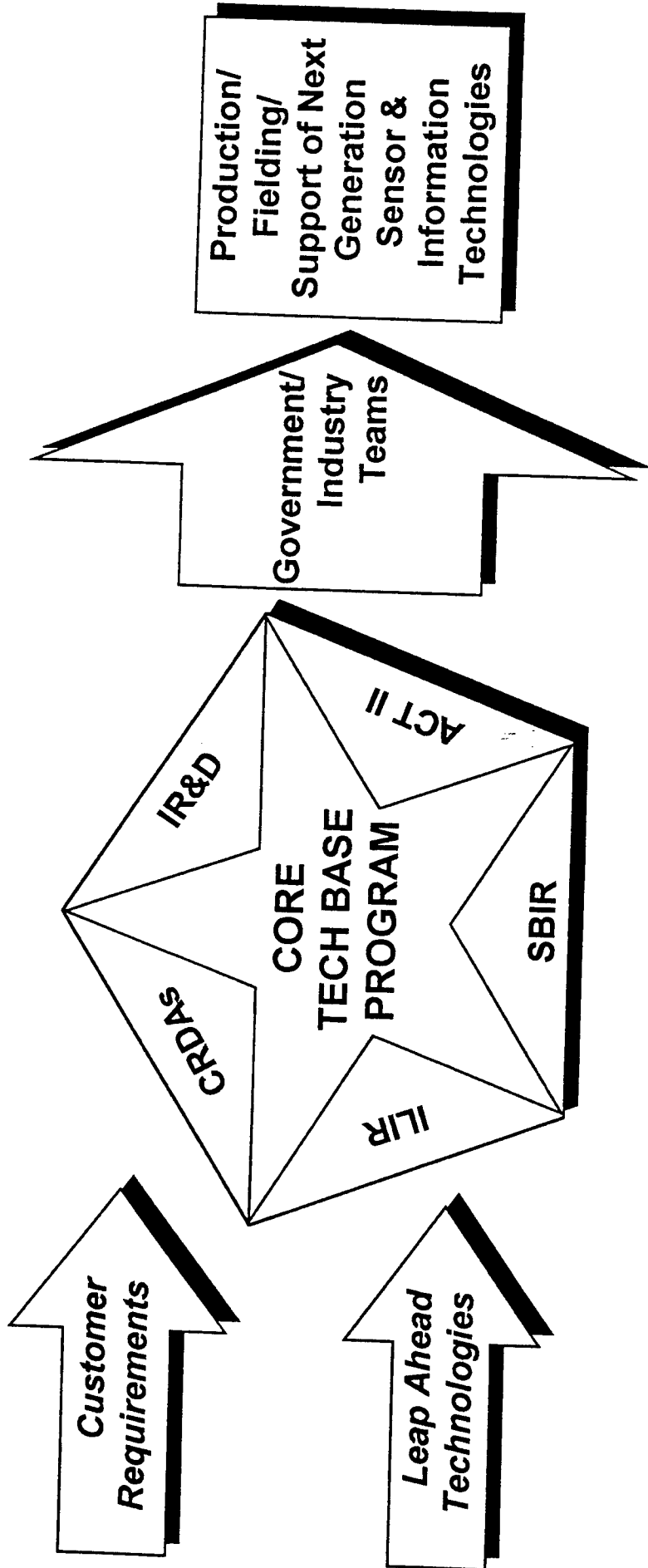

# **SOLID STATE NEAR IR SENSORS**

**US Army Communications-Electronics  
Command, Research, Development and  
Engineering Center, Night Vision and  
Electronic Sensors Directorate**

**UNCLASSIFIED**

# **DEFINITION**

## **SOLID STATE NEAR IR SENSORS**

- A low cost, light weight, low light level sensor that is exclusively solid state
- High resolution sensors that “see” radiation in the 0.8 - 1.8 micron spectral region
- Systems to support airborne, combat vehicle and infantry missions

# **STATUS**

## **SOLID STATE NEAR IR SENSORS**

- **Approved Science and Technology Objective (STO) for FY98 Exploratory Development**
- **Modernization / JWS&T Plan / DTAP Objectives Supported**
  - **JWS&T Plan - MOUT**
  - **Dominant Maneuver**

# **OBJECTIVES**

## **SOLID STATE NEAR IR SENSORS**

- 50% Reduction in Size and 25% Reduction in Weight vs Conventional I<sup>2</sup>/CCD Devices
- Greatly Reduced Blooming Artifacts
- Capable of Detecting Conventional Camouflage
- Solid State -- Low Life Cycle Costs

# SOLID STATE NEAR IR SENSORS

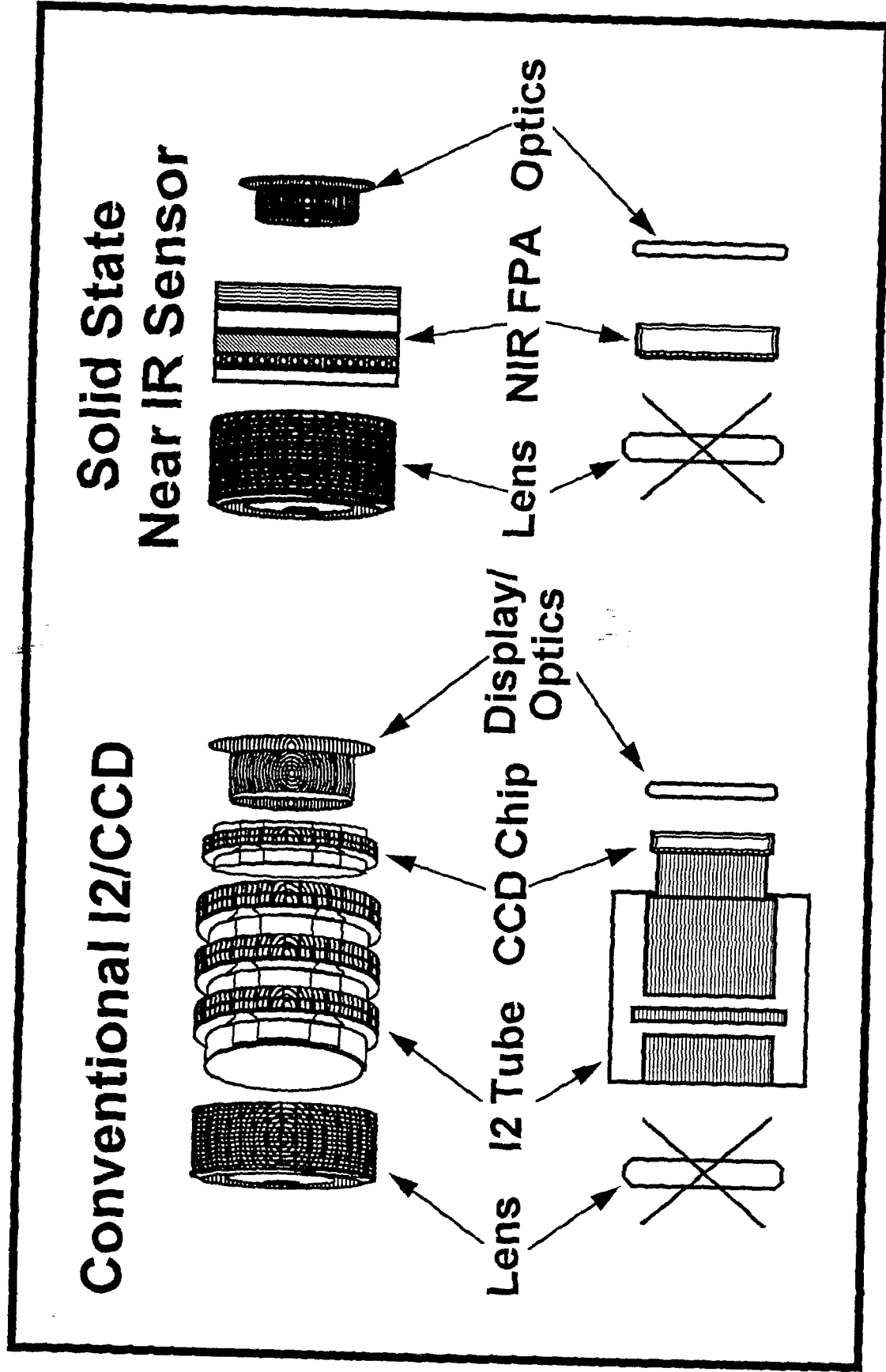

# **APPROACH**

## **SOLID STATE NEAR IR SENSORS**

- **Develop active/passive devices to protect air/ground vehicles from EO/IR guided threats**
- **Focus on sources/optics, pointing/tracking, missile plume and laser sensors including advanced jamming techniques against missiles**
- **Emphasis on integration of EW architecture infused with low cost NDI technology**

# **CONTRACT OPPORTUNITY**

**TITLE:** Solid State Near IR Sensors

**OBJECTIVE:** Low Light Sensors in the 0.8 - 1.8 Micron Waveband

**PROPOSED CONTRACT TYPE:** Cost Plus Award Fee

## **KEY MILESTONES:**

Award	2QFY99
Integration	2QFY01
Demonstration	4QFY01

**ESTIMATED VALUE:** \$14M - \$18M

**TECH POC/TEL:** Phil Perconti / (703) 704-1369

**CONTRACT POC/TEL:** Bill Applegate (908) 532-3508

# **Integrated Situational Awareness & Countermeasures (ISACM)**

**US Army Communications-Electronics  
Command, Research, Development and  
Engineering Center, Night Vision and  
Electronic Sensors Directorate**

**UNCLASSIFIED**

# **DEFINITION**

## **ISACM**

**An integrated modular multispectral RF, IR, EO, Laser warning electronic combat suite for Army Aviation with subsets for ground vehicles providing situational awareness, targeting, protection and combat ID assist with real time C4I links between air, ground vehicles and fusion centers.**

# **STATUS**

## **ISACM**

- **FY97 - Request for FY99 STO and ATD has been submitted for approval**
- **Use Integrated Concept Team (ICT)**
  - **Previous Sister Program, RD&J transitioned 100% into PM-AEC's ALQ-211**
  - **Project Arrangement with a foreign government in process, to include engineer resident in US**
  - **Program includes research pull from IEWD, DARPA, Wright Labs, NRL and AAT**

# **OBJECTIVES**

## **ISACM**

- Defeat the next generation of threats that use multispectral sensors, advanced processing and integrated air defense
- Precision Emitter Geolocation & Specific Emitter Identification for Situational Awareness, Targeting and Combat ID Assist (<2% range)
- Combine RF, Missile and Laser Warning Sensors to maximum practical extent
- Reduce installed sensor/A-kit weight by 50% and increase MTBF 200%

# ISACM

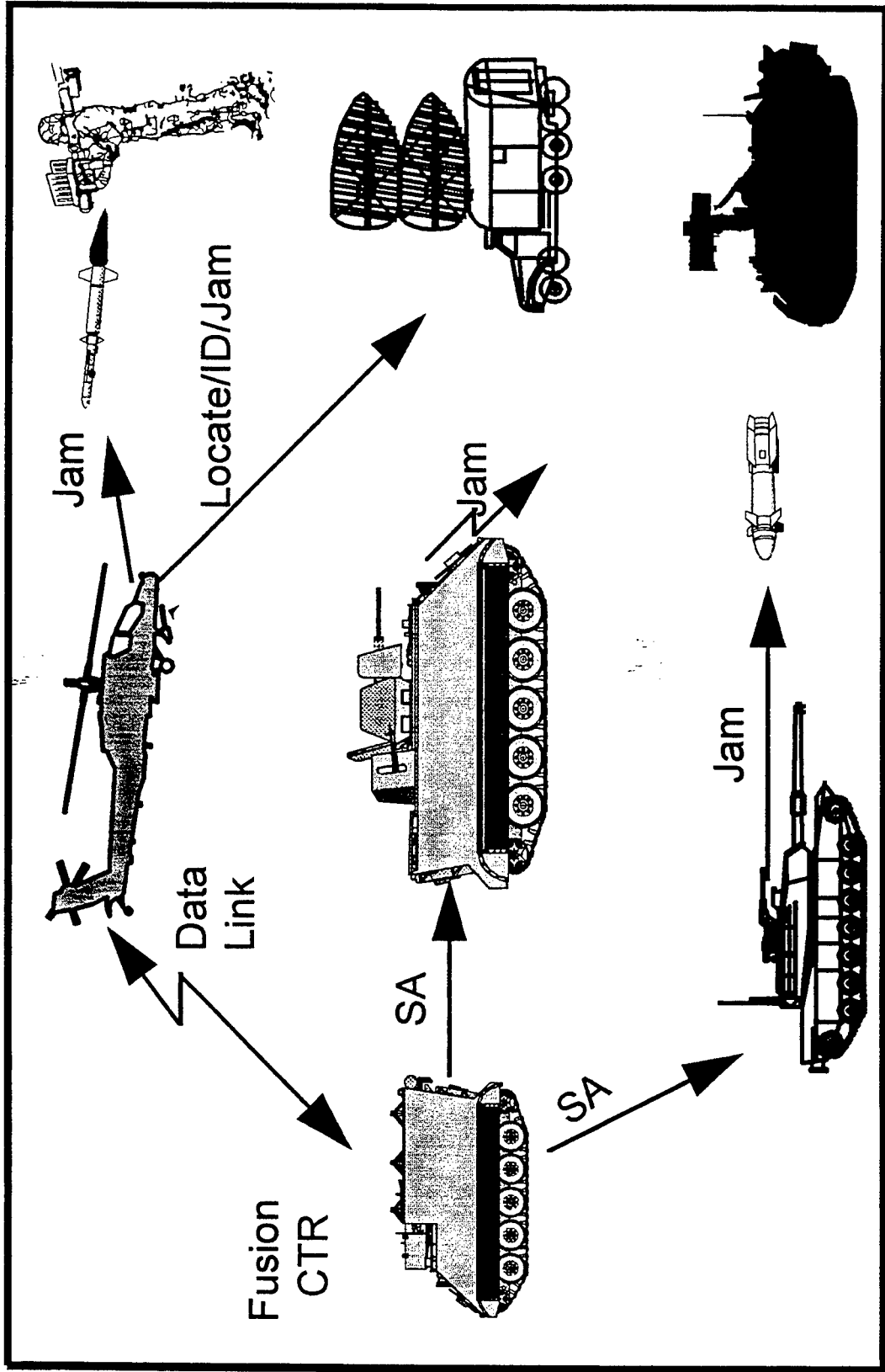

# **APPROACH**

## **ISACM**

- Modular updates to ALQ-211, 212 and AVR-2A and tied to PM-AEC's Upgrade Program.
- Update CECOM DIL/SIL, link to Ft. Rucker / Ft. Knox simulators and conduct distributed interactive simulation development as one integrated PM, User, CECOM Team!
- Install in aircraft and ground vehicles and conduct field testing, transition to EMD.

# **CONTRACT OPPORTUNITY**

**TITLE:** ISACM

**OBJECTIVE:** Demonstrate an Integrated Modular Multispectral RF, IR, EO Laser warning combat suite for Army Aviation and ground vehicles

**PROPOSED CONTRACT TYPE:** TBD

## **KEY MILESTONES:**

- Award 1QFY99
- Integration 2QFY02
- Demonstration 1QFY03

**ESTIMATED VALUE:** \$20M - \$25M

**TECH POC/TEL:** Robert Zanzalari / (908) 427-4676

**CONTRACT POC/TEL:** Bill Applegate (908) 532-3508

# **Low Cost EO/IR Countermeasures**

**US Army Communications-Electronics  
Command, Research, Development and  
Engineering Center, Night Vision and  
Electronic Sensors Directorate**

**UNCLASSIFIED**

# **DEFINITION**

## **Low Cost EO/IR CM**

### **Low Cost EO/IR CM:**

**Active/passive countermeasure devices to protect Army aircraft and ground vehicles from EO/IR guided threats.**

### **Components:**

**Laser sources, non-mechanical beam steering, multi-spectral missile warning and advanced EW techniques against imaging and multi-spectral IR/EO/UV missiles.**

# **STATUS**

## **Low Cost EO/IR CM**

- **Proposed Science and Technology Objective (STO) for FY99 - 03 Technology Base Program (6.2)**
- **Planned Transition to FY02-05 CAGES ATD**

# **OBJECTIVES**

## **Low Cost EO/IR CM**

- **Design and develop missile warning, laser and point/track brassboards**
- **Develop threat models and SIL capability to support EW technique development**
- **Assemble concept demonstration hardware**
- **Conduct captive seeker and live fire tests vs advanced threats.**

# Low Cost EO/IR CM

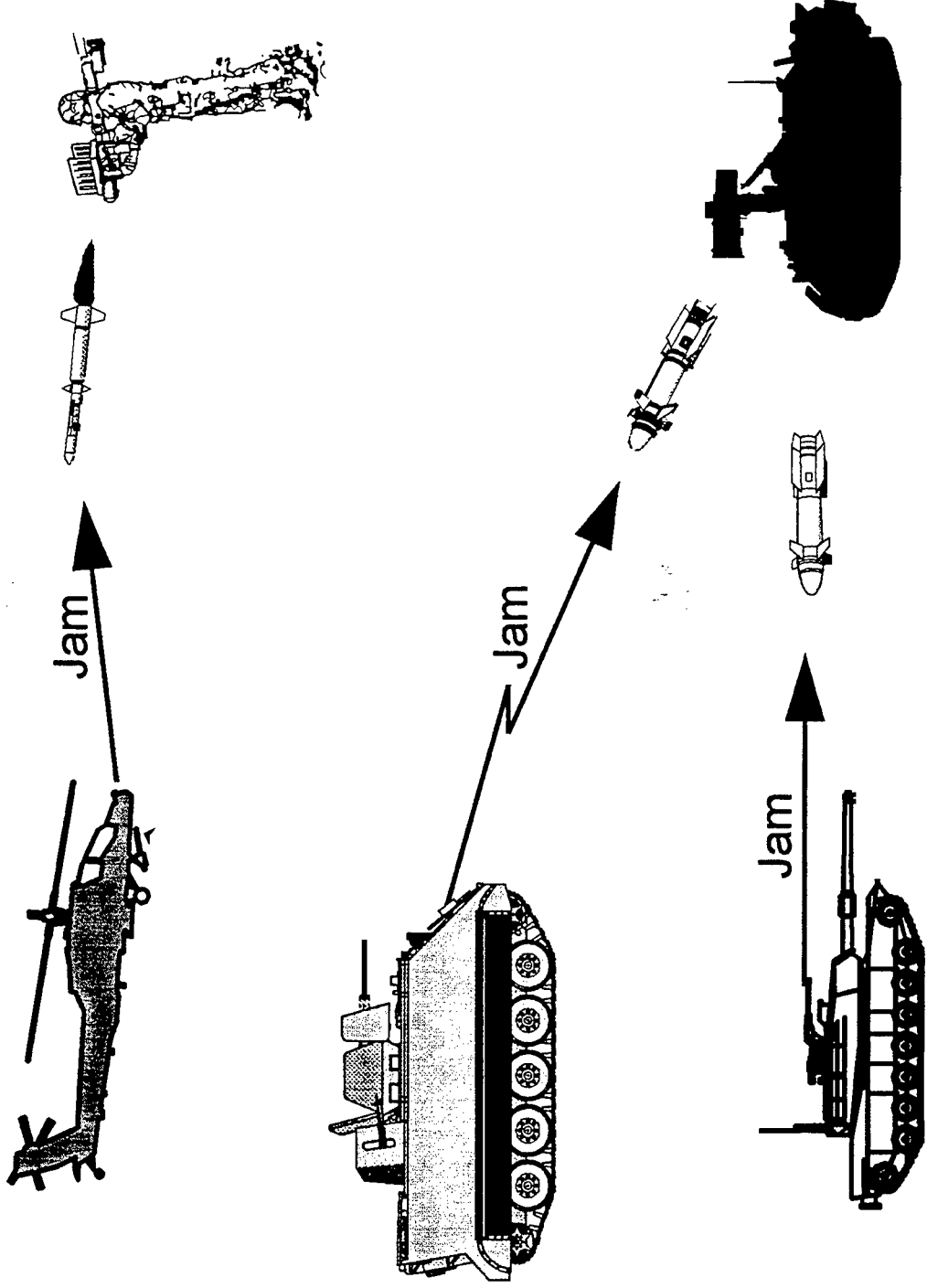

# APPROACH

## Low Cost EO/IR CM

- Innovative approach needed for imaging and beamrider threats
- Horizontal technology integration across air and ground platforms
- Address low cost sensor and source technology for:
  - Future Scout, Cavalry Vehicle
  - Future Infantry Vehicle

# **CONTRACT OPPORTUNITY**

**TITLE:** Low Cost EO/IR Countermeasures

**OBJECTIVE:** Advanced Technology for ground and aircraft self-protection systems

**PROPOSED CONTRACT TYPE:** BAA

## **KEY MILESTONES:**

Award	1QFY99
Non-mechanical Beam Steering	2QFY99
Multi-band laser	2QFY99
Multi-spectral missile warning	2QFY00

**ESTIMATED VALUE:** \$18M - \$22M

**TECH POC/TEL:** Joe O'Connell / (908)427-4870

**CONTRACT POC/TEL:** Bill Applegate (908) 532-3508

**MULTI-FUNCTION STARING SENSOR SUITE  
(MFS3)**

**US Army Communications-Electronics  
Command, Research, Development and  
Engineering Center, Night Vision and  
Electronic Sensors Directorate**

**UNCLASSIFIED**

# **DEFINITION**

## **MULTI-FUNCTION STARING SENSOR SUITE (MFS3)**

- A modular, reconfigurable, suite of advanced sensors for non-cooperative target ID, mortar/sniper location, and air defense for ground vehicles
- System to support the Future Scout Cavalry System, Bradley Stinger Fighting Vehicle-Enhanced, Future Infantry Vehicle, and the Reconnaissance Surveillance and Target Acquisition Vehicle

# **STATUS**

## **MULTI-FUNCTION STARING SENSOR SUITE (MFS3)**

- Approved Science and Technology Objective (STO) and Advanced Technology Demonstration (ATD)
- Scheduled for FY98 Start

# **OBJECTIVES**

## **MULTI-FUNCTION STARING SENSOR SUITE (MFS3)**

- **Demonstrate a modular, reconfigurable Multi-Function Staring Sensor Suite that integrates multiple advanced sensor components**
- **Provide ground vehicles and amphibious assault vehicles with a compact, affordable, sensor suite for long range non-cooperative target ID, mortar/sniper fire location and air defense against low signature targets**

# MULTI-FUNCTION STARING SENSOR SUITE (MFS3)

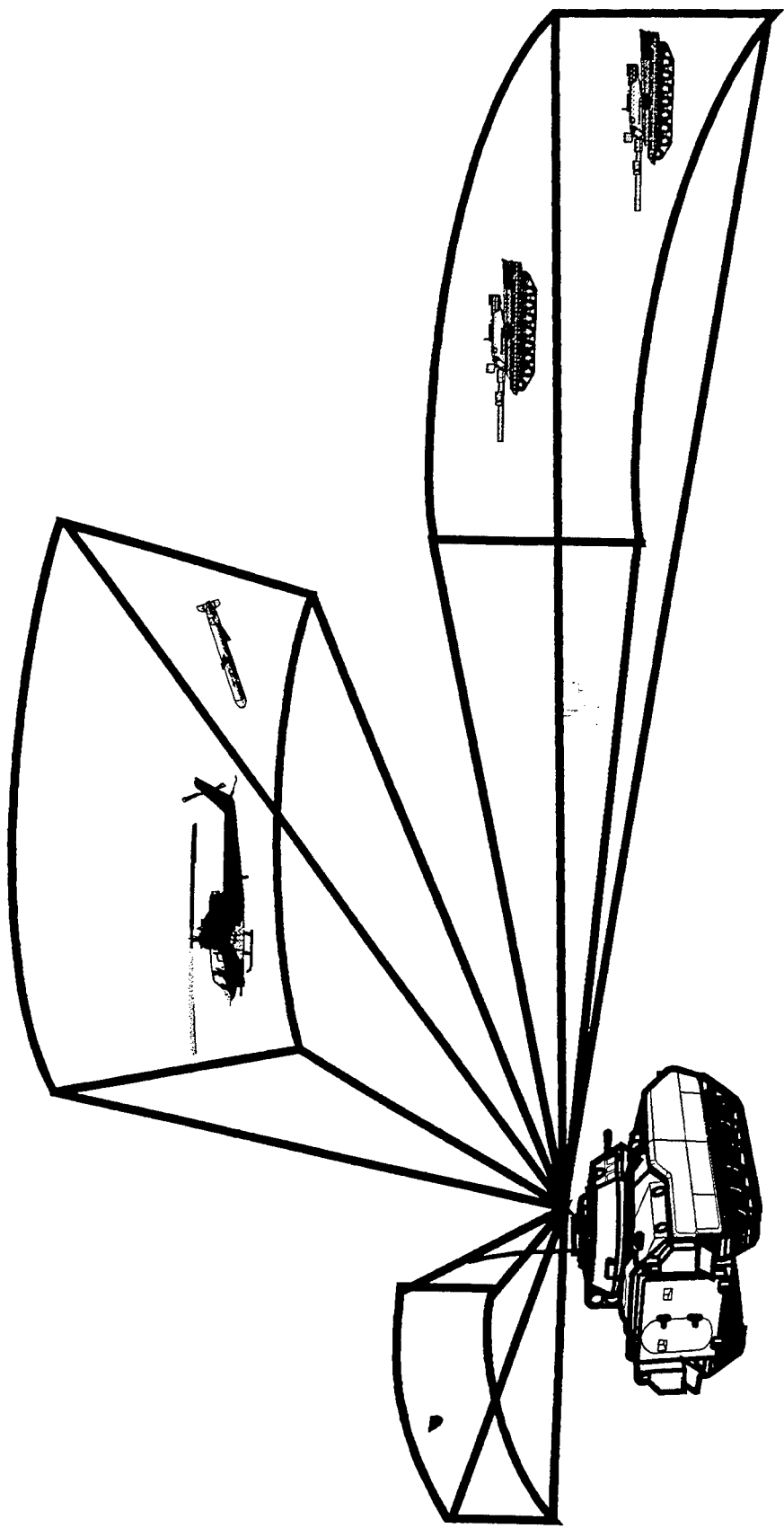

# **APPROACH**

## **MULTI-FUNCTION STARING SENSOR SUITE (MFS3)**

- Confirm Sens/Res Goals with Modeling, Simulation, and Early Field Tests
- Develop Modular Sensor Backplane to Accommodate Multiple Sensor Interfaces
- Demonstrate Reconfigurable Sensor with ATR in an Operational Environment
  - Staring FLIR
  - Multifunction Laser
  - Acoustic Cueing Sensors

# **CONTRACT OPPORTUNITY**

**TITLE:** Multi-Function Sensor Suite (MFS3)

**OBJECTIVE:** Demonstrate a fully integrated multi-band target acquisition system

**PROPOSED CONTRACT TYPE:** Cost Plus Incentive Fees

## **KEY MILESTONES:**

Award	2QFY98
Integration	2QFY00
Demonstration	2QFY01

**ESTIMATED VALUE:** \$20M - \$25M

**TECH POC/TEL:** Paul Laster / (703) 704-3492

**CONTRACT POC/TEL:** Debbie Gilligan (908) 532-3508

# **Micro Eyesafe Solid State Laser Sources**

**US Army Communications-Electronics  
Command, Research, Development and  
Engineering Center, Night Vision and  
Electronic Sensors Directorate**

**UNCLASSIFIED**

# **DEFINITION**

## **Micro Eyesafe Solid State Lasers**

Low cost, lightweight lasers to benefit the warfighter for multiple applications including micro rangefinders, combat ID systems, training, vehicle obstacle avoidance, as well as compact devices for IRCM and munitions.

# STATUS

## Micro Eyesafe Solid State Lasers

- Proposed STO for FY99 Start
- Basic requirements identified
- Key technologies and concepts to be explored in FY98 internal program.

# **OBJECTIVES**

## **Micro Eyesafe Solid State Lasers**

- **Develop and demonstrate ultra compact solid state laser sources for use in micro-rangefinders, low cost ladars, combat ID and other applications where high peak power, low cost and light weight lasers are required.**

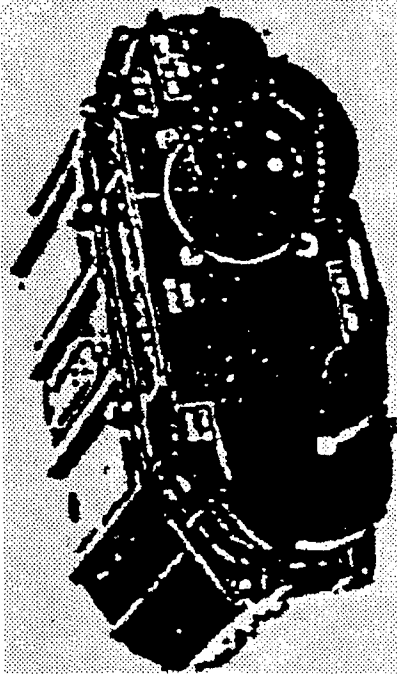

HANDHELD

COMPACT



MINI

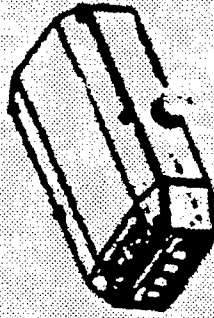

LASER RANGE FINDER DEVELOPMENT



MICRO

# APPROACH

## Micro Eyesafe Solid State Lasers

- Develop micro diode pumped solid state lasers with integral passive Q switches and OPO for low cost devices.
- Develop eyesafe laser diodes using improved materials, multiple quantum wells and carrier stopper layers for 10 times higher peak powers.

# **CONTRACT OPPORTUNITY**

## **Micro Eyesafe Solid State Lasers**

**TITLE:** Micro Eyesafe Solid State Laser Sources

**OBJECTIVE:** Develop low cost, ultra-compact solid state laser sources for multiple applications

**PROPOSED CONTRACT TYPE:** BAA, CPFF

**KEY MILESTONES:** Award 1QFY99

**ESTIMATED VALUE:** \$3M - \$4M

**POC:** Ward Trussell / (703) 704-1355

**CONTRACT POC:** Bill Applegate (908)532-3508

# **Lightweight, Airborne Multi-Spectral Countermine Detection System**

**US Army Communications-Electronics  
Command, Research, Development and  
Engineering Center, Night Vision and  
Electronic Sensors Directorate**

**UNCLASSIFIED**

# **DEFINITION**

## **Lightweight, Airborne Multi-Spectral Countermine Detection System**

An “on-the-move”, limited area (point) detection, route reconnaissance and identification of nuisance mines capability in support of the lightweight future tactical UAV (Unmanned Aerial Vehicle)

# **STATUS**

## **Lightweight, Airborne Multi-Spectral Countermine Detection System**

- New start FY98
- Sensor design requirements being defined

# **OBJECTIVES**

## **Lightweight, Airborne Multi-Spectral Countermine Detection System**

- Develop a lightweight, stabilized, airborne standoff mine detection sensor capable of being mounted on a tactical UAV
- Provide for limited area (point) detection, limited corridor route reconnaissance and detection of nuisance mines along roads

# **APPROACH**

## **Lightweight, Airborne Multi-Spectral Countermine Detection System**

- Utilize Airborne Standoff Minefield Detection Program technology investments
- Explore innovative concept and technology to support a lightweight airborne standoff mine detection capability
- Develop sensors and mine detection algorithm for integration on a tactical UAV

# **CONTRACT OPPORTUNITY**

## **Lightweight, Airborne Multi-Spectral Countermine Detection System**

**Objective:** Develop a lightweight sensor and mine detection algorithm

**Proposed Contract Type:** Cost plus incentive fee

**Key Milestones:** BAA 1QFY98 for exploring concepts and initiating follow-on sensor algorithm and component development

FY01 complete sensor and algorithm development

**Estimated Value:** \$7-15M (Including follow-on)

**POC Name/Phone:** Bob Barnard (703)704-1066

# **MINE HUNTER/KILLER**

**US Army Communications-Electronics  
Command, Research, Development and  
Engineering Center, Night Vision and  
Electronic Sensors Directorate**

**UNCLASSIFIED**

# **DEFINITION**

## **MINE HUNTER/KILLER**

Provide the Army with a reliable, forward looking, “on-the-move”, standoff detection and neutralization of landmines capability from a vehicular platform moving at tactical speeds

# **STATUS**

## **MINE HUNTER/KILLER**

- Started in FY96
- Captures Vehicle Mounted Mine Detector technology investments
- Modeling and analysis on-going
- Detection and Neutralization requirements being defined

# **OBJECTIVES**

## **MINE HUNTER/KILLER**

- **Develop an integrated system concept for autonomous forward-looking land mine detection and neutralization mounted on a tactical UGV**
- **Provide for on-the-move forward-looking detection and neutralization of mines at a safe standoff distance at maneuver speeds**

# MINE HUNTER/KILLER

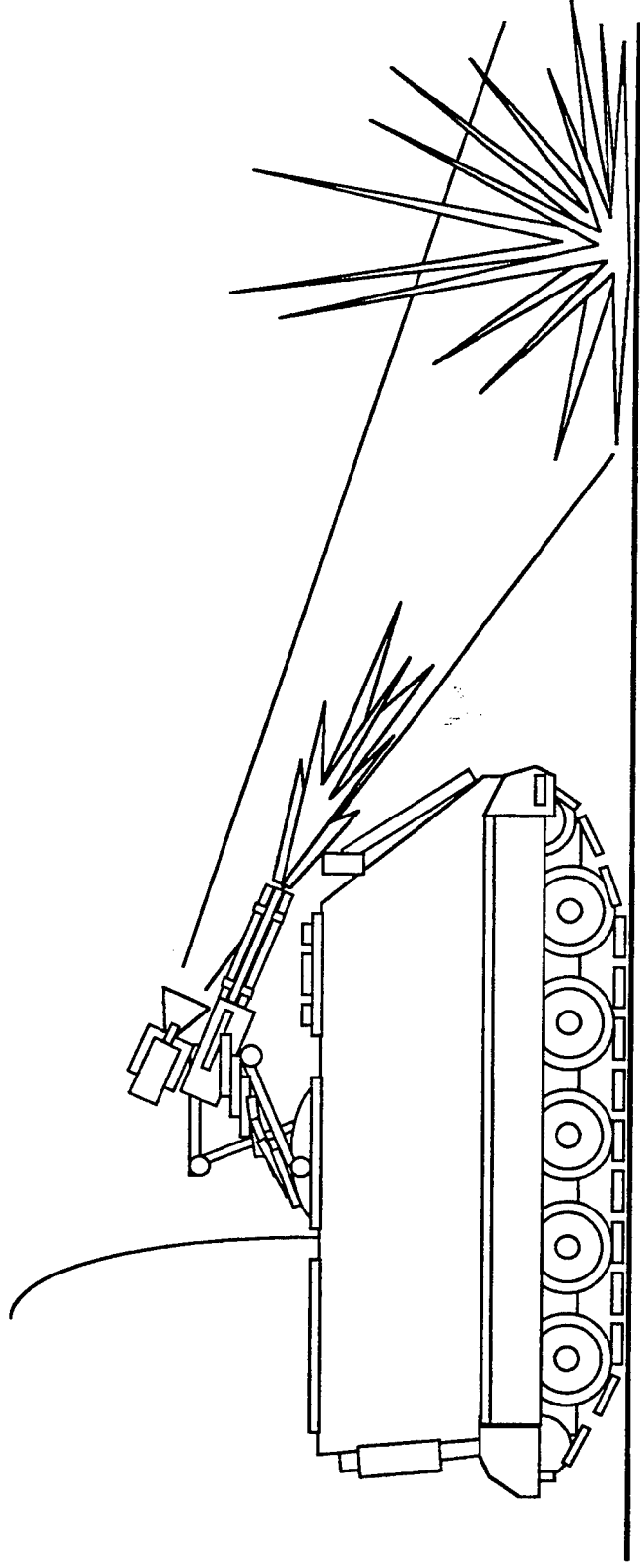

# APPROACH

## MINE HUNTER/KILLER

- Develop standoff neutralizers for individual buried and surface laid anti-tank mines
- Utilize developments in mobile platform weapons stabilization and fire control programs
- Combine fire control and neutralization technologies onto an existing military vehicle with desired mobility and compatibility with Army standard teleremote system
- Leverage stand-off mine detection technologies from the Vehicle Mounted Mine Detector (VMMD) / Ground - Standoff Mine Detection System (G-STAMIDS) Program

# **CONTRACT OPPORTUNITY**

## **MINE HUNTER/KILLER**

**Title:** Mine Hunter/Killer

**Objective:** Develop forward-looking detection, mine detection algorithm neutralizer device for land mines at maneuver speeds

**Proposed Contract Type:** Cost plus incentive fees

**Key Milestones:** Neutralization BAA 4QFY96

**Estimated Value:** \$6 - \$15M (Including follow-on)

**POC Name/Phone:** Ricky Stanfield (703) 704-2452

# NOTES

# Command, Control and Systems Integration Directorate



**George R. Oliva, Jr.**

Director

UNCLASSIFIED

POINT PAPER

SUBJECT: C2SID Overview for the APBI.

OBJECTIVE: To provide information on C2SID organization and contract opportunities in Command Control, Modeling Simulation and Power Sources.

FACTS: C2SID's strategy to efficiently meet mission requirements are to pursue Dual Use Technologies and to sponsor Small Business Innovative Research (SBIRs). The focus is on the following areas of technology:

- o Battlespace Command and Control
- o Battle Planning
- o Advanced Command, Control and Communications Performance Assessment
- o Navigation Technology for the Digital Battlefield
- o Battlespace Tactical Navigation
- o Advanced Lightweight Portable Power System
- o Silent Energy Sources for Tactical Applications

CONCLUSION: This briefing provides general requirements and current funding ranges for anticipated contracts.

BRIEFER: Mr. George R. Oliva, Jr., Acting Director, C2SID, AMSEL-RD-C2-D, (908) 427-4851.

Encl  
Briefing Charts

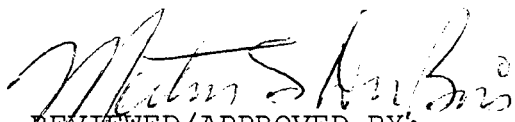
  
REVIEWED/APPROVED BY:  
MERTON S. DUBOIS  
Chief, Operations Division

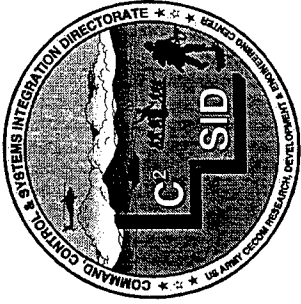

**COMMAND, CONTROL and SYSTEMS  
INTEGRATION DIRECTORATE  
STRATEGY**

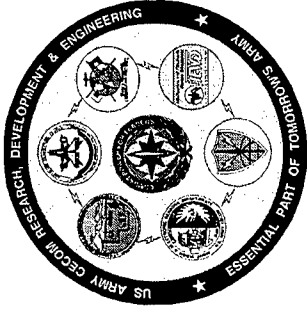

**Team with DARPA and Industry on:**

- Dual Use Technologies
  - Information Operations
  - Modeling and Simulation
  - Situation / Information Visualization
  - Distributed Multimedia Database Management System
- SBIR's

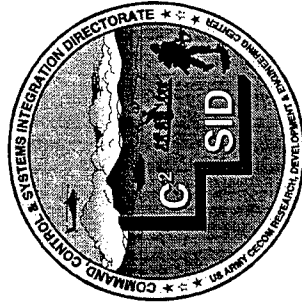

# COMMAND, CONTROL and SYSTEMS INTEGRATION DIRECTORATE



## ATD

- Battlespace Command and Control
- 

## STO's

- (Approved) • Battle Planning
- (Approved) • Advanced Command, Control and Communications Performance Assessment
- (Approved) • Navigation Technology for the Digital Battlefield
- (Pending) • Battlespace Tactical Navigation
- (Pending) • Advanced Lightweight Portable Power System
- (Pending) • Silent Energy Sources for Tactical Applications

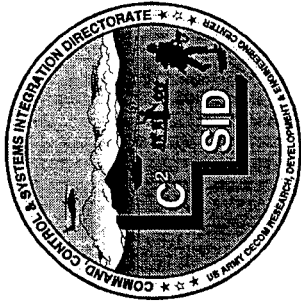

# COMMAND, CONTROL and SYSTEMS INTEGRATION DIRECTORATE **INITIATIVES**

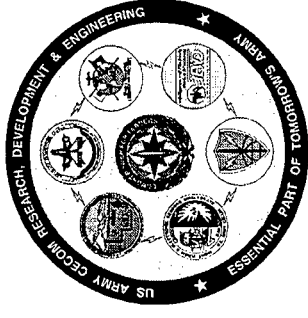

- Develop Advanced C2 Systems and Architecture Concepts
- Develop Advanced Battlefield Visualization and Mission Rehearsal Capabilities
- Develop Advanced Situational Awareness Capability in all Environments
- Develop Advanced Power Generation and Environmental Control Techniques

# Modeling and Simulation

## System Performance Model

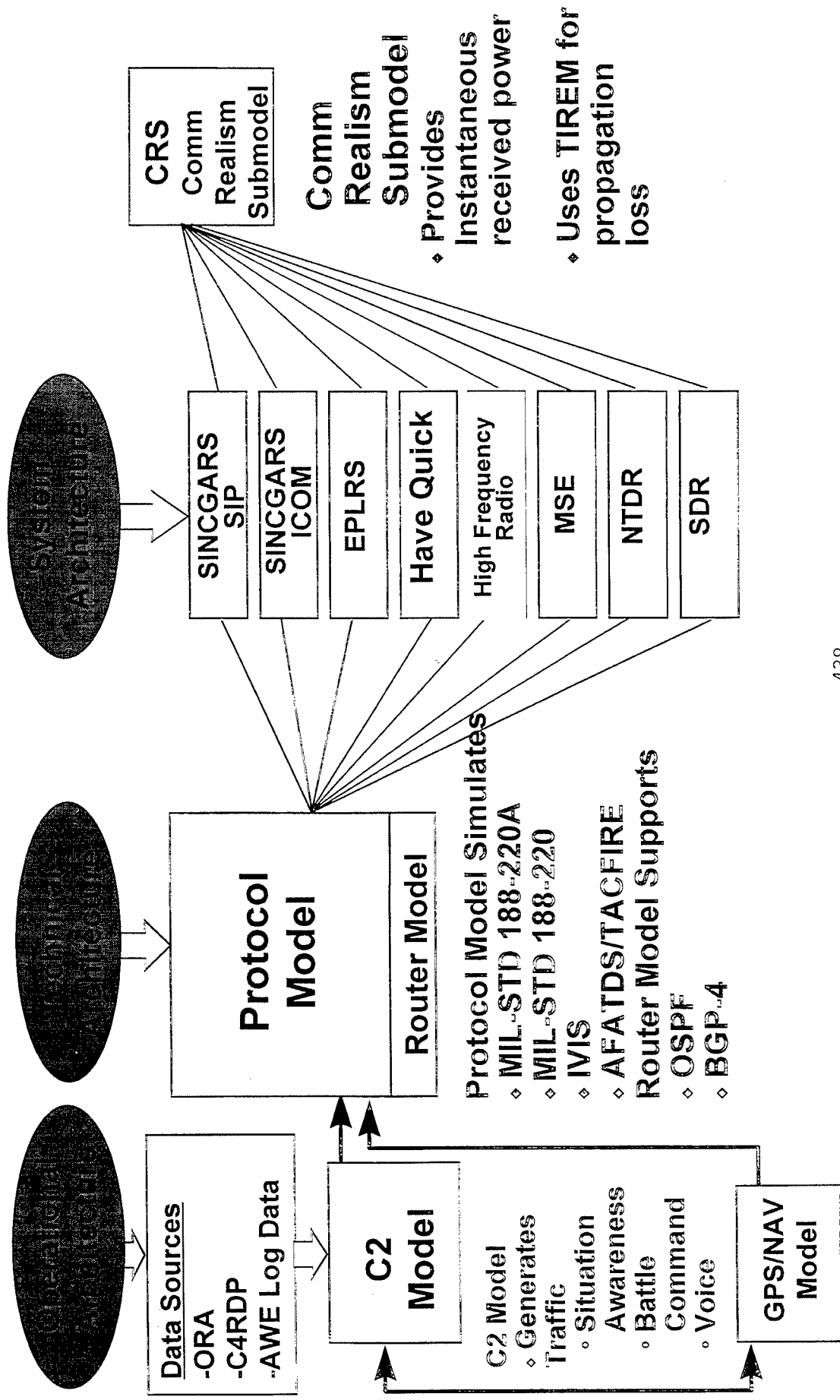

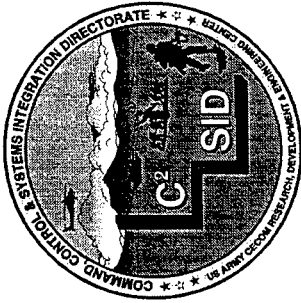

**COMMAND, CONTROL and SYSTEMS  
INTEGRATION DIRECTORATE  
CONTRACT OPPORTUNITY**

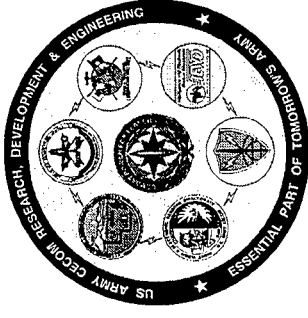

**Title:** Modeling and Simulation

**Objectives:**

- Provide Modeling and Simulation Tools to Expedite Transition of Emerging C3 Technology to the Field
- Employ Next Generation Performance Models (in OPTNET) to Optimize Battlefield Information Flow
- Provide Real-Time Models of Emerging Communications Systems that Support Man-in-the-Loop Evaluation, Experimentation and Realistic Training

**Type:** SBIR Solicitations (BAA)

**Award Dates:** FY98-01

**POC:** Chandu Sheth; (908) 427-3588

**Contracting POC:** Andrew Dellomo; (908) 532-1530

# Enhancing Battlespace Awareness and Vitality

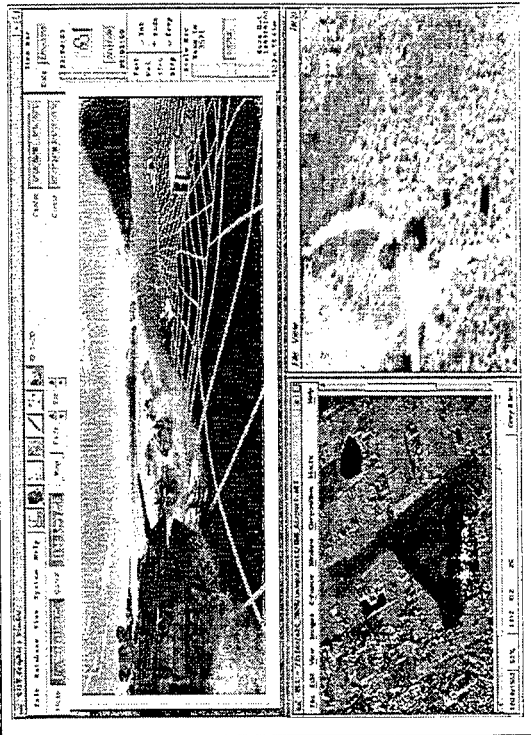
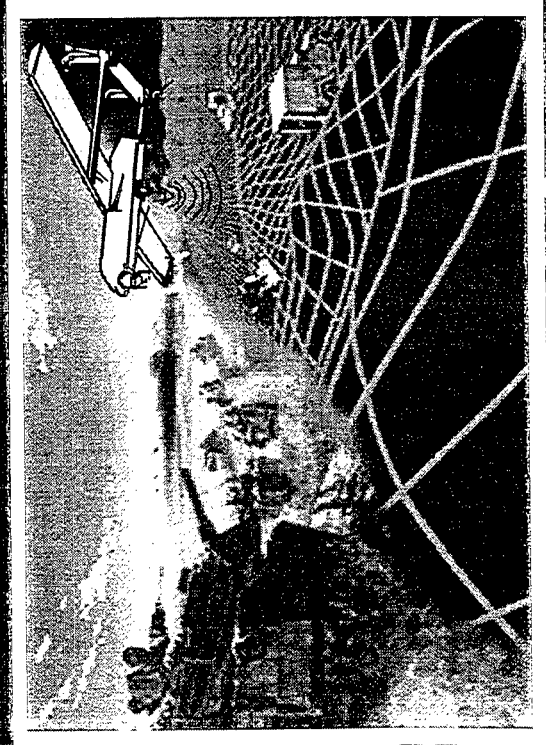

Providing a  
Consistent and  
Cohesive  
Picture of the  
Digital  
Battlespace

Exchange and Employ

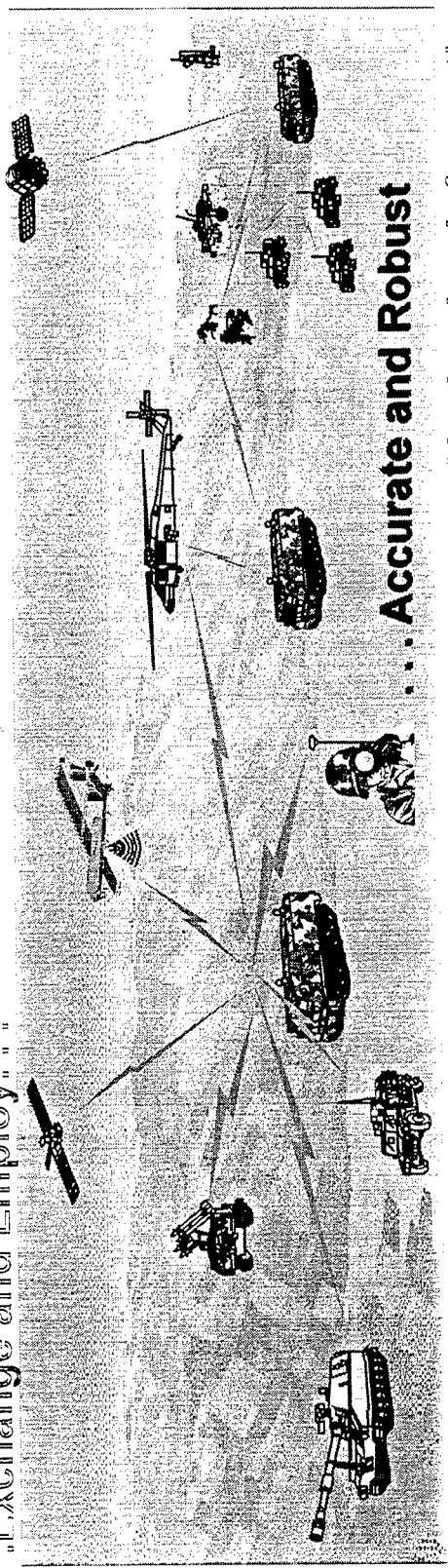

Accurate and Robust

Battlespace Navigation Information

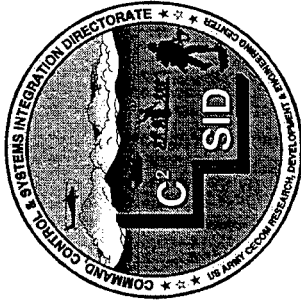

**COMMAND, CONTROL and SYSTEMS  
INTEGRATION DIRECTORATE  
CONTRACT OPPORTUNITY**



**Title:** Precision Navigation

**Objective:**

- Decrease Reliance on External GPS through Development of Robust Navigation Technology and System Concepts
- Employ Self-Contained, Integrated RF and Electro-Optic Sensors
- Correlate Digital Terrain, Feature and Image Databases

**Type:** SBIR Solicitations (BAA)

**Award Dates:** FY98-03

**POC:** Paul Olson; (908) 427-3912

**Contracting POC:** Andrew Dellomo; (908) 532-1530

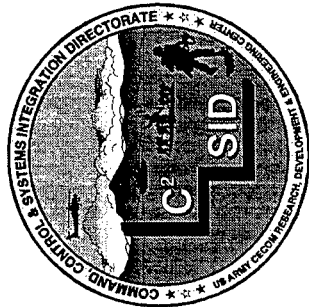

# Advanced Power Sources



**Tactical Electric Power Unit**

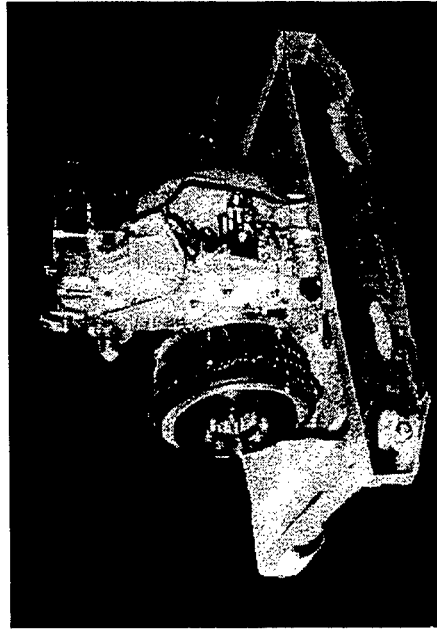

**5 KW Advanced Lightweight Portable Power System**

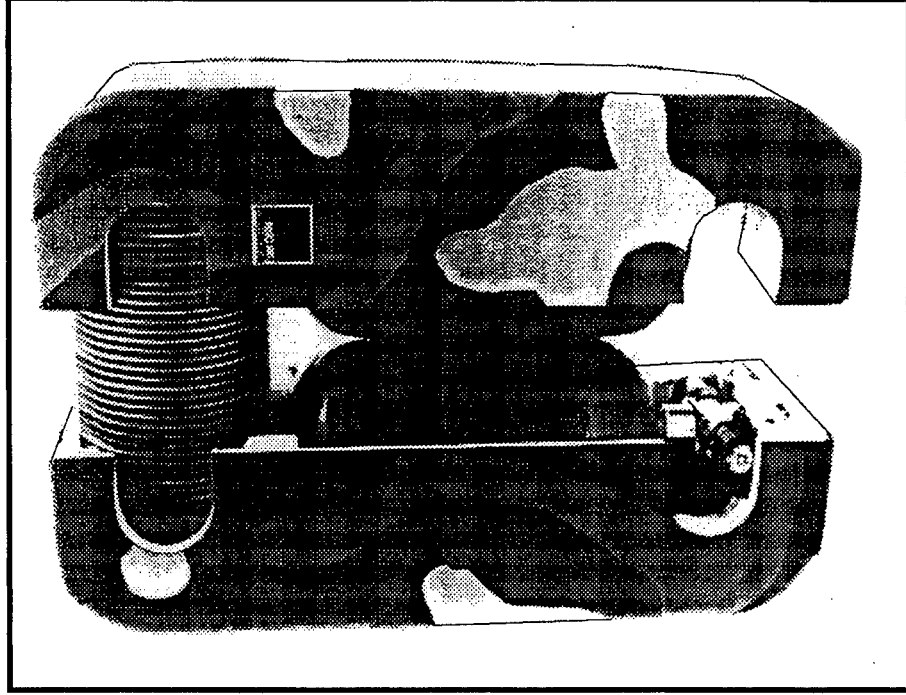

**Fuel Cell**

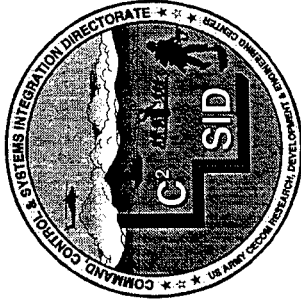

# COMMAND, CONTROL and SYSTEMS INTEGRATION DIRECTORATE CONTRACT OPPORTUNITY



**Title:** Advanced Power Sources

**Objective:**

- Demonstrate Portable Engine Driven Generator Operable on Middle Distillate Fuels (JP8, DF9)
- Integrate Commercial Engines, State-of-the-Art Alternators and Power Electronic Technologies
- Enhance Electrical Generation, Storage and Conditioning
- Demonstrate Silent, Lightweight, Liquid Fueled Fuel Cell Power Sources to Reduce Weight and Logistics Burden Associated with Batteries
- Move Methanol Fuel Cells out of Laboratory and into the Field for Tech Demos

**Type:** SBIR Solicitations (BAA)

**Award Dates:** FY98-01

**POC's:** Selma Nawrocki; (703) 704-3377 / Richard Jacobs; (703) 704-2637

**Contracting POC:** Anna Kimberly; (703) 325-5800

# Battle Planning (BP) STO

**Objective:** WIN THE INFORMATION WAR / DOMINATE MANEUVER  
 Develop, integrate, and demonstrate emerging technologies to electronically visualize the battlespace and collaboratively plan, rehearse, execute and monitor the battle.

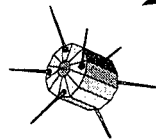

DIRECT BROADCAST  
 SATELLITE



RELEVANT COMMON BATTLESPACE VISUALIZATION/  
 SITUATION AWARENESS, 3D PERSPECTIVE VIEWS



DECISION  
 AIDS /  
 TACTICAL  
 AIDS



NATURAL LANGUAGE  
 SPEECH UNDERSTANDING

**Focus:**

- *Commander / Work-Station Interface to the Battlespace*
- *HW & SW tools necessary to achieve objective.*

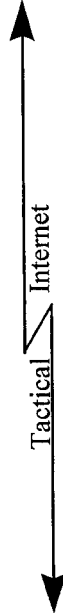

ELECTRONIC / COLLABORATIVE  
 BATTLE PLANNING,  
 REHEARSAL, EXECUTION & MONITORING

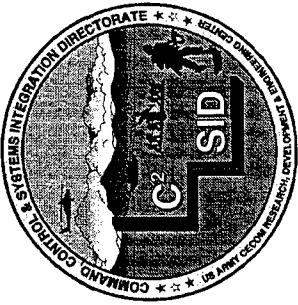

# COMMAND, CONTROL and SYSTEMS INTEGRATION DIRECTORATE CONTRACT OPPORTUNITY



Title: Battle Planning

Objective:

- Develop, Integrate and Demonstrate Emerging Technologies to Electronically Visualize the Battlespace and Collaboratively Plan, Rehearse, Execute and Monitor the Battle
- Develop Next Generation Distributed, Object Based Command and Control Tools Utilizing Decision Aides, Visualization and Internet Technology

Type: SBIR Solicitations. Phase I: \$100K Max, Phase II: \$750K Max

Award Dates: FY98-00

POC: Dr. Laksmi Rebbapragada; (908) 427-4029

Contracting POC: Andrew Dellomo; (908) 532-1530

# NOTES

# SPACE & TERRESTRIAL COMMUNICATIONS DIRECTORATE



**COL KENNETH A. THOMAS  
ACTING DIRECTOR**

**UNCLASSIFIED**

Point Paper

SUBJECT: Space & Terrestrial Communications Directorate APBI Input

PURPOSE: To inform the APBI audience of contractual opportunities within S&TCD.

FACTS:

- S&TCD's R&D program is comprised of Advanced Technology Demonstrations (ATDs) and Science and Technology Objectives (STOs).
- Three contractual opportunities exist through the STOs and ATDs.
- The first opportunity is a procurement through a Broad Agency Announcement (BAA) of a six channel VHF/UHF multiplexer to reduce cosite interference, to be awarded in the 1 Qtr FY98.
- The second opportunity is the procurement through a Broad Agency Announcement of a prototype satellite antenna positioner and tracking system. This is projected to be awarded in 2 Qtr FY98.
- The third opportunity, through the C2 Protect and Attack ATD, was briefed by IEWD, as they are the lead for Information Operations.

BRIEFER: Kenneth A. Thomas, COL, AMSEL-RD-ST-D, (908) 427-4449.

# S&T Communications Directorate Strategy

*The S&TCD vision is a future battlefield where seamless, multilevel secure (MLS), wideband communications allow the warfighter to harness rapidly advancing information-systems technology while ensuring that communications connectivity is never an impediment to the success of an operation.*

- **Promote Dual Use Technologies**
- **Capitalize on Commercial Advances**
- **Be the Army Focal Point for Space-Based and Space-Dependent Communications Technology**
- **Serve as “Technical Bridge” between battlelabs & PEO/PM**
- **Build Seamless Worldwide Infrastructure**
- **Focus on the Customer**

# **S&T Communications Directorate**

## **Focus**

- **Advanced Technology Demonstrations**
- **Science and Technology Objectives**

# **S&T Communications Directorate**

## **Focus (cont)**

**Battlefield Information Transmission Systems (BITS) /  
Digital Battlefield Communications (DBC) Advanced  
Technology Demonstration (ATD)**

- **Asynchronous Transfer Mode**
- **Global Broadcast Service**
- **Unmanned Aerial Vehicle Relay**
- **High Capacity Trunk Radio**
- **Surrogate Digital Radio (Digital Networking Radio)**
- **Radio Access Point**
- **Terrestrial Personal Communications Systems**
- **Phased Array Antennas**
- **Wideband High Frequency Radio**
- **Tactical Mobile Subscriber IP**

# **S&T Communications Directorate**

## **Focus (cont)**

### **Science and Technology Objectives**

- **Networks & Protocols**
- **Integrated Photonics**
- **Range Extension**
- **Improved Spectrum Efficiency Modeling & Simulation**
- **Advanced Communications Performance Assessment**
- **Soldier Personal Communications Systems**
- **Antennas**
- **Communications Integration and Cosite Mitigation**
- **C2 Protect and Attack for Information Operations**
- **SPEAKeasy Multiband/Multimode Radio**
- **Universal Transaction Services (Provisional)**

# **S&T Communications Directorate Initiatives**

- **Seamless Communications**
- **Executive Agent Mission**
- **Level III Program Management**

# S&T Communications Directorate

## Initiatives (cont)

- **Seamless Communications**
  - **Goal:** To provide an affordable, survivable, self-managing, multilevel-secure communications capability with sufficient capacity to meet all joint warfighter requirements
  - **Outcome:** To ensure that warfighter information needs, including user-transparent multimedia connectivity, are fulfilled over the entire combat/garrison operational continuum

# S&T Communications Directorate

## Initiatives (cont)

- How?
  - **Objective 1:** Demonstrate internetworked, high-data-capacity, secure wire and wireless communications during the TF XXI Advanced Warfighting Experiment (AWE) and other experiments
  - **Objective 2:** Develop modifications to commercial off-the-shelf (COTS) products to meet military operational requirements
  - **Objective 3:** Develop initial communication prototypes to achieve military operational requirements
  - **Objective 4:** Conduct interactive experiments between service labs.

# **S&T Communications Directorate**

## **Initiatives (cont)**

- **Executive Agent for Network Management**
- **Level II Programs**
  - **Digital Communications Satellite Subsystem**
  - **Standard Tactical Entry Point**
  - **AN/USC-28 Satellite Communications Set**
  - **Transportable Single Channel Transponder Receiver**
  - **Radio Frequency Interface Subsystem**
  - **KY99/100 Minterm**

# Contractual Opportunity

**TITLE:** CICM VHF/UHF Cosite Mitigation for Brigade Light Digital TOC (LDTOC)

**OBJECTIVE:** Develop VHF/UHF Cosite Multiplexer to couple 4 VHF SINGGARS, 1 VHF MSRT & 1 UHF EPLRS to Single Broadband Antenna, and Mitigate Cosite Interference

**CONTRACT TYPE:**

- FFP
- New BAA Entitled "VHF/UHF Cosite Mitigation for Brigade Light Digital TOC (LDTOC)"

**ESTIMATED VALUE:** \$700 - 900K

**FY98 KEY MILESTONES:**

- Contract Award: 1 Qtr FY98 (Nov 97)
- Prototype Development: 1 Qtr - 3 Qtr FY98 (Nov 97 - Jul 98)
- LDTOC Feasibility Demonstration: 4 Qtr FY98 (Jul - Sep 98)

**POC:** Steve Goodall, (908)532-0445

**CONTRACT POC:** Andrew Dellomo, (908) 532-1530

# Contract Opportunity

**TITLE:** SHF Satellite Comm OTM Antenna Positioner/  
Tracker

**OBJECTIVE:** Develop a prototype two-foot-dish-antenna  
positioner/tracker for use with SHF DSCS satellites.

**PROPOSED CONTRACT TYPE:**

- CPEF
- Broad Agency Announcement DAAB07-94-R-D015

**ESTIMATED VALUE:** \$400K to \$700K

**KEY MILESTONES:**

- Delivery of laboratory prototype: FY 98
- Vehicle mounted prototype and field demonstration: FY00
- Contract Award Dates: 2 Qtr FY98 (Feb 98) and  
1 Qtr FY00 (Nov 00)

**POC:** Neil Valletero, (908) 427-2804

**CONTRACT POC:** Andrew Dellomo, (908) 532-1530

# NOTES

# **SESSION VI**

## **COMMAND, CONTROL AND COMMUNICATIONS TECHNOLOGIES AND MODERNIZATION**

### **MODERATOR**

**MR. ROBERT R. LEHNES  
DEPUTY**

**PROGRAM EXECUTIVE OFFICER  
COMMUNICATIONS SYSTEMS**

**ADVANCED PLANNING BRIEFING TO INDUSTRY**

**APBI**

**SESSION VI**

**COMMAND, CONTROL AND  
COMMUNICATIONS TECHNOLOGIES  
AND MODERNIZATION**

**MR ROBERT LEHNES**

**DEPUTY PROGRAM EXECUTIVE OFFICER, COMMUNICATIONS SYSTEMS  
PROGRAM EXECUTIVE OFFICE, COMMAND, CONTROL AND COMMUNICATIONS SYSTEMS**

# PROGRAM EXECUTIVE OFFICE COMMAND, CONTROL, AND COMMUNICATIONS SYSTEMS

**FAX NUMBERS:**  
 MG CAMPBELL AND DEPUTYS: 908-427-4030 -- DSN 987  
 HRO/REO/HTI: (909) 389-0042 (Commercial Only)  
 FIO: (908) 542-1364 (Commercial Only)  
 OPS/PSBM FAX: (908) 532-0146 -- DSN 987  
 E-Mail: lastname@ccom6.monmouth.army.mil

**OFFICE OF THE PEO**  
 MG WILLIAM CAMPBELL, PEO  
 MR. BENNETT HART, DPEO CCS  
 MR. ROBERT LEHNES, DPEO COMM  
 MAJ STEPHEN WINTER, XO

**ADDRESS:**  
 PEO CCS  
 ATTN: SFAE-C3S  
 FORT MONMOUTH, NJ 07703  
 FEDEX ADD: BLDG 2700  
 RM 3C124

As Of: 2 Apr 97

**PENTAGON LNO**  
 LTC BYRON ATHAN - DSN 225-8446  
 MS. MARY QUIROZ - DSN 225-8444  
 MS. KATHY COLLIER - DSN 225-8447  
 MR. GARY PRATHER - DSN 224-8406

**HORIZONTAL TECHINTEG**  
 MR. STAN LEVINE  
 (908) 532-0180 - DSN 992  
 SFAE-C3S-HTI

**FORCE XXINTEG**  
 MR. MICHAEL ALBARELLI  
 (908) 427-4797 -- DSN 987  
 SFAE-C3S-FIO

**FIO (FT HOOD)**  
 LTC JESSE BARBER  
 (817) 288-4035 -- DSN 738

**READINESS ENGINEERING**  
 MR. RICHARD KOVAL  
 (908) 427-2677 -- DSN 987  
 SFAE-C3S-REO

**PROCSPTIBUS MGT**  
 DR. DEBORAH FRANK  
 (908) 532-0140 -- DSN 992  
 SFAE-C3S-PMO

**HUMAN RESOURCES**  
 MRS. WANDA WOHLIN  
 (908) 532-0143 DSN 992  
 SFAE-C3S-HRO

**OPERATIONS**  
 MRS. JOSEPHINE VAN HOLT  
 532-0082 -- DSN 992  
 SFAE-C3S-OPS

**PMADCCS**  
 COL THOMAS HALLER  
 (205) 895-3441 -- DSN 788  
 SFAE-C3S-AD

**PMAPPLIQUE**  
 COL DEAN NAKAGAWA  
 (908) 427-3237 -- DSN 987  
 SFAE-C3S-AP

**PMCHS**  
 DR. DAVE USECHAK(A)  
 (908) 427-4675 -- DSN 987  
 SFAE-C3S-CHS

**PD CMCMS**  
 LTC JOHN KIMMEL  
 (703) 275-8114 -- DSN 235  
 SFAE-C3S-NAR

**PMFATDS**  
 COL STEVEN BOUTELLE  
 (908) 427-3090 -- DSN 987  
 SFAE-C3S-FS

**PMGPS**  
 LTC JOSEPH LOFGREN  
 (908) 532-6301 -- DSN 992  
 SFAE-C3S-GPS

**PMINTEL FUSION**  
 COL LAWRENCE ARROL  
 (703) 275-8110 -- DSN 235  
 SFAE-C3S-INT

**PMJTACS**  
 COL JOHN URAS  
 (908) 532-0740 -- DSN 992  
 SFAE-C3S-JTC

**PM Milsatcom**  
 COL MIKE MAZZUCCHI  
 (908) 532-9767 X4001 - DSN 992  
 SFAE-C3S-MSA

**PMOPTADS**  
 COL STANLEY LEIA  
 (908) 532-4041 -- DSN 992  
 SFAE-C3S-MVR

**PMSTCCS**  
 COL BARRY WRIGHT  
 (703) 806-5687 -- DSN 656  
 SFAE-C3S-STR

**PMTRCS**  
 COL LALIT PIPLANI  
 (908) 427-3063 -- DSN 987  
 SFAE-C3S-TRC

**PD CTIS**  
 MR. DAVID THACKER  
 (703) 428-6876 -- DSN 328  
 CETEC-TL-G

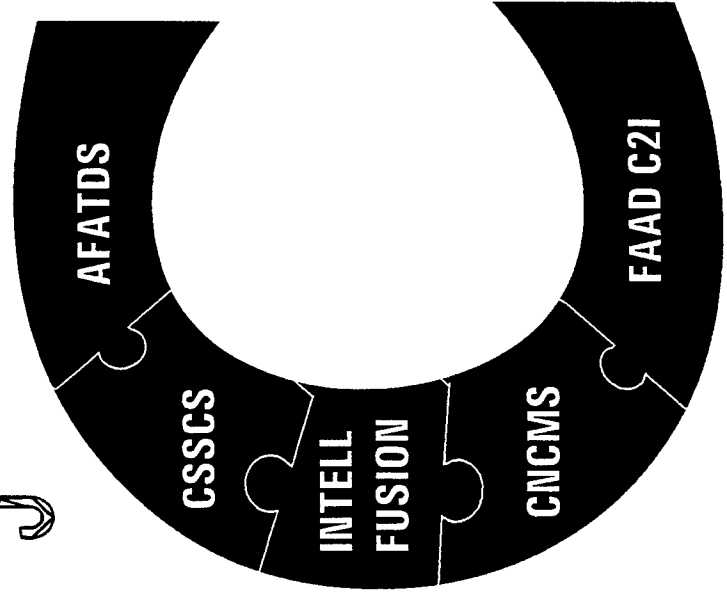
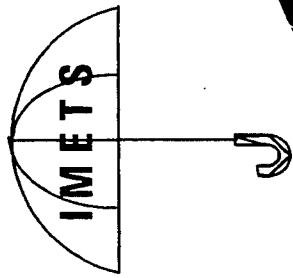

# Command & Control Systems

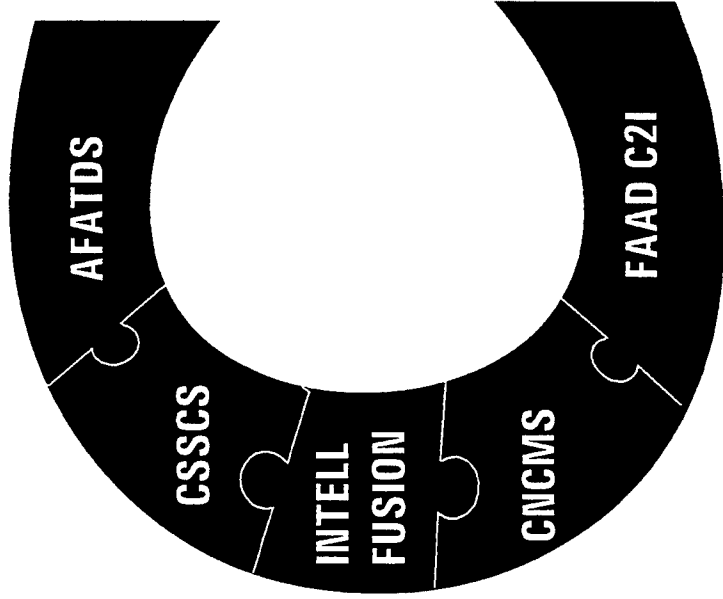
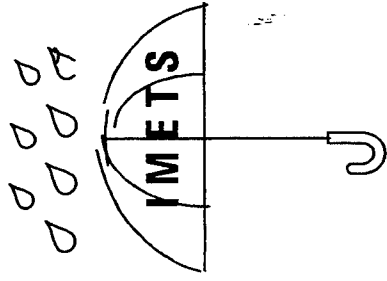

## Command & Control Systems

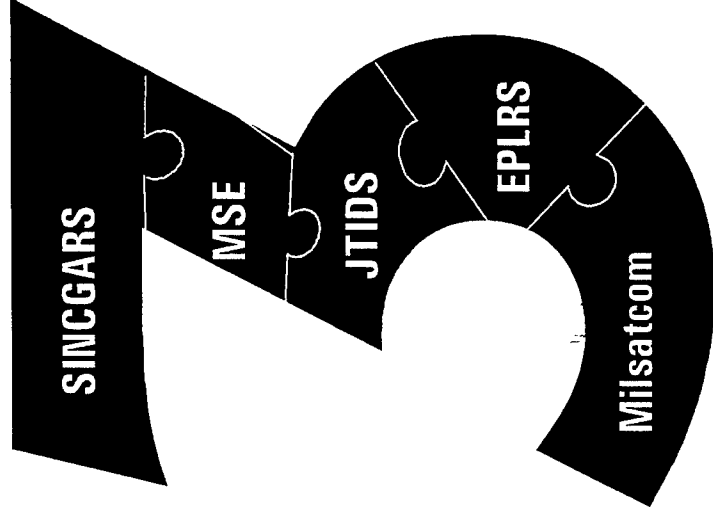

## Communications Systems

DDDD

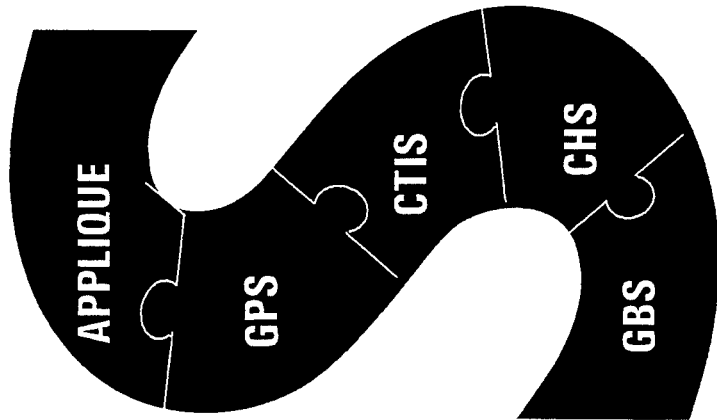
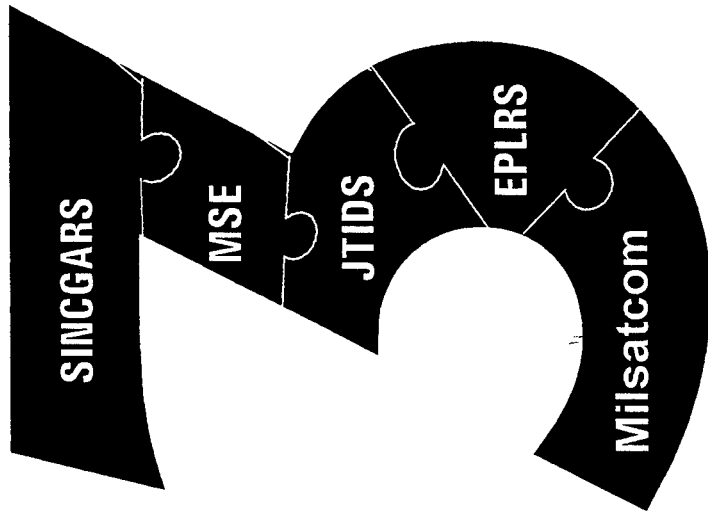
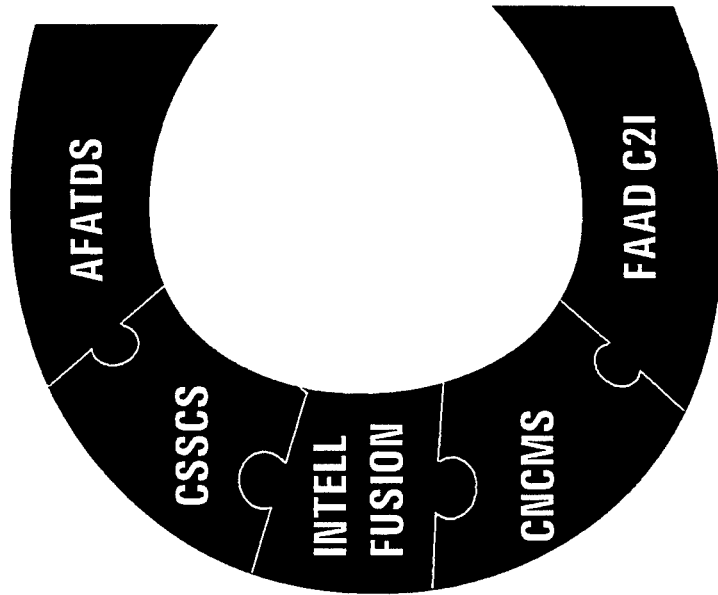
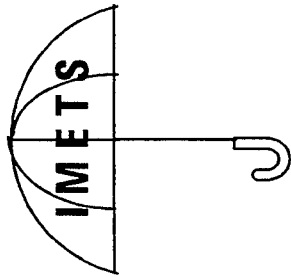

# Command & Control Systems

# Communications Systems

# Common Support Systems

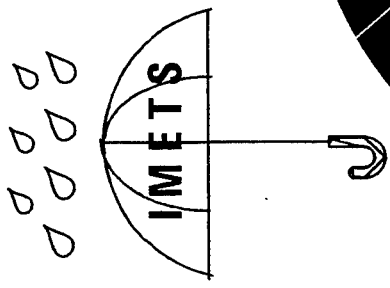

# PREO

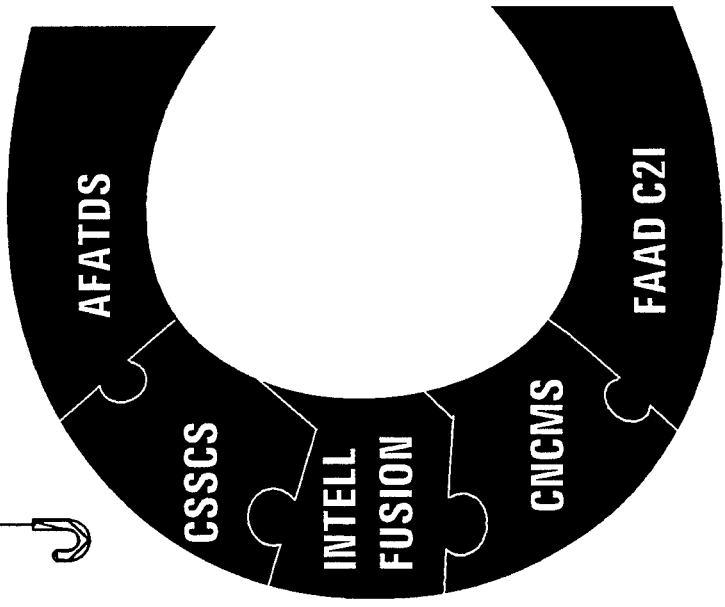

**Command & Control  
Systems**

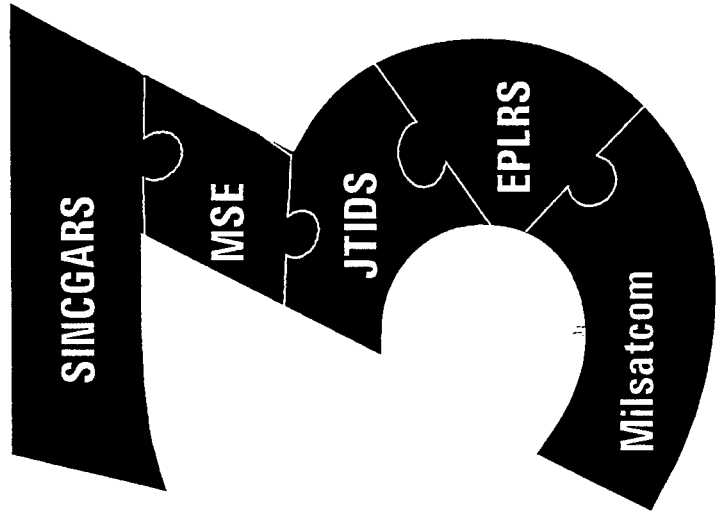

**Communications  
Systems**

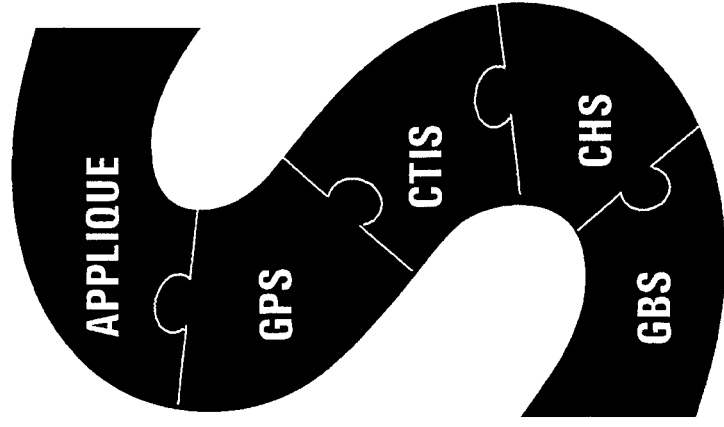

**Common Support  
Systems**

## **SINGLE PROCESS INITIATIVE**

- **IN MANY CONTRACTING FACILITIES, SEVERAL DIFFERENT PROCESSES OR SPECIFICATIONS MAY BE USED FOR SIMILAR MANUFACTURING OR MANAGEMENT OPERATIONS**
- **THIS IS INEFFICIENT AND LEADS TO INCREASED COST AND ADMINISTRATION WORKLOAD FOR BOTH CONTRACTOR AND GOVERNMENT.**
- **THE ARMY NEEDS TO REDUCE THE NUMBER OF PROCESSES USED SO THAT WE CAN SAVE MONEY.**

# STATUS OF ON-GOING PROJECTS

- HIGH CAPACITY LOS RADIO PROGRAM (HCLOS)
- SHORT RANGE WIDE BAND RADIO SRWBR

THESE TWO EFFORTS HAVE BEEN GROUPED INTO ONE CONTRACT TO INCLUDE THE ACQUISITION OF A MULTIPLEXER AND SHELTER INTEGRATION

## ACUS MODERNIZATION PROGRAM

RFP RELEASE                      1ST QTR FY98  
CONT AWD                              2ND QTR FY98

ACUS CONTRACT RANGE  
\$125 - \$250

# **STATUS OF ON-GOING PROJECTS**

## **AN/GSC-52 MODERNIZATION PROGRAM**

**OBJECTIVE : EXTENDED SYSTEM OPERATIONAL LIFE**

**PROPOSED CONTRACT TYPE: FFP/T&M**

**CONTRACT AWARD: 2nd QTR FY 98**

**ESTIMATED VALUE: \$110 - \$125M**

# COMMAND, CONTROL AND COMMUNICATIONS TECHNOLOGIES AND MODERNIZATION

## AGENDA

- **AREA COMMON USER SYSTEM (ACUS) RADIO MODERNIZATION PROGRAM**
  - MR. KENNETH CHANEY  
Project Manager, Joint Tactical Area Communications Systems
- **SINGLE CHANNEL ANTI-JAM MANPORTABLE (SCAMP) BLOCK II**
  - MR. CARL SWENSON  
Project Manager, Milsatcom
- **DEFENSE SATELLITE COMMUNICATIONS SYSTEMS (DSCS) SPECTRUM MANAGEMENT SYSTEM (DSMS)**
  - MR. RONALD JOHNSON  
Project Manager, Milsatcom

# COMMAND, CONTROL AND COMMUNICATIONS TECHNOLOGIES AND MODERNIZATION

## AGENDA CONTINUED

- **COMMON NETWORK PLANNING SOFTWARE (CNPS)**
  - MR. RONALD JOHNSON  
Project Manager, Milsatcom
- **AN/GSC-52 MODERNIZATION PROGRAM**
  - MR. RONALD JOHNSON  
Project Manager, Milsatcom

# NOTES

# AREA COMMON USER SYSTEM (ACUS) RADIO MODERNIZATION PROGRAM

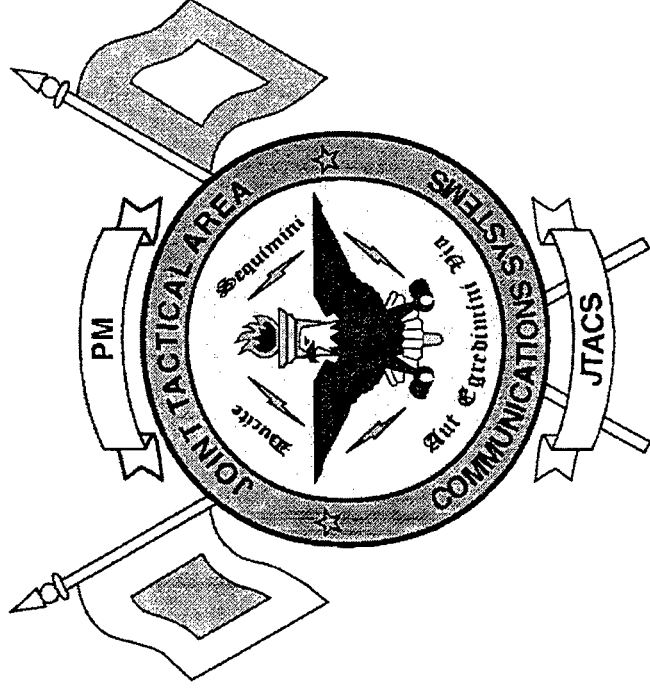

**KENNETH CHANEY**  
**PROJECT LEADER**  
**PM JTACS**

**UNCLASSIFIED**

08 MAY 1997

POINT PAPER

SUBJECT: AREA COMMON USER SYSTEM (ACUS) RADIO MODERNIZATION PROGRAM

PURPOSE: The ACUS Radio Modernization Program to be presented as part of the Advance Planning Briefing for Industry (APBI) will describe the contract opportunity available for this program.

FACTS:

- The ACUS Radio Modernization Program will support increased data transmission capacity requirements for the ACUS as outlined in the ACUS Modernization Plan (ACUS MP).
- Increased data transmission capacity radios will be fielded concurrently with the First Digitized Division (FDD) which is currently scheduled for FY00'.
- The program will consist of a modification to existing MSE and TRI-TAC shelters and will consist of: installation kit, High Capacity Line of Sight Radio (HCLOS) and Short Range Wide Band Radio (SRWBR) radio systems, and multiplexers.
- The RFP release for the ACUS Radio Mod program will be in 1QFY98'

BRIEFER: Kenneth Chaney, Electronics Engineer, SFAE-C3S-JTC-ITI, X23525.



Allan J. Schnabolk  
Chief, Information Transport and  
Integration Division

# **ACUS RADIO MODERNIZATION PROGRAM SYSTEM DEFINITION**

- **TACTICAL LINE OF SIGHT (LOS) RADIO SYSTEM TO SUPPORT INCREASED DATA TRANSMISSION CAPACITY REQUIREMENTS FOR THE ACUS**
  
- **PROGRAM CONSISTS OF RADIOS, ANTENNAS, MULTIPLEXERS, AND INTEGRATION OF EQUIPMENT INTO SHELTERIZED RADIO TERMINAL ASSEMBLAGES**
  
- **PROVIDE REPLACEMENT RADIO AND ANTENNA SYSTEM FOR
  - **ECHELONS CORPS AND BELOW (ECB) - AN/GRC-226(V) USED FOR INTER-NODAL NODE CENTER SWITCH (NCS) TO NCS CONNECTIVITY****

# **ACUS RADIO MODERNIZATION PROGRAM SYSTEM DEFINITION (CONT'D)**

- ECHELONS ABOVE CORPS (EAC) - AN/GRC-222  
USED FOR AN/TTC-39D TO AN/TTC-39D  
CONNECTIVITY**
- EAC - AN/GRC-222 USED FOR SHORT RANGE WIDE  
BAND RADIO (SRWBR) DOWN THE HILL  
CONNECTIVITY**
- PROVIDE REPLACEMENT SUPER GROUP AND  
MASTER GROUP MULTIPLEXERS**
- INTEGRATION - REMOVE OLD RADIOS AND  
EQUIPMENT, INSTALL NEW RADIOS AND EQUIPMENT**

# ACUS RADIO MODERNIZATION PROGRAM ECB ARCHITECTURE

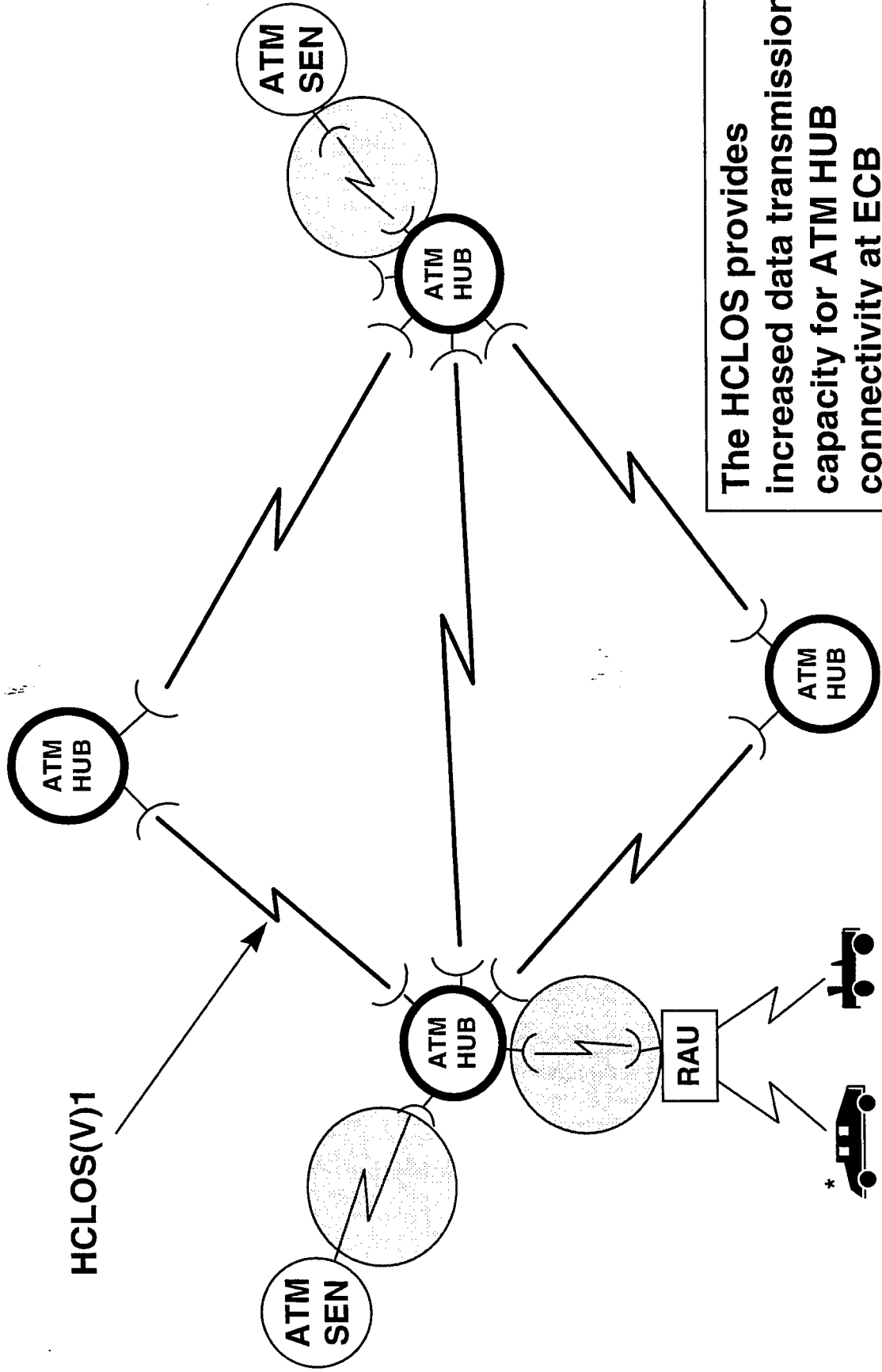

# ACUS RADIO MODERNIZATION PROGRAM EAC ARCHITECTURE

The HCLOS(V)2 provides increased data transmission capacity for ATM HUB to ATM HUB links at EAC. The SRWBR provides increased data transmission capacity for Top-of-the-Hill to Bottom-of-the-Hill at EAC

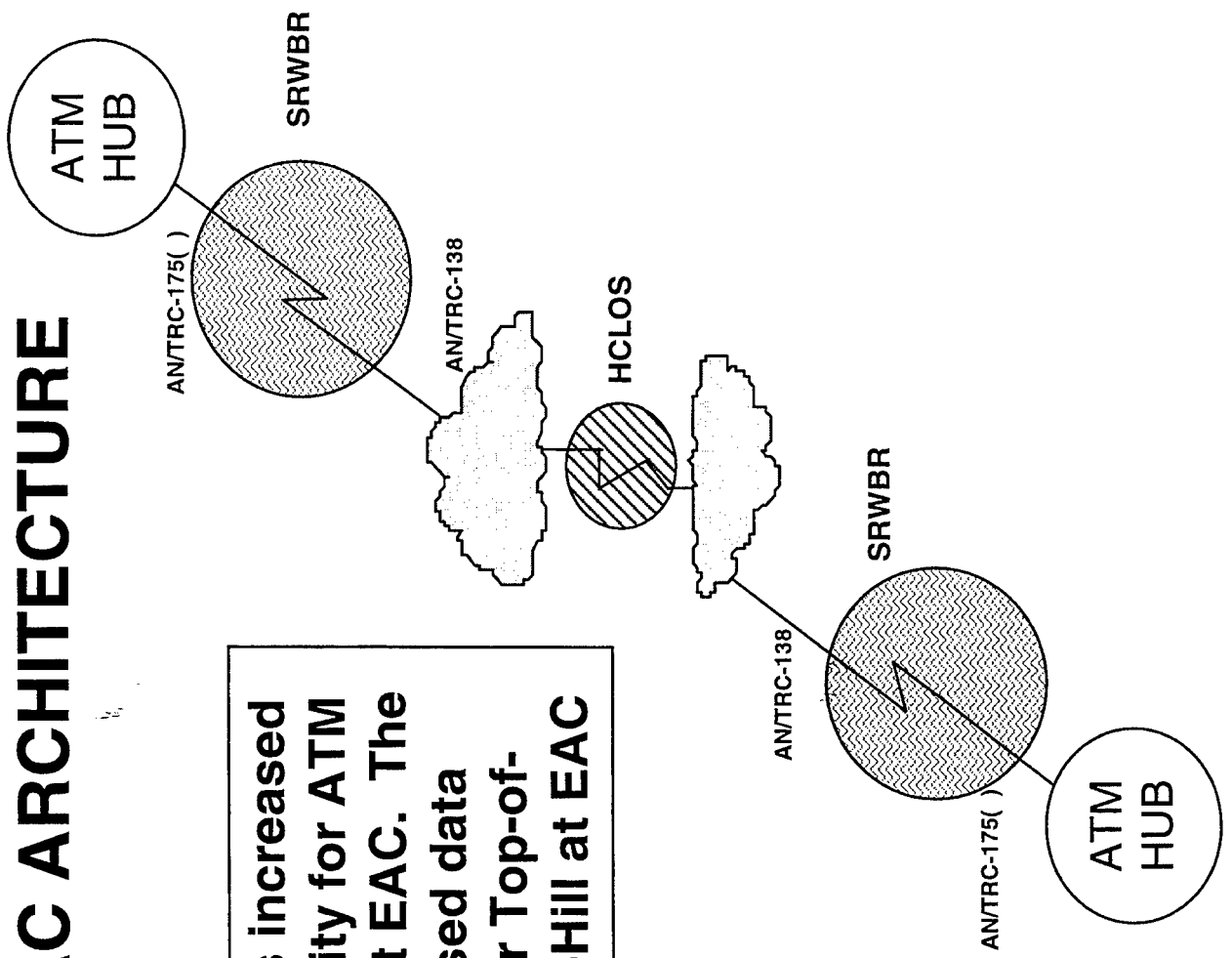

# **HCLOS RADIO SYSTEM PROGRAM STATUS**

- **MISSION NEED STATEMENT (ACUS MODERNIZATION PLAN)  
APPROVED 10 APRIL 1996**
- **OPERATIONAL REQUIREMENTS DOCUMENT (USER  
FUNCTIONAL DESCRIPTION [UFD]) APRIL 1997**
- **SPECTRUM SUPPORTABILITY ANALYSIS COMPLETED  
(JOINT SPECTRUM CENTER)**
- **FREQUENCY ALLOCATION REQUESTS (ONGOING)**
- **DRAFT RFP JULY 1997**
- **RFP RELEASE 1QFY98**
- **CONTRACT AWARD 2QFY98**

# **HCLoS SYSTEM REQUIREMENTS**

## **ECB**

- **HCLoS(V)1**
  - **MEET EXISTING OPERATIONAL REQUIREMENTS FOR THE MSE AN/TRC-190(A)(V)3 LOS ASSEMBLAGE**
    - **25Km (NOM) AND 40 Km (MAX) LINK DISTANCE (15m MAST)**
    - **30 MINUTE SETUP AND TEARDOWN TIME**
  - **99.9% LINK AVAILABILITY**
  - **STATIONARY OPERATION**
  - **FREQUENCY RANGE (TBD)**
  - **BANDWIDTH EFFICIENT MODULATION**

# **HCLOS SYSTEM REQUIREMENTS (CONT'D)**

## **ECB**

- **HCLOS(V)1**
- **DATA RATES**
  - **LEGACY MSE TRI-TAC RATES: 1024,1152, 1536, 2048, 2304, 4096, 4608**
  - **1544 AND 8192 Kbps**
- **BASE BAND INTERFACE**
  - **TRI-TAC / MSE BALANCED NRZ**
- **REMOTE CONTROL / MONITORING (SNMP)**
  - **RS-422, 64Kbps**

# **HCLOS SYSTEM REQUIREMENTS (CONT'D)**

## **EAC**

- **HCLOS(V)2**
  - **MEET EXISTING OPERATIONAL REQUIREMENTS FOR THE AN/TRC-138(B)(C) DGM ASSEMBLAGE**
  - **25 MILES (40 Km) LINK DISTANCE (30m MAST)**
  - **99.9% LINK AVAILABILITY**
  - **STATIONARY OPERATION**
  - **FREQUENCY RANGE (TBD)**
  - **BANDWIDTH EFFICIENT MODULATION**

# **HCLOS SYSTEM REQUIREMENTS (CONT'D)**

## **EAC**

- **HCLOS(V)2**
  - **DATA RATES**
    - **LEGACY MSE TRI-TAC RATES: 1024,1152, 1536, 2048, 2304, 4096, 4608**
    - **1544 AND 8192 Kbps**
  - **BASE BAND INTERFACE**
    - **TRI-TAC / MSE BALANCED NRZ**
  - **REMOTE CONTROL / MONITORING (SNMP)**
    - **RS-422, 64 Kbps**

# HCLOS SYSTEM REQUIREMENTS (CONT'D)

## EAC

- SRWBR (HCLOS(V)3)
  - MEET EXISTING OPERATIONAL REQUIREMENTS FOR AN/TRC-138(B)(C), AN/TRC-175(A)(B)
  - 8 Km LINK DISTANCE (30m MAST)
  - 99.9% LINK AVAILABILITY
  - STATIONARY OPERATION
  - FREQUENCY RANGE (TBD)
  - BANDWIDTH EFFICIENT MODULATION
  - DATA RATE 44.736 Mbps(DS3)
  - BASEBAND INTERFACE DS3 COAXIAL
  - REMOTE CONTROL / MONITORING (SNMP)
    - RS-422, 64Kbps

# ACUS RADIO MODERNIZATION PROGRAM CONTRACT OPPORTUNITY

**TITLE: ACUS RADIO MODERNIZATION PROGRAM**

## **OBJECTIVE**

- REPLACE INTERNODAL LOS RADIO LINKS FOR ECB AND EAC  
TO INCREASE DATA TRANSMISSION CAPACITY
- HCLOS/SRWBR RADIO
- SHELTER INTEGRATION

**PROPOSED CONTRACT TYPE: PRODUCTION, FIRM FIXED PRICE (FFP)**

## **KEY MILESTONES**

- DRAFT RFP RELEASE 4QFY97
- RFP RELEASE 1QFY98
- CONTRACT AWARD 2QFY98
- DELIVERY 1QFY00 - 1QFY10
- FIELDING 3QFY00 - 4QFY10

**ESTIMATED VALUE: \$125M - \$250M**

**TECH POC / TEL #: KEN CHANEY, (908) 532-3525**

**CONTRACT POC / TEL #: KEN TEDESCHI, (908) 532-4846**

# NOTES

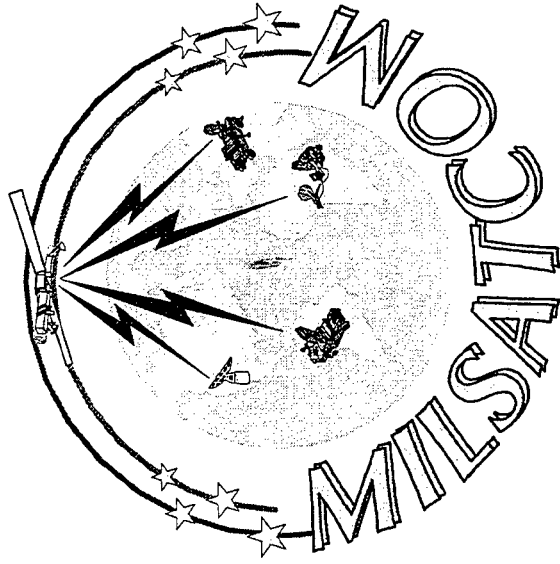

# **SINGLE CHANNEL ANTI-JAM MANPORTABLE TERMINAL SCAMP BLOCK II**

**Presented By: Carl Swenson  
Project Leader, SCAMP BLOCK II  
Project Manager, Milsatcom**

**UNCLASSIFIED**

POINT PAPER

SUBJECT: Single Channel Anti-jam Manportable (SCAMP) Block II Terminal

OBJECTIVE: The Block II SCAMP is the lightweight Milstar manportable single channel satellite terminal. It will provide the Army and Special Operations Forces worldwide secure voice and data communications capability with low probability of detection/interception.

FACTS:

- The Block II SCAMP is the objective manportable Milstar terminal.
- Engineering Feasibility Efforts to prove the feasibility of a lightweight (12-15 lb.) manportable Milstar terminal will conclude in FY 99 with prototype demonstrations with Lincoln Laboratory. The demonstrations will support a Milestone II decision in 4QFY99.
- The Army will award two competitive EMD contracts. The contractors will each develop, manufacture and test 15 EMD SCAMP Block II terminals. The schedule is as follows:

RFP Release: 4QFY99

Award: 2QFY00

- The contracts will be Cost Plus type contracts and will be awarded through a Best Value evaluation process. Expected contract duration is approximately 30 months.

BRIEFER: Mr. Carl Swenson, Project Leader, SCAMP Block II, SFAE-C3S-MSA, (908) 532-5425.

MICHAEL R. MAZZUCCHI  
Colonel, Signal Corps  
Project Manager, Milsatcom

# SCAMP BLOCK II

## SYSTEM DEFINITION

- Milstar Manportable Satellite Terminal
- Worldwide Range Extension of Critical C4I Information
- Special Operations & All Army Echelons
- Provides Anti-jam, Low Probability of Intercept / Detection

### Interface Capabilities

- Terminal Baseband
  - Low Data (LDR) Voice
  - Red Serial Data Port
- External Baseband
  - PC's, LCU
  - Range Extend Army Common User System (Voice & Data)
- Range Extend Tactical Internet

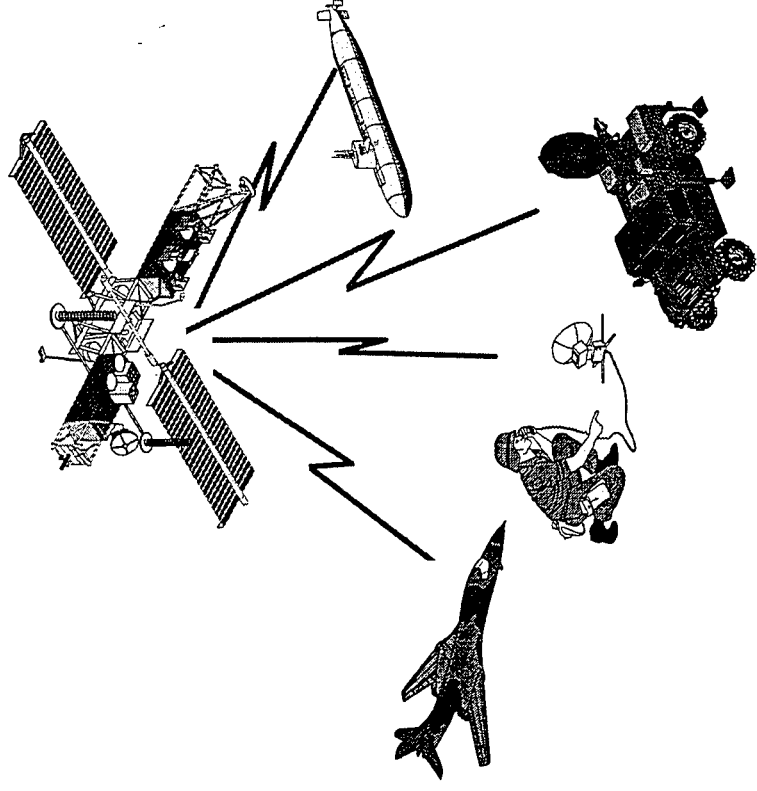

# SCAMP BLOCK II SYSTEM REQUIREMENTS

	<b>BLOCK I</b>	<b>BLOCK II</b>
WEIGHT	37 LBS	12-15 LBS
COMMUNICATION MODE	LDR DATA 75-2400 Bps LDR VOICE 2400 Bps	LDR DATA 75-2400 Bps LDR VOICE 2400 Bps
VOICE QUALITY	>= STU III	HIGH QUALITY VOICE RECOGNITION
RANGE EXTENSION	SINGGARS (DATA ONLY) ACUS (DATA ONLY)	SINGGARS (DATA & VOICE) ACUS (DATA & VOICE)
BATTERY DURATION	10 HOURS	24 HOURS 96 HOURS (OBJECTIVE)
MTBOMF	600 HOURS	1250 HOURS
SETUP TIME	<10 MINUTES	OBJECTIVE 5 MINUTES
COMM ON THE MOVE	NO	OBJECTIVE
PAGING	NO	YES
QUANTITY	312 ALL SERVICES	2549 ARMY OTHERS TBD

# **SCAMP BLOCK II PROGRAM STATUS**

- Engineering Feasibility Efforts (EFE) Near Term Goals
  - Complete DARPA Sponsored Efforts
    - Single Chip Milstar Modem Module - Oct 97 (COMMQUEST)
    - Low Power, 800 Mhz Direct Digital Synthesizer - Dec 97 (TI)
  - Continue Other EFE (Lincoln Laboratory)
    - Complete Prototype RF Generator
    - Lightweight, Composite Drive Motors
    - Continue Paging System Prototype
    - Structure
    - Antenna / Feed
    - Transmitter / Receiver
- Demonstrate Block II Prototype Capabilities to Support 4QFY99 Milestone II Decision

# PICTORIAL OF SCAMP TECHNOLOGY DEVELOPMENT PLAN

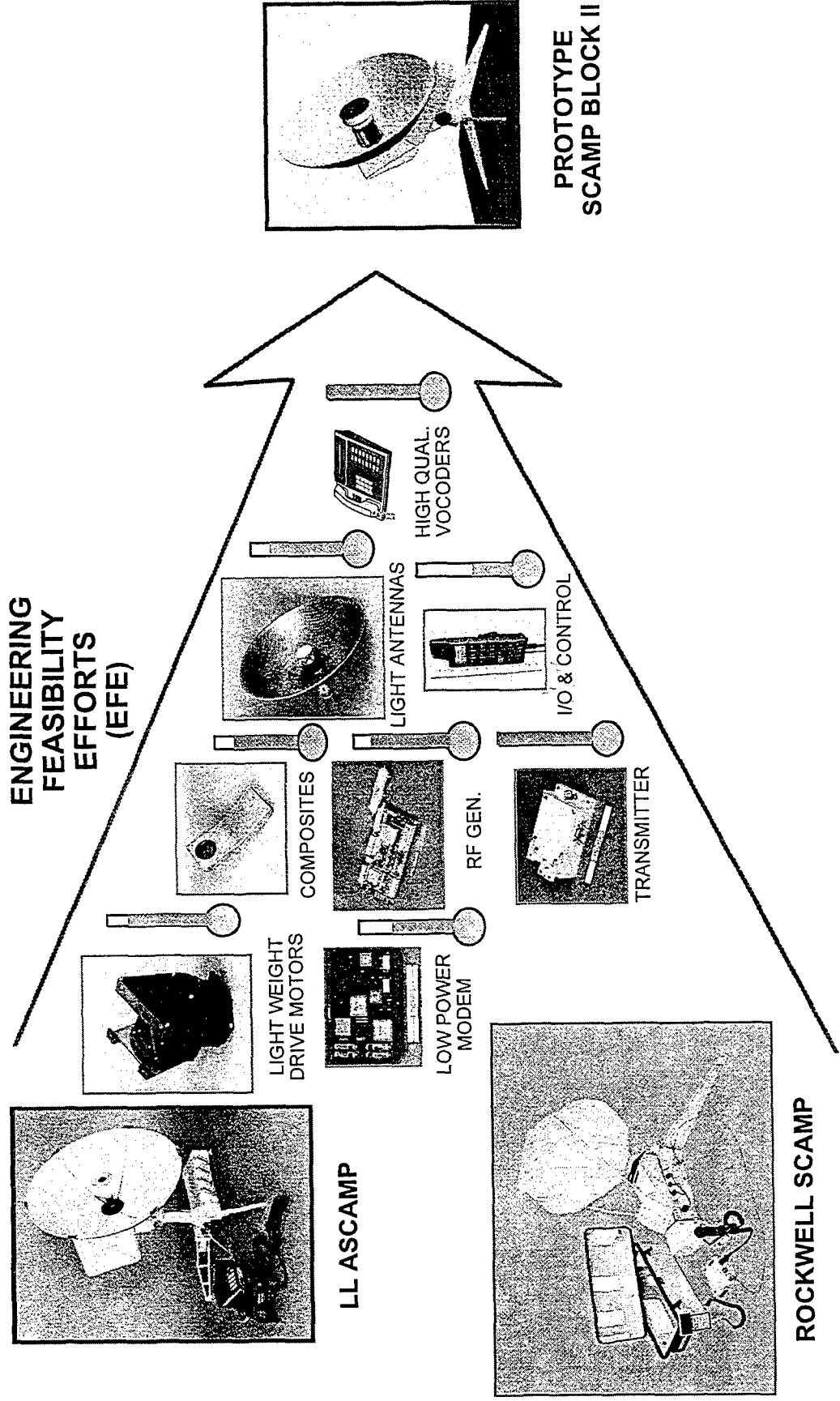

# **SCAMP BLOCK II ACQUISITION STRATEGY**

- Complete Engineering Feasibility Efforts
  - Prototype Demonstrations in FY99 (Lincoln Laboratory)
- Enter EMD Phase to Develop Compliant Block II Terminal
  - Dual Competitive Awards
  - Implements Acquisition Streamlining Initiatives
- Downselect to LRIP / FRP
  - Single LRIP Contract With Full Rate Production Options
  - Up to 2549 Terminals - Army

# SCAMP BLOCK II SCHEDULE

	FY97	FY98	FY99	FY00	FY01	FY02	FY03	FY04
ENGINEERING FEASIBILITY EFFORTS		<div style="border: 1px solid black; padding: 2px;">                     PROTOTYPE DEVELOP Lincoln Laboratory                 </div>	<div style="border: 1px solid black; padding: 2px;">                     PROTOTYPE DEMOS/EVALS Lincoln Laboratory                 </div>					
		MILSATCOM ARCHITECT/DIGITAL BATTLEFLD						
SCHEDULE			<div style="border: 1px solid black; padding: 2px;">                     MS II DECISION                 </div>					<div style="border: 1px solid black; padding: 2px;">                     MS III DECISION                 </div>
						<div style="border: 1px solid black; padding: 2px;">                     EMD / LRIP                 </div>		<div style="border: 1px solid black; padding: 2px;">                     FRP                 </div>
						<div style="border: 1px solid black; padding: 2px;">                     TT                 </div>		<div style="border: 1px solid black; padding: 2px;">                     TT / IOT                 </div>
							<div style="border: 1px solid black; padding: 2px;">                     LRIP AWARD (SINGLE CONTRACTOR)                 </div>	<div style="border: 1px solid black; padding: 2px;">                     AWARD FRP OPTIONS                 </div>
				<div style="border: 1px solid black; padding: 2px;">                     AWARD EMD (2 CONTRACTORS)                 </div>				

# **SCAMP BLOCK II CONTRACT OPPORTUNITY**

- Objective: Develop and Test Approximately 15 / Contract SCAMP Block II Engineering Manufacturing Development Terminals
  - Two (Competitive Development) EMD Contractors
- Proposed Contract Type: Cost Plus Award Fee
- Key Milestones:
  - RFP 4QFY99
  - Award 2QFY00
- Estimated Value: EMD Contract: \$25-35M / Each
- Technical POC: Mr. Carl Swenson (908)532-5425  
(908)532-5425 Email: swensonc@doim6.monmouth.army.mil
- Acquisition POC: Mr. Larry Asch (908)532-5486

# NOTES



**PRODUCT MANAGER**  
**DSCS CONTROL**  
**RONALD F. JOHNSON**

Point Paper

Subject: Defense Satellite Communications System (DSCS) Advanced Planning Briefing to Industry (APBI)

OBJECTIVE: Present upcoming DSCS program contract opportunities to industry. Acquisitions are planned to modernize the AN/GSC-52 Satellite Communications Terminals (52 Mod), and replace existing systems with the DSCS Spectrum Management System (DSMS) and the Common Network Planning Software (CNPS).

FACTS:

- o 52 Mod Modernize 39 each existing earth terminals at world wide locations.
  - o Design and integrate GFE electronics
  - o Fabricate 4 each Restoral Terminals for use during installation
  - o Perform installation
  - o Refurbish antennas
  - o FFP contract
  - o Award Jan 98
  - o Project Leader Mr. Gerald Christophe 908 532-9728 X5811
  
- o DSMS Design replacement system for DSCS Automatic Spectrum Analyzer
  - o Fabricate 26 each systems
  - o Generate Army Technical Architecture compliant software
  - o Maximize use of COTS hardware and software
  - o Install at world wide locations
  - o FFP contract
  - o Award Jan 98
  - o Project :Leader Mr. Victor Phillipuk 908 532-9728 X5821
  
- o CNPS Develop replacement software for DSCS Network Planning Software
  - o Army Technical Architecture compliant
  - o Maximize use of COTS software
  - o FFP contract
  - o Award Jan 98
  - o Project Leader Mr. David Morrissey 908 532-9728 X5808

BRIEFER: Mr. Ronald F. Johnson, Product Manager DSCS Control and Acting Product Manager DSCS Terminals, PM Milsatcom, 908 532-2593

ACTION OFFICER  
Ronald F. Johnson

**DEFENSE SATELLITE  
COMMUNICATIONS SYSTEM  
SPECTRUM MANAGEMENT SYSTEM**

**Unclassified**

# DEFENSE SATELLITE COMMUNICATIONS SYSTEM SPECTRUM MANAGEMENT SYSTEM

## System Definition

- Replace current Defense Satellite Communications System Spectrum Analyzer hardware and software
- Monitor Defense Satellite Communications System Satellite Communications frequency bands
- Provide usage data for all allocation/reallocation of users to maximize efficiency

# DSCS SATELLITE NETWORK

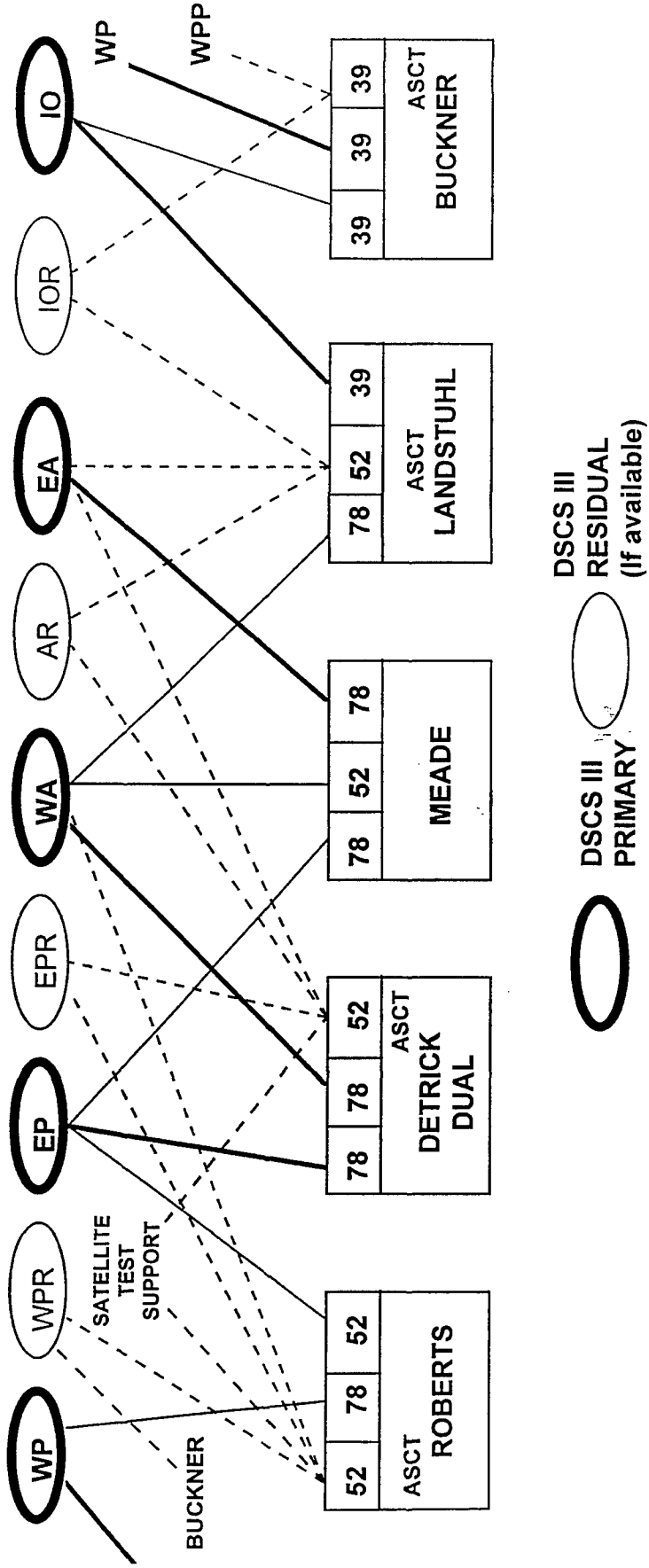

78=AN/FSC-78 52=AN/GSC-52 39=AN/GSC-39  
 ASCT=AUXILIARY SATELLITE CONTROL TERMINAL

———— PRIMARY ————— SECONDARY - - - - - ASCT

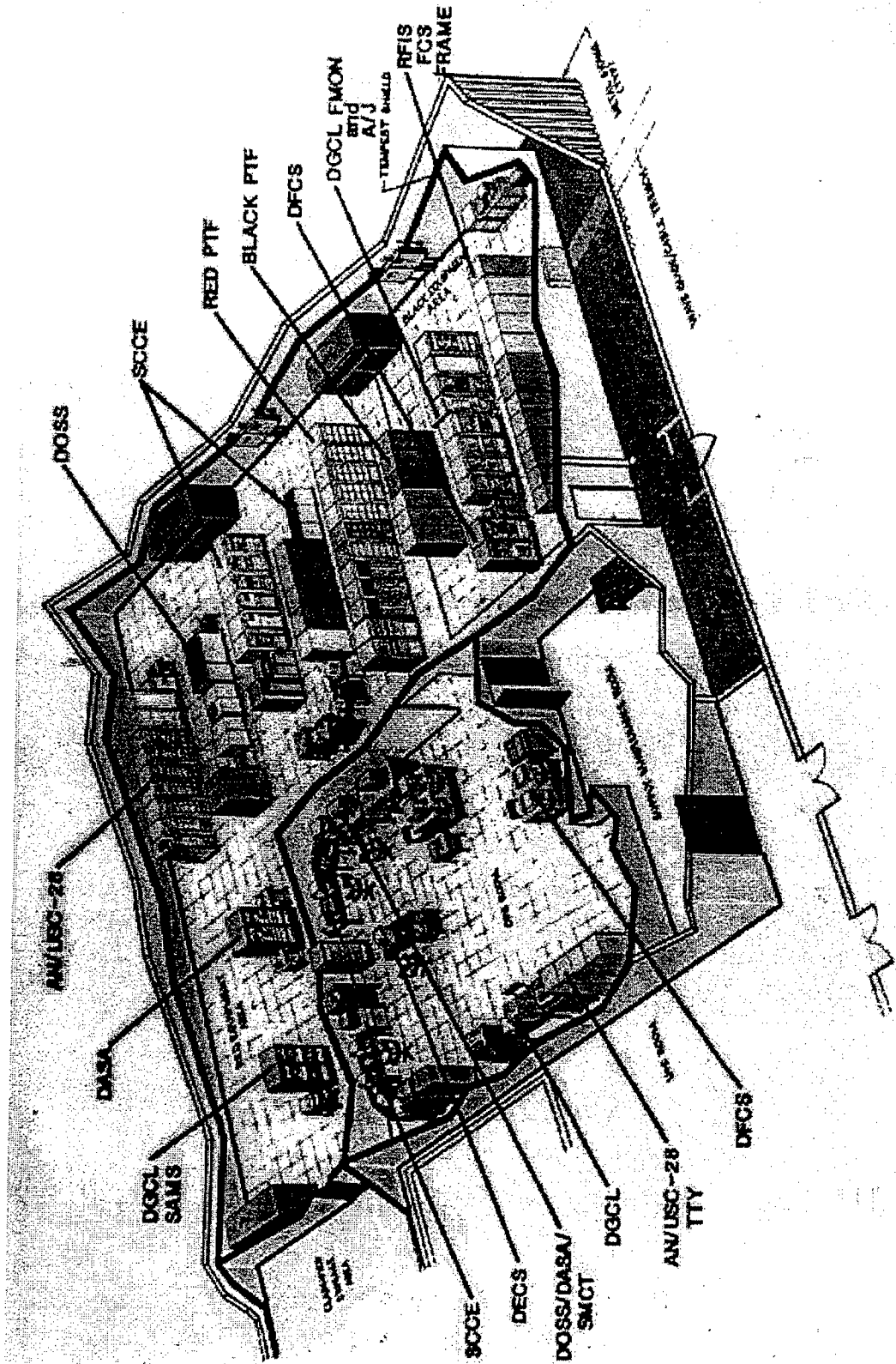

# DEFENSE SATELLITE COMMUNICATIONS SYSTEM SPECTRUM MANAGEMENT SYSTEM

## System Requirements

- Provide Army Technical Architecture (ATA) & Common Operating Environment (COE) compliant software and hardware
- Provide Enhanced Spectral Bandwidth and Power Monitoring capability in near real time
- Provide Enhanced Signal Analysis capability for existing/future military and commercial satellite systems
- Provide user-friendly interface/operating system
- Increase reliability and maintainability
- Maximize commercial-off-the-shelf

**DEFENSE SATELLITE COMMUNICATIONS  
SYSTEM SPECTRUM MANAGEMENT SYSTEM**

**Contract Opportunities**

**Objective:** Non-Developmental Item (NDI)  
Acquisition

**Proposed Contract Type:** Firm Fixed Price

**Key Milestones:** RFP Release: Jul 97  
Award: Jan 98  
Begin Fielding: Jan 00

**Estimated Value:** \$8M to \$10M

**Tech POC/Tel#:** Mr. Victor Phillipuk  
908-532-9728 Ext 5821

**Contract POC/Tel#:** Mr. Kevin Coakley  
908-532-2924

# **COMMON NETWORK PLANNING SOFTWARE**

**Unclassified**

# COMMON NETWORK PLANNING SOFTWARE

## System Definition

- Replace Defense Satellite Communications System Network Planning Software
- Plan Defense Satellite Communications System & commercial SHF links
- Improved planning performance
- Reduced operator workload
- Reduced life cycle maintenance costs

# DSCS SATELLITE NETWORK

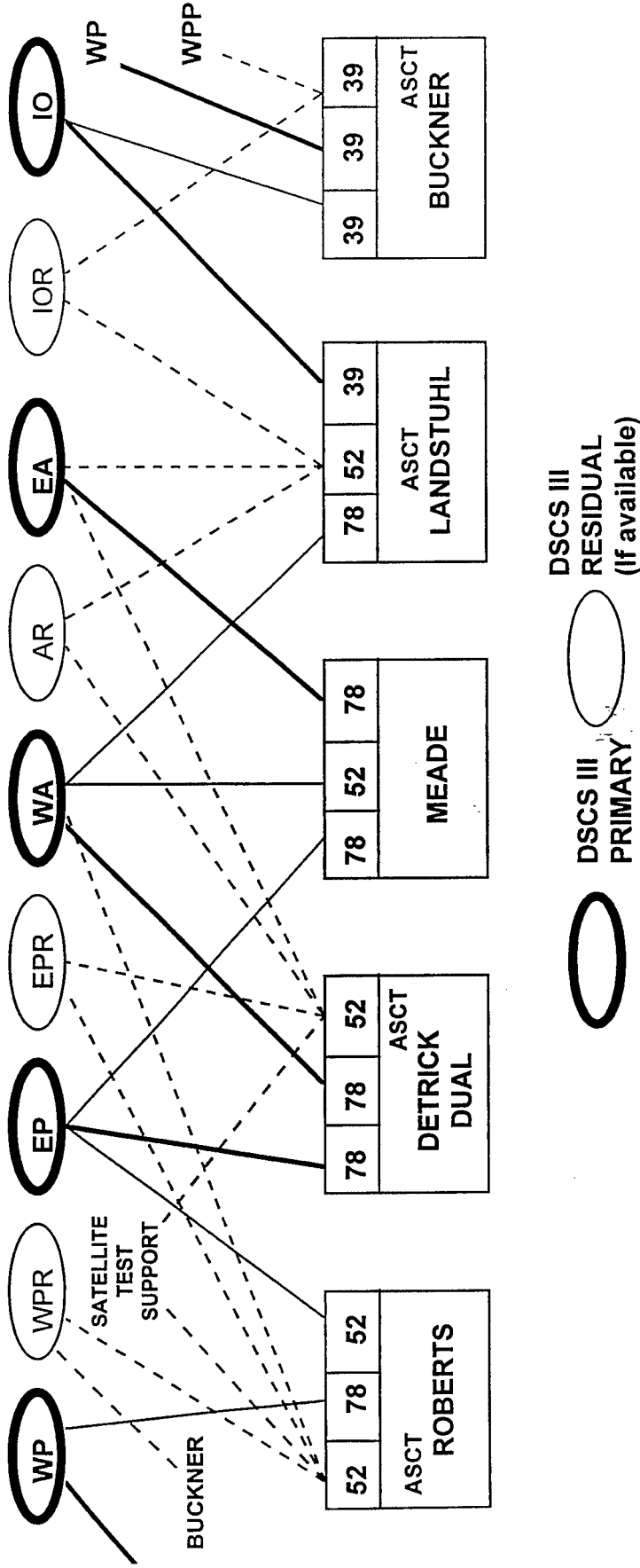

78=AN/FSC-78 52=AN/GSC-52 39=AN/GSC-39  
 ASCT=AUXILIARY SATELLITE CONTROL TERMINAL

PRIMARY ————— SECONDARY - - - - - ASCT



# COMMON NETWORK PLANNING SOFTWARE

## System Requirements

- Generic planner
- Retain Defense Satellite Communications System Network Planning Software algorithm
- Easily accommodate enhancements
- Army Technical Architecture (ATA) and Common Operating Environment (COE) compliant

# COMMON NETWORK PLANNING SOFTWARE

## Contract Opportunities

**Objective:** Acquire new Satellite  
Communications Network  
Planning Tool

**Proposed Contract Type:** Firm Fixed Price

**Key Milestones:**

RFP Release:	Jul 97
Award:	Jan 98
Begin Fielding:	Jun 01

**Estimated Value:** \$10M to \$15M

**Tech POC/Tel#:** Mr. David Morrissey  
908-532-9728 Ext 5808

**Contract POC/Tel#:** Mr. Kevin Coakley  
908-532-2924

# AN/GSC-52 MODERNIZATION PROGRAM

**Unclassified**

# **AN/GSC-52 MODERNIZATION PROGRAM**

## **System Definition**

- Extend the life of the AN/GSC-52 Terminals
- Improve operational availability
- Increase reliability
- Eliminate antenna component obsolescence
- Maximize commonality with the AN/FSC-78/79 and AN/GSC-39 Terminals
- Reduce operation and support cost

# AN/GSC-52 STATE OF THE ART MEDIUM TERMINAL (SAMT)

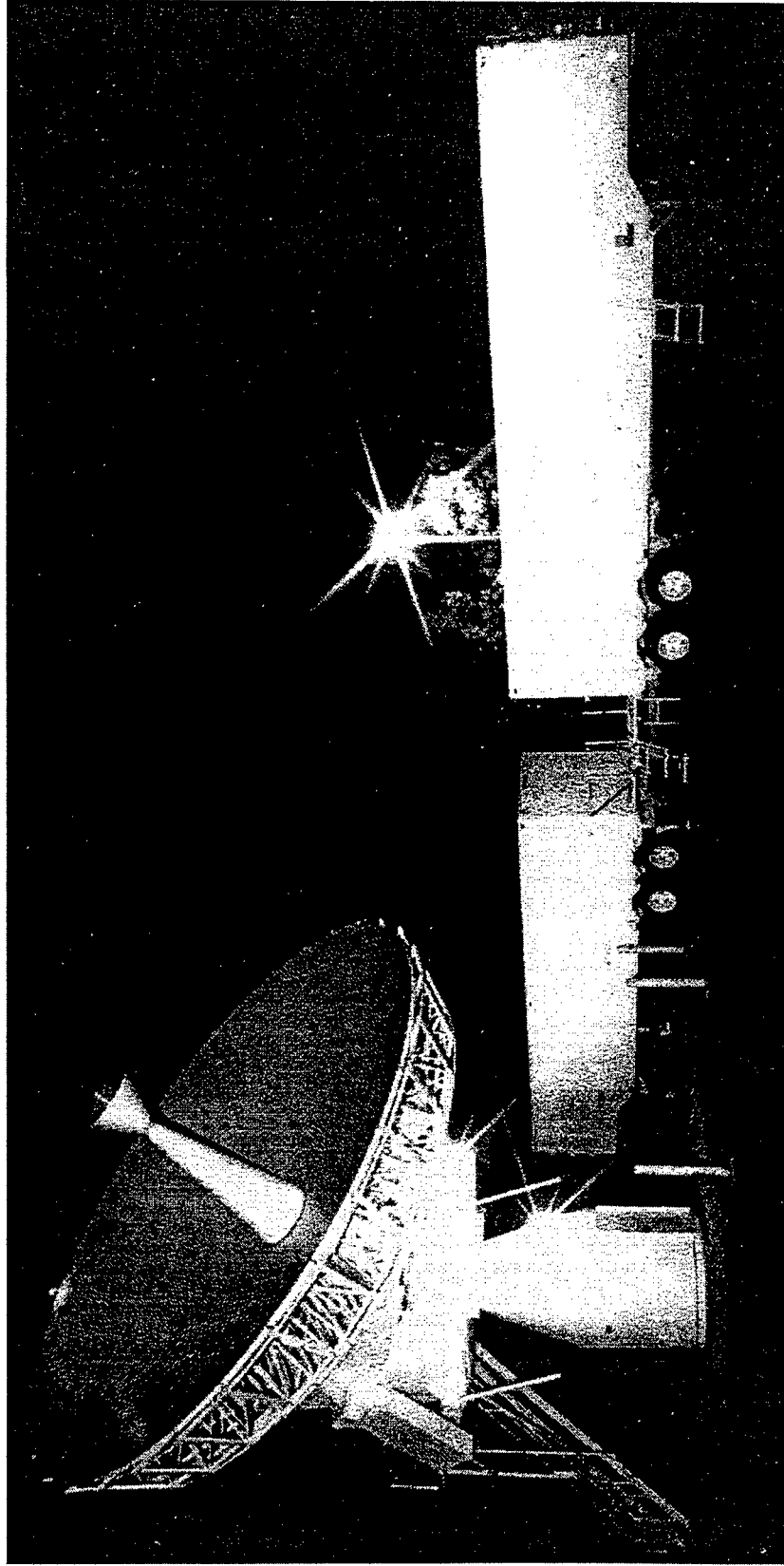

# **DEFENSE SATELLITE COMMUNICATIONS SYSTEM TERMINAL STATUS/SYSTEM**

- Fixed Satellite Communications Terminals
  - AN/FSC-78/79 - Fixed Configuration
  - AN/GSC-39 - Fixed & Vanized Configurations
  - AN/GSC-52 - Fixed & Vanized Configurations
- AN/FCS-78/79(HT) & AN/GSC-39(MT) Modernization
  - Ongoing - Completed Nov 98
- RF Components acquired from HT/MT Modernization
  - Contract and provided as GFE

# **AN/GSC-52 MODERNIZATION PROGRAM**

## **System Requirements**

- System design/integration
- Modification Work Order kits
- Antenna upgrades
- Antenna refurbishment
- Site surveys
- Installation
- Integrated Logistics Support (ILS)

# AN/GSC-52 MODERNIZATION PROGRAM

## Contract Opportunities

**Objective:**

Non-Developmental  
Acquisition of Terminal  
Modernization

**Proposed Contract Type:**

Firm Fixed Price/T&M

**Key Milestones:**

RFP Release: Aug 97  
Award: Jan 98  
Begin Fielding: Apr 01

**Estimated Value:**

\$110M to \$125M

**Tech POC/Tel#:**

Mr. Gerald Christophe  
908-532-9728 Ext 5811

**Contract POC/Tel#:**

Mr. Theodore Kordower  
908-532-1889

# NOTES

# **EXECUTIVE PANEL**

**MG GERARD P. BROHM  
CG, CECOM**

**MG DAVID R. GUST  
PEO, IEW&S**

**MR. EUGENE FAMOLARI, JR.  
ASSOCIATE TECH DIR, CECOM RD&E**

**MR. EDWARD G. ELGART  
DEPUTY ASSISTANT SECRETARY OF THE  
ARMY-PROCUREMENT (ACTING)**

**MRS. KATHRYN T. H. SZYMANSKI  
CHIEF COUNSEL, CECOM**

**MR. ANTHONY A. LaPLACA  
DIR, CECOM LRC**

**MR. ROBERT R. LEHNES  
DPEO, COMM SYS  
PEO C3S**

**MR. THOMAS J. MICHELLI  
ACTING DIR, SYSTEMS MGMT CENTER, CECOM**

**SYMPOSIUM  
PARTICIPANTS**

GENERAL JOHNNIE E. WILSON  
HQ, US Army Materiel Command  
AMCCG  
5001 Eisenhower Avenue  
Alexandria, Virginia 22333-0001  
(703) 617-9625

MG GERARD P. BROHM  
HQ, US Army Communications-Electronics Command  
AMSEL-CG  
Fort Monmouth, New Jersey 07703  
(908) 532-1515

MG DAVID R. GUST  
PEO, Intelligence, Electronic Warfare and Sensors  
SFAE-IEW  
Fort Monmouth, New Jersey 07703  
(908) 427-2153

MR. EUGENE FAMOLARI, JR.  
HQ, US Army Communications-Electronics Command  
AMSEL-RD-ADA  
Fort Monmouth, New Jersey 07703  
(908) 427-3967

MR. EDWARD G. ELGART  
HQ, US Army Communications-Electronics Command  
AMSEL-AC  
Fort Monmouth, New Jersey 07703  
(908) 532-5601

MS. KATHRYN T. H. SZYMANSKI  
HQ, US Army Communications-Electronics Command  
AMSEL-LG  
Fort Monmouth, New Jersey 07703  
(908) 532-3120

MR. ANTHONY A. LaPLACA  
HQ, US Army Communications-Electronics Command  
AMSEL-LC  
Fort Monmouth, New Jersey 07703  
(908) 532-5757

MR. ROBERT R. LEHNES  
PEO, Command, Control and Communications Systems  
SFAE-C3S-CM  
Fort Monmouth, New Jersey 07703  
(908) 427-4148

MR. THOMAS J. MICHELLI  
HQ, US Army Communications-Electronics Command  
AMSEL-IS-D  
Fort Monmouth, New Jersey 07703  
(908) 532-7960

COL SCIPIO de KANTER  
PM, Information Management & Telecommunications  
Pentagon Renovation  
AMSEL-IS-PR  
Arlington, Virginia 22202-3712  
(703) 607-9095

COL KENNETH A. THOMAS  
HQ, US Army Communications-Electronics Command  
AMSEL-RD-ST-D  
Fort Monmouth, New Jersey 07703  
(908) 427-4449

LTC THOMAS M. COLE  
PM, FIREFINDER  
SFAE-IEW-FF  
Fort Monmouth, New Jersey 07703  
(908) 427-5618

LTC MARY FULLER  
PM, Small Computer Program  
AMSEL-IS-SCP  
Fort Monmouth, New Jersey 07703  
(908) 427-6791

MR. EDWARD T. BAIR  
PEO, Intelligence and Electronic Warfare  
SFAE-IEW-D  
Fort Monmouth, New Jersey 07703  
(908) 532-0179

MR. KENNETH M. CHANEY  
PEO, Command, Control and Communications Systems  
SFAE-C3S-JTC-ITI  
Fort Monmouth, New Jersey 07703  
(908) 532-3525

MR. RAOUL CORDEAUX  
HQ, US Army Communications-Electronics Command  
AMSEL-IM  
Fort Monmouth, New Jersey 07703  
(908) 532-1126

MR. RICHARD S. COZBY  
HQ, US Army Test and Evaluation Command  
AMSTE-TM-T  
Aberdeen Proving Ground, Maryland 21005-5005  
(410) 278-1481

MR. LARRY L. FILLIAN  
HQ, US Army Communications-Electronics Command  
AMSEL-RD-NV-OD  
Fort Belvoir, Virginia 22060-5806  
(703) 704-1172

DR. FRANK JENIA  
HQ, US Army Communications-Electronics Command  
AMSEL-RD-IE-TD  
Fort Huachuca, Arizona 85613-5300  
(520) 538-8792

MR. ROBERT A. KATULKA  
Tobyhanna Army Depot  
SIOTY-BU  
11 Hap Arnold Boulevard  
Tobyhanna, Pennsylvania 18466-5051  
(717) 895-7083

MRS. MARY KELLY  
PEO, Standard Army Management Information Systems  
SFAE-PS  
9350 Hall Road  
Suite 142  
Fort Belvoir, Virginia 22060-5526  
(703) 806-4200

MR. RONALD F. JOHNSON  
PEO, Command, Control and Communications Systems  
SFAE-C3S-MSA-DC  
Fort Monmouth, New Jersey 07703  
(908) 532-9728

MR. LOUIS D. LIGENO  
HQ, US Army Industrial Operations Command  
AMSIO-AEB  
Rock Island, Illinois 61299-6000  
DSN 793-8583

DR. LOUIS MARQUET  
HQ, US Army Communications-Electronics Command  
AMSEL-RD-NV-OD  
Fort Monmouth, New Jersey 07703  
(703) 704-1172

MR. BRIAN MURRAY  
PM, Night Vision/Reconnaissance Surveillance and Target Acquisition  
SFAE-IEW-NV-LOG  
Fort Belvoir, Virginia 22060-5086  
(703) 704-3498

MR. GEORGE R. OLIVA, JR.  
HQ, US Army Communications-Electronics Command  
AMSEL-RD-C2  
Fort Monmouth, New Jersey 07703  
(908) 427-4851

DR. RICHARD A. POISEL  
HQ, US Army Communications-Electronics Command  
AMSEL-RD-IEW-OD  
Fort Monmouth, New Jersey 07703  
(908) 427-5556

MR. RICHARD RICCELLI  
HQ, US Army Communications-Electronics Command  
AMSEL-LC-LEO-E-EP  
Fort Monmouth, New Jersey 07703  
(908) 532-3056

MR. JAMES M. SKURKA  
HQ, US Army Simulation, Training and Instrumentation Command  
AMSTI-DC  
12350 Research Parkway  
Orlando, Florida 32826-3276  
DSN 970-3502

MR. PATRICK R. SNOW, JR.  
HQ, US Army Soldier Systems Command  
SSCNC-IW  
Natick, Massachusetts 01760-5000  
DSN 256-5436

MR. CARL M. SWENSON  
PEO, Command, Control and Communications Systems  
SFAE-C3S-MSA-TMD  
Fort Monmouth, New Jersey 07703  
(908) 532-5425

MR. DENNIS TURNER  
HQ, US Army Communications-Electronics Command  
AMSEL-RD-SE-D  
Fort Monmouth, New Jersey 07703  
(908) 532-8207

MR. ARTHUR C. WIDMAIER  
HQ, US Army Communications-Electronics Command  
AMSEL-SB  
Fort Monmouth, New Jersey 07703  
(908) 532-4511

## ACRONYMS

(A)	Acting
AAC	Army Acquisition Corps
AAE	Army Acquisition Executive
ABC	Activity Based Costing
ACQ	Acquisition
AC/RC	Active Component/Reserve Component
ACS	Aerial Common Sensor
ACUS	Area Common User System
ADMIN	Administration
ADP	Automated Data Processing
ADO	Associate Director of Operations
ADS	Army Development Office
ADV	Advanced
AFATDS	Advanced Field Artillery Tactical Data System
AI	Artificial Intelligence
AIE	Army Interoperability Engineering
AIN	Army Interoperability Network
AIT	Automated Identification Technology
ALT	Administrative Lead Time
AM	Army Management
AMC	U.S. Army Materiel Command
AMCAM	U.S. Army Materiel Command Deputy Chief of Staff for Ammunition
AMCLG	U.S. Army Materiel Command Deputy Chief of Staff for Logistics & Operations
AMCMI	U.S. Army Materiel Command Deputy Chief of Staff for Intelligence
AMCRDA	U.S. Army Materiel Command Deputy Chief of Staff for Research, Development & Acquisition
AMSAA	U.S. Army Materiel Systems Analysis Activity
ANVIS	Aviation Night Vision Imaging Systems
APBI	Advance Planning Briefing for Industry
APPS	Applications
AQL	Advanced Quicklook
AR	Army Regulation
ARAT	Army Reprogramming Analysis Team
ARC	Army Reuse Center
ARL	Army Research Laboratory
ASCT	Auxiliary Satellite Control Terminal
ATA	Army Technical Architecture
ATCOM	U.S. Army Aviation and Troop Command
ATD	Advanced Technology Demonstration

ATM	Asynchronous Transfer Mode
AUM	Asset Utilization Model
AVNS	Avionics
AWE	Army Warfighting Experiment
AWR	Army War Reserve
BAA	Broad Agency Announcement
BADD	Battlefield Awareness Data Dissemination
BCIS	Battlefield Combat Identification Systems
BCS	Battery Computer System
BGP4	Border Gate Patrol
BITS	Battlefield Information Transmission Systems
BLDG	Building
BQ	Bachelor Quarters
BR	Branch
BRAC	Base Realignment and Closure
BTU	British Thermal Unit
C2	Command and Control
C4I	Communications, Command, Control and Computers Intelligence
C4IEWS	Communications, Command, Control and Computers Intelligence and Electronic Warfare Systems (TEAM CECOM)
C4RDP	Command, Control, Communications and Computers Requirements Definition Program
CAD	Cost Analysis Division
CAISI	Combat Service Support Automated Information System Interface
CAIV	Cost as an Independent Variable
CALS	Continuous Acquisition and Life-Cycle Support; <b>ALSO:</b> Computer Assisted Logistics Systems
CBD	Commerce Business Daily
CCD	Configuration Control Document
CCS	Command & Control Systems
CECOM	U.S. Army Communications-Electronics Command
CF	Copy Furnished
CG	Commanding General
CGSC	Commanding General Signal Corp
CHS	Common Hardware/Software
CICM	Communications Integration and Cosite Mitigation
CI ACTD	Combat Identification Advanced Concept Technology Demonstration
CINC	Commander-in-Chief
CLDP	Civilian Leadership Development Program
CMD	Command
CMM	Capability Maturity Model
CNCMS	Counternarcotics Command and Management System
CNPS	Common Network Planning Software
COE	Common Operating Environment

COL	Colonel
COMINT	Communications Intelligence
COMM	Communications
COMP	Competitive
CONUS	Continental United States
COTS	Commercial Off-the-Shelf
CPFF	Cost Plus Fixed Fee
CPT	Captain
CPU	Central Processing Unit
CRDA	Chief, Research Development and Acquisition
CRS	Communications Realism Submodel
CSA	Chief of Staff of the Army
CSLA	Communications Security Logistics Activity
CSSCS	Combat Service Support Control System
CTASC-II	Corps Theater ADP Service Center, Phase II
CTIS	Combat Terrain Information System
CTR	Center
CTT	Commanders Tactical Terminal
CUITN	Common User Information Transport Network
DA	Department of the Army
DAC	Discretionary Access Control
DAMMS-R	Department Army Movements Management System - Redesign
DARPA	Defense Advanced Research Projects Agency
DB2I	Database-to-Database Interface
DBC	Digital Battlefield Communications
DBM	Data Base Management
DBS	Direct Broadcast Satellite
DCI	Directorate for Corporate Information
DCPDS-MOD	Defense Civilian Personnel Data System - Modernization
DCSPER	Deputy Chief of Staff for Personnel
DCSOPS	Deputy Chief of Staff for Operations
DDN	Defense Data Network
DEW	Directed Energy Weapon (Vehicle)
DF9	Diesel Fuel #9
DII	Defense Information Infrastructure
DIL	Digital Integrated Laboratories
DISA	Defense Information Systems Agency
DLA	Defense Logistics Agency
DLS	Depot Logistics System
DMM	Materiel Management Directorate
DMS	Defense Messaging System
DoD	Department of Defense
DOPMA	Defense Officer Personnel Management Activity
DOS	Disk Operating System
DPEO	Deputy Program Executive Officer

DRE	Readiness Directorate
DSCS	Defense Satellite Communications System
DSMS	Defense Spectrum Management System
DSN	Defense Switched Network
DSSMP	Digital Switched Systems Modernization Program
DVD	Direct Vendor Delivery
DVE	Driver's Vision Enhancer
EA	Executive Agent; <b>ALSO:</b> Electronic Attack
EAC	Echelons Above Corps
EBB	Electronic Bulletin Board
ECB	Echelons Corps and Below
EFE	Engineering Feasibility Efforts
ELINT	Electronics Intelligence
EMD	Engineering and Manufacturing Development
EO	Equal Opportunity
EPLRS	Enhanced Position Location Reporting System
ES/EA	Electronic Support/Electronic Attack
ESSO	European Software Support Office
ETLOS	Enhanced Target Location and Observation System
EUCOM	European Command
EW	Electronic Warfare
FA	Functional Area
FAAD	Forward Area Air Defense
FFP	Firm-Fixed Price
FG	Field Grade
FLOT	Forward Line of Troops
FLTC	Flexible Long Term Contract
FMS	Foreign Military Sales
FOC	Future Operational Capabilities
FREQ	Frequency
FRP	Full Rate Production
FSED	Fire Support Engineering Division
FT	Fort
FTS2000	Federal Telecommunications System 2000
FUE	First Unit Equipment
FWD	Forward
FY	Fiscal Year
GBCS (L)	Ground Based Common Sensor - Light
GBS	Global Broadcast Services
GFE	Government Furnished Equipment
GOTS	Government Off-the-Shelf
GPS	Global Positioning System
GRCS	Guardrail Common Sensor
GSM	Ground Station Module
HBCU/MI	Historically Black Colleges & Universities/Minority Institutions

HQ	Headquarters
HRMM	Human Resource Management Model
HS3	Hunter Sensor Suite Surrogate
HSMS	Hazardous Substance Management System
HTI	Horizontal Technology Integration
HT/MT	Heavy Terminal/Medium Terminal
HW	Hardware
IAS	Infrastructure Architecture Solutions
ICOM	Integrated Communication
ICS3	Integrated Combat Service Support System
ICT	Integrated Concept Team
ID	Identify
IDIQ	Indefinite Delivery/Indefinite Quantity
IETMS	Interactive Electronic Technical Manuals
IEW	Intelligence and Electronic Warfare
IEWD	Intelligence and Electronic Warfare Directorate
IEW&S	Intelligence Electronics Warfare & Sensors
IFSAS	Initial Fire Support Automated System
ILAP	Integrated Logistics Analysis Program
ILOGS	Integrated Logistics Systems
ILS	Industrial Logistics System
ILSC	Industrial Logistics Systems Center
IMA	Information Mission Area
IM&T	Information Management and Technology
IMETS	Integrated Meteorological System
IMMC	Intelligence Materiel Management Center
INOD	Improved Night/Day Observation/Fire Control Device
IO	Information Operations
IOC	U.S. Army Industrial Operations Command
IP	Internet Protocol
IPD	Intelligent Product Data
IPM	Inventory Projection Model
IPT	Integrated Process Team
IR	Internal Review
IR&D	Independent Research & Development
ISACM	Integrated Situational Awareness & Countermeasures
ISCCO	Information Systems Command Contracting Office
ISDN	Integrated Services Digital Network
ISEC	Information Systems Engineering Command
ISMA	Information Systems Management Activity
ISSAA	Information Systems Selection Acquisition Agency
ISSC	Information Systems Software Center
IVIS	Inter Vehicular Information System
JCALs	Joint Computer-Aided Acquisition and Logistics Support
JP8	Jet Propellant #8

JRISS	Joint Recruiting Information Support System
JSTARS	Joint Surveillance Target Attack Radar System
JTA	Joint Technical Architecture
JTACS	Joint Tactical Area Communications Systems
JTIDS	Joint Tactical Information Distribution System
JTT	Joint Tactical Terminal
KSSO	Korean Software Support Office
KW	Kilo Watt (1000 Watts of Electrical Power)
LAN	Local Area Network
LAR	Logistics Assistance Representative
LCC	Life Cycle Cost
LCM	Life Cycle Model
LCU	Line Control Unit
LDAP	Leader Development Action Plan
LDR	Low Data Voice
LDTOC	Light Digital Tactical Operations Center
LEO	Logistics Engineering Operations Directorate
LLDR	Lightweight Laser Designator Rangefinder
LMD	Logistics & Maintenance Directorate
LMI	Logistics Management Institute
LOC	Location; <b>ALSO:</b> Lines of Code
LOS	Line of Sight
LRC	Logistics and Readiness Center
LSSC	Logistics Systems Support Center
LT	Lieutenant
LTC	Lieutenant Colonel
LVRS	Lightweight Video Reconnaissance System
M	Million
MAC	Mandatory Access Control
MACOM	Major Command
MAGS	Manage Authorized Grades and Skills
MAJ	Major
MARC	Maintenance Manpower Requirements Criteria
MB	Megabyte
MIDAS	Multiplexer Integration & DCSS Automated System
MILDEP	Military Deputy
MILSATCOM	Military Satellite Communications
MIL-STD	Military Standard
MLRS	Multiple Launch Rocket System
MLS	Multilevel Secure
MMAD	Maxi-Mini and Databases
MNVD	Monocular Night Vision Device
	Movements System II
MS	Modeling and Simulation
MSE	Mobile Subscriber Equipment

MSN	Mission
MSRT	Mobile Subscriber Radiotelephone Terminal
MTMP	Major Command Telephone Modernization Program
MTS	Movement Tracking System
NAV	Navigation
NCS	Node Center Switch
NDI	Non-Developmental Item
NOM	Nomenclature
NRAD	Naval Research and Development
NRL	Naval Research Laboratory
NTDR	Near Term Data Radio
NVESD	Night Vision Electronic Sensors Directorate
NVG	Night Vision Goggle
OCONUS	Outside the Continental United States
ODAP	Officer Development Action Plan
ODS	Officer Development Office
OPNS	Operations
OPOM	Officer Personnel Management System
OPTNET	( <b>trade name</b> for software tool owned by MIL.3 Co.)
ORA	Operational Requirements Analysis
O&S	Operations & Support
OS	Operating System
OSCAR	Outside Cable Rehabilitation Program
OSCR	Operating and Support Cost Reduction
OSD	Office of the Secretary of Defense
OSPF	Open Shortest Path First
OTM	On-The-Move
PACOM	Pacific Command
PC	Personal Computer
PCS	Permanent Change of Station
PEO	Program Executive Office
PERMS	Personnel Electronic Record Management System
PERS	Personnel
PERSCOM	Personnel Command
PIPE	Product Integrity and Production Engineering
PLS-E	Palletized Load System - Enhanced
PLT	Production Lead Time
PM	Project Manager
POC	Point of Contact
POM	Program Objective Memorandum
Q or QTR	Quarter
QDR	Quality Deficiency Report
RAM	Random Access Memory
R&D	Research & Development
RDEC	Research, Development and Engineering Center

RDIT	Replication, Distribution, Installation and Training
RDP	Requirements Definition Program
RF	Radio Frequency
RFI	Request for Information
RFID	Radio Frequency Identification
RFP	Request for Proposal
RFPI	Rapid Force Projection Initiative
RSTA	Reconnaissance Surveillance & Target Acquisition
SAAS	Standard Army Ammunition System
SAIV	Schedule as an Independent Variable
SAMD	Security Assistance Management Directorate
SAMS	Standard Army Maintenance System
SAM-T	State of the Art Medium Terminal
SARSS	Standard Army Retail Supply System
SBIR	Small Business Innovative Research
SBIS	Sustaining Base Information System
SCAMP	Single Channel Anti-Jam Manportable
SDR	Surrogate Digital Radio
SED	Software Engineering Directorate
SEN	Small Extension Node
SHF	Super High Frequency
SINCGARS	Single Channel Ground and Airborne Radio System
SIDPERS	Standard Installation/Division Personnel System
SIGINT	Signal Intelligence
SIP	Single Channel Ground and Airborne Radio System Improvement Program
SKA	Skills, Knowledge, Attributes
SLAN	Secure Local Area Network
SMC	Systems Management Center
SMC-III	Small Multiuser Computer - III
SMD	Systems Management Directorate
SOF	Special Operations Forces
SOUTHCOM	Southern Command
SPBS-R	Standard Property Book System - Redesign
SR	Senior
SRWBR	Short Range Wide Band Radio
S/S	Sole Source
SSEB	Source Selection Evaluation Board
SSL	Software Solutions Laboratory
SSTS	Standard Systems Technology Support
S&T	Space & Terrestrial
S&TCD	Space & Terrestrial Communications Directorate
STACOMP	Standard Army Management Information System Tactical
STAMIS	Standard Army Management Information System
STO	Science and Technology Objective

STOW	Synthetic Theater of War
STRICOM	U.S. Army Simulation, Training and Instrumentation Command
SW	Software
SYS	System
T1	( <b>type</b> of communications line)
TACFIRE	Tactical Fire
TACMIS	Tactical Management Information Systems
TAFIM	Technical Architecture Framework for Information Management
TBD	To Be Determined
TC-AIMS II	Transportation Coordinators' Automated Information for Telecommunications
T&E	Test & Evaluation
TEED	Tactical End-to-End Encryption Device
TESAR	Tactical Endurance Synthetic Aperture Radar
TF	Task Force
TIC	Technology Integration Center
TIGER	Tactical Intelligence Generation and Evaluation Relay
TIREM	Terrain Integrated Rough Earth Model
TLOS	Target Location and Observation System
TOC	Tactical Operations Center
TPS	Test Program Sets
TRADOC	U.S. Army Training and Doctrine Command
TRCS	Tactical Radio Communications System
TSS	Tactical Switched Systems
TTP	Tactics, Techniques and Procedures
TWS	Thermal Weapon Sight
UAV	Unmanned Aerial Vehicle
UHF	Ultra High Frequency
ULLS	Unit Level Logistics System
UMS	Universal Modem System
VCSA	Vice Chief of Staff of the Army
VECP	Value Engineering Change Proposal
VHF	Very High Frequency
VHFS	Vint Hill Farms Station
VM	Value Management
VMF	Variable Message Format
VTC	Video Telecommunications
WAN	World Area Network
WIT	Wireless Interworking Testbed
WITS	Washington Interagency Telecommunications System
WRAP	Warfighter Rapid Acquisition Program
WS	Workstation
WWW	World Wide Web
Y2K	Year 2000
YG	Year Group



REPLY TO  
ATTENTION OF

AMSEL-CG

DEPARTMENT OF THE ARMY  
HEADQUARTERS, U.S. ARMY COMMUNICATIONS-ELECTRONICS COMMAND  
AND FORT MONMOUTH  
FORT MONMOUTH, NEW JERSEY 07703-5000



9 MAY 1997

MEMORANDUM FOR SEE DISTRIBUTION

SUBJECT: Director, Research Development and Engineering (RDE), CECOM, and Director CECOM Research Development and Engineering Center (CERDEC).

1. I wish to take this opportunity to announce that Mr. Robert Giordano, who serves in the dual role of Director, Research Development and Engineering, CECOM, and the Director, Research Development and Engineering Center, will be retiring from Federal service effective 1 June 1997. Bob is an outstanding senior executive, and it goes without saying that his leadership and technical skills will be sorely missed by CECOM, Team C4IEWS and the Army.
2. Effective with Mr. Giordano's retirement, Dr. Louis Marquet will serve as Acting Director, CERDEC. Dr. Marquet will have full and complete management authority over the Advanced Systems Directorate; Night Vision and Electronic Sensors Directorate; Space and Terrestrial Communications Directorate; Command, Control and Systems Integration Directorate; Intelligence and Electronic Warfare Directorate; RDEC Special Projects Office; and the Headquarters RDEC Staff.
3. Until further notice, the Software Engineering Center (SEC) and the Information Systems Engineering Command (ISEC) will report to Mr. Victor J. Ferlise, Deputy to the Commanding General, for guidance and direction.

GERARD P. BROHM  
Major General, USA  
Commanding

DISTRIBUTION:  
M, O, R

**TEAM COMMAND, CONTROL, COMMUNICATIONS AND COMPUTERS, INTELLIGENCE  
HEADQUARTERS, U.S. ARMY COMMUNICATIONS CENTER  
Fort Monmouth, New Jersey**

**COMMANDING GENERAL  
DEPUTY TO THE COMMANDING GENERAL  
DEPUTY FOR SYSTEMS ACQUISITION  
DEPUTY FOR BUSINESS & STRATEGIC PLANNING  
CHIEF OF STAFF  
COMMAND SERGEANT MAJOR**

**CENTERS**

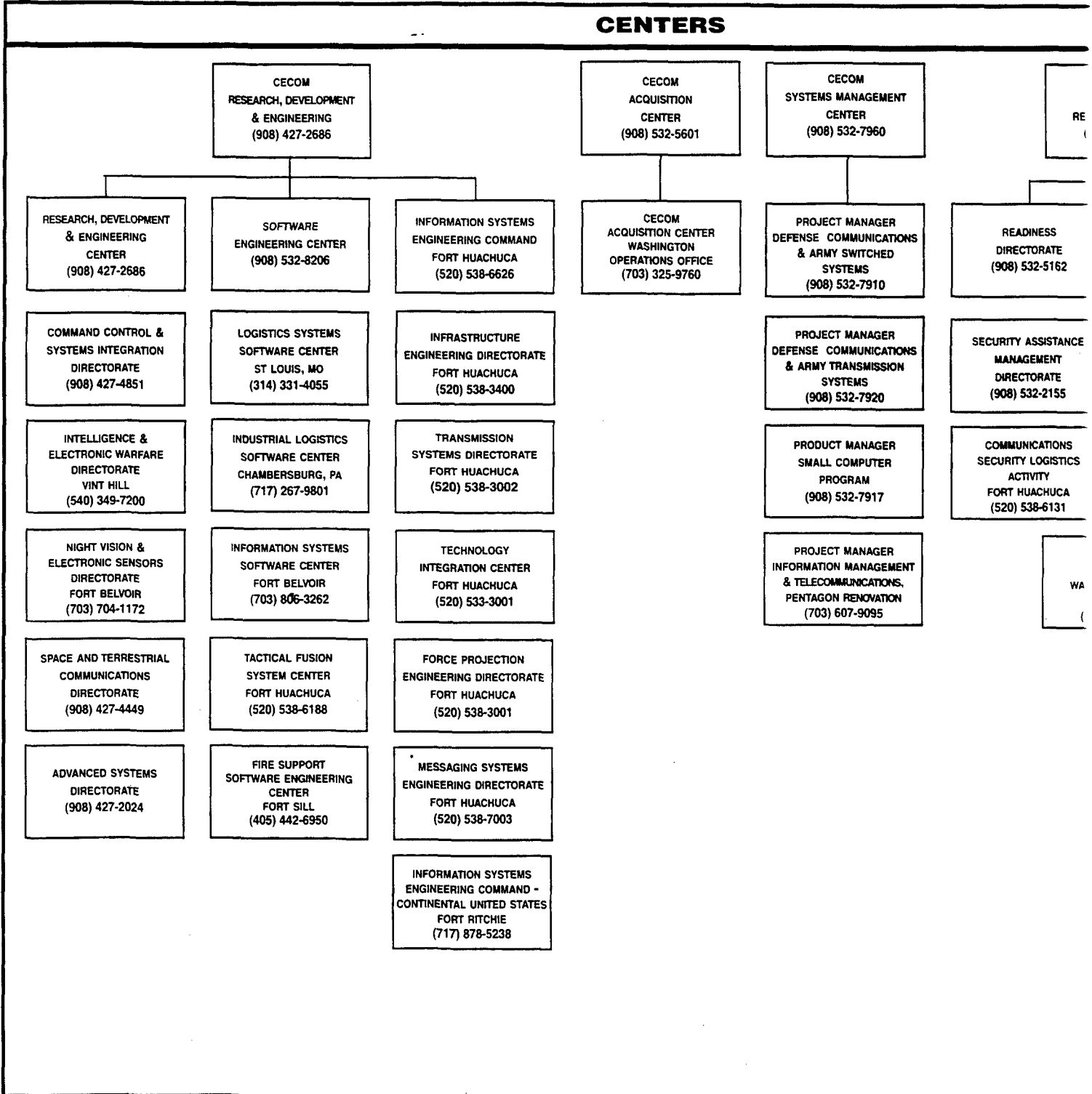

**UNOFFICIAL**

**COMPUTERS, INTELLIGENCE AND ELECTRONICS WARFARE AND SENSORS  
 COMMUNICATIONS-ELECTRONICS COMMAND  
 Fort Monmouth, New Jersey**

**COLONEL** (908) 532-1515  
**MAJOR GENERAL** (908) 532-5755  
**MAJOR** (908) 532-7960  
**MAJOR** (908) 532-3559  
**MAJOR** (908) 532-3906  
**MAJOR** (908) 532-5372

As of 16 MAY 1997

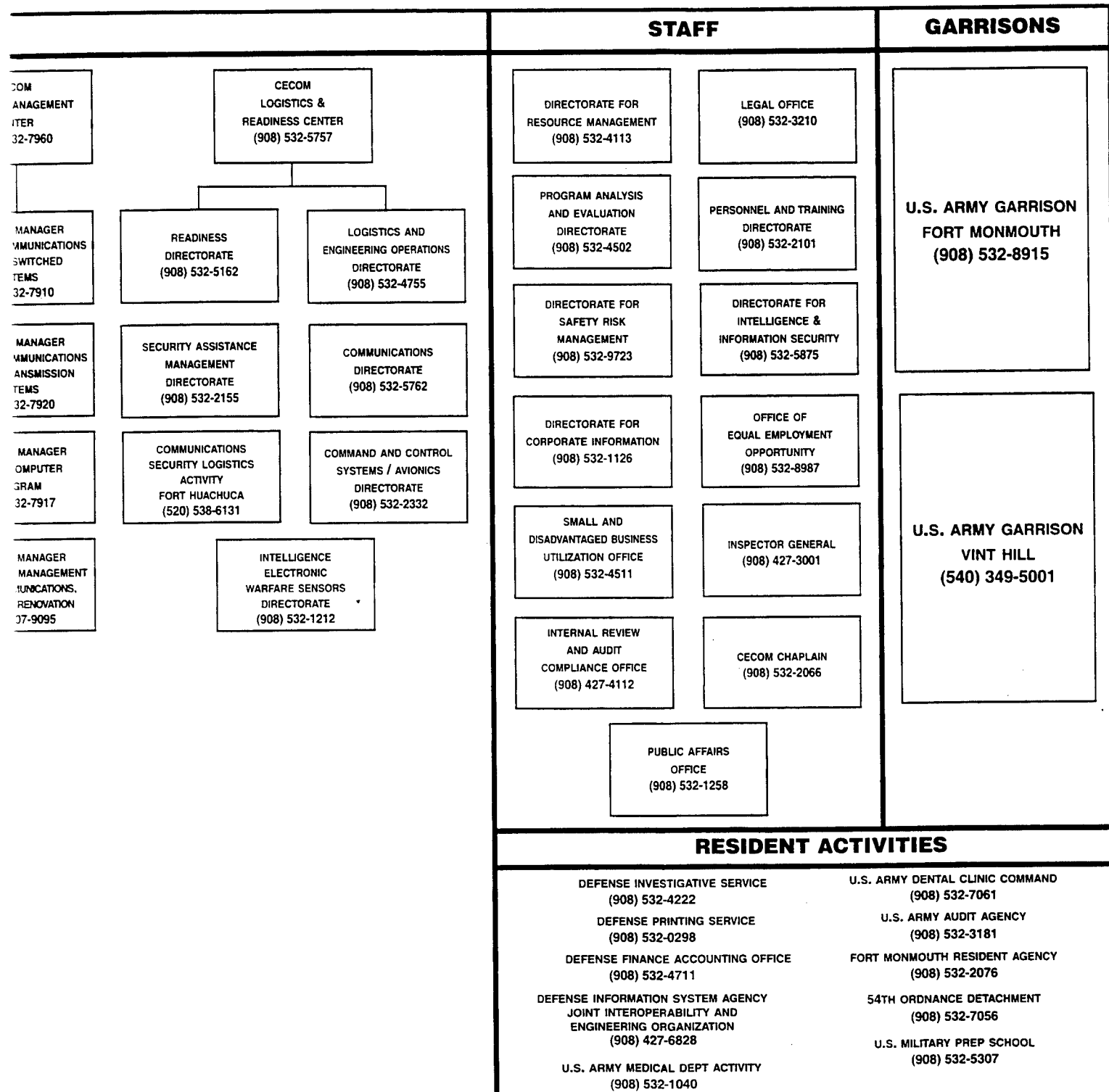

**UNOFFICIAL**

**TEAM COMMAND, CONTROL, COMMUNICATIONS AND COMPUTERS  
INTELLIGENCE AND ELECTRONICS WARFARE AND SENSORS  
PROGRAM EXECUTIVE OFFICES**

As of 16 MAY 1997

<p>PROGRAM EXECUTIVE OFFICE INTELLIGENCE AND ELECTRONIC WARFARE &amp; SENSORS (IEW&amp;S) (908) 427-2153</p>	<p>OFFICE OF THE PROJECT MANAGER JOINT PRECISION STRIKE DEMO (JPSD) FORT BELVOIR (703) 704-1943</p>	<p>OFFICE OF THE PRODUCT MANAGER COMBAT ID (908) 427-5105</p>	<p>OFFICE OF THE PROJECT MANAGER JOINT SURVEILLANCE TARGET ATTACK RADAR SYSTEMS (908) 427-5165</p>	<p>OFFICE OF THE PRODUCT MANAGER FIREFINDER (908) 427-5618</p>	<p>OFFICE OF THE PROJECT MANAGER NIGHT VISION RECONNAISSANCE SURVEILLANCE TARGET ACQUISITION (908) 427-5827</p>	<p>OFFICE OF THE PRODUCT MANAGER SENTINEL REDSTONE ARSENAL (205) 722-1673</p>	<p>OFFICE OF THE PROJECT MANAGER SIGNALS WARFARE VINT HILL (540) 349-5221</p>	<p>OFFICE OF THE PRODUCT MANAGER INFORMATION WARFARE FORT MEADE (301) 688-7351</p>	<p>PROGRAM EXECUTIVE OFFICE COMMAND, CONTROL AND COMMUNICATIONS SYSTEMS (C3S) (908) 427-4937</p>	<p>OFFICE OF THE PROJECT MANAGER MILSATCOM (908) 532-9767</p>	<p>OFFICE OF THE PROJECT MANAGER AIR DEFENSE COMMAND &amp; CONTROL SYSTEMS (ADCCS) REDSTONE ARSENAL (205) 895-3441</p>	<p>OFFICE OF THE PROJECT MANAGER ARMY TACTICAL COMMAND &amp; CONTROL SYSTEMS (ATCCS) (908) 532-4041</p>	<p>OFFICE OF THE PROJECT MANAGER APPLIQUE (908) 427-3237</p>	<p>OFFICE OF THE PRODUCT DIRECTOR COUNTER NARCOTIC COMMAND MANAGEMENT SYSTEMS (STCCS) MCLEAN, VA (703) 806-5687</p>	<p>OFFICE OF THE PROJECT MANAGER FIELD ARTILLERY TACTICAL DATA SYSTEMS (FATDS) (908) 427-3090</p>	<p>OFFICE OF THE PROJECT MANAGER STRATEGIC THEATER C2 SYSTEMS (STCCS) FORT BELVOIR (703) 806-5687</p>	<p>OFFICE OF THE PROJECT MANAGER GLOBAL POSITIONING SYSTEMS (GPS) (908) 532-6301</p>	<p>PROGRAM EXECUTIVE OFFICE STANDARD ARMY MANAGEMENT INFORMATION SYSTEMS (STAMIS) FORT BELVOIR (703) 806-4235</p>	<p>OFFICE OF THE PROJECT MANAGER INTEGRATED LOGISTICS SYSTEMS FORT LEE (804) 734-7665</p>	<p>OFFICE OF THE PROJECT MANAGER JOINT RECRUITING INFORMATION SUPPORT SYSTEMS FORT KNOX (508) 626-1101</p>	<p>OFFICE OF THE PROJECT MANAGER TACTICAL MANAGEMENT INFORMATION SYSTEMS FORT BELVOIR (703) 806-3888</p>	<p>OFFICE OF THE PROJECT MANAGER DEFENSE MESSAGE SYSTEMS FORT MONMOUTH (908) 532-5805</p>	<p>OFFICE OF THE PROJECT MANAGER SUSTAINING BASE AUTOMATION FORT BELVOIR (703) 806-0500</p>	<p>OFFICE OF THE PROJECT MANAGER STANDARD INSTALLATION DIVISION OF PERSONNEL SYSTEMS FORT BELVOIR (703) 806-4232</p>	<p>OFFICE OF THE PROJECT MANAGER JOINT COMPUTER AIDED ACQUISITION AND LOGISTICS SYSTEMS FORT BELVOIR (703) 806-3888</p>	<p>OFFICE OF THE PROJECT MANAGER TRANSPORTATION COORDINATOR - AUTOMATED INFORMATION FOR MOVEMENT SYSTEMS II FAIRFAX, VA (703) 275-9300</p>	<p>OFFICE OF THE PROJECT MANAGER TACTICAL RADIO COMMUNICATION SYSTEMS (TRCS) (908) 427-3063</p>	<p>OFFICE OF THE PROJECT MANAGER INTELLIGENCE FUSION MCLEAN, VA (703) 275-8111</p>	<p>OFFICE OF THE PROJECT DIRECTOR COMBAT TERRAIN INFORMATION SYSTEMS (CTIS) ALEXANDRIA, VA (703) 428-6876</p>	<p>OFFICE OF THE PROJECT MANAGER JOINT TACTICAL AREA COMMUNICATIONS SYSTEMS (JTACS) (908) 532-4740</p>
--	---	---	--	--	---	---	---	--	--	---	--	---	--	---	---	---	--	---	---	--	--	---	---	--	---	--	---	--	---	--

**UNOFFICIAL**