

**STRATEGIC DEFENSE SYSTEM
PROGRAM OVERVIEW**

PLEASE RETURN TO:

BMD TECHNICAL INFORMATION CENTER
BALLISTIC MISSILE DEFENSE ORGANIZATION
7100 DEFENSE PENTAGON
WASHINGTON D.C. 20301-7100

26 FEBRUARY 1988

19980819 117

U01258

**STRATEGIC DEFENSE SYSTEM
PROGRAM OVERVIEW**

26 FEBRUARY 1988

PREFACE

This briefing material provides an unclassified overview of the Strategic Defense Initiative (SDI) and the Strategic Defense System (SDS). The briefing slides review the origins of the SDI, the SDS Acquisition Strategy, the Program Elements which comprise the Phase I SDS, candidate elements for follow-on phases, and related information.

Appendix I contains a description of the Defense Acquisition Board (DAB) review process for the SDS Milestone I decision and a review of the material presented to the DAB in support of the Milestone I review. Backup slides providing more detail concerning SDI background, acquisition strategy, and issues/information relating to the Phase I and Follow-on SDS elements are provided in Appendix II of this document.

These briefing slides include some of the material presented by General Abrahamson to the DAB on 30 June 1987. The script and briefing slides have been updated to include later information concerning the SDS program status and technology developments. This briefing is intended for internal use by the SDIO and closely related DoD organizations to provide an information baseline and to assist in program review and briefing preparation activities.

STRATEGIC DEFENSE SYSTEM PROGRAM OVERVIEW

| <u>SLIDE</u> | <u>SLIDE NO.</u> | <u>PAGE</u> <u>NO.</u> |
|---|------------------|---------------------------|
| SDS Program Overview | 1 | 1 |
| Outline | 2 | 2 |
| Genesis of SDI | 3 | 3 |
| <u>SUPPORTING:</u> President's Speech | S3-1 | II-1 |
| SDI Studies | S3-2 | II-2 |
| Presidential Directive Establishes SDI | S3-3 | II-3 |
| Mission Requirements | S3-4 | II-4 |
| SDI Threat | S3-5 | II-5 |
| SDS Criteria | S3-6 | II-6 |
| | | |
| SDIO Charter and Functions | 4 | 4 |
| Path to Reliable Defenses | 5 | 5 |
| SDS Acquisition Strategy | 6 | 6 |
| <u>SUPPORTING:</u> Terminology | | II-7 |
| Manufacturing and Production | S6-1 | II-8 |
| MODIL Concept | S6-2 | II-9 |
| Cost Projection | S6-3 | II-10 |
| Element Acquisition Concept | S6-4 | II-11 |
| System Test Strategy | S6-5 | 7 |
| | 7 | |

STRATEGIC DEFENSE SYSTEM PROGRAM OVERVIEW

| <u>SLIDE</u> | <u>SLIDE NO.</u> | <u>PAGE</u> |
|---|------------------|-------------|
| <u>NO.</u> | | <u>NO.</u> |
| SDS Acquisition Process | 8 | 8 |
| Phased Deployment | 9 | 9 |
| <u>SUPPORTING:</u> Phased Deployment Timing | S9-1 | II-12 |
| SDS Phase I Core Concept | 10 | 10 |
| <u>SUPPORTING:</u> SDS Architecture Element Candidates | S10-1 | II-13 |
| Phase I Elements | 11 | 11 |
| Follow-On Elements | 12 | 12 |
| Operational Characteristics of SDS | 13 | 13 |
| BM/C ³ Approach | 14 | 14 |
| <u>SUPPORTING:</u> Concept for Boost BM/C ³ | S14-1 | II-14 |
| Boost - BM Functions | S14-2 | II-15 |
| Post Boost - BM Functions | S14-3 | II-16 |
| Post Boost Cluster Formation | S14-4 | II-17 |
| Sample BG Membership | S14-5 | II-18 |
| Midcourse - BM Functions | S14-6 | II-19 |
| BM Algorithms | S14-7 | II-20 |
| BM/C ³ Algorithm - Development Process | S14-8 | II-21 |
| Key Technology Issues - BM/C ³ | S14-9 | II-22 |

STRATEGIC DEFENSE SYSTEM PROGRAM OVERVIEW

| <u>SLIDE</u> | <u>SLIDE NO.</u> | <u>PAGE</u> <u>NO.</u> |
|--|------------------|---------------------------|
| SDS Command and Ops Center | 15 | 15 |
| Phase I - BSTS Element | 16 | 16 |
| <u>SUPPORTING:</u> Key Technology Issues - BSTS | S16-1 | II-23 |
| Phase I - Midcourse Surveillance | 17 | 17 |
| <u>SUPPORTING:</u> Midcourse Sensors Trade Study | S17-1 | II-24 |
| Phase I - SBI | 18 | 18 |
| <u>SUPPORTING:</u> Key Technology Issues - SBI | S18-1 | II-25 |
| Phase I - ERIS Element | 19 | 19 |
| <u>SUPPORTING:</u> Key Technology Issues - ERIS | S19-1 | II-26 |
| Advanced Launch System | 20 | 20 |
| <u>SUPPORTING:</u> Key Technology Issues - ALS | S20-1 | II-27 |
| The NTB Program | 21 | 21 |
| National Test Bed Program | 22 | 22 |

STRATEGIC DEFENSE SYSTEM PROGRAM OVERVIEW

| <u>SLIDE</u> | <u>SLIDE NO.</u> | <u>PAGE</u> |
|------------------------------------|------------------|-------------|
| Strategy - A Balanced Program | 23 | 23 |
| SUPPORTING: SDS Program Activities | S23-1 | II-28 |

APPENDIX I
SDS DEFENSE ACQUISITION BOARD REVIEW

| <u>SLIDE</u> | <u>SLIDE NO.</u> | <u>PAGE</u> <u>NO.</u> |
|---------------------------------|------------------|---------------------------|
| Purpose of DAB Review | DAB-1 | I-1 |
| DoDD 5000.1, MS I Decision | DAB-2 | I-2 |
| Acquisition Strategy to MS I | DAB-3 | I-3 |
| DAB | DAB-4 | I-4 |
| Outline of What Was Presented | DAB-5 | I-5 |
| SCP | DAB-6 | I-6 |
| TEMP | DAB-7 | I-7 |
| Environmental Assessment | DAB-8 | I-8 |
| DAB MS I Issues | DAB-9 | I-9 |
| Overriding Issues for DAB MS II | DAB-10 | I-10 |

APPENDIX II
SDS PROGRAM OVERVIEW SUPPORT SLIDES

| <u>SUPPORTING SLIDE</u> | <u>SUPPORTING SLIDE NO.</u> | <u>PAGE NO.</u> |
|--|---------------------------------|---------------------|
| President's Speech | S3-1 | II-1 |
| SDI Studies | S3-2 | II-2 |
| Presidential Directive Establishes SDI | S3-3 | II-3 |
| Mission Requirements | S3-4 | II-4 |
| SDI Threat | S3-5 | II-5 |
| SDS Criteria | S3-6 | II-6 |
| Terminology | S6-1 | II-7 |
| Manufacturing and Production | S6-2 | II-8 |
| MODIL Concept | S6-3 | II-9 |
| Cost Projection | S6-4 | II-10 |
| Element Acquisition Concept | S6-5 | II-11 |
| Phased Deployment Timing | S9-1 | II-12 |
| SDS Architecture Element Candidates | S10-1 | II-13 |
| Concept for Boost BM/C ³ | S14-1 | II-14 |
| Boost - BM Functions | S14-2 | II-15 |

APPENDIX II
 SDS PROGRAM OVERVIEW SUPPORT SLIDES

| <u>SUPPORTING SLIDE</u> | <u>SUPPORTING SLIDE NO.</u> | <u>PAGE NO.</u> |
|---|---------------------------------|---------------------|
| Post Boost - BM Formation | S14-3 | II-16 |
| Post Boost Cluster Formation | S14-4 | II-17 |
| Sample BG Membership | S14-5 | II-18 |
| Midcourse - BM Functions | S14-6 | II-19 |
| BM Algorithms | S14-7 | II-20 |
| BM/C ³ Algorithm - Development Process | S14-8 | II-21 |
| Key Technology Issues - BM/C ³ | S14-9 | II-22 |
| Key Technology Issues - BSTS | S16-1 | II-23 |
| Midcourse Sensors Trade Study | S17-1 | II-24 |
| Key Technology Issues - SBI | S18-1 | II-25 |
| Key Technology Issues - ERIS | S19-1 | II-26 |
| Key Technology Issues - ALS | S20-1 | II-27 |

APPENDIX II
SDS PROGRAM OVERVIEW SUPPORT SLIDES

| <u>SUPPORTING SLIDE</u> | <u>SUPPORTING SLIDE NO.</u> | <u>PAGE NO.</u> |
|-----------------------------|---------------------------------|---------------------|
| SDS Program Activities | S23-1 | II-28 |

**STRATEGIC DEFENSE SYSTEM
PROGRAM OVERVIEW**

26 FEBRUARY 1988

**STRATEGIC DEFENSE SYSTEM
PROGRAM OVERVIEW**

26 FEBRUARY 1988

SDI PROGRAM OVERVIEW

This briefing addresses the transition of the Strategic Defense System to the Demonstration/Validation phase.

It shows the progress we have made in defining the concept and technology for an operational defense against ballistic missiles and points out the specific demonstrations and validations required before the SDS Phase I can advance into full scale development.

OUTLINE

BACKGROUND

SDS ACQUISITION STRATEGY

SYSTEM CONCEPT

TECHNOLOGY ELEMENTS

SUMMARY: PROGRAM STRATEGY

OUTLINE

I want to first talk about the strategic defense requirements, because these drive not only our concepts and technology but also our Dem/Val and acquisition programs.

I will review the status of the key technologies, including the progress we've made and the development activities remaining.

Then I'll discuss the approach we plan for acquiring the systems that will make up the overall Strategic Defense System.

ORIGINS OF THE STRATEGIC DEFENSE INITIATIVE

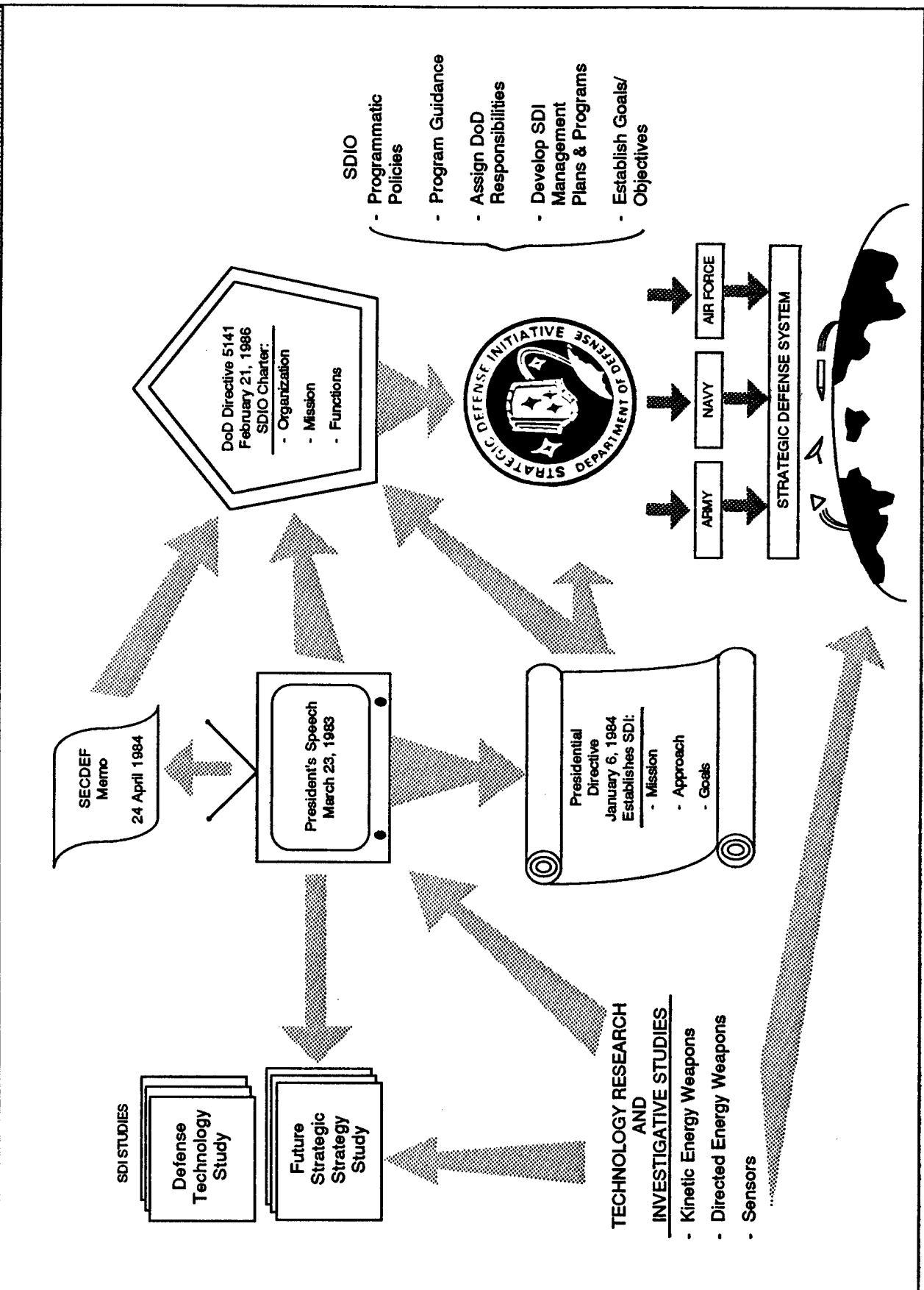

ORIGINS OF SDI

The origin of the SDI Program was the President's speech in March of 1983. The activities shown on this slide were conducted by the Strategic Defense Initiative Organization to respond to the guidance provided by the President and have resulted in a decision to enter the Strategic Defense system into the Demonstration/Validation phase of the DoD System Acquisition Process. The activities of this phase will provide for an orderly progression to the next decision point.

Supporting Slides

S3-1
S3-2
S3-3
S3-4
S3-5
S3-6

DoDD 5141.5 SDIO CHARTER/MISSION & FUNCTIONS

DoD Directive 5141.5

Charter for the Strategic Defense Initiative Organization

June 1987

- SDIO Mission
 - Conduct Vigorous Research Program
 - Provide Basis for Informed Decision Regarding the Feasibility of Eliminating the Threat Posed by Nuclear Ballistic Missiles
 - Protect Options for Near-Term Deployment.

- SDIO Functions
 - Develop Programmatic Policies
 - Issue Program Guidance
 - Assign DoD Component Responsibilities
 - Develop Systems, Standards & Procedures for Management and Support of Approved SDI Plans & Programs
 - Establish Prioritized Program Goals & Objectives
 - Evaluate DoD Component SDI Program Activities.

SDIO CHARTER AND FUNCTIONS

As was indicated earlier, the SDIO was established to execute the program directed by the President and the Secretary of Defense. This charter issued in February 1986 actually incorporated the guidance of a 1984 SecDef memo which officially established the SDIO.

THE PATH TO "THOROUGHLY RELIABLE" DEFENSES

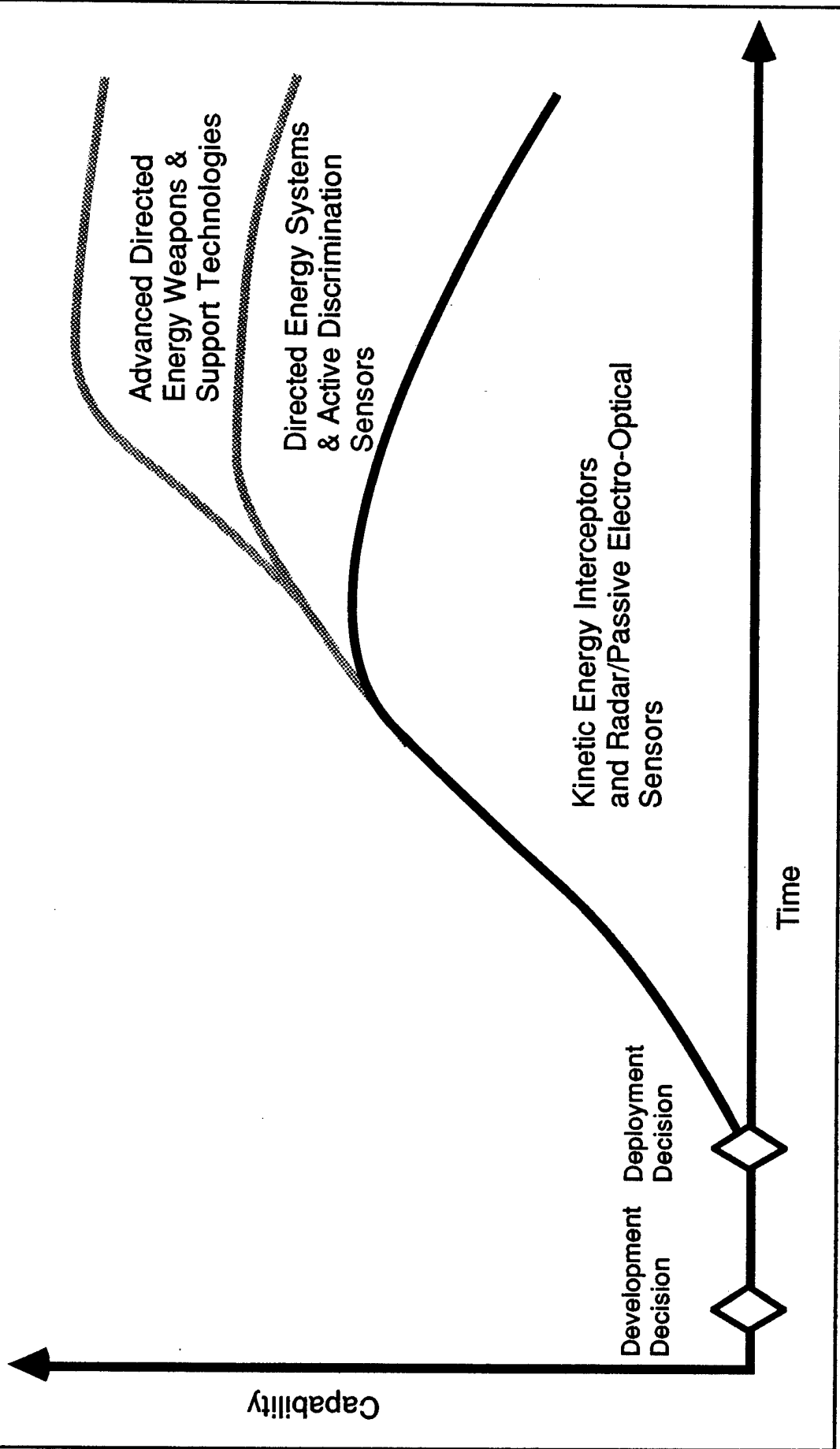

THE PATH TO "THOROUGHLY RELIABLE" DEFENSES

SDS will be developed and deployed in phases to meet the evolving threat. This phased development/deployment strategy will provide thoroughly reliable defenses over time in spite of Soviet operational adjustments and technical changes. We know that Soviet reactions and countermeasures will surely take place. The Phase I deployment of kinetic energy interceptors and radar/passive EO sensors will increase our capability significantly against the Soviet threat anticipated for this deployment period. As Soviet adjustments are made, deployed Phase II DEWs and active discrimination sensors, and Phase III Advanced DEWs will have the capability to defeat the increased threat even in a stressed warfighting environment.

The phased deployment approach coupled with a vigorous development and demonstration of follow-on technologies is explicitly designed to demonstrate our will and to lower Soviet weapon utility threshold at the earliest possible time.

SDS ACQUISITION STRATEGY

Phased Development And Deployment

- Pace Evolving Threat
- Based On Technology Advancement

Risk Reduction (Cost, Schedule And Technical)

- Experiments And Feasibility Demonstrations
- Pursue Alternative Technological Approaches
- Integrated Testing (National Test Bed)
- Baseline Technical/Cost/Schedule Plans
- Prototyping

Multiple Levels of Competition

Develop Production Capability

SDS ACQUISITION STRATEGY

The SDS Acquisition Strategy is based on a phased development and deployment. The system will be phased to keep pace with the evolving threat and to take advantage of the evolving technology. Major efforts are being directed toward technical, cost, schedule, and risk management and reduction. The core of the SDS risk reduction process is depicted on this slide. SDS acquisition strategy will emphasize multiple levels of competition--contractual as well as technological. The ultimate goal will be to select the best technologies at the best price, and at the same time develop economical and reliable production capabilities.

Supporting Slides

S6-1
S6-2
S6-3
S6-4
S6-5

NOTE: REFER TO S6-1 FOR ACRONYMS

SYSTEM TEST STRATEGY

PLANNED FOR RESTRICTIVE ABM TREATY INTERPRETATION
BUT COULD SHIFT IF THE BROADER INTERPRETATION APPROVED

"TOP-DOWN" SIMULATIONS

ARCHITECTURE STUDIES

NTB PHASE I & II

SERVICE SIMULATIONS

PHENOMENOLOGY EFFORTS

NTB PHASE III

"BOTTOM-UP" VALIDATION

HOE

FLAGE

DELTA 180

TECHNOLOGY TEST BEDS

PHENOMENOLOGY EXPTS

DOT

QUEEN MATCH

DELTA 181

JANUS

PROGRAM FLIGHT TESTS

INTEGRATED FLIGHT TEST

SATKA INTEGRATED EXPERIMENT (SIE) #1

FOLLOW-ON SIE

BM/C3 EXPERIMENTS

INTEGRATED INTERCEPTS

INTEGRATED DISCRIMINATION

NEAR-TERM SYSTEM INTEGRATION EXP

(NSITE)

SYSTEM TEST STRATEGY

System testing plans for SDS are currently based on a narrow ABM Treaty interpretation. However, they have the flexibility to shift if the broader interpretation is approved. Testing is being planned in the major categories shown.

Top down simulations will be implemented using the National Test Bed to evaluate recommended architectures and to further characterize SDS phenomenology. Inputs will also be provided from the Services' various simulation efforts.

Bottom-up validation will be provided through ongoing programs and planned experiments and special projects such as the FLAGE, Delta 181, and Program Test Flights.

Integrated flight tests are planned to develop information and prove feasibility in such areas as BM/C3, intercepts, and discrimination. Integrated flight tests will be structured using data gathered from the simulations and experiments.

SDS ACQUISITION PROCESS

Phased Development and Deployment

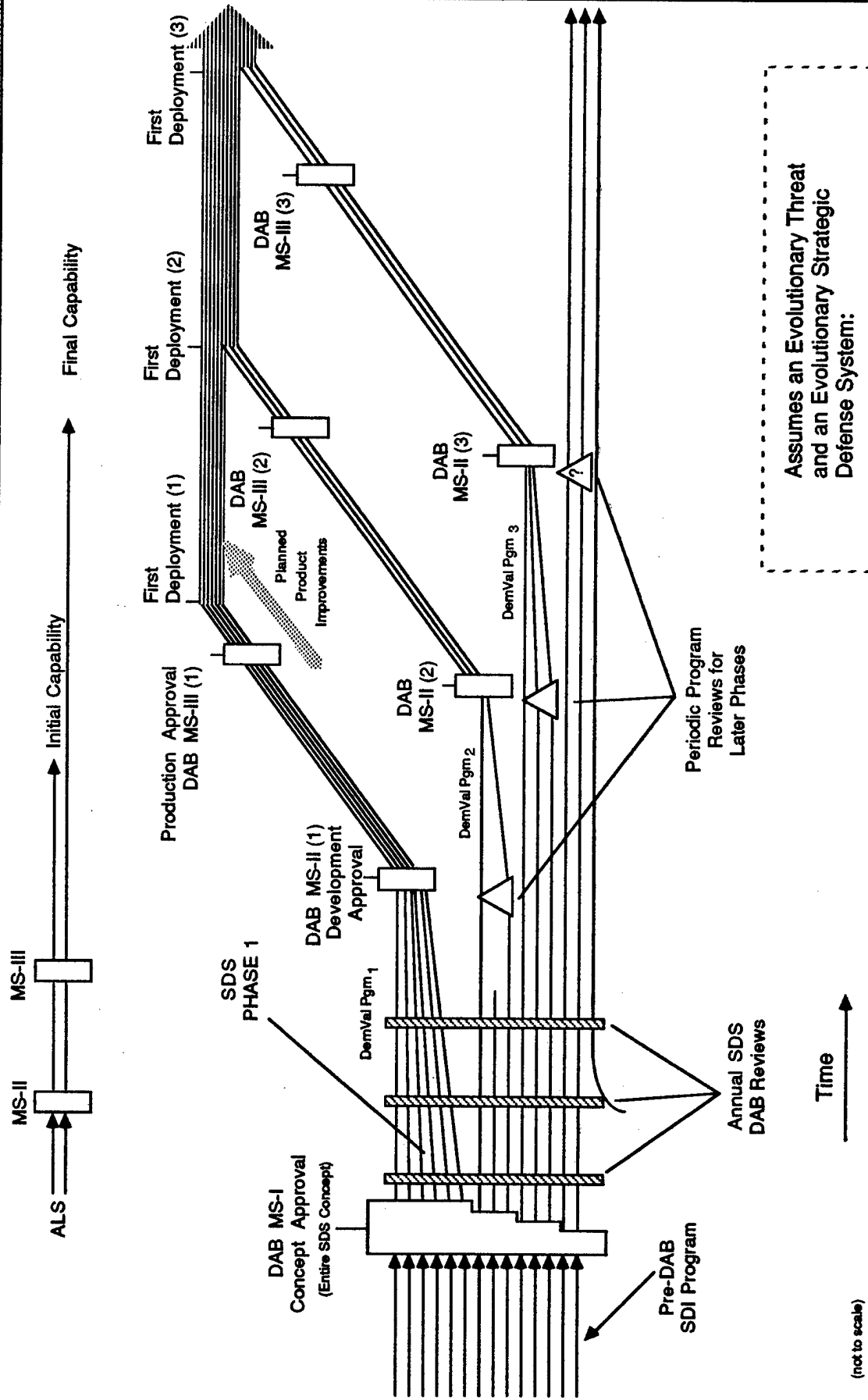

SDS ACQUISITION PROCESS

This illustrates the phased acquisition process for reaching the desired SDS. We have just traversed the first DAB MS-1, taking Phase I of the SDS into a Dem/Val program. Simultaneously, the technology program will continue for the development of elements to support Phase II and subsequent phases. The elements to be developed are a function of the technology required to meet a responsive Soviet threat and the technology which can be developed. As new technologies are developed they will be considered for entry into Dem/Val and eventual deployment. The process will continue to ensure that the SDS is always capable of performing its assigned missions, in an effective, survivable and affordable manner. Where appropriate, less successful technologies may be deleted from the program or existing elements may be enhanced by planned product improvements.

PHASED DEPLOYMENT

- BASED ON THREAT AND MISSION
- MOST LIKELY SEQUENCE
 - BOOST, POST BOOST AND LATE MIDCOURSE TO INTRODUCE UNCERTAINTY FOR ATTACK PLANNER
 - TERMINAL TO INCREASE CAPABILITY AND COUNTER SLBM
 - SUBSEQUENT ENHANCEMENTS TO PROVIDE PROGRESSIVELY GREATER DEFENSE CAPABILITIES EVEN IN FACE OF RESPONSIVE THREAT

PHASED DEPLOYMENT

The mission for the first phase of the SDS has been formulated and approved, and the design concept for the Phase I system to accomplish that mission was presented to the Defense Acquisition Board for approval.

Additionally, the concept for an ultimate SDS and the development process for achieving that concept have been formulated.

The exact sequence for accomplishing the phased development and deployment will be determined as the Soviet response to our program is identified and analyzed, to ensure that our efforts are both effective and appropriate.

Supporting Slides
S9-1

SDS PHASE 1 CORE CONCEPT

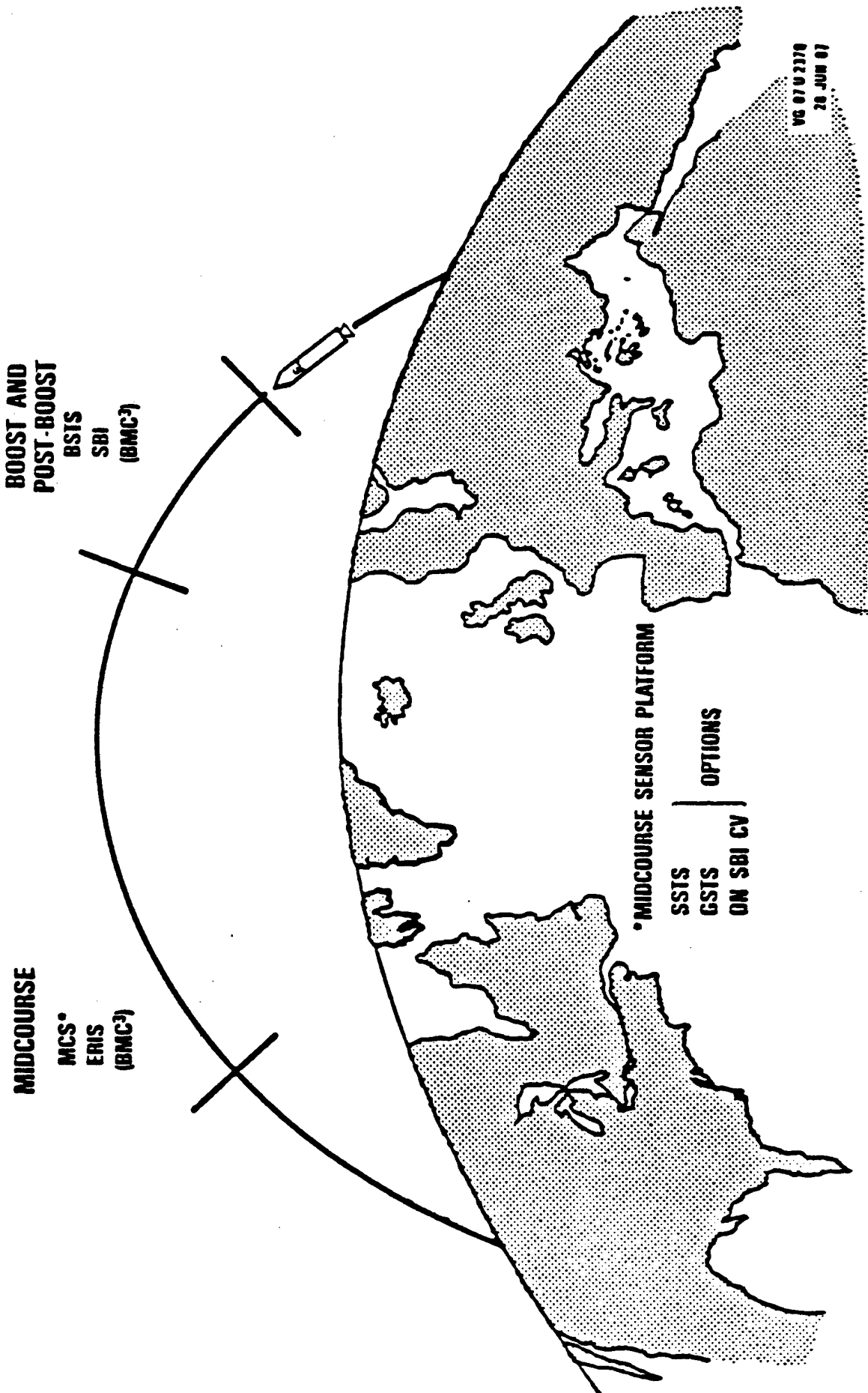

VG 07/02370
28 JUN 07

SDS PHASE I CORE CONCEPT

This slide represents the tentative design of the SDS Phase I. The elements currently transitioning into Dem/Val are as indicated, but other elements could be added if major accomplishments occur in other elements within the research program.

Supporting Slides
SI0-1

PHASE I ELEMENTS

| ELEMENT NAME | FUNCTIONS |
|---|---|
| Boost Surveillance and Tracking System (BSTS) | <ul style="list-style-type: none"> • Detection of Launches • Acquisition and Tracking of BVs and PBVs • Kill Assessment |
| Space-based Surveillance and Tracking System (SSTS) | <ul style="list-style-type: none"> • Acquire and Track PBVs, RVs and ASATs • Discrimination |
| Ground-based Surveillance and Tracking Systems (GSTS) | <ul style="list-style-type: none"> • Acquisition • Tracking • Discrimination |
| Space-based Interceptor (SBI) | <ul style="list-style-type: none"> • Disabling of Boosters, PBVs, RV and ASATs |
| Exoatmospheric Reentry Vehicle Interceptor System (ERIS) | <ul style="list-style-type: none"> • Disabling of RVs in Late Midcourse |
| Battle Management/Command, Control and Communication System (BM/C3) | <ul style="list-style-type: none"> • Man-in-Loop Control • Engagement Management • Maintaining Track Data • Target Assignment • Communications |
| | |

PHASE I ELEMENTS

The principal functions of the elements for the SDS Phase I are described here. The actual capability objectives are described in later slides. Each element is the subject of an Appendix in Vol II of the SCP.

CANDIDATE FOLLOW-ON ELEMENTS

| ELEMENT NAME | FUNCTIONS |
|---|---|
| Space-based Neutral Particle Beam Weapon (NPB) | <ul style="list-style-type: none"> • Discrimination • Disabling of Boosters, PBVs, RV and ASATs |
| High Endoatmospheric Defense Interceptor (HEDI) | <ul style="list-style-type: none"> • Disabling of RVs After Reentry |
| Airborne Optical System (AOS) | <ul style="list-style-type: none"> • Midcourse and Terminal Acquisition and Tracking |
| Ground-based Radar (GBR) | <ul style="list-style-type: none"> • Terminal Acquisition and Tracking • Discrimination |
| Space-based Laser (SBL) | <ul style="list-style-type: none"> • Disabling of Boosters and ASATs • Interactive Discrimination |
| Ground-based Hypervelocity Gun (HVG) | <ul style="list-style-type: none"> • Disabling RVs in Terminal Phase |
| Ground-based Laser (GBL) | <ul style="list-style-type: none"> • Disabling of Boosters and ASATs |
| Space-based Hypervelocity Gun (HVG) | <ul style="list-style-type: none"> ▪ Disabling of Boosters, PBVs, RVs, and ASATs |

FOLLOW-ON ELEMENTS

These are some of the potential elements for the follow-on phases and what their functions would be. Again, capability objectives are described on later slides. Each element is the subject of an Appendix in Vol 3 of the SCP.

OPERATIONAL CHARACTERISTICS OF THE SDS

- **Defensive**
 - Defend Against Ballistic Missiles
- **Responsive**
 - Provide Responsive Positive C² with Man-in-Control
- **Survivable**
 - Operate in a Hostile Environment
- **Interoperable**
 - Interoperate with External Systems Such as Strategic Offense & Tactical
- **Available**
- **Reliable**
- **Maintainable**
- **Supportable**

OPERATIONAL CHARACTERISTICS OF SDS

The operational characteristics which any Strategic Defense System must demonstrate are shown here. Of major significance is the requirement for positive control via man-in-the-loop decision capability which can preclude, reorient or terminate the activation of the system. Also, the SDS must be sufficiently survivable to perform its basic mission when the other side initiates the engagement and to degrade gracefully without catastrophic failure during a sustained engagement. It must also be completely sustainable over an extended period of time and allow for routine maintenance in an affordable manner.

BMC/3 APPROACH

APPROACH: DISTRIBUTED BMC/3

- BATTLE MANAGERS ON EACH SSTS AND CV
- IMPLICIT COORDINATION
- PARTITIONED TARGET LOAD

FEATURES:

- OPEN ARCHITECTURE
- GRACEFUL DEGRADATION
- ALLOCATION OF DECISIONS TO WEAPON PLATFORMS
- PARTITIONING TO CONTROL DP & MEMORY REQMTs
- PARTITIONING TO ALLOW CONFIDENT TESTING

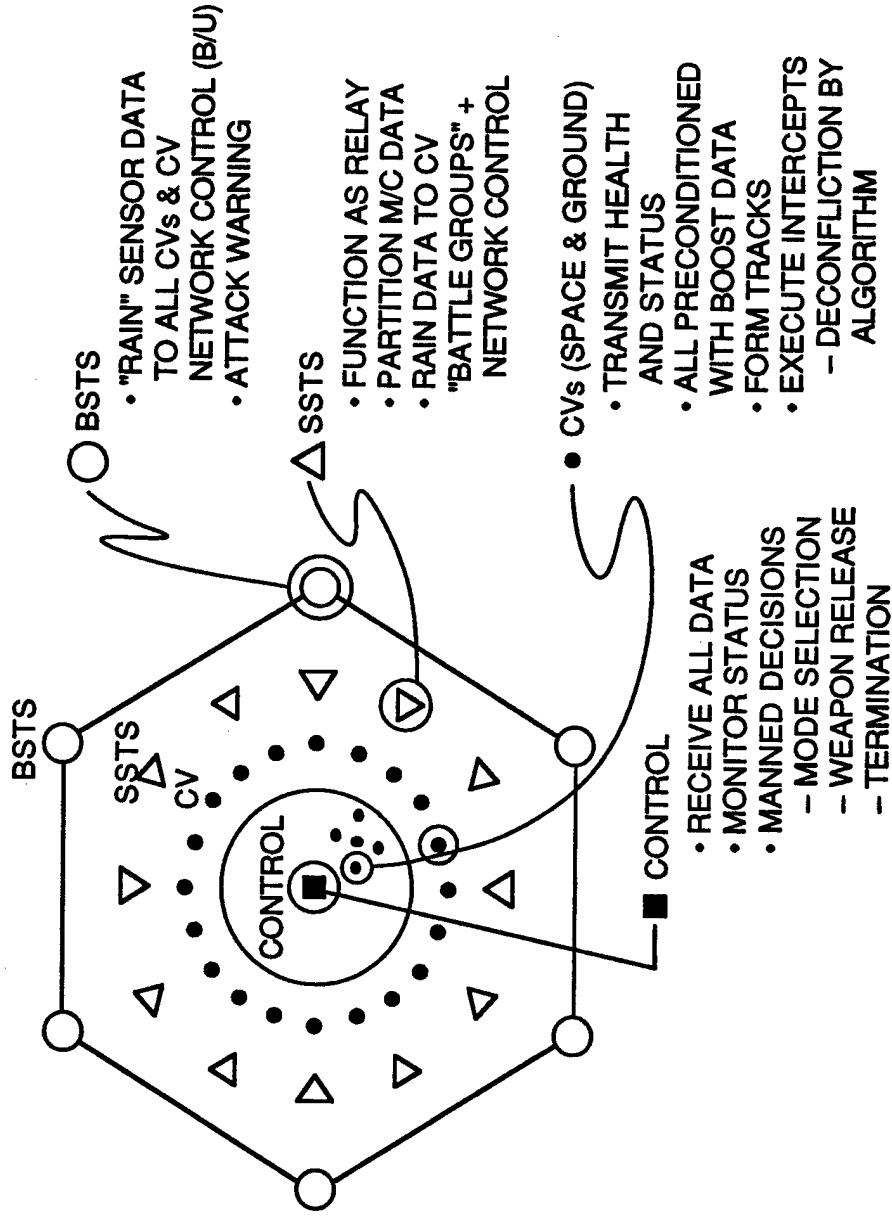

BM/C³ APPROACH

The BM/C³ approach carefully separates the C² functions, predominately human, from the heavily automated Battle Management actions. This slide reflects the Battle Management, i.e., the automated part. The interface with command center functions is indicated by the CONTROL circle, at the center. This will be expanded later.

The key concept of battle management is implicit coordination. This means provision of global data and weapon assignment rules to each of the weapon platforms. Each SBI carrier vehicle (CV) receives all track and threat inputs from BSTS and SSTs sensor elements. Each CV then computes the total Battle Management decision set, selects and executes its own part of that overall plan. Each CV has the same logic, as well as health and status updates from all other CVs (relayed by SSTs). Therefore, the globally optimal plan will be implemented without any need for a centralized or hierarchical decision structure.

Implicit coordination has the features of robustness in the presence of change (e.g., platform or communications failure), open architecture to allow unlimited growth as new elements become available, and full testability at all levels from a single platform up to the complete SDS.

Supporting Slides

S14-1
S14-2
S14-3
S14-4
S14-5
S14-6
S14-7
S14-8
S14-9

SDS COMMAND CENTER & OPERATIONS CENTER

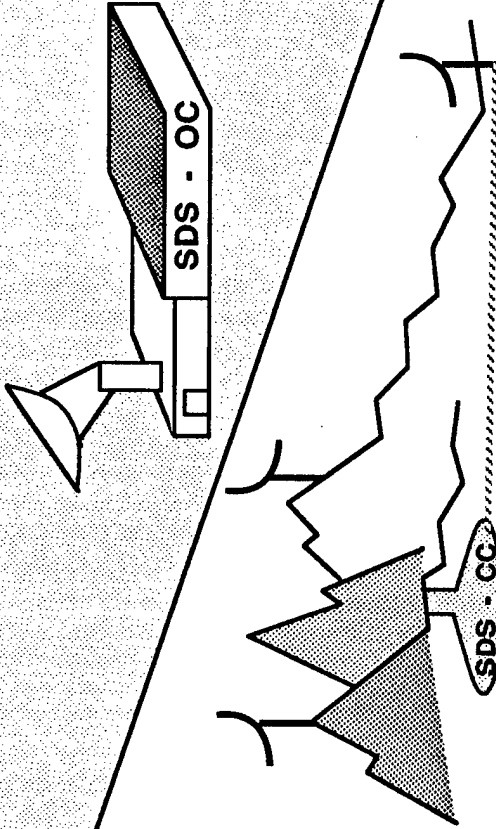

SDS - CC

FUNCTIONS

- MAINTAIN POSITIVE CONTROL
- ASSESS SITUATION
- SELECT/IMPLEMENT MODE
- COORDINATE WITH FORCES & HIGHER AUTHORITY
- EVALUATE ENGAGEMENTS
- RECONFIGURE/RECONSTITUTE
- OPERATIONAL EXERCISES

MESSAGES

- RECEIVE BSTS ALERT MESSAGE
- TRANSMIT MODE SELECT & DATA BASE UPDATE
- TRANSMIT/RECEIVE HEALTH AND STATUS
- RECEIVE TRACK REPORTS & ITW & A DATA
- TRANSMIT WEAPONS RELEASE/TERMINATION

CONNECTIVITY

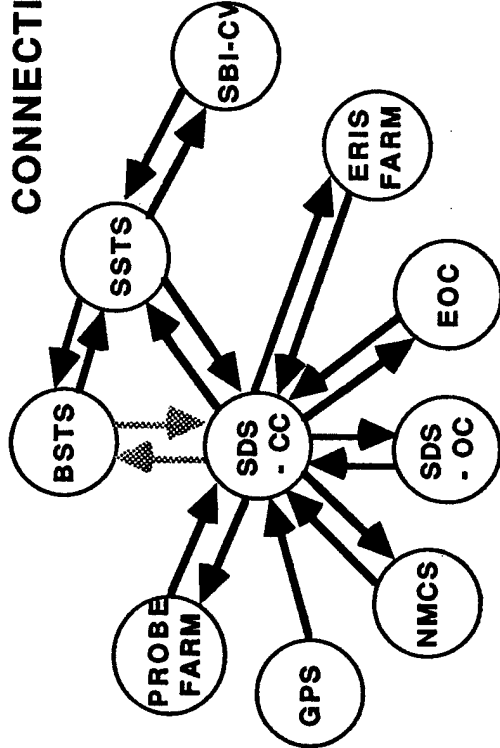

SDS - OC

FUNCTIONS

- MAINTAIN READINESS
- MAINTAIN SYSTEM CONTROL
- MANAGE DEPLOYMENT
- PLANNING
- INTELLIGENCE
- SECURITY
- COMMUNICATIONS

MESSAGES

- TRACKING, TELEMETRY AND CONTROL
- SYSTEM/ELEMENT STATUS
- RECEIVE/ACKNOWLEDGE HA DIRECTION

SDS COMMAND CENTER AND OPS CENTER

The SDS Operations Center will be a peacetime day-to-day facility, with the functions listed here. Initially, it will be located at Falcon Air Force Station, Colorado, with direct interoperability with the NORAD Cheyenne Mountain Complex. Collocated will be the Strategic Defense Command Center. This will provide crisis and hostilities control capabilities.

For the Command Center, real-time interface requirements with all the other operational SDS elements will be required. Previous slides have referred to these. In addition, terrestrial connectivity to other major commands, including NMCS and NCA, will be provided to the Command Center and the Operations Center.

Design of unified command facilities for widely geographically distributed resources is a mature technology. The algorithms, functions, and operational requirements are well understood from prior experience ranging from SAC to NMCS to EUR, and other large commands. On a previous slide, algorithm development for the Control Center was shown as only 50 percent complete. This reflected a need for specialization to the specific needs of a Strategic Defense Commander. Implementation of these algorithms, even after they become fully defined and validated, may still be an extensive process. Although the Command Center/Operations Center complex is considered low-risk, it still has a long lead time. Thus, early approval and funding support are important to meeting the national security objectives.

PHASE I - BSTS ELEMENT

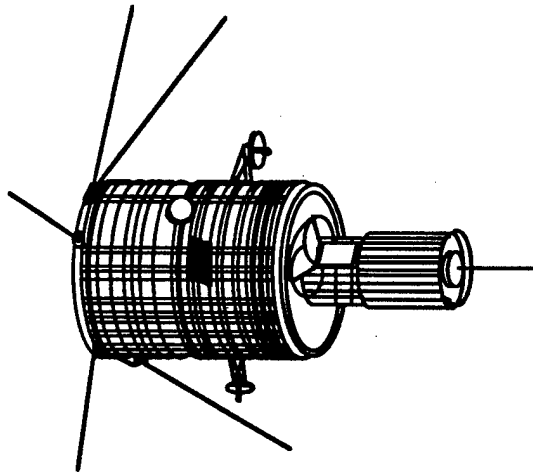

KEY REQUIREMENTS

Size: approx. 36x16 ft.

Bands: Multispectral

Sensor: Scanning or Staring

Power: 6-10 kW

Total Spacecraft Weight: 5000-7000 kg

FUNCTIONS

- Surveillance - Continuous Global Observation Of The Earth's Surface
- Detection - ICBMs, IRBMs, SLBMs
- Acquisition - Initiate Tracking Of Missiles
- Tracking - Compute State Vectors And Predict Future Positions
- Typing - Determine The Missile Type
- Kill Assessment - Provide Data To Weapons To Assist In Determination Of A Hit Or Kill
- Communications - Transmit Required Data To All Users
- Battle Management - As Determined By The SDI Architecture

PHASE I - BSTS ELEMENT

A general description of the BSTS element, to include general requirements and functions is given here. Additional details are not shown because of classification constraints.

Supporting Slides

S16-1

PHASE I - MIDCOURSE SURVEILLANCE ELEMENT

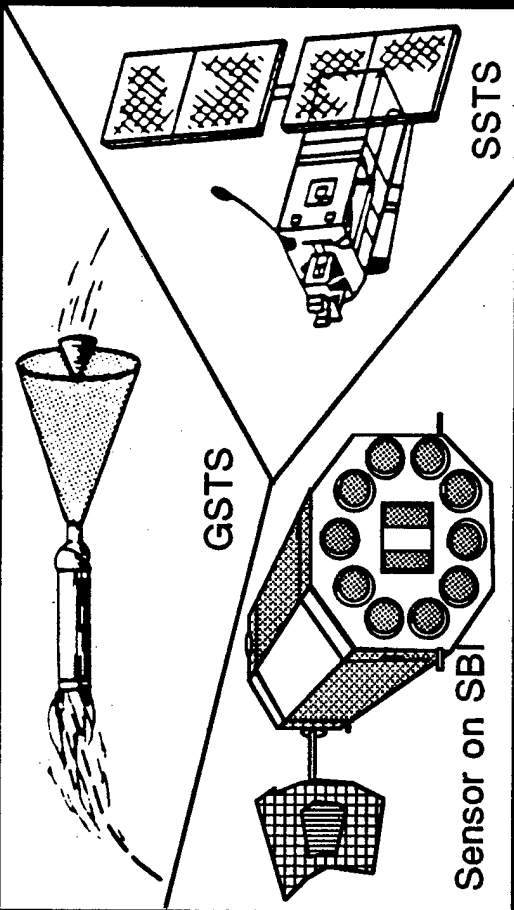

KEY PARAMETERS

Aperture: < 1.5 meters

Sensor: Scanning

Revisit Time: < 10 sec

No. Of Detectors: 1.0×10^6

Bands: Multispectral

FUNCTIONS

Acquire and Track Cold (Non Thrusting) PBV's, RV's, Decoys, ASATS

Track Data Provided via BM/C³ to SBI and ERIS

Discriminate Simple Balloon Decoys

Bulk Filter Debris and Keep Track of All Threatening Objects in Field of View

PHASE I - MIDCOURSE SURVEILLANCE

This viewgraph depicts the equivalent data for mid-course sensor elements. The carrier platform for this surveillance element is presently being addressed by a special study group which will provide its recommendations within the next six months.

Supporting Slides
SI7-1

PHASE I - SPACE BASED INTERCEPTOR ELEMENT

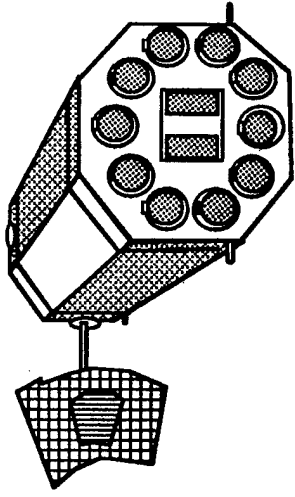

KEY REQUIREMENTS

- Carrier Vehicle
 - 3000 Kg
- Interceptor
 - Low Cost/Long Life

FUNCTIONS

- Intercept Boosters, PBVs, RVs, Self Defense Against Direct Ascent ASATs
- Carrier Vehicles
 - Store And Launch Interceptors
 - Assess Kill And Report Status
- Interceptor
 - Acquire, Home On & Destroy Target

TECH MATURITY AND HARDWARE DEVELOPMENT SUPPORTS FEASIBILITY

PHASE I - SBI DEM/VAL

The primary SDS Phase I weapon system for the Boost Phase Interceptor (SBI) is a rocket propelled kinetic kill interceptor. Because of treaty constraints, the Dem/Val program will investigate and develop this element using ground launched interceptors against ground launched targets. The carrier vehicle of the actual SBI will have multiple interceptors.

Supporting Slides

S18-1

PHASE I - ERIS ELEMENT



KEY REQUIREMENTS

- Low Cost Per RV Kill: \leq \$ 1M
- Lightweight: ~700 Kg
- Lethality Enhancer Using Impulse Kill
- "Dormant" Missile Concept

FUNCTIONS

- Accept Target State Vector Updates From Sensors (Radar, GSTS, SSTS)
- Acquire, Home On Target, Impact RV
- Destroy RV's In Late Midcourse (Exoatmospheric)

FEASIBILITY DEMONSTRATED (HOE) - LOW COST LIGHTWEIGHT IS THE GOAL

PHASE I - ERIS ELEMENT

For Midcourse interception during the SDS Phase I, the kinetic kill vehicle will be delivered by a ground launched, rocket propelled missile which will probably be based on both mobile and silo type launchers. The midcourse surveillance sensor associated with this element, as has previously been discussed, has not yet been determined.

Supporting Slides

S19-1

ADVANCED LAUNCH SYSTEM (ALS)

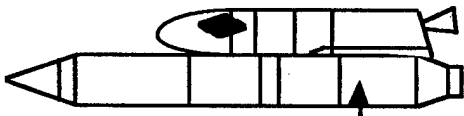

Payload Fairing
(8m x 28m) Payload
Envelope

Second Stage
- LOX/LH2 Tankage

LOX/HC First Stage
- Flyback Booster

OBJECTIVES

- ▶ Satisfy SDIO/Other DoD/NASA Requirements
- ▶ Provide 10-Fold Reduction in Launch Costs by Late '90s
- ▶ Provide Flexible/Robust Launch Capability

APPROACH

- ▶ Design Objective ALS to be Available in Late '90s
- ▶ Highly Automate Production
- ▶ Design Facilities and Operations to Support High Launch Rates

CURRENT STATUS AND SCHEDULE

- ▶ Concept Definition Began in July 1987
- ▶ July 88 - Systems Program Review
- ▶ August 89 - Program Design Review
 - Predicated on Receipt of Full Funding By SDIO/AF/NASA
- ▶ Technology Maturation Through mid-90s
 - Technology Began in SDIO Line in FY86

ADVANCED LAUNCH SYSTEM

The ALS is a vital adjunct to the SDS and will proceed at a pace established jointly with the Air Force and NASA. The requirements are for a U.S. capability to provide heavy lift into space at a significantly reduced cost for both civilian and defense purposes.

Supporting Slides

S20-1

THE NTB PROGRAM

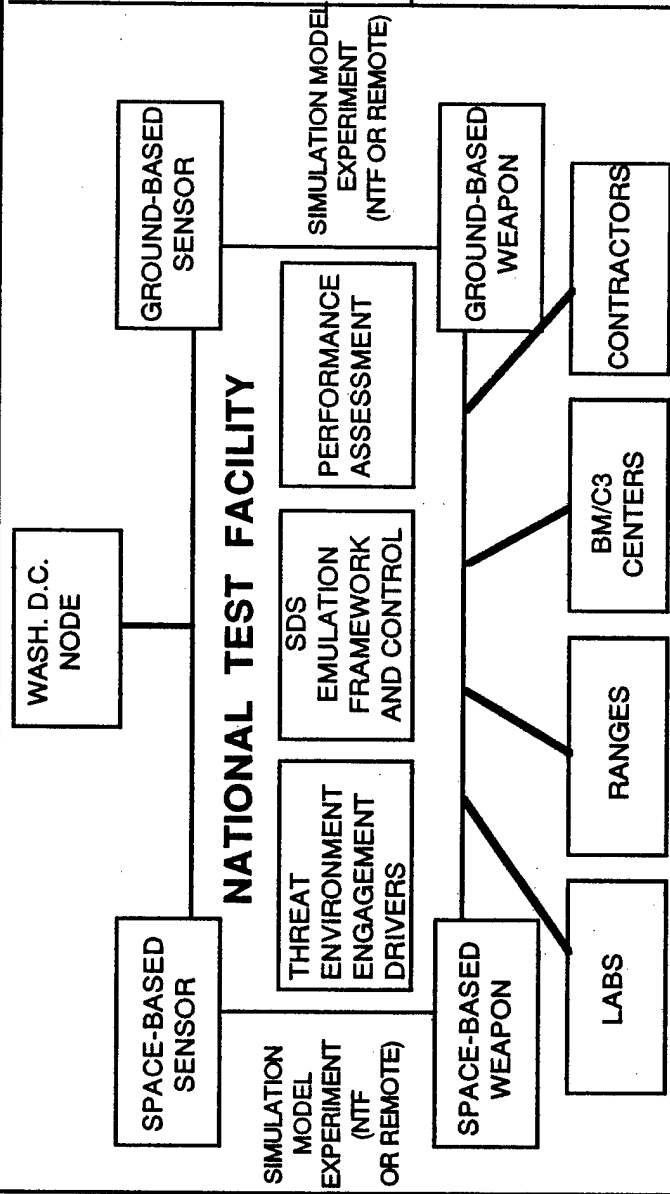

CONCEPT

- DISTRIBUTED COMMUNICATION NETWORK
 - EXPERIMENTS
 - DEVELOPMENT
 - SIMULATION
 - SUPPORT
- NTF IS CENTRAL FACILITY
 - CENTRAL CONTROL
 - COMPUTING CENTER
 - DISTRIBUTED SIMULATION FRAMEWORK
- INTEGRATED OPERATION
 - SIMULATION MODULES
 - HWIL EXPERIMENTS
 - INTEGRATION EXPERIMENTS

PROGRAM PURPOSE

- EVALUATE INTEGRATED ARCHITECTURES
- PROVIDE BM/C3 DEVELOPMENT ENVIRONMENT
- SUPPORT TECHNOLOGY VALIDATION EXPERIMENTS

PRINCIPAL NTB SERVICES

- END-TO-END SIMULATIONS
- BM/C3 EXPERIMENT ENVIRONMENT
- SDS EMULATION ENVIRONMENT
- SIMULATION DRIVER STANDARDS CONTROL
- SIMULATION & TEST DATA LIBRARY
- COMPUTING RESOURCE

THE NTB PROGRAM

The National Test Bed Program will provide the mechanism for testing and evaluating the SDS Battle Management Command and Control and Communications elements, and allow "end-to-end" simulations of the SDS. It will bring together simulations, emulations and hardware-in-the-loop by utilizing and netting worldwide (to include space) assets in both near real-time and real-time tests. It is being designed to provide the most economical and effective evaluation and validation of the SDS concept and elements, and to allow the investigation of possible alternatives.

NATIONAL TEST BED PROGRAM

DEVELOPMENT PHASES

- Early Analysis Capability (FY87)
- Early Operational Capability (FY88)
- Integrated Capability (FY89)
- Enhanced Capability (FY90+)

OBJECTIVES

- Characterize and Evaluate Existing End-to-End Simulations and Models
- Develop NTB Operational Procedures
- Provide Early Support
- Survivability
- Initial End-to-End Simulation Framework at National Test Facility (NTF)
- Relationship Between Architectural Fidelity, Scope and Runtime
- Definition of a Distributed Simulation Framework That Can Evolve to Large Scale Emulation of SDS
- Survivability
- Distributed Simulation Framework Operational with Remote Nodes
- Increased Fidelity and Scope
- Validation of NTB Processes and Procedures
- Survivability
- Enhanced Scope and Fidelity
- Survivability

NATIONAL TEST BED PROGRAM

The management of cost and technical risk will be addressed through a combination of techniques, to include innovative testing strategies and extensive use of simulations when experiments are not feasible. The time phased objectives of this evolutionary program are as shown on the slide.

STRATEGY: A BALANCED PROGRAM

TECHNOLOGY
(Technology Development:
Phase I and Follow-On)

- Sensors
- Weapons
- BM/C3
- Phenomenology
- Survivability
- etc....

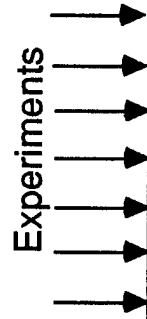
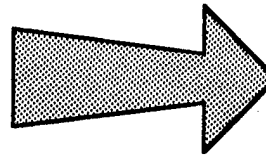

SYSTEMS
(Architectures /
SDS-Phase I Dem/Val)

- Integration
- System Elements
- NTB
- Arch Concepts
- Program Mgmt
- etc....

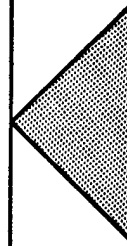
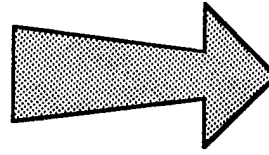

STRATEGY- A BALANCED PROGRAM

The major management emphasis, therefore, is to maintain a balanced program which ensures that the SDS Phase I system will continue to be developed as planned while encouraging and supporting the progress of technologies and elements for follow-on phases of the SDS.

Supporting Slides

S23-1

APPENDIX I

SDS DEFENSE ACQUISITION BOARD REVIEW

PURPOSE OF DAB REVIEW

Confirm Program Readiness For The Demonstration/Validation Phase

Connect SDI to the DoD Acquisition Process

Position The Program To Progress In An Orderly Manner To A Timely
And Informed FSD For The First Phase Of An Evolutionary SDS

Optimize The Contributions Of The Many Involved Organizations

PURPOSE OF DAB REVIEW

The DAB review was conducted to assist the SDI Program Director in validating the goals, objectives and progress of the program to date, to allow scrutiny of the program and to enter it into the Department of Defense System Acquisition Process. The DAB process allowed a crystallization of the goals, objectives and achievements of the R&D program into a recognized defense system concept, and set the stage for progressing towards an informed development decision.

DAB-1

From DoDD 5000.1, Para 4b

The Milestone I Decision

- Is**
- The First Secretary of Defense Milestone Decision
 - [A Basis For] Concept Selection and Entry Into the Demonstration and Validation Phase
 - A Validation of the Requirement Based Upon Preliminary Evaluation of Concepts, IOC Threat, Costs, Schedule, Readiness Objectives, and Affordability

- Is Based On**
- A System Concept Paper (SCP) and a Test and Evaluation Master Plan (TEMP)

- Provides**
- Authority to Proceed With the Demonstration and Validation Phase, and to Develop the System Sufficiently to Support a Milestone II Decision

- Shall Establish**
- Thresholds and Objectives to Be Met and Reviewed At the Next Milestone, Acquisition Strategy, and Dollar Threshold...Through The Next Milestone

DODD 5000.1, MS-I DECISION

This slide briefly describes the actual purposes and significance of a MS I decision.

DAB-2

ACQUISITION STRATEGY UP TO MILESTONE I

- ESTABLISHED AN SDI MANAGEMENT INFRASTRUCTURE

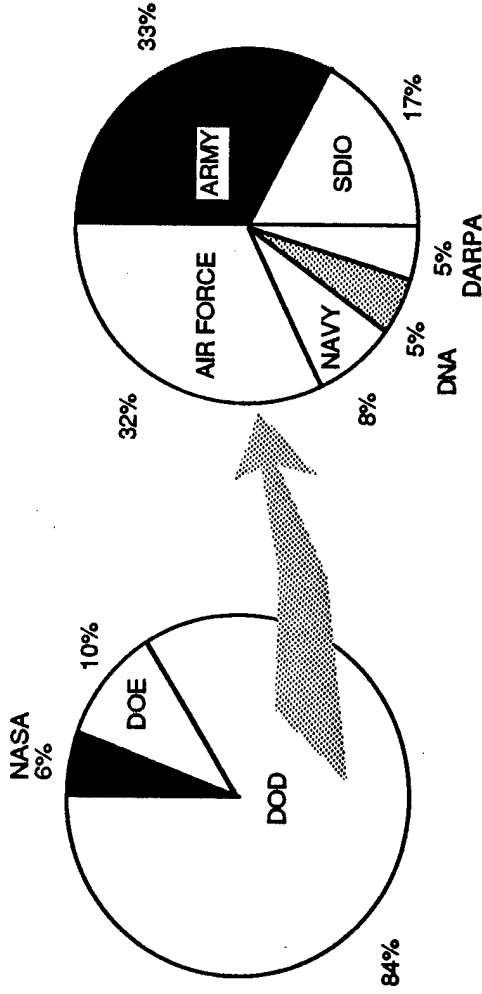

- RESPONSIVE TASKING SYSTEM
- SIMPLIFIED REPORTING
- SDI ORIENTED CONTRACTOR ORGANIZATIONS
- PROPERLY STAFFED AND CHARTERED SDIO
- ARCHITECTURE AND "RED TEAM" STRUCTURES
- RESPONSIVE AND COMPETITIVE CONTRACTING
- "HORSE RACE"
- MULTIPLE DESIGN STUDIES
- STRONG TECHNOLOGY BASE EFFORTS

ACQUISITION STRATEGY UP TO MILESTONE I

The SDI management and contracting structure established to date has proven effective and is ready to transition to the Dem/Val phase. Currently, DoD manages 84% of overall SDI activities, and is augmented by NASA and Department of Energy. Of the DoD portion, the USAF accounts for 32%, the Army 33%, and the Navy 8%. DNA, DARPA and the SDIO make up the balance. The SDI management has been structured to provide responsive tasking and simplified reporting, with SDIO having the overall management charter.

Responsive and competitive contracting will continue to be a key element of the acquisition strategy. It will be implemented via horse race efforts, multiple design studies, and strong technology base efforts.

DEFENSE ACQUISITION BOARD (DAB)

STRATEGIC SYSTEMS CMTE.

SECDEF

DAB

SDIO

- | | | |
|--|---|--|
| <ul style="list-style-type: none"> • Generated Information for Required Docs • Reviewed and Worked Issues From OSD • Submitted Formal Documentation 17-29 June 1987 | <ul style="list-style-type: none"> • Chaired by DUSDRE • Reviewed USD(A) Issues and Responses by SDIO • Determined DAB Issues • Reviewed Program 23 June 1987 | <ul style="list-style-type: none"> • Chaired by USD(A) • Reviewed SDI Program and Discussed Issues • Formulated Recommendations • Met 30 June 1987 and 8 July 1987 |
|--|---|--|

- Discussion of DAB Outcome With USD(A)
- Discussion and Issuance of Required Decisions

OUTCOME

OUTCOME

OUTCOME

OUTCOME

- | | | |
|---|---|--|
| <ul style="list-style-type: none"> • SCP • TEMP • Program Plan • Supporting Documentation | <ul style="list-style-type: none"> • Recommendations MS I Issues • Initial Draft ADM to USD(A) • Recommendations ADM | <ul style="list-style-type: none"> • Approval |
|---|---|--|

DAB

The new guidelines for the MS-I decision review, the activities, and the responsibilities of the major participants for the SDS MS-I are shown on this slide.

The schedule of when specific activities took place is also shown.

DAB-4

AN OUTLINE OF WHAT WAS PRESENTED TO THE DAB

Outline the SDI Program

Mission and Threat
Technologies, Systems, and Epoch Definition
Schedules, Costs, and Milestones
Operational and Support Concepts
Production Planning

What SDI Has Done to Date

Technology Exploration
Architecture Development and Trade-Offs
Cost and Risk Studies
Experiments

Dem/Val Program

- Develop Preliminary System Specifications
- Prepare for Full-Scale Engineering Development
- Conduct Comprehensive Experiments
 - Flight Test Vehicles & Follow-On Experiments
 - BM/C3 Experimental Versions
 - Integration Experiments
- Continue Technology Exploration
 - Basic Technology Work & Technology Roadmaps
 - Transition of Technology Through DemVal

OUTLINE OF WHAT WAS PRESENTED

The information generated by SDIO for presentation to the DAB is shown here. Not all of the information was presented for all of the potential SDS elements, but the SDS Phase I elements were described in sufficient detail to allow a decision on transitioning them into a Dem/Val program.

The documentation for the SDI program was presented in the System Concept Paper, the Test & Evaluation Master Plan, the Program Plan, and other associated documents.

SDS SYSTEM CONCEPT PAPER

Volume I

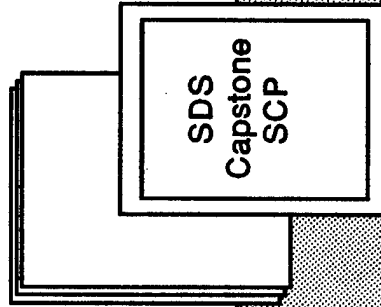

- SCP Capstone Only
(Covers Entire Evolutionary SDS)

Volume II

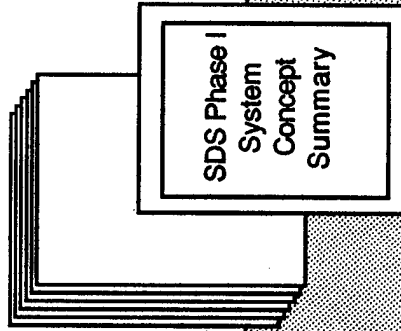

- System Description and Operation Summary
- SCP Appendices 1-7

Emphasis
on
Phase I

Volume III

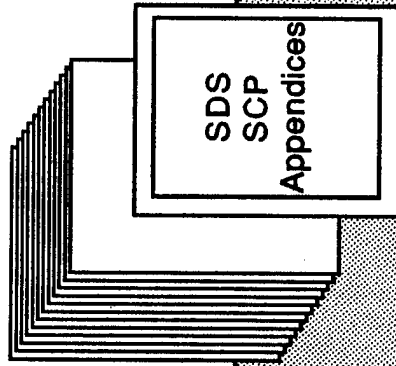

- SCP Appendices 8-22
(Follow-On Elements and Related Technologies)

SCP

The SCP was published in three volumes. The first two volumes describe the Phase 1 system and the overall concept. Volume three addresses potential elements for the follow-on phases and general technology initiatives.

DAB-6

TEST AND EVALUATION MASTER PLAN (TEMP)

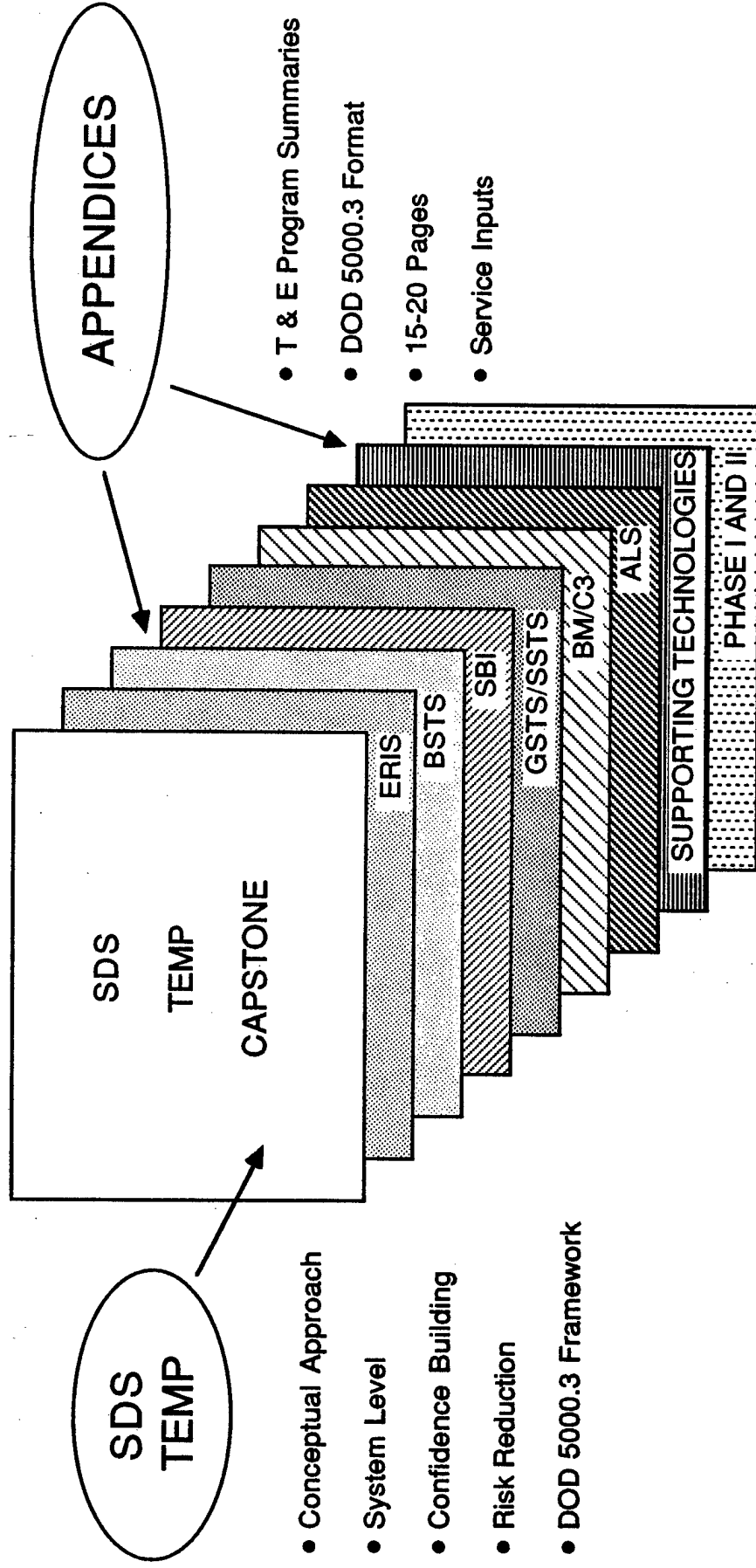

SDS
TEMP

- Conceptual Approach
- System Level
- Confidence Building
- Risk Reduction
- DOD 5000.3 Framework

APPENDICES

- T & E Program Summaries
- DOD 5000.3 Format
- 15-20 Pages
- Service Inputs

SDS
TEMP
CAPSTONE

ERIS
BSTS
SBI
GSTS/SSSTS
BMC3
ALS

SUPPORTING TECHNOLOGIES
PHASE I AND II

TEMP

The TEMP was published in one volume, but the breakdown of the document parallels that of the SCP. It is primarily based on inputs from the Services and the SDIO directorates.

DAB-7

ENVIRONMENTAL ASSESSMENT

Process

Individual Element Assessments Prior to DAB MS-I
Cumulative Assessment

DAB MS-I Phase I Elements
Scope Follow-on Environmental Issues

30-Day Comment Period - August/September

Results - Anticipate No Significant Impact

Cumulative Test Effects at Kwajalein Being Addressed
by Army EIS

ENVIRONMENTAL ASSESSMENT

SDIO has been evaluating the potential environmental impact of the Phase I SDS. The evaluations are complete, and indications are that none of the Phase I systems will have any significant impact. There are still some environmental issues concerning test definition and cumulative test effects. These concerns are currently being rigorously addressed.

DAB-8

DAB MS-I ISSUES

SYSTEM INTEGRATION

Within SDIO - Strengthen SDIO "Systems"

System Architecture Level

Original Plan - SDII (Dedicated FFRDC) Delayed
SecDef Approved Competitive Options

Interim - Existing FFRDC Task Force
IDA, MITRE and Aerospace Work
(Work Within Sponsoring Agreement)
Phase One Engineering Team (POET)

Detailed Element Contractor Interface

Re-evaluating Concept (BMC³ + Integrator)

Interviewing Systems Integrator Contractors

Acquisition Plan in July 1987

Objective: On Contract ASAP

DAB MS-I ISSUES

The principal Milestone I issues centered on ensuring an integrated, effective Strategic Defense System. The SDS is a "System of Systems" which requires centralized focus and control to successfully manage the critical decisions and trade-offs to be accomplished within an integrated systems approach. At the system architecture level, the plan is to establish a dedicated Federally Funded Research and Development Center (FFRDC), acting in conjunction with an SDI Integrator. As an interim measure, existing FFRDCs are being utilized.

SDIO has been evaluating the required element interfaces very closely and is currently evaluating the possibility of awarding a single BM/C3 and Systems Integration contract. A draft SDS Acquisition Management Plan will be available for review this fiscal year with the objective to have the contract award as soon as possible.

DAB-9

OVERRIDING ISSUES FOR DAB MS-II

Technical

**System-of-Systems Confidence
Technology Achievement
Industrial Base Readiness**

Managerial

**Responsive Management Structure
Full "Integration" & BM/C3 Capability**

Operational

**Operational Concept and Requirement Validation
Roles and Mission Assignments**

Defined Forum For the National Decision

OVERRIDING ISSUES FOR DAB MS-II

For Milestone II, the overriding issues which must be addressed in the Dem/Val phase are technical, managerial, and operational.

Technical issues begin with the feasibility of designing and operating an SDS as a distributed "System of Systems." Critical questions concern the timely achievement of key technology levels and the readiness of industrial capacity and manufacturing methods. Also, the necessary follow-on technology for Phase II SDS must have previously entered Dem/Val phase to ensure proper response to anticipated Soviet developments.

Major management issues arise from the scope and complexity of the program. A responsive management structure is needed to ensure effective program control, and to ensure integration capabilities and quick reaction techniques are available to the changing circumstances. A total system integration capability, to include the BM/C3 element, must be achieved.

The operational concept and requirements must be continuously updated and validated, and there must be traceability from the requirements to the system specifications. Organizational roles and missions will have to be assigned soon.

Given the importance and visibility of SDS, we must expect Milestone II to provide a forum for a national decision.

DAB-10

APPENDIX II

SDS PROGRAM OVERVIEW SUPPORT SLIDES

PRESIDENT'S SPEECH MARCH 23, 1983

Proposed the Strategic Defense Initiative To:

- Capitalize on the Very Real Possibility That Science and Technology Can Create a Future in Which Nuclear Missiles Become Less and Less Capable of Achieving Their Mission
- Provide a Hedge Against Potential for Soviet Efforts to Exploit Ballistic Missile Defense Technologies Including Complete Breakout From the Existing ABM Treaty
- Provide a Hedge Against Possible New Soviet Offensive Threats Against Key Elements of Our Deterrent Forces

PRESIDENT'S SPEECH

The President's goal in establishing the Strategic Defense Initiative was to first shift the basis of nuclear war deterrence from complete reliance on Mutually Assured Destruction (MAD) by offensive weapons to a balanced offensive-defensive basis, with the eventual elimination of the threat from nuclear ballistic missiles.

SDI STUDIES

Defense Technology Study (Fletcher Study)

- Recommendation - Structure a Broad-Based Research and Technology Development Effort Focused on Establishing Technical Feasibility, as Opposed to Initiating System-Level Development.

Future Strategic Strategy Study

- Recommendation - Establish and Maintain Options for Deployment of Advanced Defenses Against the Ballistic Missile.

SDI STUDIES

The immediate DoD response to the President's guidance was the establishment of these two study groups.

The Fletcher Study provided the technical guidance for proceeding with the SDI Research and Development program and has been the foundation for the activities to date. It developed the understanding of existing and potential technology available for accomplishing an effective ballistic missile defense, and identified both technology limited and fiscally limited programs which could be pursued.

The current SDI program has actually been constrained to funding levels substantially below that which the Fletcher study recommended.

PRESIDENTIAL DIRECTIVE ESTABLISHES SDI

Presidential Directive
"Strategic Defense Initiative"
January 6, 1984

- SDI Mission - Improve Security of US and Allies and Provide a More Stable Basis For Deterrence.
- SDI Approach - Phased Deployment of an Evolutionary Strategic Defense System.
- SDI Goals - Support Transition From Offensive to Defensive Deterrence.
 - Ultimately Lead to Elimination of Ballistic Missiles
 - Provide Deterrence to Any Near-Term Expansion of Soviet ABM Capability
 - Provide Incentives to the Soviet Union For Negotiating the Reduction of Nuclear Forces.

PRESIDENTIAL DIRECTIVE ESTABLISHES SDI

Following the recommendations of the DTS and the FS³, a Presidential directive was signed to formally initiate the program.

Note that the approach called for a Phased Deployment of an evolutionary defense system and that the goals identified start with a transition in deterrence strategy with an ultimate objective of eliminating the threat of ballistic missiles.

The key is to influence Soviet thinking towards a reduction in nuclear forces with their eventual elimination.

MISSION REQUIREMENTS

- The Goals of Defense Deployments are:
 - Deny the Soviets Confidence in the Military Effectiveness and Political Utility of a Ballistic Missile Attack
 - Secure Significant Military Capability for the U.S. and its Allies to Deter Aggression and Support Their Mutual Strategy in the Event Deterrence Should Fail
 - Secure a Defense Dominated Strategic Environment in Which the U.S. and its Allies Can Deny to any Aggressor the Military Utility of Ballistic Missile Attack
- Phase I Mission Requirements (JCSM-93-87, 23 June 1987)
 - Implement First Phase of a Multiphase BM Defense System to:
 - Enhance Future Deterrence Posture
 - Contribute to Denial of Soviet War Aims and Limit Damage From Strategic BM Attack.

MISSION REQUIREMENTS

The technology for the first phase in the evolutionary system is now ready to enter the Demonstration/Validation phase. Specific mission requirements for this phase were established by JCSM-93-87, and these have also been translated into top level capability requirements. Specific technical requirements for the system elements will be developed over the course of the Dem/Val program, as will the requirements for the follow-on phases of the SDS.

SDI THREAT

- **Ballistic Missile Attack**
 - **Intercontinental (ICBM)**
 - **Intermediate Range (IRBM)**
 - **Submarine Launched (SLBM)**
- **Active Countermeasures to SDS Such as Anti-Satellite Attack**
- **Passive Countermeasures to SDS Such as Decoys and Fast Boosters**
- **ABM Breakout**

SDI THREAT

This slide summarizes the source of the threats to which the SDS must respond, the exact details are of course classified. Please recognize that we are concerned with the safety and security of our Allies as well as that of the U.S., and hence the inclusion of intermediate range ballistic missiles.

STRATEGIC DEFENSE SYSTEM CRITERIA

MILITARILY EFFECTIVE

SURVIVABLE

COST EFFECTIVE

(AT THE MARGIN--MORE THAN
AN ECONOMIC CONCEPT)

STRATEGIC DEFENSE SYSTEM CRITERIA

The SDS must have military utility at each proposed level of deployment and it must be responsive to an evolving threat. It must instill in Soviet military planners a significant uncertainty that a preemptive strike against the U.S. will be effective.

The SDS must be able to avoid or withstand man-made hostile environments long enough to accomplish its mission. A mix of system hardening, shoot-back and tactical methods to enhance the likelihood of SDS element readiness in a stressed environment has been designed into the various concept architectures.

Finally, the SDS must be cost-effective. This concept is not a simple marginal return or return on investment but is much more complicated and not only economic in nature.

TERMINOLOGY

- SDI** The Research Program
- SDS** A Future Deployed BMD System
- ELEMENT** A Vehicle or Separately Defined Program Within SDS

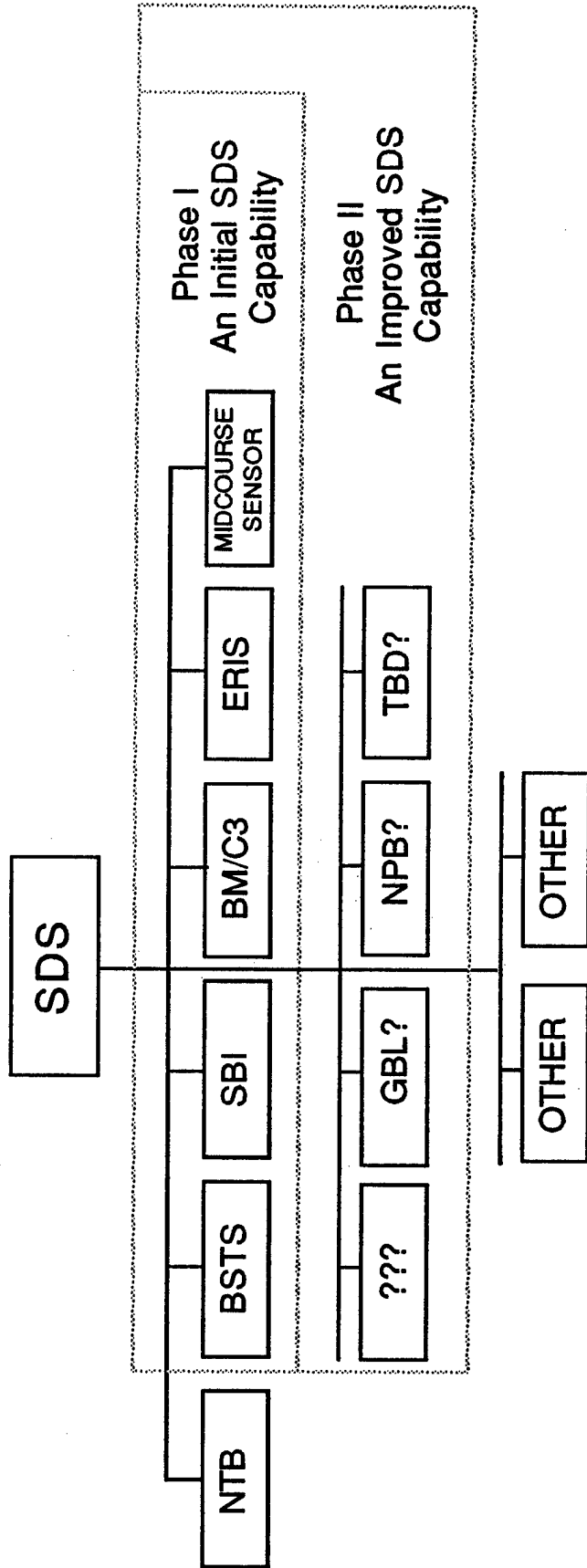

TERMINOLOGY

Before continuing, let me define some acronyms. SDI or Strategic Defense Initiative is the name given to the entire research program.

- SDS - Strategic Defense System: A future deployed ballistic missile defense system, composed of selected proven elements and supporting programs.
- NTB - National Test Bed: A network of facilities for conducting SDS end-to-end simulations and hardware testing.
- BSTS- Boost Surveillance and Tracking System: A space-based electro-optical sensor system to detect, classify and track hostile ballistic missiles in the boost and post-boost phases of their trajectory, and to provide that information to other system elements.
- SBI - Space-Based Interceptor: A kinetic energy interceptor designed for the boost, post-boost, and midcourse phases.
- BM/C3- Battle Management; Command, Control, and Communications: A system of hierarchical command and control, distributed/automated battle management, space and ground communications, and a network of fixed and mobile centers to control SDS operations.
- ERIS- Exoatmospheric Reentry-Vehicle Interceptor System: A ground-based kinetic energy interceptor designed for the late midcourse phase.
- Midcourse Sensor: A sensor to detect, classify and track targets during the midcourse phase, to be selected from a set of sensor options including a Ground-based (missile-borne) Surveillance and Tracking System (GSTS), a Space-based Surveillance and Tracking System (SSTS); and sensors on SBI carrier vehicles (CV). The information would be provided to other SDS elements for action.
- GBL/SBL- Ground-Based Laser/Space-Based Laser: Directed energy elements being developed to provide interactive discrimination and target kill assessments of missiles and RVs.
- NPB - Neutral Particle Beams: Directed energy device to provide interactive discrimination, and possibly target kill for RVs in the midcourse phase.
- TBD - To Be Determined (Make-up of follow-on phases will be determined by results of future research and test activities.)

MANUFACTURING AND PRODUCTION PROGRAM

Manufacturing Technology

Producibility

Industrial Base Development

Manufacturing Cost Reduction

MODIL (Mfg Opns Development Integration Lab)

MANUFACTURING AND PRODUCTION

Key to making the SDS affordable is the planning for and development of a comprehensive manufacturing and producibility program, with major initiatives to reduce costs and establish a responsive and capable industrial base. The funding of MODILS is essential to accomplishing these objectives.

OVERVIEW OF MODIL CONCEPT

WHAT? PROGRAM FOR DEVELOPING, DEMONSTRATING, VALIDATING, AND DISSEMINATING INNOVATIVE CONCEPTS FOR REDUCING COSTS

WHY? COST OBJECTIVES REQUIRE FUNDAMENTAL CHANGES IN INDUSTRY PRACTICES AND MANUFACTURING APPROACHES

HOW? IDENTIFY WHAT'S NEEDED, REMOVE IMPEDIMENTS, PROVE-OUT CONCEPTS AND PROMOTE INDUSTRY IMPLEMENTATION

WHERE? IN A NATIONAL MODIL FACILITY FOR MANUFACTURING DEVELOPMENT, WITH LINKAGES TO OTHER ELEMENTS OF THE INDUSTRIAL INFRASTRUCTURE

WHEN? STARTING AS SOON AS POSSIBLE

MODIL CONCEPT

This viewgraph describes the MODIL approach in a straightforward what, why, how, where and when format. Note the bottom box which indicates we need to start the process now if we are to be successful in meeting production and deployment goals.

COST PROJECTION

Cost Projections Vary Reasonably for Most Element Systems

SBI is the Obvious Exception

In a Research-to-Cost Program

Set Contractual Cost Goals

Institute New "Production-Base Efforts"

Where Required

Accelerate Key Technology Investments

Set Cost Reduction Goals for Other Elements

Improve and Validate Costing Algorithms for New Technology

COST PROJECTION

Examination of the cost estimates indicate a reasonable degree of variation, with the obvious exception of the SBI program. SBI will need major cost research to reduce this uncertainty. Other techniques for reducing uncertainty, and ultimately cost, will be to set contractual cost goals, institute new production base efforts, and accelerate key technology investments.

Cost reduction goals will also be set for other elements. Efforts are required, in particular, to improve and validate costing algorithms for the new technology, upon which SDS is strongly dependent.

ELEMENT ACQUISITION CONCEPT

Prior to Milestone I

Demonstrate Feasibility

Demonstrate Integration Into SDS

Provide Technology Base for Development

Provide Production Base for Deployment

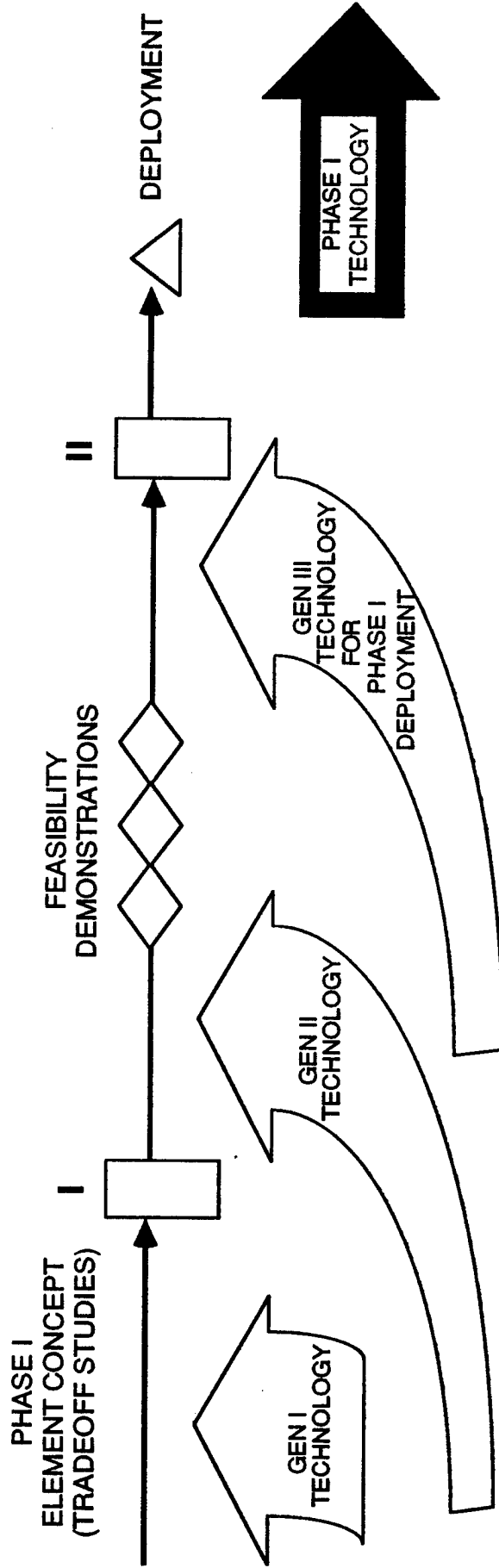

ELEMENT ACQUISITION CONCEPT

Each element of the Strategic Defense System will proceed through a similar acquisition process. Prior to MS-I, each element must prove its feasibility, demonstrate that it can be integrated into the SDS architecture, provide a technology base for development, and provide a production base for deployment.

In most cases, rigorous analysis in the form of trade-off studies were accomplished for each individual element identified to form the integrated Phase I SDS capability. BM/C3, BSTS, SBI, and ERIS passed the above criteria based on those studies, and technical evaluation plans were developed. A study is ongoing to select the optimum midcourse sensor element(s). As the technologies mature, they will be included in the feasibility demonstrations for MS-I. Technology changes appropriate to each individual element will be incorporated prior to MS-II approval and deployment.

It should be noted that a technology may have advanced two generations past the level reviewed at Milestone I as Milestone II approaches and the full-scale development decision is considered. Should this occur, it is imperative that the technology remain as approved at the Milestone II decision and that this technology be deployed after the Milestone II and III decisions.

PHASED DEPLOYMENT TIMING

KEY ISSUES

Confidence for U. S. Decisionmakers
Discourage Soviet Countermeasures

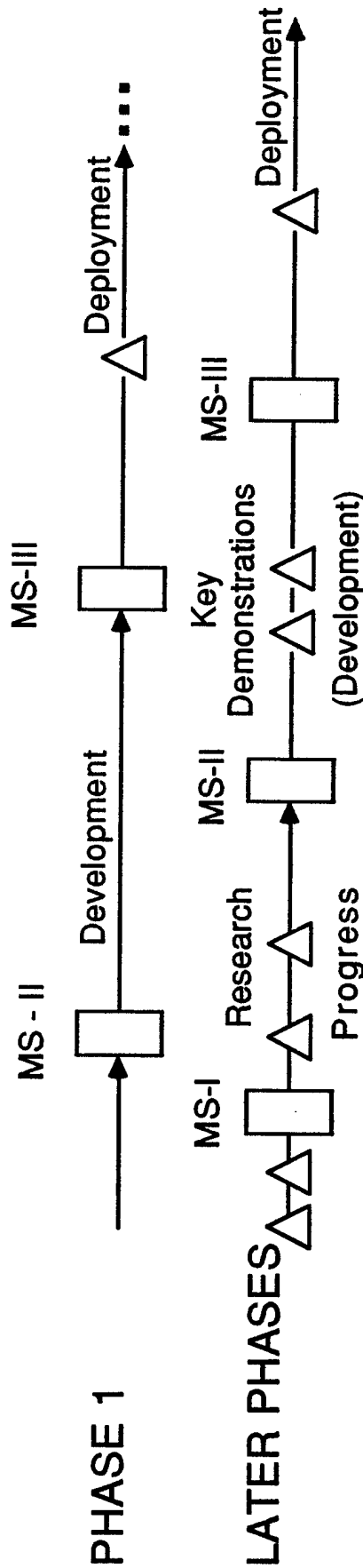

Later Phase Deployment Should Be Within Soviet
R&D Response Time for Phase I System

PHASED DEPLOYMENT TIMING

The timing of the phased deployment of SDS is critical. The later SDS phases must be deployed within the projected Soviet response time to Phase I (within 3 to 5 years) to ensure US Planners' confidence in SDS and to discourage Soviet countermeasures. The objective is to drive and keep the Soviets below the ballistic missile utility threshold, and to assure that the US can develop and deploy strategic defenses within the timelines that the Soviets could realistically react with countermeasures.

SDS ARCHITECTURE ELEMENT CANDIDATES

MIDCOURSE

SSTS
GSTS
ERIS
(BM/C3)
SBI
SBL
GBL
NPB

TERMINAL

LEDI
HEDI
GBR
AOS
HVG
(BM/C3)

BOOST AND POST-BOOST

BSTS
SBI
SBL
GBL
NPB

(BM/C3)

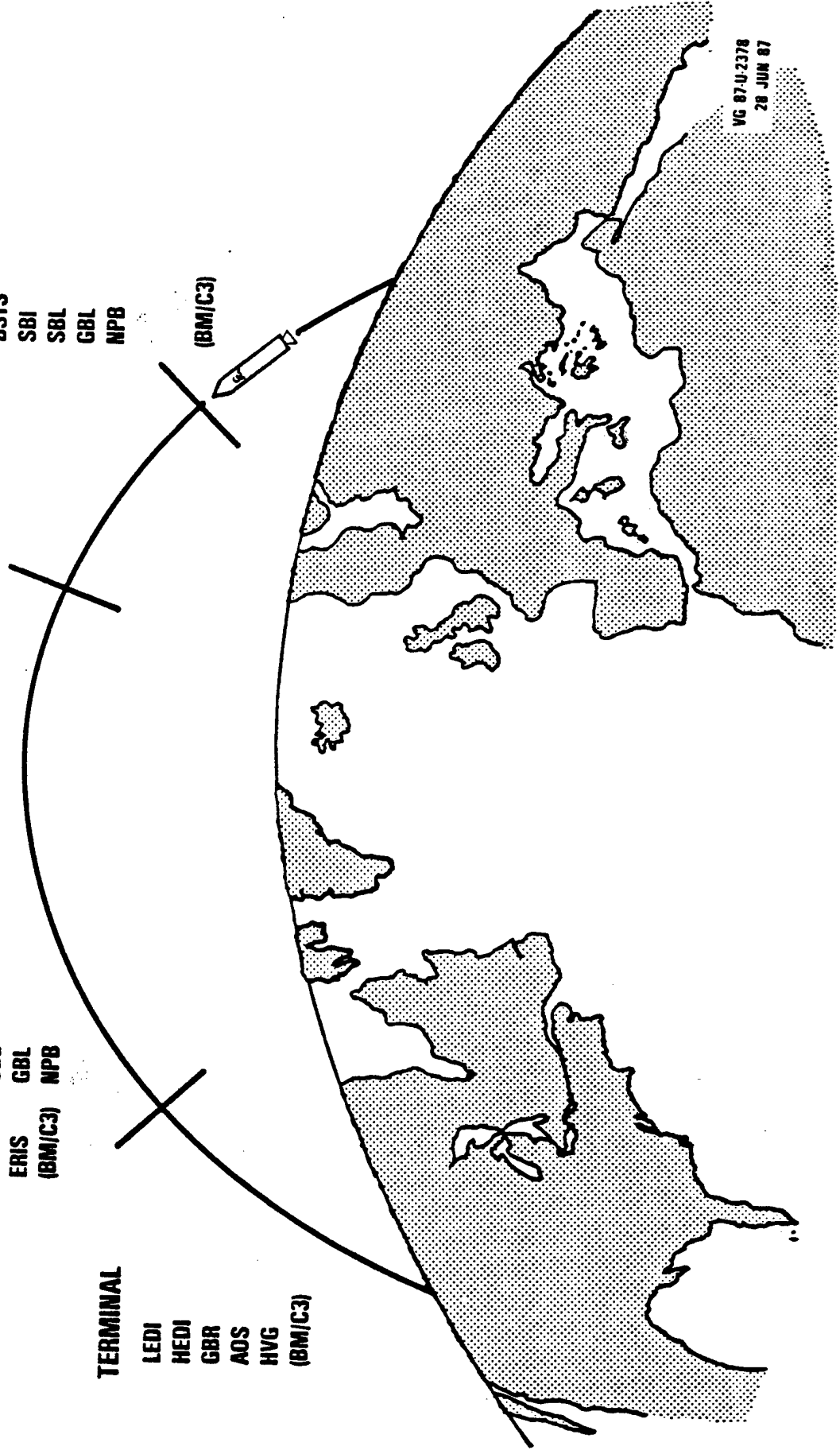

SDS ARCHITECTURE ELEMENT CANDIDATES

The elements of the follow-on and ultimate SDS system may include many, if not all, of the elements portrayed here. However, technology may provide completely different elements with capabilities beyond these currently envisioned.

S10-1

CONCEPT FOR BOOST BM/C³ (SPACE-BASED SYSTEMS)

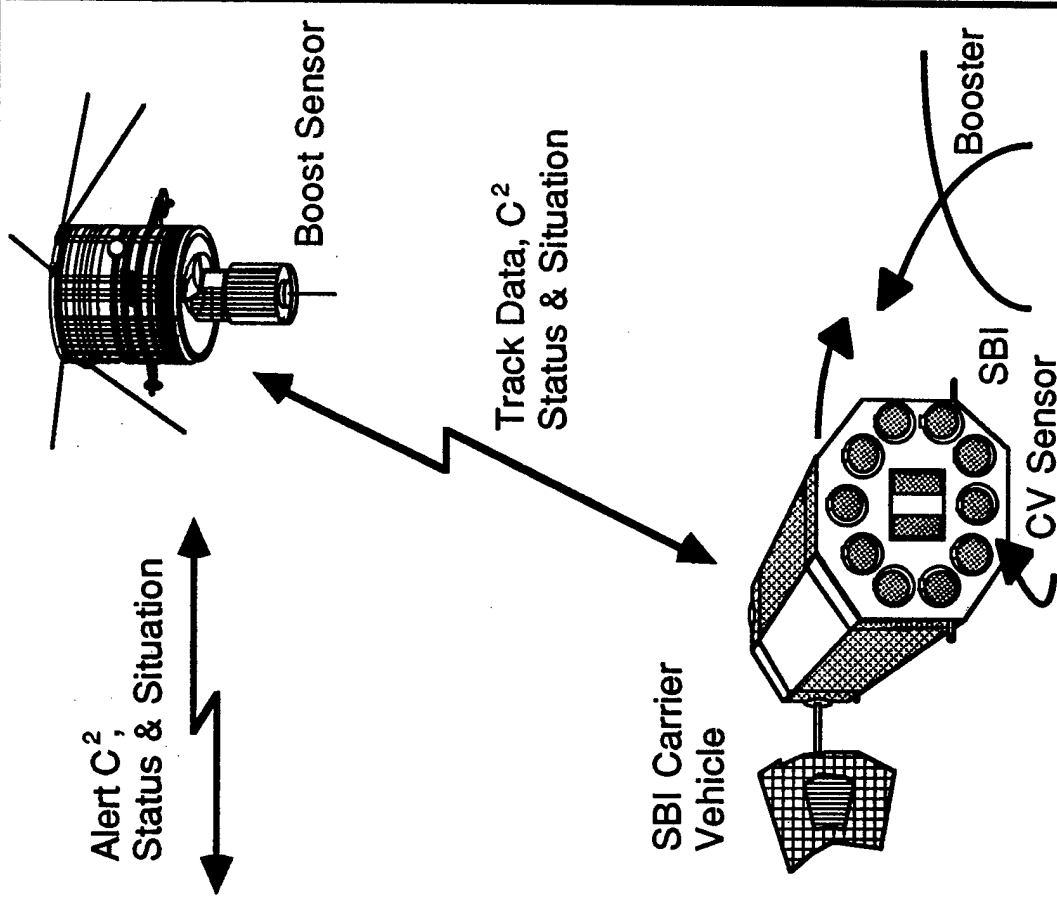

- Boost Sensors "Broadcast" Mono Boost Track Data
- Battle Manager on SBI-CV
 - Forms Booster Track File From Multiple Boost Sensors
 - Implements Commanded Strategy and Tactics to Effect a Coordinated Defense
 - Performs Weapon-Target Assignments
 - Commands SBI Flyout to Terminal Homing
 - Reports Status and Situation

CONCEPT FOR BOOST BM/C³

One concept has the boost phase sensors and battle managers distributed between the sensor satellite and the weapons carrier vehicles. The sensor sends information to all carrier vehicles within its broadcasting range and they must determine if they can respond. If so, an engagement will be initiated.

BOOST - BM FUNCTIONS

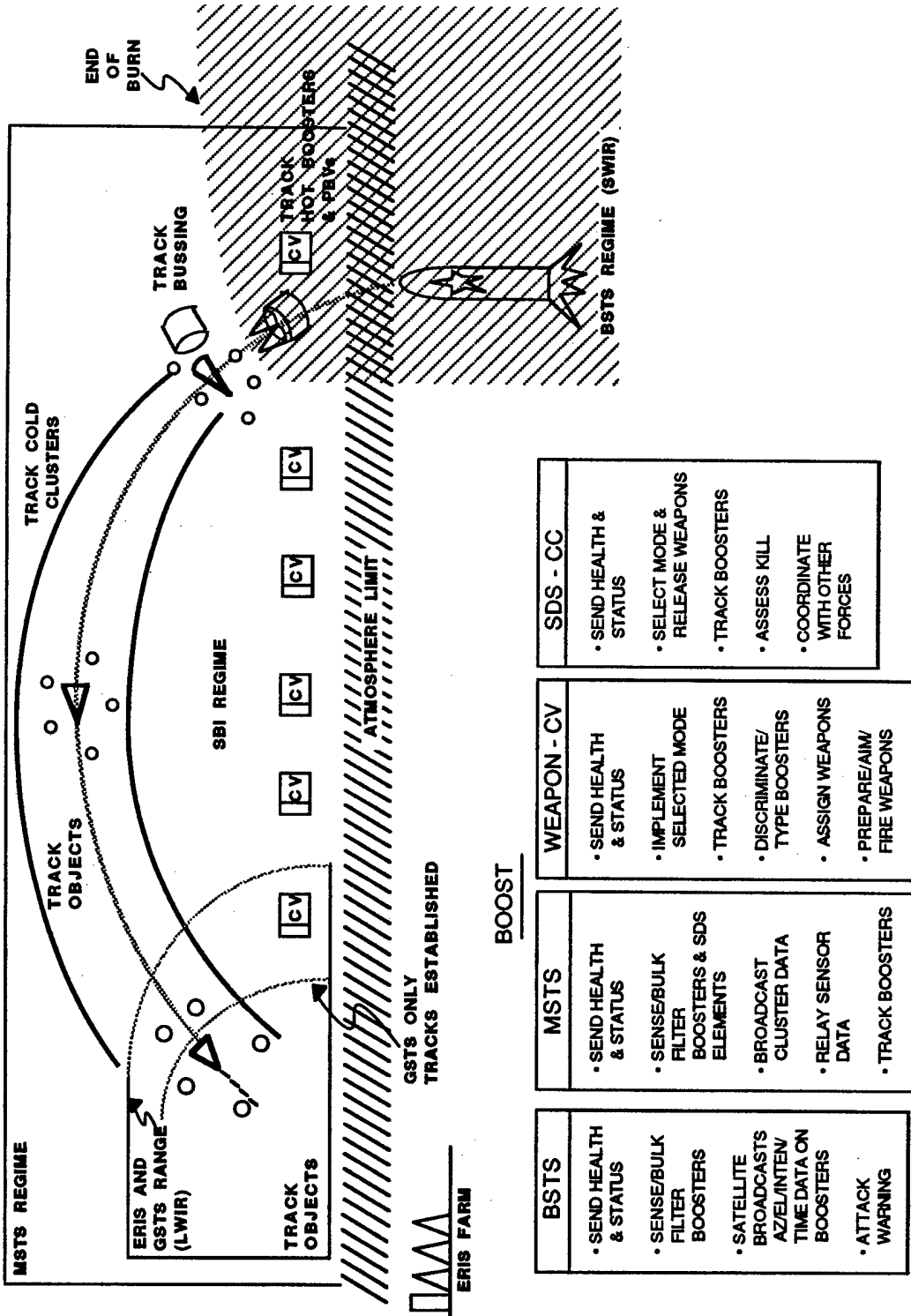

| BOOST | |
|--------------------|--|
| BSTS | <ul style="list-style-type: none"> • SEND HEALTH & STATUS • SENSE/BULK FILTER BOOSTERS • SATELLITE BROADCASTS AZ/EL/INTEN/TIME DATA ON BOOSTERS • ATTACK WARNING |
| MSTS | <ul style="list-style-type: none"> • SEND HEALTH & STATUS • SENSE/BULK FILTER BOOSTERS & SDS ELEMENTS • BROADCAST CLUSTER DATA • RELAY SENSOR DATA • TRACK BOOSTERS |
| WEAPON - CV | <ul style="list-style-type: none"> • SEND HEALTH & STATUS • IMPLEMENT SELECTED MODE • TRACK BOOSTERS • DISCRIMINATE/TYPE BOOSTERS • ASSIGN WEAPONS • PREPARE/AIM/FIRE WEAPONS • SEND INFLIGHT GUIDANCE • ASSESS KILL |
| SDS - CC | <ul style="list-style-type: none"> • SEND HEALTH & STATUS • SELECT MODE & RELEASE WEAPONS • TRACK BOOSTERS • ASSESS KILL • COORDINATE WITH OTHER FORCES |

BOOST BM FUNCTIONS

During each phase of an attack, the separate elements of the SDS have well defined BM/C³ functions. For Boost Phase, i.e., the period when missiles exhibit hot plumes, the functions are shown here. This period is relatively brief. Fast response is essential for SDS system effectiveness. That response can be achieved because the traffic volume is small, since no MIRV or decoy deployment will have occurred.

Note that the Command Center has the human functions of Mode Selection, based on BSTS Attack Warning message. The automated battle management aboard the SBI Carrier Vehicle (CV) includes implementation of the selected mode.

POST BOOST - BM FUNCTIONS

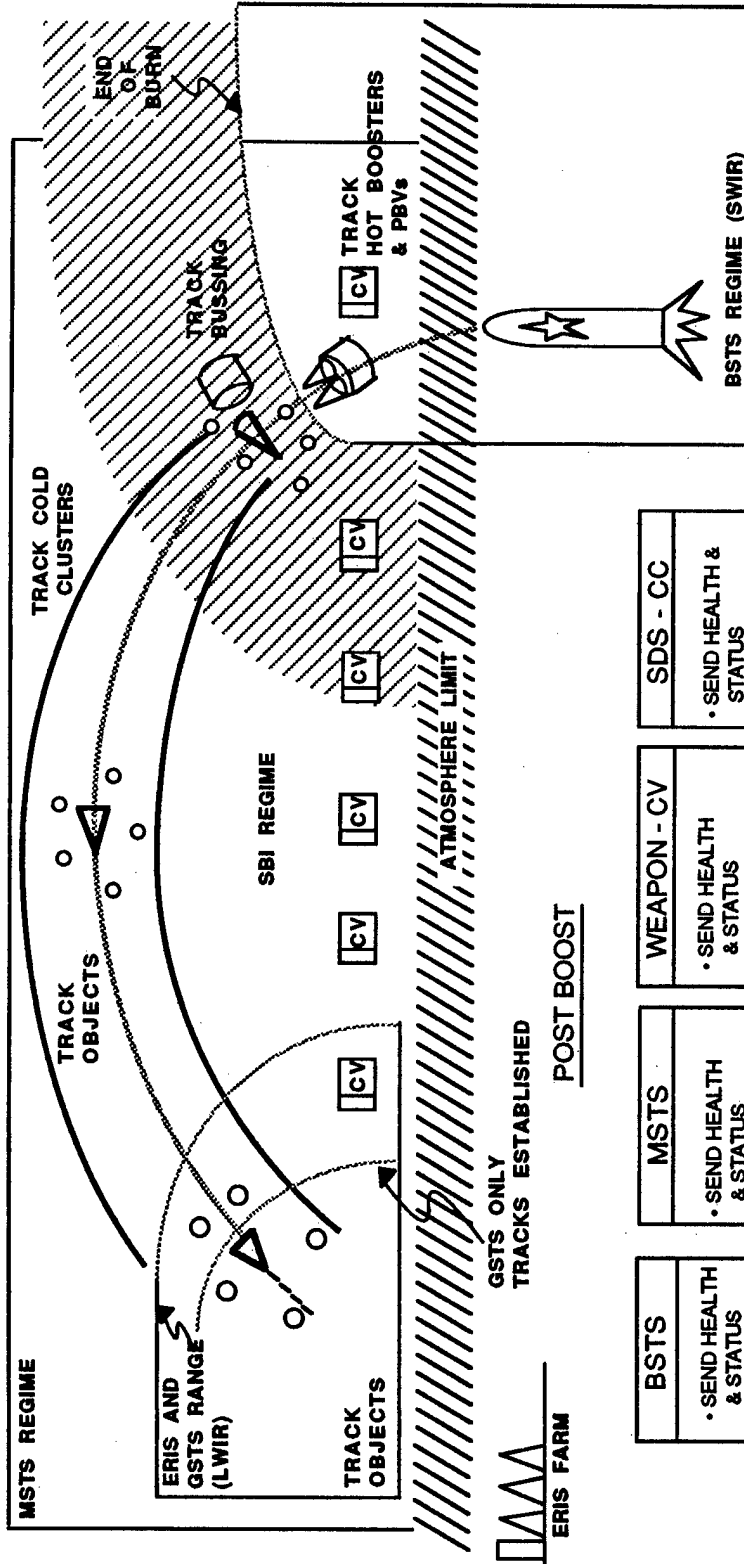

BSTS
 • SEND HEALTH & STATUS

MSTS
 • SEND HEALTH & STATUS
 • SENSE/BULK FILTER
 • BROADCAST CLUSTER DATA
 • PARTITION THREAT
 • SEND OBJECT DATA & CLUSTER TRACKS

WEAPON - CV
 • SEND HEALTH & STATUS
 • TRACK CLUSTERS
 • PARTITION THREAT (REF DEFENSE OPT)
 • INITIALIZE OBJECT TRACKERS
 • SEND INFLIGHT GUIDANCE
 • ASSESS KILL

SDS - CC
 • SEND HEALTH & STATUS
 • SELECT PREFERENTIAL DEFENSE OPTS.
 • TRACK CLUSTERS
 • ASSESS KILL
 • COORDINATE WITH OTHER FORCES

POST BOOST - BM FUNCTIONS

In the Post Boost era of an attack, traffic loads steadily increase for several minutes as busses off-load independent RVs and decoys. The Battle Management functions in this period are shown here. Primary sensor activities shift from BSTS to MSTS because of the change from hot to cold targets. SBI remains the intercept weapon. With SWIR and LWIR sensors, it is able to track hot and cold objects. Timing requirements, while still stressing, are less critical because Post-Boost intercept is permitted using MSTS data.

POST BOOST CLUSTER FORMATION

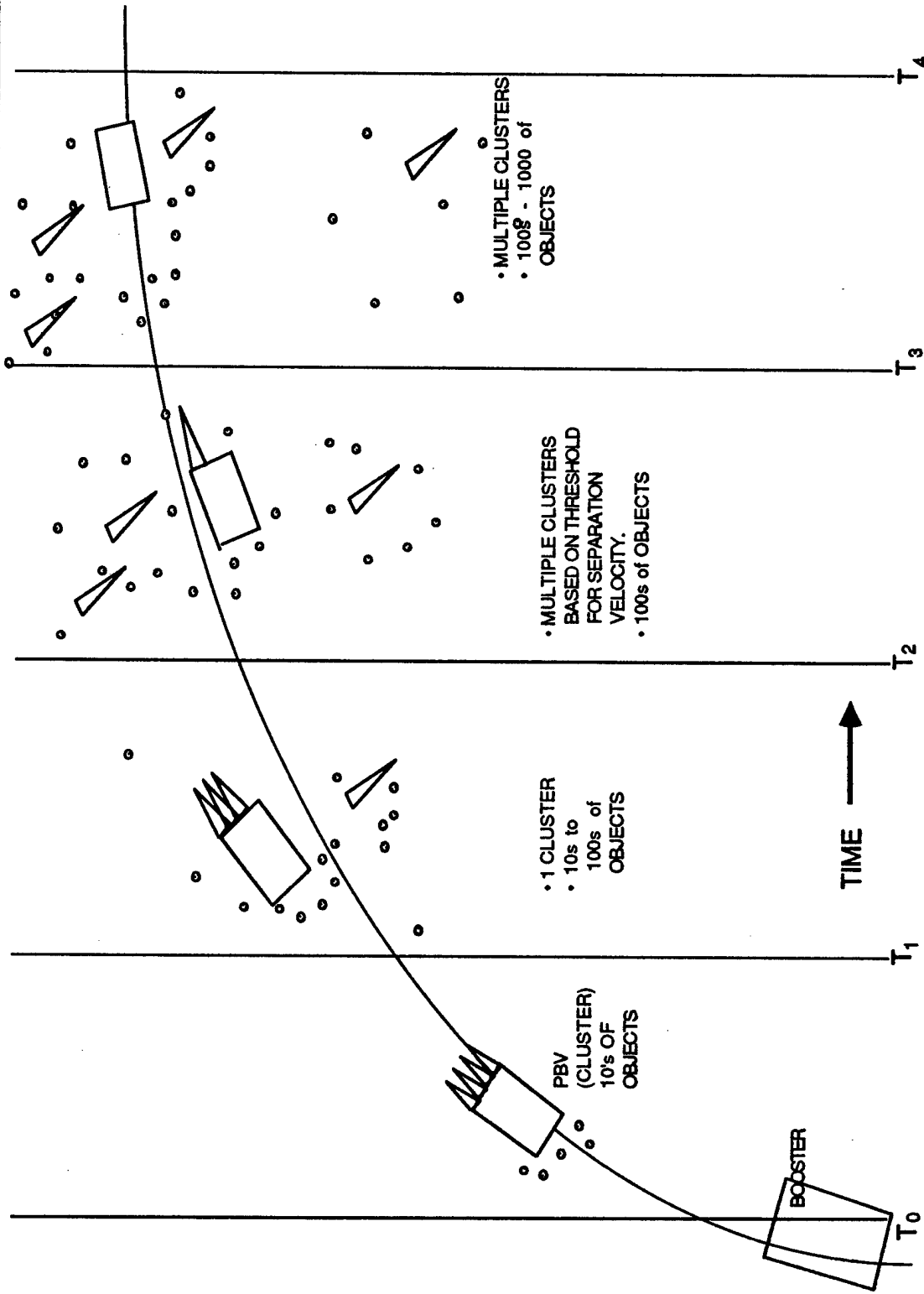

CLUSTERS AND OBJECTS ASSOCIATED WITH BOOSTER THREAT TUBE

POST BOOST - CLUSTER FORMATION

This slide illustrates the growth of threat traffic over time in the tube associated with any one missile. The trade-off is between the number of objects that must be tracked, discriminated, and engaged versus available reaction time to conduct the interception. The SDI multi-tier architecture is designed to ensure appropriate platforms are in place (sensors and weapons) to deal with this changing character of the threat during the strategic exchange.

It is the role of BM/C³ to ensure that during each phase in the battle, the weapons and sensors are properly employed. For each threat tube, a battle group will be defined consisting of platforms available to engage the threat. Implicit coordination, as described earlier, will ensure efficient use of all resources at all epochs.

SAMPLE BG MEMBERSHIP

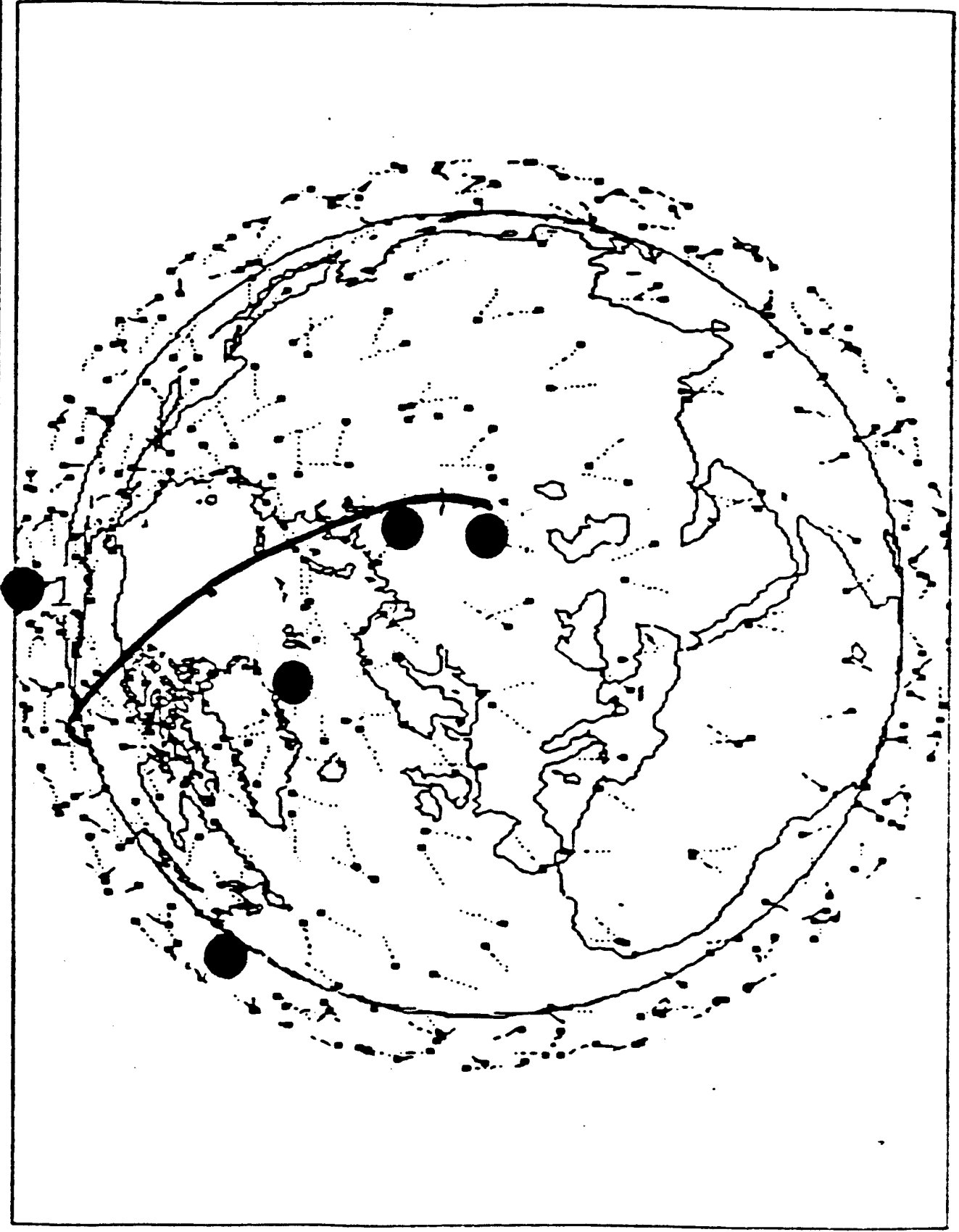

SAMPLE BATTLE GROUP (BG) MEMBERSHIP

A threat tube, from launch to impact, spans a geographical area thousands of kilometers in extent. The set of defensive platforms that will be in place to interact with the threat at the proper time collectively are called a battle group and are illustrated here. Under the implicit coordination doctrine, for any individual platform, battle group membership changes continuously during an attack.

S14-5

MIDCOURSE - BM FUNCTIONS

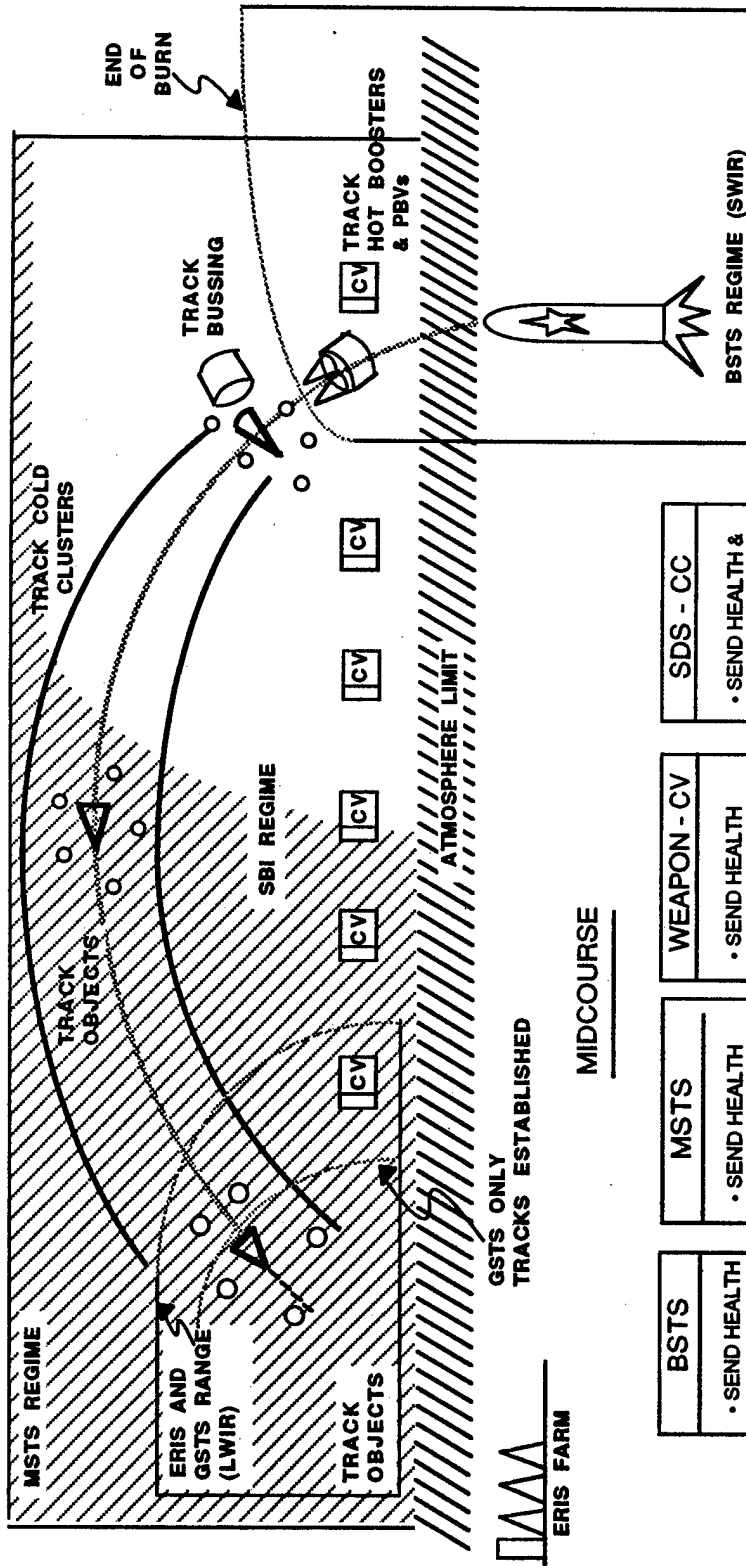

GSTS ONLY
TRACKS ESTABLISHED

MIDCOURSE

| BSTS |
|--|
| <ul style="list-style-type: none"> • SEND HEALTH & STATUS |

| MSTS |
|--|
| <ul style="list-style-type: none"> • SEND HEALTH & STATUS • SENSE/BULK FILTER • BROADCAST CLUSTER DATA • TRACK CLUSTERS • SEND OBJECT DATA AND IPP DATA |

| WEAPON - CV |
|--|
| <ul style="list-style-type: none"> • SEND HEALTH & STATUS • TRACK CLUSTERS • TRACK OBJECTS • ASSIGN WEAPONS • PREPARE/AIM/FIRE WEAPONS • SEND INFLIGHT GUIDANCE • ASSESS KILL |

| SDS - CC |
|---|
| <ul style="list-style-type: none"> • SEND HEALTH & STATUS • TRACK CLUSTERS • ASSESS KILL • SITUATION ASSESSMENT • ADJUST BATTLE PLAN • COORDINATE WITH OTHER FORCES |

MIDCOURSE - BM FUNCTIONS

In the midcourse period, battle time, measured in minutes, is much greater, but threat traffic grows to millions of objects. The main battle management functions continue to reside in the SBI and MSTs elements as shown here. In later midcourse, the GSTS sensors and ERIS interceptors also become active.

S14-6

BM ALGORITHMS

| <u>ALGORITHM CLASS</u> | <u>CONTRACTOR (AGENT)</u> | <u>MATURITY</u> |
|---|---|-----------------|
| TRACKING CORRELATION | MERIT (NRL) ALPHATECH (ARMY) PAR CORPORATION (ARMY) ESL (DARPA) VERAC (NAVY) | 40% |
| TYPING /DISCRIMINATION | ESL (DARPA) COMMAND SYSTEMS GROUP (NAVY) | 20% |
| PARTITIONING/BG ORGANIZATION | ALPHATECH (AF) TRW (SDIO) SDC (ARMY) CARNEGIE-MELLON UNIV. (ARMY) | 30% |
| WEAPON ASSIGNMENT/SCHEDULING | ALPHATECH (ARMY) AT&T (NRL) | 50% |
| COMMAND & CONTROL SDS MODE SITUATION ASSESSMENT | TRW (SDIO) GOULD (NAVY) TRACOR (NAVY) | 50% |
| FIRE CONTROL | SDIO/T-KE | 60% |
| KILL ASSESSMENT | COMMAND SYS GROUP (NAVY) | 20% |

BM ALGORITHMS

There are several classes of algorithms, as listed here, in different stages of completion. Tracking correlation refers to multi-sensor coordination. Discrimination has been given a limited priority in the SDS Phase I system, for which the enemy threat is more restricted.

Battle group organization and membership is an important function that requires early increased efforts.

Weapon to Target assignment has been recognized from the start as a key function, and all architecture efforts until now have included it as a consideration. As a result, substantial progress has been attained.

Finally, the Command and Control functions are further defined on a later chart.

BM/C 3 ALGORITHM DEVELOPMENT PROCESS

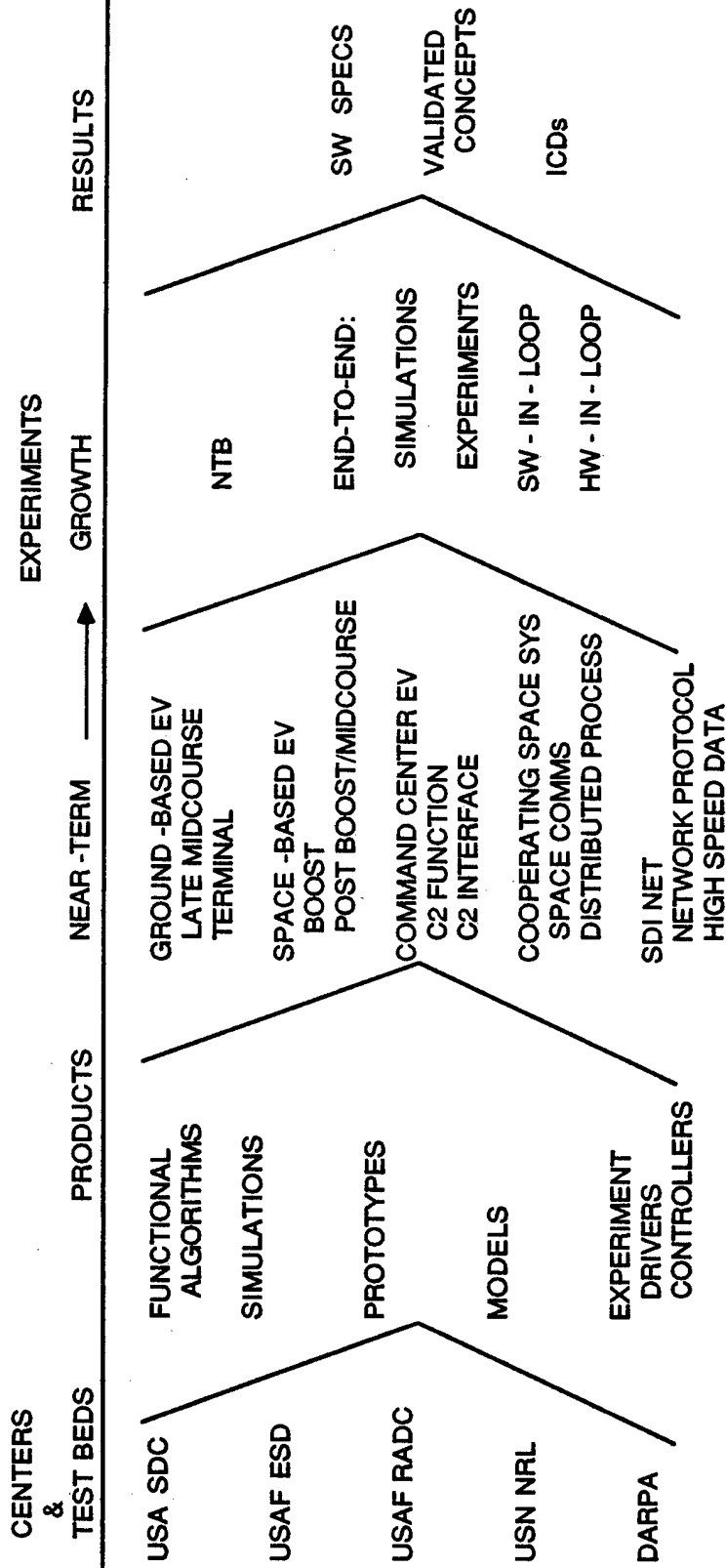

BM/C³ ALGORITHM - DEVELOPMENT PROCESS

The various battle management functions that have been cited in each tier of the engagement will be implemented by algorithms. Development, testing and verification of the algorithms are major responsibilities of SDI.

The process of algorithm development is shown here in a flow chart. This process is a familiar sequence for weapon system hardware/software creation. For the SDS, the scope is much greater than any prior system; however, the essential steps are the same.

Experimental Versions and Test Beds are under development in several agencies, with well-defined plans to establish trial operation of hardware- and software-in-the-loop in a terrestrial environment, the NTB. If a broad interpretation of the ABM Treaty is subsequently adopted, this can proceed also to space-based validation.

KEY TECHNOLOGY ISSUES FOR BM/C3 SYSTEM

| KEY TECHNOLOGY AREA | ISSUES |
|---------------------|--|
| Data Processing | <ul style="list-style-type: none">• High Throughput Hardware• Fault-Tolerant Hardware and Software• Processing Intensive Trusted Software• Adaptive Networking Algorithms |
| Logistics | <ul style="list-style-type: none">• Man-Machine Interfaces |
| Communications | <ul style="list-style-type: none">• 60 GHz Communication Hardware |

KEY TECHNOLOGY ISSUES - BM/C³

The specific technical issues which must be resolved to provide a BM/C³ capability are shown on this viewgraph.

KEY TECHNOLOGY ISSUES FOR BSTS SYSTEM

| KEY TECHNOLOGY AREA | ISSUES |
|--------------------------|--|
| Focal Plane Arrays (FPA) | <ul style="list-style-type: none"> • Number of Pixels • Performance • Producibility • Hardness |
| Signal Processing | <ul style="list-style-type: none"> • Throughput Speed • Size • Producibility • Hardness |
| Optics | <ul style="list-style-type: none"> • Hardness • Optics Size and Quality |
| FPA Cooling | <ul style="list-style-type: none"> • Performance • Reliability |
| Electric Power | <ul style="list-style-type: none"> • Solar Efficiency • Hardness • Size |

KEY TECHNOLOGY ISSUES - BSTS

Based on the technology required versus the technology currently available, these are the issues which must be addressed. Again, the specifics are classified.

S16-1

MIDCOURSE SENSORS TRADE STUDY

- Purpose: Determine Best Sensor Mix on SBI, SSTS, and GSTS
- SDIO, With Services and MIT/LL Will Conduct Fall Study
- Concept Definitions Complete
- SCIT Contracts Support Study and Allow Implementation of Decision
- Generic Technology Program Supports ALL Options
- Preliminary Results to the DAB By December 1987;
Final Decision Provided by Early 1988.

MIDCOURSE SENSORS TRADE STUDY

The midcourse sensor study objective and status is shown here.

S17-1

KEY TECHNOLOGY ISSUES FOR SBI ELEMENT

| KEY TECHNOLOGY AREA | ISSUES |
|--|--|
| Advanced Optics and Focal Plane Arrays | <ul style="list-style-type: none">• Performance• Producibility• Hardness• Testing |
| Signal Processing | <ul style="list-style-type: none">• Throughput Speed• Size• Producibility• Hardness |
| Guidance, Navigation and Control | <ul style="list-style-type: none">• Lightweight, Accurate IMUs |
| Structures | <ul style="list-style-type: none">• Optics Stabilized and Isolated From Vehicle Structure |

KEY TECHNOLOGY ISSUES - SBI

In general, the technology issues to be addressed are weight reduction, miniaturization of key components, efficient sensors and the development of high impulse, fast burning propellants.

S18-1

KEY TECHNOLOGY ISSUES FOR ERIS ELEMENT

| KEY TECHNOLOGY AREA | ISSUES |
|-------------------------------------|--|
| Low Cost Miniature-Kill-Vehicles | <ul style="list-style-type: none">• Lethality• Hit-to-Kill Design |
| Advanced Propellants and Structures | <ul style="list-style-type: none">• Materials• Manufacturing Techniques• Solid vs. Liquid Propellant• Cost• Ruggedness |
| Midcourse Guidance | <ul style="list-style-type: none">• Optimum Sensors• Command Link Design• Electronics• Navigation Accuracy |

KEY TECHNOLOGY ISSUES - ERIS

This slide shows the technical issues associated with the ERIS.

S19-1

KEY TECHNOLOGY ISSUES FOR ALS SYSTEM

| KEY TECHNOLOGY AREA | ISSUES |
|---------------------|---|
| Affordability | <ul style="list-style-type: none">• Low Cost Per Launch |
| Producibility | <ul style="list-style-type: none">• System Availability When Required |

KEY TECHNOLOGY ISSUES - ALS

The two key issues shown here involve the whole spectrum of technology, to include materials, lightweight structures, improved propulsion and efficient design which will ultimately result in a ten-fold reduction in the per pound launch costs, as well as a heavy lift capability in the late '90s.

S20-1

SDS PROGRAM ACTIVITIES

CONCEPT EXPLORATION DEMONSTRATION/ VALIDATION FULL-SCALE DEVELOPMENT

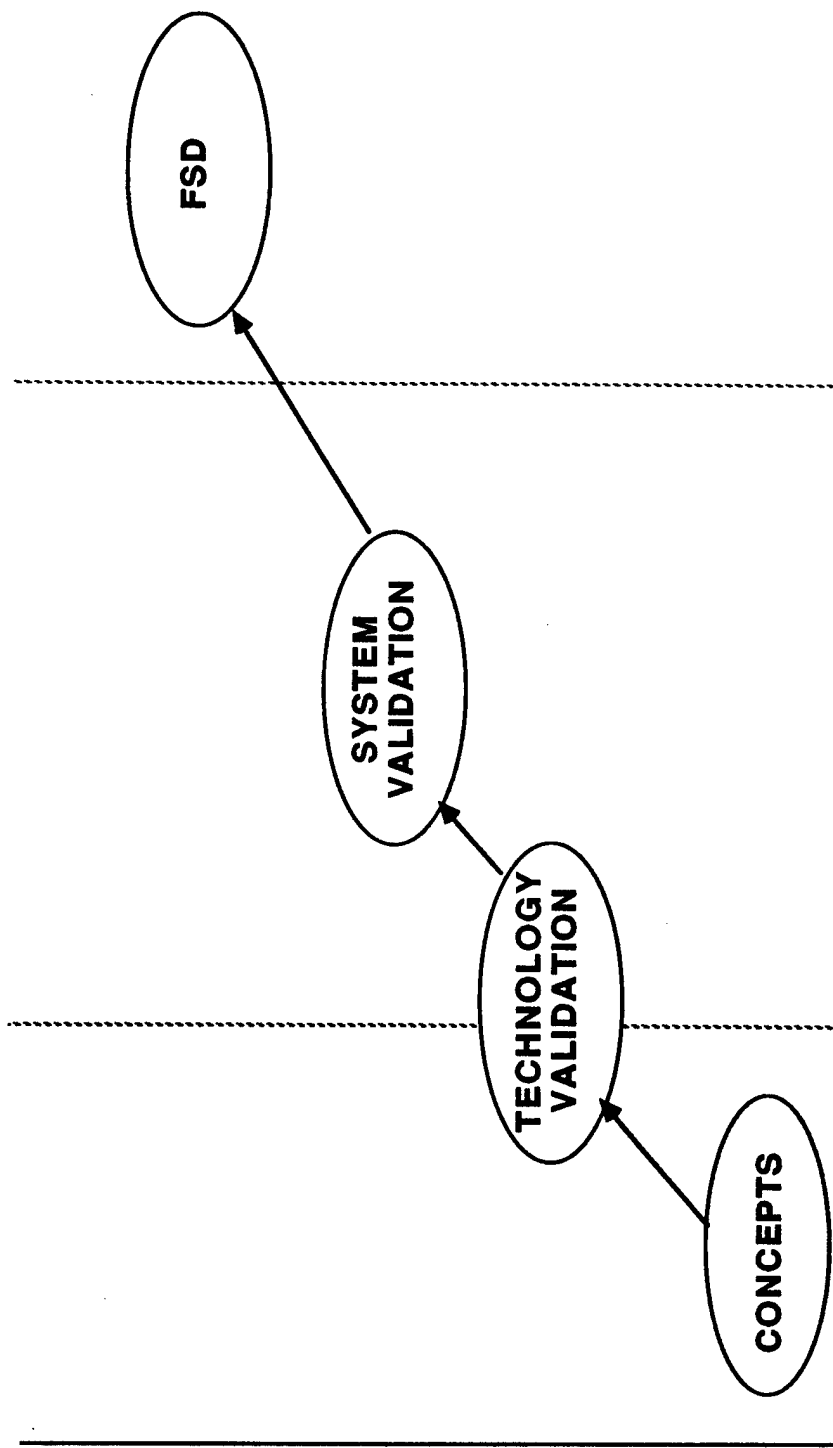

C A P A B I L I T Y

TECHNOLOGY DEVELOPMENT/CONTINUING RESEARCH

SDS PROGRAM ACTIVITIES

As previously described, Phase I of the SDS is in the Demonstration/Validation phase of development. However, there are other important elements currently entering technology validation and they could enter the Dem/Val phase during the next few years. To pursue these technologies most efficiently and at low risk requires that the SDIP be funded at the level requested by the President. New and innovative technologies are also being pursued at the concepts level and will be transitioned as they are proven.

S23-1