

REPORT DOCUMENTATION PAGEForm Approved
OMB No. 074-0188

Public reporting burden for this collection of information is estimated to average 1 hour per response, including the time for reviewing instructions, searching existing data sources, gathering and maintaining the data needed, and completing and reviewing this collection of information. Send comments regarding this burden estimate or any other aspect of this collection of information, including suggestions for reducing this burden to Washington Headquarters Services, Directorate for Information Operations and Reports, 1215 Jefferson Davis Highway, Suite 1204, Arlington, VA 22202-4302, and to the Office of Management and Budget, Paperwork Reduction Project (0704-0188), Washington, DC 20503

1. AGENCY USE ONLY (Leave blank)		2. REPORT DATE 1/5/99	3. REPORT TYPE AND DATES COVERED LESSONS LEARNED REVIEW	
4. TITLE AND SUBTITLE ADVANCED DISTRIBUTED SIMULATION TECHNOLOGY II MILITARY OPERATIONS IN URBAN TERRAIN (MOUT-IS) LESSONS LEARNED REVIEW			5. FUNDING NUMBERS	
6. AUTHOR(S)				
7. PERFORMING ORGANIZATION NAME(S) AND ADDRESS(ES) LOCKHEED MARTIN CORPORATION MARTIN MARIETTA TECHNOLOGIES, INC INFORMATION SYSTEMS COMPANY 12506 LAKE UNDERHILL ROAD ORLANDO, FL 32825			8. PERFORMING ORGANIZATION REPORT NUMBER ADST-II-CDRL-MOUTIS-9800199	
9. SPONSORING / MONITORING AGENCY NAME(S) AND ADDRESS(ES) NAWCTSD/STRICOM 12350 RESEARCH PARKWAY ORLANDO, FL 32826-3224			10. SPONSORING / MONITORING AGENCY REPORT NUMBER	
11. SUPPLEMENTARY NOTES				
12a. DISTRIBUTION / AVAILABILITY STATEMENT APPROVED FOR PUBLIC RELEASE; DISTRIBUTION IS UNLIMITED			12b. DISTRIBUTION CODE	
13. ABSTRACT (Maximum 200 Words) IMPLEMENT A SIMULATION-BASED ACQUISITION PROCESS THA FULLY INTEGRATES THE EFFORTS OF PMs, TACOM AND THE MOUNTED MANEUVER BATTLE LAB THROUGHOUT ALL PHASES IN THE DEVELOPMENT OF FUTURE MOUNTED WARFARE SYSTEMS.				
14. SUBJECT TERMS			15. NUMBER OF PAGES	
			16. PRICE CODE	
17. SECURITY CLASSIFICATION OF REPORT UNCLASSIFIED	18. SECURITY CLASSIFICATION OF THIS PAGE UNCLASSIFIED	19. SECURITY CLASSIFICATION OF ABSTRACT UNCLASSIFIED	20. LIMITATION OF ABSTRACT	

**ADVANCED DISTRIBUTED
SIMULATION TECHNOLOGY II
(ADST II)**

**MILITARY OPERATIONS IN URBAN
TERRAIN (MOUT-IS)**

DELIVERY ORDER #0054

CDRL AB01

LESSONS LEARNED REVIEW



FOR: NAWCTSD/STRICOM
12350 Research Parkway
Orlando, FL 32826-3224
N61339-96-D-0002
DI-MGMT-80227

BY: Lockheed Martin Corporation
ADST II
P.O. Box 780217
Orlando, FL 32878-0217

Approved for public release; distribution unlimited.

19990226019

Agenda

- 0900-0920 Office call with COL Gunzelman
- 0920-1015 Briefing on MMBL programs and capabilities (Chaffee)
- 1020-1100 TARDEC NAC brief on SMART - SIM TLC
- 1100-1200 Discussion
- 1200-1300 Lunch @ Leader's Club
- 1300- Tour of Test Bed/Discussion

SBA GOALS FOR FUTURE MOUNTED SYSTEMS DEVELOPMENT

Implement a Simulation-Based Acquisition process that fully integrates the efforts of PMs, TACOM and the Mounted Maneuver Battle Lab throughout all phases in the development of future mounted warfare systems.

Simulation Based Acquisition

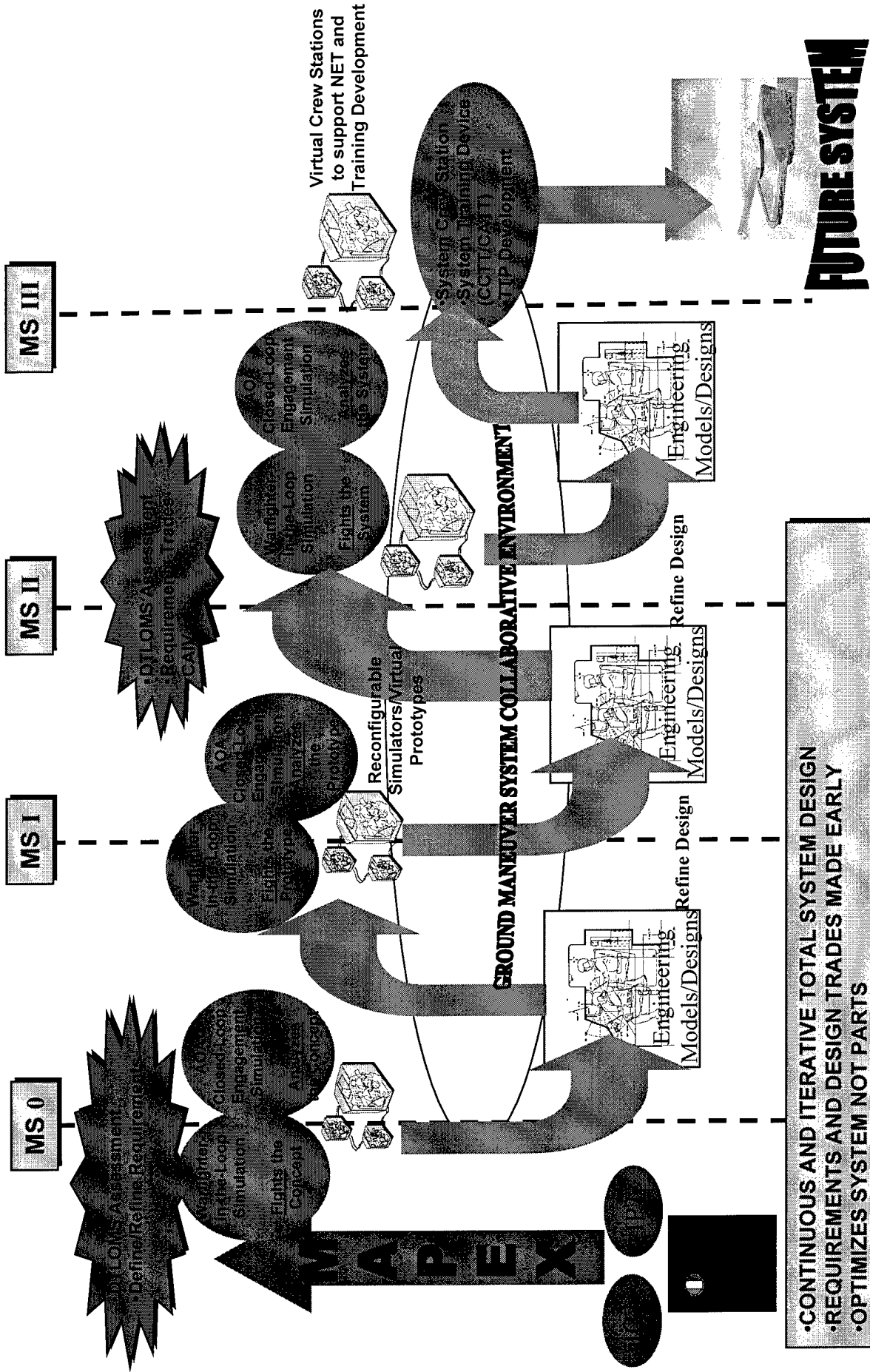

- CONTINUOUS AND ITERATIVE TOTAL SYSTEM DESIGN
- REQUIREMENTS AND DESIGN TRADES MADE EARLY
- OPTIMIZES SYSTEM NOT PARTS
- INTEGRATED PARTNERSHIP WITH COMBAT AND MATERIAL DEVELOPERS
- USER-FOCUSED THROUGHOUT

BATTLE LAB EXPERIENCE WITH SBA RELATED ACTIVITIES

•FSCS/TRACER

- Mast Height
- Crew Issues
- Sensor package issues
- TTP

•XUV

- User Interface Issues
- Design Considerations
- Operational insights/requirements

**Battle Lab is prepared to be integrated player throughout system development,
not just in early concept development**

Many Opportunities for the Future

- Strike Force
- FSCS
- NAC Alternatives
- FCS

Multiple SBA Opportunities

Technology evaluations:

- Survivability
 - Lighter Armor/APS
 - Sensors
- Lethality
 - Guns/Missiles(MIB) or other
 - Sensor to shooter
- Mobility
 - Platforms-wheel vs. Track
- C4ISR
 - Embedded C4
 - Scouts
- Robotics
 - Applications across domains
- Common Crew Station
- Others

NOW

FUTURE

01-E-24 FORUM NOVO

<ZD MM>OZD

Battle Lab Value-Added

- **Manprint**
 - Low to High Fidelity Simulation
 - Task Analysis/Verification
 - Fightability
- **Vehicle**
 - CGF Prototype
 - “Detectability” (Probability of Detection, Visual Models)
 - Sensors (FLIR, MCD, Radar, Etc.)
 - Dynamics (Vehicle, Visual Models, Etc.)
 - Munitions / Weapon System
 - Module Software / Algorithm development
- **Concurrent Tactics, Techniques & Procedures Development**
 - Combined Arms Synthetic Environment
 - Realistic, Dynamic OPFOR
- **Joint / Combined Synthetic Battlefield**
 - “Extended Battlefield”
 - C4I
 - Data Fusion
 - Force on Force Analysis

Potential Benefits of Battle Lab Involvement

- Lower Cost System
- Enhanced Capability/Usability
- Faster Development Cycle
- TTPs Developed w/ System
- Soldiers Trained as System Developed
- Early “Value Added” Assessments
- Avoids “Gold Platings”
- Total System Design(DTLOMS Optimized)

The Road Ahead

- **Begin creation of Ground System “Collaborative Environment”**
- **Identify Potential High-Payoff Systems/Opportunities**
 - **FSCS**
 - **NAC Alternatives (Medium Tactical Vehicle)**
 - **Common Crew Station**
 - **FCS**
- **Develop Plan and Brief thru the “Building”**

Back-ups

Why is M&S Important?

US style of war is becoming technologically complex and dependent on distributed and interconnected systems.

- M&S will become a core tool in Revolution in Military Affairs for planning and conducting warfare—especially since intuition based on past wars becomes less helpful over time
- M&S will become a core feature of system development and acquisition, as is already the case in leading edge commercial industry
- M&S should be seen as enterprise technology, in itself—a part of our Revolution in Business Affairs

Dr. Patricia Sanders
Dir., Test, Systems Engineering, and Evaluation
OUSD(A&T)
DMSO Industry Days, June 1-3 1998

Known Benefits of M&S

*Consistent and Pervasive Evidence that M&S
used Effectively Provides Substantial,
Quantifiable Benefit as Measured in:*

- Cost
- Schedule
- Productivity
- Quality and Performance

Final Report: *Study on the Effectiveness of Modeling and Simulation in the Weapon System Acquisition Process*
<http://www.acq.osd.mil/te/pubdocs/acqstudy.htm>

Notional SBA Process for the Mounted Force

DFDs/BATTLELABS/DTDD

CONCEPTS
DOCTRINE

USMIPFORS
Leaders/Soldiers/Units
in Simulation



USMIPFORS
Leaders/Soldiers/Units
in Simulation



USMIPFORS
Leaders/Soldiers/Units
in Simulation



NEW
REQUIREMENTS

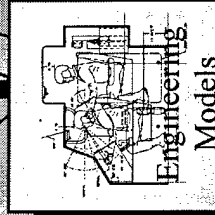
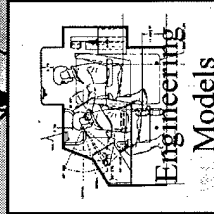
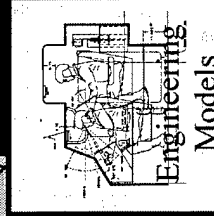

TECHNOLOGY

PMs/RDECS



- CONTINUOUS AND ITERATIVE TOTAL SYSTEM DESIGN
- OPTIMIZE NEW SYSTEMS THRU SIMULATION-BASED DTLOMS DESIGN
 - CAIV
 - AOA
- INTEGRATED PARTNERSHIP BETWEEN COMBAT & MATERIAL DEVELOPERS
- USER-FOCUSED THROUGHOUT

Objectives

The Armor Center/MMBL and TACOM/TARDEC jointly develop an approach to Simulation Based Acquisition that maximizes the capabilities of both organizations to contribute to efficiently and effectively developing future systems.

Enablers

- Common Process Model
- Compatible Simulation Technologies
- Memorandum of Agreement



MOUT-IS ACTD DELIVERY ORDER



Lessons Learned Agenda

830 - 900	<i>Project Overview</i>	<i>C. Anderson</i>
900 - 1000	<i>System Overview</i>	<i>W. Holbrook</i>
1000 - 1100	<i>Experiment Support</i>	<i>M. Bushman</i>
1100 - 1200	<i>LUNCH</i>	
1200 - 1300	<i>Data Collection</i>	<i>F. Gomez</i>
1300 - 1400	<i>Observations</i>	<i>IPT</i>
1400 - 1500	<i>Recommended Enhancements</i>	<i>IPT</i>
1500 - 1600	<i>Recommended Future Tasks</i>	<i>C. Anderson</i>
1600 - 1630	<i>Summary / Open Items</i>	<i>IPT</i>

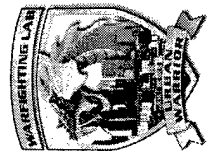



MOUT-IS ACTD DELIVERY ORDER



PROJECT OVERVIEW

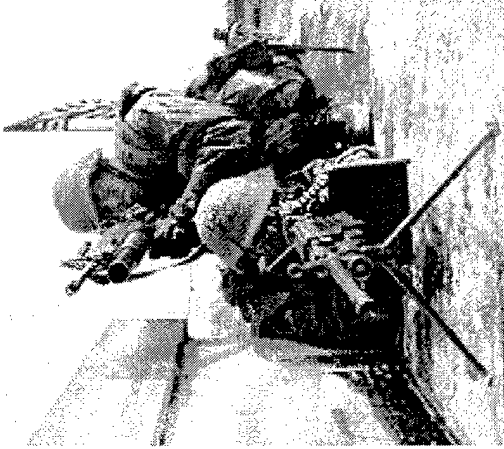

MILITARY OPERATION IN URBAN TERRAIN INSTRUMENTATION SYSTEM ADVANCED CONCEPT TECHNOLOGY DEMONSTRATION

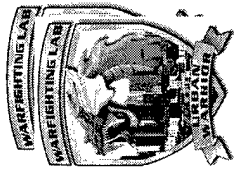



MOUT-IS ACTD DELIVERY ORDER



PROJECT OBJECTIVES

- *Develop, integrate, test, operate and maintain the Camp Lejeune MOUT-IS to allow the USMC to evaluate and refine the Technologies, Tactics, Techniques, and Procedures required for operations in a MOUT environment.*
- *Provide the capability for MOUT training/exercise in an instrumented maneuver area to allow the near real time monitoring and recording of individual and unit performance.*
- *Provide a systems engineering approach to allow for future growth to large system capacities, and to support emerging DIS/HLA standards and considerations to be able to interface the MOUT-IS with other live, virtual and constructive simulation systems.*

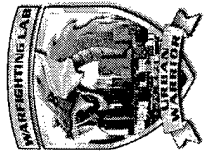



MOUT-IS ACTD DELIVERY ORDER



ADST DELIVERY ORDER SCOPE

- *Utilize 3rd Gen instrumented MILES equipment (GFE) to support assessment of two (2) platoons of Marines in a MOUT environment.*
- *Provide instrumentation within two (2) buildings at the Camp Lejeune MOUT site to track indoor player positions and fire events.*
- *Provide an outdoor instrumentation capability within the Camp Lejeune MOUT site utilizing differential GPS .*
- *Provide an Operations Center with exercise control, data collection and data assessment capabilities.*
- *Provide DIS interface for Synthetic Environment viewing and future growth to other distributed simulation exercises.*
- *Provide LOE Operations and Maintenance support at the Camp Lejeune MOUT site.*





MOUT-IS ACTD DELIVERY ORDER

DELIVERY ORDERKEY PARTICIPANTS



SPONSORS

- DoD - MOUT ACTD
 - Col Anderson
 - Carol Fitzgerald
- MCWL
 - Major Brad Sargent
- AWT
 - George Solhan

INTEGRATED PROJECT TEAM

- STRICOM - ADST II
 - MAJ Tom Coffman
 - Jim Grosse
 - Tim Priebe
 - ADST II PMO
- LMIS
 - Brian O'Connor
 - ADST II PMO

NAWCTSD

- John Mills
- James Bostick
- Joe Cameron

PRIME DEVELOPERS

- LMIS-EO
- Reality by Design
- InterSense
- LMSG

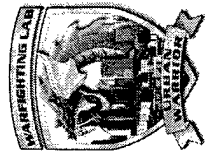



MOUT-IS ACTD DELIVERY ORDER



CONTRACT FUNDING PROFILE

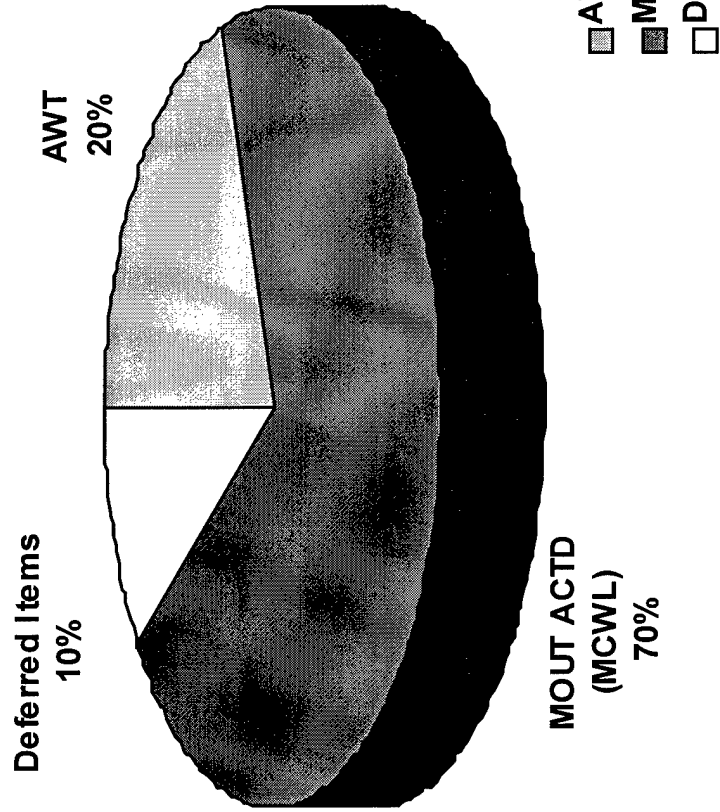

- AWT
- MOUT ACTD (MCWL)
- Deferred Items

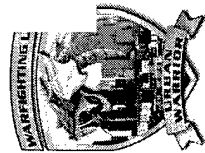

7



MOUT-IS ACTD DELIVERY ORDER COST BREAKOUT

TOTAL CONTRACT VALUE \$7.1 M

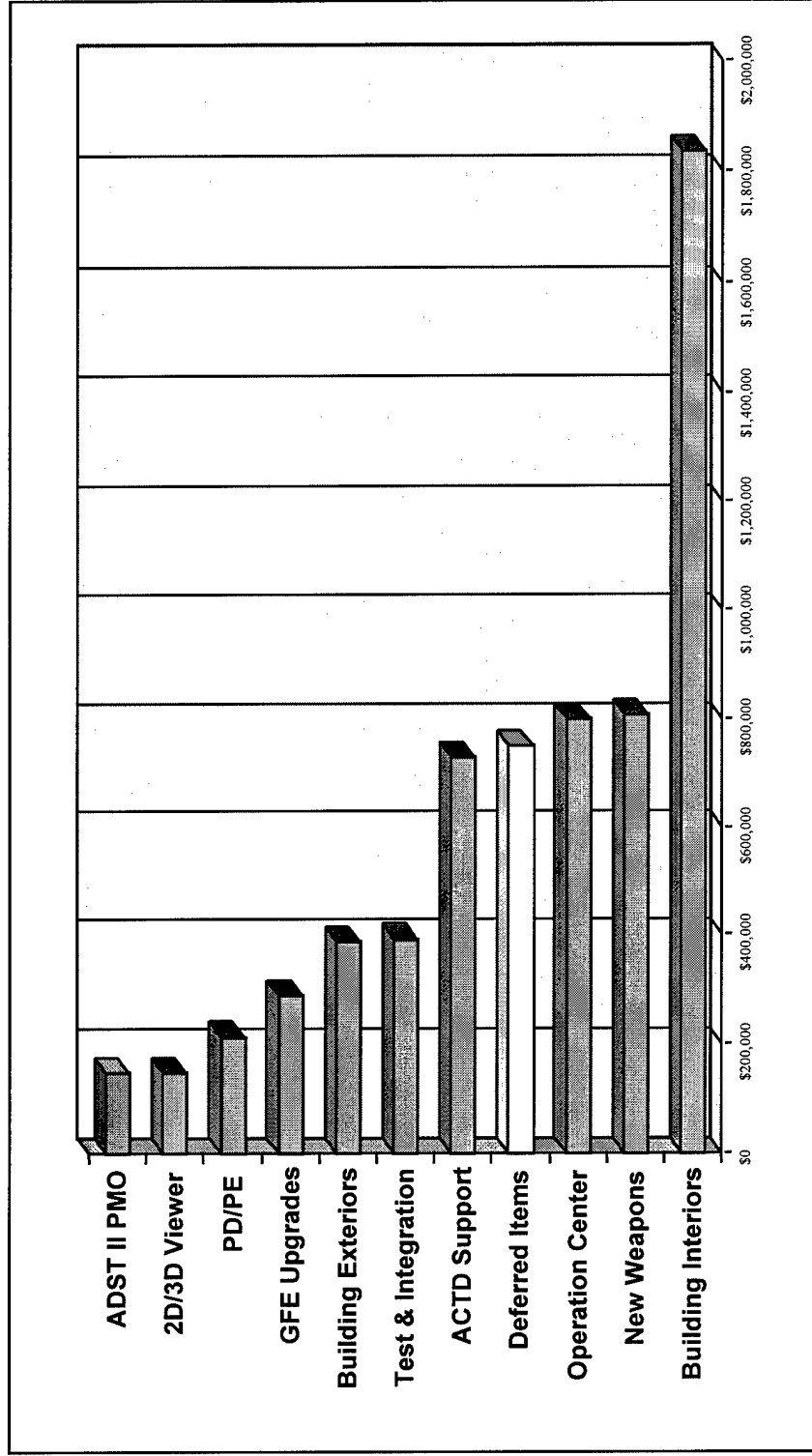



MOUT-IS ACTD DELIVERY ORDER



KEY PROJECT MILESTONES

Contract Award	September '97	✓
Start of Work Conference	October '97	✓
Site Survey	October '97	✓
Technical Interchange Meeting #1	December '97	✓
Technical Interchange Meeting #2	February '98	✓
Phase I Technical Demonstration	March '98	✓
Start Installation at Camp Lejeune	March '98	✓
Complete Integration and Test	July '98	✓
Start MOUT ACTD Experiment Support	July '98	✓
Complete MOUT ACTD Experiment Support	Aug '98	✓

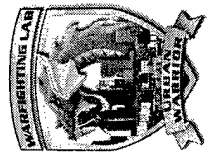

[Handwritten signature]



MOUT-IS ACTD DELIVERY ORDER

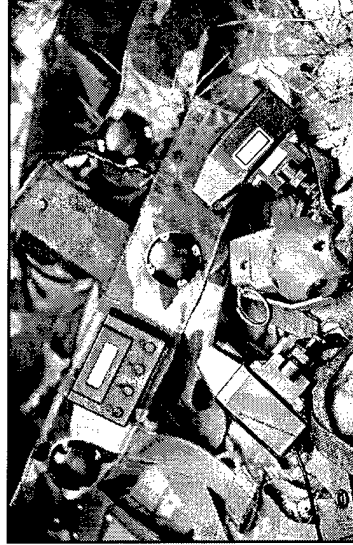
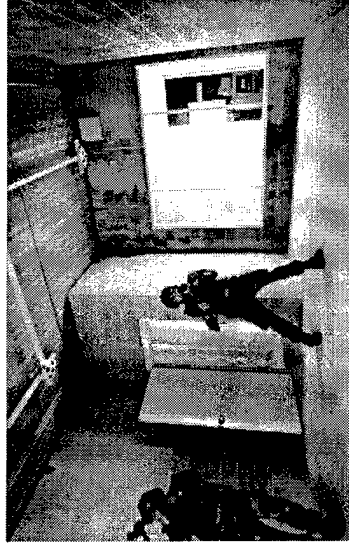
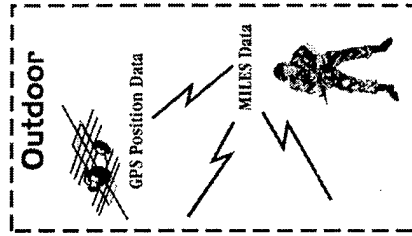
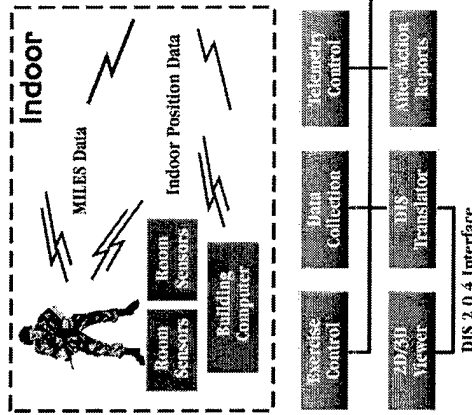

Live View

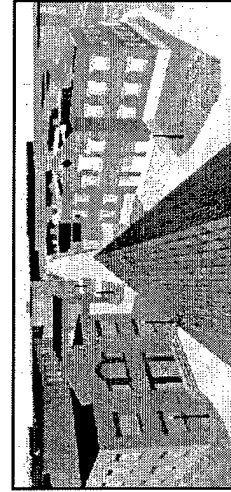

Virtual View

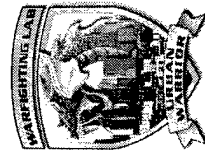



MOUT-IS ACTD DELIVERY ORDER

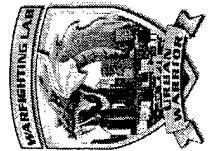
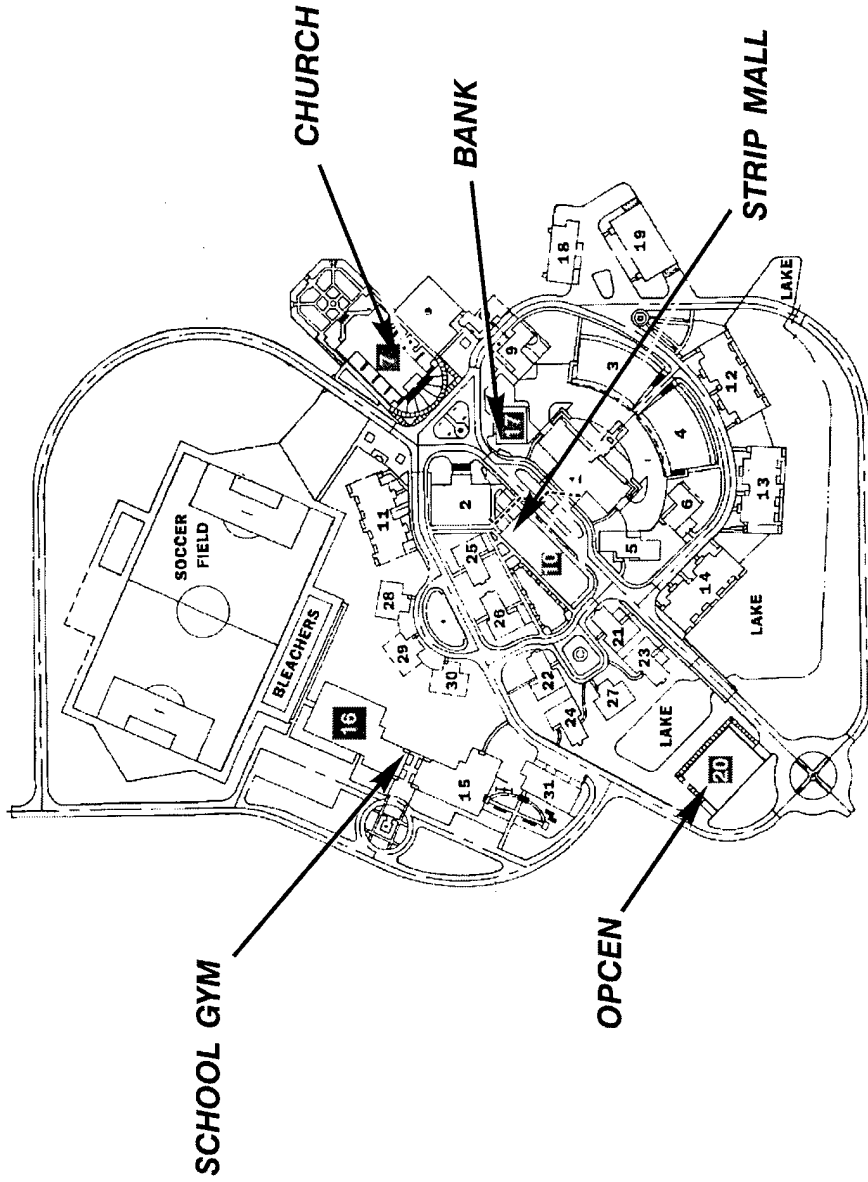



MOUT-IS ACTD DELIVERY ORDER



Strip Mall (Building 10)

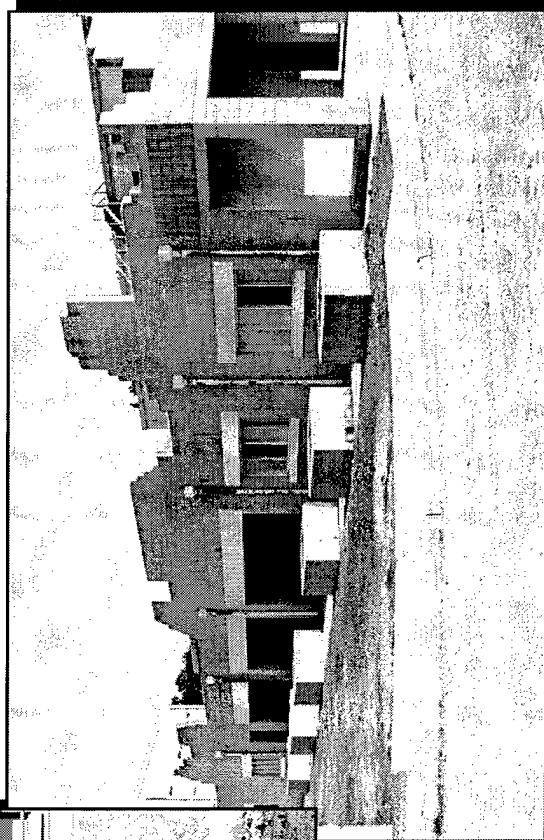
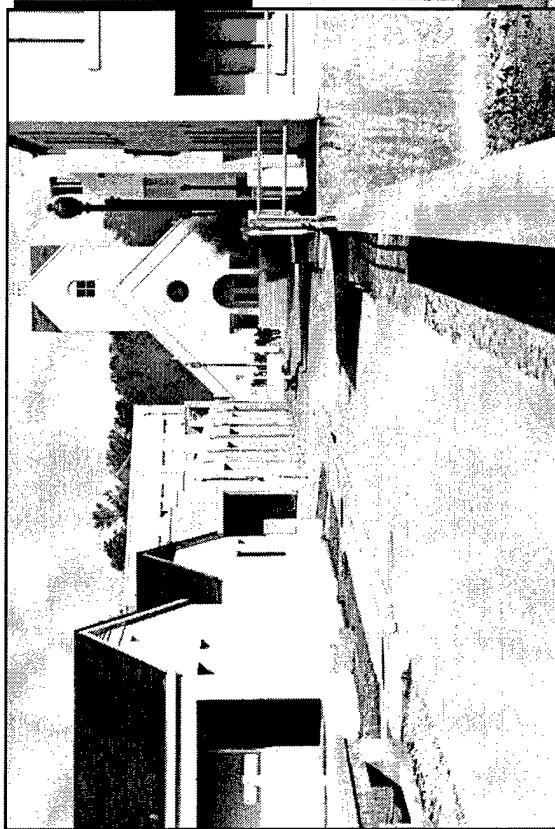

9760-134.GDR 3/98



c:\mout\moutles.ppt





MOUT-IS ACTD DELIVERY ORDER



Bank (Building 17)

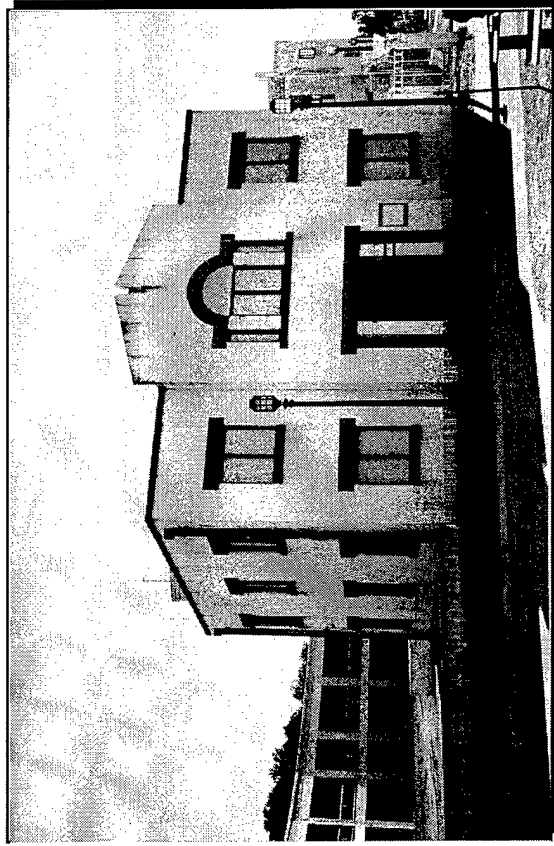

9760-146.CDF 3/98

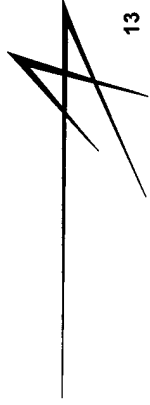



MOUT-IS ACTD DELIVERY ORDER



AFTER ACTION REVIEW SYSTEM

- **AAR Reports**
 - **Exercise Time**
 - **Fire Events**
 - **Kills**
 - **Near Misses**
 - **Weapons Type**
 - **Location**
 - **Range**
 - **Individual Activity**
 - **Fire Team**
 - **Squad**
 - **Platoon**
 - **Weapons Effectiveness**
 - **Fratricide**
- **Exercise Playback**
 - **Start**
 - **Fast Forward**
 - **Pause**
- **2D Plan View Displays**
 - **Fire Indication**
 - **Paired Firing Lines**
 - **Player Status**
- **3D Stealth Viewer**
 - **Virtual Overview for Briefing**
 - **Standing, Kneeling, Prone**
 - **Shaded or Wireframe**
- **Projection System**
 - **AAR Displays**
 - **Presentations**
 - **Video**

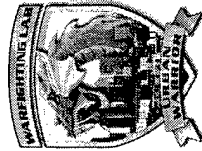



MOUT-IS ACTD DELIVERY ORDER



AFTER ACTION REPORT EXAMPLE

Time	Player	Role	Location	Weapon	Rounds	Event	Opponent	Range
8:01:07	Jones	Squad B	8320/3855	M-16	16	Near Miss	Smith	42m
8:01:22	Smith	OpFor	Bldg 10 Rm 6	M-249	38	Kill	Johnson	108m
8:03:41	Coffman	Squad A	8331/3870	M-203	2	Kill	Grosse	Fratricide

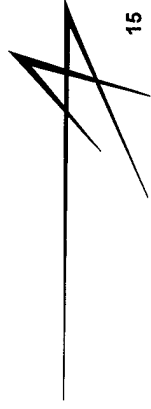
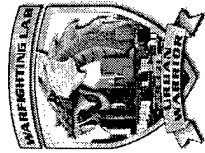



MOUT-IS ACTD DELIVERY ORDER



MOUT-IS PRODUCTS & SERVICES

- *Bldg 10 & 17 Indoor Tracking*
- *Outdoor Tracking (1 sq. km)*
- *AAR System*
- *MILES Equipment*
 - 170 *Hand Grenades*
 - 75 *Player Vests*
 - 59 *M-16 SATs*
 - 24 *M-203 SATs*
 - 24 *Generic Vehicle kits*
 - 8 *M-249 SATs*
 - 4 *M1A1 Vehicle Kits*
- *Simulated Area Weapons Effects*
 - *Artillery*
 - *Mortars*
 - *Minifields*
 - *Chemical*
 - *Nuclear*
- *New Equipment Training*
- *Experiment Support (O&M)*
- *Training Manual*
- *Range Operations Manual*
- *System Maintenance Manual*
- *Tools and Test Equipment*
- *Articles*
- *Brochures*
- *Booth Panels*
- *Web Page*
- *Video Tape*

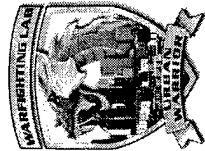



MOUT-IS ACTD DELIVERY ORDER



ENHANCEMENTS PROVIDED AT NO ADDITIONAL COST

- *More accurate indoor position accuracy*
- *3 Additional M203 SATS (24 vs 21)*
- *10 Additional Grenades (170 vs 160)*
- *M249 SAT new production units provided (instead of using RIS units)*
- *M16A2 SAT adaptation to M4 weapon*
- *Modification of the SATS to use simunition rather than blank fire during ACTD experiment*
- *Spare hardware for lightening strike damage*
- *Video projector and theater screen*

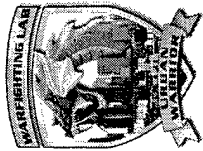



MOUT-IS ACTD DELIVERY ORDER



FUTURE ENHANCEMENTS

- AAR ENHANCEMENTS
- OUTDOOR POSITION STUDY
- OPCEN IMPROVEMENTS
- DIGITAL VIDEO SYSTEM
- M240G & M249 SATs
- M203 SIMULATION KIT
- MILES VEHICLE KIT INTEGRATION
- AT4/SMAW
- AREA WEAPONS EFFECTS ENHANCEMENTS
- CASUALTY CARDS
- LONG HAUL CONNECTIVITY
- YEAR 2000 COMPLIANCE
- OTHER WEAPONS SYSTEMS STUDY

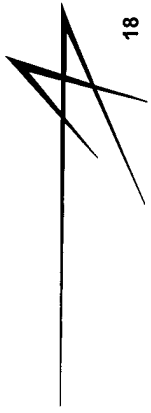
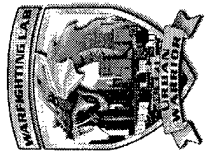



MOUT-IS ACTD DELIVERY ORDER



SUMMARY

- SYSTEM PROVIDES STATE OF THE ART INSTRUMENTATION CAPABILITIES TO THE USMC
- SIGNIFICANT ELEMENT OF THE DoD's MOUT ACTD PROGRAM
- IMPORTANT FEEDER PROGRAM INTO LARGER USMC MOUT-IS AND RANGE INSTRUMENTATION SYSTEM (RIS) INITIATIVES
- PROVIDES LIVE PLAYER CAPABILITY TO VIRTUAL AND CONSTRUCTIVE SIMULATIONS IN SUPPORT OF DIS/HLA OBJECTIVES

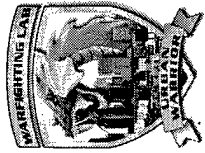



MOUT-IS ACTD



Data Collection

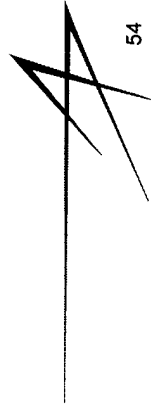
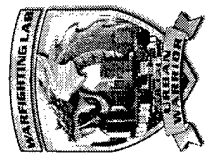



MOUT-IS ACTD

Technical Support Team



- **Contractor Logistics Support and Training**
 - Mike Bushman and Sam Jannati
- **Software Engineering**
 - Camp Lejeune
 - Paul Mikusky, Pete Torpey, Mohammed Rahman, George Marschalk, Dave Kunishima, and Mike Harrington
 - Pomona
 - Larry George, Randell Beltran, Ken Brown, Bruce Crabtree, and Carolyn Le
- **System Engineering**
 - Bill Holbrook and Frank Gomez

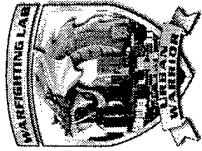



MOUT-IS ACTD



Typical Scenario Description

- **Blue Force**
 - One Marine Squad
 - South of Building 10 (Strip Mall)
 - Utilized new technologies
 - Executed various tactics, techniques, and procedures
- **Opposition Force**
 - One Marine Fire Team
 - Inside Strip Mall
 - Standard Fighting Equipment

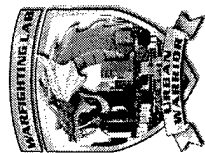



MOUT-IS ACTD



Data Collection

- **Building Computer**
 - UTM Position of each Marine (*Tenths of meters*)
 - X, Y, and Z (*Hundredths of an inch*)
- **Operation Center**
 - Collect raw data from all player sources
 - RF and In Room Positioning Systems
 - Produce correlated events from data base for AAR and exercise playback
- **Player Unit**
 - GPS Position, and Direct Fire / Indirect Fire Player Events

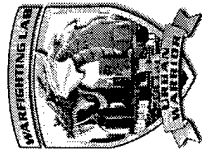



MOUT-IS ACTD



Building 10 UTM Outline

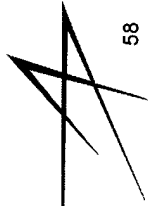
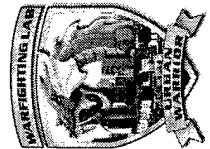
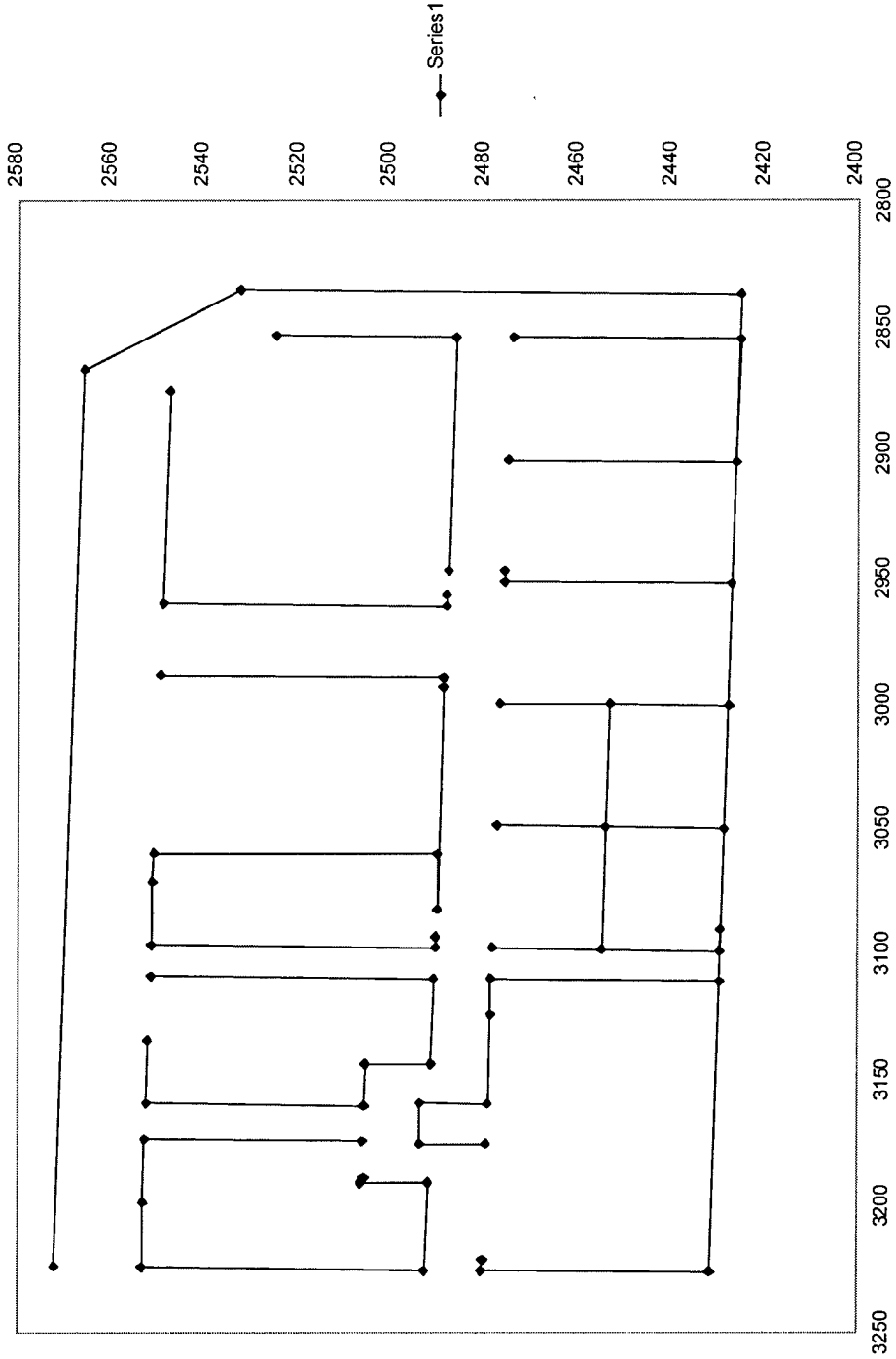



MOUT-IS ACTD



Building Computer UTM Data

PID 1015 Walkaround Bldg. 10

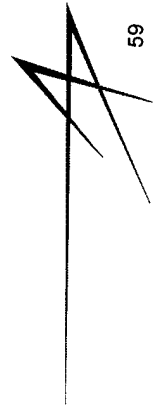
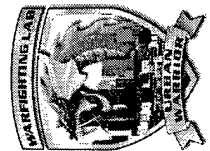
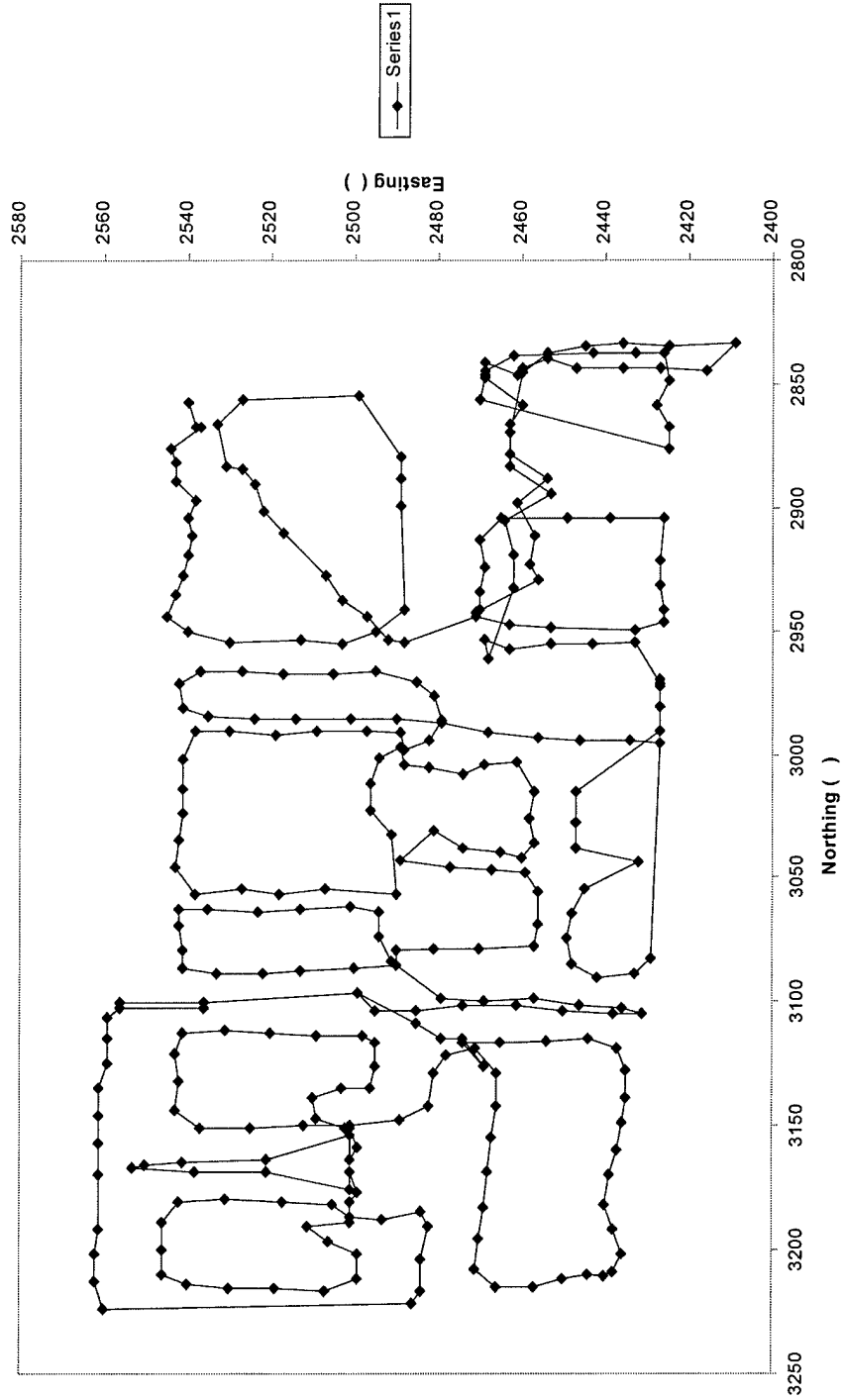



MOUT-IS ACTD

IRPS Static Accuracy Single PID 1100 Data Points

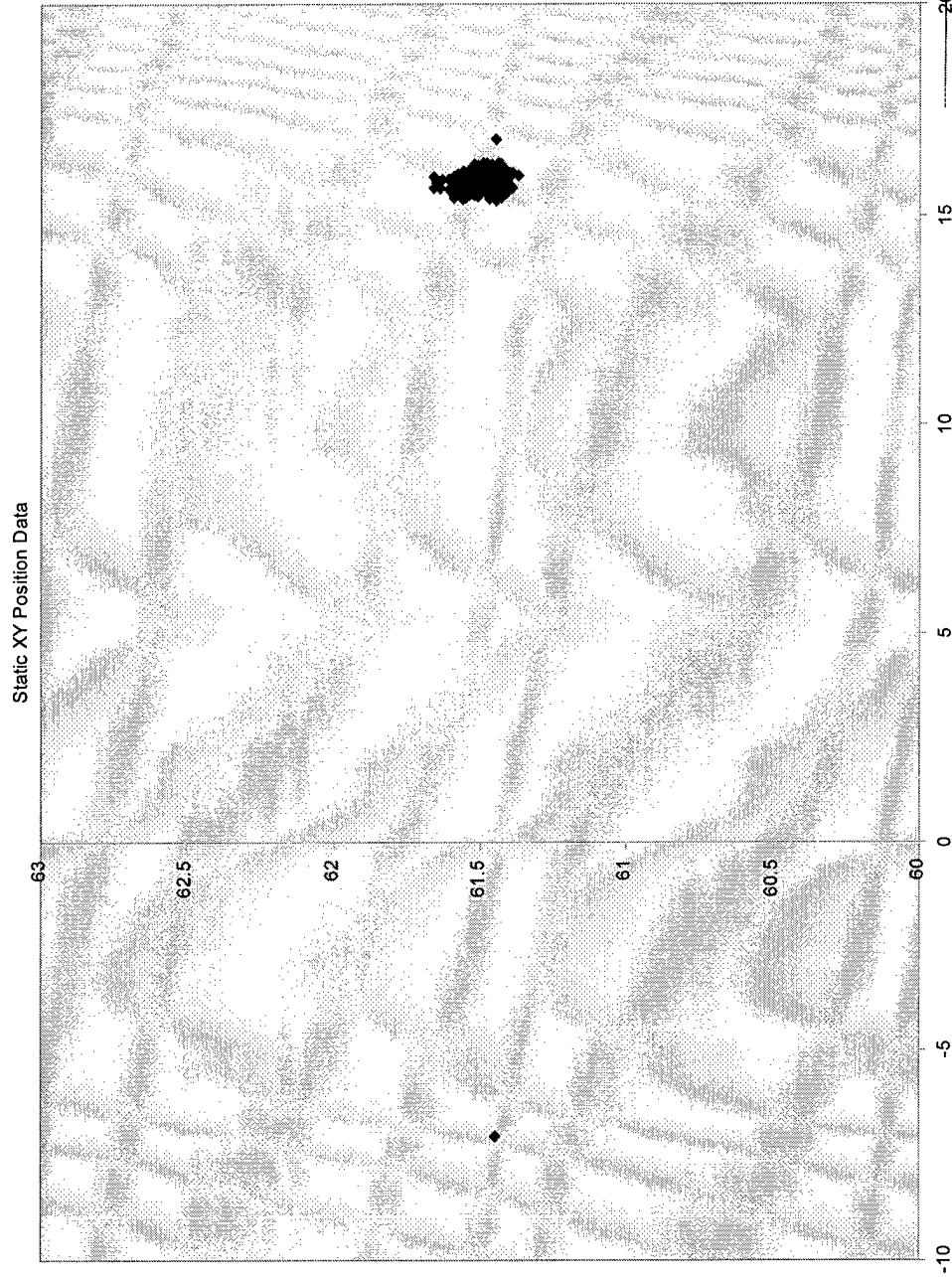

y, Inches

x, Inches

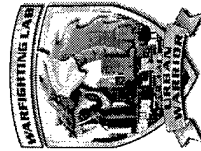



MOUT-IS ACTD



AAR Functional Capabilities

- *Firing events by chronological order*
- *BLUEFOR/OPFOR Direct Fire Engagements*
- *Crew, Platoon and Company Marksmanship Grand Summary*
- *Engagement Activity/Accuracy Report*
- *Engagement Range Against targets*
- *Firing Events Summary*
- *Weapon and Target Selection Summary*

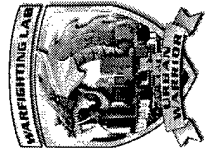



MOUT-IS ACTD

After Action Review Reports



INDIVIDUAL ACTIVITY REPORT

Exercise Name : ACTD 2 Squad Scenario 3b 8-24
 Comment : 1998-08-24 22:06:07.2
 Started : 1998-08-24 22:28:35.5
 Ended :
 Scenario Name : ACTD 2 Squad - Scenario 3b
 Purpose : ACTD Squad 3 and Op For
 Comment :
 Modified : 1998-08-24 19:44

Player Name: Perry
 PID: 0201
 Company/Platoon/Squad: A/2/3/A

Day	Time	Sgd Pos	Attacking Entity	PID	Sgd Pos	Targeted Entity	PID	Weapon	Rnds	Event	Player Position	Attacker/Victim Pos.	Range (M)
Mo	22:13:42.0	2	A/2/3/A Perry	0201				M203 Gre	1	MOEFF	9381838287		
Mo	22:17:06.3	2	A/2/3/A Perry	0201				M203 Gre	1	MOEFF	9381638285		
Mo	22:17:24.5	2	A/2/3/A Perry	0201				M203 Gre	1	MOEFF	9384638285		
Mo	22:17:43.7	2	A/2/3/A Perry	0201				M16 Gren	1	MOEFF	9384638284		
Mo	22:19:21.3	2	A/2/3/A Perry	0201				M203 Gre	1	MOEFF	9385038300		
Mo	22:19:27.5	2	A/2/3/A Perry	0201				M203 Gre	1	MOEFF	9385038300		
Mo	22:22:05.3	2	A/2/3/A Perry	0201				M203 Gre	1	MOEFF	9385038300		
Mo	22:22:53.8	8	D/1/1/A Lytle	0325	2	A/2/3/A Perry	0201	M16(203)	5	Kill	9385438296	9385338309	133

Player Name:
 PID: 0229
 Company/Platoon/Squad: D/1/2/A

Day	Time	Sgd Pos	Attacking Entity	PID	Sgd Pos	Targeted Entity	PID	Weapon	Rnds	Event	Player Position	Attacker/Victim Pos.	Range (M)
Mo	22:20:58.8		Grenade	3329	4	D/1/2/A	0229	M67 Gren	1	Kill	9382438196		

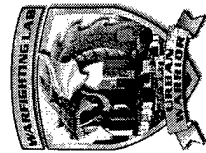



MOUT-IS ACTD AAR Reports



CHRONOLOGICAL ACTIVITY REPORT

Exercise Name : ACTD 2 Squad Scenario 3b 8-24
 Comment :
 Started : 1998-08-24 22:06:07.2
 Ended : 1998-08-24 22:28:35.5
 Scenario Name : ACTD 2 Squad - Scenario 3b
 Purpose : ACTD Squad 3 and Op For
 Comment :
 Modified : 1998-08-24 19:44

Rng Day (M)	Time	Sqd	Pos	Attacking Entity	PID	Sqd	Pos	Targeted Entity	PID	Weapon	Rnds	Event	Attacker/ Victim Pos.	Target Position
Mo	22:13:12.0	2	A/2/3/A	Perry	0201					M203 Gre	1	NoEff	9381838287	
Mo	22:15:02.9	2	A/2/3/A	Perry	0201					M203 Gre	1	NoEff	9381638295	
Mo	22:17:09.4	2	A/2/3/A	Perry	0201					M203 Gre	1	NoEff	9384638285	
Mo	22:17:24.5	2	A/2/3/A	Perry	0201					M203 Gre	1	NoEff	9384638284	
Mo	22:17:43.7	2	A/2/3/A	Perry	0201					M16 (203)	1	NoEff	9384638284	
Mo	22:19:02.3	4	D/1/1/A	Burke	0313					M16	4	NoEff	9385338322	
Mo	22:19:06.3	4	D/1/1/A	Burke	0313					M16	1	NoEff	9385338322	
Mo	22:19:12.3	4	D/1/1/A	Burke	0313					M16	6	NoEff	9384638321	
Mo	22:19:21.3	2	A/2/3/A	Perry	0201					M203 Gre	1	NoEff	9385038300	
Mo	22:19:27.5	2	A/2/3/A	Perry	0201					M203 Gre	1	NoEff	9385038300	
Mo	22:20:32.0			Grenade	3329	12	D/1/1/A	Ortiz	1009	M67 Gren	1	Kill	9382138206	
Mo	22:20:56.2			Grenade	3329	6	D/1/2/A		0233	M67 Gren	1	Kill	9382538199	
Mo	22:20:58.8			Grenade	3329	4	D/1/2/A		0229	M67 Gren	1	Kill	9382438196	
Mo	22:21:50.6	4	D/1/1/A	Burke	0313	11	A/2/3/A	Gorreo	0255	Light Mi	1	NMiss	9384538283	
Mo	22:21:51.5	4	D/1/1/A	Burke	0313	11	A/2/3/A	Gorreo	0255	Light Mi	1	NMiss	9384538283	
Mo	22:21:51.6	4	D/1/1/A	Burke	0313					M16	8	NoEff	9384938314	
Mo	22:22:05.3	2	A/2/3/A	Perry	0201					M203 Gre	1	NoEff	9385038300	
Mo	22:22:54.0	8	D/1/1/A	Lytte	0325	11	A/2/3/A	Gorreo	0255	Light Mi	1	NMiss	9385438298	
Mo	22:22:54.3	8	D/1/1/A	Lytte	0325	2	A/2/3/A	Perry	0201	M16 (203)	5	Kill	9385338309	9385438296
Mo	22:23:00.5	8	D/1/1/A	Lytte	0325					M16 (203)	3	NoEff	9385338316	
Mo	22:23:01.9			Grenade	3329	5	D/1/1/A	Gutierrez	0319	M67 Gren	1	Kill	9384938310	
Mo	22:23:04.1	8	D/1/1/A	Lytte	0325					M16 (203)	3	NoEff	9385338310	

page 1

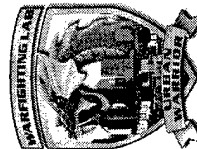

09/21/98



MOUT-IS ACTD



AAR Reports - Microsoft Excel

Sum of Rnds		Event		NMiss	NoEff	Grand Total
Attacker	Target	Kill				
Burke	Bullock	3	4			7
	Gorreo		2			2
	Put	4	6			10
	Ski	1	3			4
	(blank)		4		38	42
	Burke Total	8	19		38	65
	Gorreo (blank)				2	2
	Gorreo Total				2	2
Grenade	Gutierrez	1				1
	Ortiz	1				1
	Wilson	1				1
	(blank)	2				2
	Grenade Total	5				5
Hunt	Gorreo		3			3
	(blank)				8	8
	Hunt Total		3		8	11
Lytle	Gorreo		1			1
	Perry	5				5
	(blank)				20	20
	Lytle Total	5	1		20	26
	Perry (blank)				8	8
	Perry Total				8	8
	Spring (blank)				1	1
	Spring Total				1	1
	Tussel (blank)				1	1
	Tussel Total				1	1
	Woods		1			1
	Hunt					

Pivot Table Example

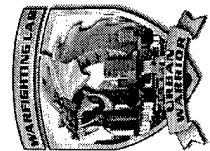



MOUT-IS ACTD

AAR Graphics

- Microsoft Excel

Example of ACTD Chart Data 8/24/98

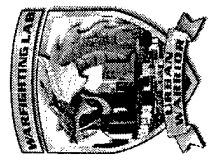
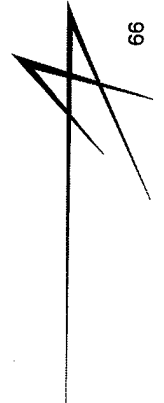
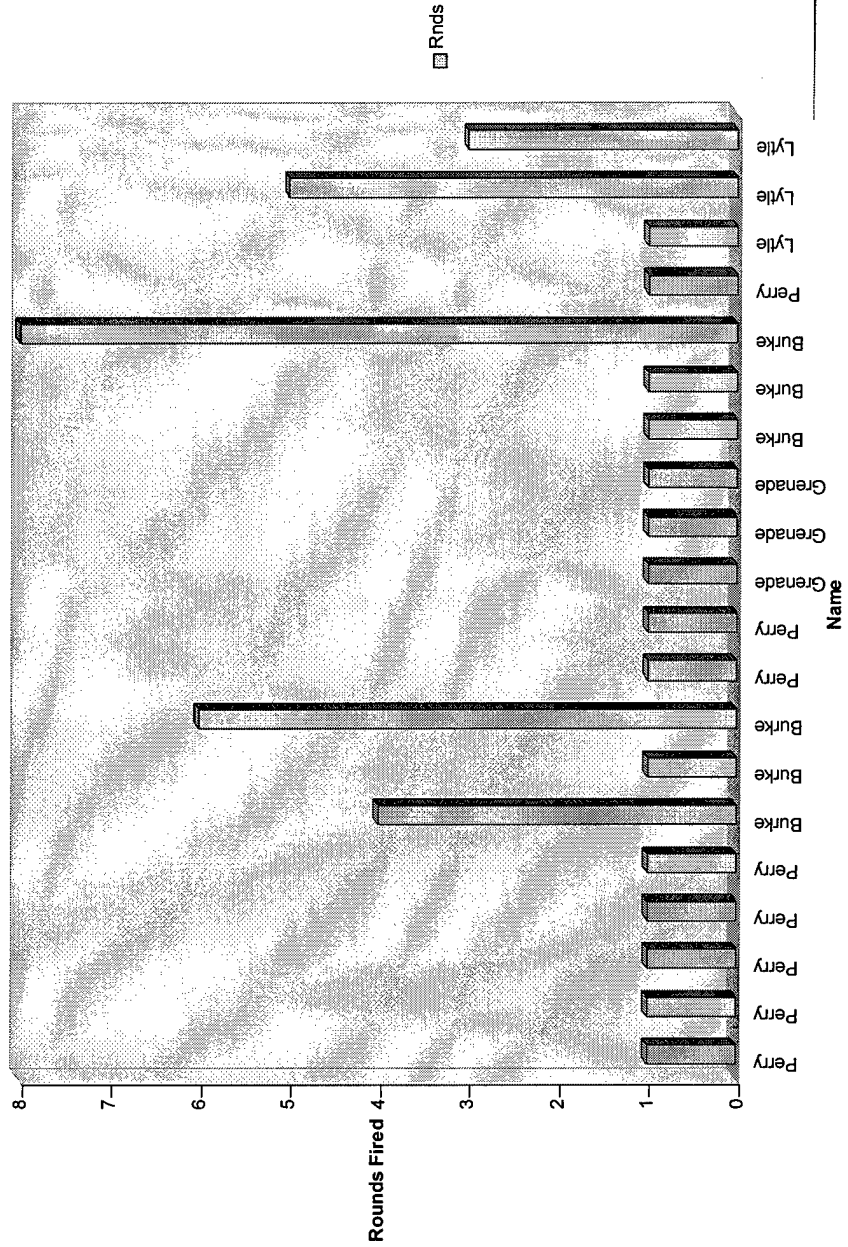



MOUT-IS ACTD



AAR Reports - Microsoft Excel

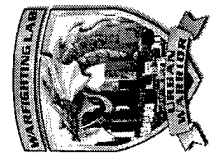
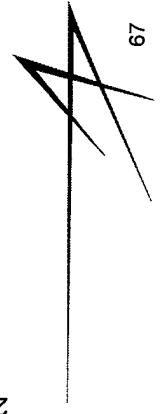
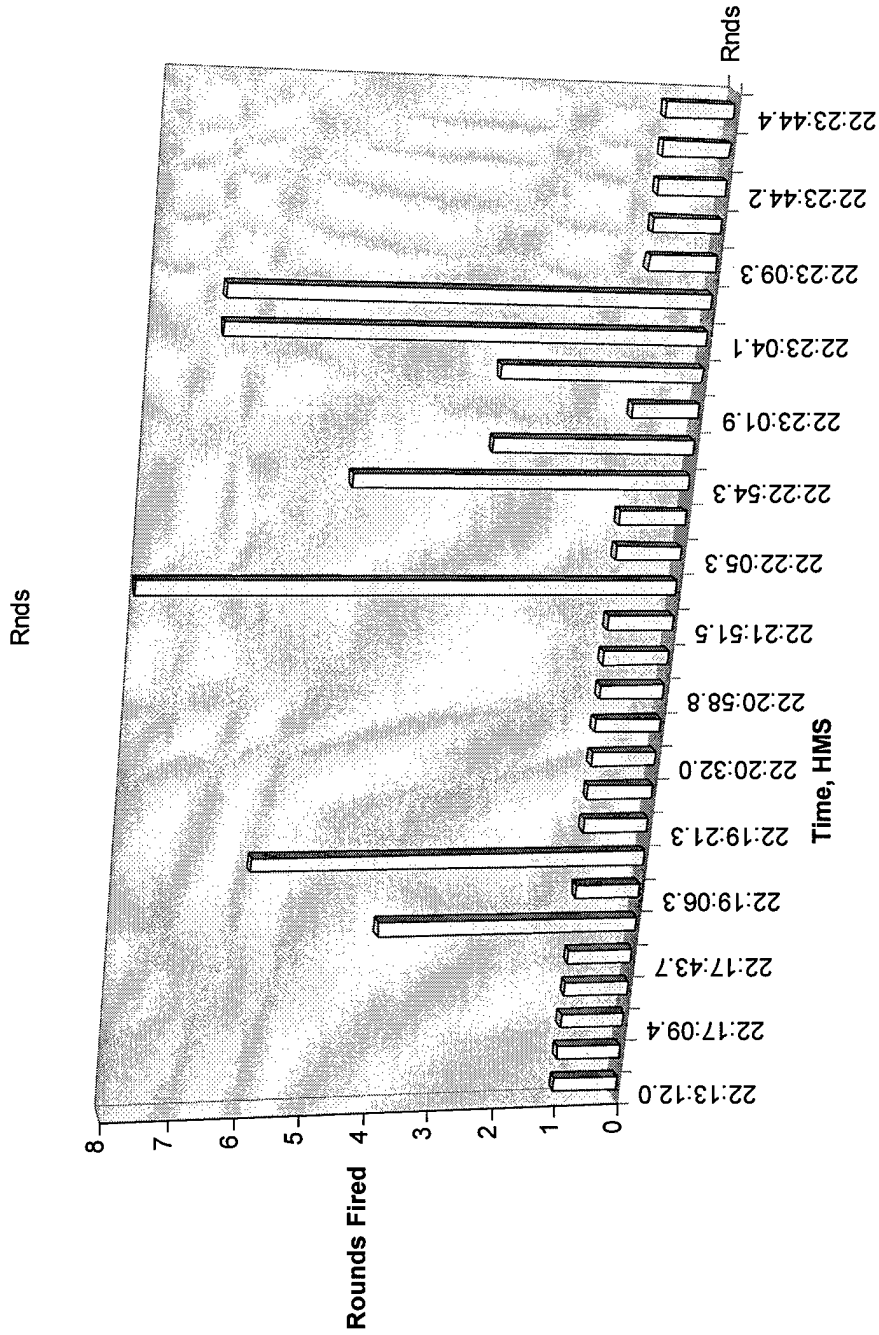



MOUT-IS ACTD



Observations During Experiment Support

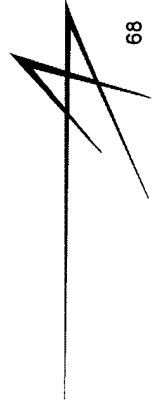



MOUT-IS ACTD



Observations During Experiment Support

- *RF Connectivity during experiments 98%-100%*
- *Initialization time less than 10 minutes*
- *Use of 2D and 3D graphics provided essential overview of Battle*
- *GPS data*
 - *3D differential fix data good approaching MOUT Site and down main street*
 - *GPS did not provide good position data near buildings due to blockage of satellites*
- *In Room Positioning System provided fairly accurate data for most indoor locations*

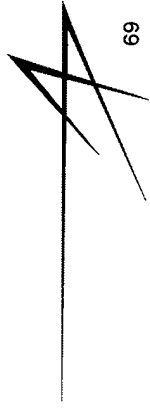
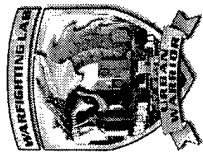



MOUT-IS ACTD



Observations During Experiment Support

- **Small Arms Transmitter**
 - 3rd Generation SAT reliability and effectiveness high
 - SAT Snaps
 - Velcro successfully held SAT tool in place
 - Generally accepted by Marines as work around
 - Total Rounds Count
 - Kept by SAT and transmitted to vest as event data
 - Requires new message to transmit to OPCEN
- **Grenade**
 - Overall received many positive comments on performance
 - Control BIT during exercise initialization
 - Decrease time required to reset grenade (currently set to 1 hour)
 - Initial beep upon handle release is not desired
 - Recommend metal covering to simulate “sound” of throw
- **Player Position Snapback requires fine tuning**

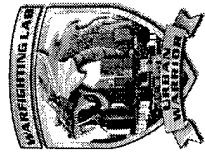



MOUT-IS ACTD

ACTD Observations

(continued)

- **M203 Simulation**
 - Demonstrated as workable solution with available GFE
 - Research aiming techniques for enhanced M203 training
- **After Action Review Data**
 - Representative of events that occurred
 - Provided ability to upload into stand alone spread sheet environment
 - Improve statistical and graphical analyses of reported data
 - Need more controlled tests to verify some anomalies reported
- **Simunitions vs. Blanks**
 - Less kills reported with simunition than blanks
 - Total simunition kills 7; Total blank kills 30
 - Define system requirements for simunition integration
- **M4 Weapon Simulation provided by use of M16A2 SAT worked well**
 - Needs further integration testing



09/21/98

A



MOUT-IS ACTD



Recommended Future Tasks





MOUT-IS ACTD

Recommended Future Tasks

- *Ship GFE to Camp Lejeune*
- *Need disposition of other material and tooling*
- *Follow-up visit to Camp Lejeune in October to receive hardware, verification of on-site equipment and return of necessary hardware*
- *Retain subset of equipment in Pomona for either new development or support of testing/usage in Camp Lejeune*
- *Reprogram remaining player equipment to current version software ("M")*
- *Train Marine personnel on playback capability*
- *Start efforts to support an ACTD experiment in January 1999*
 - *Need to define level of activity throughout the year*
 - *Hire and train personnel as appropriate*
 - *Need turn-on for new task by November 1998*
- *Retain storage container and telephone service*
- *Additional System Enhancements*

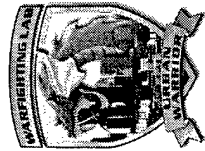



MOUT-IS ACTD



Experiment Support

Logistics and Training

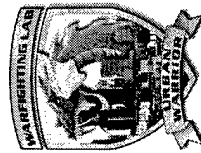



MOUT-IS ACTD



Experiment Support Tasks

- *Plan, implement, and provide support for MOUT-IS/ADST II experiments*
- *Base support on contract and the Customer's objectives:*
 - *Operations*
 - *Maintenance*
 - *Material*
 - *Technical Documentation*
 - *Turn-key operation and staffing requirements*

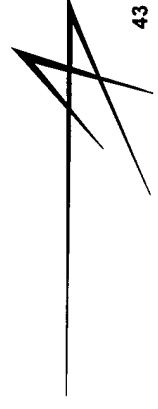



MOUT-IS ACTD



MOUT-IS Experiment Support Background

- **Man site facility during MOUT-IS/ADST II experiments**
 - Start-up OPCEN, scenario loading, pre-operational readiness checks of MOUT-IS site & equipment
 - Pair 3RD GEN MILES Player Equipment
 - Issue, receive, and provide inventory accounting of 3RD GEN MILES Player Equipment
 - Install and remove MOUT-IS building equipment
- **Provide player equipment training to 90 Marines**
- **Assist experiments staff with scheduling and MOUT-IS/ADST II collected data & AAR reports**

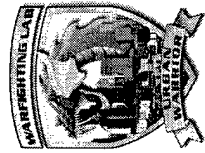



MOUT-IS ACTD



Experiment Support Operations Background

- *Exchange and repair 3RD GEN MILES Player Equipment*
- *Exchange Indirect Fire harness and transponder batteries*
 - *Provide technical assistance and advice to USMC, evaluators and OCs*
- **Maintain positive inventory control of MOUT-IS:**
 - *Hardware*
 - *Spares*
 - *Tools and test equipment*
 - *Documentation*
 - *Inventory records*

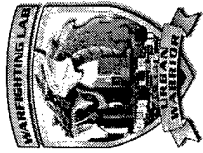

A handwritten signature in black ink, consisting of a stylized 'A' shape with a horizontal line extending to the right.



MOUT-IS ACTD



Experiment Support Staffing - 2 Shift Support

- **Two system operators**
 - Operates and maintains MOUT-IS Computer System
- **Two system maintenance technicians**
 - Repairs and maintains system electronics and player equipment
- **One site manager/lead technician**
 - Supervises operations and maintenance tasks and interfaces with unit undergoing training

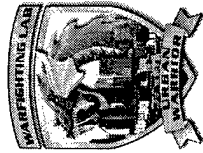



MOUT-IS ACTD



Execution Timeline

(Prior to Exercise Start)

- **2 1/2 Hours** **Range setup**
Setup/checkout buildings
Setup OPCEN
- **2 Hours** **Player equipment setup**

Player equipment briefing
Prep transponders for issue
Prep player equipment for issue
monitor range player pool
- **1 Hour** **Monitor range player pool**
- **50 Minutes** **Issue player equipment**





MOUT-IS ACTD



Execution Timeline

- **6 Hours**
MOUT Experiment Support
 Operate OPCEN
 Player Equipment (Squad) Initialization
 ON-call Technical Assistance
 Maintain Player Equipment

- **1 Hour**
End Experiment Support
 Print Reports
 Assist with AAR Prep
 Marines clean equipment
 Turn in Player Equipment
 Inventory Equipment
 Close out OPCEN & Range

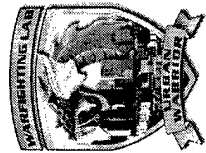



MOUT-IS ACTD



Player Equipment Setup

- **Background**
 - *Equipment was setup by squad/team from lowest to highest PID. Equipment setup consisted of attaching the rechargeable battery to the manworn system, turning on the system, pairing the system (Head Harness, Indirect Fire Harness), checking system status, and adding the helmet transponder to the helmet harness*

- **Observations**
 - *Verified boresight of all SATs manually after multiple uses over one month*
 - *Only 3 SATs out of boresight*
 - *Adding transponder battery and checking transponder PID*
 - *Accountability of equipment easy*
 - *Creation of scenarios fast and easy*
 - *Added extra equipment (PIDs) to each Squad*

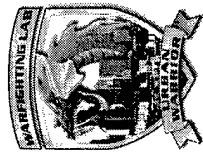



MOUT-IS ACTD



Issue Player Equipment

- **Background**
 - *Equipment was issued according to the Unit's MOUT "Battle" Roster; In Squad and Team order. Following issue, Marines paired SATs to their vests, checked out equipment, and verified SAT Zero (fired at 50M Center-of-Mass target and Head Shot target)*
 - **Observations**
 - *Issue controlled by Squad Leader*
 - *SATs issued separately*
 - *Last minute Player Equipment installation before Mission execution = Reduced Reaction Time by support personnel*
 - *SAT Zero needs to be verified*
 - *Plan for use of Blank Ammunition for SAT verification*





MOUT-IS ACTD



Exercise Support

- **Background**
 - Executed squad missions using three primary scenarios; Contact Team Support started 30 minutes before each Bluefor Squad's execution of their mission. The OPFOR Team was checked before each mission. All players put on their 3RD GEN Equipment and was checked by CLS
 - **Observations**
 - Pre-position of Spare Player Equipment and Support Equipment
 - Observers use of controller guns for OC kills
 - Use of squad assembly areas for contact team support
 - OC require briefing prior to exercise
 - Time of Scenario Initialization (10 - 15 minutes)
 - Control of testing events - must keep support assets informed

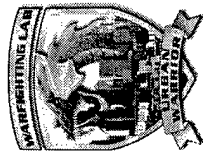



MOUT-IS ACTD



Turn-in Player Equipment

- **Background**
 - *Equipment turn in was conducted by team and squad*
 - *Items were attached to the direct fire vest except for the hand grenades*

- **Observations**
 - *Turn in was fast and controlled*
 - *All equipment was accounted for*





MOUT-IS ACTD



Recommended Actions

- *Inventory equipment*
- *Close out OPCEN and range*
- *Preparation for Follow-on Support*
 - *Test Equipment*
 - *Hiring and training range personnel*

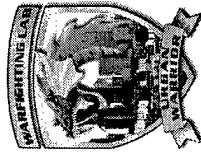

MOUT-IS ACTD Delivery Order

Lessons Learned

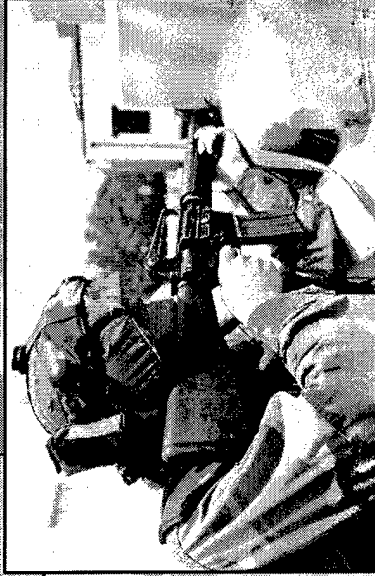
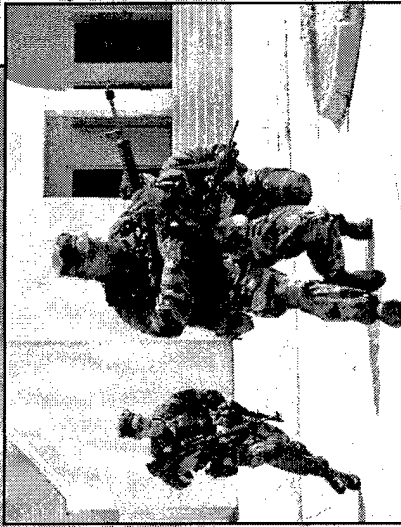
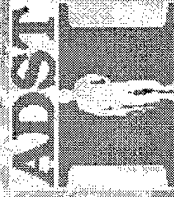

LOCKHEED MARTIN PROPRIETARY DATA



MOUT-IS ACTD



Systems Overview

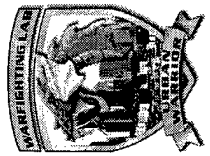

c:\moutsys\vw\bh.ppt





MOUT-IS ACTD



Requirements Overview



c:\moutis\svwbh.ppt





MOUT-IS ACTD

REQUIREMENTS OVERVIEW



SUMMARY

- *Requirements listed by proposal topic*
- *Some performance requirements changed as program evolved*
- *Additional capability provided to enhance AAR presentations*
- *Achieved or exceeded all proposed objectives with exception of outdoor position accuracy*

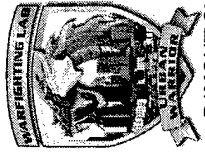

c:\mout\sysvwbh.ppt

P: MOUTOVWBHO.PPT

A handwritten signature consisting of a stylized 'A' with a horizontal line underneath it.



MOUT-IS ACTD

REQUIREMENTS OVERVIEW



INSTRUMENTATION CONFIGURATION

- *Based on RIS system*
- *Indoor ultrasonic triangulation sensors*
- *10 MHz ethernet UDP LAN*
- *Wireless ethernet LAN links to OPCEN*
- *96 player capacity UHF telemetry network*
Note: 4 UHF channels, 32 TDMA slots per channel
- *MOUT site provides electrical power*
- *3 UHF channels spaced 1.0 MHz apart (403 to 424 MHz)*





MOUT-IS ACTD REQUIREMENTS OVERVIEW



RIS SOFTWARE CHANGES

- ***Provide configurable squad size to 15***
 - *Enhanced to 25 with a default of 13*
- ***Increased DIS translator accuracy to +/- 6 inches***
- ***Add MOUT features to OPCEN computers***
 - *TNC data correlation*
 - *Modify map graphics*
 - *New status screens*
 - *Data base configuration changes*
 - *Enhanced with new AAR report formats*
 - *Provided exporting capability to Excel spreadsheet*



- ***Develop building tracking computer interface***

c:\mout\sysvwbh.ppt





MOUT-IS ACTD

REQUIREMENTS OVERVIEW



INSTRUMENTED DEVICES

- *75 RIS manworn player units*
- *Add ultrasonic room transponders*
- *Weapons linked to manworn PID*
- *Long life and rechargeable batteries*
- *All outdoor data stored by manworn and sent to OPCEN*
- *Indoor fire events stored by manworn*
- *Indoor position data only sent to OPCEN*

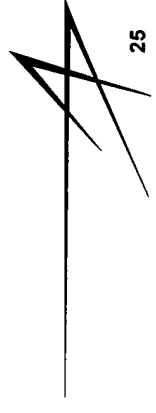
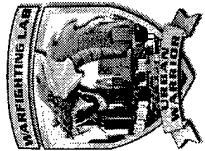



MOUT-IS ACTD

REQUIREMENTS OVERVIEW



WEAPONS

- **Small arms transmitters for:**
 - M16A2
 - M249 SAW (Provided new production units)
 - M240 G (RIS units could not be used)
 - Shotgun (Deferred)
- **Anti tank weapons (deferred)**
- **M203**
 - Adapt 3rd Generation SAT with trigger cable
- **Grenades**
 - Provided new design and production units

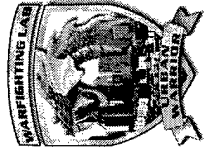



MOUT-IS ACTD



REQUIREMENTS OVERVIEW

BUILDING EXTERIORS / OPCEN

- *Implemented improvements to differential GPS broadcasts to achieve 2-3 meters CEP*
- *Outdoor update rate every 5 seconds*
- *Two RIS range repeaters*
- *RIS OPCEN*
- *Display zoom factor modifications for MOUT Map Graphics*

Zoom 1: Both Buildings

Zoom 16: One to two rooms

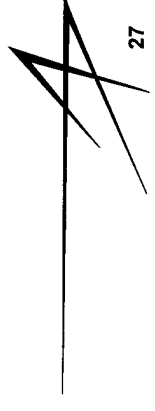
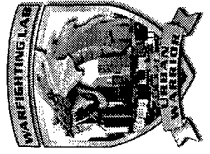



MOUT-IS ACTD



REQUIREMENTS OVERVIEW

BUILDING EXTERIORS / OPCEN (CONTD.)

- **DIS 2.0.4 Compliant**
Additional Enhancements
 - Civilian player types
 - Replay capability
 - 0.1 meter resolution
 - GPS quality message filtering
 - Partial heading/velocity solution
 - Shouldering/orienting weapon for firing
- **SVS 2D/3D viewer and database**

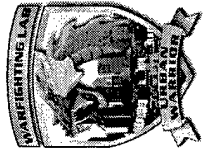



MOUT-IS ACTD REQUIREMENTS OVERVIEW



BUILDING INTERIORS

- *Player position accuracy enhanced from 1 to .1 meters*
- *75 Players tracked inside buildings*
 - *Enhanced to 100*
- *50 Players per room maximum*
- *Position update rate for 50 players: 1.5 seconds*
- *One room system can cover up to a 30' x 30' room*
- *RS 422 connections to building computer from room systems*
- *Instrumented buildings 10 and 17*

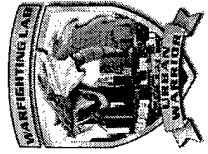



MOUT-IS ACTD



Range System Description



c:\mout\sysvwbh.ppt





MOUT-IS ACTD



Player Unit Data Communications

- **Outdoors**
 - *Position location: using UHF link*
 - *Weapons fire/casualty assessment - UHF link*

- **Indoors**
 - *Position location - In room processing system*
 - *Weapons fire/casualty assessment - UHF link*

- **Seamless transition from outdoors to indoors**



MOUT-IS ACTD

MOUT Range Instrumentation

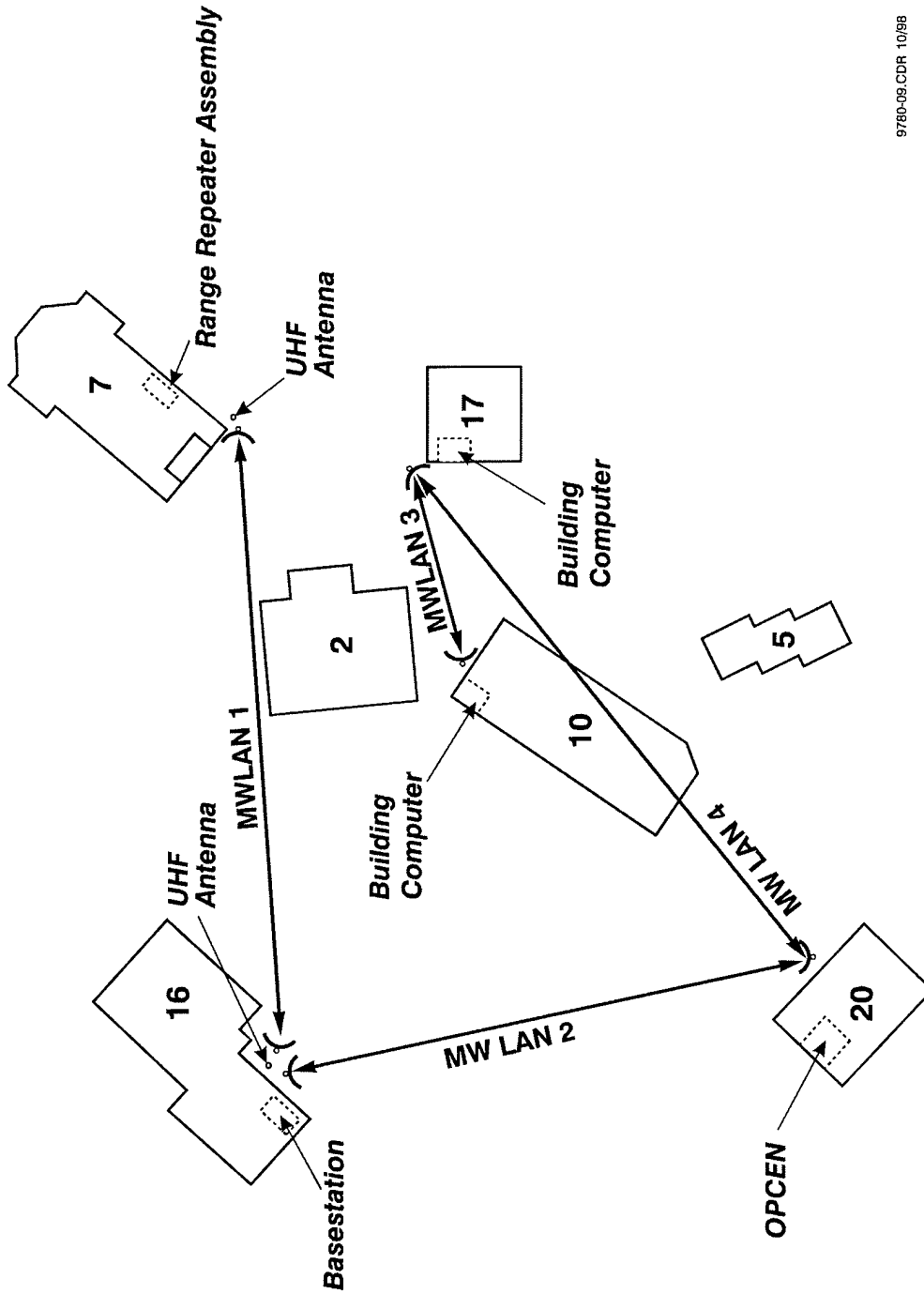

9780-09.CDR 10/98





MOUT-IS ACTD Operational Center (OpCen)

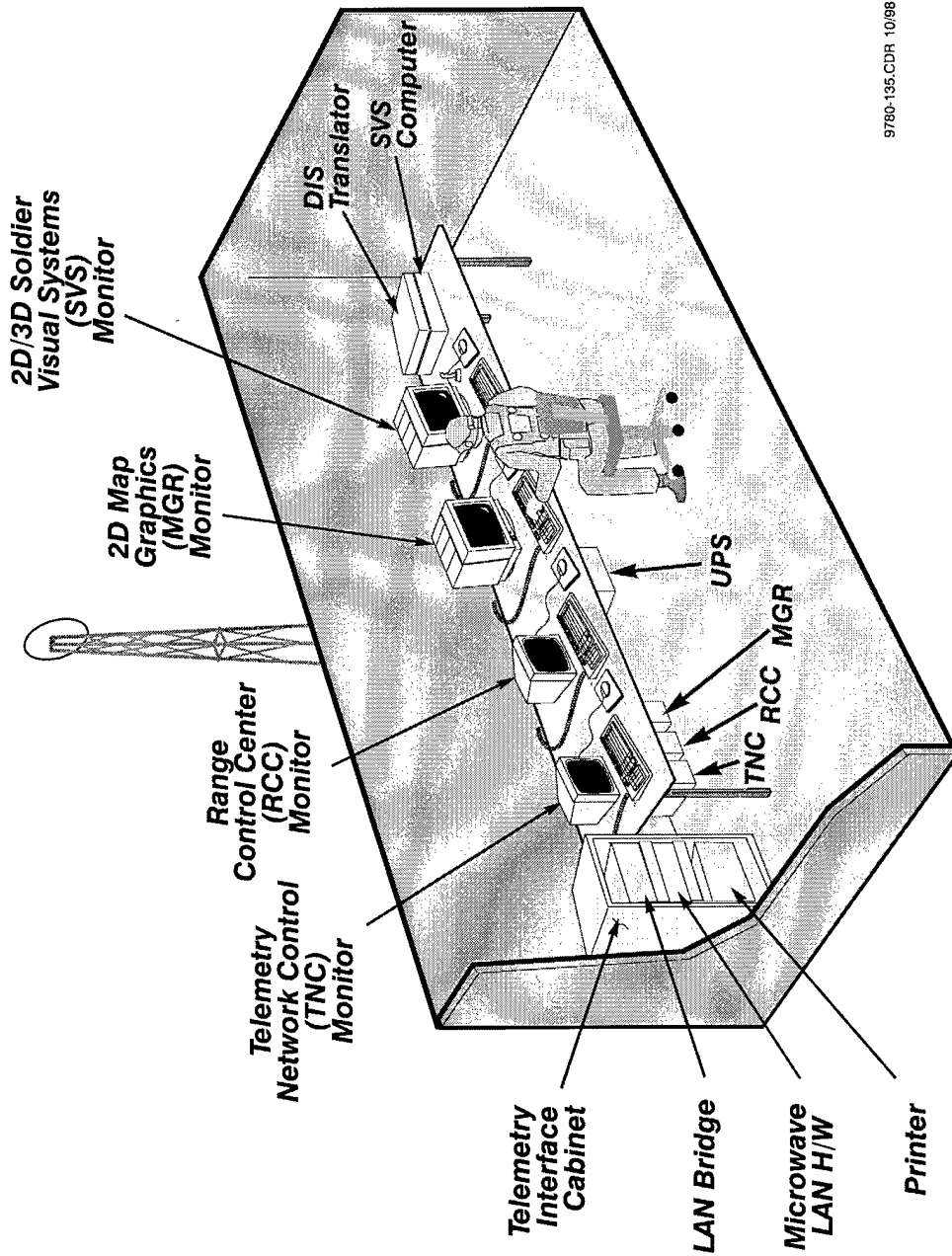

9780-135.CDR 10/98

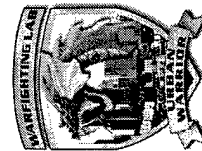

c:\mout\sysvw\wh.ppt



MOUT-IS ACTD

System Overview

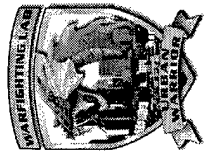
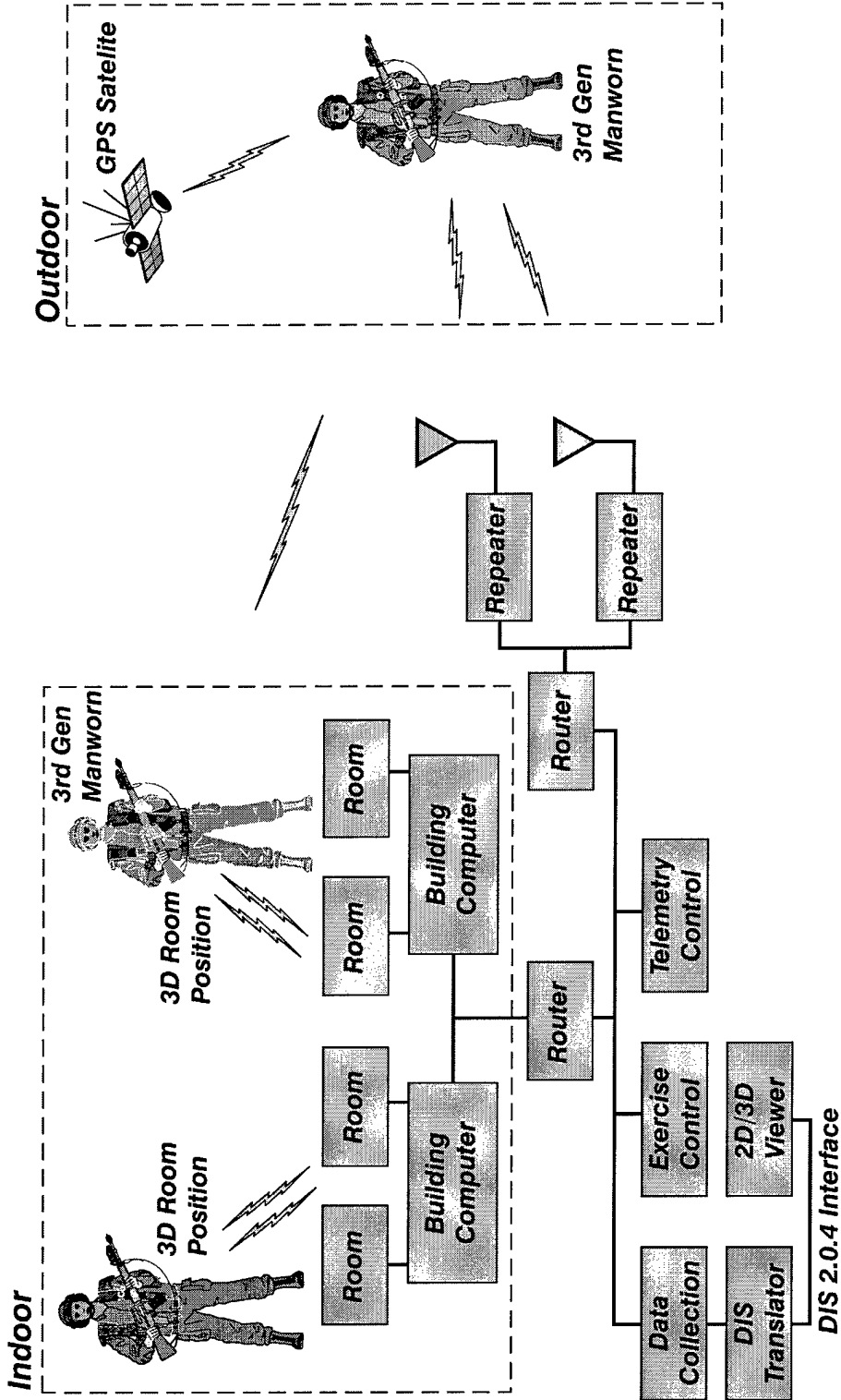

c:\mout\sysvwbh.ppt

9780-143-CDR 3/98





MOUT-IS ACTD



Player Equipment

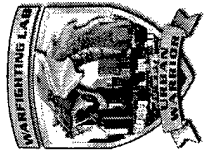

c:\mout\sysvwbh.ppt





MOUT-IS ACTD



MOUT Player Equipment

- **Weapon Simulators**
 - M16A2 SAT
 - M249 SAW SAT
 - M16A2/M203 SAT
 - Hand grenade
- **Player Units**
 - 3rd Generation MILES direct fire vest and helmet harness
 - 3rd Generation instrumented vest
 - M203 fire event relay subsystem
 - Helmet mounted transponder for indoor tracking





MOUT-IS ACTD Player Equipment

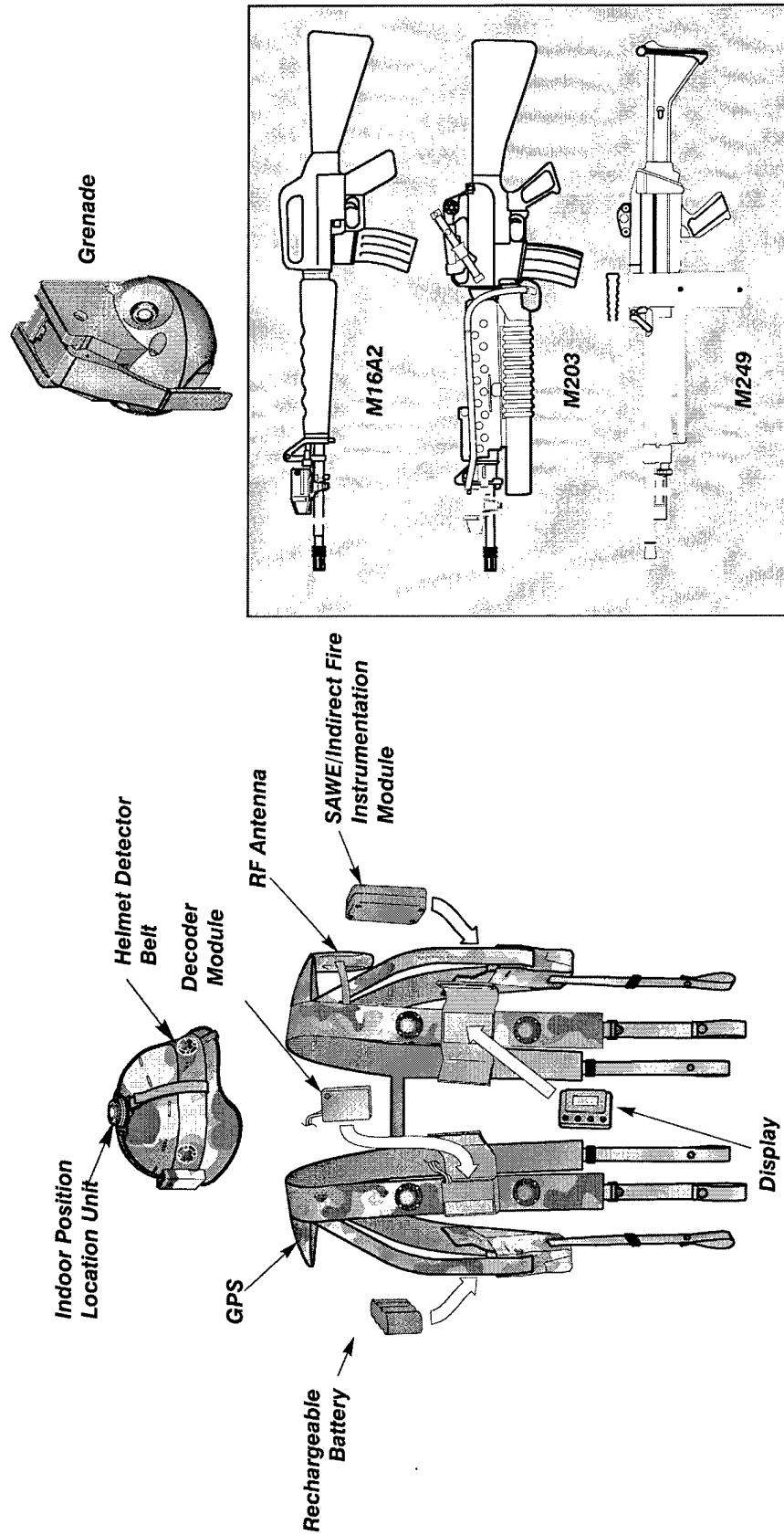

9780.148.CDR.1088

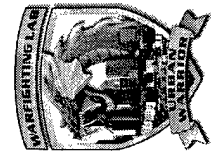

c:\mout\sysvwbh.ppt

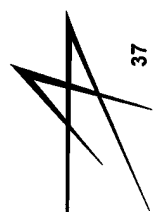



MOUT-IS ACTD



Player Equipment M16A2

- *Provided latest configuration of production 3rd Generation MILES M16A2 SAT's*
- *Uses universal bracket for mounting onto M16A2 weapon*
- *Powered by replaceable lithium battery*
- *Has new regulator circuits which draws only a few microamps while SAT is in Off State*
- *Improved/replaceable microphone assembly*
- *Uses simplified pairing scheme implemented on production 3rd Generation hardware*



c:\mout\sysv\wbh.ppt

38



MOUT-IS ACTD



Player Equipment M203

- **Uses latest version of production 3rd Generation SAT for both M16A2 and M203 simulation**
 - Uses trigger switch mounted on trigger of M203 and routed to the SAT via cable to command SAT to fire
- **Transmits MILES Code 19 (24 words) with the same PID as the paired manworn**
 - Default of 27 grenade rounds are loaded into the SAT
 - 5 seconds delay between rounds to simulate loading time of grenade onto the M203
 - Uses universal bracket to mount 3rd Generation SAT onto an M16A2

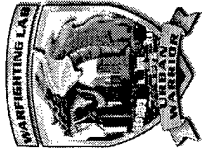



MOUT-IS ACTD



M203 Indirect Fire Approach

SEQUENCE

- ① M203 FIRES
- ② SENSOR VEST TRIGGERS WALL MOUNTED M203 SAT
- ③ PLAYER UNITS IN SAT LASER BEAM PATH PERFORM RTCA
- ④ OPCEN TREATS EVENT AS A NORMAL DIRECT FIRE ENGAGEMENT

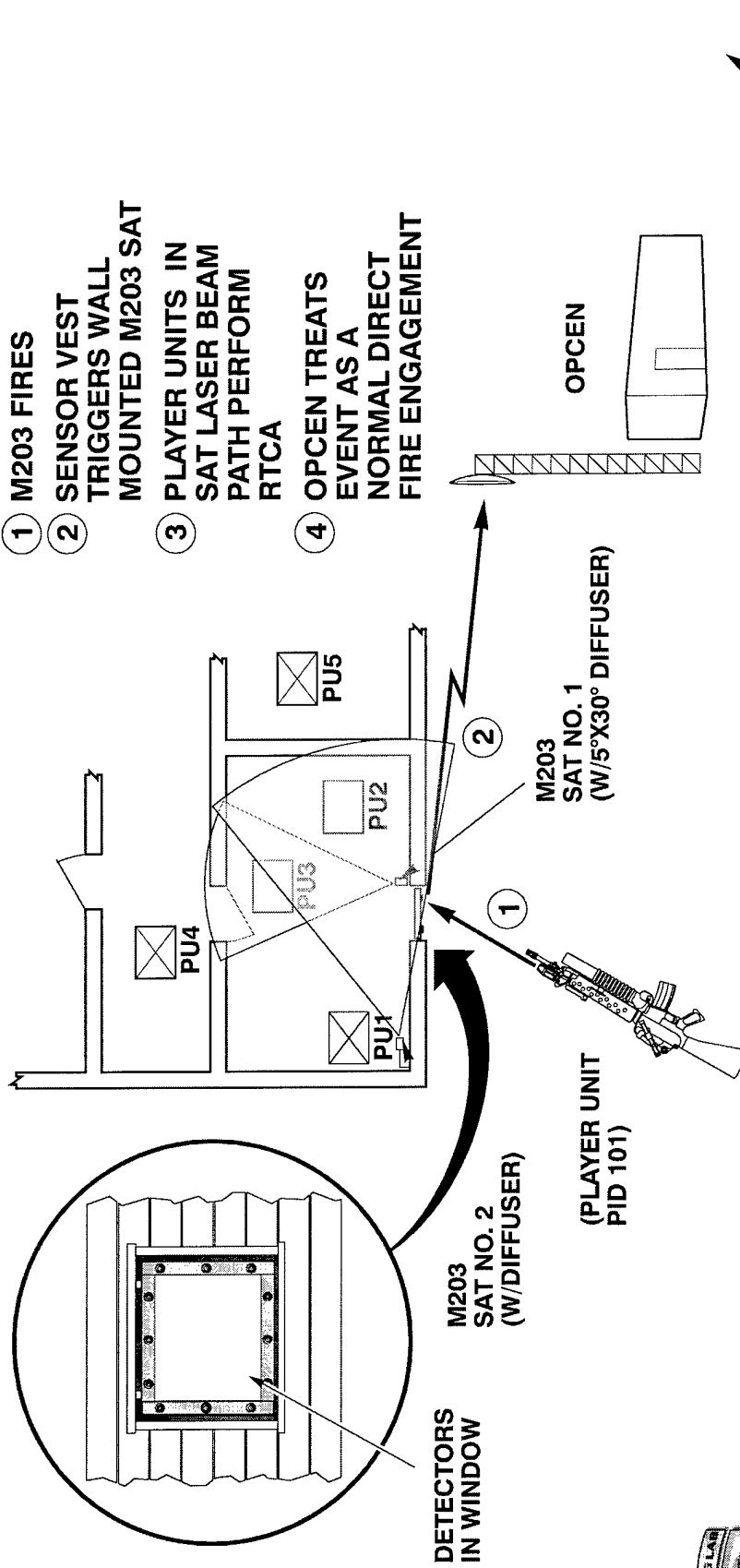

9780-110.CDR 10/98

c:\mout\sys\wbh.ppt

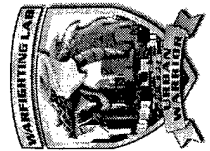



MOUT-IS ACTD



PLAYER EQUIPMENT WEAPONS TRANSMITTERS - GRENADE

- Grenade Simulator Has Similar Size and Configuration as Actual Grenade
- Simulate 50% Kill to Players Within a Radius of 10 Feet
- Grenade Blast Simulated With Buzzer (Also Aids Retrieval)
- Powered by Replaceable Battery
- Uses Pin and Handles of Actual M67 Grenade

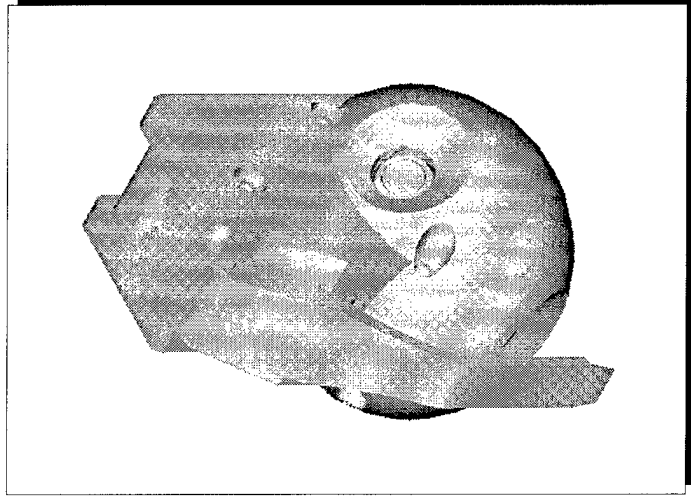

9760-154.CDR 10/88

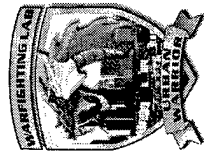

c:\mout\sysv\wbh.ppt

