

NDIA

1999

Tactical Wheeled Vehicles
Conference

How Healthy Is Our Fleet ?

Proceedings

January 31-February 2, 1999

Double Tree Hotel & Monterey Conference Center
Monterey, California

Event #955

DTIC QUALITY INSPECTED 4

19990601 017

DISTRIBUTION STATEMENT A
Approved for Public Release
Distribution Unlimited

Table of Contents

Monday, February 1, 1999

"Industrial Committee of Tank & Automotive Producers Update," by Colonel David H. Longley.....	1
"Keynote Address," by The Honorable Paul J. Hoeper, U.S. Army Acquisition Executive and Assistant Secretary of the Army for Research, Development and Acquisition.....	17
Session I	
Mr. William A. Daoulas, Alpha International, Inc., Mr. Michael T. Chase, Cambridge International, Inc., and Mr. J. David Wilson, Robinson International, Inc.....	29
"U.S. Army Transportation Center," by Brigadier General Gilbert S. Harper, Commanding General (CG).....	44
"Director-Army National Guard," by Colonel Glenn W. Walker, Chief of Logistics, Army National Guard.....	69
"Chief, United States Army Reserve," by Brigadier General James	

R. Helmly, Deputy Chief, Army Reserve.....90

Session II

"U.S. Army Materiel Command (AMC)," by General Johnnie E. Wilson,
Commanding General.....112

"Deputy Chief of Staff, Operations & Plans," by Colonel Michael A. Vane,
Director of Integration, Office of the Deputy Chief of Staff for
Operations and Plans.....135

"Marine Corps Systems Command," by Colonel Michael M. Kephart,
Director of Combat Support, Logistic Support and Training Systems.....157

"Quality Subcommittee Report," by Mr. Ronald Scholtes.....173

"Foreign Sales of Tactical Wheeled Vehicles," by Mr. A. Robert Keltz,
Director, International Development and Security Assistance, Office
of the Under Secretary of the Army.....178

"Changing Regulatory Laws affecting the Tactical Wheeled Vehicle Fleet,"
by Major General Charles S. Mahan, Jr., Commanding General, 21st Theater
Army Area Command.....197

Tuesday, February 2, 1999

Session III

"Defense Logistics Agency," by Brigadier General Mary Saunders, OSDCI & L, USAF.....	214
"U.S. Army Tank-automotive and Armaments Command," by Major General Roy E. Beauchamp, Commanding General, TACOM.....	249
"TACOM/PEO-GCSS TWV Programs/Activity," by Mr. J.Chapin, Director, TARDEC; Mr. D. Mehney, Director, Acquisition Center; Colonel (P) J. Urias, Deputy for Systems Acquisition; and Mr. Albert P. Puzzuoli, Deputy Program Executive Officer, GCSS.....	313
Panel Discussion & Questions:	
· Mr. J. Chapin, Director, TARDEC.....	320
· Mr. D. Mehney, Director, Acquisition Center.....	357
· Mr. Albert P. Puzzuoli, Deputy Program Executive Officer, GCSS.....	373
· Colonel (P) J. Urias, Deputy for Systems Acquisition.....	393

**INDUSTRIAL COMMITTEE
OF TANK & AUTOMOTIVE
PRODUCERS (ICTAP)**

Dave Longley, Recorder
United Defense

ICTAP CHARTER

- **PURPOSE:** Forum for principal managers at TACOM and Senior Executives from industry to meet and review issues of common interest and concerns
- **OBJECTIVES:**
 - Forum for discussion and exchange of views
 - Feedback from senior industry representatives
 - Discuss DoD, Army and TACOM Policies
 - Discuss emerging issues in Government and Industry which affect readiness of tank/automotive systems

ICTAP MEMBERSHIP

GOVERNMENT

- CG TACOM
- PEO GCSS
- Director, TARDEC
- Director, IMMC
- Director, Acquisition Center
- Deputy for Acquisitions
- Ex. Direction Operations, TARDEC
- Director Defense Supply Center, Columbus

NDIA

- Vice President

*Permanent Member

(Membership 2 Years-1/2 Rotate Yearly)

INDUSTRY

- Oshkosh*
- AM General*
- Steward & Stevenson SVC*
- GM Canada
- Caterpillar
- Allison Transmission
- United Defense*
- General Dynamics Land Sys*
- Premier Prof. Systems
- Motor Products Intl.
- Lear Siegler SVC
- Barnes & Reinecke
- LAU Defense Systems

ICTAP CHARTER (Continued)

- **VP Operations NDIA, in coordination with CG TACOM, Appoint a Chairman**
 - **1st Chairman: Tom Rabaut, President and CEO, United Defense**
 - **Current Chairman, James Armour, President and CEO, AM General Corp.**
 - **Serves 2 Years**
- **ICTAP meets 2-3 times per year**
 - **4 meetings to-date**

ICTAP

- **Four meetings since chartered in March '97**
 - NDIA hosted inaugural meeting
 - Industry hosted second meeting
 - TACOM hosted third meeting
 - Industry hosted fourth meeting
- **Topics for discussion are generated by Government/Industry/NDIA Members**

ICTAP

- **First Meeting**
 - June 1997
 - Hosted by NDIA
 - General Exchange of Information
- **Agenda**
 - TACOM: Goals/Objectives
 - TARDEC: Status of Programs
 - Industry: Company Organizations
 - Charter Discussion

ICTAP

- **Second Meeting: November 1997**
 - **Host: United Defense, Anniston, AL**
- **Agenda:**
 - **MG Beauchamp: State of TACOM**
 - **MG Michitsch: Industry Study-AAN**
 - **Mr. Weinberg, Caterpillar: Best Value**
 - **Mr. Mehney, TACOM: Acquisition Reform**
 - **Tour/Briefing: Anniston Army Depot**
 - **Tour UDLP M113 Facility - Partnering**

ICTAP

- **Third Meeting: May 1997**
 - **Host: TACOM, MG Beauchamp**
- **Agenda**
 - **MG(R) Greenberg: NDIA Overview**
 - **Col. Dougherty: DLA/DSCC Overview**
 - **Mr. Holly:**
 - » **TACOM Focused**
 - » **Sustainment Concept**

ICTAP

- **Third Meeting (Continued)**
 - **Mr. Young: TACOM Industrial Base Management**
 - **Mr. Siegel: PM Abrams, Obsolescence Integrated Circuits**
 - **Mr. O'Bryon: OSD/DOT&E, Live Fire Testing Status**

ICTAP

- **Fourth Meeting: December 1998**
 - **Host: Pulse Tech**
- **Agenda**
 - **MG Beauchamp: TACOM Reorganization**
 - **Al Puzzouli: Deputy PEO, GCSS**
 - **Creation of PEOs**
 - **Who, Where, What is PEO, GCSS**
 - **Managing Systems Life Cycle Costs**
 - **How PEO, GCSS Manages**

ICTAP

- **Agenda (Continued)**
 - **LTC Cooper: PM Abrams**
 - **Challenges Now Through 2030**
 - **O&S Cost Initiatives**
 - **Engine Modernization**
 - **Contractor Logistic Support (CLS)**
 - **Abrams Integrated Management (AIM)**
 - **Modernization Through Spares**

ICTAP

- **Agenda (Continued)**
 - **Mr. Art Adlam: TACOM**
 - **Simulation Based Acquisition, Government Perspective**
 - **SBA → SMART**
 - **SBA At TACOM**
 - **Virtual Mock-Up**
 - **Man-In-The-Loop Motion Base Simulation**
 - **Virtual Factory**

ICTAP

- **Agenda (Continued)**
 - **Simulation Based Acquisition - Industry Perspective**
 - **What is it?**
 - **UDLP Initiatives**
 - **Culture**
 - » **IPPTs**
 - **Process**
 - » **Simulation Based Design**
 - » **Simulation - Emulation - Stimulation**
 - » **Integrated Product CAD/CAM**

ICTAP

- **Agenda (Continued)**
 - **Environment**
 - » **Common Operating Environment**
 - » **Virtual Enterprise Environment**
 - » **System Integration Environment**

ICTAP

- **Next Meeting: 19 April, Atlanta, GA**
 - **Host: NDIA**
- **Agenda (tentative)**
 - **Focus Sustainment Update: TACOM**
 - **Reorganization of Foreign Military Sales**
 - **TACOM Reorganization - Deputy for Corporate Management**

ICTAP

- Publishing an article on Simulation Based Acquisition: “*A New Way To Help The Soldier*”
 - National Defense Magazine (Jan/Feb)
 - Other Defense/R&D/Academic Journals
- ICTAP Minutes and Briefings on TACOM Web Page

REMARKS AS PREPARED FOR DELIVERY BY

**The Honorable Paul J. Hooper
Assistant Secretary of the Army (RD&A)
Keynote Address
1999 Tactical Wheeled Vehicles Conference
"How Healthy is Our Fleet?"
Monterey, California
February 1, 1999**

Earlier this month, I went on a staff ride to Manassas with some of the senior military leaders in Army Acquisition and some of the senior folks from the Industry side. On a Staff Ride, we go out to a battlefield with an Army Historian, walk the terrain and learn about the factors that defined the outcome of the battle. Yesterday, as I flew out here, I fell to musing about the role of tactical wheeled vehicles at the First Battle of Bull Run.

At that time, our tactical wheeled vehicles were mule-drawn wagons. A six-mule wagon could haul a maximum of 4000 pounds on good roads in the best of conditions. In practice, the load seldom exceeded 2000 pounds and half of that was feed for them Army's mules and horses. A wagon could travel between 12 and 24 miles per day. You can see how the tactical wheeled vehicles of the day limited the reach and effectiveness of the armies.

At the beginning of the Civil War, around the time of the First Battle of Bull Run, the standard for the Union Army was 28 wagons per thousand men. By 1864, the growing recognition of the value these vehicles created caused the Union to increase this ratio to 36 wagons per thousand men. On the "march to the sea", Sherman's army operated

with 40 wagons per thousand soldiers. Much had changed since First Bull Run, but many of the principles of ground warfare remain essentially unchanged. Tactical wheeled vehicles were important then, and they are important now.

The Battle of First Bull Run occurred during a time of revolution in military affairs. Up to that time, it was the largest battle fought on the American continent, with about 18,000 soldiers engaged on each side. The commanders in that battle had never commanded forces on this scale, so the battle tactics stopped at the regimental level. First Bull Run marked our first use of rifled shot and rifled artillery – technological advances that dramatically changed tactics.

We are now in a similar period of revolution in military affairs. The application of information technology to warfare has enormous implications to both strategy and equipment. Our business practices are also changing dramatically. It is not simply, as is sometimes said, that we must achieve a revolution in business affairs to pay for the revolution in military affairs. Yes, we need to find efficiencies, and it is terribly important to do so. We will not be able to buy all that we need if we cannot find those efficiencies. But the operational needs of the Army demand, by

themselves, that we change our ways of doing business. It will not be possible to field the weapon systems essential to the digitized force and the Army After Next without changing the way we develop, acquire, and support them.

We will have the fundamental platforms we are digitizing today for, perhaps, twenty-five to thirty years. During that time, we will add platforms to the system of systems that will be the digitized force of the future, and will be part of the Army After Next. We want the systems we will add in the future to be compatible with the systems we plan to field by 2000. And we want the ability to upgrade the systems we are building today to the performance that we know technology advances will make possible for future systems.

The fact that we are going to have many of our platforms in place for so many years means that we will need to modernize them significantly over time. We may give the wrong impression when we say that seventy percent of the platforms for the Army After Next are fielded now or shortly will be. That is true enough, in terms of the outside appearance. Many of our Tactical Wheeled Vehicles (HMMWV, FMTV, PLS, HETS) in the field today will be part of the Army After Next. They will probably look

much the same as they do today. We do not plan to give them a cosmetic face-lift, but they will get numerous transplants. Our 33-Ton Truck/Trailer, the Palletized Load System (PLS), will still look like today's PLS, but it will have more efficient commercial engines with a digitized cab that incorporates both a Movement Tracking System and a "Sealed Hood" concept. This digitized cab will give our soldiers enhanced mobility, capacity, reliability, and situational awareness.

Digitization, as with the digitized cab in PLS, is the application of information technologies to Army weapon systems so our soldiers and leaders can acquire, exchange, and employ timely information throughout the battlespace. Whether built in a platform or added capability, digitization depends on information and communication technologies. It is the Army's highest research, development and acquisition priority. We have all seen the rapid advances of the past fifteen years, since IBM brought out its first personal computer. The computer chips that these technologies depend on are doubling in power every eighteen months. Our time to field for a fairly large system is about twelve years. How can we keep the systems we will field in the next few years compatible with the systems we will be fielding ten or

twenty years from now? Both will be part of the digitized Army of 2020.

We will have to change the way we do business. We used to design point solutions for specific platforms using military-unique components and architectures. To succeed in the future, we must use open architectures that allow horizontal technology integration across systems of systems. It is not simply that commercial information technologies are cheaper, although they can be. Nor is it always true that commercial solutions are more capable than the point solutions we have incorporated in the past. It will often be possible to design a military-unique solution that is more capable than anything presently available from the commercial market. The problem is that we take an average of twelve years to field a major system, while the power of the computer chips on which the commercial digital technology depends doubles every eighteen months. The most important reason for us to gain access to commercial technology is not to save money; it is to get on the commercial innovation cycle using an open architecture. If we do this, we will gain the ability to modernize our weaponry through the timely insertion of communications and information technology – brain transplants.

022

The use of open architectures that accept commercial upgrades is not limited to digital technologies. A major goal of the FMTV program was to simplify the overall support system. Specifically, commonality of components was a design criterion. As a result, there is more than eighty- percent commonality between the Light Medium Tactical Vehicle (LMTV) and the Medium Tactical Vehicle (MTV). This translates to a reduction in inventory and material handling requirements, as well as simplified operator and maintenance training. The approach also allows insertion of improved technologies, as we are doing with the current buy.

As we modernize to add capability, we must also bring down operation and support (O&S) costs. One important initiative in this area is Modernization Through Spares. Tires and batteries are major cost drivers for our Tactical Wheeled Vehicles. Let's take our Heavy Expanded Mobility Tactical Truck (HEMTT) fleet – 12,600 strong – each with eight tires. That's more than 100,000 tires. By capitalizing on the modernization through spares initiative, we replaced the old tires with ones that have a higher load rating, improved tread design, and are common with PLS and the Heavy Equipment Transporter System (HETS). The new tire can even be patched.

I want to apply this concept to the rest of the fleet. As we explore all areas to cut O&S costs and, at the same time, reduce the logistics burden, it seems to me that a significant reduction in the different types of tires we use and carry around is important. Some have mentioned a fifty percent reduction. I don't know what the answer is, but we need to take a serious look at this.

I also mentioned that batteries are a major cost driver in our Tactical Wheeled Vehicles. What is being done to address this problem? The PLS program is replacing its current 145 amp alternator with a 200 amp that provides more output during high load events. Also, a master disconnect switch has been added to prevent the constant draw of current placed on the battery by the Electronic Control Units. Together, these improvements are extending battery life in PLS.

How do we come to grips with the fact that we must either invest in the future or else consume ourselves with O&S costs? The Army will continue to recapitalize our vehicles where it makes sense. We are completing a very successful 2-1/2 ton remanufacturing program this year that helped modernize our medium fleet and control increasing O&S costs while the Family

of Medium Tactical Vehicles (FMTV) program was ramping up. We will begin the same type of program for the HEMTT fleet starting in Fiscal Year 2000 in order to maintain readiness and control O&S costs until the Future Heavy Tactical Truck program is in place around the 2010 time frame. The HEMTT remanufacturing program will also provide an opportunity to adjust the mix of HEMTT variants by converting cargo trucks into HEMTTs with a Load Handling System similar to PLS.

O&S costs can make up 70 to 80 percent of a system's total life cycle cost. Reducing total ownership costs for Army systems is a high priority. The acquisition and logistics communities have instituted reform initiatives targeting lower system ownership costs. All of us charged with giving soldiers what they need must work together on this: those involved in combat development, requirements determination, training development, financial management, materiel development, and logistics. Integrated Process Teams or IPTs, with representatives from these functional disciplines, are a program tool for identifying total ownership cost reduction opportunities. Our plan is to find ways to save both acquisition and O&S dollars during system design as well as through deployed system modifications and upgrades. I have already given you an example of deployed system

modifications, so let me try to give you an example in system design.

Considering the earliest stages of development, the Army developed the 21st Century Truck concept with a primary goal to reduce emissions and improve fuel economy in future light, medium, and heavy commercial and military trucks. Last September, I approved the implementation plan for 21st Century Truck. It is consistent with Army After Next goals to reduce the fuel requirements of a deployed force. Technology areas will focus on propulsion, vehicle intelligence, advanced materials, aerodynamics, and alternative fuels. The key to this effort will be to develop a strong, enduring partnership among government, commercial industry, and academia. I am pleased by the support we have received from major commercial truck, powertrain, and component manufacturers.

In the area of modifications and upgrades, we discovered that our High Mobility Multipurpose Wheeled Vehicles (HMMWVs) go through a lot of glow plugs. These are the devices that raise the temperature of the fuel and air mixture in diesel engines when the engine is not hot enough to create combustion. HMMWVs have a protective control box in the ignition that is supposed to

turn on the glow plugs under appropriate conditions. The problem is that soldiers will often turn the ignition on and off repeatedly when they try to start a HMMVW on a cold day. This confused the electronics on our HMMVWs and allowed the glow plugs to reach two thousand degrees Fahrenheit, when they burned out. It is not that the protective control box was badly designed. It was constrained by the technology of the time – our HMMVWs were designed fifteen years ago. Glow plugs are one of the top ten cost drivers in HMMVWs.

To solve this problem, our Tank Automotive and Armaments Command (TACOM) formed a team comprising TACOM's Research, Development and Engineering Center (TARDEC), the Acquisition Center, the HMMVW program manager and the Integrated Material Management Center to analyze the problem. To get the solution into the field, TACOM teamed with Lau Technologies. The result is a new, solid state device based on state-of-the-art commercial technologies. The form factor is exactly the same so replacement is easy.

What did we get? TACOM and Lau have solved our glow plug burnout problem, which used to be one of the top ten cost drivers on HMMVWs. The new protective control box also allows engines to start if several glow plugs are burned out through

normal wear. The bottom line is that we have reduced O&S costs, improved reliability, and given our soldiers an extra margin of safety all at the same time.

I am glad to have this chance to talk to you about how we will provide for the needs of the digitized army and the Army After Next. I have talked about new systems, open architecture, modernization through spares, and recapitalization. All are tactics aimed at our overall strategy of completing digitization and preparing for the Army After Next while dramatically bringing down O&S costs and reducing our logistics footprint. During the next few days, we will have a chance add new ideas. The really good ideas will come from working together. We have big problems to solve. Let's work together and get on with it.

**CONGRESSIONAL
PERSPECTIVE**

**1999 TACTICAL WHEELED
VEHICLES CONFERENCE**

February 1, 1999

**Michael Chase
William Daoulas
J. David Willson**

FY 1999 CONGRESSIONAL ACTION ON DEFENSE

• Regular Appropriation Bill

• Supplemental Bill

- \$9 Billion
- "Emergency"
- Increased FY 1999 Base for FY 2000
- Less Pressure for FY 1999
Reprogramming/Rescissions
- Will Not Happen Again This Year

106TH CONGRESS

- Leadership Changes

- New House Speaker
- New SASC Chairman/Subcommittee Chairman
- New HAC Chairman/Subcommittee Chairman

- Staff Changes

- Other Changes

- Smaller Republican Majority in the House
- Fewer Veterans
- New House and Senate Rules

106th CONGRESS LEGISLATIVE AGENDA

• Impact of Impeachment Proceedings

• Issues Intertwined:

- Social Security
- Education
- Tax Cuts
- Defense Increase
- Surplus

• New Budget Agreement/Summit?

DEFENSE BUDGET FOR FY 2000

- President's Budget Increase Will Not Be Cut By Congress
- Firewalls Are Down in FY 2000
- Congressional Defense Increases Dependent on Resolution of Other Issues
- Trucks Continue to be Low Priority

UNITED STATES SENATE COMMITTEE ON APPROPRIATIONS

Ted Stevens (AK)

Committee Chairman

REPUBLICANS

Thad Cochran (MS)

Arlen Specter (PA)

Pete V. Domenici (NM)

Christopher S. Bond (MO)

Slade Gorton (WA)

Mitch McConnell (KY)

Conrad Burns (MT)

Richard C. Shelby (AL)

Judd Gregg (NH)

Robert Bennett (UT)

Larry Craig (ID)

Kay Bailey Hutchinson (TX)

Jon Kyl (AZ)

Robert Byrd (WV)

Ranking Member

DEMOCRATS

Daniel K. Inouye (HI)

Ernest F. Hollings (SC)

Patrick J. Leahy (VT)

Frank R. Lautenberg (NJ)

Tom Harkin (IA)

Barbara A. Mikulski (MD)

Harry Reid (NV)

Herb Kohl (WI)

Patty Murray (WA)

Byron Dorgan (ND)

Diane Feinstein (CA)

Richard Durbin (IL)

034

**SENATE APPROPRIATIONS
COMMITTEE
DEFENSE SUBCOMMITTEE**

Ted Stevens (AK)

Subcommittee Chairman

REPUBLICANS

Thad Cochran (MS)

Arlen Specter (PA)

Pete V. Domenici (NM)

Christopher S. Bond (MO)

Mitch McConnell (KY)

Richard C. Shelby (AL)

Judd Gregg (NH)

Kay Bailey Hutchinson (TX)

Daniel K. Inouye (HI)

Ranking Member

DEMOCRATS

Ernest F. Hollings (SC)

Robert C. Byrd (WV)

Patrick J. Leahy (VT)

Frank R. Lautenberg (NJ)

Tom Harkin (IA)

Byron L. Dorgan (ND)

Richard Durbin (IL)

NOTE: Gary Reese has been replaced by Kraig Siracuse to handle relevant Army programs.

1/28/99

030

UNITED STATES SENATE COMMITTEE ON ARMED SERVICES

***John Warner (VA)**

Chairman

REPUBLICANS

Strom Thurmond (SC)

John McCain (AZ)

Bob Smith (NH)

James M. Inhofe (OK)

Rick Santorum (PA)

Olympia J. Snowe (ME)

Pat Roberts (KS)

Wayne Allard (CO)

Tim Hutchinson (AR)

Jeff Session (AL)

Carl Levin (MI)

Ranking Member

DEMOCRATS

Edward M. Kennedy (MA)

Jeff Bingaman (NM)

Robert C. Byrd (WV)

Charles S. Robb (VA)

Joseph I. Lieberman (CT)

Max Cleland (GA)

Mary Landrieu (LA)

Jack Reed (RI)

** New Chairman*

036

1/28/99

SENATE ARMED SERVICES
COMMITTEE
AIRLAND FORCES
SUBCOMMITTEE

***Rick Santorum (PA)**
Chairman

REPUBLICANS

James M. Inhofe (OK)

Pat Roberts (KS)

Wayne Allard (CO)

Tim Hutchinson (AK)

*** Joseph I. Lieberman (CT)**
Ranking Member

DEMOCRATS

Max Cleland (GA)

Mary L. Landrieu (LA)

Jack Reed (RI)

* New Chairman

* New Ranking Member

037

U.S. HOUSE OF REPRESENTATIVES COMMITTEE ON APPROPRIATIONS

REPUBLICANS

* **C.W. Bill Young (FL)**

Chairman

REPUBLICANS

C.W. Bill Young (FL)

Ralph Regula (OH)

Jerry Lewis (CA)

John Edward Porter (IL)

Harold Rogers (KY)

Joe Skeen (NM)

Frank R. Wolf (VA)

Tom DeLay (TX)

Jim Kolbe (AZ)

Ron Packard (CA)

Sonny Callahan (AL)

James T. Walsh (NY)

Charles H. Taylor (NC)

David L. Hobson (OH)

Ernest J. Isook (OK)

Henry Bonilla (TX)

Joe Knollenberg (MI)

Dan Miller (FL)

REPUBLICANS (CON'T)

Jay Dickey (AK)

Jack Kingston (GA)

Rodney Frelinghuysen (NJ)

Roger F. Wicker (MS)

Michael P. Forbes (NY)

George R. Nethercutt, Jr. (WA)

Mark W. Neumann (WI)

Todd Tiahrt (KS)

Zach Wamp (TN)

Tom Latham (IA)

Anne Meagher Northrup (KY)

Robert B. Aderholt (AL)

JoAnn Emerson (MO)

John E. Sununu (NH)

Kay Granger (TX)

John E. Peterson (PA)

* New Chairman

038

U.S. HOUSE OF REPRESENTATIVES
COMMITTEE ON APPROPRIATIONS

DEMOCRATS

David Obey (WI)
Ranking Member

DEMOCRATS

John P. Murtha (PA)
Norman D. Dicks (WA)
Martin Olav Sabo (MN)
Julian C. Dixon (CA)
Steny H. Hoyer (MD)
Alan B. Mollohan (WV)
Marcy Kaptur (OH)
Nancy Pelosi (CA)
Peter J. Visclosky (IN)
Nita M. Lowey (NY)
Jose E. Serrano (NY)
Rosa DeLauro (CT)

DEMOCRATS (CON'T)

James P. Moran (VA)
John W. Olver (MA)
Ed Pastor (AZ)
Carrie Meek (CL)
David E. Price (NC)
Chet Edwards (TX)
Bud Cramer (AL)
James Clyburn (SC)
Maurice Hinchey (NY)
Sam Farr (CA)
Jesse Jackson (IL)
Carolyn Kilpatrick (MI)
Allen Boyd (FL)

039

U.S. HOUSE OF REPRESENTATIVES
COMMITTEE ON APPROPRIATIONS
** DEFENSE SUBCOMMITTEE

* Jerry Lewis (CA)

Chairman

REPUBLICANS

C.W. Bill Young (FL)

Jerry Lewis (CA)

Joe Skeen (NM)

David L. Hobson (OH)

Henry Bonilla (TX)

George R. Nethercutt, Jr.. (WV)

Ernest J. Istook (OH)

Randy (Duke) Cunningham (CA)

Jay Dickey (AR)

Rodney Frelinghuysen (NJ)

John P. Murtha (PA)

Ranking Member

DEMOCRATS

Norman Dicks (WA)

Martin Olav Sabo (MN)

Julian C. Dixon (CA)

Peter J. Visclosky (IN)

James Moran (VA)

* New Chairman

** The 106th Congress renamed the
House National Security
Subcommittee to the Defense
Subcommittee.

1/28/99

040

U.S. HOUSE OF REPRESENTATIVES
ARMED SERVICES COMMITTEE

REPUBLICANS

Floyd Spence (SC)

Chairman

Bob Stump (AZ)

Vice Chairman

REPUBLICANS

Duncan L. Hunter (CA)

John R. Kasich (OH)

Herbert H. Bateman (VA)

James V. Hansen (UT)

Curt Weldon (PA)

Joel Hefley (CO)

Jim Saxton (NJ)

Steve Buyer (IN)

Tillie Fowler (FL)

John M. McHugh (NY)

James M. Talent (MO)

Terry Everett (AL)

Roscoe G. Bartlett (MD)

Howard (Buck) McKeon (CA)

J.C. Watts, Jr. (OK)

William M. (Mac) Thornberry (TX)

John N. Hostettler (IN)

REPUBLICANS (CON'T)

Saxby Chambliss (GA)

Van Hilleary (TN)

Joe Scarborough (FL)

Walter B. Jones (NC)

Lindsey Graham (SC)

Jim Ryun (KS)

Bob Riley (AL)

Jim Gibbons (NV)

Mary Bono (CA)

Joseph K. Pitts (PA)

Robert (Robin) Hayes (NC)

Steve Kuykendall (CA)

Donald L. Sherwood (PA)

NOTE: The 106th Congress
renamed the House Committee
on National Security to the
House Armed Services
Committee.

U.S. HOUSE OF REPRESENTATIVES
COMMITTEE ON ARMED SERVICES

DEMOCRATS

* **Ike Skelton (MO)**

Ranking Member

DEMOCRATS

Norman Sisisky (VA)

John M. Spratt, Jr. (SC)

Solomon P. Ortiz (TX)

Owens B. Pickett (VA)

Lane Evans (IL)

Gene Taylor (MS)

Neil Abercrombie (HI)

Martin T. Meehan (MA)

Robert A. Underwood (Guam)

Patrick Kennedy (RI)

Rod R. Blagojevich (IL)

Silvestre Reyes (TX)

Thomas H. Allen (ME)

Vic Snyder (AR)

Jim Turner (TX)

Adam Smith (WA)

DEMOCRATS (CON'T)

Loretta Sanchez (CA)

James H. Maloney (CT)

Mike McIntyre (NC)

Ciro Rodriguez (TX)

Cynthia McKinney (GA)

Ellen Tauscher (CA)

Robert Brady (PA)

Robert Andrews (NJ)

Baron Hill (IN)

Mike Thompson (CA)

John Larson (CA)

* **New Ranking Member**

042

U.S. HOUSE OF REPRESENTATIVES
COMMITTEE ON ARMED SERVICES
MILITARY PROCUREMENT
SUBCOMMITTEE

Duncan L. Hunter (CA)

Chairman

REPUBLICANS

Floyd Spence (SC)

Bob Stump (AZ)

James V. Hansen (UT)

Jim Saxton (NJ)

James M. Talent (MO)

Terry Everett (AL)

J.C. Watts, Jr. (OK)

William M. (Mac) Thornberry (TX)

Lindsey Graham (SC)

Jim Ryun (KS)

Jim Gibbons (NV)

Mary Bono (CA)

Joseph Pitts (PA)

Robin Hayes (NC)

*** Norman Sisisky (VA)**

Ranking Member

DEMOCRATS

Ike Skelton (MO)

John M. Spratt, Jr. (SC)

Lane Evans (IL)

Rod R. Blagojevich (IL)

Thomas H. Allen (ME)

Jim Turner (TX)

Adam Smith (WA)

James H. Maloney (CT)

Mike McIntyre (NC)

Cynthia McKinney (GA)

Ellen Tauscher (CA)

Robert Brady (PA)

* New Ranking Member

043

F O R C E

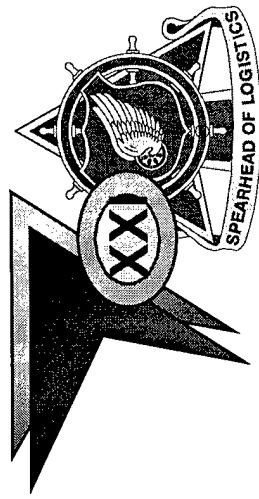

TRANSPORTATION CORPS

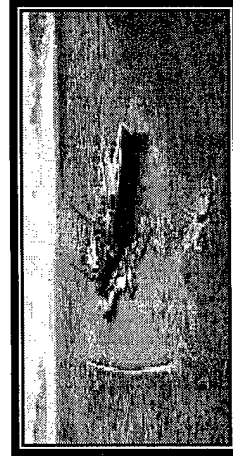

Chief of Transportation
BG Gilbert S. Harper

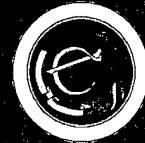

F O R C E

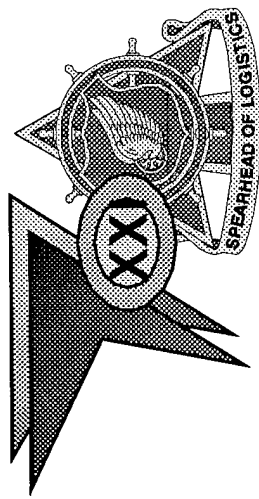

TRANSPORTATION CORPS

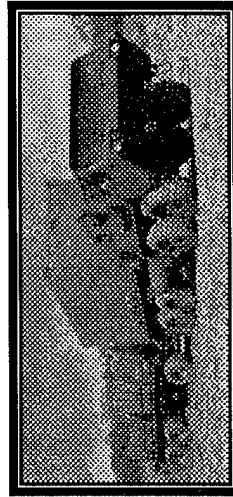
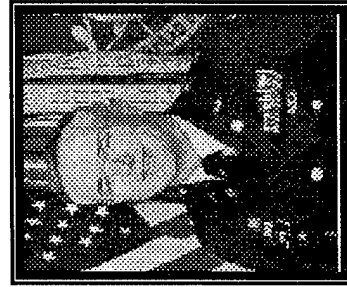
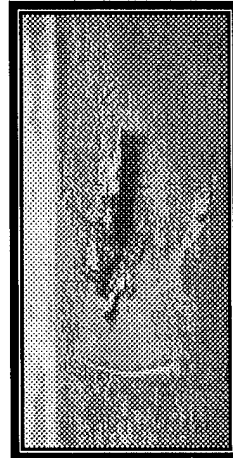
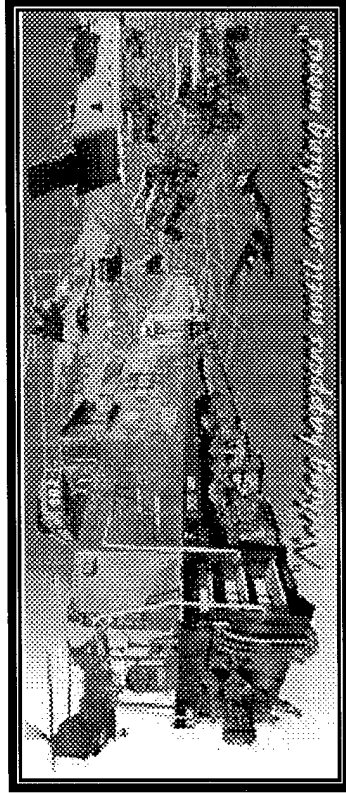

Chief of Transportation
BG Gilbert S. Harper





Strategic Transportation

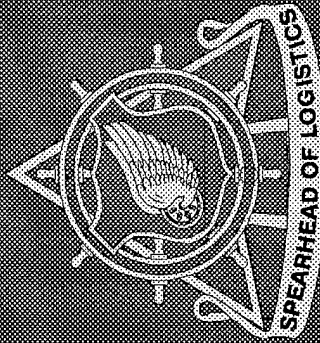

If you look at war as a sport....

"In 1939, Hitler had the best Army, the best equipment, the best organization and the whole country behind him. But in 1945, Berlin stood in ruins because Hitler could not win on the road."

—Marv Levy, former Head Coach, Buffalo Bills.



**..... A power projection
Army must be able to win
on the road.**

"A task without vision is drudgery.

A vision without a task is a dream.

A task with a vision is victory."

— Unknown

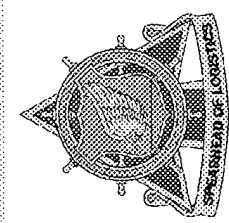

AMERICA'S ARMY TRANSPORTATION CORPS STRATEGIC VISION

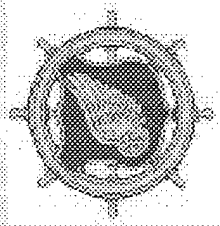

- The Transportation Corps will lead America's Army in the transition to an integrated, transportation-based global distribution system capable of efficient operations in peace and war. It will serve as a combat force multiplier by anticipating and fulfilling wartime theater support demands with unprecedented speed and flexibility.
- The Transportation Corps will lead in the development of force deployment, transportation-based distribution doctrine and integrated training. It will emphasize increased velocity through modernization, synchronization and adaptability in support of our force projection Army.
- The Transportation Corps will leverage emerging technologies and thrive on the digitized battlefield. It will provide movement control and direct delivery to deployed forces in a dynamically fluid, nonlinear battlefield in Force XXI and into the Army After Next.
- The Transportation Corps' soldiers and civilians will lead and perform multifunctional and joint logistics roles. Professional development will produce ethically, technically and tactically sound leaders.
- The Transportation Corps will lead the Department of Defense in deployment and power projection training and education. The Transportation Corps' soldiers and civilians will provide the professional transportation and distribution logistics expertise in Joint Commands and Defense Agencies.

GILBERT S. HARPER
Brigadier General, U.S. Army
Chief of Transportation

THE TASK

Dominant

*The Army Must Be Able To
Simultaneously Project,
Sustain and Fight...*

- 1 Light Brigade by C-17
- 1 Light Division by C-17
- 1 Heavy Brigade Afloat by C-16
- 2 Heavy Divisions from CONUS by C-50
- 5 Division Contingency Corps with C-50

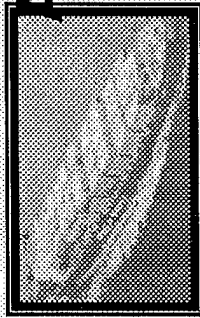

Army Deployment Comparisons

Tons of Supplies & Equipment

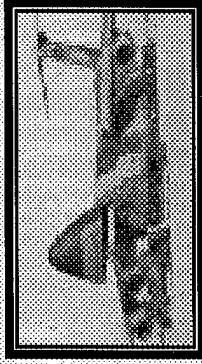

First 30 Days

SEALIFT

AIRLIFT

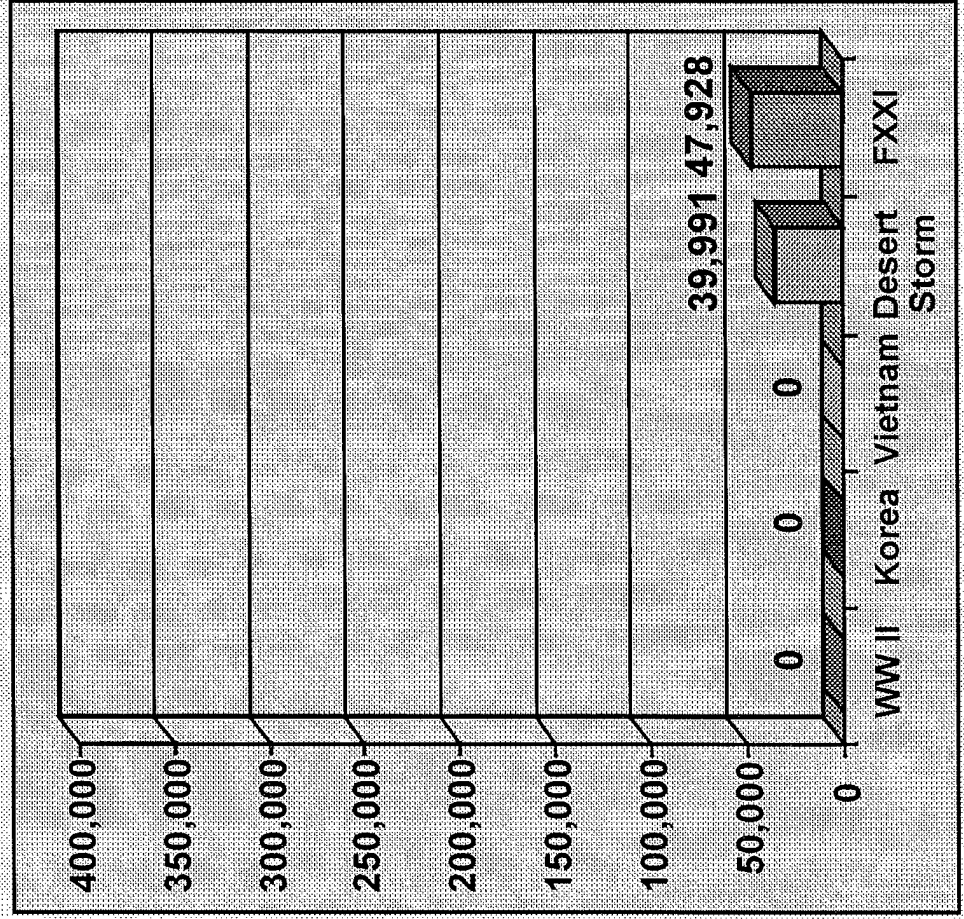
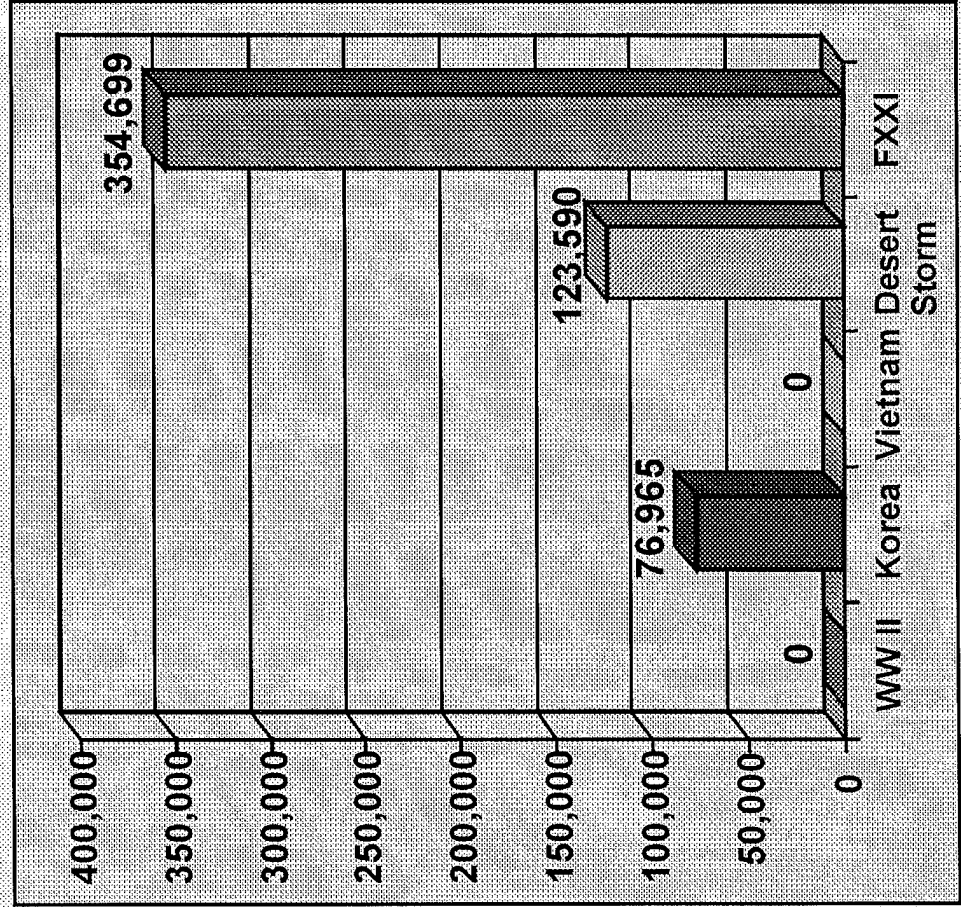

Logistics Process

T = Today
 F = Force XXI
 A = Army After Next

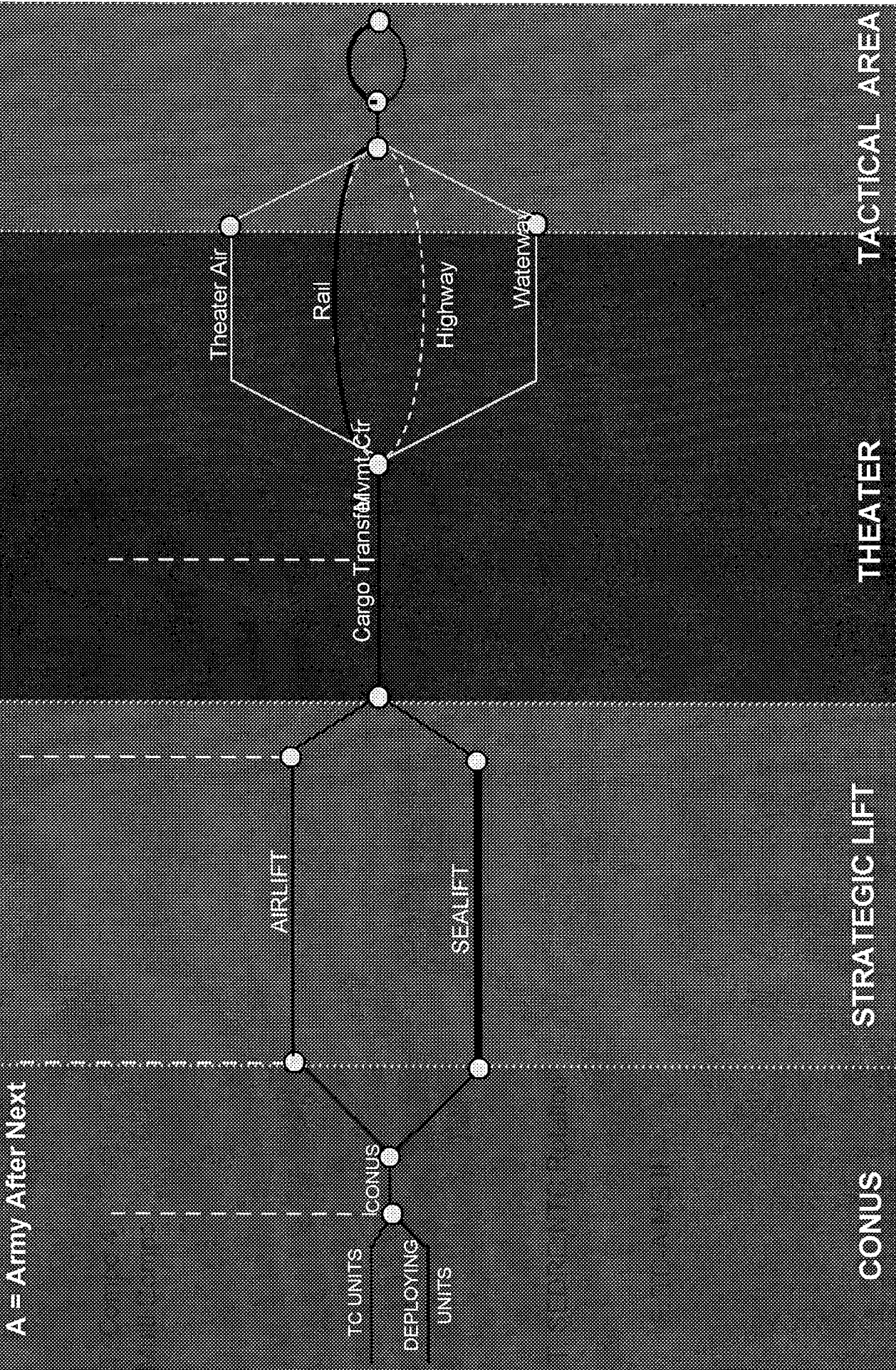

Force Projection

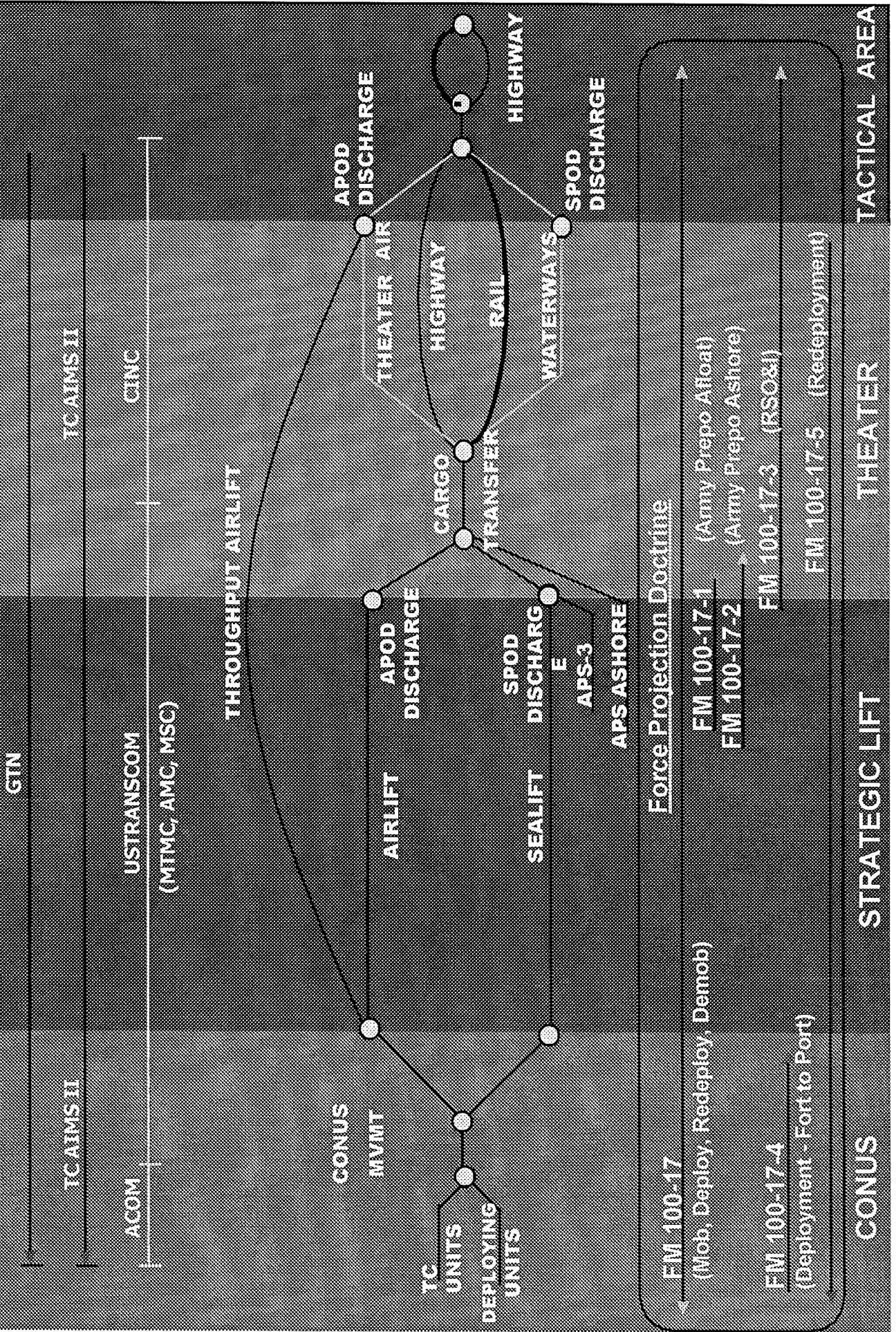

Operational and Tactical Transportation

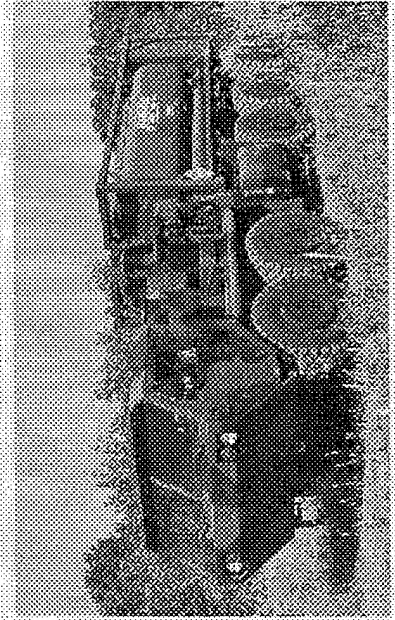
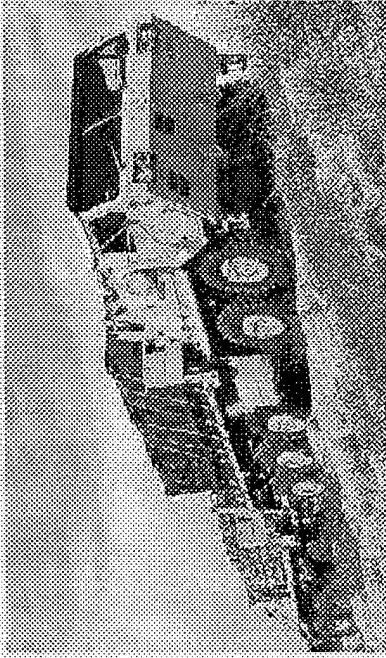
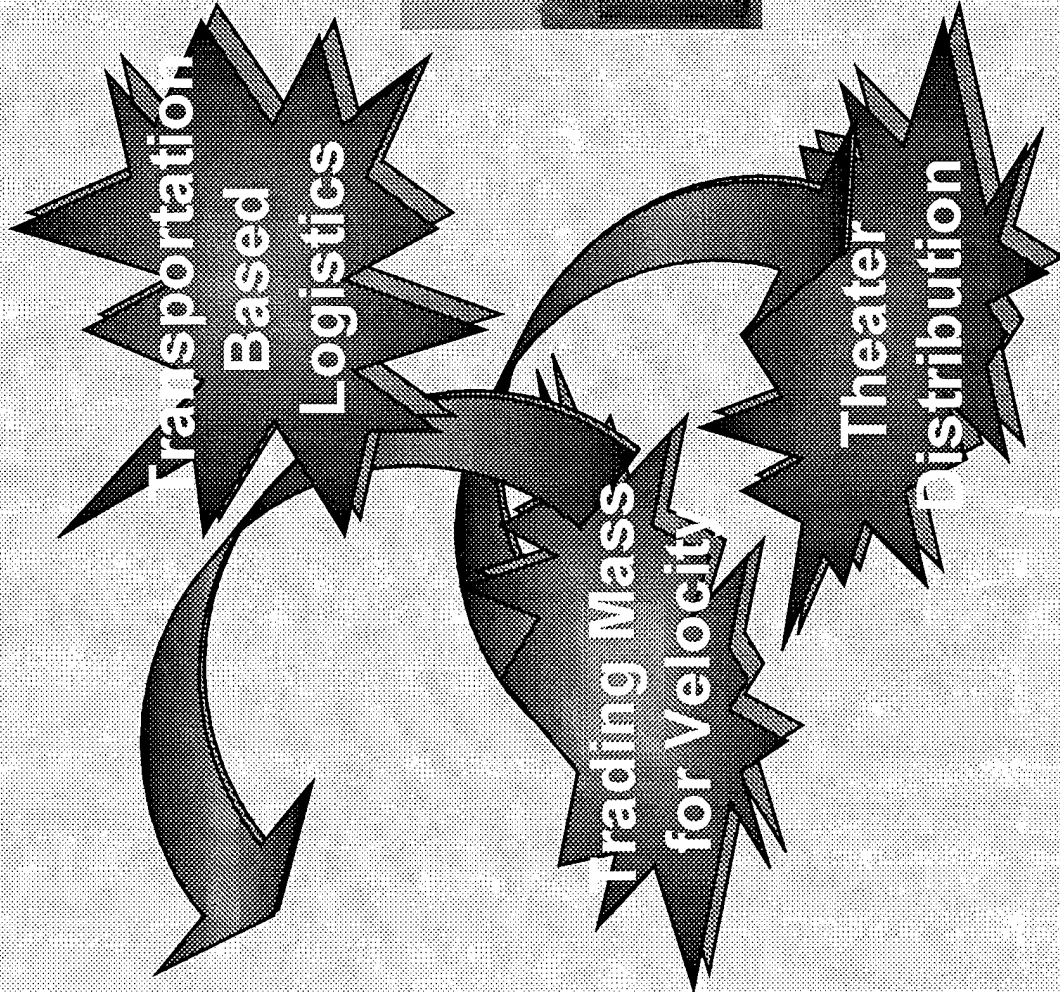

The Future

"The Future ain't what it used to be"

— Yogi Berra



BATTLESPACE

Force XXI

The Expanding Battlefield

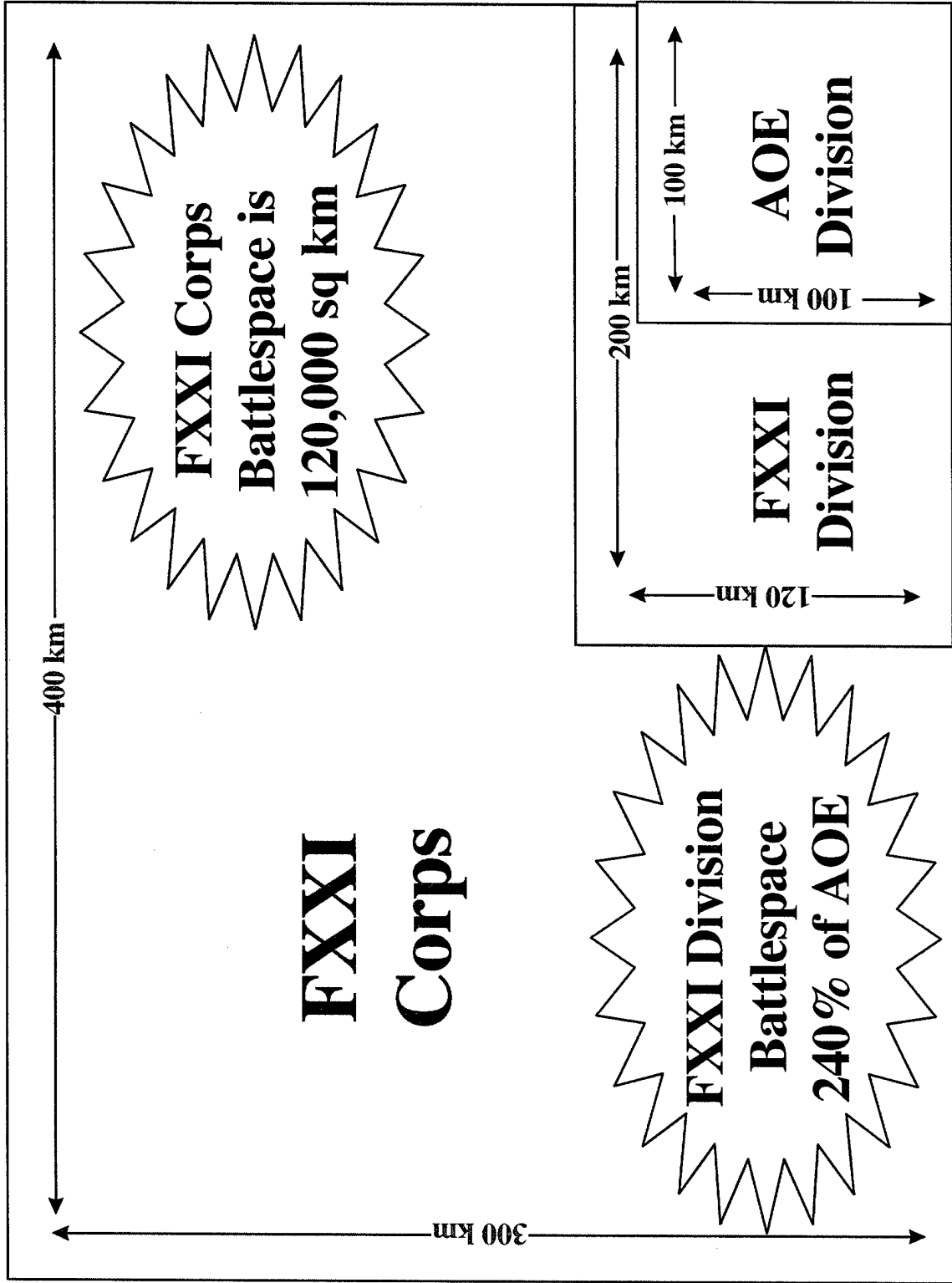

Challenging The Laws of Physics

EXXI:

Corps XXI's area is 300km x 400km

This equates to ~~120,000 sq km~~

110

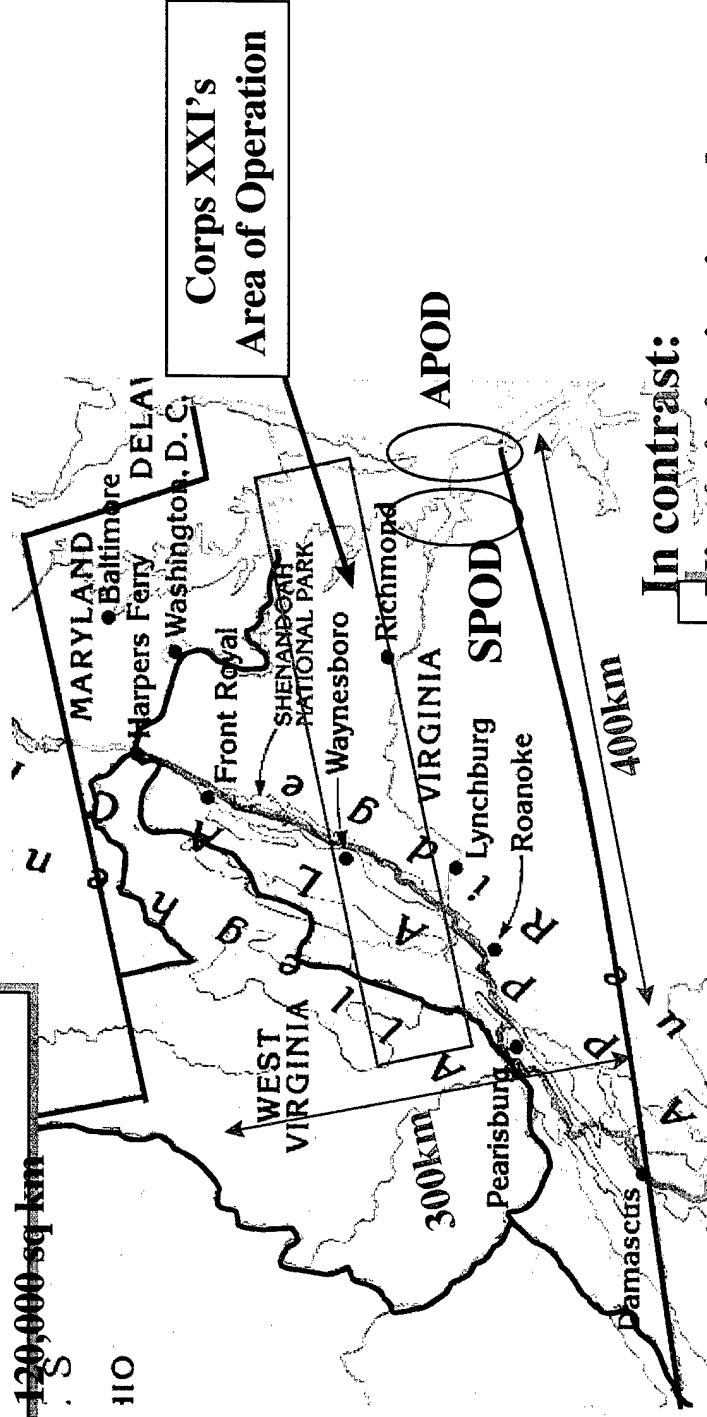

In contrast:

Virginia's size is only

105,586 sq km

Road Distance

The Rest of the Story

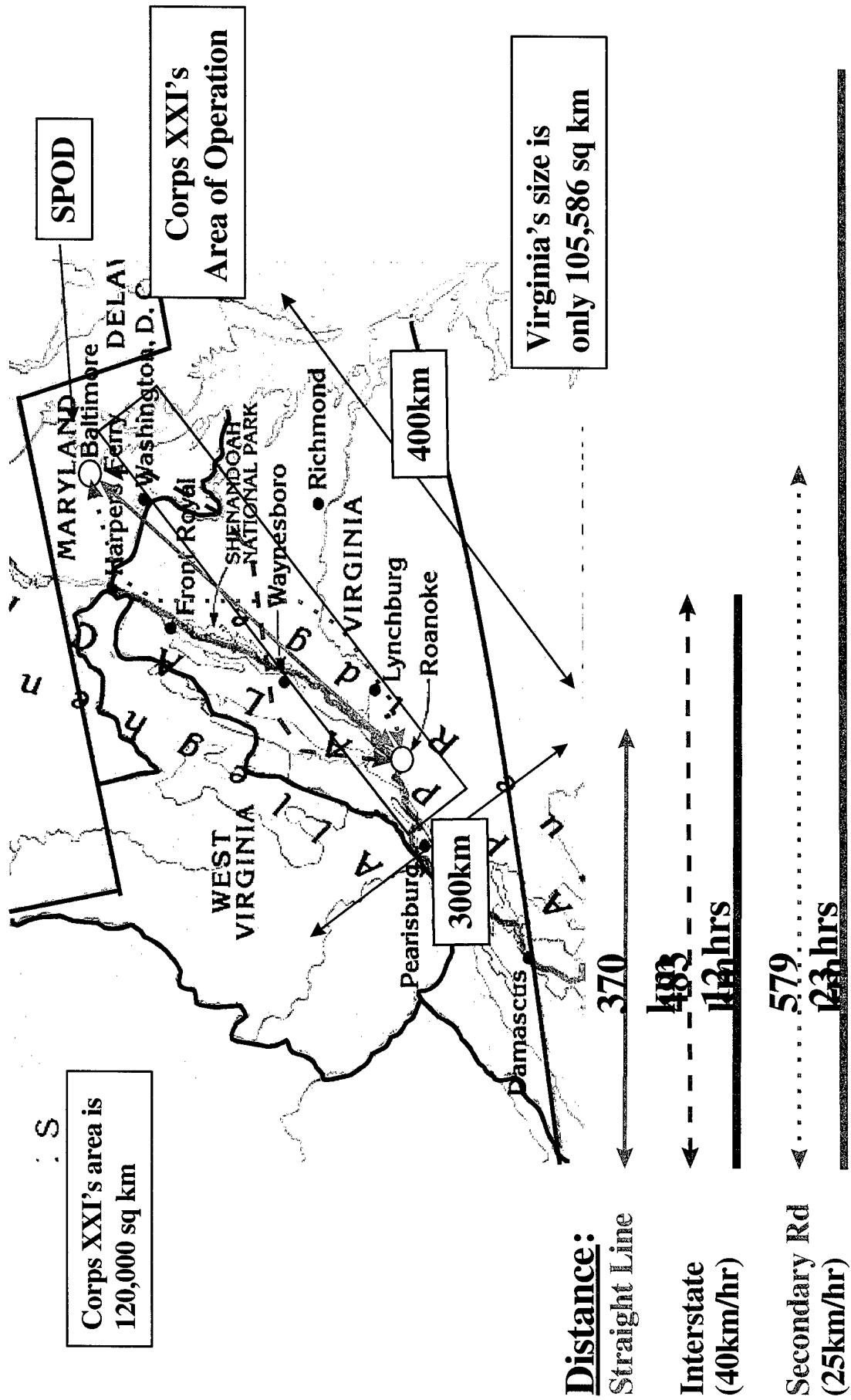

A decorative border resembling a scroll, with a curved top-left corner and a curved bottom-right corner, enclosing the main text.

TRANSPORTATION BASED LOGISTICS

Force XXI

Focused On Throughput

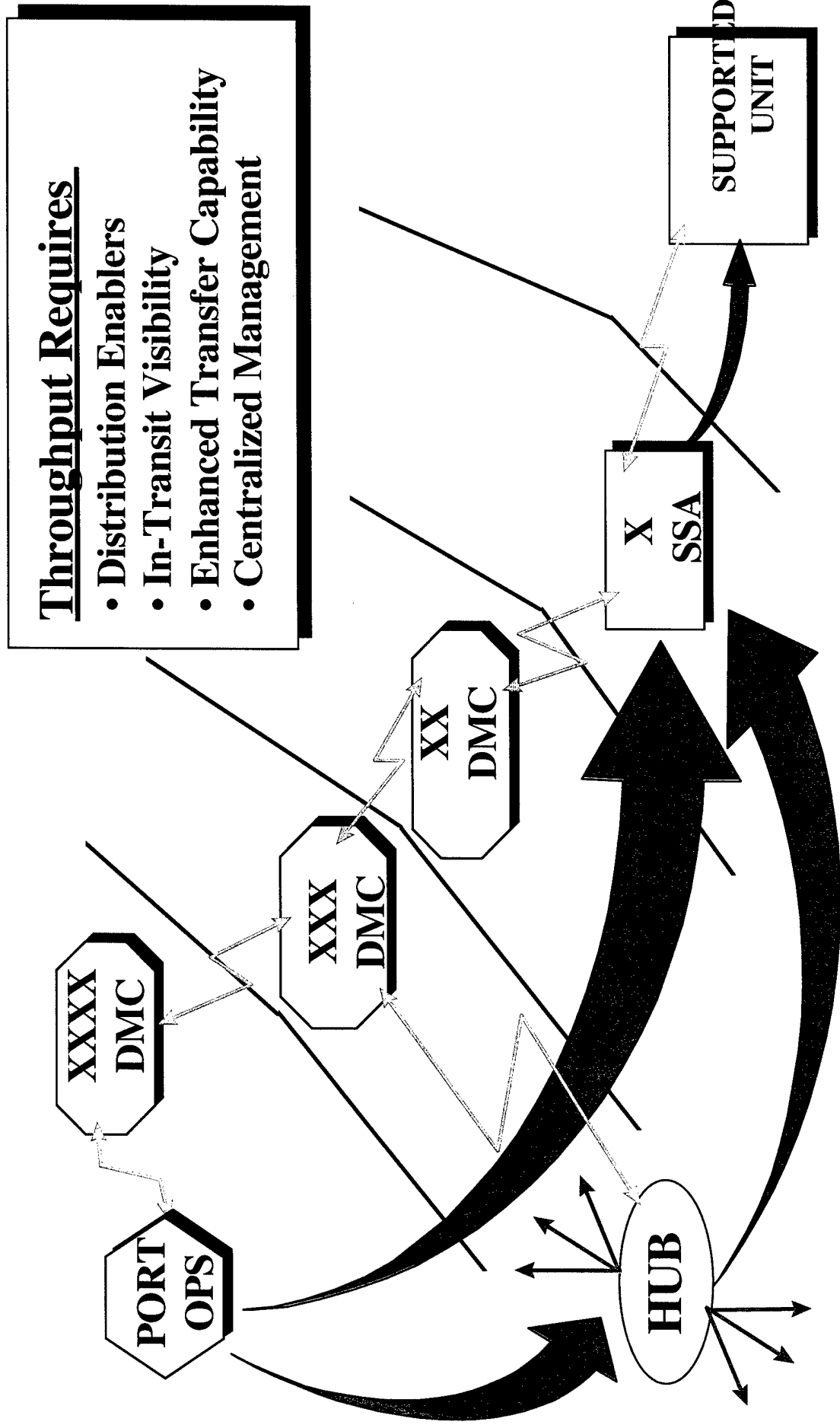

Battlefield Distribution Enablers

Linkage

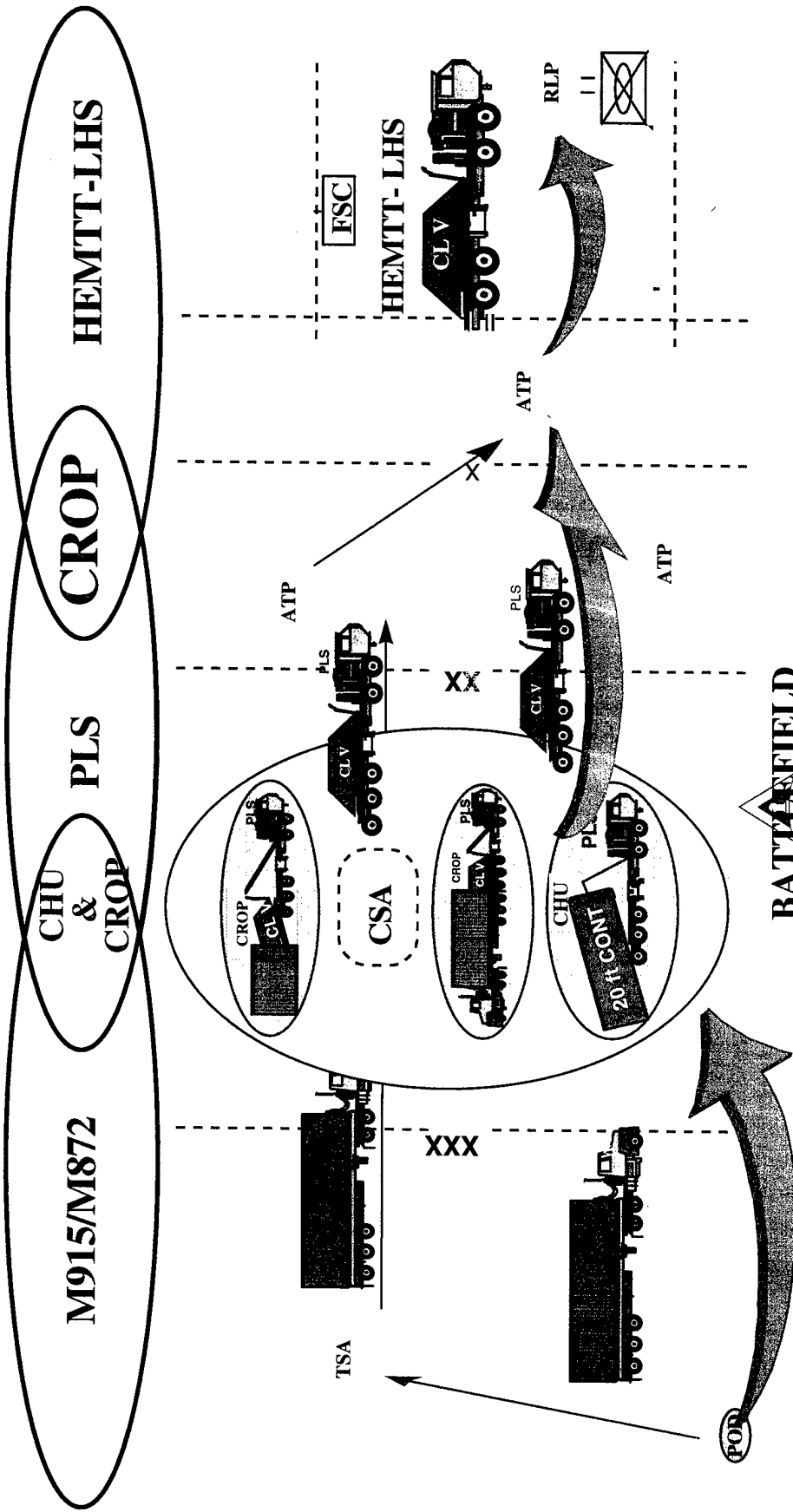

**“REVOLUTION IN
MILITARY
LOGISTICS”**

**“REVOLUTION IN
MILITARY
AFFAIRS”**

Intermodal Transfer Challenges

Need
Enhanced
Transfer
Capability

- Transfer from tractor/trailer to PLS/LHS
- Container Handling
 - 40 ft Containers
 - CROP Insertion/Extraction
- Transporting Container Handling Equipment
- Air Transportability
- Rough Terrain
- Mud

Minimize Handling

Maximize Speed

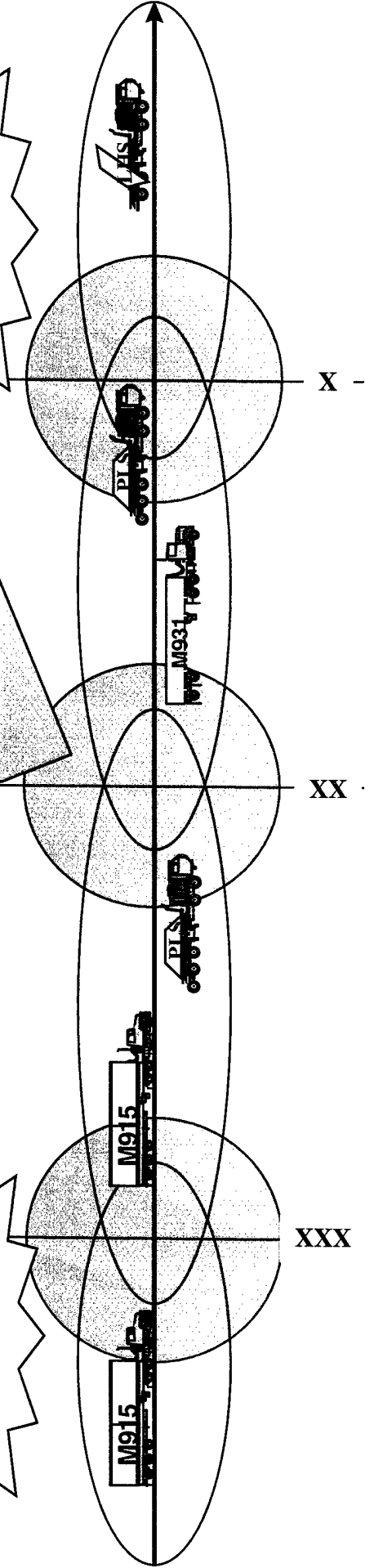

In-Transit Visibility

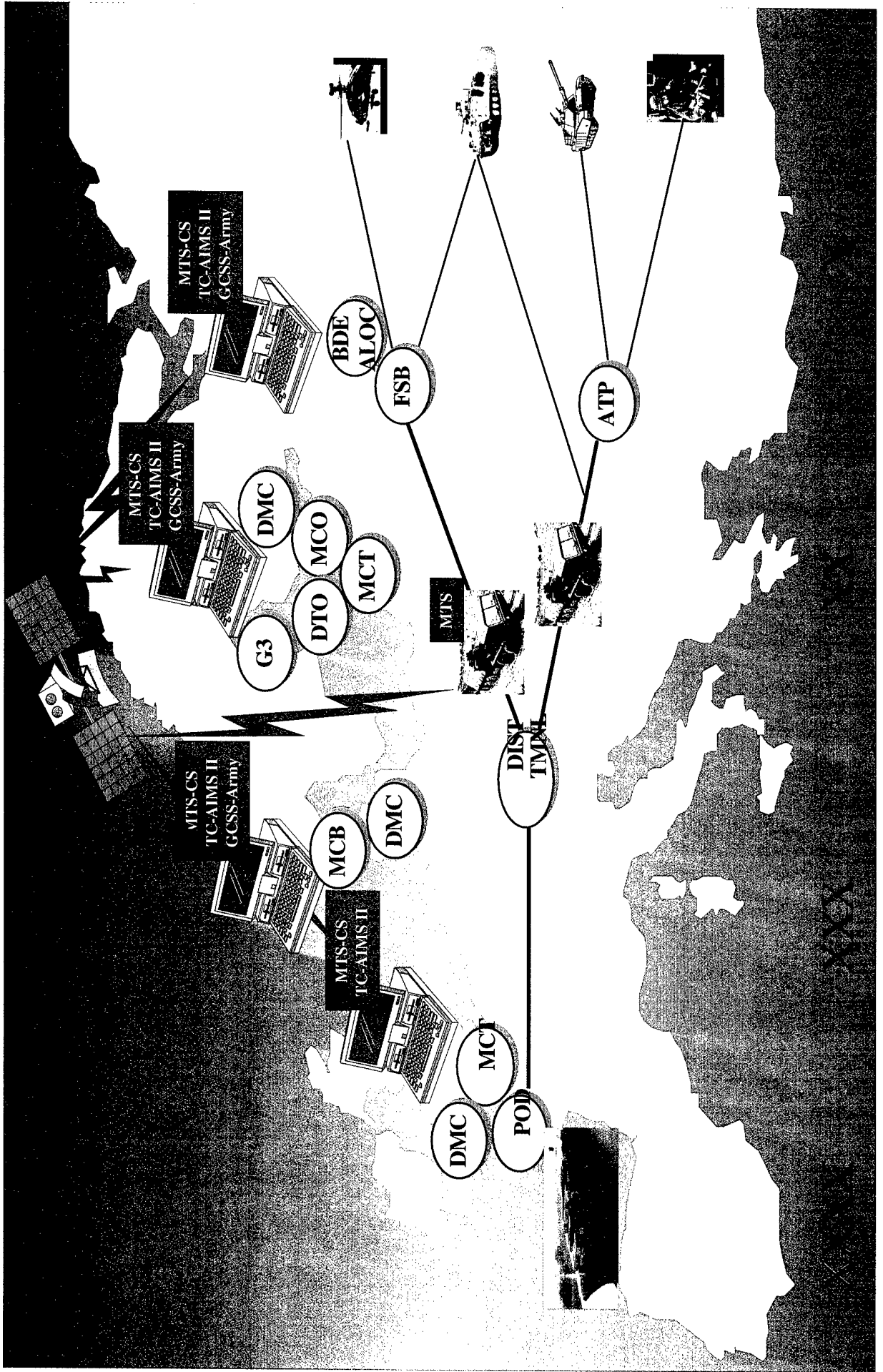

Increased Optempo

Smaller Force

Velocity

"We only win at war because we fight another government. If we fought private industry we would not last until noontime."

— R.I. Fitzhenry

We need industries help

Force Projection

Greater Distances

Declining Budgets

What Can Industry Do to Make our TWV's Better?

➤ **Increased Range**

- Division battle space increased by 240%
- Need Larger fuel capacity
- More fuel efficient engines

➤ **Increased reliability**

- Need reduced mechanical failures
- Improved sub-component reliability
- reduce the number of critical parts
- Combine/simplify subsystems to reduce failure modes

➤ **Lightweight & Rugged**

- Larger battle-space
- More dependence on air transport
- Must withstand effects of terrain

➤ **Better maintainability**

- 11% fewer Division personnel
- Limited number of vehicles – no extras
- Improve diagnostics/prognostics
- Improve trouble-shooting methods
- Quick replacement parts and components
- Lube for life components

➤ **Better fuel economy**

- Army Goal-50% reduction in fuel consumption
- More fuel efficient power plants

➤ **Reduced O&S Cost**

- Less Defense \$
- Better to buy beans and bullets than wiper blades
- Top O&S drivers for trucks – batteries, tires, light bulbs, brake pads, and glow plugs.

➤ **Increase Economic Useful Life**

- Short \$ - can't buy new as often.
- Modernization through spares
- Increased corrosion protection

➤ **Modularity**

- Same as maintainability
- Must replace forward, fix to the rear

➤ **Crew Protection**

- Protect crew from injuries
- Improved vehicle survivability
- Lighter weight protection to increase payload

Goals & Objectives

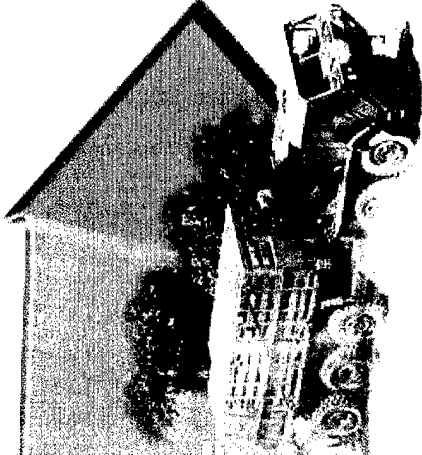

**Transportation Summit
16-17 DEC 1998
TACOM**

- Improve the communications between the Combat Developer and Materiel Developer.
- Achieve a stronger alliance with industry.
- Develop a team strategy to efficiently adopt commercial technology in the "Spiral Modernization" of our legacy fleets.
- Speak with one voice

"We must indeed all hang together, or, most assuredly, we shall all hang separately."

--Benjamin Franklin's reply in response to a John Hancock remark that the revolutionaries should be unanimous in their action; made at the signing of the Declaration of independence on July 4, 1776.



Army Tactical Wheeled Vehicle Community

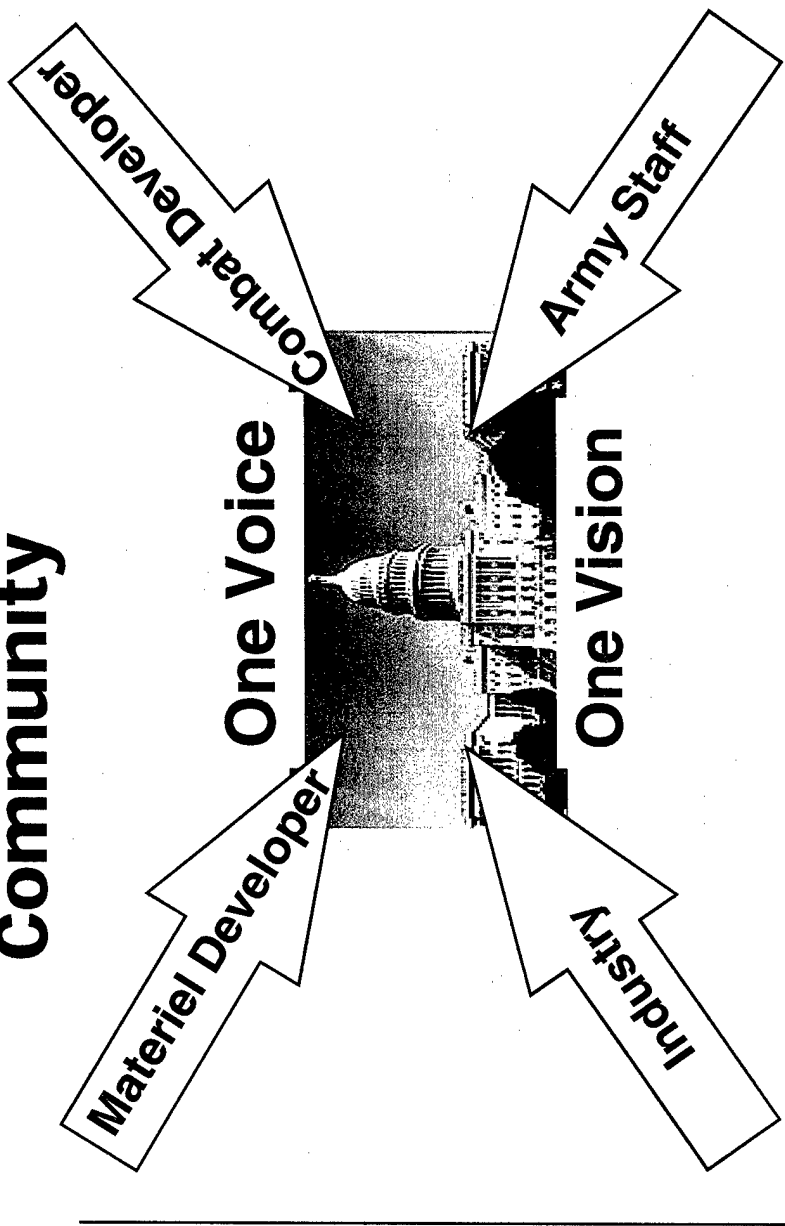



ARMY NATIONAL GUARD



TACTICAL W... SUSTAINMENT

Ready — Relevant — One Army, Building for the Future



NO BUCKLE CHALLENGES

- Problem - P
- Meet War - W
- Solution - Execution
- Program for Selected

Ready — Relevant — One Army, Building for the Future



ARMY NATIONAL BOARD SCENARIO

- Shortage of equipment and personnel
- Exacerbated by the need for more equipment
- Equipment is Phased Out
- Cascaded Vehicle Use by the AC
- Modernization is Stretched Over the Next

Ready — Relevant — One Army, Building for the Future



TWO MIL SCENARIO

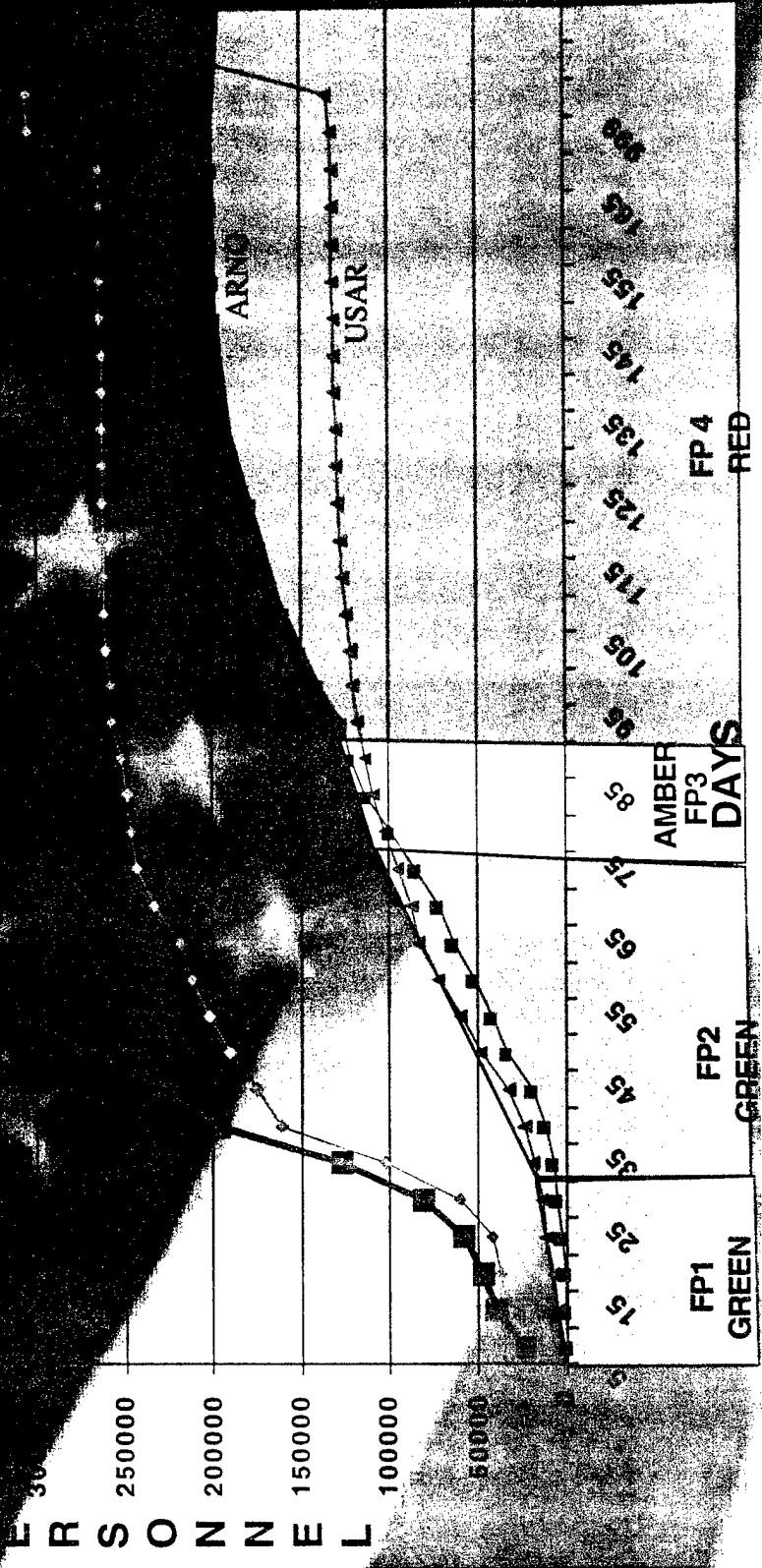

Ready — Relevant — One Army. Building for the Future



RC EQUIPMENT STATUS

ARMY	301	46
USARV	5	
TOTAL		
FP1	11,022	3,521
FP2	28,344	9,052
FP3	50,389	16,092
FP4	67,712	21,624
	24,894	3,703

Ready — Relevant — One Army. Building for the Future



FLEET STATUS



**"SOLDIERS DESERVE CAPABLE
TAXPAYERS DESERVES AFFORDABLE
-US ARMY 1997 MODERNIZATION PLAN**

What Does the RC Want?

Safe and Reliable, Supportable Fleets

Ready — Relevant — One Army, Building for the Future

HMMWV

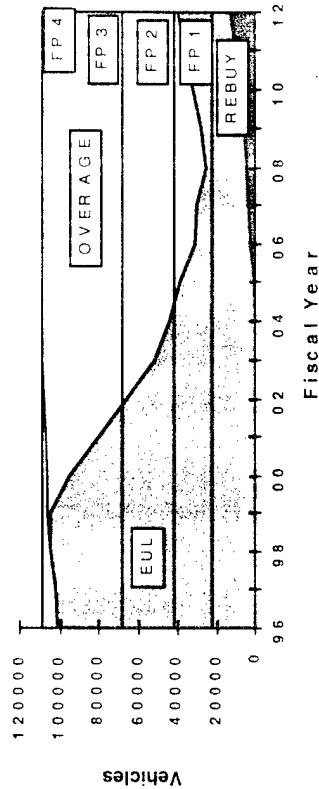



FLEETS STATUS

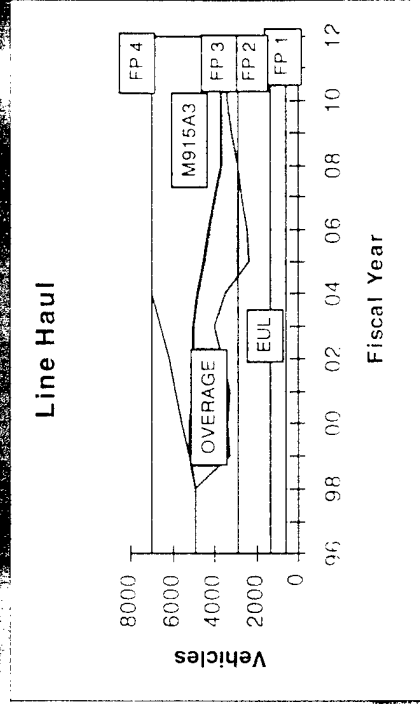
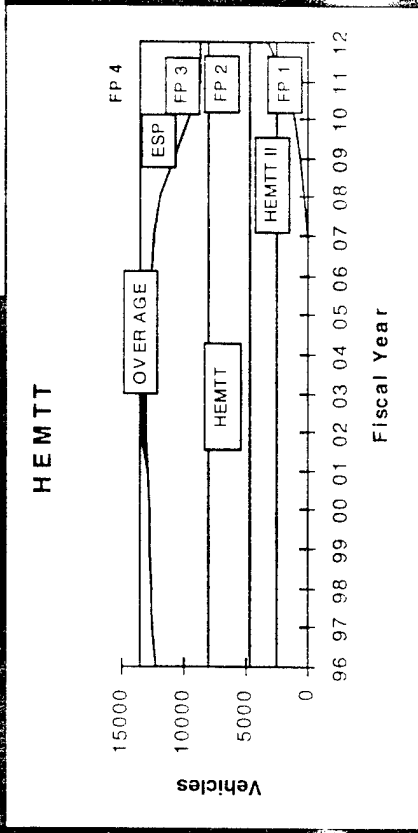
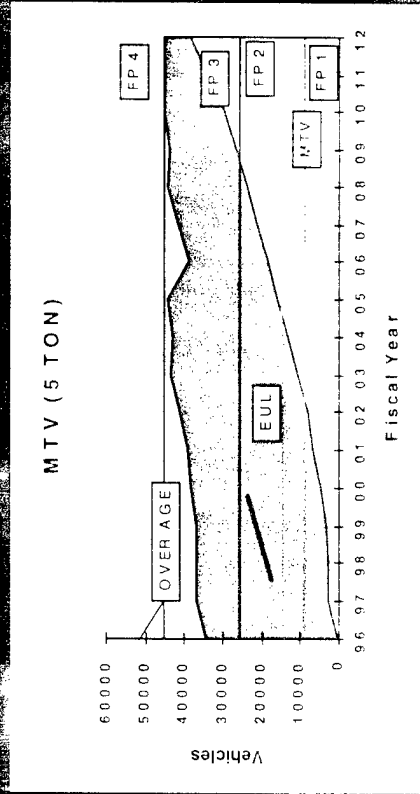

Ready — Relevant — One Army, Building for the Future



FLEETSIAUS

- HEMTT II Production For Over Match
- HMMWV Procurement

- FMTV Fielding Continues Throughout
- Remanufacture Of HMMWV, HEMTT
- Trailer Procurement
- Line Haul Procurement & Remanufacture
- HETS Procurement
- PLS
- HEMTT-LHS

“SOLDIERS DESERVE CAPABLE TOW, AND TAXPAYERS DESERVE AFFORDABILITY”

US ARMY 1997 MODERNIZATION PLAN

Ready — Relevant — One Army. Building for the Future



PROCUREMENT OF EQUIPMENT

ASSETS

AMBER

AMBER

ASSETS MEET REQUIREMENTS NOT OVER AGE

FP 1&2 OK OVERAGE

FP 1 & 2 OK OVERAGE

Total

RC RATING

GREEN - Adequate Required Operational

- Limited Quantity Required Operational

RED - Required Operational Capability does not meet Required Support Capability is Insufficient to Defeat the Threat or Provide the Required Support
Capability is Based on Vehicles not Having Exceeded their US

Ready — Relevant — One Army, Building for the Future



PROCUREMENT OF EQUIPMENT

MEDIUM FLEET

AMBER

FP 1&2 OK
OVERAGE

AMBER

OVERAGE

GOOD FILL ALL FP

TOTAL FOR

RC 2 1/2 Ton Fleet
FP 1-4
FP 3 & 4

RC 5 Ton Fleet

FP 1-4 GREEN

GREEN - Adequate
the Required Op

- Limited Operational
Required Operational

- Required Operational Capability Does not
Capability is Insufficient to Defeat the Threat or Provide the
Required Support.

Capability is Based on Vehicles not Having Exceeded their USE

Ready — Relevant — One Army. Building for the Future



PROCUREMENT OF EQUIPMENT

HEAVY FLEET PHYSICAL DESIGN

HEAVY FLEET COMMERCIAL DESIGN

NEAR-TERM FY 99-05	

AC & RC Heavy Fleets

Capability is Based on Vehicles not Having Exceeded their USL

Ready — Relevant — One Army, Building for the Future



ACCELERATING
PROGRAMS
EFFECTIVENESS
DUE TO INSUFFICI

Ready — Relevant — One Army. Building for the Future



AGE OF ARC FLEET

Inc.

16

mag

Hydraulic

Trailer Decks

Brake Systems

Drive Train

Ready — Relevant — One Army. Building for the Future



MAINTENANCE PROGRAM GAPS

- Previous
- No Depot Level
- At Some Point, Tac
- Rehabilitation to Resto

Ready — Relevant — One Army. Building for the Future



TRUCK MAINTENANCE

- on D
- Labor Hours is
- BLTM-TRM Model
- AC Deferred Maintenance
- Cascading
- RC Fleet Age is Major Contributor
- RETROEUR Program Must Be
- Truck Sustainment Programs are Necessary to Create a Capable Fleet

Ready — Relevant — One Army. Building for the Future



CASCADING EQUIPMENT



- **No Formal Program**
→ **Equipment Often Not**
- **RC Imperative is to Fill Shortfalls**
- **Second Priority is to Modernize**
- **BRMO Often a Source of Equipment**

Ready — Relevant — One Army, Building for the Future



PROCUREMENT OF EQUIPMENT

3. MR

- AC Modernization Trucks to RC

- Procurement Program as N
- Evolving Requirements

Ready — Relevant — One Army, Building for the Future



SERVICEABILITY/RELEVANT CITY

ARNG 1
USAR 1



Ready — Relevant — One Army. Building for the Future



SERVICEABILITY/RELIABILITY

- More Accurate [unclear] [unclear]
 - JCS Due Out of Control System/Method
- FMC Status vs TM 10/20 [unclear]
 - Not Preferred Status [unclear] [unclear]
 - Doors, Bumpers, etc., [unclear] [unclear]
 - Not a Measure of Reliability [unclear]
- Obsolete/Excess Filling EOH Shortages
 - [unclear]

Ready — Relevant — One Army, Building for the Future



COMMUNICATION

- Cascade
- New Procurement
- No Other Sustainment

Ready — Relevant — One Army, Building for the Future



State of the Army Reserve

Briefing for the 1999

Tactical Wheeled Vehicles Conference



BG James R. Helmly

Deputy Chief, Army Reserve

Ready — Relevant — One Army, Leading for the Future

DAAR-LO

AGENDA

- Today's USAR Environment
- Tactical Wheeled Vehicles Status
- Initiatives
- Summary

Missions

- Provide trained and ready combat support
/combat service support units to rapidly
mobilize and deploy

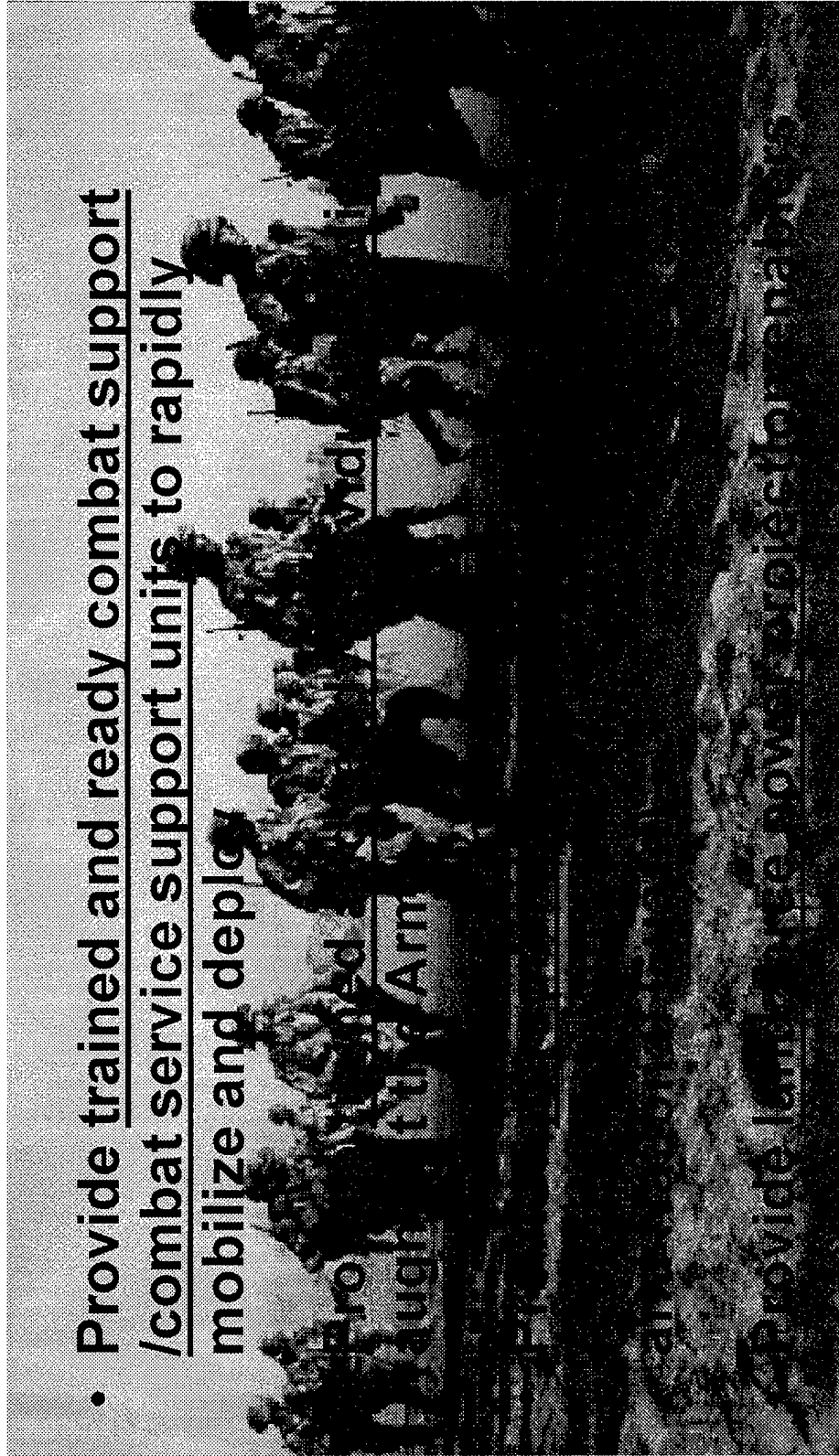

Provide land, air, and power projection enablers

Trained and ready

- Combat service support/combat support
- 424 Force Support Package units
- 73% of the RC forces deployed for Bosnia

Power projection

- Transportation Terminal Units
- Garrison support
- Installation medical support

Training readiness enablers

- Initial Entry Training
- Lane training/battle simulations
- Skill training/professional education/ROTC

Trained soldiers

- Joint Readiness Units
- Individual Mobilization Augmentee
- IRR mobilization pool



FULL SPECTRUM CAPABILITIES

- Fully Engaged
- Ready, Relevant, Reliable
- Unique Capabilities
- Supporting the Nation & America's Army

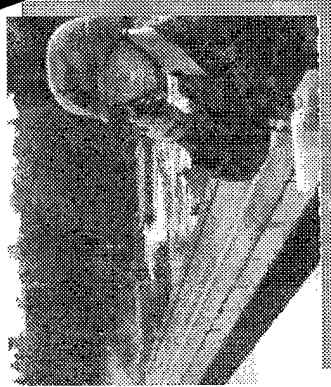

JOINT ENDEAVOR/JOINT GUARD

- Forward Presence
- Peace Enforcement
- Humanitarian Support
- Domestic Support/Community Assistance
- Partnership for Peace
- Overseas Duty Training

Army Reserve OPTEMPO

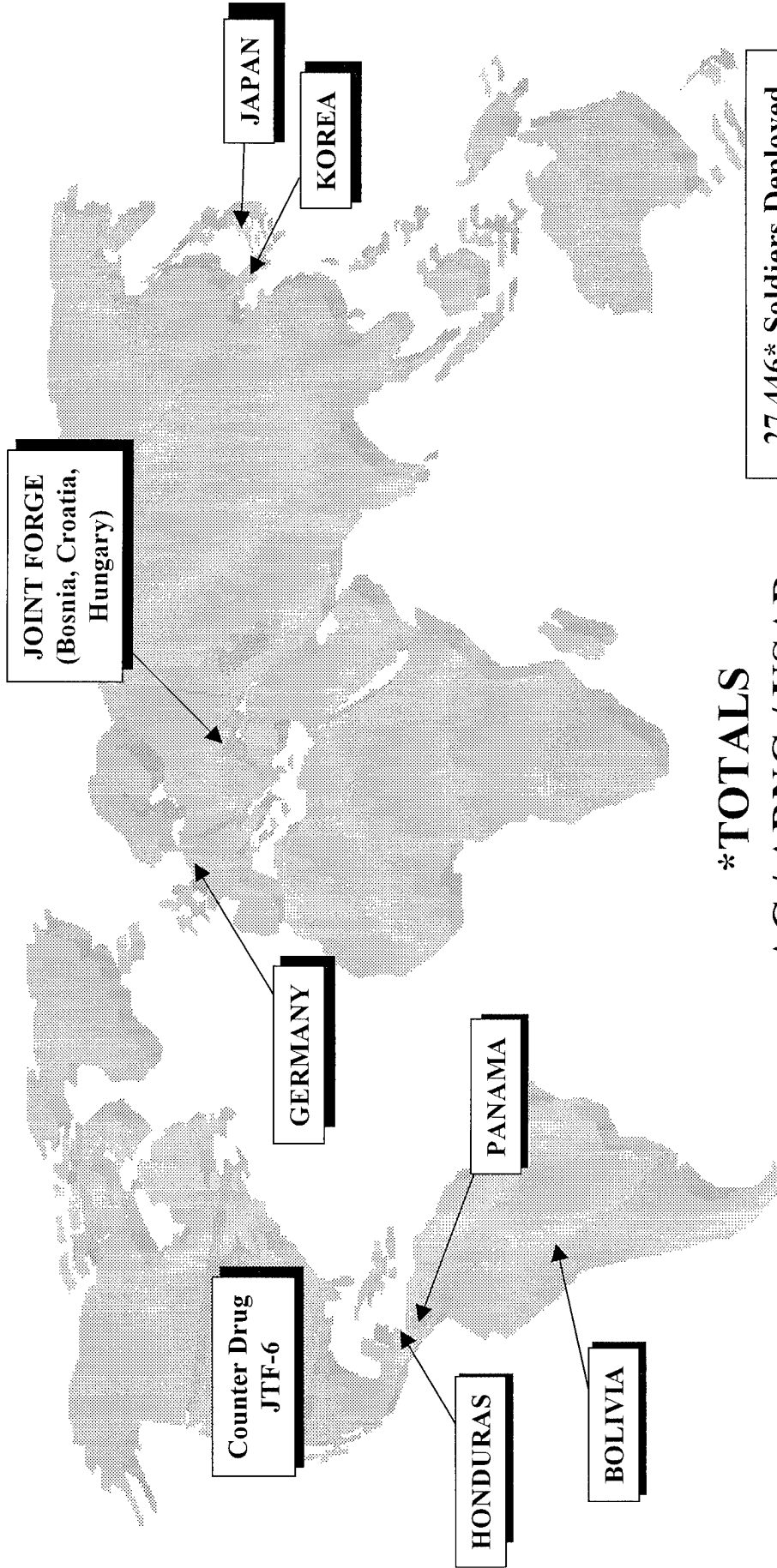

*TOTALS

AC / ARNG / USAR

23,821 / 2,157 / 1,468

(As of 21 January 1999)

27,446* Soldiers Deployed
on CONOPS or Exercises in
58 Countries.

DISASTER RELIEF HURRICANE MITCH

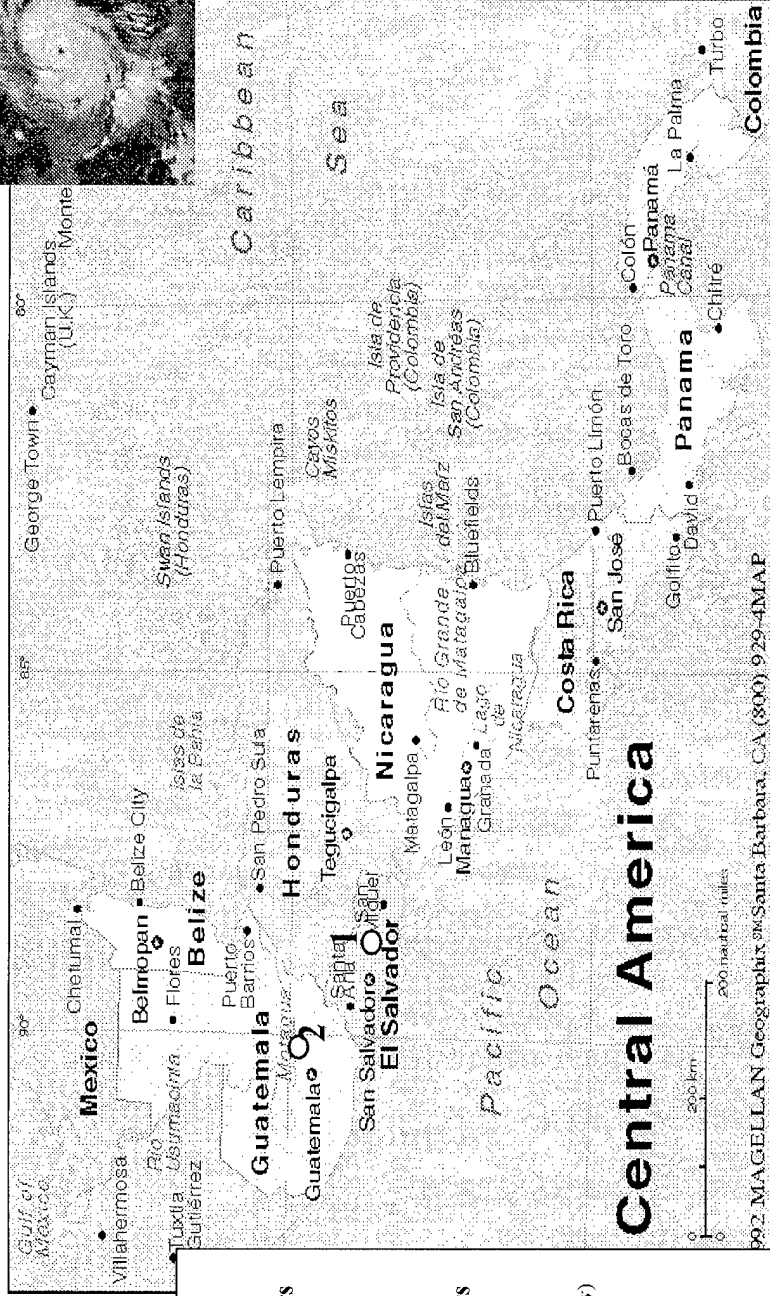
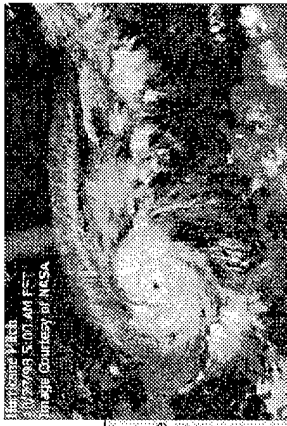

USAR TASK FORCES

1 - GUATEMALA

(Approximately 1,500 soldiers from 21 units from March-August 1999)

2 - EL SALVADOR

(Approximately 1,900 soldiers from 26 units from March-August 1999)

- Engineer Battalions (Combat)(Heavy)
- Engineer Companies
- Combat Support Equipment
- Dump Truck
- Bridge
- Well Drilling
- Military Police Companies (Guard)
- AG Companies (Postal)
- Hospitals (Cbt)(Spt)
- Veterinary Detachments
- Field Services Companies
- Water Purification Teams
- Civil Affairs Teams
- Public Affairs Teams
- Signal Corps Teams
- Direct Support Maintenance Sections
- Direct Support Supply Companies
- Chaplain Teams

MISSION: Plan, organize, and deploy two Task Forces (El Salvador and Guatemala) in support of USCINCSO's disaster relief effort in Central America with a deployment window of 15 Mar 99 through 15 Aug 99.

America's Army in Transition

FY 99 By Component (MTOE ONLY)

National Guard (NG)

45%

Active

Component (AC)

38%

Army Reserve (USAR)

17%

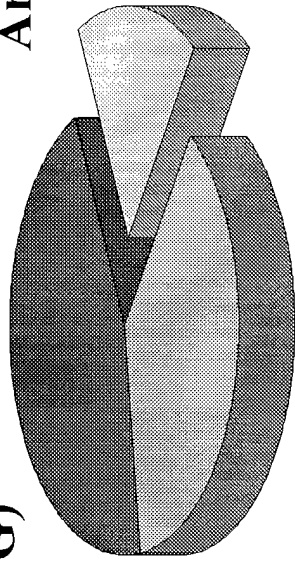

*Cbt

NG 56%

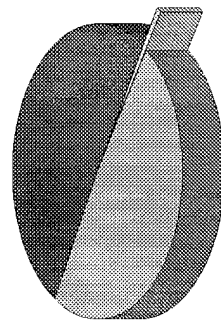

AC 43%

*Cbt Spt

NG 36%

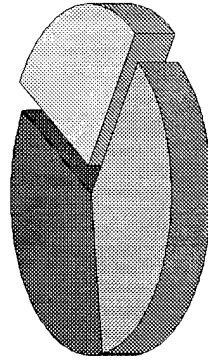

AC 38%

*Cbt Svc Spt

USAR 26%



AC 28%

America's Army's Battlefield Logisticians

- USAR Core Competencies
(percent of Total Army assets)
- Petroleum Supply Battalions - 92%
 - Railway Units - 100%
 - EPW Brigades - 100%
 - Chemical Battalions - 75%
 - Petroleum Groups - 50%
 - Medical Brigades - 85%
 - Transportation Groups - 80%
 - Water Supply Battalions - 100%
 - Motor Battalions - 78%
 - Civil Affairs units - 97%

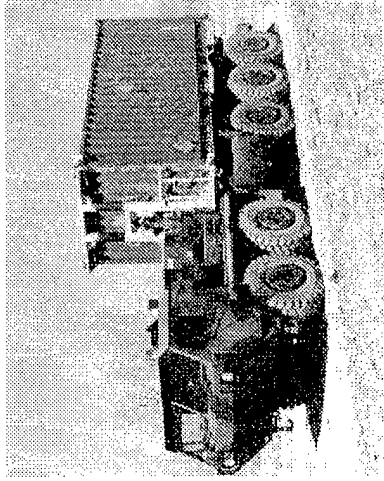
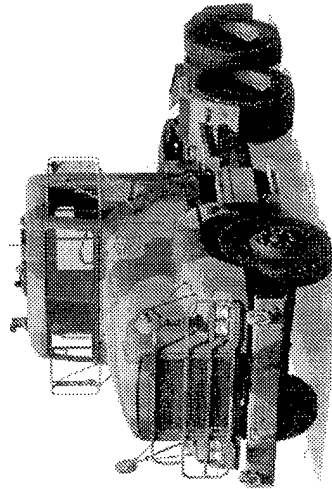
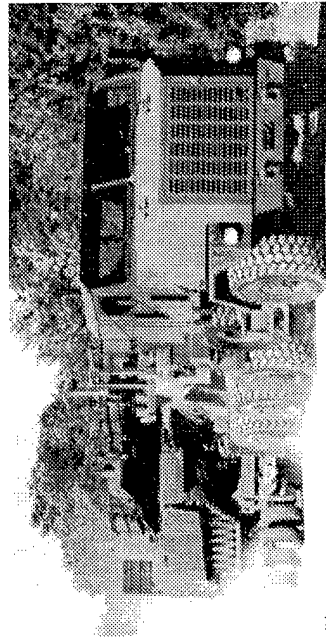

Common USAR Equipment
(Required Unit Equipment)

- HETs - 485
- HMMWVs - 10,143
- 5 Ton Trucks - 8,084
- 2 1/2 Ton Trucks - 4,676
- Line Haul Tractors - 2094
- Palletized Load Systems - 711
- HEMTT Wreckers - 339
- 20 Ton Dump Trucks - 456
- Tactical Firetrucks - 79
- HEMTT Common Bridge Trans - 284

Mission Success Requires A Modernized, Well-Maintained, Tactical Wheeled Vehicle Fleet

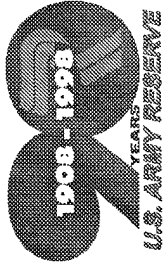

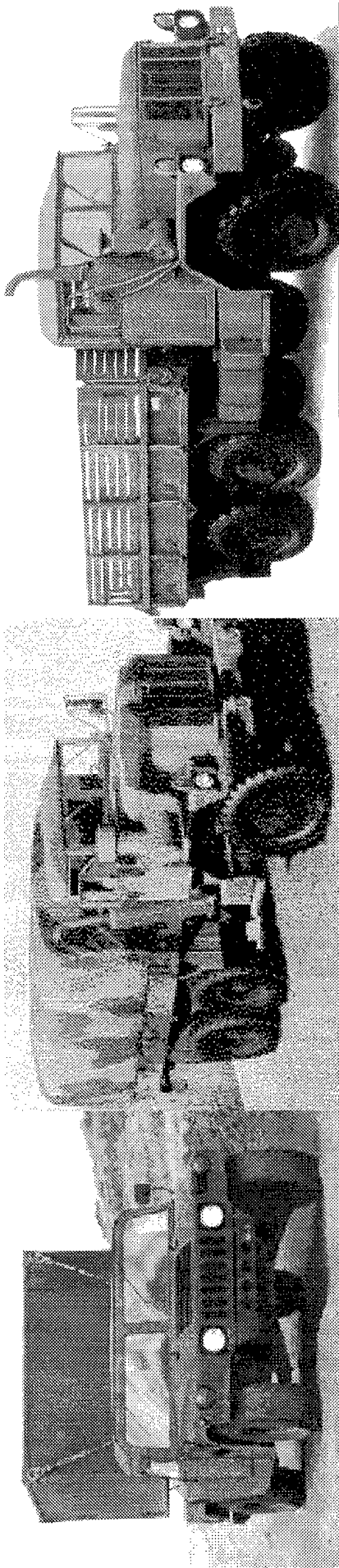

Army Reserve Tactical Wheeled Vehicles Status

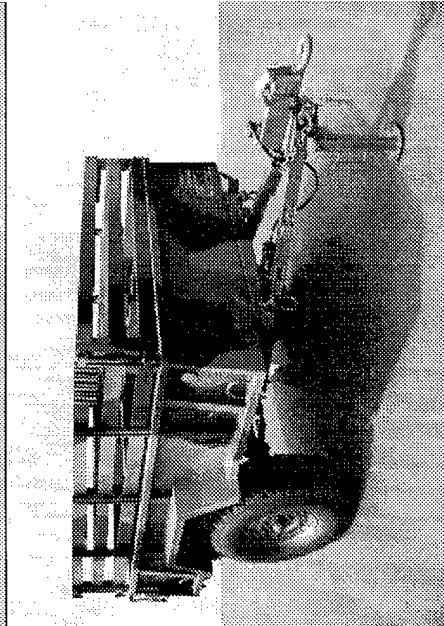
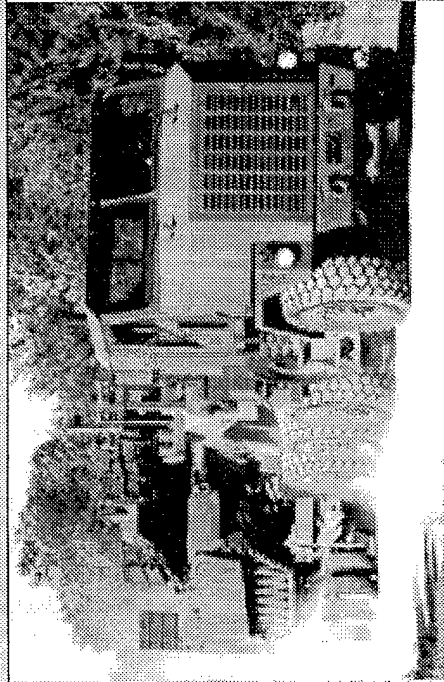
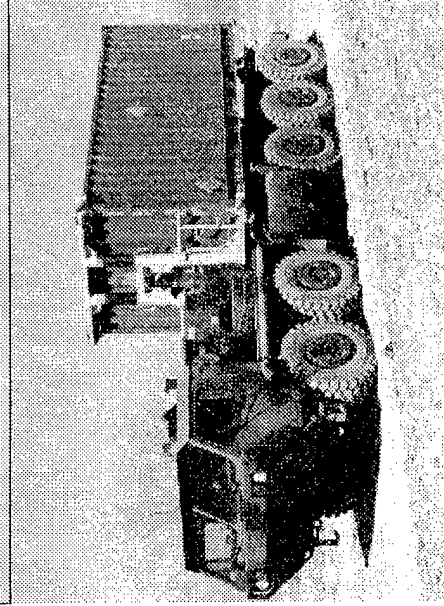

USAR TRUCK FLEET SCENARIO

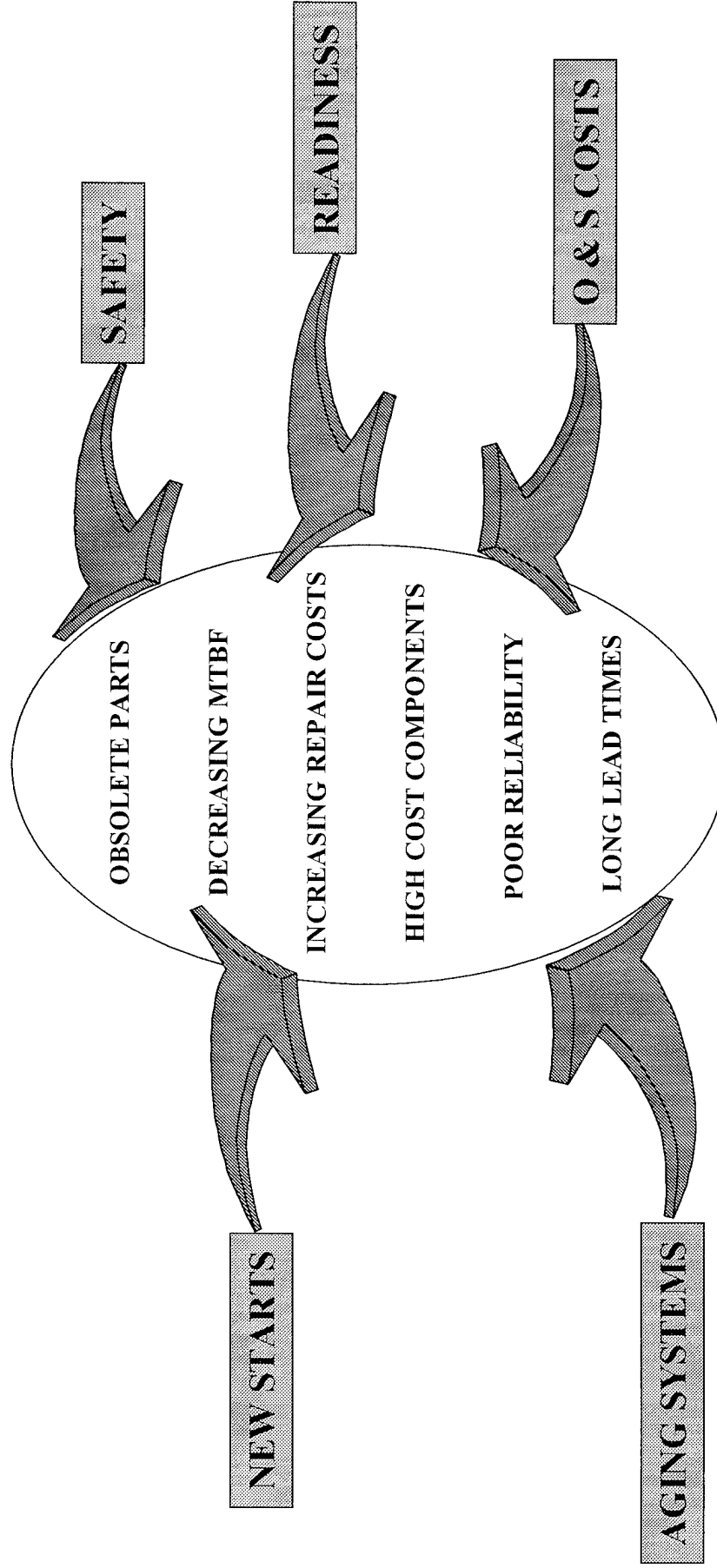

USAR/INDUSTRY PARTNERSHIP SOLUTIONS

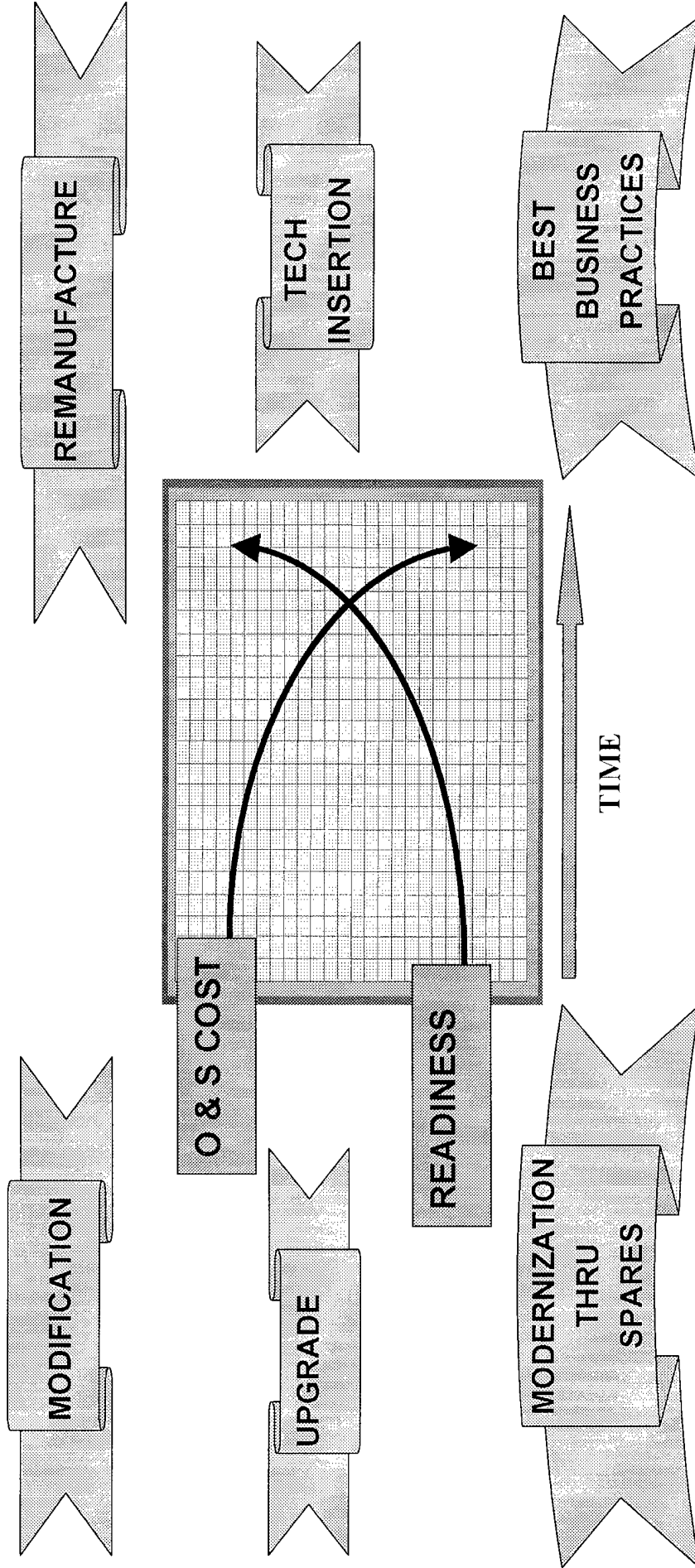

..... the Future Direction

Partnering With The Truck Industry

- **REMANUFACTURE**
- **TECH INSERTIONS**
- **PRODUCT IMPROVEMENTS**
- **REPAIR PARTS DISTRIBUTION**
- **MODERNIZATION THRU SPARES**
- **NEW BUYS**
- **PRODUCTION SURGE**
- **MULTI-USE/PURPOSE VEHICLES**
- **MILITARY ADAPTATION OF
COMMERCIAL MODELS**

USAR fielding strategy is tiered to field FP1&2 with new vehicles and remanufacturing the remaining vehicles for the lower tiers.

SUSTAINMENT INITIATIVES

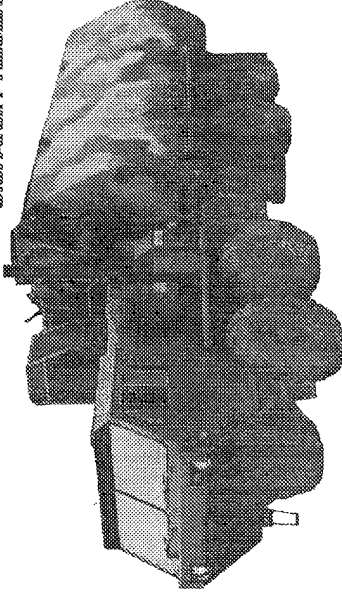

HEMTT Common Bridge Transport (CBT):

	QTY	NEW COST	CONVERSION	COST SAVING
FY95	100	\$10,300,000	\$8,500,000	\$1,800,000
FY96	102	\$10,506,000	\$8,670,000	\$1,836,000
FY97	28	\$2,884,000	\$2,380,000	\$ 504,000
FY98	10	\$1,030,000	\$ 850,000	\$ 180,000
FY99	40	\$4,120,000	\$3,400,000	\$ 720,000

- Army Reserve Has Five MTOE Multi-Role Bridge Companies
- Combines Both Float and Fixed Bridging Into One Unit
- Will Be FSP 1 or 2
- Each Company Authorized 56 CBTs
- HEMTT CBT Is a Pacing Item.
- USAR Initiated a Program to Convert HEMTTs to the CBTs to Meet Requirement

WORK TO BE COMPLETED AT VARIOUS SITES IN U.S. (OSHKOSH, WI)

Ready — Relevant — One Army, Building for the Future

DAAR-LO

America's Army Reserve

Working With The Trucking Industry to Break Paradigms

M915 TO M915A4:

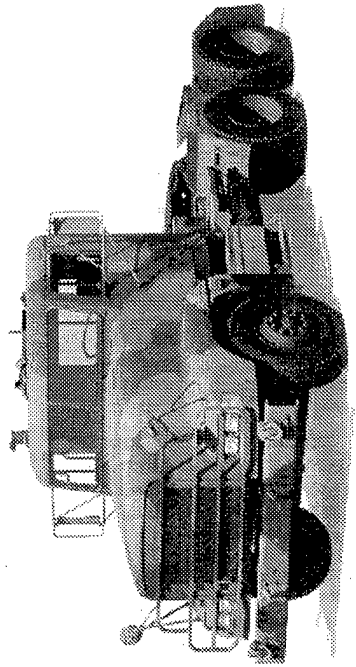

FY98	QTY	NEW COST	REFURB	COST SAVING
	2	\$ 234,000	\$ 169,000	\$ 65,000
FY99	60	\$7,020,000	\$5,070,000	\$1,950,000

Tactical Wheeled Advanced Technology Demonstrator--Proven Performance:

- Army Reserve Force XXI Contribution
- Showcased Potential Applications of Emerging Technologies
- Decreased Costly Vehicle Life Cycle Maintenance
- Enhanced Crew Performance and Safety
- Developed Smart Business Practices

Safety Package

Electronic Stroke Alert
Collision Avoidance System
Heads-Up Display

Efficiency Package

Dial your Oil Change
Never Lo Oil System
Prelube Starter

Enhancement Package

Muffler Silencer
Proheat System
Rust Protectant

OTHER INITIATIVES

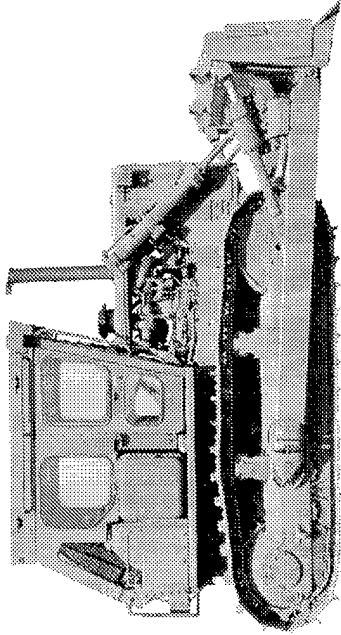

D7F Dozers:

	QTY	NEW COST	REFURB	COST SAVING
FY96	151	\$36,240,000	\$12,042,000	\$24,198,000
FY97	73	\$17,520,000	\$ 5,822,000	\$11,698,000
FY98	6	\$ 1,440,000	\$ 418,600	\$1,021,4000

- USARC Conducted Comprehensive Inspection and Analysis of the Total USAR D7F Fleet.
- TACOM/Partners in Industry Designed and Implemented a Total Rebuild Program.
 - Took Broken Down System, Refurbished It, Returned New System-With a New Warranty.
 - 230 of the USAR D7F Fleet Has Been Refurbished.

WORK TO BE COMPLETED AT VARIOUS CATERPILLAR SITES IN U.S. (IL, WI, AL, SC, IA, NY, MI, AK, PA, CA, FL, MA, VA, NM, KY, MD, AR, PR, OK, MN, CO)

FUTURE INITIATIVES

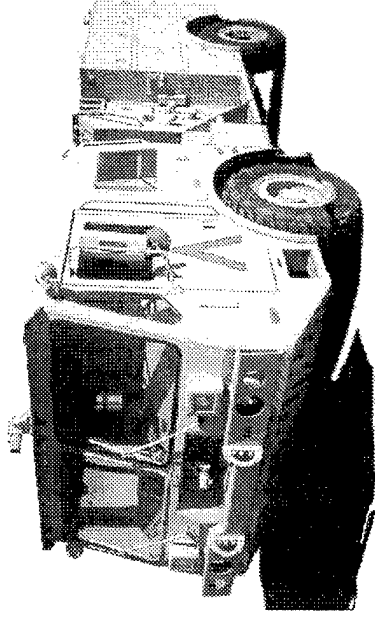

Fire Truck Assessment:

FY99	QTY	EST NEW COST	EST GLIDER COST*
	75	\$26,250,000	\$15,000,000

- Industry Partner Conducted Comprehensive Inspection and Analysis of the Current Army Reserve MAC I Fire Trucks.
- Objective to Identify and Document Any Major Safety or Operational Problems and Shortfalls.
- Visited 13 Sites, Major Manufacturers, and Interfaced With Users and TACOM.
- Recommendations Provided for Best Method of Overcoming the Problems and Shortfalls.
- Options Include IROAN Program, Glidering the Fire Trucks, Partial Upgrades, or Buying New Vehicles. Decision Pending.
- DA Prepared to Buy HEMTT Firetrucks for USAR.

*Glidering Firetruck would require retaining the chassis and axles

Reserve Components Procurement Exhibit (P-1R)

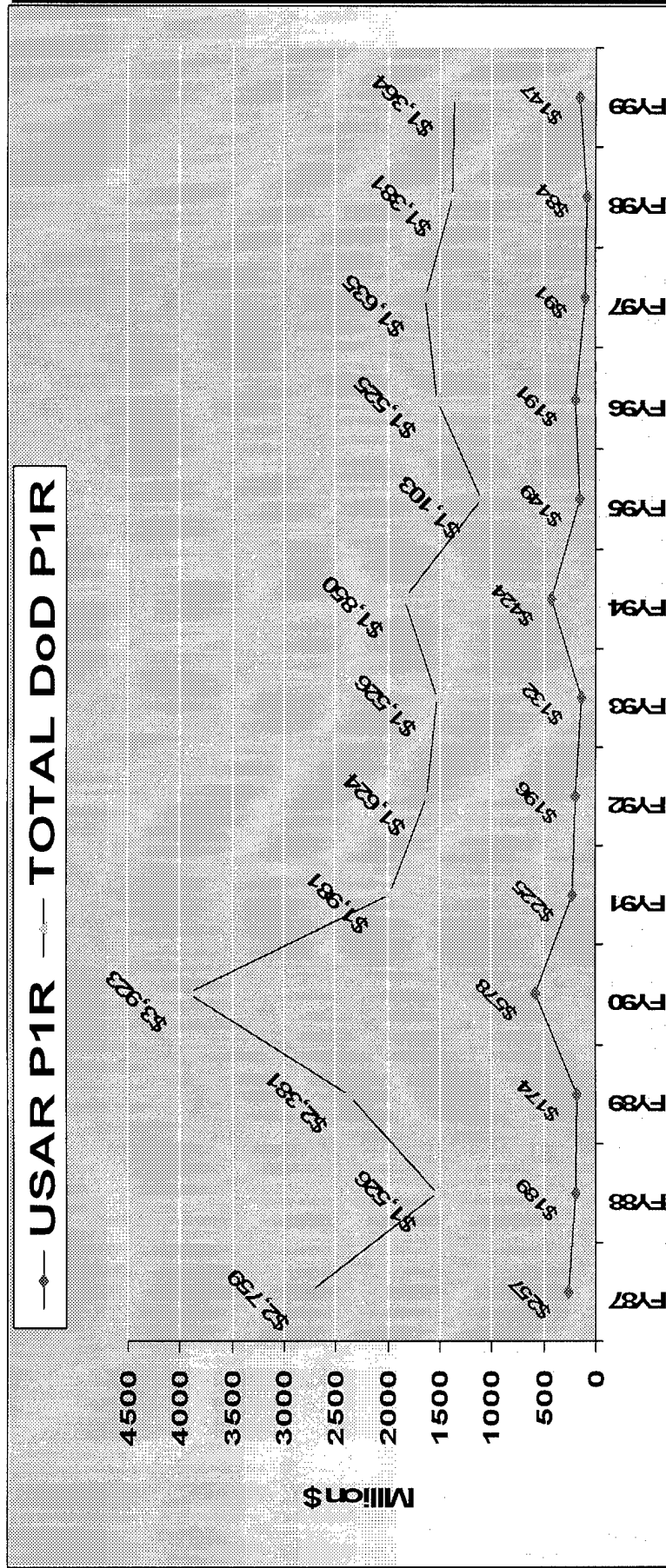

The Reserve Components Procurement Exhibit (P-1R) is a subset of the Department of Defense Procurement Programs (P-1) exhibit and reflects the Service estimate for those funds which will be used to procure equipment for the National Guard and Reserve. (Does not include NGREA or Congressional Adds.) The P-1R is only a snapshot of a point in time. Fiscal resources, programmatic, and priority changes may have revised data shown above.

PRESIDENT'S BUDGET P1R

FY98 P1R
\$84.4M

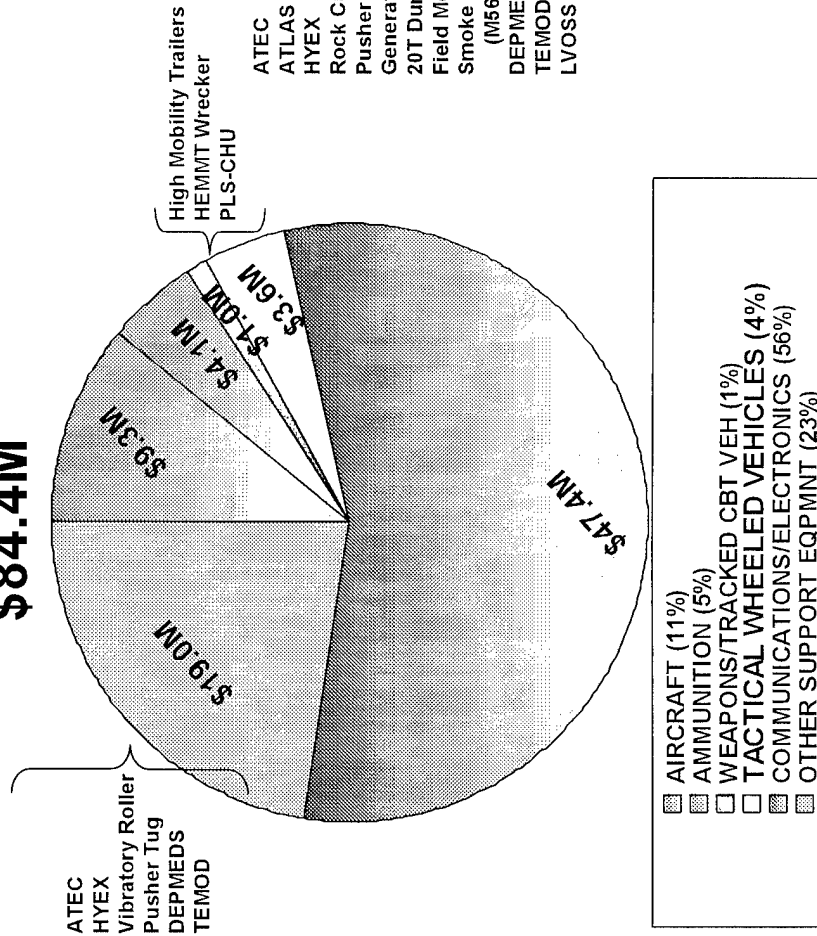

FY99 P1R
\$147.0M

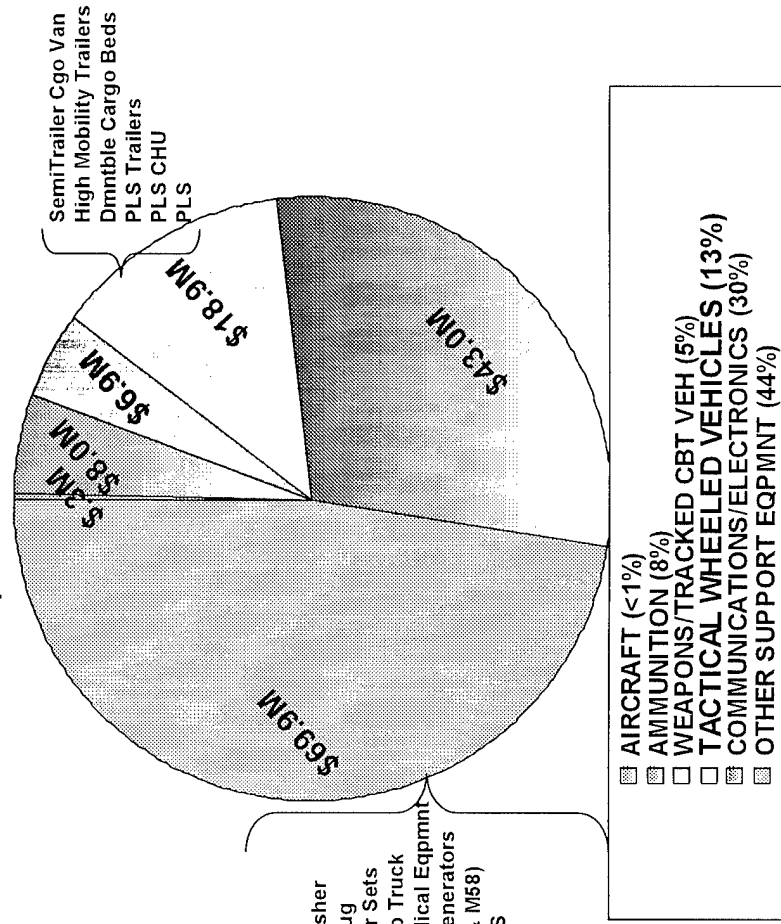

CONGRESSIONAL ADDS

FY98 Congressional

Adds

\$8.0M

USAR
\$8M - All Terrain Crane

- USAR
- ARNG

ARNG
 \$83M - UH-60 Blackhawks
 \$ 3M - UH-60L Blackhawk Kits
 \$95M - Bradley FV Upgrades
 \$40M - FASV
 \$56M - Paladin
 \$ 5M - MELIOS NVD

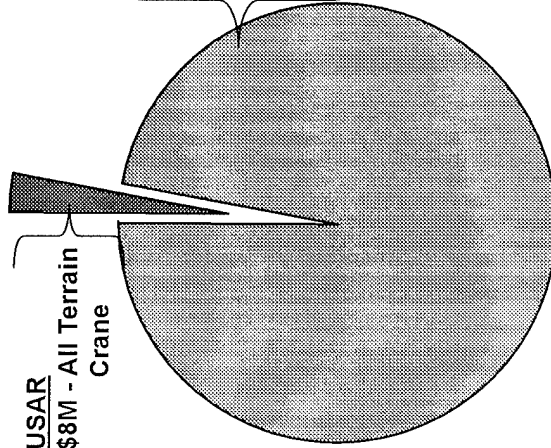

\$282.0M

FY99 Congressional

Adds

\$9.5M

USAR
 \$8M - All Terrain Crane
 \$1.5M - HYEX
 Laser Leveler

- USAR
- ARNG

ARNG
 \$58.1M - UH-60 Blackhawk
 \$13.2M - Medium Truck ESP
 \$30.0M - MLRS
 \$ 3.0M - R2000 Eng Flush Sys
 \$70.0M - Bradley Upgrades
 \$44.0M - SINGARS
 \$ 3.0M - AH-64 VMES
 \$ 3.0M - Engagement Skills Trainer

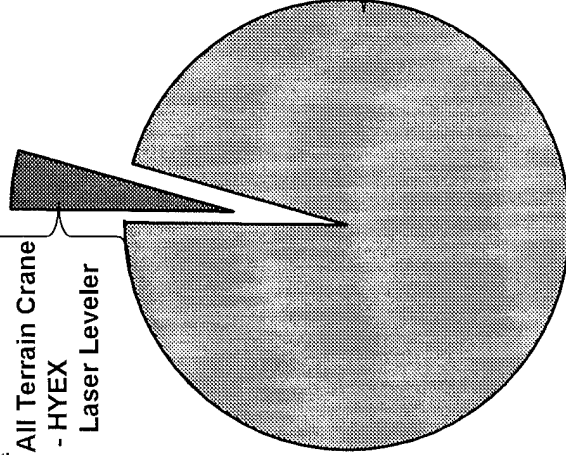

\$224.3M

CONGRESSIONAL ADDS ARE COMBAT ARMS AND COMBAT SUPPORT ORIENTED

National Guard & Reserve

Equipment Appropriation (NGREA)

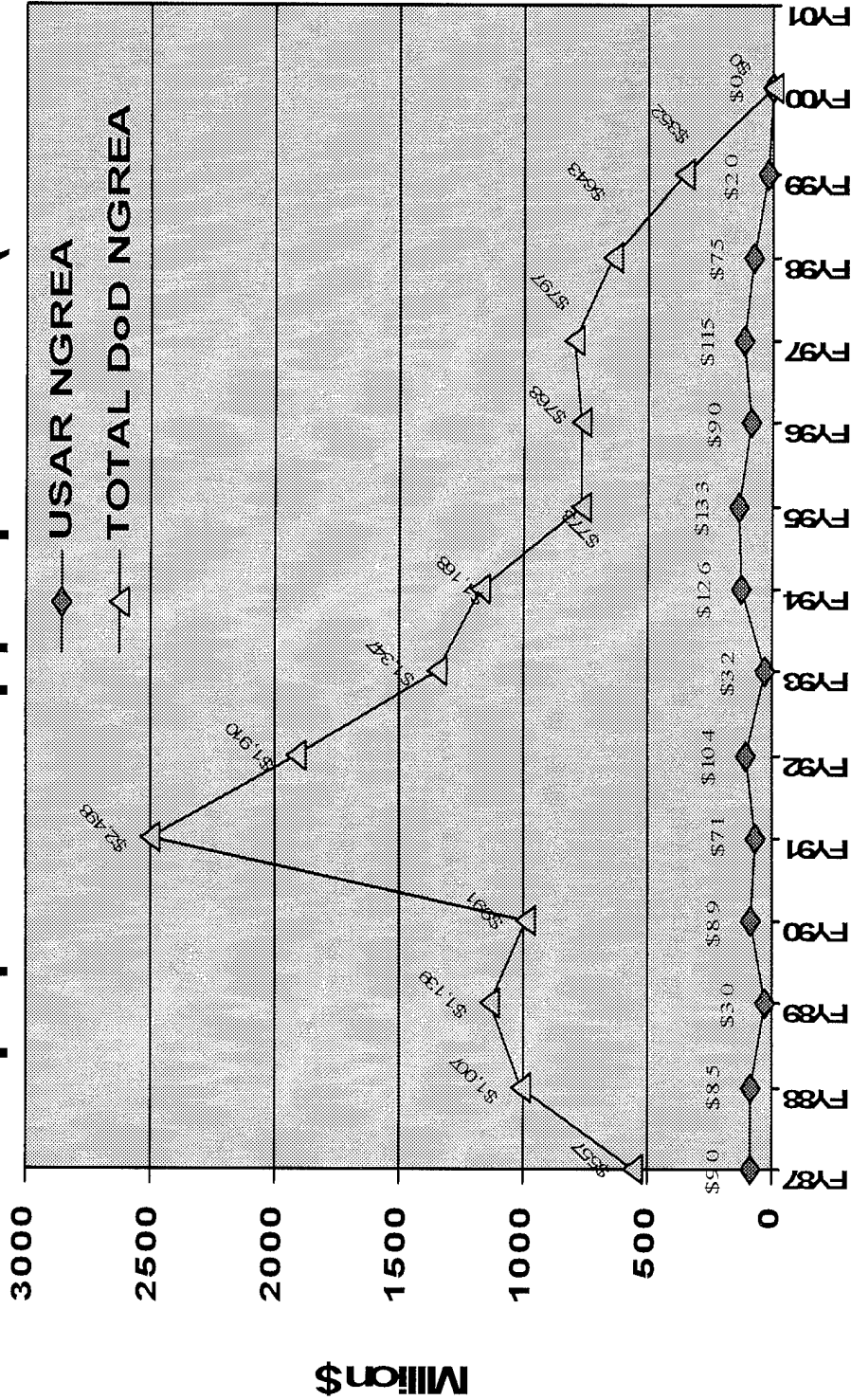

Congress expects DoD and DA to fund Reserve Component Equipment Procurement Without NGREA. Declining NGREA reduces the flexibility needed to pursue priority equipment acquisition.

What We Need From Industry

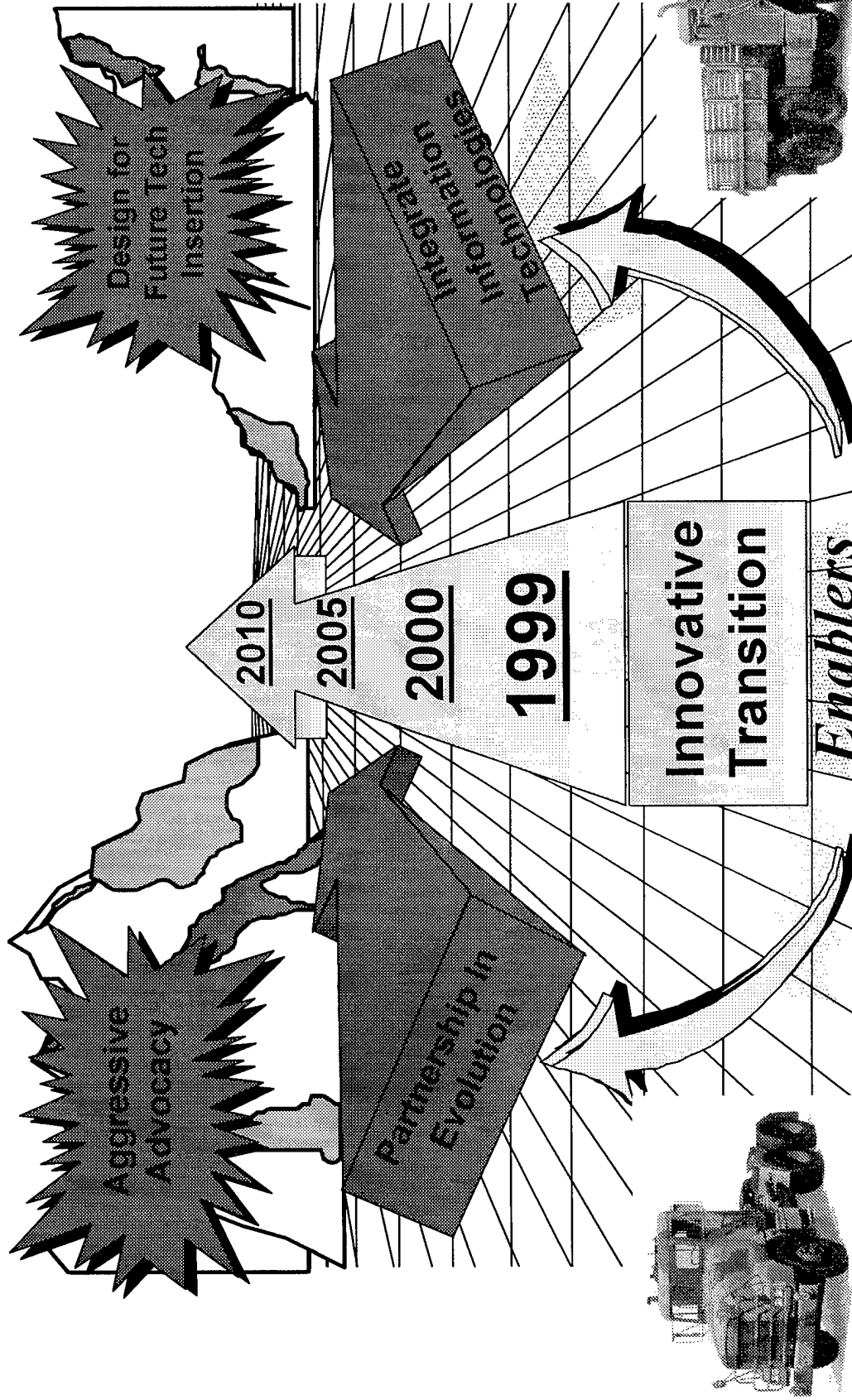

The USAR's Future Is In Partnership With Industry

***A value-added leader
in America's Army
and the Nation ...***

***... trained, ready, and
relevant ... enabling
the Army in peace
and war to achieve
total victory.***

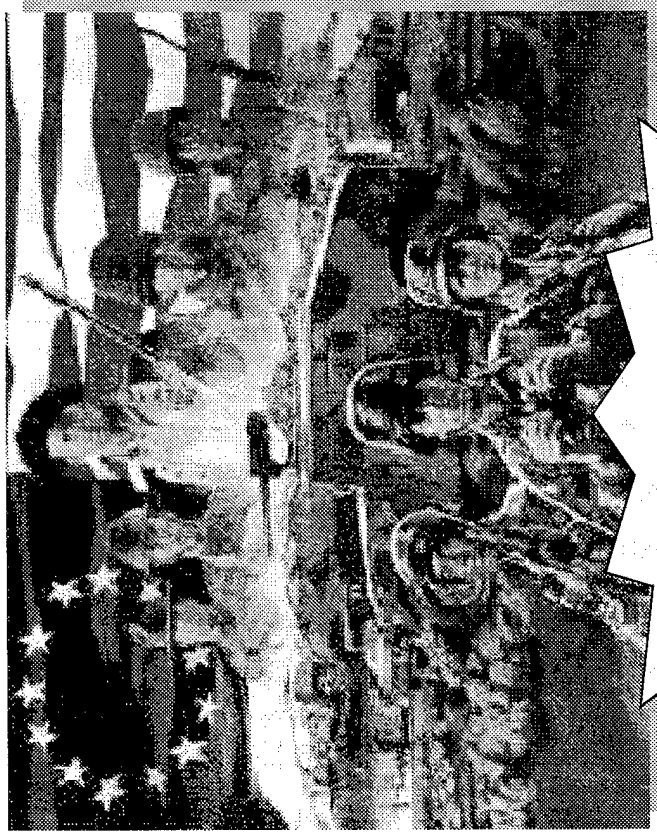

***“Mission first,
soldiers always”***

GEN Wilson

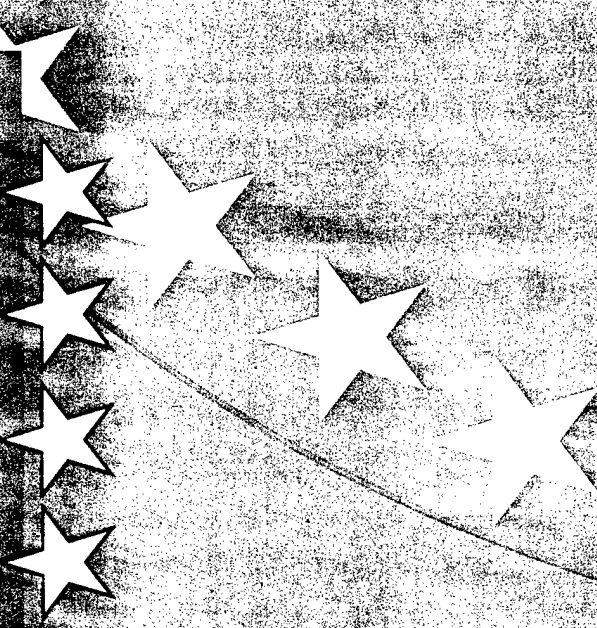

AIRNIXY

MATERIAL

COMMAND

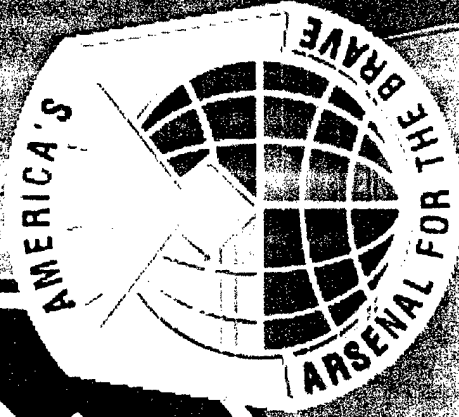
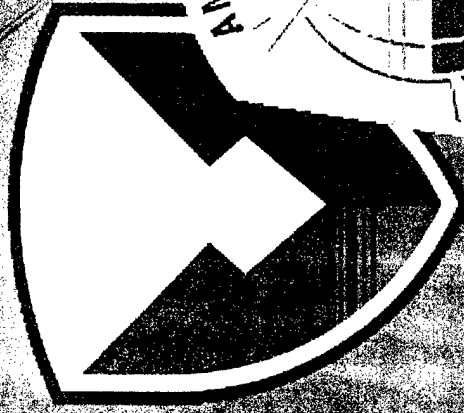

**Tactical Wheeled
Vehicle Conference**

1 February 1999

Relevant, Responsive & Ready!

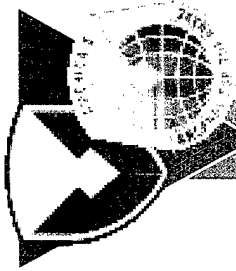

The Army's Materiel Command



Strategic Intent: "To Be the Army's Materiel Command... Relevant, Responsive, and Ready!"



The Army Vision

The World's Best Army, a full spectrum force - trained and ready for victory. A Total Force of quality soldiers and civilians.

- ✓ A values-based organization
- ✓ An integral part of the Joint Team
- ✓ Equipped with the most modern weapons and equipment the Country can provide
- ✓ Able to respond to our Nation's needs
- ✓ Changing to meet the challenges of today...tomorrow...and the 21st Century

"Soldiers Are Our Credentials"

The AMC Vision

"The Leader in equipping and sustaining America's Army through superior technology and responsive support assuring worldwide power projection and decisive victory."

"America's Arsenal for the Brave"

America's Arsenal For The Brave

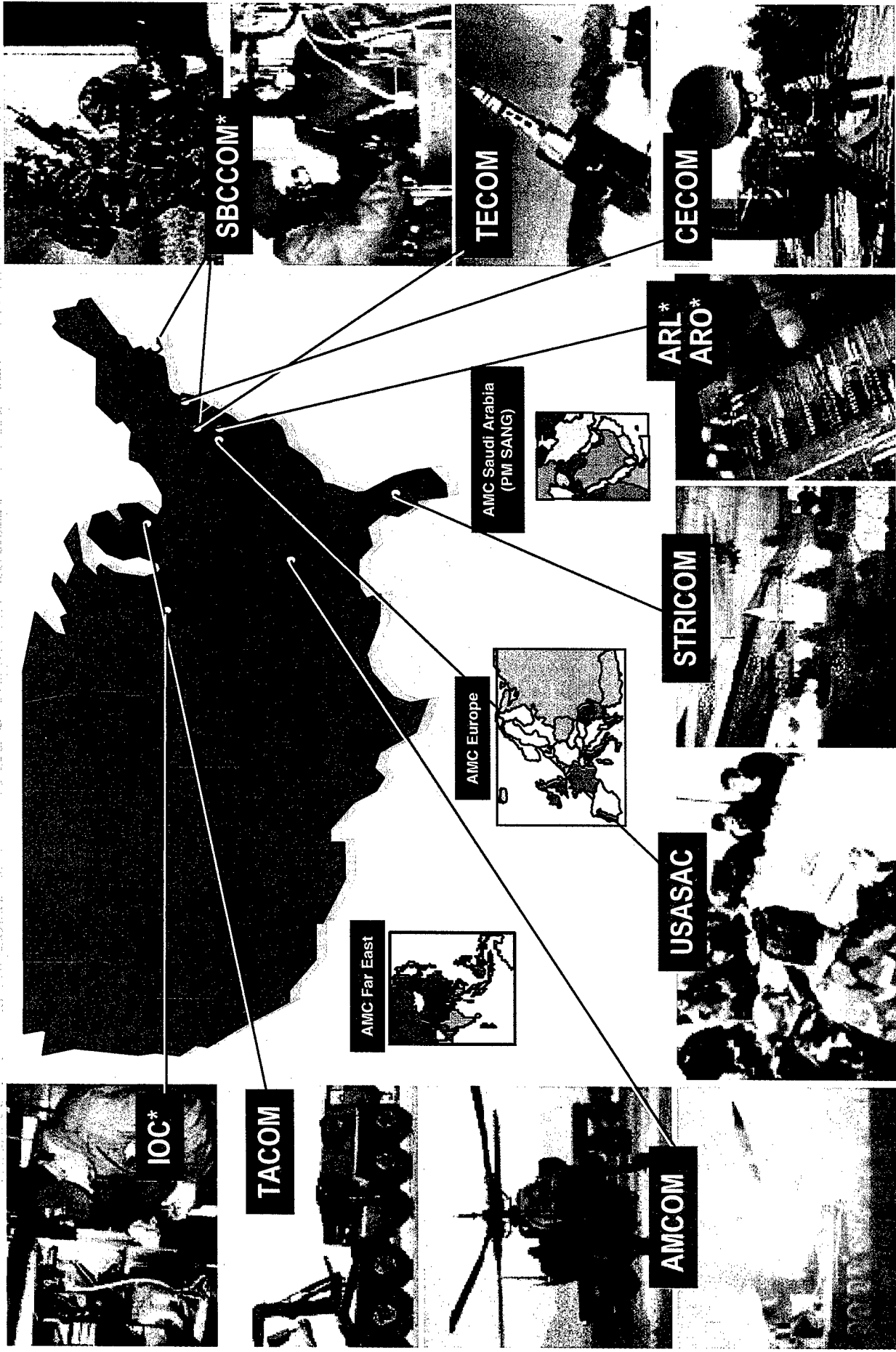



AMC Business Includes

FY98*

Expenditures

\$19.5 Billion

\$8.0B Direct

\$11.5B Reimbursable from

Non-AMC

*Awaiting Final Report/MS

Research, Development, & Acquisition

- 17 AMC R&D Labs
- 9 Test Centers/Ranges
- 120+ College/Universities
- 74% of Army S&T Funds
- 40% of Army RDA Funds
- 148 Patents
- 371 ACAT I-IV Programs

Ammunition Wholesale Stockpile
Total: 3.2 Million Tons

\$22.4B Conv Ammo
\$10.8B Missiles
\$33.2B Total



People

58,158 Civilians

2,714 Military

200,000+ Family Members



Depot Maintenance

\$1.7 Billion FY98

Inventories

\$7.27 Billion

(Wholesale Secondary Items)

Requisitions Processed

1.2 Million Army

6.8 Million DLA

(Secondary Items)

\$3.4B Sales \$1.2B Credits

Contracting (FY98)

>24K Actions (>\$25K each)

82% Productivity (Qty)

47% Productivity (\$\$\$)

Outsourcing Trend (FY98)

Depot Maintenance

35%

Tech Base

67%

BASOPs 28%



AMC's Manpower Targets

Military

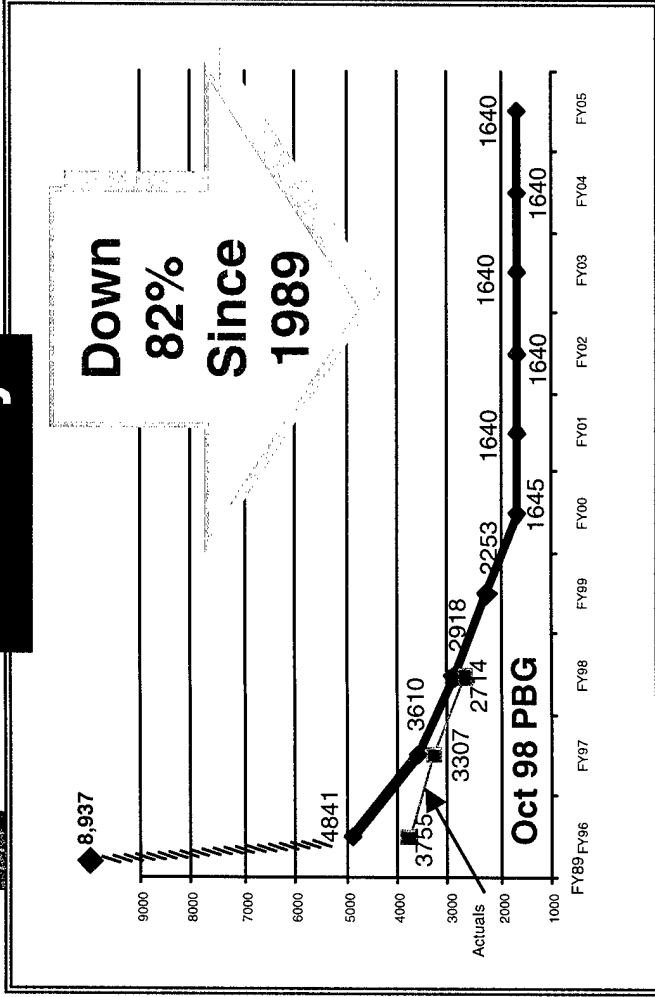

Civilian

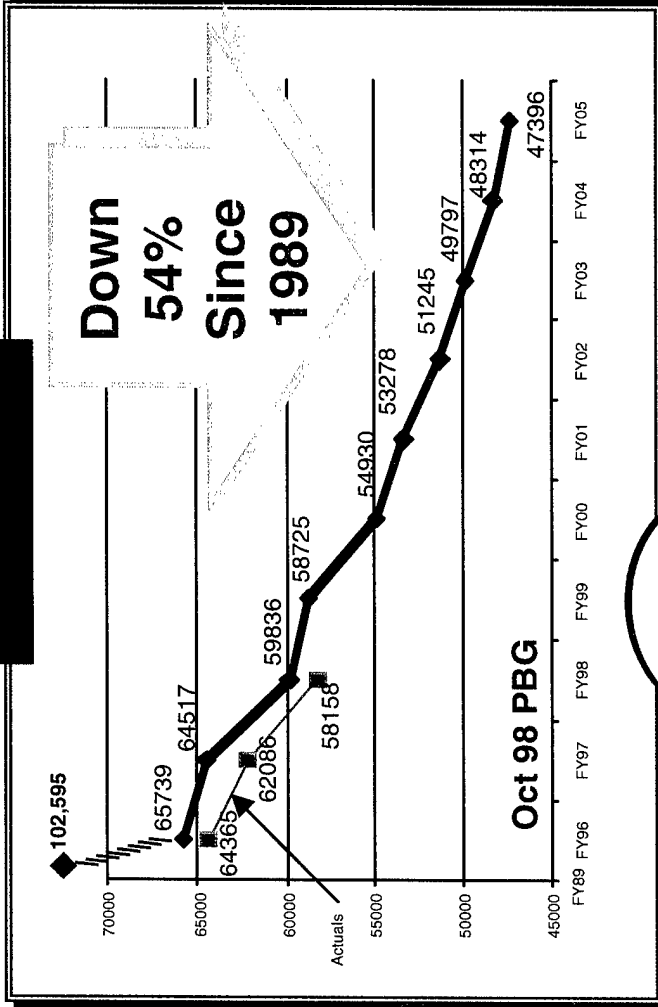

Current Program Budget

Guidance Calls for:

- Eliminating 1,074 (or 39.5%) of Soldiers Between End FY98 and FY01
- Eliminating 10,762 (or 18.5%) of AMC Civilian Workforce Between End FY98 and FY05

Retirement Eligible:

1989: 15%
2004: 50%

Average Age of AMC Workforce:
1989: 42.1
Today: 47.0

AMC Today – And Into the Future – Means...



**Logistics Power
Projection**

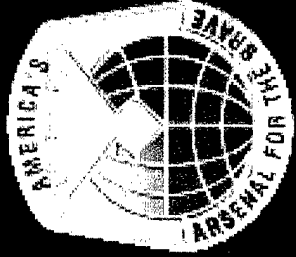

**Technology
Generation/
Application**

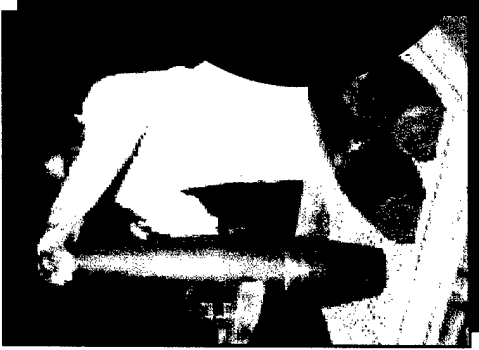

**Acquisition
Excellence**

Information Technology
- A Key Enabler -

Generate Warfighting Capability...One-of-a-Kind Integrator...Capital Asset



Logistics Power Projection

*Shifting Focus from Stockpiles in Theater to Power
Projection of Mobil Stocks*

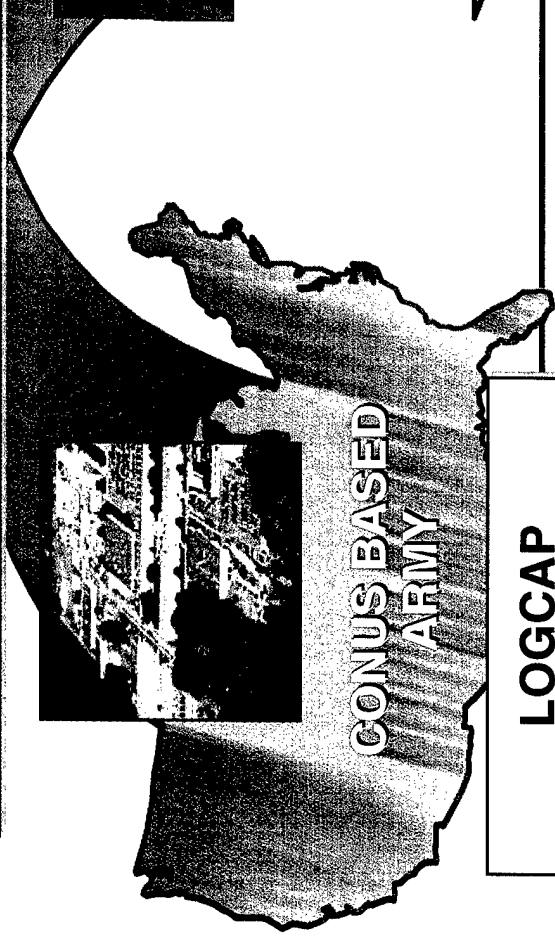

...Sealift
Now...13 2001...16

....Airlift
Now...47 2006...120

- LOGCAP
- APS
- Wholesale Log Mod
- ISM
- Single Stock Fund

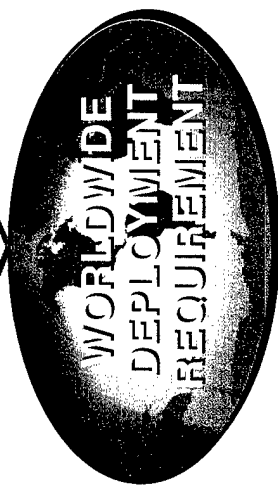

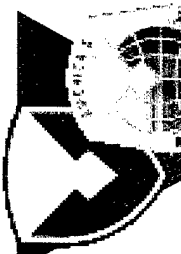

Army Pre-Geographic

OP Project Stocks
Sustainment Stocks
Norway:
155 SP FA Battalion
Sustainment Stocks

Stocks (APS)

Sustainment Stocks
(DPG Based)
\$6.9B Required
-\$2.1B in Offsets

APS
CONU

APS-5 SW ASIA
Kuwait: 2X1 Brigade
Sustainment Stocks
OP Project Stocks
ITT Corp
Qatar: 2X1 Brigade
Sustainment Stocks
LSI Corp

APS-4 PACIFIC
Korea: 2X1 Brigade
OP Project Stocks
Sustainment Stocks
Japan: OP Project Stocks
Sustainment Stocks



★ APS-3 HQ
CHARLESTON

★ APS-2
EUROPE

★ APS-5
SW ASIA

★ NORWAY

★ BENELUX

★ ITALY

★ KUWAIT

★ QATAR

★ APS-3
AFLOAT

APS-3 AFLOAT

Afloat: 2X2 Brigades
OP Project Stocks
Sustainment Stocks
Dyncorp-
Maintenance Surveillance

APS-Afloat

- 8 Transloads through Nov 00
- End State 16 Ships
- 30-36 Months Maint Cycle

**5 Locations;
\$6.9B Requirement;
Project & Sustainment Stocks**



Civilian Contractors on the Battlefield

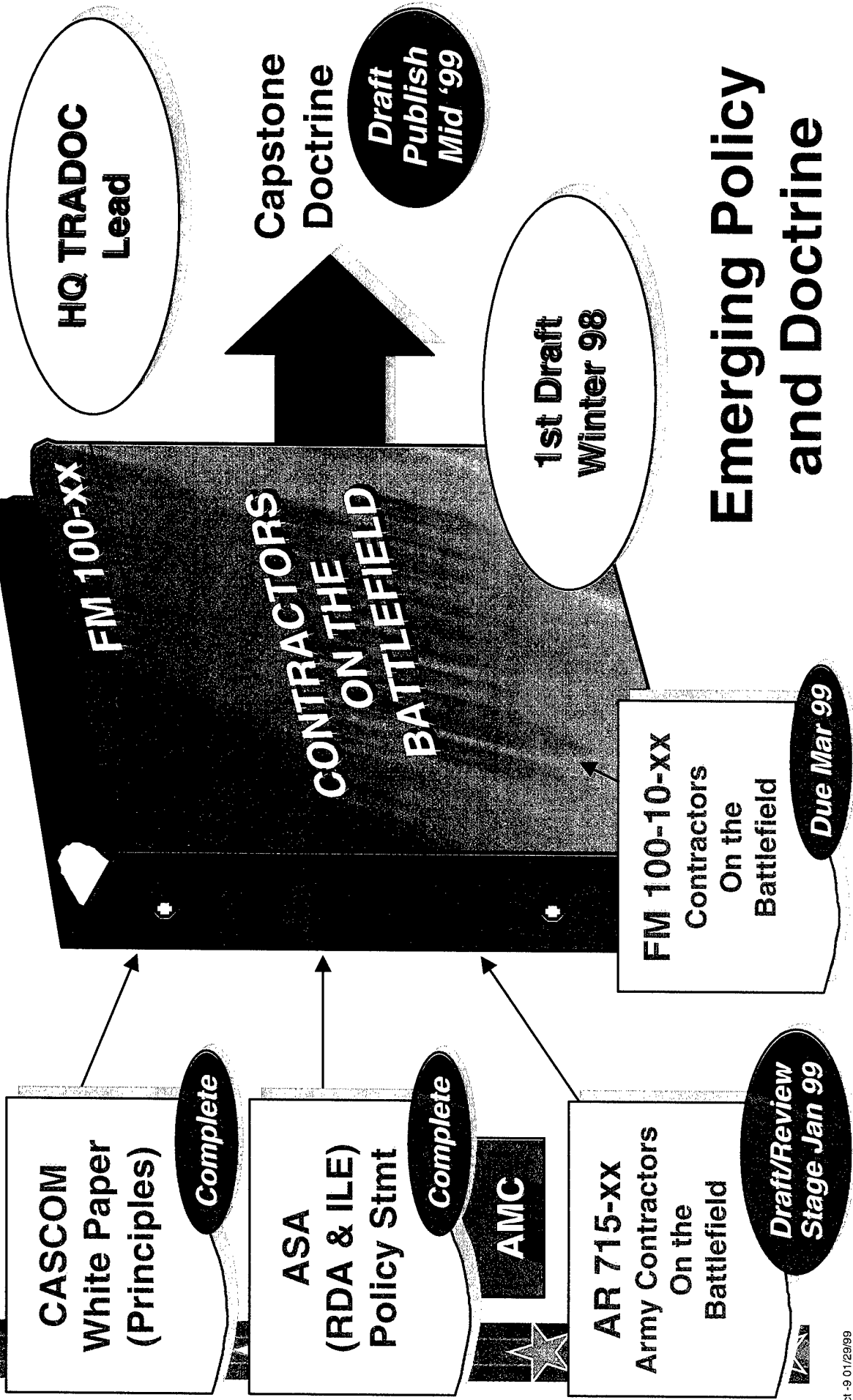

Emerging Policy and Doctrine

America's Ability to Fight & Win is Priority #1

Civilian Contractors on the Battlefield Play an Increasingly Important Role

- **Civilian Contractors are Integral to Army Field Sustainment**
- **Pressure to Outsource & Privatize are Increasing & Make Good Business Sense... in many cases**
- **Challenges Related to Contractors on the Battlefield Must be Addressed**





Acquisition Excellence

REVOLUTIONIZING ACQUISITION

Administrative Lead Time/
Procurement Lead Time Reduction

Modeling &
Simulation

Credit Card

Prime Vendor Support

Virtual Testing

Modernization thru Spares

Cost as an
Independent
Variable

Best Value

Roadshows
COTS

Past
Performance

Performance Specifications

Integrated Product &
Process Development

Partnering

OSCR/TOC

Corporate
Contracting

Electronic Commerce /
Electronic Data Interchange

Army Single
Process Initiative

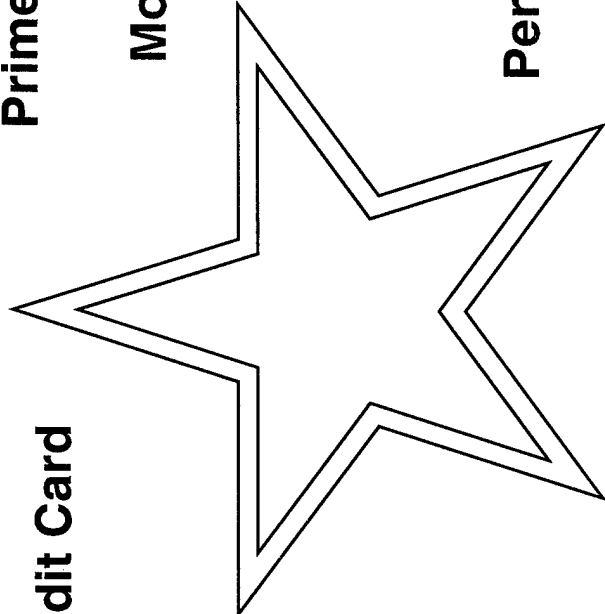



WE NEED INDUSTRY HELP ...

Administrative/Production Lead Time (ALT/PLT)

THE PROMISE	FY 97	FY 98	FY 99	FY 00	FY 01	FY 02	FY 03	POM TOTAL
Cost	0	0	0	0	0	0	0	0
Savings (SMA DBOF)	195*	50	27	14	14	12	10	322
NET	195	50	27	14	14	12	10	322

PLT
Represents
77% of Our
Current
Lead Time

**ALT/PLT GOALS:
DOLLAR
WEIGHTED**

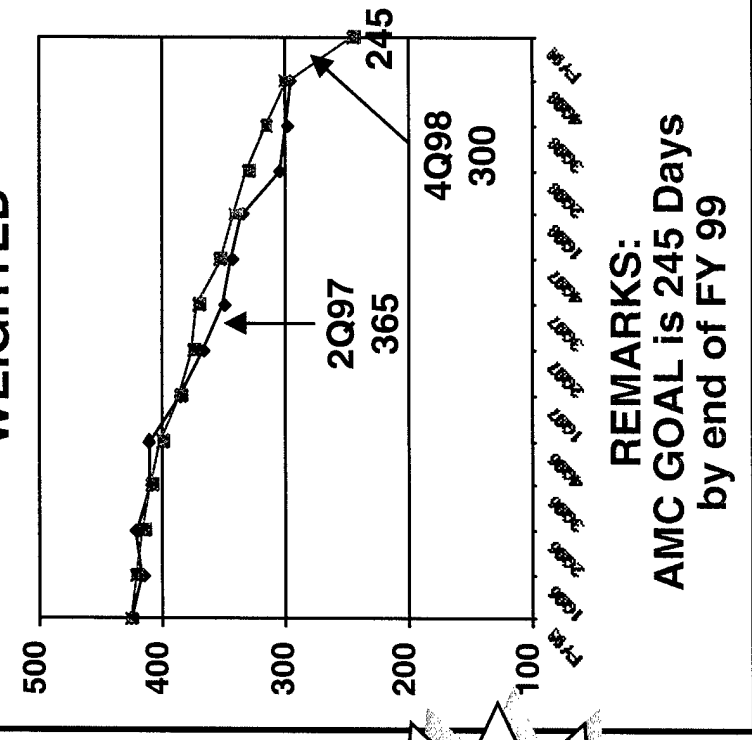

**REMARKS:
AMC GOAL is 245 Days
by end of FY 99**

* FY97 savings of \$195M taken in FY97 BES

Initiatives:

- Long Term Contracting
- Electronic Ordering
- Ordering Officers
- Data Base Scrubs
- Best Value w/ schedule as an Independent Variable

IDIQ

(Indefinite Delivery Indefinite Quantity)
Multi-year
Multiple Items



Acquisition Excellence

MIL SPECS AND STDs REFORM

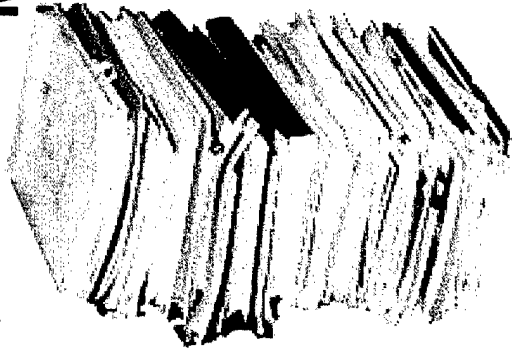

**100%
Scrubbed**

**Army Completed
Review of 12,354
Specs & STDs**

DUSD(AR) PAT
Team Led by
**AMC Principal Deputy
for Acquisition**

SECDEF, 1994

“...moving to greater use of performance and commercial specifications is one of the most important actions that DoD must take to ensure we are able to meet our military, economic and policy objectives in the future.”

BLUEPRINT FOR CHANGE

STDs:

176 Canceled
131 Inactivated
139 Converted

SPECS:

2108 Canceled
2922 Inactivated
776 Converted
3890 Transferred to DLA
2212 Retailed as Detail (Includes 1458 by Institute of Heraldry)

**Challenging
Four Year
Goal Successfully
Completed in Oct 98**

A Case Study in Progress!



Electronic Contracting

*We're on
the Web*

Moving to "Paper-Free" Acquisition

- * "One Stop" Entry Point for Industry into AMC

Business Process:

- * Contracting Opportunities Across Army via Web Page Links
 - View RFPs / IFBs / RFQs
 - View Attachments / Exhibits "Online"
 - Automated Link to Tech Data Packages
 - Electronic Downloading via Modem

Policy:

- * Contracting Guides
- * Past Performance Pamphlet
- * FAR / DFAR Links

www.army-acquisition.net



Acquisition Business Web Site

"Serving the U.S. Army Acquisition Community"

Army Contracting Opportunities

Your entry to all open Army Solicitations

Acquisition Business

Solicitations,
Executive Information System,
Electronic Commerce Links,
Solicitation Maintenance,
Registration and Feedback

Source Selection Resource Center

Obtain Source Selection Guidance:
Best Value
Past Performance
Oral Presentations
Debriefings

Acquisition Tool Set

Bid & Response Gathering-
Requirements- Feedback
Download Documents



AMC Science & Technology Team

71% S&T Outsourced

42% S&T Outsourced

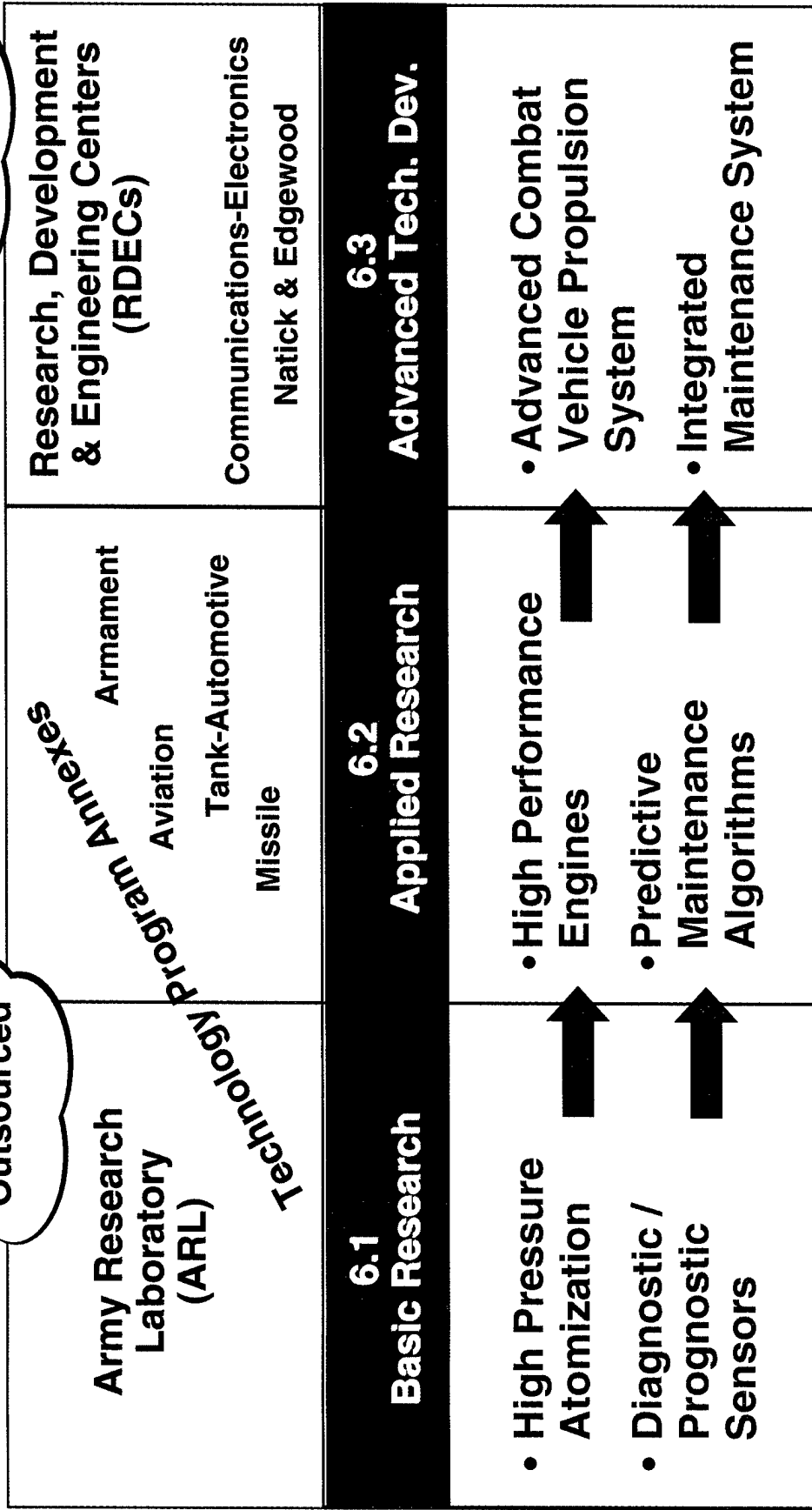

ARL & RDECs provide the S&T necessary for decisive victory.

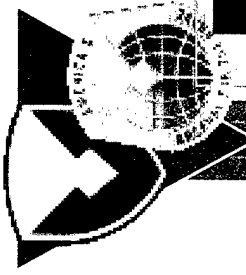

AMC R&D Partnerships with Industry and Academia



National Automotive Center
TACOM

Dual use Automotive Technology with...

- DoD Agencies
- Dept of Education
- Dept of Commerce
- Dept of Transportation
- Academia
- Industry

Chrysler
Ford
General Motors

\$19M



National Rotorcraft Technical Center
AMCOM

Collaborative Rotorcraft R & D between...

- Army and Navy
- NASA
- Fed Aviation Admin (FAA)
- Academia
- Industry

Sikorsky
Boeing
Bell

\$2M



Army Federated Labs
ARL

Partnering Science and Technology with...

- Universities
- HBCU/MI
- Industry
- Telecomm
- Adv Sensors
- Adv Displays

Lockheed Sanders
MIT
Motorola

\$22M

Partnering is critical to making technology work for soldiers.

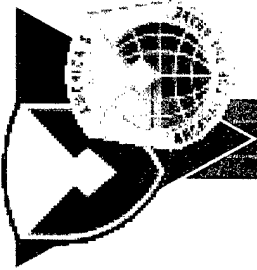

Technology Generation and Application

ARL Project:
Reduce Fuel Consumption by 75% before 2020

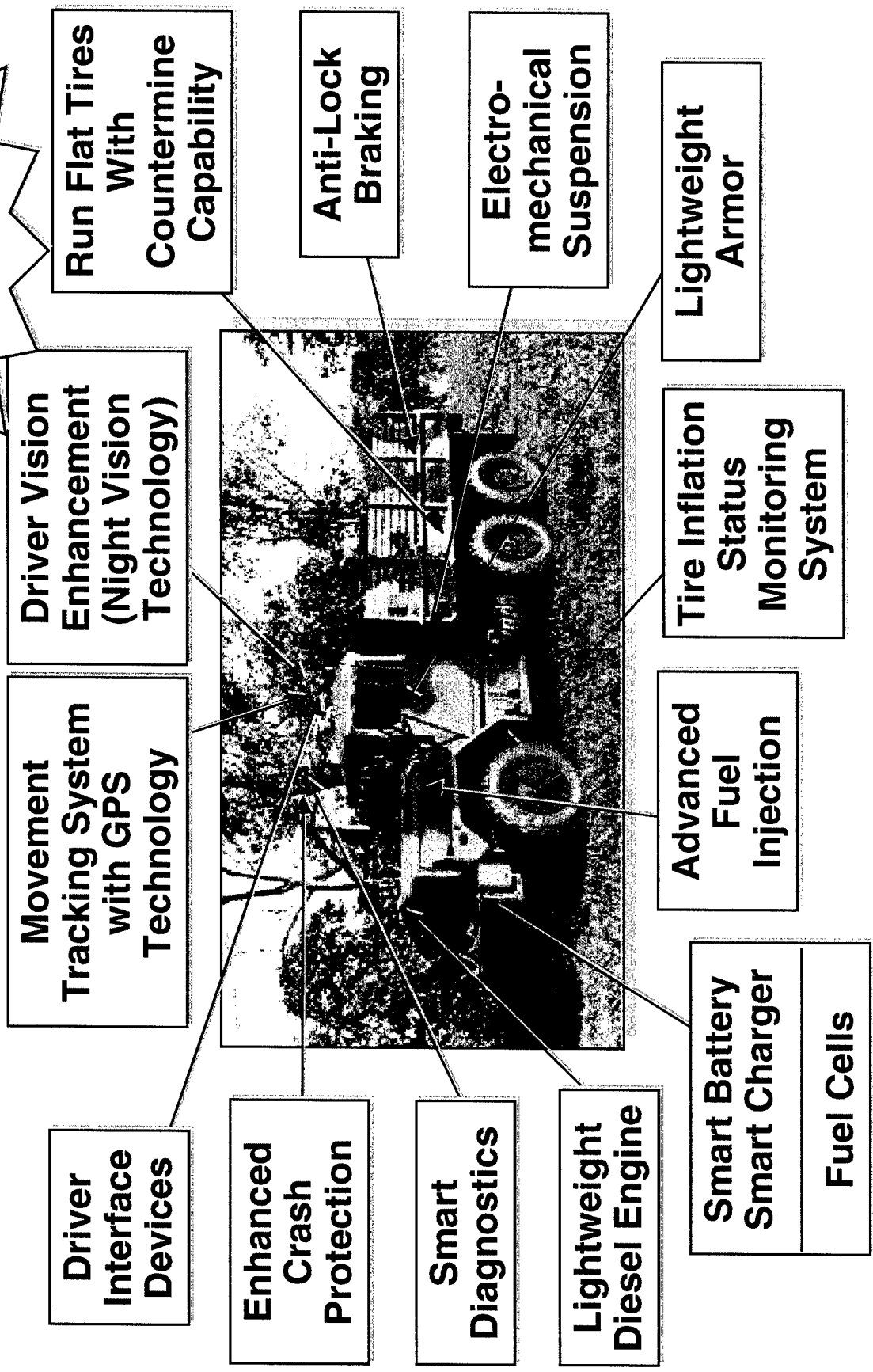



Trucks: What It Takes

TANKS = 116
 TRACKS = 240
 HOWITZERS = 18

TANKS = 203
 TRACKS = 721
 HOWITZERS = 54
 MLRS = 18

HMMWV = 301
 2-1/2 TON = 139
 5 TON = 84
 HEMTT = 94
 PLS = 40
TOTAL = 658

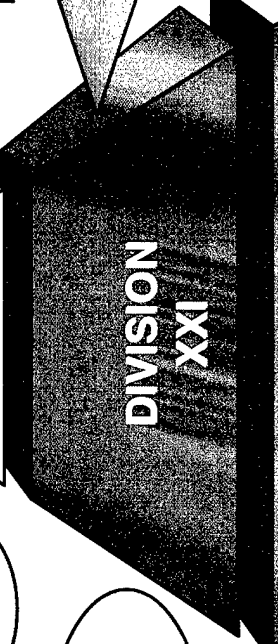
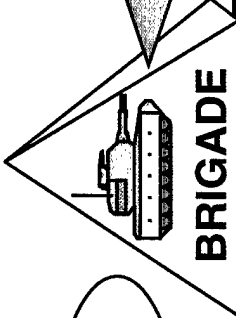

HMMWV = 1914
 2-1/2 TON = 673
 5 TON = 549
 HEMTT = 426
 PLS = 165
 HETS = 24
TOTAL = 3751

HMMWV = 11,565
 2-1/2 TON = 3,640
 5 TON = 4,695
 HEMTT = 424
 PLS = 180
 HETS = 481
TOTAL = 20,986

CORPS - TRADOC IS REVIEWING

**“SOMETIMES SOLDIERS
 LIKE ME NEED TO BE
 REMINDED THAT TRUCKS
 ARE AS IMPORTANT
 AS TANKS”
 GEN. NORMAN SCHWARZKOPF**

**19, 229 VARIOUS TRUCKS
 TAACOM**



America's Army - Bosnia Deployment

TRUCKS IN BOSNIA TO DATE:

CUCV = 420
 HMMWV = 3,452
 2-1/2 TON = 558
 5 TON = 1,675
 ENGR TRK = 58
 LINE HAUL = 79
 HEMTT = 330
 PLS = 108
 HETS = 72

TOTAL = 5,077

UNIT AREAS

- BAUMHOLDER
- BAD KREUZNACH
- KAISERSLAUTERN

HIGHWAY
 MAIN SUPPLY ROUTES:
 719-868 MILES

KAPOSVAR

INTERMEDIATE
 STAGING BASE

FUEL SUPPORT
 REQUIRES
 137 5,000
 GALLON
 TANKERS

ZAGREB

RIVER SAVA

TUZLA

MAIN SUPPORT
 AREA



Truck Requirements

Support the Fleet

Light 124,170
 Medium 83,551
 Heavy 30,474
 Total 238,195

Does Not Include COMPO 4

By FY 97
 90% 2.5 Tons
 34% 5 Tons
OVER AGED!

By FY 00
 77% 2.5 Tons
 22% 5 Tons
OVER AGED!

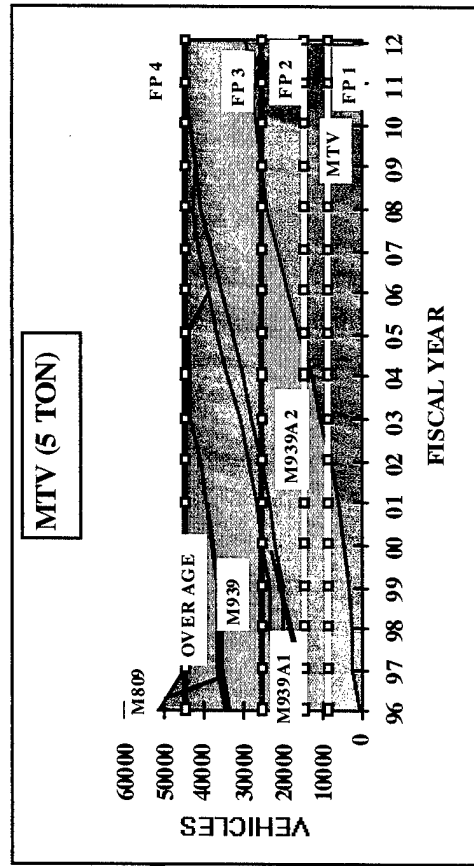
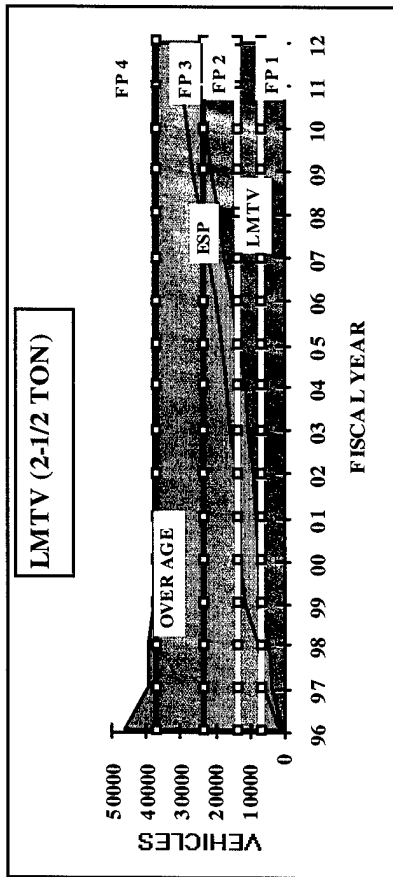
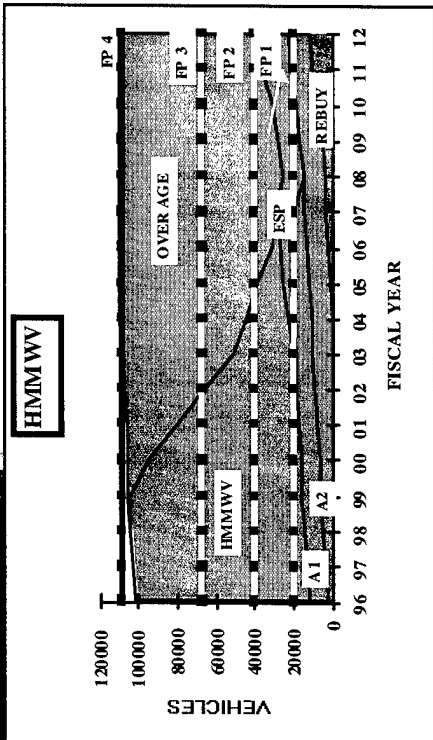



Trucks Update & Procurement Trends

Tactical and Support Vehicles - 1997 - 2000

- 1997 TOTAL \$725.7M
- 1998 TOTAL \$479.3M
- 1999 TOTAL \$756.1M
- 2000 TOTAL \$893.5M

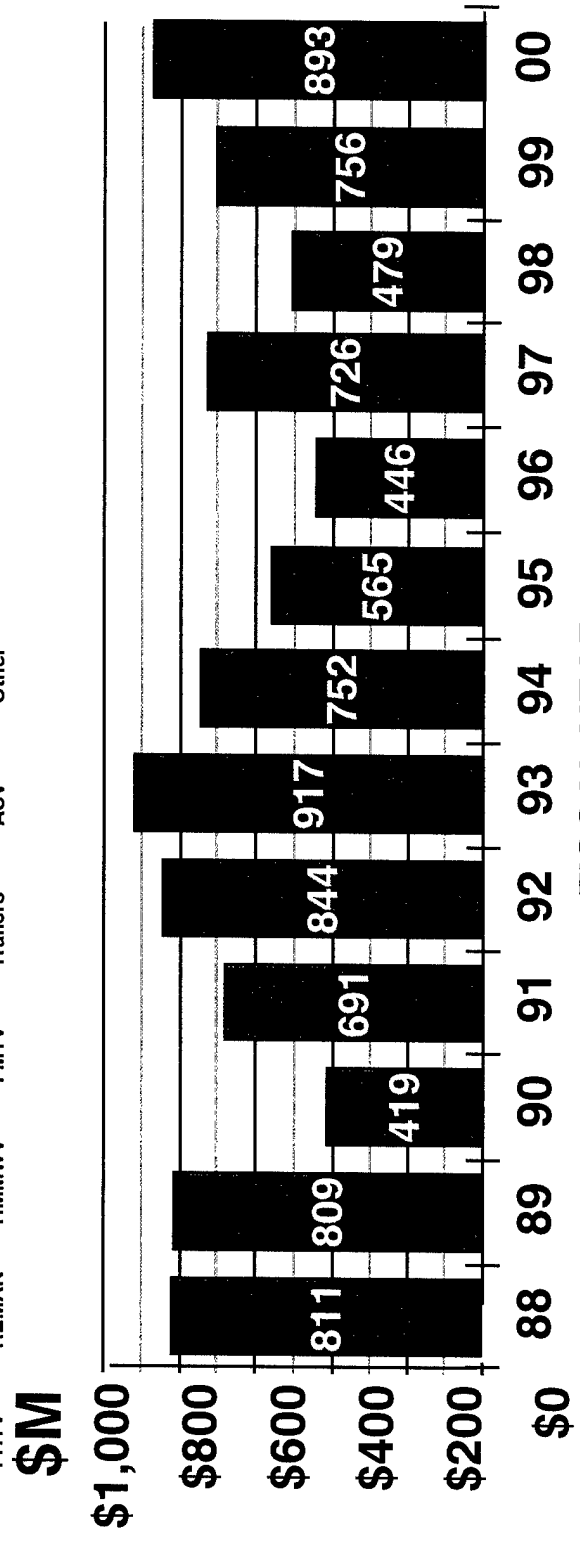
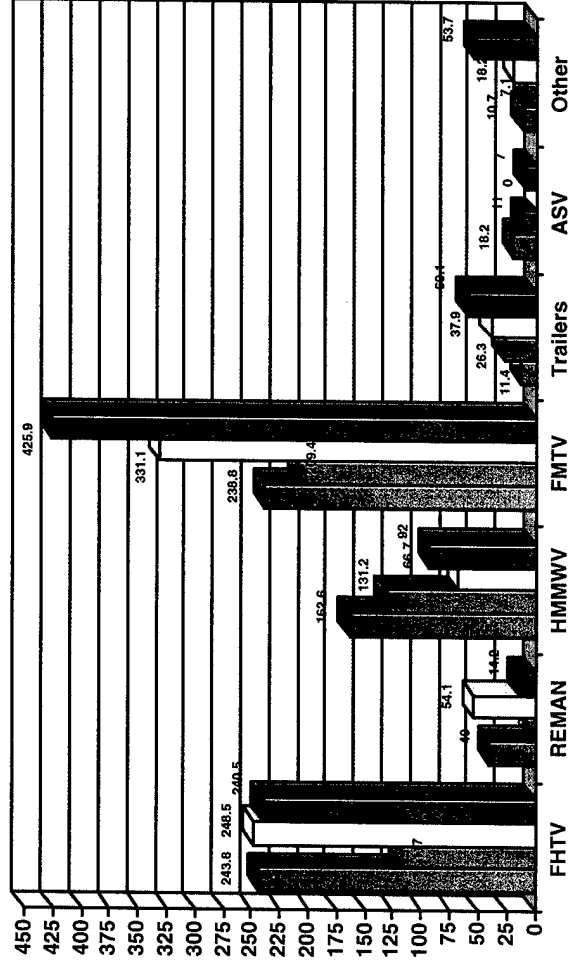

FISCAL YEAR



WE NEED INDUSTRY HELP...

Partnering With Industry

National Automotive Center Examples

- ★ **Lightweight Diesel Engine - Cummins**
- ★ **Protective Coatings - Polymer**
- ★ **Smart Diagnostics - Hughes**
- ★ **Run Flat Tires with Countermeasures Capabilities - Hutchinson**
- ★ **Electro-mechanical Suspension System - University of Texas**



Conclusions

- ★ **Change in Environment From Military-Industrial Complex to an Industrial-Military Complex**
- ★ **Requirements Based on Capability Instead of Threat**
- ★ **AMC Has an Increased Role in TWV**
- ★ **Budget Pressures Are a “Fact of Life”**
 - Congressional Plus-Ups Have Helped in the Past
 - Keen Interest in FMTV Production
 - Other Customers Continue to Support Remanufacture
- ★ **Trucks Will Be More Important Than Ever in the Paradigm Shift From a Supply-Based Distribution System to a Transportation-Based Distribution System, Especially PLS**
- ★ **Industry Has Truly Served the Army Well**

Thanks For Your Support to the Army

SOLDIERS Are Our Credentials!



1999 TACTICAL WHEELED
VEHICLE CONFERENCE - "HOW
HEALTHY IS OUR FLEET?"
ODCSOPS PERSPECTIVE



FEBRUARY 1, 1999

COL(P) MICHAEL A. VANE
DIRECTOR OF INTEGRATION
ODCSOPS

America's ARMY

SOLDIERS Are Our Credentials!



TOPICS



- **MODERNIZATION AND FUNDING**
- **INITIATIVES**
- **NEW DIVISION DESIGN**
- **ECONOMIC USEFUL LIFE**
- **FLEET STATUS**
- **SUMMARY**

America's ARMY

SOLDIERS Are Our Credentials!

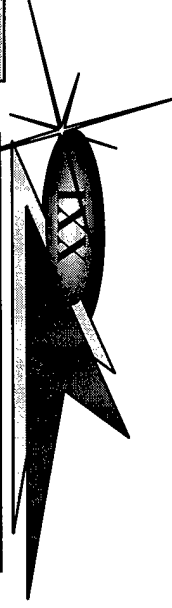

ARMY TOP 10

- 1. Non offset funding for all Contingency Operations**
- 2. Quality of Life Issues (Pay, Pay reform, Retirement benefits, Housing and Medical)**
- 3. Support Army Endstrength & Manyears (AC; RC; Civ) Initiatives**
- 4. Fund O&M as allocated and at least to the requested level:**
 - Ground OPTEMPO and Flying Hours (All Components)
 - BASOPS and RPM
 - Depot Maintenance
- 5. Fund Digitization, FORCE XXI and AECF as Requested**
 - Technologies across C4I and weapons platforms
 - FDD by FY 00 and an FDC by FY 04
- 6. Total Army Force Integration.**
- 7. Critical Warfighter Initiatives**
 - Comanche
 - Crusader
- 8. Institutional Training Policy**
- 9. Preserve MILCON (1+1 Barracks initiative and Deployment Platforms).**
- 10. Strategic Mobility (infrastructure, Prepo Bde Sets and Strategic Lift).**

America's ARMY

SOLDIERS Are Our Credentials!

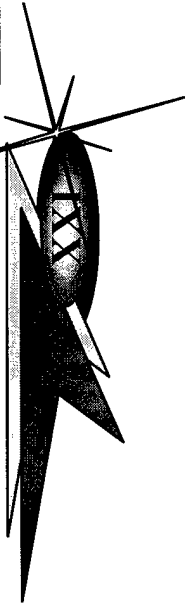

ARMY INVESTMENT OPPORTUNITIES

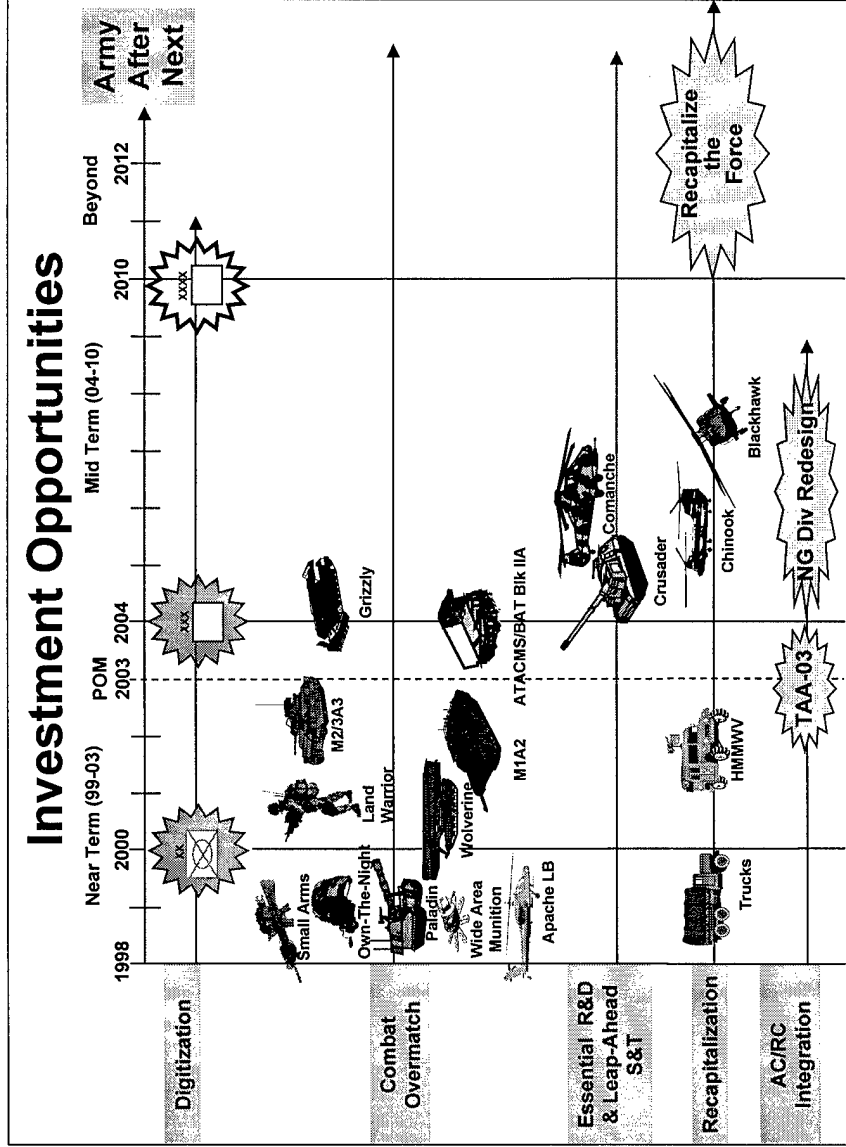

America's ARMY

SOLDIERS Are Our Credentials!

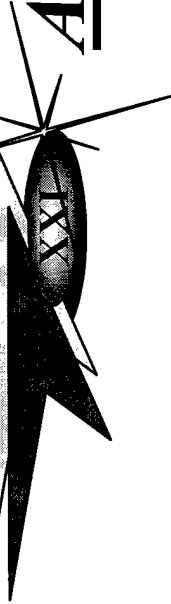

ARMY INVESTMENT STRATEGY

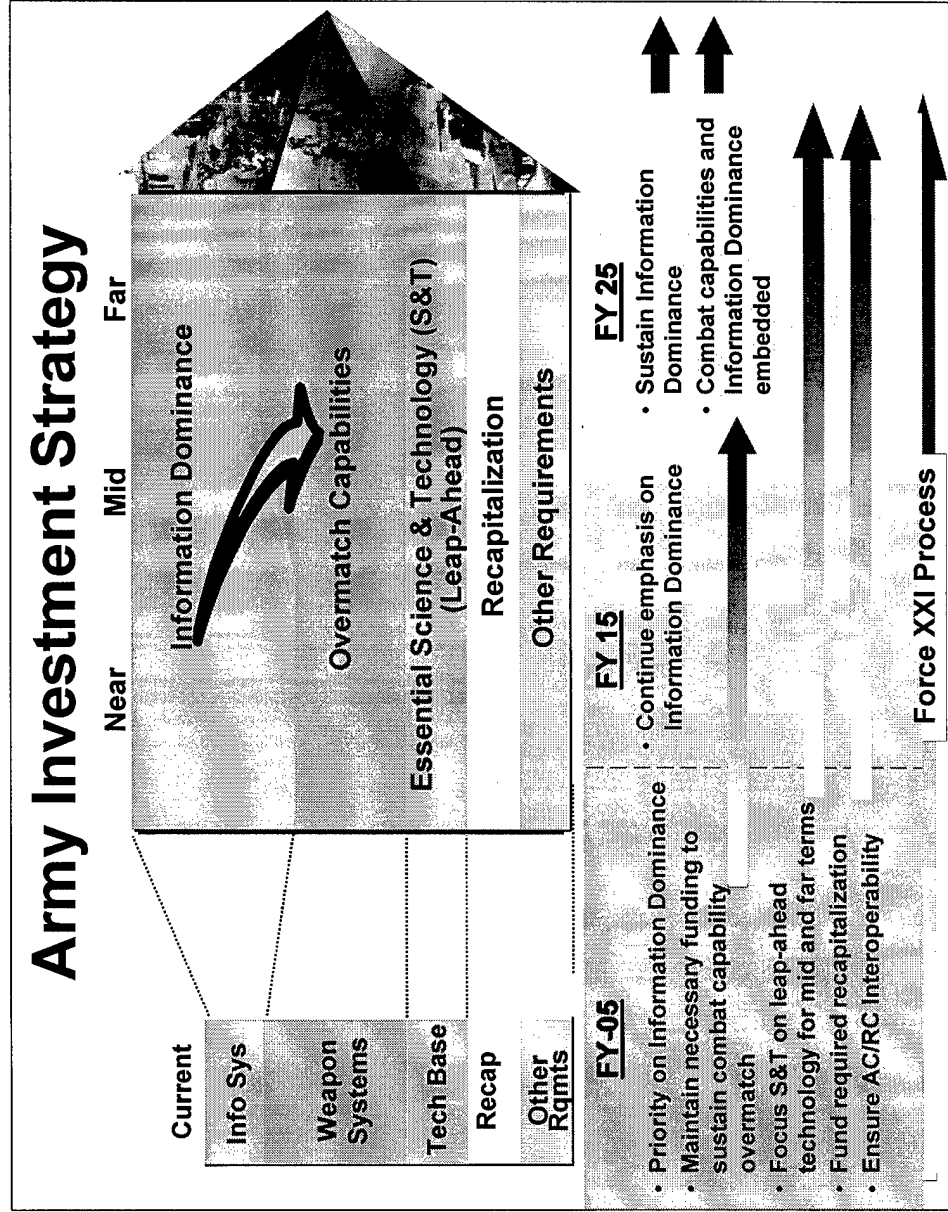

America's ARMY

SOLDIERS Are Our Credentials!

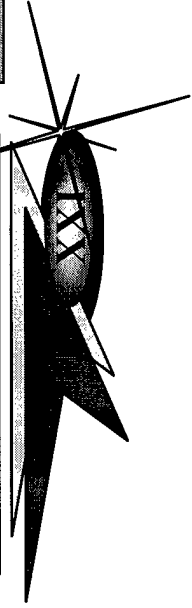

FUNDING FACTS

- DEFENSE BUDGET IS 3 PERCENT OF THE GROSS DOMESTIC PRODUCT.
- DEFENSE BUDGET IS 15 PERCENT OF THE FEDERAL BUDGET.
- THE ARMY BUDGET IS 25 PERCENT OF THE DEFENSE BUDGET.
- RESEARCH DEVELOPMENT AND ACQUISITION (RDA) IS 19 PERCENT OF THE ARMY BUDGET .
- TRUCK PROCUREMENT IS 7 PERCENT OF THE RDA BUDGET .

America's ARMY

SOLDIERS Are Our Credentials!



FUNDING PROFILE

\$1.1B AVG PER YEAR 98-05
\$1.2B AVG PER YEAR 00-05

TWV FUNDING

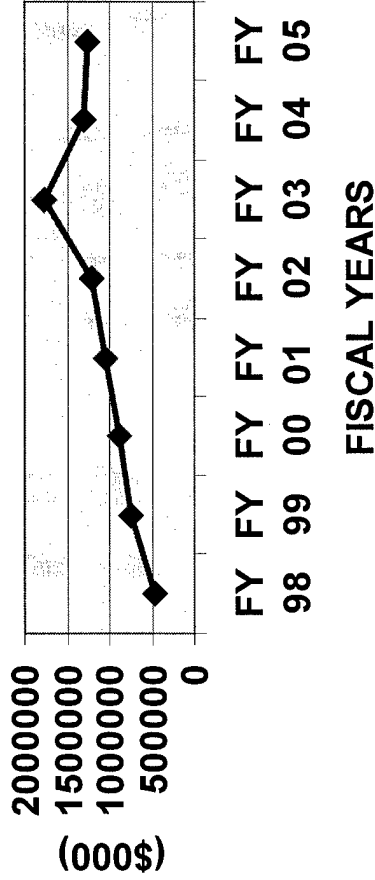

RC FUNDING
\$382M AVG PER YEAR 98-05
\$473M AVG PER YEAR 00-05

America's ARMY

SOLDIERS Are Our Credentials!



NATIONAL AUTOMOTIVE CENTER (NAC)

- PART OF THE TANK-AUTOMOTIVE AND ARMAMENTS COMMAND (TACOM)
- DOD FOCAL POINT FOR COLLABORATIVE AUTOMOTIVE R&D WITH INDUSTRY, ACADEMIA AND OTHER GOVERNMENT AGENCIES
- RESPONSIBLE FOR ACCELERATING THE INFUSION OF COMMERCIAL TECHNOLOGY INTO MILITARY LAND WARFARE SYSTEMS
- LEVERAGES DOD INVESTMENT IN MILITARY LAND WARFARE SYSTEMS THROUGH STRATEGIC, COST-SHARED PARTNERSHIPS; ARMY'S LEADER IN DUAL-USE APPLICATION
- FOCUS IN FIVE TECHNOLOGY AREAS: FUEL EFFICIENCY, VEHICLE MODERNIZATION, SAFETY, MAINTENANCE AND LOGISTICS, AND MANUFACTURING INNOVATION
- PRESENT INITIATIVES: HYBRID ELECTRIC, ADVANCED DIESELS, FUEL CELL HYBRIDS, NEXT GENERATION TACTICAL TRUCK TECHNOLOGIES, WASTE OIL REUTILIZATION, SMART TRUCK TECHNOLOGIES, AND COLLABORATIVE DESIGN

America's ARMY

SOLDIERS Are Our Credentials!

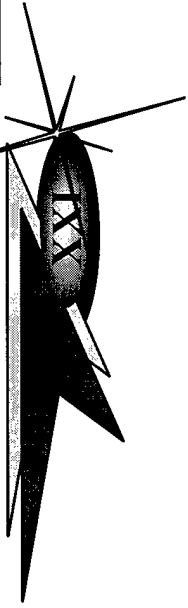

CREW
PROTECTION

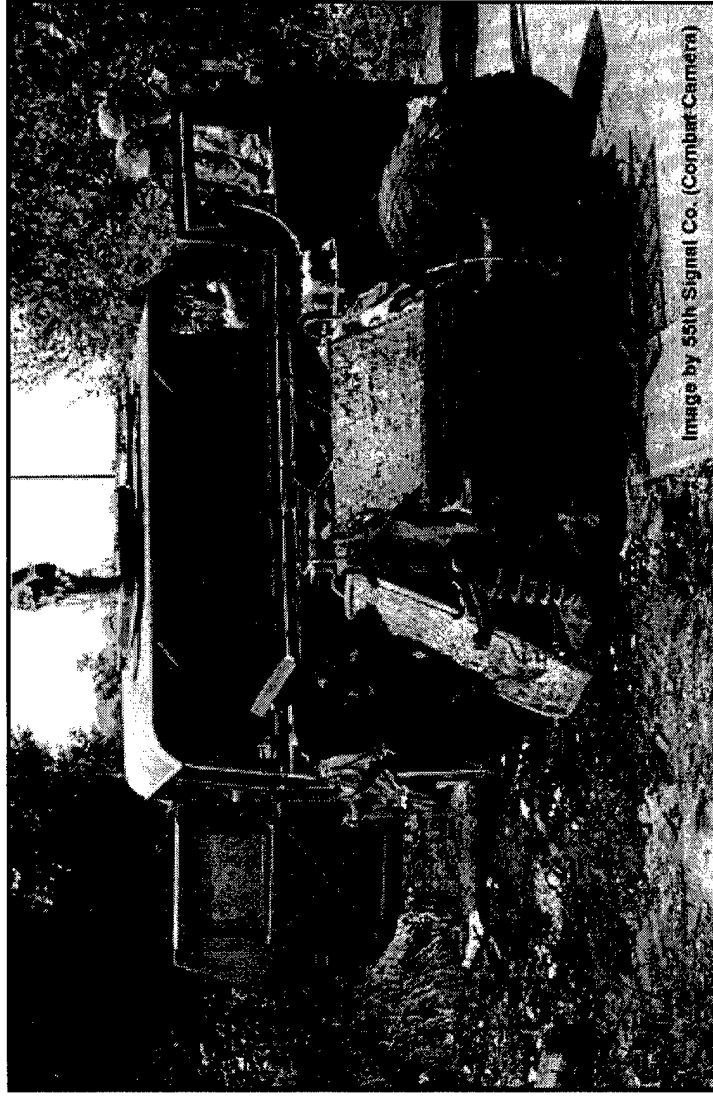

Image by 55th Signal Co. (Combat Camera)

America's ARMY

SOLDIERS Are Our Credentials!

MOVEMENT TRACKING SYSTEM

REQUIREMENT

33,379 (EST)

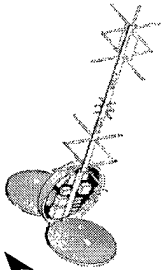

Near-Real Time Position Locations of Mobile Unit
Messaging Capability to Re-direct Mobile Unit Due to:

- Congestion
- Enemy Situation
- Change in Plan (Destination Unit Moved, or Priority Shift)

**EXPANDED FROM
PLS TO ALL TWV.**

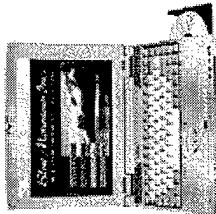

WRAP PROGRAM

CONTROL STATION

(not dependent on
landline)

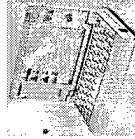

I/O Device w/ Map
Subscriber Controller
GPS Antenna
Satellite Antenna

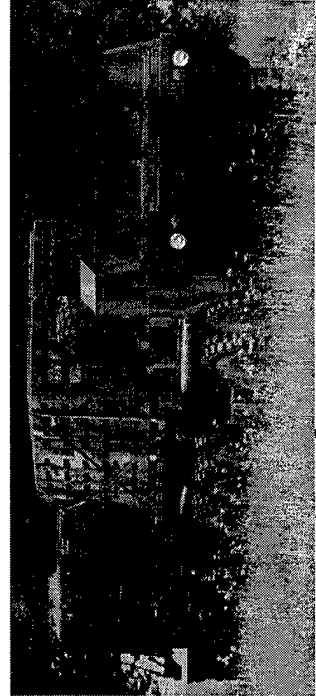

America's ARMY

SOLDIERS Are Our Credentials!

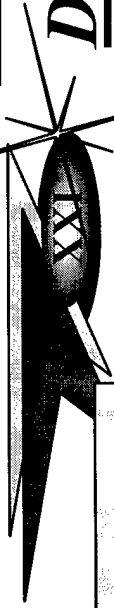

DIVISION DESIGN COMPARE

- HMMWV + 22
- ASV + 29
- LMTV -102
- MTV - 57
- HEAVY +84

- TRAILERS -25
- TRUCKS -24

INCREASE IN HEAVY
MORE EXPENSIVE
VEHICLES.

AOE vs D-XXI HEAVY MECH DIVISIONS

TACTICAL WHEELED VEHICLES

LIN	AOE		DXXI		TYPE	LIN	TYPE	AOE		DXXI		TYPE	AOE		DXXI	
	QTY	Δ	QTY	Δ				QTY	Δ	QTY	Δ		QTY	Δ	QTY	Δ
D34883	7	0	T45465	HEMAT, TRL, M989A1	71	208	137	T96838	FLT BED TRL, 7.5-TON, M1073	22	8	-14				
G34805	13	-3	T58161	HEMTT, TNKR W/W, M978	26	33	7	W95811	1-1/2T TRL, M105	54	36	-18				
S70027	115	44	T59048	HET, TRACTOR, M1070	24	24	0	W98825	WATER TRL, M149	199	184	-15				
S70243	1	1	T59278	HEMTT, CGO, M977	112	25	-87	Z06421	ASV	0	29	29				
S70517	10	6	T60081	LMTV, CGO, M1078	582	505	-77	Z36088	LMTV, TRL, M1082	503	352	-151				
S70859	24	24	T60149	LMTV, CGO W/W, M1078	137	103	-34	Z36204	1-1/4T TRL, M1102	100	144	44				
S73372	70	74	T61103	TRUCK TRAC, LINE HAUL	1	0	-1	Z36272	3/4T TRL, M1101	404	460	56				
S74832	23	15	T61239	MTV, TRACTOR, M1088	241	187	-54	Z62562	HMMWV, EXP CAP, XM1113	61	59	-2				
S75038	5	0	T61307	MTV, TRAC W/W, M1088	12	16	4	Z62630	HMMWV, ARMD, XM1114	133	106	-27				
S75175	55	46	T61494	HMMWV, CGO, M988	1201	1237	36	Z90712	MTV, TRL, M1095	38	34	-4				
T07679	326	368	T61562	HMMWV, CGO, W/W, M1038	126	98	-28	Z94047	MTV, TANKER, M1091	56	32	-24				
T38844	27	27	T61704	MTV, LWB, M1085	33	17	-16	Z94560	MTV, EXP VAN, M1087	44	72	28				
T39518	53	132	T61772	MTV, LWB W/W, M1085	1	0	-1	TOTALS		5527	5478	-49				
T39586	36	48	T61908	MTV, CGO, M1083	133	173	40	<i>DISCOM</i>		1733	2631	898				
T39654	6	6	T63093	HEMTT, WRKR, M984	51	37	-14	<i>NON DISCOM</i>		3794	2847	-947				
Z40639	0	0	T87243	HEMTT, TNKR, M978	159	145	-14	<i>% of DIV in DISCOM</i>		31.4%	48.0%	16.7%				
T40999	9	111	T92242	HMMWV, ARMT CR, M1025	18	19	1	B83002	BED CGO, PLS, M1077	108	324	216				
T41067	54	54	T93484	LMTV, VAN, M1079	56	65	9	Z27727	CONTAINER LIFT KIT (GLK)	3	10	7				
T41135	9	4	-5	T93761	PLS, TRL, M1076	9	45	36								
T41203	39	15	-24	T94709	MTV, WRKR, M1089	38	33	-5								

UPDATED 8/10/98

America's ARMY

SOLDIERS Are Our Credentials!



**CURRENT FLEET AGE BY
FORCE PACKAGE AND COMPO**

FLEET	EUL	R3	FP 1		FP 2		FP 3		FP 4	
			AC	NG	AC	NG	AC	NG	AC	NG
CUCV	11	1997	11.7	11.7	11.8	11.7	11.7	11.7	11.7	11.7
HMMVV	14	1999	7.2	7	7.3	5.9	7.2	7.3	7.7	8
2.5 T	20	2013(LMTV)	18.8	25.6	27.4	28.6	27.5	27.1	27.6	27.5
5 T	22	2015(MTV)	9.8	16.3	10.4	23.7	18	13.1	12.1	20.8
M915	20	1998	13.6	12.4	7.6	3.3	0	15.5	12.6	14.9
HEMTT	20	2004	10	9.7	9.7	10.2	9.4	10.3	9.6	14.8
PLS	20	2012	2.1	2.1	2	0	0	2	2	10
HET	20	2012	3.1	3.3	4.4	0	0	7.7	3.5	2.1
LET/MET	20	1998	11.4	7.2	9.8	7.5	7.5	14.8	11.8	18.5
ALL			10.1	13.3	11.3	10.3	12.4	11.9	12.6	11.8
								14.3	15.8	16.4

**VEHICLE AGE BY FORCE PACKAGE SHOWS RESULTS
OF FIELDING PRIORITIES.**

America's ARMY

SOLDIERS Are Our Credentials!



OVERALL FLEET AGE

FLEET AVERAGE AGE 1998 vs END POM/EPA

VEHICLE	ECONOMIC LIFE	MAX FLEET AVE % AGE OBJECTIVE OVER	FLEET AVERAGE AGE	
			1998	2014
CUCV	12	6	12.6	N/A
HMMWV	15	7.5	7.9	17.0
SUSV	15	7.5	7.1	22.9
M151	15	N/A	20.7	N/A
M880	7	N/A	20.1	N/A
2-1/2 TON	20	10	23.3	13.8
5 TON	22	11	14.3	6.9
PLS	20	10	2.4	16.0
HEMTT	20	10	10.7	6.7
ENG TRAC	20	10	12.8	15.7
LINE HAUL	20	10	14.5	12.8
HET	20	10	6.2	14.8
YARD TRAC	10	5	16.6	8.3
TOTAL AVG		8.8	13.0	13.5

FUNDING IN POM AND EPP JUST MAINTAINS AGE

America's ARMY

SOLDIERS Are Our Credentials!

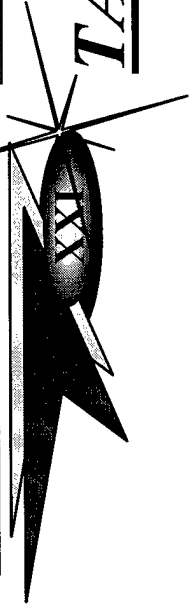

TACTICAL WHEELED VEHICLE
USEFUL LIFE
DETERMINATION PROGRAM
(TWVULDP)

- METRIC CURRENTLY USED TO DETERMINE FLEET REPLACEMENT TIMES.
- MID 1980'S METHODOLOGY.
- UPDATE REQUIRED BASED ON NEW DATA AVAILABLE FOR FLEET MANAGEMENT.
- IPT FORMED IN OCTOBER TO REVIEW. JOINT OPS/SARD CHAIR.
- FLEET PLANNING OFFICE IN TACOM HAS PROGRAM LEAD.
- LIGHT FLEET FIRST TO BE REVIEWED.
- FINAL REPORT OCTOBER 1999.

America's ARMY

SOLDIERS Are Our Credentials!

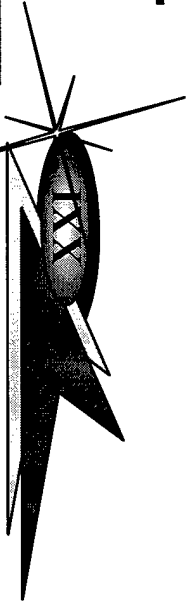

TW FLEET STATUS

- **LIGHT**
- **MEDIUM**
- **HEAVY TACTICAL**
- **HEAVY COMMERCIAL**

America's ARMY

SOLDIERS Are Our Credentials!

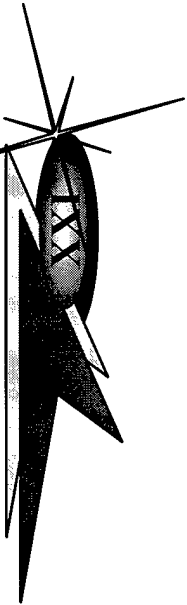

HMMWV STATUS

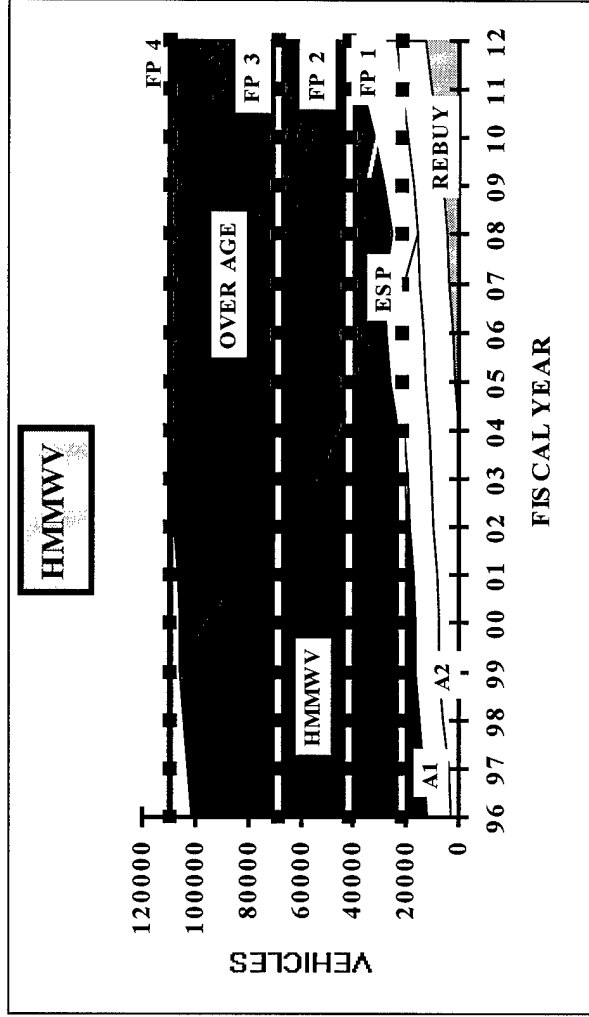
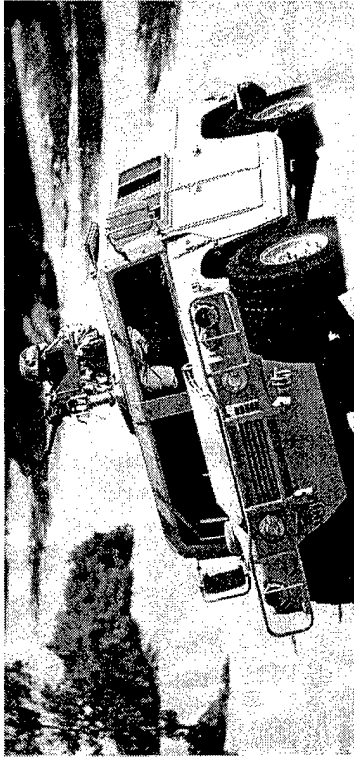

WILL REQUIRE ADDITIONAL FUNDING TO COMBAT OVER AGE PROBLEM. ANALYSIS BASED ON AOA TO BE SUBMITTED TO CONGRESS THIS QUARTER.

America's ARMY

SOLDIERS Are Our Credentials!

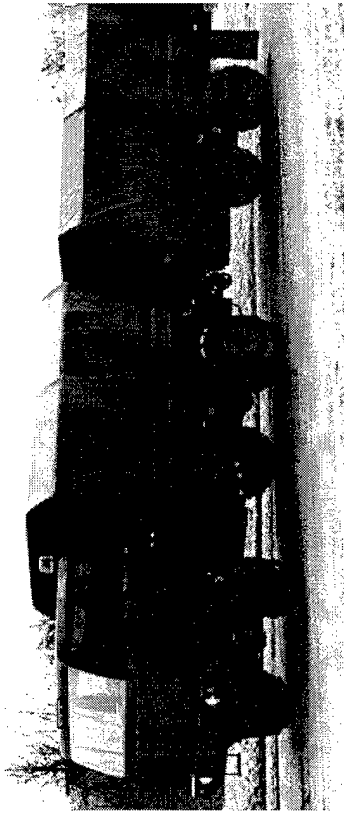

LMTV (2-1/2 TON) STATUS

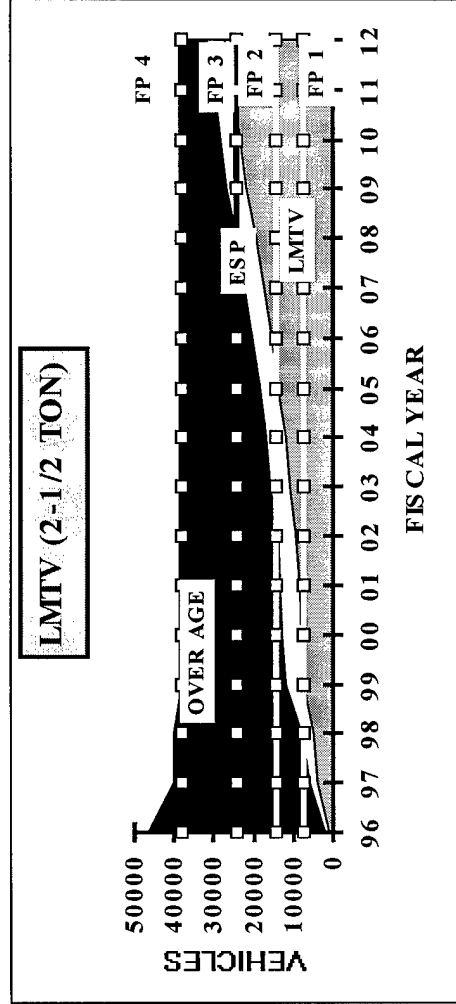

**MOVEMENT OF FUNDS FROM ESP HELPS
IMPROVE VEHICLE FILL!**

America's ARMY

SOLDIERS Are Our Credentials!



MTV (5-TON) STATUS

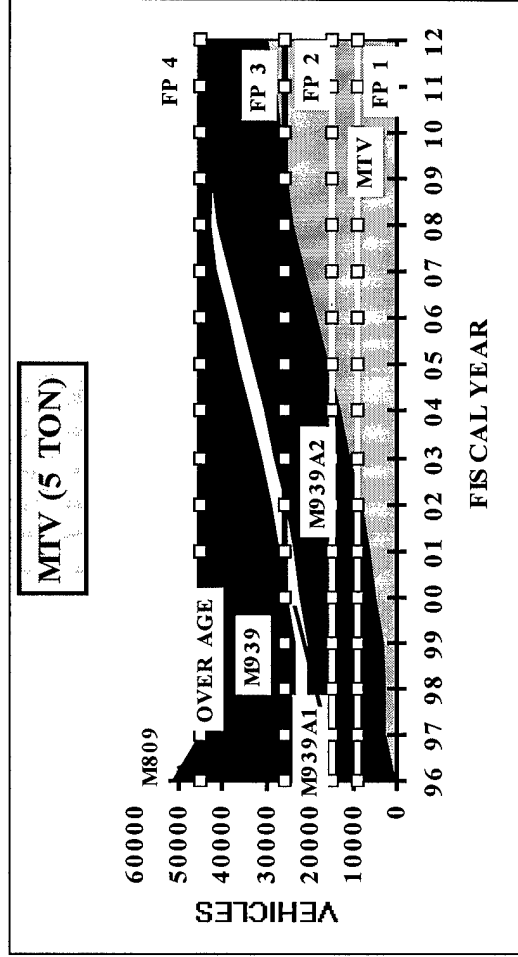
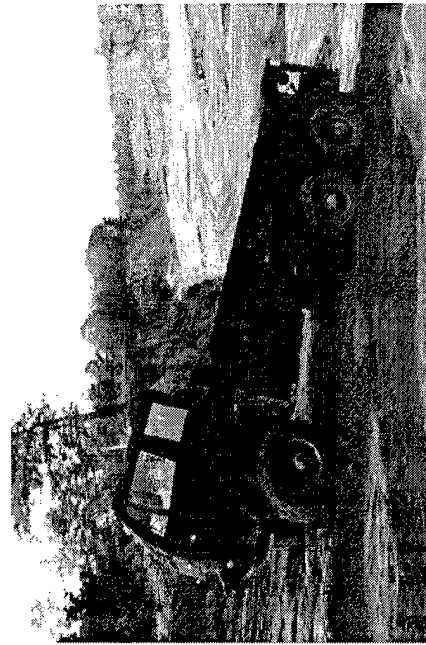

**OVERALL THE FIVE TON FLEET REMAINS
IN GOOD SHAPE.**

America's ARMY

SOLDIERS Are Our Credentials!

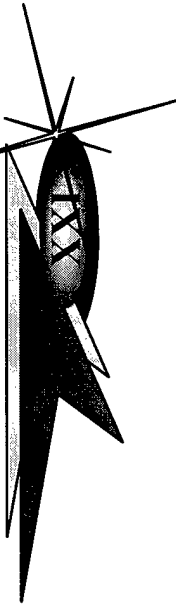

HEAVY TACTICAL TRUCK STATUS

PLS

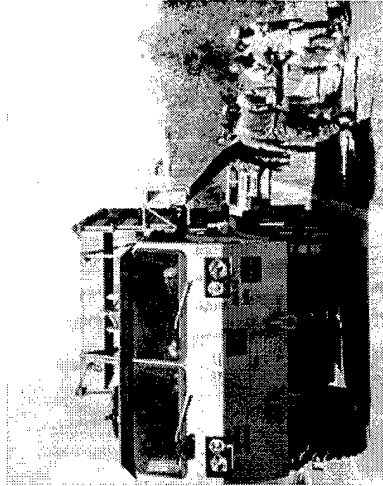
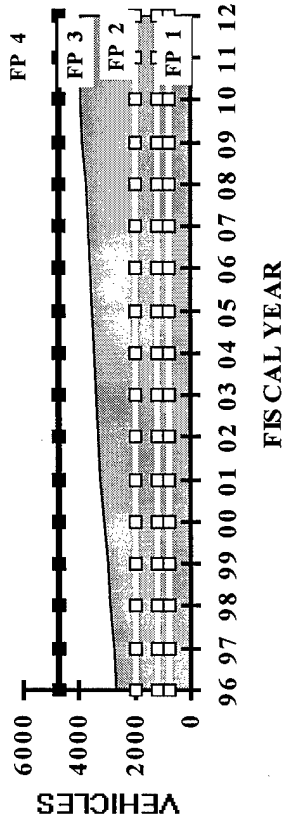

HEMTT

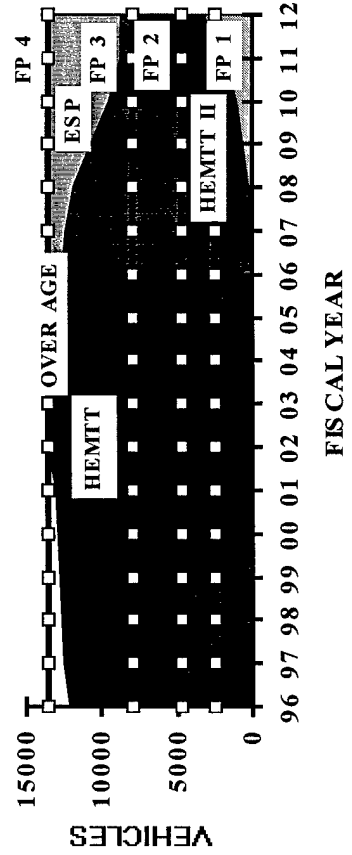

HEETS

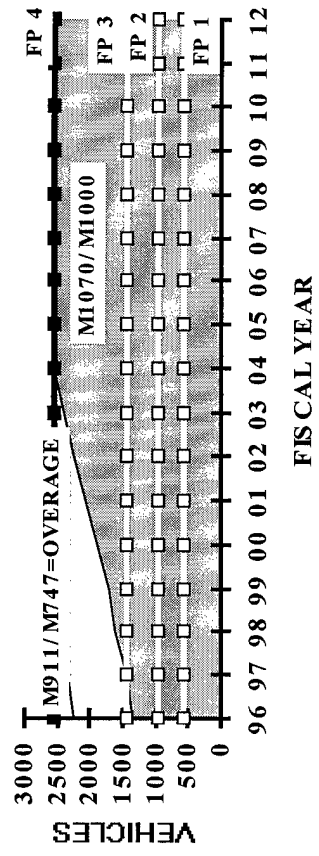

OVERALL HEAVY FLEET IN GOOD SHAPE

America's ARMY

SOLDIERS Are Our Credentials!

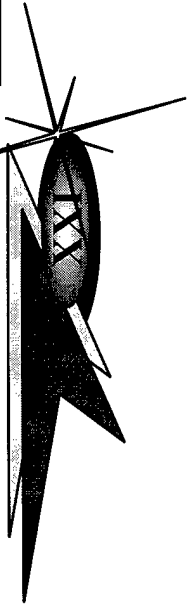

LINE HAUL TRACTOR STATUS

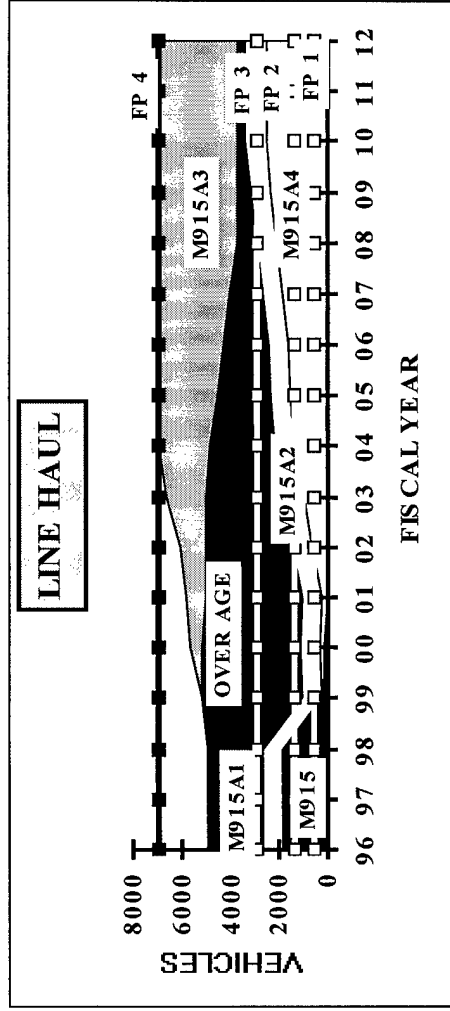
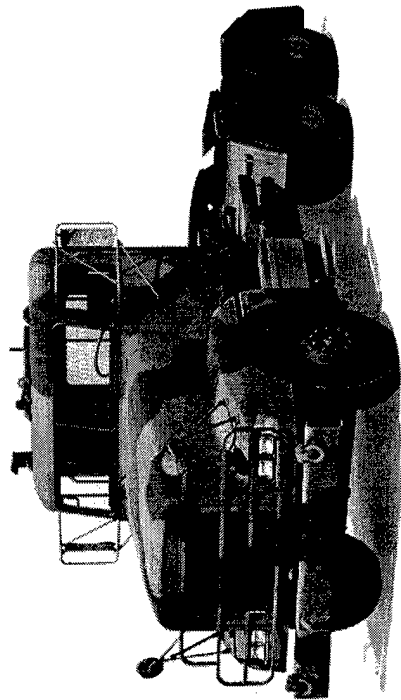

LINE HAUL FLEET IN GOOD SHAPE. MAJORITY OF NEW TRUCKS ARE FOR NG AND AR.

America's ARMY

SOLDIERS Are Our Credentials!

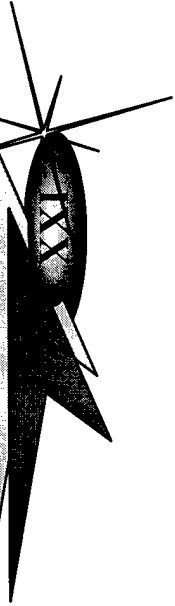

CONGRESSIONAL, **SUPPORT**

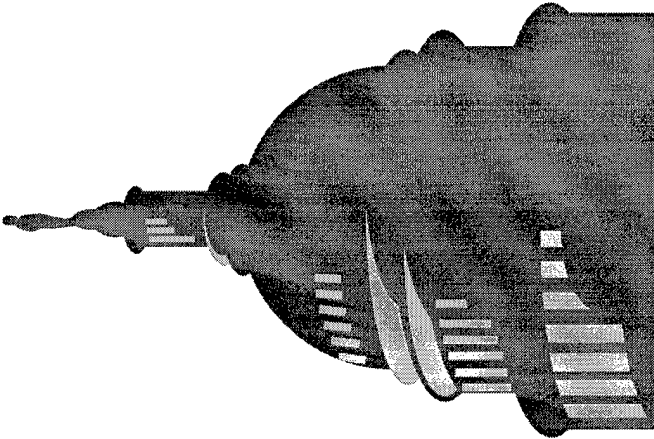

KEY PLUS UPS:

- **\$3.8M FORWARD REPAIR SYSTEM - HEAVY(FRS-H) - WRAP FUNDING**
- **\$55M HMMWV PRODUCTION.**
- **\$13.2M 2-1/2 TON EXTENDED SERVICE PROGRAM (ESP).**
- **\$6M SELF LOAD/OFF-LOAD TRAILER.**

OVERALL: +\$82.6M - \$26.9M = NET \$55.7M

America's ARMY



SUMMARY

- **FUNDING FOR TACTICAL WHEELED VEHICLES CONTINUES TO HOLD UP WELL.**
- **LIGHT FLEET AOA BASE FOR FUTURE COURSE.**
- **NATIONAL GUARD AND ARMY RESERVE TO RECEIVE NEW TRUCKS AND TRAILERS**
- **METRIC TO DETERMINE FLEET REPLACEMENT UNDER REVIEW.**
- **THANKS TO INDUSTRY AND CONGRESS FOR CONTINUED SUPPORT OF PROGRAMS.**

**AN ARMY PREVIOUSLY
TRAVELED ON ITS
STOMACH - NOW IT
TRAVELS ON ITS
WHEELS.**



1999 NDIA Tactical Wheeled Vehicles Conference

Marine Corps Systems Command

Col Mike Kephart, USMC
Director, Combat Support & Logistics Equipment



Agenda



- **Marine Corps Materiel Command**
- **CSLE Organization**
- **Programs**
- **Future Challenges**
- **What You Can Do**



Marine Corps Materiel Command

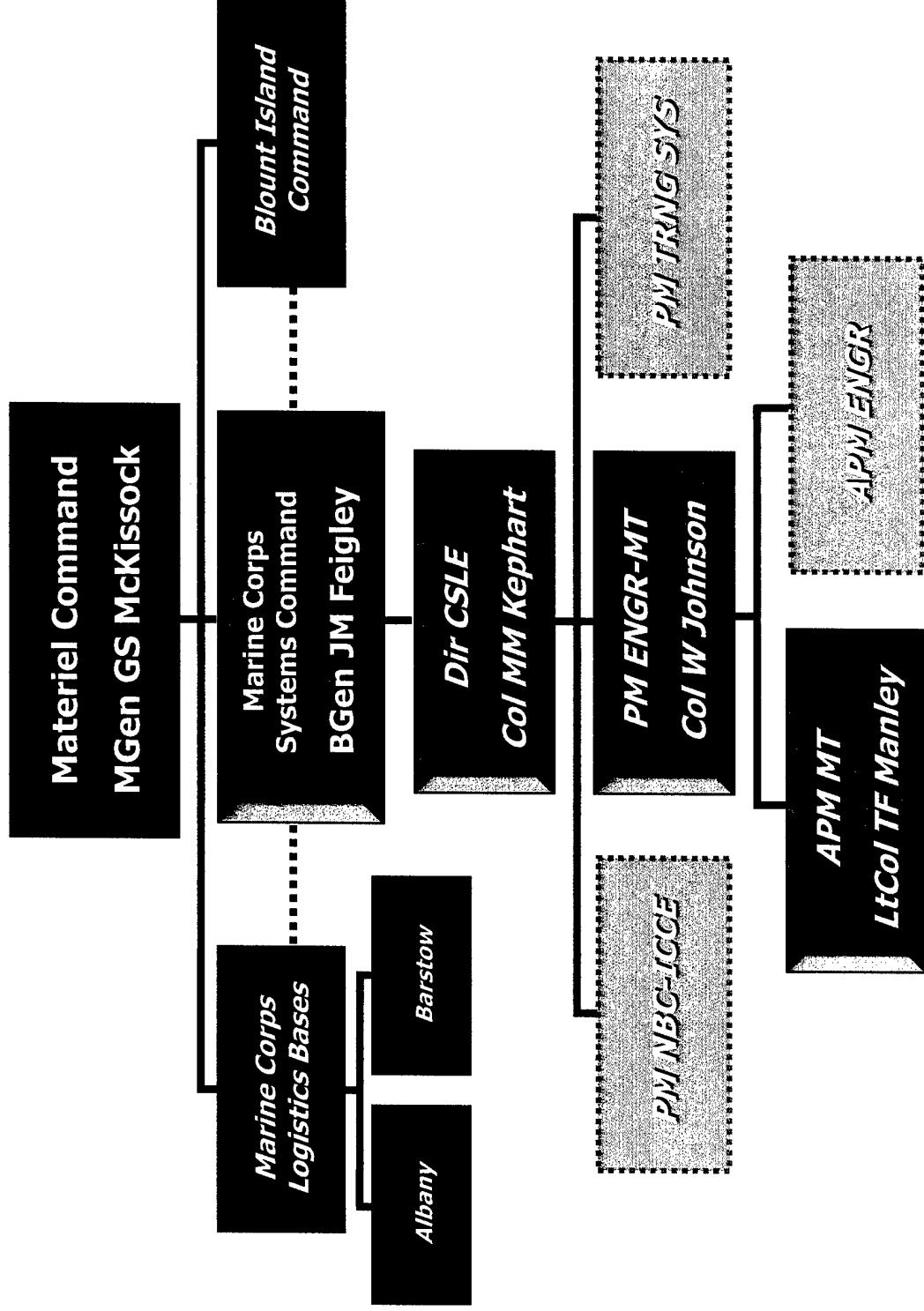



APM Motor Transport

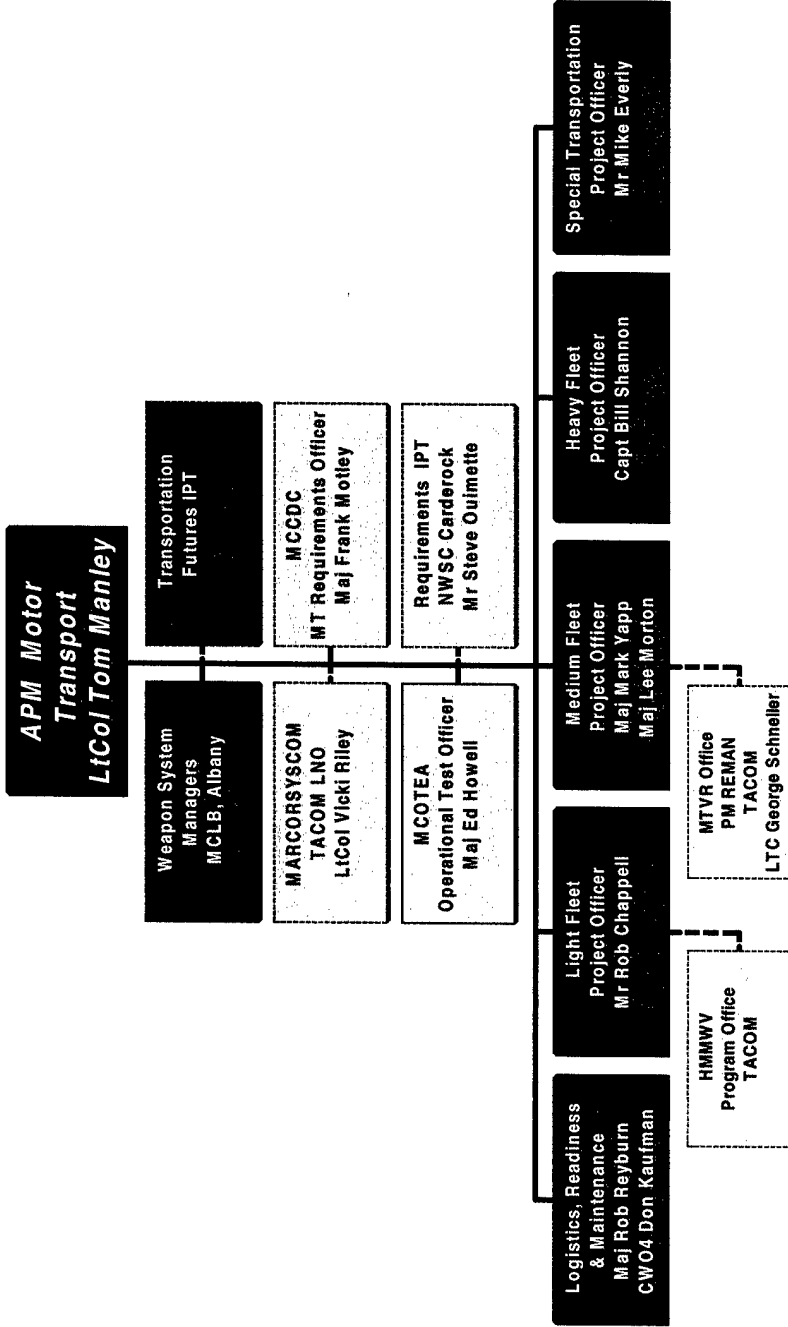

Mission: Provide the management and support for Materiel Life Cycle Management (MLCM), to include research, development, acquisition & sustainment, of Motor Transport and associated transportation systems in order to support OMFTS and STOM while reducing TOC.



Light Fleet

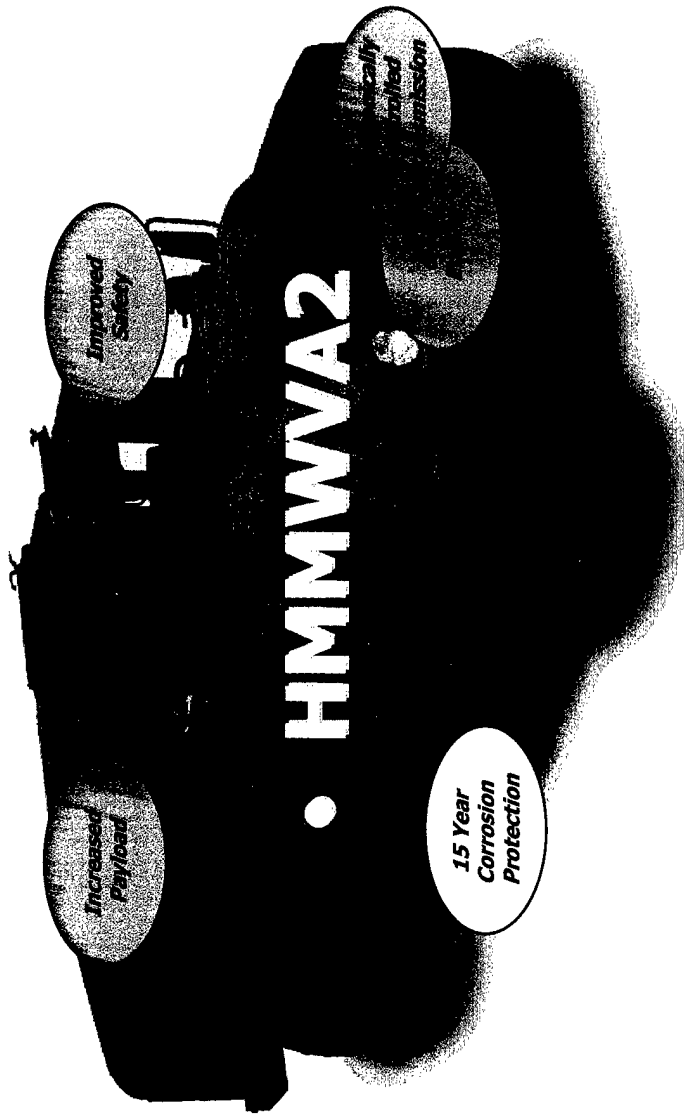

- **HMMWV**
- **M101A3 / M116A3 Trailers**
- **Internally Transportable - Light Tactical Vehicle (IT-LTV)**



Medium Fleet

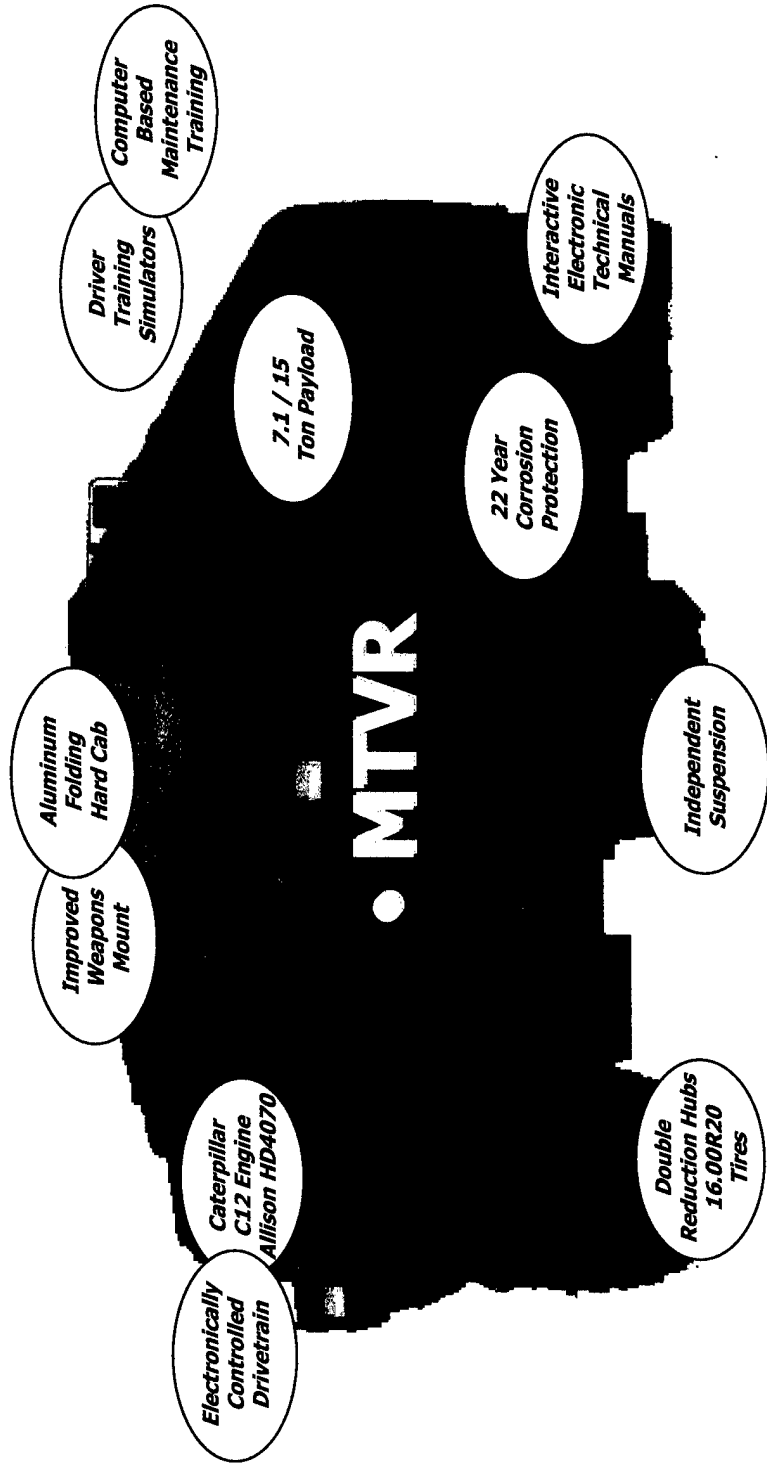

● M809/939 5-Ton Series Trucks

● Medium Trailers

- M105 / M149 / M353 Trailers
- MTVR Trailers



Heavy Fleet

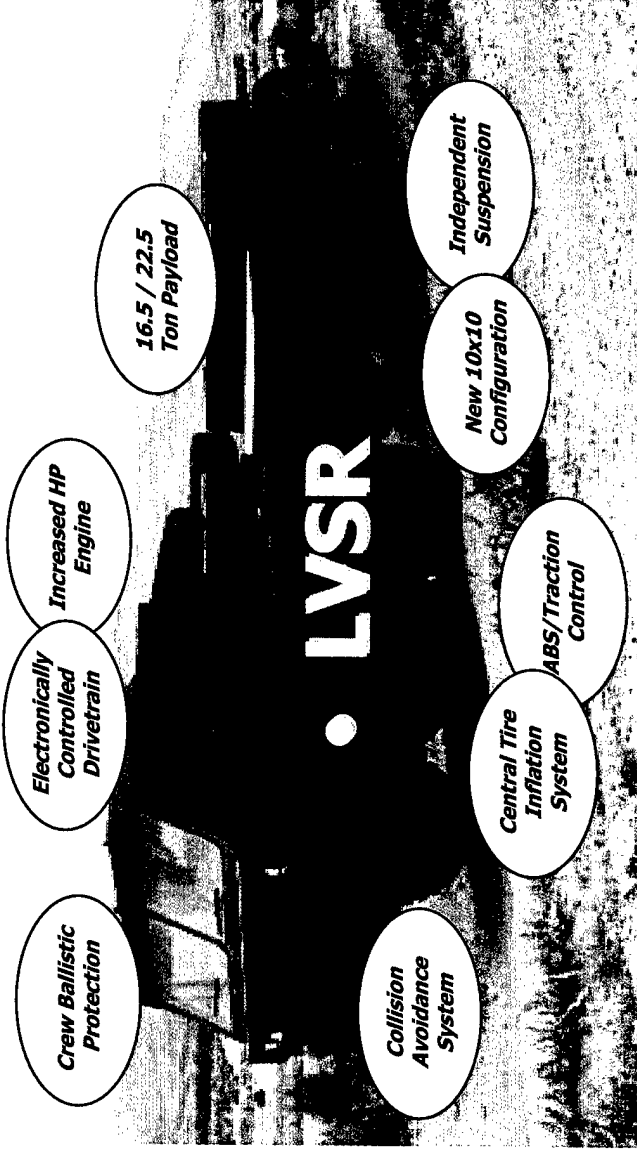

- **M870A2 Lowbed Semitrailer**
- **Tactical Fuel Transport & Refueling**
 - M970 Refueler Semitrailer
 - Aircraft Refueling Capability (ARC)
- **Commercial Tractor**



Special Fleet

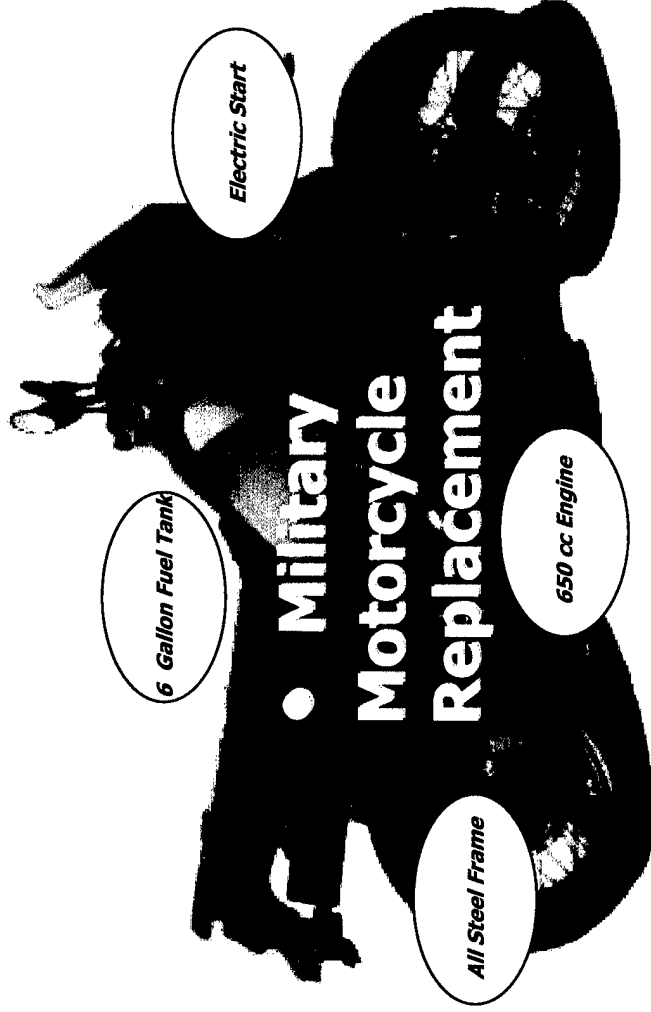

- **P-19A Crash, Fire & Rescue**
- **Heavy Equipment Transporter (70+ Ton)**
- **Motor Transport Modification Program**



Transportation Futures IPT



Mission: Establish & execute a multi-disciplinary approach to addressing all the issues related to fielding the current & future fleet of transportation & distribution assets to support future Marine Corps Operations

- **Goals**
 - Establish, refine & reinforce transportation systems acquisition
 - Identify & analyze applicable emerging technologies
 - Examine strategies to streamline procurement & fielding
 - Identify, analyze & resolve critical programmatic issues
 - Provide historical visibility into the decision making process

- ***Meets Quarterly***

Provide the Marine Corps Transportation "Roadmap"



Transportation Futures IPT

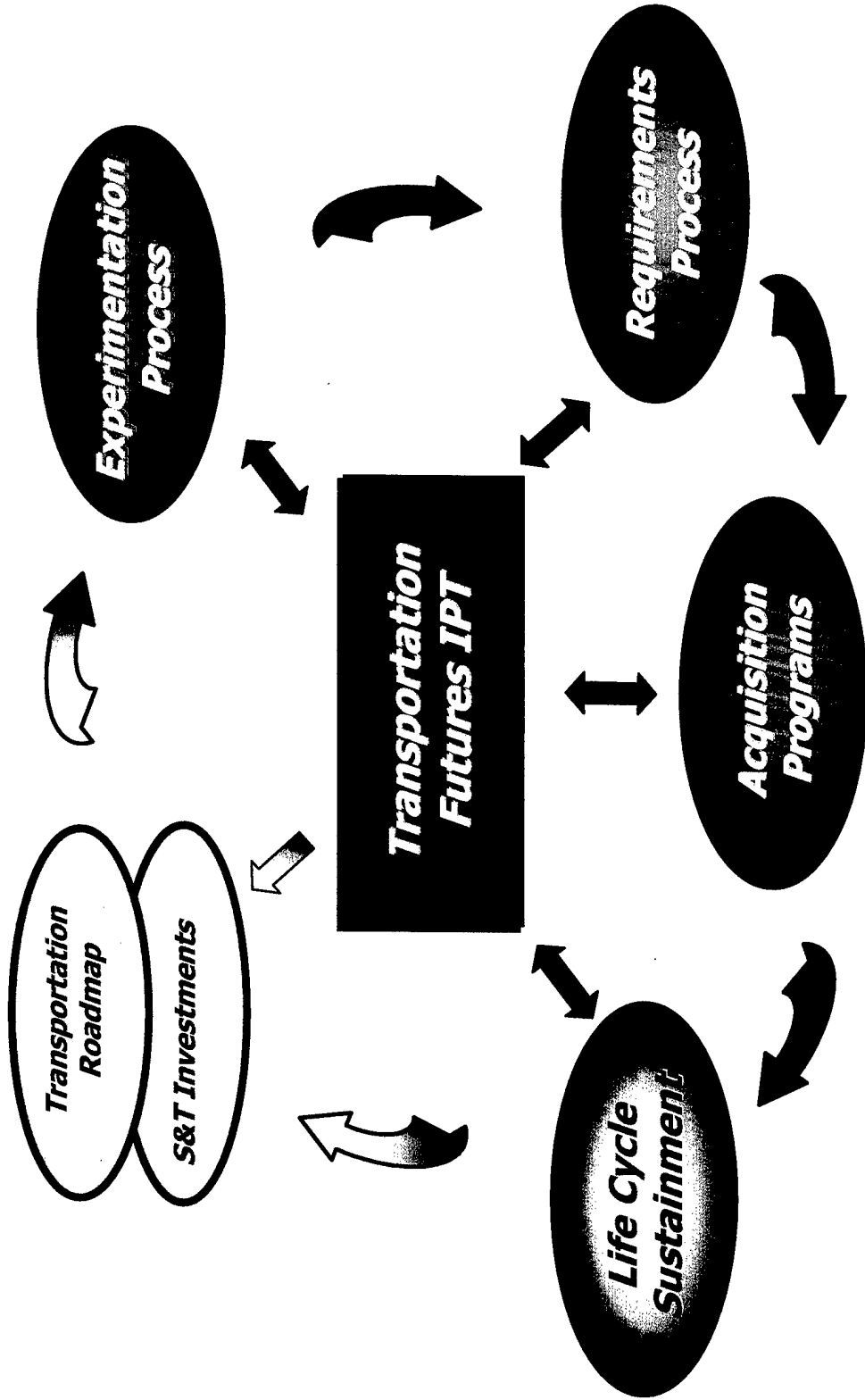



Motor Transport & Seabased Logistics in Support of OMFTS

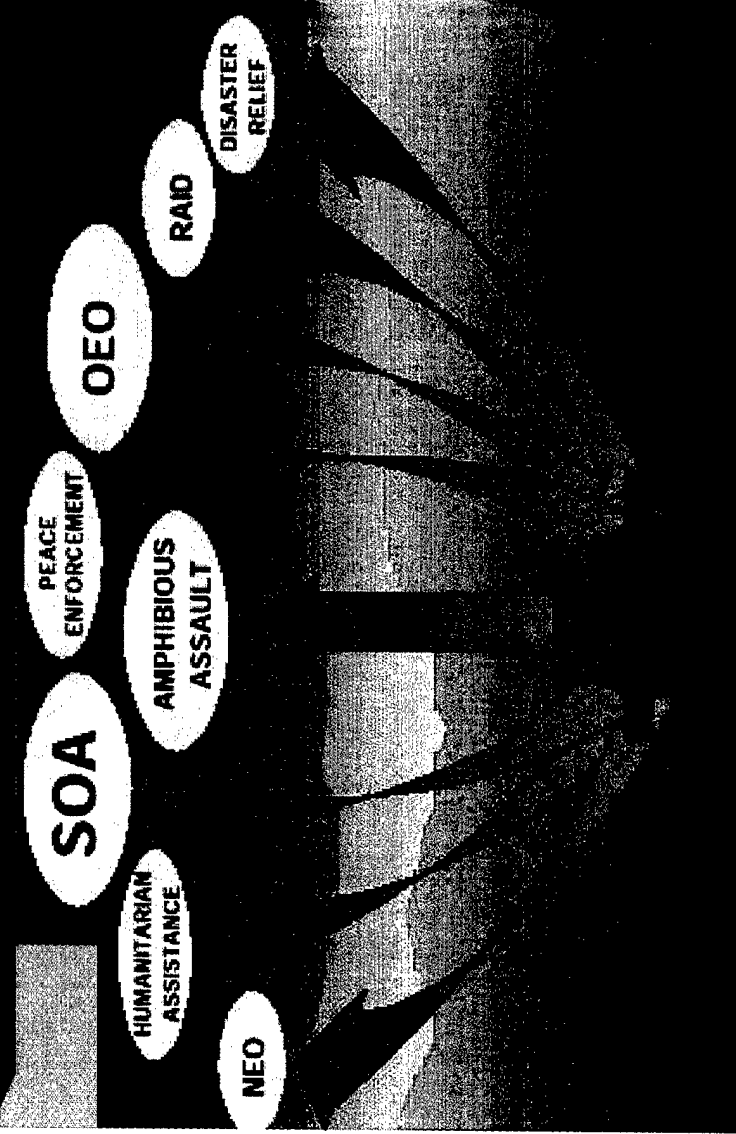

- Primacy of the Sea Base Reduce or Eliminate the Footprint
- Reduced Demand Seabased Support - Light Force Ashore
- In-stride Sustainment Automated Logistics for Maneuver Units
- Adaptive Response Expanded Missions - Joint Support
- Reconstitute at Sea Build & Restore Combat Power



Reduce Burden of Logistics Support



- ***Precision Logistics vs Traditional Logistics Tail***
- ***Logistics Support Systems That ...***
 - ***Use less fuel***
 - ***Require little or no maintenance over a given period, e.g., a month***
 - ***Can predict internal failures***
 - ***Leverage Technology***
 - ***Maintenance free batteries***
 - ***Reusable filters***
 - ***Onboard oil analysis***

Logistics Focused on Supporting Operational Forces



Reduce Total Ownership Costs

- ***Maintenance***
 - ***Shorter, more responsive repair part pipelines***
 - ***More precise repair parts accountability***
 - ***Predictive maintenance capabilities***
- ***New Technology***
 - ***Fewer, more reliable batteries***
 - ***Reusable filters & Onboard oil analysis***
- ***Industry Experience & Best Practices***

Do It Cheaper By Doing It Smarter



Corrosion Protection

- ***Corrosion is #1 Maintenance Problem***
 - ***Marine Corps environment***
 - ***BIG impact on vehicle life***
- ***Two Approaches***
 - ***Design into new system (MTVR & HMMWVA2)***
 - ***Fixing Existing Systems***
 - ***Less clear solutions***
 - ***Potentially more difficult & costly than new***
- ***What Is Out There & What Can Work?***

Makes Otherwise Sound Vehicles Unserviceable



Best Use of Technology

- ***What is Out There?***
- ***Is It Applicable for ...***
 - **Insertion into existing systems**
 - **Design into new systems**
- ***What Is Impact on TOC?***
- ***Improve the Process***
 - **Models & Simulation throughout System Life Cycle**
 - **Integrated Process & Product Development**

More Questions Than Answers



What You Can Do



- ***Let Us Know of Ways to Answer Challenges***
- ***Ideas for the MT Modification Line***
 - Existing Commercial Solutions versus New Design
 - Talk to Project Officers
- ***Better Ways to Facilitate ...***
 - Government - Industry Cooperation
 - Teaming

Give Us Your Ideas for Solutions

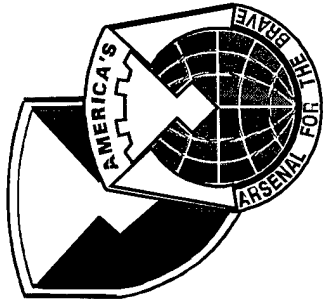

ZACOM
*Mobility and Firepower
for America's Army*



QUALITY ASSURANCE
SUBCOMMITTEE REPORT
1 FEBRUARY 1999

Briefer: Ronald Scholtes
Date: February 1, 1999

1/4

Tank-automotive & Armaments Command

Committed to Excellence

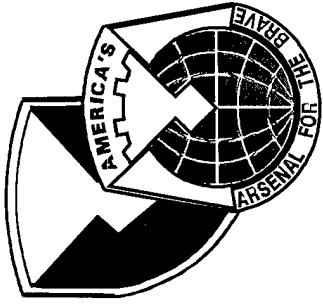

NEW APPROACH

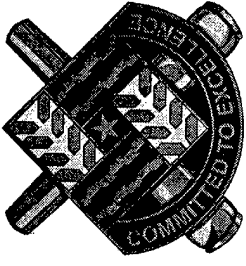

- MID-YEAR MEETINGS
- TESTING COMMUNITY PERSONNEL
JOINED OUR SUBCOMMITTEE

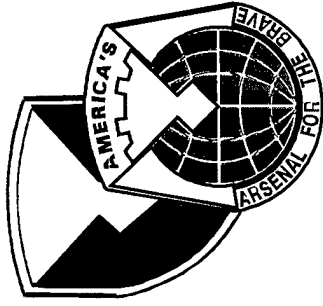

AUGUST 1998

TOPICS



- DLA POLICY FOR ISO 9000
- USING COMMERCIAL TEST STANDARDS
- ELECTRONIC DD250 PROCESS
- NATIONAL AUTOMOTIVE CENTER PROJECTS

3/4

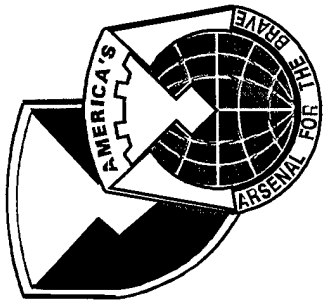

JANUARY 1999

TOPICS

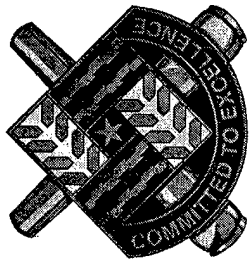

- ACQUISITION REFORM UPDATE
- CURRENT NATIONAL AUTOMOTIVE CENTER PROJECTS
- ISO 9000 PROGRAM
- CONTRACTOR PERFORMANCE CERTIFICATION PROGRAM
- ELECTRONIC DD250 PROCESS
- TESTING USING COMMERCIAL STANDARDS

4/4

Committed to Excellence

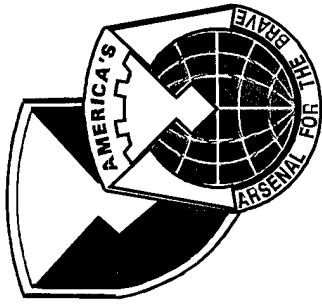

POINTS OF CONTACT



- Mr. Walt Botich
AM General Corporation
Commercial (219) 258-7523
Email - wbotich@amgeneral.com
- Mr. Ronald Scholtes
TARDEC, Engineering Business Group
Commercial (810) 574-6153
Email - scholter@tacom.army.mil



**DEFENSE SECURITY COOPERATION AGENCY:
THE CHANGING ENVIRONMENT AND FMS RE-
ENGINEERING**

**MR ROBERT KELTZ
DEPUTY DIRECTOR,
DSCA
1 FEBRUARY 1999**



SECURITY COOPERATION: A KEY POLICY TOOL FOR THE 21st CENTURY



- BUILD INSTITUTIONS TO KEEP AMERICANS SAFE AND THE WORLD PEACEFUL
- SUSTAIN OUR PROSPERITY AND EXPAND GLOBAL ECONOMY
- PROMOTE AMERICAN PRINCIPLES & VALUES

- TO ENHANCE OUR SECURITY WITH MILITARY FORCES THAT ARE READY TO FIGHT
- TO BOLSTER AMERICA'S ECONOMIC REVITALIZATION
- TO PROMOTE DEMOCRACY ABROAD

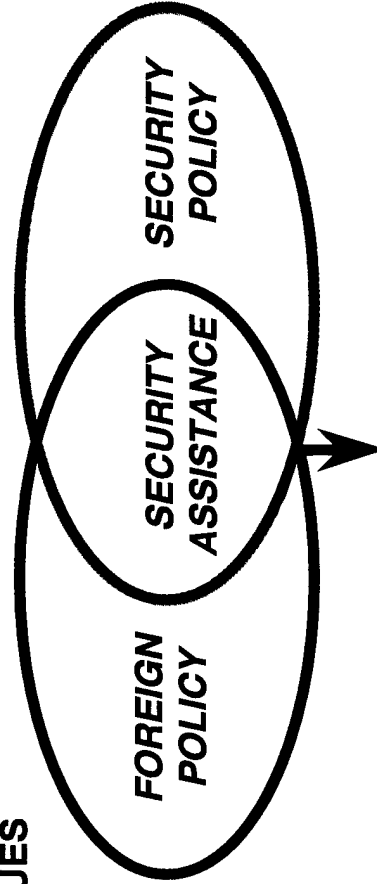

- COALITION BUILDING
- FORWARD PRESENCE
- INTEROPERABILITY
- REGIONAL STABILITY
- CRISIS MANAGEMENT
- THEATER DETERRENCE



MILITARY ASSISTANCE PROGRAM



-
- **FMS SALES = \$8.6B & FMS DELIVERIES = \$13.9B IN FY98**
 - **SALES TO 137 COUNTRIES AND INT'L ORGANIZATIONS**
 - **PIPELINE OF \$70B IN PRIOR YEAR SALES**
 - **OVER \$3B IN GRANT ASSISTANCE IN FY97 - FY99**
 - **IMET PROGRAMS OF \$50M WITH 118 COUNTRIES IN FY99**
 - **DSCA OVERSEES 15,000+ FMS CASES WORTH \$222B**
 - **DSCA MANAGES \$370M IN FY99 ADMINISTRATIVE BUDGETS**
 - **SECURITY ASSISTANCE FY98 WORK-YEARS: 5,246**
 - **712 SAOs IN OVERSEAS SA ORGANIZATIONS**



FUNCTIONAL VIEW OF SECURITY ASSISTANCE COMMUNITY



5,246 WORK YEARS FY 98

HEADQUARTERS
(135)

DSCA ACTIVITIES
(167)

FIELD AGENCIES
(578)

IMPLEMENTERS
(3,555)

UNIFIED COMMANDS
(99)

SAO'S
(712)

DSCA HQ

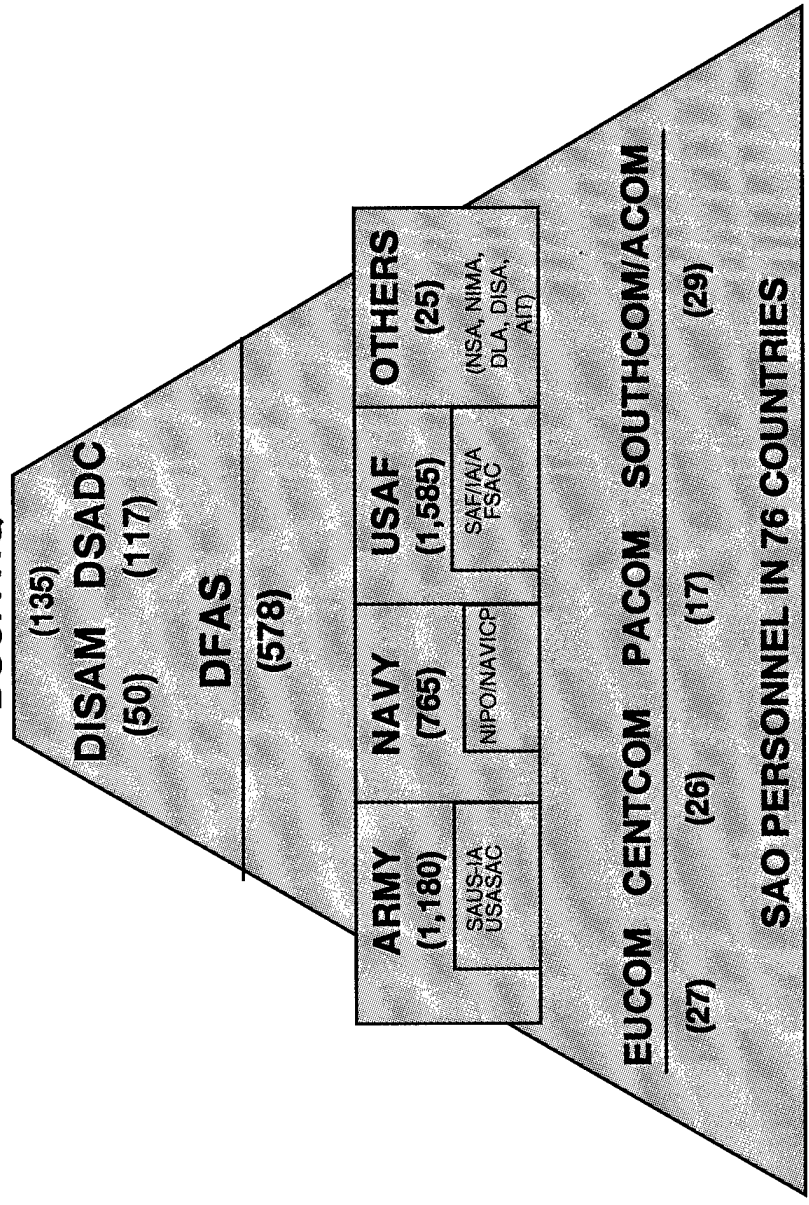



FOREIGN MILITARY SALES: WORLDWIDE SALES

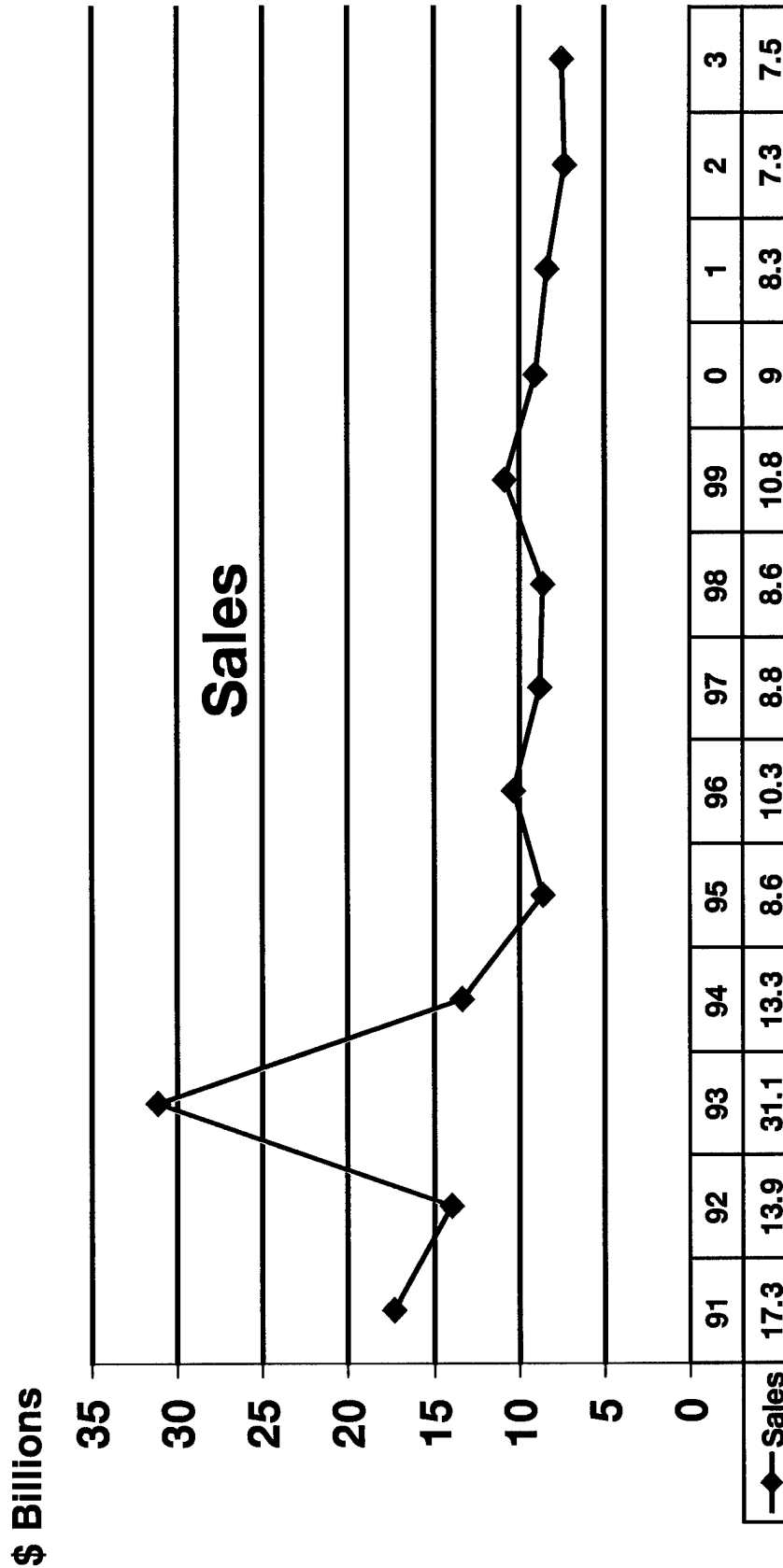



FOREIGN MILITARY SALES: Regional Breakdown



(in Billions)

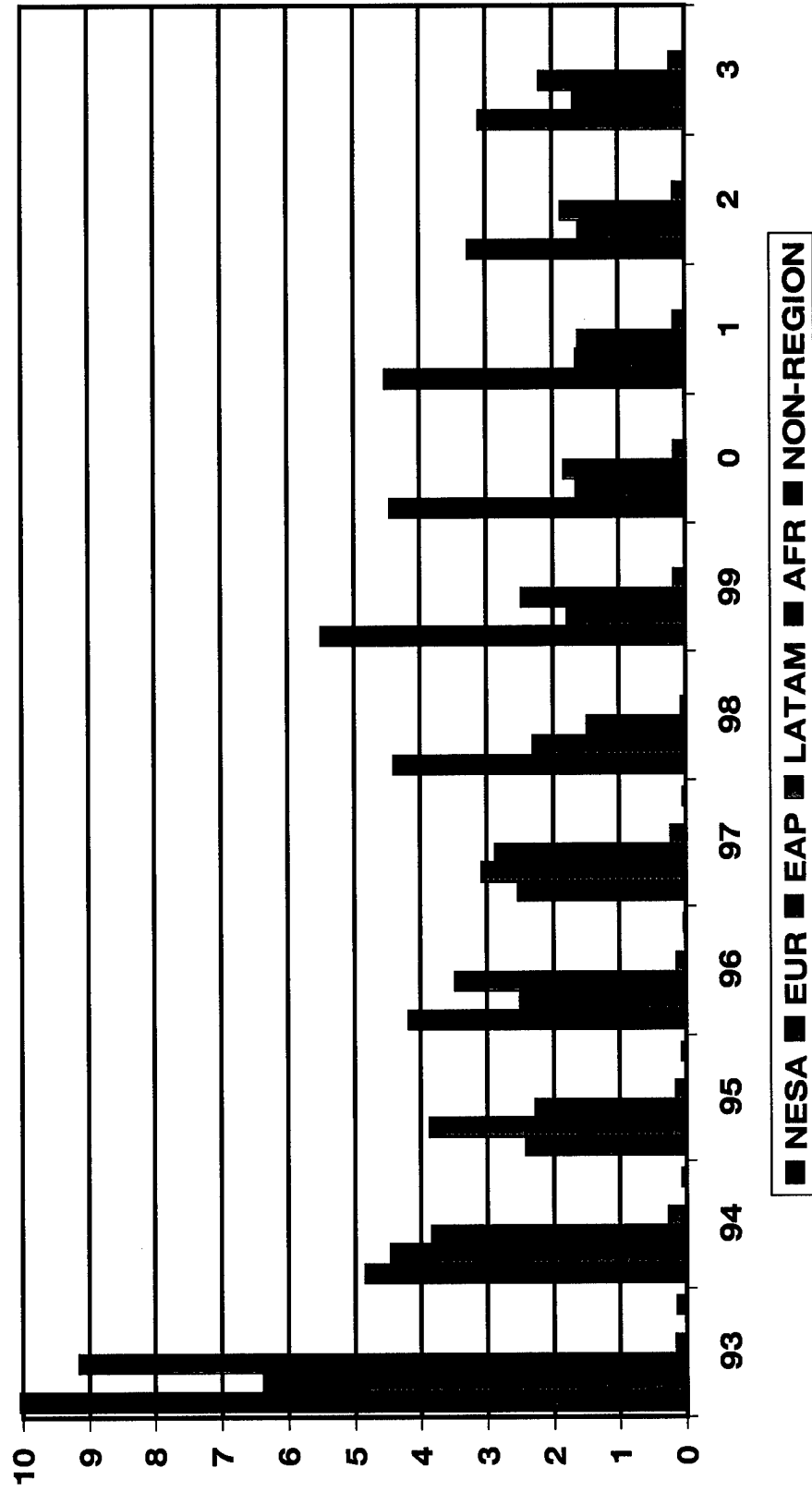



U.S. GOVERNMENT TACTICAL WHEELED VEHICLE SALES



-
- **NOT REALLY ANY NEW SALES PENDING OR ON HORIZON**
 - **SOME MINOR SUSTAINMENT CASES FOR EXISTING FLEETS**
 - **BULK OF SALES GO ON DIRECT COMMERCIAL BASIS (CUSTOMER PREFERENCE)**
 - **VARIABLES AT WORK IN MARKETPLACE THAT WE CAN'T CONTROL**
 - **DESIRE OF CUSTOMERS TO GO INDIGENOUS WHENEVER POSSIBLE**
 - **MANY VIABLE PRODUCERS**



DSCA MAJOR EFFORTS



External

- RE-ENGINEER THE FMS PROCESS AND MEET CUSTOMER NEEDS
- MAINTAIN SECURITY ASSISTANCE TRUST FUND SOLVENCY
- MAINTAIN SOLVENCY OF CUSTOMER TRUST FUNDS
- ENSURE CONTINUED VIABILITY OF AGENCY

Internal

- IMPLEMENT AGENCY 5 YEAR STRATEGIC PLAN
- COMPLETE AGENCY'S BUSINESS PERFORMANCE PLAN FOR DEFENSE MANAGEMENT COUNCIL
- DEVELOP & FIELD DSAMS



FUNCTIONS ACQUIRED UNDER DEFENSE REFORM INITIATIVE



- HA/D PROGRAMS TRANSFERRED TO DSCA - MARCH 1998
- WARSAW INITIATIVE (PFP) PROGRAM MANAGEMENT FUNCTIONS - AUG 98
- FOREIGN COMPARATIVE TEST PROGRAM - AUG 98
- INTERNATIONAL ARMAMENTS COOPERATION/DEFENSE EXPORT LOAN GUARANTEE PROGRAM - NOT COMING TO DSCA

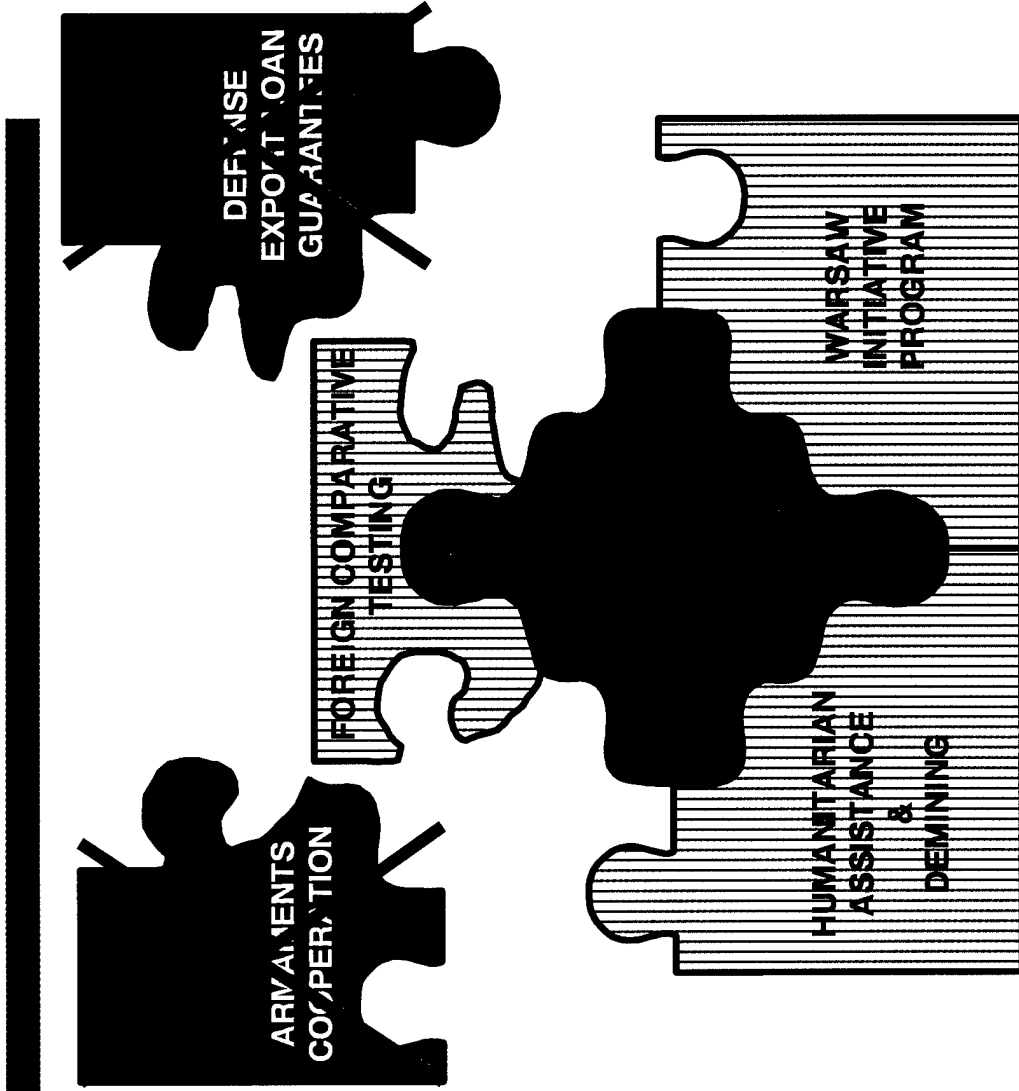



DEFENSE SECURITY COOPERATION AGENCY (DSCA)

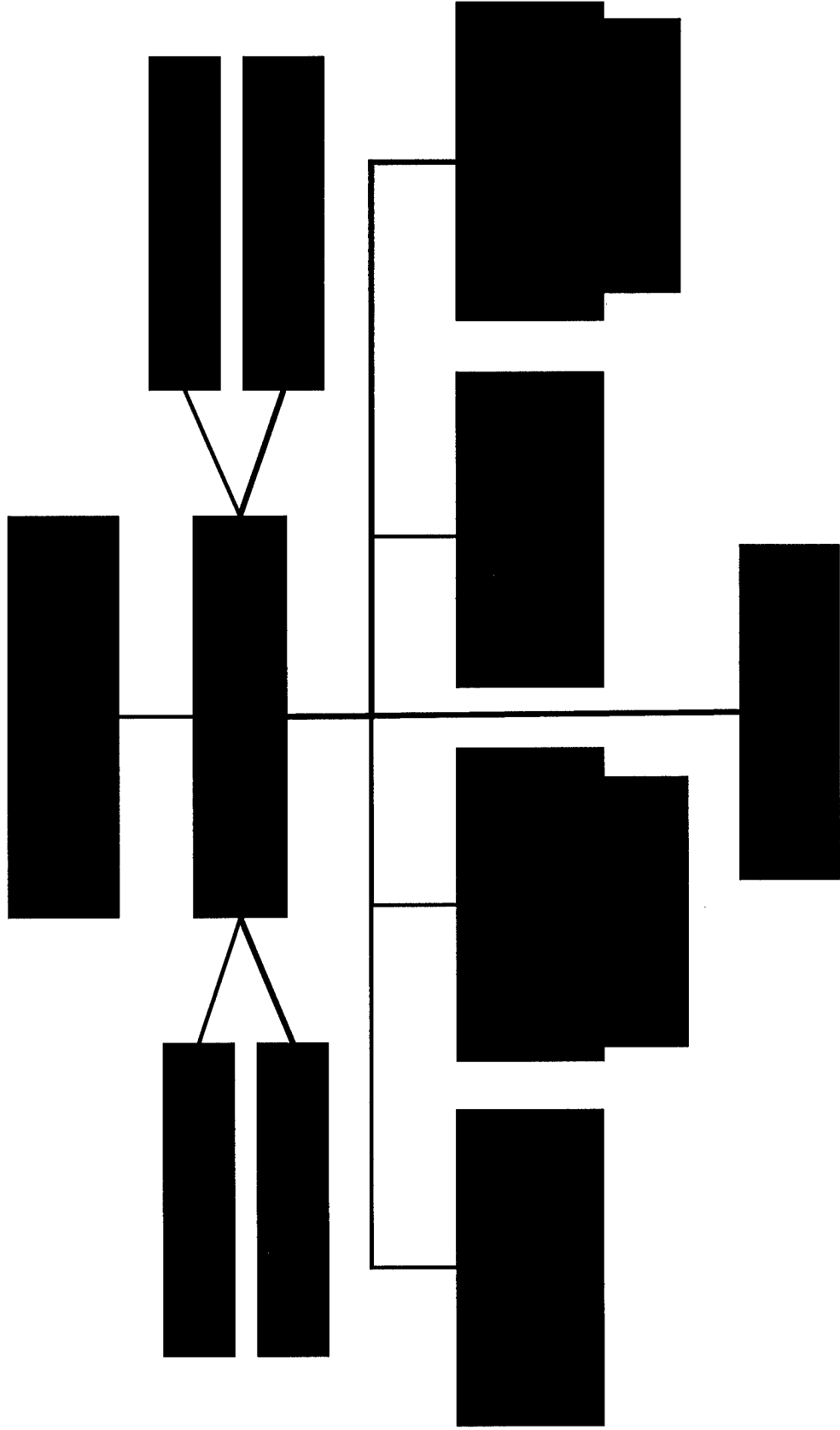



AGENCY STRATEGIC PLANNING



-
- **RESPONDS TO THE GOVERNMENT PERFORMANCE AND RESULTS ACT**
 - **DEPSECDEF DIRECTION REQUIRES PERFORMANCE CONTRACTS FOR ALL DEFENSE AGENCIES**
 - **PLAN SETS SPECIFIC, MEASURABLE PERFORMANCE OBJECTIVES FOR DSCA**
 - **BASIS FOR PERFORMANCE CONTRACT BETWEEN DSCA DIRECTOR AND THE DEPSECDEF**
 - **WILL BE PART OF THE DSCA ANNUAL PROGRAM OBJECTIVE MEMORANDUM (POM) SUBMISSION**



RE-ENGINEERING THE FMS SYSTEM



WRAPPED
in **RED TAPE**

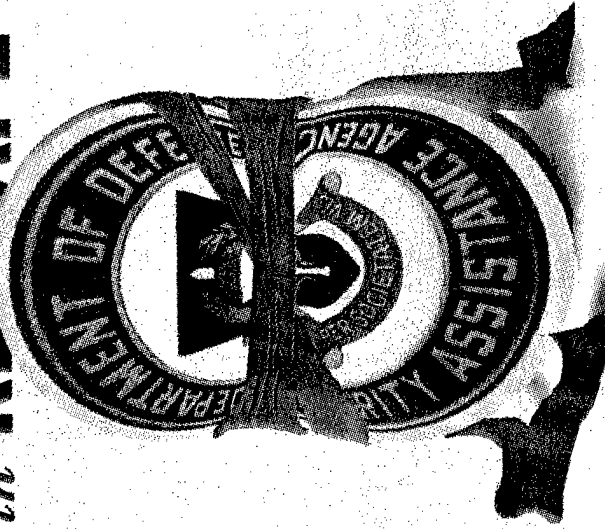

***Customers Abandon FMS;
Cite High Cost, Inflexibility***

- FMS SYSTEM FACING CHALLENGES
- INDUSTRY WANTS MORE FROM FMS SYSTEM
 - RAPID POLICY DECISIONS
 - STRONGER ADVOCACY
 - MORE SUPPORT FOR SALES EFFORTS
- MAJOR CUSTOMERS WANT:
 - GREATER PARTICIPATION
 - SHORTER TIMELINES
 - FASTER RELEASE APPROVALS
 - FEWER SURCHARGES



DEVELOPING A CONSENSUS FOR CHANGE



DR. HAMRE MEMO
12 MAY 98

OSD STAFF

AIA

ABA

NAVY

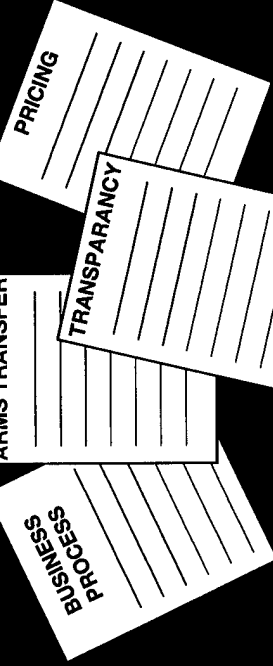

AIR FORCE

DSCA

DLA

NDIA

ALESA

ARMY

- STRATEGIC PLAN SURVEY
- DUTCH & JAPANESE
- DEFENSE ATTACHE & MOU COMMUNITY



NEEDED ACTIONS



TRANSPARENCY*

(9 & 23 NOV)

- RELATIONSHIP WITH INDUSTRY
- LOA PREPARATION
- CONTRACT PREPARATION



- RELATIONSHIP WITH INDUSTRY POLICY MEMO*
- DSCA POLICY MEMO
- FOREIGN CONTRACTING POLICY MEMO

PRICING, COST RECOVERY*

(18 NOV & 9 DEC)

- NTE/FFP LOAS
- ADJUST FMS SURCHARGES
- USG COST RECOVERY
- ALTERNATIVES TO DFAS/DCMC



- LEGISLATIVE CHANGE
- ACTIVITY BASED COSTING ANALYSIS
- LEGISLATIVE CHANGE
- POSSIBLE OUTSOURCING

* Presented to DPACT 26 Jan 99



NEEDED ACTIONS



TECH TRANSFER

(30 NOV & 14 DEC)

- ARMS TRANSFER POLICY REVIEW GROUP
- IMPROVE BUREAUCRATIC PROCESS
- FOREIGN DISCLOSURE



- ATPRG POLICY MEMO (18 DEC 98)*
- POSSIBLE I/TAR REVISIONS
- ASSESSMENT OF INFORMATION RELEASE CRITERIA
- USDP/POLICY ON ACCESS

METRICS/PROCESS RE-ENGINEERING

(18 DEC)

- DEVELOP PERFORMANCE MEASURES
- RE-ENGINEER ENTIRE SECURITY COOPERATION PROCESS



- METRICS EFFORT BEGUN (OCT 98)
- CONTRACTOR SUPPORT IMPLEMENTED

* Presented to DPACT 26 Jan 99



CURRENT ACTIVITIES



-
- 8 JAN - FINAL COORDINATION WITH
INDUSTRY ON 1ST TWO WHITE
PAPERS
 - 11 JAN - DPACT COORDINATION
 - 26 JAN - DPACT
 - 8 FEB - MEET WITH MILDEPS TO
COORDINATE RE-INVENTION
EFFORTS



COMPLETING REMAINING GROUNDWORK



TWO WHITE PAPERS TO BE FINISHED

- **ARMS TRANSFER & TECHNOLOGY/DATA RELEASE**
 - **DSCA AND DUSD(PS) COOPERATIVELY REWRITE PAPER**
 - **VET PAPERS THROUGH DoD COMMUNITY AND INDUSTRY**
 - **TARGET COMPLETION DATE 15 MARCH**
- **METRICS & PROCESS RE-ENGINEERING**
 - **PAPER BEING CO-DEVELOPED WITH MILDEPS AND DLA**
 - **TARGET COMPLETION DATE 29 MARCH**



THE FUTURE



-
- SECURITY COOPERATION REFLECTS ON USG AND DEMONSTRATES COMMITMENT TO SECURITY NEEDS OF OUR FRIENDS AND ALLIES
 - SECURITY COOPERATION WILL CONTINUE TO BE AN IMPORTANT TOOL FOR POLICY MAKERS
 - WE CAN EXPECT:
 - CONTINUED SCRUTINY OF FOREIGN AID REQUESTS
 - CONTINUED PRESSURE TO REDUCE MANPOWER RESOURCES
 - INCREASED COMPETITIVE MARKET FOR SMALLER DEFENSE BUDGETS



AGENCY VISION



-
- TO BE THE PREMIER AGENCY RECOGNIZED AND RESPECTED FOR LEADERSHIP, EXPERTISE, INNOVATION, AND RESULTS IN SECURITY COOPERATION...
- A HIGHLY QUALIFIED TEAM OF MOTIVATED PROFESSIONALS
 - VITAL TO SUPPORTING US INTERESTS AND SECURITY RELATIONSHIP
 - THE INTERNATIONAL PARTNER OF CHOICE
- ...MASTERING THE CHALLENGES OF A CHANGING GLOBAL ENVIRONMENT.

Decisive

Supportive

Committed

Accessible



21ST TAACOM

UPDATED USAREUR HAZARDOUS MATERIEL HANDLING REQUIREMENTS

HOW DOES IT AFFECT FLEET READINESS?



21ST TAACOM

AGENDA



- BACKGROUND
-
- ISSUES
- HAZMAT DRIVER'S LICENSING REQUIREMENTS
- HAZMAT UNIT SAFETY OFFICER REQUIREMENT
- HAZMAT TRANSPORTATION WAIVERS
- JOINT VEHICLE INSPECTION
- ANNUAL B3 VEHICLE CERTIFICATION
-
- CONCLUSIONS



21ST TAACOM

BACKGROUND

- MARCH 1998 - SUPPLEMENTAL AGREEMENT TO SOFA GOES INTO EFFECT
- AUTHORIZES NATO HOST NATIONS TO ENFORCE COMPLIANCE WITH LOCAL ENVIRONMENTAL AND HAZMAT REGULATIONS AND LAWS BY U.S. FORCES STATIONED IN EUROPE
- U.S. FORCES UNABLE TO IMMEDIATELY COMPLY WITH EUROPEAN REGULATIONS AND LAWS
- U.S. FORCES FORCED TO ADOPT "PHASE-IN" COMPLIANCE



21ST TAACOM

ISSUES

- **WAIVER OF REQUIREMENTS PREVENTING U.S. FORCES FROM TRANSPORTING HAZMAT OVER EUROPEAN HIGHWAYS**
- **CONDUCT USAREUR AND GERMAN FEDERAL MINISTRY OF TRANSPORT JOINT VEHICLE INSPECTION**
- **WAIVER OF REQUIREMENT FOR ANNUAL B3 VEHICLE CERTIFICATION**



21ST TAACOM



HAZMAT DRIVER'S LICENSING REQUIREMENTS

- EFFECTIVE 1 JANUARY 1999, ALL U.S. TRANSPORTERS (MILITARY AND CIVILIAN) OF HAZMAT IN EUROPE ARE REQUIRED TO BE LICENSED IAW ACCORD EUROPEEN RELATIF AU TRANSPORT DES MATIERES DANGEROUSE PAR ROUTE (ADR)
- TO MEET THIS REQUIREMENT, USARERUR WILL:
 - MAXIMIZE USE OF HAZMAT 11 COURSE, VILSECK, GERMANY
 - MAXIMIZE USE OF MACOM DRIVER'S ACADEMIES
 - EMPLOY MOBILE TRAINING TEAMS



21ST TAACOM

HAZMAT UNIT SAFETY ADVISORS

- EFFECTIVE 1 JANUARY 2000, ALL U.S. FORCES, DETACHMENT SIZE AND LARGER, ARE REQUIRED TO HAVE AT LEAST ONE UNIT SAFETY ADVISOR TRAINED AND CERTIFIED IAW ADR
- UNIT SAFETY ADVISOR IS RESPONSIBLE AND PERSONALLY LIABLE FOR TRANSPORTATION OF HAZMAT
- USAREUR IS DEVELOPING ALTERNATIVE COURSES OF ACTION FOR THE TRAINING AND CERTIFICATION OF UNIT SAFETY ADVISORS



21ST TAACOM

JOINT VEHICLE INSPECTION

• SEPTEMBER 1998 - USAREUR AND GERMAN FEDERAL MINISTRY OF TRANSPORT CONDUCTED A JOINT VEHICLE INSPECTION

• PRELIMINARY RESULTS:

- MECHANISM TO LIMIT VEHICLE TOP SPEED
- TANKERS REQUIRE SWITCH TO DISCONNECT VEHICLE BATTERY
- VEHICLES REQUIRED TO HAVE NON-FLAMMABLE TARPS AND CANVASES
- SHIELDING REQUIRED AROUND ALL WIRING
- TANKERS MUST BE DOUBLE WALLED AND SPECIALLY REINFORCE
- VEHICLES REQUIRED TO HAVE ABS



21ST TAACOM



JOINT VEHICLE INSPECTION (CONT'D)

- **USAREUR STILL AWAITING OFFICIAL INSPECTION RESULTS**
- **USAREUR HAS NOTIFIED TACOM OF INSPECTION AND PRELIMINARY RESULTS FOR FUTURE VEHICLE MODIFICATION AND PROCUREMENT REQUIREMENTS**
- **FUTURE ACTIONS DEPENDENT UPON GERMAN MINISTRY OF TRANSPORT RECOMMENDATIONS**
- **WILL REQUEST WAIVER OF CURRENT DEFICIENCIES; FUTURE PROCUREMENTS MUST MEET ADR STANDARDS**

21ST TAACOM

HAZMAT WAIVERS

- DECEMBER 1998 - USAREUR SUBMITTED 18 WAIVER REQUESTS TO ALLOW U.S. FORCES TO CONTINUE TRANSPORTATION OF HAZMAT
- WAIVER REQUESTS VARY FROM OPERATIONAL PROCEDURES TO VEHICLE OWNER IDENTIFICATION ON THE VEHICLE TO VEHICLE ROUTE DETERMINATION
- ALL WAIVERS INITIALLY APPROVED; AWAITING FINAL CONFIRMATION FROM FEDERAL MINISTRY OF TRANSPORT
- TRANSPORT OF HAZMAT CONTINUES UNTIL 30 JUNE 1999 WHEN FINAL CONFIRMATION MUST BE RECEIVED



21ST TAACOM



ANNUAL B3 VEHICLE CERTIFICATION

- ADR REQUIRES ANNUAL MECHANICAL INSPECTION AND CERTIFICATION OF ALL VEHICLES DESIGNATED TO TRANSPORT HAZMAT
- USAREUR IS REQUESTING WAIVER OF THIS REQUIREMENT
- USAREUR IS DEVELOPING A PROGRAM TO INSPECT AND CERTIFY THESE VEHICLES IN THE EVENT OF WAIVER DENIAL



21ST TAACOM

CONCLUSIONS

- GOAL IS TO CONTINUE TO WORK ON ADR COMPLIANCE
- SHORT TERM SOLUTION - WAIVE THOSE REQUIREMENTS WHICH ARE NOT IMMEDIATELY ATTAINABLE
- LONG TERM SOLUTION - MODIFY FLEET TO COMPLY WITH ADR STANDARDS

21ST TAACOM

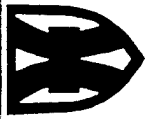

FUTURE TACTICAL WHEELED VEHICLES



21ST TAACOM

AGENDA

- MISSION REQUIREMENTS
-
- FUNCTIONAL REQUIREMENTS
-
- ORGANIZATIONAL STRUCTURES
-
- INDUSTRY SUPPORT
-

21ST TAACOM



MISSION REQUIREMENTS

AIR DEPLOYABLE

**LONGER
DISTANCES
SUPERHIGHWAYS
TO
MUDDY FIELDS**

**TACTICAL
WHEELED
VEHICLES**

**MISSION
REQUIREMENTS**

**SUPPLIER
TO SOLDIER
CONTAINER
HANDLING**

INTEGRAL LOADING AND UNLOADING

21ST TAACOM

FUNCTIONAL REQUIREMENTS

MEETS
WORLD WIDE
REGULATIONS



IN TRANSIT
VISIBILITY

INCREASED
VELOCITY



CREW
PROTECTION

MODULAR



DECREASED SUPPORT COSTS

INCREASED OPTEMPO



FLEXIBLE

MATERIEL INVENTORY IN TRANSIT TO NEED

21ST TAACOM

ORGANIZATIONAL STRUCTURES

- MODULAR
- VARIETY OF CAPABILITY
- FLEXIBLE
- EXPRESS SERVICE
- MULTI-CAPABLE DRIVERS
- SIMPLIFIED LOGISTICS

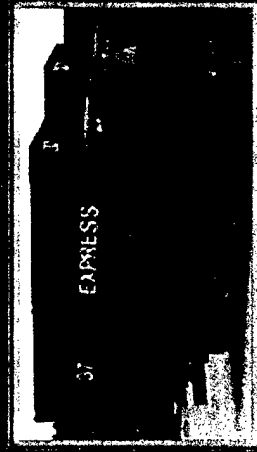
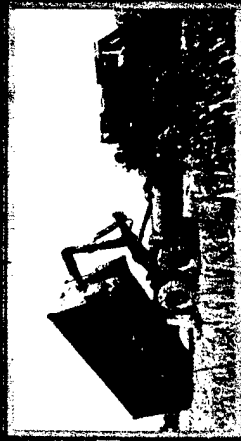

16



21ST TAACOM

INDUSTRY SUPPORT

- USE PROVEN TECHNOLOGY
- CASH IN ON COMMERCIAL DEVELOPMENTS
- LESS FUNDING FOR LOGISTICS
- VEHICLES MUST PASS WORLD WIDE REQUIREMENTS
- FEWER TRANSPORTATION NODES
- INCREASED USE OF CONTAINERS
- NEED MORE INTEGRATED AND INDEPENDENT MHE

DEFENSE LOGISTICS AGENCY



Defense Logistics Agency
America's Logistics Combat Support Agency

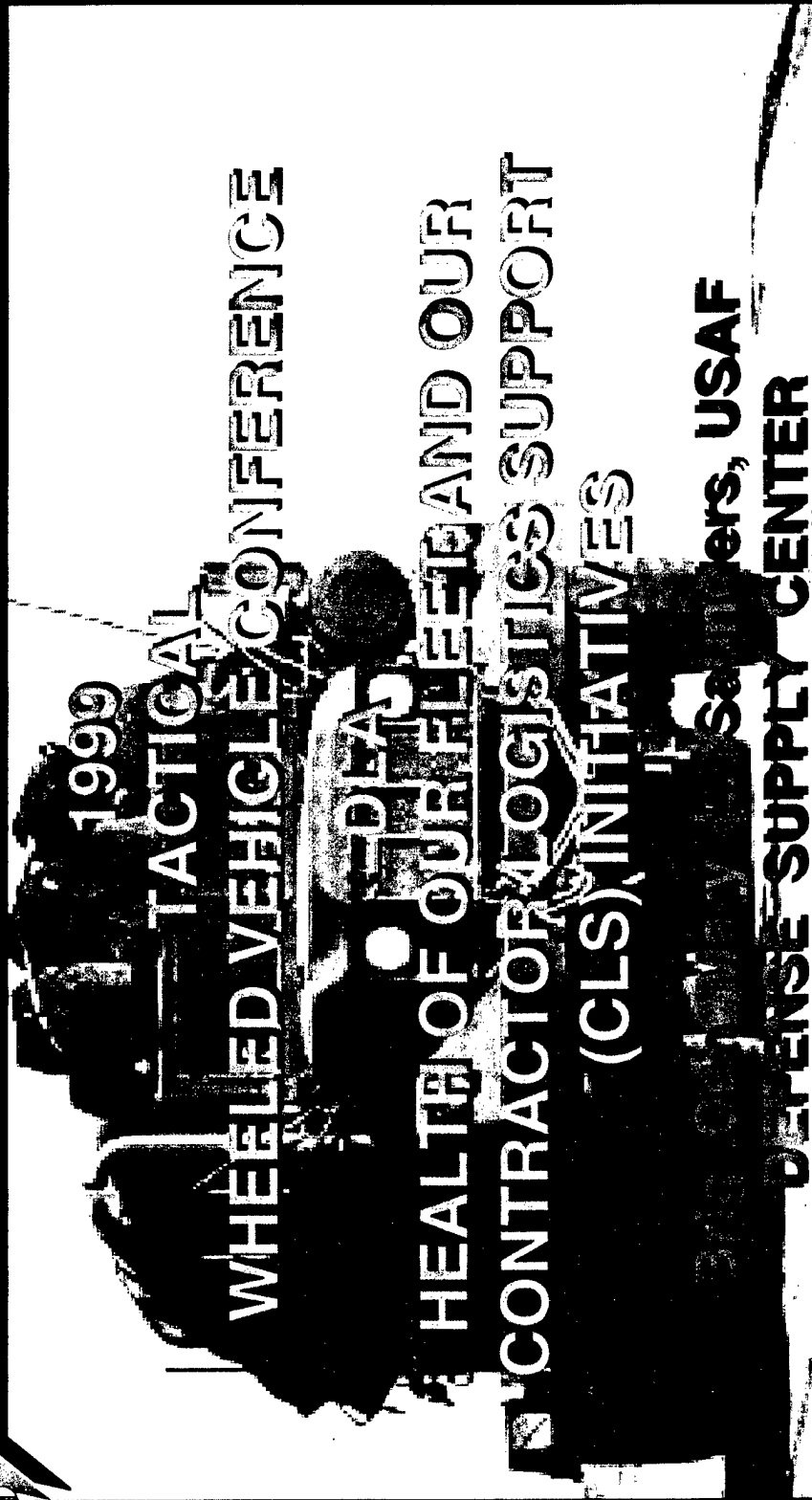

1999

TACTICAL
WHEELED VEHICLE CONFERENCE

PLEASE

HEALTH OF OUR FLEETS AND OUR
CONTRACTOR LOGISTICS SUPPORT
(CLS) INITIATIVES

if you are a member, USAF

DEFENSE SUPPLY CENTER

COLUMBUS

2 FEBRUARY 1999

DEFENSE LOGISTICS AGENCY

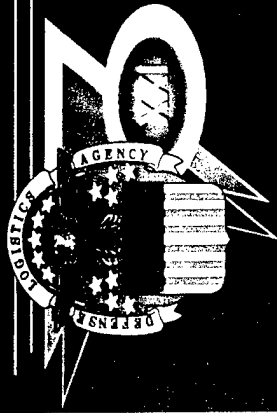

DLA



- WHO WE ARE

- HOW WE DO BUSINESS

- HOW WE MEASURE HEALTH / SUCCESS

- CLS INITIATIVES

- SUMMARY

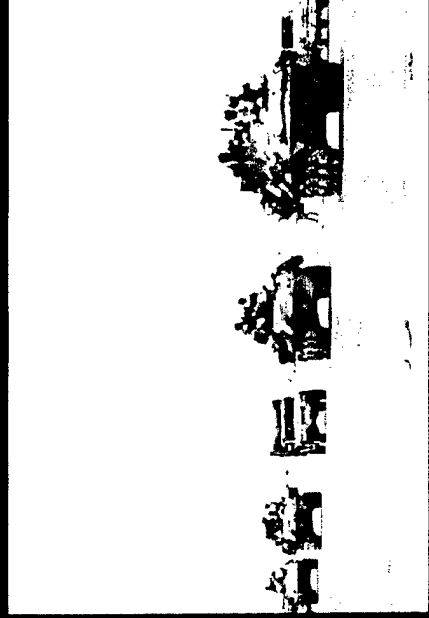



Where We Fit

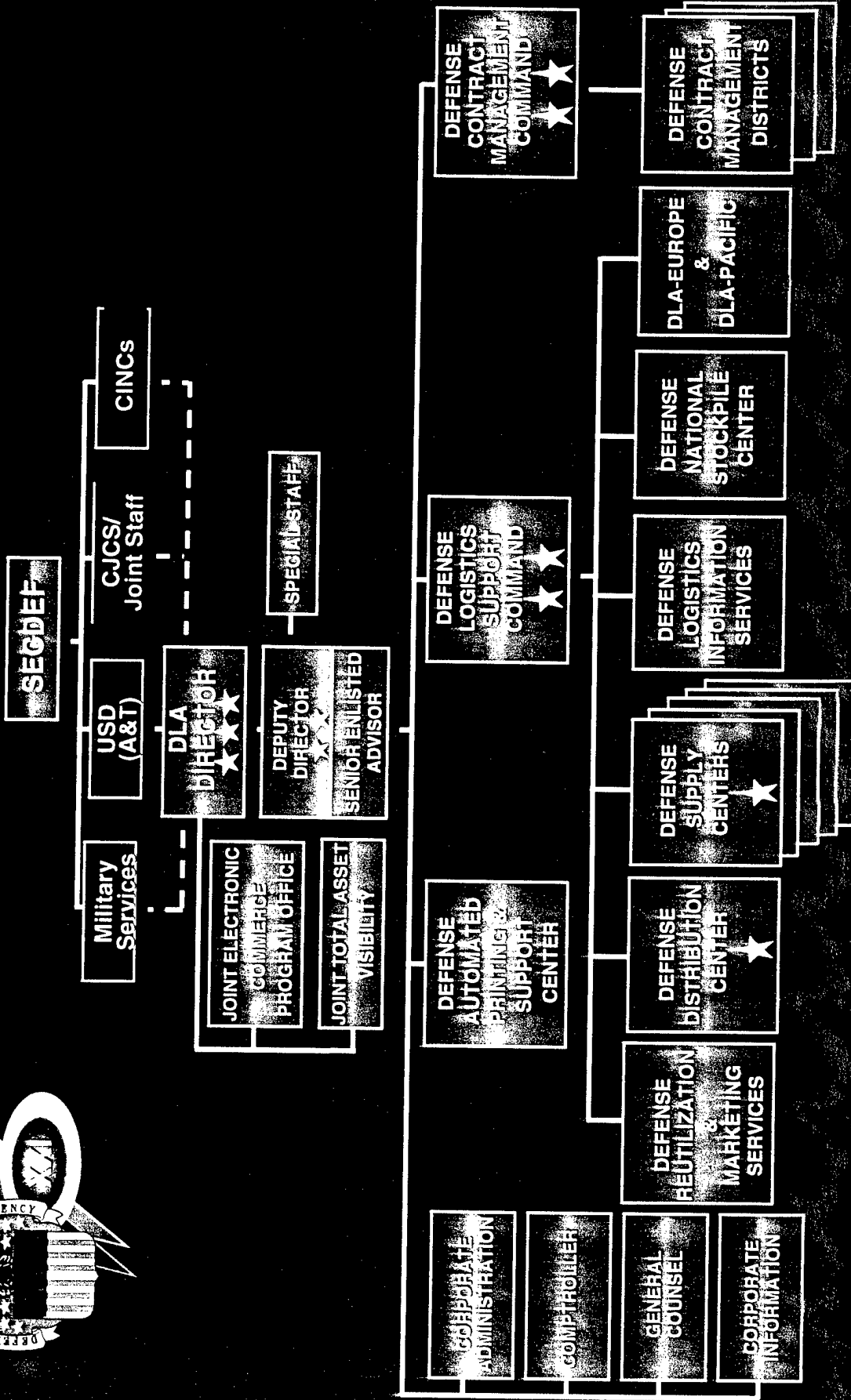

DEFENSE LOGISTICS AGENCY

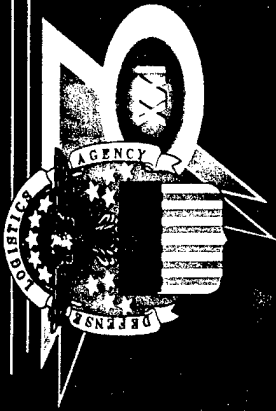

DLA

OUR MISSION...

To provide acquisition and *focused logistics support* to America's Armed Forces in peace and war--around the clock, around the world.

VISION...

To be America's logistics combat support agency... the *warfighter's choice* for integrated life cycle solutions through teamwork and *partnership*.

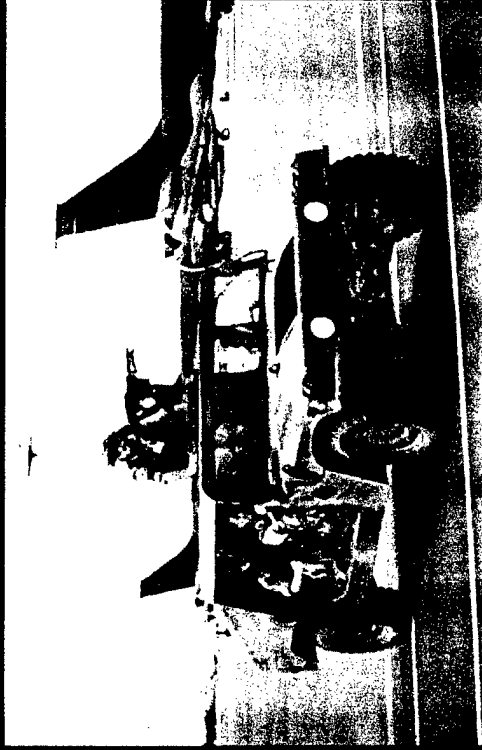

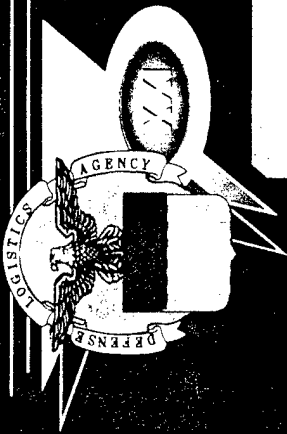

OUR STRATEGIC GOALS

1. Consistently provide *responsive*, best value supplies and services to our customers.

2. Serve as a *catalyst* for the Revolution in Business Affairs and Acquisition Reform.

3. Ensure our workforce is enabled to deliver and sustain *world class performance*.

4. Rapidly *exploit technology* to provide agile, responsive, interoperable solutions.

5. Aggressively pursue *partnerships* with industry and our suppliers.

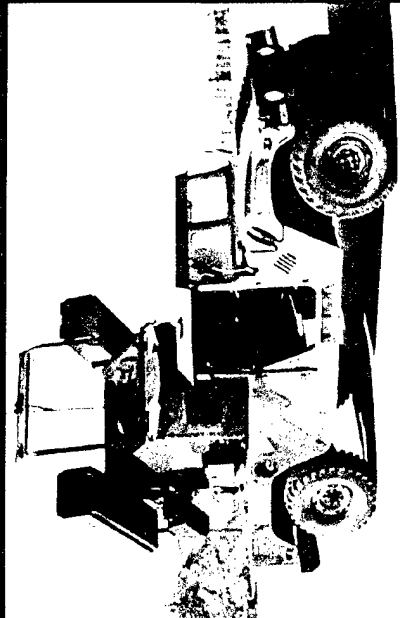
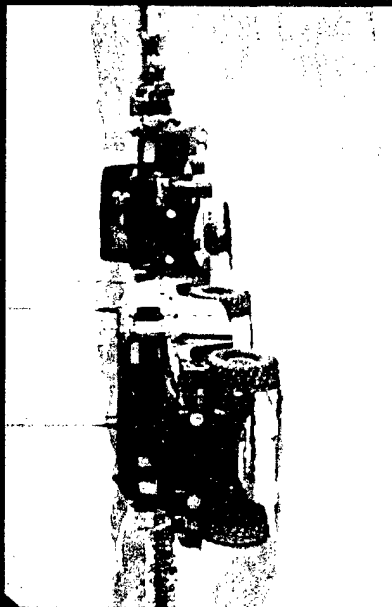

“We must have a logistics system which tailors what we provide to what our customers *require*- not what is convenient for us - and does so in dramatically reduced time frames, reliably and consistently.”



Preparing for the Future What Does the DLA Strategic Plan Do?

- **Right Focus**
 - On Warfighter Readiness & Capability
 - Ties DoD Goals and Direction to the Workplace
- **Right Size**
 - Major Infrastructure Changes
- **Right Enablers**
 - Business Process Change
 - Smaller, Multi-skilled Workforce
 - Acquisition Reform
 - Partnerships with Customers and Industry
 - Information Technology
- **Linked to POM**

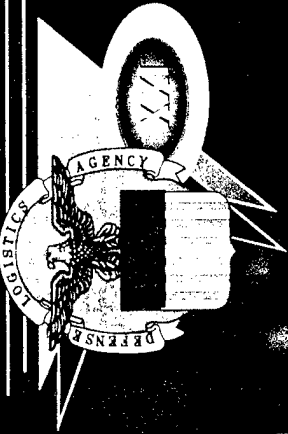

Defense Logistics Support Command

1394 Weapon Systems Supported

- \$11.6B Inventory
- \$12B Annual Sales
- \$25M Annual Reutilization/Disposals
- \$27M Receipts and Issues annually
- All DoD Wholesale Inventories

Functions:

- Supply Management
- Procurement
- Distribution
- Logistics Information Management Support
- Stockpile Management
- Reutilization Marketing
- Energy Support
- Management

Activities

- Defense Supply Centers
- Defense Reutilization & Marketing Service
- Defense Distribution Center
- Defense National Stockpile Center
- Defense Logistics Information Service
- DLA Europe
- DLA Pacific

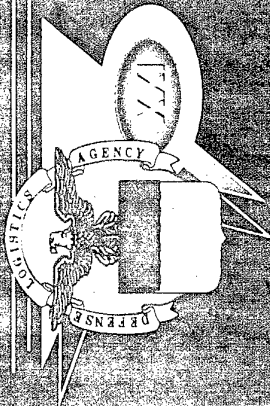

DLA: An Integral Part of the Warfighting Team

CLASS	TYPE SUPPORT	PROVIDER	DLA
		SERVICES	
I	Subsistence		100%
II	Clothing, Tents		100%
III	Bulk Fuel		100%
IV	Pkg POL		100%
V	Ammo	100%	
VI	Comfort Items		100%
VII	End Items	100%	
VIII	Medical		100%
IX	Reparables	100%	
X	Non Reparables	4%	96%
	Energy		100%
	Log Info	10%	90%
	Recruitment	10%	90%

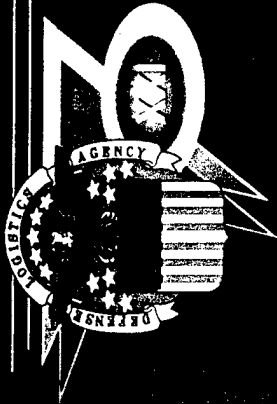

DLA Where We Are

Wholesale

Defense Supply Center
Philadelphia & DISC
LEAD CENTER
TROOP & GEN SUPPLY

Defense Supply
Center
Columbus OH
LEAD CENTER
LAND & SEA

Defense Supply Center
Richmond VA
LEAD CENTER
AVIATION

Defense Energy Support
Center - Ft. Belvoir VA

Retail

1995
12 Customer Assistance Reps

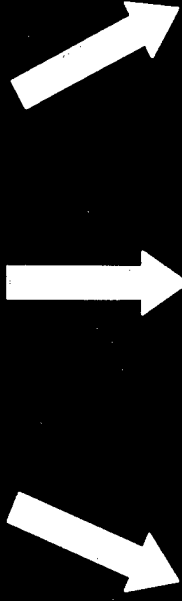

1999
71 Customer Support Reps
CONUS/OCONUS
At Major Activities



Volume - - ICP Workload (Non - Energy)

NSNs Managed vs DLA FTEs

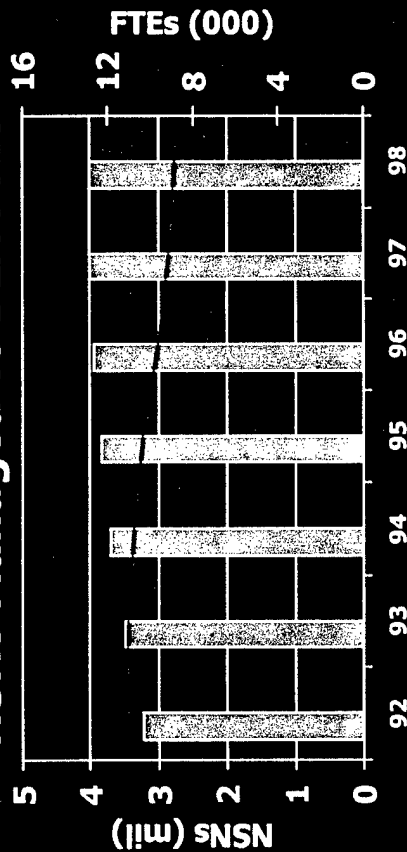

Requisitions Processed

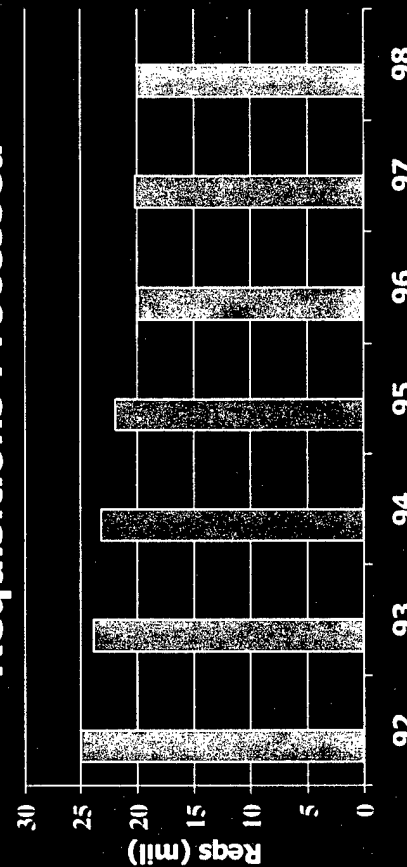

Gross Sales

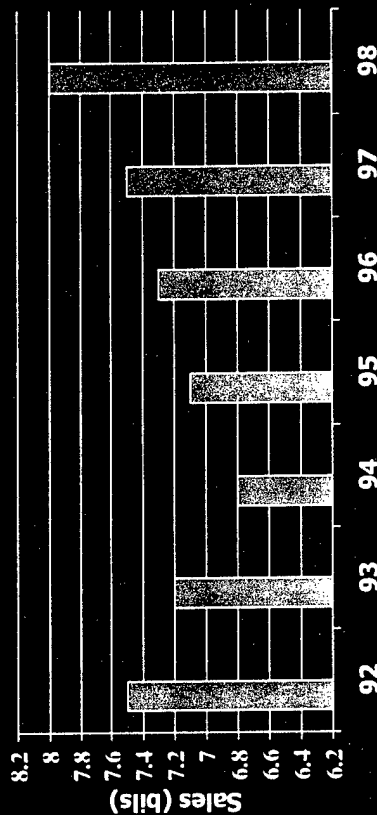

Fortune 500 -
DLSC Ranks 92d
\$14.3 Billion

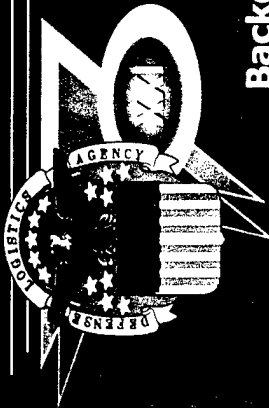

System Performance

Backorders

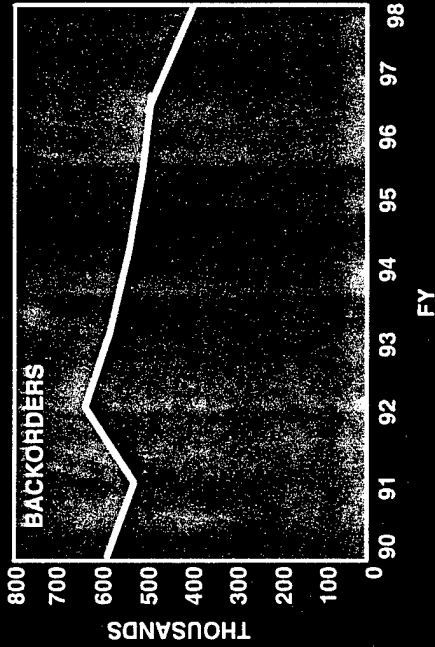

Line Items Transferred from the Services--
 1992-1995: 763K
 1996-1998 : 152K
 Internal Realignment--
 1996-1999: 650K

Supply Materiel Availability (SMA)

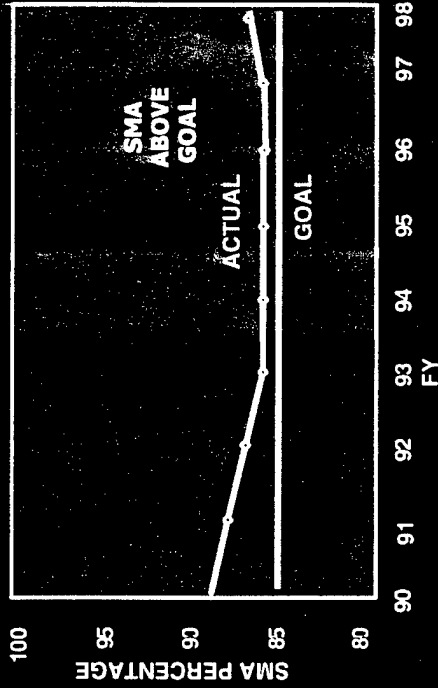

Logistics Response Time

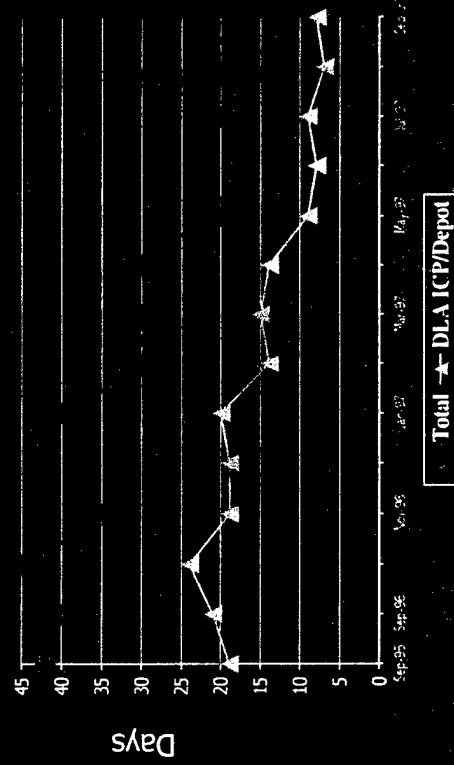

Logistics Response Time - With (LMARS)

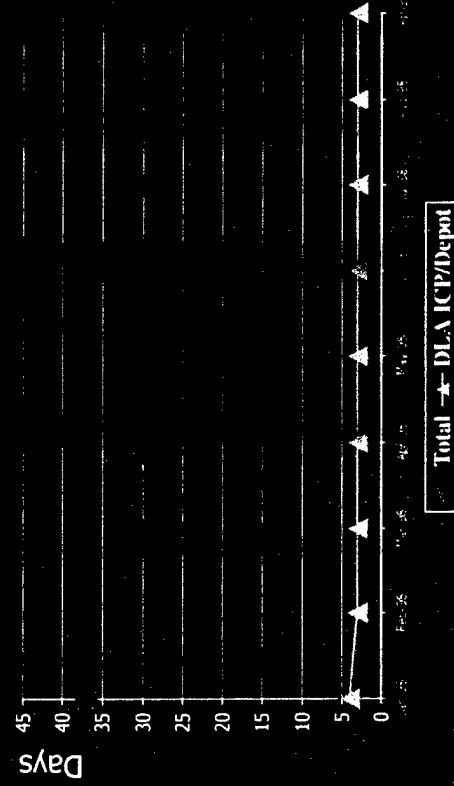



SUPPLY AVAILABILITY BY SERVICE

DLA GOAL 85%

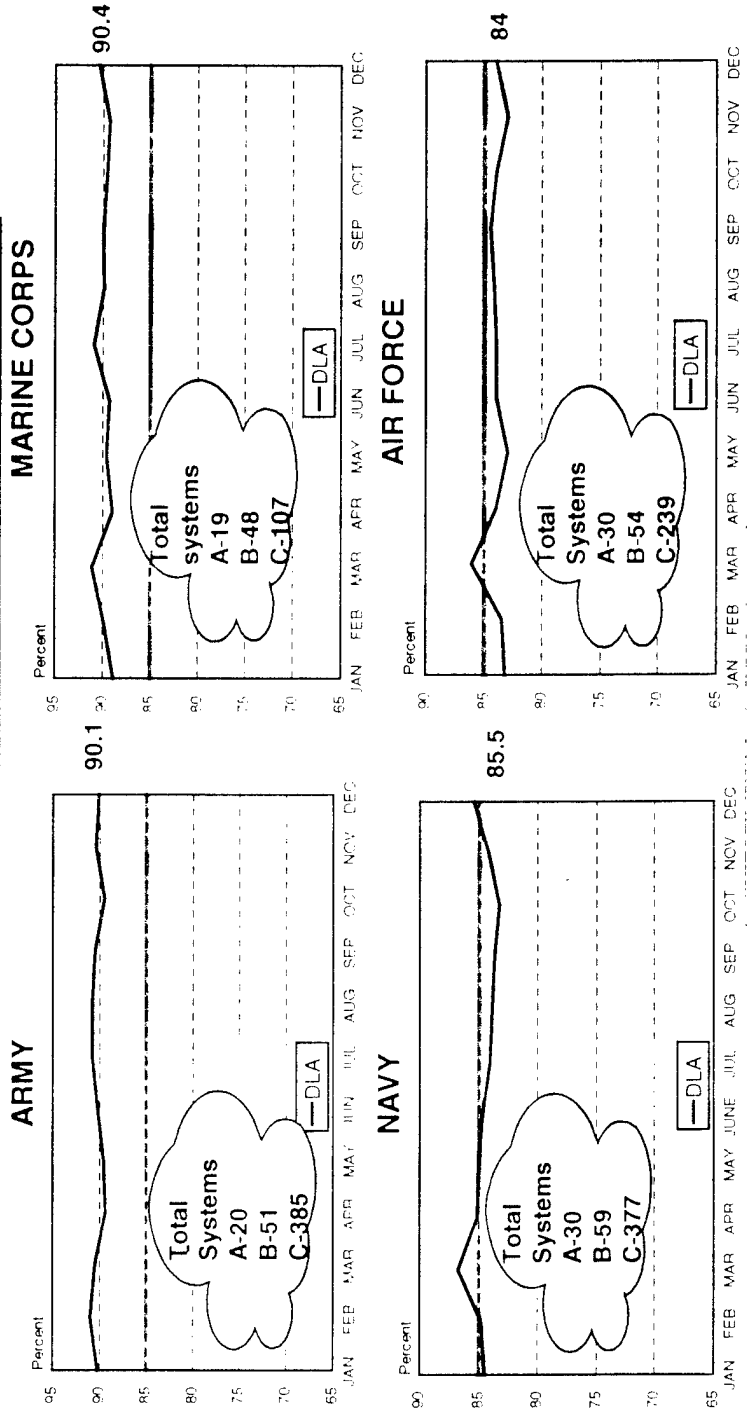

**Overall Weapon System
Supply Availability - 87.5%**



Weapons Systems Performance Measures

Weapons Systems Categorized by Criticality in Support of National Military Strategy

	Services		
	Total	ARMY	USMC
Level A: Most Critical	98	20	19
Level B: Critical	202	51	48
Level C: Less Critical	1094	385	107
All Levels	1394	456	174

With emphasis on readiness drivers for any key Weapon System

Below Goal Dec 98

	Army	USMC
Level A:	0	1
Level B:	0	2
Level C:	15	5



Focusing on Weapon System Support

Tiered Inventory Investment

TIER 1 MOST ESSENTIAL 87%

TIER 2 ESSENTIAL 85%

TIER 3 LESS ESSENTIAL 83%

- Business vs Readiness Trade - off
 - * Business: Fast - moving, low - cost, low risk items
 - * Readiness: Items critical to weapon systems and military operations
- Optimize support within resource constraints
- Weapon system coding essential



Focusing on Weapons System Support

Lead Center Concept...

- Establishes Centers of Excellence
DSCC - Land and Sea
DSCR - Aviation
DISC / DSCP - Troop Support & General Supply
- Provides Single Wpns System Point of Contact at the Program Level (Weapon System Support Manager)
- Works with Service Pgm Mgrs to Resolve Fleet Wide Readiness / Supply Support Issues for DLA Supported Weapon Systems
- Acts as the Primary Catalyst for Inter - Agency Support

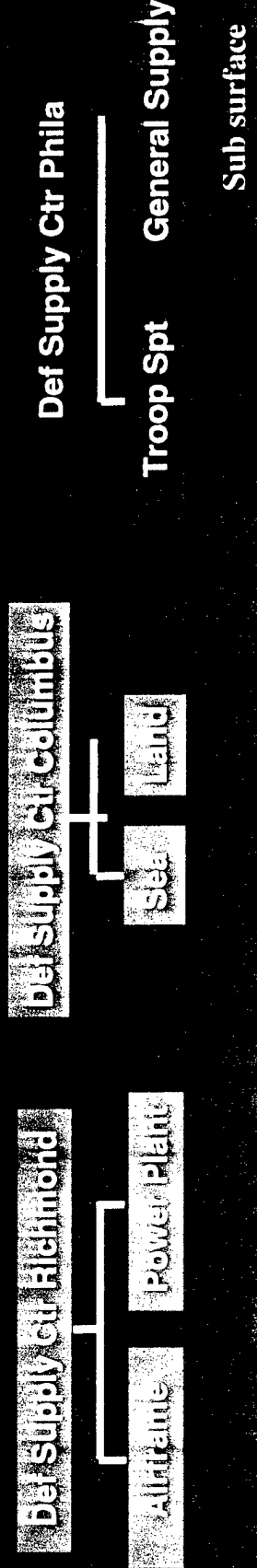



TACTICAL WHEELED VEHICLES HEALTHH

LEVEL	SYSTEM	SVC	NSNS	DEC 98	DEC 98
			MGD BY DLA	FMC	S/A
A	HEMTT	ARMY	9,347	89	90
A	HMMWV	ARMY	7,035	93	88
A	HMMWV	USMC	5,451	89	91
A	LVS	USMC	7,391	89	92
A	TRACTOR RT	USMC	1,718	91	94
B	Firetruck P19/20/23	AF	1,777	92	94
B	PLS	ARMY	5,805	93	91
C	HET	ARMY	5,626	95	85
C	FMTV	ARMY	7,187	98	86
C	TRUCK 5T M900 Series	ARMY	7,651	93	87

READINESS AND SUPPLY AVAILABILITY



HMMWV

HEMTT

100

90

80

90

80

70

READINESS %

READINESS %

● S/A

● S/A

70

80

90

JAN FEB MAR APR MAY JUN JUL AUG SEP OCT NOV DEC

JAN FEB MAR APR MAY JUN JUL AUG SEP OCT NOV DEC

	JAN	FEB	MAR	APR	MAY	JUN	JUL	AUG	SEP	OCT	NOV	DEC
HMMWV												
READINESS	94	94	94	94	94	95	95	94	93	94	94	93
S/A	89	88	87	87	88	91	91	91	90	89	89	88
HEMTT												
READINESS	91	90	89	90	91	90	90	88	89	89	89	89
S/A	94	93	93	93	93	94	94	95	95	93	92	90

TOTAL NSNS	7,035
ECI NSN	1,802
AVG MO DMDS	82,992

TOTAL NSNS	9,347
ECI NSNS	2,021
AVG MO DMDS	37,003



DEFENSE LOGISTICS AGENCY READINESS AND SUPPLY AVAILABILITY

FMTV

LVS

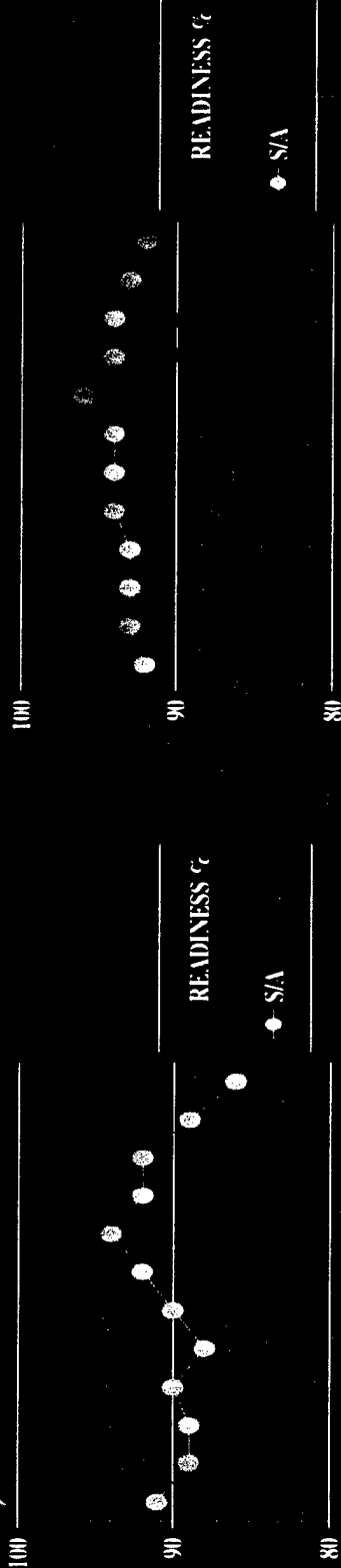

70 JAN FEB MAR APR MAY JUN JUL AUG SEP OCT NOV DEC

70 JAN FEB MAR APR MAY JUN JUL AUG SEP OCT NOV DEC

	JAN	FEB	MAR	APR	MAY	JUN	JUL	AUG	SEP	OCT	NOV	DEC
FMTV												
READINESS %	95	97	96	93	91	91	95	97	97	97	97	97
S/A	91	89	89	90	88	90	92	94	92	92	89	86
LVS												
READINESS %	86	86	88	89	88	87	89	89	90	90	89	89
S/A	92	93	93	93	94	94	94	96	94	94	93	92

TOTAL NSN	7,187
ECI NSN	1,640
AVG MO DMDS	16,067

TOTAL NSNS	7,391
ECI NSN	1,515
AVG MO DMDS	3,280



Contractor Logistic Support DLA Corporate Strategy

- **PARTNER with Service Project and Program Managers**
- **Obtain best value from existing DoD Inventories**
- **Leverage Wholesale Contracting Resources**
- **Tailor CLS to customer, system, commodity, region**

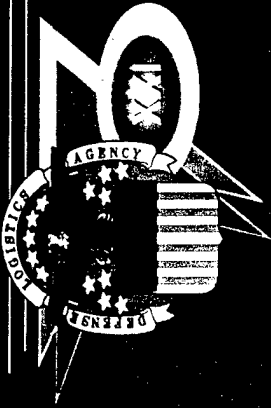

CONTRACTOR LOGISTICS SUPPORT

POSSIBLE PROs:

- Modernization Through Spares
- Reduced Cycle Times
- Reliability Based Logistics & Trigger Based Item Management
- Single Logistics Face to the Warfighter for the System
- Reduced Government Logistics Footprint
- Cost Savings for the Specific Weapon System's Support

POSSIBLE CONs:

- May not effectively use existing Service / DLSC investment in inventory / pipeline
- Degrades nationally leveraged buying power for consumables (as well as common reparable) across systems
- May drive up the total cost of logistics support across DoD
 - * Unless infrastructure / investment intelligently used
- Multiple Contractors on the Battlefield
- Poor integration in requesting and receiving support



WHAT DLA OFFERS

- **Over 35 Years Experience in Supply Chain Management for Consumable Materiel Support to the Warfighter**
- **Nationally Leveraged Buying Power Across Weapons Systems / Military Services**
- **Inventory of Critical Consumable Parts for Weapon Systems**
 - **Surge and Sustainment**
- **Recognized Government Leader in EC / EDI**
- **Extensive Warehouse / Distribution Network**
 - **New: Dedicated Truck Service for Time Definite Delivery and Tailored Logistics Support**
- **Innovative Methods of Support Using Best Commercial Practices**

DEFENSE LOGISTICS AGENCY



DLA ELECTRONIC COMMERCE

INITIATIVES

- E Check
- E Commerce
- E Data Interchange
- E Document Access
- E Document Mgmt

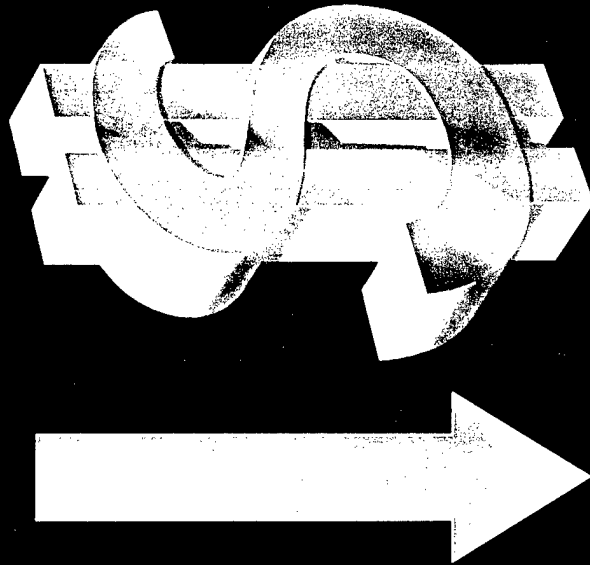

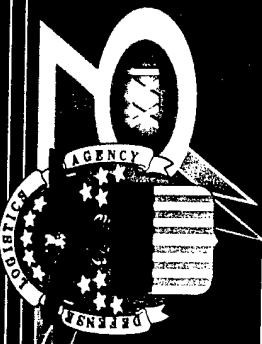

Direct Vendor Delivery/ Prime Vendor Arrangements

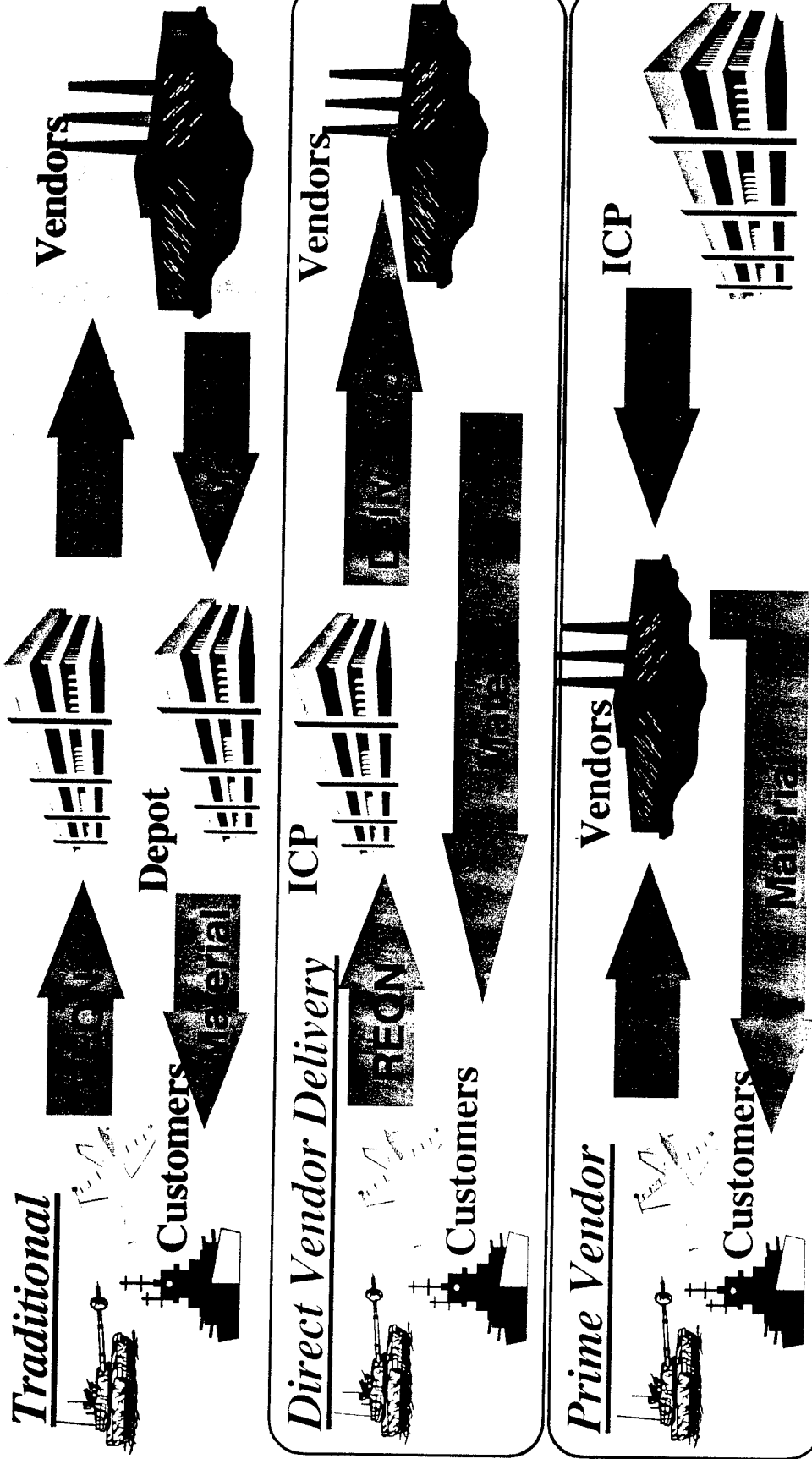



Shift to Commercial Practices ...Prime Vendor/ Virtual Prime Vendor

DEFENSE LOGISTICS AGENCY

PRIME VENDOR

Pharmaceutical ▲
Medical/Surgical ▲

Mail Order Pharmacy ▲

Subsistence ▲

Clothing & Textile ▲

Wood Products ▲

Marine - Life Saving and Diving

Material Handling ▲

Metals ▲

HAZMAT Systems ▲

Fleet Automotive ▲

VIRTUAL PRIME VENDOR

C-130 ▲

Maintenance, Repair & Operations ▲

Industrial Prime Vendor (Benchmark) ▲

C-5 ▲

VPV Uniforms ▲

Manager of Suppliers - NOT Supplies

▲ = Initial Award

▲ = Future Award

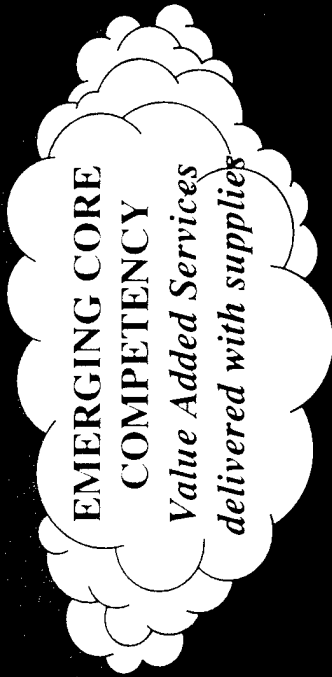



ICP WORKLOAD

Contract Actions

	FY95	FY96	FY97	FY98
Prime Vendor	\$551.8M	\$827.8M	\$1.06B	\$1.3B
Virtual Prime Vendor	0	0	\$7.8M	\$14.4M
Corporate Contracts	\$3.5M	\$28.9M	\$89.3M	\$86.2M
Long Term Contracts	\$2.6B	\$2.1B	\$2.3B	\$3.6B
Total Obligated	\$3.1B	\$3.0B	\$3.3B	\$6.4B

DEFENSE LOGISTICS AGENCY

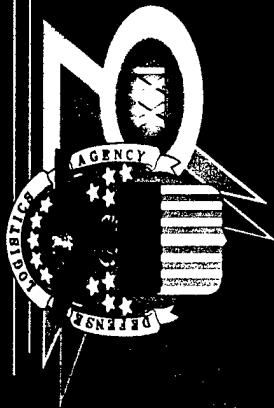

DLA CLS INITIATIVES

- Prime Vendor
- Virtual Prime Vendor
- Prime Vendor Overseas
- Industrial Prime Vendor
- EMALL
- Re-Refined Oil
- MTRV
- Corporate Contracts

**FLEXIBLE
TAILORED**

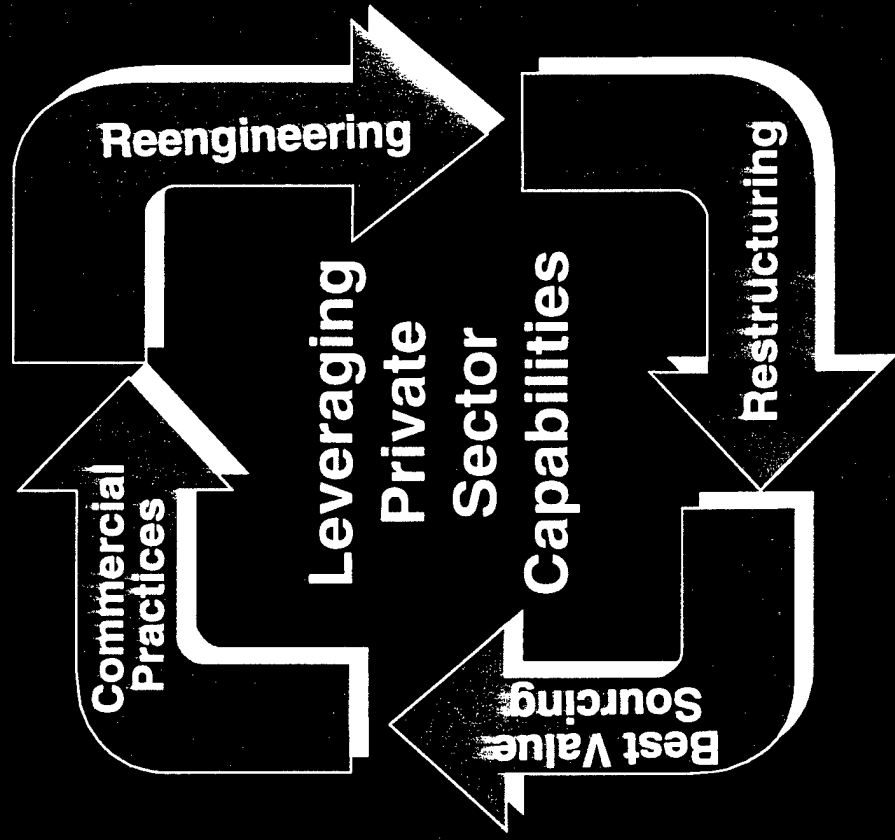

DEFENSE LOGISTICS AGENCY



PRIME VENDOR

What it is: One Vendor under long term contract. Provides all materiel in a Product Line or Commodity to a Major Customer. Commercial Materiel using existing distribution systems.

Examples: Subsistence and Medical

Volume: \$ 1.3 Billion FY98

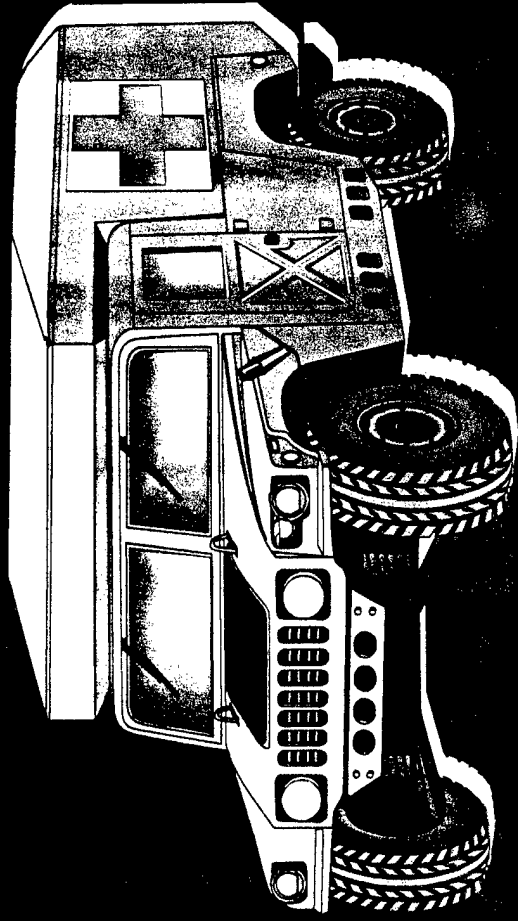

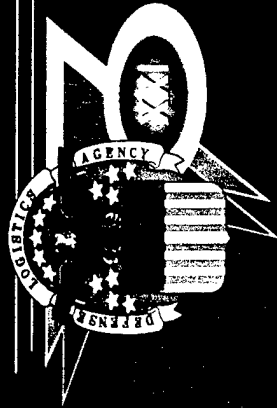

VIRTUAL PRIME VENDOR

What it is: Regional Focus to provide parts and tech support, inventory mgmt, requisitioning and forecasting for specific weapon system support

Examples: Fleet Automotive Support Initiatives (FASI)
Covering AMG (5Tons, HMMWVs)
Oshkosh (LVS, P19 Firetruck)
Caterpillar (D7 Dozer, 621B Scraper)
Award Projected 2Q99 (Camp Pendleton)
(Camp Lejeune)

Volume: 2, 180 NSNs Annual Dollar \$14.9M

DEFENSE LOGISTICS AGENCY



PRIME VENDOR OVERSEAS

What it is: One Vendor provides centralized support coverage for commercially available parts to support Overseas customers

Examples: Prime Vendor Overseas supports 800 Contractors Cage Codes for part number and overseas requests submitted via MILSTRIP using Project Code JZC

Volume: 1252 NSNs, Price Listing, Estimated Annual Dollar \$5M



DEFENSE LOGISTICS AGENCY



INDUSTRIAL PRIME VENDOR

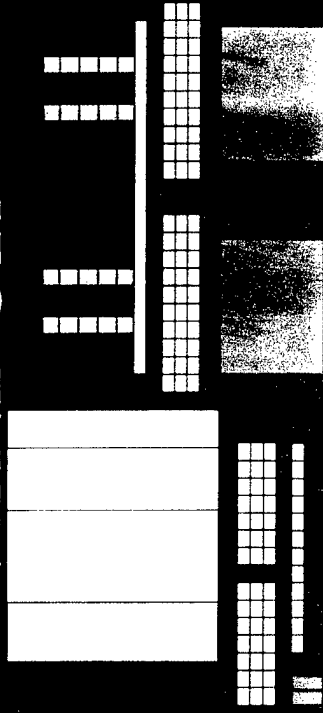

What it is: Aligns Prime Vendor Relationship to Industrial Posture.
Promotes horizontal integration across Weapon Systems.
Exploits emerging technology across Industry.

Examples: Types of Items targeted: O'Rings, Bolts, Screws, Nuts, Fasteners, Seals, Couplings, Rivets. Targeted customers include large maintenance operations.

Volume: Currently 43,000 NSNs Annual Demand Value \$22 M

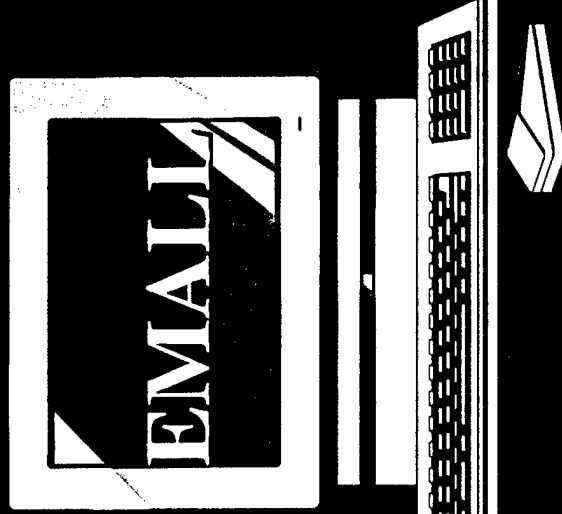

What it is: Customer Shopping via Internet to Access Both DoD and Vendor Inventory. Includes robust search engine via Part#, NSN, Manufacturer, Vendor Catalog

Examples: Allows customer shopping and decision point purchasing via DoD Standard Requisitioning or IMPAC Credit Card

Volume: Currently 2 million items, 9 Vendors



RE - REFINED OIL

What it is: Closed Loop Delivery of new and pick up of old
10W30/15W40 Oil

Examples: 7 Day Delivery of bulk and packaged products via
Direct Vendor Delivery. Current Customers Ft. Carson
Ft. Riley, Ft. Hood.

Volume: 12 NSNs, 13 Military Bases, 5 Federal Agencies

DEFENSE LOGISTICS AGENCY



Medium Tactical Vehicle Replacement

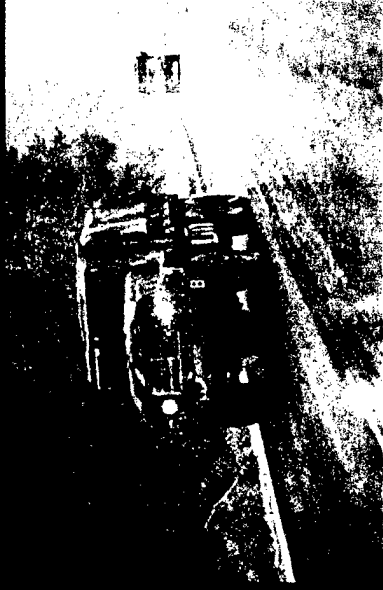

What it is: Tailored CLS to support USMC Medium Tactical Vehicle Fleet. Intent to replace with more robust vehicles and lifecycle logistics support.

Examples: MTRV is a 5 year logistics support contract designed to decrease order ship time, reduce retail stockage and costs.

Volume: Current Coverage for 5,666 vehicles with increase options

DEFENSE LOGISTICS AGENCY



DLA Corporate Contracts Highlighting Tactical Wheeled Vehicles

COMPANY	TOTAL COVERAGE #NSNs/PART#s	ANNUALS	DELIVERY	WARD TERMS
AMGEN	560/NA	9.3M	DVD 21 DAYS	95.5 Year
CUMMINS	3529/Price List	5.5M	DVD 7 DAYS	94/2 Year
Stewart & Stevenson	256/NA	1.2M	DVD 10/30 DAYS	98/5 Year
BTMC	1167/Price List	1M	DVD 30 DAYS	98/5 Year
KOMATSU	1418/Price List	2.6M	DVD 5 DAYS	97/5 Year
NAPA	0/200K	1.5M	DVD 5 DAYS	6/Impact Card
OSHKOSH	1717/NA	7.4M	DVD 10/30 DAYS	95/5
CROVEN AMERICA	1443/Price List	1M	DVD 7 DAYS	98/5



SUMMARY

One Team - One Focus

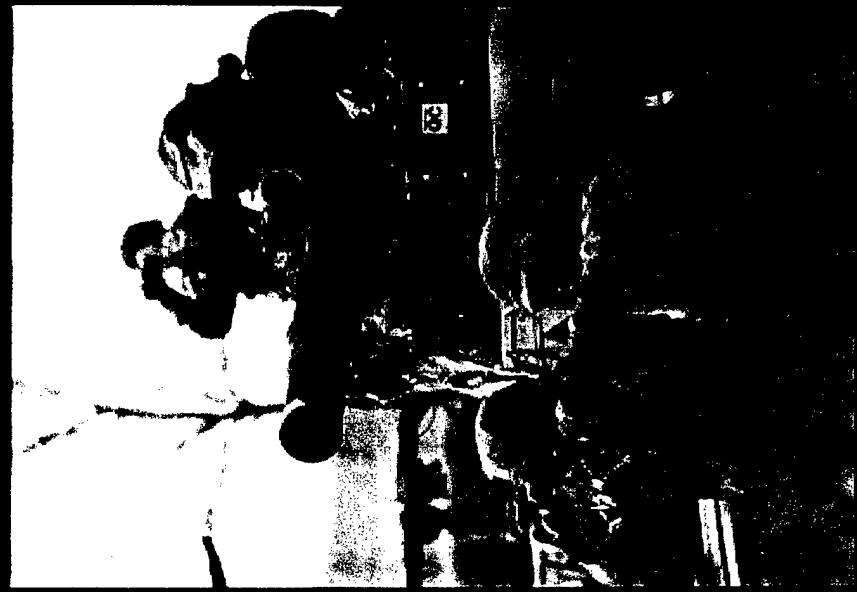

Weapon System Focus

Readiness Driver for DoD

Expectations ↑ Resources ↓

CLS Leader and Partner

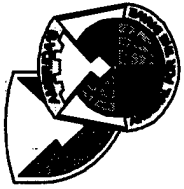

ZACOM

*Mobility and Firepower
for America's Army*

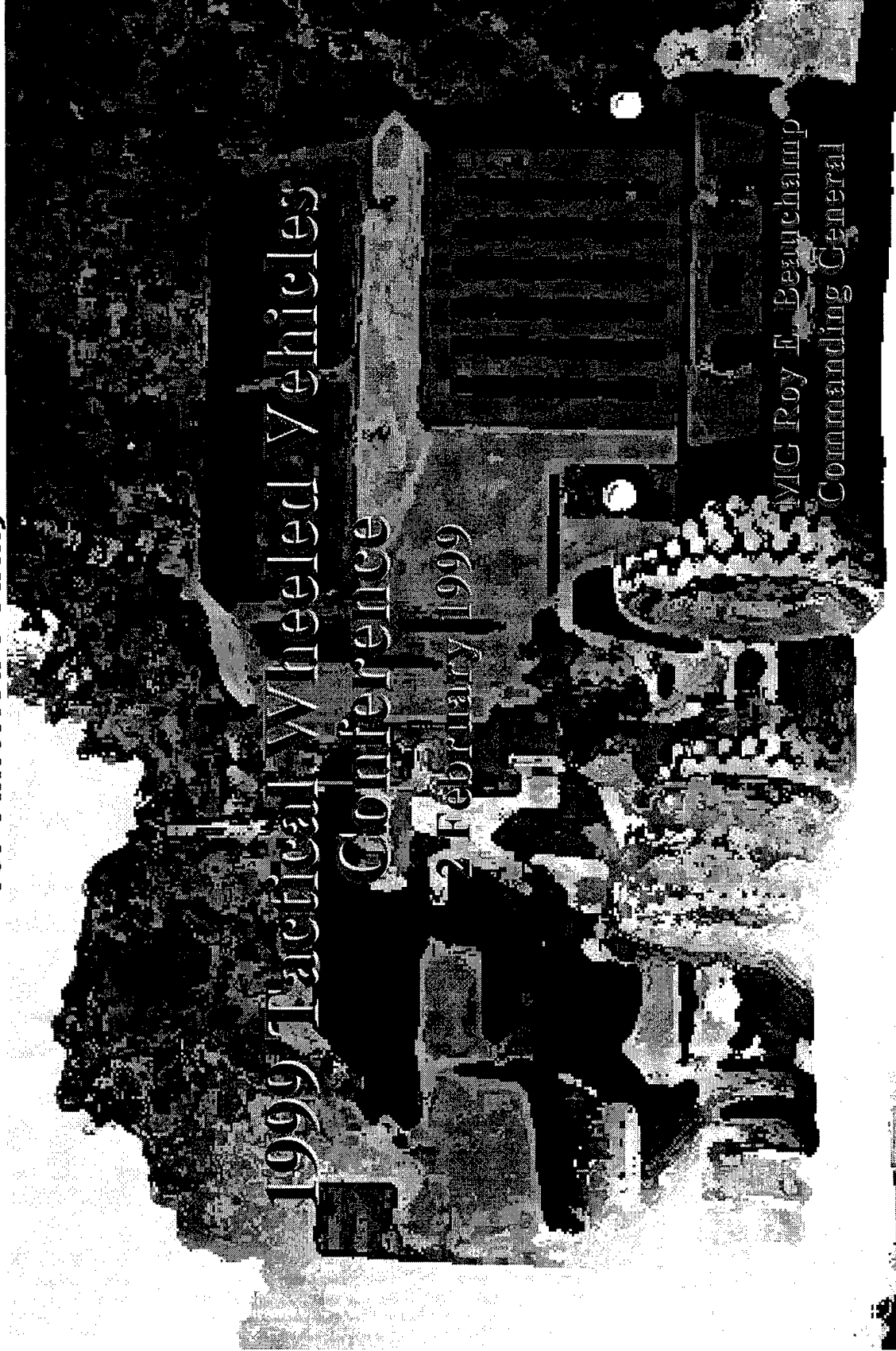

1999 Tactical Wheeled Vehicles Conference

2 February 1999

MG Roy F. Beauchamp
Commanding General

Tank-automotive & Armaments **COMMAND**
249

Distribution Statement A - Approved for
Public Release; Distribution Unlimited

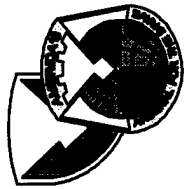

Briefing Outline

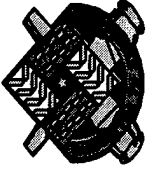

- TACOM
- TACOM and Trucks
- Army Fleet/Distribution
- Procurement
- Research and Development
- Sustainment
- Need Your Help!

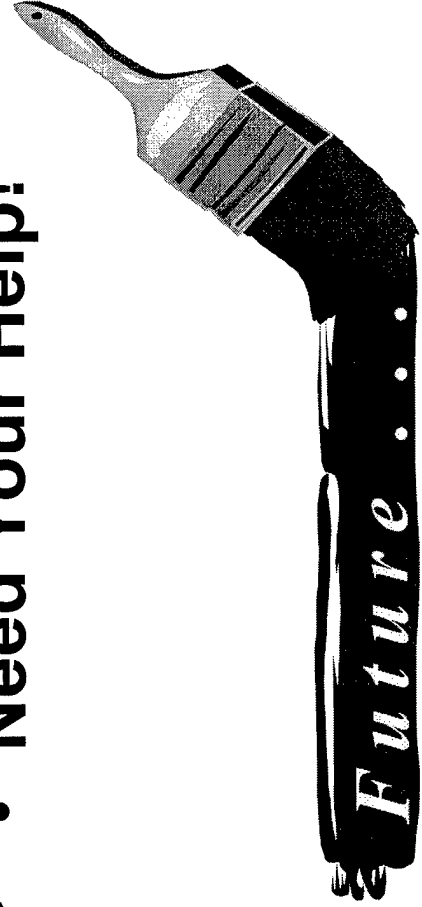
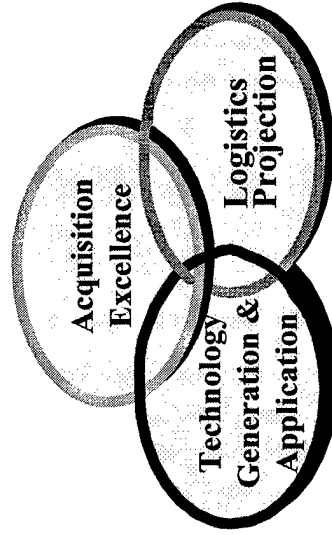
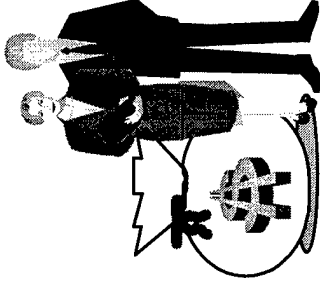
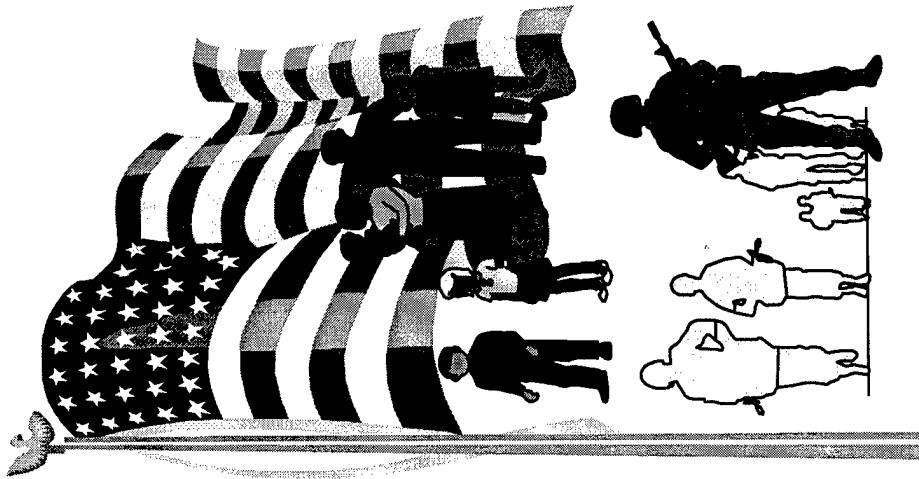

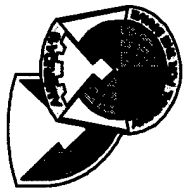

Our Higher Headquarters



Department of Defense

Department of the Army

Army Materiel Command

Tank-automotive & Armaments COMmand

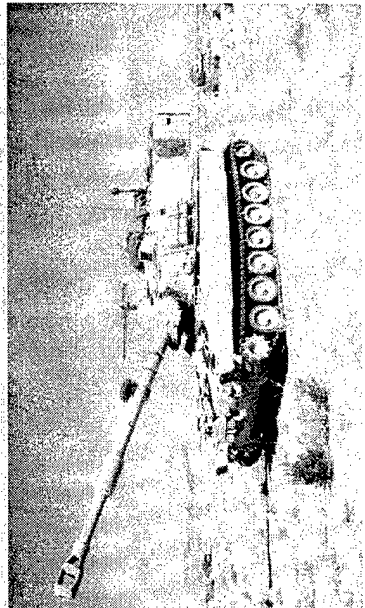

2/2/99

3/55

Committed to Excellence

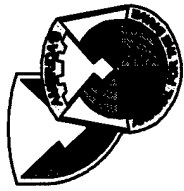

A Common Vision



Taking America's Army into the 21st Century

Army Vision

The World's Best Army, a full spectrum force- trained and ready for victory. A Total Force of quality soldiers and civilians:

- A values-based organization
- An integral part of the Joint Team
- Equipped with the most modern weapons and equipment the Country can provide
- Able to respond to our Nation's needs
- Changing to meet challenges of today . . . tomorrow . . . and the 21st Century.

Tank-automotive & Armaments **COM**mand

- To make the technology and sustainment systems work for soldiers through the seamless integration of S&T, R&D, Acquisition, Log Sustainment and Soldier Readiness.
- To create a business environment at TACOM where every associate understands the requirement to control costs and manage from the customer perspective and understands their inherent responsibility to do so.

Army Materiel Command Strategic Vision

The leader in equipping and sustaining America's Army through superior technology and responsive support assuring worldwide power projection and decisive victory.

2/2/99

4/55

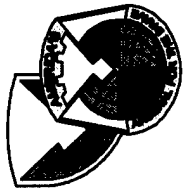

Vision For The Future Business Environment In TACOM

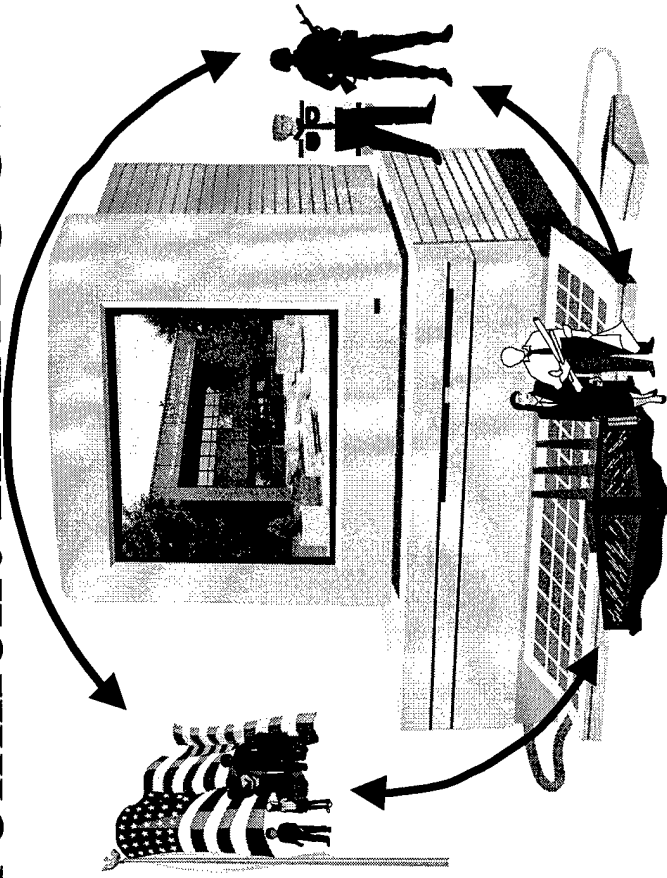

A fully integrated business environment connected by a fully integrated data environment using commercial business processes to integrate business operations within each organization, across major Commands, across Services, across DoD and across Industry.



A corporate management structure for which the organizing principle is multi-functional work teams to institutionalize the concept of integrated process teams; a highly decentralized structure which uses the integrated data environment to link desk top "servers" to facilitate the transformation of data into actionable information to enable more efficient, fully integrated business operations at reduced cost.

5/55





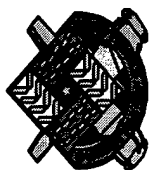

COMMON GOALS



- **Manage From the Customer Perspective...**
- **Increase Customer Satisfaction**
- **Reduce the Cost of Doing Business**
- **Work the Partnerships.**

COMMITMENT TO OUR

- **Customers ...**
We Are Your Partners In Readiness 
- **Suppliers .Professional Business**
Relationships-- Mutually Beneficial 
- **Associates ...**
Challenging, Satisfying
Work--A Stake In The Corporation 
- **Stockholders ...**
Good Stewardship 

2/2/99

Committed to Excellence



TACOMMISSION

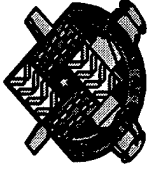

-To Generate Warfighting Capability for the Army

-To Sustain the Warfighting Readiness of the Army

-To manage the Army's Investment in S&T, R&D and Sustainment for the Army

3,269 Weapon Systems
32,048 NSNS
300 Systems in Acq Pipeline

-Serve as the Life Cycle Manager and Integrator for Ground Combat and Support Equipment

FORCE

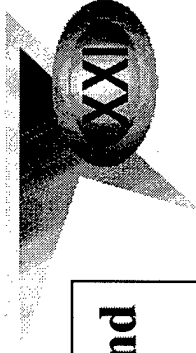

Tank-automotive & Armaments Command

Research, Develop, Field and Support

Mobility and Armament Systems Total Life Cycle

To Support Army Readiness

Combat Vehicles
Tactical Vehicles
Trailers
Construction Equipment
Materiel Handling Equipment
Tactical Bridges

Fuel & Water Distribution Eqpt
Sets, Kits & Outfits
Shop Equipment
Chemical Defense Equipment
Howitzers
Large Caliber Guns
Mortars
Rifles
Machine Guns
Ammo
Aircraft Armaments
Demolitions & Explosives^{7/55}
Rail
Watercraft
Petro & Lub Eqpt

Committed to Excellence

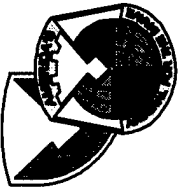

Tank-automotive & Armaments COMmand



We Are Your Partners In Readiness

Mobility

Firepower

Systems Integration

Survivability

Lethality



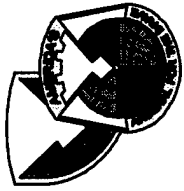

Current and Future Armaments and Automotive-ank



7,900 Associates
(11,711 w/Depots)

LEGAL OFFICE

TACOM
COMMANDING GENERAL
DEP TO THE COMMANDER
CHIEF OF STAFF

INSPECTOR GENERAL
PERSONAL AND
SPECIAL STAFF
BUSINESS CENTER

U.S. ARMY
GARRISON-
SELFRIDGE
BUSINESS CENTER

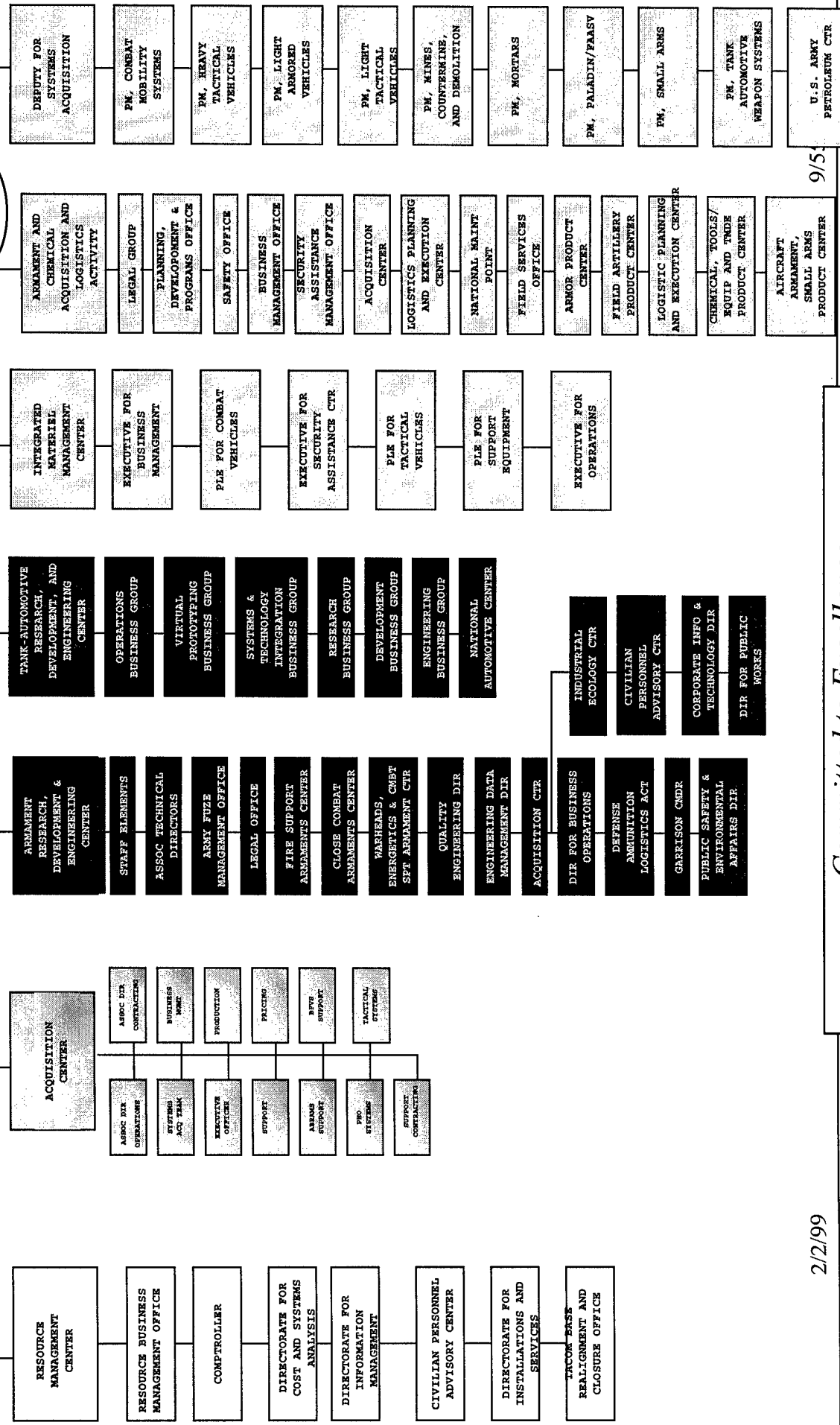

9/5

2/2/99

Committed to Excellence

257

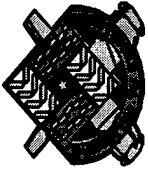
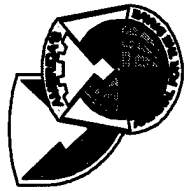

Current Corporate Process

Today

Complex Business Process

- DSA
- ACALA
- ARDEC
- TARDEC
- IMMIC
- ACQ CTR
- RMC

- Science & Technology
- Research & Development
- Acquisition
- Sustainment Mgt.
- Readiness Management
- Life Cycle Engineering Management
- Human Resources
- Facilities & Infrastructure
- Information & Business Management

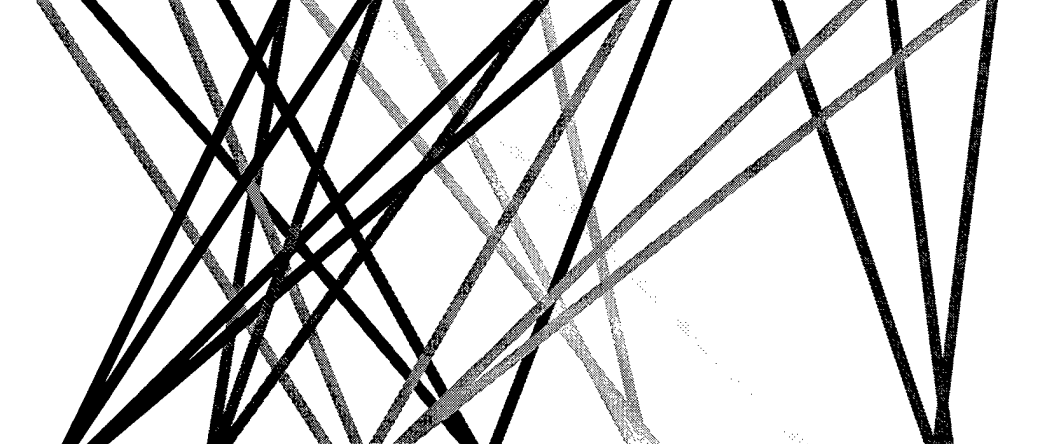

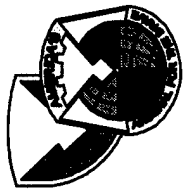

How we will do it - Structure TACOM of the Future (Concept)



FY 04
5,994 Associates
RRAD (9,490 w/ Depots)

CG
Dep to the Cdr
Cofs

STAFF

ANAD
RRAD

**DEPUTY FOR CORPORATE
 MANAGEMENT**

**DEPUTY FOR
 RESEARCH DEVELOPMENT &
 ENGINEERING**
CDR PICATINNY

**DEPUTY FOR LIFE
 CYCLE MGT**

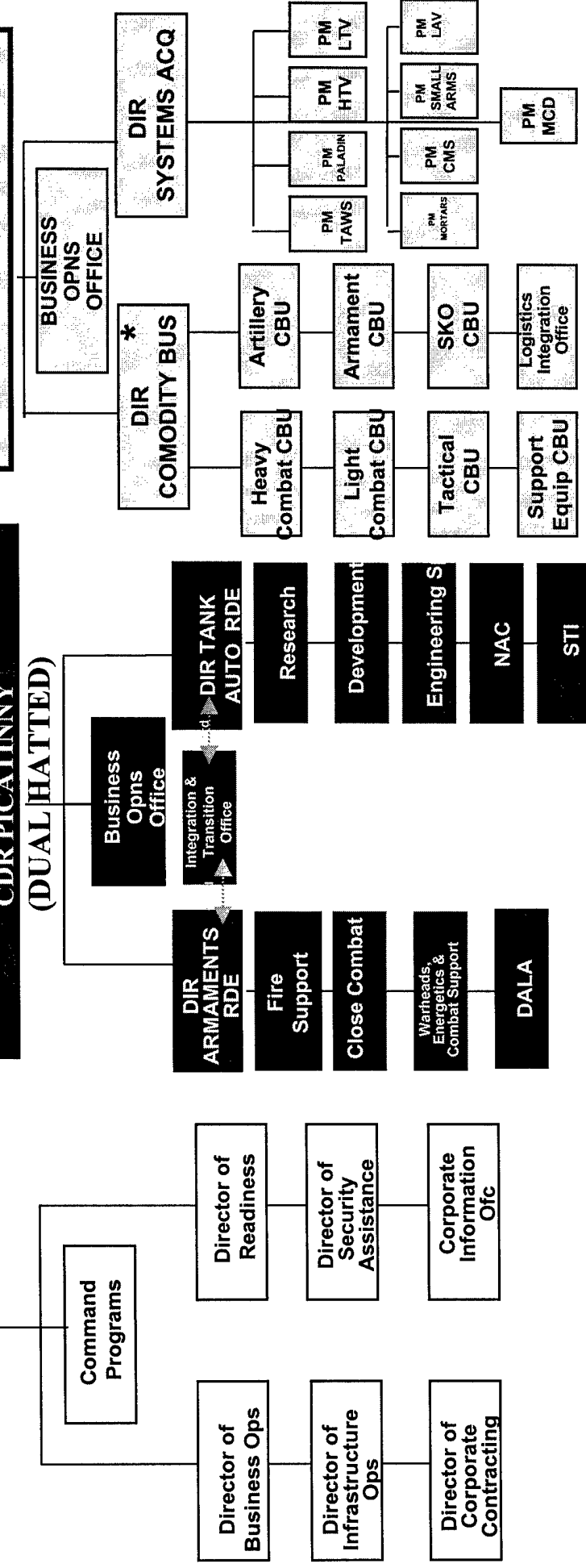

*ACALA Site Mgr.
 11/55

2/2/99

Committed to Excellence

2.5.9

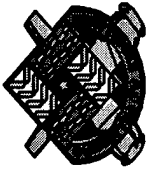
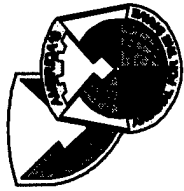

Integrated Corporate Process

Tomorrow

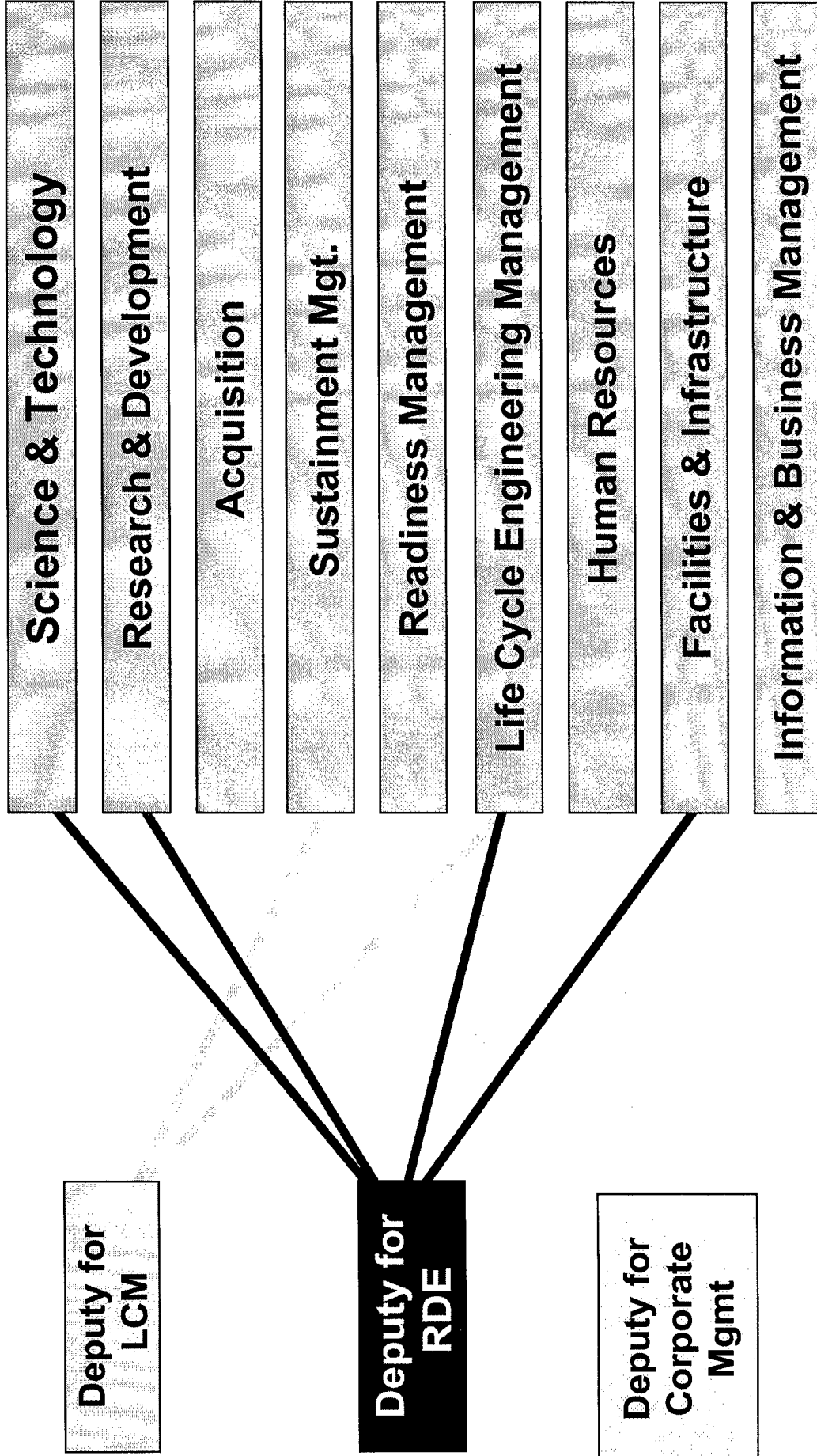

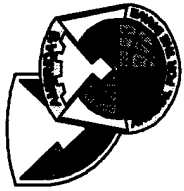

Projected FY99 Resources

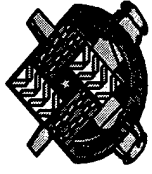

**Credits & Expenses-
Other Agencies:**

**Operating
Costs:**

\$.40B

Total \$\$ Executed:

Contracting:

\$4.60B

\$.63B

Depots:

\$.53B

\$6.20B

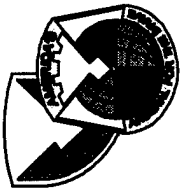

What TACOM Buys

ARDEC

WARREN

ACALA

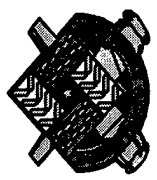

R&D and Initial Production		R&D, Production Sustainment		Production Sustainment	
• MUNITIONS	• WEAPONS & ARMAMENT SYS	• COMBAT VEHICLES	• TACTICAL VEHICLES/TRAILERS	• HOWITZERS	• COMBAT VEH
• FIRE CONTROL SYSTEMS	• FUZES	• SUPPORT EQUIP	• TACTICAL BRIDGES	• TRAINING DEVICES	• ARMAMENTS
• WARHEAD MISSILES	• ROCKET MOTORS	• FUEL & WATER DISTRIBUTION	• MORTARS	• CHEM DEFENSE	• RIFLES
• TRAINING ITEMS	• LOG AND GENERAL SUPPORT	• SYSTEMS	• AIRCRAFT ARMTS	• MACHINE GUNS	• HANDGUNS
• POLLUTION PREVENTION			• RECOVERY VEH	• FIRE CONTROL SYS	• GUNS (105 - 165MM)

- Weapons
- Munitions
- Combat Vehicles
- Support Vehicles
- Chemical Defense
- Machine Guns
- Aircraft Armaments
- Support Equipment

\$860 Million **\$3.1 Billion** **\$486 Million**
Est. Oblig. **Est. Oblig.** **Est. Oblig.**

TACOM FY98 Obligations \$4.6 Billion

Committed to Excellence

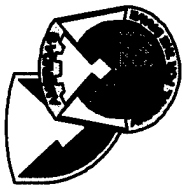

Weapon System Prime And Major Subcontractors In 24 States



Over 2,050 Contractors Support Us...



AM GENERAL*
ALLISON TRANSMISSION
STEWART WARNER
CUMMINS ENGINE

GENERAL DYNAMICS LAND SYSTEMS HQ (GDLS)*
DETROIT DIESEL
GIBRALTOR
EATON
ROCKWELL

UDLP*
ALLIANT TECH

DONALDSON

FREIGHTLINER

DEPT of ENERGY

UDLP*
HUGHES AIRCRAFT
HONEYWELL
AEROJET

ALLIEDSIGNAL
Mc DONNELL DOUGLAS
OLIN

STEWART STEVENSON*
TEXAS INSTRUMENT
ELECTRO SPACE

SYSTEMS & ELECTRONICS INC

SPLIT BALL BEARING

SACO DEFENSE

TEXTRON DEFENSE
COLTS'

GDLS*
UDLP*
EAST PENN
CHAMBERLAIN
MINE SAFETY
BULOVA

UNITED DEFENSE, LP
(UDLP) HQ*

UDLP*
GMMVO
GOODYEAR
DANA SPICER

FNMI

GILLMAN
TEXTRON
CATERPILLAR
TITAN WHEEL UDLP*

MARTIN MARIETTA
OLIN

* Prime Contractors
No Contractors located in Alaska and Hawaii
As of Mar 1998/2/99

...located throughout the United States!
15/55

Committed to Excellence

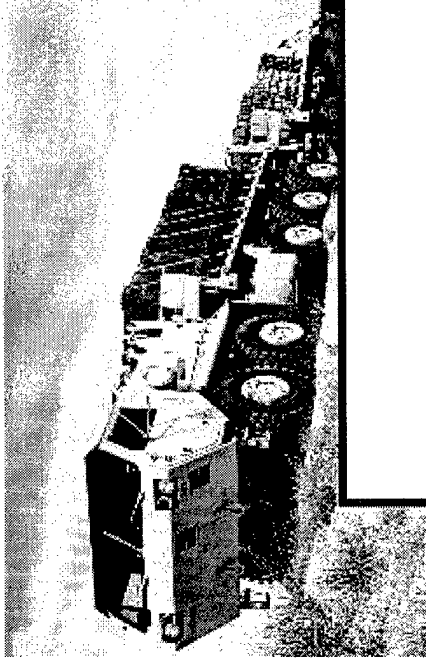
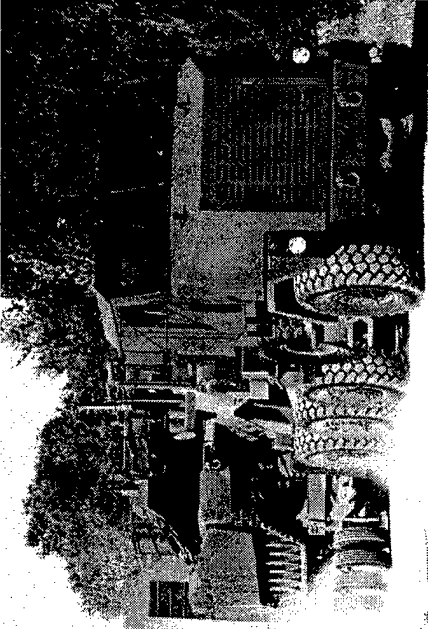
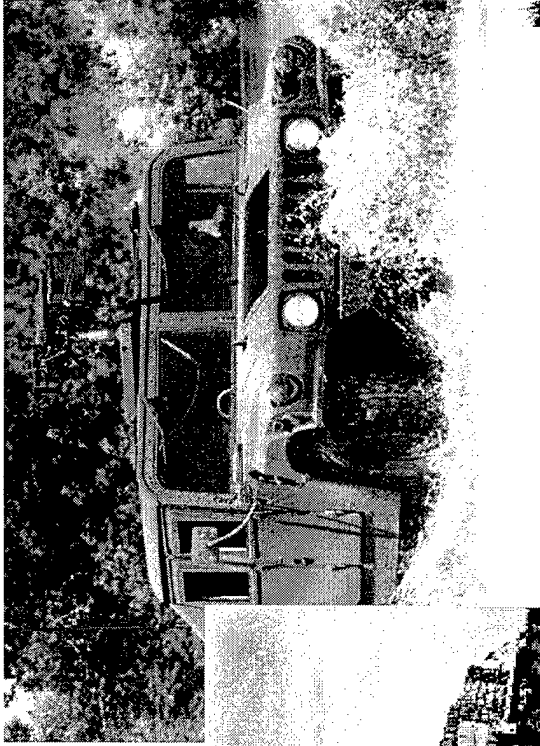
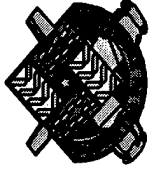
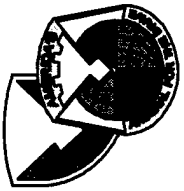

TACOM Tactical Wheeled Vehicles

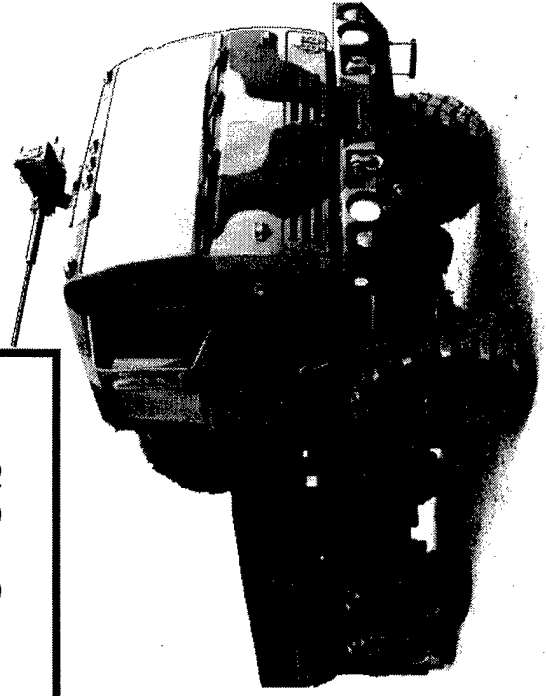
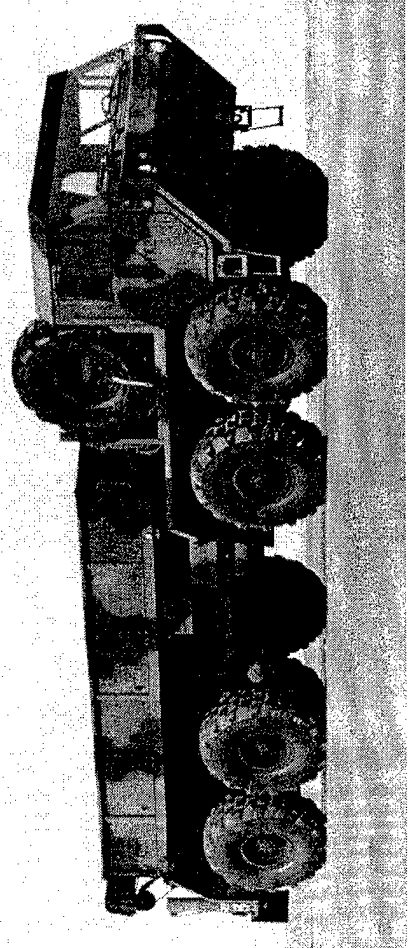

2/2/99

16/55

Committed to Excellence

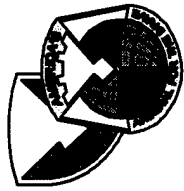

Tactical Wheeled Vehicle Fleet

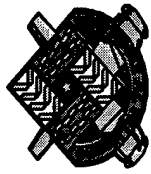

LIGHT TRUCKS/TRAILERS	
DENSITY TRUCKS:	123,996
HISTORICAL OR%:	94%
CURRENT OR%:	92%
AGE RANGE:	NEW - 16 YRS
AVG AGE:	9 YRS
DENSITY TRAILERS:	21,035
HISTORICAL OR%:	97%
CURRENT OR%:	99%
AVG AGE:	20.8 YRS

MED. TRUCKS/TRAILERS	
DENSITY TRUCKS:	96,210
HISTORICAL OR%:	91%
CURRENT OR%:	92%
AGE RANGE	NEW - 27 YRS
AVG AGE:	18.7 YRS
DENSITY TRAILERS:	64,113
HISTORICAL OR%:	96%
CURRENT OR%:	94%
AVG AGE:	8 - 31 YRS
ONLY 9500 TRAILERS ARE REPORTABLE.	

HEAVY TRUCKS/TRAILERS	
DENSITY TRUCKS:	26,440
HISTORICAL OR%:	92%
CURRENT OR%:	90%
AGE RANGE:	NEW - 20 YRS
AVG AGE:	10.8 YRS
DENSITY TRAILERS:	25,281
HISTORICAL OR%:	97%
CURRENT OR%:	97%
AVG AGE:	15.2 YRS
DENSITY FLATRACKS: 10,468 NOT OR% REPORTABLE.	

U.S. ARMY

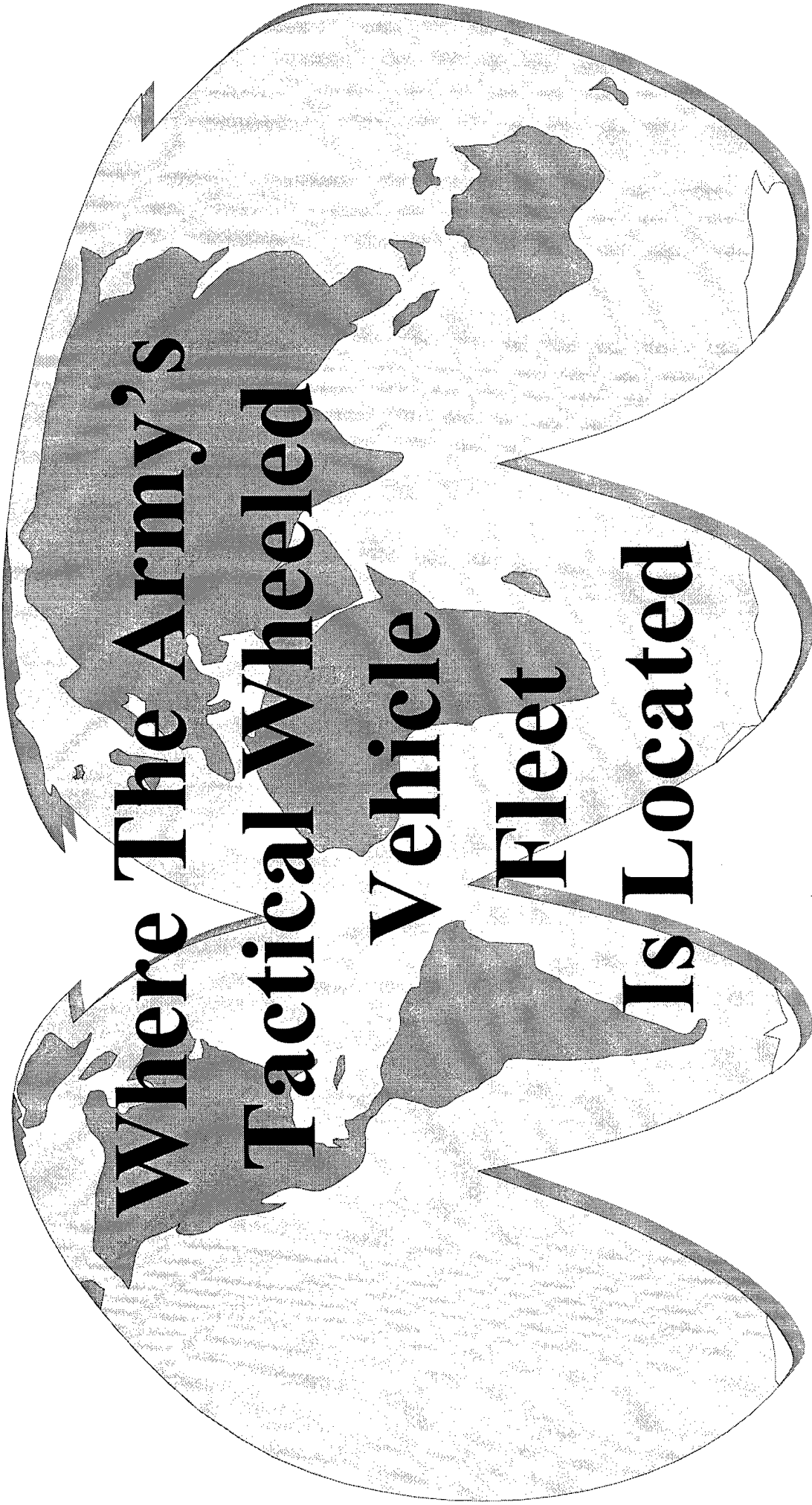
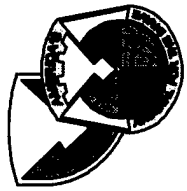

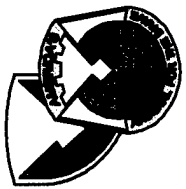

Tactical Wheeled Vehicle and Trailer Fleet

246,646 Trucks

110,429 Trailers

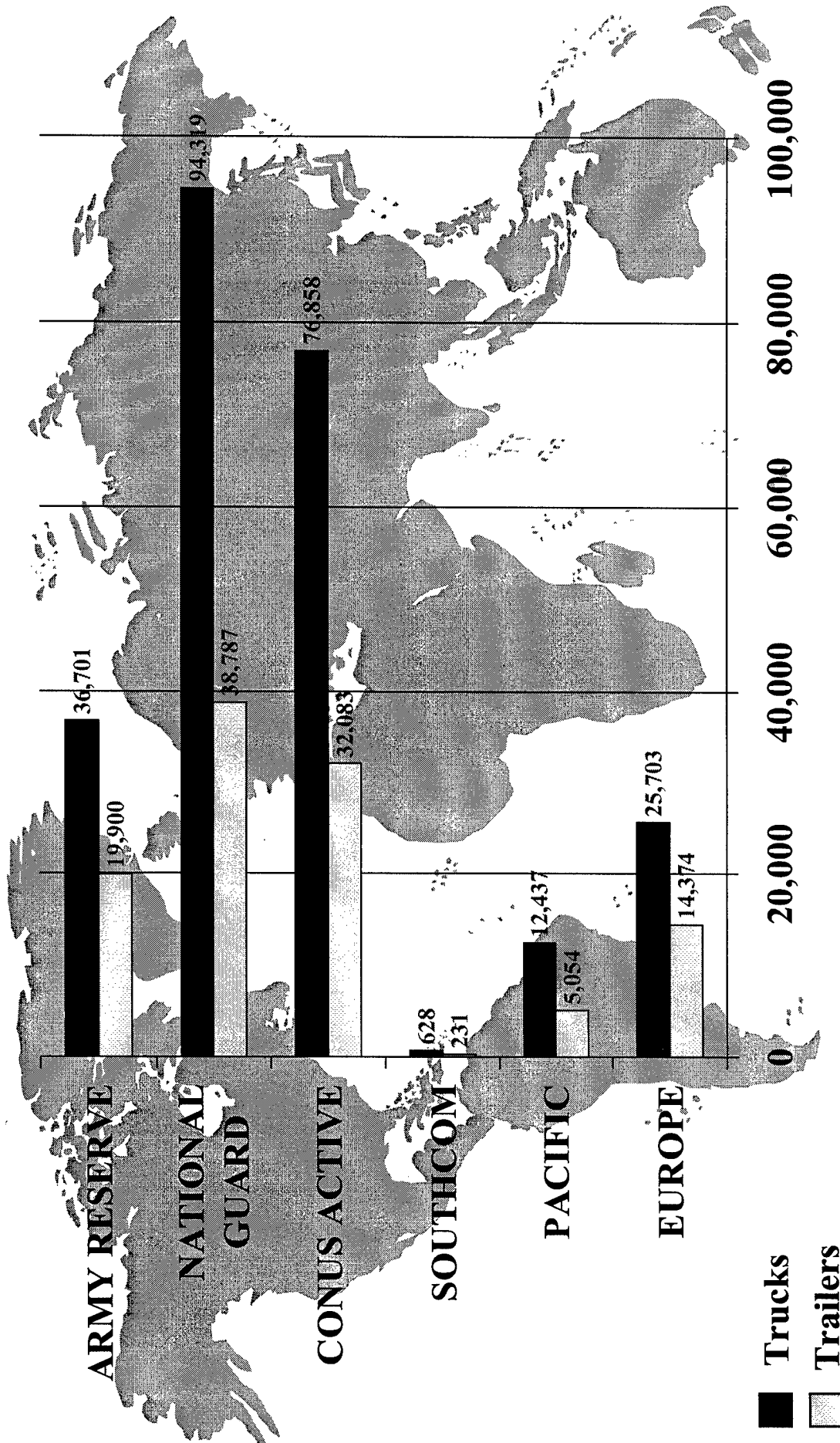
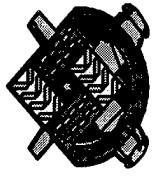

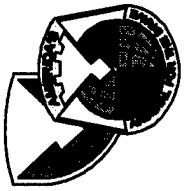

Heavy Tactical Wheeled Vehicle Fleet

26,440 Trucks 25,281 Trailers

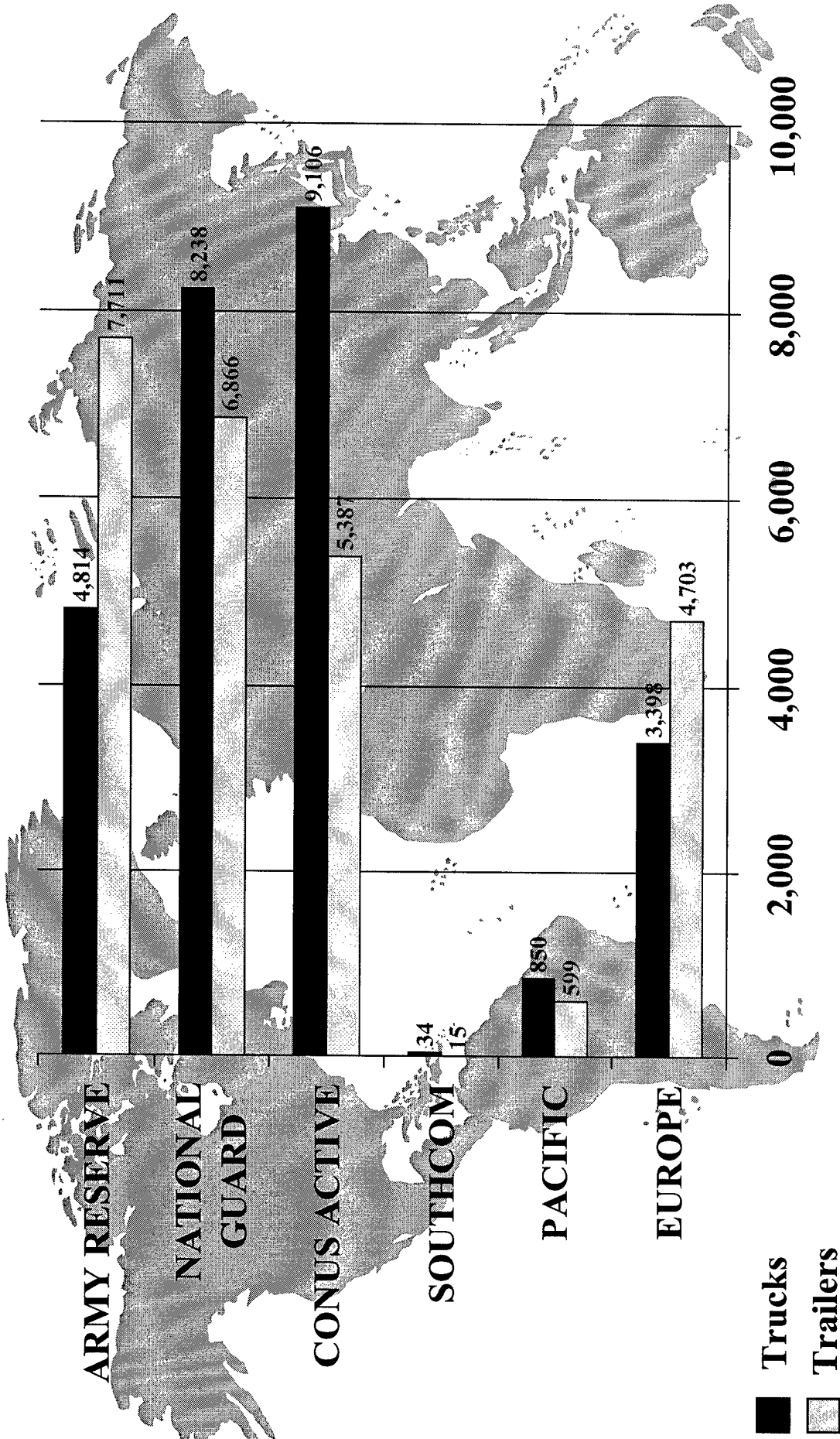

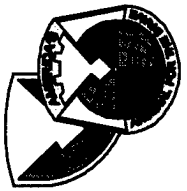

Medium Tactical Wheeled Vehicle Fleet

96,210 Trucks
64,113 Trailers

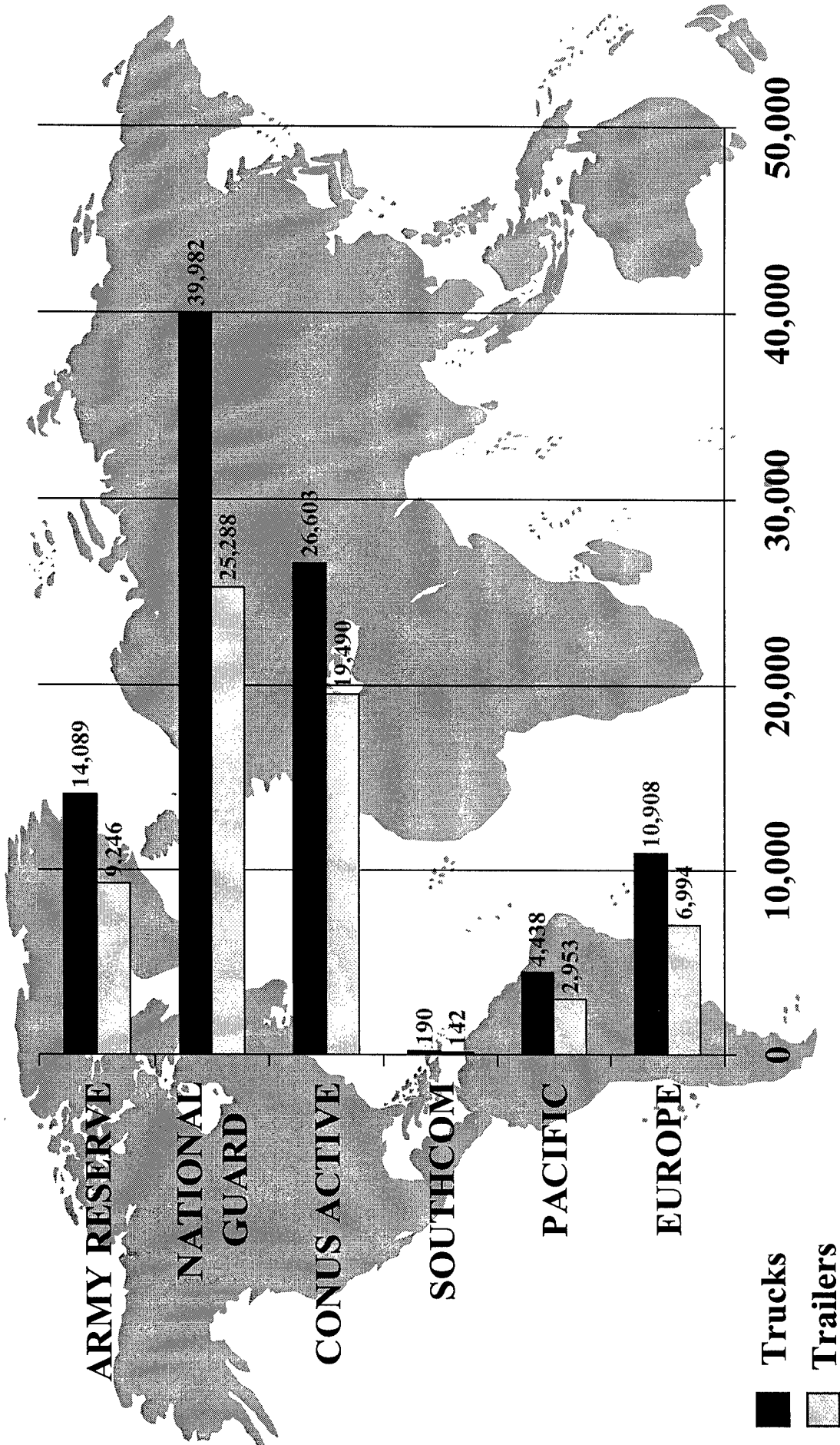
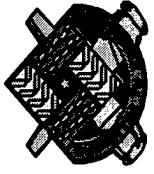

■ Trucks
▨ Trailers

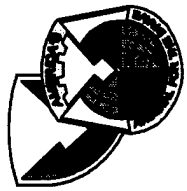

Light Tactical Wheeled Vehicle Fleet

123,996 Trucks 21,035 Trailers

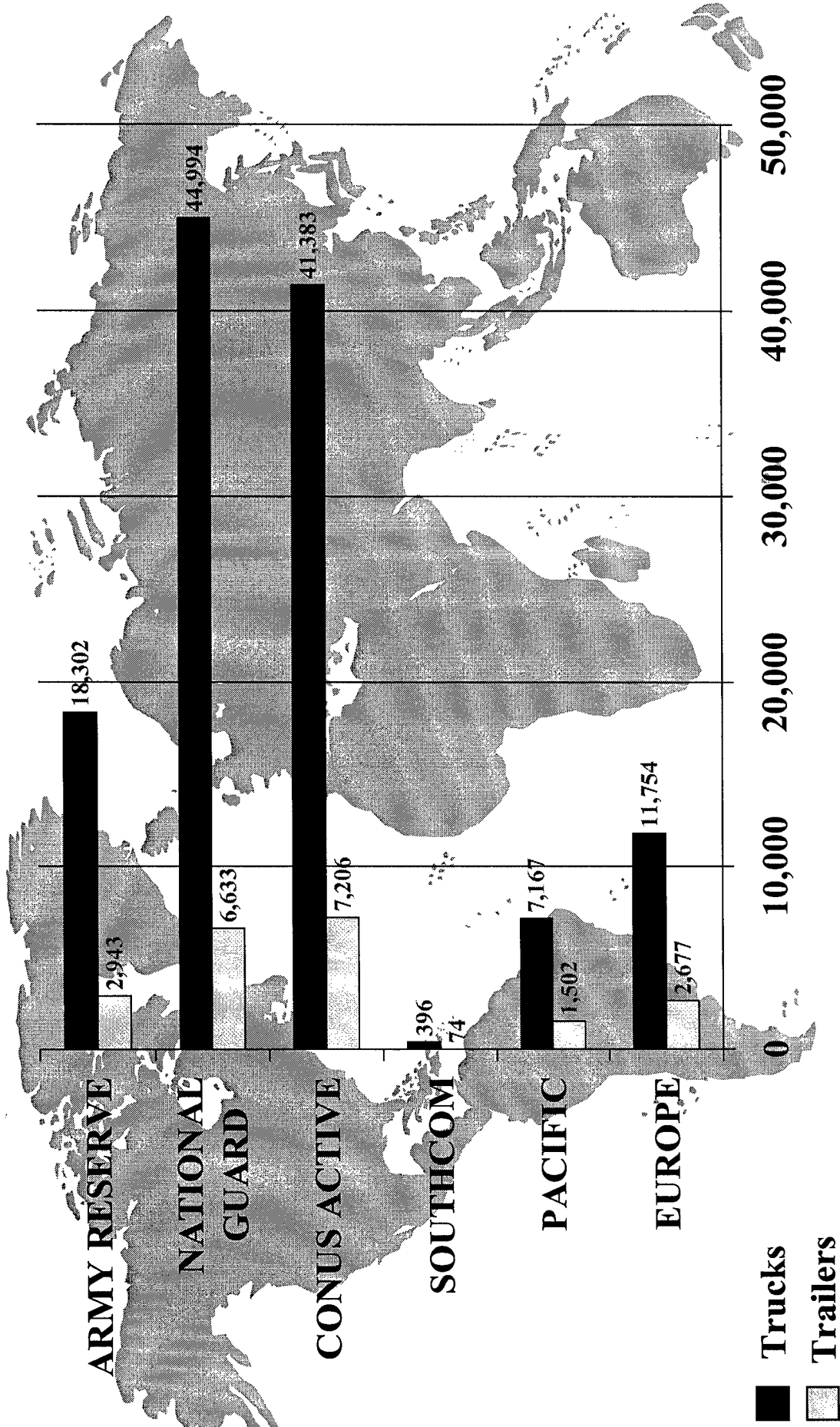
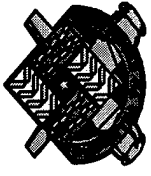

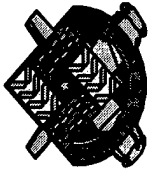
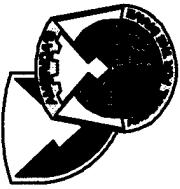

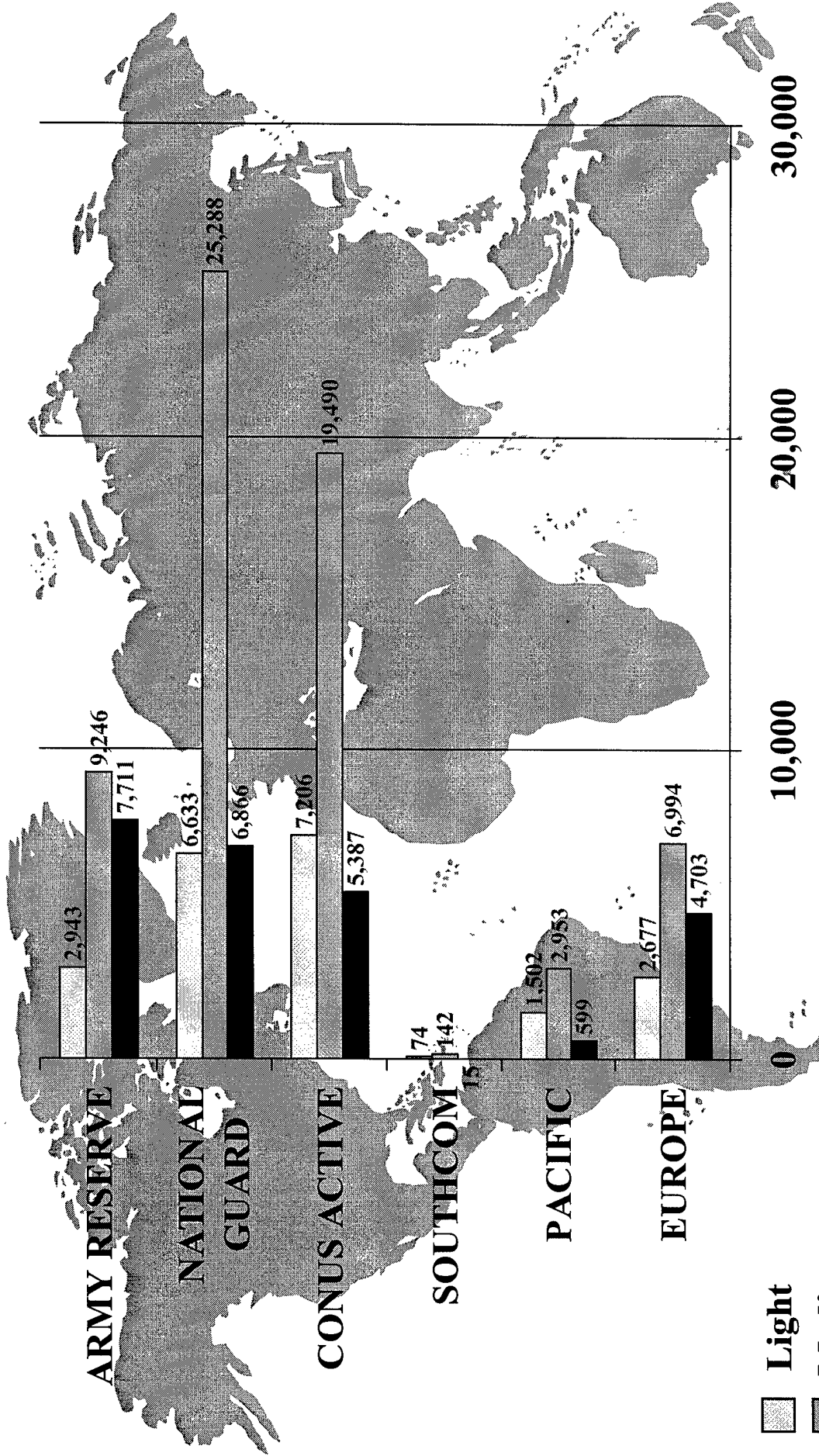

Trailers

110,429



 Light
 Medium
 Heavy

2/2/99

23/55

Committed to Excellence

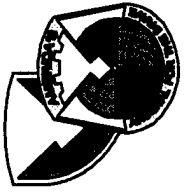

Tactical Wheeled Vehicles Operation and Support Cost



- **Fleet cost \$1.7 billion to operate and support in FY98**
- **Operation and Support Cost Drivers:**
 - **Labor/ Mechanic**
 - **Parts (Engines, Tires, Batteries, etc.)**
 - **Petroleum, Oil and Lubricants**

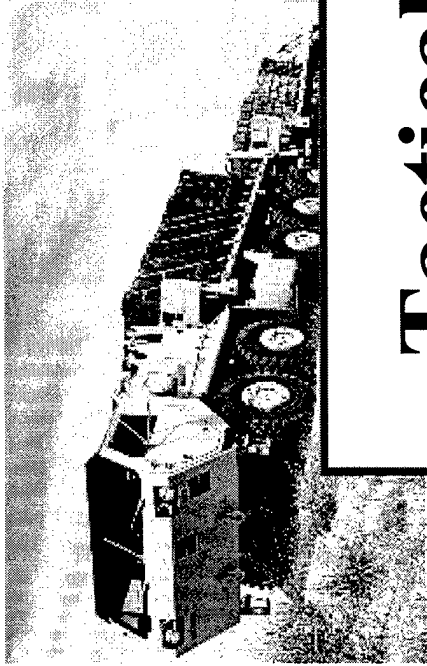
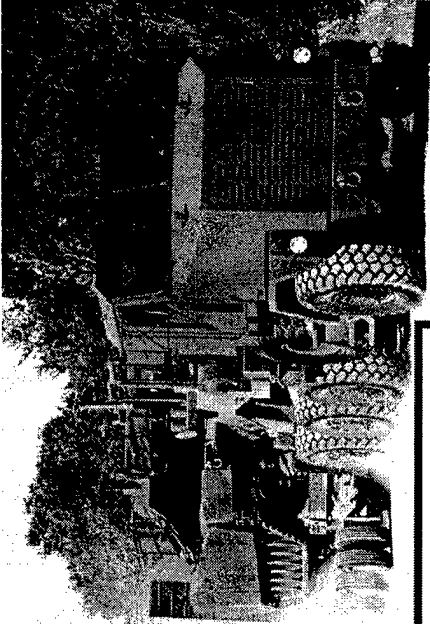
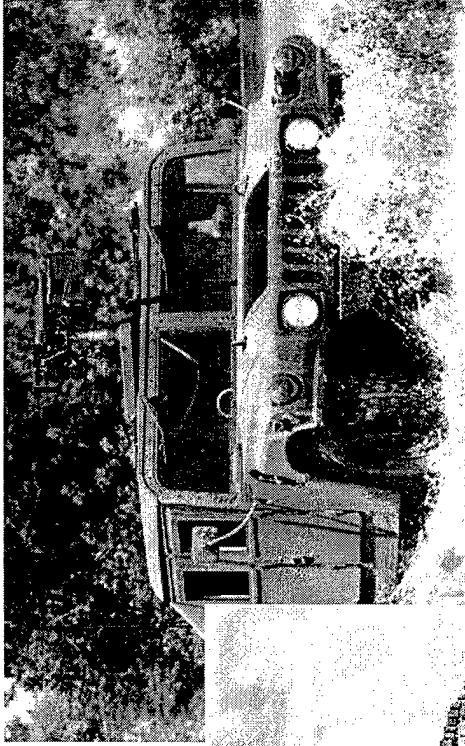
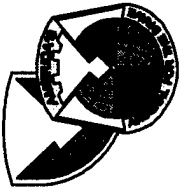

Tactical Wheeled Vehicle Procurement

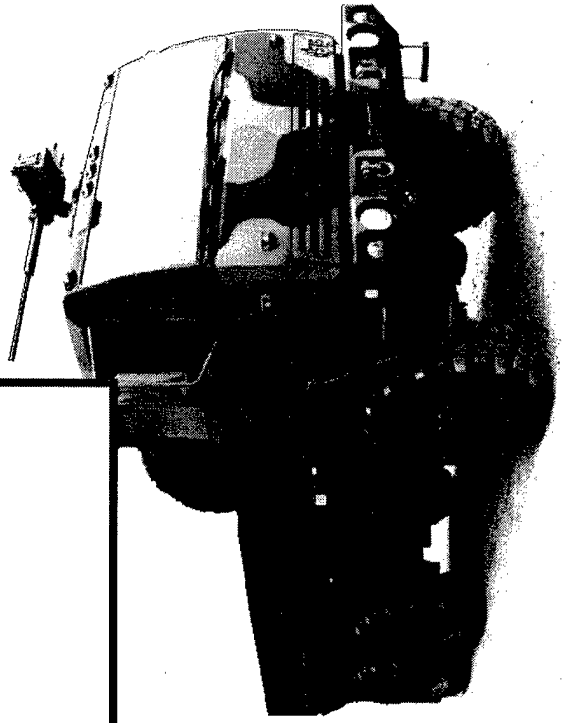
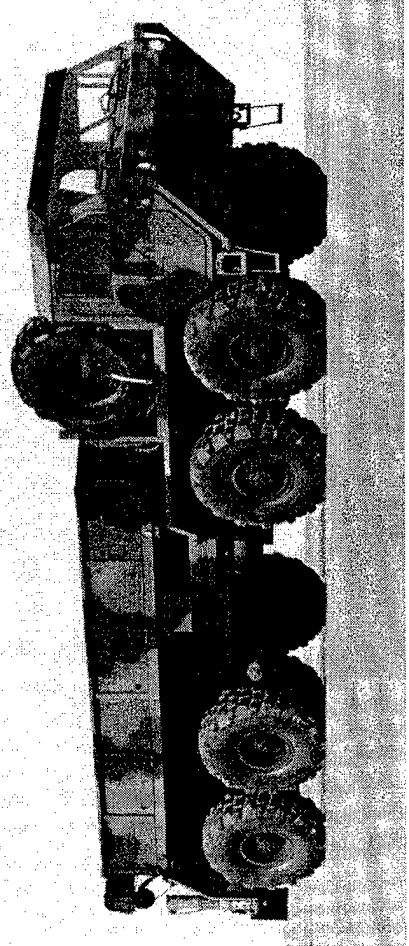

2/2/99

25/55

Committed to Excellence

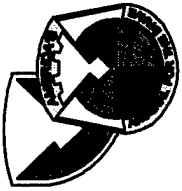

Building to the 21st Century Maintaining Capability

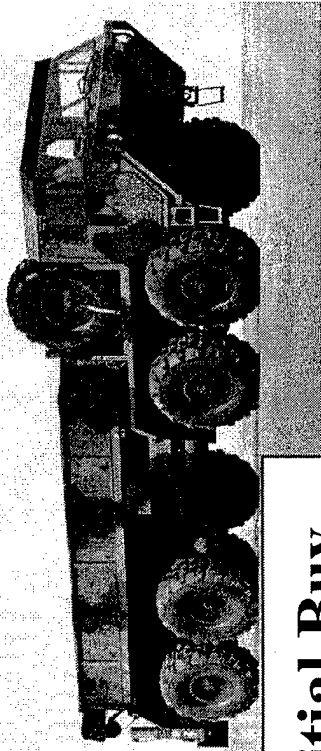
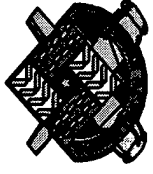

Initial Buy

“New Buys” w/Modifications.

**Rebuild/
Remanufacture**

**Upgrade
Rebuild
Remanufacture
Modernize
through Spares**

**Future Tactical
Wheeled Vehicle**

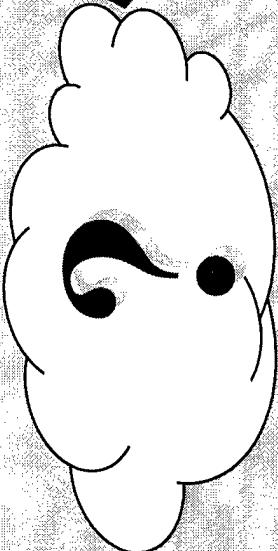
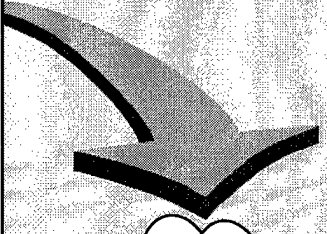

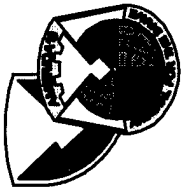

Tactical Wheeled Vehicle Projected Fleet Procurements

2/2/99

27/55

Committed to Excellence

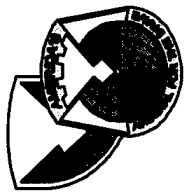

Heavy Tactical Wheeled Vehicles Production/ESP

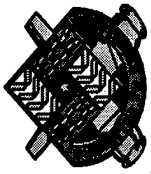

\$1.04B

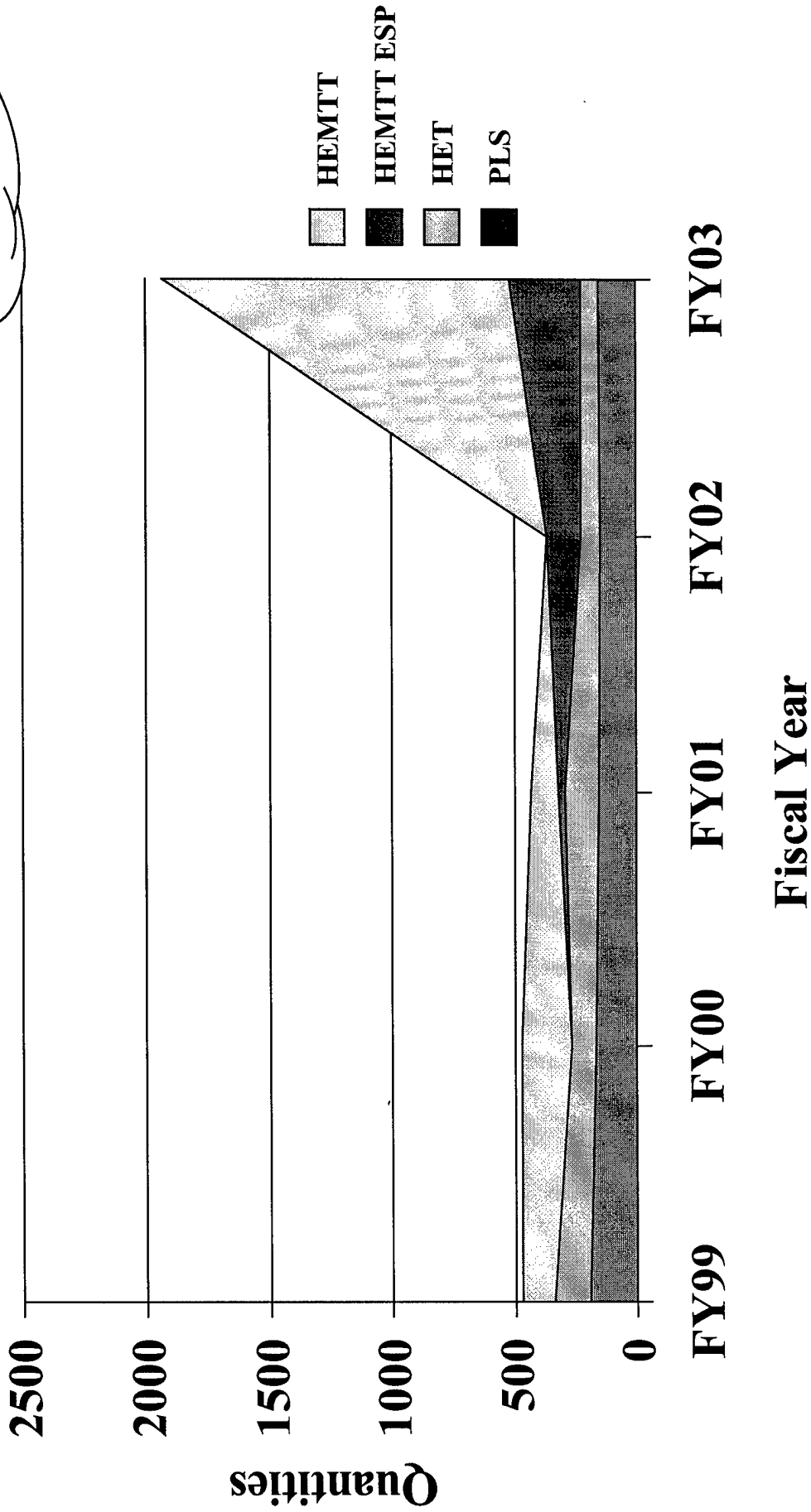

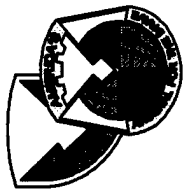

Medium Tactical Wheeled Vehicles Production/ESP

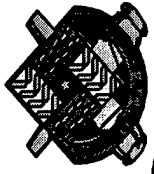

\$3.7B

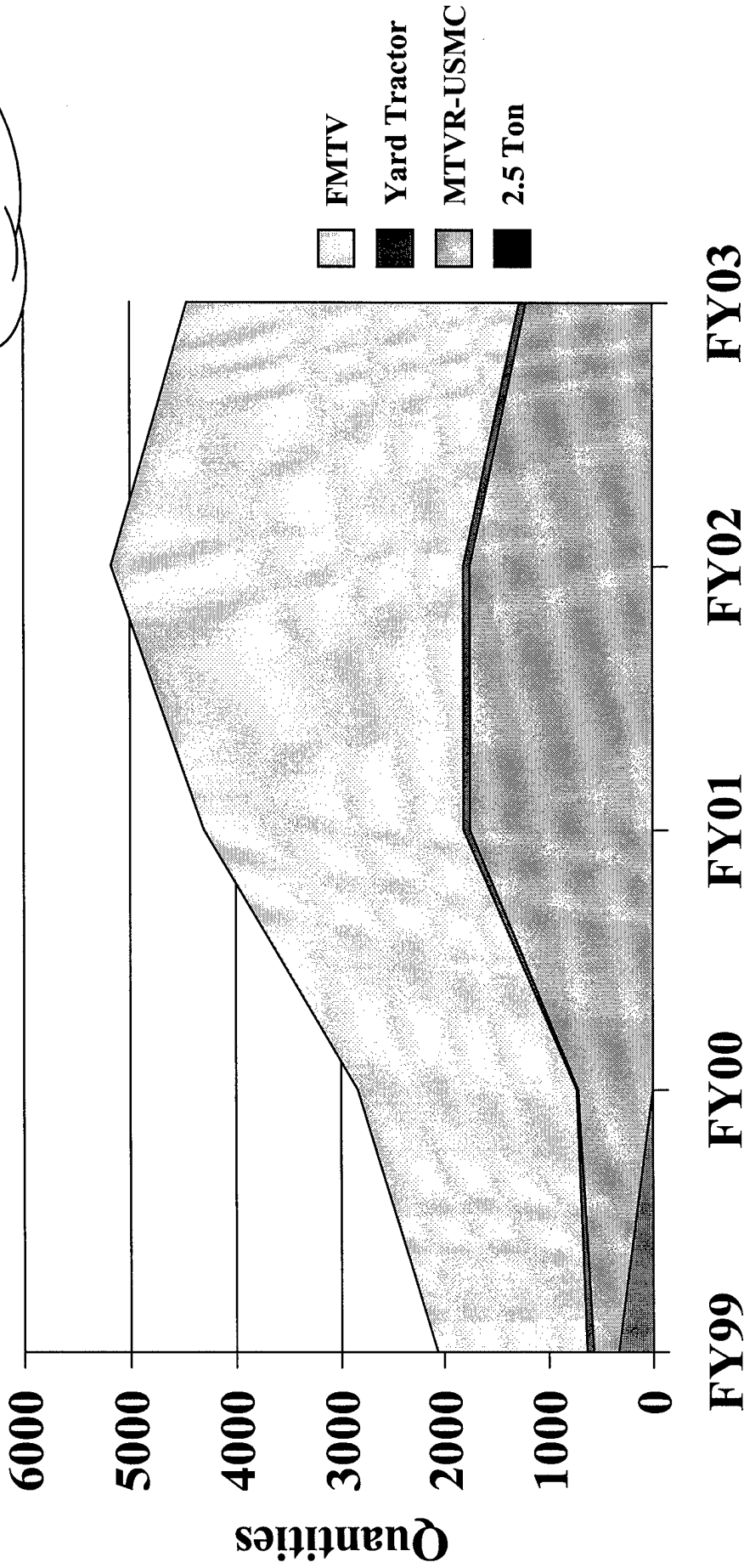



Light Tactical Wheeled Vehicles Production/ESP

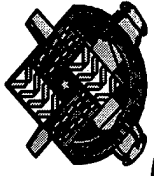

\$722M

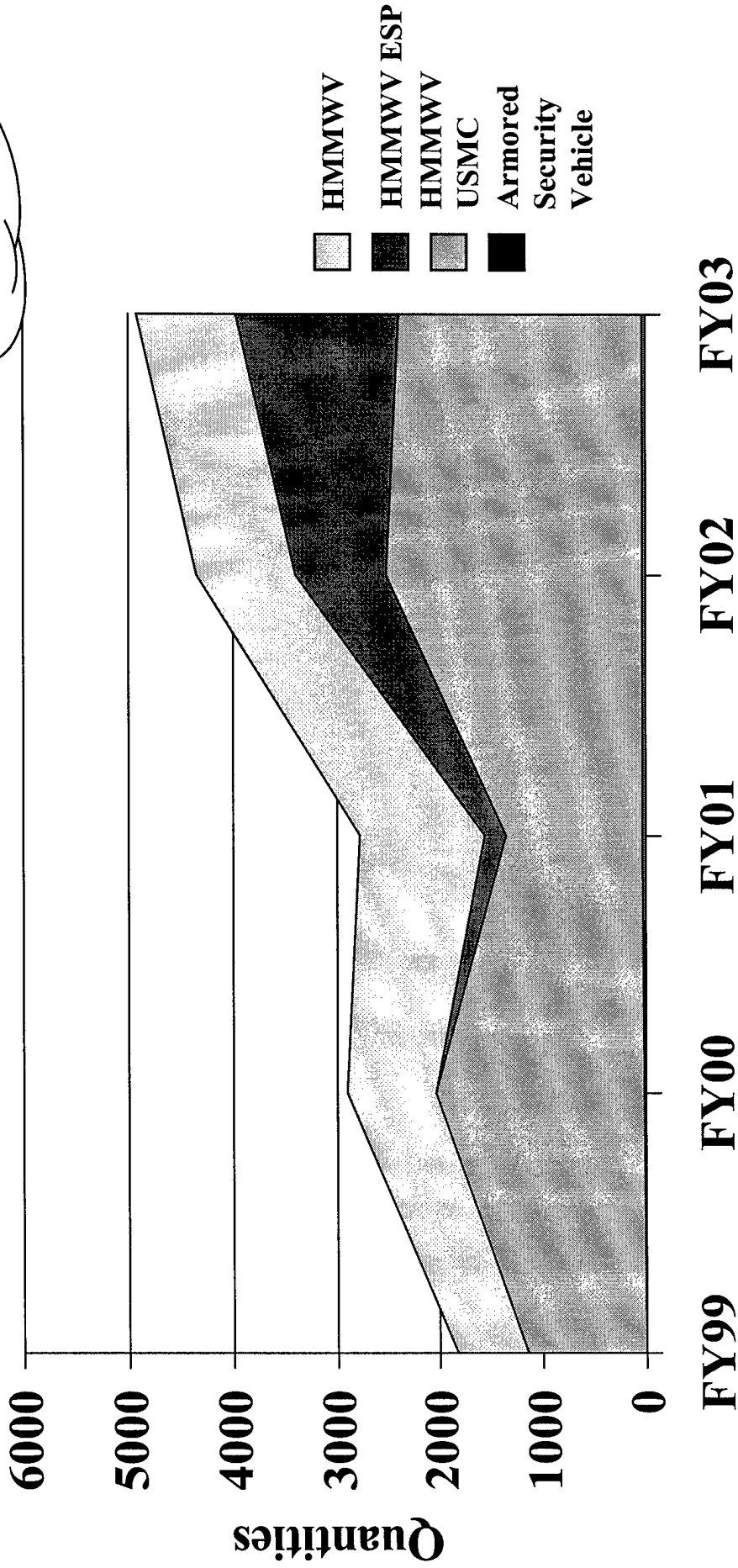

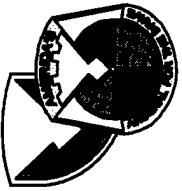

Line Haul Trucks Production/ESP



\$403M

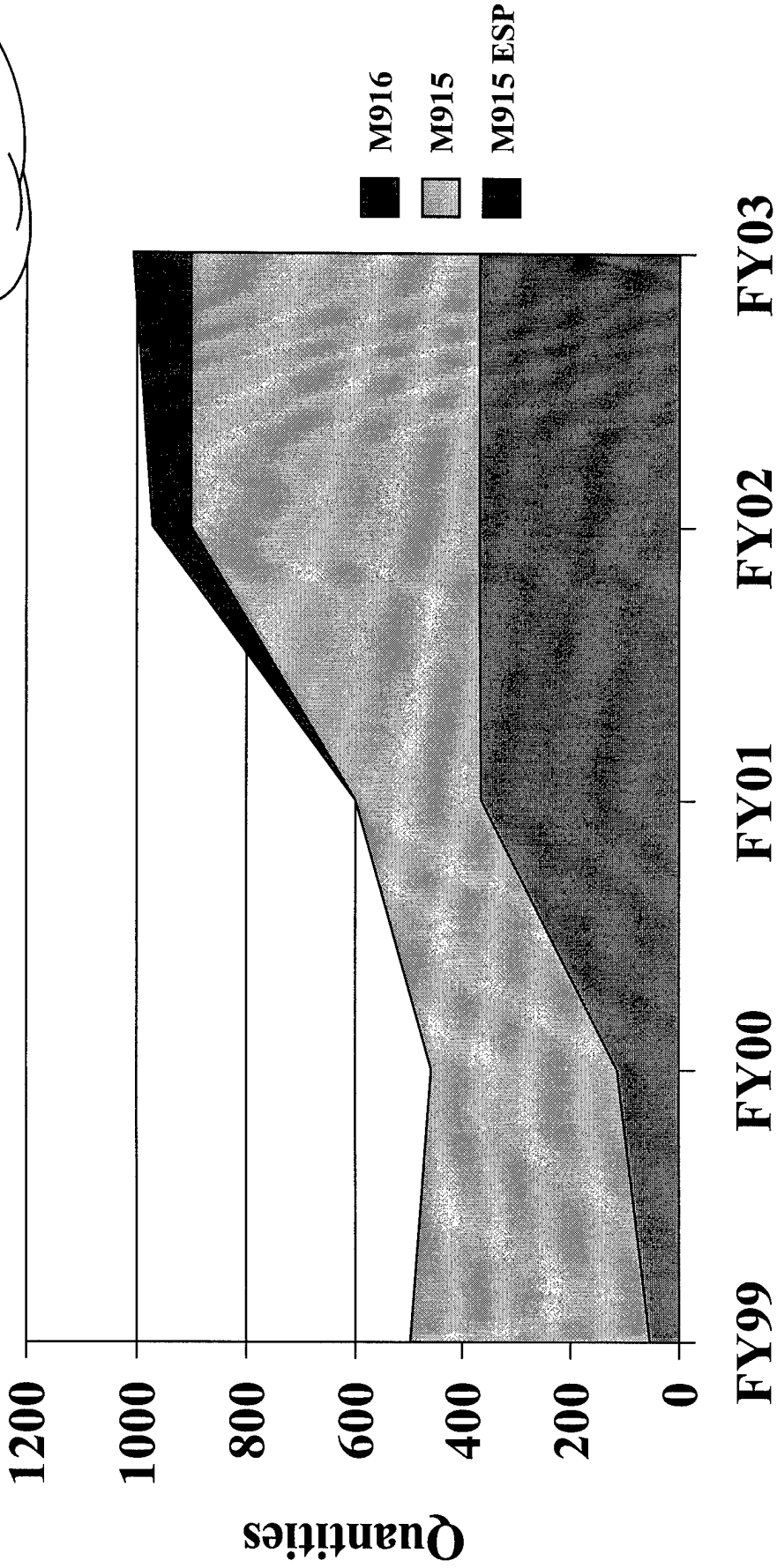

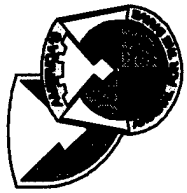

Trailers Production/ESP



\$4.86M

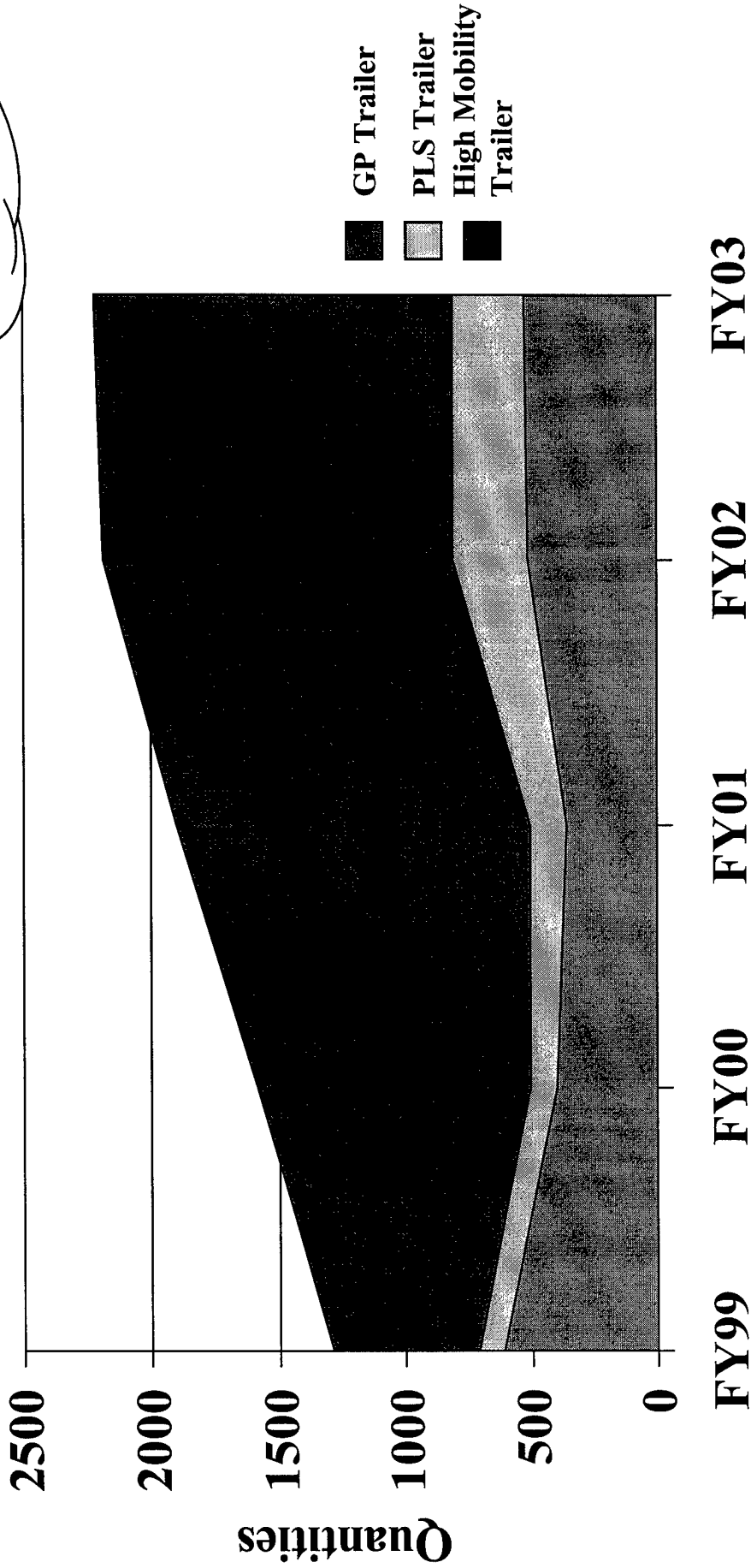

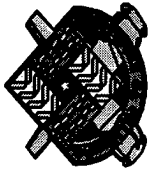
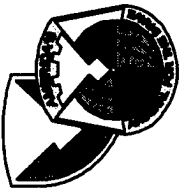

TACOM & Tactical Wheeled Vehicles

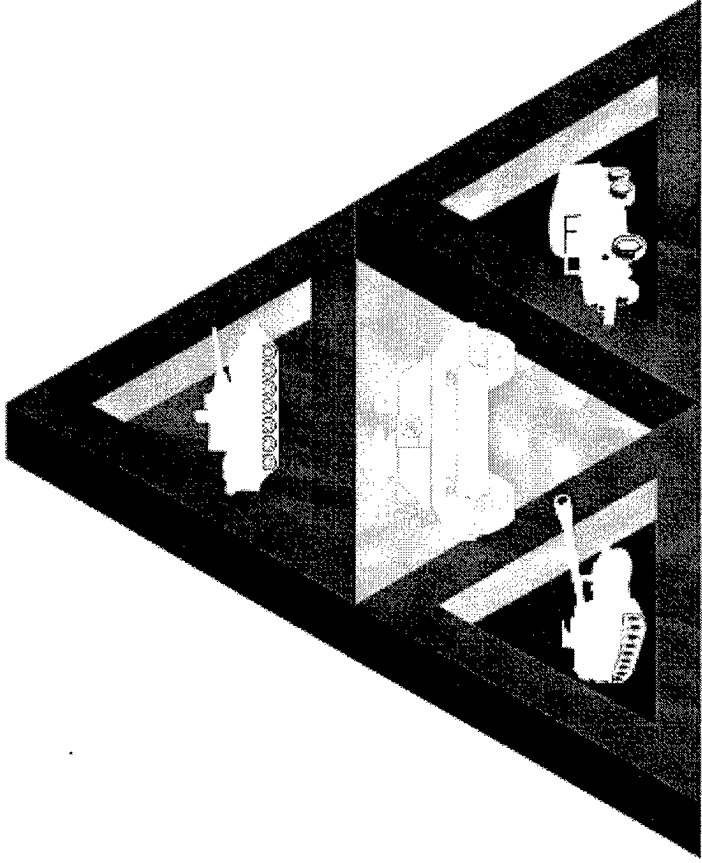

T A R D E C

Research, Development & Engineering

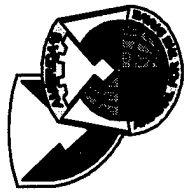

Commercially Based Tactical Truck (COMBATT)

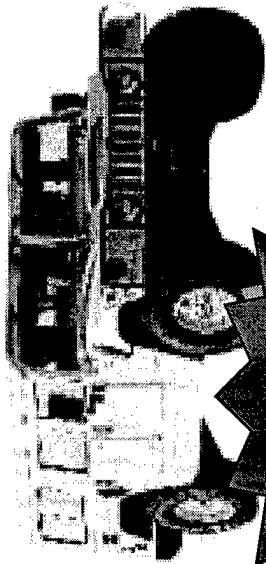

**Military
Needs**

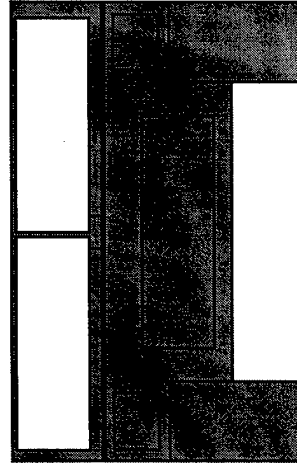
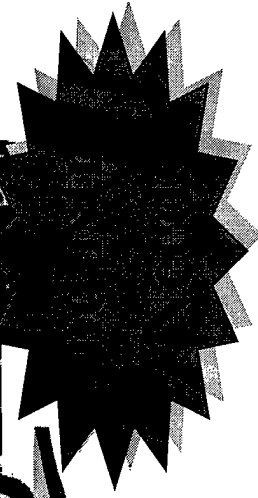
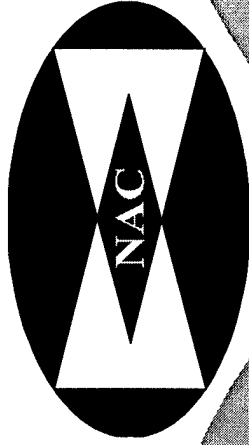

Next Generation Light Tactical Truck

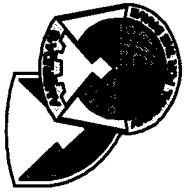

What **COMBATT** is



- A **DEMONSTRATION** of the ability to merge commercial automotive technologies and military **NEEDS** for the NextGen LTV and HMMWV technology insertion.
- Dual Use Application Program Resulting from Broad Agency Announcement.
- Participation by OSD, TACOM and:

<u>Company</u>	<u>Platform</u>
Chrysler	2000 Ram
Ford	1998 F350
AMG	1998 HMMWV

- Managed jointly by NAC and ERIM International.

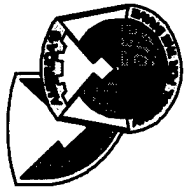

Propulsion System Requirements 21st Century Truck



Needs/Requisites

- Increased Power Density
- Improved Durability
- Improved Fuel Efficiency
- Legislative Compliance
- Commercially Based

Technological Solutions

- Advanced Materials
- Smart Sensors
- Digital Controls/
Architecture
- Functional Integration
- Hybrid Approach
- Fuel Cells
- Alternative Fuels

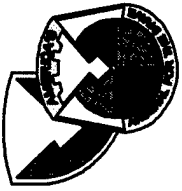

OSCR Program

Operation and Support Cost Reduction is....

Anything and everything that lowers the recurring cost of owning, maintaining, or sustaining the system

HTI	SAVE	Major	Value	PIPs	RM&S	SMA-	Tech	MTS
	Mods	Engr				OSCR	Base	

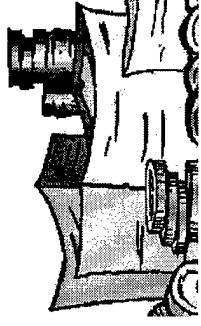
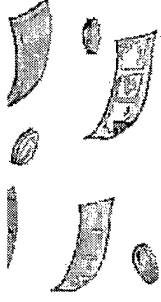
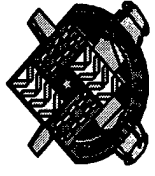

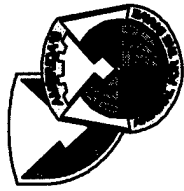

TACOM's SMA OSCR PROJECT SUMMARY



- **Successful Projects:**

M915A4 Engine & Suspension Assy	M109/M992 Fuel Cells
Redesign HMMWV Soft Top Doors	Gunfire Simulator Circuit Card
Calcium Maintenance Free Battery	M119A1 Spare Parts Redesign
Galvanization of M939 Series Hood	Alternate Power Sys for SUSV
Replace Tritium Lamps w/LEDs	ROWPU Improvements
Ceramic Material Plasma Spray	AH64A Improved CRT Cable Strain Relief
M295 Equip Decontamination Kit	AH64A CRT Wire Splice
Recoil Exerciser 155m Howitzer	Improved Track Lock BCS
AGT 1500 Eng Blade Repair	M10 Charger Simplification
Smart Battery and Charger	One-Piece Periscope (M117)
Fiber Optic Gyro, M2	AH-64A Helmet Cable Improvement
Drain Plug Kit Replacement BFW	M203A1 Grenade Launcher Handguard
Improved Moldboard Ext BCS	Alt. Source for Variable Speed Fan, M113

- **26 Initiatives Funded with \$6.6M Investment (FY96-99)**
- **Projected Field Savings for POM (FY98-03) \$34.5M**

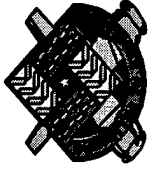
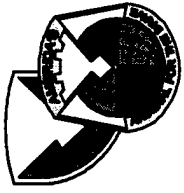

Blueprint For Change: Standardization Reform Effort

	<i>Yesterday</i>	<i>Today</i>
Active Specifications and Standards	5,147	1,075
Performance Specifications	--	157
Commercial Item Descriptions	--	127

Highlights: New Non-Government Standards -- 24

Cancelled 1,057 documents Inactivated 1,832 documents

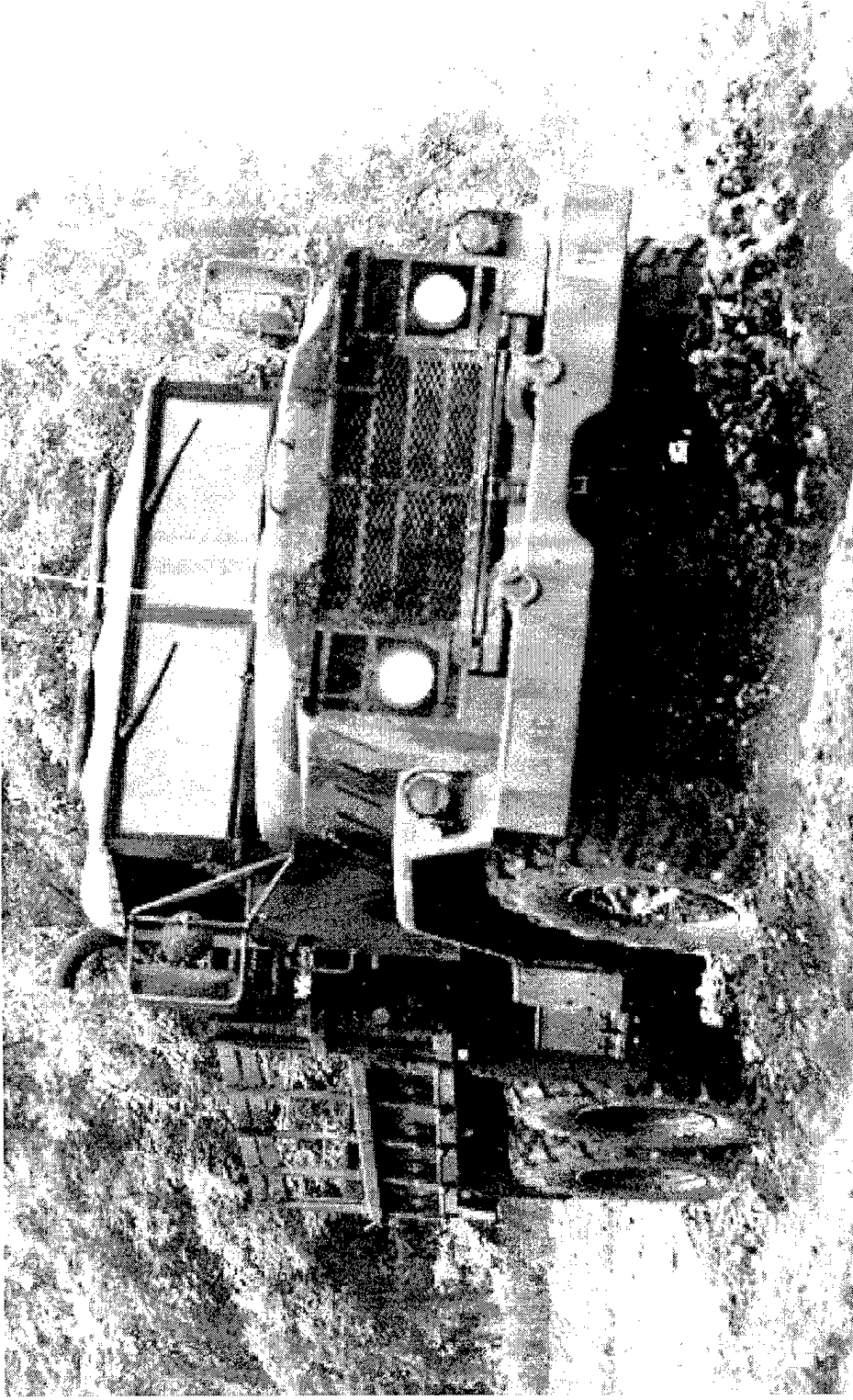
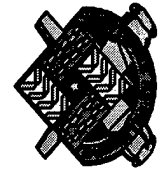
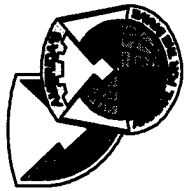

TACOM and Tactical Wheeled Vehicle Sustainment

2/2/99

40/55

Committed to Excellence

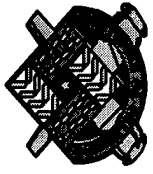
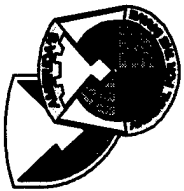

Tactical Wheeled Vehicle Sustainment Challenges

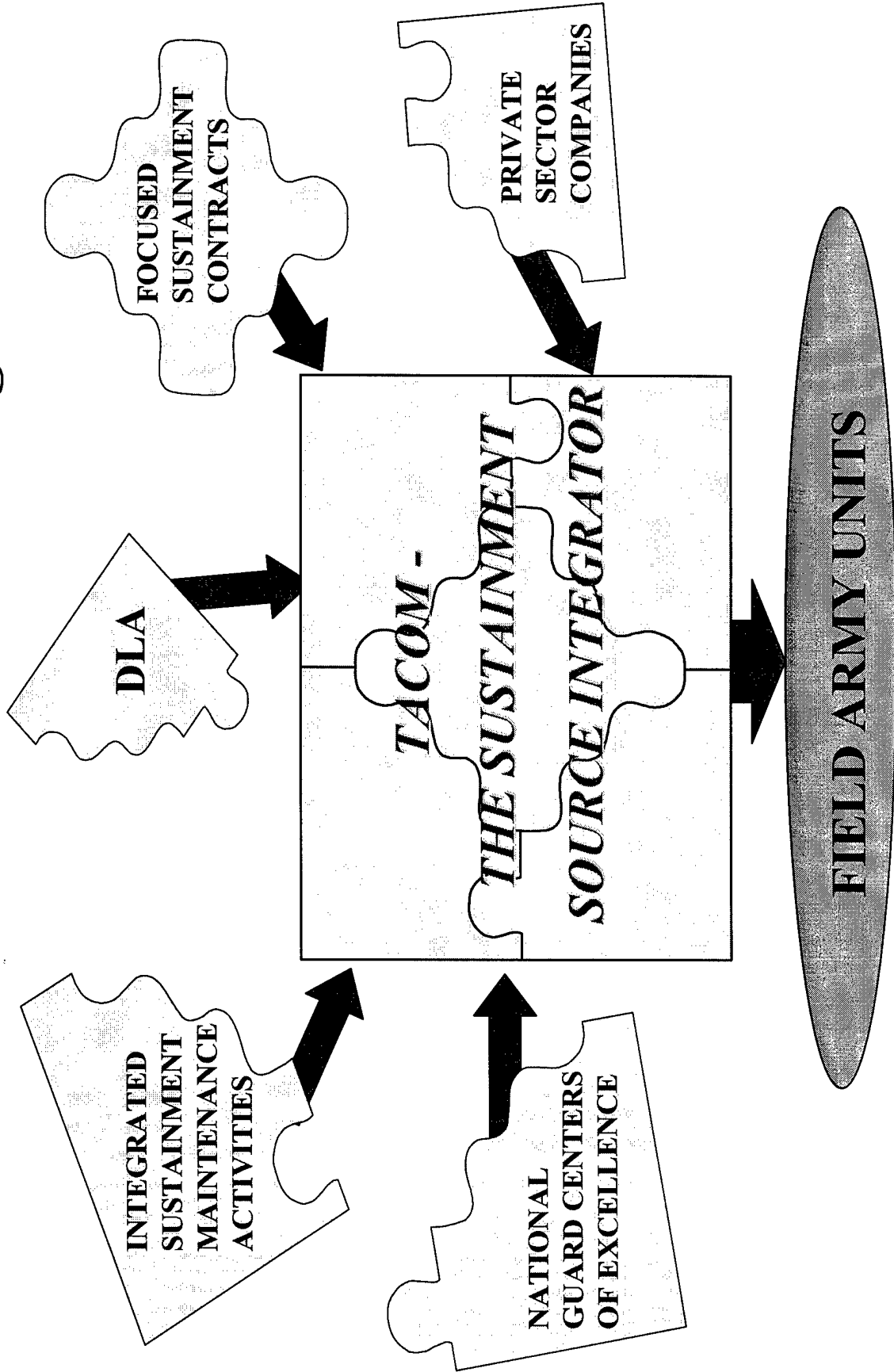

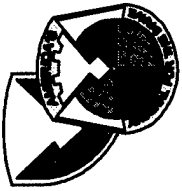

Tactical Wheeled Vehicle Sustainment Challenges



WHAT WE'RE DOING:

INTEGRATED, MULTI-FUNCTIONAL COMMODITY BUSINESS UNITS (CBU)
SUSTAINMENT SOURCE INTEGRATOR - FOCUSED SUSTAINMENT
MANAGE FROM THE CUSTOMER'S PERSPECTIVE - READINESS CELL
INCREASE LONG TERM CONTRACTS WITH OUR VENDORS
BUY "RESPONSE" NOT INVENTORY
REDUCE COSTS/REDUCE SURCHARGE
REDUCE ADMINISTRATIVE AND PRODUCTION LEAD TIMES
REDUCE INVENTORY
REDUCE BACK ORDER AGE

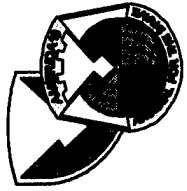

Commodity Business Unit (CBU) Multi-Functional Team Development



BEFORE

Multi-Functional
Teams made up of
Specialized Associates

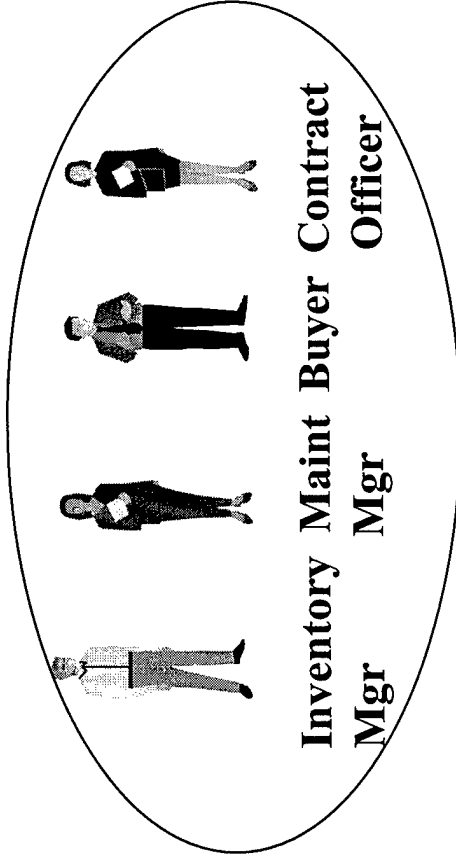

Reinforces
Stovepipes

AFTER

Multi-Functional Teams
made up of Multi-
Functional Associates

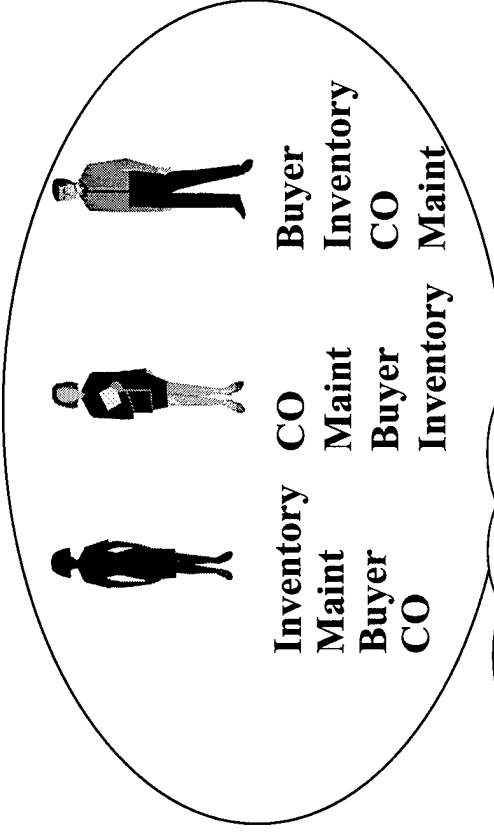

Encourages Process
Re-Engineering

Development to Multi-Functionalism: Osmosis is not good
enough.

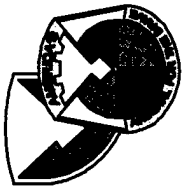

NATIONAL MAINTENANCE FOCUS



CURRENT SITUATION IS ...

An Army Sustainment Stampede...

- PEO INITIATIVES . . .
- AMC MAJOR SUBORDINATE COMMAND ACTIONS AND INITIATIVES . . .
- FIELD ARMY INITIATIVES . . .

e.g.,

ISM and SRA proliferation; independent repair programs; post-camp, station individual contracts for support

e.g.,

PALADIN BUSINESS CASE STUDY;

M1A2 CLS;

e.g.,

Traditional five-level maintenance operations

Legacy system support and sustainment

Integrated Logistics Support planning and execution

“CURRENT NEED IS FOR A SUSTAINMENT SOURCE INTEGRATOR ...”

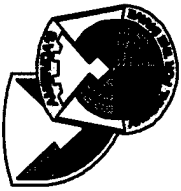

NATIONAL MAINTENANCE FOCUS

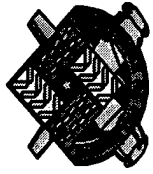

WHAT IS FOCUSED SUSTAINMENT?

LEVERAGE TACOM CONTRACTING EXPERTISE BY SELECTING "BEST OF BREED" FROM OVER 40 STOVEPIPES

Multiple awards; multiple contractors

Work assignment protocols to select "best" source for each deliverable

IDIQ CONTRACT INSTRUMENT

- EQUIPMENT EVALUATION
- DIAGNOSTICS
- TECHNICAL ASSISTANCE
- WRENCH TURNING
- TRAINING
- PARTS SOURCING
- MATERIEL FIELDING
- LOGISTICS DATABASE UPDATES:
 - PROVISIONING DATA
 - TECHNICAL MANUALS
- RECOMMENDED CHANGES TO EQUIPMENT (EIR/ECP)

Priced by hour... Buy only hours needed.

"TACOM - SUSTAINMENT SOURCE INTEGRATOR"

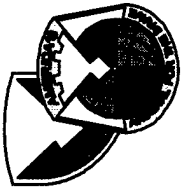

**DCG for
CORPORATE MGMT**

**DIRECTORATE OF
READINESS OPERATIONS**

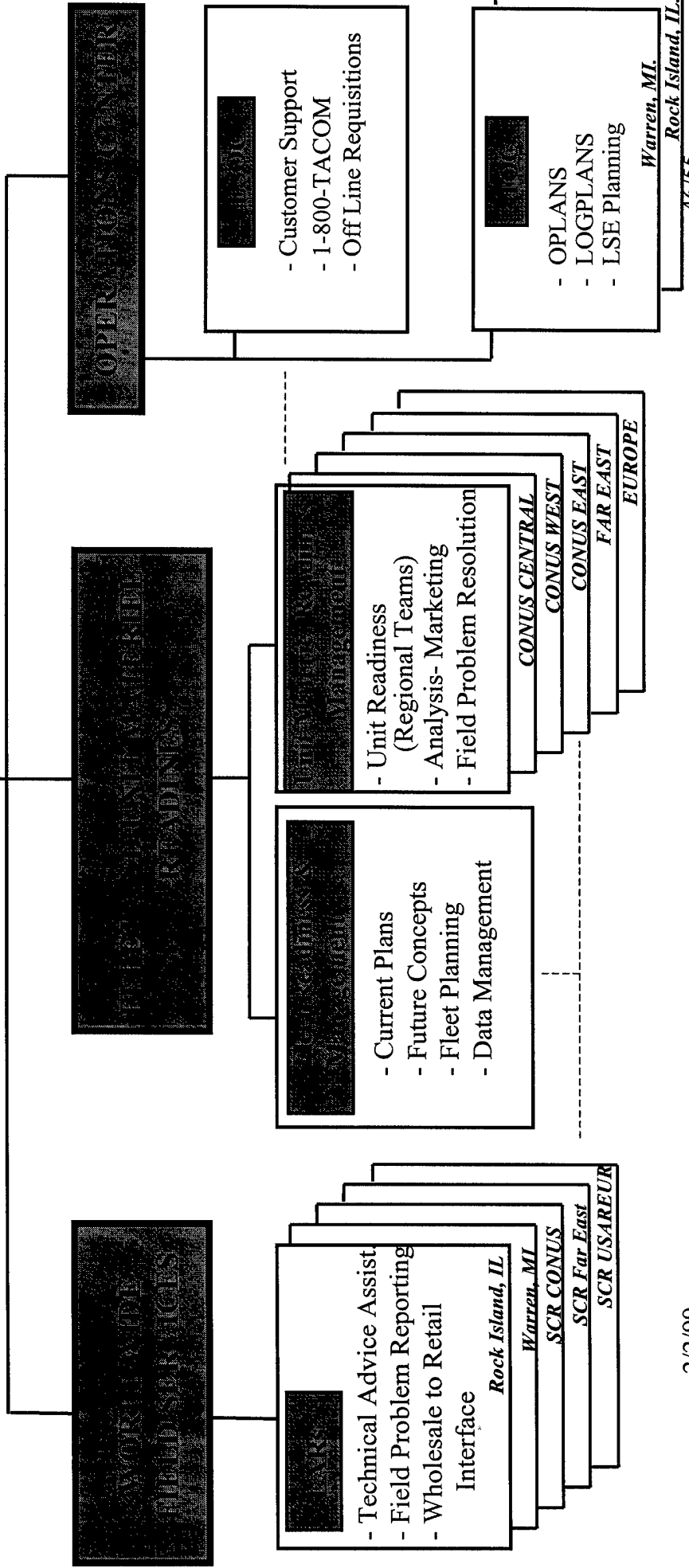

Committed to Excellence

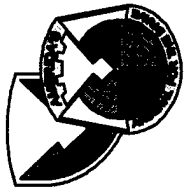

UNIT MATERIEL READINESS TEAMS

REGIONAL ALIGNMENT



**FAR EAST
8th USA**

CONUS WEST

**CONUS CENTRAL
5th USA**

**CONUS EAST
1st & 3rd USA**

**EUROPE
7th USA**

MCUs

- 2 Inf Div
- 172 Separate Inf Bde
- 25 Inf Div

Non-Divisional Units

- 19 SUPCOM
- 17 Aviation

USAR/NG



MCUs

- 3 Arm Cav Rgmt
- 1 Bde / 25 Inf Div
- 3 Bde / 2 Inf Div
- 1 Special Forces Grp

Non-Divisional Units

- 11 Armored Cav Rgmt
- National Tng Center

USAR/NG

MCUs

- 1 Cavalry Div
- 3 Bde / 1 Arm Div
- 4 Inf Div
- 10 Special Forces Grp
- 1 Bde / 1 Inf Div

Non-Divisional Units

- 11/31/35/108 ADA
- 3 Corp Arty
- FA Tng Ctr
- 13 COSCOM
- Ft. Clayton PANAMA

USAR/NG

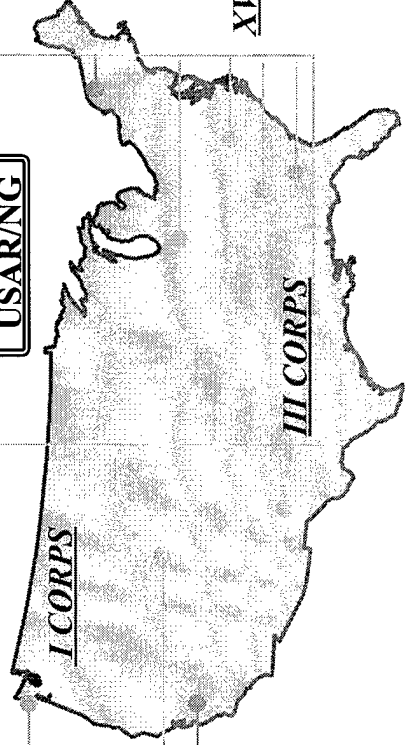

MCUs

- 2 Arm Cav Rgmt
- 3 Inf Div
- 10 Inf Div
- 101 Air Assault Div
- 82 Airborne Div
- 3/5/7 Special Forces Grp
- 75 Ranger Rgmt
- 160 Spec Ops Avia Rgmt

Non-Divisional Units

- 20 Engineering Bde
- 1 COSCOM
- 159 Aviation Bde

USAR/NG

XVIII CORPS

MCUs

- 1 Inf Div
- 1 Arm Div

Non-Divisional Units

- 69 Air Defense Arty
- 21 TAACOM
- SETAF
- Task Force 4-64
- Joint Forge
- V CORPS**

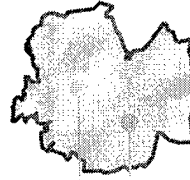

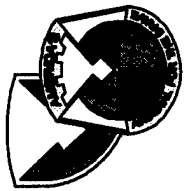

TACOM ALT/PLT REDUCTION PROGRAM LONG TERM CONTRACT PERFORMANCE

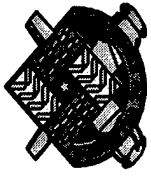

PERFORMANCE

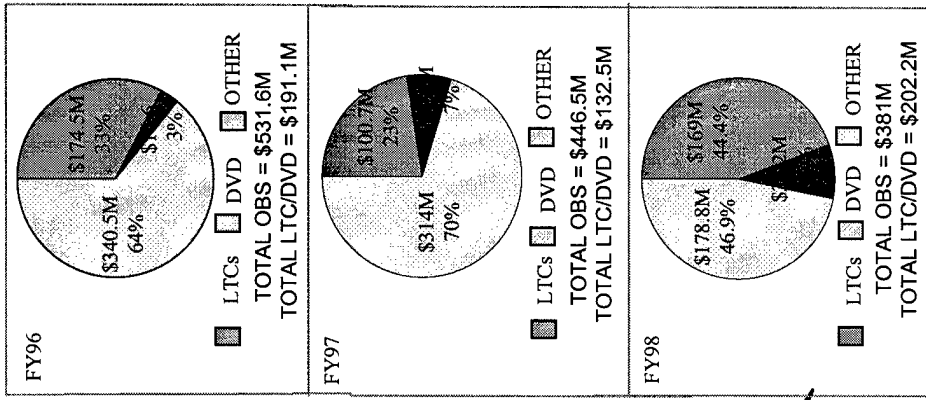
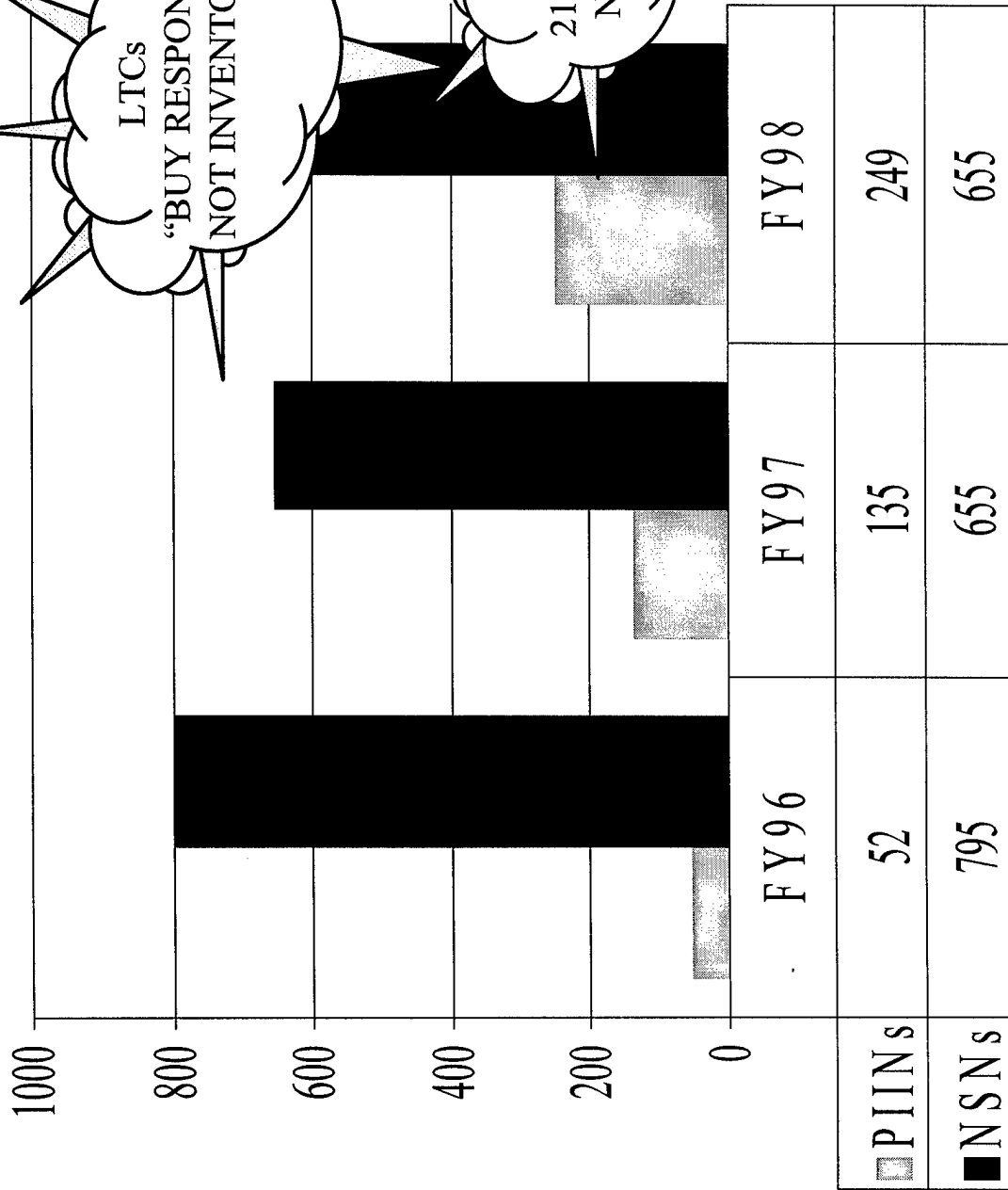

TACTICAL DIVISION:
122 LTC NSNs
58 PIINs

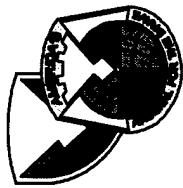

ALT/PLT REDUCTION PROGRAM TACOM MILESTONES

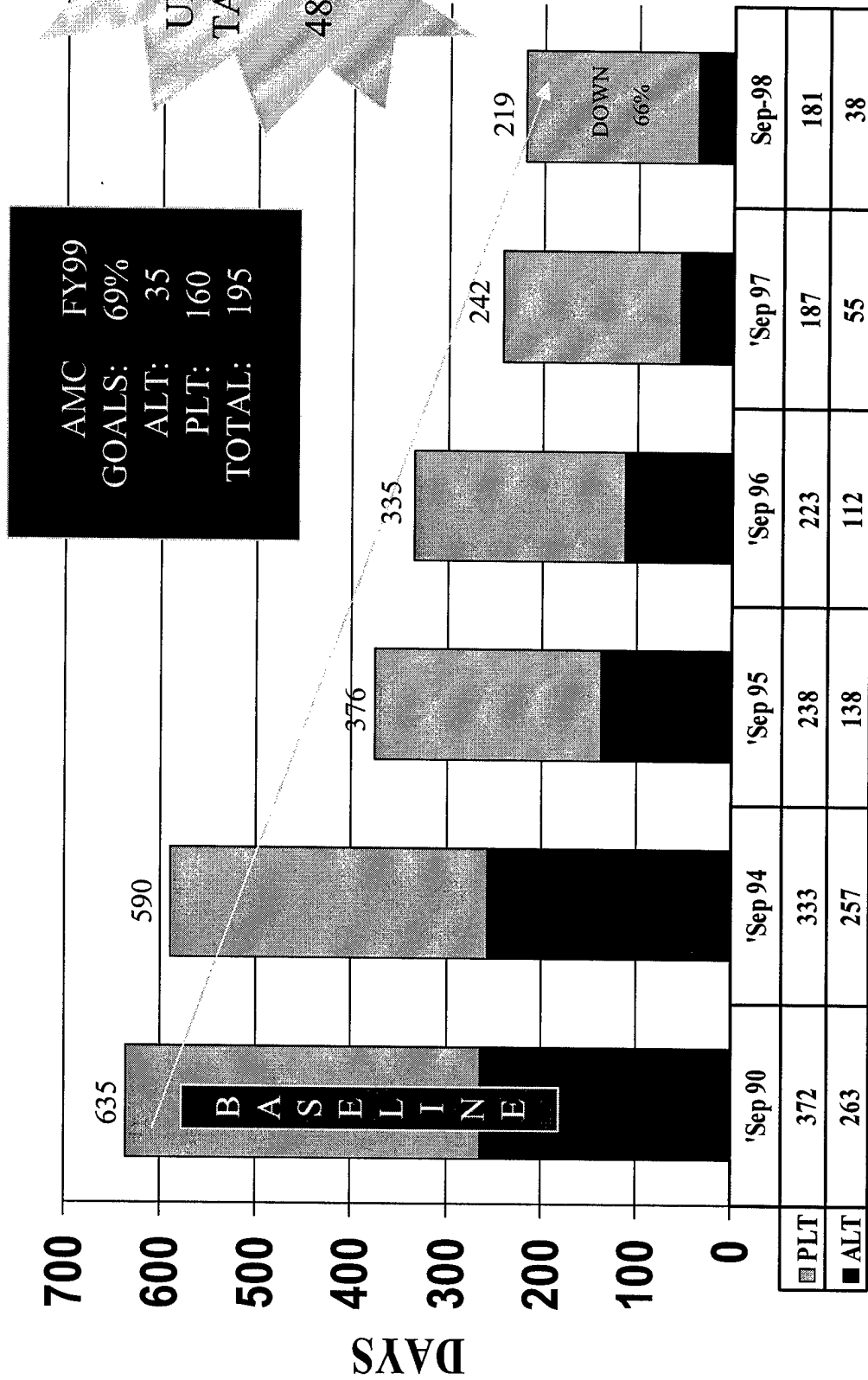

SOURCE DOCUMENT - Sep 98 STRAT

2/2/99

Committed to Excellence

49/55

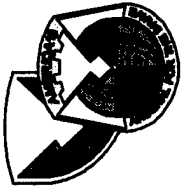

We Need Your Help!

Future Truck Technology Needs



- Propulsion
 - Fuel Efficient
 - “Clean”
 - More Power
- Suspension and Running Gear
 - Independent
 - Active/Semi-Active
 - Anti-Lock Brakes
 - Automatic Traction Control
- Wheels/Tires
 - Improved Run Flat
 - Central Tire Inflation System
 - Band Track
- Electronics
 - Situation Awareness
 - Movement Tracking System
- Improved Deployability
 - Reduced Weight
 - Reduced “Footprint”
- Extended Fleet Life
 - Diagnostics/Prognostics
 - Increased Corrosion Protection
- Safety
 - Collision Warning System
 - Crew Safety Protection
 - Improved Ergonomics

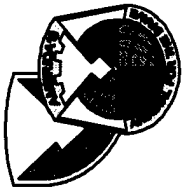

Conclusions:

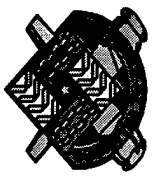

- **Total cost of ownership is critical**
 - **Aging fleet**
 - **Operation and Support cost consideration**
- **TACOM is source integrator for TWV sustainment**
- **Must renew the fleet**
 - **Rebuild**
 - **Remanufacture**
 - **Buy new**

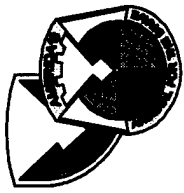

What is a soldier without TACOM?

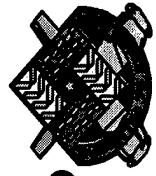

MAKING TECHNOLOGY WORK FOR SOLDIERS

2/2/99

52/55

Committed to Excellence

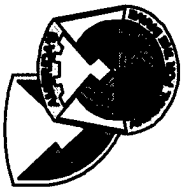

A Tourist!



U.S.A.

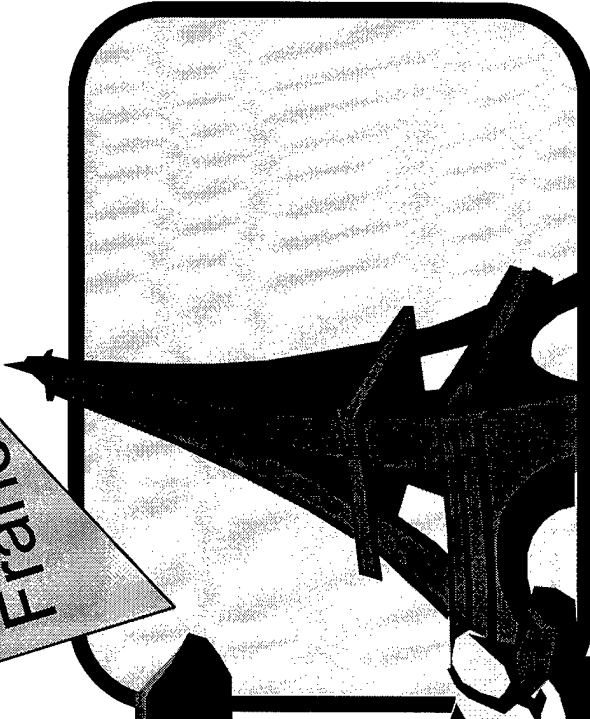

France

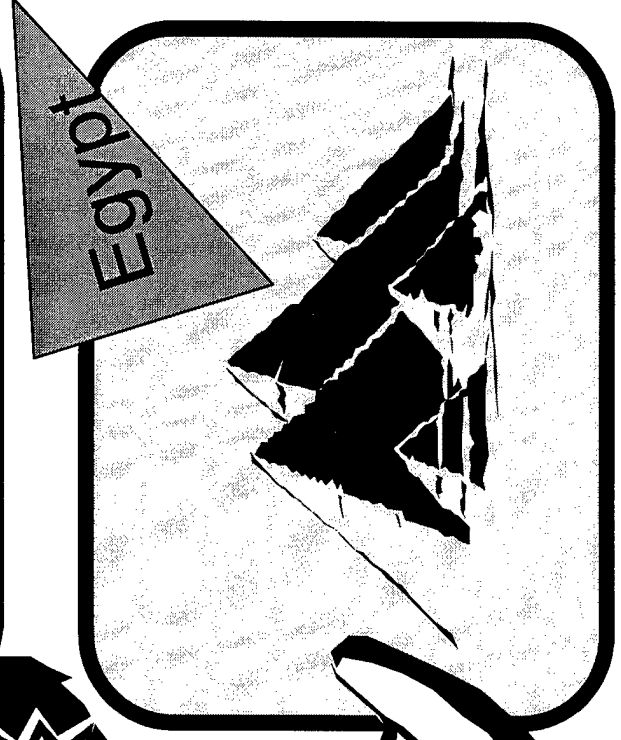
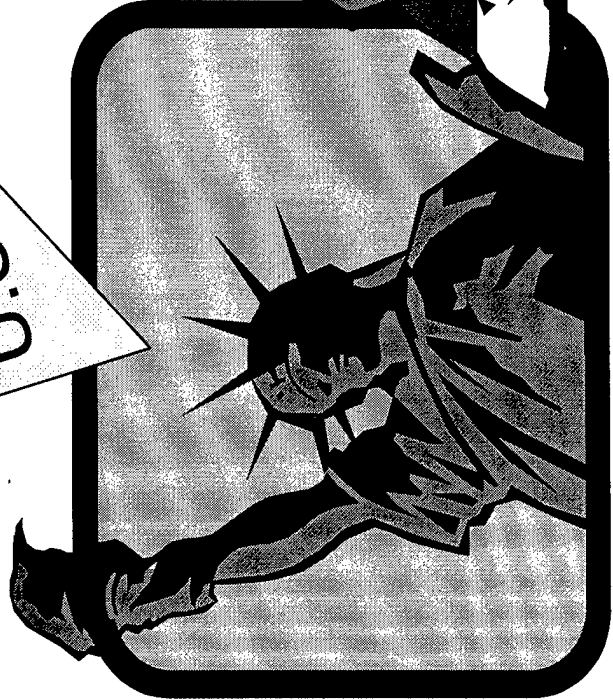

Egypt

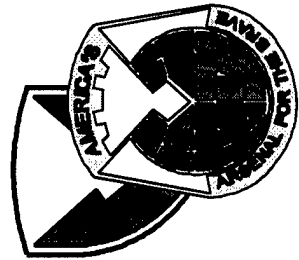

ZACOM

*Mobility and Firepower
for America's Army*

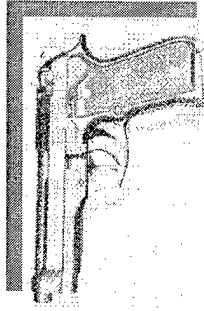
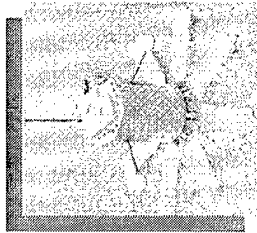
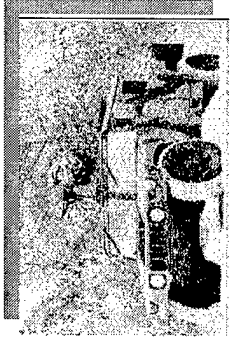
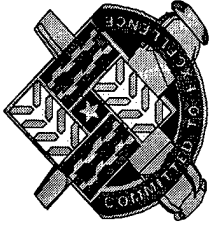

TANKS AND TRUCKS

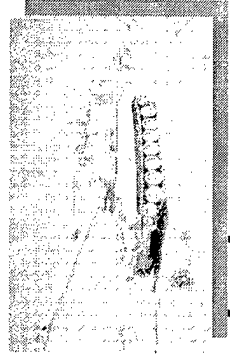
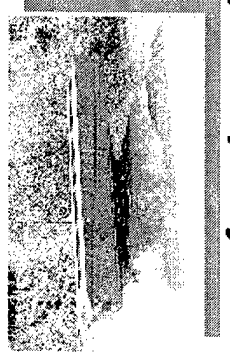
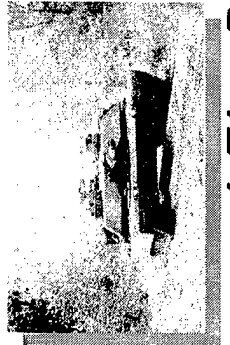
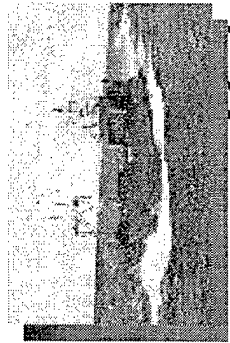
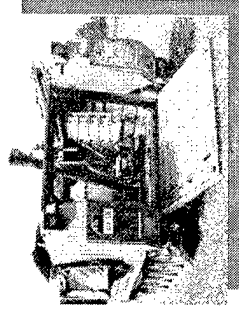

Mobility and Fire Power for America's Army

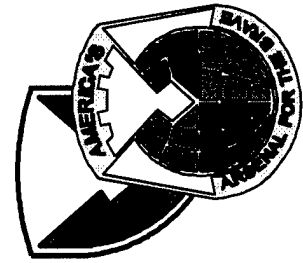

ZACOM

*Mobility and Firepower
for America's Army*

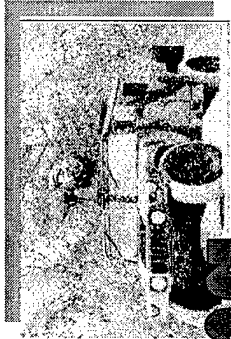
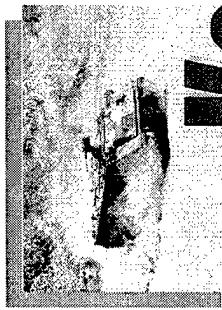
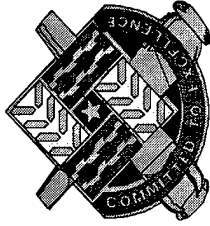

Keep On Trucking

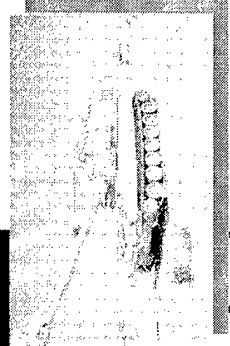
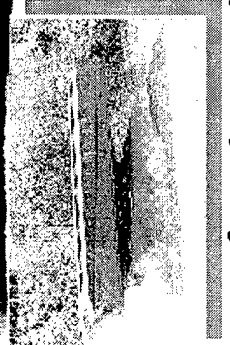
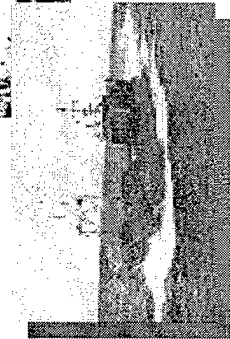
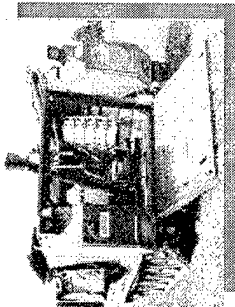
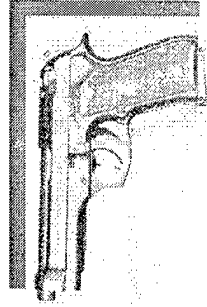
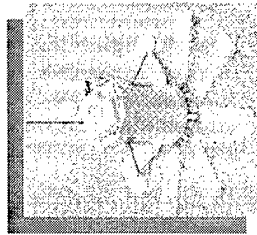

Mobility and Fire Power for America's Army

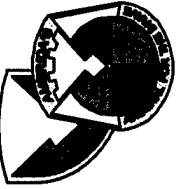

Backup Charts

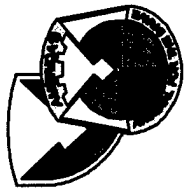

ON HAND INVENTORY

AWCF CLASS 2,4,9 BY CATEGORY



INVENTORY DOLLAR VALUE

STRAT

- ACTIVE
- ECONOMIC RET
- CONTINGENCY RET
- POTENTIAL DOD EXCESS

SSIR

- ACTIVE
- ECONOMIC RETENTION
- CONTINGENCY RETENTION
- POTENTIAL DOD EXCESS
- IN-TRANSIT

INVENTORY BY LOCATION

- ANNISTON
- SAN JOAQUIN
- ROCK ISLAND
- NEW CUMBERLAND/SUSQUEHANNA
- RED RIVER
- LETTERKENNY
- OTHERS

4000 3000 2000 1000 0 \$ 0 1000 2000 3000 4000

IN MILLIONS

O N D J F M A M J J A S

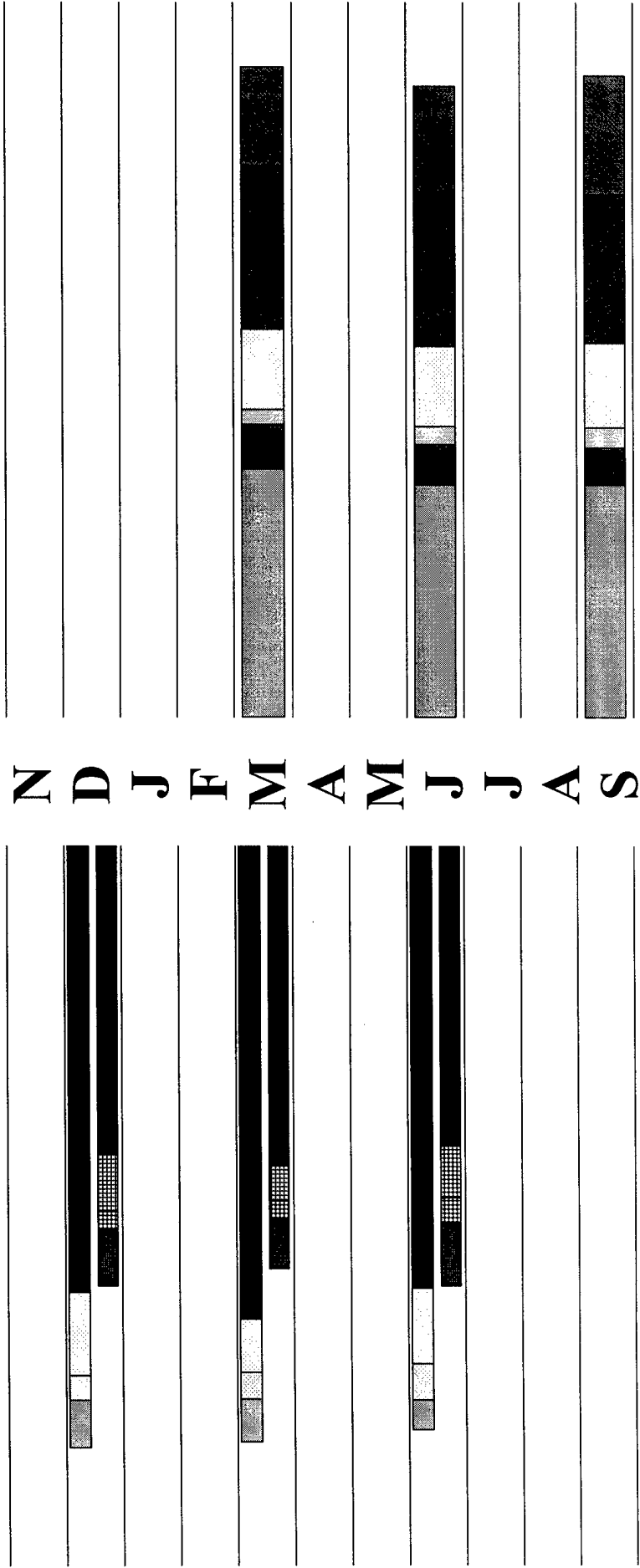

2/2/99

57/55

Committed to Excellence

305

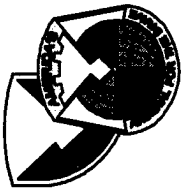

DOLLAR VALUE of STOCKED BACKORDERS vs. STOCKED BACKORDER LINES

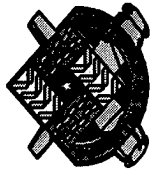

Dollar Value of backorders (thousands) Backorder Lines

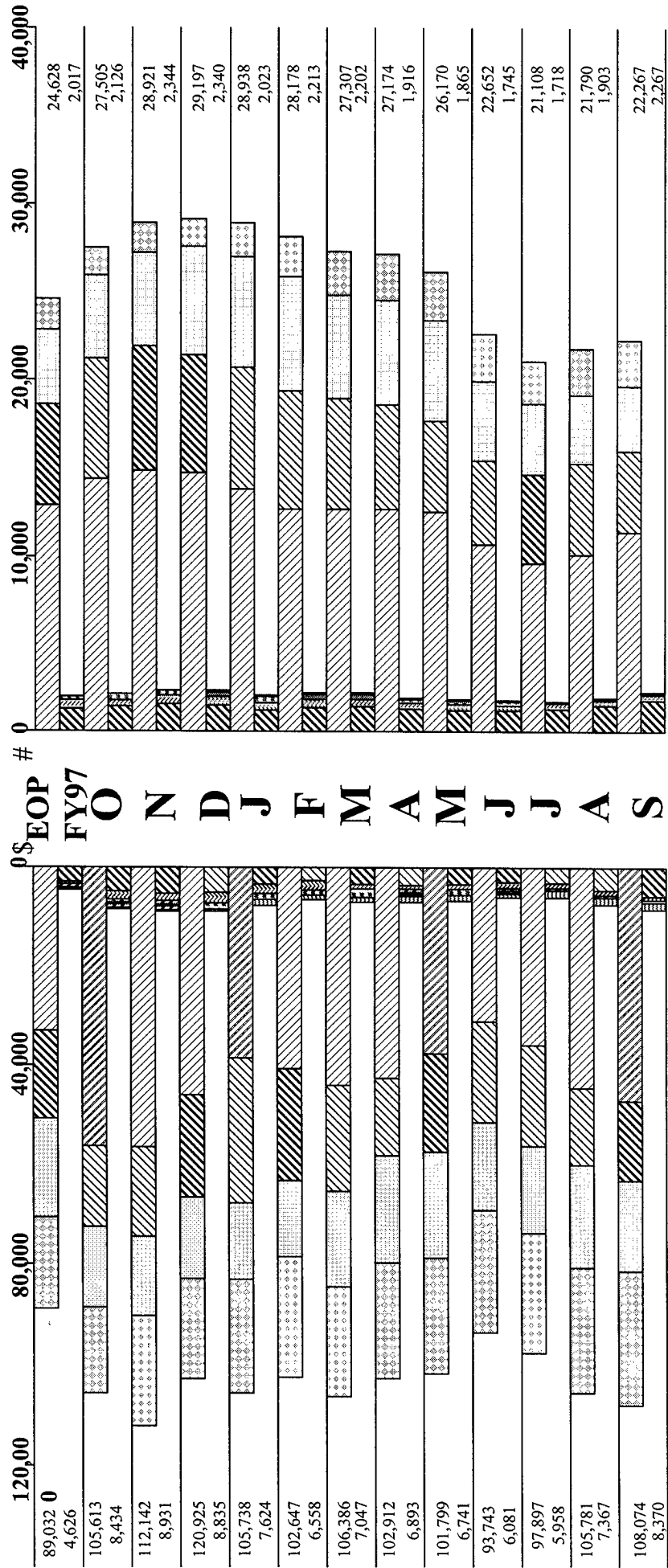
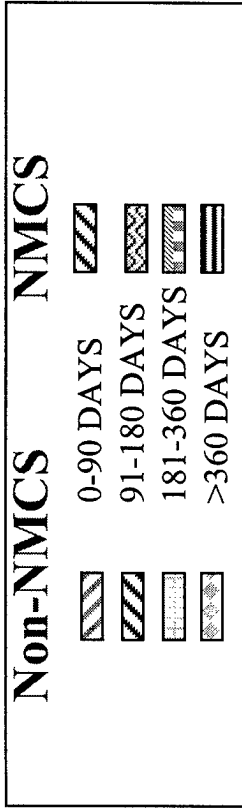

Source: MILSTEP
58/55

EOP = End of Period

2/2/99

Committed to Excellence

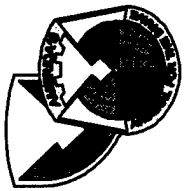

DORMANT STOCK

Supply Class 2, 4, 9

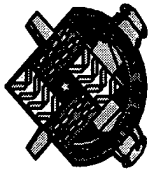

DOLLARS BY LOCATION



DOLLARS BY PLE/PRODUCT CENTER

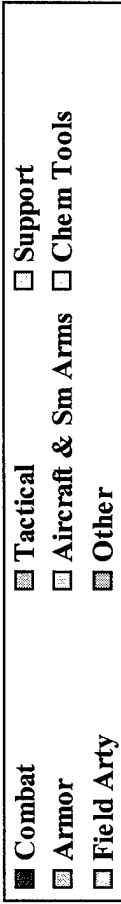

Goal 5%

Goal 5%
59/55

2/2/99

Committed to Excellence



Heavy Tactical Wheeled Vehicles Production/ESP

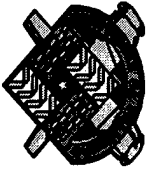

Info
Only

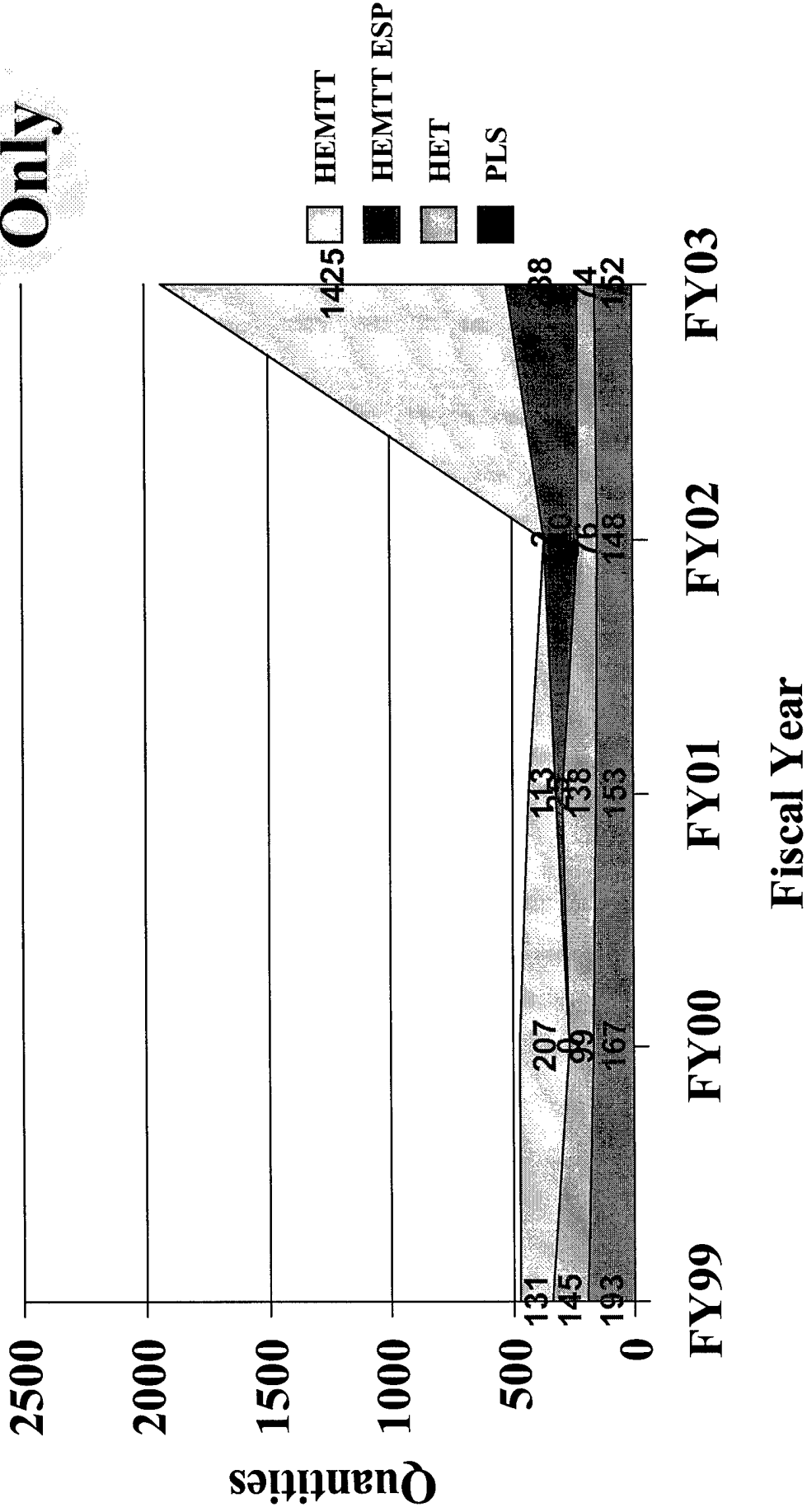

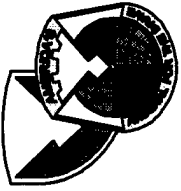

Medium Tactical Wheeled Vehicles Production/ESP



**Info
Only**

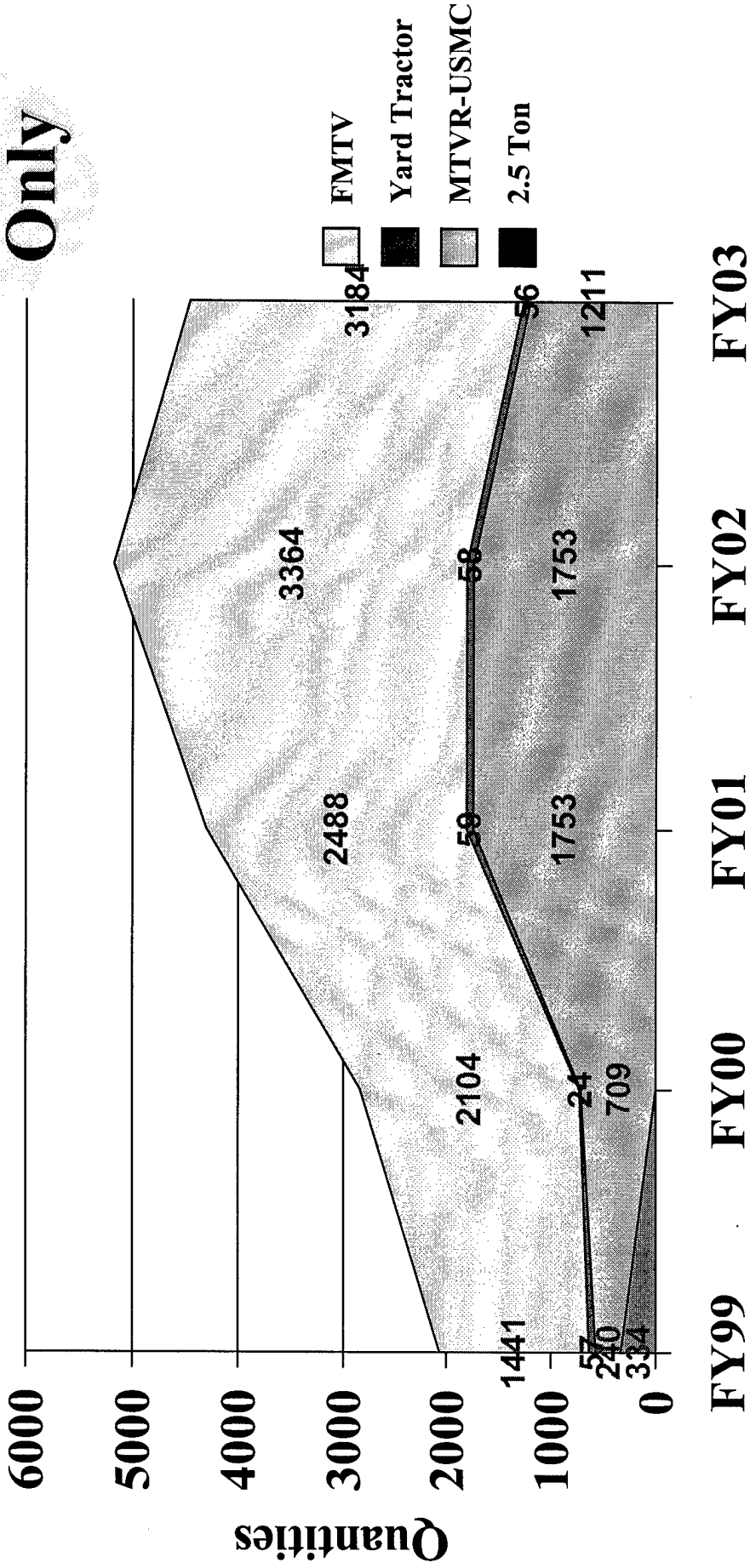

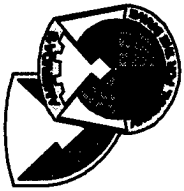

Light Tactical Wheeled Vehicles Production/ESP

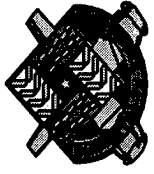

**Info
Only**

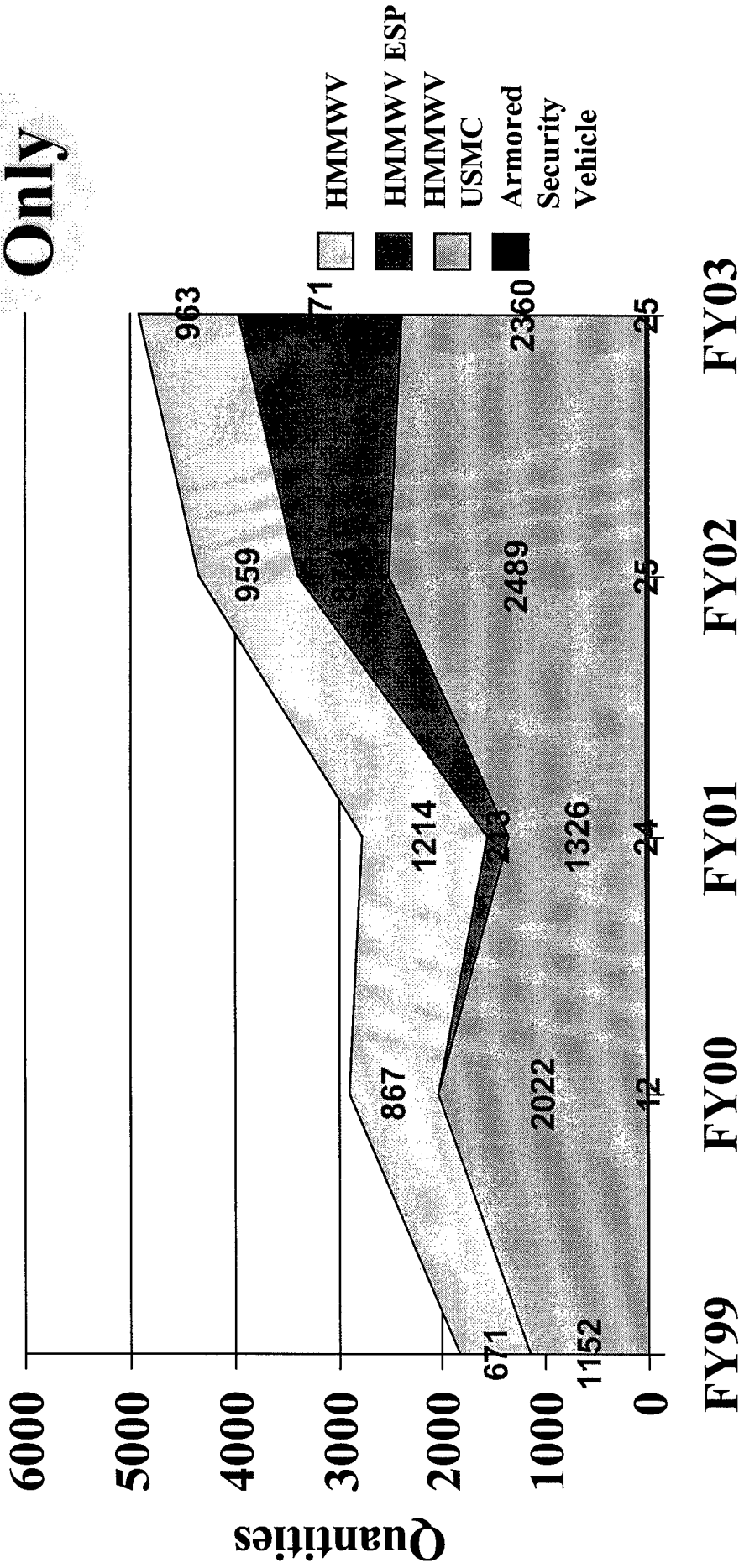

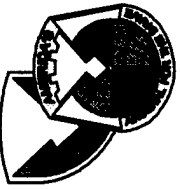

Line Haul Trucks Production/ESP



**Info
Only**

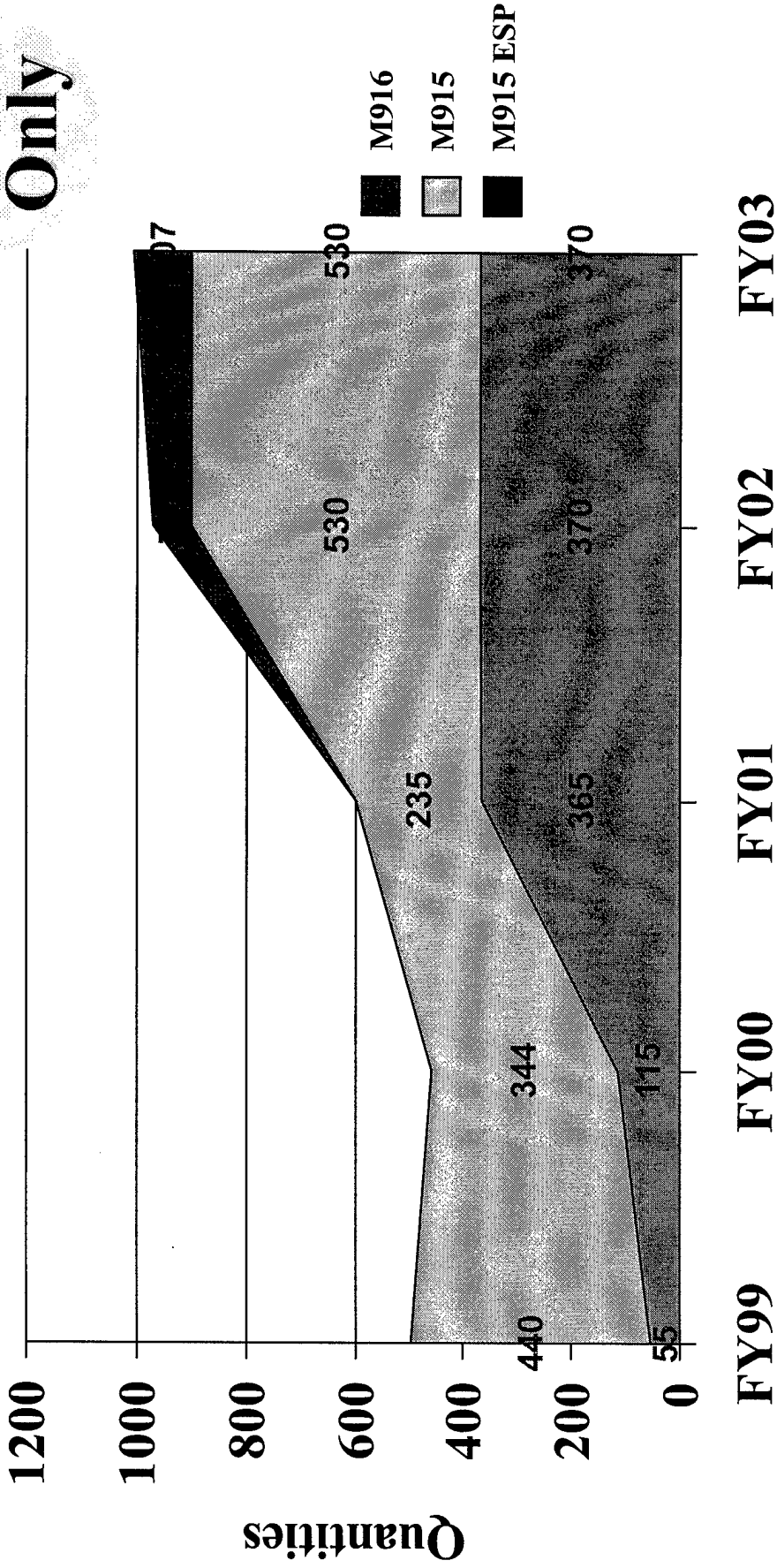

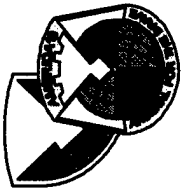

Trailers Production/ESP

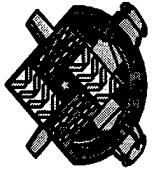

**Info
Only**

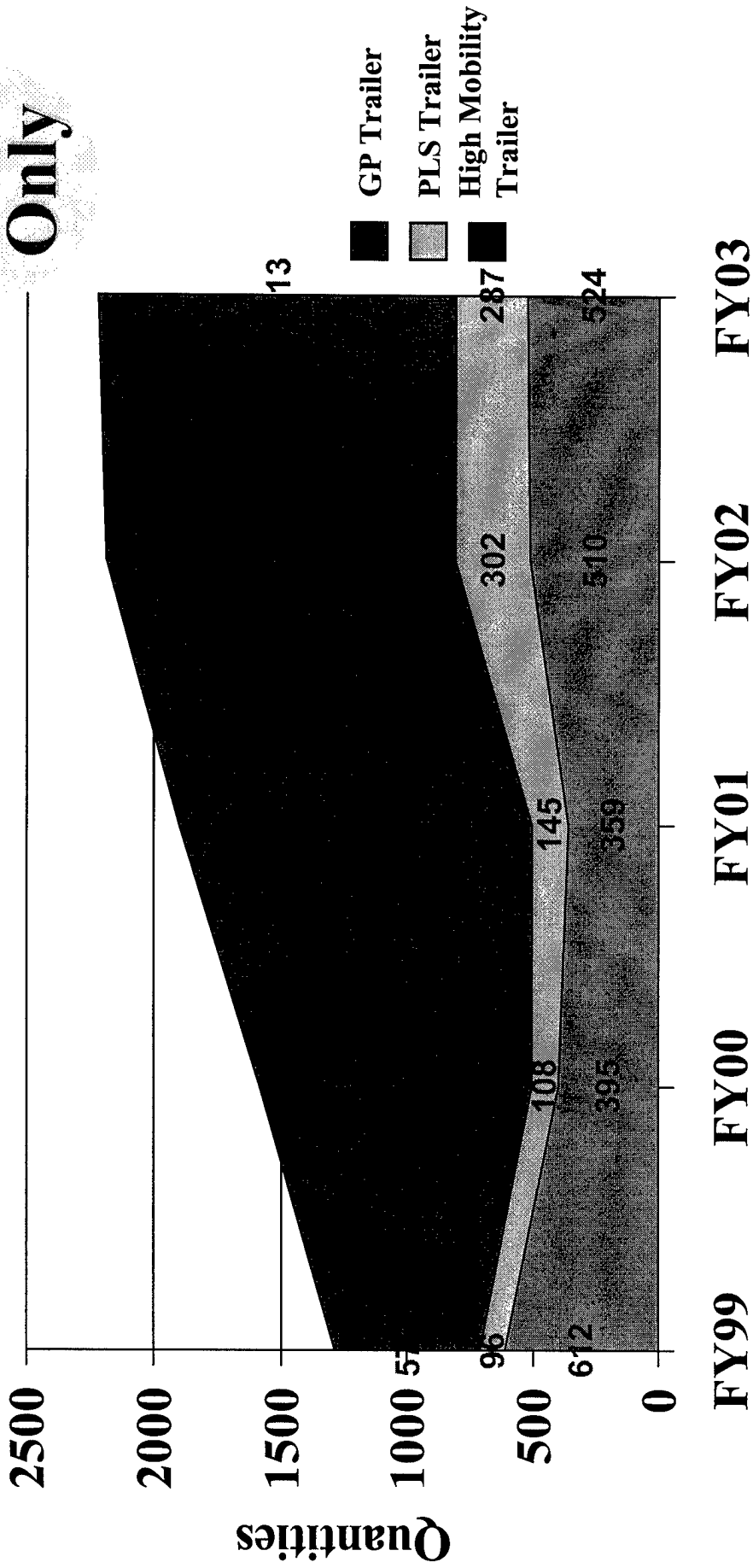

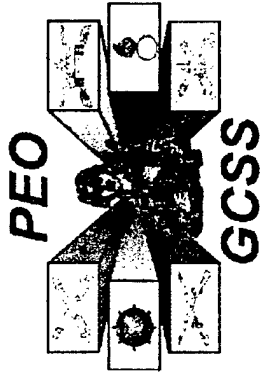

TACOM / PEO-GCSS TWV PROGRAMS / ACTIVITY

NDIA TWV Conference
Monterey, California
2 February 1999





TACOM / PEO-GCSS

Speakers

Mr. Jerry Chapin - Director, TARDEC

Mr. Dan Mehney - Director, TACOM Acquisition Center

Mr. Al Puzzuoli - Deputy, PEO-GCSS

**COL(P) John Urias - Deputy, Systems Acquisition
(Deputy for Life Cycle Mgt.)**

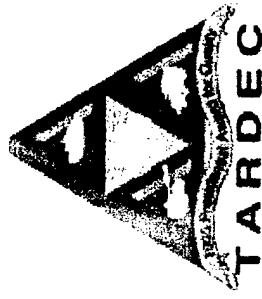
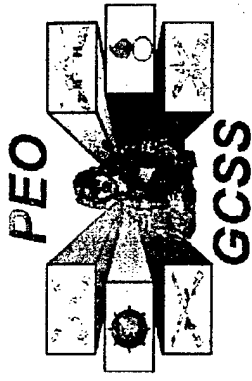
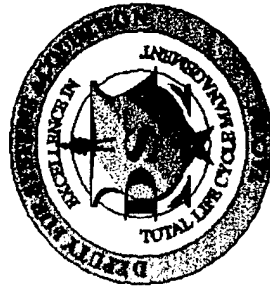

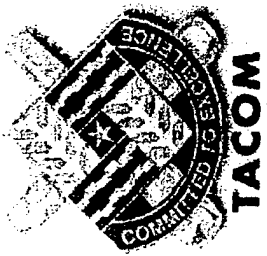

TACOM / PEO-GCSS Topics

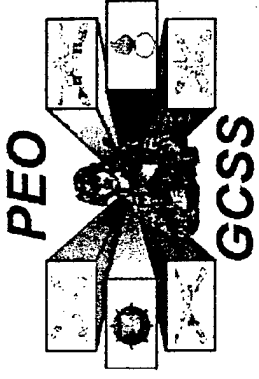

Organizations and Responsibilities

Procurement and Production

Sustainment

Emerging Systems and Technologies

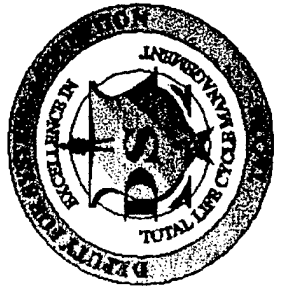

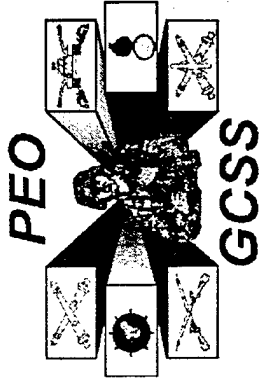

Organization & Responsibilities

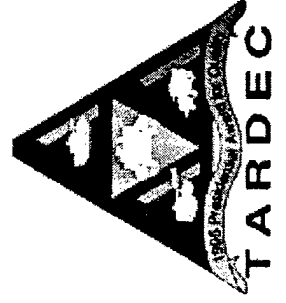
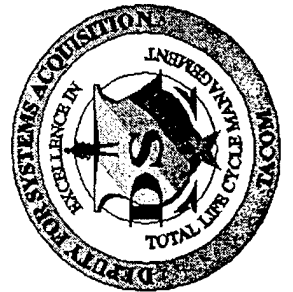

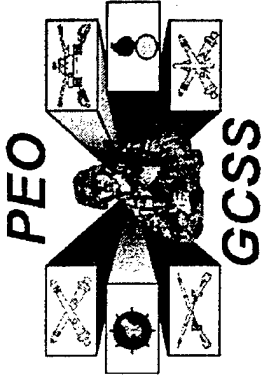

Procurement & Production

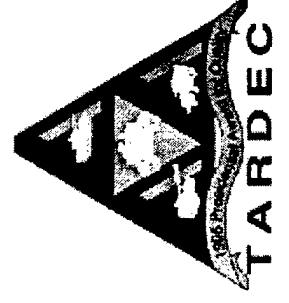
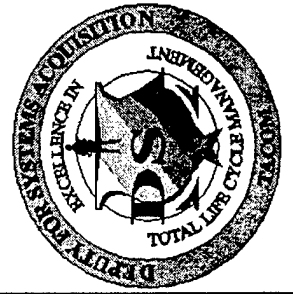

Sustainment

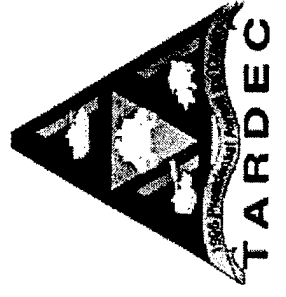
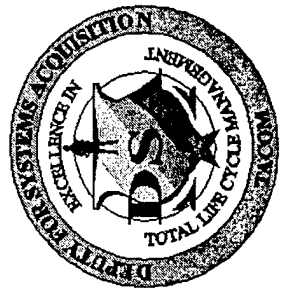
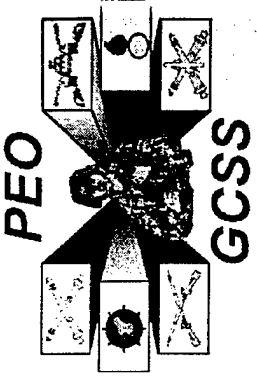

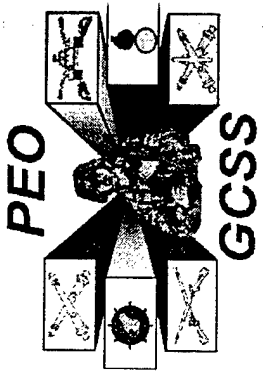

Emerging Systems & Technologies

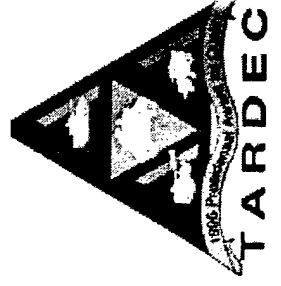
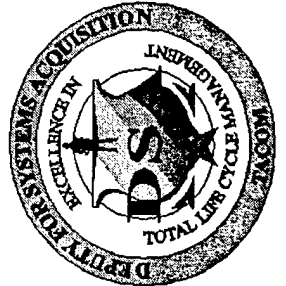

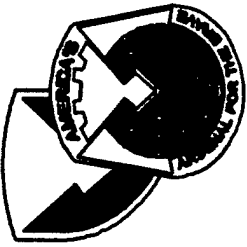

ZACOM
*Mobility and Firepower
for America's Army*

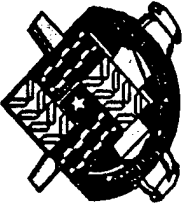

1999 Tactical Wheeled Vehicle Conference

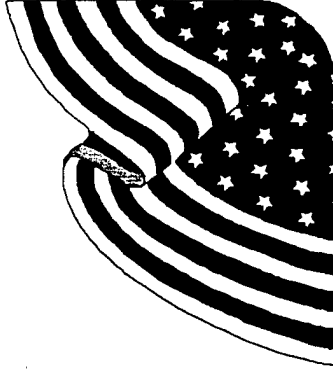

1-2 February 1999

Jerry L. Chapin
Director
**Tank Automotive Research,
Development and Engineering Center**

Tank-automotive & Armaments COMMAND

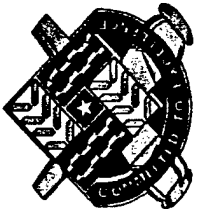

TARDEC's Organization

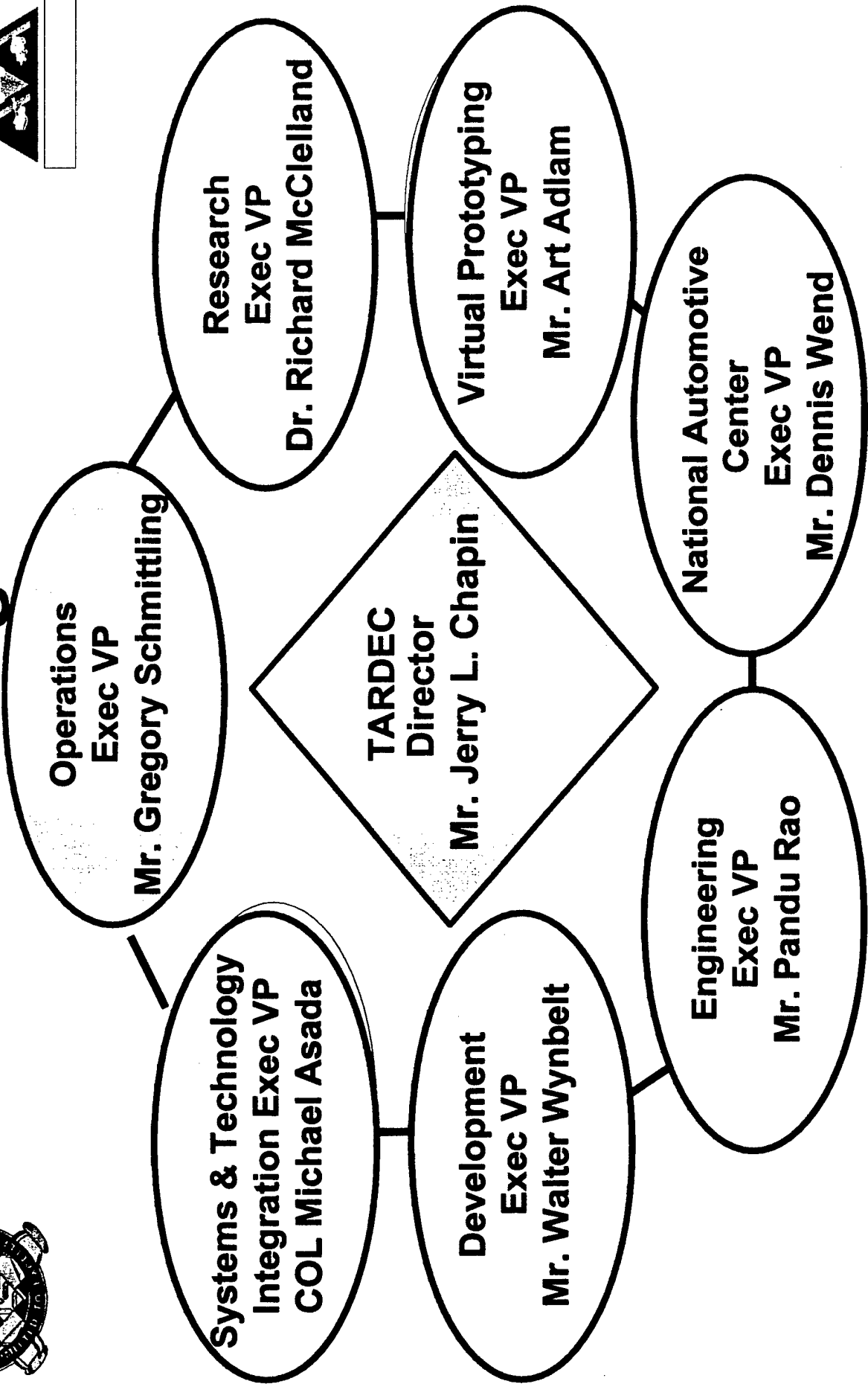
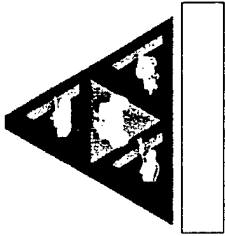

Committed to Excellence

TARDEC's Mission

- Ground Combat Systems
- Combat Support Systems
- Combat Service Support Systems



T E C H N O L O G Y
D U A L - U S E

R E S E A R C H

D E V E L O P M E N T

E N G I N E E R I N G

Committed to Excellence

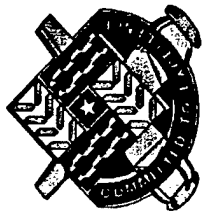

System's Integration

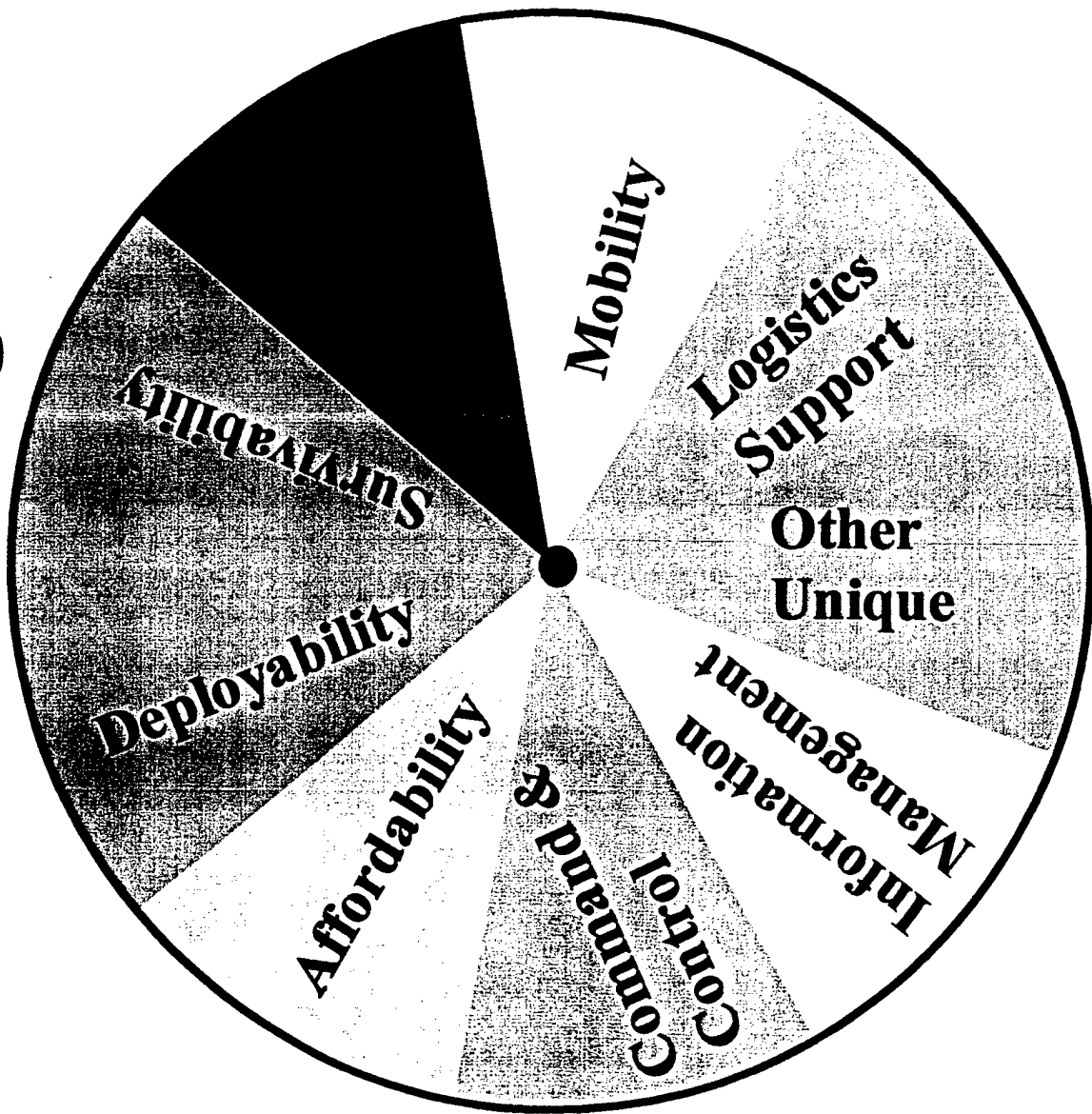
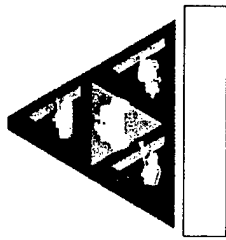

Committed to Excellence

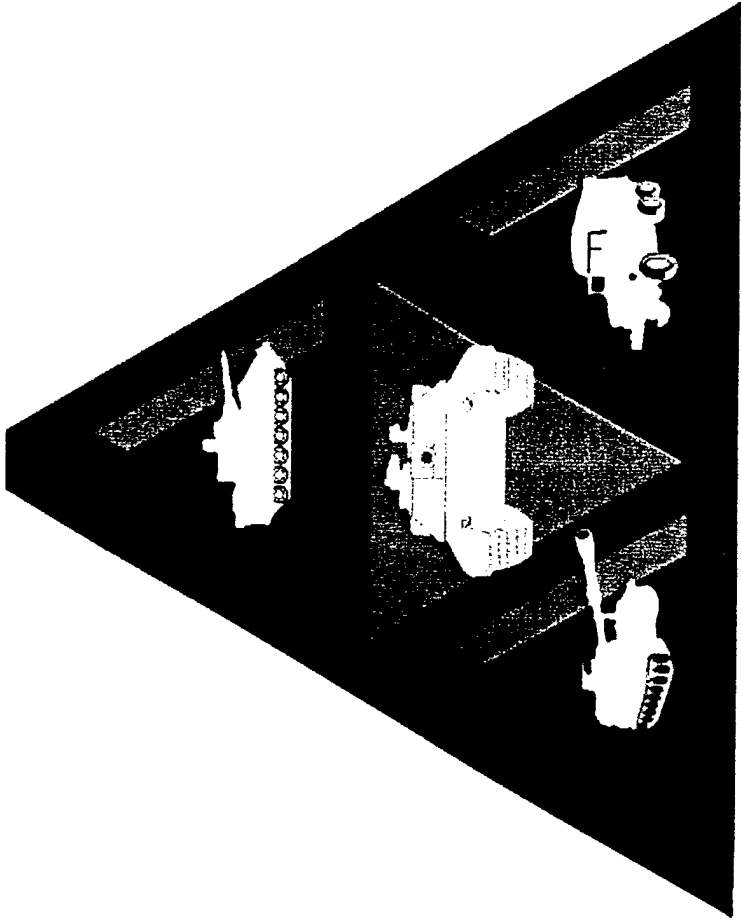
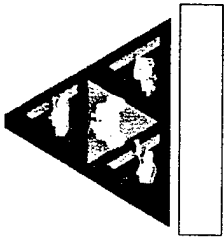
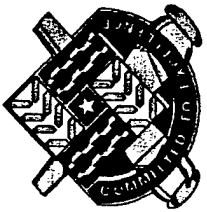

T A R D E C

**Operation and Support Cost Reduction
(OSCR)**

Committed to Excellence



TACOM's SMA-OSCR

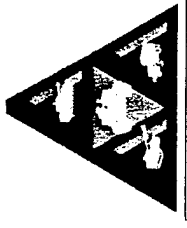

Project/Funding Summary

- 36 Initiatives funded with \$5.7M investment (FY96-99)

- 2 Approved projects waiting for funding (\$0.9M)



Committed to Excellence

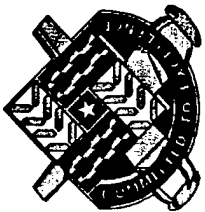

TACOM OSCR PROGRAM

INVESTMENT vs. SAVINGS

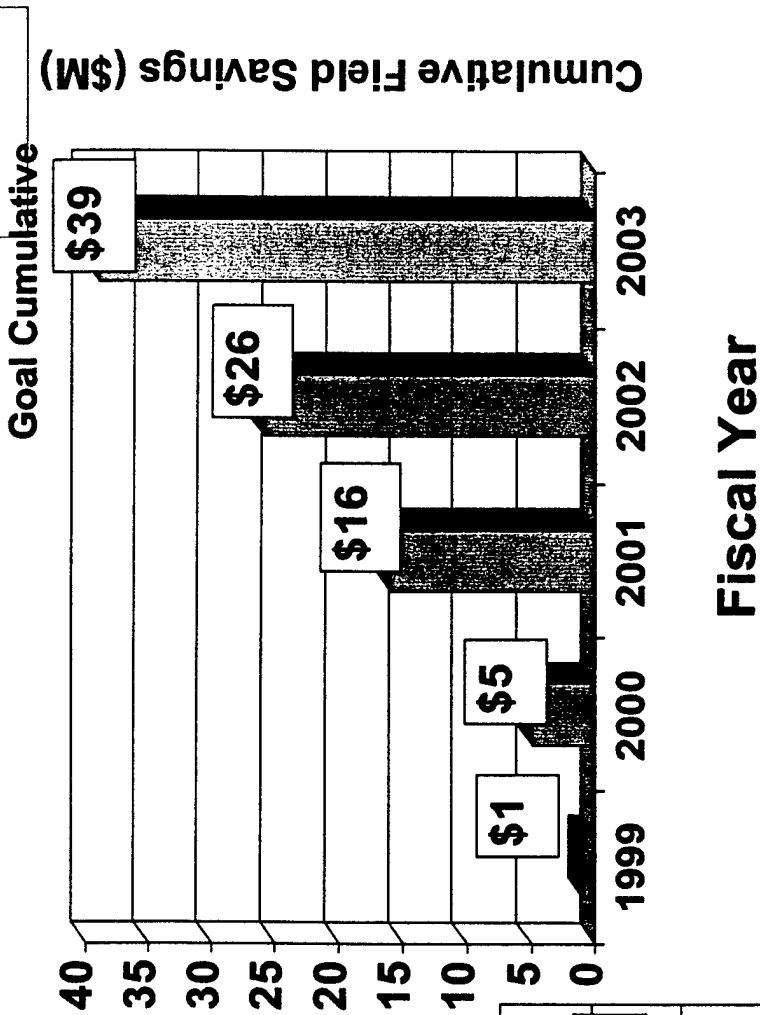
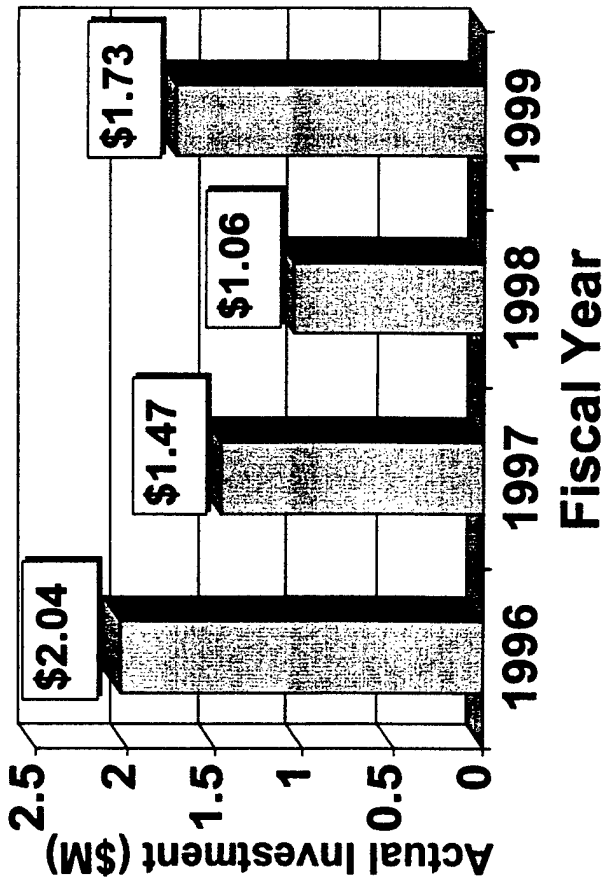
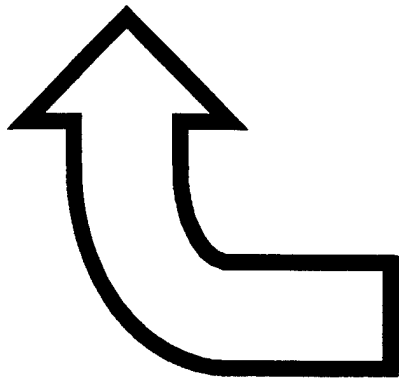

Committed to Excellence

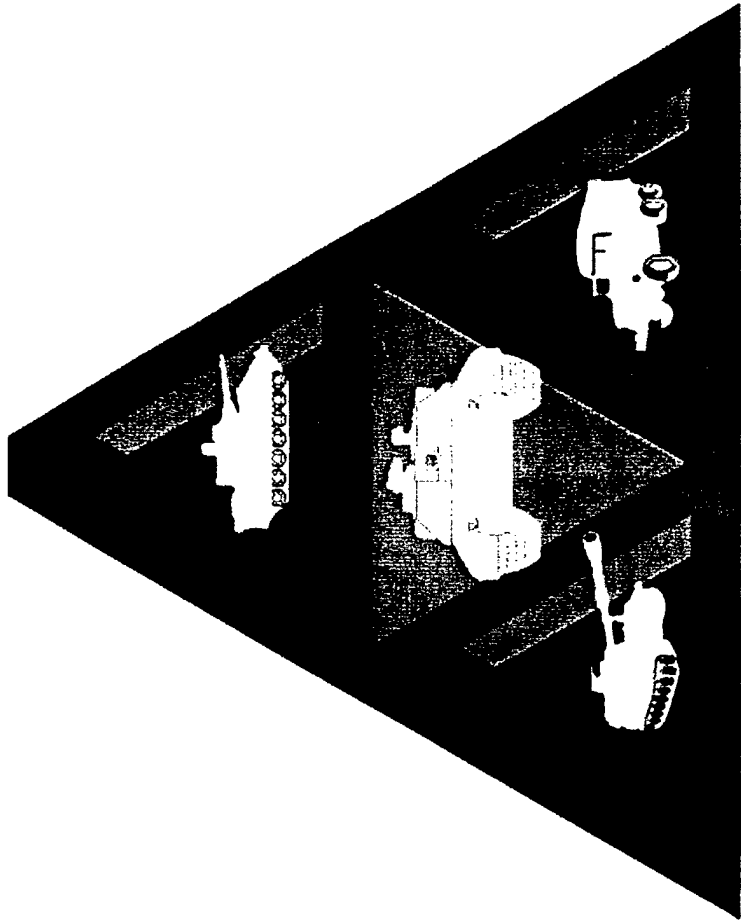
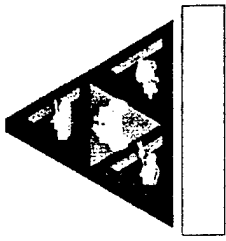
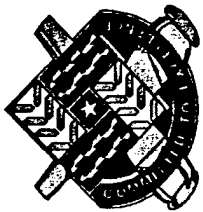

T A R D E C

Batteries

Committed to Excellence



Vehicle Battery Consumption

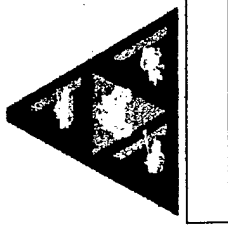

**FY 96-98
Cumulative Savings
\$5.6M**



Units

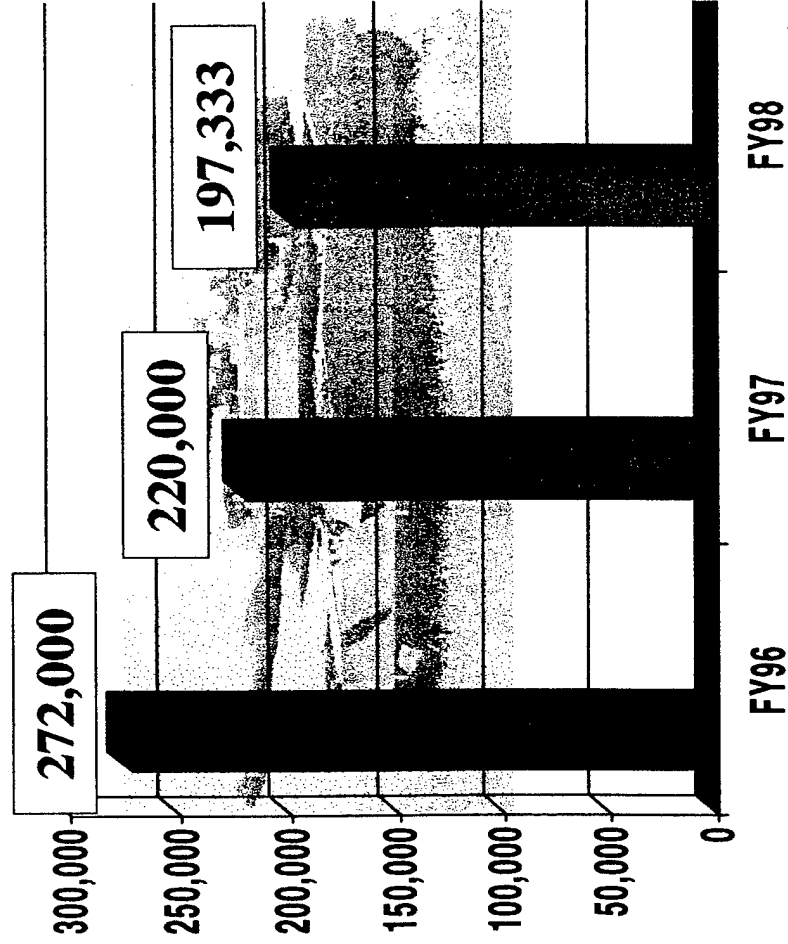
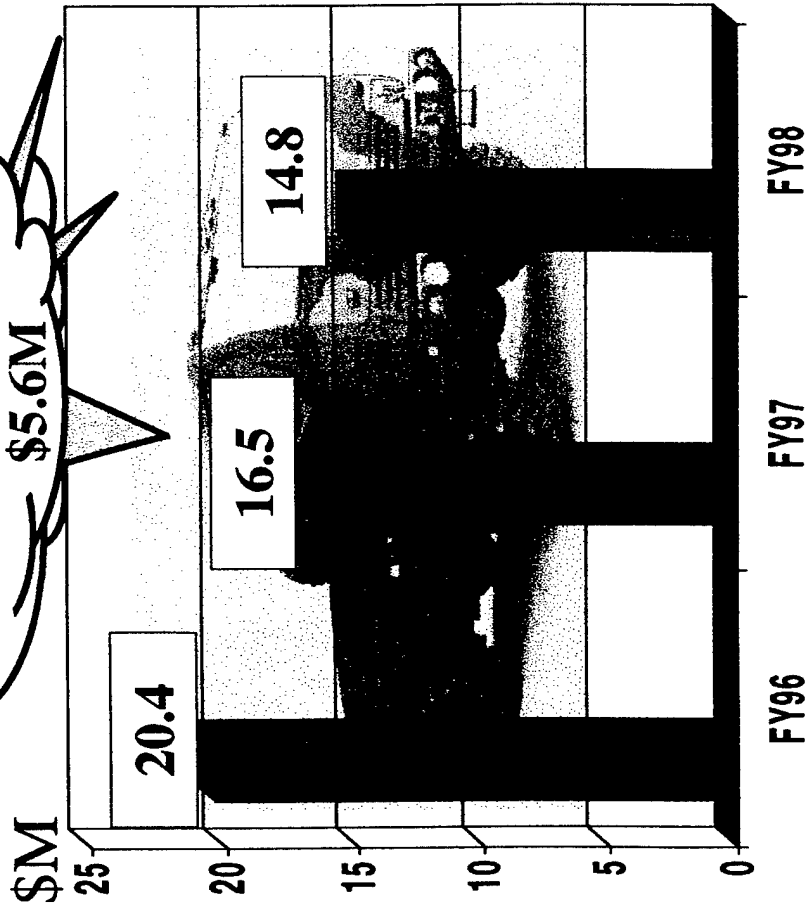

Committed to Excellence

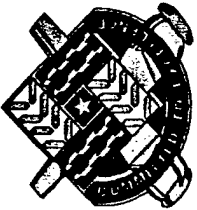

Vehicle Battery Consumption (\$M)

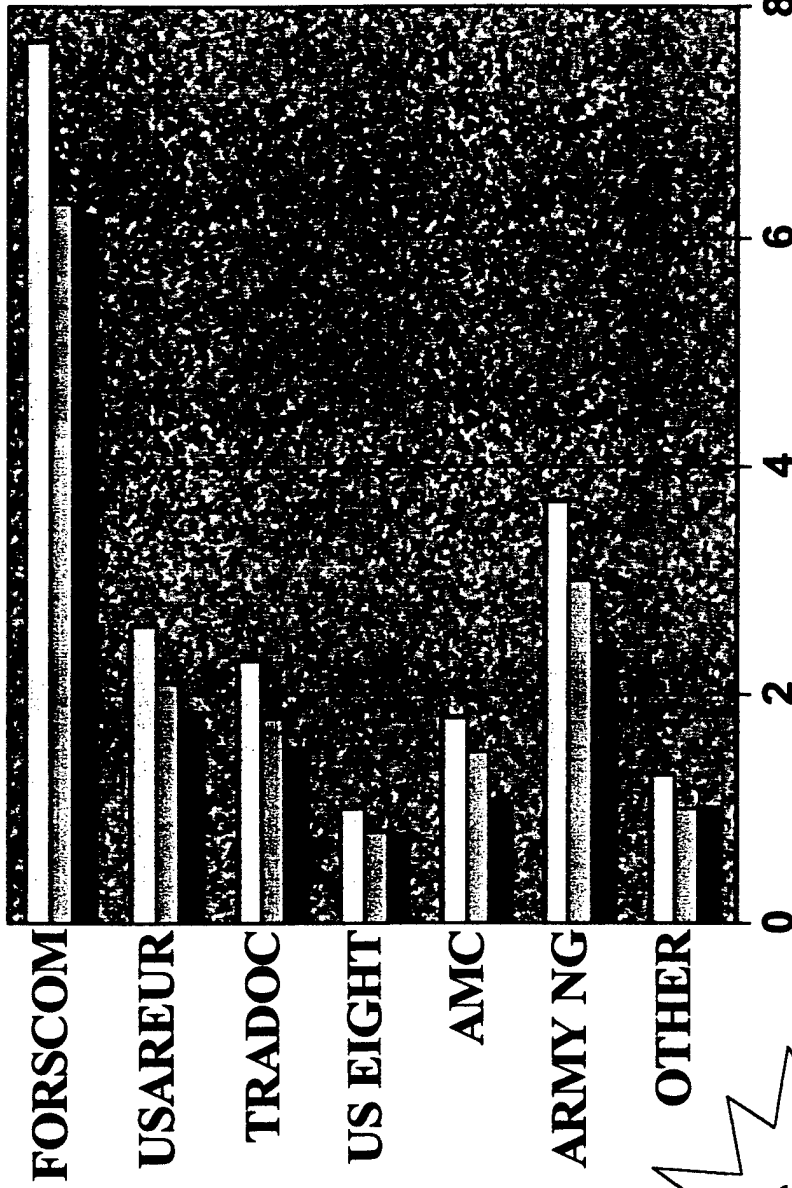
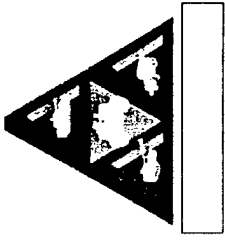

FY 97
\$16.5M

■ FY 98
 ▒ FY 97
 □ FY 96

FY 96
\$20.4M

FY 98
\$14.8M

Cumulative Cost Avoidance \$5.6M

Committed to Excellence

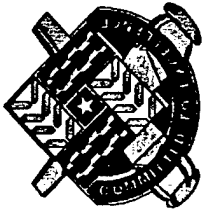

TACOM's Battery Management Program

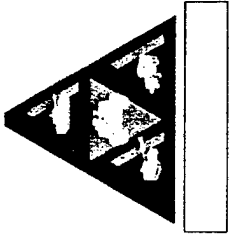

- Awareness
 - Maintenance
 - Equipment
 - Recovery
- Advanced Technology
 - Current
 - Solar Panels
 - Maintenance Free Batteries
 - Battery Maintainers/Chargers
 - Future
 - Smart Batteries
 - Ultra Capacitors
 - Advanced Battery Design
 - Fuel Cells



Committed to Excellence

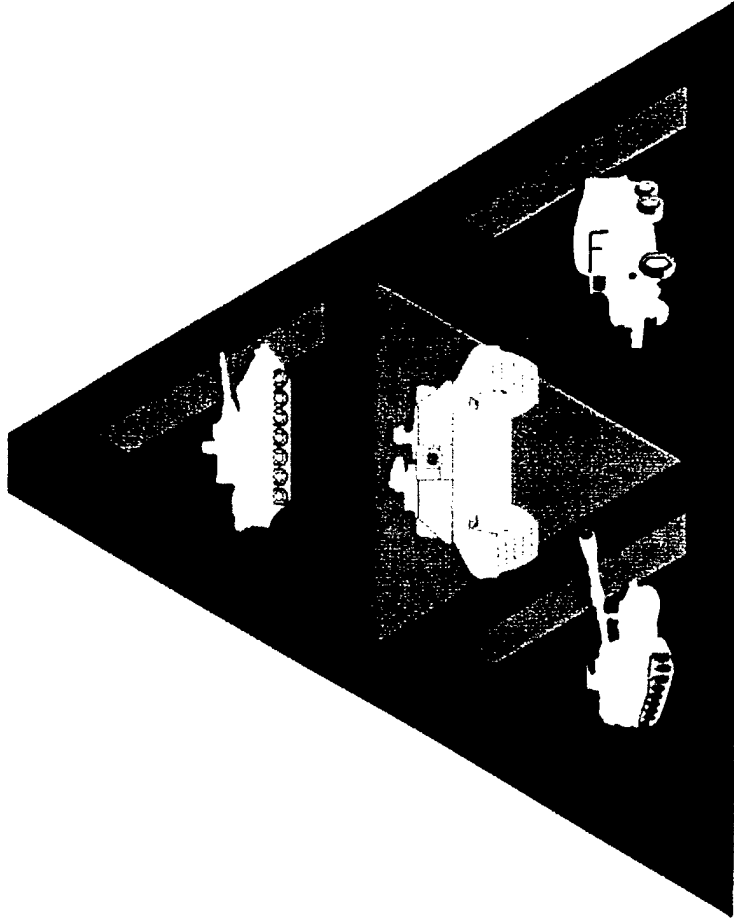
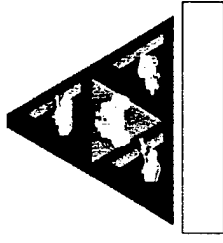
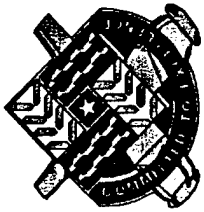

T A R D E C

Waste Oil Reutilization

Committed to Excellence



Waste Engine Oil Reutilization

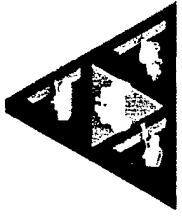

- **Need:** Reduce military costs associated with used/waste oil.
- **Objective:** Develop environmentally friendly, low cost used engine oil disposal system that recovers used oil energy for vehicle use (with savings of one gallon of used oil recovered equals one gallon of JP-8 saved).
- **Concept:** Blend proportioned amounts of used vehicle crankcase oil and JP-8 fuel at regular oil change intervals, returning mixture to vehicle fuel tank.

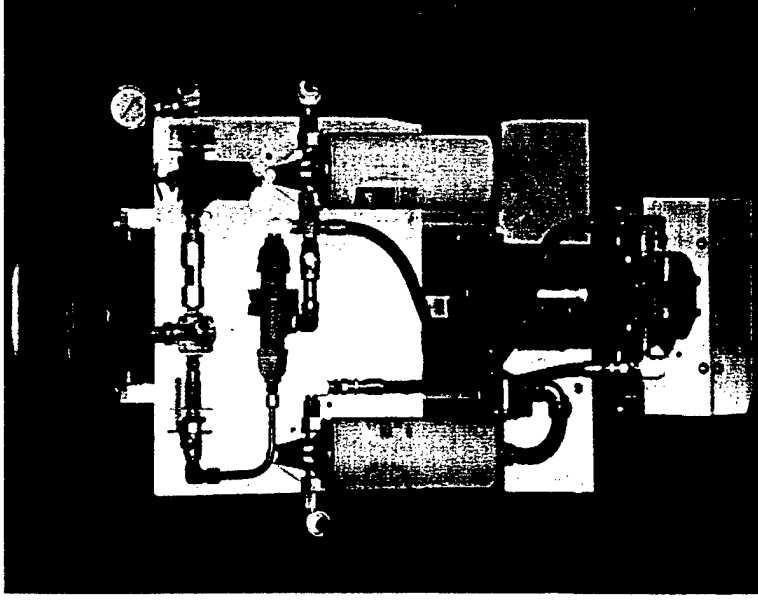

- **Technology:** Filtration/blending system
- **Key Points:**
 - Will meet EPA emission standards.
 - No degradation of vehicle components or performance.

Committed to Excellence

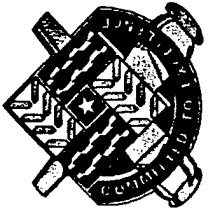

Waste Engine Oil Reutilization

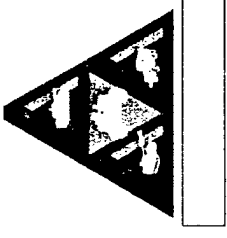

- **Test Results:**

- Emissions test results at Southwest Research Institute fell below EPA ceilings on HMMWV and DD series 60 engines.
- Durability test results at TARDEC Fuels and Lubricants Research Facility showed little or no performance degradation in 6.2L and 6V53T engines.
- 6 month field demo at National Training Center, Ft Irwin, CA completed without any degradation of vehicle performance

- **Current Status:**

- Two (2) Blenders are being provided to each of the following: National Training Center (NTC) - Fort Irwin; CA, Fort Polk, LA and; Fort Lewis, WA.
- Blenders are to be provided to the Soldiers/Users for evaluation and feedback.

Committed to Excellence

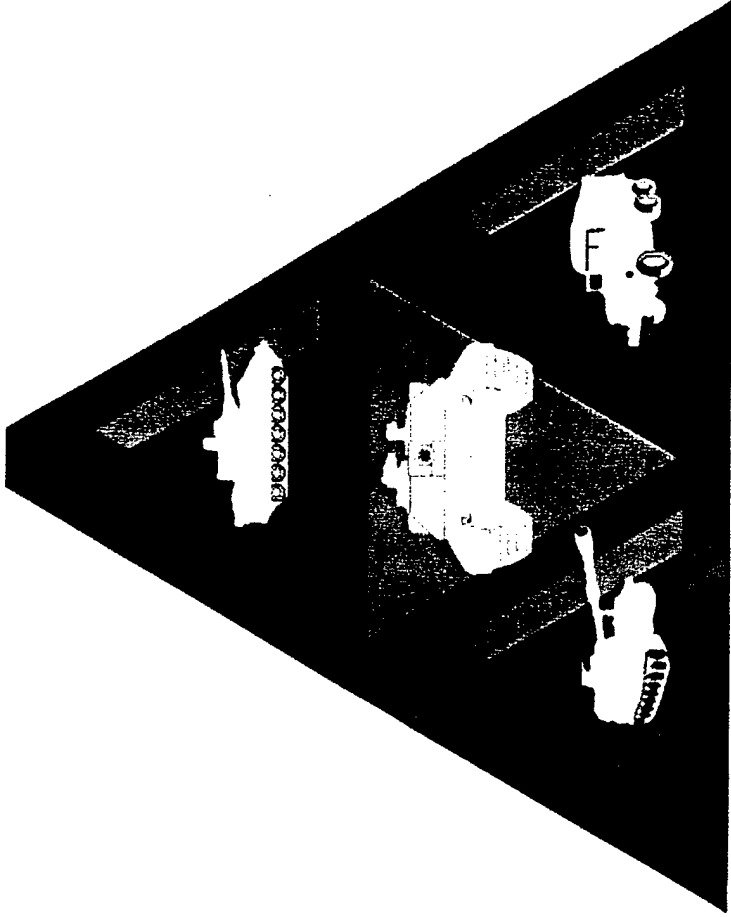
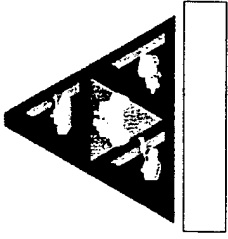
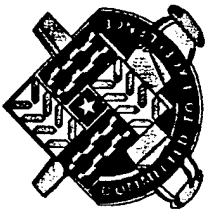

T A R D E C

21st Century Truck

Committed to Excellence

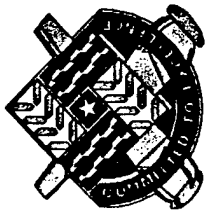

21st Century Truck Initiative Government/Industry Partnership

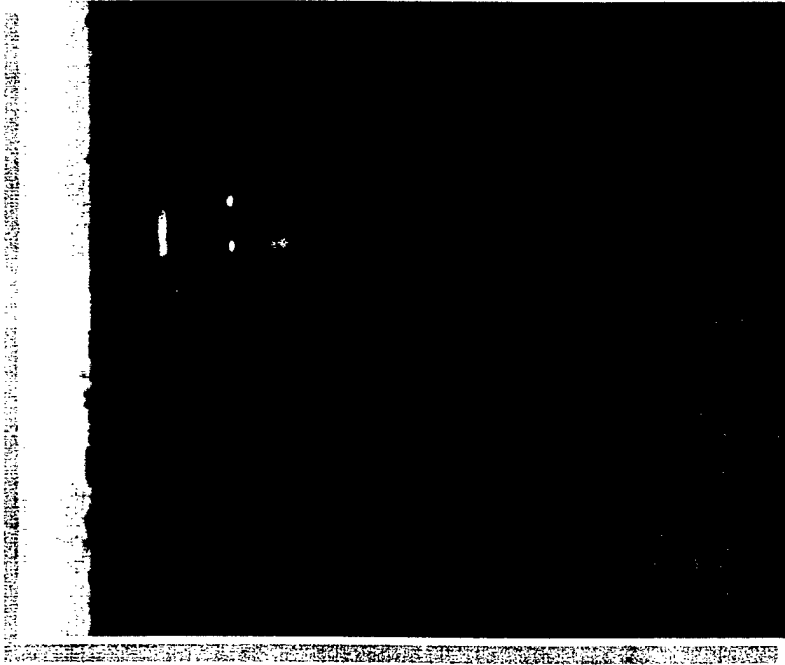
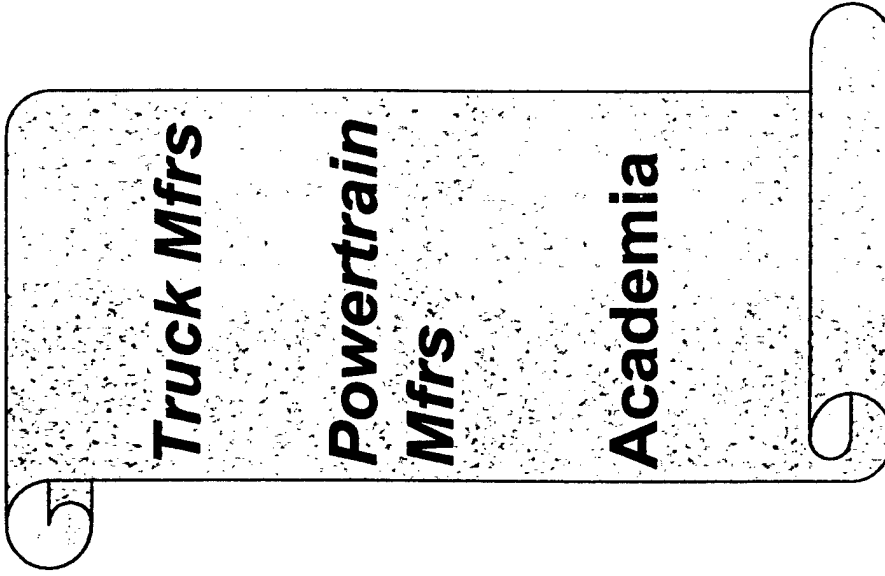
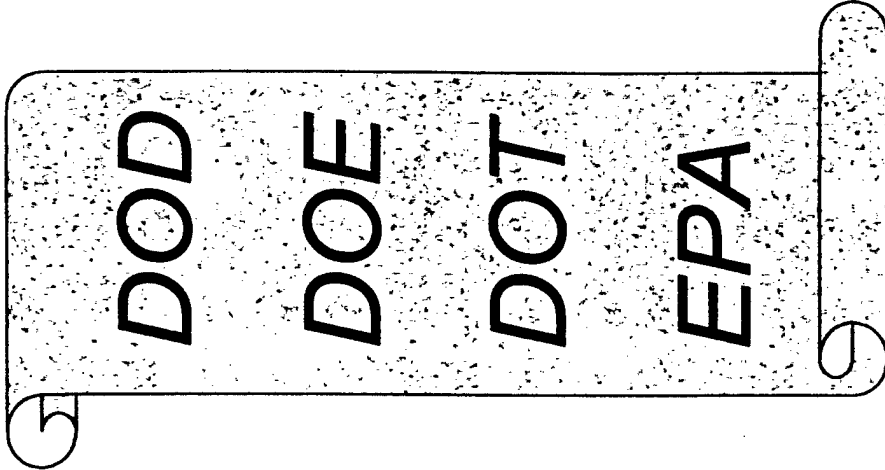
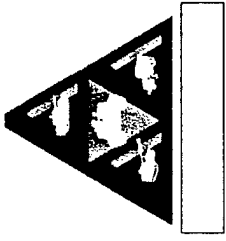

Committed to Excellence



21st Century Truck Initiative Trucks are Vital to the Army

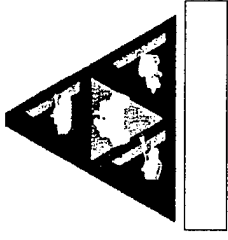

and to the Country

Trucks Provide the Logistical Backbone to the Army

Trucks Account for Over 75% of the Nation's Freight Business

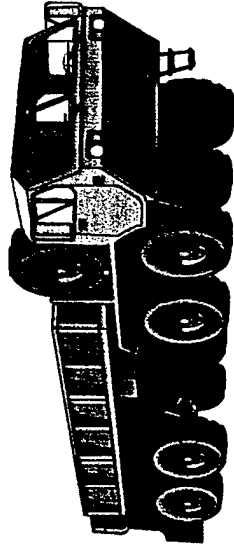

Fuel constitutes 70% of bulk tonnage needed to sustain a military force on the battlefield. This equates to about 600,000 gallons per day.
-Fuel Efficient AAN Task Force

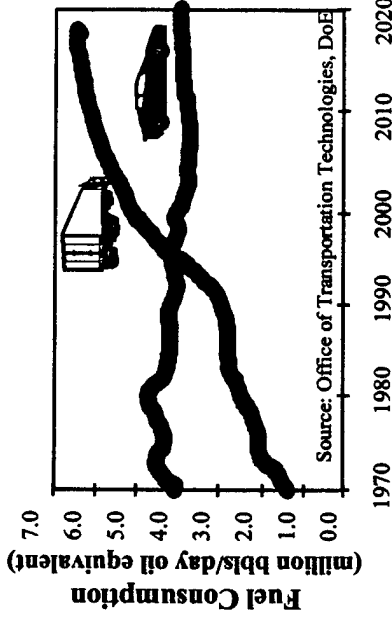

Light, Medium, and Heavy Trucks burn more fuel than cars

Army After Next Goal:

“...75% Reduction in Fuel Requirements for a Deployed Force...”

Committed to Excellence



21st Century Truck Initiative Goals

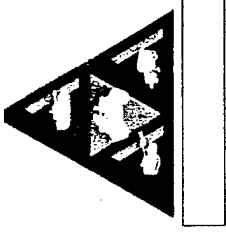

- **Economic “leap-ahead” vehicle**
 - Increase fuel efficiency
 - Reduce cost of operation
 - Increase power generation performance



- **Environmentally friendly vehicle**
 - Reduce emissions
 - Reduce damage to infrastructure

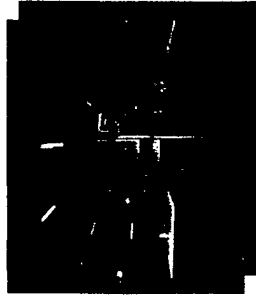

- **“Smart” truck for safety and security**
 - Integrate new Vetronics and data bus technology
 - Develop user friendly information and navigation to increase driver awareness/alertness

Committed to Excellence



21st Century Truck Initiative

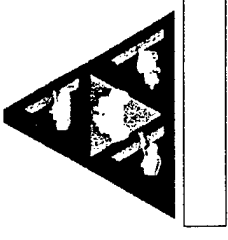

NAC Programs

- **Optimized Motor and Motor Controller (*ISE Research*)**
- **Soft - Switching Inverter (*General Motors*)**
- **Parallel Hybrid Electric Class 8 Linehaul Tractor (*Radian*)**
- **Series Hybrid Electric FMTV (*Lockheed Martin Control Systems*)**
- **Diesel Reformer Fuel Cell Hybrid (*Sunline Services Group*)**

Other Initiatives

- **Hybrid Electric HMMWV (*PEI*)**
- **Hybrid Electric M113 (*UDLP*)**
- **Hybrid Electric BFVS (*UDLP*)**

Committed to Excellence

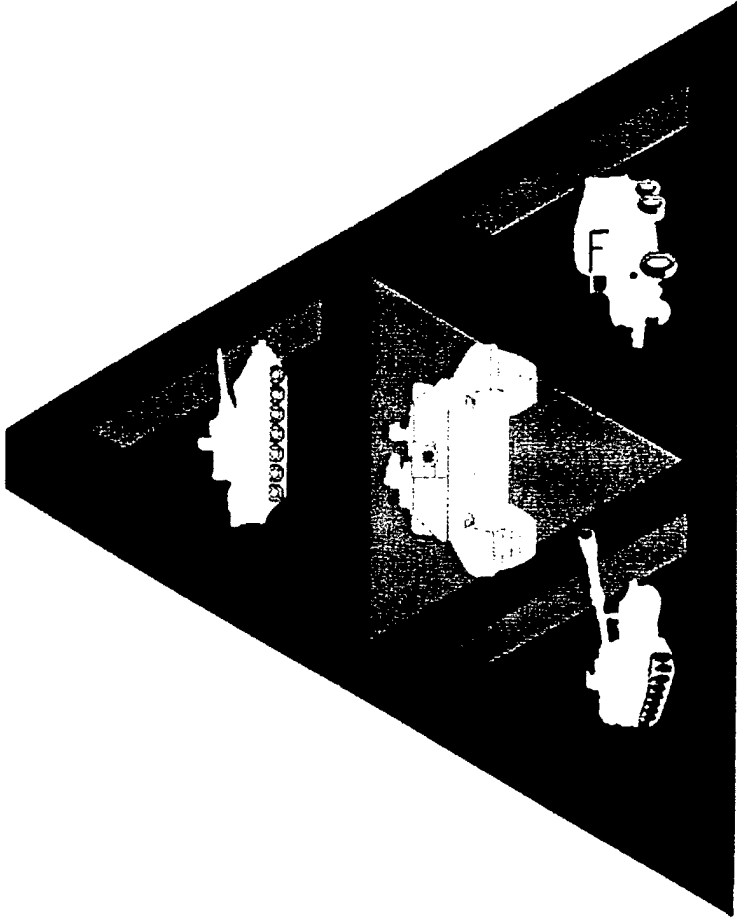
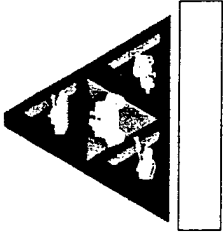
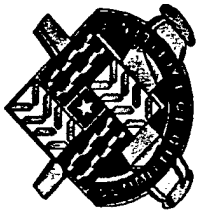

T A R D E C

**Commercially Based Tactical Truck
(COMBATT)**

Committed to Excellence



Commercially Based Tactical Truck (COMBATT)

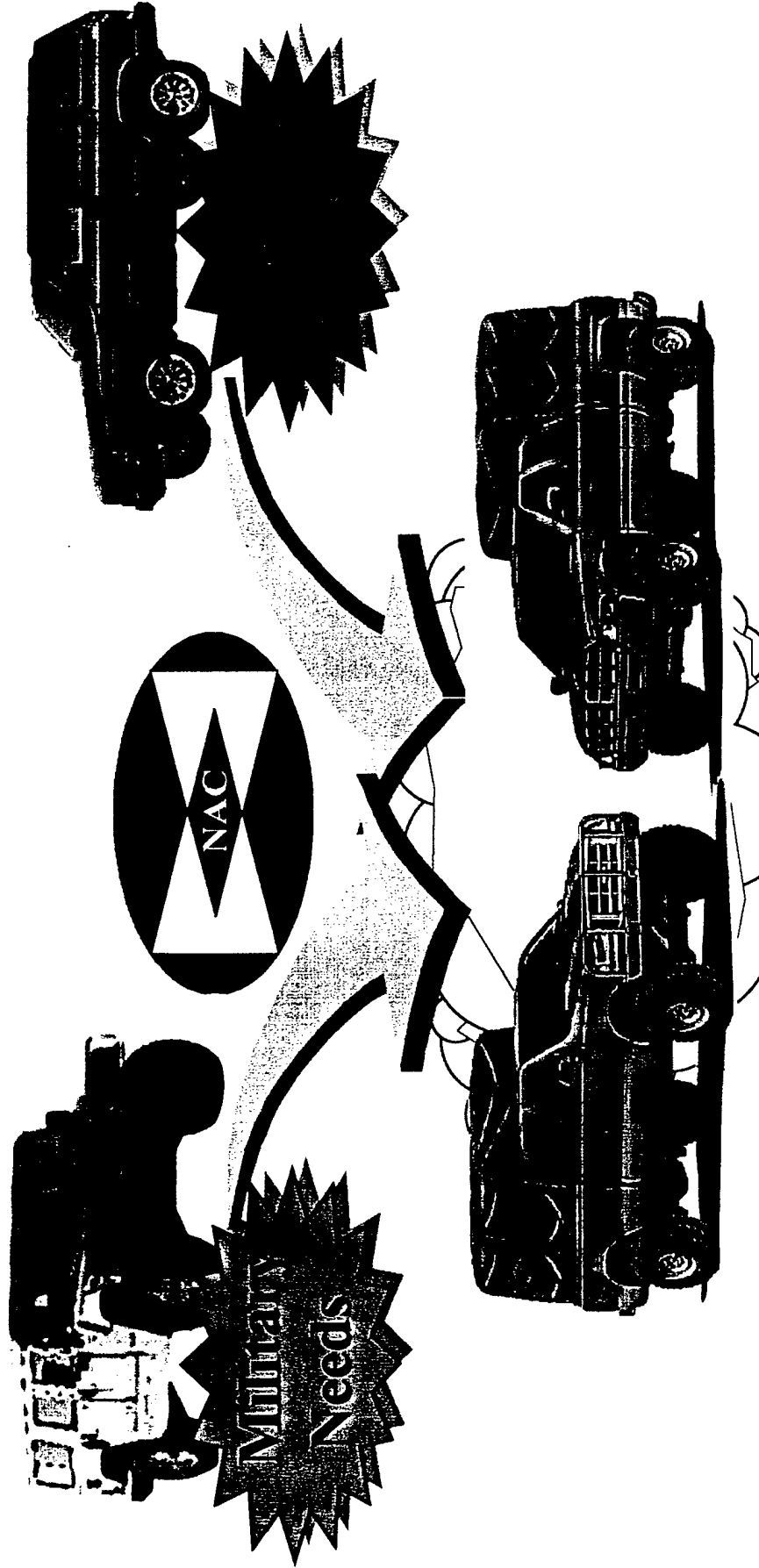
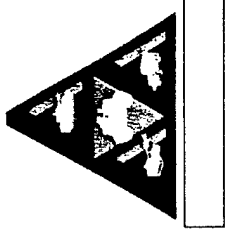

HMMWV Requirements for the 21st Century

Committed to Excellence



Two Part Program

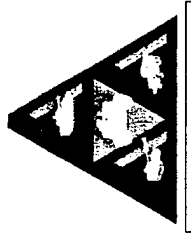

- **1. Modify Ford F350 and Dodge Ram Trucks**
 - **WHY- Enhance performance in military environment**
 - » **Increase off road mobility especially in soft soil conditions**
 - » **Increase to 4,550 lb payload**
 - » **Militarize (black out lights, camouflage paint, personal weapon mounts, tie downs/lifting eyes, antennae mounts)**
 - » **Take advantage of current electronics and enhance as needed**

- **2. Modify HMMWV with New Technology**
 - **WHY - Insertion into HMMWV Remanufacture Program**
 - » **Enhance safety**
 - » **Increase reliability**
 - » **Reduce Operational and Support (O&S) costs**
 - » **Insert new electronics**

Committed to Excellence



COMBATT Highlights

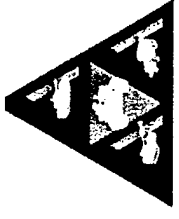

- **Four phase program over 2 years**
 - Requirements planning and analysis
 - Design to requirements
 - Build to design
 - Demonstration and evaluation
- **Demonstration**
 - Appropriately modified commercially based trucks can approach performance of HMMWV cargo troop carrier variant
- **Approach:**
 - Listen to the USER
 - Share engineering decisions with PM-LTV and original equipment manufacturers
 - Work with Army Testing Community (Actual and Simulated)
 - Waterways Experiment Station (Mobility)

Committed to Excellence

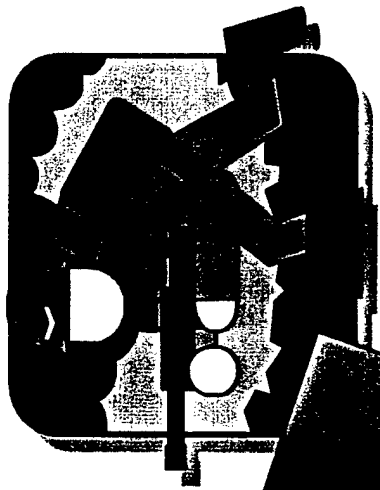
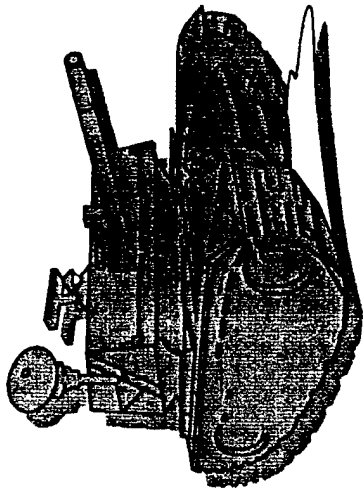
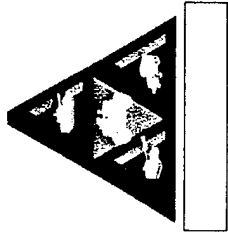
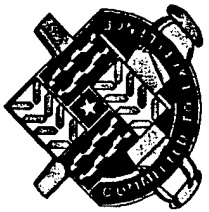

PARTNERSHIP WITH INDUSTRY

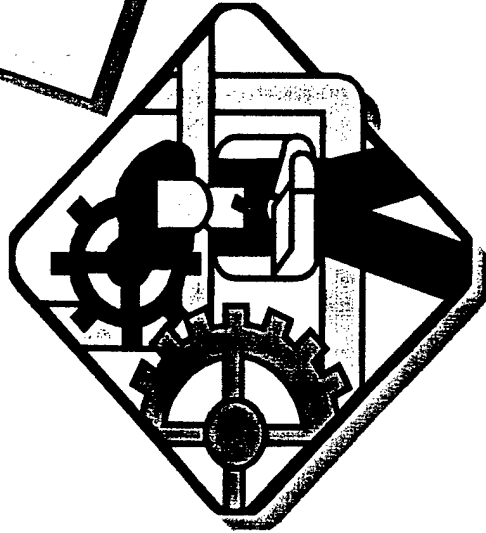
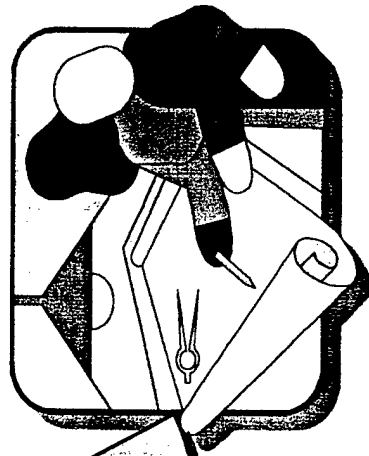

Committed to Excellence



Other Customers

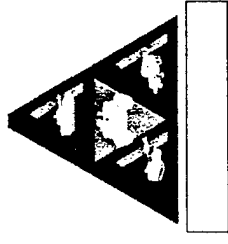

- **MTL Services:**
 - Has identified potential customers from:
 - US Departments of Justice, Treasury, Interior, Transportation, State and Local Law Enforcement
 - Germany and Great Britain
- **Could influence production numbers/costs**
- **Informal working group of Federal agencies**
 - TACOM will chair
 - May develop shared performance goals
 - May share costs

Committed to Excellence

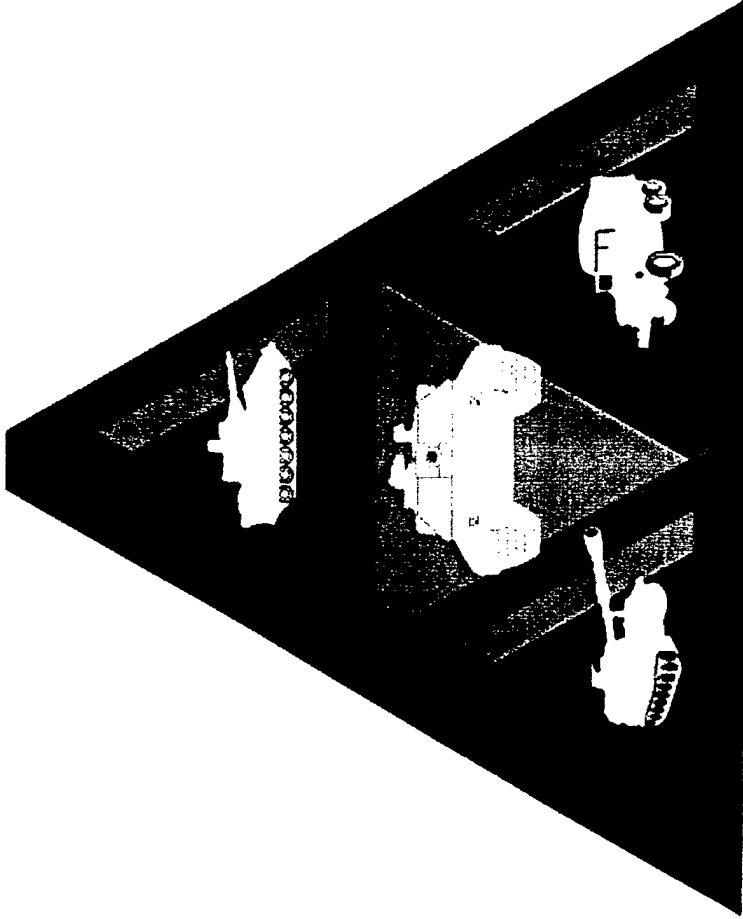
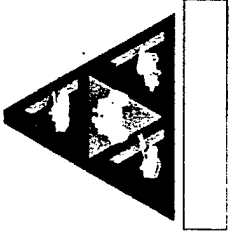
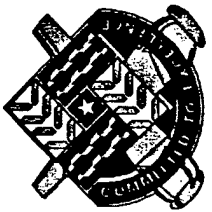

T A R D E C

Hybrid Electric Vehicles

Committed to Excellence

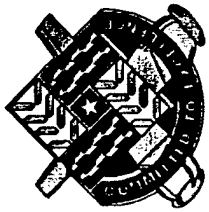

Series Hybrid FMTV

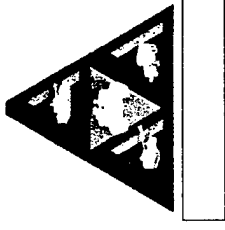

- Need: FY99 AAN Technology short list includes hybrid power systems, fuel efficiency. AAN goal is to reduce fuel requirements 75% by 2025



- Objective: Demonstrate greatly improved FMTV fuel economy and performance using commercial hybrid electric drive system for medium vehicles.

Committed to Excellence



Series Hybrid FMTV

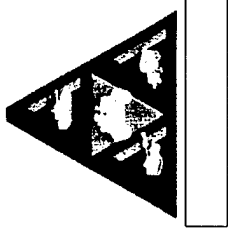

• Description: Lockheed-Martin (LMCS) and Stewart and Stevenson will apply LMCS' commercial hybrid drive system for medium trucks (HybriDrive) to an M1078 Light Tactical Vehicle

- Benefits
 - Faster Acceleration
 - Improved Traction
 - Can supply mobile power
 - Fuel efficiency improved 50%
 - Reduced brake, axle and differential wear

Committed to Excellence

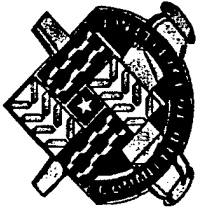

Parallel Hybrid Line Haul Truck

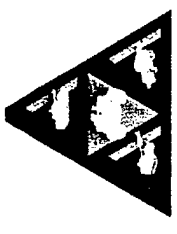

- Need: FY99 AAN Technology short list includes hybrid power systems, fuel efficiency. AAN goal is to reduce fuel requirements 75% by 2025
- Objective: Demonstrate greatly improved M915 fuel economy and performance using parallel hybrid electric drive system. Leverage off commercial Mack Truck application.



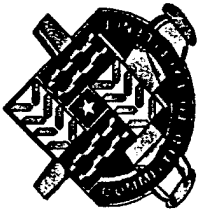

Parallel Hybrid Line Haul Truck

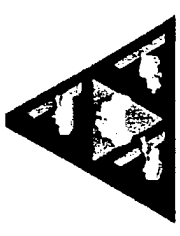

• Description: RADIAN, Inc., with Lockheed Martin (LMCS) and Mack Truck, will develop a parallel hybrid electric drive train for a Mack CL series line haul truck chassis. The CL chassis is similar to the M915 Truck Tractor.

- Benefits
 - Faster Acceleration
 - Can supply mobile power
 - Fuel efficiency improved 50%
 - Reduced brake, axle and differential wear
 - Gradeability improved to meet M915 requirements in all climates

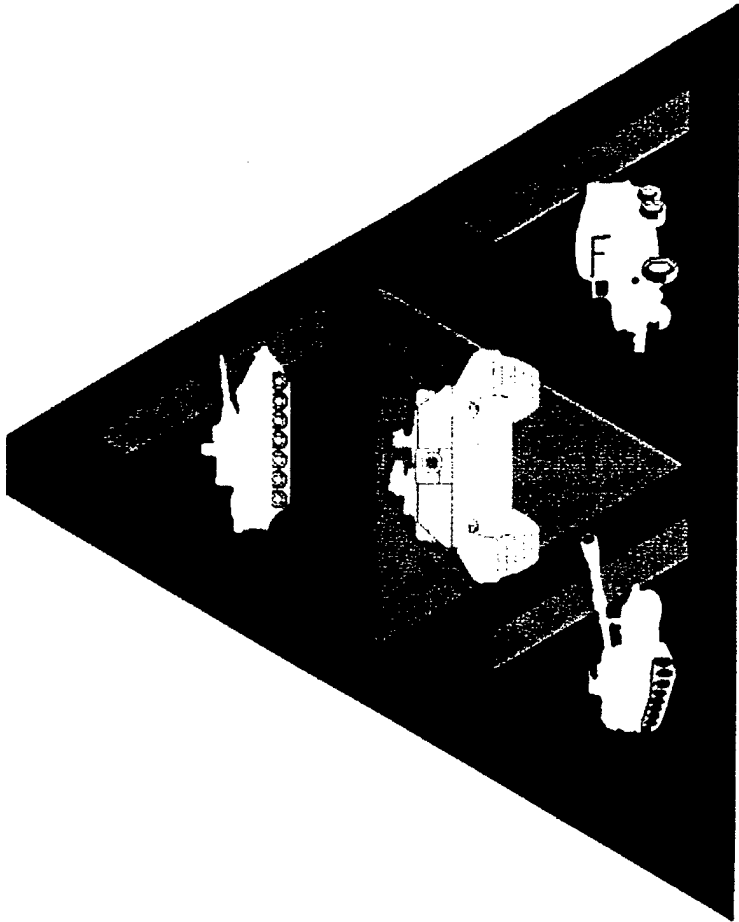
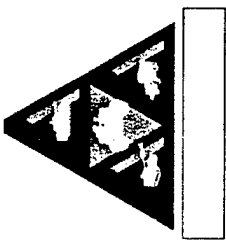

T A R D E C

Crew Protection

Committed to Excellence

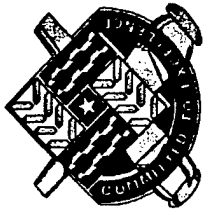

Crew Protection Kits for Operation Joint Endeavor

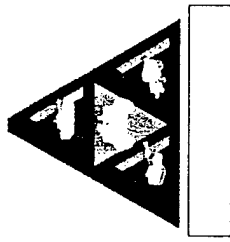

Challenge:

Provide an immediate response to the requirement to protect Tactical Wheeled Vehicles against over 6 million mines & small arms fire.

Requirement:

Protect the vehicle crews from:

1. Anti-Tank Blast Mines (12 lb. TNT)
2. Small Arms (infantry rifle) fire
3. Anti-personnel fragmenting mines

Response:

# of kits Produced	165	54	186
Kit Weight Added:	1,860 lbs	2,006 lbs	2,053 lbs
Per-unit Production Costs:	\$34,500	\$45,405	\$36,000
Per-unit Installation Time:	65 manhours	35 manhours	40 manhours

*Industry design and fabrication.

Committed to Excellence



PLS CREW PROTECTION KIT

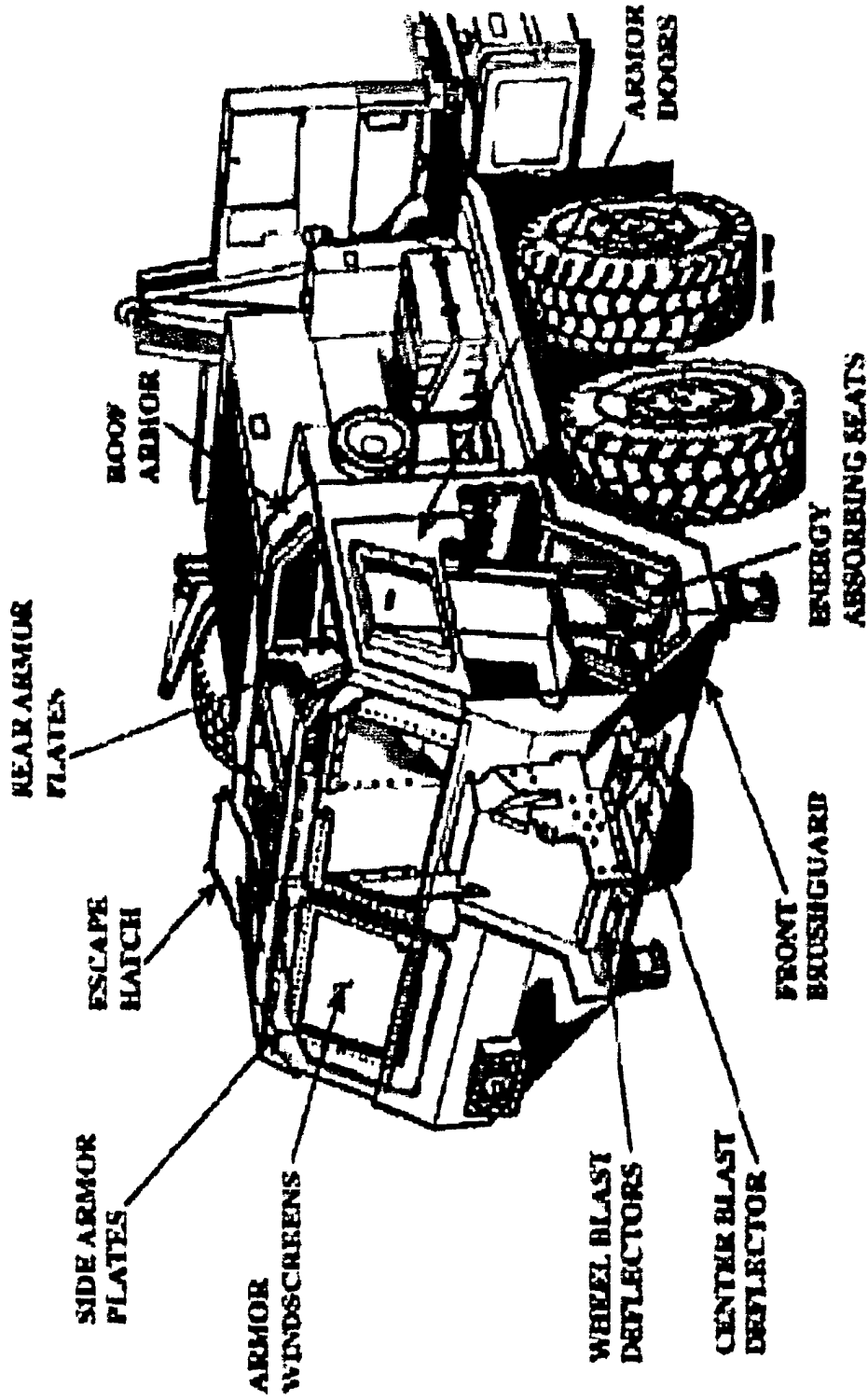
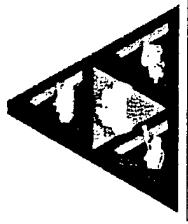

Committed to Excellence

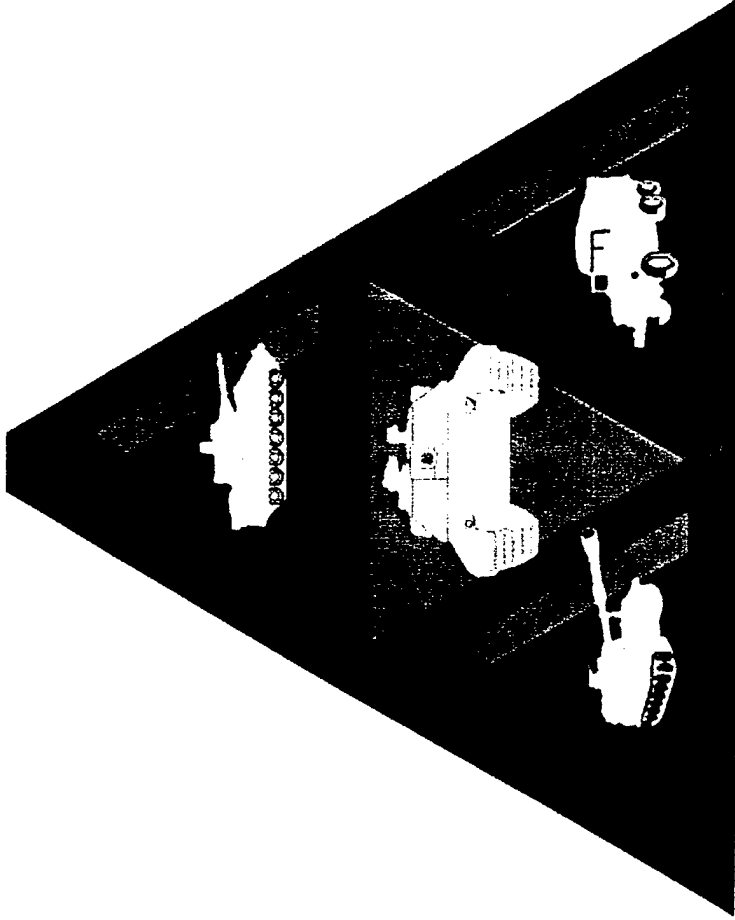
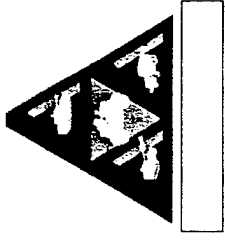

T A R D E C

Corrosion

Committed to Excellence

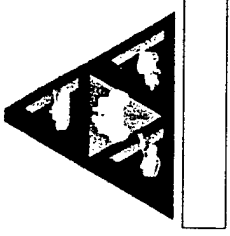

Current Status of the Fleet - an overview

- ◆ 800 Thousand Ground Vehicles in Army, NG and AR Units
- ◆ Positioned in a Variety of Locations and Various Environments, Long Term Storage (WRM), Active etc.
- ◆ Investment in 5 Ton Truck is ~ \$80 to 120 K (new)
- ◆ Corrosion Maintenance Costs \$800 to 1200/year/5T vehicle
- ◆ Cost to Replace One 5 Ton Cab is ~ \$17 K
- ◆ Total Cost to the Army is ~ \$2 B / Year !!!! (Battelle Study)

Committed to Excellence



Accomplishments To Date

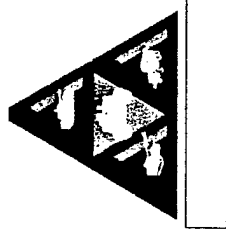

- ◆ Army's First ACT on an Entire Vehicle
 - HMMWV - at TRC in Ohio (80's)
 - FMTV - on going - at TRC and APG
- ◆ Cape Canaveral Marine Exposure Facility
 - JEEP Bodies and Door of 5 Ton Truck
 - ▶ Coatings and Repair Procedures
 - ▶ Construction, Design and Adv. Mfg. Techniques
- ◆ Field Evaluation of COTS:
 - Zinc Rich Primers and Thermal Spray
 - Corrosion Inhibiting Coatings: CarWell, Z-Tech etc.
 - Chip and Abrasion Resistant Coatings

Committed to Excellence



Accomplishments To Date - continued

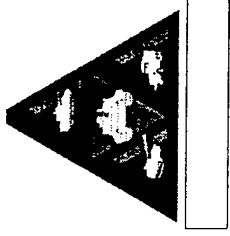

- ◆ Composites
 - Driveshafts
 - HMMWV Hood
- ◆ Non - Ferrous Metals
 - Hatch Covers for Bradley and M-1 parts
 - Base Plate for 80 mm Mortar
 - FreightLiner M-915 Tractor has an All Aluminum Model
 - 5 Ton Truck Stainless Steel Cab

Committed to Excellence

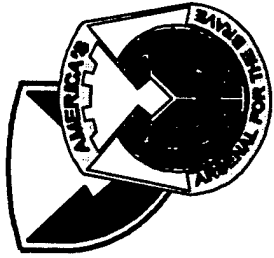

**U.S. Army Tank-automotive &
Armaments Command**

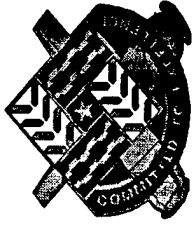

Acquisition Center Overview

NDIA Tactical Wheeled Vehicle Conference

1-2 February 1999

Daniel G. Mehney

Director, Acquisition Center

Committed to Excellence

**U.S. Army Tank-automotive & Armaments COMMAND
TACOM**

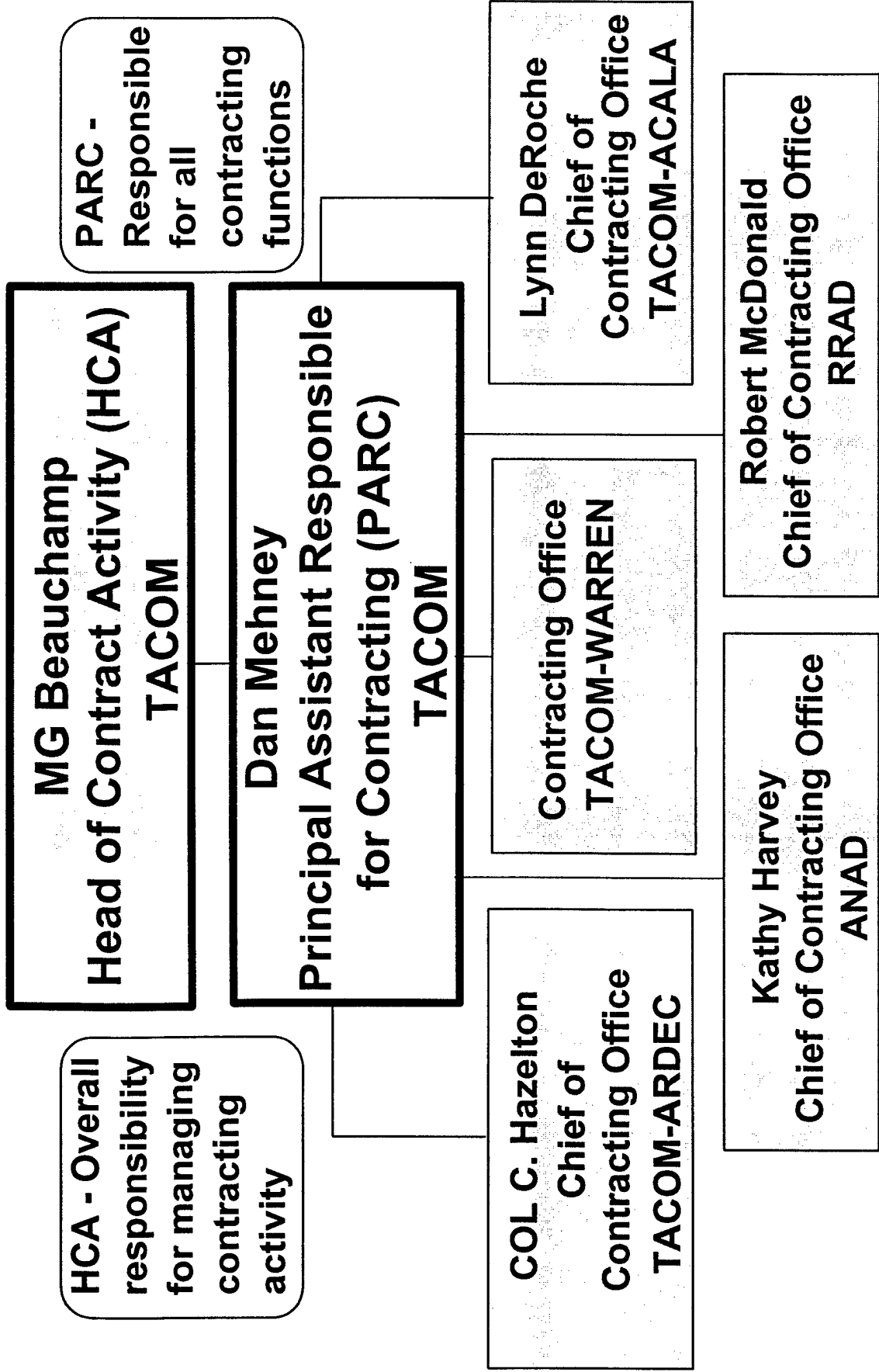

ACQUISITION CENTER ORGANIZATION

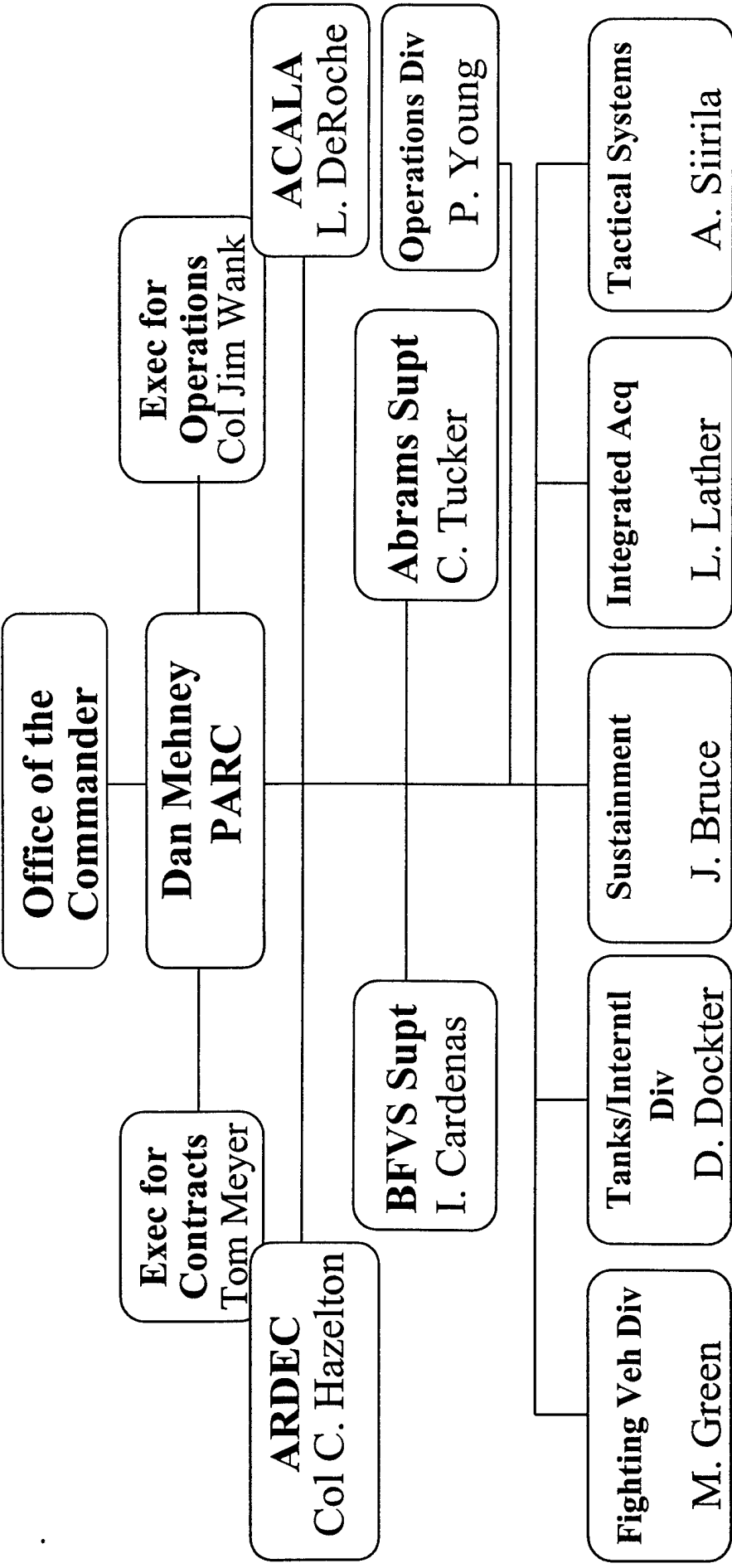

Committed to Excellence

ACQUISITION CENTER ORGANIZATIONAL DEVELOPMENT

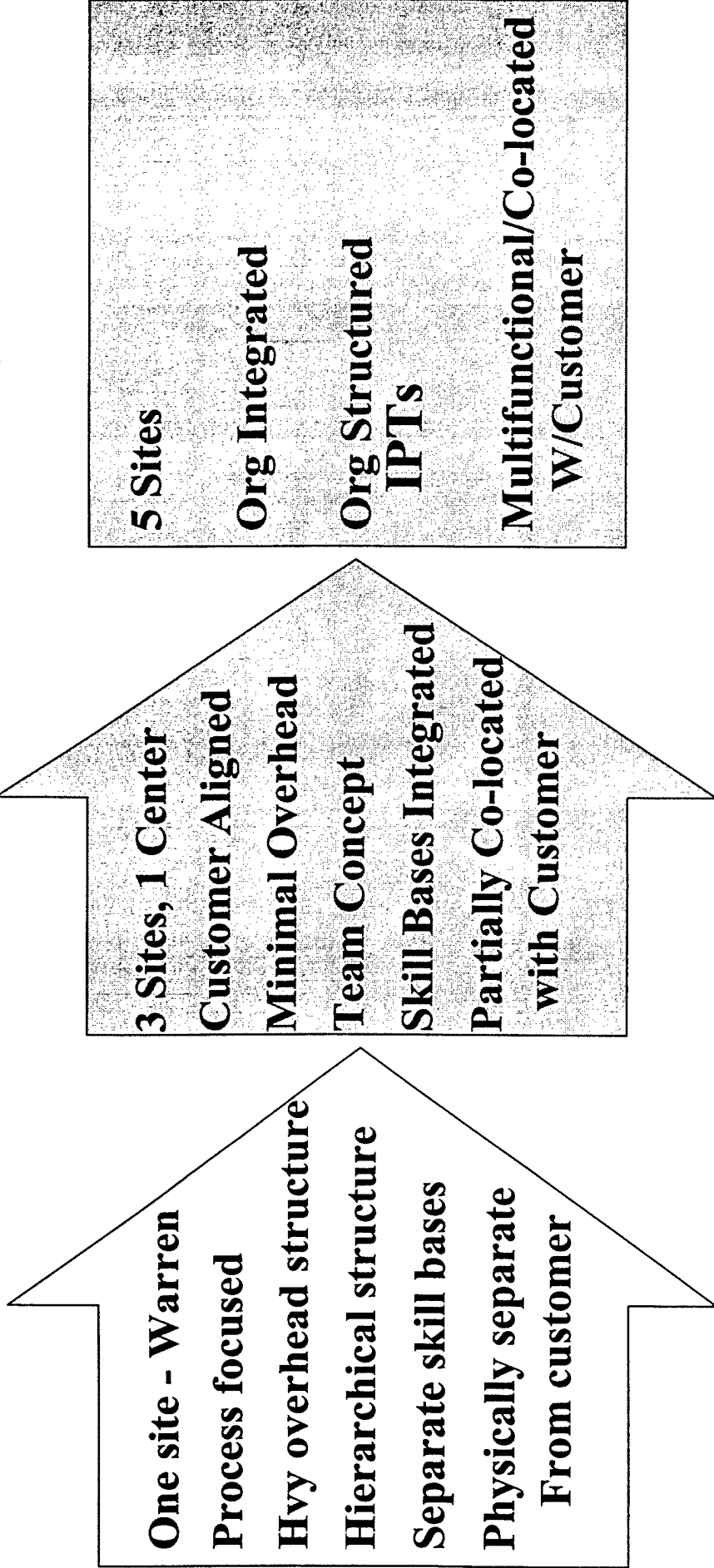

FY92	FY98	FY99 (in process)
-------------	-------------	--------------------------

Committed to Excellence

TACOM TOTAL FY99 OBLIGATION PROJECTIONS

Fund by Customer: \$4.59 Billion Estimated Obligation

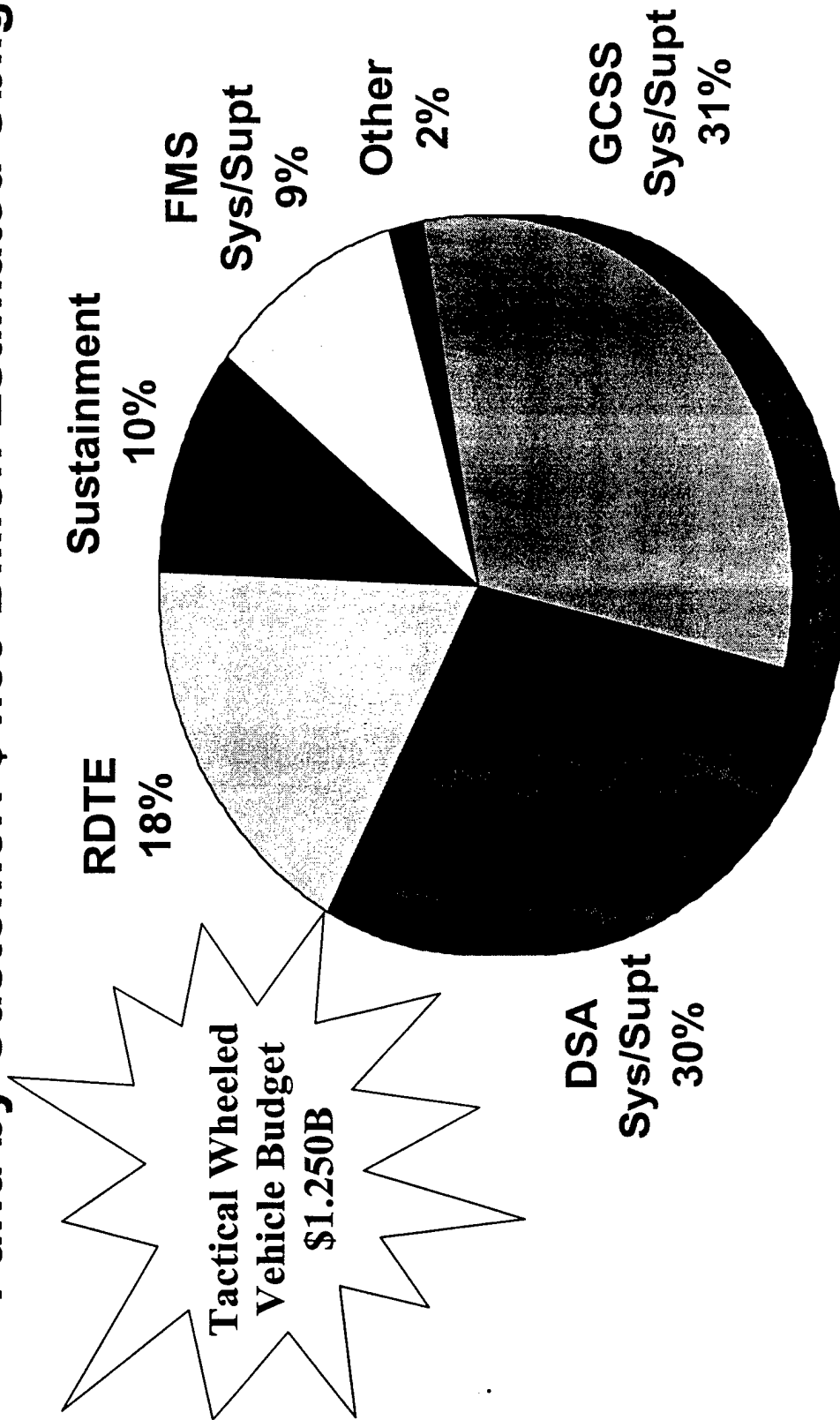

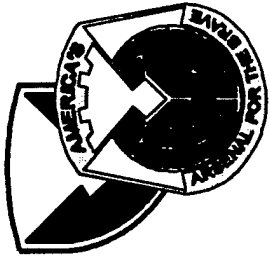

**U.S. Army Tank-automotive &
Armaments Command**



**Reform & Streamlining
Perspective**

NDIA Tactical Wheeled Vehicle Conference

1-2 February 1999

Daniel G. Mehney

Director, Acquisition Center

Committed to Excellence

Where We Were!

(FY92)



**“Arms-length” Often Adversarial
Limited Industry Input
Functionally Segregated; Consecutive
Processing**

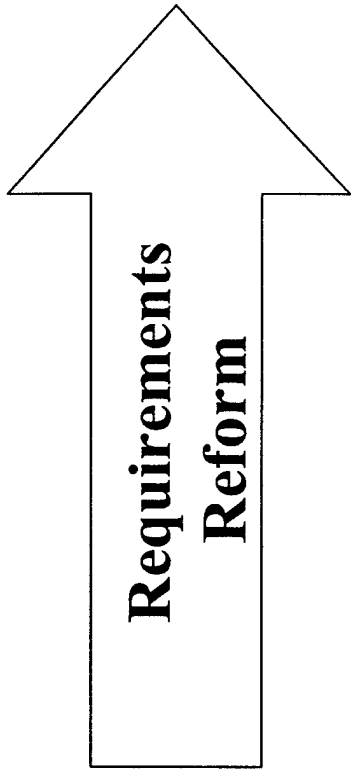

**Design Specifications
Government Configuration Control
Extensive, Redundant Testing
Unique Processes and Products
Commercial Items The Exception**

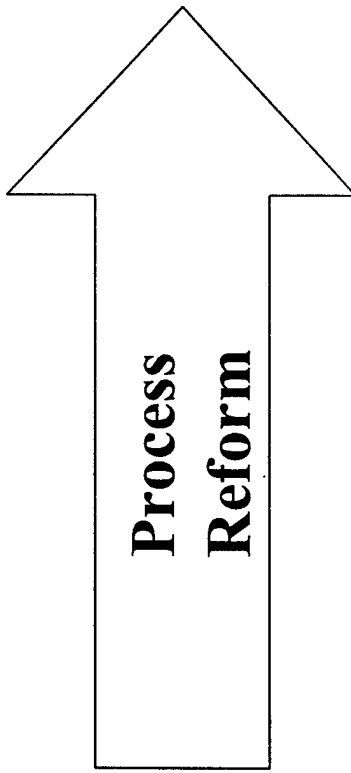

**Rule Based Process
Paper Process, Drawings & Aperture
Cards
Limited Imprest Fund Authority (<\$50)
Low Bid Preferred Approach
Large Inventories**

Where We Are!

**Government/Industry
Relationships**

**Partnering
Integrated Product Teams
Concurrency in Procurement
(ALPHA Contracting)
Alternative Dispute Resolution**

**Requirements
Reform**

**Performance Based Requirements
Contractor Configuration Control
Simulation in Lieu of Hard Testing
Single Process Initiative
Commercial Products & Processes**

**Process
Reform**

**Business Based Process
Electronics/WWW/EDI
Credit Cards
Long Term Contracts
Past Performance Evaluation
Best Value
Direct Vendor Delivery**

8

Committed to Excellence

Where We're Going!



Government/Industry Relationships

Qualified Supplier List
Leveraged Business with DCMC/
DLA & Industry
Prime Vendor
Longer Term, Fewer Contracts
Focus on Small Business Participation
Corporate Contracts



Requirements Reform

Shorter Cycle Times
Logistics Reform & Privatization
Modernization Thru Spares
Commercial Products
Focus On Reducing Cost of
Ownership/Life Cycle Cost



Process Reform

Commercial Based Process
Electronic Contracting & Ordering
Electronic Shopping Malls/Virtual
Contracting Web Site
Expand Credit Card Use
More Integrated Product Teams
Automated Best Value
Buy Response, Not Inventory

Committed to Excellence

Current Acquisition Examples

Vibratory Roller

- **Upfront communications**
 - ▶ **Draft spec released for industry comment**
 - ▶ **Pre-proposal conference held**
 - ▶ **RFP posted on the Web**
- **Streamlined evaluation criteria**
- **Used oral proposals for some areas**
- **Performance spec**
- **Negotiating manual supplementation after award using Alpha**
- **User to decide how much supplementation based on cost (CAIV)**
- **Testing only military unique requirements; relying on commercial market acceptability for most requirements**

Current Acquisition Examples

MTVR

- **Performance Spec - only 11 MIL-SPECS or MIL-STDs**
- **Shared design/perf simulation capabilities w/contractors**
- **Used modeling/simulation to eval tech areas not tested**
- **Both draft and final Phase II RFP posted to web site**
- **Oral presentations used for portions of Phase II proposal**
- **Electronic data deliverables**
- **Partnering agreement anticipated**

Potential/Pending/Recent Regulatory/ Statutory Changes

- **Price based acquisition - DOD study group formed**
- **Price reasonableness - FY99 Authorization Act requires supporting data from industry**
- **Corporate Restructuring - Proposed rule published to capture savings**
- **Non-conforming mat'l/conditional acceptance - Proposed FAR rule requires PCO to withhold funds**
- **Depot maintenance competition - FY99 Appropriations Act requires comparable cost basis; excludes A-76 requirements**
- **FMS Procedure Reform - ongoing DOD process action team**

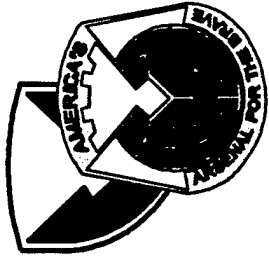

**U.S. Army Tank-automotive &
Armaments Command**



Industrial Base

NDIA Tactical Wheeled Vehicle Conference

1-2 February 1999

**Daniel G. Mehney
Director, Acquisition Center**

Committed to Excellence

TACTICAL WHEELED VEHICLES

REQUIREMENTS \$\$\$

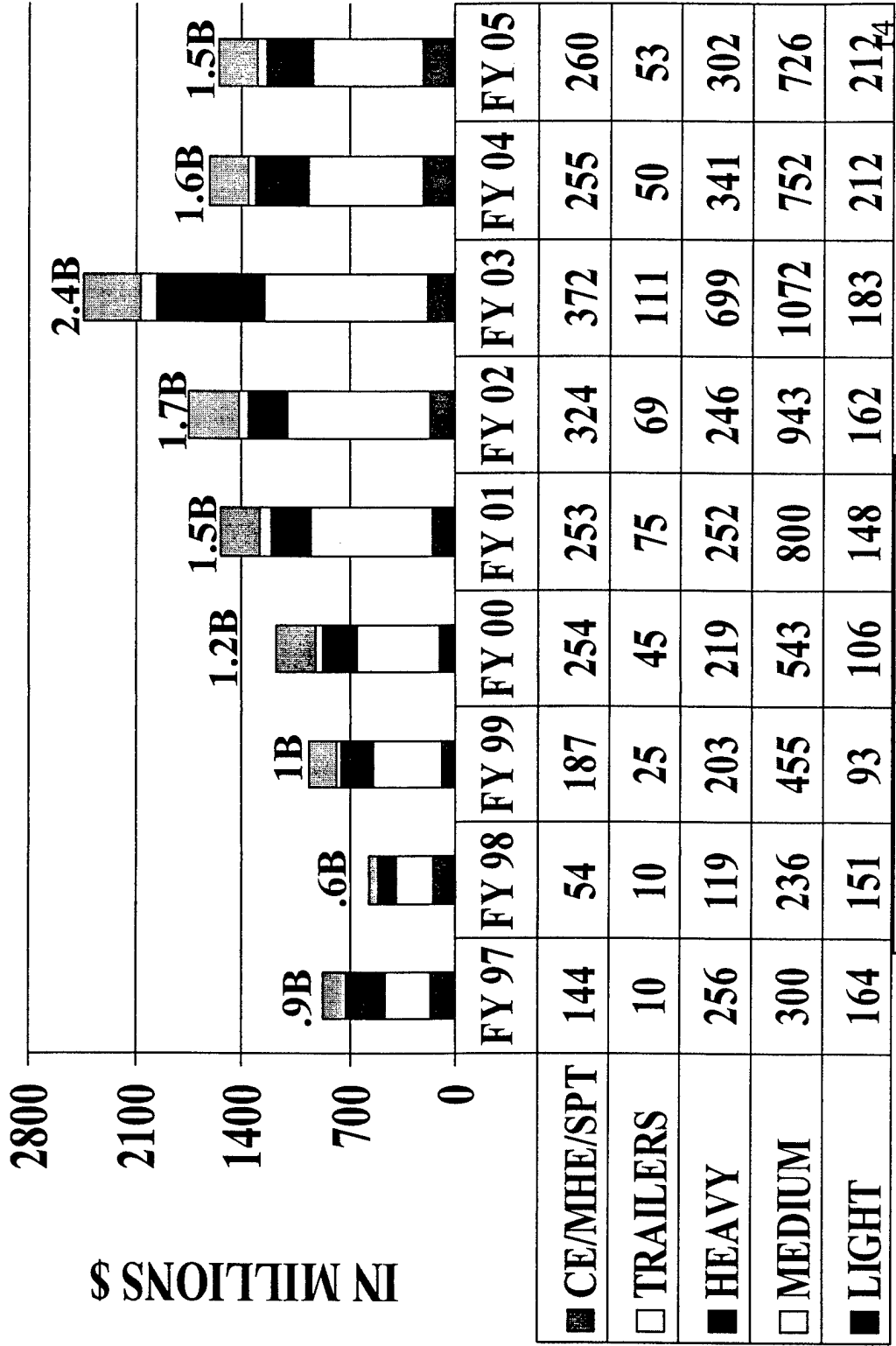

Committed to Excellence

TACTICAL WHEELED VEHICLES

PRODUCTION PROFILE

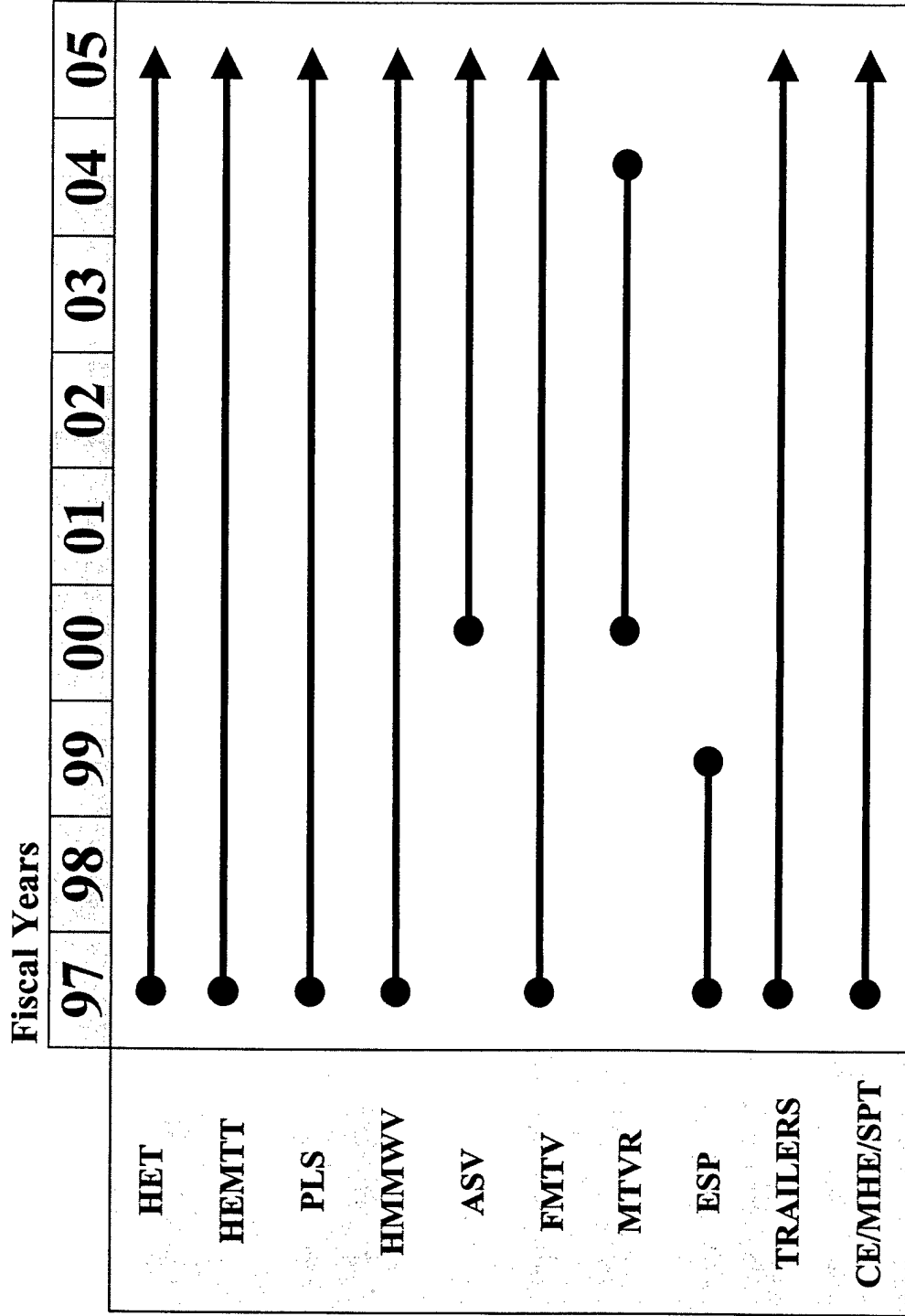

TACTICAL WHEELED VEHICLES

FUTURE INDUSTRIAL BASE ASSESSMENT

- **Tactical Wheeled Vehicle Industrial Base Assessment now in process - Target Completion 30 Sep 99**
- **Essential that industry contributes to the assessment**
- **Study limited to new vehicle production impacts on industry regarding engineering support and STS requirements**
- **Identify parts that will no longer be manufactured so that appropriate resolution can be immediately initiated**
- **Determine industry impacts on Force XXI and Army After Next requirements in order to maintain and sustain an effective Tactical Wheeled Vehicle industrial base**

1999

Tactical Wheeled Vehicles Conference

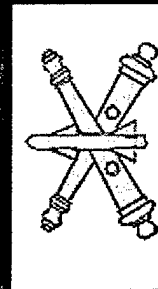
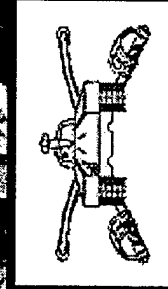
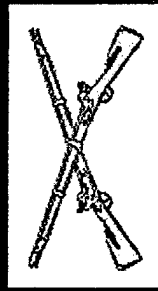
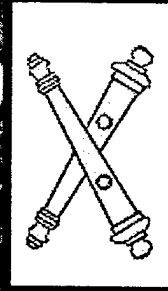

Presented by

Mr. Albert Puzzuoli
Deputy Program Executive Officer,
Ground Combat & Support Systems

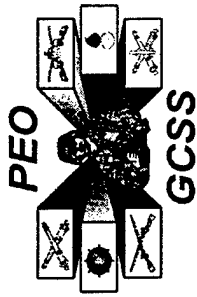

Mission Statement

**To Maintain a Total Army Perspective in Managing
the Development, Acquisition, Testing, Systems
Integration, Product Improvement and Fielding
That Places the Best Ground Combat and Support
Systems in the Hands of our Soldiers**

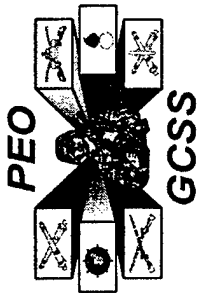

Army PEO Structure

Acquisition Executive
Pentagon

MG J. R. Snider
Aviation
Huntsville, AL

BG S. W. Boutelle
Command, Control & Comm Sys
Ft. Monmouth, NJ

COL S. deKanter
Standard Army Management Info
Ft. Belvoir, VA

BG D. L. Montgomery
Air Missile Defense
Huntsville, AL

COL (P) J.W. Holly
Tactical Missiles
Redstone Arsenal, AL

MG D. Gust
Intel Electronic Warfare & Sensors
Ft. Monmouth, NJ

MG J. F. Michitsch
Ground Combat & Support Systems
Picatinny Arsenal, NJ
Warren, MI

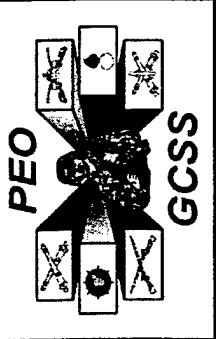

Current Organization

★★
PEO GCSS

APEOS
 Admin
 Chief of Staff

**DPEO
 Fire Support Systems**

Int'l Programs
 (FMS)

**DPEO
 Maneuver Systems**

PM Abrams
 M1A1
 M1A2

PM Bradley
 M3A3
 C2V
 BFIST

PM Medium Tactical Vehicles
 Gnd Sys Integration
 SMP
 REMAN

PM Crusader
 Armaments/Munitions
 Resupply
 Mobility

JPM LW 155

PM Tank Main Armament System

PM Sense & Destroy Armor
 XM982 (FY99 GOSC)

1	PEO
8	Project Managers
11	Product Managers
305	Personnel

Procurement and Production

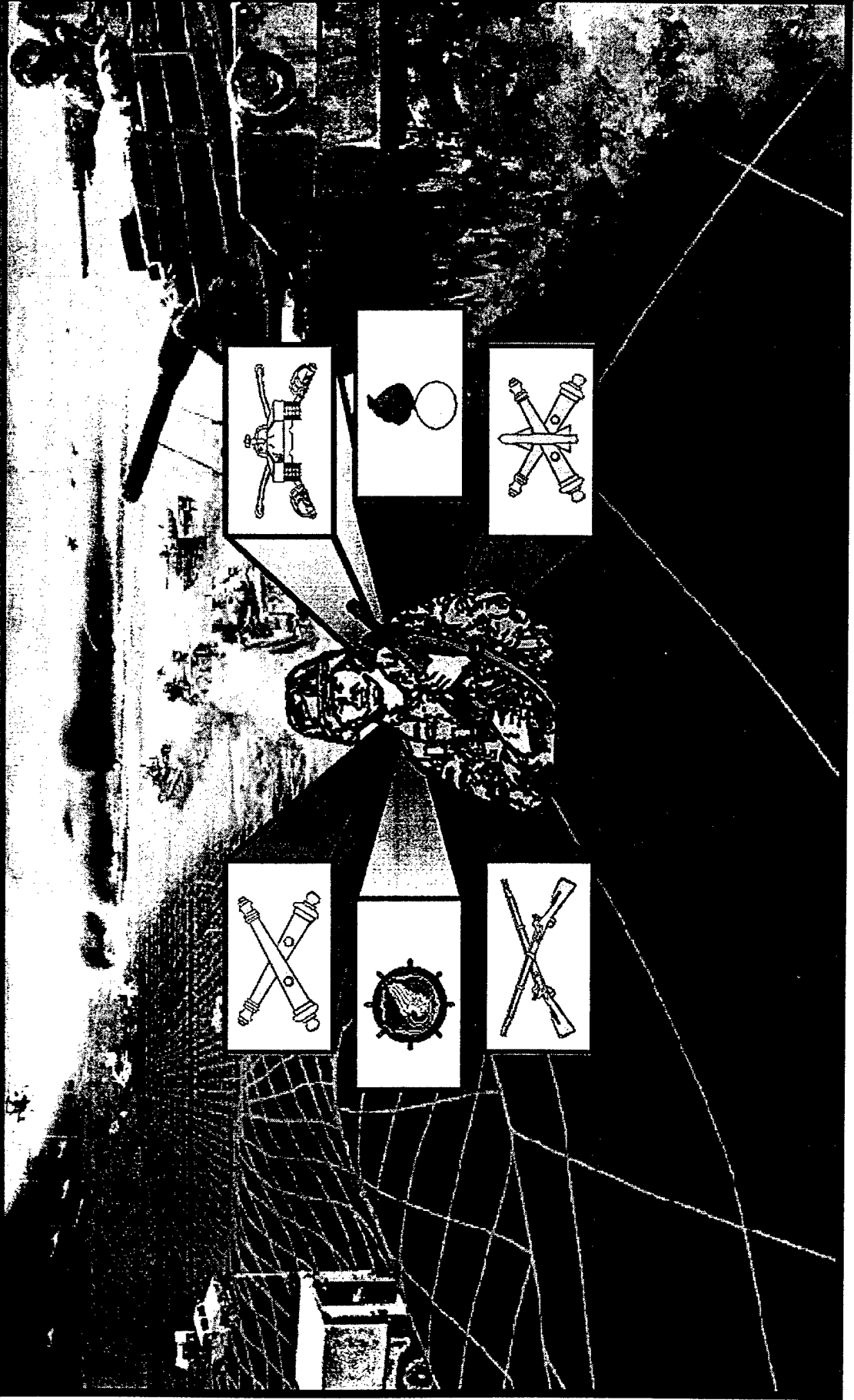
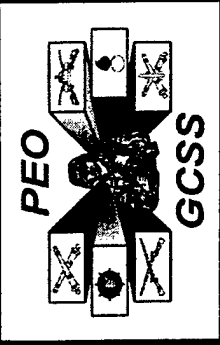



FMTV Program Background

- FMTV - 14 Truck Models in the 2 1/2 and 5 Ton Payload Class with over 80% Commonality and 2 Complementary Trailers
- 85,000 Vehicle AAO Required over 30 Years
- First Production Awarded in Oct 91 to Stewart & Stevenson (S&S) for 11,300 Trucks in 12 Models
- First Unit Equipped Date - Jan 96
- Second Production (A1) Awarded in Oct 98 to S&S for 8,668 Trucks in 11 Models and 1,560 Tactical Trailers
- Phase I FMTV Second Source Awarded in Oct 98 to AM General and Oshkosh for 3 Pre-Production Vehicles Each

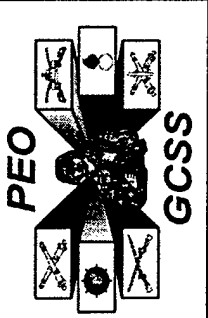

A1 Model Production Upgrades

- Chassis
 - CAT 3126 Engine w/Electronic Control (EPA 98 Compliant)
 - Allison World Transmission Electronic Controls (WTEC III)
 - Meritor Hub Reduction Axles w/Antilock Brake System (ABS) (DOT 98 Compliant)
 - SAE J 1708/1939 Compatible Data Bus
- Interactive Electronic Technical Manuals (IETMs)
- New M1082 Light Trailer with 2 1/2 Ton Payload
- New M1095 Medium Trailer with 5 Ton Payload



FMTV Driveline Improvements

ENGINE FLYWHEEL HOUSING

- Nodular vs. Grey Iron with Increased Wall Thickness → Increases Strength

DRIVESHAFT

- Larger Diameter Tube → Reduces Dynamic Deflection

YOKE

- Full Round vs. Strap Attachment → Increases Retention Force

U-JOINT

- Nylon vs. Steel Thrust Washers → Increases Fatigue Life



ESP Current Programs

- Purchased with FY99 Funds 600 Vehicles
- Total Program Buy 5,488 Vehicles
- Production Line Scheduled to Close April 1999
- Fielding Completed by June 1999

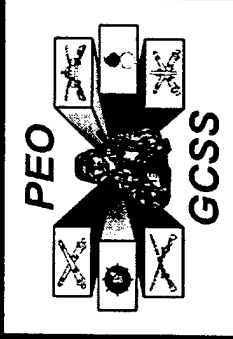

ESP Termination/Rational

- Insufficient Funds to Support Economic Production of Both ESP and FMTV
- ESP Funds Shifted to Purchase Additional LMTVs for the Reserves
- Medium Fleet Modernized by 2017 With a Mixture of LMTVs and ESPs
- 2 1/2 and 5 Ton Requirements Filled with FMTVs by 2022

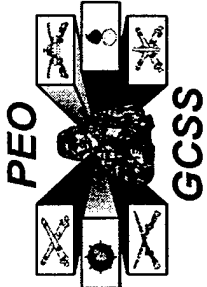

MTVR Requirements

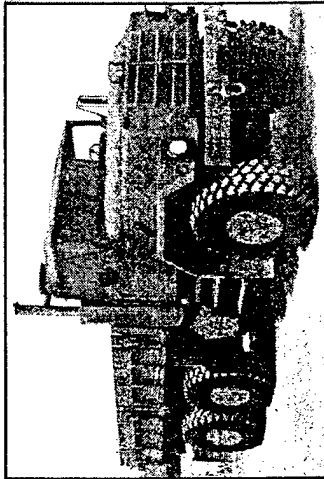

MOBILITY

Tactical High Mission Profile
(30% Highway/Secondary Roads,
70% Trails and Cross-Country)



CARGO CAPABILITY

7.1 Tons Cross-Country,
15 Tons Highway

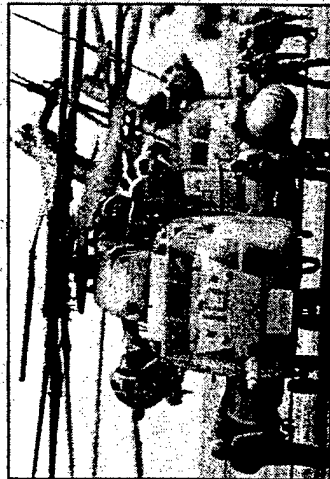

CH53 HELICOPTER LIFT

Vehicle Weight Less Than
28,000 Pounds

22 Year
Corrosion Protection

Field Support

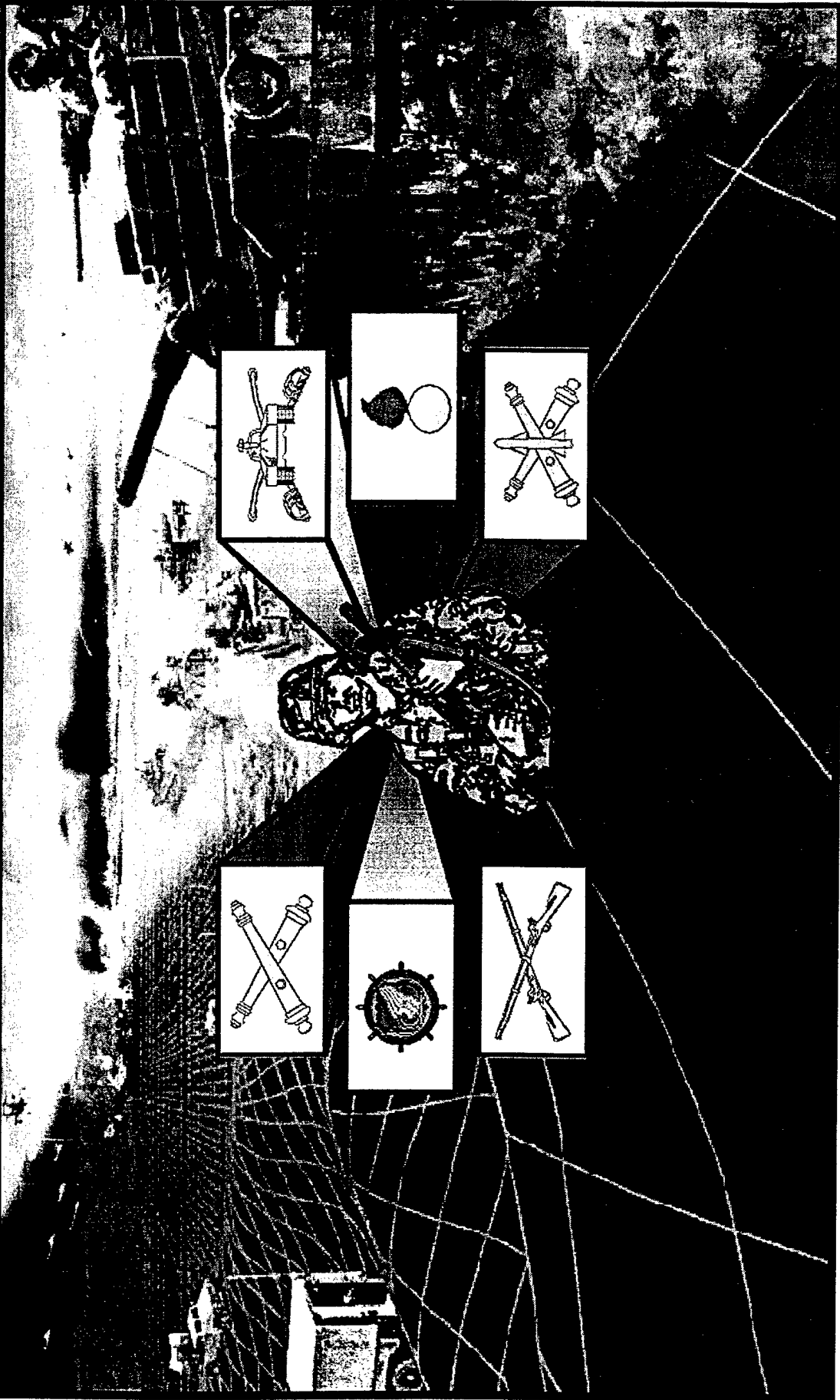
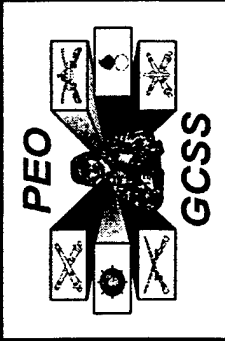

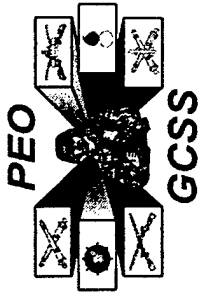

FMTV Contractor Logistic Support

- Vehicle Manufacturer as Source of Supply
 - DLA Corporate Contract
- Field Focus
 - Onsite Technical Representatives
 - Warranty Program (18 Month/12,000 Miles)
 - Retraining Classes
 - PQDR Responsiveness
- Contractor Parts Support (After Market Sales)
 - 24 Hour Turn Around Time on Part Delivery
 - Full Parts Delivery Support
 - IMPAC Card Response to Field

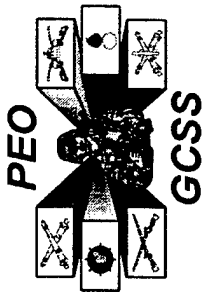

MTRV Contractor Logistics Support

Customer Focus

- Onsite Tech Rep
- 24-Hour Hotline
- Improve Order & Ship Cycle Time
- Reduce Stockage

Contractor Focus

- Beyond Traditional Govt/Industry Supply Method
- Electronic Commerce with Direct Vendor Delivery
- Performance Metrics
- Supply Chain Management
- Encourage Innovation

Partnering

- Warranty Tracking by Contractor
- Life Cycle Cost Accounting
- Total Asset Intransit Visibility

OEM as Complete Source of Supply

Emerging Systems & Technologies

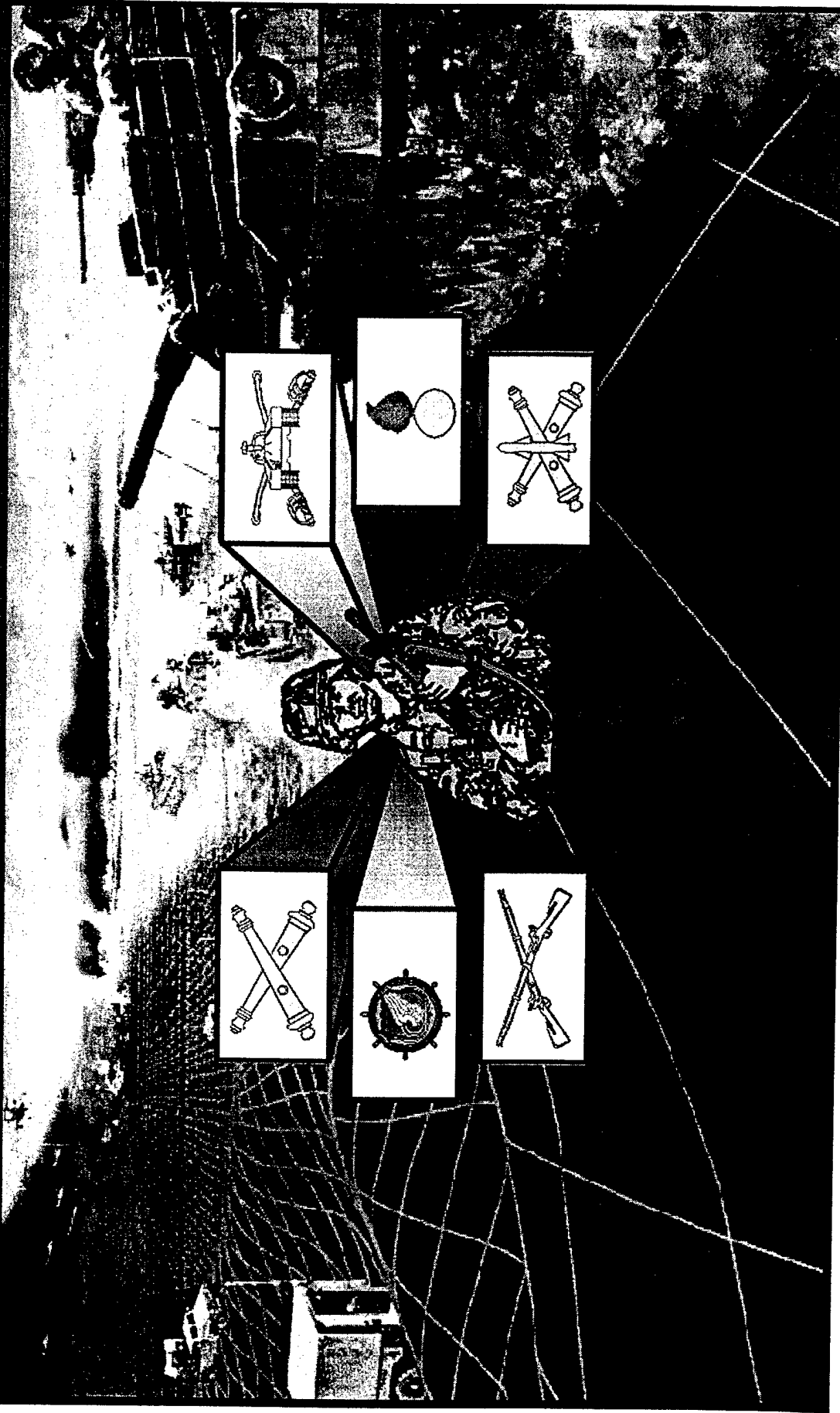

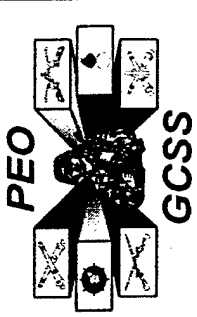

MTVR Acquisition Strategy

- Two Phase Acquisition
 - Phase I - Prototypes and Testing; Completed April 98
 - Phase II - Downselect to one Production Supplier
- Production Contract Awarded to Oshkosh Truck Corporation
- 5 Year Multi-Year Contract to buy all of the USMC Medium Truck Requirements
- Initial Production Model Will be the Standard and Long Wheel Base Cargo
- Parallel Development Effort for Dump, Telephone Maintenance, Trailer and Wrecker Variants

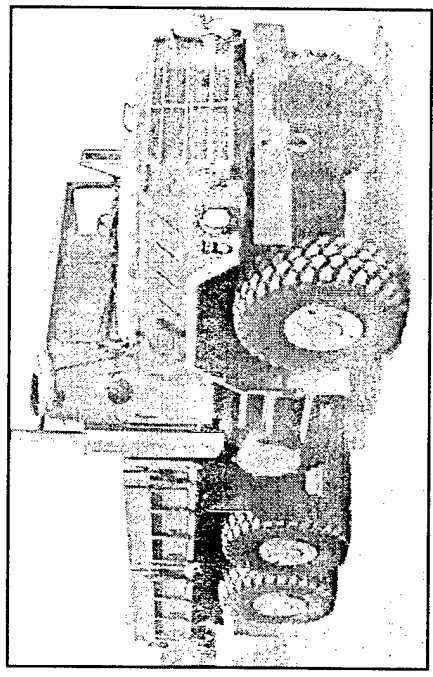

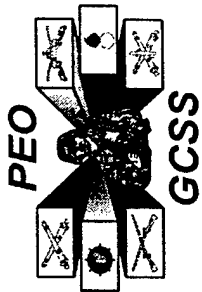

Second Source Plan/Approach

- **AAE Directive 11 Sep 97-** Introduce Competition at Earliest Junction
Possible Within Current Funding Streams
- **Acquisition Plan Approved 27 Nov 97 - Two-Phase Approach to Prepare Second Source for Competition with the Current FMTV Manufacturer in FY03**
 - **Phase I-** Multiple Competitive Pre-Production Awarded Oct 98
Each Contractor Builds 3 Vehicles to System Performance Specification w/ TDP Provided for Reference
 - **Phase II-** Competitive Second Source Production Award
Downselect Planned in FY00 for 3-Year Multiyear
- **Beginning in FY03-** Stewart and Stevenson and Second Source
Compete for Share of Follow-On 5-Year Competitive Multi-year
Production Contracts



Second Source Current Status

- Phase I Awarded 30 Oct 98 to AM General and Oshkosh Truck Corporations
- Fixed Firm Price (FFP) Contract to Build Three Pre-Production Vehicles:

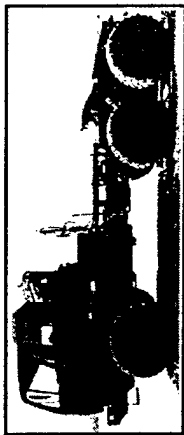

MTV TRACTOR

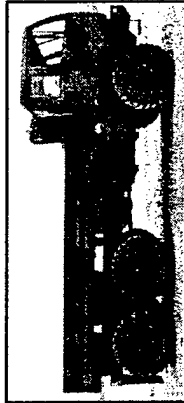

MTV CARGO

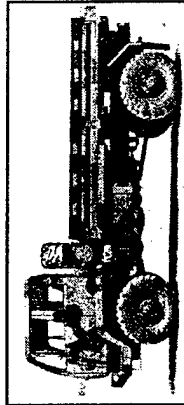

LMTV CARGO

- Goal-Achieve Maximum Operational Effectiveness at the Lowest Possible Cost by Maximizing Vehicle Commonality Among the FMTV A1 Fleet
Emphasis is Placed on Minimizing Operating and Sustainment Costs

Milestones:

PHASE I

Acquisition Plan Approved	27 Nov 97
D&F Approved	27 Feb 98
J&A Approved	28 Feb 98
Phase I Awarded	30 Oct 98
Delivery	27 Jul 98
6,000 Mile Technical Test	Jul 99-Sep 99

PHASE II

Release Final RFP	Nov 99
Proposals Due	Dec 99
Source Selection Evaluation	Dec 99-Feb 00
Certification of Compliance	Feb 00-Jun 00
w/ Congressional Language	Jun 00
Award Phase II	

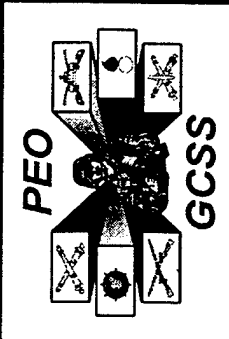

Second Source Schedule

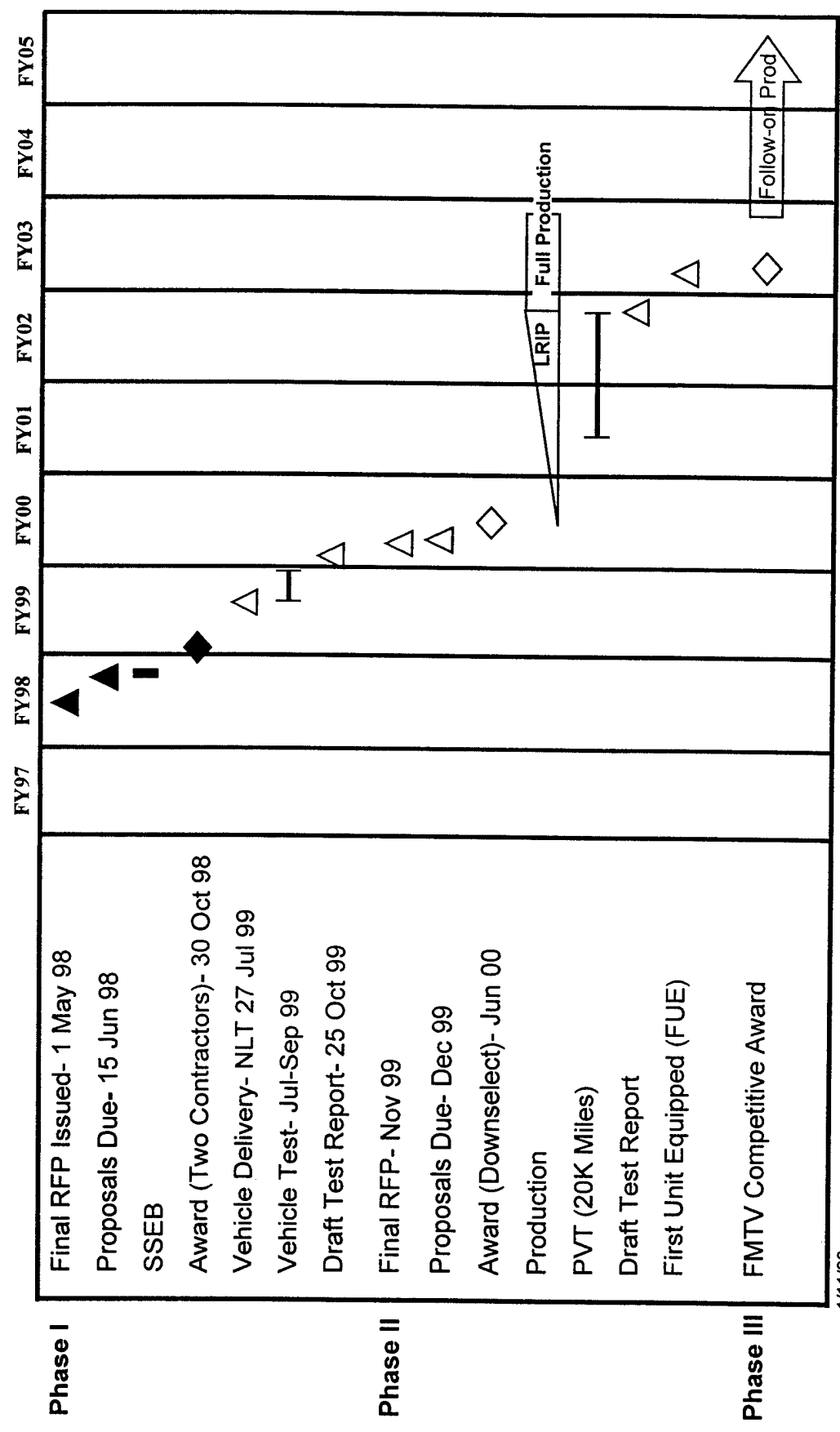

1/11/99

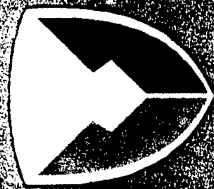

AMC

Deputy for Systems Acquisition Tactical Wheeled Vehicles Conference

"The Road to the Future"

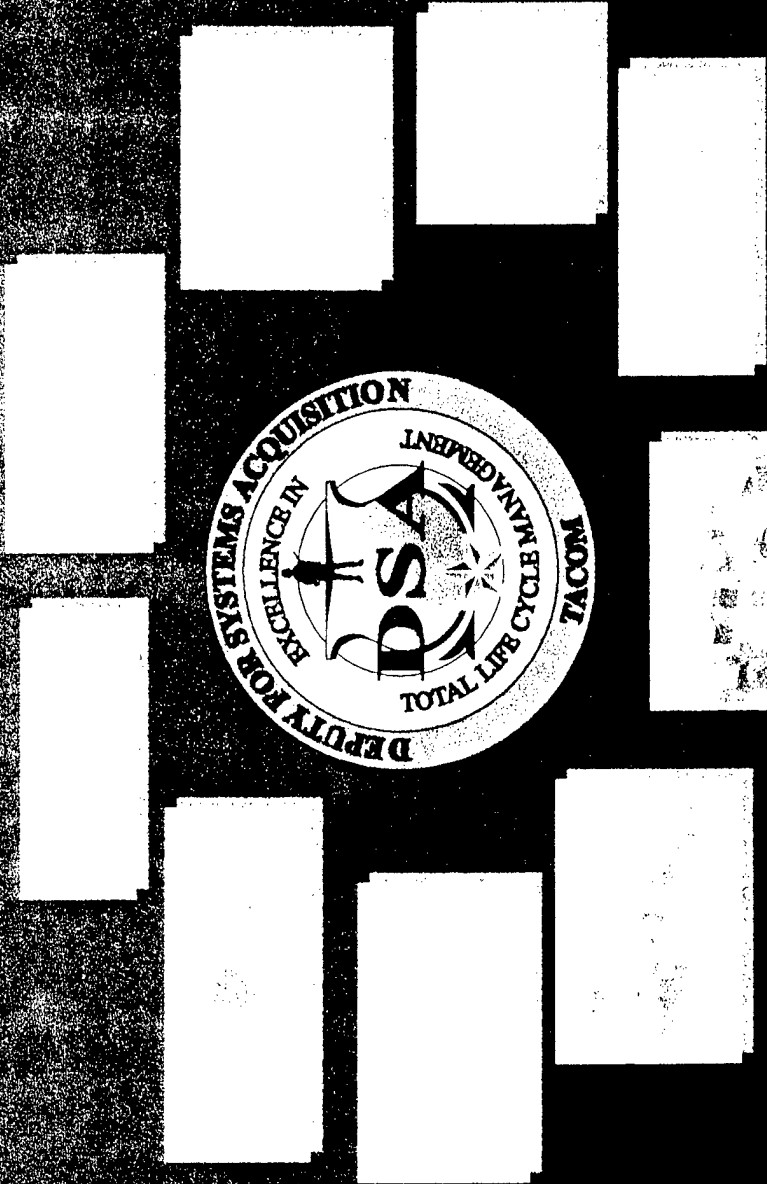

COL (P) John M. Urias
Deputy for Systems Acquisition

Bank-automotive & Armaments Command
Committed to Excellence

2 February 1999

The Army's Focus for the Future

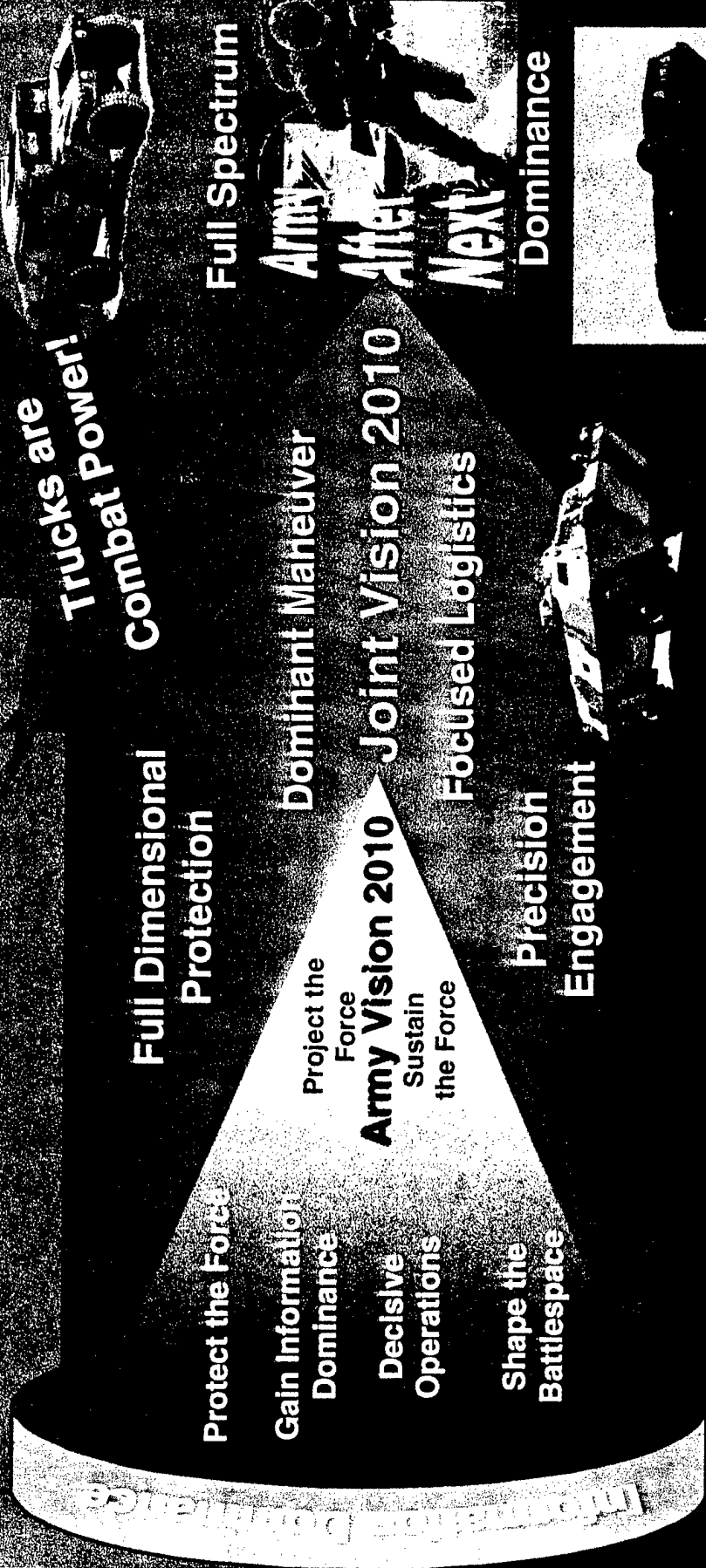

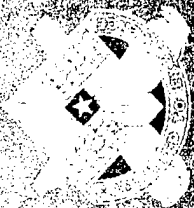

TACOM

TWV Linkage to Army Digitization

Actively Participating to Meet Key Milestones

- ◆ Task Force Limited User Test Validation Aug 98
- ◆ 1st Fully Digitized Division by FY00
- ◆ 2d Fully Digitized Division by FY03
- ◆ 1st Fully Digitized Corps by FY04
- ◆ 2d Fully Digitized Corps by FY06



Heavy Tactical Vehicles (HTV)

HEMTT

Currently Working
Appliqué + Integration

PLS-E

Movement Tracking
System (MTS) is
ACOE Compliant

• MTS Successful in Bosnia

Light Tactical Vehicles (LTV)

HMMWV
and
ASV

• Systems Outfitted
and Played in TF
XXI AWE

• Currently Working
Appliqué + Integration

Tank Automotive

Weapons Systems (TAWs)

• Systems Outfitted
and Played in TF
XXI AWE

• Currently Working
Appliqué + Integration

5 Ton
Truck

3 / 14

Committed to Excellence

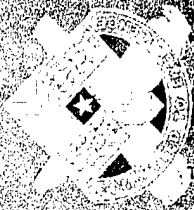

TACOM

What is Next?



TACOM's Weapon Systems on Move

- M915 Upgrade
- COMBATT
- REMAN vs. New
- Leasing
- CE/MHE Rebuild Programs
- MTS
- ABS

Force XXI

- MTS
- Automatic Cruise
- Applique
- Paladin
- AFCS XXI

Army After Next

- Knowledge
- Speed
- Agility
- Ultra Reliability



Leveraging Commercial Technology

4 / 14

Committed to Excellence



Heavy Fleet Road Map to AAN

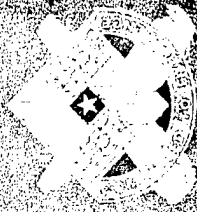

TACOM

PMO

HEMTT LHS

PMO



Safety

TARDEC

Technology Insertion Opportunities

Technology Survey / CBD

Submit Concept STO Jan 99

Concept Analysis

Submit ATD STO Jan 00

Award ATD Contract

Detailed Design / Virtual Prototyping

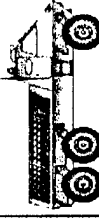

NAC

Technology Insertion Opportunities

Sealed Hood



Line Haul (class 8) Parallel Hybrid Electric



RDTE '05

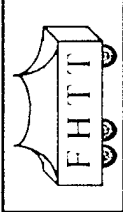

Production '08

5 / 14

Committed to Excellence

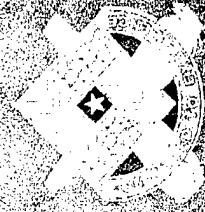

TACOM

LEADER/FOLLOWER CONVOY REQUIREMENT



**A convoy of tactical wheeled vehicles having:
A crew driven lead vehicle.
One or more vehicles w/o crew.**

Increase:

- **Productivity**
- **Efficiency**
- **Safety**
- **Control**
- **Command & Asset
Resource Management**
- **Reduce human risk**
- **LOS/NLOS capable.**

Integrates future robotic & logistic technologies.

- **Added benefits:**
 - **Can provide feed-back data**
 - **location, route, fuel status, inventory, real time messaging, diagnostics, driver physiology.**
- **Reduce O&S costs.**

6/14

Committed to Excellence

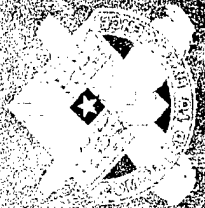

TACOM

LEADER/FOLLOWER APPLICATION TO HEAVY FLEET HTVs w/Convoy Missions

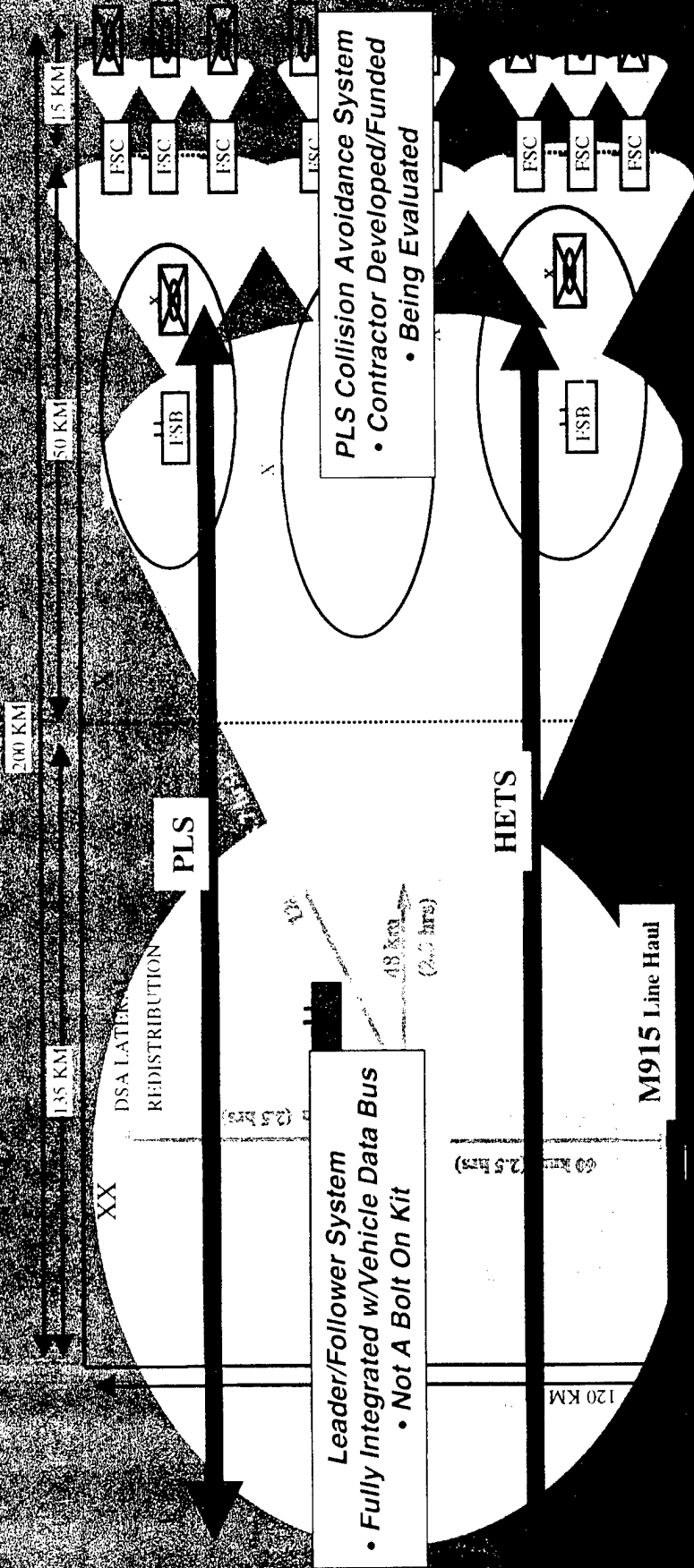

Leader/Follower System
 • Fully Integrated w/Vehicle Data Bus
 • Not A Bolt On Kit

PLS Collision Avoidance System
 • Contractor Developed/Funded
 • Being Evaluated

- INDICATES LINE HAUL RADIUS
- INDICATES LOCAL HAUL RADIUS

Committed to Excellence

"SEALED HOOD" Concept

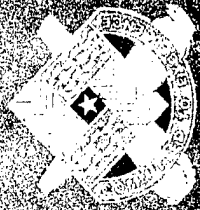

Extension of the HEMTT ESP

Combines:

- Highly reliable vehicle components
- J1939 data bus, sensors & displays

Method:

Provide operator requirements on display:

- fuel levels
- trans. oil temps
- system voltage
- air filter indication
- coolant levels, etc.

Result:

Hood opened only for Maintenance.

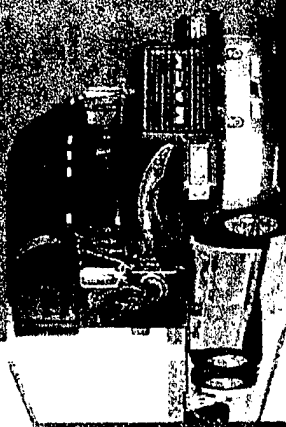
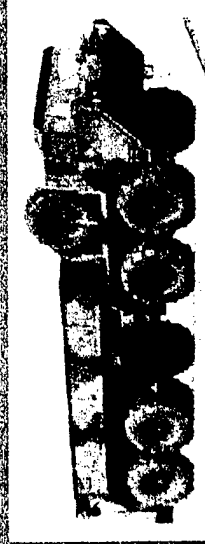

Line Haul (class 8) Parallel Hybrid Electric

- Fuel Economy
- EPA Requirements
- Performance
 - acceleration
 - stealth
 - on-board power

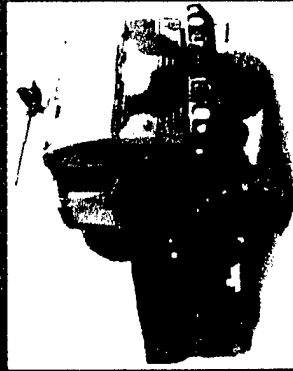

FMTV Series Hybrid Electric



Electric HMMWV

Alternative Propulsion Programs

8 / 14

Committed to Excellence

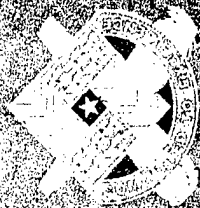

TACOM

LTV LCM Strategy



• Recapitalize Investment:

- Supports a Recapitalization Effort to Improve the Condition of the Fleet Within Economic Threshold
 - Leverage off Previous Investment
 - Recoup Residual Value
 - Extend Life of the Legacy by Improving RAM

• Maintain Production:

- Maintains HMMWV Production for AAO Requirements:
 - Replacement Vehicles
 - Heavy Variants
 - USMC and USAF Requirements
 - Spares for Legacy Fleet

• Modernize Fleet:

- Leverages Commercially Based Tactical Truck (COMBATT) Technology Demonstration Program
 - Insert Commercial Technologies
 - Meet Army XXI, Legislative Requirements

Extended Life

AAO
121,692
Vehicles

Tech
Insertion

9/14

Committed to Excellence

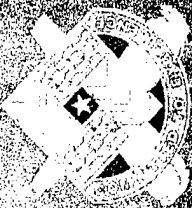

TACOM

LTV Strategy Spiral Modernization

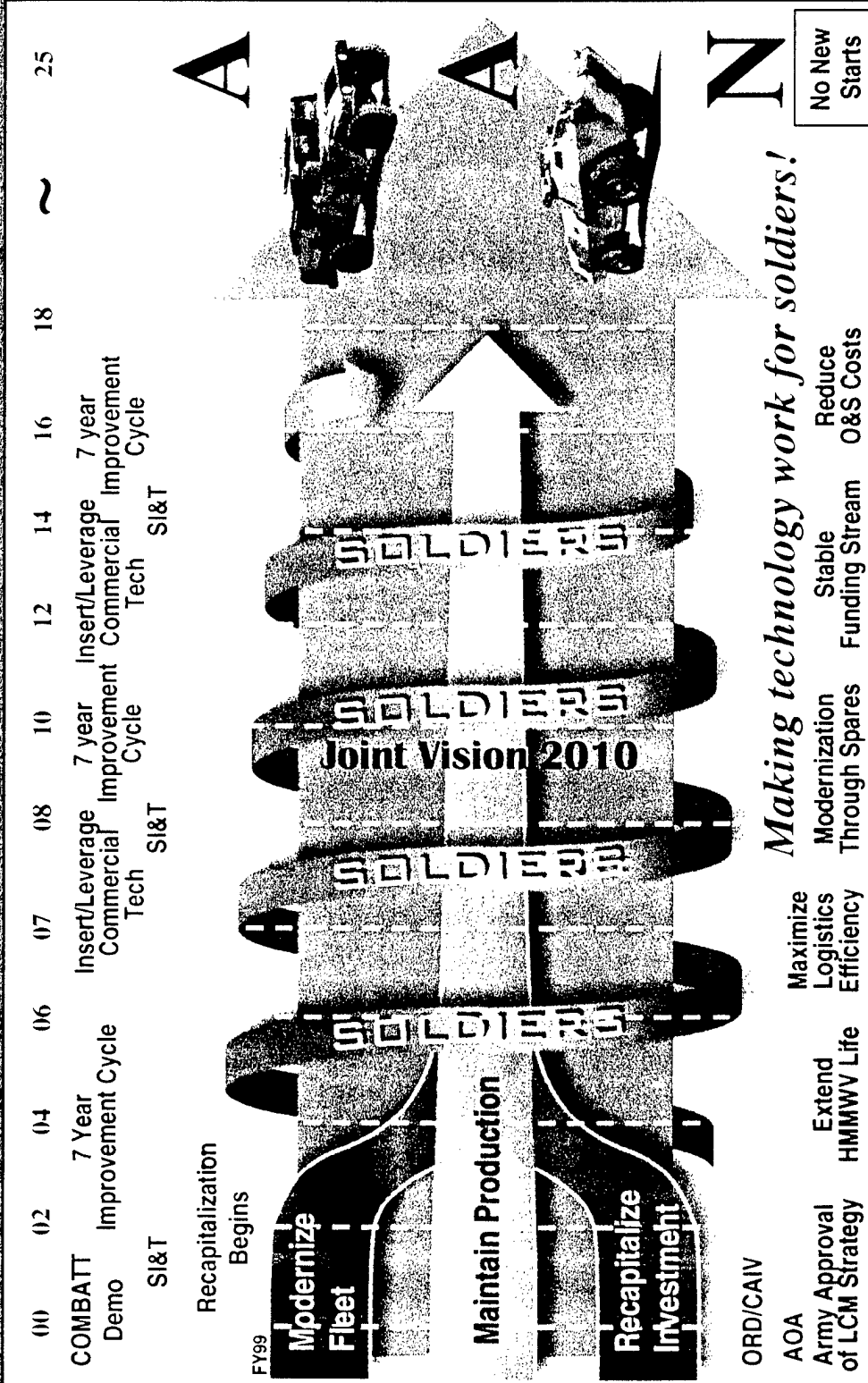

Making technology work for soldiers!

Committed to Excellence

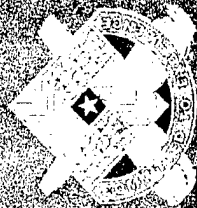

TACOM

"There's a Lot of Carnivores in the DoD!"

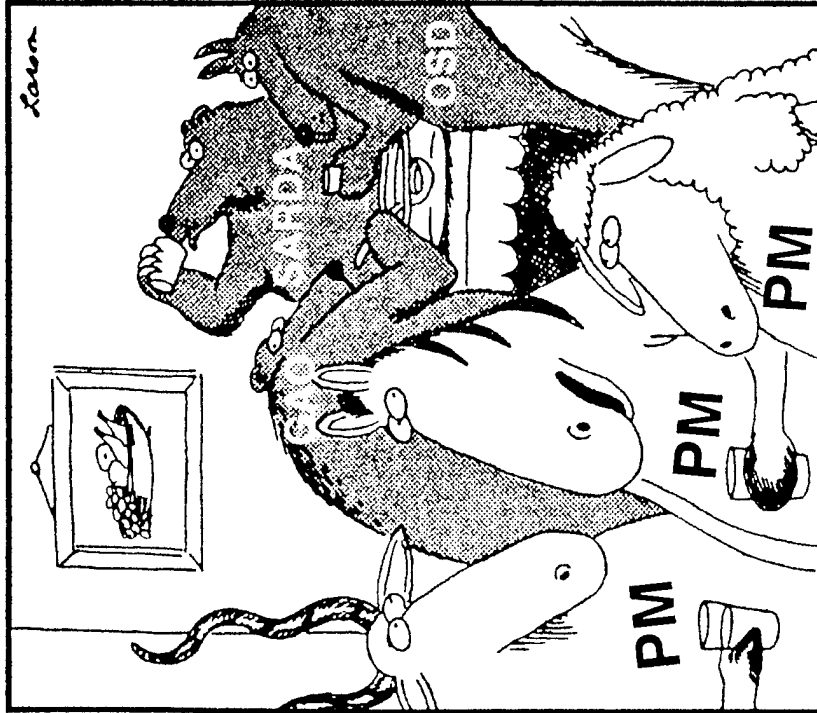

"I don't like this. ... The carnivores have been boozing it up at the punchbowl all night—drinking, looking around, drinking, looking around ..."

11/14

Committed to Excellence

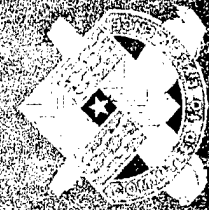

Food for Thought

The Way We do Business Today
Congress

Congress



Industry/Lobbyists



- Stovepiped
- Vulnerable to Funding Cuts
- Separate Visions
- Lack of Integrated TWV Strategy
- Lacks Cohesiveness
- Individual Lobbying Efforts
- Competing Interests

The Future of Manufacturing and the U.S. Economy

Tomorrow's Possibilities

One Team, One Voice

- Overarching Vision
- Synchronized Requirements
- Integrated Vision
- Stronger Position against \$ Cuts
- Cohesive Lobbying Efforts
- Unified Interests

Strength in Numbers - Total Approach!

12/14

Committed to Excellence

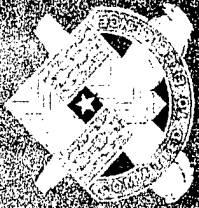

TRACOM

Summary



- Trucks Are Combat Power
- “Systems that Kill, Don’t kill much of anything without Trucks!”
- Logistics Requirements will exponentially increase in Army After Next
- Think Out of the Box!

To Keep Pace with Army’s JV2010 & AAN Requirements additional Funding is Necessary!

Committed to Excellence

13 / 14

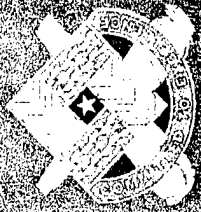

EDASOIM

The Bottom Line



“The difficulty lies, not in the new ideas, but in escaping from the old ones...”

John Maynard Keynes, Economist

Committed to Excellence

14 / 14

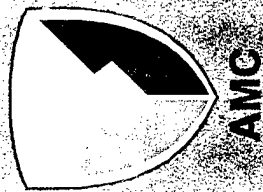

Deputy for Systems Acquisition
Tactical Wheeled Vehicles Conference
"Organization & Responsibilities"

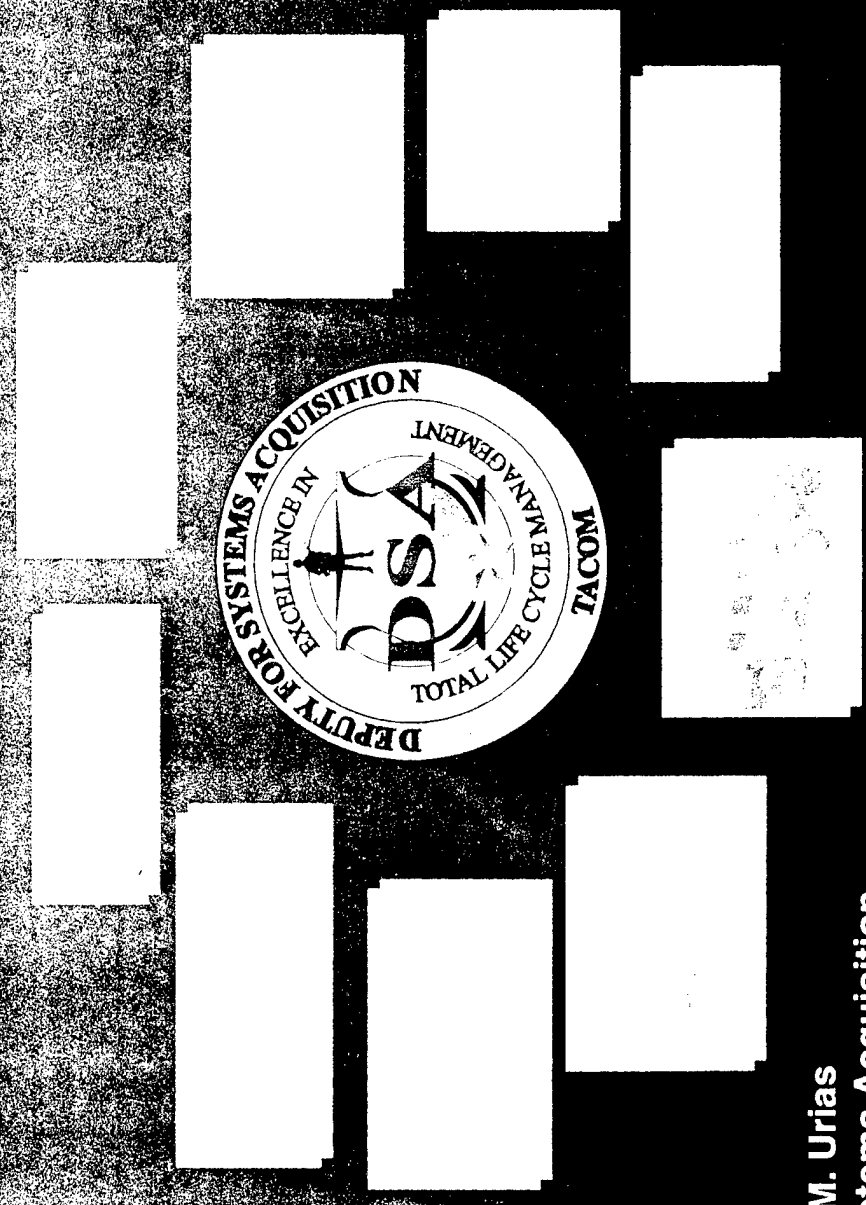
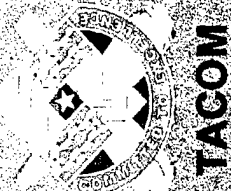

COL (P) John M. Urias
Deputy for Systems Acquisition

Tank-automotive & Armaments Command
Committed to Excellence

2 February 1999



The DSA

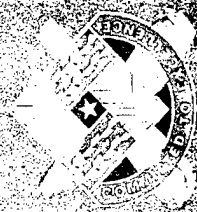

TACOM



"And so you just threw everything together? ... Mathews, a posse is something you have to organize."

2 Feb 99

2 / 10

Committed to Excellence

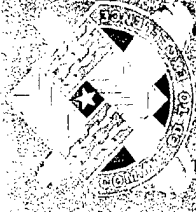

TACOM

Where We Bring Innovative & Supportive Armaments Components (TACOM)



- TACOM Mission**
- To Generate Warfighting Capability for the Army
 - To Sustain the Warfighting Readiness of the Army
 - To Manage the Army's Investment in S&T, R&D and Sustainment for the Army
 - Serve as the Life Cycle Manager and Integrator for Ground Combat Equipment

TACOM CG

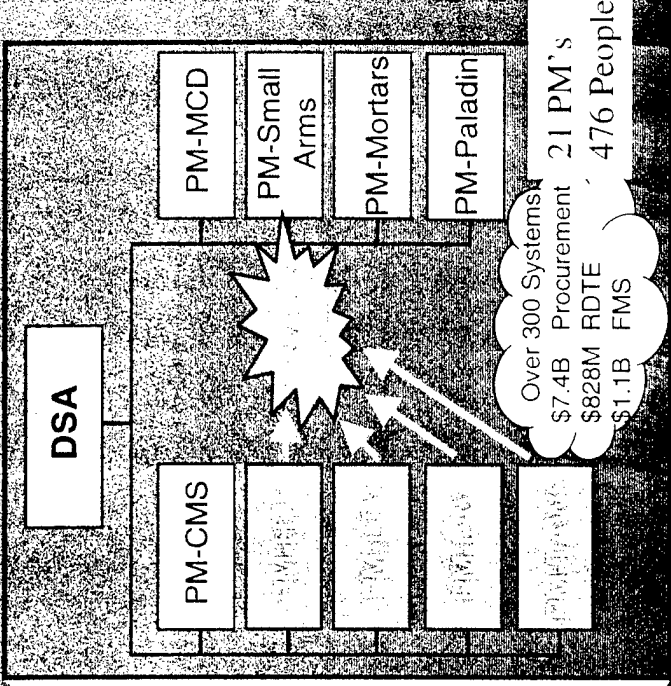
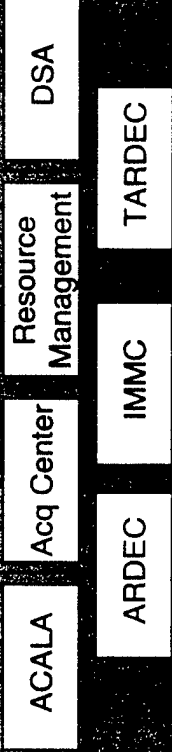

Tank-automotive & Armaments Command

Research, Develop, Field and Support Mobility and Armaments Systems

Total Life Cycle
To Support Army Readiness

- Mortars
- Rifles
- Machine Guns
- Ammo
- Aircraft Armaments
- Demolitions & Explosives
- Rail
- Watercraft
- Seis, Kits & Outfits
- Shop Equipment
- Chemical Defense Equipment
- Howitzers
- Large Caliber Guns

TACOM VISION

To make the technology and sustainment systems work for soldiers through the seamless integration

To create where every associate understands the requirement to and understands their inherent responsibility to do so.

Committed to Excellence

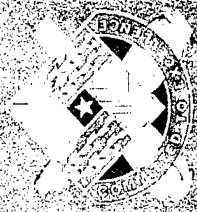

TACOM

Mission



**In Partnership with our Customers and Industry,
Develop, Produce, Field, and Sustain Technologically
Advanced World Class Equipment, Systems and
Capabilities for the 21st Century Warfighter.**

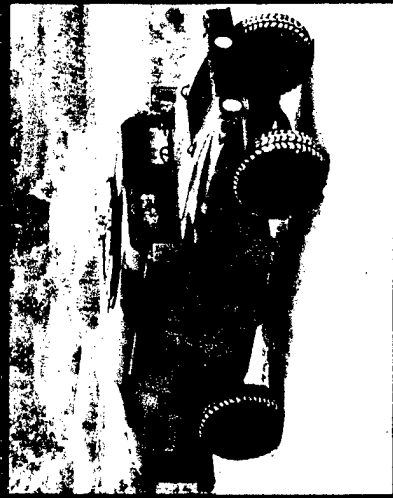

2 Feb 99

Committed to Excellence

4 / 10

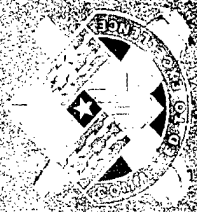

TACOM

Vision



- Develop and maintain a multi-functional work area that fully embraces the **integrated process** concept, with a **single point of contact** for all **requirements of TACOM of the Future**.
- Harmonize the DSA efforts with the other business centers and outside agencies to **leveraging their unique capabilities** in order to **enhance customer service** and our other customers.
- Execute **total life cycle management** for all programs with emphasis on efficiency and cost reductions.
- Institutionalize an **operational culture** wherein the **acquisition capabilities** are the standard way of doing business.
- Build **productive relationships** with contractors and customers ensuring **successful relationships with industry**.
- Create an organizational structure that automatically responds to the fast changing environment while **maintaining a high level of performance** the direction of Joint Vision 2010 and Army After Next.

2 Feb 99

Committed to Excellence

5 / 10

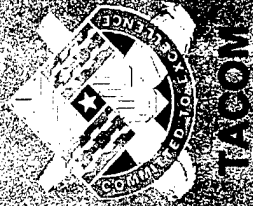

PM Heavy Tactical Vehicles (HTV)

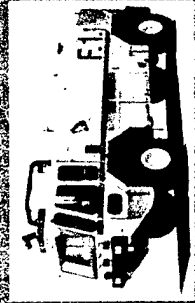
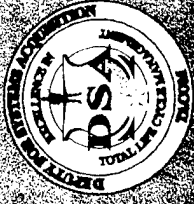

M977 (HEMTT)



Advanced Tactical Fire Truck

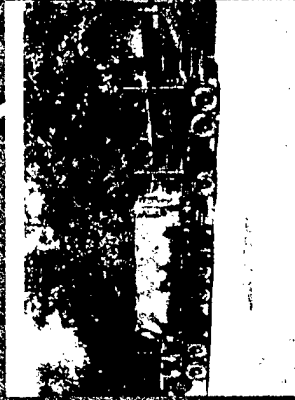

M1977 (Common Bridge Transporter CBT)

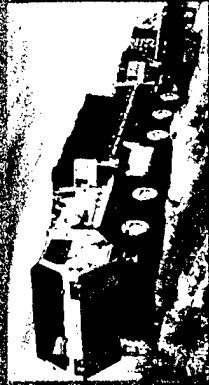

M1074/M1075 (PLS)

2,100+ BRIDGES
13,000+ HEMTTs
1,600+ HETs



M1070 (New HET Tractor)



M984 (HEMTT Wrecker)



M983 (Patriot Tractor)

“Providing Transportation & Bridging Solutions For Force XXI and Beyond”

2 Feb 99

6 / 10

Committed to Excellence

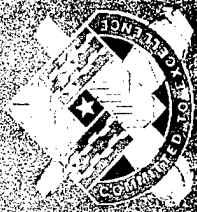

TACOM CSMO

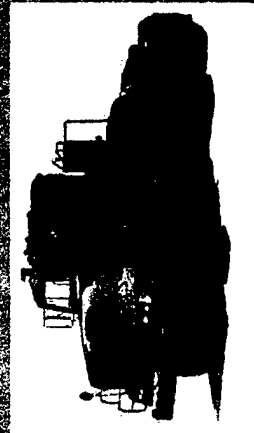

M915/67 Series



M939 5 Ton



Yard Tractor

PM Tank Automotive Weapons Systems



CME

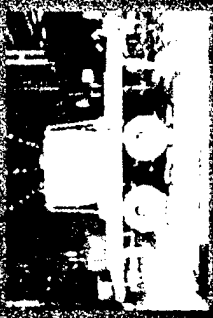

M1061A1 Fuel Pod

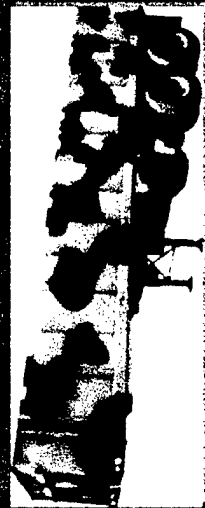

**M871A2
22.5 Ton Semitrailer**



**M129A4 12 Ton
Semitrailer Van**



**Asphalt Mixing
Plant (AMP)**



RTCH

**37,000+ TRACTORS/
TRUCKS
66,000+ TRAILERS**

2 Feb 99

“Strategic Mobility and Beyond”

Committed to Excellence

7 / 10

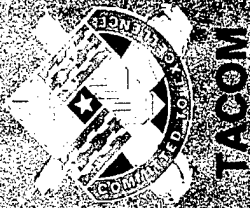

PM Light Tactical Vehicles (LTV)

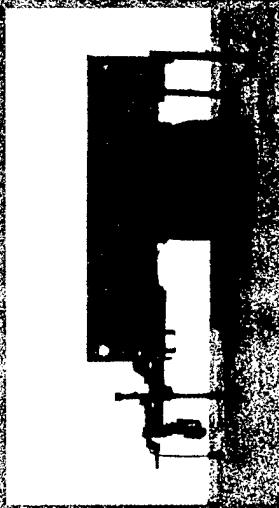

**M1101/M1102 High
Mobility Trailer (HMT)**

**135,000+ HMMWV
6,000+ HMT
1,700+ ASV REQ**

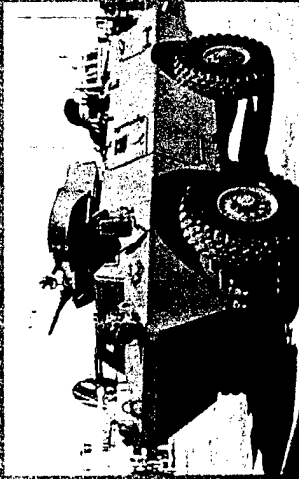

**Armored
Security Vehicle**



HMMWV

“Light Trucks-Multiservice Mobility & Backbone of the Force”

2 Feb 99

8 / 10

Committed to Excellence

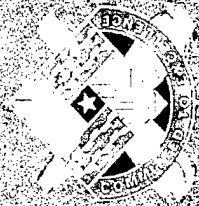

TACOM

DSA FUNDING PROFILE

FY99 Budget Estimate Submission (\$M) FY99-05



	<u>PROCUREMENT</u>	<u>RDT&E</u>	<u>TOTAL</u>
PM, TAWS	3,633.417	138.712	3,772.129
PM, PALADIN	49.222	0.000	49.222
PM, LTV	1,069.781	18.700	1,088.481
PM, MCD	1,298.797	441.297	1,740.094
PM, CMS	1,571.634	197.532	1,769.166
PM, HTV	2,264.030	35.404	2,299.434
PM, SMALL ARMS	355.327	295.433	650.760
PM, LAV	197.268	22.047	219.315
PM, MORTARS	673.897	0.000	673.897
TOTAL	11,113.373	1,149.125	12,262.498

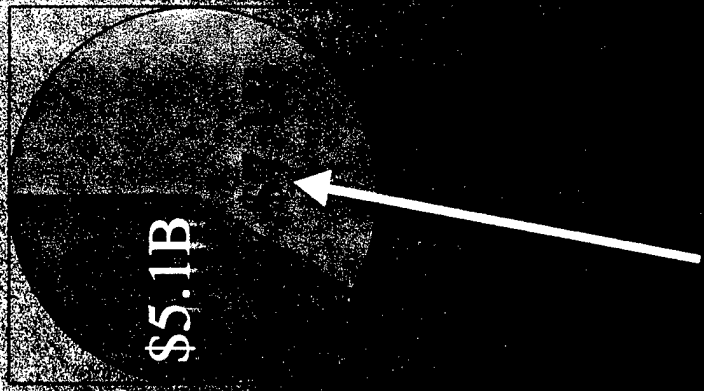

Tactical Wheels

2 Feb 99

9/10

Committed to Excellence

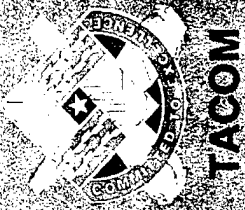

DSA Organization and Mission Summary



- **Extremely Diverse Systems in Very High Densities**
- **Systems of Systems Approach to Development**
- **Life Cycle Management Focus**

2 Feb 99

Committed to Excellence

10 / 10

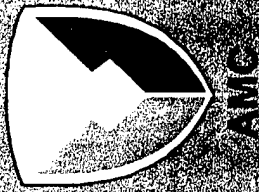

Deputy for Systems Acquisition Tactical Wheeled Vehicles Conference "Spiral Modernization"

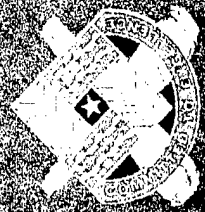

AMC

ACQ/IN

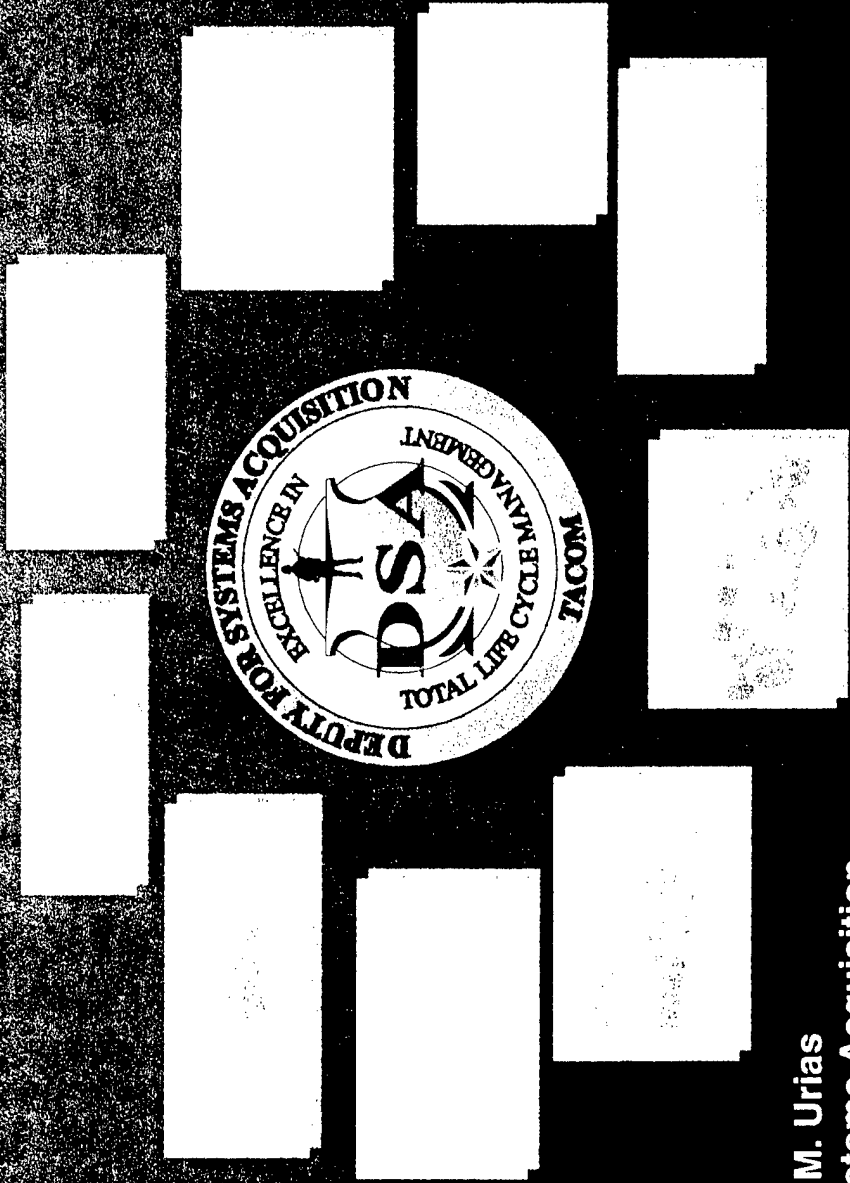

COL (P) John M. Urias
Deputy for Systems Acquisition

Bank-automotive & armaments Command
Committed to Excellence

2 February 1999

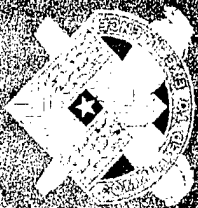

TACOM

The Army's Focus for the Future



Trucks are
Combat Power!

Full Dimensional
Protection

Protect the Force

Gain Information
Dominance

Decisive
Operations

Shape the
Battlespace

Project the
Force
Sustain
the Force

Army Vision 2010

Joint Vision 2010

Dominant Maneuver

Focused Logistics

Precision
Engagement

Full Spectrum



Dominance



Committed to Excellence

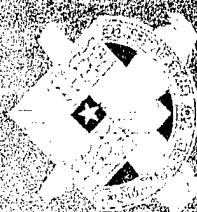

TACOM



The Challenge of Reality

- Indefinite Support Horizon
- Few if any New Starts
- Maximum Reliance on Technology
- Future Operations will place greater demand on the TWV Fleet

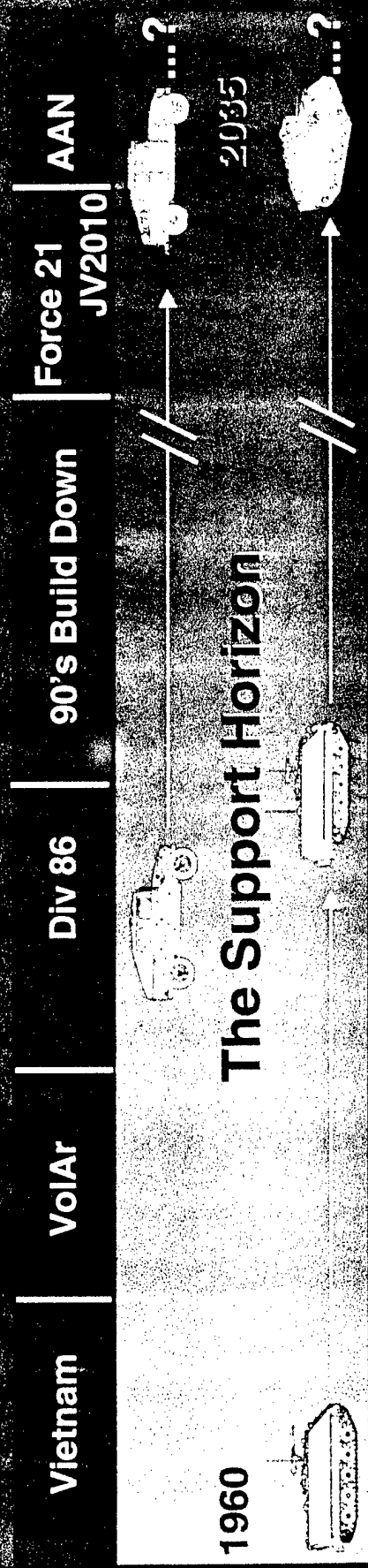

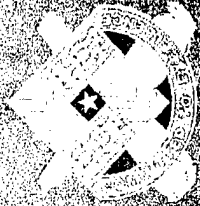

TACOM

How Things Changed When Life Cycle Management Became a PM Responsibility!

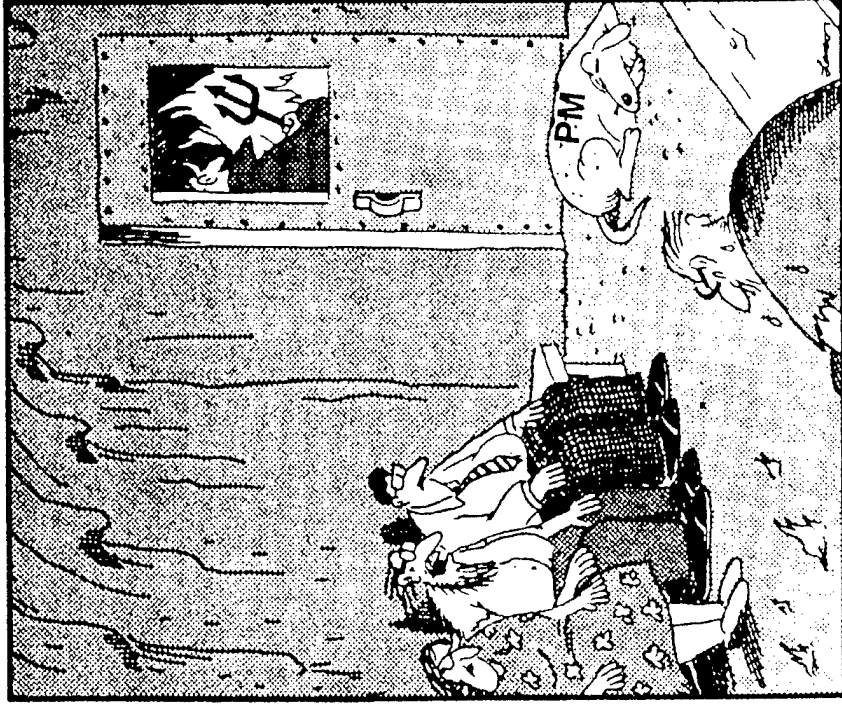

"His story? Well, I dunno. ... I always assumed he was just a bad dog."



A Change in Focus

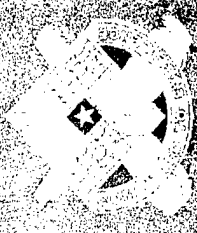

TACOM

AAE Memorandum

New PM Charter

Effectively immediately, Program Executives Officers (PEOs) and Major Commands (MACOMs) who manage ACAT systems are responsible for the management of total life cycle costs for these systems.

PM's can't execute LCM Alone! Requires Line Item Mgt & Program Mgt!

You are responsible for the Life Cycle Management of your programs and will actively manage within approved resources, program cost, performance and schedule and provide assessments of program status, risk and contractor performance.

Cost, Schedule, Performance



Total Life Cycle = RDTE + Procurement + Sustainment + Modernization + ???

Committed to Excellence



"We Shop the LOM Gun First and Are Just Now Asking the Questions!"

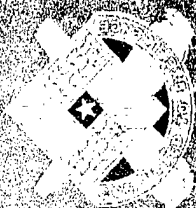

TACOM

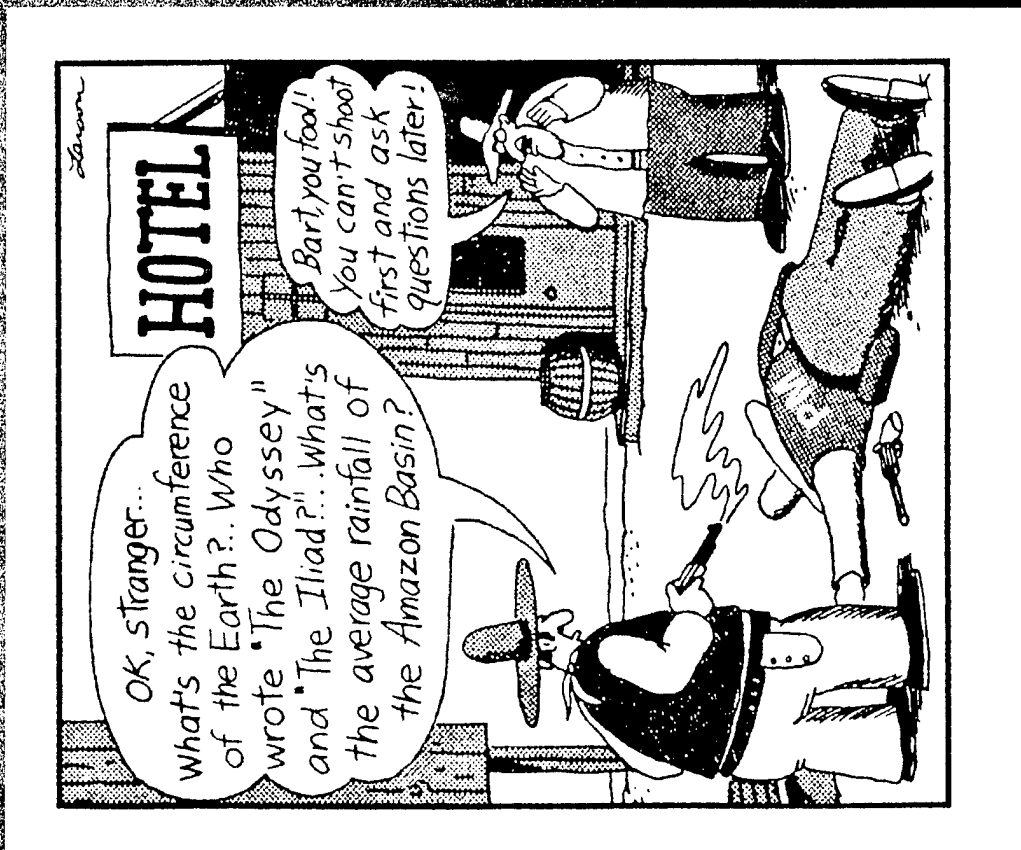

5/9

Committed to Excellence

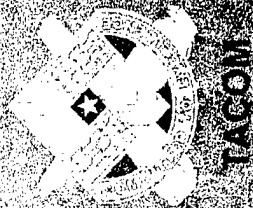

Spiral Modernization The Road to the Future



Force XXI Joint Vision 2010 Army After Next

Modernize the Fleet

Recapitalize Investment

Changing

And Evolving

User Requirements

CONTINUAL

TECHNOLOGICAL

INSERTION

...the future of the Army is not just about the hardware, it's about the people who will use it. ...

7/9

Committed to Excellence

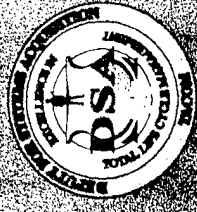

We Don't Want to Fix the World...
We Just Want a Better Truck

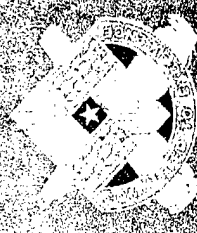

TACOM

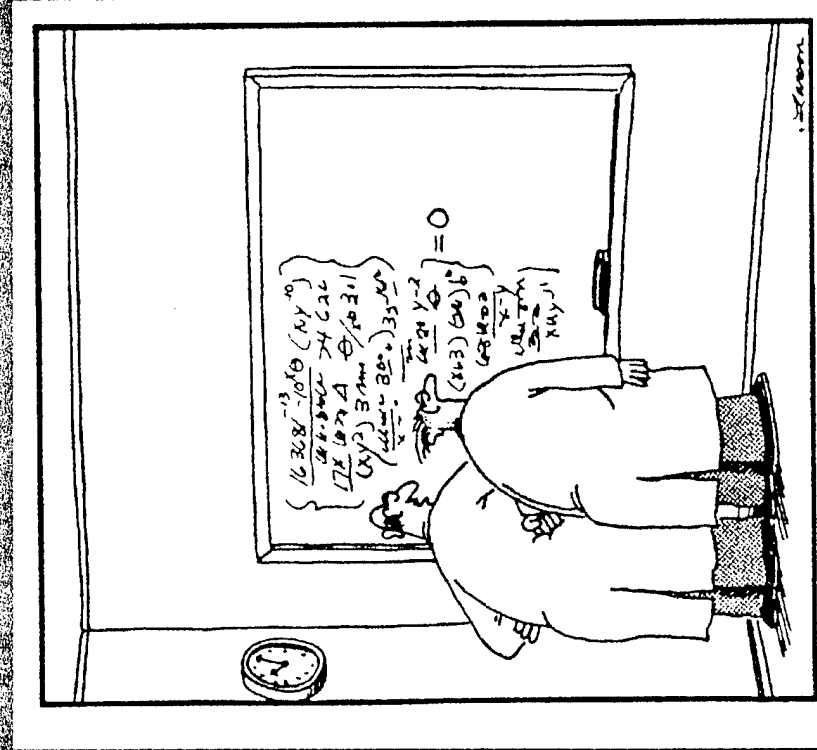

"No doubt about it, Ellington—we've mathematically expressed the purpose of the universe. God, how I love the thrill of scientific discovery!"

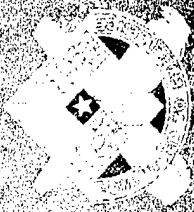

TACOM

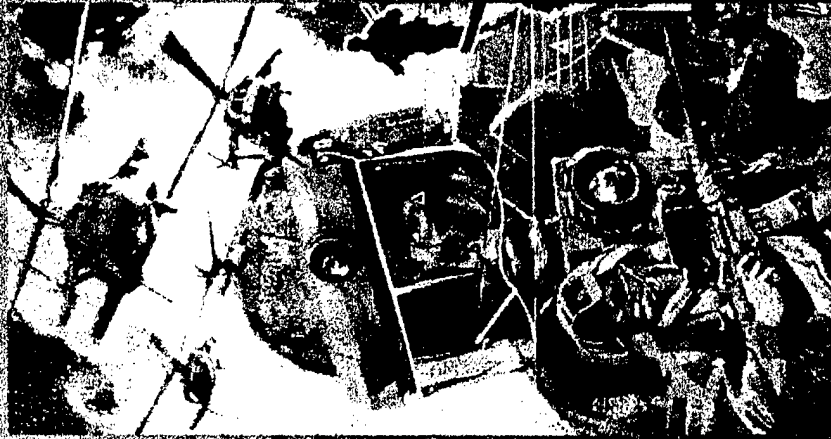

Industry Involvement



- Maximum use of Modeling and Simulation Tools where Applicable
- Test Community Acceptance of Simulation Based Acquisition
- Continued use of Government/Industry Partnering Arrangements
- Total Life Cycle Focus

9/9

Committed to Excellence

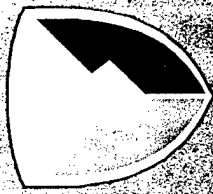

AMC

Deputy for Systems Acquisition Tactical Wheeled Vehicles Conference "Health of the Wheeled Vehicle Fleet"

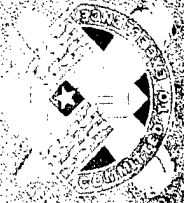

TACOM

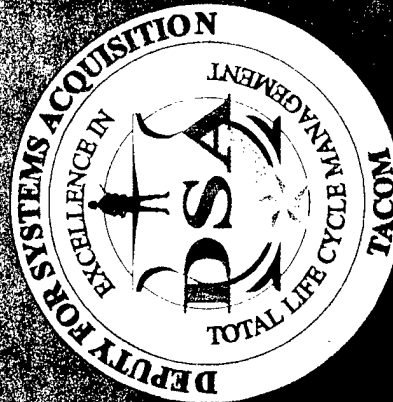
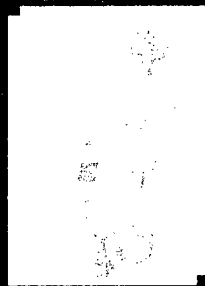
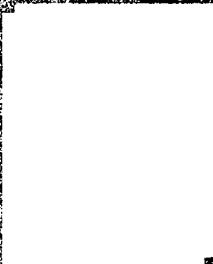

COL (P) John M. Urias
Deputy for Systems Acquisition

Tank-automotive & Armaments Command
Committed to Excellence

2 February 1999

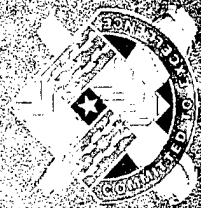

Heavy Tactical Vehicles Status



TACOM

HEMTT

Requirements

- AAO: 13,602
- Procured to Date: 12,578

Status

- OSD Pilot: PM Oversight of Product Support
- LHS Acceleration
- ESP Startup
- Fleet Readiness Marginal

HET

Requirements

- AAO: 2,554
- Procured to Date: 1,950

Status

- Tech Insertion Program
- System Concept

PLS-E

Requirements

- AAO: 4,764
- Procured to Date: 3,298

Status

- Applications Continue to Grow
 - Engineer Mission Module
 - Heavy Dry Support Bridge Launcher
 - Forward Repair System (FRS)
 - Fuel and Water
- FRS Acceleration

HTV Ongoing Actions:
Army Stabilizing HTV Budget Into Future
Closer Coordination of PM-TARDEC-NAC Future Concept Work
Heavy Fleet Continues to Grow

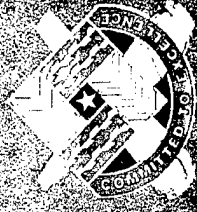

Line Haul Fleet Status



M915A4

Requirements

- AAO: 6,956
- Procured to Date: 0 (171 on Contract)

Status

- 171 Kits on Contract
- Testing On-Going @ APG

M916A3

Requirements

- AAO: 2,736
- Procured to Date: 2,920

Status

- Additional Procurement on Next Generation Contract

M915

Requirements

- AAO: 6,956
- Procured to Date: 5,004

Status

- 440 A3s will go on Contract - 2Q99
- M915-Next Generation Targeted for Contract 2Q00

M917A1

Requirements

- AAO: 1,060
- Procured to Date: 307 Received/ 665-on Contract

Status

- Currently Being Fielded

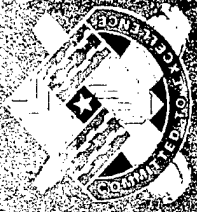

TACOM

Line Haul Fleet Status (Cont)

M878A2

M939



Requirements

- AAO: 330
- Procured to Date: (M878A2s)
33 Basic 162 A1s

Status

- Replacing all Existing (Buying 333)
due to 25 Years age w/ Life Expectancy
of 10 Years

Requirements

- AAO: 32,000
- Procured to Date: 32,000 (approx)
We won't buy anymore

Status

- To Enhance Safety and Diminish
Operations Errors, we are Installing ABS
Brakes and Replacing Bias Ply Tires with
Radial

FWTD

Requirements

- AAO: 121
- Procured to Date: 0

Committed to Excellence

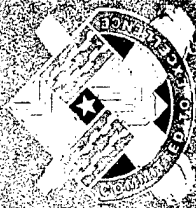

TACOM

Light Tactical Vehicles

HMMWV



HIGH MOBILITY TRAILER

Requirements

- AAO: 121,692 (45,474 FP1&2; 76,218 FP3&4)
- Procured to Date: Total: 135,579
- USMC: 18,582 USAF: 3,790 Navy: 585
- FMS: 9,769 Army: 102,853

Status

- Aging Fleet
- Continued HMMWV Production
- Increased Payload Demands
- Fleet Modernization Plan Being Implemented
- Corrosion Prevention Pkg in Prod Vehicles
- USMC Replacing Fleet with new Prod Vehicles

Requirements

- AAO: 29,554 (13,140 FP1&2; 16,414 FP3&4)
- Procured to Date: 6,077

Status

- Correct Technical Issues
- Field in Priority
- Competitive Rebuy to Performance Requirements
- Customer Requirements Increasing

ASV

Requirements

- AAO: 1,794 (810 FP1&2; 984 FP3&4)
- Procured to Date: 4 Prototypes

Status

- Entering Production
- Concern for Weight & Cost of Armor
- Remote Turret
- Increased Emphasis on Digitization

Committed to Excellence

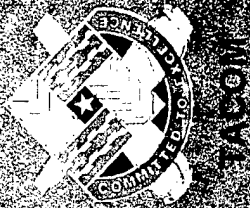

"So Just How Healthy is the TWV Fleet?"

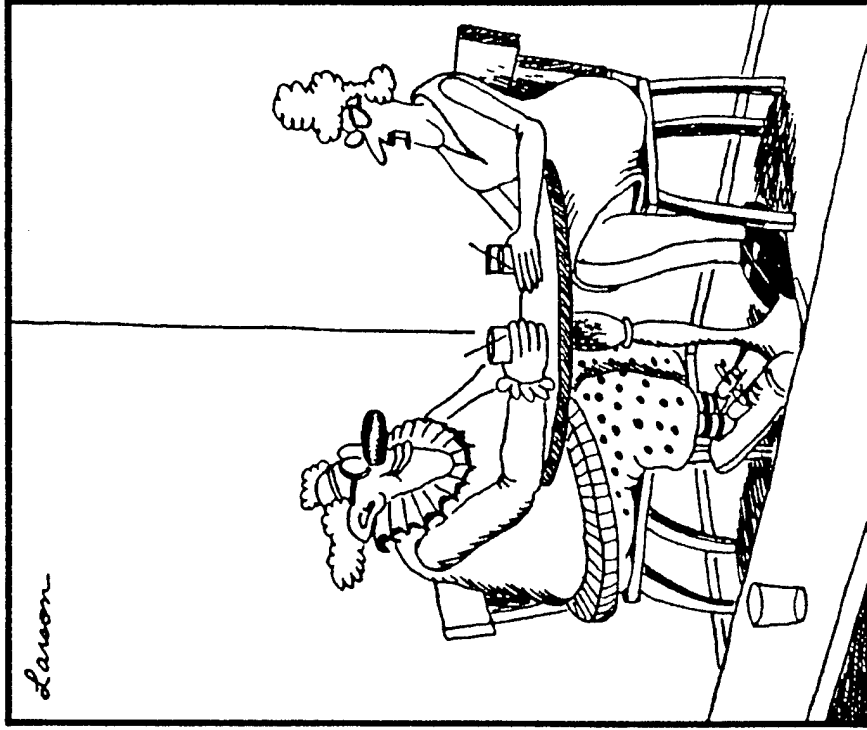

"And I like honesty in a relationship. ... I'm not into playing games."

6/9

Committed to Excellence

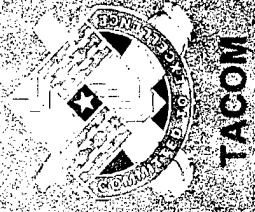

Heavy Fleet - Tactical Design



NEAR-TERM FY 99-05	MID-TERM FY 06-15	FAR-TERM FY 15-25
[REDACTED]	[REDACTED]	[REDACTED]

OVERALL ALL FLEETS IN GOOD SHAPE

HEAVY FLEET - COMMERCIAL DESIGN

NEAR-TERM FY 99-05	MID-TERM FY 06-15	FAR-TERM FY 15-25
[REDACTED]	[REDACTED]	[REDACTED]

ASSETS MEET REQUIREMENTS - OVER AGE OK

7/9

Committed to Excellence

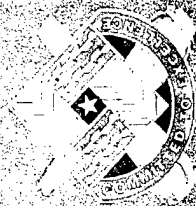

TACOM

Light Fleet



NEAR-TERM FY 99-05	MID-TERM FY 06-15	FAR-TERM FY 15-25
[REDACTED]	AMBER	AMBER

ASSETS MEET REQUIREMENTS NOT OVER AGE

FP 1 & 2 OK OVERAGE

FP 1 & 2 OK OVERAGE

TRAILERS

NEAR-TERM FY 99-05	MID-TERM FY 06-15	FAR-TERM FY 15-25
AMBER		

SHORTAGE

FILL

FILL

8/9

Committed to Excellence

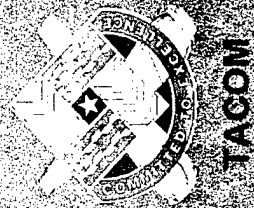

Summary



- *Overall Health of the Tactical Wheeled Fleet is Adequate, however Fleets are aging.*
- *Innovative Modernization Strategies are required to meet minimum requirements of JV2010 & AAN.*

Committed to Excellence

9 / 9