

Contract No. GS35F4155D

(Unclassified)

PHASE II REPORT

**USAF LOGISTICS PROCESS
OPTIMIZATION STUDY
for the
Aircraft Asset Sustainment Process**

AFLMA Project LM9731101

Volume III of III

**Future To Be
Asset Sustainment
Process Model**

Prepared for:

AFLMA
501 Ward Street
Maxwell AFB,
Gunter Annex, AL 36114-3236

Prepared by:

Intergraph Corporation
Federal Systems
Enterprise Services Division
Huntsville AL 35894-0001

**Reproduced From
Best Available Copy**

19990601 088

31 December 1998

This page left intentionally blank

TABLE OF CONTENTS

1.0	BACKGROUND	1
2.0	METHODOLOGY	1
3.0	DISCUSSION	2
4.0	CONCLUSION	2
5.0	RECOMMENDATIONS.....	3
6.0	MODEL	
	NUMERIC TABLE OF CONTENTS.....	4
	ALPHABETIC TABLE OF CONTENTS	6

This page left intentionally blank

1.0 BACKGROUND

In March 1998, HQ USAF/ILXI reviewed the AFLMA/Intergraph Reengineering Team's As Is and To Be process models and requested the team develop a To Be model for a more distant future asset sustainment scenario, unconstrained by today's logistics information systems limitations. The team developed the initial 'distant future' To Be process model after reviewing published Air Force documents on vision, future doctrine, and mission forecasts.

2.0 METHODOLOGY

We reviewed sources including:

- Air Force 2025
- Joint Vision 2010
- Supply 2000
- Quadrennial Defense Review
- Air Force Long Range Plan
- Air Force Logistics Strategic Plan
- DOD Logistic Strategic Plan
- Global Engagement: A Vision for the 21st Century Air Force
- Global Combat Support System Concept of Operations
- 1998 Scientific Advisory Board report on Air Expeditionary Force (AEF) concepts

Using these publications, the AFLMA/Intergraph Reengineering Team merged the presented concepts with current technology and functional momentum. The result was the team's outlined perception of an IDEF-3 future (roughly 10-20 years out) logistics process model.

This future model is based on the team's understanding of the strategic vision and reflects processes meant to:

- Increase efficiency and speed of Air Force logistic systems
- Eliminate redundant, overlapping processes between stove-piped organizations
- Increase the reliability of the logistic systems (including data accuracy)
- Provide an overarching model for the development of all future Air Force logistics

This future process model incorporates current technologies as well as future, emerging technologies. The team did not limit the process model to steps required by current legacy systems, processes, or functional stovepipes.

The model incorporates the principles of Shared Data Environment (SHADE), improved Reliability Centered Maintenance (RCM), increased automation and world-wide web utilization, Forward Support Locations (FSLs), centralized weapon systems management, Expeditionary Aerospace Forces (eAF), and Agile Combat Support concepts.

3.0 DISCUSSION

At the request of Lt Gen William Hallin, HQ USAF/IL, the concepts and process impacts built into the future model were briefed to his deputy and the HQ USAF/IL directorates on 21 and 22 May 1998. The IL staff, in general, agreed that there is benefit to having a process-centric reengineering approach; however, they could not reach consensus on a unified view regarding the future vision of logistics.

Contentious issues included centralized weapons system management and the concept of using forward support locations (more specifically whether they would be established on a regionalized or ad hoc basis). While the concept, as it was presented in our briefing, advocated one centralized office to resolve logistics support shortfalls, some of the IL staff indicated they disagreed with this concept. In their opinion, Air Force leadership seemed to be leaning toward decentralized control and reliance on automated decision tools such as EXPRESS, Standard Base Supply processes, and the Military Standard Requisitioning and Issue Procedures (MILSTRIP) to determine priorities and outcomes for critical asset support to the war fighter.

Use of Forward Support Locations (FSL) for Agile Combat Support was a relatively new concept with many different interpretations of the implementation methodology. While there appeared to be agreement on the probability of future reliance on FSLs to achieve agile logistics, there was also disagreement. Views appeared to be divided upon whether FSLs should be established based upon peace-time operating locations for specific regions or whether FSLs should be established on an ad hoc basis depending on the theater of operations and type of crisis response.

While the IL staff did agree there is a need to have a vision, methodology, and process that can be used to focus and monitor logistics improvements, they did not necessarily support the use of this project as a vehicle to develop that future vision. The staff agreed that the lack of consensus indicated there is the need for an IL meeting with the "future of logistics" as a topic.

4.0 CONCLUSION

The inability of the IL staff to reach a consensus on the methods needed to achieve the logistics goals and objectives outlined in future doctrine indicates the need for an IL meeting with the future of logistics as a topic. The purpose of this meeting should be

twofold: 1) to foster discussions on the future processes and concepts for logistics and 2) to establish written strategic direction for all future efforts from reengineering to logistics information system modernization. The ideas presented and embedded in this Future To Be Asset Sustainment Process Model can be used to initiate these discussions. As the future relies heavily on Joint operations, coordination with other services is warranted to obtain their vision.

Benefit from using these Future To Be Asset Sustainment Process Model include:

1. Use as an overarching model to be the framework and guide for all future logistics studies and improvement efforts. Using this framework provides IL with a "road map" to determine which areas need further work, and the priority that work should be given. The model would also serve as a guidepost to insure the studies are all working towards the same end goal.
2. Use as a blueprint for developing future logistics information systems. Each process within the model contains "placeholders" where data requirements can be specified in detail and the interrelationship of each data element to data needed by other systems can be examined.

5.0 RECOMMENDATIONS

1. HQ USAF/IL establish and publish a strategic vision that successfully bridges strategy to operations planning that will provide specific insight for implementing the logistics goals and objectives outlined in future doctrine.
2. Once this occurs, use the Future To Be Asset Sustainment Process Model presented in this volume as a starting point to refine the logistics processes of the future.
3. After a new Future Model has been developed, promote its use for refining logistics information systems architecture(s) and shared data requirements.

This page left intentionally blank

Numeric Table of Contents

	<u>Page No.</u>
Scenario: Future To Be Asset Sustainment Process	1 - 13
Process Flow Decomps	
<hr/>	
In-Bound Receipt- Future	14 - 15
Evaluate Post Flight Data	16 - 17
DRMS Process	18 - 19
Inventory-Future	20 - 21
Evaluate Troubleshooting Data-	22 - 23
Sortie Recovery Future	24 - 26
Sortie Flown Exceeds (OBMS) Component Parameters*	27 -28
A/C To Be Launched to Repair Site	29 - 30
Mission Capable Aircraft (Parked) - Future	31 - 32
Sortie Generation- Future	33 -35
Producing Mission Capable A/C- Future	36 - 38
Issue Process - Future	39 - 40
Asset Movement - Future	41 - 43
Issue Request & Requisition Processing- Future	44 - 45
Asset Removal- Future	46 - 47
Identify Failure- Future	48 - 49
Non-Air Force Inventory	50 - 51
Base Intermediate Mx Asset Repair/ Mfg-Work Around	52 - 62
Fuel, Munitions, Engines, & Other Mission Equip	63 - 64
Sortie Launch- Future	65 - 71
Wholesale (Depot or Contract) Process- Work Around	72 - 78
Non-Sortie Related Logistics Processes	79 - 80
In-Check Asset	81 - 82
In-Check Container	83 - 85
RCM Analysis	86 - 87
Mx Tech Performs Pre-Flight Inspection	88 - 89
Mx Mgr Directs Refuel of A/C	90 - 91
Maintenance Manager Directs Configuration of A/C	92 - 94
Technician Prepares Asset for Shipment	95 - 97
Goes to Wholesale (Depot or Contract) Processing	98 - 99
Maintenance Manager Status Notification	100 - 101
Redball Repair Process	102 - 103
SSC Repair Planning & D035K / AWS Update	104 - 105
IM Reviews Requisitions	106 - 107
Receive Requisition	108 - 109
D035 Checks if Serviceable Asset Available	110 - 111
Serviceable Asset Post Repair Processing	112 - 113
DLA Pulls Unserviceable Asset or Parts Fr Storage	114 - 115
Unserviceable Asset Preparation & Movement to Repair	116 - 117
Serviceable Asset Distribution Prioritization	118 - 119
DLA Ships Asset	120 - 121

Process Flow Decomps	Page No.
Consumable Requisition & Demand Processing	122 - 123
DLA Receiving	124 - 126
DLA Pulls Serviceable Asset From Storage	127 - 128
EXPRESS Calculates Repair & Distribution Priority	129 - 131
Disposal	132 - 133
Tech Scans 1348 Requisition w/SATS	134 - 135
Tech Finds Asset Discrepancies	136 - 139
Transportation Processes Discrepancy Claim	140 - 141
Tech Finds Container Discrepancies	142 - 143
D035A Audits Requisition for Data Field Accuracy	144 - 145
DLA Prepares Asset For Storage or Shipping	146 - 147
DLA Determines Carrier	148 - 149
DLA Tech Manually Inputs Asset Info into D035K	150 -151
EXPRESS Runs Supportability Check	152 - 153
FM, SSC, & Shop Review EXPRESS Repair List	154 - 156
Supply Processes Discrepancy Claim	157 - 158
Tech Scans Asset (w/Discrepancy) with SATS	159 - 160

Alphabetic Table of Contents

	<u>Page No.</u>
Scenario: Future To Be Asset Sustainment Process	1 - 13
 Process Flow Decomps	
<hr/>	
A/C To Be Launched to Repair Site	29 - 30
Asset Movement - Future	41 - 43
Asset Removal- Future	46 - 47
Base Intermediate Mx Asset Repair/ Mfg-Work Around	52 - 62
Consumable Requisition & Demand Processing	122 - 123
D035 Checks if Serviceable Asset Available	110 - 111
D035A Audits Requisition for Data Field Accuracy	144 - 145
Disposal	132 - 133
DLA Determines Carrier	148 - 149
DLA Prepares Asset For Storage or Shipping	146 - 147
DLA Pulls Serviceable Asset From Storage	127 - 128
DLA Pulls Unserviceable Asset or Parts Fr Storage	114 - 115
DLA Receiving	124 - 126
DLA Ships Asset	120 - 121
DLA Tech Manually Inputs Asset Info into D035K	150 -151
DRMS Process	18 - 19
Evaluate Post Flight Data	16 - 17
Evaluate Troubleshooting Data-	22 23
EXPRESS Calculates Repair & Distribution Priority	129 - 131
EXPRESS Runs Supportability Check	152 - 153
FM, SSC, & Shop Review EXPRESS Repair List	154 - 156
Fuel, Munitions, Engines, & Other Mission Equip	63 - 64
Goes to Wholesale (Depot or Contract) Processing	98 - 99
Identify Failure- Future	48 - 49
IM Reviews Requisitions	106 - 107
In-Bound Receipt- Future	14 - 15
In-Check Asset	81 - 82
In-Check Container	83 - 85
Inventory-Future	20 - 21
Issue Process - Future	39 - 40
Issue Request & Requisition Processing- Future	44 - 45
Maintenance Manager Directs Configuration of A/C	92 - 94
Maintenance Manager Status Notification	100 - 101
Mission Capable Aircraft (Parked) - Future	31 - 32
Mx Mgr Directs Refuel of A/C	90 - 91
Mx Tech Performs Pre-Flight Inspection	88 - 89
Non-Air Force Inventory	50 -51
Non-Sortie Related Logistics Processes	79 - 80
Producing Mission Capable A/C- Future	36 - 38
RCM Analysis	86 - 87
Receive Requisition	108 - 109

Process Flow Decomps	Page No.
Redball Repair Process	102 103
Serviceable Asset Distribution Prioritization	118 - 119
Serviceable Asset Post Repair Processing	112 - 113
Sortie Flown Exceeds (OBMS) Component Parameters	27 -28
Sortie Generation- Future	33 -35
Sortie Launch- Future	65 - 71
Sortie Recovery Future	24 - 26
SSC Repair Planning & D035K / AWS Update	104 - 105
Supply Processes Discrepancy Claim	157 - 158
Tech Finds Asset Discrepancies	136 - 139
Tech Finds Container Discrepancies	142 - 143
Tech Scans 1348 Requisition w/SATS	134 - 135
Tech Scans Asset (w/Discrepancy) with SATS	159 - 160
Technician Prepares Asset for Shipment	95 - 97
Transportation Processes Discrepancy Claim	140 - 141
Unserviceable Asset Preparation & Movement to Repair	116 - 117
Wholesale (Depot or Contract) Process- Work Around	72 - 78

Scenario: Future To Be Asset Sustainment Process

①

ent Process

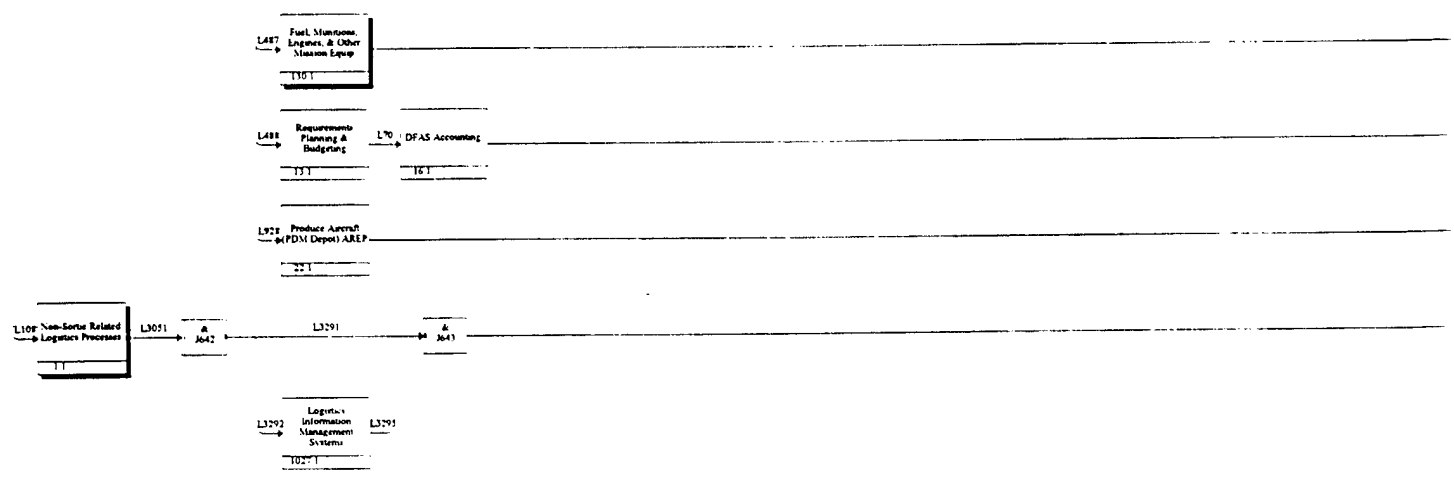
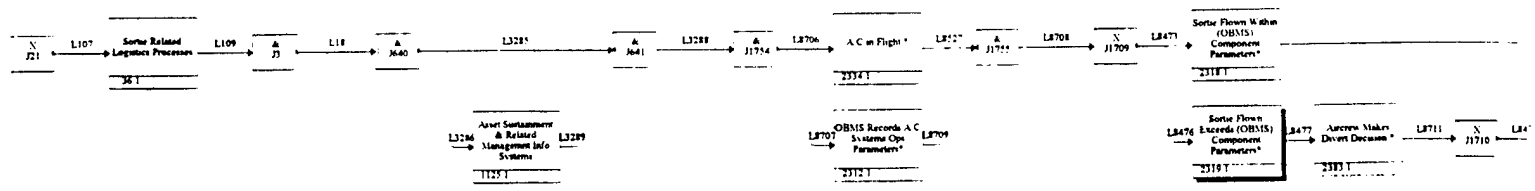

Date: 10/29/98
 Process Rev: 1
 Time: 10:30:21

Working
 x Draft
 Recommended
 Publication

N
 RE
 OF
 U

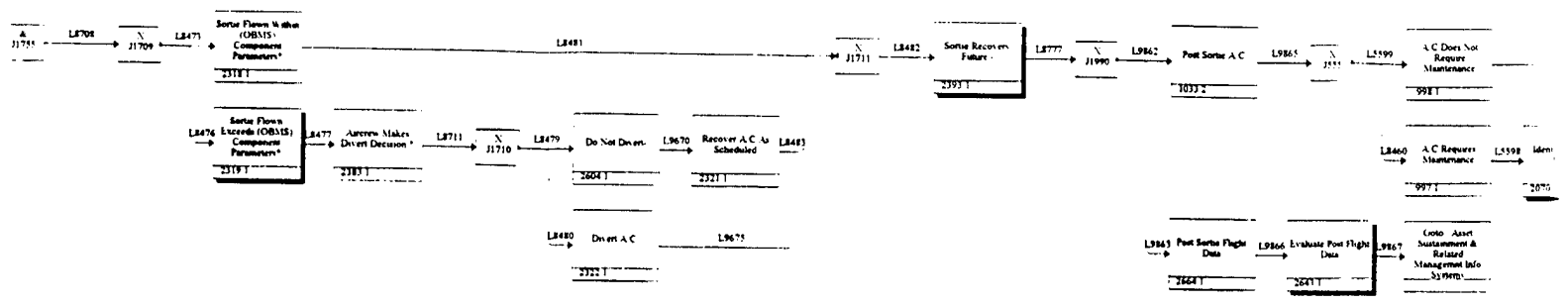

READER

DATE

Context

Neither the US Gov't or Intergraph has any responsibility or liability for any consequences of any use, misuse, inability to use, or reliance upon the information contained herein.

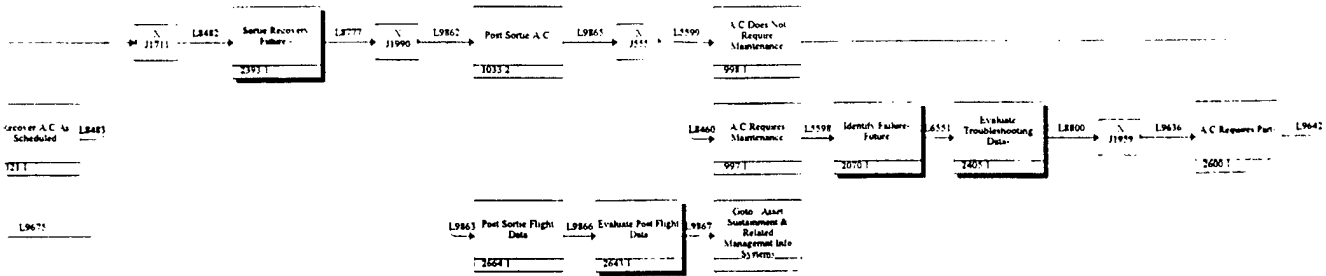

L964] A/C Does Not Require Part. L2591

19919

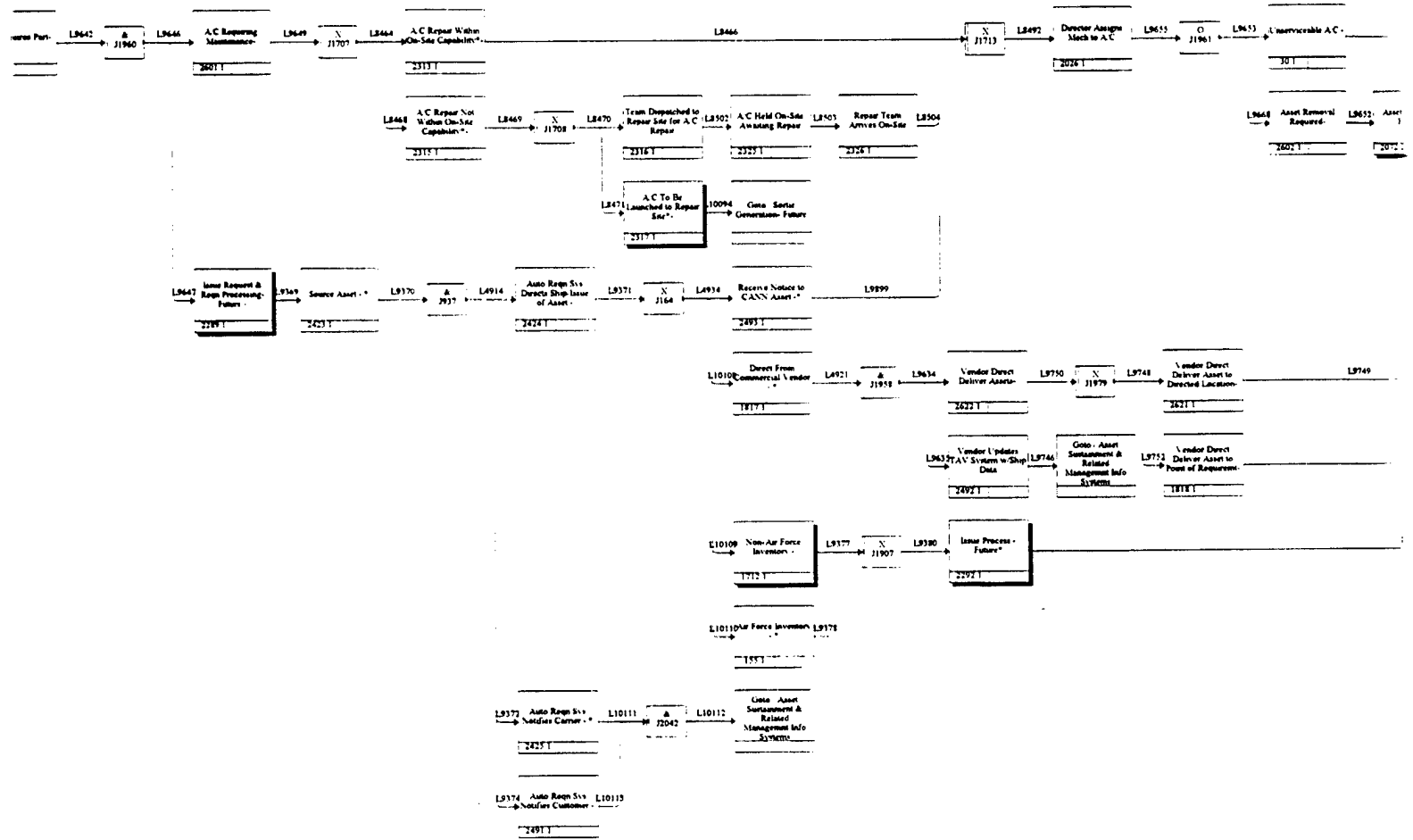

Does Not use Part

L73
L2859



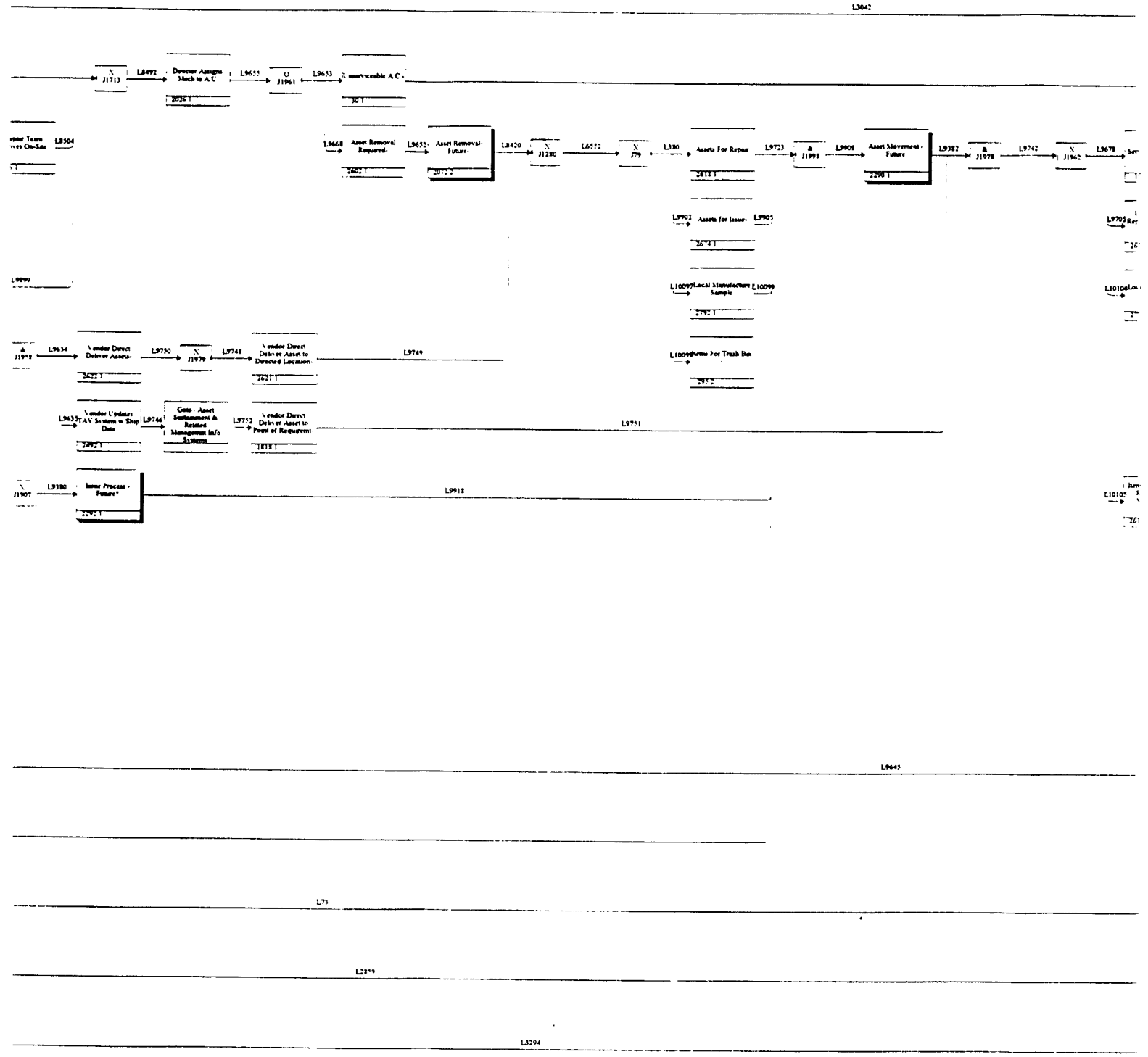

READER

DATE

Context

Neither the US Gov't or Intergraph has any responsibility or liability for any consequences of any use, misuse, inability to use, or reliance upon the information contained herein.

L3042

L9672

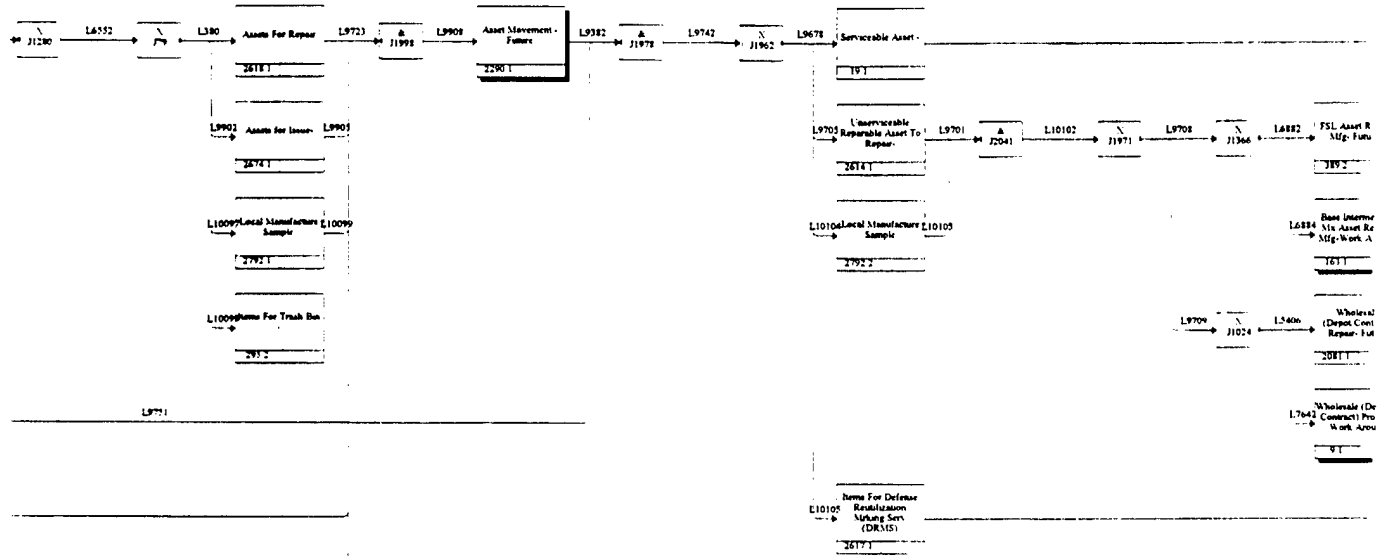

L9645

L3294

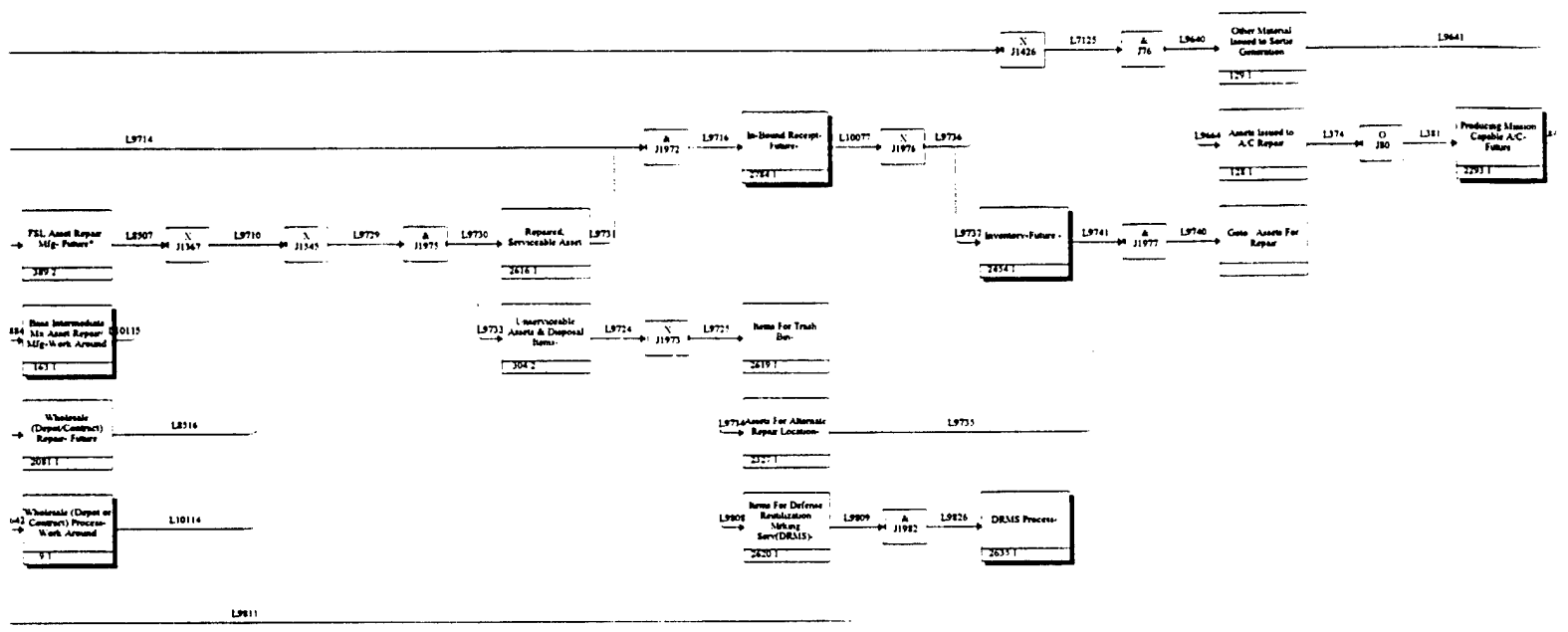

am	Date: 10/29/98	Working	READER	DATE
Process Rev: 1		x	Draft	
			Recommended	
Time: 10:30:21			Publication	

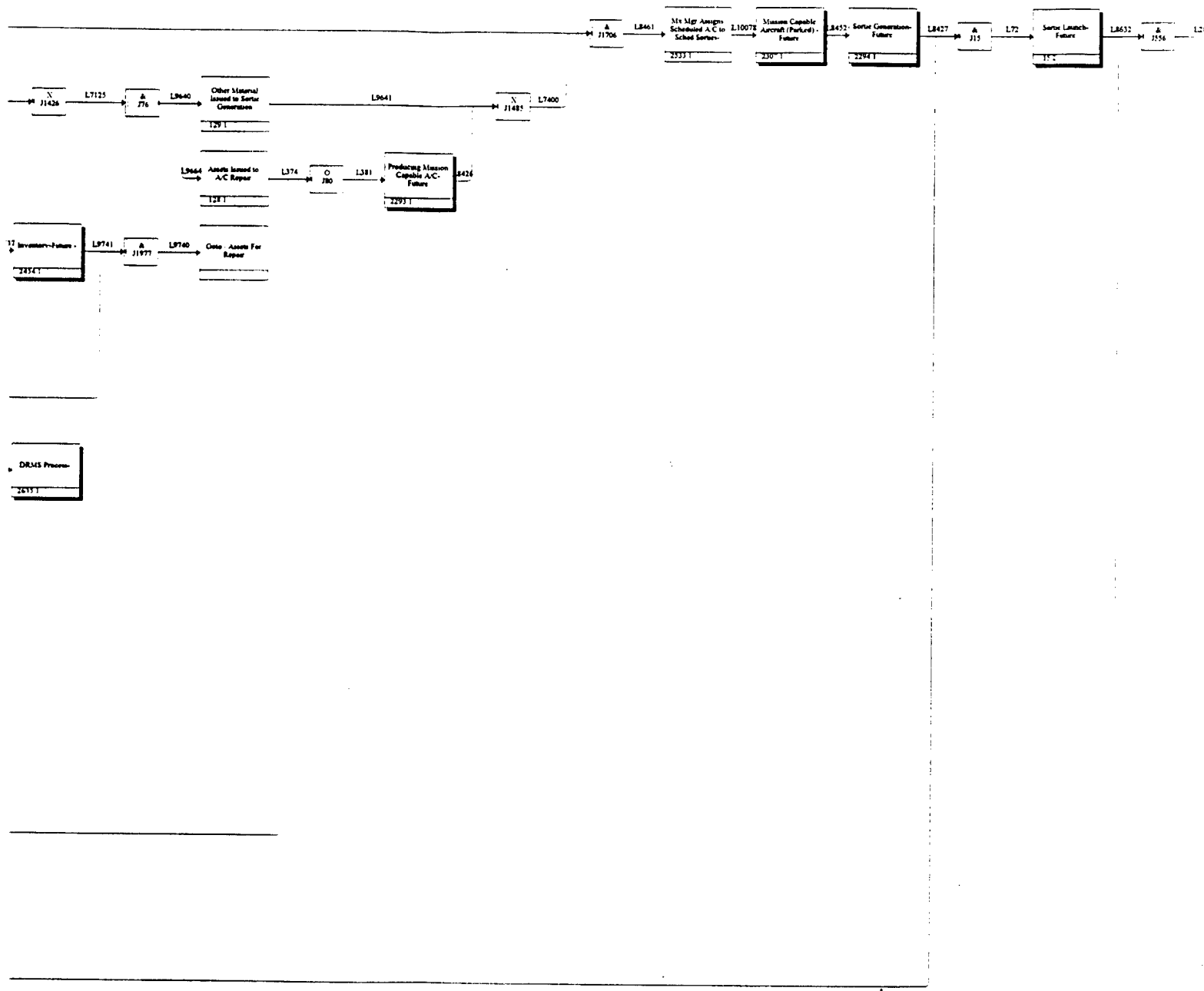

DRMS Process
26131

READER

DATE

Context

Neither the US Gov't or Intergraph has any responsibility or liability for any consequences of any use, misuse, inability to use, or reliance upon the information contained herein.

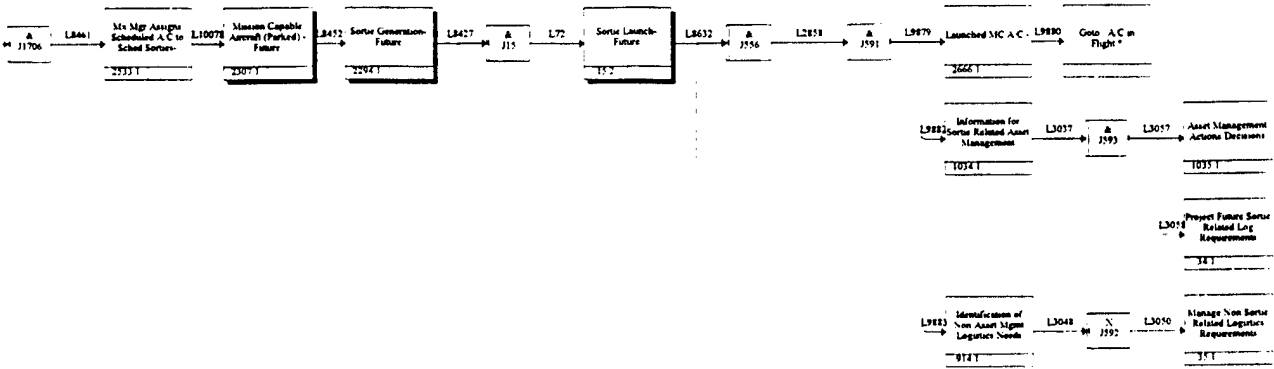

At:
 Approved for Public Release

Author: AFLMA Process Optimization Team
 Project: Future To Be- Asset Sustainment Process
 Notes: 1 2 3 4 5 6 7 8 9 10

Date: 10/29/98
 Rev: 1
 Time: 10:30:21

Working
 Draft
 Record
 Public

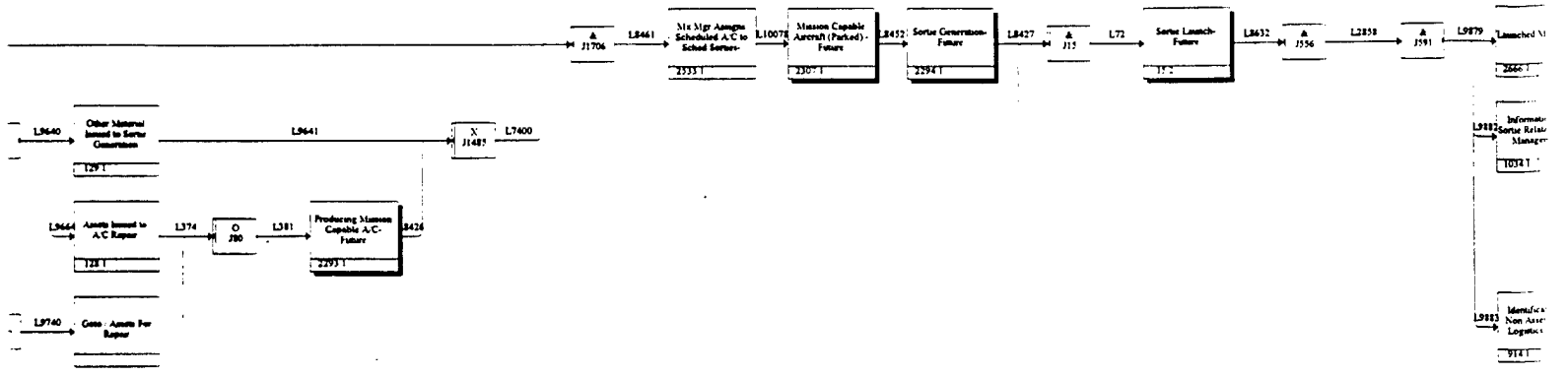

im Date: 10/29/98

Process Rev: 1

Time: 10:30:21

Working

READER

DATE

x Draft

Recommended

Publication

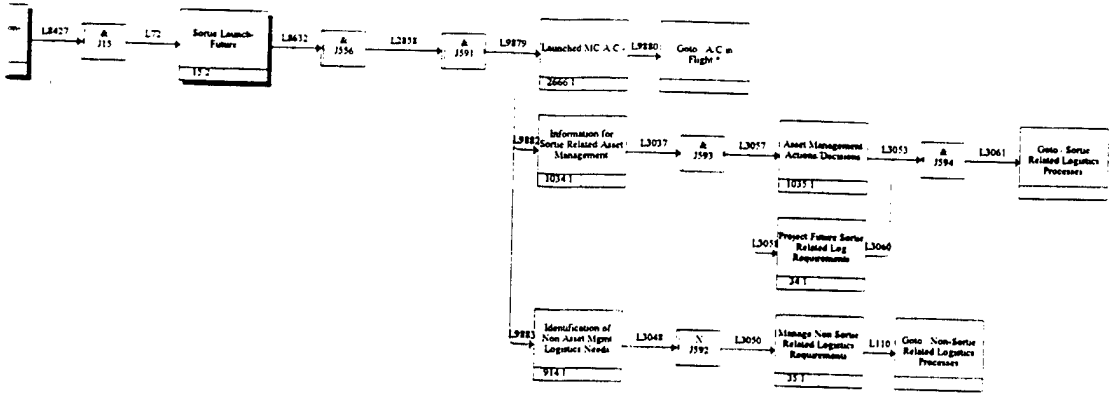

READER

DATE

Context

Neither the US Gov't or Intergraph has any responsibility or liability for any consequences of any use, misuse, inability to use, or reliance upon the information contained herein.

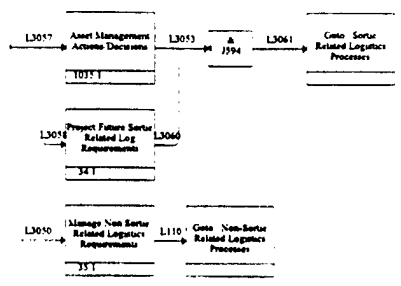

Process Flow Decomp: In-Bound Receipt- Future-

Used At: Not Approved for Public Release

Author: Project: Future To Be- Asset Sustainment Pro Rev: 1

Date: 10/29/98

Notes: 1 2 3 4 5 6 7 8 9 10 Time: 10:15:19

Working: Draft Recommended Publication

READER: DATE

Context: Neither the US Gov't or Intergraph has any responsibility or liability for any consequences of any use, misuse, inability to use, or reliance upon the information contained herein.

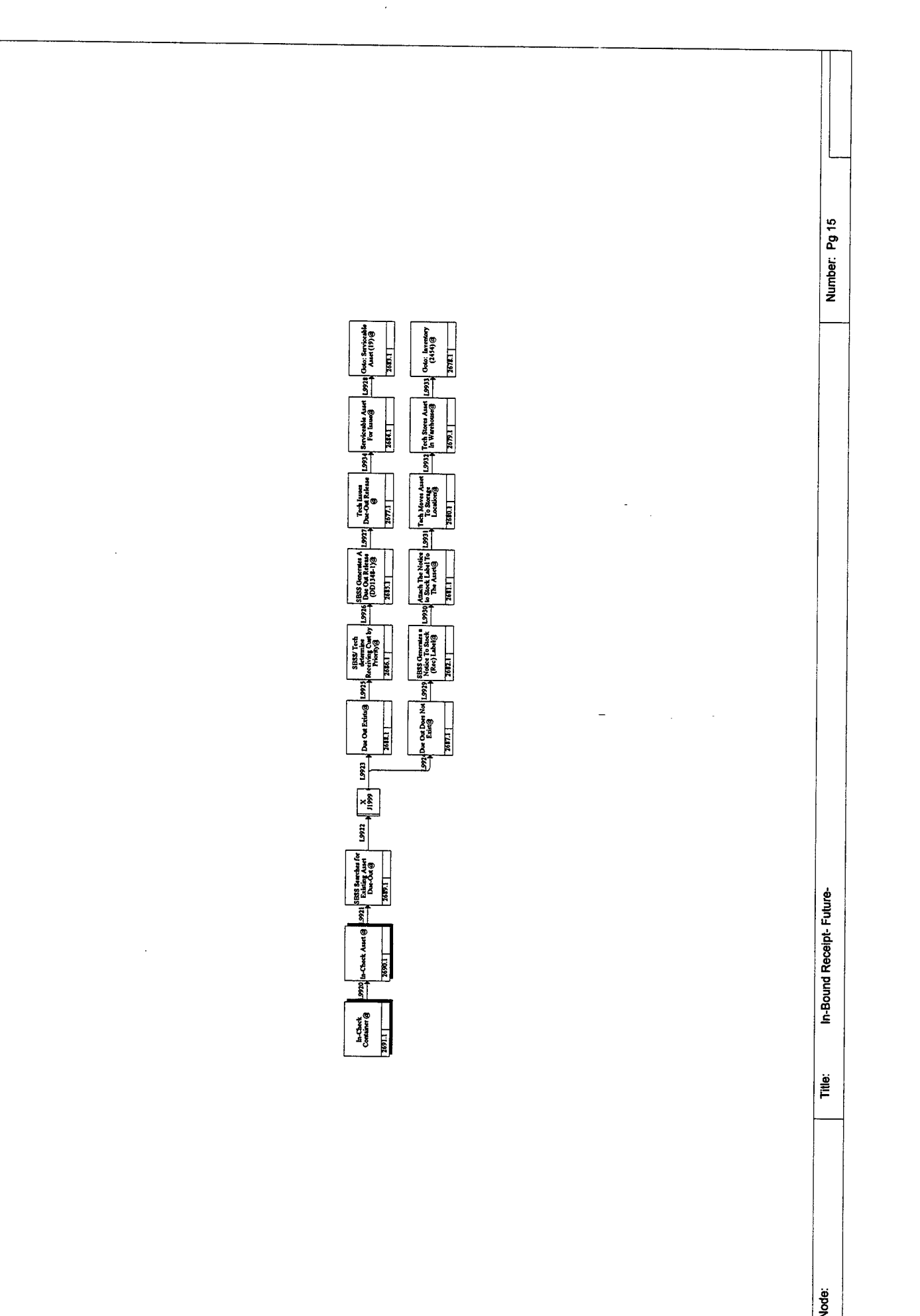

Process Flow Decomp: Evaluate Post Flight Data

Used AI: Not Approved for Public Release

Author: AFLMA Reengineering Team Date: 10/29/98

Project: Future To Be- Asset Sustainment Pro Rev. 1

Notes: 1 2 3 4 5 6 7 8 9 10 Time: 09:58:19

Working: Draft Recommended Publication

READER: DATE:

Context: Neither the US Gov't or Intergraph has any responsibility or liability for any consequences of any use, misuse, inability to use, or reliance upon the information contained herein.

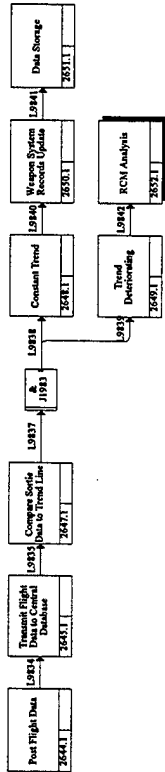

Process Flow Decomp: DRMS Process-

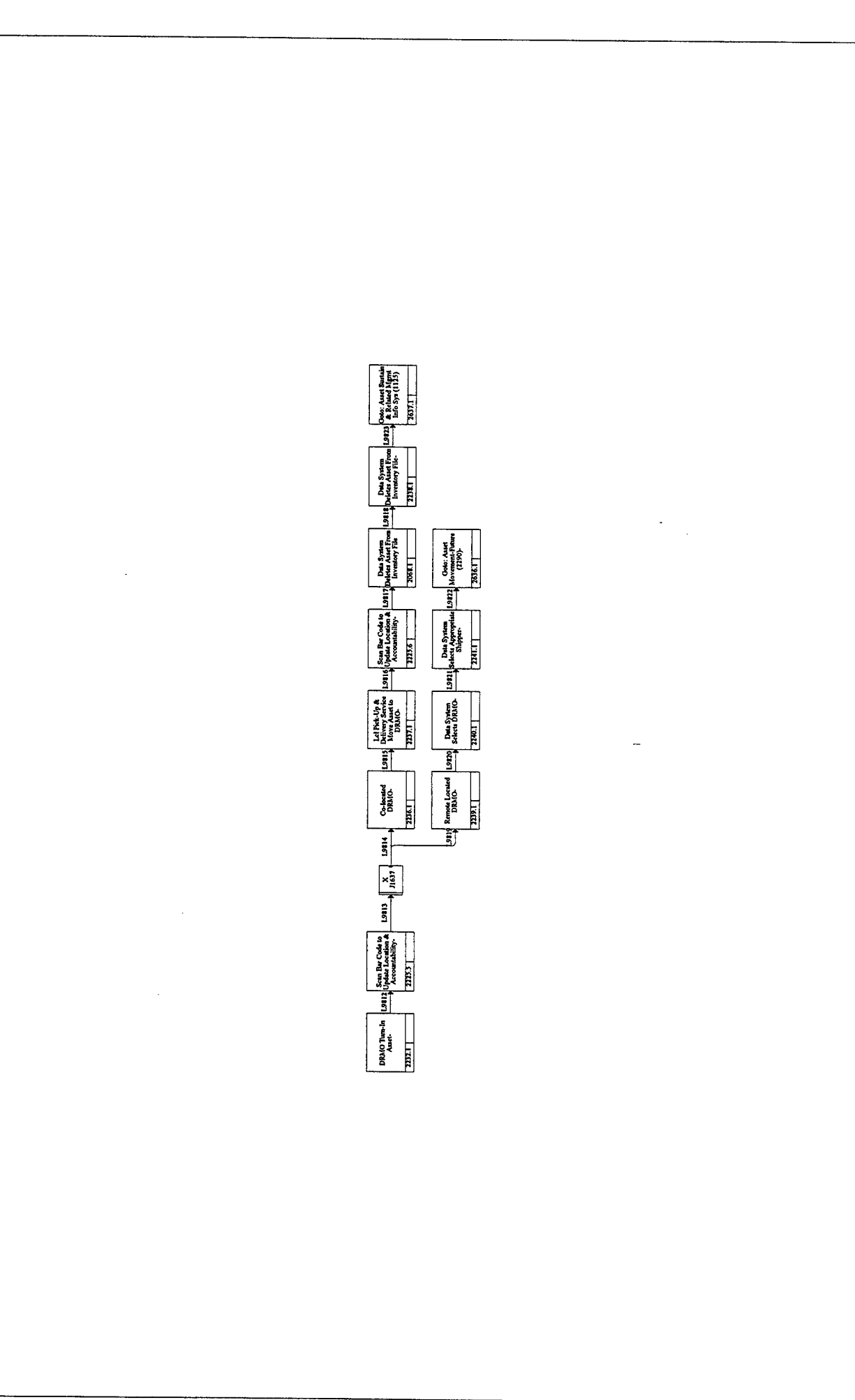

Process Flow Decomp: Inventory-Future

Used At: Not Approved for Public Release

Author: AFLMA Reengineering Team Date: 10/29/98

Project: Future To Be- Asset Sustainment Pro Rev: 1

Notes: 1 2 3 4 5 6 7 8 9 10 Time: 10:15:00

Working: Draft Recommended Publication

READER: DATE:

Context: Neither the US Gov't or Intergraph has any responsibility or liability for any consequences of any use, misuse, inability to use, or reliance upon the information contained herein.

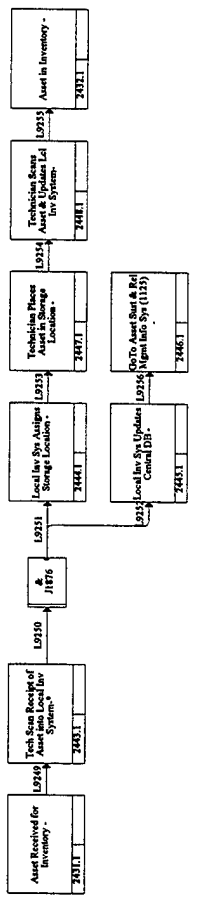

Process Flow Decomp: Evaluate Troubleshooting Data-

Used At: Not Approved for Public Release

Author: AFLMA Reengineering Team Date: 10/29/98
Project: Future To Be-Asset Sustainment Pro Rev: 1
Notes: 1 2 3 4 5 6 7 8 9 10 Time: 10:00:30

Working: X Draft Recommended Publication

READER DATE

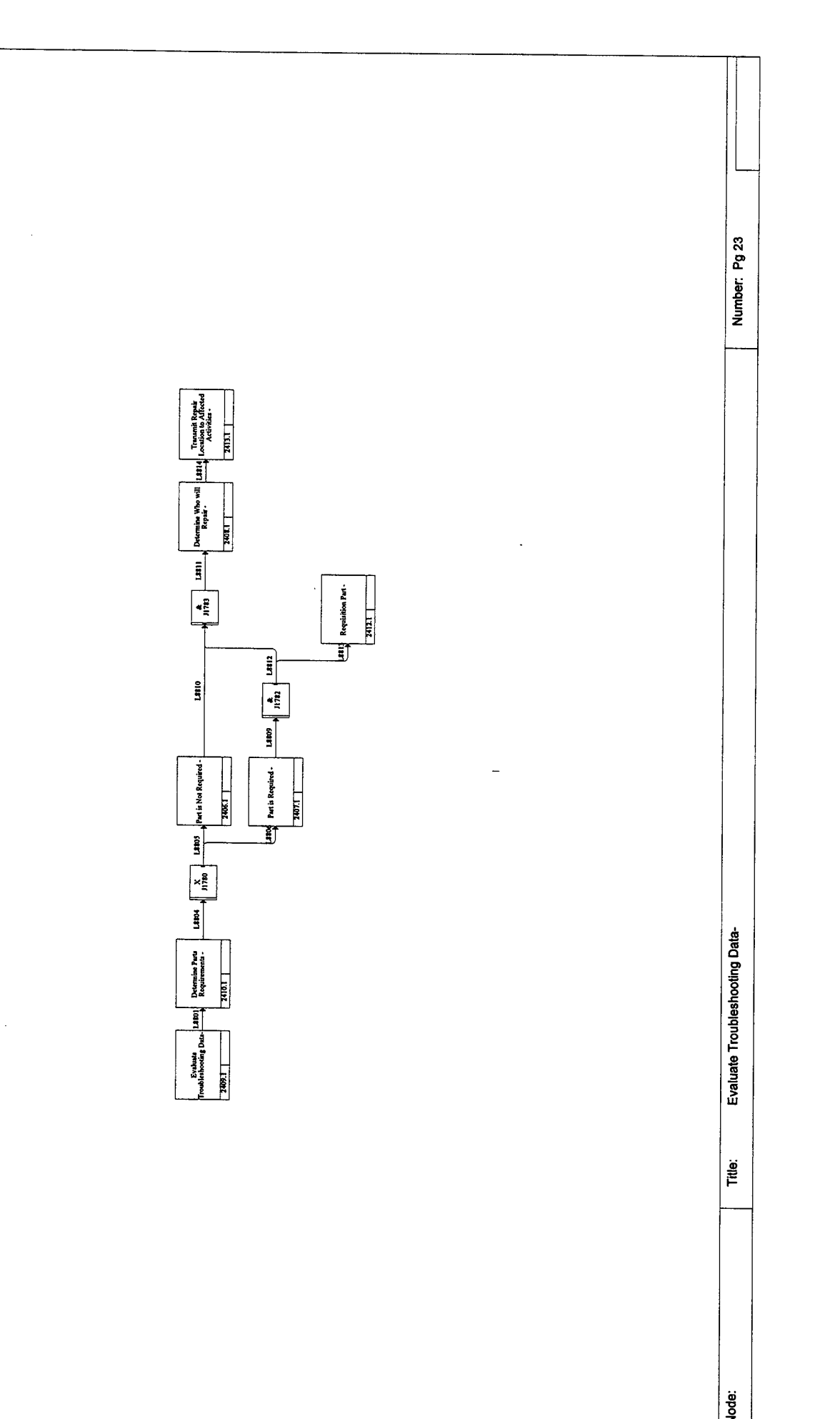

Context: Neither the US Gov't or Intergraph has any responsibility or liability for any consequences of any use, misuse, inability to use, or reliance upon the information contained herein.

Title: Evaluate Troubleshooting Data

Node:

Process Flow Decomp: Sortie Recovery- Future -

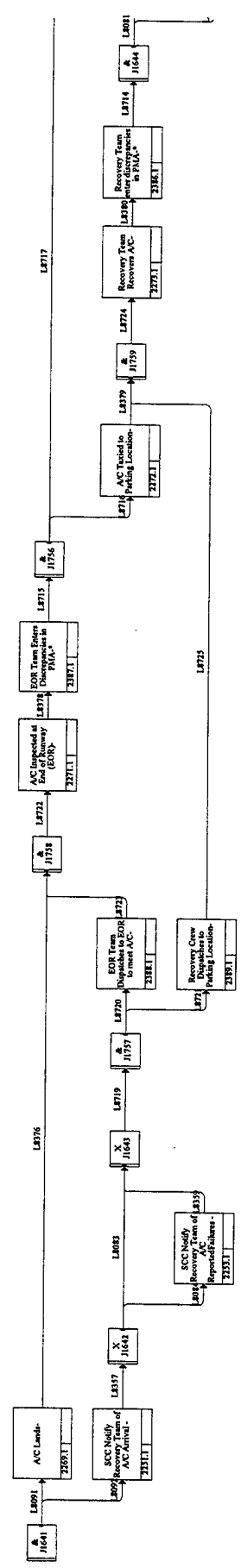

Used At: Not Approved for Public Release

Author: AFLMA Reengineering Team

Date: 10/29/98

Project: Future To Be- Asset Sustainment Pro Rev. 1

Notes: 1 2 3 4 5 6 7 8 9 10

Time: 09:58:53

Working: X

Reader: Draft

Publication: Recommended

Context: Neither the US Gov't or Intergraph has any responsibility or liability for any consequences of any use, misuse, inability to use, or reliance upon the information contained herein.

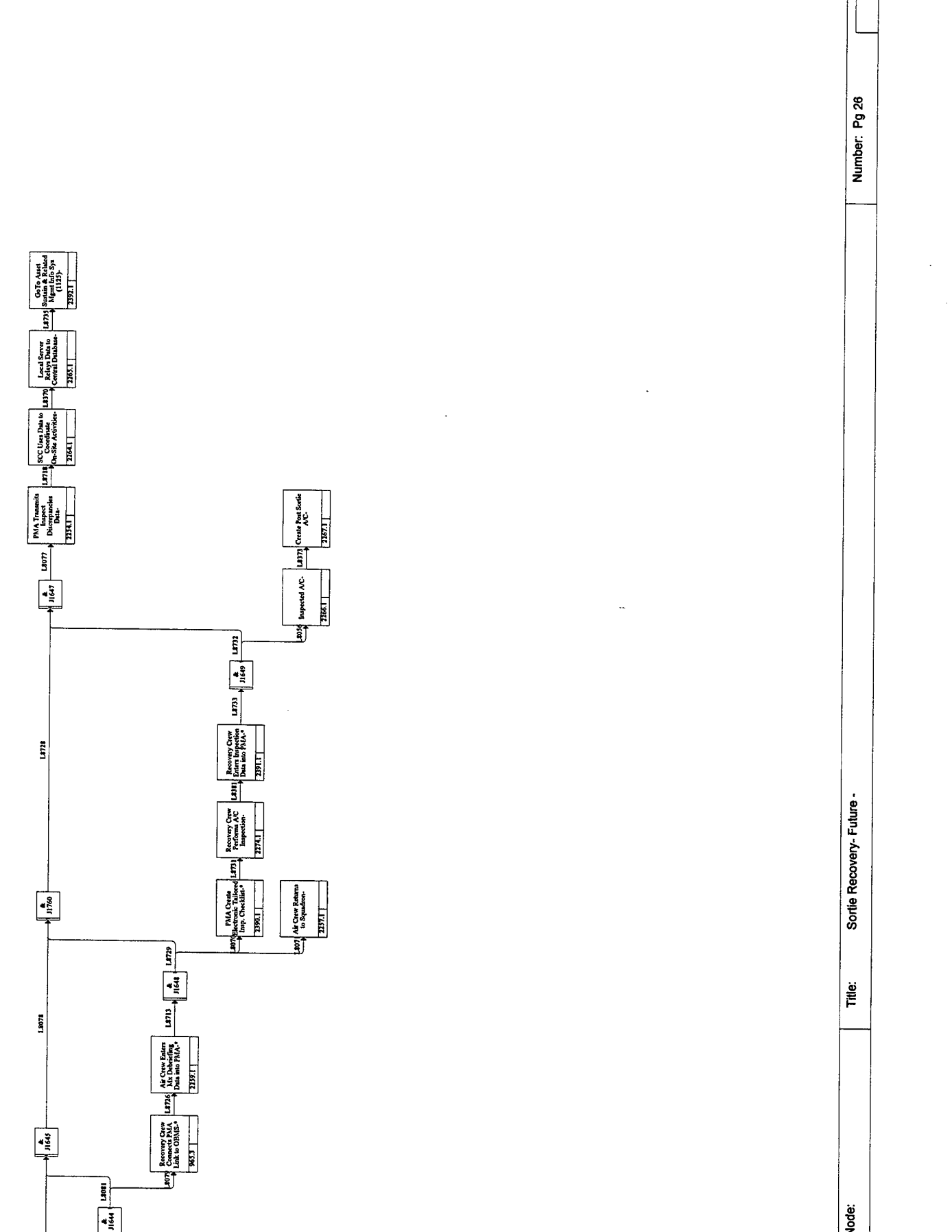

Process Flow Decomp: Sortie Flown Exceeds (OBMS) Component Parameters

Used At: Not Approved for Public Release

Author: AFLMA Reengineering Team
 Project: Future To Be- Asset Sustainment Pro
 Notes: 1 2 3 4 5 6 7 8 9 10

Date: 10/29/98
 Rev: 1
 Time: 09:59:07

Working: Draft
 Recommended
 Publication

READER: _____ DATE: _____

Context: Neither the US Gov't or Intergraph has any responsibility or liability for any consequences of any use, misuse, inability to use, or reliance upon the information contained herein.

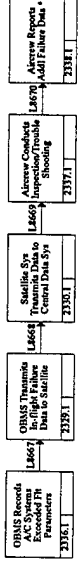

Process Flow Decomp: A/C To Be Launched to Repair Site*.-

Used At: Not Approved for Public Release	Author: AFLMA Reengineering Team	Date: 10/29/98	Context Neither the US Gov't or Intergraph has any responsibility or liability for any consequences of any use, misuse, inability to use, or reliance upon the information contained herein.
	Project: Future To Be-Asset Sustainment Pro	Rev: 1	
Notes: 1 2 3 4 5 6 7 8 9 10	Time: 10:01:42	Working	READER
		<input checked="" type="checkbox"/> Draft	DATE
		<input type="checkbox"/> Recommended	
		<input type="checkbox"/> Publication	

Mx Mgr Receives
 Notification to
 Prepare A/C
 2323.1

Process Flow Decomp: Mission Capable Aircraft (Parked) - Future

Used At:
Not Approved for Public
Release

Author: AFLMA Reengineering Team
 Project: Future To Be- Asset Sustainment Pro Rev: 1
 Notes: 1 2 3 4 5 6 7 8 9 10
 Date: 10/29/98
 Time: 10:17:01

Working
 Draft
 Recommended
 Publication

READER

DATE

Context
 Neither the US Gov't or Intergraph has
 any responsibility or liability for any
 consequences of any use, misuse,
 inability to use, or reliance upon the
 information contained herein.

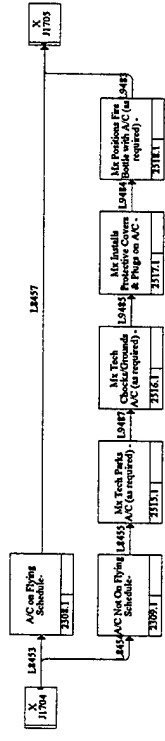

Node:

Title: Mission Capable Aircraft (Parked) - Future

Number: Pg 32

Process Flow Decomp: Sortie Generation- Future

Working	Reader	DATE
<input checked="" type="checkbox"/>		
<input type="checkbox"/>		
<input type="checkbox"/>		
<input type="checkbox"/>		

Context
 Neither the US Gov't or Intergraph has any responsibility or liability for any consequences of any use, misuse, inability to use, or reliance upon the information contained herein.

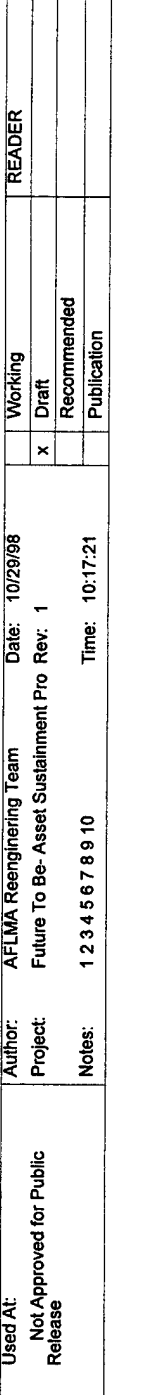

Used At: Not Approved for Public Release	Author: AFLMA Reengineering Team Project: Future To Be- Asset Sustainment Pro Notes: 1 2 3 4 5 6 7 8 9 10	Date: 10/29/08 Rev: 1 Time: 10:17:21	Working <input checked="" type="checkbox"/> Draft <input type="checkbox"/> Recommended <input type="checkbox"/> Publication	READER	DATE	Context Neither the US Gov't or Intergraph has any responsibility or liability for any consequences of any use, misuse, inability to use, or reliance upon the information contained herein.
---	---	--	--	--------	------	---



Process Flow Decomp: Producing Mission Capable A/C- Future

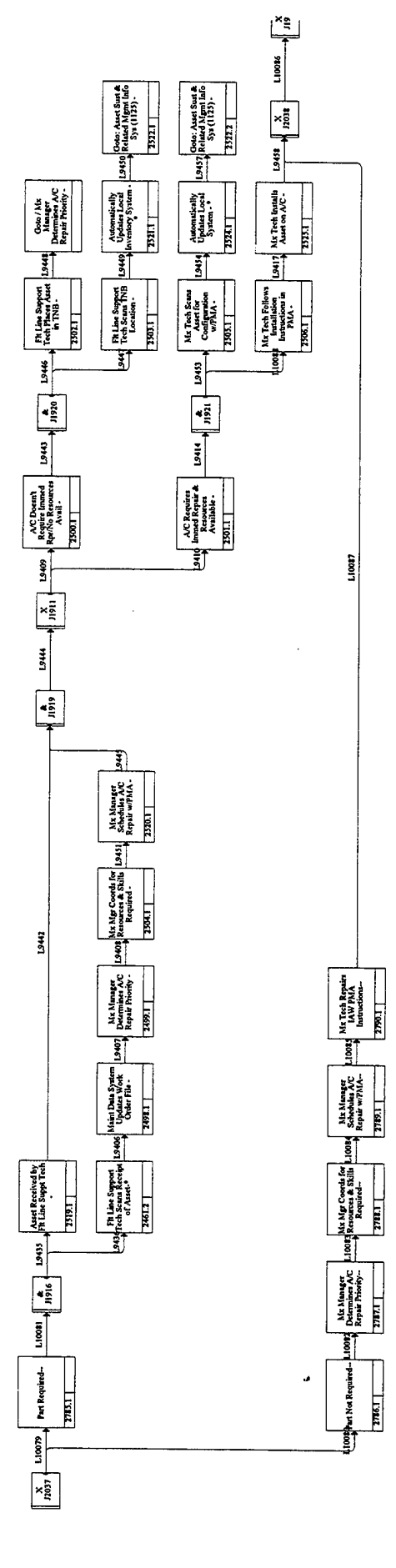

Working	READER	DATE
X		

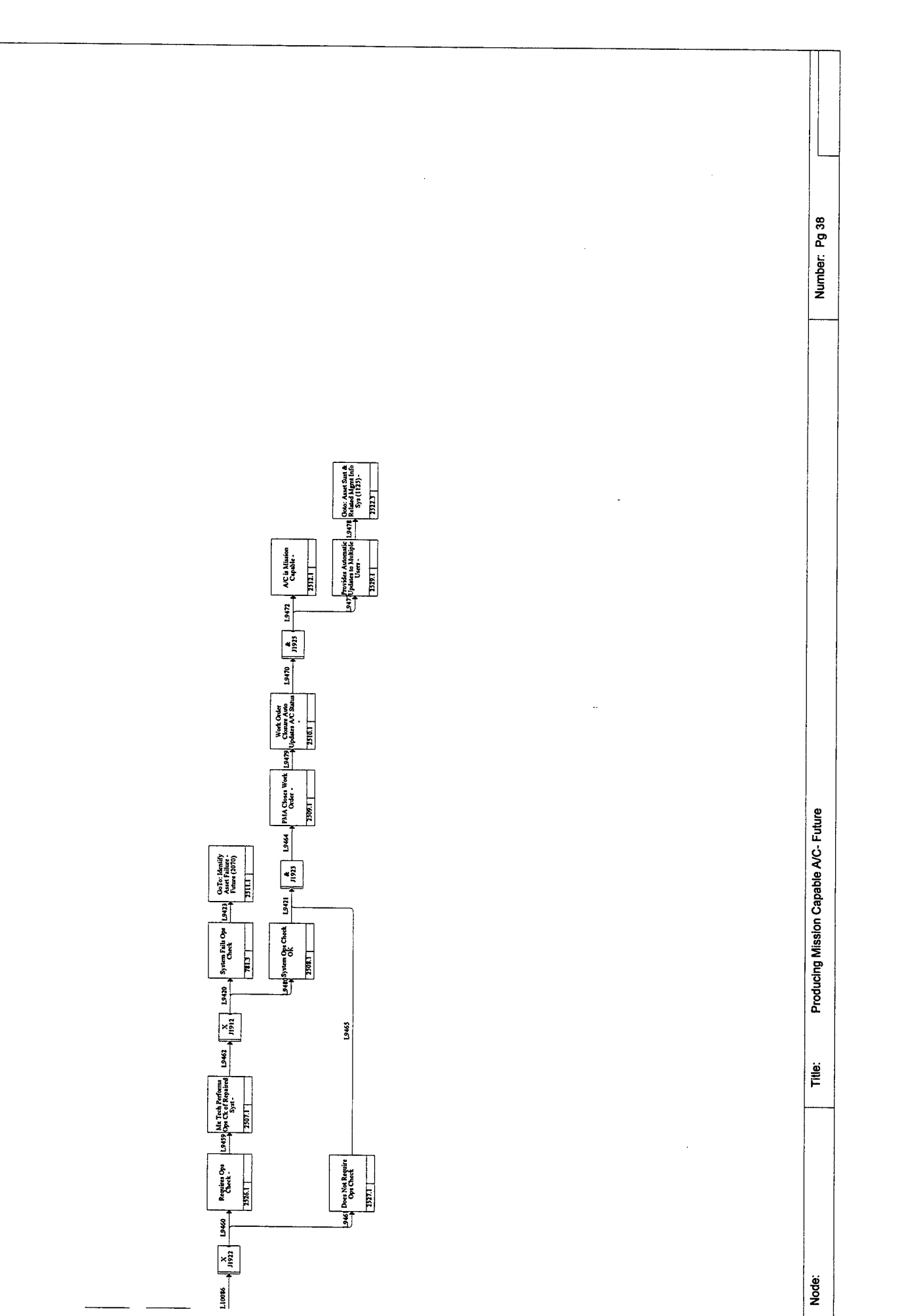

Process Flow Decomp: Issue Process - Future*

Used At: Not Approved for Public Release

Author: AFLMA Reengineering Team
 Project: Future To Be- Asset Sustainment Pro Rev: 1
 Notes: 1 2 3 4 5 6 7 8 9 10 Time: 15:18:03

Date: 10/28/98

Working Draft Recommended Publication

READER DATE

Context

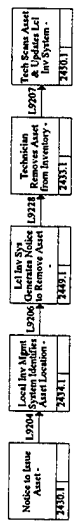

Title: Issue Process - Future*

Number: Pg 40

Node:

Process Flow Decomp: Asset Movement - Future

Used At: Not Approved for Public Release

Author: AFLMA Reengineering Team
 Date: 10/29/98
 Project: Future To Be- Asset Sustainment Pro Rev. 1
 Notes: 1 2 3 4 5 6 7 8 9 10
 Time: 10:04:15

Working

Draft
 Recommended
 Publication

READER

DATE

Context

Neither the US Gov't or Intergraph has any responsibility or liability for any consequences of any use, misuse, inability to use, or reliance upon the information contained herein.

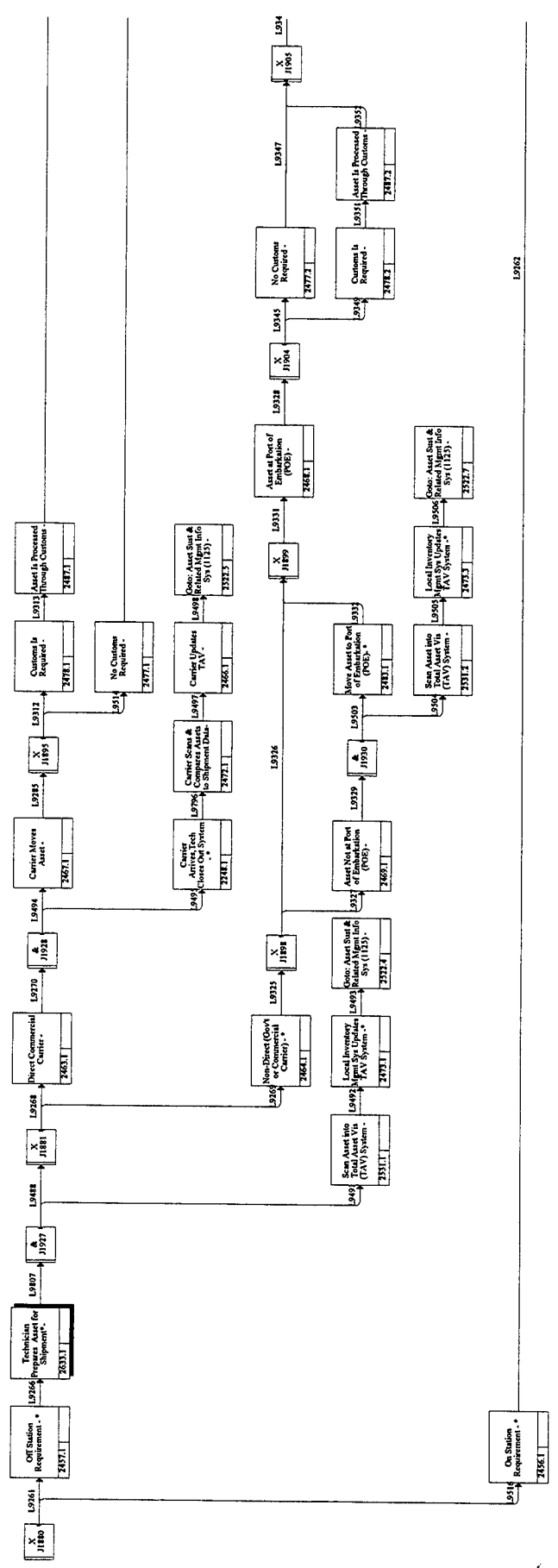

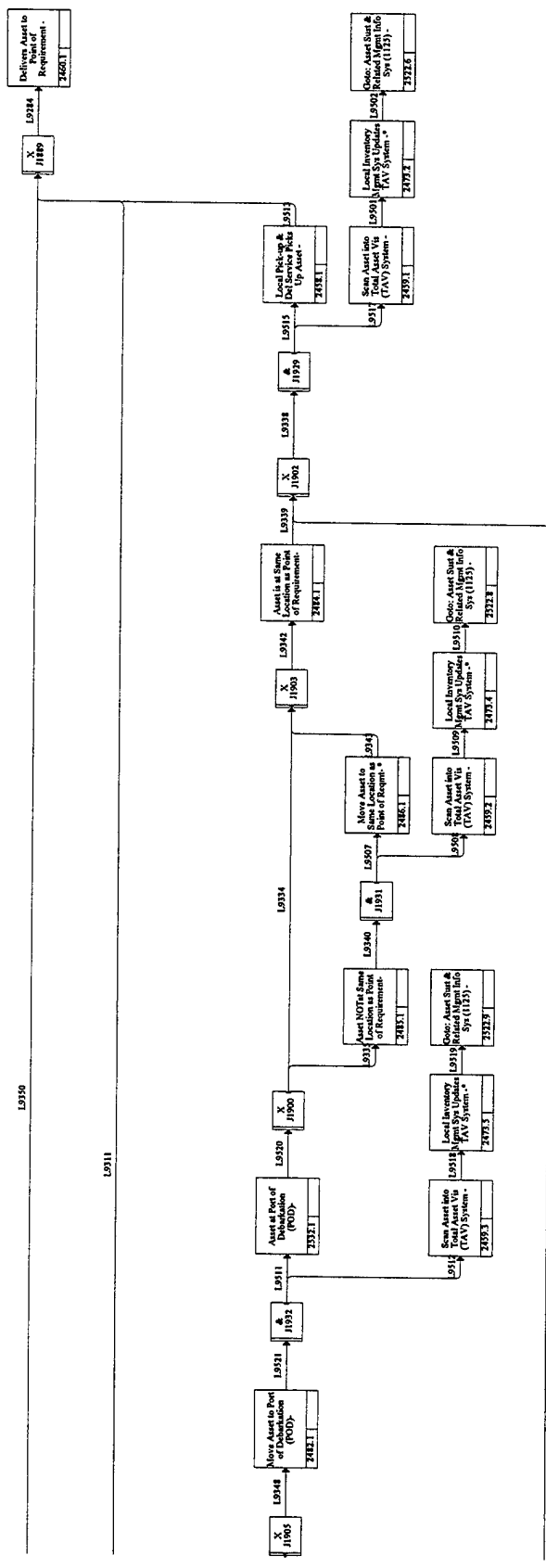

Process Flow Decomp: Issue Request & Reqn Processing- Future -

Used At: Not Approved for Public Release

Author: AFLMA Reengineering Team Date: 10/29/88
 Project: Future To Be-Asset Sustainment Pro Rev: 1
 Notes: 1 2 3 4 5 6 7 8 9 10 Time: 10:01:02

Working: Draft: Recommended: Publication:
 Reader: _____ Date: _____

Context: Neither the US Gov't or Intergraph has any responsibility or liability for any consequences of any use, misuse, inability to use, or reliance upon the information contained herein.

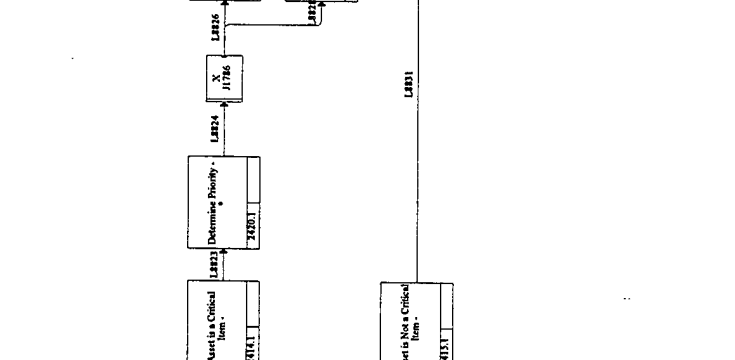

Process Flow Decomp: Asset Removal- Future-

Used At: Not Approved for Public Release

Author: AFLMA Reengineering Team Date: 10/29/98

Project: Future To Be- Asset Sustainment Pro Rev: 1

Notes: 1 2 3 4 5 6 7 8 9 10 Time: 10:03:44

Working: Draft Recommended Publication

Reader: _____ DATE: _____

Context: Neither the US Govt or Intergraph has any responsibility or liability for any consequences of any use, misuse, inability to use, or reliance upon the information contained herein.

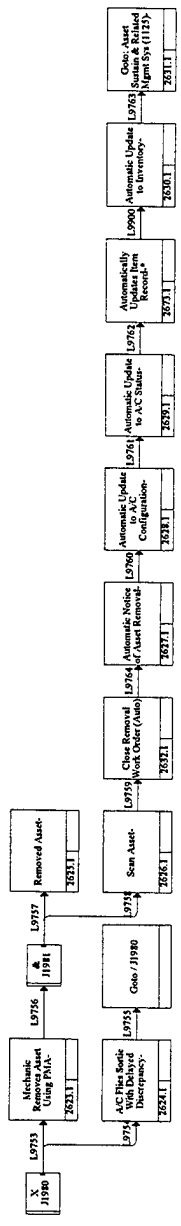

Process Flow Decomp: Identify Failure- Future

Process Flow Decomp: Non-Air Force Inventory

Used At: Not Approved for Public Release

Author: AFLMA Reengineering Team Date: 10/29/98

Project: Future To Be- Asset Sustainment Pro Rev: 1

Notes: 1 2 3 4 5 6 7 8 9 10 Time: 10:02:15

Working	READER	DATE	Context
<input checked="" type="checkbox"/>			Neither the US Gov't or Intergraph has any responsibility or liability for any consequences of any use, misuse, inability to use, or reliance upon the information contained herein.
<input type="checkbox"/>			
<input type="checkbox"/>			

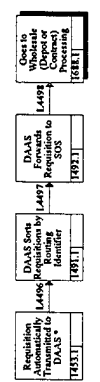

Process Flow Decomp: Base Intermediate Mx Asset Repair/ Mfg-Work Around

t Repair/ Mfg-Work Around

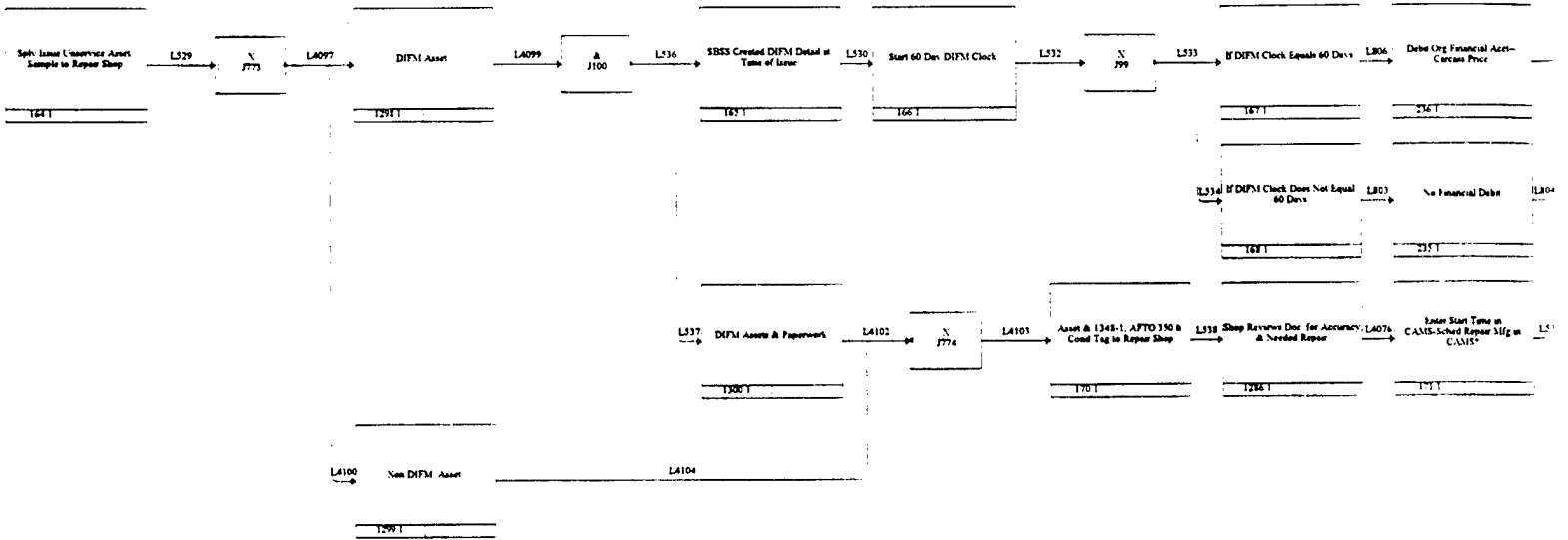

1

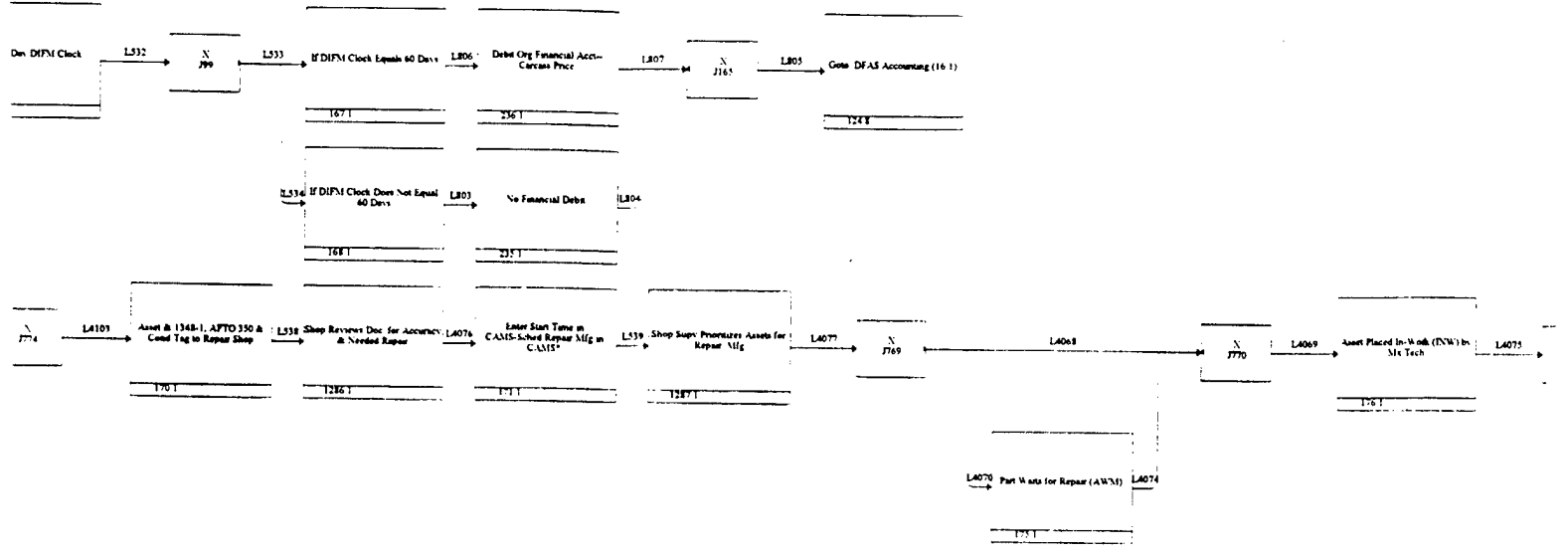

READER

DATE

Context

Neither the US Gov't or Intergraph has any responsibility or liability for any consequences of any use, misuse, inability to use, or reliance upon the information contained herein.

Get DFAS Accounting (16 1)

1241

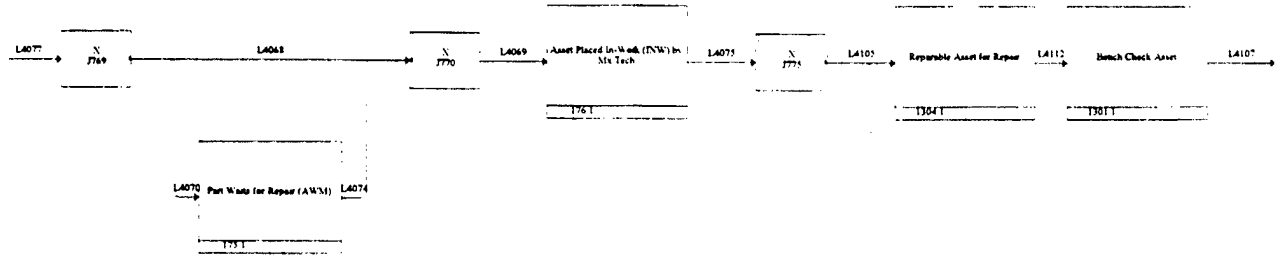

LA108 Local/Manufacture Sample → LA110 Analyze Sample → LA113 Research Tech D

1301 1302 1306

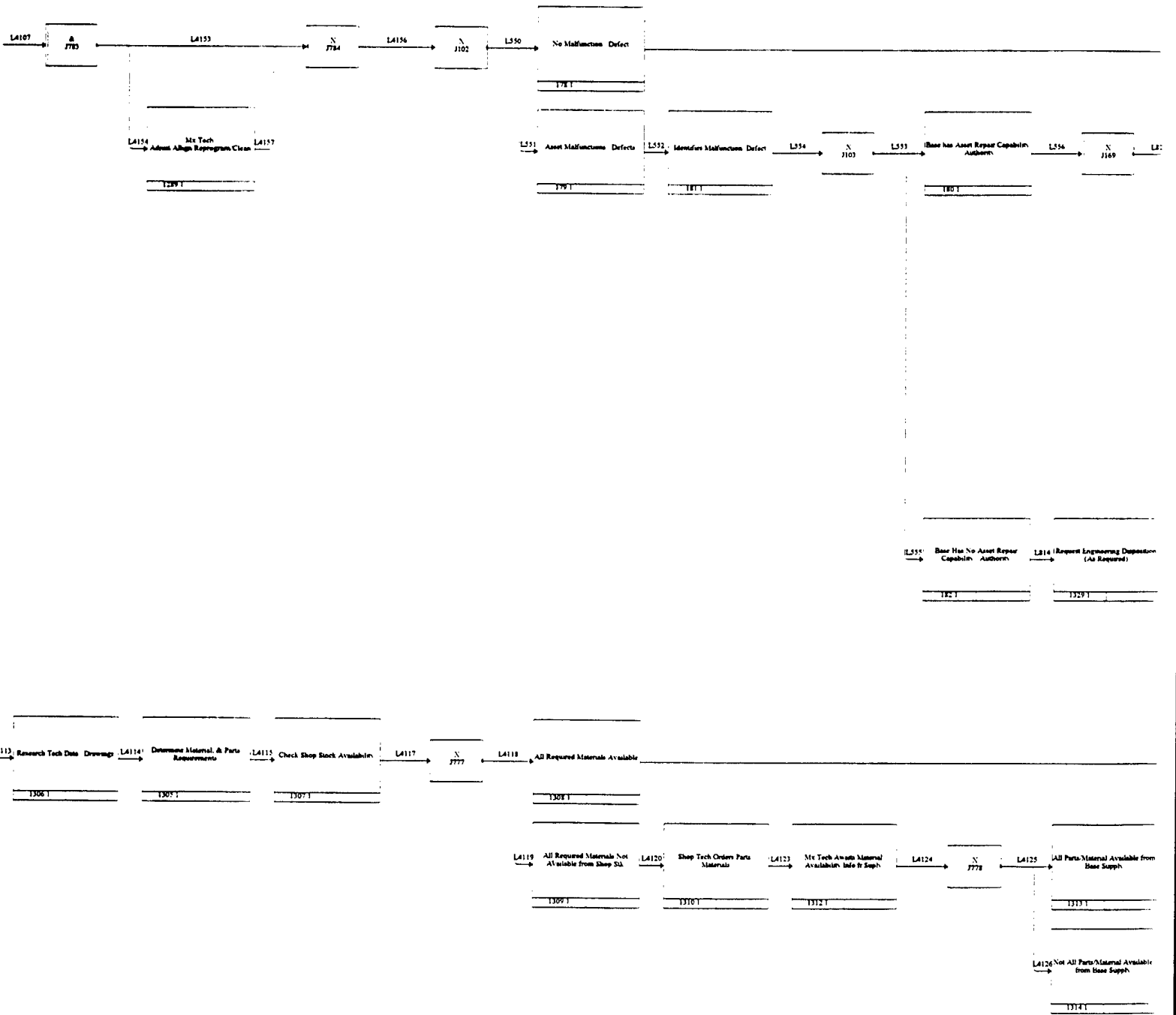

Date: 10/29/98

Working

READER

DATE

nt Process Rev: 1

x Draft

Recommended

Time: 10:06:57

Publication

L809



2

READER

DATE

Context

Neither the US Gov't or Intergraph has any responsibility or liability for any consequences of any use, misuse, inability to use, or reliance upon the information contained herein.

LB09

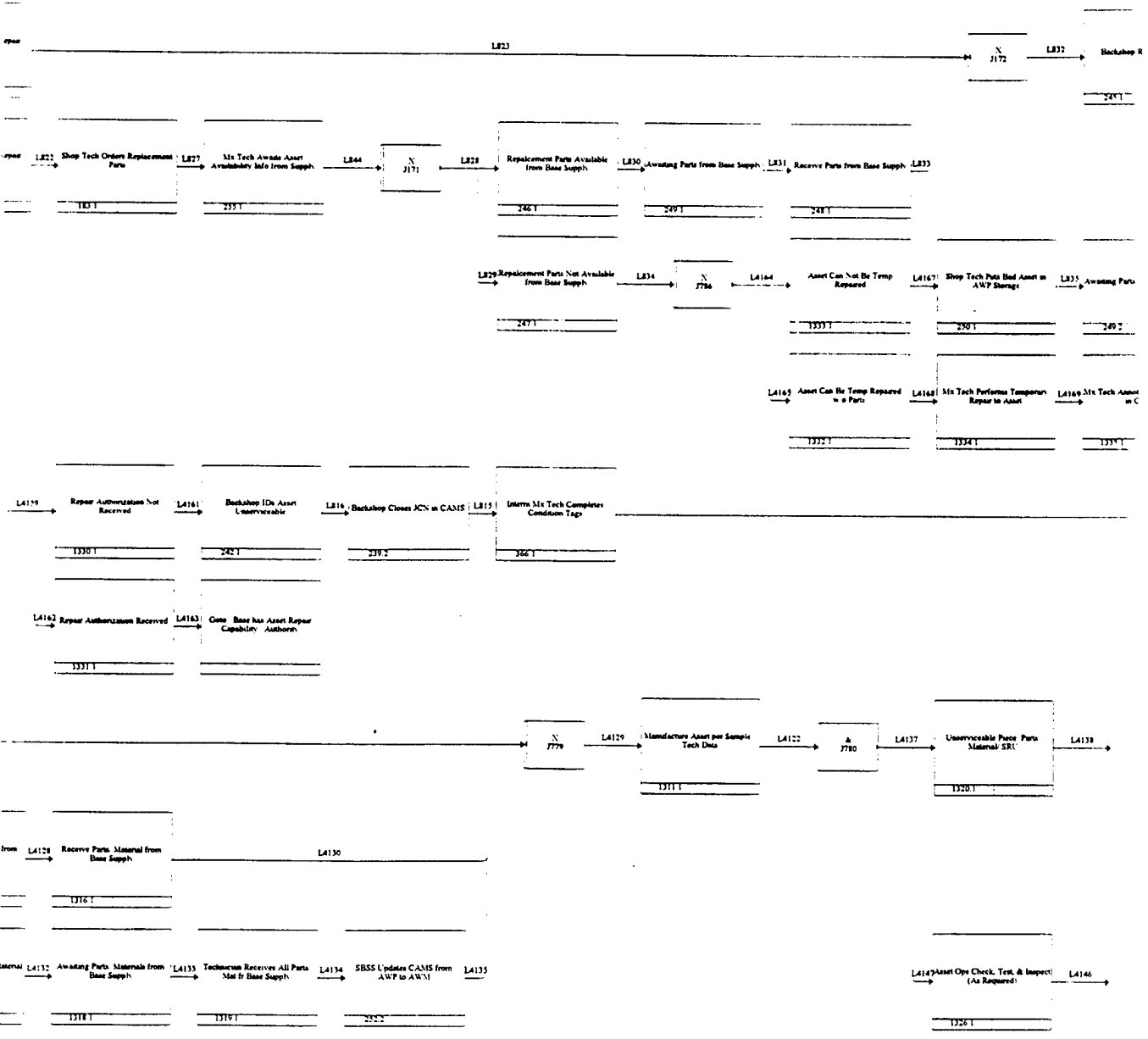

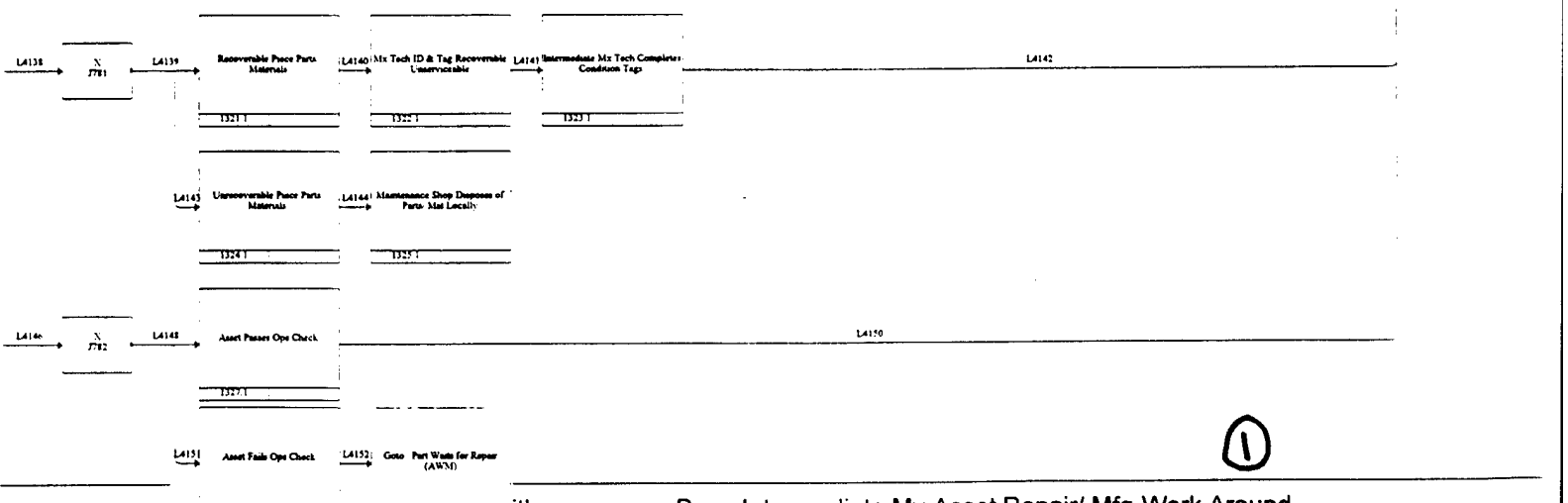
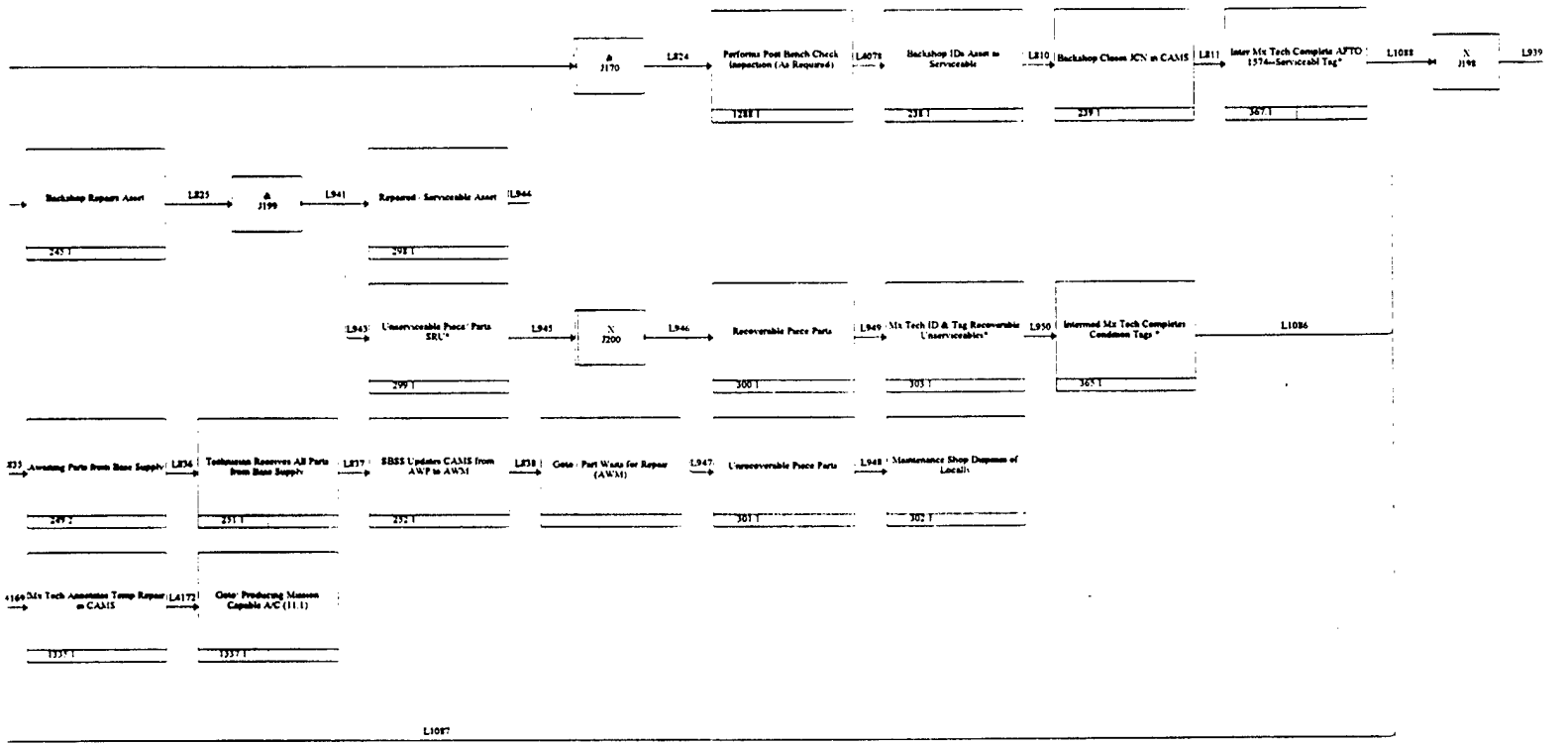

Date: 10/29/98	Working	READER	DATE
ment Process Rev: 1	x Draft		
	Recommended		
Time: 10:06:57	Publication		

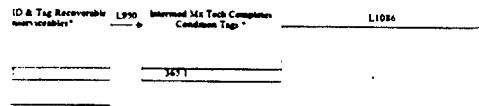
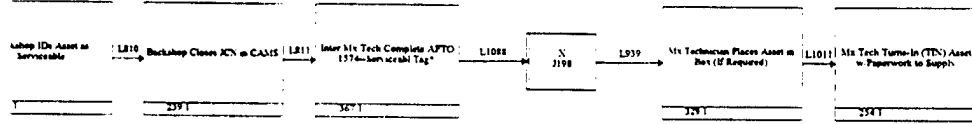

also Shop Disposes of Locals

L4142

2

READER

DATE

Context

ded

Neither the US Gov't or Intergraph has any responsibility or liability for any consequences of any use, misuse, inability to use, or reliance upon the information contained herein.

Can Place Asset in (If Required) (L1011) Ma Tech Turn-in (TEN) Asset Paperwork to Supply

2547

3

Process Flow Decomp: Fuel, Munitions, Engines, & Other Mission Equip

Used AI: Not Approved for Public Release	Author: AFLMA Reengineering Team	Date: 10/29/98	Working	READER	Context
	Project: Future To Be- Asset Sustainment Pro	Rev: 1	<input checked="" type="checkbox"/> Draft		Neither the US Gov't or Intergraph has any responsibility or liability for any consequences of any use, misuse, inability to use, or reliance upon the information contained herein.
	Notes: 1 2 3 4 5 6 7 8 9 10	Time: 09:59:21	<input type="checkbox"/> Recommended		
			<input type="checkbox"/> Publication		

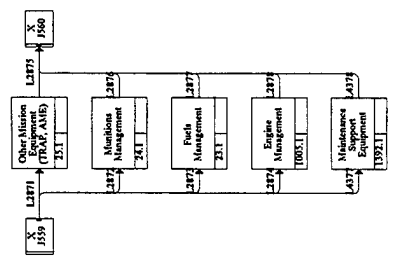

Process Flow Decomp: Sortie Launch- Future



inch- Future

At: ot Approved for Public Release	Author:	AFLMA Reengineering Team	Date:	10/29/98	Work
	Project:	Future To Be- Asset Sustainment Process	Rev:	1	x Draft
	Notes:	1 2 3 4 5 6 7 8 9 10	Time:	10:18:32	Recc
					Publi

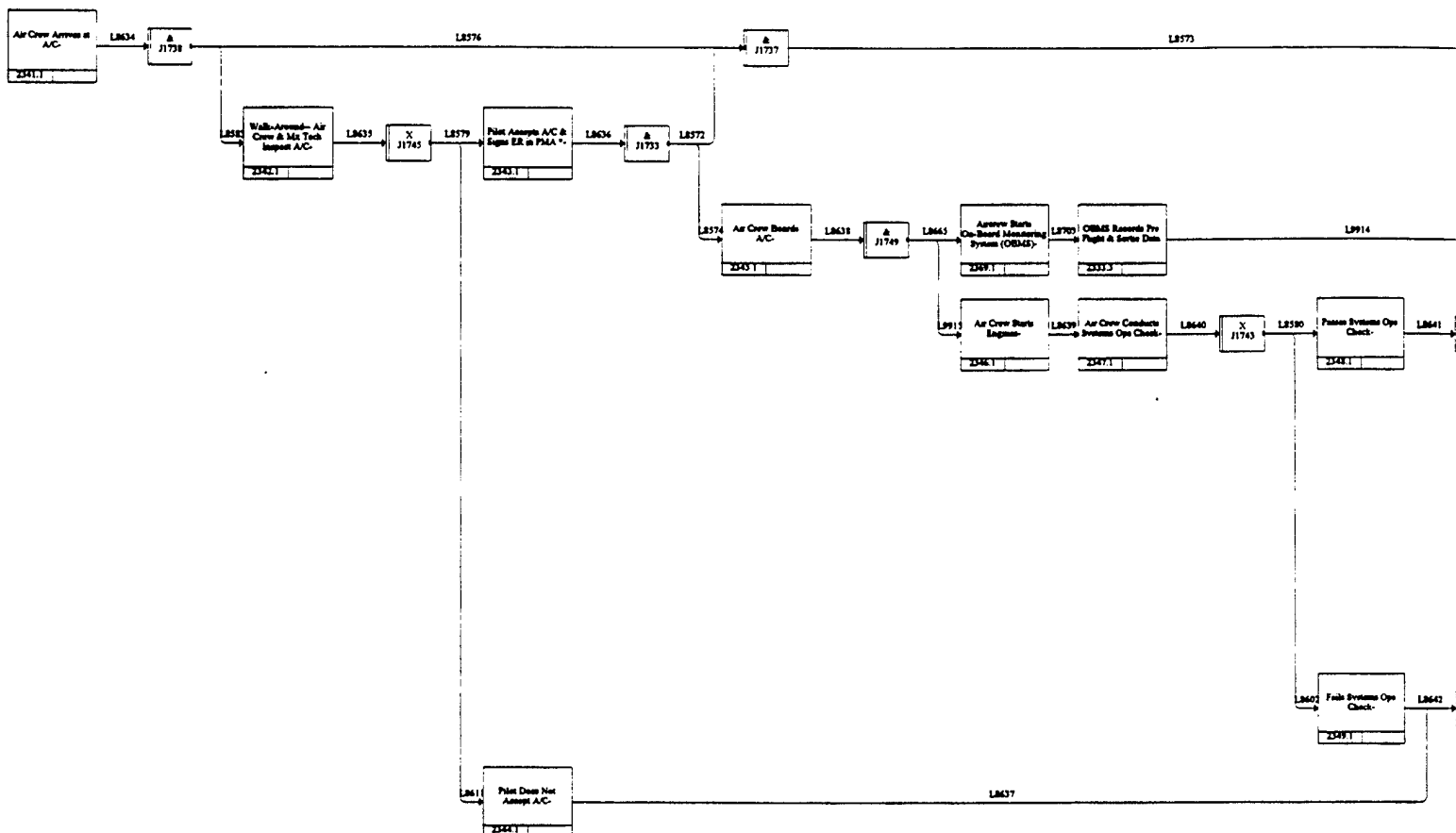

Date: 10/29/98	Working	READER	DATE
nt Process Rev: 1	X Draft		
Time: 10:18:32	Recommended		
	Publication		

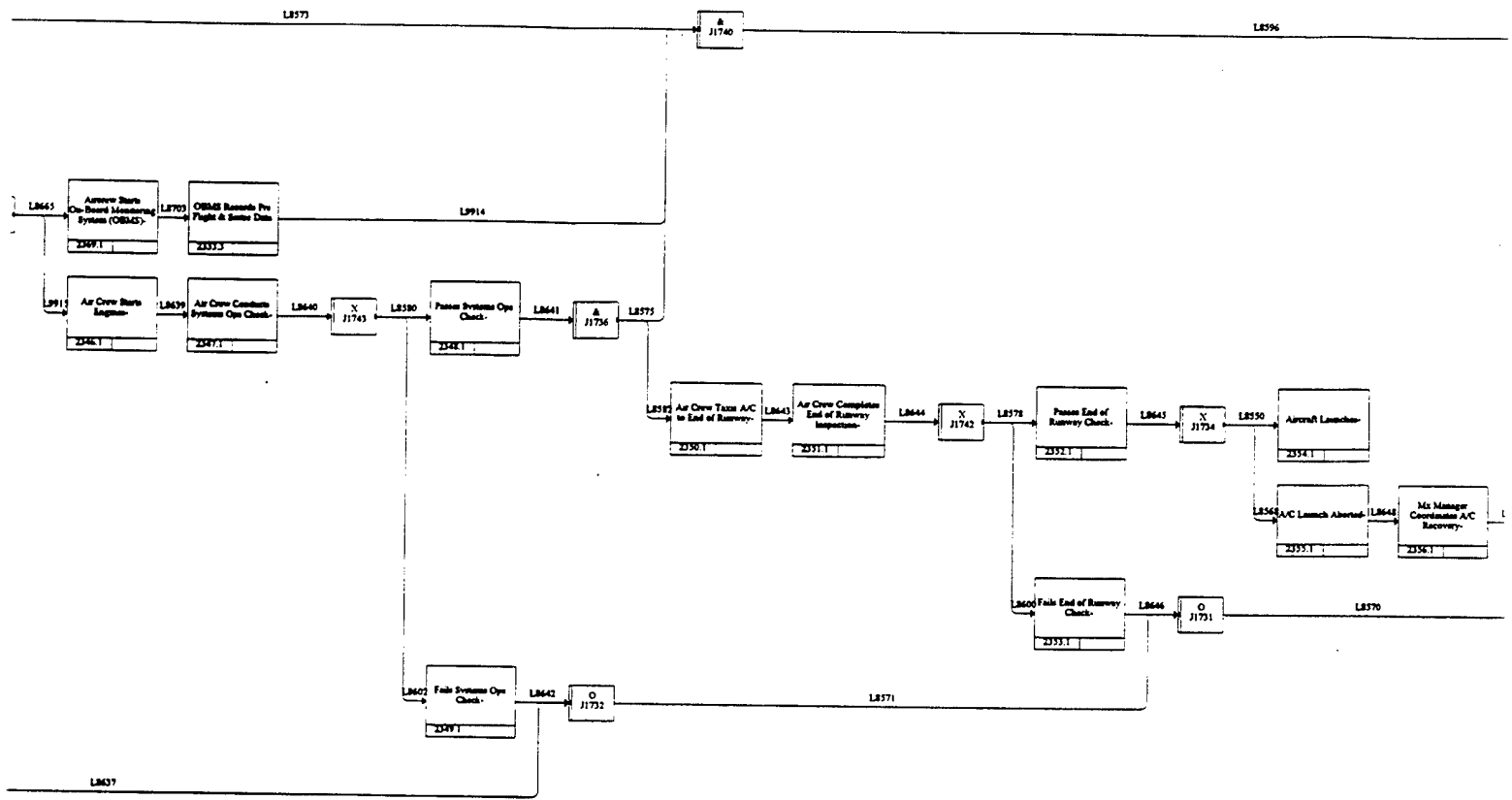

READER

DATE

Context

Neither the US Gov't or Intergraph has any responsibility or liability for any consequences of any use, misuse, inability to use, or reliance upon the information contained herein.

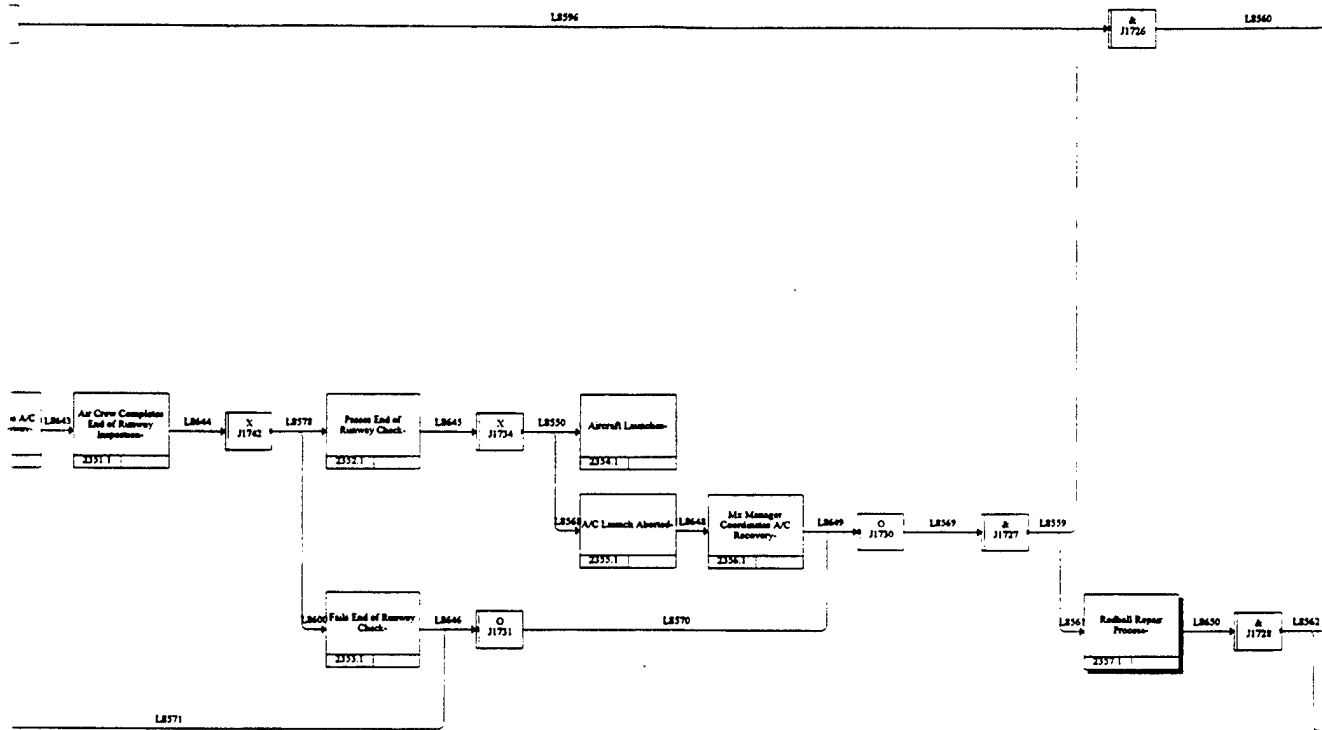

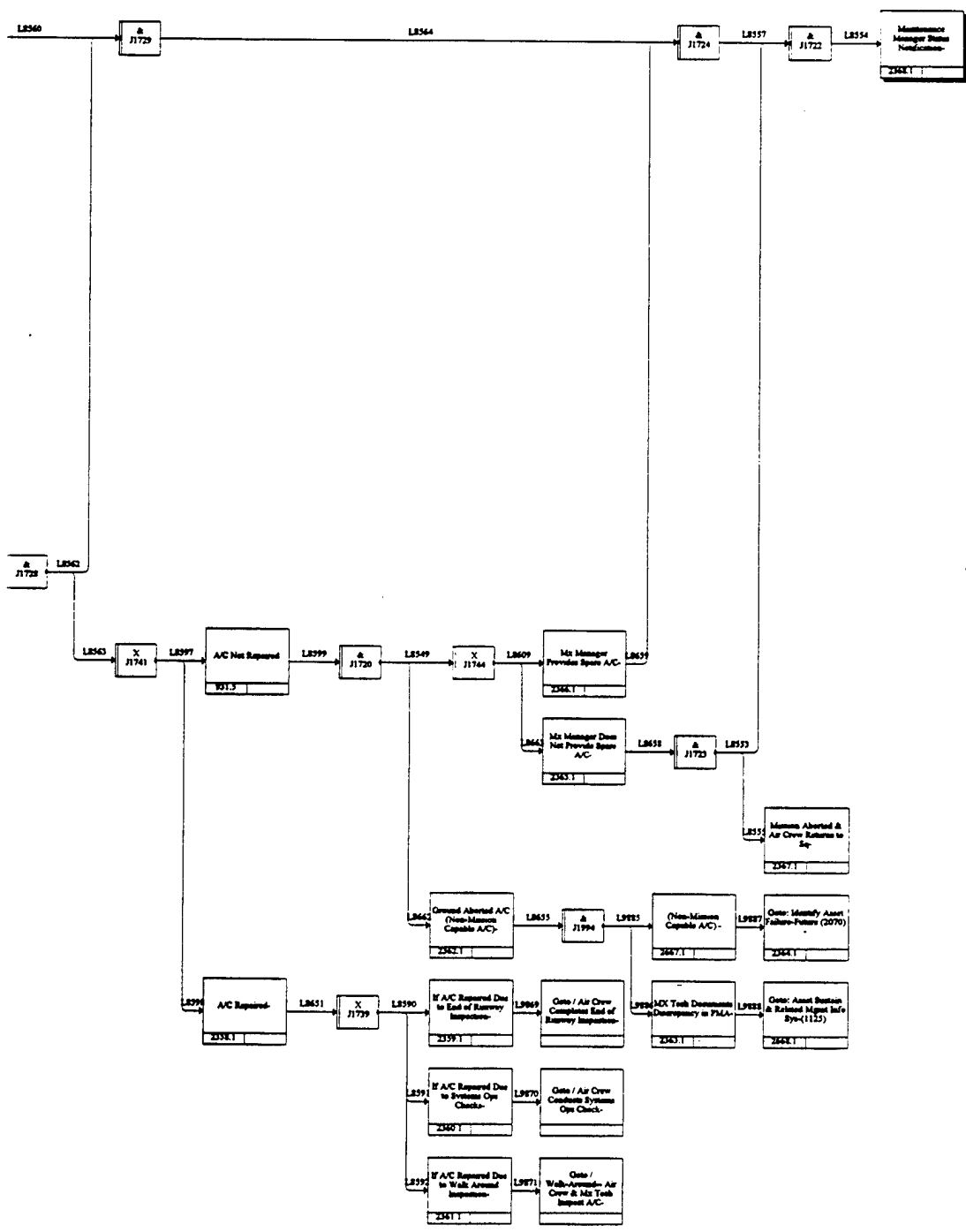

Date: 10/29/98		Working	READER	DATE
Process Rev: 1	x	Draft		
		Recommended		
Time: 10:18:32		Publication		

Management
Manager Status
Notations

	READER	DATE	Context
			Neither the US Gov't or Intergraph has any responsibility or liability for any consequences of any use, misuse, inability to use, or reliance upon the information contained herein.

Process Flow Decomp: Wholesale (Depot or Contract) Process- Work Around

act) Process- Work Around

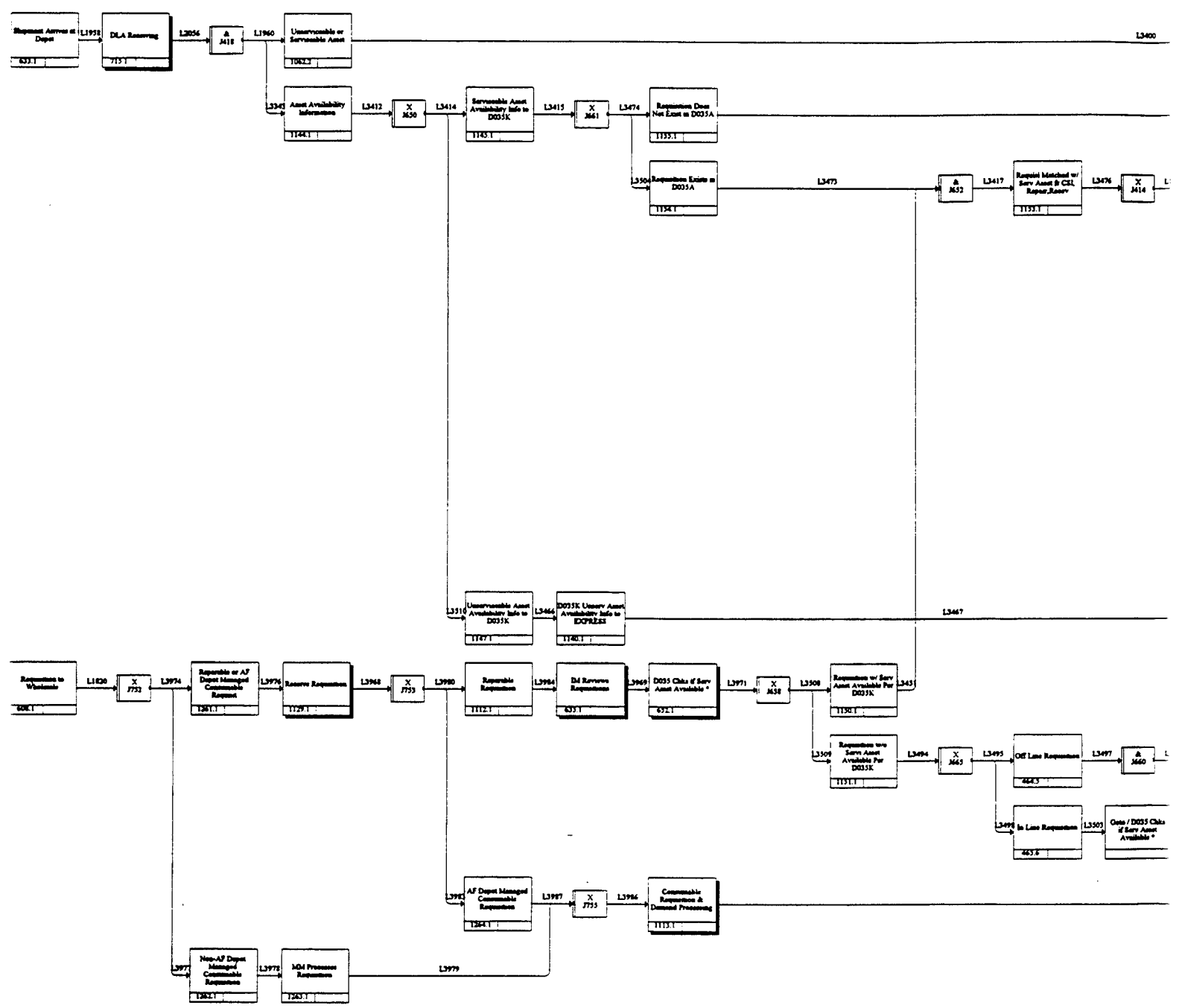

Date: 10/29/98	Working	READER	DATE
Process Rev: 1	X Draft		
	Recommended		
Time: 10:07:24	Publication		

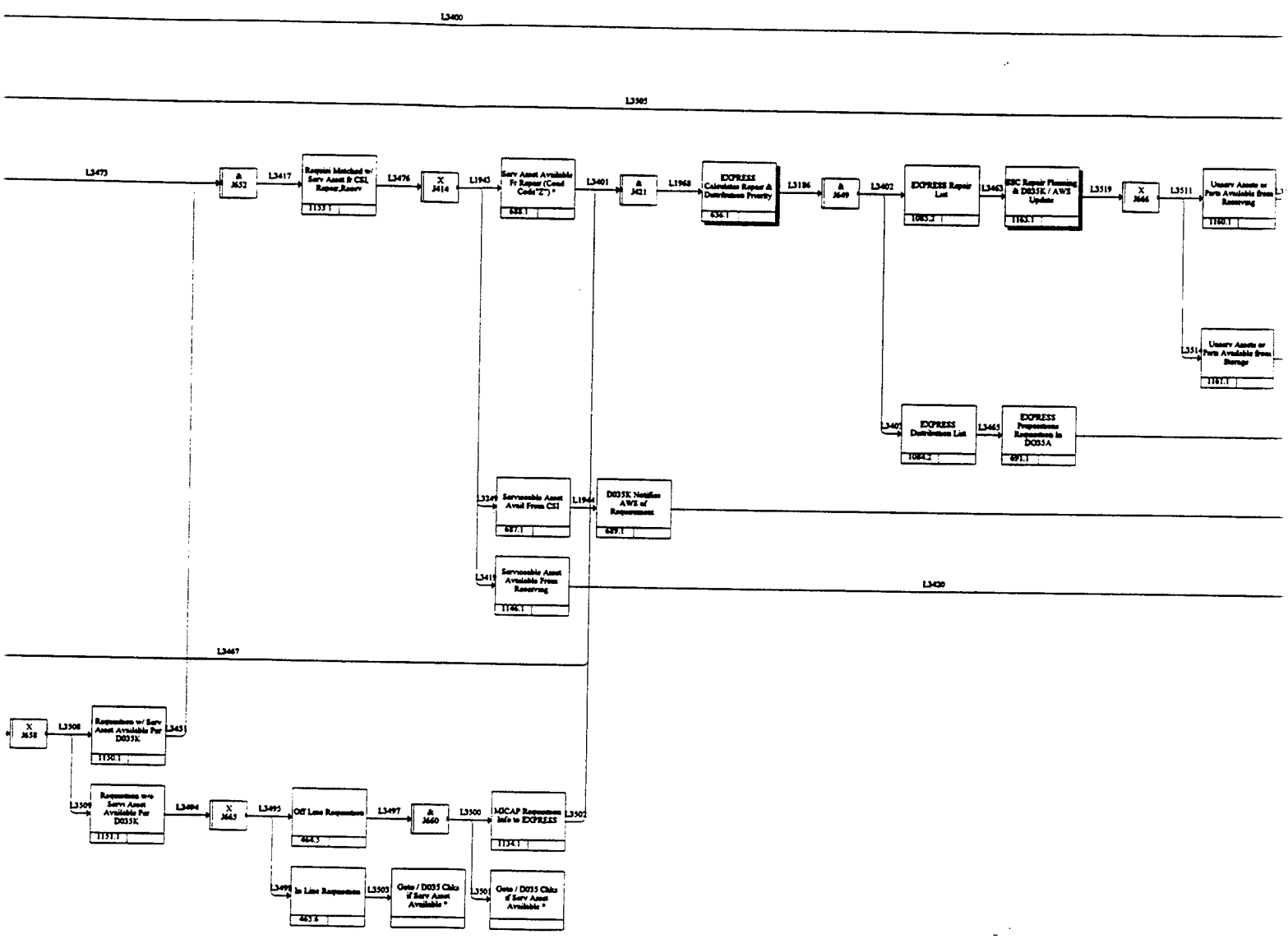

READER

DATE

Context

Neither the US Gov't or Intergraph has any responsibility or liability for any consequences of any use, misuse, inability to use, or reliance upon the information contained herein.

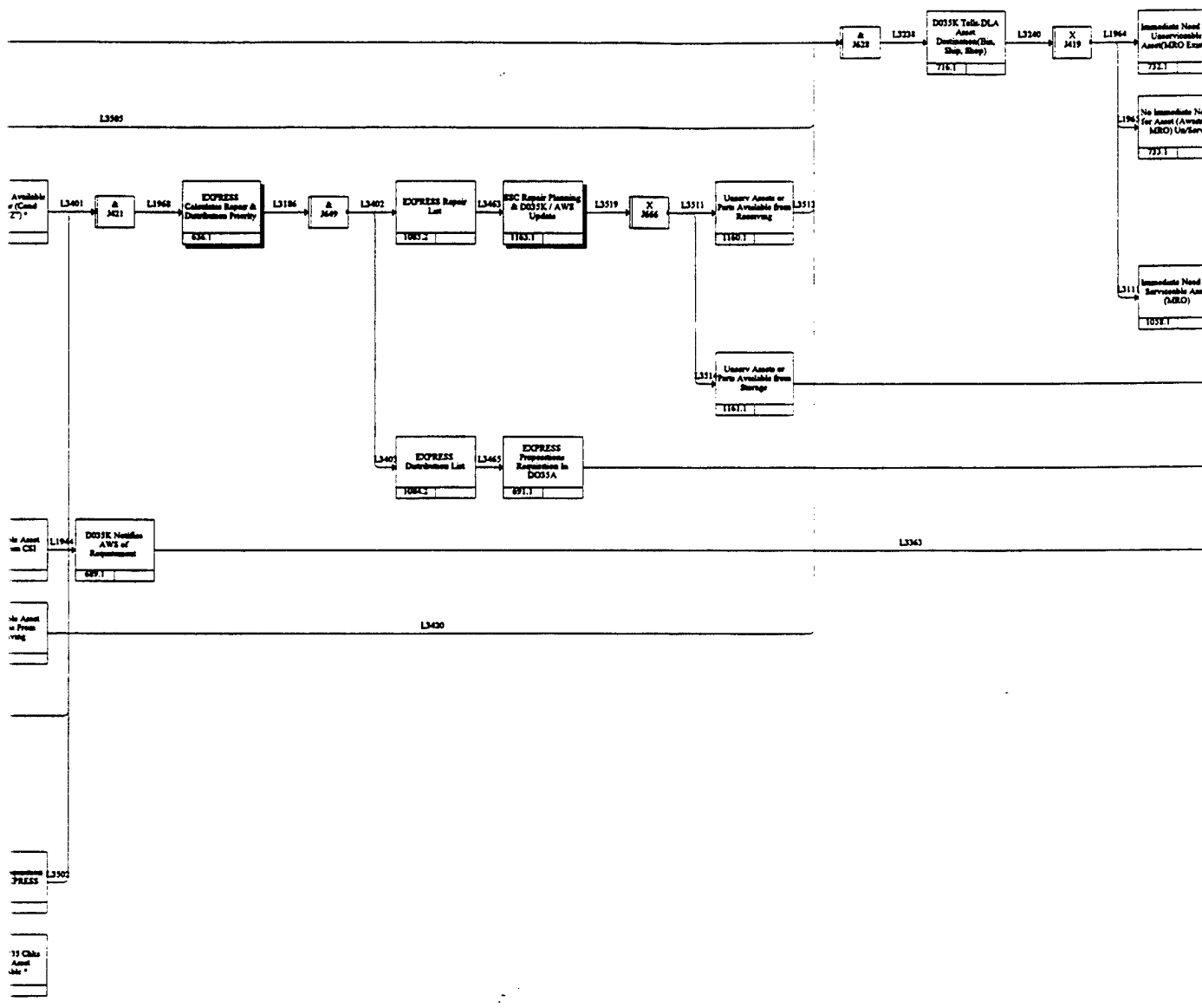

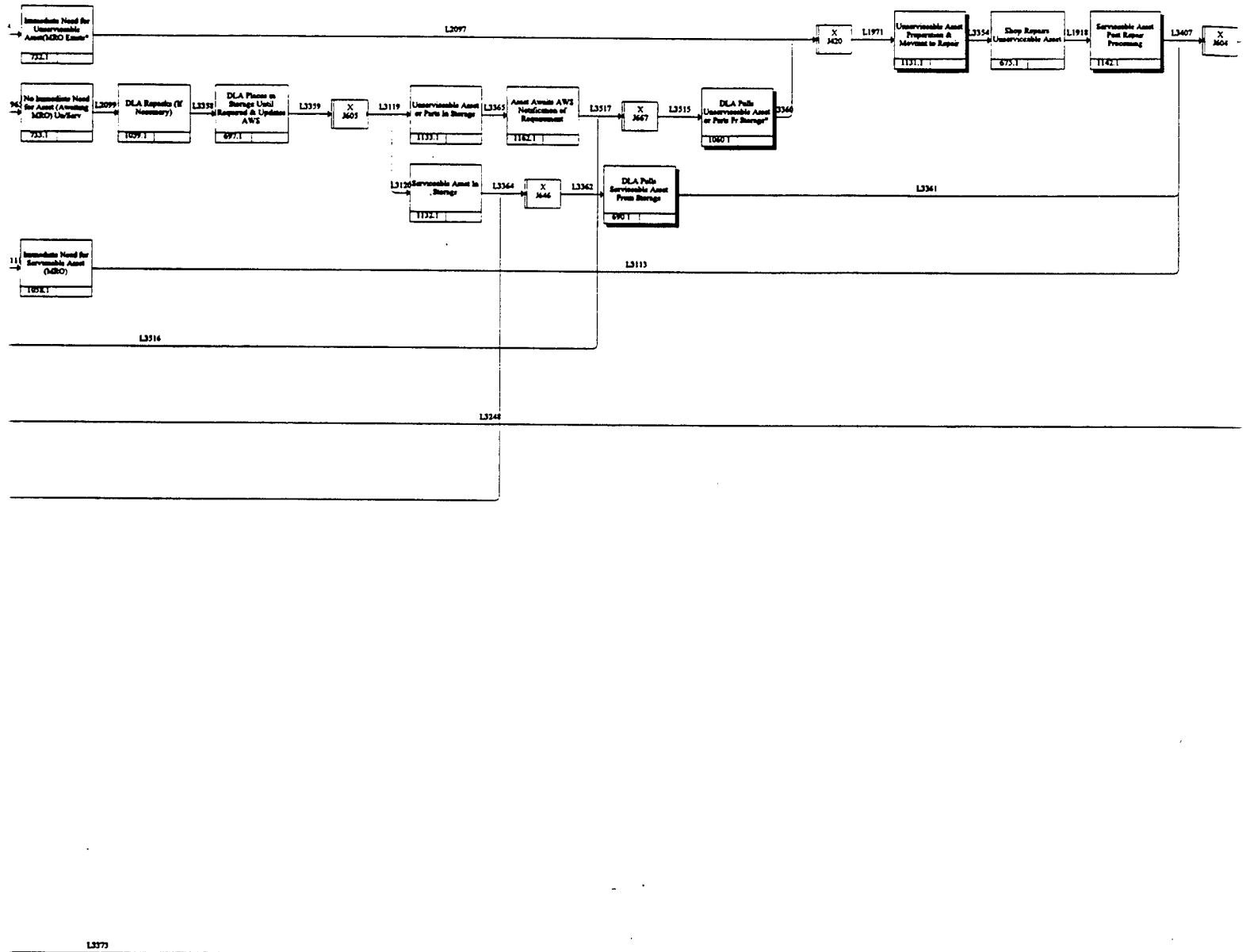

Date: 10/29/98	Working	READER	DATE
Process Rev: 1	X Draft		
	Recommended		
Time: 10:07:24	Publication		

Number of up

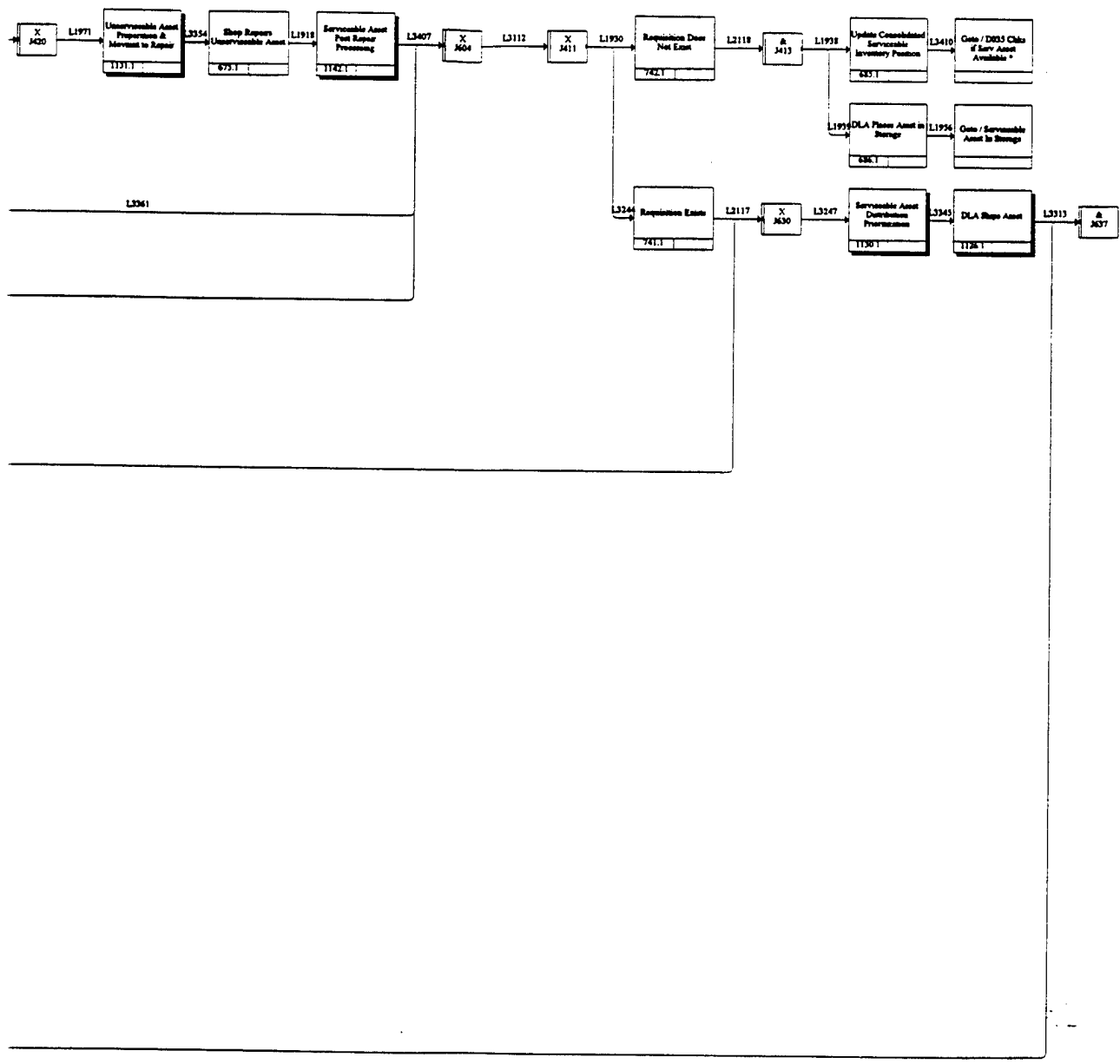

2

READER

DATE

Context

Neither the US Gov't or Intergraph has any responsibility or liability for any consequences of any use, misuse, inability to use, or reliance upon the information contained herein.

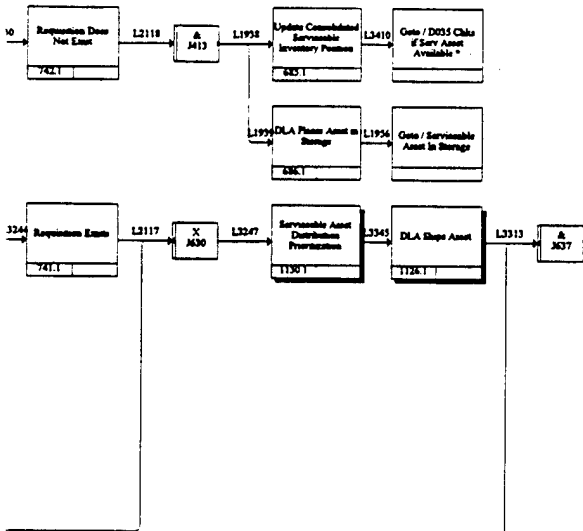

3

Process Flow Decomp: Non-Sortie Related Logistics Processes

Used At: Not Approved for Public Release

Author: AFLMA Reengineering Team
 Project: Future To Be-Asset Sustainment Pro Rev: 1
 Notes: 1 2 3 4 5 6 7 8 9 10 Time: 09:59:34

Date: 10/29/98

Working: Draft Recommended Publication

READER: _____ DATE: _____

Context: Neither the US Gov't or Intergraph has any responsibility or liability for any consequences of any use, misuse, inability to use, or reliance upon the information contained herein.

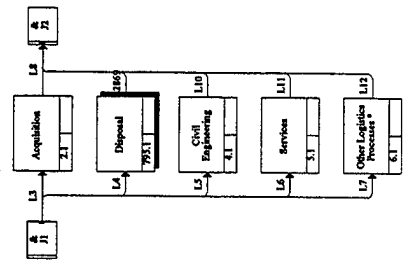

Project: Future To Be- Asset Sustainment Process; Date: 10/30/98

Process Flow Decomp: In-Check Asset @

Working	READER	DATE	Context
<input checked="" type="checkbox"/>			
<input type="checkbox"/>			
<input type="checkbox"/>			
<input type="checkbox"/>			

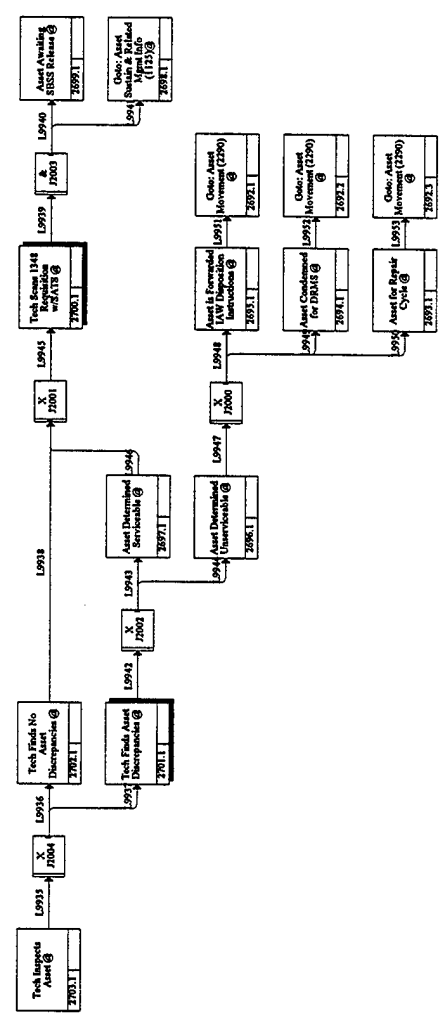

Process Flow Decomp: In-Check Container @

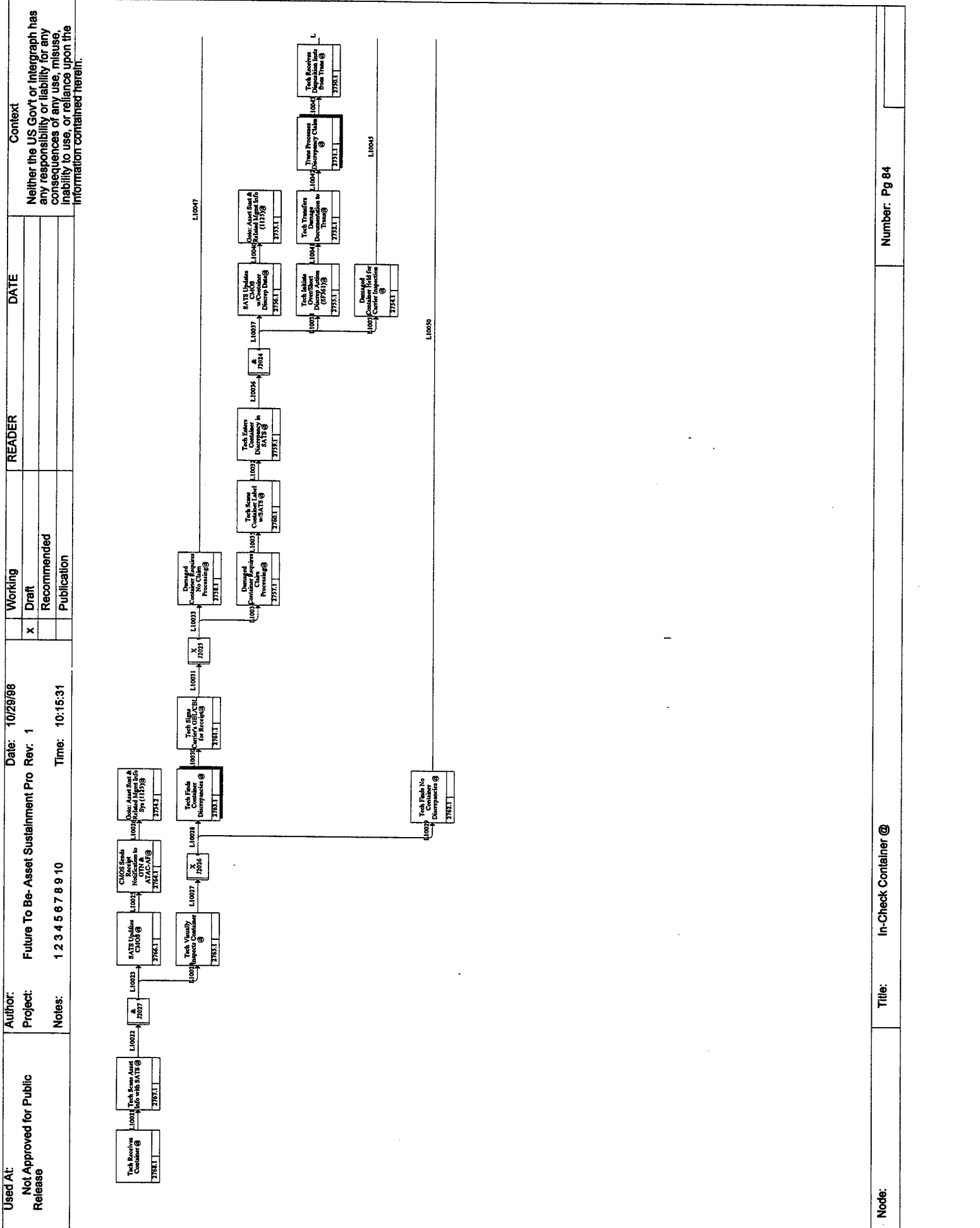

Used At: Not Approved for Public Release
 Author: Date: 10/29/88
 Project: Future To Be- Asset Sustainment Pro Rev: 1
 Notes: 1 2 3 4 5 6 7 8 9 10 Time: 10:15:31
 Working Reader DATE
 Draft Recommended
 Publication

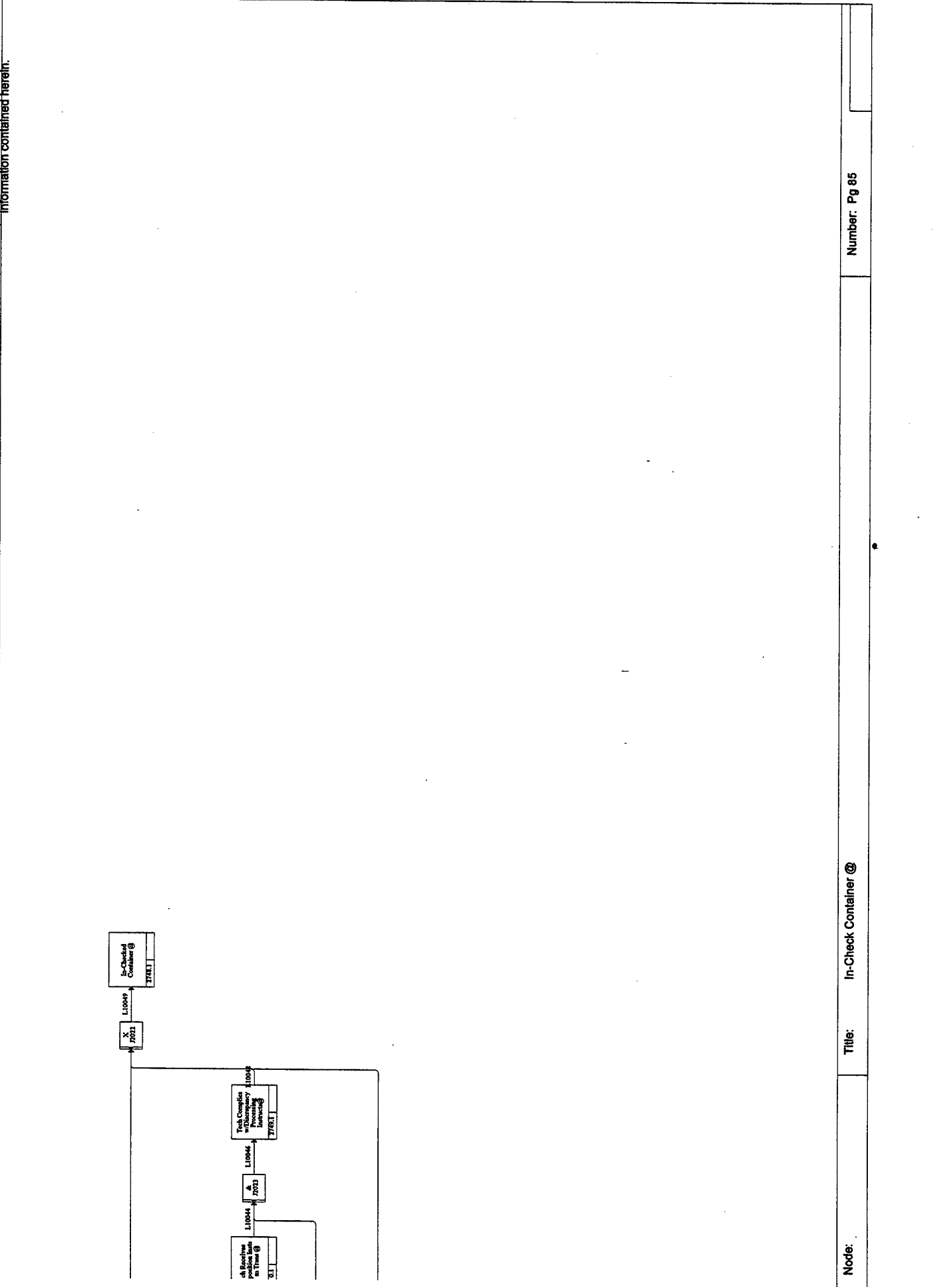

Process Flow Decomp: RCM Analysis

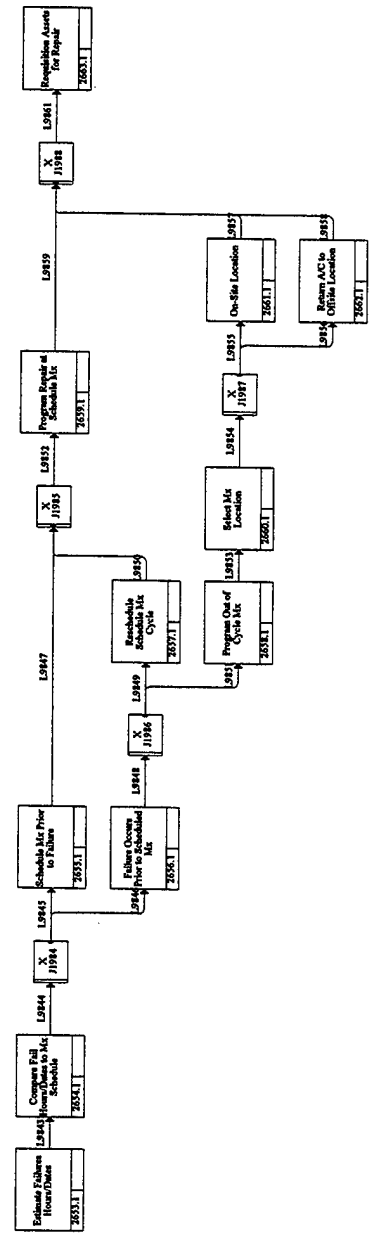

Process Flow Decomp: Mx Tech Performs Pre-Flight Inspection -

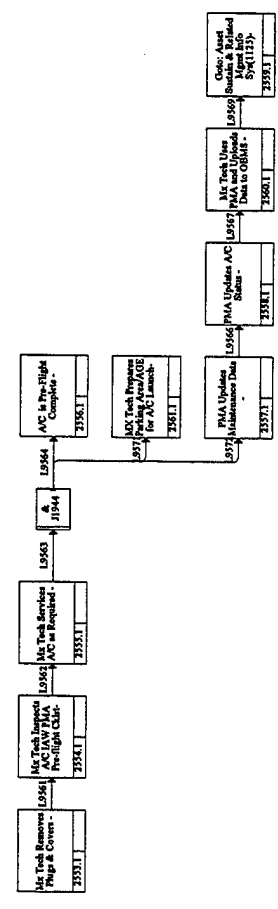

Process Flow Decomp: Mx Mgr Directs Refuel of A/C -

Used At: Not Approved for Public Release

Author: AFLMA Reengineering Team
 Project: Future To Be- Asset Sustainment Pro Rev: 1
 Date: 10/29/98
 Notes: 1 2 3 4 5 6 7 8 9 10 Time: 10:17:46

Working: x
 Draft:
 Recommended:
 Publication:

Context: Neither the US Gov't or Intergraph has any responsibility or liability for any consequences of any use, misuse, inability to use, or reliance upon the information contained herein.

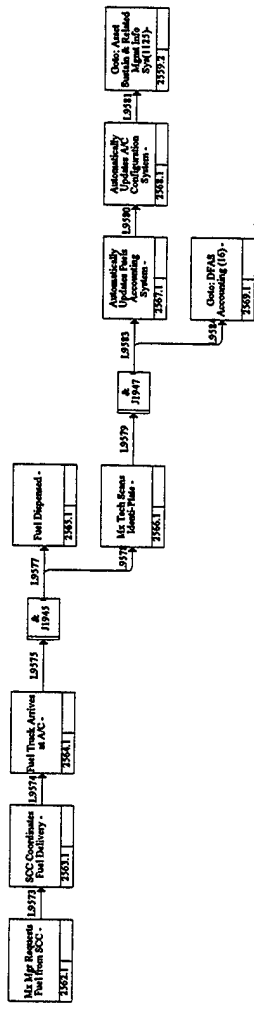

Project: Future To Be- Asset Sustainment Process; Date: 10/30/98

Process Flow Decomp: Maintenance Manager Directs Configuration of A/C -

Working	Recommended	Publication
X		

DATE	READER

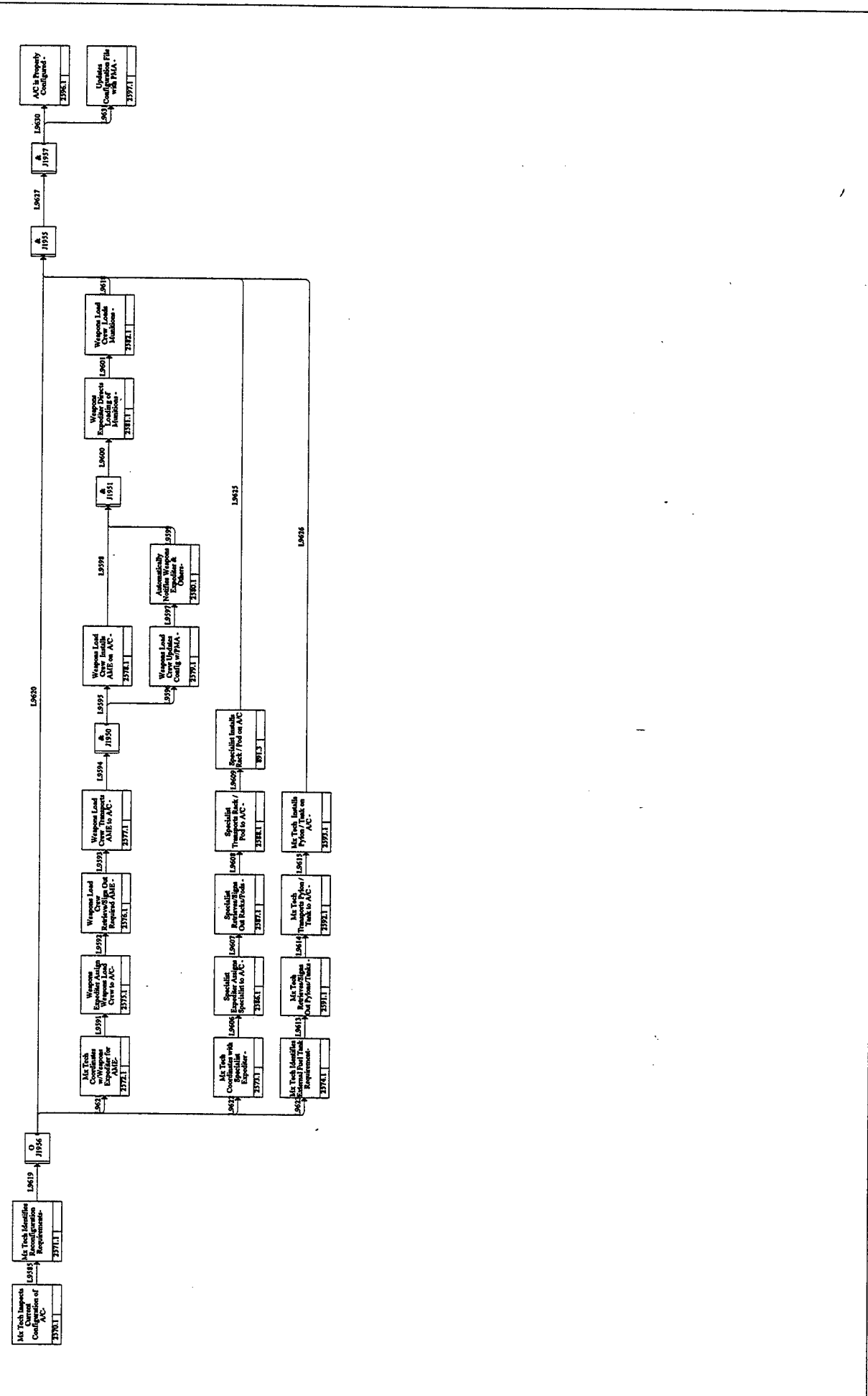

Used AI: Not Approved for Public Release

Author: AFLMA Reengineering Team Date: 10/29/98

Project: Future To Be- Asset Sustainment Pro Rev: 1

Notes: 1 2 3 4 5 6 7 8 9 10 Time: 10:17:32

Working	READER	DATE
<input checked="" type="checkbox"/>		
<input type="checkbox"/>		
<input type="checkbox"/>		
<input type="checkbox"/>		

Context

Neither the US Gov't or Intergraph has any responsibility or liability for any consequences of any use, misuse, inability to use, or reliance upon the information contained herein.

A is Property Configured.
396.1

Update File [L832] with PMA.
397.1

Automatic Notifications Sent to Personnel Display.
7398.1

Other Asset Sustain & Related Support [L833] [L834] [L835] [L836] [L837] [L838] [L839] [L840] [L841] [L842] [L843] [L844] [L845] [L846] [L847] [L848] [L849] [L850] [L851] [L852] [L853] [L854] [L855] [L856] [L857] [L858] [L859] [L860] [L861] [L862] [L863] [L864] [L865] [L866] [L867] [L868] [L869] [L870] [L871] [L872] [L873] [L874] [L875] [L876] [L877] [L878] [L879] [L880] [L881] [L882] [L883] [L884] [L885] [L886] [L887] [L888] [L889] [L890] [L891] [L892] [L893] [L894] [L895] [L896] [L897] [L898] [L899] [L900] [L901] [L902] [L903] [L904] [L905] [L906] [L907] [L908] [L909] [L910] [L911] [L912] [L913] [L914] [L915] [L916] [L917] [L918] [L919] [L920] [L921] [L922] [L923] [L924] [L925] [L926] [L927] [L928] [L929] [L930] [L931] [L932] [L933] [L934] [L935] [L936] [L937] [L938] [L939] [L940] [L941] [L942] [L943] [L944] [L945] [L946] [L947] [L948] [L949] [L950] [L951] [L952] [L953] [L954] [L955] [L956] [L957] [L958] [L959] [L960] [L961] [L962] [L963] [L964] [L965] [L966] [L967] [L968] [L969] [L970] [L971] [L972] [L973] [L974] [L975] [L976] [L977] [L978] [L979] [L980] [L981] [L982] [L983] [L984] [L985] [L986] [L987] [L988] [L989] [L990] [L991] [L992] [L993] [L994] [L995] [L996] [L997] [L998] [L999] [1000]

Project: Future To Be- Asset Sustainment Process; Date: 10/30/98

Process Flow Decomp: Technician Prepares Asset for Shipment*-

Used At: **Not Approved for Public Release**
 Author: **AF/LMA Reengineering Team** Date: **10/29/98**
 Project: **Future To Be-Asset Sustainment Pro** Rev: **1**
 Notes: **1 2 3 4 5 6 7 8 9 10** Time: **10:04:28**

Working: **X**
 Draft:
 Recommended:
 Publication:

READER: _____ DATE: _____

Context: Neither the US Govt or Intergraph has any responsibility or liability for any consequences of any use, misuse, inability to use, or reliance upon the information contained hereof.

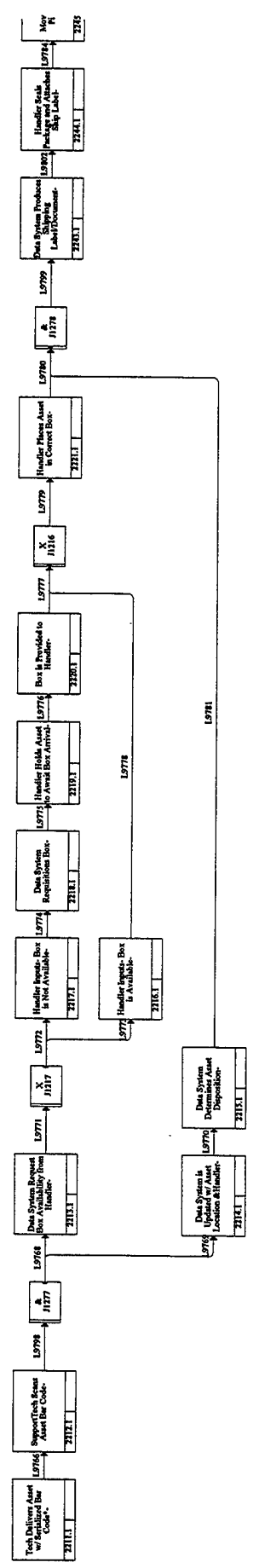

Used At: Not Approved for Public Release

Author: AFLMA Reengineering Team Date: 10/29/98

Project: Future To Be- Asset Sustainment Pro Rev: 1

Notes: 1 2 3 4 5 6 7 8 9 10 Time: 10:04:28

Working: Draft Recommended Publication

READER: _____ DATE: _____

Context: Neither the US Gov't or Intergraph has any responsibility or liability for any consequences of any use, misuse, inability to use, or reliance upon the information contained herein.

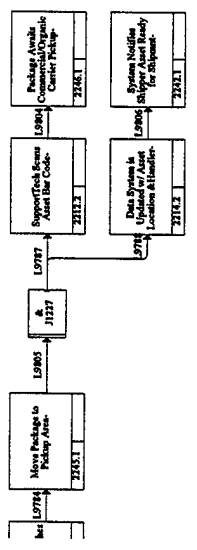

Process Flow Decomp: Goes to Wholesale (Depot or Contract) Processing

Used At: Not Approved for Public Release

Author: AFLMA Reengineering Team Date: 10/29/98

Project: Future To Be- Asset Sustainment Pro Rev: 1

Notes: 1 2 3 4 5 6 7 8 9 10 Time: 10:02:31

Working DATE

Draft

Recommended

Publication

Context

Neither the US Gov't or Intergraph has any responsibility or liability for any consequences of any use, misuse, inability to use, or reliance upon the information contained herein.

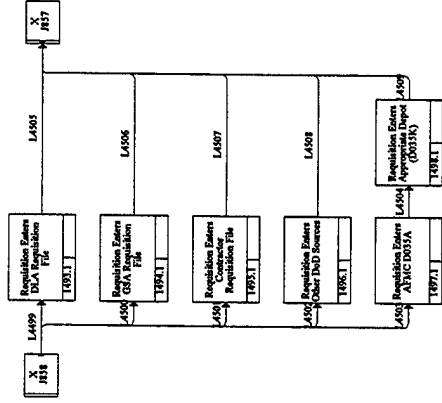

Process Flow Decomp: Maintenance Manager Status Notification-

Used At: Not Approved for Public Release

Author: AFLMA Reengineering Team Date: 10/29/98

Project: Future To Be-Asset Sustainment Pro Rev: 1

Notes: 1 2 3 4 5 6 7 8 9 10 Time: 10:19:18

Working: Draft Recommended Publication

READER: _____ DATE: _____

Context: Neither the US Gov't or Intergraph has any responsibility or liability for any consequences of any use, misuse, inability to use, or reliance upon the information contained herein.

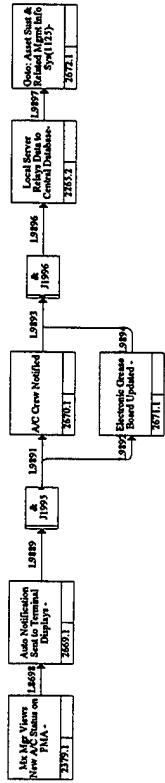

Process Flow Decomp: Redball Repair Process-

Used At: Not Approved for Public Release

Author: AFLMA Reengineering Team Date: 10/29/98

Project: Future To Be-Asset Sustainment Pro Rev: 1

Notes: 1 2 3 4 5 6 7 8 9 10 Time: 10:18:59

Working: X

Reader: Draft

Publication: Recommended

DATE

Context: Neither the US Gov't or Intergraph has any responsibility or liability for any consequences of any use, misuse, inability to use, or reliance upon the information contained herein.

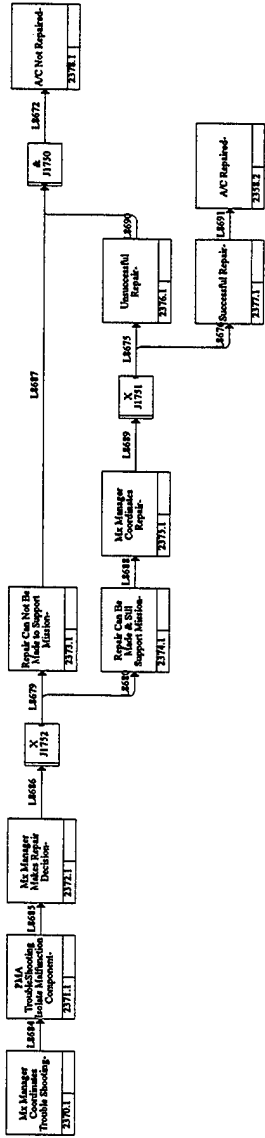

Process Flow Decom: SSC Repair Planning & D035K / AWS Update

Used At: Not Approved for Public Release	Author: AFLMA Reengineering Team Project: Future To Be- Asset Sustainment Pro Notes: 1 2 3 4 5 6 7 8 9 10	Date: 10/29/88 Rev: 1 Time: 10:10:38	Working <input checked="" type="checkbox"/> Draft <input type="checkbox"/> Recommended <input type="checkbox"/> Publication	READER	DATE	Context Neither the US Gov't or Intergraph has any responsibility or liability for any consequences of any use, misuse, inability to use, or reliance upon the information contained herein.
---	---	--	--	--------	------	---

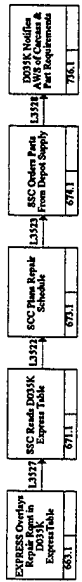

Process Flow Decomp: IM Reviews Requisitions

Working	Reader	DATE	Context
<input checked="checked" type="checkbox"/>			Neither the US Gov't or Intergraph has any responsibility or liability for any consequences of any use, misuse, inability to use, or reliance upon the information contained herein.
<input type="checkbox"/>			
<input type="checkbox"/>			

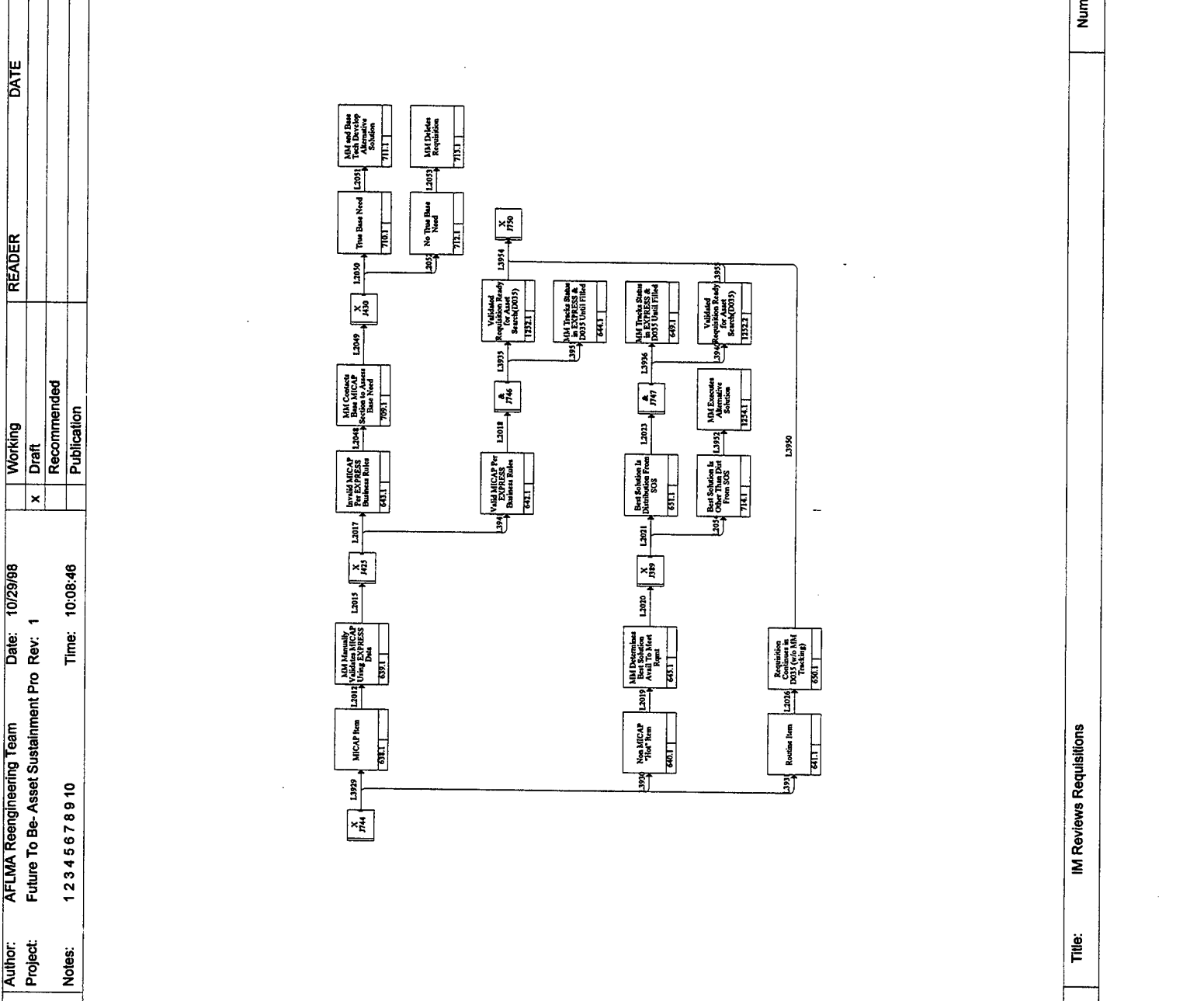

Process Flow Decomp: Receive Requisition

Used At: Not Approved for Public Release

Author: AFLMA Reengineering Team

Project: Future To Be- Asset Sustainment Pro

Notes: 1 2 3 4 5 6 7 8 9 10

Date: 10/29/98

Rev: 1

Time: 10:08:06

Working: Draft

Recommended:

Publication:

READER: _____

DATE: _____

Context: Neither the US Gov't or Intergraph has any responsibility or liability for any consequences of any use, misuse, inability to use, or reliance upon the information contained herein.

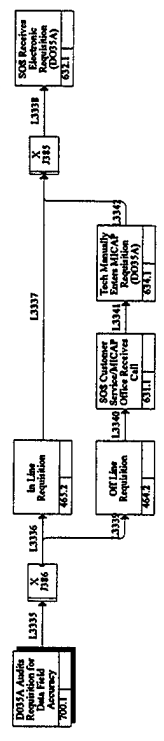

Process Flow Decomp: D035 Chks if Serv Asset Available

Used At: Not Approved for Public Release	Author: Project: Notes:	AF/LMA Reengineering Team Future To Be- Asset Sustainment Pro 1 2 3 4 5 6 7 8 9 10	Date: Rev: Time:	10/29/98 1 10:09:07	Working Draft Recommended Publication	READER	DATE	Context Neither the US Gov't or Intergraph has any responsibility or liability for any consequences of any use, misuse, inability to use, or reliance upon the information contained herein.
---	-------------------------------	--	------------------------	---------------------------	--	--------	------	---

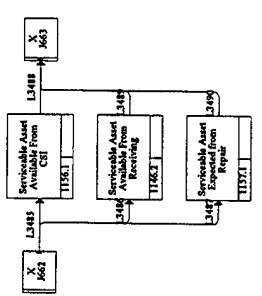

Process Flow Decomp: Serviceable Asset Post Repair Processing

Used At: Not Approved for Public Release

Author: AFLMA Reengineering Team Date: 10/29/88

Project: Future To Be- Asset Sustainment Pro Rev: 1

Notes: 1 2 3 4 5 6 7 8 9 10 Time: 10:12:01

Working

Draft

Recommended

Publication

READER

DATE

Context

Neither the US Gov't or Intergraph has any responsibility or liability for any consequences of any use, misuse, inability to use, or reliance upon the information contained herein.

Shop Delivered
Serviceable Asset
to SIC
79Z.I

SIC Change
Controlled to
Z-Serviceable
(00135K)
10Z.I

DLA Prepares
Asset For Storage
or Shipping
11Z.I

Process Flow Decomp: DLA Pulls Unserviceable Asset or Parts Fr Storage

Used At: Not Approved for Public Release

Author: AFLMA Reengineering Team Date: 10/29/88

Project: Future To Be- Asset Sustainment Pro Rev: 1

Notes: 1 2 3 4 5 6 7 8 9 10 Time: 10:11:24

Working: Draft: Recommended: Publication:

READER: DATE: Context: Neither the US Govt or Intergraph has any responsibility or liability for any consequences of any use, misuse, inability to use, or reliance upon the information contained herein.

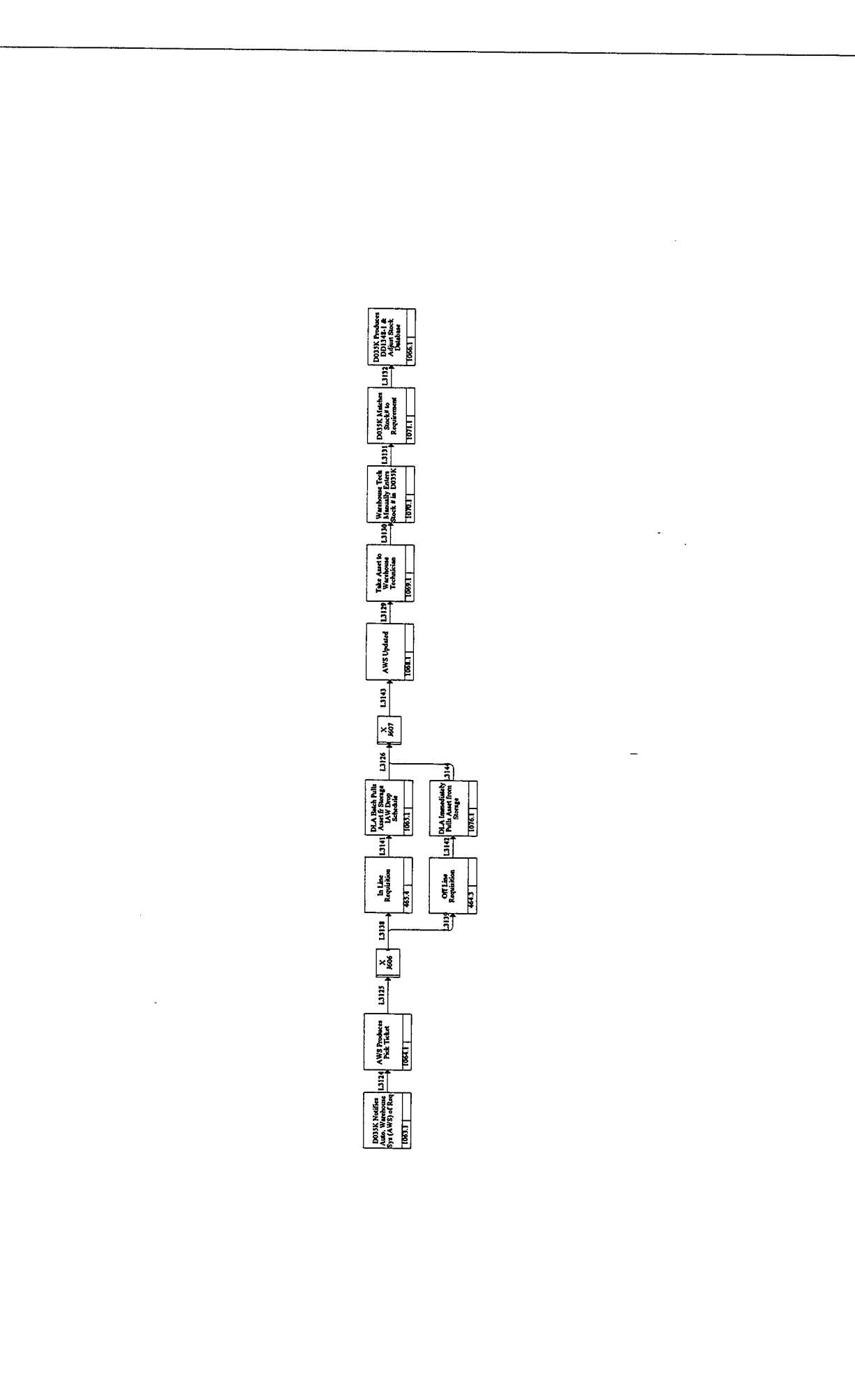

Process Flow Decomp: Unserviceable Asset Preparation & Movmnt to Repair

Used AI: Not Approved for Public Release

Author: AFLMA Reengineering Team
 Project: Future To Be- Asset Sustainment Pro Rev: 1
 Notes: 1 2 3 4 5 6 7 8 9 10 Date: 10/29/98 Time: 10:11:41

Working	READER	DATE
<input checked="" type="checkbox"/>		
<input type="checkbox"/>		
<input type="checkbox"/>		
<input type="checkbox"/>		

Context
 Neither the US Gov't or Intergraph has any responsibility or liability for any consequences of any use, misuse, inability to use, or reliance upon the information contained herein.

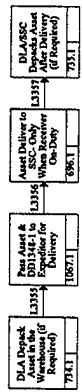

Process Flow Decomp: Serviceable Asset Distribution Prioritization

Used At: Not Approved for Public Release

Author: AFLMA Reengineering Team
 Project: Future To Be-Asset Sustainment Pro
 Notes: 1 2 3 4 5 6 7 8 9 10

Date: 10/29/88
 Rev: 1
 Time: 10:12:29

Working: Draft
 Recommended
 Publication

READER: _____ DATE: _____

Context: Neither the US Govt or Intergraph has any responsibility or liability for any consequences of any use, misuse, inability to use, or reliance upon the information contained herein.

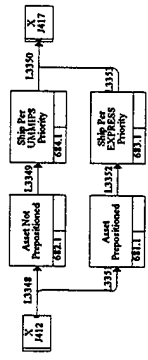

Project: Future To Be- Asset Sustainment Process; Date: 10/30/98

Process Flow Decomp: DLA Ships Asset

Used At: Not Approved for Public Release

Author: AFLMA Reengineering Team

Date: 10/29/88

Project: Future To Be- Asset Sustainment Pro Rev. 1

Notes: 1 2 3 4 5 6 7 8 9 10

Time: 10:12:45

Working

Draft

Recommended

Publication

READER

DATE

Context

Neither the US Gov't or Intergraph has any responsibility or liability for any consequences of any use, misuse, inability to use, or reliance upon the information contained herein.

DLA Over-Packs
Statement (if
required)

133146

DLA Distribution
Agency
DDI/507

133146

DLA Distribution
Center

133146

DDI/507

DLA Office
Shipping Label
Package

133146

Process Flow Decomp: Consumable Requisition & Demand Processing

Used At: Not Approved for Public Release	Author: AFLMA Reengineering Team	Date: 10/29/98	Working	Context
	Project: Future To Be- Asset Sustainment Pro	Rev: 1	<input checked="" type="checkbox"/> Draft	Neither the US Gov't or Intergraph has any responsibility or liability for any consequences of any use, misuse, inability to use, or reliance upon the information contained herein.
	Notes: 1 2 3 4 5 6 7 8 9 10	Time: 10:09:29	<input type="checkbox"/> Recommended	
			<input type="checkbox"/> Publication	
			READER	
			DATE	

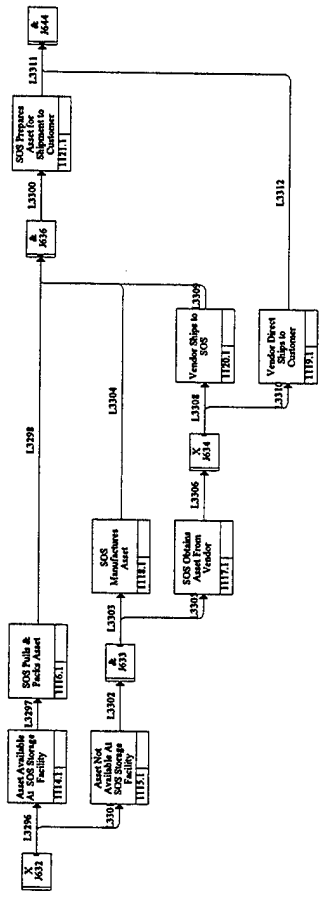

Process Flow Decomp: DLA Receiving

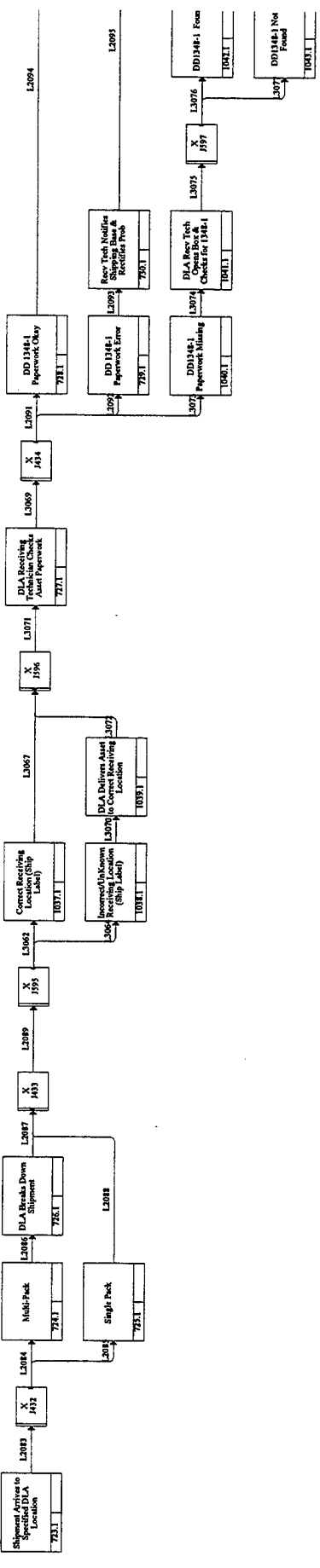

Used At: **Not Approved for Public Release**
 Author: **AFLMA Reengineering Team** Date: **10/29/88**
 Project: **Future To Be-Asset Sustainment Pro** Rev: **1**
 Notes: **1 2 3 4 5 6 7 8 9 10** Time: **10:07:49**
 Working: Draft
 Recommended:
 Publication:

Context: Neither the US Gov't or Intergraph has any responsibility or liability for any consequences of any use, misuse, inability to use, or reliance upon the information contained herein.

READER: _____ DATE: _____

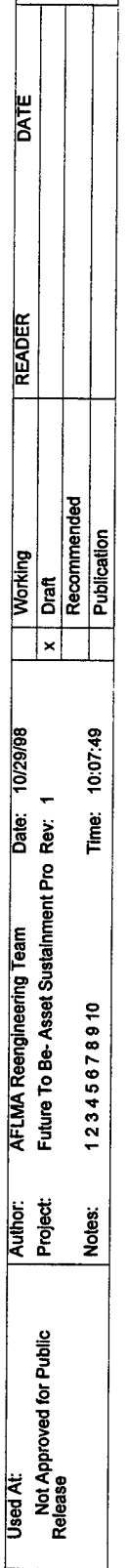

Process Flow Decomp: DLA Pulls Serviceable Asset From Storage

Used At: Not Approved for Public Release

Author: AFLMA Reengineering Team
 Project: Future To Be- Asset Sustainment Pro Rev: 1
 Date: 10/29/98
 Time: 10:11:01

Notes: 1 2 3 4 5 6 7 8 9 10

Working: X
 Draft:
 Recommended:
 Publication:

Reader: DATE

Context: Neither the US Gov't or Intergraph has any responsibility or liability for any consequences of any use, misuse, inability to use, or reliance upon the information contained herein.

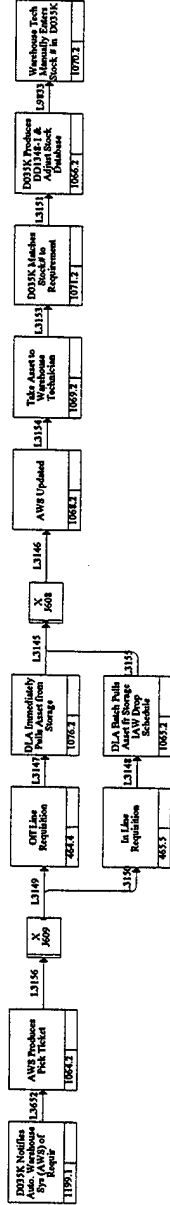

Process Flow Decomp: EXPRESS Calculates Repair & Distribution Priority

Used At: Not Approved for Public Release

Author: AFLMA Reengineering Team
 Project: Future To Be-Asset Sustainment Pro
 Date: 10/29/88
 Rev: 1

Notes: 1 2 3 4 5 6 7 8 9 10
 Time: 10:09:50

Working: X
 Draft
 Recommended
 Publication

READER

DATE

Context: Neither the US Gov't or Intergraph has any responsibility or liability for any consequences of any use, misuse, inability to use, or reliance upon the information contained herein.

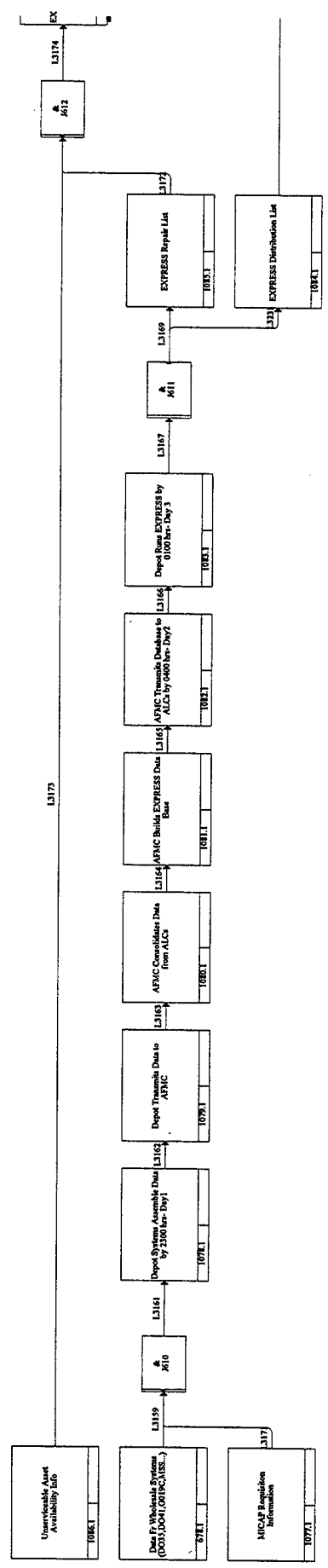

Used At: Not Approved for Public Release

Author: AFLMA Reengineering Team

Project: Future To Be-Asset Sustainment Pro

Notes: 1 2 3 4 5 6 7 8 9 10

Date: 10/29/98

Rev: 1

Time: 10:09:50

Working: Draft

Recommended:

Publication:

READER: _____

DATE: _____

Context: Neither the US Gov't or Intergraph has any responsibility or liability for any consequences of any use, misuse, inability to use, or reliance upon the information contained herein.

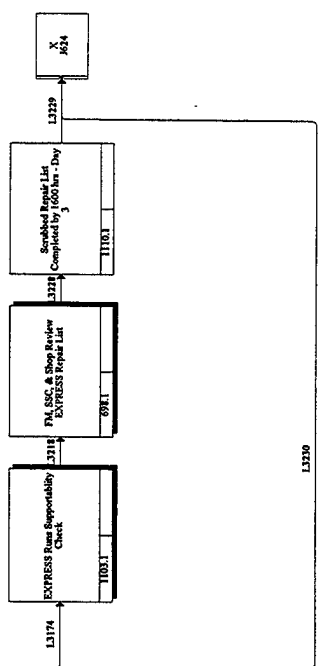

Process Flow Decomp: Disposable

Used At: Not Approved for Public Release

Author: AFLMA Reengineering Team
 Project: Future To Be-Asset Sustainment Pro Rev: 1
 Notes: 1 2 3 4 5 6 7 8 9 10 Time: 15:45:07

Date: 11/12/97

Working: Draft: Recommended: Publication:

READER: _____ DATE: _____

Context: Neither the US Govt or Intergraph has any responsibility or liability for any consequences of any use, misuse, inability to use, or reliance upon the information contained herein.

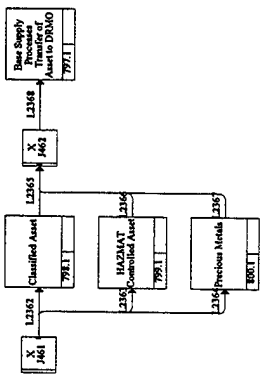

Project: Future To Be- Asset Sustainment Process; Date: 10/30/98

Process Flow Decomp: Tech Scans 1348 Requisition w/SATS @

Used At: Not Approved for Public Release

Author: Date: 5/13/98

Project: Future To Be- Asset Sustainment Pro Rev: 1

Notes: 1 2 3 4 5 6 7 8 9 10 Time: 08:25:10

Working Draft Recommended Publication

READER

DATE

Context

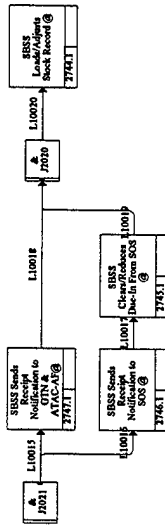

Process Flow Decomp: Tech Finds Asset Discrepancies @

Used At: Not Approved for Public Release

Author: Date: 5/13/98
 Project: Future To Be- Asset Sustainment Pro Rev: 1
 Notes: 1 2 3 4 5 6 7 8 9 10 Time: 08:25:09

Working
 Draft
 Recommended
 Publication

READER DATE

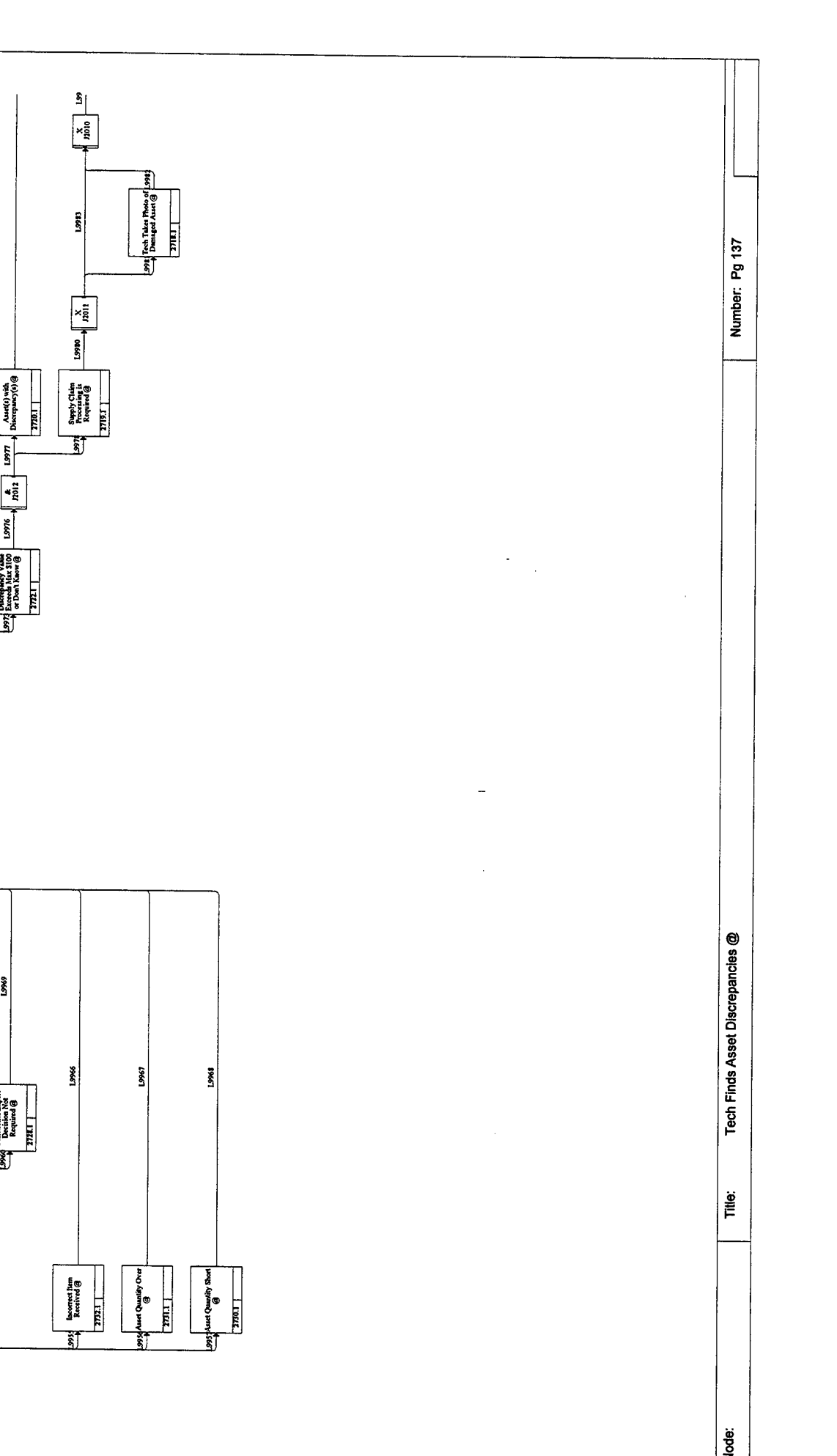

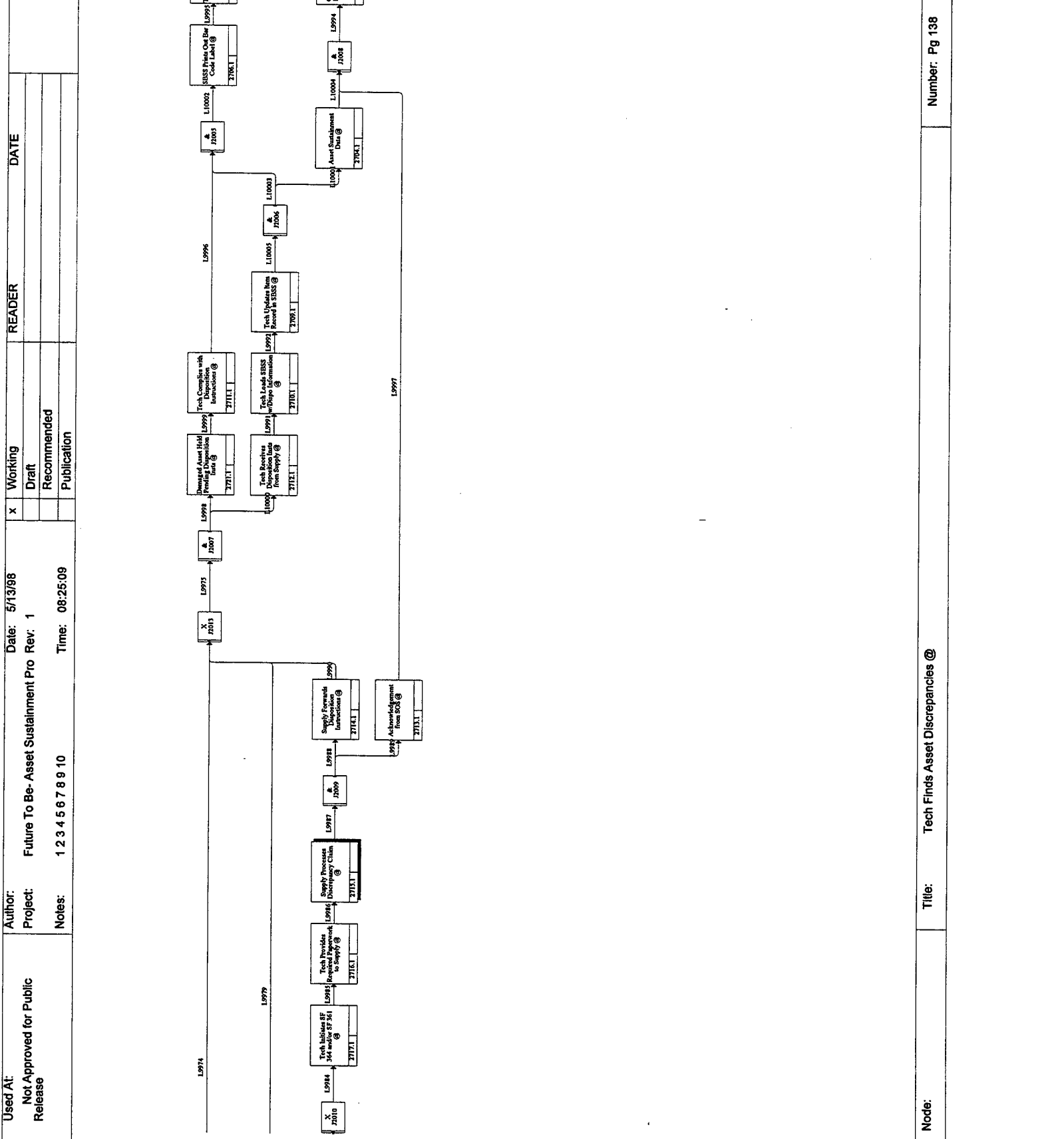

Used At: Not Approved for Public Release

Author: Project: Future To Be- Asset Sustainment Pro Rev: 1

Date: 5/13/98 Time: 08:25:09

Notes: 1 2 3 4 5 6 7 8 9 10

Working Draft Recommended Publication

x

READER

DATE

Context

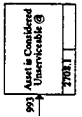

Title: Tech Finds Asset Discrepancies @

Number: Pg 139

Node:

Process Flow Decomp: Trans Processes Discrepancy Claim @

Used At: Not Approved for Public Release

Author: Date: 10/29/88
Project: Future To Be-Asset Sustainment Pro Rev: 1
Notes: 1 2 3 4 5 6 7 8 9 10 Time: 10:15:56

Working: x Draft
Recommended
Publication

READER: DATE

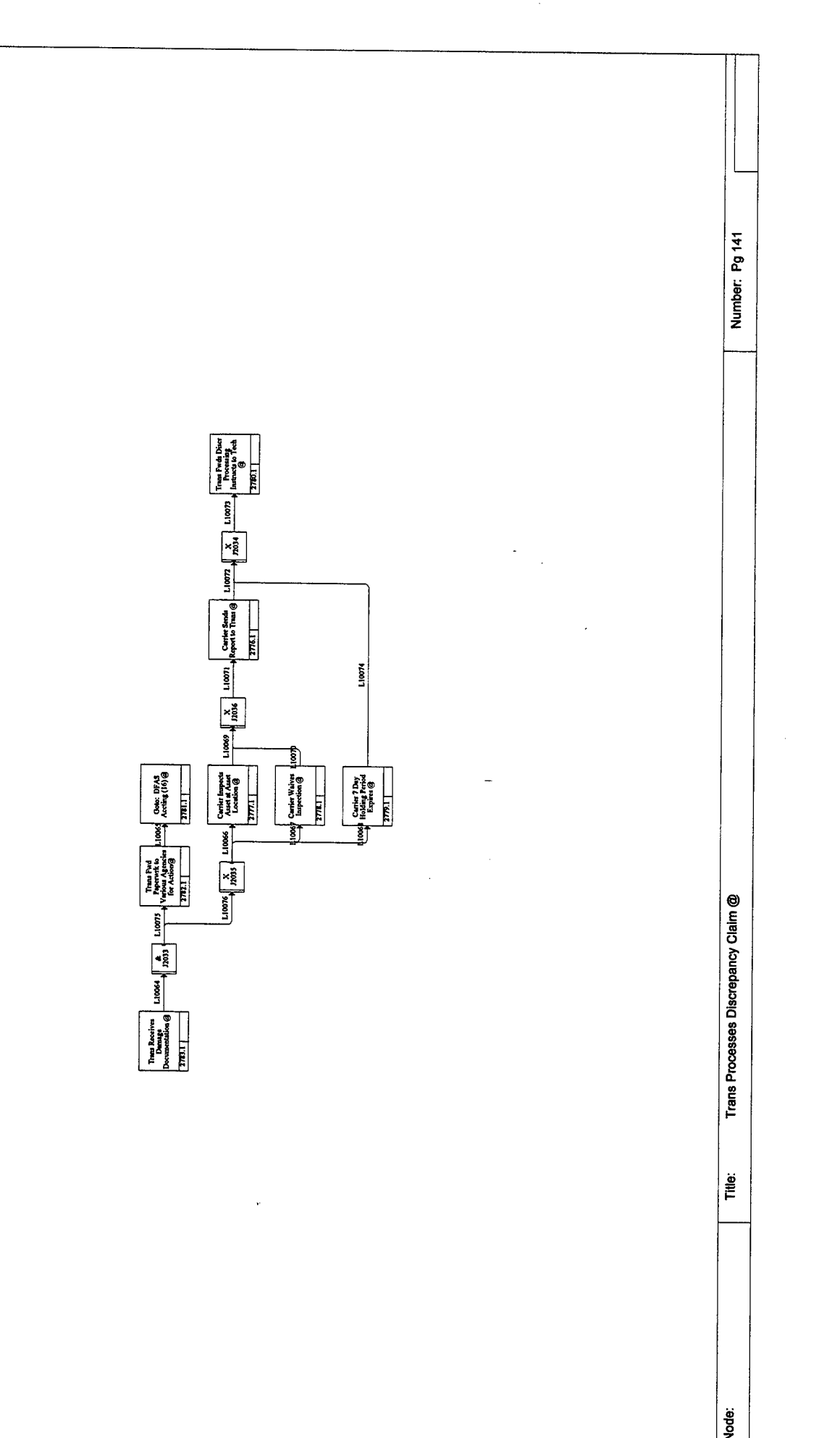

Process Flow Decomp: Tech Finds Container Discrepancies @

Used At: Not Approved for Public Release

Author: Project: Future To Be- Asset Sustainment Pro Rev: 1

Date: 10/29/98

Notes: 1 2 3 4 5 6 7 8 9 10 Time: 10:15:42

Working: Draft

Recommended: X

Publication:

Reader: DATE

Context: Neither the US Gov't or Intergraph has any responsibility or liability for any consequences of any use, misuse, inability to use, or reliance upon the information contained herein.

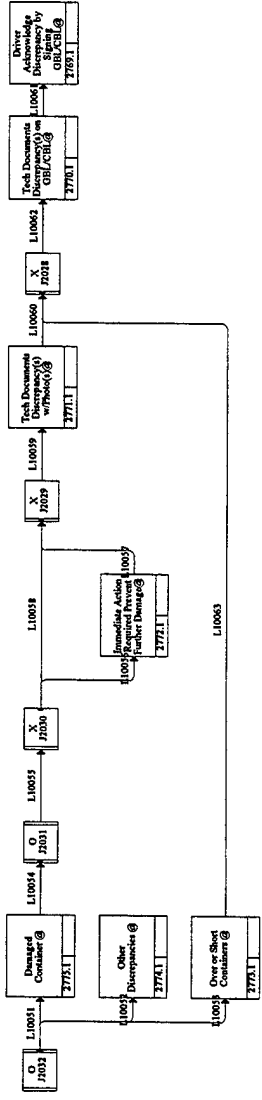

Process Flow Decomp: D035A Audits Requisition for Data Field Accuracy

Used At: Not Approved for Public Release	Author: AFLMA Reengineering Team Project: Future To Be-Asset Sustainment Pro Notes: 1 2 3 4 5 6 7 8 9 10	Date: 10/29/98 Rev: 1 Time: 10:08:18	Working Draft Recommended Publication	READER	DATE	Context Neither the US Gov't or Intergraph has any responsibility or liability for any consequences of any use, misuse, inability to use, or reliance upon the information contained herein.
---	--	--	--	--------	------	---

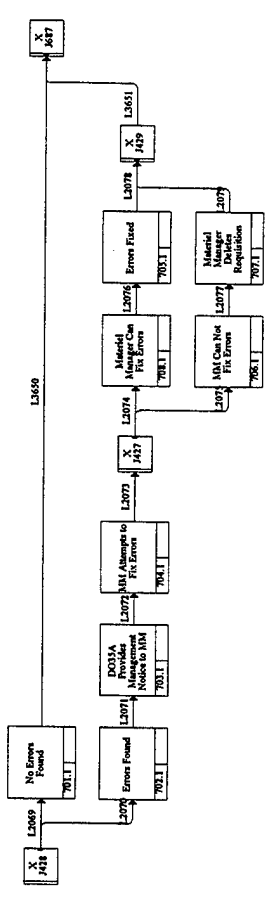

Process Flow Decomp: DLA Prepares Asset For Storage or Shipping

Used At: Not Approved for Public Release

Author: AFLMA Reengineering Team
 Project: Future To Be- Asset Sustainment Pro Rev: 1
 Notes: 1 2 3 4 5 6 7 8 9 10 Date: 10/29/98 Time: 10:12:11

Working	READER	DATE
<input checked="" type="checkbox"/>		
<input type="checkbox"/>		
<input type="checkbox"/>		
<input type="checkbox"/>		

Context
 Neither the US Gov't or Intergraph has any responsibility or liability for any consequences of any use, misuse, inability to use, or reliance upon the information contained herein.

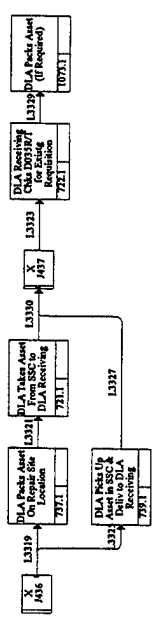

Process Flow Decomp: DLA Determines Carrier

Author: AFLMA Reengineering Team Date: 10/29/98
 Project: Future To Be- Asset Sustainment Pro Rev: 1
 Notes: 1 2 3 4 5 6 7 8 9 10 Time: 10:12:57

Working	READER	DATE
x		

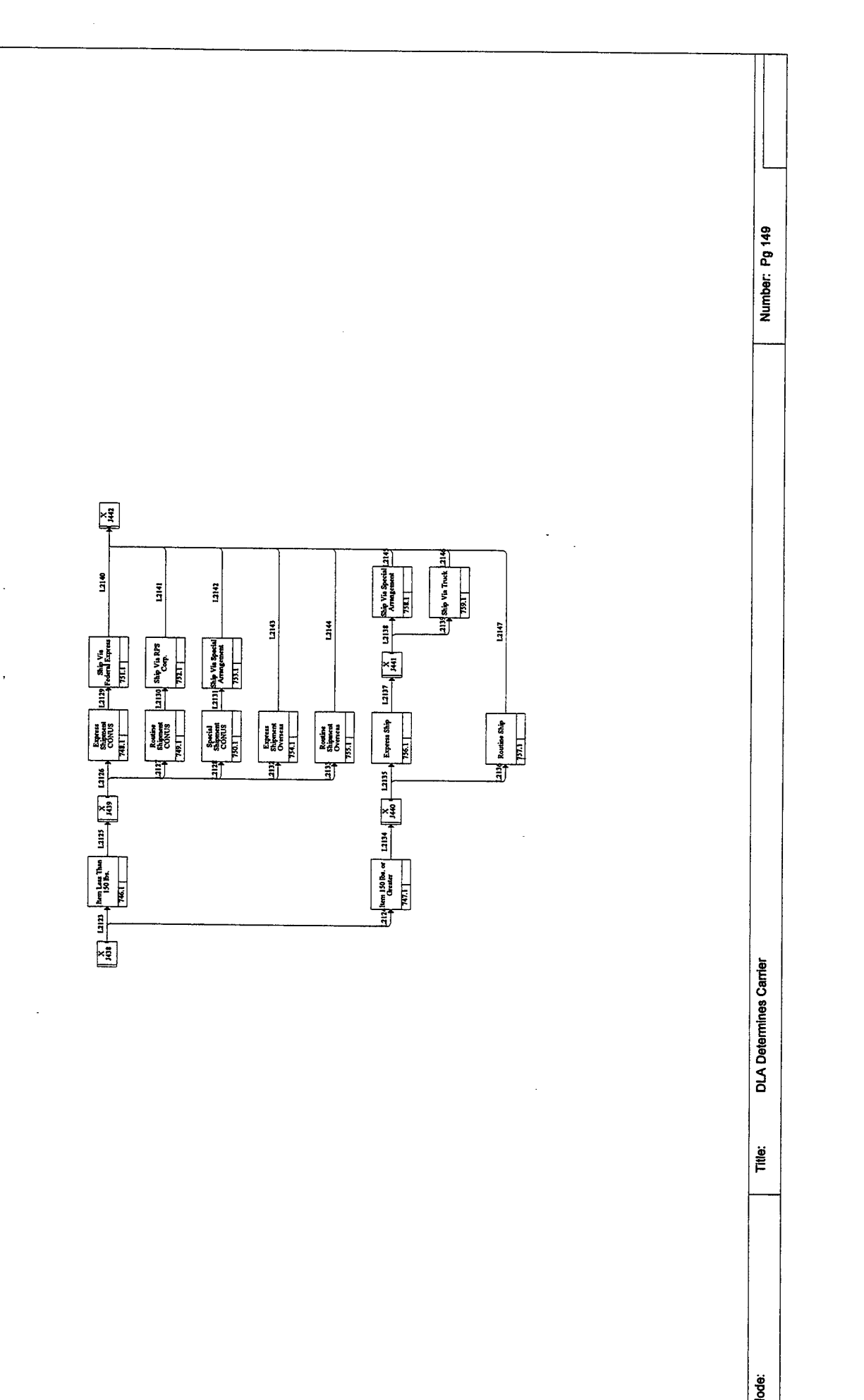

Process Flow Decomp: DLA Tech Manually Inputs Asset Info into D035K

Author: AFLMA Reengineering Team
 Project: Future To Be-Asset Sustainment Pro Rev. 1
 Notes: 1 2 3 4 5 6 7 8 9 10
 Date: 2/25/98
 Time: 08:44:07

Working	
Draft	
Recommended	
Publication	x

READER	

Context

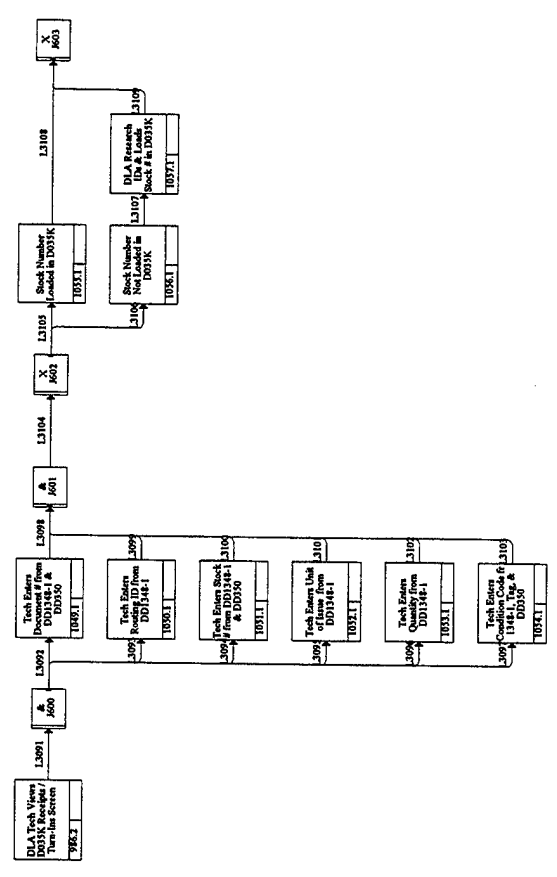

Process Flow Decomp: EXPRESS Runs Supportability Check

Used At: Not Approved for Public Release

Author: AFLMA Reengineering Team
 Project: Future To Be- Asset Sustainment Pro
 Notes: 1 2 3 4 5 6 7 8 9 10

Date: 10/29/88
 Rev: 1
 Time: 10:10:02

Working: Draft Recommended Publication

READER: _____ DATE: _____

Context: Neither the U.S. Gov't or Intergraph has any responsibility or liability for any consequences of any use, misuse, inability to use, or reliance upon the information contained herein.

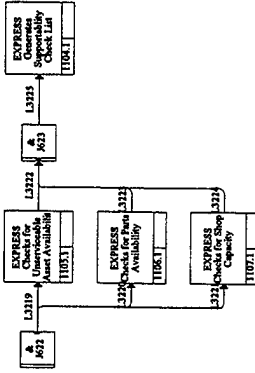

Process Flow Decomp: FM, SSC, & Shop Review EXPRESS Repair List

Used At: Not Approved for Public Release

Author: AFLMA Reengineering Team Date: 10/29/98

Project: Future To Be- Asset Sustainment Pro Rev: 1

Notes: 1 2 3 4 5 6 7 8 9 10 Time: 10:10:17

Working: X Draft Recommended Publication

Context: Neither the US Govt or Intergraph has any responsibility or liability for any consequences of any use, misuse, inability to use, or reliance upon the information contained herein.

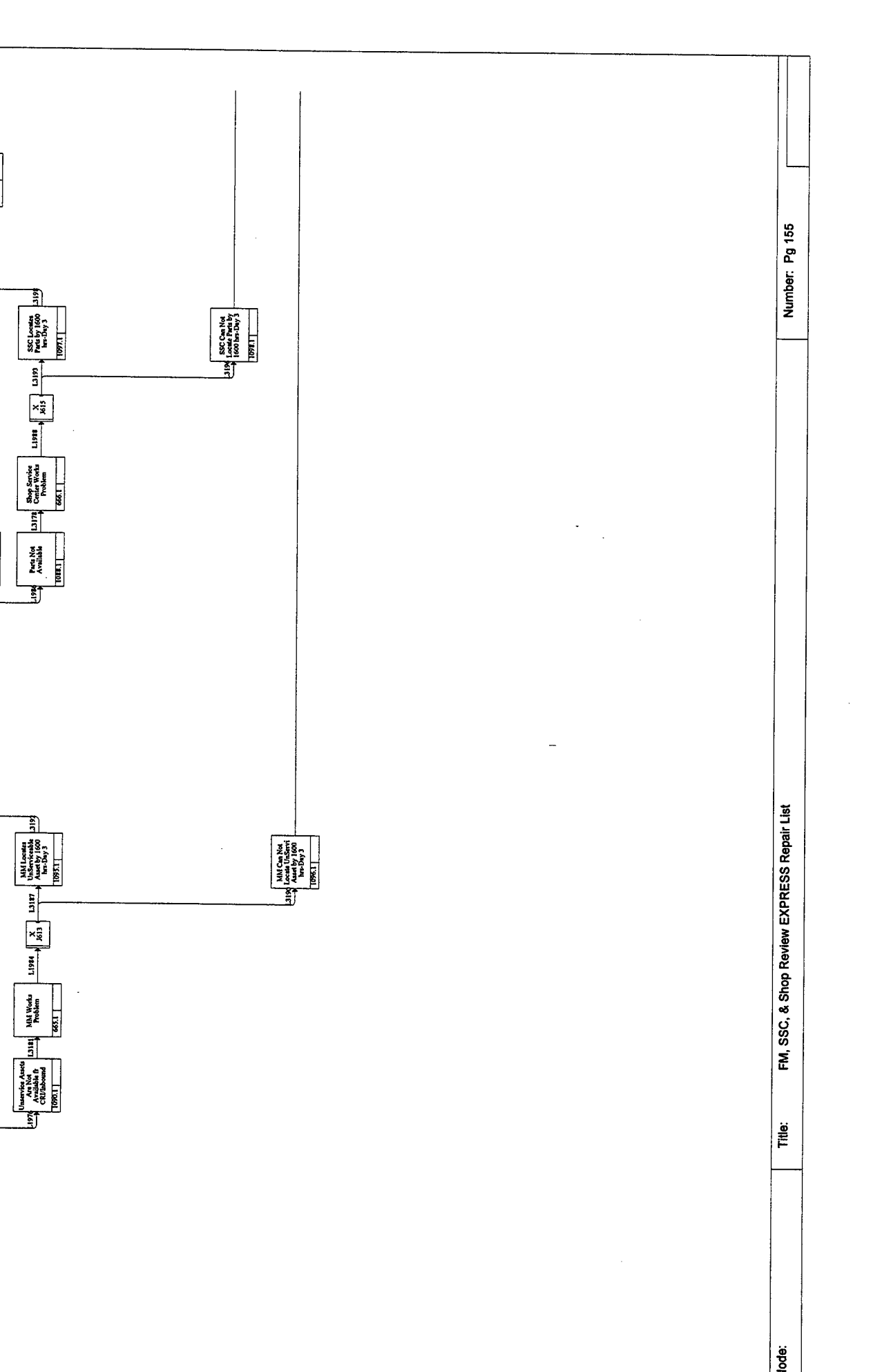

Process Flow Decomp: Supply Processes Discrepancy Claim @

Used At:	Author:	Date:	Project:	Notes:	Time:	Context
Not Approved for Public Release	Future To Be- Asset Sustainment Pro	5/13/98	Rev: 1	1 2 3 4 5 6 7 8 9 10	08:25:10	
x	Working	READER	DATE	Draft	Recommended	Publication

Supply Receive Paperwork from Tech @ 7/8/91

Supply Initiates Request Report @ 7/8/91

Supply Send Report Back to Tech @ 7/8/91

Supply Receive Disposition Information @ 7/8/91

Node: Title: Supply Processes Discrepancy Claim @

Number: Pg 158

Process Flow Decomp: Tech Scans Asset (w/Discrepancy) with SATS @

Used AI: Not Approved for Public Release	Author:	Date: 5/13/98	x Working	READER	DATE	Context
	Project:	Future To Be-Asset Sustainment Pro Rev: 1		Draft		
Notes:	1 2 3 4 5 6 7 8 9 10	Time: 08:25:10		Recommended		
				Publication		

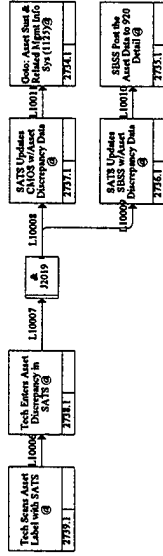

REPORT DOCUMENTATION PAGEFORM APPROVED
OMB No. 0704-0188

Public reporting burden for this collection of information is estimated to average 1 hour per response, including the time for reviewing instructions, searching existing data sources, gathering and maintaining the data needed, and completing and reviewing the collection of information. Send comments regarding this burden estimate or any other aspect of this collection of information, including suggestions for reducing this burden, to Washington Headquarters Services, Directorate for Information, Operations and Reports, 1215 Jefferson Davis Highway, Suite 1204, Arlington VA 22202-4302, and to the Office of Management and Budget, Paperwork Reduction Project (0704-0188), Washington DC, 20503.

1. AGENCY USE ONLY (Leave Blank)		2. REPORT DATE December 1998	3. REPORT TYPE AND DATES COVERED Final Report - Volume III	
4. TITLE AND SUBTITLE Logistics Process Optimization Study Volume III - Future Retail Aircraft Asset Sustainment Process Models			5. FUNDING NUMBERS	
6. AUTHOR(S) Anthony Adamson, Intergraph Corporation, Coml (256) 730-7762 Dorothy J. Tribble, Major, AFLMA/LGM, DSN 596-4581				
7. PERFORMING ORGANIZATION NAME(S) AND ADDRESS(ES) Air Force Logistics Management Agency/LGM 501 Ward Street Maxwell AFB, Gunter Annex AL 36114-3236			8. PERFORMING ORGANIZATION REPORT NUMBER LM199731101	
9. SPONSORING/MONITORING AGENCY NAME(S) AND ADDRESS(ES) HQ USAF/ILM 1030 Air Force Pentagon, Washington, DC 20330-1030			10. SPONSORING/MONITORING AGENCY REPORT NUMBER Contract GS35F4155D	
11. SUPPLEMENTARY NOTES Phase I was completed and published by Intergraph Corporation in a separate 2-volume set: Volume 1, USAF Logistics Asset Sustainment As-Is Process Report, and Volume 2, As-Is Models.				
12a. DISTRIBUTION/AVAILABILITY STATEMENT Approved for public release; distribution is unlimited.			12b. DISTRIBUTION CODE A	
13. ABSTRACT (Maximum 200 Words) This USAF Logistics Process Optimization Study for the Aircraft Asset Sustainment Process -- Phase II Report is the second in a series of technical reports prepared under AFLMA Project LM9731101. It is published as three separate volumes. Volume I, USAF Logistics Process Optimization Study for the Aircraft Asset Sustainment Process -- Phase II Report, discusses the result and cost/benefit analysis of testing three initiatives at Langley Air Force Base as possible solutions to several findings discussed in the Phase I Report, USAF Logistics Asset Sustainment As Is Process. Volume II, (To Be Models), contains the To-Be Retail Asset Sustainment Process Model displaying the activities and functions related to the improved processes for receipt, storage, issue and delivery of materiel as tested at Langley Air Force Base, Virginia. Volume III, (Future Retail Aircraft Asset Sustainment Process Models,) is published as a stand-alone volume of this report. Volume III contains a discussion of the Reengineering Team's efforts in the development of a logistics process model for a more distant future asset sustainment scenario unconstrained by today's logistics information systems limitations. It also contains a process model reflecting the Reengineering Team's vision of the future asset sustainment process.				
14. SUBJECT TERMS Logistics, reengineering, process, model, aircraft, asset, sustainment, optimization, IDEF, As-Is, To-Be			15. NUMBER OF PAGES 152	16. PRICE CODE
17. SECURITY CLASSIFICATION OF REPORT Unclassified	18. SECURITY CLASSIFICATION OF THIS PAGE Unclassified	19. SECURITY CLASSIFICATION OF ABSTRACT Unclassified	20. LIMITATION OF ABSTRACT	